

TEST REPORT

CERTIFICATE OF CONFORMITY

Standard: 47 CFR FCC Part 15, Subpart C (Section 15.247)
47 CFR FCC Part 15, Subpart E (Section 15.407)

Report No.: RFBBQZ-WTW-P22110099-5

FCC ID: PY323100586

Product: BE19000 WiFi 7 Router

Brand: NETGEAR

Model No.: RS700

Received Date: 2023/2/14

Test Date: 2023/5/16

Issued Date: 2023/5/24

Applicant and NETGEAR, Inc.

Manufacturer:

Address: 350 East Plumeria Drive San Jose, CA 95134

Issued By: Bureau Veritas Consumer Products Services (H.K.) Ltd., Taoyuan Branch
Lin Kou Laboratories

Lab Address: No. 47-2, 14th Ling, Chia Pau Vil., Lin Kou Dist., New Taipei City, Taiwan

Test Location: No. 19, Hwa Ya 2nd Rd., Wen Hwa Vil., Kewi Shan Dist., Taoyuan City 33383, Taiwan

FCC Registration / 788550 / TW0003

Designation Number:

Approved by: _____

Jeremy Lin

Date: _____

2023/5/24

Jeremy Lin / Project Engineer

This test report consists of 38 pages in total. It may be duplicated completely for legal use with the approval of the applicant. It should not be reproduced except in full, without the written approval of our laboratory. The test results in the report only apply to the tested sample. The test results in this report are traceable to the national or international standards.

Prepared by : Celine Chou / Senior Specialist



This report is governed by, and incorporates by reference, the Conditions of Testing as posted at the date of issuance of this report at <http://www.bureauveritas.com/home/about-us/our-business/cps/about-us/terms-conditions/> and is intended for your exclusive use. Any copying or replication of this report to or for any other person or entity, or use of our name or trademark, is permitted only with our prior written permission. This report sets forth our findings solely with respect to the test samples identified herein. The results set forth in this report are not indicative or representative of the quality or characteristics of the lot from which a test sample was taken or any similar or identical product unless specifically and expressly noted. Our report includes all of the tests requested by you and the results thereof based upon the information that you provided to us. Measurement uncertainty is only provided upon request for accredited tests. Statements of conformity are based on simple acceptance criteria without taking measurement uncertainty into account, unless otherwise requested in writing. You have 60 days from date of issuance of this report to notify us of any material error or omission caused by our negligence or if you require measurement uncertainty; provided, however, that such notice shall be in writing and shall specifically address the issue you wish to raise. A failure to raise such issue within the prescribed time shall constitute your unqualified acceptance of the completeness of this report, the tests conducted and the correctness of the report contents.

Table of Contents

| | |
|---------------------------------------------------------------------|-----------|
| Release Control Record | 3 |
| 1 Certificate | 4 |
| 2 Summary of Test Results | 5 |
| 2.1 Measurement Uncertainty | 5 |
| 2.2 Supplementary Information | 5 |
| 3 General Information | 6 |
| 3.1 General Description of EUT | 6 |
| 3.2 Antenna Description of EUT | 9 |
| 3.3 Channel List | 11 |
| 3.4 Test Mode Applicability and Tested Channel Detail | 17 |
| 3.5 Test Program Used and Operation Descriptions | 18 |
| 3.6 Connection Diagram of EUT and Peripheral Devices | 18 |
| 3.7 Configuration of Peripheral Devices and Cable Connections | 18 |
| 4 Test Instruments | 19 |
| 4.1 Conducted Out of Band Emissions | 19 |
| 4.2 Unwanted Emissions below 1 GHz | 19 |
| 4.3 Unwanted Emissions above 1 GHz | 20 |
| 5 Limits of Test Items | 21 |
| 5.1 Conducted Out of Band Emissions | 21 |
| 5.2 Unwanted Emissions below 1 GHz | 21 |
| 5.3 Unwanted Emissions above 1 GHz | 21 |
| 6 Test Arrangements | 24 |
| 6.1 Conducted Out of Band Emissions | 24 |
| 6.1.1 Test Setup | 24 |
| 6.1.2 Test Procedure | 24 |
| 6.2 Unwanted Emissions below 1 GHz | 25 |
| 6.2.1 Test Setup | 25 |
| 6.2.2 Test Procedure | 26 |
| 6.3 Unwanted Emissions above 1 GHz | 27 |
| 6.3.1 Test Setup | 27 |
| 6.3.2 Test Procedure | 27 |
| 7 Test Results of Test Item | 28 |
| 7.1 Conducted Out of Band Emissions | 28 |
| 7.2 Unwanted Emissions below 1 GHz | 30 |
| 7.3 Unwanted Emissions above 1 GHz | 34 |
| 8 Pictures of Test Arrangements | 37 |
| 9 Information of the Testing Laboratories | 38 |



Release Control Record

| Issue No. | Description | Date Issued |
|------------------------|-------------------|-------------|
| RFBBQZ-WTW-P22110099-5 | Original release. | 2023/5/24 |

1 Certificate

Product: BE19000 WiFi 7 Router

Brand: NETGEAR

Test Model: RS700

Sample Status: Engineering sample

Applicant: NETGEAR, Inc.

Test Date: 2023/5/16

Standard: 47 CFR FCC Part 15, Subpart C (Section 15.247)
47 CFR FCC Part 15, Subpart E (Section 15.407)

Measurement procedure: ANSI C63.10-2013

The above equipment has been tested by **Bureau Veritas Consumer Products Services (H.K.) Ltd., Taoyuan Branch**, and found compliance with the requirement of the above standards. The test record, data evaluation & Equipment Under Test (EUT) configurations represented herein are true and accurate accounts of the measurements of the sample's RF characteristics under the conditions specified in this report.

2 Summary of Test Results

| 47 CFR FCC Part 15, Subpart C (Section 15.247) 47 CFR FCC Part 15, Subpart E (Section 15.407) | | | |
|-----------------------------------------------------------------------------------------------------------------------------------------------------------------------|---------------------------------|--------|---------------------------------------------------|
| Clause | Test Item | Result | Remark |
| 15.205 / 15.209 / 15.247(d) 15.407(b)(9) | Unwanted Emissions below 1 GHz | Pass | Minimum passing margin is -6.6 dB at 46.87 MHz |
| 15.205 / 15.209 / 15.247(d) 15.407(b) (1/10) 15.407(b) (2/10) 15.407(b) (3/10) 15.407(b) (4(i)/10) 15.407(b)(5) 15.407(b)(6) 15.407(b)(10) | Unwanted Emissions above 1 GHz | Pass | Minimum passing margin is -4.9 dB at 11690.00 MHz |
| 15.247(d) | Conducted Out of Band Emissions | Pass | Meet the requirement of limit. |

Note: Determining compliance based on the results of the compliance measurement, not taking into account measurement instrumentation uncertainty.

2.1 Measurement Uncertainty

Where relevant, the following measurement uncertainty levels have been estimated for tests performed on the EUT as specified in CISPR 16-4-2:

| Parameter | Specification | Uncertainty (±) |
|--------------------------------|-----------------|-----------------|
| Unwanted Emissions below 1 GHz | 9 kHz ~ 30 MHz | 2.44 dB |
| | 30 MHz ~ 1 GHz | 2.02 dB |
| Unwanted Emissions above 1 GHz | 1 GHz ~ 18 GHz | 1.01 dB |
| | 18 GHz ~ 40 GHz | 1.15 dB |

The other instruments specified are routine verified to remain within the calibrated levels, no measurement uncertainty is required to be calculated.

2.2 Supplementary Information

There is not any deviation from the test standards for the test method, and no modifications required for compliance.

3 General Information

3.1 General Description of EUT

| | |
|-----------------------|----------------------------------------------------------------------------------------------------------------------------------------------------------------------------------------------------------------------------------------------------------------------------------------------------------------------------------------------------------------------------------------------------------------------------|
| Product | BE19000 WiFi 7 Router |
| Brand | NETGEAR |
| Test Model | RS700 |
| Status of EUT | Engineering sample |
| Power Supply Rating | 19 Vdc from adapter |
| Modulation Type | CCK, DQPSK, DBPSK for DSSS 64QAM, 16QAM, QPSK, BPSK for OFDM 256QAM for OFDM in VHT and ac mode 1024QAM for OFDMA in 11ax mode only 4096QAM for OFDMA in 11be EHT mode |
| Modulation Technology | DSSS, OFDM, OFDMA |
| Transfer Rate | 802.11b: up to 11 Mbps 802.11g: up to 54 Mbps 802.11a: up to 54 Mbps 802.11n: up to 600 Mbps VHT (2.4GHz Band): up to 800 Mbps 802.11ac (5GHz Band): up to 3466.7 Mbps 802.11ax (2.4GHz Band): up to 1147.1 Mbps 802.11ax (5GHz and 6GHz Band): up to 4803.9 Mbps 802.11be (2.4GHz Band): up to 1376.4 Mbps 802.11be (5GHz Band): up to 5764.8 Mbps 802.11be (6GHz Band): up to 11529.6 Mbps |
| Operating Frequency | 2412 ~ 2462 MHz 5180 ~ 5320 MHz 5500 ~ 5720 MHz 5475 ~ 5825 MHz 5845 ~ 5885 MHz 6115 ~ 6415 MHz 6435 ~ 6525 MHz 6525 ~ 6875 MHz 6875 ~ 7115 MHz |

| | |
|-------------------|--------------------------------------------------------------------------------------------------------------------------------------------------------------------------------------------------------------------------------------------------------------------------------------------------------------------------------------------------------------------------------------------------------------------------------------------------------------------------------------------------------------------------------------------------------------------------------------------------------------------------------------------------------------------------------------------------------------------------------------------------------------------------------------------------------------------------------------------------------------------------------------------------------------------------------------------------------------------------------------------------------------------------------------------------------------------------------------------------------------------------------------------------------------------------------------------------------------------------------------------------------------------------------------------------------------------------------------------------------------------------------------------------------------------------------------------------------------------------------------------------------------------------------------------------------------------------------------------------------------------|
| Number of Channel | <p>2412 ~ 2462 MHz: 802.11b, 802.11g, 802.11n (HT20), VHT20, 802.11ax (HE20), 802.11be (EHT20): 11 802.11n (HT40), VHT40, 802.11ax (HE40), 802.11be (EHT40): 7</p> <p>5180 ~ 5320 MHz: 802.11a, 802.11n (HT20), 802.11ac (VHT20), 802.11ax (HE20), 802.11be (EHT20): 8 802.11n (HT40), 802.11ac (VHT40), 802.11ax (HE40), 802.11be (EHT40): 4 802.11ac (VHT80), 802.11ax (HE80), 802.11be (EHT80): 2 802.11ac (VHT160), 802.11ax (HE160), 802.11be (EHT160): 1</p> <p>5500 ~ 5720 MHz: 802.11a, 802.11n (HT20), 802.11ac (VHT20), 802.11ax (HE20), 802.11be (EHT20): 12 802.11n (HT40), 802.11ac (VHT40), 802.11ax (HE40), 802.11be (EHT40): 6 802.11ac (VHT80), 802.11ax (HE80), 802.11be (EHT80): 3 802.11ac (VHT160), 802.11ax (HE160), 802.11 be (EHT160): 1</p> <p>5745 ~ 5825 MHz: 802.11a, 802.11n (HT20), 802.11ac (VHT20), 802.11ax (HE20), 802.11be (EHT20): 5 802.11n (HT40), 802.11ac (VHT40), 802.11ax (HE40), 802.11 be (EHT40): 2 802.11ac (VHT80), 802.11ax (HE80), 802.11be (EHT80): 1</p> <p>5845 ~ 5885 MHz: 802.11a, 802.11n (HT20), 802.11ac (VHT20), 802.11ax (HE20), 802.11be (EHT20): 3 802.11n (HT40), 802.11ac (VHT40), 802.11ax (HE40), 802.11be (EHT40): 2 802.11ac (VHT80), 802.11ax (HE80), 802.11be (EHT80): 1 802.11ac (VHT160), 802.11ax (HE160), 802.11be (EHT160): 1</p> <p>6115 ~ 7115 MHz: 802.11a, 802.11ax (HE20), 802.11be (EHT20): 51 802.11ax (HE40), 802.11be (EHT40): 25 802.11ax (HE80), 802.11be (EHT80): 12 802.11ax (HE160), 802.11be (EHT160): 6 802.11be (EHT320): 5</p> |
|-------------------|--------------------------------------------------------------------------------------------------------------------------------------------------------------------------------------------------------------------------------------------------------------------------------------------------------------------------------------------------------------------------------------------------------------------------------------------------------------------------------------------------------------------------------------------------------------------------------------------------------------------------------------------------------------------------------------------------------------------------------------------------------------------------------------------------------------------------------------------------------------------------------------------------------------------------------------------------------------------------------------------------------------------------------------------------------------------------------------------------------------------------------------------------------------------------------------------------------------------------------------------------------------------------------------------------------------------------------------------------------------------------------------------------------------------------------------------------------------------------------------------------------------------------------------------------------------------------------------------------------------------|

| | |
|------------------------------------------------|-----------------------------------------------------------|
| Output Power | CDD Mode: |
| | 2412 ~ 2462 MHz : Conducted Power: 29.55 dBm (902.379 mW) |
| | 5180 ~ 5320 MHz : Conducted Power: 29.38 dBm (867.769 mW) |
| | 5500 ~ 5720 MHz : Conducted Power: 23.38 dBm (217.921 mW) |
| | 5745 ~ 5825 MHz : Conducted Power: 29.34 dBm (859.238 mW) |
| | 5845 ~ 5885 MHz : EIRP: 30.15 dBm (1035.142 mW) |
| | 6115 ~ 6415 MHz : EIRP: 14.89 dBm (30.832 mW) |
| | 6435 ~ 6525 MHz : EIRP: 14.69 dBm (29.444 mW) |
| | 6525 ~ 6875 MHz : EIRP: 14.81 dBm (30.269 mW) |
| | 6875 ~ 7115 MHz : EIRP: 14.89 dBm (30.832 mW) |
| | Beamforming (4T1S) Mode: |
| | 2412 ~ 2462 MHz : Conducted Power: 29.55 dBm (902.379 mW) |
| | 5180 ~ 5320 MHz : Conducted Power: 29.29 dBm (849.953 mW) |
| | 5500 ~ 5720 MHz : Conducted Power: 23.36 dBm (217.008 mW) |
| | 5745 ~ 5825 MHz : Conducted Power: 29.34 dBm (859.238 mW) |
| | 5845 ~ 5885 MHz : EIRP: 34.06 dBm (2546.83 mW) |
| 6115 ~ 6415 MHz : EIRP: 29.78 dBm (950.605 mW) | |
| 6435 ~ 6525 MHz : EIRP: 29.65 dBm (922.571 mW) | |
| 6525 ~ 6875 MHz : EIRP: 29.70 dBm (933.254 mW) | |
| 6875 ~ 7115 MHz : EIRP: 29.51 dBm (893.305 mW) | |
| Beamforming (4T4S) Mode: | |
| 6115 ~ 6415 MHz : EIRP: 29.80 dBm (954.993 mW) | |
| 6435 ~ 6525 MHz : EIRP: 29.73 dBm (939.723 mW) | |
| 6525 ~ 6875 MHz : EIRP: 29.71 dBm (935.406 mW) | |
| 6875 ~ 7115 MHz : EIRP: 29.60 dBm (912.011 mW) | |

Note:

1. The EUT uses following accessories.

| Item | Brand | Model | Part Number | Specification |
|----------------|---------|--------------|--------------|--------------------------------------------------------------------------------------------------------------------------------------|
| Adapter 1 | NETGEAR | AD200F10 | 332-11480-02 | AC Input : 100-120 Vac, 50/60 Hz, 1.7 A DC Output : 19 Vdc, 3.16 A, 60 W DC Output Cable : 1.8 m non-shielded and without core |
| Adapter 2 | NETGEAR | 2AEC060K 1 | 332-11578-01 | AC Input : 100-120 Vac, 50/60 Hz, 1.7 A DC Output : 19 Vdc, 3.16 A, 60 W DC Output Cable : 1.8 m non-shielded and without core |
| Ethernet Cable | NETGEAR | 312-10147-01 | - | 2m non-shielded and without core |

2. Simultaneously transmission condition.

| Condition | Technology | | |
|-----------|---------------|-------------|-------------|
| 1 | WLAN (2.4GHz) | WLAN (5GHz) | WLAN (6GHz) |

Note: The emission of the simultaneous operation has been evaluated and no non-compliance was found.

3. The above EUT information is declared by manufacturer and for more detailed features description, please refer to the manufacturer's specifications or user's manual.

3.2 Antenna Description of EUT

1. The antenna information is listed as below.

For 2.4G and 5G

| Antenna Type | Dipole |
|-----------------|------------------------|
| Connector Type | ipex(MHF) |
| Antenna Gain | Directional Gain (dBi) |
| 2400~2483.5 MHz | 6.06 |
| 5150~5250 MHz | 5.99 |
| 5250~5350 MHz | 6.05 |
| 5470~5725 MHz | 6.03 |
| 5725~5850 MHz | 6.06 |

* The detailed antenna information, please refer to the BV CPS report no.: RFBBQZ-WTW-P22110099-6.

For 5.9G and 6G

| Type | Connector | Frequency Range | Ant 0 (dBi) | Ant 1 (dBi) | Ant 2 (dBi) | Ant 3 (dBi) |
|--------|-----------|-----------------|-------------|-------------|-------------|-------------|
| Dipole | ipex(MHF) | 5850~5895 MHz | 2.70 | 2.50 | 2.90 | 2.80 |
| Dipole | ipex(MHF) | 5925~6425 MHz | 3.40 | 3.20 | 3.00 | 3.30 |
| Dipole | ipex(MHF) | 6425~6525 MHz | 3.30 | 3.10 | 2.90 | 3.20 |
| Dipole | ipex(MHF) | 6525~6875 MHz | 3.00 | 2.80 | 2.60 | 2.90 |
| Dipole | ipex(MHF) | 6875~7125 MHz | 3.30 | 3.10 | 2.90 | 3.00 |

* Detail antenna specification please refer to antenna datasheet and/or antenna measurement report.

2. The EUT incorporates a MIMO function:

For 2.4G

| Modulation Mode | Beamforming Mode | Tx & Rx Configuration | |
|------------------|------------------|-----------------------|-----|
| 802.11b | Not Support | 4TX | 4RX |
| 802.11g | Not Support | 4TX | 4RX |
| 802.11n (HT20) | Support | 4TX | 4RX |
| 802.11n (HT40) | Support | 4TX | 4RX |
| VHT20 | Support | 4TX | 4RX |
| VHT40 | Support | 4TX | 4RX |
| 802.11ax (HE20) | Support | 4TX | 4RX |
| 802.11ax (HE40) | Support | 4TX | 4RX |
| 802.11be (EHT20) | Support | 4TX | 4RX |
| 802.11be (EHT40) | Support | 4TX | 4RX |

Note: For 802.11ax and 802.11be, the EUT not support Partial RU.

For 5G and 5.9G

| Modulation Mode | Beamforming Mode | Tx & Rx Configuration | |
|-------------------|------------------|-----------------------|-----|
| 802.11a | Not Support | 4TX | 4RX |
| 802.11n (HT20) | Support | 4TX | 4RX |
| 802.11n (HT40) | Support | 4TX | 4RX |
| 802.11ac (VHT20) | Support | 4TX | 4RX |
| 802.11ac (VHT40) | Support | 4TX | 4RX |
| 802.11ac (VHT80) | Support | 4TX | 4RX |
| 802.11ac (VHT160) | Support | 4TX | 4RX |
| 802.11ax (HE20) | Support | 4TX | 4RX |
| 802.11ax (HE40) | Support | 4TX | 4RX |
| 802.11ax (HE80) | Support | 4TX | 4RX |
| 802.11ax (HE160) | Support | 4TX | 4RX |
| 802.11be (EHT20) | Support | 4TX | 4RX |
| 802.11be (EHT40) | Support | 4TX | 4RX |
| 802.11be (EHT80) | Support | 4TX | 4RX |
| 802.11be (EHT160) | Support | 4TX | 4RX |

Note: For 802.11ax and 802.11be, the EUT not support Partial RU.

For 6G

| Modulation Mode | Beamforming Mode | Tx & Rx Configuration | |
|-------------------|------------------|-------------------------------------|-----|
| 802.11a | Not Support | 4TX | 4RX |
| 802.11ax (HE20) | Support | 4TX (Nss 1 / Nss 2 / Nss 3 / Nss 4) | 4RX |
| 802.11ax (HE40) | Support | 4TX (Nss 1 / Nss 2 / Nss 3 / Nss 4) | 4RX |
| 802.11ax (HE80) | Support | 4TX (Nss 1 / Nss 2 / Nss 3 / Nss 4) | 4RX |
| 802.11ax (HE160) | Support | 4TX (Nss 1 / Nss 2 / Nss 3 / Nss 4) | 4RX |
| 802.11be (EHT20) | Support | 4TX (Nss 1 / Nss 2 / Nss 3 / Nss 4) | 4RX |
| 802.11be (EHT40) | Support | 4TX (Nss 1 / Nss 2 / Nss 3 / Nss 4) | 4RX |
| 802.11be (EHT80) | Support | 4TX (Nss 1 / Nss 2 / Nss 3 / Nss 4) | 4RX |
| 802.11be (EHT160) | Support | 4TX (Nss 1 / Nss 2 / Nss 3 / Nss 4) | 4RX |
| 802.11be (EHT320) | Support | 4TX (Nss 1 / Nss 2 / Nss 3 / Nss 4) | 4RX |

Note: For 802.11ax and 802.11be, the EUT not support Partial RU.

3.3 Channel List

FOR 2412 ~ 2462 MHz

11 channels are provided for 802.11b, 802.11g, 802.11n (HT20), VHT20, 802.11ax (HE20), 802.11be (EHT20):

| Channel | Frequency | Channel | Frequency |
|---------|-----------|---------|-----------|
| 1 | 2412 MHz | 7 | 2442 MHz |
| 2 | 2417 MHz | 8 | 2447 MHz |
| 3 | 2422 MHz | 9 | 2452 MHz |
| 4 | 2427 MHz | 10 | 2457 MHz |
| 5 | 2432 MHz | 11 | 2462 MHz |
| 6 | 2437 MHz | | |

7 channels are provided for 802.11n (HT40), VHT40, 802.11ax (HE40), 802.11be (EHT40):

| Channel | Frequency | Channel | Frequency |
|---------|-----------|---------|-----------|
| 3 | 2422 MHz | 7 | 2442 MHz |
| 4 | 2427 MHz | 8 | 2447 MHz |
| 5 | 2432 MHz | 9 | 2452 MHz |
| 6 | 2437 MHz | | |

FOR 5180 ~ 5320 MHz

8 channels are provided for 802.11a, 802.11n (HT20), 802.11ac (VHT20), 802.11ax (HE20), 802.11be (EHT20):

| Channel | Frequency | Channel | Frequency |
|---------|-----------|---------|-----------|
| 36 | 5180 MHz | 52 | 5260 MHz |
| 40 | 5200 MHz | 56 | 5280 MHz |
| 44 | 5220 MHz | 60 | 5300 MHz |
| 48 | 5240 MHz | 64 | 5320 MHz |

4 channels are provided for 802.11n (HT40), 802.11ac (VHT40), 802.11ax (HE40), 802.11be (EHT40):

| Channel | Frequency | Channel | Frequency |
|---------|-----------|---------|-----------|
| 38 | 5190 MHz | 54 | 5270 MHz |
| 46 | 5230 MHz | 62 | 5310 MHz |

2 channels are provided for 802.11ac (VHT80), 802.11ax (HE80), 802.11be (EHT80):

| Channel | Frequency | Channel | Frequency |
|---------|-----------|---------|-----------|
| 42 | 5210 MHz | 58 | 5290 MHz |

1 straddle channel is provided for 802.11ac (VHT160), 802.11ax (HE160), 802.11be (EHT160):

| Channel | Frequency |
|---------|-----------|
| 50 | 5250 MHz |

FOR 5500 ~ 5720 MHz

12 channels are provided for 802.11a, 802.11n (HT20), 802.11ac (VHT20), 802.11ax (HE20), 802.11be (EHT20):

| Channel | Frequency | Channel | Frequency |
|---------|-----------|---------|-----------|
| 100 | 5500 MHz | 124 | 5620 MHz |
| 104 | 5520 MHz | 128 | 5640 MHz |
| 108 | 5540 MHz | 132 | 5660 MHz |
| 112 | 5560 MHz | 136 | 5680 MHz |
| 116 | 5580 MHz | 140 | 5700 MHz |
| 120 | 5600 MHz | 144 | 5720 MHz |

6 channels are provided for 802.11n (HT40), 802.11ac (VHT40), 802.11ax (HE40), 802.11be (EHT40):

| Channel | Frequency | Channel | Frequency |
|---------|-----------|---------|-----------|
| 102 | 5510 MHz | 126 | 5630 MHz |
| 110 | 5550 MHz | 134 | 5670 MHz |
| 118 | 5590 MHz | 142 | 5710 MHz |

3 channels are provided for 802.11ac (VHT80), 802.11ax (HE80), 802.11be (EHT80):

| Channel | Frequency | Channel | Frequency |
|---------|-----------|---------|-----------|
| 106 | 5530 MHz | 138 | 5690 MHz |
| 122 | 5610 MHz | | |

1 straddle channel is provided for 802.11ac (VHT160), 802.11ax (HE160), 802.11be (EHT160):

| Channel | Frequency |
|---------|-----------|
| 114 | 5570 MHz |

FOR 5745 ~ 5825 MHz:

5 channels are provided for 802.11a, 802.11n (HT20), 802.11ac (VHT20), 802.11ax (HE20), 802.11be (EHT20):

| Channel | Frequency | Channel | Frequency |
|---------|-----------|---------|-----------|
| 149 | 5745 MHz | 161 | 5805 MHz |
| 153 | 5765 MHz | 165 | 5825 MHz |
| 157 | 5785 MHz | | |

2 channels are provided for 802.11n (HT40), 802.11ac (VHT40), 802.11ax (HE40), 802.11be (EHT40):

| Channel | Frequency | Channel | Frequency |
|---------|-----------|---------|-----------|
| 151 | 5755 MHz | 159 | 5795 MHz |

1 channels is provided for 802.11ac (VHT80), 802.11ax (HE80), 802.11be (EHT80):

| Channel | Frequency |
|---------|-----------|
| 155 | 5775 MHz |

FOR 5845 ~ 5885 MHz

3 channels are provided for 802.11a, 802.11n (HT20), 802.11ac (VHT20), 802.11ax (HE20), 802.11be (EHT20):

| Channel | Frequency | Channel | Frequency | Channel | Frequency |
|---------|-----------|---------|-----------|---------|-----------|
| *169 | 5845 MHz | 173 | 5865 MHz | 177 | 5885 MHz |

2 channels are provided for 802.11n (HT40), 802.11ac (VHT40), 802.11ax (HE40), 802.11be (EHT40):

| Channel | Frequency | Channel | Frequency |
|---------|-----------|---------|-----------|
| *167 | 5835 MHz | 175 | 5875 MHz |

1 channel is provided for 802.11ac (VHT80), 802.11ax (HE80), 802.11be (EHT80):

| Channel | Frequency |
|---------|-----------|
| *171 | 5855 MHz |

1 channel is provided for 802.11ac (VHT160), 802.11ax (HE160), 802.11be (EHT160):

| Channel | Frequency |
|---------|-----------|
| *163 | 5815 MHz |

Note: * U-NII-3 & -4 span channels.

FOR 6155 ~ 6415 MHz:

16 channels are provided for 802.11a, 802.11ax (HE20), 802.11be (EHT20):

| Channel | Frequency | Channel | Frequency | Channel | Frequency | Channel | Frequency |
|---------|-----------|---------|-----------|---------|-----------|---------|-----------|
| 33 | 6115 MHz | 37 | 6135 MHz | 41 | 6155 MHz | 45 | 6175 MHz |
| 49 | 6195 MHz | 53 | 6215 MHz | 57 | 6235 MHz | 61 | 6255 MHz |
| 65 | 6275 MHz | 69 | 6295 MHz | 73 | 6315 MHz | 77 | 6335 MHz |
| 81 | 6355 MHz | 85 | 6375 MHz | 89 | 6395 MHz | 93 | 6415 MHz |

8 channels are provided for 802.11ax (HE40), 802.11be (EHT40):

| Channel | Frequency | Channel | Frequency | Channel | Frequency | Channel | Frequency |
|---------|-----------|---------|-----------|---------|-----------|---------|-----------|
| 35 | 6125 MHz | 43 | 6165 MHz | 51 | 6205 MHz | 59 | 6245 MHz |
| 67 | 6285 MHz | 75 | 6325 MHz | 83 | 6365 MHz | 91 | 6405 MHz |

4 channels are provided for 802.11ax (HE80), 802.11be (EHT80):

| Channel | Frequency | Channel | Frequency | Channel | Frequency | Channel | Frequency |
|---------|-----------|---------|-----------|---------|-----------|---------|-----------|
| 39 | 6145 MHz | 55 | 6225 MHz | 71 | 6305 MHz | 87 | 6385 MHz |

2 channels are provided for 802.11ax (HE160), 802.11be (EHT160):

| Channel | Frequency | Channel | Frequency |
|---------|-----------|---------|-----------|
| 47 | 6185 MHz | 79 | 6345 MHz |

1 channel is provided for 802.11be (EHT320):

| Channel | Frequency |
|---------|-----------|
| 63 | 6265 MHz |

FOR 6435 ~ 6525 MHz:

5 channels are provided for 802.11a, 802.11ax (HE20), 802.11be (EHT20):

| Channel | Frequency | Channel | Frequency | Channel | Frequency | Channel | Frequency |
|---------|-----------|---------|-----------|---------|-----------|---------|-----------|
| 97 | 6435 MHz | 101 | 6455 MHz | 105 | 6475 MHz | 109 | 6495 MHz |
| 113 | 6515 MHz | | | | | | |

3 channels are provided for 802.11ax (HE40), 802.11be (EHT40):

| Channel | Frequency | Channel | Frequency | Channel | Frequency |
|---------|-----------|---------|-----------|---------|-----------|
| 99 | 6445 MHz | 107 | 6485 MHz | *115 | 6525 MHz |

1 channel is provided for 802.11ax (HE80), 802.11be (EHT80):

| Channel | Frequency |
|---------|-----------|
| 103 | 6465 MHz |

1 channel is provided for 802.11ax (HE160), 802.11be (EHT160):

| Channel | Frequency |
|---------|-----------|
| *111 | 6505 MHz |

1 channel is provided for 802.11be (EHT320):

| Channel | Frequency |
|---------|-----------|
| *95 | 6425 MHz |

FOR 6525 ~ 6865 MHz:

17 channels are provided for 802.11a, 802.11ax (HE20), 802.11be (EHT20):

| Channel | Frequency | Channel | Frequency | Channel | Frequency | Channel | Frequency |
|---------|-----------|---------|-----------|---------|-----------|---------|-----------|
| 117 | 6535 MHz | 121 | 6555 MHz | 125 | 6575 MHz | 129 | 6595 MHz |
| 133 | 6615 MHz | 137 | 6635 MHz | 141 | 6655 MHz | 145 | 6675 MHz |
| 149 | 6695 MHz | 153 | 6715 MHz | 157 | 6735 MHz | 161 | 6755 MHz |
| 165 | 6775 MHz | 169 | 6795 MHz | 173 | 6815 MHz | 177 | 6835 MHz |
| 181 | 6855 MHz | | | | | | |

8 channels are provided for 802.11ax (HE40), 802.11be (EHT40):

| Channel | Frequency | Channel | Frequency | Channel | Frequency | Channel | Frequency |
|---------|-----------|---------|-----------|---------|-----------|---------|-----------|
| 123 | 6565 MHz | 131 | 6605 MHz | 139 | 6645 MHz | 147 | 6685 MHz |
| 155 | 6725 MHz | 163 | 6765 MHz | 171 | 6805 MHz | 179 | 6845 MHz |

5 channels are provided for 802.11ax (HE80), 802.11be (EHT80):

| Channel | Frequency | Channel | Frequency | Channel | Frequency | Channel | Frequency |
|---------|-----------|---------|-----------|---------|-----------|---------|-----------|
| *119 | 6545 MHz | 135 | 6625 MHz | 151 | 6705 MHz | 167 | 6785 MHz |
| *183 | 6865 MHz | | | | | | |

2 channels are provided for 802.11ax (HE160), 802.11be (EHT160):

| Channel | Frequency | Channel | Frequency |
|---------|-----------|---------|-----------|
| 143 | 6665 MHz | 175 | *6825 MHz |

2 channels are provided for 802.11be (EHT320):

| Channel | Frequency | Channel | Frequency |
|---------|-----------|---------|-----------|
| *127 | 6585 MHz | *159 | 6745 MHz |

FOR 6875 ~ 7115 MHz:

13 channels are provided for 802.11a, 802.11ax (HE20), 802.11be (EHT20):

| Channel | Frequency | Channel | Frequency | Channel | Frequency | Channel | Frequency |
|---------|-----------|---------|-----------|---------|-----------|---------|-----------|
| 185 | 6875 MHz | 189 | 6895 MHz | 193 | 6915 MHz | 197 | 6935 MHz |
| 201 | 6955 MHz | 205 | 6975 MHz | 209 | 6995 MHz | 213 | 7015 MHz |
| 217 | 7035 MHz | 221 | 7055 MHz | 225 | 7075 MHz | 229 | 7095 MHz |
| 233 | 7115 MHz | | | | | | |

6 channels are provided for 802.11ax (HE40), 802.11be (EHT40):

| Channel | Frequency | Channel | Frequency | Channel | Frequency | Channel | Frequency |
|---------|-----------|---------|-----------|---------|-----------|---------|-----------|
| 187 | 6885 MHz | 195 | 6925 MHz | 203 | 6965 MHz | 211 | 7005 MHz |
| 219 | 7045 MHz | 227 | 7085 MHz | | | | |

2 channels are provided for 802.11ax (HE80), 802.11be (EHT80):

| Channel | Frequency | Channel | Frequency |
|---------|-----------|---------|-----------|
| 199 | 6945 MHz | 215 | 7025 MHz |

1 channel is provided for 802.11ax (HE160), 802.11be (EHT160):

| Channel | Frequency |
|---------|-----------|
| 207 | 6985 MHz |

1 channel is provided for 802.11be (EHT320):

| Channel | Frequency |
|---------|-----------|
| *191 | 6905 MHz |

Note: * mean these are straddle channels.

3.4 Test Mode Applicability and Tested Channel Detail

| | |
|-------------|---------------------------------------------------------------------------------------------------------------------------------------|
| Pre-Scan: | EUT can be used in the following ways: XYZ 3-axis. Pre-scan in these ways and find the worst case as a representative test condition. |
| Worst Case: | X / Y / Z Worst Condition: Z Axis. |

Following channel(s) was (were) selected for the final test as listed below:

| Test Item | EUT Configure Mode | Mode | Signal Mode | Tested Channel | Modulation | Data Rate Parameter |
|---------------------------------|--------------------|---------------------------------------------------------|-------------|----------------|------------|---------------------|
| Unwanted Emissions below 1 GHz | - | 802.11be (EHT20) + 802.11a + 802.11be (EHT320) | CDD | 6 + 40 + 63 | BPSK | 6Mb/s + MCS0 |
| | - | 802.11be (EHT20) + 802.11be (EHT20) + 802.11be (EHT320) | CDD | 6 + 169 + 63 | BPSK | 6Mb/s + MCS0 |
| Unwanted Emissions above 1 GHz | - | 802.11be (EHT20) + 802.11a + 802.11be (EHT320) | CDD | 6 + 40 + 63 | BPSK | 6Mb/s + MCS0 |
| | - | 802.11be (EHT20) + 802.11be (EHT20) + 802.11be (EHT320) | CDD | 6 + 169 + 63 | BPSK | 6Mb/s + MCS0 |
| Conducted Out of Band Emissions | - | 802.11be (EHT20) + 802.11a + 802.11be (EHT320) | CDD | 6 + 40 + 63 | BPSK | 6Mb/s + MCS0 |
| | - | 802.11be (EHT20) + 802.11be (EHT20) + 802.11be (EHT320) | CDD | 6 + 169 + 63 | BPSK | 6Mb/s + MCS0 |
| EUT Configure Mode: | - | EUT powered by adapter 1 | | | | |

3.5 Test Program Used and Operation Descriptions

Controlling software accessMTool_REL_3_2_1_5 has been activated to set the EUT under transmission condition continuously at specific channel frequency.

3.6 Connection Diagram of EUT and Peripheral Devices

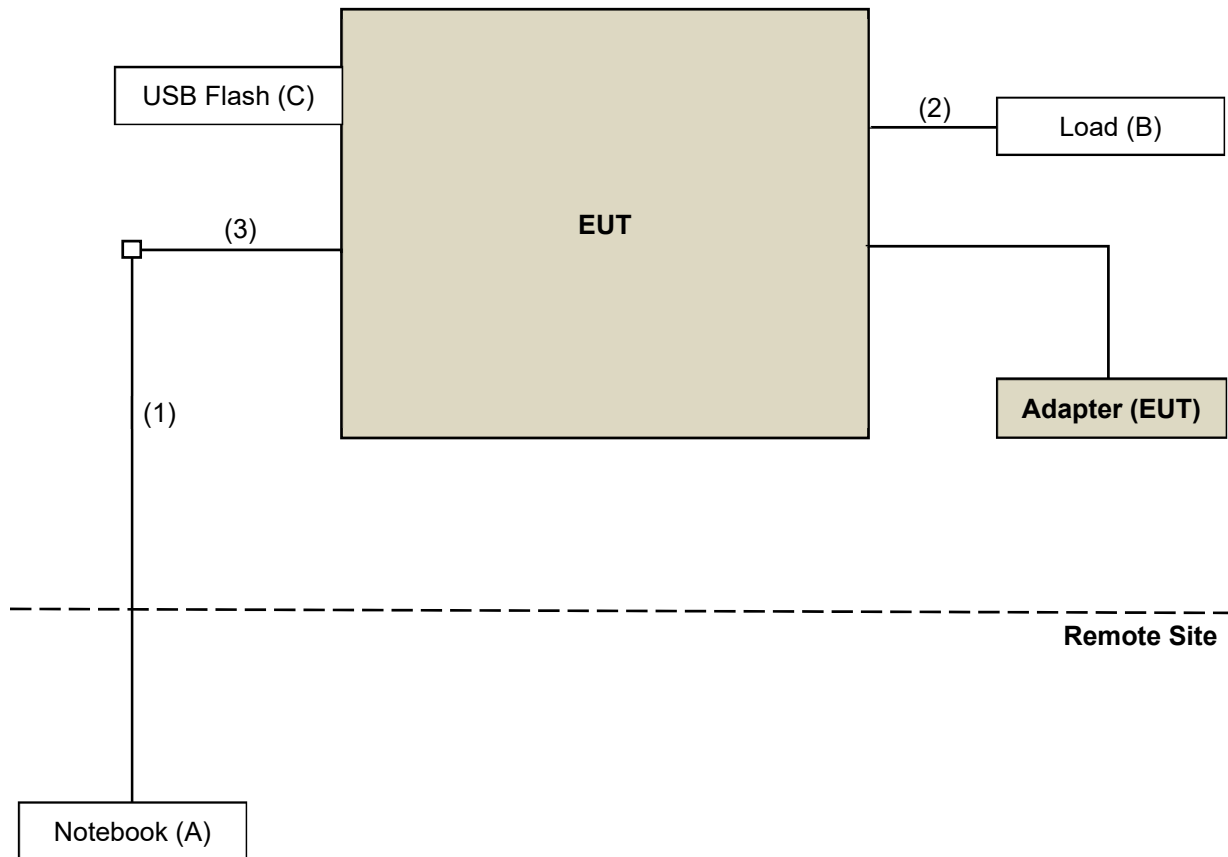

3.7 Configuration of Peripheral Devices and Cable Connections

| ID | Product | Brand | Model No. | Serial No. | FCC ID | Remarks |
|----|-----------|---------|-------------|------------|--------|-----------------|
| A | Notebook | DELL | E5430 | 2RL3YW1 | N/A | Provided by Lab |
| B | Load | N/A | N/A | N/A | N/A | Provided by Lab |
| C | USB Flash | SanDisk | SDDDC3-032G | N/A | N/A | Provided by Lab |

| ID | Cable Descriptions | Qty. | Length (m) | Shielding (Yes/No) | Cores (Qty.) | Remarks |
|----|--------------------|------|------------|--------------------|--------------|------------------|
| 1 | LAN Cable | 1 | 10 | N | N | Provided by Lab |
| 2 | LAN Cable | 5 | 1.5 | N | N | Provided by Lab |
| 3 | Ethernet Cable | 1 | 2.0 | N | N | Accessory of EUT |

4 Test Instruments

The calibration interval of the all test instruments are 12 months and the calibrations are traceable to NML/ROC and NIST/USA.

4.1 Conducted Out of Band Emissions

| Description Manufacturer | Model No. | Serial No. | Calibrated Date | Calibrated Until |
|-------------------------------------|----------------------------------|------------|--------------------|---------------------|
| Signal and spectrum analyzer R&S | FSV3044 | 101105 | 2023/2/22 | 2024/2/21 |
| Software BV | ADT_RF Test Software V6.6.5.4 | N/A | N/A | N/A |

Notes:

1. The test was performed in Oven room.
2. Tested Date: 2023/5/16

4.2 Unwanted Emissions below 1 GHz

| Description Manufacturer | Model No. | Serial No. | Calibrated Date | Calibrated Until |
|---------------------------------|------------------------------|---------------|--------------------|---------------------|
| Antenna Tower inn-co GmbH | MA 4000 | 010303 | N/A | N/A |
| Bi_Log Antenna Schwarbeck | VULB9168 | 9168-155 | 2022/10/21 | 2023/10/20 |
| Loop Antenna EMCI | EM-6879 | 269 | 2022/9/19 | 2023/9/18 |
| Loop Antenna TESEQ | HLA 6121 | 45745 | 2022/7/27 | 2023/7/26 |
| Pre-amplifier EMCI | EMC001340 | 980201 | 2022/9/23 | 2023/9/22 |
| Pre_Amplifier Agilent | 8447D | 2944A10631 | 2023/5/7 | 2024/5/6 |
| RF Coaxial Cable EMCI | 5D-NM-BM | 140903+140902 | 2023/1/7 | 2024/1/6 |
| RF Coaxial Cable WOKEN | 8D-FB | Cable-CH4-01 | 2022/7/9 | 2023/7/8 |
| Software BV ADT | ADT_Radiated_ V7.6.15.9.5 | N/A | N/A | N/A |
| Spectrum Analyzer R&S | FSW43 | 101866 | 2023/1/10 | 2024/1/9 |
| Test Receiver R&S | ESR3+ | 102782 | 2022/12/12 | 2023/12/11 |
| Turn Table BV ADT | TT100 | TT93021705 | N/A | N/A |
| Turn Table Controller BV ADT | SC100 | SC93021705 | N/A | N/A |

Notes:

1. The test was performed in HY - 966 chamber 3.
2. Tested Date: 2023/5/16

4.3 Unwanted Emissions above 1 GHz

| Description Manufacturer | Model No. | Serial No. | Calibrated Date | Calibrated Until |
|---------------------------------------|------------------------------|----------------------|--------------------|---------------------|
| Antenna Tower inn-co GmbH | MA 4000 | 010303 | N/A | N/A |
| Boresight antenna tower fixture BV | BAF-02 | 5 | N/A | N/A |
| Horn Antenna Schwarzbeck | 9120D | 9120D-408 | 2022/11/13 | 2023/11/12 |
| | BBHA 9170 | 9170-480 | 2022/11/13 | 2023/11/12 |
| | | BBHA9170241 | 2022/10/20 | 2023/10/19 |
| | | BBHA9170243 | 2022/11/13 | 2023/11/12 |
| Pre-Amplifier EMCI | EMC 184045 | 980116 | 2022/10/1 | 2023/9/30 |
| Pre_Amplifier KEYSIGHT | 83017A | MY53270295 | 2023/5/7 | 2024/5/6 |
| RF cable HUBER+SUHNER | Sucoflex 104 | MY 13380+295012/04 | 2023/5/7 | 2024/5/6 |
| RF Coaxial Cable EMCI | EMC102-KM-KM-600 | 150928 | 2022/7/9 | 2023/7/8 |
| | EMC102-KM-KM-3000 | 150929 | 2022/7/9 | 2023/7/8 |
| RF Coaxial Cable HUBER+SUHNER | SUCOFLEX 104 | Cable-CH4-03(250724) | 2023/5/7 | 2024/5/6 |
| Software BV ADT | ADT_Radiated_ V7.6.15.9.5 | N/A | N/A | N/A |
| Spectrum Analyzer R&S | FSW43 | 101866 | 2023/1/10 | 2024/1/9 |
| Test Receiver R&S | ESR3+ | 102782 | 2022/12/12 | 2023/12/11 |
| Turn Table BV ADT | TT100 | TT93021705 | N/A | N/A |
| Turn Table Controller BV ADT | SC100 | SC93021705 | N/A | N/A |

Notes:

1. The test was performed in HY - 966 chamber 3.
2. Tested Date: 2023/5/16

5 Limits of Test Items

5.1 Conducted Out of Band Emissions

Below 30 dB of the highest emission level of operating band (in 100 kHz Resolution Bandwidth).

5.2 Unwanted Emissions below 1 GHz

Radiated emissions up to 1 GHz which fall in the restricted bands must comply with the radiated emission limits specified as below table. Other emissions shall be at least 30 dB below the highest level of the desired power:

| Frequencies (MHz) | Field Strength (microvolts/meter) | Measurement Distance (meters) |
|-------------------|-----------------------------------|-------------------------------|
| 0.009 ~ 0.490 | 2400/F(kHz) | 300 |
| 0.490 ~ 1.705 | 24000/F(kHz) | 30 |
| 1.705 ~ 30.0 | 30 | 30 |
| 30 ~ 88 | 100 | 3 |
| 88 ~ 216 | 150 | 3 |
| 216 ~ 960 | 200 | 3 |
| Above 960 | 500 | 3 |

Notes:

1. The lower limit shall apply at the transition frequencies.
2. Emission level (dBuV/m) = 20 log Emission level (uV/m).

5.3 Unwanted Emissions above 1 GHz

Radiated emissions above 1 GHz which fall in the restricted bands must comply with the radiated emission limits specified as below table. Other emissions shall be at least 30 dB below the highest level of the desired power

| Frequencies (MHz) | Field Strength (microvolts/meter) | Measurement Distance (meters) |
|-------------------|-----------------------------------|-------------------------------|
| Above 960 | 500 | 3 |

Notes:

1. The lower limit shall apply at the transition frequencies.
2. Emission level (dBuV/m) = 20 log Emission level (uV/m).
3. For frequencies above 1000 MHz, the field strength limits are based on average detector, however, the peak field strength of any emission shall not exceed the maximum permitted average limits, specified above by more than 20 dB under any condition of modulation.

For 5.15-5.850 GHz band limits of unwanted emission out of the restricted bands

| Applicable To | Limit | |
|------------------------------------------------------------|-----------------------|-----------------|
| 789033 D02 General UNII Test Procedure New Rules v02r01 | Field Strength at 3 m | |
| | PK: 74 (dBµV/m) | AV: 54 (dBµV/m) |

For transmitters operating in the 5.15-5.25 GHz band:

| Applicable To | EIRP Limit | Equivalent Field Strength at 3 m |
|---------------|-------------------|----------------------------------|
| 15.407(b)(1) | PK: -27 (dBm/MHz) | PK: 68.2 (dBµV/m) |

For transmitters operating in the 5.25-5.35 GHz band:

| Applicable To | EIRP Limit | Equivalent Field Strength at 3 m |
|---------------|-------------------|----------------------------------|
| 15.407(b)(2) | PK: -27 (dBm/MHz) | PK: 68.2 (dBµV/m) |

For transmitters operating in the 5.47-5.725 GHz band:

| Applicable To | EIRP Limit | Equivalent Field Strength at 3 m |
|---------------|-------------------|----------------------------------|
| 15.407(b)(3) | PK: -27 (dBm/MHz) | PK: 68.2 (dBµV/m) |

For transmitters operating in the 5.725-5.850 GHz band:

| Applicable To | EIRP Limit | Equivalent Field Strength at 3 m |
|-----------------|----------------------------------|----------------------------------|
| 15.407(b)(4)(i) | PK: -27 (dBm/MHz) ^{*1} | PK: 68.2 (dBµV/m) ^{*1} |
| | PK: 10 (dBm/MHz) ^{*2} | PK: 105.2 (dBµV/m) ^{*2} |
| | PK: 15.6 (dBm/MHz) ^{*3} | PK: 110.8 (dBµV/m) ^{*3} |
| | PK: 27 (dBm/MHz) ^{*4} | PK: 122.2 (dBµV/m) ^{*4} |

^{*1} beyond 75 MHz or more above of the band edge.

^{*2} below the band edge increasing linearly to 10 dBm/MHz at 25 MHz above.

^{*3} below the band edge increasing linearly to a level of 15.6 dBm/MHz at 5 MHz above.

^{*4} from 5 MHz above or below the band edge increasing linearly to a level of 27 dBm/MHz at the band edge.

Note: The following formula is used to convert the equipment isotropic radiated power (eirp) to field strength:

$$E = \frac{1000000 \sqrt{30P}}{3} \mu\text{V/m, where P is the eirp (Watts).}$$

For transmitters operating in the 5.850-5.895 GHz band:

- (i) For an indoor access point or subordinate device, all emissions at or above 5.895 GHz shall not exceed an e.i.r.p. of 15 dBm/MHz and shall decrease linearly to an e.i.r.p. of -7 dBm/MHz at or above 5.925 GHz.
- (ii) For a client device, all emissions at or above 5.895 GHz shall not exceed an e.i.r.p. of -5 dBm/MHz and shall decrease linearly to an e.i.r.p. of -27 dBm/MHz at or above 5.925 GHz.
- (iii) For a client device or indoor access point or subordinate device, all emissions below 5.725 GHz shall not exceed an e.i.r.p. of -27 dBm/MHz at 5.65 GHz increasing linearly to 10 dBm/MHz at 5.7 GHz, and from 5.7 GHz increasing linearly to a level of 15.6 dBm/MHz at 5.72 GHz, and from 5.72 GHz increasing linearly to a level of 27 dBm/MHz at 5.725 GHz.

Note:

The following formula is used to convert the equipment isotropic radiated power (eirp) to field strength:

$$E = \frac{1000000 \sqrt{30P}}{3} \mu\text{V/m, where P is the eirp (Watts).}$$

For 5.925-7.125 GHz band limits of unwanted emission out of the restricted bands

| Frequencies (MHz) | EIRP Limit | Equivalent Field Strength at 3 m |
|-------------------------|------------------------|----------------------------------|
| 5925 MHz > F > 7125 MHz | Peak: -7 (dBm/MHz) | 88.2 (dBuV/m) |
| | Average: -27 (dBm/MHz) | 68.2 (dBuV/m) |

Note: The following formula is used to convert the equipment isotropic radiated power (eirp) to field strength:

$$E = \frac{1000000 \sqrt{30P}}{3} \mu\text{V/m, where P is the eirp (Watts).}$$

6 Test Arrangements

6.1 Conducted Out of Band Emissions

6.1.1 Test Setup

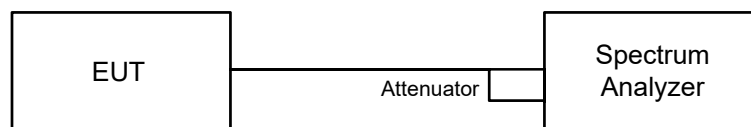

6.1.2 Test Procedure

MEASUREMENT PROCEDURE REF

- Set the RBW = 100 kHz.
- Set the VBW \geq 300 kHz.
- Detector = peak.
- Sweep time = auto couple.
- Trace mode = max hold.
- Allow trace to fully stabilize.
- Use the peak marker function to determine the maximum power level in any 100 kHz band segment within the fundamental EBW.

MEASUREMENT PROCEDURE OOB

- Set RBW = 100 kHz.
- Set VBW \geq 300 kHz.
- Detector = peak.
- Sweep = auto couple.
- Trace Mode = max hold.
- Allow trace to fully stabilize.
- Use the peak marker function to determine the maximum amplitude level.

6.2 Unwanted Emissions below 1 GHz

6.2.1 Test Setup

For Radiated emission below 30 MHz

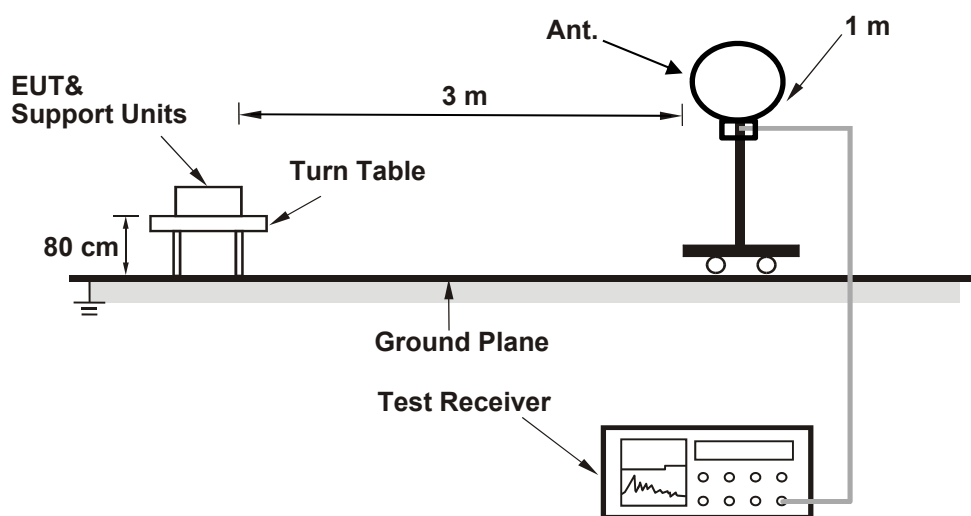

For Radiated emission above 30 MHz

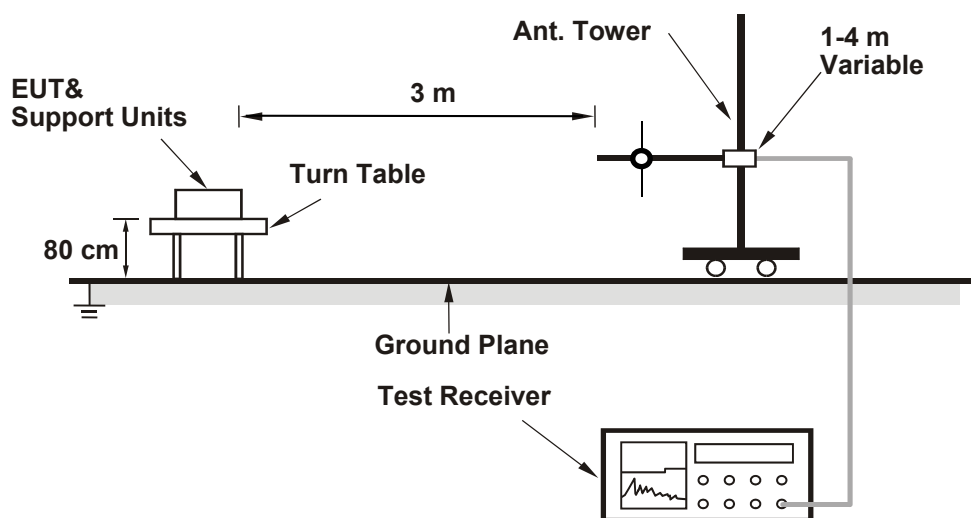

For the actual test configuration, please refer to the attached file (Test Setup Photo).

6.2.2 Test Procedure

For Radiated emission below 30 MHz

- a. The EUT was placed on the top of a rotating table 0.8 meters above the ground at 3 meter chamber room for test. The table was rotated 360 degrees to determine the position of the highest radiation.
- b. The EUT was set 3 meters away from the interference-receiving antenna, which was mounted on the top of a variable-height antenna tower.
- c. Parallel, perpendicular, and ground-parallel orientations of the antenna are set to make the measurement.
- d. For each suspected emission, the EUT was arranged to its worst case and the rotatable table was turned from 0 degrees to 360 degrees to find the maximum reading.
- e. The test-receiver system was set to Quasi-Peak Detect Function and Specified Bandwidth with Maximum Hold Mode, except for the frequency band (9 kHz to 90 kHz and 110 kHz to 490 kHz) set to average detect function and peak detect function.

Notes:

1. The resolution bandwidth and video bandwidth of test receiver/spectrum analyzer is 200 Hz at frequency below 150 kHz.
2. The resolution bandwidth and video bandwidth of test receiver/spectrum analyzer is 9 kHz or 10 kHz at frequency (150 kHz to 30 MHz).
3. All modes of operation were investigated and the worst-case emissions are reported.

For Radiated emission above 30 MHz

- a. The EUT was placed on the top of a rotating table 0.8 meters above the ground at 3 meter chamber room for test. The table was rotated 360 degrees to determine the position of the highest radiation.
- b. The EUT was set 3 meters away from the interference-receiving antenna, which was mounted on the top of a variable-height antenna tower.
- c. The height of antenna is varied from one meter to four meters above the ground to determine the maximum value of the field strength. Both horizontal and vertical polarizations of the antenna are set to make the measurement.
- d. For each suspected emission, the EUT was arranged to its worst case and then the antenna was tuned to heights from 1 meter to 4 meters and the rotatable table was turned from 0 degrees to 360 degrees to find the maximum reading.
- e. The test-receiver system was set to quasi-peak detect function and specified bandwidth with maximum hold mode when the test frequency is below 1 GHz.

Notes:

1. The resolution bandwidth and video bandwidth of test receiver/spectrum analyzer is 120 kHz for Quasi-peak detection (QP) at frequency below 1 GHz.
2. All modes of operation were investigated and the worst-case emissions are reported.

6.3 Unwanted Emissions above 1 GHz

6.3.1 Test Setup

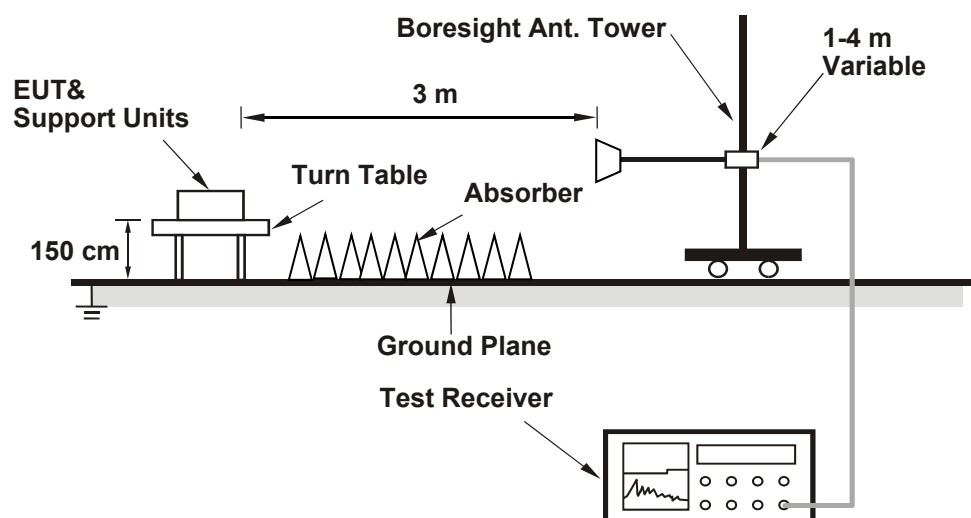

For the actual test configuration, please refer to the attached file (Test Setup Photo).

6.3.2 Test Procedure

- The EUT was placed on the top of a rotating table 1.5 meters above the ground at 3 meter chamber room for test. The table was rotated 360 degrees to determine the position of the highest radiation.
- The EUT was set 3 meters away from the interference-receiving antenna, which was mounted on the top of a variable-height antenna tower.
- The height of antenna is varied from one meter to four meters above the ground to determine the maximum value of the field strength. Both horizontal and vertical polarizations of the antenna are set to make the measurement.
- For each suspected emission, the EUT was arranged to its worst case and then the antenna was tuned to heights from 1 meter to 4 meters and the rotatable table was turned from 0 degrees to 360 degrees to find the maximum reading.
- The test-receiver system was set to peak and average detects function and specified bandwidth with maximum hold mode when the test frequency is above 1 GHz. If the peak reading value also meets average limit, measurement with the average detector is unnecessary.

Notes:

- The resolution bandwidth of test receiver/spectrum analyzer is 1 MHz and the video bandwidth is 3 MHz for Peak detection (PK) and Average detection (AV) at frequency above 1 GHz.
- For fundamental and harmonic signal measurement, the resolution bandwidth of test receiver/spectrum analyzer is 1 MHz and the video bandwidth is $\geq 1/T$ (Duty cycle $< 98\%$) or 10 Hz (Duty cycle $\geq 98\%$) for Average detection (AV) at frequency above 1 GHz.
- All modes of operation were investigated and the worst-case emissions are reported.

7 Test Results of Test Item

7.1 Conducted Out of Band Emissions

| | | | | | |
|--------------|----------------|---------------------------|--------------|------------|--------------|
| Input Power: | 120 Vac, 60 Hz | Environmental Conditions: | 25°C, 60% RH | Tested By: | Jisyong Wang |
|--------------|----------------|---------------------------|--------------|------------|--------------|

802.11be (EHT20) + 802.11a

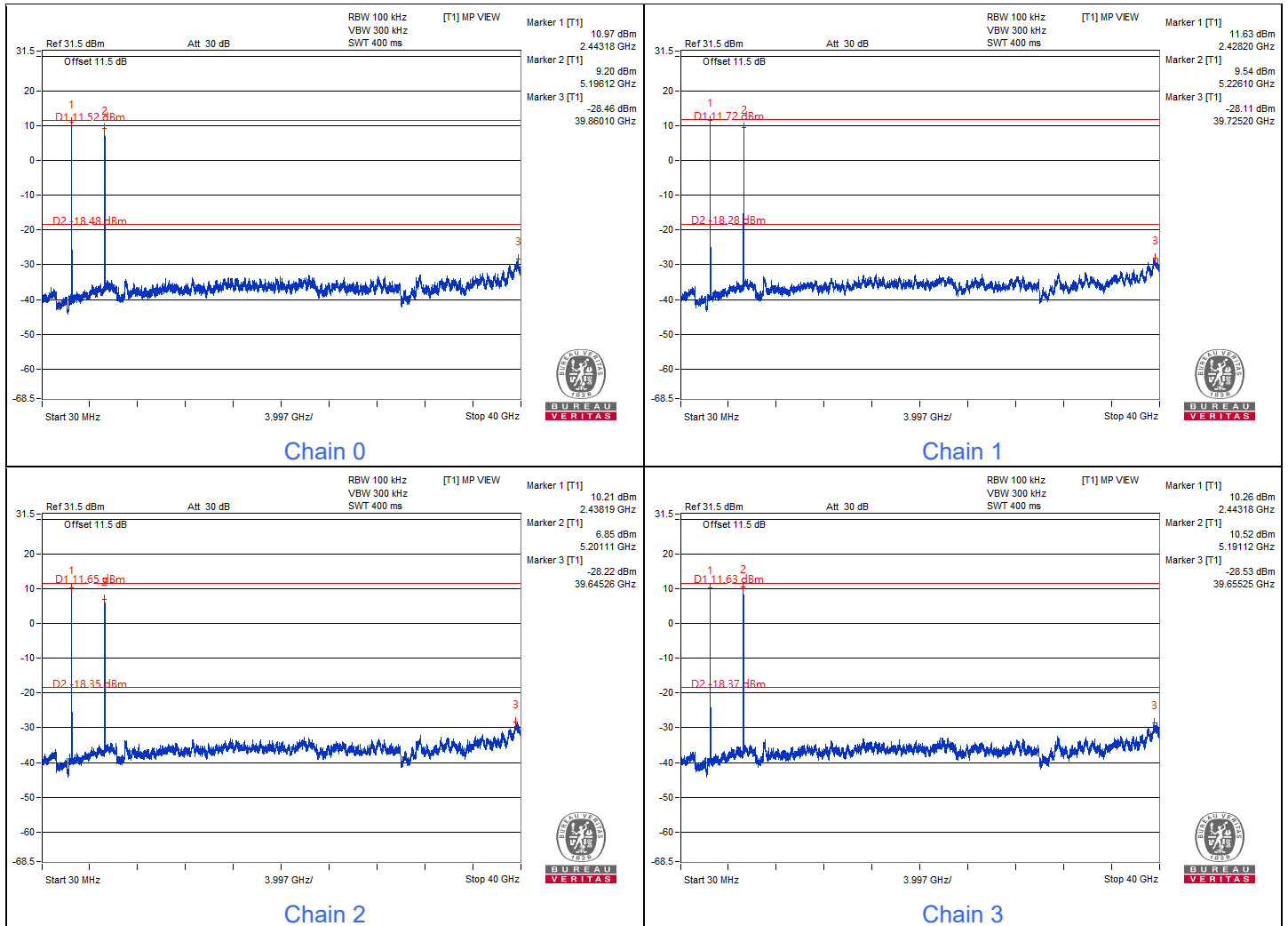



802.11be (EHT20) + 802.11be (EHT20)

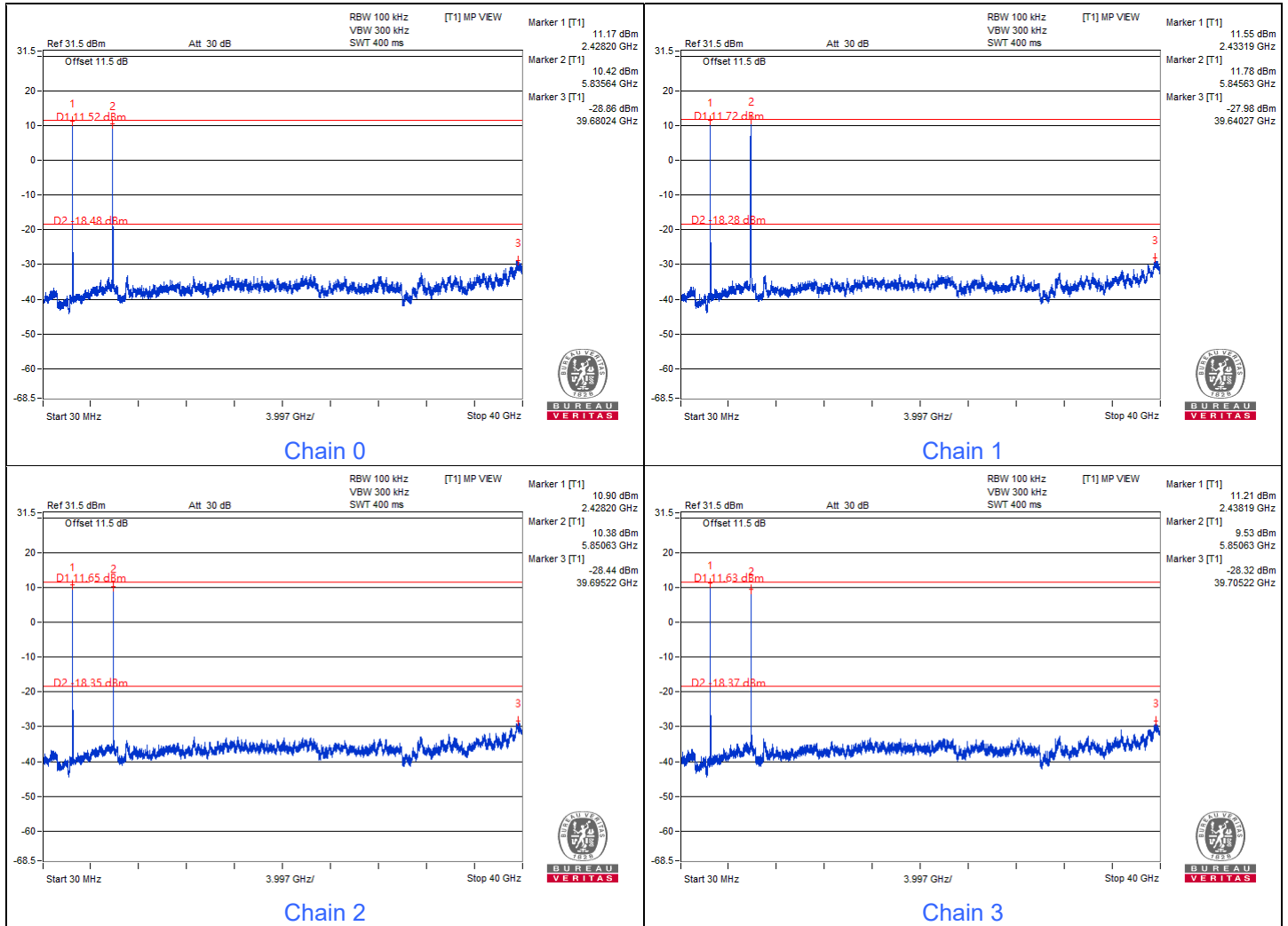

7.2 Unwanted Emissions below 1 GHz

| | | | |
|------------------------|------------------------------------------------------|------------------------------------------|------------------------------------------------------------|
| RF Mode | 802.11be (EHT20) + 802.11a + 802.11be (EHT320) | Channel | CH 6 : 2437 MHz + CH 40 : 5200 MHz+ CH 63 : 6265 MHz |
| Frequency Range | 30 MHz ~ 1 GHz | Detector Function & Bandwidth | (QP) RB = 120kHz |
| Input Power | 120 Vac, 60 Hz | Environmental Conditions | 23°C, 66% RH |
| Tested By | Luis Lee | | |

Antenna Polarity & Test Distance : Horizontal at 3 m

| No | Frequency (MHz) | Emission Level (dBuV/m) | Limit (dBuV/m) | Margin (dB) | Antenna Height (m) | Table Angle (Degree) | Raw Value (dBuV) | Correction Factor (dB/m) |
|----|-----------------|-------------------------|----------------|-------------|--------------------|----------------------|------------------|--------------------------|
| 1 | 58.12 | 28.1 QP | 40.0 | -11.9 | 1.00 H | 283 | 37.3 | -9.2 |
| 2 | 97.48 | 29.6 QP | 43.5 | -13.9 | 1.49 H | 131 | 43.3 | -13.7 |
| 3 | 305.54 | 26.1 QP | 46.0 | -19.9 | 1.00 H | 19 | 33.3 | -7.2 |
| 4 | 389.88 | 29.5 QP | 46.0 | -16.5 | 1.00 H | 197 | 35.4 | -5.9 |
| 5 | 457.36 | 27.3 QP | 46.0 | -18.7 | 1.00 H | 198 | 31.9 | -4.6 |
| 6 | 492.51 | 30.7 QP | 46.0 | -15.3 | 1.00 H | 266 | 35.1 | -4.4 |

Remarks:

1. Emission Level(dBuV/m) = Raw Value(dBuV) + Correction Factor(dB/m)
2. Correction Factor(dB/m) = Antenna Factor(dB/m) + Cable Factor(dB) – Pre-Amplifier Factor(dB)
3. Margin value = Emission Level – Limit value
4. The other emission levels were very low against the limit of frequency range 30 MHz ~ 1 GHz.
5. The emission levels were very low against the limit of frequency range 9 kHz ~ 30 MHz: the amplitude of spurious emissions attenuated more than 20 dB below the permissible value to be report.

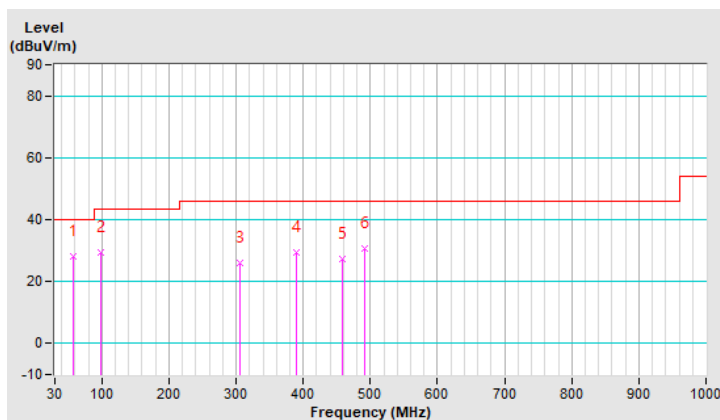

| | | | |
|------------------------|------------------------------------------------------|------------------------------------------|------------------------------------------------------------|
| RF Mode | 802.11be (EHT20) + 802.11a + 802.11be (EHT320) | Channel | CH 6 : 2437 MHz + CH 40 : 5200 MHz+ CH 63 : 6265 MHz |
| Frequency Range | 30 MHz ~ 1 GHz | Detector Function & Bandwidth | (QP) RB = 120kHz |
| Input Power | 120 Vac, 60 Hz | Environmental Conditions | 23°C, 66% RH |
| Tested By | Luis Lee | | |

| Antenna Polarity & Test Distance : Vertical at 3 m | | | | | | | | |
|----------------------------------------------------|-----------------|-------------------------|----------------|-------------|--------------------|----------------------|------------------|--------------------------|
| No | Frequency (MHz) | Emission Level (dBuV/m) | Limit (dBuV/m) | Margin (dB) | Antenna Height (m) | Table Angle (Degree) | Raw Value (dBuV) | Correction Factor (dB/m) |
| 1 | 48.28 | 32.8 QP | 40.0 | -7.2 | 1.49 V | 16 | 41.6 | -8.8 |
| 2 | 111.54 | 30.0 QP | 43.5 | -13.5 | 1.00 V | 73 | 41.6 | -11.6 |
| 3 | 229.62 | 32.2 QP | 46.0 | -13.8 | 1.49 V | 16 | 43.2 | -11.0 |
| 4 | 256.33 | 28.1 QP | 46.0 | -17.9 | 1.49 V | 348 | 37.1 | -9.0 |
| 5 | 347.71 | 32.3 QP | 46.0 | -13.7 | 1.49 V | 16 | 39.0 | -6.7 |
| 6 | 477.04 | 27.3 QP | 46.0 | -18.7 | 1.00 V | 267 | 31.9 | -4.6 |

Remarks:

1. Emission Level(dBuV/m) = Raw Value(dBuV) + Correction Factor(dB/m)
2. Correction Factor(dB/m) = Antenna Factor(dB/m) + Cable Factor(dB) – Pre-Amplifier Factor(dB)
3. Margin value = Emission Level – Limit value
4. The other emission levels were very low against the limit of frequency range 30 MHz ~ 1 GHz.
5. The emission levels were very low against the limit of frequency range 9 kHz ~ 30 MHz: the amplitude of spurious emissions attenuated more than 20 dB below the permissible value to be report.

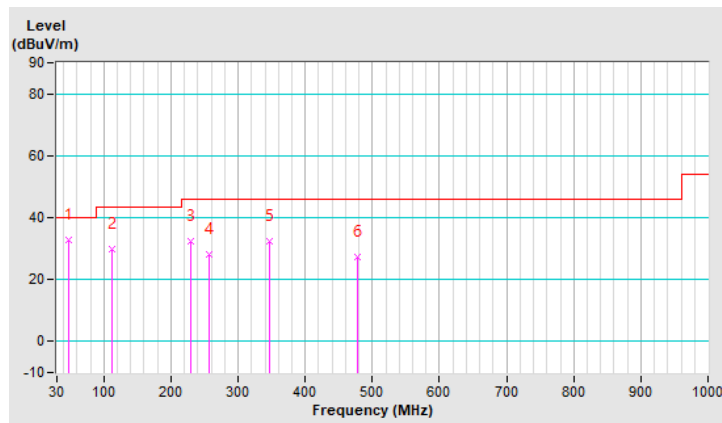

| | | | |
|------------------------|---------------------------------------------------------------|------------------------------------------|-------------------------------------------------------------|
| RF Mode | 802.11be (EHT20) + 802.11be (EHT20) + 802.11be (EHT320) | Channel | CH 6 : 2437 MHz + CH 169 : 5845 MHz+ CH 63 : 6265 MHz |
| Frequency Range | 30 MHz ~ 1 GHz | Detector Function & Bandwidth | (QP) RB = 120kHz |
| Input Power | 120 Vac, 60 Hz | Environmental Conditions | 23°C, 66% RH |
| Tested By | Luis Lee | | |

Antenna Polarity & Test Distance : Horizontal at 3 m

| No | Frequency (MHz) | Emission Level (dBuV/m) | Limit (dBuV/m) | Margin (dB) | Antenna Height (m) | Table Angle (Degree) | Raw Value (dBuV) | Correction Factor (dB/m) |
|----|-----------------|-------------------------|----------------|-------------|--------------------|----------------------|------------------|--------------------------|
| 1 | 58.12 | 28.2 QP | 40.0 | -11.8 | 1.01 H | 268 | 37.4 | -9.2 |
| 2 | 97.48 | 29.6 QP | 43.5 | -13.9 | 1.50 H | 163 | 43.3 | -13.7 |
| 3 | 229.62 | 34.6 QP | 46.0 | -11.4 | 1.01 H | 20 | 45.6 | -11.0 |
| 4 | 340.68 | 26.3 QP | 46.0 | -19.7 | 1.01 H | 23 | 33.0 | -6.7 |
| 5 | 392.70 | 30.9 QP | 46.0 | -15.1 | 1.01 H | 243 | 36.8 | -5.9 |
| 6 | 492.51 | 31.9 QP | 46.0 | -14.1 | 1.01 H | 264 | 36.3 | -4.4 |

Remarks:

1. Emission Level(dBuV/m) = Raw Value(dBuV) + Correction Factor(dB/m)
2. Correction Factor(dB/m) = Antenna Factor(dB/m) + Cable Factor(dB) – Pre-Amplifier Factor(dB)
3. Margin value = Emission Level – Limit value
4. The other emission levels were very low against the limit of frequency range 30 MHz ~ 1 GHz.
5. The emission levels were very low against the limit of frequency range 9 kHz ~ 30 MHz: the amplitude of spurious emissions attenuated more than 20 dB below the permissible value to be report.

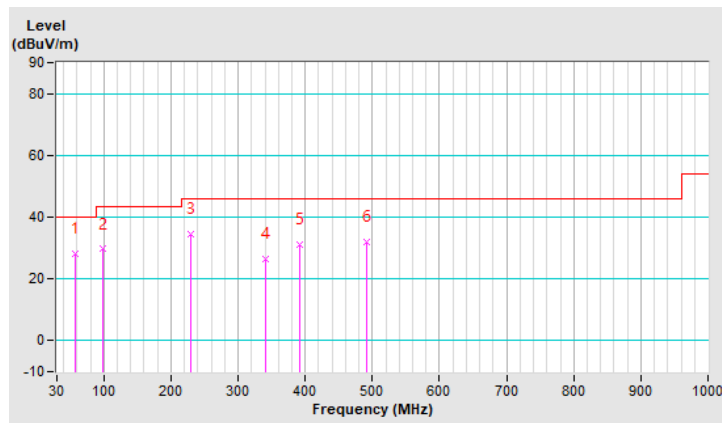

| | | | |
|------------------------|---------------------------------------------------------------|------------------------------------------|-------------------------------------------------------------|
| RF Mode | 802.11be (EHT20) + 802.11be (EHT20) + 802.11be (EHT320) | Channel | CH 6 : 2437 MHz + CH 169 : 5845 MHz+ CH 63 : 6265 MHz |
| Frequency Range | 30 MHz ~ 1 GHz | Detector Function & Bandwidth | (QP) RB = 120kHz |
| Input Power | 120 Vac, 60 Hz | Environmental Conditions | 23°C, 66% RH |
| Tested By | Luis Lee | | |

| Antenna Polarity & Test Distance : Vertical at 3 m | | | | | | | | |
|----------------------------------------------------|-----------------|-------------------------|----------------|-------------|--------------------|----------------------|------------------|--------------------------|
| No | Frequency (MHz) | Emission Level (dBuV/m) | Limit (dBuV/m) | Margin (dB) | Antenna Height (m) | Table Angle (Degree) | Raw Value (dBuV) | Correction Factor (dB/m) |
| 1 | 46.87 | 33.4 QP | 40.0 | -6.6 | 1.01 V | 53 | 42.3 | -8.9 |
| 2 | 110.13 | 29.7 QP | 43.5 | -13.8 | 1.01 V | 90 | 41.5 | -11.8 |
| 3 | 224.00 | 25.2 QP | 46.0 | -20.8 | 1.01 V | 34 | 36.4 | -11.2 |
| 4 | 256.33 | 28.4 QP | 46.0 | -17.6 | 1.50 V | 289 | 37.4 | -9.0 |
| 5 | 304.13 | 25.2 QP | 46.0 | -20.8 | 1.01 V | 18 | 32.5 | -7.3 |
| 6 | 543.12 | 27.0 QP | 46.0 | -19.0 | 1.01 V | 16 | 30.5 | -3.5 |

Remarks:

1. Emission Level(dBuV/m) = Raw Value(dBuV) + Correction Factor(dB/m)
2. Correction Factor(dB/m) = Antenna Factor(dB/m) + Cable Factor(dB) – Pre-Amplifier Factor(dB)
3. Margin value = Emission Level – Limit value
4. The other emission levels were very low against the limit of frequency range 30 MHz ~ 1 GHz.
5. The emission levels were very low against the limit of frequency range 9 kHz ~ 30 MHz: the amplitude of spurious emissions attenuated more than 20 dB below the permissible value to be report.

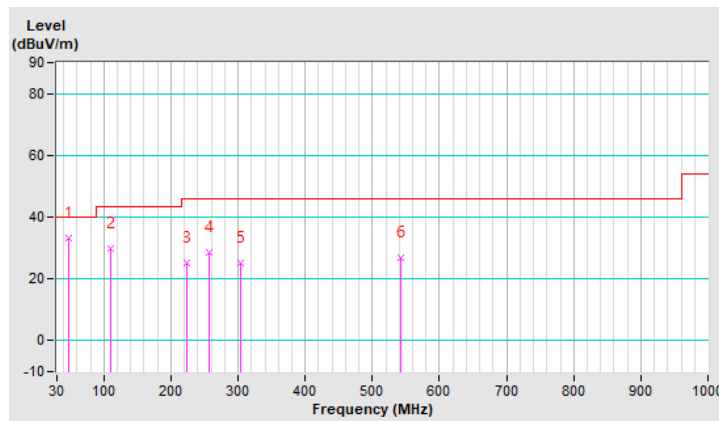

7.3 Unwanted Emissions above 1 GHz

| | | | |
|------------------------|------------------------------------------------------|------------------------------------------|------------------------------------------------------------|
| RF Mode | 802.11be (EHT20) + 802.11a + 802.11be (EHT320) | Channel | CH 6 : 2437 MHz + CH 40 : 5200 MHz+ CH 63 : 6265 MHz |
| Frequency Range | 1 GHz ~ 40 GHz | Detector Function & Bandwidth | (PK) RB = 1 MHz, VB = 3 MHz (AV) RB = 1 MHz, VB = 10 Hz |
| Input Power | 120 Vac, 60 Hz | Environmental Conditions | 23°C, 66% RH |
| Tested By | Luis Lee | | |

Antenna Polarity & Test Distance : Horizontal at 3 m

| No | Frequency (MHz) | Emission Level (dBuV/m) | Limit (dBuV/m) | Margin (dB) | Antenna Height (m) | Table Angle (Degree) | Raw Value (dBuV) | Correction Factor (dB/m) |
|----|-----------------|-------------------------|----------------|-------------|--------------------|----------------------|------------------|--------------------------|
| 1 | *2437.00 | 121.2 PK | | | 2.07 H | 105 | 86.5 | 34.7 |
| 2 | *2437.00 | 110.0 AV | | | 2.07 H | 105 | 75.3 | 34.7 |
| 3 | 4874.00 | 50.4 PK | 74.0 | -23.6 | 1.16 H | 318 | 37.1 | 13.3 |
| 4 | 4874.00 | 37.5 AV | 54.0 | -16.5 | 1.16 H | 318 | 24.2 | 13.3 |
| 5 | *5200.00 | 118.0 PK | | | 1.88 H | 162 | 75.5 | 42.5 |
| 6 | *5200.00 | 108.0 AV | | | 1.88 H | 162 | 65.5 | 42.5 |
| 7 | #5925.00 | 61.4 PK | 88.2 | -26.8 | 1.77 H | 34 | 47.8 | 13.6 |
| 8 | #5925.00 | 48.0 AV | 68.2 | -20.2 | 1.77 H | 34 | 34.4 | 13.6 |
| 9 | *6265.00 | 107.1 PK | | | 1.77 H | 34 | 62.4 | 44.7 |
| 10 | *6265.00 | 94.0 AV | | | 1.77 H | 34 | 49.3 | 44.7 |
| 11 | #10400.00 | 63.1 PK | 68.2 | -5.1 | 1.93 H | 314 | 40.4 | 22.7 |
| 12 | 12530.00 | 61.1 PK | 74.0 | -12.9 | 1.89 H | 217 | 39.4 | 21.7 |
| 13 | 12530.00 | 47.8 AV | 54.0 | -6.2 | 1.89 H | 217 | 26.1 | 21.7 |

Antenna Polarity & Test Distance : Vertical at 3 m

| No | Frequency (MHz) | Emission Level (dBuV/m) | Limit (dBuV/m) | Margin (dB) | Antenna Height (m) | Table Angle (Degree) | Raw Value (dBuV) | Correction Factor (dB/m) |
|----|-----------------|-------------------------|----------------|-------------|--------------------|----------------------|------------------|--------------------------|
| 1 | *2437.00 | 122.4 PK | | | 2.19 V | 52 | 87.7 | 34.7 |
| 2 | *2437.00 | 111.2 AV | | | 2.19 V | 52 | 76.5 | 34.7 |
| 3 | 4874.00 | 50.4 PK | 74.0 | -23.6 | 1.56 V | 284 | 37.1 | 13.3 |
| 4 | 4874.00 | 37.5 AV | 54.0 | -16.5 | 1.56 V | 284 | 24.2 | 13.3 |
| 5 | *5200.00 | 122.8 PK | | | 1.49 V | 99 | 80.3 | 42.5 |
| 6 | *5200.00 | 122.5 AV | | | 1.49 V | 99 | 80.0 | 42.5 |
| 7 | #5925.00 | 62.0 PK | 88.2 | -26.2 | 1.49 V | 258 | 48.4 | 13.6 |
| 8 | #5925.00 | 48.1 AV | 68.2 | -20.1 | 1.49 V | 258 | 34.5 | 13.6 |
| 9 | *6265.00 | 109.4 PK | | | 1.49 V | 258 | 64.7 | 44.7 |
| 10 | *6265.00 | 97.4 AV | | | 1.49 V | 258 | 52.7 | 44.7 |
| 11 | #10400.00 | 63.2 PK | 68.2 | -5.0 | 1.56 V | 209 | 40.5 | 22.7 |
| 12 | 12530.00 | 61.2 PK | 74.0 | -12.8 | 1.42 V | 268 | 39.5 | 21.7 |
| 13 | 12530.00 | 48.2 AV | 54.0 | -5.8 | 1.42 V | 268 | 26.5 | 21.7 |

Remarks:

1. Emission Level(dBuV/m) = Raw Value(dBuV) + Correction Factor(dB/m)
2. Correction Factor(dB/m) = Antenna Factor(dB/m) + Cable Factor(dB) – Pre-Amplifier Factor(dB)
3. Margin value = Emission Level – Limit value
4. The other emission levels were very low against the limit.
5. " * " : Fundamental frequency, the limit was restricted at the RF Output Power.
6. " # " : The radiated frequency is out of the restricted band.



| | | | |
|------------------------|---------------------------------------------------------------|------------------------------------------|-------------------------------------------------------------|
| RF Mode | 802.11be (EHT20) + 802.11be (EHT20) + 802.11be (EHT320) | Channel | CH 6 : 2437 MHz + CH 169 : 5845 MHz+ CH 63 : 6265 MHz |
| Frequency Range | 1 GHz ~ 40 GHz | Detector Function & Bandwidth | (PK) RB = 1 MHz, VB = 3 MHz (AV) RB = 1 MHz, VB = 10 Hz |
| Input Power | 120 Vac, 60 Hz | Environmental Conditions | 23°C, 66% RH |
| Tested By | Luis Lee | | |

| Antenna Polarity & Test Distance : Horizontal at 3 m | | | | | | | | |
|------------------------------------------------------|-----------------|-------------------------|----------------|-------------|--------------------|----------------------|------------------|--------------------------|
| No | Frequency (MHz) | Emission Level (dBuV/m) | Limit (dBuV/m) | Margin (dB) | Antenna Height (m) | Table Angle (Degree) | Raw Value (dBuV) | Correction Factor (dB/m) |
| 1 | *2437.00 | 121.1 PK | | | 2.11 H | 109 | 86.4 | 34.7 |
| 2 | *2437.00 | 109.9 AV | | | 2.11 H | 109 | 75.2 | 34.7 |
| 3 | 4874.00 | 50.2 PK | 74.0 | -23.8 | 1.18 H | 312 | 36.9 | 13.3 |
| 4 | 4874.00 | 37.6 AV | 54.0 | -16.4 | 1.18 H | 312 | 24.3 | 13.3 |
| 5 | #5650.00 | 60.7 PK | 68.2 | -7.5 | 2.92 H | 130 | 48.0 | 12.7 |
| 6 | *5845.00 | 119.8 PK | | | 2.92 H | 130 | 76.0 | 43.8 |
| 7 | *5845.00 | 108.0 AV | | | 2.92 H | 130 | 64.2 | 43.8 |
| 8 | #5925.00 | 61.3 PK | 88.2 | -26.9 | 1.86 H | 36 | 47.7 | 13.6 |
| 9 | #5925.00 | 47.9 AV | 68.2 | -20.3 | 1.86 H | 36 | 34.3 | 13.6 |
| 10 | *6265.00 | 107.2 PK | | | 1.86 H | 36 | 62.5 | 44.7 |
| 11 | *6265.00 | 93.9 AV | | | 1.86 H | 36 | 49.2 | 44.7 |
| 12 | 11690.00 | 62.5 PK | 74.0 | -11.5 | 1.78 H | 310 | 39.4 | 23.1 |
| 13 | 11690.00 | 48.8 AV | 54.0 | -5.2 | 1.78 H | 310 | 25.7 | 23.1 |
| 14 | 12530.00 | 61.0 PK | 74.0 | -13.0 | 1.91 H | 214 | 39.3 | 21.7 |
| 15 | 12530.00 | 47.6 AV | 54.0 | -6.4 | 1.91 H | 214 | 25.9 | 21.7 |

| Antenna Polarity & Test Distance : Vertical at 3 m | | | | | | | | |
|----------------------------------------------------|-----------------|-------------------------|----------------|-------------|--------------------|----------------------|------------------|--------------------------|
| No | Frequency (MHz) | Emission Level (dBuV/m) | Limit (dBuV/m) | Margin (dB) | Antenna Height (m) | Table Angle (Degree) | Raw Value (dBuV) | Correction Factor (dB/m) |
| 1 | *2437.00 | 122.1 PK | | | 2.14 V | 60 | 87.4 | 34.7 |
| 2 | *2437.00 | 111.0 AV | | | 2.14 V | 60 | 76.3 | 34.7 |
| 3 | 4874.00 | 50.3 PK | 74.0 | -23.7 | 1.60 V | 288 | 37.0 | 13.3 |
| 4 | 4874.00 | 37.8 AV | 54.0 | -16.2 | 1.60 V | 288 | 24.5 | 13.3 |
| 5 | #5650.00 | 61.1 PK | 68.2 | -7.1 | 1.95 V | 99 | 48.4 | 12.7 |
| 6 | *5845.00 | 125.2 PK | | | 1.95 V | 99 | 81.4 | 43.8 |
| 7 | *5845.00 | 112.6 AV | | | 1.95 V | 99 | 68.8 | 43.8 |
| 8 | #5925.00 | 61.8 PK | 88.2 | -26.4 | 1.43 V | 255 | 48.2 | 13.6 |
| 9 | #5925.00 | 48.0 AV | 68.2 | -20.2 | 1.43 V | 255 | 34.4 | 13.6 |
| 10 | *6265.00 | 109.2 PK | | | 1.43 V | 255 | 64.5 | 44.7 |
| 11 | *6265.00 | 97.3 AV | | | 1.43 V | 255 | 52.6 | 44.7 |
| 12 | 11690.00 | 63.0 PK | 74.0 | -11.0 | 1.65 V | 122 | 39.9 | 23.1 |
| 13 | 11690.00 | 49.1 AV | 54.0 | -4.9 | 1.65 V | 122 | 26.0 | 23.1 |
| 14 | 12530.00 | 61.1 PK | 74.0 | -12.9 | 1.48 V | 277 | 39.4 | 21.7 |
| 15 | 12530.00 | 48.2 AV | 54.0 | -5.8 | 1.48 V | 277 | 26.5 | 21.7 |

Remarks:

1. Emission Level(dBuV/m) = Raw Value(dBuV) + Correction Factor(dB/m)
2. Correction Factor(dB/m) = Antenna Factor(dB/m) + Cable Factor(dB) – Pre-Amplifier Factor(dB)
3. Margin value = Emission Level – Limit value
4. The other emission levels were very low against the limit.
5. " * " : Fundamental frequency, the limit was restricted at the RF Output Power.
6. " # " : The radiated frequency is out of the restricted band.

Plot of Band Edge

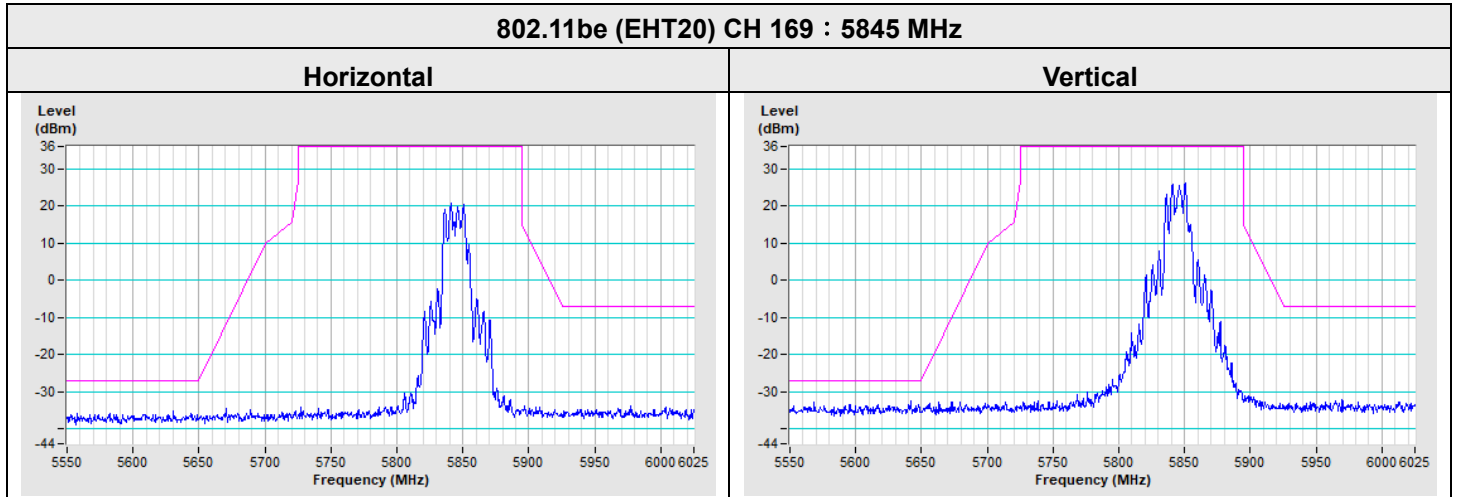

8 Pictures of Test Arrangements

Please refer to the attached file (Test Setup Photo)



9 Information of the Testing Laboratories

We, Bureau Veritas Consumer Products Services (H.K.) Ltd., Taoyuan Branch, were founded in 1988 to provide our best service in EMC, Radio, Telecom and Safety consultation. Our laboratories are FCC recognized accredited test firms and accredited according to ISO/IEC 17025.

If you have any comments, please feel free to contact us at the following:

Lin Kou EMC/RF Lab

Tel: 886-2-26052180

Fax: 886-2-26051924

Hsin Chu EMC/RF/Telecom Lab

Tel: 886-3-6668565

Fax: 886-3-6668323

Hwa Ya EMC/RF/Safety Lab

Tel: 886-3-3183232

Fax: 886-3-3270892

Email: service.adt@bureauveritas.com

Web Site: <http://ee.bureauveritas.com.tw>

The address and road map of all our labs can be found in our web site also.

--- END ---