

# TEST REPORT

## CERTIFICATE OF CONFORMITY

**Standard:** 47 CFR FCC Part 15, Subpart E (Section 15.407)

**Report No.:** RFBBQZ-WTW-P22110099-4

**FCC ID:** PY323100586

**Product:** BE19000 WiFi 7 Router

**Brand:** NETGEAR

**Model No.:** RS700

**Received Date:** 2023/2/14

**Test Date:** 2023/4/16 ~ 2023/5/23

**Issued Date:** 2023/5/24

**Applicant and Manufacturer:** NETGEAR, Inc.

**Address:** 350 East Plumeria Drive San Jose, CA 95134

**Issued By:** Bureau Veritas Consumer Products Services (H.K.) Ltd., Taoyuan Branch  
Lin Kou Laboratories

**Lab Address:** No. 47-2, 14th Ling, Chia Pau Vil., Lin Kou Dist., New Taipei City, Taiwan

**Test Location:** No. 19, Hwa Ya 2nd Rd., Wen Hwa Vil., Kewi Shan Dist., Taoyuan City 33383, Taiwan

**FCC Registration /** 788550 / TW0003

**Designation Number:**

**Approved by:** Jeremy Lin, **Date:** 2023/5/24  
Jeremy Lin / Project Engineer

This test report consists of 277 pages in total. It may be duplicated completely for legal use with the approval of the applicant. It should not be reproduced except in full, without the written approval of our laboratory. The test results in the report only apply to the tested sample. The test results in this report are traceable to the national or international standards.

Prepared by : Celine Chou / Senior Specialist



This report is governed by, and incorporates by reference, the Conditions of Testing as posted at the date of issuance of this report at <http://www.bureauveritas.com/home/about-us/our-business/cps/about-us/terms-conditions/> and is intended for your exclusive use. Any copying or replication of this report to or for any other person or entity, or use of our name or trademark, is permitted only with our prior written permission. This report sets forth our findings solely with respect to the test samples identified herein. The results set forth in this report are not indicative or representative of the quality or characteristics of the lot from which a test sample was taken or any similar or identical product unless specifically and expressly noted. Our report includes all of the tests requested by you and the results thereof based upon the information that you provided to us. Measurement uncertainty is only provided upon request for accredited tests. Statements of conformity are based on simple acceptance criteria without taking measurement uncertainty into account, unless otherwise requested in writing. You have 60 days from date of issuance of this report to notify us of any material error or omission caused by our negligence or if you require measurement uncertainty; provided, however, that such notice shall be in writing and shall specifically address the issue you wish to raise. A failure to raise such issue within the prescribed time shall constitute your unqualified acceptance of the completeness of this report, the tests conducted and the correctness of the report contents.

## Table of Contents

<b>Release Control Record</b> .....	<b>4</b>
<b>1 Certificate</b> .....	<b>5</b>
<b>2 Summary of Test Results</b> .....	<b>6</b>
2.1 Measurement Uncertainty .....	6
2.2 Supplementary Information .....	6
<b>3 General Information</b> .....	<b>7</b>
3.1 General Description of EUT .....	7
3.2 Antenna Description of EUT .....	9
3.3 Channel List .....	10
3.4 Test Mode Applicability and Tested Channel Detail .....	13
3.5 Duty Cycle of Test Signal .....	15
3.6 Test Program Used and Operation Descriptions .....	18
3.7 Connection Diagram of EUT and Peripheral Devices .....	18
3.8 Configuration of Peripheral Devices and Cable Connections .....	18
<b>4 Test Instruments</b> .....	<b>19</b>
4.1 RF Output Power .....	19
4.2 Power Spectral Density .....	19
4.3 Emission Bandwidth .....	20
4.4 In-Band Emission Mask .....	20
4.5 Occupied Bandwidth .....	20
4.6 Frequency Stability .....	20
4.7 Contention-based Protocol .....	21
4.8 AC Power Conducted Emissions .....	21
4.9 Unwanted Emissions below 1 GHz .....	22
4.10 Unwanted Emissions above 1 GHz .....	23
<b>5 Limits of Test Items</b> .....	<b>24</b>
5.1 RF Output Power .....	24
5.2 Power Spectral Density .....	24
5.3 Emission Bandwidth .....	24
5.4 In-Band Emission Mask .....	24
5.5 Occupied Bandwidth .....	24
5.6 Frequency Stability .....	24
5.7 Contention-based Protocol .....	25
5.8 AC Power Conducted Emissions .....	25
5.9 Unwanted Emissions below 1 GHz .....	25
5.10 Unwanted Emissions above 1 GHz .....	26
<b>6 Test Arrangements</b> .....	<b>27</b>
6.1 RF Output Power .....	27
6.1.1 Test Setup .....	27
6.1.2 Test Procedure .....	27
6.2 Power Spectral Density .....	28
6.2.1 Test Setup .....	28
6.2.2 Test Procedure .....	28
6.3 Emission Bandwidth .....	29
6.3.1 Test Setup .....	29
6.3.2 Test Procedure .....	29
6.4 In-Band Emission Mask .....	29
6.4.1 Test Setup .....	29
6.4.2 Test Procedure .....	29
6.5 Occupied Bandwidth .....	30
6.5.1 Test Setup .....	30
6.5.2 Test Procedure .....	30
6.6 Frequency Stability .....	30
6.6.1 Test Setup .....	30



6.6.2	Test Procedure.....	30
6.7	Contention-based Protocol.....	31
6.7.1	Test Setup.....	31
6.7.2	Test Procedure.....	31
6.8	AC Power Conducted Emissions.....	32
6.8.1	Test Setup.....	32
6.8.2	Test Procedure.....	32
6.9	Unwanted Emissions below 1 GHz.....	33
6.9.1	Test Setup.....	33
6.9.2	Test Procedure.....	34
6.10	Unwanted Emissions above 1 GHz.....	35
6.10.1	Test Setup.....	35
6.10.2	Test Procedure.....	35
<b>7</b>	<b>Test Results of Test Item.....</b>	<b>36</b>
7.1	RF Output Power.....	36
7.2	Power Spectral Density.....	43
7.3	Emission Bandwidth.....	50
7.4	In-Band Emission Mask.....	57
7.5	Occupied Bandwidth.....	132
7.6	Frequency Stability.....	139
7.7	Contention-based Protocol.....	140
7.8	AC Power Conducted Emissions.....	149
7.9	Unwanted Emissions below 1 GHz.....	153
7.10	Unwanted Emissions above 1 GHz.....	157
<b>8</b>	<b>Operational Restrictions for 6 GHz U-NII Devices.....</b>	<b>275</b>
<b>9</b>	<b>Pictures of Test Arrangements.....</b>	<b>276</b>
<b>10</b>	<b>Information of the Testing Laboratories.....</b>	<b>277</b>



## Release Control Record

Issue No.	Description	Date Issued
RFBBQZ-WTW-P22110099-4	Original release.	2023/5/24

## 1 Certificate

**Product:** BE19000 WiFi 7 Router

**Brand:** NETGEAR

**Test Model:** RS700

**Sample Status:** Engineering sample

**Applicant:** NETGEAR, Inc.

**Test Date:** 2023/4/16 ~ 2023/5/23

**Standard:** 47 CFR FCC Part 15, Subpart E (Section 15.407)

**Measurement** ANSI C63.10-2013

**procedure:**

KDB 987594 D02 U-NII 6 GHz EMC Measurement v01v01

KDB 789033 D02 General UNII Test Procedure New Rules v02r01

KDB 412172 D01 Determining ERP and EIRP v01r01

The above equipment has been tested by **Bureau Veritas Consumer Products Services (H.K.) Ltd., Taoyuan Branch**, and found compliance with the requirement of the above standards. The test record, data evaluation & Equipment Under Test (EUT) configurations represented herein are true and accurate accounts of the measurements of the sample's RF characteristics under the conditions specified in this report.

## 2 Summary of Test Results

47 CFR FCC Part 15, Subpart E (Section 15.407)			
Clause	Test Item	Result	Remark
15.407(a)(5)	RF Output Power	Pass	Meet the requirement of limit.
15.407(a)(5)	Power Spectral Density	Pass	Meet the requirement of limit.
15.407(a)(10)	Occupied Bandwidth	Pass	Meet the requirement of limit.
15.407(b)(9)	AC Power Conducted Emissions	Pass	Minimum passing margin is -7.87 dB at 0.47000 MHz
15.407(b)(9)	Unwanted Emissions below 1 GHz	Pass	Minimum passing margin is -5.9 dB at 52.49 MHz
15.407(b)(6) 15.407(b)(10)	Unwanted Emissions above 1 GHz	Pass	Minimum passing margin is -0.3 dB at 7250.00 MHz
15.407(b)(7)	In-Band Emission Mask	Pass	Meet the requirement of limit.
15.407(d)(6)	Contention-based Protocol	Pass	Meet the requirement of limit.
15.407(g)	Frequency Stability	Pass	Meet the requirement of limit.
15.407(d)	Operational restrictions for 6 GHz U-NII devices	Pass	Declaration by applicant.
15.203	Antenna Requirement	Pass	Antenna connector is ipex(MHF) not a standard connector.
---	Emission Bandwidth	-	Reference only.

Note: Determining compliance based on the results of the compliance measurement, not taking into account measurement instrumentation uncertainty.

### 2.1 Measurement Uncertainty

Where relevant, the following measurement uncertainty levels have been estimated for tests performed on the EUT as specified in CISPR 16-4-2:

Measurement	Specification	Expanded Uncertainty (k=2) (±)
AC Power Conducted Emissions	9 kHz ~ 30 MHz	2.99 dB
Unwanted Emissions below 1 GHz	9 kHz ~ 30 MHz	3.59 dB
	30 MHz ~ 1 GHz	3.64 dB
Unwanted Emissions above 1 GHz	1 GHz ~ 18 GHz	2.29 dB
	18 GHz ~ 40 GHz	2.29 dB

The other instruments specified are routine verified to remain within the calibrated levels, no measurement uncertainty is required to be calculated.

### 2.2 Supplementary Information

There is not any deviation from the test standards for the test method, and no modifications required for compliance.

### 3 General Information

#### 3.1 General Description of EUT

Product	BE19000 WiFi 7 Router
Brand	NETGEAR
Test Model	RS700
Status of EUT	Engineering sample
Power Supply Rating	19 Vdc from adapter
Modulation Type	64QAM, 16QAM, QPSK, BPSK for OFDM 256QAM for OFDM in 11ac mode only 1024QAM for OFDMA in 11ax mode only 4096QAM for OFDMA in 11be EHT mode
Modulation Technology	OFDM, OFDMA
Transfer Rate	802.11a: up to 54 Mbps 802.11n: up to 600 Mbps 802.11ac: up to 3466.7 Mbps 802.11ax: up to 4803.9 Mbps 802.11be: up to 11529.6 Mbps
Operating Frequency	6115 ~ 6415 MHz 6435 ~ 6525 MHz 6525 ~ 6875 MHz 6875 ~ 7115 MHz
Number of Channel	802.11a, 802.11ax (HE20), 802.11be (EHT20): 51 802.11ax (HE40), 802.11be (EHT40): 25 802.11ax (HE80), 802.11be (EHT80): 12 802.11ax (HE160), 802.11be (EHT160): 6 802.11be (EHT320): 5
Output Power	CDD Mode: 6115 ~ 6415 MHz : EIRP: 14.89 dBm (30.832 mW) 6435 ~ 6525 MHz : EIRP: 14.69 dBm (29.444 mW) 6525 ~ 6875 MHz : EIRP: 14.81 dBm (30.269 mW) 6875 ~ 7115 MHz : EIRP: 14.89 dBm (30.832 mW) Beamforming (4T1S) Mode: 6115 ~ 6415 MHz : EIRP: 29.78 dBm (950.605 mW) 6435 ~ 6525 MHz : EIRP: 29.65 dBm (922.571 mW) 6525 ~ 6875 MHz : EIRP: 29.70 dBm (933.254 mW) 6875 ~ 7115 MHz : EIRP: 29.51 dBm (893.305 mW) Beamforming (4T4S) Mode: 6115 ~ 6415 MHz : EIRP: 29.80 dBm (954.993 mW) 6435 ~ 6525 MHz : EIRP: 29.73 dBm (939.723 mW) 6525 ~ 6875 MHz : EIRP: 29.71 dBm (935.406 mW) 6875 ~ 7115 MHz : EIRP: 29.60 dBm (912.011 mW)
EUT Category	Indoor AP

Note:

1. The EUT uses following accessories.

Item	Brand	Model	Part Number	Specification
Adapter 1	NETGEAR	AD200F10	332-11480-02	AC Input : 100-120 Vac, 50/60 Hz, 1.7 A DC Output : 19 Vdc, 3.16 A, 60 W DC Output Cable : 1.8 m non-shielded and without core
Adapter 2	NETGEAR	2AEC060K 1	332-11578-01	AC Input : 100-120 Vac, 50/60 Hz, 1.7 A DC Output : 19 Vdc, 3.16 A, 60 W DC Output Cable : 1.8 m non-shielded and without core
Ethernet Cable	NETGEAR	312-10147-01	-	2m non-shielded and without core

2. Simultaneously transmission condition.

Condition	Technology		
1	WLAN (2.4GHz)	WLAN (5GHz)	WLAN (6GHz)

Note: The emission of the simultaneous operation has been evaluated and no non-compliance was found.

3. The above EUT information is declared by manufacturer and for more detailed features description, please refer to the manufacturer's specifications or user's manual.



### 3.2 Antenna Description of EUT

1. The antenna information is listed as below.

Type	Connector	Frequency Range	Ant 0 (dBi)	Ant 1 (dBi)	Ant 2 (dBi)	Ant 3 (dBi)
Dipole	ipex(MHF)	5925~6425 MHz	3.40	3.20	3.00	3.30
Dipole	ipex(MHF)	6425~6525 MHz	3.30	3.10	2.90	3.20
Dipole	ipex(MHF)	6525~6875 MHz	3.00	2.80	2.60	2.90
Dipole	ipex(MHF)	6875~7125 MHz	3.30	3.10	2.90	3.00

\* Detail antenna specification please refer to antenna datasheet and/or antenna measurement report.

\* Only the maximum gain value of each band is listed, please refer to the antenna specification for the rest.

2. The EUT incorporates a MIMO function:

Modulation Mode	Beamforming Mode	Tx & Rx Configuration	
802.11a	Not Support	4TX	4RX
802.11ax (HE20)	Support	4TX (Nss 1 / Nss 2 / Nss 3 / Nss 4)	4RX
802.11ax (HE40)	Support	4TX (Nss 1 / Nss 2 / Nss 3 / Nss 4)	4RX
802.11ax (HE80)	Support	4TX (Nss 1 / Nss 2 / Nss 3 / Nss 4)	4RX
802.11ax (HE160)	Support	4TX (Nss 1 / Nss 2 / Nss 3 / Nss 4)	4RX
802.11be (EHT20)	Support	4TX (Nss 1 / Nss 2 / Nss 3 / Nss 4)	4RX
802.11be (EHT40)	Support	4TX (Nss 1 / Nss 2 / Nss 3 / Nss 4)	4RX
802.11be (EHT80)	Support	4TX (Nss 1 / Nss 2 / Nss 3 / Nss 4)	4RX
802.11be (EHT160)	Support	4TX (Nss 1 / Nss 2 / Nss 3 / Nss 4)	4RX
802.11be (EHT320)	Support	4TX (Nss 1 / Nss 2 / Nss 3 / Nss 4)	4RX

Note:

1. The EUT support Beamforming and CDD mode, therefore both mode were investigated and the worst case scenario was identified. The worst case data were presented in test report.
2. The modulation and bandwidth are similar for 802.11ax mode for 20 MHz (40 MHz, 80 MHz, 160MHz), and 802.11be mode for 20 MHz (40 MHz, 80 MHz, 160MHz), therefore the manufacturer will control the power for 802.11ax mode is the same as the 802.11be or more lower than it and investigated worst case to representative mode in test report.
3. For 802.11ax and 802.11be, the EUT not support Partial RU.
4. The EUT device modulation technique OFDMA does not support channel puncturing/bandwidth reduction mechanisms.

### 3.3 Channel List

#### U-NII-5:

16 channels are provided for 802.11a, 802.11ax (HE20), 802.11be (EHT20):

Channel	Frequency	Channel	Frequency	Channel	Frequency	Channel	Frequency
33	6115 MHz	37	6135 MHz	41	6155 MHz	45	6175 MHz
49	6195 MHz	53	6215 MHz	57	6235 MHz	61	6255 MHz
65	6275 MHz	69	6295 MHz	73	6315 MHz	77	6335 MHz
81	6355 MHz	85	6375 MHz	89	6395 MHz	93	6415 MHz

8 channels are provided for 802.11ax (HE40), 802.11be (EHT40):

Channel	Frequency	Channel	Frequency	Channel	Frequency	Channel	Frequency
35	6125 MHz	43	6165 MHz	51	6205 MHz	59	6245 MHz
67	6285 MHz	75	6325 MHz	83	6365 MHz	91	6405 MHz

4 channels are provided for 802.11ax (HE80), 802.11be (EHT80):

Channel	Frequency	Channel	Frequency	Channel	Frequency	Channel	Frequency
39	6145 MHz	55	6225 MHz	71	6305 MHz	87	6385 MHz

2 channels are provided for 802.11ax (HE160), 802.11be (EHT160):

Channel	Frequency	Channel	Frequency
47	6185 MHz	79	6345 MHz

1 channel is provided for 802.11be (EHT320):

Channel	Frequency
63	6265 MHz

#### U-NII-6:

5 channels are provided for 802.11a, 802.11ax (HE20), 802.11be (EHT20):

Channel	Frequency	Channel	Frequency	Channel	Frequency	Channel	Frequency
97	6435 MHz	101	6455 MHz	105	6475 MHz	109	6495 MHz
113	6515 MHz						

3 channels are provided for 802.11ax (HE40), 802.11be (EHT40):

Channel	Frequency	Channel	Frequency	Channel	Frequency
99	6445 MHz	107	6485 MHz	*115	6525 MHz

1 channel is provided for 802.11ax (HE80), 802.11be (EHT80):

Channel	Frequency
103	6465 MHz

1 channel is provided for 802.11ax (HE160), 802.11be (EHT160):

Channel	Frequency
*111	6505 MHz

1 channel is provided for 802.11be (EHT320):

Channel	Frequency
*95	6425 MHz

**U-NII-7:**

17 channels are provided for 802.11a, 802.11ax (HE20), 802.11be (EHT20):

Channel	Frequency	Channel	Frequency	Channel	Frequency	Channel	Frequency
117	6535 MHz	121	6555 MHz	125	6575 MHz	129	6595 MHz
133	6615 MHz	137	6635 MHz	141	6655 MHz	145	6675 MHz
149	6695 MHz	153	6715 MHz	157	6735 MHz	161	6755 MHz
165	6775 MHz	169	6795 MHz	173	6815 MHz	177	6835 MHz
181	6855 MHz						

8 channels are provided for 802.11ax (HE40), 802.11be (EHT40):

Channel	Frequency	Channel	Frequency	Channel	Frequency	Channel	Frequency
123	6565 MHz	131	6605 MHz	139	6645 MHz	147	6685 MHz
155	6725 MHz	163	6765 MHz	171	6805 MHz	179	6845 MHz

5 channels are provided for 802.11ax (HE80), 802.11be (EHT80):

Channel	Frequency	Channel	Frequency	Channel	Frequency	Channel	Frequency
*119	6545 MHz	135	6625 MHz	151	6705 MHz	167	6785 MHz
*183	6865 MHz						

2 channels are provided for 802.11ax (HE160), 802.11be (EHT160):

Channel	Frequency	Channel	Frequency
143	6665 MHz	175	*6825 MHz

2 channels are provided for 802.11be (EHT320):

Channel	Frequency	Channel	Frequency
*127	6585 MHz	*159	6745 MHz

**U-NII-8:**

13 channels are provided for 802.11a, 802.11ax (HE20), 802.11be (EHT20):

Channel	Frequency	Channel	Frequency	Channel	Frequency	Channel	Frequency
185	6875 MHz	189	6895 MHz	193	6915 MHz	197	6935 MHz
201	6955 MHz	205	6975 MHz	209	6995 MHz	213	7015 MHz
217	7035 MHz	221	7055 MHz	225	7075 MHz	229	7095 MHz
233	7115 MHz						

6 channels are provided for 802.11ax (HE40), 802.11be (EHT40):

Channel	Frequency	Channel	Frequency	Channel	Frequency	Channel	Frequency
187	6885 MHz	195	6925 MHz	203	6965 MHz	211	7005 MHz
219	7045 MHz	227	7085 MHz				

2 channels are provided for 802.11ax (HE80), 802.11be (EHT80):

Channel	Frequency	Channel	Frequency
199	6945 MHz	215	7025 MHz

1 channel is provided for 802.11ax (HE160), 802.11be (EHT160):

Channel	Frequency
207	6985 MHz

1 channel is provided for 802.11be (EHT320):

Channel	Frequency
*191	6905 MHz

Note: \* mean these are straddle channels.

### 3.4 Test Mode Applicability and Tested Channel Detail

Pre-Scan:	EUT can be used in the following ways: XYZ 3-axis. Pre-scan in these ways and find the worst case as a representative test condition.
Worst Case:	X / Y / Z Worst Condition: Z Axis.

Following channel(s) was (were) selected for the final test as listed below:

Test Item	EUT Configure Mode	Mode	Signal Mode	Tested Channel	Modulation	Data Rate Parameter
RF Output Power / Power Spectral Density / Emission Bandwidth / In-Band Emission Mask / Occupied Bandwidth	B	802.11a	CDD	33, 61, 93, 97, 105, 113, 117, 149, 181, 185, 209, 229, 233	BPSK	6Mb/s
		802.11be (EHT20)	Beamforming (4T1S) / Beamforming (4T4S)	33, 61, 93, 97, 105, 113, 117, 149, 181, 185, 209, 229, 233	BPSK	MCS0
		802.11be (EHT40)		35, 59, 91, 99, 107, 115, 123, 155, 179, 187, 211, 227	BPSK	MCS0
		802.11be (EHT80)		39, 55, 87, 103, 119, 135, 151, 167, 183, 199, 215	BPSK	MCS0
		802.11be (EHT160)		47, 79, 111, 143, 175, 207	BPSK	MCS0
		802.11be (EHT320)		63, 95, 127, 159, 191	BPSK	MCS0
Frequency Stability	B	802.11a	CDD	33	un-modulation	-
Contention-based Protocol	B	802.11be (EHT20)	-	45, 105, 149, 209	BPSK	MCS0
		802.11be (EHT320)		63, 95, 127, 191	BPSK	MCS0
AC Power Conducted Emissions	A, B	802.11be (EHT320)	Beamforming (4T4S)	63	BPSK	MCS0
Unwanted Emissions below 1 GHz	A, B	802.11be (EHT320)	Beamforming (4T4S)	63	BPSK	MCS0

Test Item	EUT Configure Mode	Mode	Signal Mode	Tested Channel	Modulation	Data Rate Parameter
Unwanted Emissions above 1 GHz	B	802.11a	CDD	33, 61, 93, 97, 105, 113, 117, 149, 181, 185, 209, 229, 233	BPSK	6Mb/s
		802.11be (EHT20)	Beamforming (4T1S) / Beamforming (4T4S)	33, 61, 93, 97, 105, 113, 117, 149, 181, 185, 209, 229, 233	BPSK	MCS0
		802.11be (EHT40)		35, 59, 91, 99, 107, 115, 123, 155, 179, 187, 211, 227	BPSK	MCS0
		802.11be (EHT80)		39, 55, 87, 103, 119, 135, 151, 167, 183, 199, 215	BPSK	MCS0
		802.11be (EHT160)		47, 79, 111, 143, 175, 207	BPSK	MCS0
		802.11be (EHT320)		63, 95, 127, 159, 191	BPSK	MCS0
EUT Configure Mode:	A	EUT powered by adapter 1				
	B	EUT powered by adapter 2				

### 3.5 Duty Cycle of Test Signal

802.11a: Duty cycle = 3.015 ms / 3.035 ms x 100% = 99.3%

802.11be (EHT20) Beamforming: Duty cycle = 2.875 ms / 2.895 ms x 100% = 99.3%

802.11be (EHT40) Beamforming: Duty cycle = 2.855 ms / 2.88 ms x 100% = 99.1%

802.11be (EHT80) Beamforming: Duty cycle = 2.85 ms / 2.875 ms x 100% = 99.1%

802.11be (EHT160) Beamforming: Duty cycle = 2.85 ms / 2.87 ms x 100% = 99.3%

802.11be (EHT320) Beamforming: Duty cycle = 2.85 ms / 2.875 ms x 100% = 99.1%

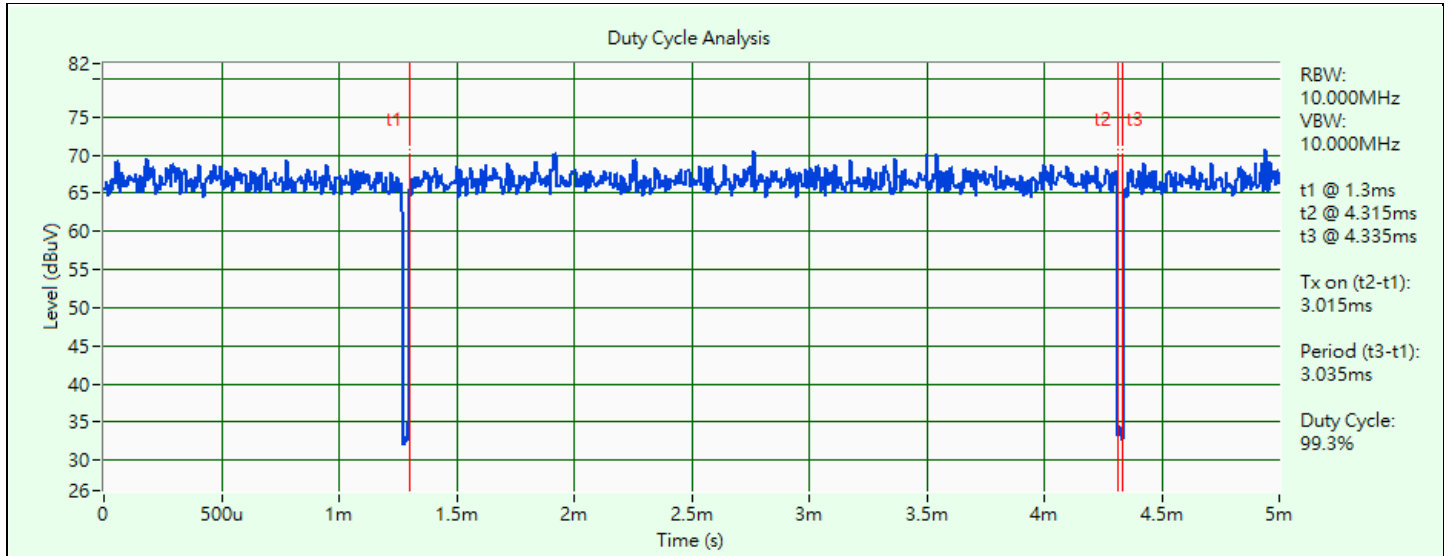

802.11a

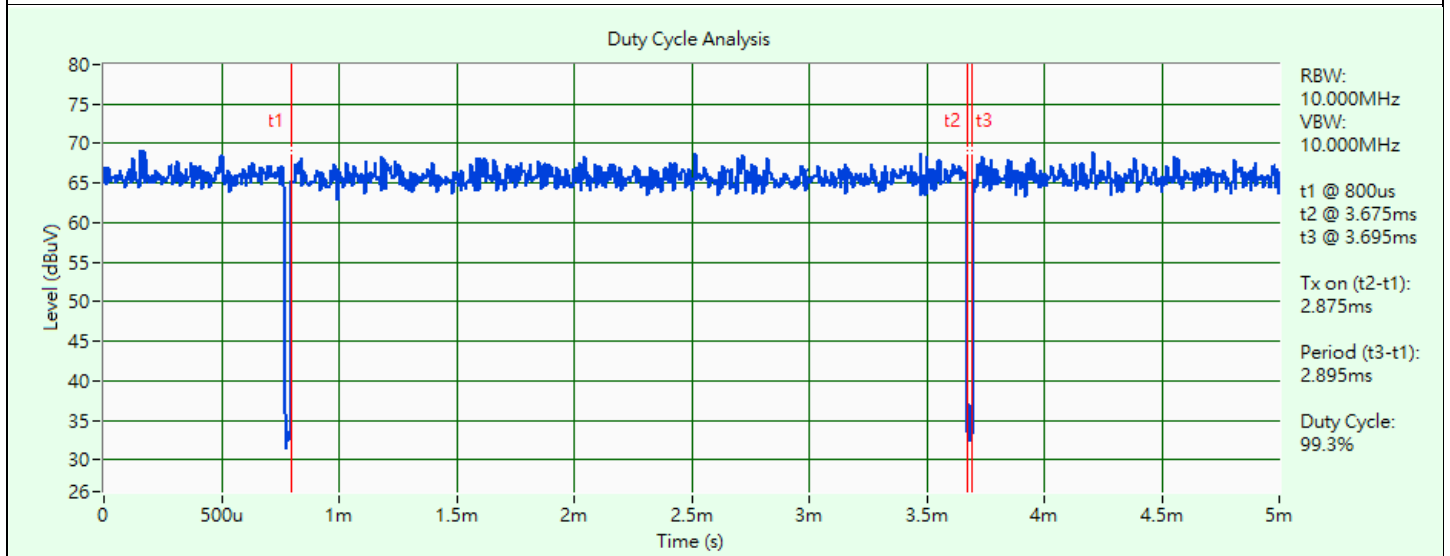

802.11be (EHT20) Beamforming

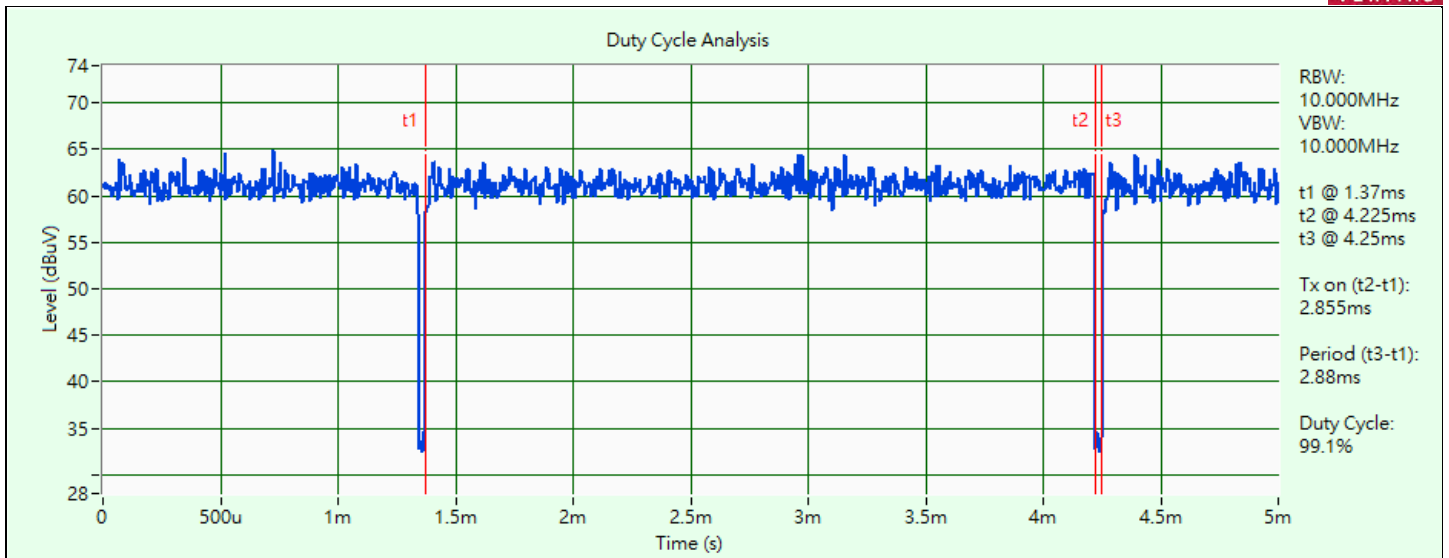

802.11be (EHT40) Beamforming

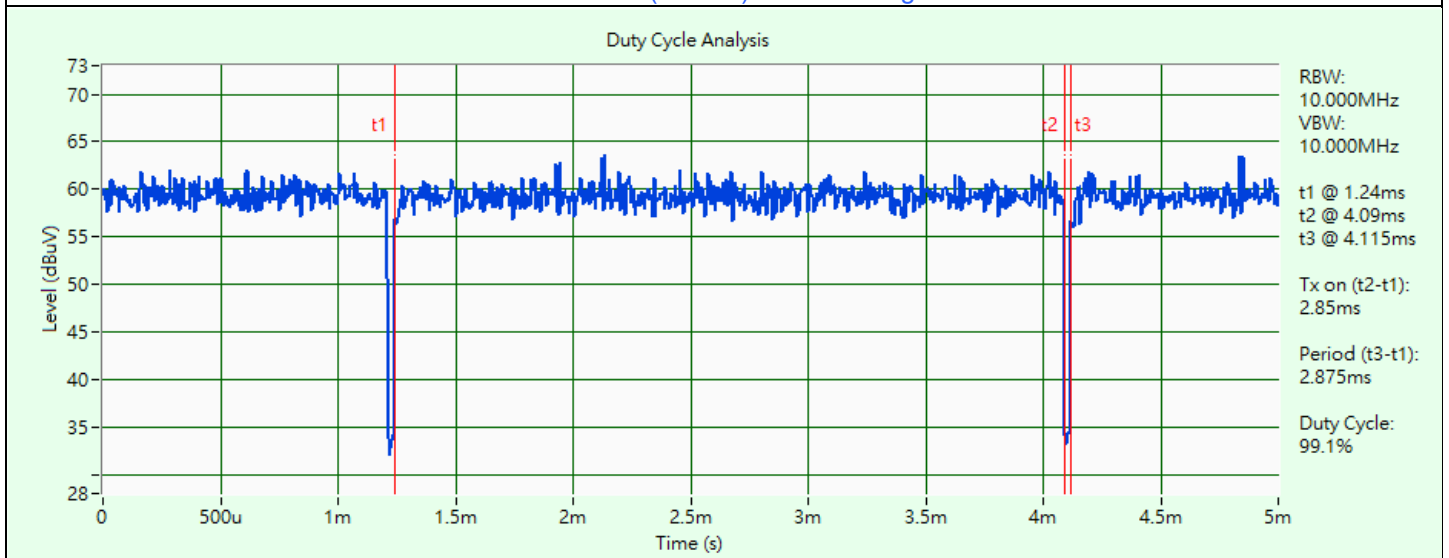

802.11be (EHT80) Beamforming

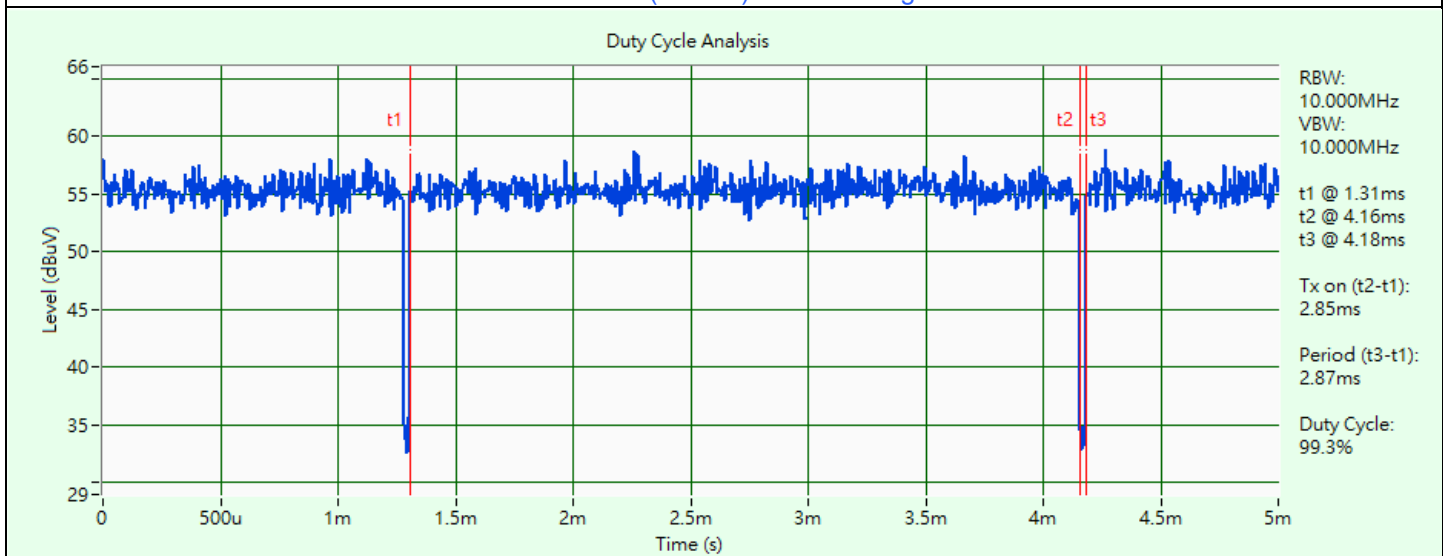

802.11be (EHT160) Beamforming



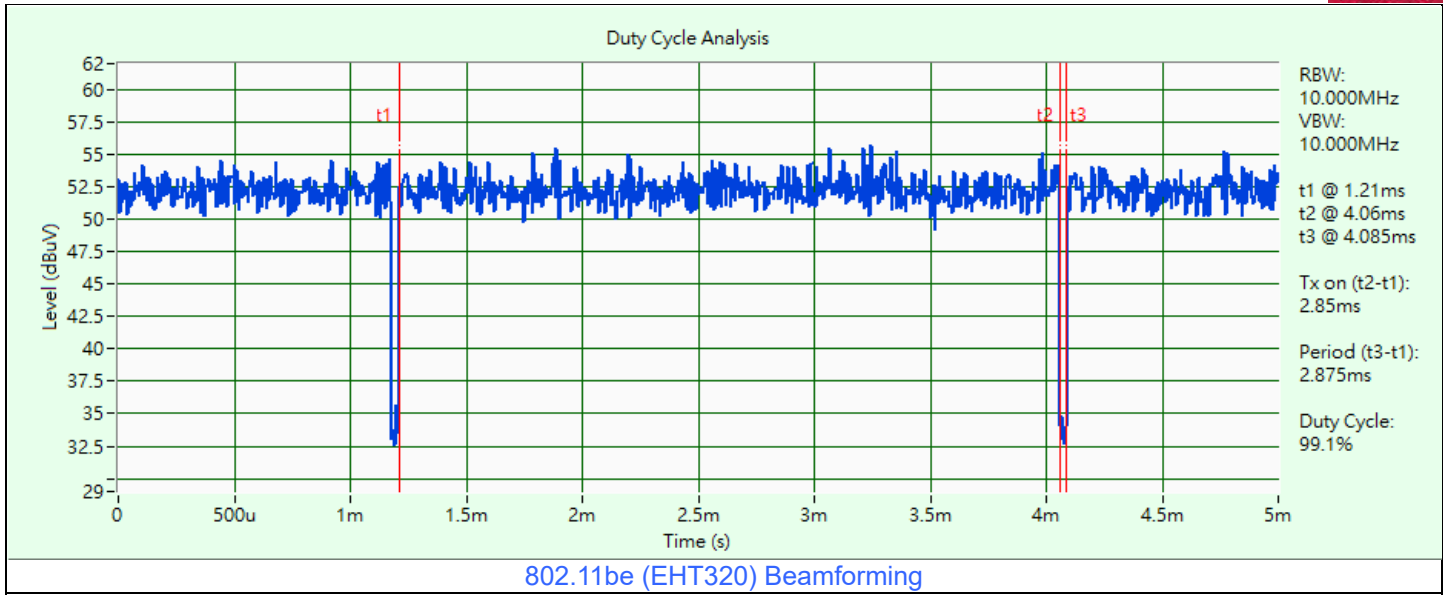

### 3.6 Test Program Used and Operation Descriptions

Controlling software accessMTool\_REL\_3\_2\_1\_5 has been activated to set the EUT under transmission condition continuously at specific channel frequency.

### 3.7 Connection Diagram of EUT and Peripheral Devices

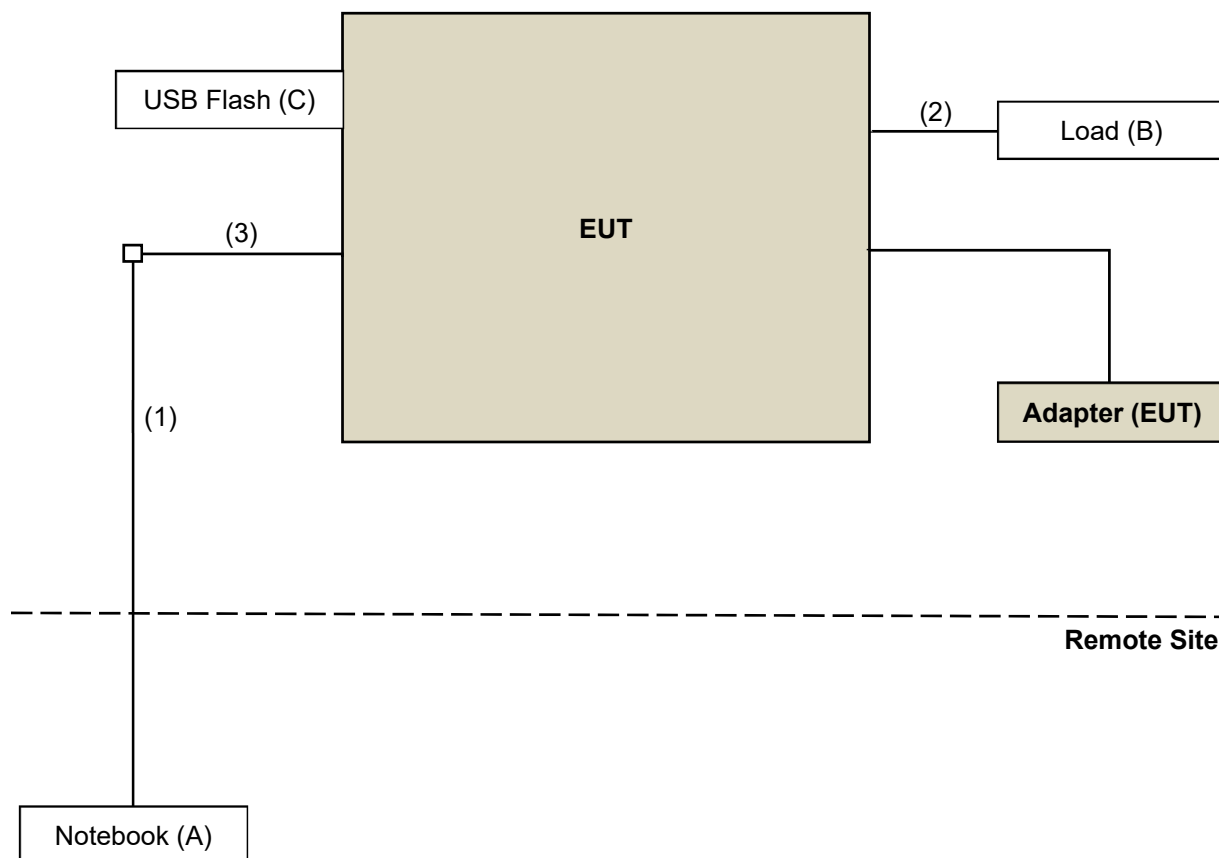

### 3.8 Configuration of Peripheral Devices and Cable Connections

ID	Product	Brand	Model No.	Serial No.	FCC ID	Remarks
A	Notebook	DELL	E5430	2RL3YW1	N/A	Provided by Lab
B	Load	N/A	N/A	N/A	N/A	Provided by Lab
C	USB Flash	SanDisk	SDDDC3-032G	N/A	N/A	Provided by Lab

ID	Cable Descriptions	Qty.	Length (m)	Shielding (Yes/No)	Cores (Qty.)	Remarks
1	LAN Cable	1	10	N	N	Provided by Lab
2	LAN Cable	4	1.5	N	N	Provided by Lab
3	Ethernet Cable	1	2.0	N	N	Accessory of EUT

## 4 Test Instruments

The calibration interval of the all test instruments are 12 months and the calibrations are traceable to NML/ROC and NIST/USA.

### 4.1 RF Output Power

Description Manufacturer	Model No.	Serial No.	Calibrated Date	Calibrated Until
Antenna Tower inn-co GmbH	MA 4000	010303	N/A	N/A
Boresight antenna tower fixture BV	BAF-02	5	N/A	N/A
Horn Antenna Schwarzbeck	9120D	9120D-408	2022/11/13	2023/11/12
	BBHA 9170	9170-480	2022/11/13	2023/11/12
		BBHA9170241	2022/10/20	2023/10/19
		BBHA9170243	2022/11/13	2023/11/12
Pre-Amplifier EMCI	EMC 184045	980116	2022/10/1	2023/9/30
Pre_Amplifier KEYSIGHT	83017A	MY53270295	2022/5/14	2023/5/13
RF cable HUBER+SUHNER	Sucoflex 104	MY 13380+295012/04	2022/5/14	2023/5/13
RF Coaxial Cable EMCI	EMC102-KM-KM-600	150928	2022/7/9	2023/7/8
	EMC102-KM-KM-3000	150929	2022/7/9	2023/7/8
RF Coaxial Cable HUBER+SUHNER	SUCOFLEX 104	Cable-CH4-03(250724)	2022/5/14	2023/5/13
Software BV ADT	ADT_Radiated_ V7.6.15.9.5	N/A	N/A	N/A
Spectrum Analyzer R&S	FSW43	101866	2023/1/10	2024/1/9
Test Receiver R&S	ESR3+	102782	2022/12/12	2023/12/11
Turn Table BV ADT	TT100	TT93021705	N/A	N/A
Turn Table Controller BV ADT	SC100	SC93021705	N/A	N/A

Notes:

1. The test was performed in HY - 966 chamber 3.
2. Tested Date: 2023/5/12

### 4.2 Power Spectral Density

Refer to section 4.1 to get information of the instruments.

### 4.3 Emission Bandwidth

Description Manufacturer	Model No.	Serial No.	Calibrated Date	Calibrated Until
Signal and spectrum analyzer R&S	FSV3044	101105	2023/2/22	2024/2/21
Software BV	ADT_RF Test Software V6.6.5.4	N/A	N/A	N/A

Notes:

1. The test was performed in Oven room.
2. Tested Date: 2023/5/12 ~ 2023/5/13

### 4.4 In-Band Emission Mask

Refer to section 4.3 to get information of the instruments.

### 4.5 Occupied Bandwidth

Refer to section 4.3 to get information of the instruments.

### 4.6 Frequency Stability

Description Manufacturer	Model No.	Serial No.	Calibrated Date	Calibrated Until
AC power supply JIN YIH Technology	6905S	1720444	N/A	N/A
Digital Multimeter Fluke	87-III	70360742	2022/6/23	2023/6/22
Signal and spectrum analyzer R&S	FSV3044	101105	2023/2/22	2024/2/21
Software BV	ADT_RF Test Software V6.6.5.4	N/A	N/A	N/A
Temperature & Humidity Chamber TERCHY	HRM-120RF	931022	2022/12/27	2023/12/26

Notes:

1. The test was performed in Oven room.
2. Tested Date: 2023/5/12

#### 4.7 Contention-based Protocol

Description Manufacturer	Model No.	Serial No.	Calibrated Date	Calibrated Until
Combiner / Splitter (Model:ZN2PD-9G) Mini-Circuits	ZN2PD-9G	ZN2PD-9G	2022/6/9	2023/6/8
MXG Vector signal generator KEYSIGHT	N5182B	MY53052282	2023/1/6	2024/1/5
N9030B - PXA Signal Analyzer KEYSIGHT	N9030B	MY57140488	2023/3/6	2024/3/5
PXA KEYSIGHT	N9030B	MY57140953	2022/7/1	2023/6/30
Signal Analyzer Agilent	N9010A	MY52220207	2023/1/3	2024/1/2
Signal Analyzer R&S	FSV7	102538	2022/7/19	2023/7/18

Notes:

1. The test was performed in Adaptivity room.
2. Tested Date: 2023/4/16 ~ 2023/5/23

#### 4.8 AC Power Conducted Emissions

Description Manufacturer	Model No.	Serial No.	Calibrated Date	Calibrated Until
LISN R&S	ESH3-Z5	100311	2022/9/12	2023/9/11
LISN ROHDE & SCHWARZ	ENV216	101826	2023/3/23	2024/3/22
RF Coaxial Cable WOKEN	5D-FB	Cable-cond1-01	2023/1/7	2024/1/6
Software BVADT	BVADT_Conc_ V7.3.7.4	N/A	N/A	N/A
Test Receiver Rohde&Schwarz	ESCI	100613	2022/12/5	2023/12/4
V-LISN Schwarzbeck	NNBL 8226-2	8226-142	2022/8/31	2023/8/30

Notes:

1. The test was performed in HY - Conduction 1.
2. Tested Date: 2023/4/26 ~ 2023/5/5

#### 4.9 Unwanted Emissions below 1 GHz

Description Manufacturer	Model No.	Serial No.	Calibrated Date	Calibrated Until
Antenna Tower inn-co GmbH	MA 4000	010303	N/A	N/A
Bi_Log Antenna Schwarbeck	VULB9168	9168-155	2022/10/21	2023/10/20
Loop Antenna EMCI	EM-6879	269	2022/9/19	2023/9/18
Loop Antenna TESEQ	HLA 6121	45745	2022/7/27	2023/7/26
Pre-amplifier EMCI	EMC001340	980201	2022/9/23	2023/9/22
Pre_Amplifier Agilent	8447D	2944A10631	2022/5/14	2023/5/13
RF Coaxial Cable EMCI	5D-NM-BM	140903+140902	2023/1/7	2024/1/6
RF Coaxial Cable WOKEN	8D-FB	Cable-CH4-01	2022/7/9	2023/7/8
Software BV ADT	ADT_Radiated_ V7.6.15.9.5	N/A	N/A	N/A
Spectrum Analyzer R&S	FSW43	101866	2023/1/10	2024/1/9
Test Receiver R&S	ESR3+	102782	2022/12/12	2023/12/11
Turn Table BV ADT	TT100	TT93021705	N/A	N/A
Turn Table Controller BV ADT	SC100	SC93021705	N/A	N/A

Notes:

1. The test was performed in HY - 966 chamber 3.
2. Tested Date: 2023/5/5

#### 4.10 Unwanted Emissions above 1 GHz

Description Manufacturer	Model No.	Serial No.	Calibrated Date	Calibrated Until
Antenna Tower inn-co GmbH	MA 4000	010303	N/A	N/A
Boresight antenna tower fixture BV	BAF-02	5	N/A	N/A
Horn Antenna Schwarzbeck	9120D	9120D-408	2022/11/13	2023/11/12
	BBHA 9170	9170-480	2022/11/13	2023/11/12
		BBHA9170241	2022/10/20	2023/10/19
		BBHA9170243	2022/11/13	2023/11/12
Pre-Amplifier EMCI	EMC 184045	980116	2022/10/1	2023/9/30
Pre_Amplifier KEYSIGHT	83017A	MY53270295	2023/5/7	2024/5/6
RF cable HUBER+SUHNER	Sucoflex 104	MY 13380+295012/04	2023/5/7	2024/5/6
RF Coaxial Cable EMCI	EMC102-KM-KM-600	150928	2022/7/9	2023/7/8
	EMC102-KM-KM-3000	150929	2022/7/9	2023/7/8
RF Coaxial Cable HUBER+SUHNER	SUCOFLEX 104	Cable-CH4-03(250724)	2023/5/7	2024/5/6
Software BV ADT	ADT_Radiated_ V7.6.15.9.5	N/A	N/A	N/A
Spectrum Analyzer R&S	FSW43	101866	2023/1/10	2024/1/9
Test Receiver R&S	ESR3+	102782	2022/12/12	2023/12/11
Turn Table BV ADT	TT100	TT93021705	N/A	N/A
Turn Table Controller BV ADT	SC100	SC93021705	N/A	N/A

Notes:

1. The test was performed in HY - 966 chamber 3.
2. Tested Date: 2023/5/8 ~ 2023/5/11

## 5 Limits of Test Items

### 5.1 RF Output Power

Operation Band	EUT Category	Limit
		Max Average Power
U-NII-5 U-NII-6 U-NII-7 U-NII-8	Indoor AP	EIRP 30 dBm

### 5.2 Power Spectral Density

Operation Band	EUT Category	Limit
		Peak Power Density
U-NII-5 U-NII-6 U-NII-7 U-NII-8	Indoor AP	EIRP 5 dBm/MHz

### 5.3 Emission Bandwidth

The results are for reference only.

### 5.4 In-Band Emission Mask

Test Item	Frequencies (MHz)	(X) dBc <sup>*1</sup>
Emission Mask	At 1 MHz outside of channel edge	20
	At one channel bandwidth from the channel center <sup>*2</sup>	28
	At one- and one-half times the channel bandwidth away from channel center <sup>*3</sup>	40
	More than one- and one-half times the channel bandwidth	40

\*1 : The power spectral density must be suppressed by "x" dB

\*2 : At frequencies between one megahertz outside an unlicensed device's channel edge and one channel bandwidth from the center of the channel, the limits must be linearly interpolated between 20 dB and 28 dB suppression,

\*3 : At frequencies between one and one- and one-half times an unlicensed device's channel bandwidth, the limits must be linearly interpolated between 28 dB and 40 dB suppression.

### 5.5 Occupied Bandwidth

The maximum transmitter channel bandwidth for U-NII devices in the 5.925-7.125 GHz band is 320 MHz.

### 5.6 Frequency Stability

The frequency of the carrier signal shall be maintained within band of operation.



## 5.7 Contention-based Protocol

Unlicensed indoor low-power devices must detect co-channel radio frequency power that is at least -62 dBm (The threshold is referenced to a 0 dBi antenna gain.) or lower. Additionally, indoor low-power devices must detect co-channel energy with 90% or greater certainty.

## 5.8 AC Power Conducted Emissions

Frequency (MHz)	Conducted Limit (dBuV)	
	Quasi-peak	Average
0.15 - 0.5	66 - 56	56 - 46
0.50 - 5.0	56	46
5.0 - 30.0	60	50

Notes:

1. The lower limit shall apply at the transition frequencies.
2. The limit decreases in line with the logarithm of the frequency in the range of 0.15 to 0.50 MHz.

## 5.9 Unwanted Emissions below 1 GHz

Radiated emissions which fall in the restricted bands must comply with the radiated emission limits specified as below table.

Frequencies (MHz)	Field Strength (microvolts/meter)	Measurement Distance (meters)
0.009 ~ 0.490	2400/F(kHz)	300
0.490 ~ 1.705	24000/F(kHz)	30
1.705 ~ 30.0	30	30
30 ~ 88	100	3
88 ~ 216	150	3
216 ~ 960	200	3
Above 960	500	3

Notes:

1. The lower limit shall apply at the transition frequencies.
2. Emission level (dBuV/m) = 20 log Emission level (uV/m).

## 5.10 Unwanted Emissions above 1 GHz

Radiated emissions which fall in the restricted bands must comply with the radiated emission limits specified as below table.

Frequencies (MHz)	Field Strength (microvolts/meter)	Measurement Distance (meters)
Above 960	500	3

Notes:

1. The lower limit shall apply at the transition frequencies.
2. Emission level (dBuV/m) = 20 log Emission level (uV/m).
3. For frequencies above 1000 MHz, the field strength limits are based on average detector, however, the peak field strength of any emission shall not exceed the maximum permitted average limits, specified above by more than 20 dB under any condition of modulation.

Limits of unwanted emission out of the restricted bands

Frequencies (MHz)	EIRP Limit	Equivalent Field Strength at 3 m
5925 MHz > F > 7125 MHz	Peak: -7 (dBm/MHz)	88.2 (dBuV/m)
	Average: -27 (dBm/MHz)	68.2 (dBuV/m)

Note: The following formula is used to convert the equipment isotropic radiated power (eirp) to field strength:

$$E = \frac{1000000}{3} \sqrt{30 P} \quad \mu\text{V/m, where } P \text{ is the eirp (Watts).}$$

## 6 Test Arrangements

### 6.1 RF Output Power

#### 6.1.1 Test Setup

Radiated Measurement Method

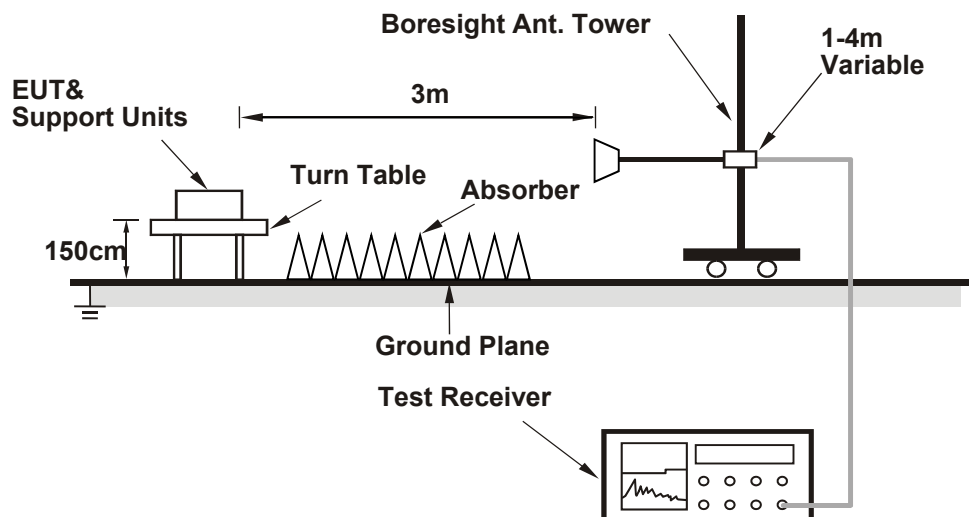

#### 6.1.2 Test Procedure

Radiated Measurement Method

- The EUT was placed on the top of a rotating table 1.5 meters above the ground at 3 meter chamber room for test. The table was rotated 360 degrees to determine the position of the highest radiation.
- The EUT was set 3 meters away from the interference-receiving antenna, which was mounted on the top of a variable-height antenna tower.
- The height of antenna is varied from one meter to four meters above the ground to determine the maximum value of the field strength. Both horizontal and vertical polarizations of the antenna are set to make the measurement.
- Perform a field strength measurement and record the worse read value, is the field strength value via a spectrum reading obtained corrected for antenna factor, cable loss and pre-amplifier factor and then mathematically convert the measured field strength level to EIRP level.
- Follow ANSI C63.10 section 12.7.3,  $EIRP \text{ Value (dBm)} = \text{Field Strength Value (dBuV/m)} + \text{Correction Factor @ 3 m}$ .
- $\text{Correction Factor (dB) @ 3 m} = 20\log(D) - 104.77$ ; where D is the measurement distance @3 m = -95.23 dB

Spectrum analyzer setting as below:

Method SA-1

- Set span to encompass the entire emission bandwidth (EBW) of the signal.
- Set RBW = 1 MHz, Set VBW  $\geq$  3 MHz, Detector = RMS
- Sweep points  $\geq [2 \times \text{span} / \text{RBW}]$ . (This gives bin-to-bin spacing  $\leq \text{RBW} / 2$ , so that narrowband signals are not lost between frequency bins.)
- Sweep time = auto, trigger set to "free run".
- Trace average at least 100 traces in power averaging mode.
- Record the max value

## 6.2 Power Spectral Density

### 6.2.1 Test Setup

#### Radiated Measurement Method

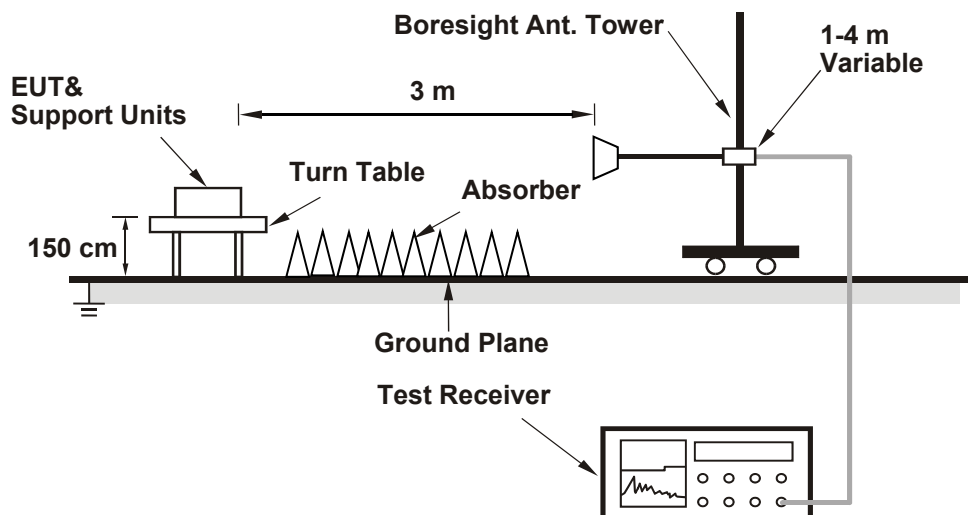

### 6.2.2 Test Procedure

#### Radiated Measurement Method

- The EUT was placed on the top of a rotating table 1.5 meters above the ground at 3 meter chamber room for test. The table was rotated 360 degrees to determine the position of the highest radiation.
- The EUT was set 3 meters away from the interference-receiving antenna, which was mounted on the top of a variable-height antenna tower.
- The height of antenna is varied from one meter to four meters above the ground to determine the maximum value of the field strength. Both horizontal and vertical polarizations of the antenna are set to make the measurement.
- Perform a field strength measurement and record the worse read value, is the field strength value via a spectrum reading obtained corrected for antenna factor, cable loss and pre-amplifier factor and then mathematically convert the measured field strength level to EIRP level.
- Follow ANSI C63.10 section 12.7.3,  $EIRP \text{ Value (dBm)} = \text{Field Strength Value (dBuV/m)} + \text{Correction Factor @ 3 m}$ .
- $\text{Correction Factor (dB) @ 3 m} = 20\log(D) - 104.77$ ; where D is the measurement distance @3 m = -95.23 dB

Spectrum analyzer setting as below:

#### Method SA-1

- Set span to encompass the entire emission bandwidth (EBW) of the signal.
- Set RBW = 1 MHz, Set VBW  $\geq$  3 MHz, Detector = RMS
- Sweep points  $\geq [2 \times \text{span} / \text{RBW}]$ . (This gives bin-to-bin spacing  $\leq$  RBW / 2, so that narrowband signals are not lost between frequency bins.)
- Sweep time = auto, trigger set to "free run".
- Trace average at least 100 traces in power averaging mode.
- Record the max value

## 6.3 Emission Bandwidth

### 6.3.1 Test Setup

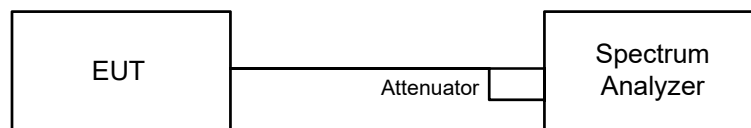

### 6.3.2 Test Procedure

- Set RBW = approximately 1% of the emission bandwidth.
- Set the VBW > RBW.
- Detector = Peak.
- Trace mode = max hold.
- Measure the maximum width of the emission that is 26 dB down from the peak of the emission. Compare this with the RBW setting of the analyzer. Readjust RBW and repeat measurement as needed until the RBW/EBW ratio is approximately 1%.

## 6.4 In-Band Emission Mask

### 6.4.1 Test Setup

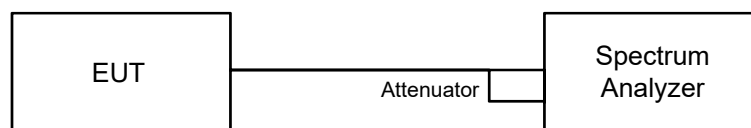

### 6.4.2 Test Procedure

- Connect output of the antenna port to a spectrum analyzer and adjust appropriate attenuation.
- Measure the 26 dB EBW using the test procedure 12.4.1 of ANSI C63.10-2013. (Determine the channel edge.)
- Measure the power spectral density (for emissions mask reference) using the following procedure:
  - Set the span to encompass the entire 26 dB EBW of the signal.
  - Set RBW = same RBW used for 26 dB EBW measurement.
  - Set VBW  $\geq [3 \times \text{RBW}]$ .
  - Number of points in sweep  $\geq [2 \times \text{span} / \text{RBW}]$ .
  - Sweep time = auto.
  - Detector = RMS (i.e., power averaging).
  - Trace average at least 100 traces in power averaging (rms) mode.
  - Use the peak search function on the instrument to find the peak of the spectrum.
- Using the measuring equipment limit line function, develop the emissions mask based on the following requirements. The emissions power spectral density must be reduced below the peak power spectral density (in dB) as follows:
  - Suppressed by 20 dB at 1 MHz outside of the channel edge. (The channel edge is defined as the 26-dB point on either side of the carrier center frequency.)
  - Suppressed by 28 dB at one channel bandwidth from the channel center.
  - Suppressed by 40 dB at one- and one-half times the channel bandwidth from the channel center.
- Adjust the span to encompass the entire mask as necessary and clear trace.
- Trace average at least 100 traces in power averaging (rms) mode.
- Adjust the reference level as necessary so that the crest of the channel touches the top of the emission mask

## 6.5 Occupied Bandwidth

### 6.5.1 Test Setup

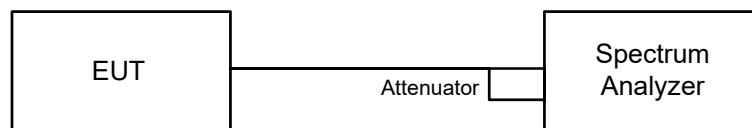

### 6.5.2 Test Procedure

The transmitter output was connected to the spectrum analyzer through an attenuator. The bandwidth of the fundamental frequency was measured by spectrum analyzer with resolution bandwidth in the range of 1% to 5% of the anticipated emission bandwidth, and a video bandwidth at least 3x the resolution bandwidth and set the detector to Sampling. The width of a frequency band such that, below the lower and above the upper frequency limits, the mean powers emitted are each equal to a specified percentage 0.5% of the total mean power of a given emission.

## 6.6 Frequency Stability

### 6.6.1 Test Setup

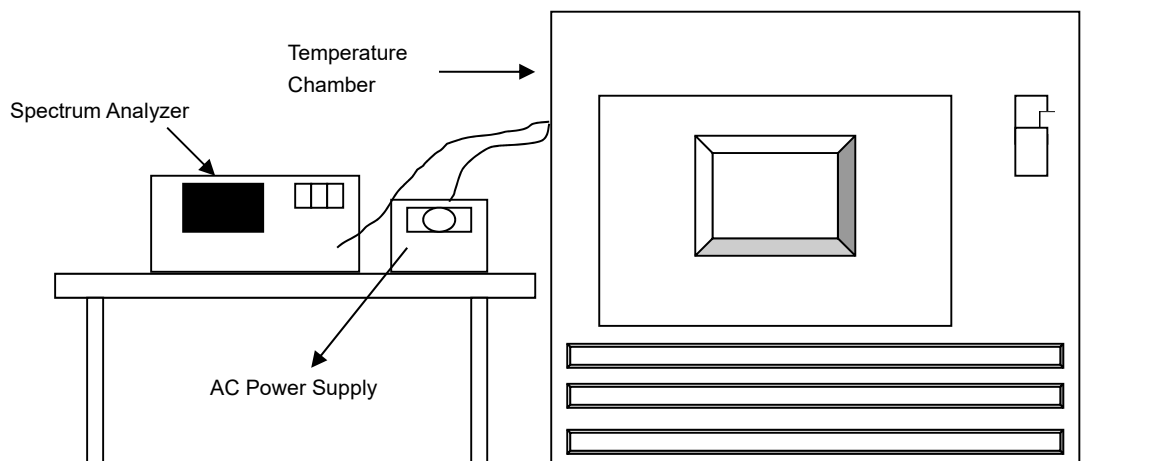

### 6.6.2 Test Procedure

- The EUT was placed inside the environmental test chamber and powered by nominal AC voltage.
- Turn the EUT on and couple its output to a spectrum analyzer.
- Turn the EUT off and set the chamber to the highest temperature specified.
- Allow sufficient time (approximately 30 min) for the temperature of the chamber to stabilize, turn the EUT on and measure the operating frequency after 2, 5, and 10 Minutes.
- Repeat step (d) with the temperature chamber set to the next desired temperature until measurements down to the lowest specified temperature have been completed.
- The test chamber was allowed to stabilize at +20 degree C for a minimum of 30 Minutes. The supply voltage was then adjusted on the EUT from 85% to 115% and the frequency record.

## 6.7 Contention-based Protocol

### 6.7.1 Test Setup

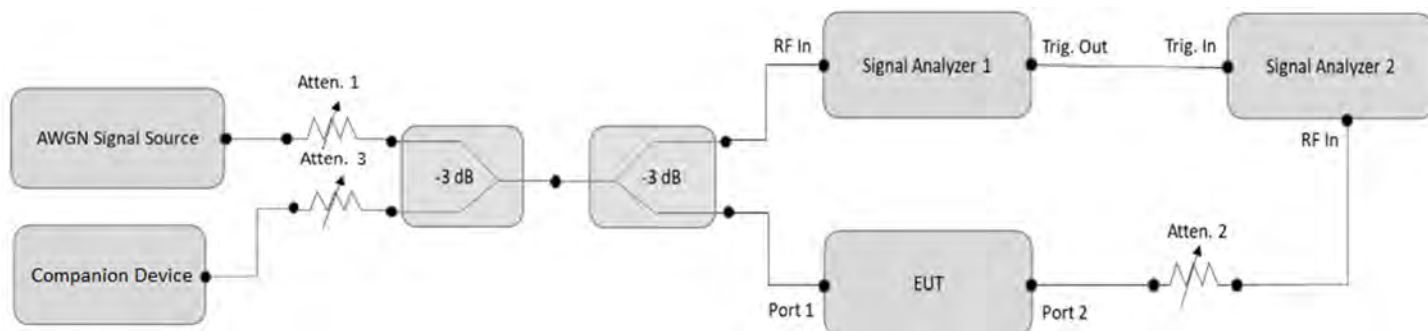

### 6.7.2 Test Procedure

- Set the signal analyzer center frequency to the nominal EUT channel center frequency. The span range of the signal analyzer shall be between two times and five times the OBW of the EUT. Connect the output port of the EUT to the signal analyzer 2. Ensure that the attenuator 2 provides enough attenuation to not overload the signal analyzer 2 receiver.
- Monitoring the signal analyzer 2, verify the EUT is operating and transmitting with the parameters (set as following section 4.7.5 EUT operating condition).
- Determine number of times detection threshold test as following table,

If	Number of Tests	Placement of Incumbent Transmission
$BW_{EUT} \leq BW_{Inc}$	Once	Same as EUT transmission
$BW_{Inc} < BW_{EUT} \leq 2x BW_{Inc}$	Once	Contained within $BW_{EUT}$
$2x BW_{Inc} < BW_{EUT} \leq 4x BW_{Inc}$	Twice. (Incumbent transmission is contained within $BW_{EUT}$ )	Closely to the lower edge and upper edge of the EUT Channel
$BW_{EUT} > 4x BW_{Inc}$	Three times	Closely to the lower edge, in the middle and upper edge of the EUT Channel

- Using an AWGN signal source, generate (but do not transmit, i.e., RF OFF) a 10 MHz-wide AWGN signal. Use step c table to determine the center frequency of the 10 MHz AWGN signal relative to the EUT's channel bandwidth and center frequency.
- Set the AWGN signal power to an extremely low level (more than 20 dB below the -62 dBm threshold). Connect the AWGN signal source, via a 3-dB splitter, to the signal analyzer 1 and the EUT.
- Transmit the AWGN signal (RF ON) and verify its characteristics on the signal analyzer 1.
- Monitor the signal analyzer 2 to verify if the AWGN signal has been detected and the EUT has ceased transmission. If the EUT continues to transmit, then incrementally increase the AWGN signal power level until the EUT stops transmitting.
- (Including all losses in the RF paths) Determine and record the AWGN signal power level (at the EUT's antenna port) at which the EUT ceased transmission. Repeat the procedure at least 10 times to verify the EUT can detect an AWGN signal with 90% (or better) level of certainty.
- Refer to step c table to determine number of times the detection threshold testing needs to be repeated. If testing is required more than once, then go back to step d, choose a different center frequency for the AWGN signal and repeat the process.

## 6.8 AC Power Conducted Emissions

### 6.8.1 Test Setup

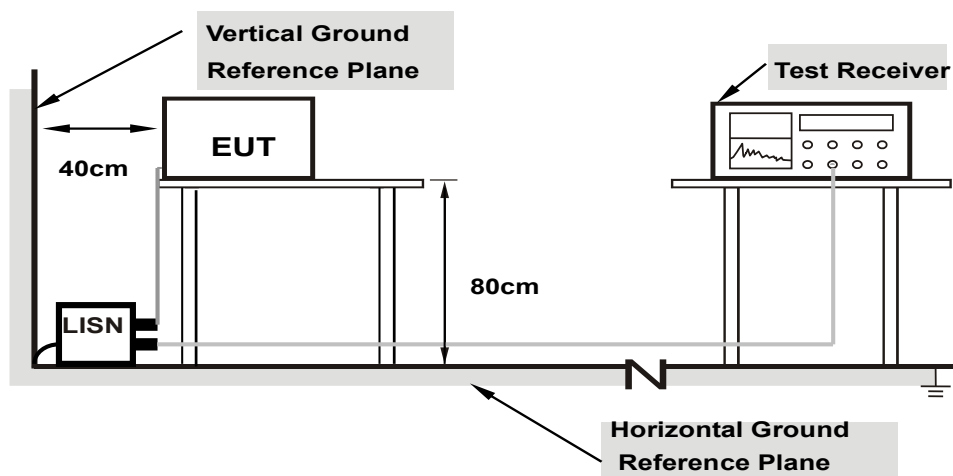

**Note: 1.Support units were connected to second LISN.**

For the actual test configuration, please refer to the attached file (Test Setup Photo).

### 6.8.2 Test Procedure

- The EUT was placed on a 0.8 meter to the top of table and placed 0.4 meters from the conducting wall of the shielded room with EUT being connected to the power mains through a line impedance stabilization network (LISN). Other support units were connected to the power mains through another LISN. The two LISNs provide 50 ohm/ 50 uH of coupling impedance for the measuring instrument.
- Both lines of the power mains connected to the EUT were checked for maximum conducted interference.
- The frequency range from 150 kHz to 30 MHz was searched. Emission levels under (Limit – 20 dB) was not recorded.

Note: The resolution bandwidth and video bandwidth of test receiver is 9 kHz for quasi-peak detection (QP) and average detection (AV) at frequency 0.15 MHz-30 MHz.



## 6.9 Unwanted Emissions below 1 GHz

### 6.9.1 Test Setup

#### For Radiated emission below 30 MHz

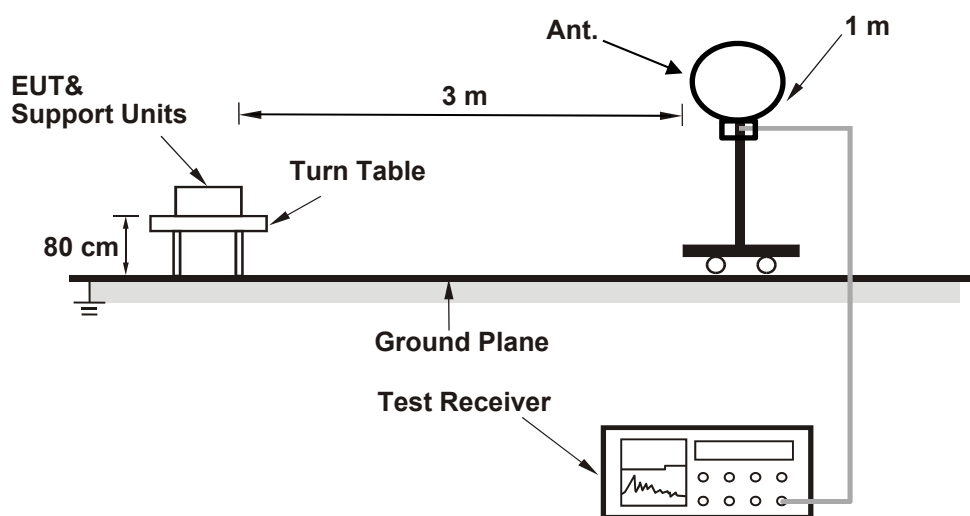

#### For Radiated emission above 30 MHz

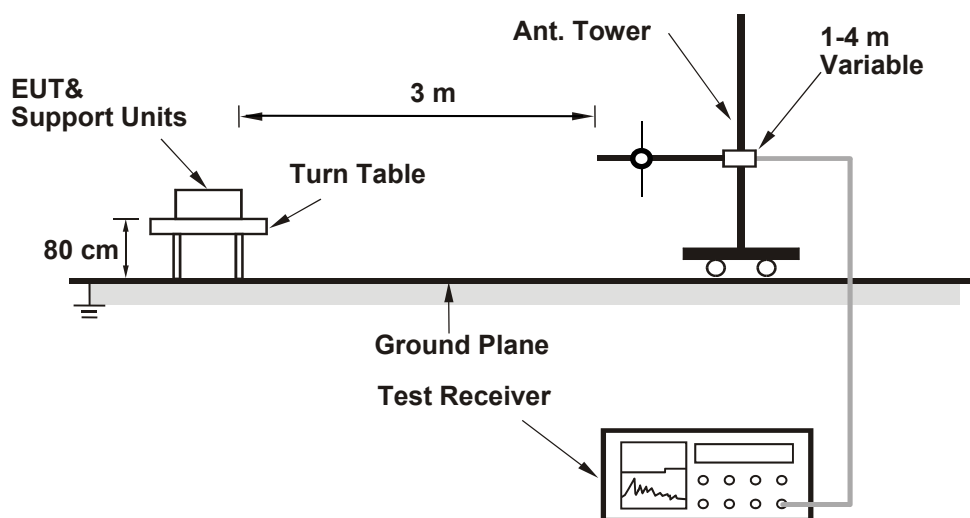

For the actual test configuration, please refer to the attached file (Test Setup Photo).

## 6.9.2 Test Procedure

### For Radiated emission below 30 MHz

- a. The EUT was placed on the top of a rotating table 0.8 meters above the ground at 3 meter chamber room for test. The table was rotated 360 degrees to determine the position of the highest radiation.
- b. The EUT was set 3 meters away from the interference-receiving antenna, which was mounted on the top of a variable-height antenna tower.
- c. Parallel, perpendicular, and ground-parallel orientations of the antenna are set to make the measurement.
- d. For each suspected emission, the EUT was arranged to its worst case and the rotatable table was turned from 0 degrees to 360 degrees to find the maximum reading.
- e. The test-receiver system was set to Quasi-Peak Detect Function and Specified Bandwidth with Maximum Hold Mode, except for the frequency band (9 kHz to 90 kHz and 110 kHz to 490 kHz) set to average detect function and peak detect function.

#### Notes:

1. The resolution bandwidth and video bandwidth of test receiver/spectrum analyzer is 200 Hz at frequency below 150 kHz.
2. The resolution bandwidth and video bandwidth of test receiver/spectrum analyzer is 9 kHz or 10 kHz at frequency (150 kHz to 30 MHz).
3. All modes of operation were investigated and the worst-case emissions are reported.

### For Radiated emission above 30 MHz

- a. The EUT was placed on the top of a rotating table 0.8 meters above the ground at 3 meter chamber room for test. The table was rotated 360 degrees to determine the position of the highest radiation.
- b. The EUT was set 3 meters away from the interference-receiving antenna, which was mounted on the top of a variable-height antenna tower.
- c. The height of antenna is varied from one meter to four meters above the ground to determine the maximum value of the field strength. Both horizontal and vertical polarizations of the antenna are set to make the measurement.
- d. For each suspected emission, the EUT was arranged to its worst case and then the antenna was tuned to heights from 1 meter to 4 meters and the rotatable table was turned from 0 degrees to 360 degrees to find the maximum reading.
- e. The test-receiver system was set to Quasi-peak(QP) detect function, Average(AV) detect function, Peak(PK) detect function and specified bandwidth with maximum hold mode when the test frequency is below 1 GHz.

#### Notes:

1. The resolution bandwidth and video bandwidth of test receiver/spectrum analyzer is 120 kHz for Quasi-peak detection (QP), Average detection (AV), Peak detection (PK) at frequency (30MHz to 1 GHz).
2. All modes of operation were investigated and the worst-case emissions are reported.

## 6.10 Unwanted Emissions above 1 GHz

### 6.10.1 Test Setup

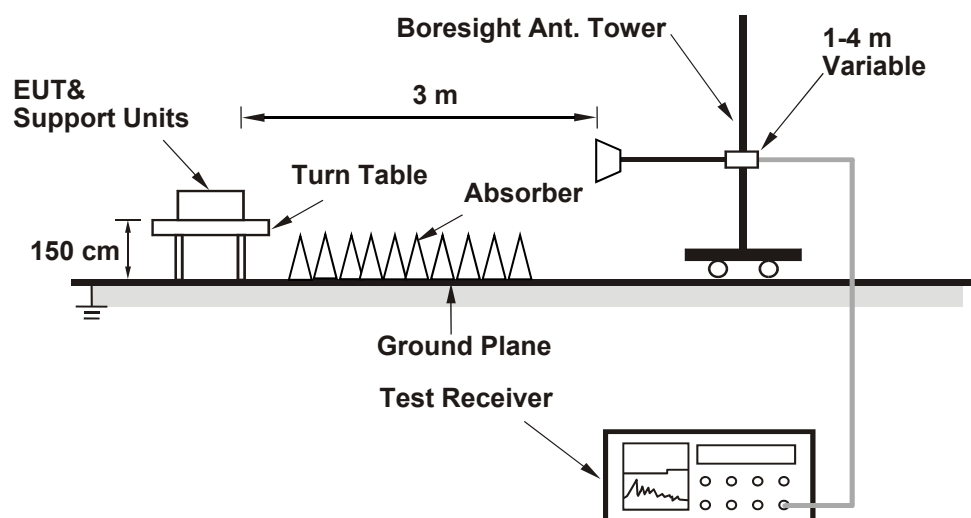

For the actual test configuration, please refer to the attached file (Test Setup Photo).

### 6.10.2 Test Procedure

- The EUT was placed on the top of a rotating table 1.5 meters above the ground at 3 meter chamber room for test. The table was rotated 360 degrees to determine the position of the highest radiation.
- The EUT was set 3 meters away from the interference-receiving antenna, which was mounted on the top of a variable-height antenna tower.
- The height of antenna is varied from one meter to four meters above the ground to determine the maximum value of the field strength. Both horizontal and vertical polarizations of the antenna are set to make the measurement.
- For each suspected emission, the EUT was arranged to its worst case and then the antenna was tuned to heights from 1 meter to 4 meters and the rotatable table was turned from 0 degrees to 360 degrees to find the maximum reading.
- The test-receiver system was set to peak and average detects function and specified bandwidth with maximum hold mode when the test frequency is above 1 GHz. If the peak reading value also meets average limit, measurement with the average detector is unnecessary.

#### Notes:

- The resolution bandwidth of test receiver/spectrum analyzer is 1 MHz and the video bandwidth is 3 MHz for Peak detection (PK) and Average detection (AV) at frequency above 1 GHz.
- For fundamental and harmonic signal measurement, the resolution bandwidth of test receiver/spectrum analyzer is 1 MHz and the video bandwidth is  $\geq 1/T$  (Duty cycle  $< 98\%$ ) or 10 Hz (Duty cycle  $\geq 98\%$ ) for Average detection (AV) at frequency above 1 GHz.
- All modes of operation were investigated and the worst-case emissions are reported.

## 7 Test Results of Test Item

### 7.1 RF Output Power

Input Power:	120 Vac, 60 Hz	Environmental Conditions:	25°C, 60% RH	Tested By:	Alan Wu
--------------	----------------	---------------------------	--------------	------------	---------

#### 802.11a

Chan.	Chan. Freq. (MHz)	Field Strength (dBuV/m)	Correction Factor (dB)	EIRP (mW)	EIRP (dBm)	EIRP Limit (dBm)	Test Result
33	6115	110.12	-95.23	30.832	14.89	30	Pass
61	6255	109.82	-95.23	28.774	14.59	30	Pass
93	6415	109.80	-95.23	28.642	14.57	30	Pass
97	6435	109.85	-95.23	28.973	14.62	30	Pass
105	6475	109.92	-95.23	29.444	14.69	30	Pass
113	6515	109.91	-95.23	29.376	14.68	30	Pass
117	6535	109.75	-95.23	28.314	14.52	30	Pass
149	6695	110.04	-95.23	30.269	14.81	30	Pass
181	6855	109.74	-95.23	28.249	14.51	30	Pass
185	6875	110.11	-95.23	30.761	14.88	30	Pass
209	6995	109.82	-95.23	28.774	14.59	30	Pass
229	7095	110.12	-95.23	30.832	14.89	30	Pass
233	7115	109.98	-95.23	29.854	14.75	30	Pass

Spectrum Plot of Maximum Value

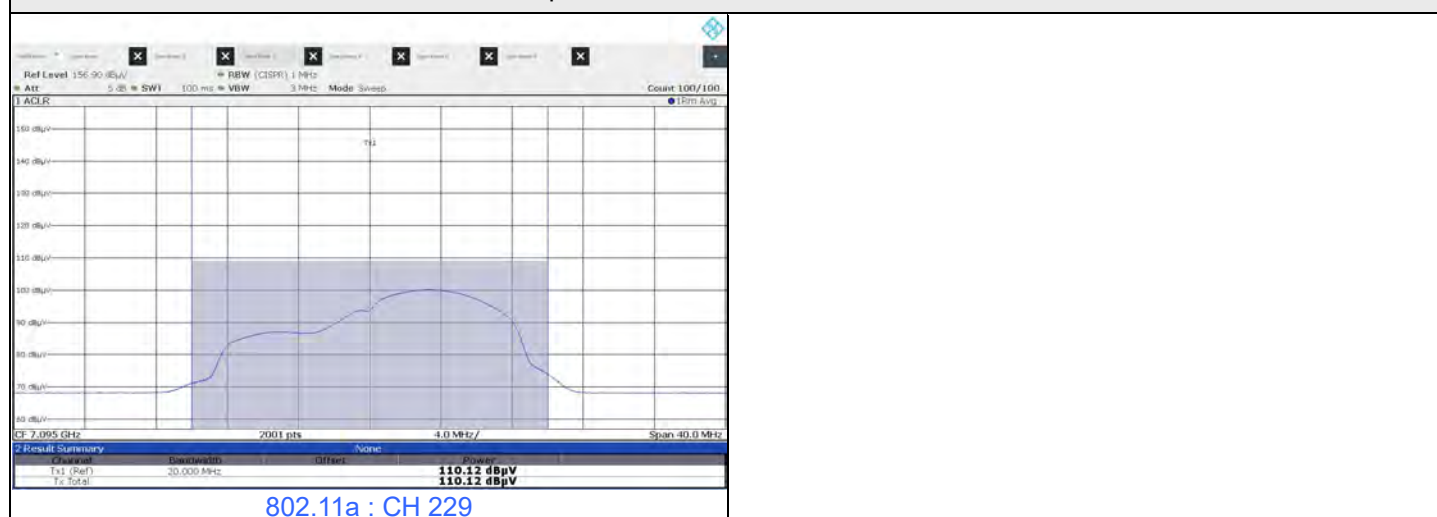

## Beamforming (4T1S)

### 802.11be (EHT20) Beamforming

Chan.	Chan. Freq. (MHz)	Field Strength (dBuV/m)	Correction Factor (dB)	EIRP (mW)	EIRP (dBm)	EIRP Limit (dBm)	Test Result
33	6115	114.49	-95.23	84.333	19.26	30	Pass
61	6255	114.39	-95.23	82.414	19.16	30	Pass
93	6415	114.68	-95.23	88.105	19.45	30	Pass
97	6435	114.35	-95.23	81.658	19.12	30	Pass
105	6475	114.71	-95.23	88.716	19.48	30	Pass
113	6515	114.43	-95.23	83.176	19.20	30	Pass
117	6535	114.69	-95.23	88.308	19.46	30	Pass
149	6695	114.61	-95.23	86.696	19.38	30	Pass
181	6855	114.56	-95.23	85.704	19.33	30	Pass
185	6875	114.51	-95.23	84.723	19.28	30	Pass
209	6995	114.50	-95.23	84.528	19.27	30	Pass
229	7095	114.36	-95.23	81.846	19.13	30	Pass
233	7115	104.07	-95.23	7.656	8.84	30	Pass

### 802.11be (EHT40) Beamforming

Chan.	Chan. Freq. (MHz)	Field Strength (dBuV/m)	Correction Factor (dB)	EIRP (mW)	EIRP (dBm)	EIRP Limit (dBm)	Test Result
35	6125	118.08	-95.23	192.752	22.85	30	Pass
59	6245	117.68	-95.23	175.792	22.45	30	Pass
91	6405	117.95	-95.23	187.068	22.72	30	Pass
99	6445	118.05	-95.23	191.426	22.82	30	Pass
107	6485	118.00	-95.23	189.234	22.77	30	Pass
115	6525	117.80	-95.23	180.717	22.57	30	Pass
123	6565	118.11	-95.23	194.089	22.88	30	Pass
155	6725	117.81	-95.23	181.134	22.58	30	Pass
179	6845	117.67	-95.23	175.388	22.44	30	Pass
187	6885	117.96	-95.23	187.499	22.73	30	Pass
211	7005	117.98	-95.23	188.365	22.75	30	Pass
227	7085	117.99	-95.23	188.799	22.76	30	Pass

### 802.11be (EHT80) Beamforming

Chan.	Chan. Freq. (MHz)	Field Strength (dBuV/m)	Correction Factor (dB)	EIRP (mW)	EIRP (dBm)	EIRP Limit (dBm)	Test Result
39	6145	120.15	-95.23	310.456	24.92	30	Pass
55	6225	120.34	-95.23	324.34	25.11	30	Pass
87	6385	120.32	-95.23	322.849	25.09	30	Pass
103	6465	120.03	-95.23	301.995	24.80	30	Pass
119	6545	120.13	-95.23	309.03	24.90	30	Pass
135	6625	120.45	-95.23	332.66	25.22	30	Pass
151	6705	120.32	-95.23	322.849	25.09	30	Pass
167	6785	120.37	-95.23	326.588	25.14	30	Pass
183	6865	120.36	-95.23	325.837	25.13	30	Pass
199	6945	120.26	-95.23	318.42	25.03	30	Pass
215	7025	120.33	-95.23	323.594	25.10	30	Pass

### 802.11be (EHT160) Beamforming

Chan.	Chan. Freq. (MHz)	Field Strength (dBuV/m)	Correction Factor (dB)	EIRP (mW)	EIRP (dBm)	EIRP Limit (dBm)	Test Result
47	6185	123.46	-95.23	665.273	28.23	30	Pass
79	6345	123.68	-95.23	699.842	28.45	30	Pass
111	6505	123.50	-95.23	671.429	28.27	30	Pass
143	6665	123.75	-95.23	711.214	28.52	30	Pass
175	6825	123.36	-95.23	650.13	28.13	30	Pass
207	6985	123.36	-95.23	650.13	28.13	30	Pass

### 802.11be (EHT320) Beamforming

Chan.	Chan. Freq. (MHz)	Field Strength (dBuV/m)	Correction Factor (dB)	EIRP (mW)	EIRP (dBm)	EIRP Limit (dBm)	Test Result
63	6265	125.01	-95.23	950.605	29.78	30	Pass
95	6425	124.88	-95.23	922.571	29.65	30	Pass
127	6585	124.93	-95.23	933.254	29.70	30	Pass
159	6745	124.76	-95.23	897.429	29.53	30	Pass
191	6905	124.74	-95.23	893.305	29.51	30	Pass

### Spectrum Plot of Maximum Value

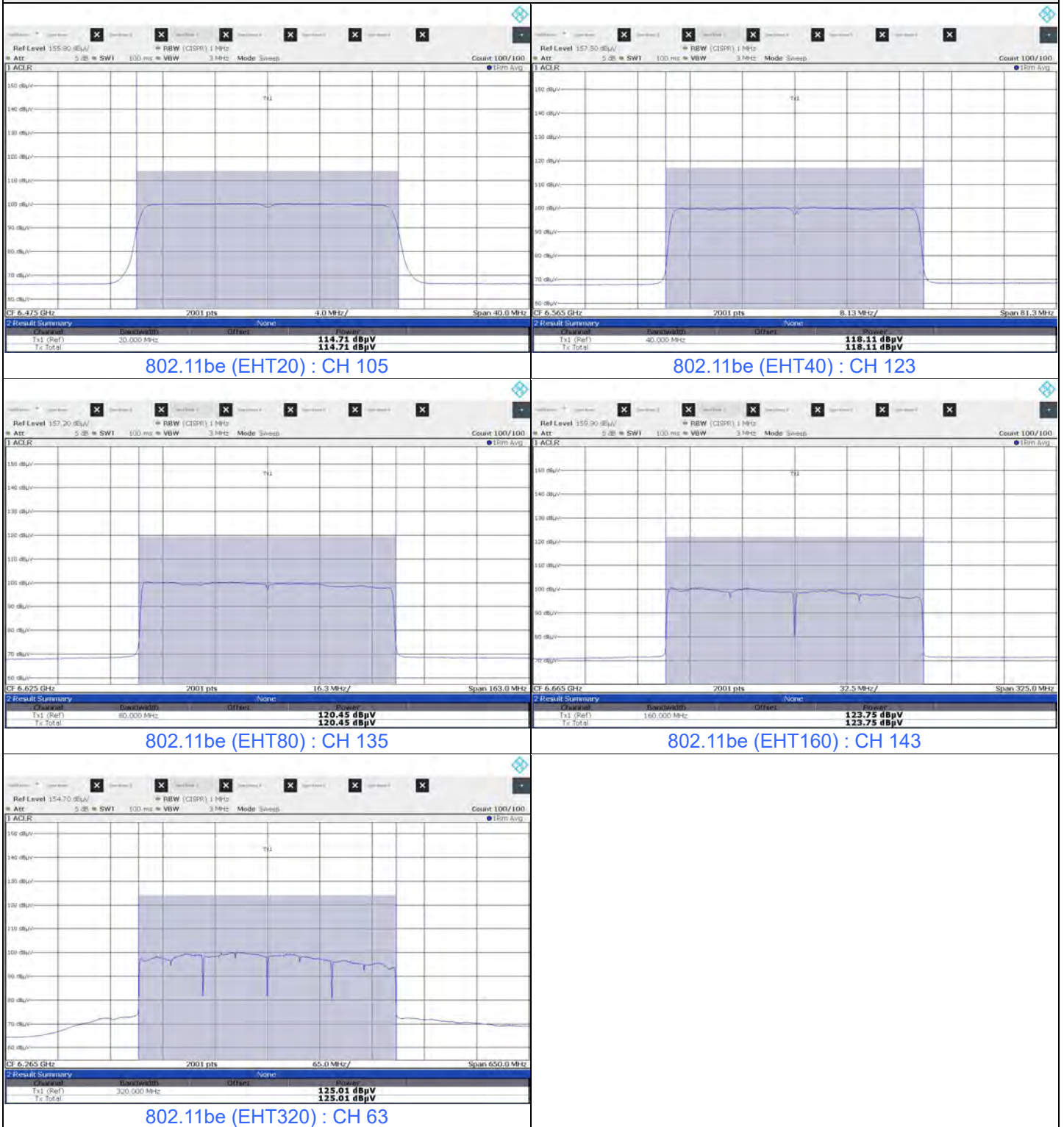

## Beamforming (4T4S)

### 802.11be (EHT20) Beamforming

Chan.	Chan. Freq. (MHz)	Field Strength (dBuV/m)	Correction Factor (dB)	EIRP (mW)	EIRP (dBm)	EIRP Limit (dBm)	Test Result
33	6115	114.40	-95.23	82.604	19.17	30	Pass
61	6255	114.33	-95.23	81.283	19.10	30	Pass
93	6415	114.62	-95.23	86.896	19.39	30	Pass
97	6435	114.28	-95.23	80.353	19.05	30	Pass
105	6475	114.64	-95.23	87.297	19.41	30	Pass
113	6515	114.35	-95.23	81.658	19.12	30	Pass
117	6535	114.63	-95.23	87.096	19.40	30	Pass
149	6695	114.58	-95.23	86.099	19.35	30	Pass
181	6855	114.55	-95.23	85.507	19.32	30	Pass
185	6875	114.43	-95.23	83.176	19.20	30	Pass
209	6995	114.41	-95.23	82.794	19.18	30	Pass
229	7095	114.27	-95.23	80.168	19.04	30	Pass
233	7115	99.08	-95.23	2.427	3.85	30	Pass

### 802.11be (EHT40) Beamforming

Chan.	Chan. Freq. (MHz)	Field Strength (dBuV/m)	Correction Factor (dB)	EIRP (mW)	EIRP (dBm)	EIRP Limit (dBm)	Test Result
35	6125	118.00	-95.23	189.234	22.77	30	Pass
59	6245	117.64	-95.23	174.181	22.41	30	Pass
91	6405	117.88	-95.23	184.077	22.65	30	Pass
99	6445	118.00	-95.23	189.234	22.77	30	Pass
107	6485	117.97	-95.23	187.932	22.74	30	Pass
115	6525	117.77	-95.23	179.473	22.54	30	Pass
123	6565	118.05	-95.23	191.426	22.82	30	Pass
155	6725	117.75	-95.23	178.649	22.52	30	Pass
179	6845	117.66	-95.23	174.985	22.43	30	Pass
187	6885	117.90	-95.23	184.927	22.67	30	Pass
211	7005	117.90	-95.23	184.927	22.67	30	Pass
227	7085	117.94	-95.23	186.638	22.71	30	Pass



### 802.11be (EHT80) Beamforming

Chan.	Chan. Freq. (MHz)	Field Strength (dBuV/m)	Correction Factor (dB)	EIRP (mW)	EIRP (dBm)	EIRP Limit (dBm)	Test Result
39	6145	120.10	-95.23	306.902	24.87	30	Pass
55	6225	120.27	-95.23	319.154	25.04	30	Pass
87	6385	120.26	-95.23	318.42	25.03	30	Pass
103	6465	120.00	-95.23	299.916	24.77	30	Pass
119	6545	120.04	-95.23	302.691	24.81	30	Pass
135	6625	120.40	-95.23	328.852	25.17	30	Pass
151	6705	120.30	-95.23	321.366	25.07	30	Pass
167	6785	120.33	-95.23	323.594	25.10	30	Pass
183	6865	120.34	-95.23	324.34	25.11	30	Pass
199	6945	120.24	-95.23	316.957	25.01	30	Pass
215	7025	120.24	-95.23	316.957	25.01	30	Pass

### 802.11be (EHT160) Beamforming

Chan.	Chan. Freq. (MHz)	Field Strength (dBuV/m)	Correction Factor (dB)	EIRP (mW)	EIRP (dBm)	EIRP Limit (dBm)	Test Result
47	6185	123.41	-95.23	657.658	28.18	30	Pass
79	6345	123.66	-95.23	696.627	28.43	30	Pass
111	6505	123.48	-95.23	668.344	28.25	30	Pass
143	6665	123.71	-95.23	704.693	28.48	30	Pass
175	6825	123.31	-95.23	642.688	28.08	30	Pass
207	6985	123.29	-95.23	639.735	28.06	30	Pass

### 802.11be (EHT320) Beamforming

Chan.	Chan. Freq. (MHz)	Field Strength (dBuV/m)	Correction Factor (dB)	EIRP (mW)	EIRP (dBm)	EIRP Limit (dBm)	Test Result
63	6265	125.03	-95.23	954.993	29.80	30	Pass
95	6425	124.96	-95.23	939.723	29.73	30	Pass
127	6585	124.94	-95.23	935.406	29.71	30	Pass
159	6745	124.83	-95.23	912.011	29.60	30	Pass
191	6905	124.83	-95.23	912.011	29.60	30	Pass



### Spectrum Plot of Maximum Value

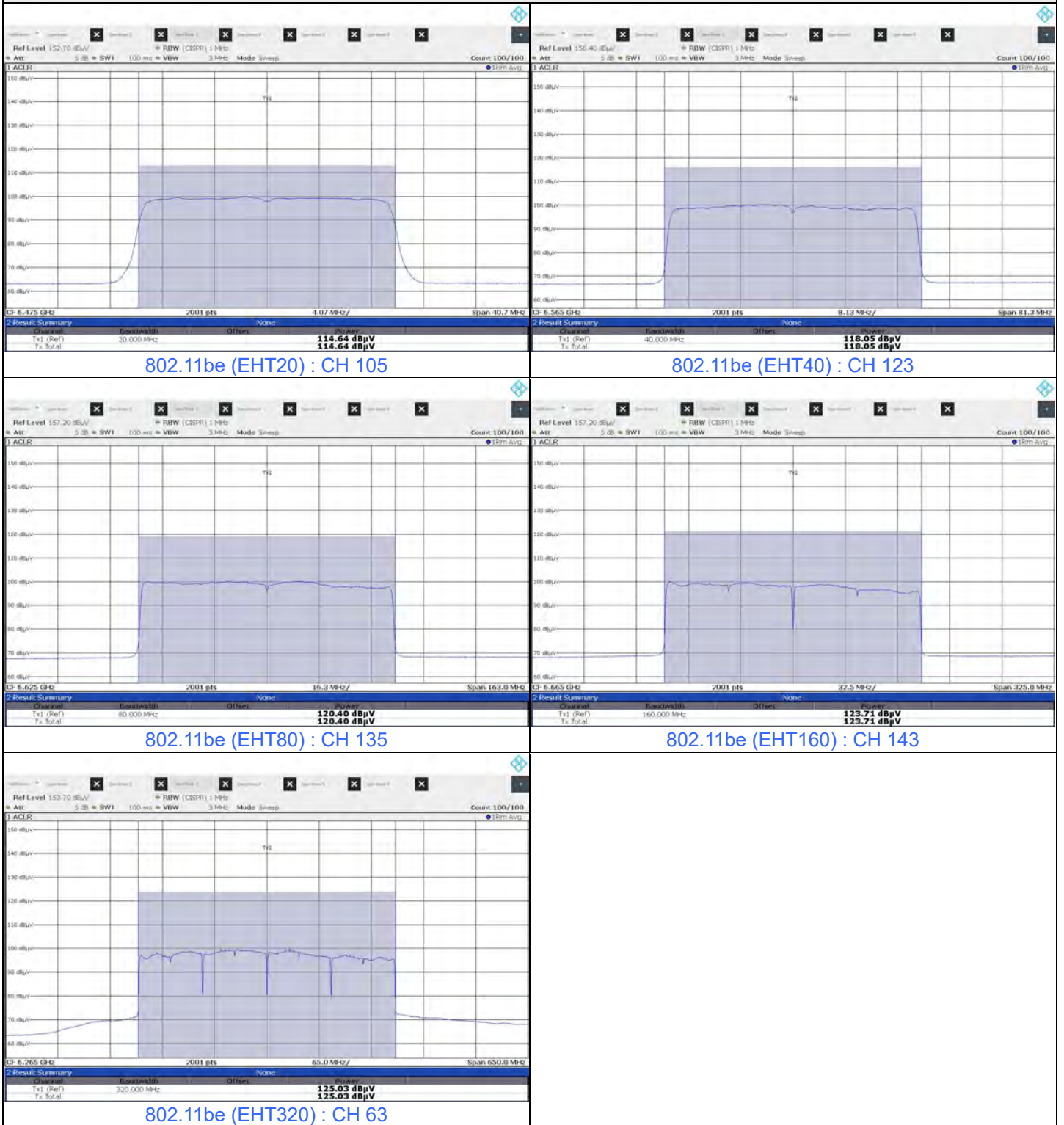

## 7.2 Power Spectral Density

Input Power:	120 Vac, 60 Hz	Environmental Conditions:	25°C, 60% RH	Tested By:	Alan Wu
--------------	----------------	---------------------------	--------------	------------	---------

### 802.11a

Chan.	Chan. Freq. (MHz)	Field Strength (dBuV/m)	Correction Factor (dB)	EIRP PSD (dBm/MHz)	EIRP PSD Limit (dBm/MHz)	Test Result
33	6115	100.16	-95.23	4.93	5	Pass
61	6255	100.18	-95.23	4.95	5	Pass
93	6415	100.20	-95.23	4.97	5	Pass
97	6435	100.17	-95.23	4.94	5	Pass
105	6475	100.15	-95.23	4.92	5	Pass
113	6515	100.19	-95.23	4.96	5	Pass
117	6535	100.18	-95.23	4.95	5	Pass
149	6695	100.19	-95.23	4.96	5	Pass
181	6855	100.15	-95.23	4.92	5	Pass
185	6875	100.16	-95.23	4.93	5	Pass
209	6995	100.19	-95.23	4.96	5	Pass
229	7095	100.21	-95.23	4.98	5	Pass
233	7115	100.02	-95.23	4.79	5	Pass

Spectrum Plot of Maximum Value

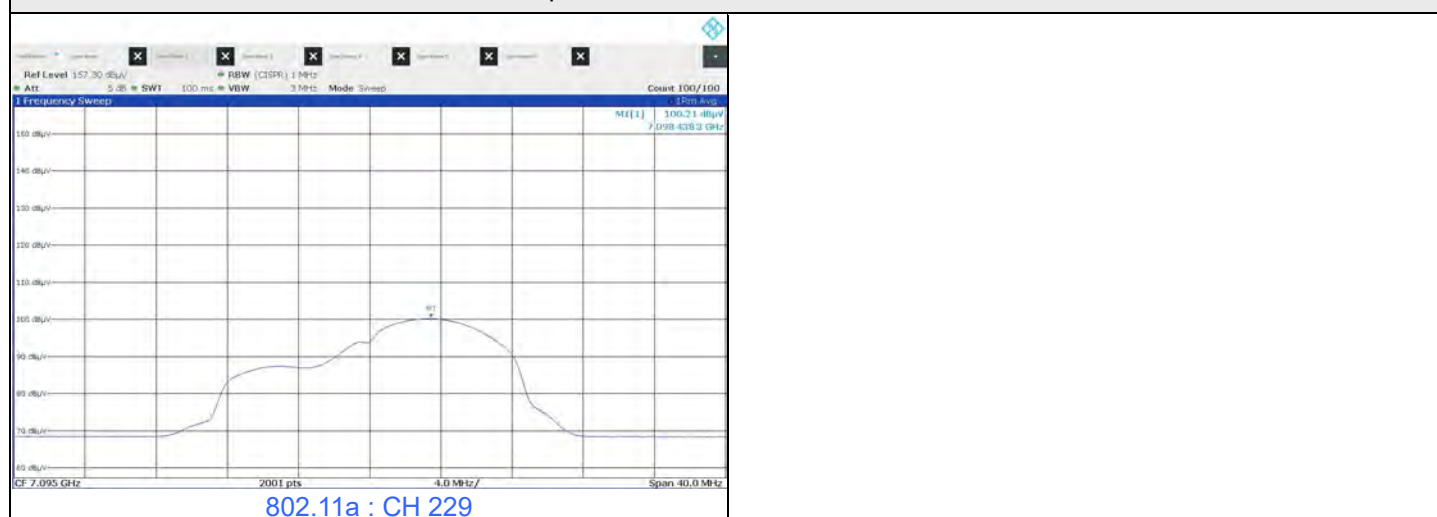

## Beamforming (4T1S)

### 802.11be (EHT20) Beamforming

Chan.	Chan. Freq. (MHz)	Field Strength (dBuV/m)	Correction Factor (dB)	EIRP PSD (dBm/MHz)	EIRP PSD Limit (dBm/MHz)	Test Result
33	6115	100.17	-95.23	4.94	5	Pass
61	6255	100.16	-95.23	4.93	5	Pass
93	6415	100.20	-95.23	4.97	5	Pass
97	6435	100.13	-95.23	4.90	5	Pass
105	6475	100.21	-95.23	4.98	5	Pass
113	6515	100.19	-95.23	4.96	5	Pass
117	6535	100.15	-95.23	4.92	5	Pass
149	6695	100.18	-95.23	4.95	5	Pass
181	6855	100.16	-95.23	4.93	5	Pass
185	6875	100.18	-95.23	4.95	5	Pass
209	6995	100.18	-95.23	4.95	5	Pass
229	7095	100.09	-95.23	4.86	5	Pass
233	7115	88.78	-95.23	-6.45	5	Pass

### 802.11be (EHT40) Beamforming

Chan.	Chan. Freq. (MHz)	Field Strength (dBuV/m)	Correction Factor (dB)	EIRP PSD (dBm/MHz)	EIRP PSD Limit (dBm/MHz)	Test Result
35	6125	100.18	-95.23	4.95	5	Pass
59	6245	100.18	-95.23	4.95	5	Pass
91	6405	100.19	-95.23	4.96	5	Pass
99	6445	100.15	-95.23	4.92	5	Pass
107	6485	100.19	-95.23	4.96	5	Pass
115	6525	100.14	-95.23	4.91	5	Pass
123	6565	100.20	-95.23	4.97	5	Pass
155	6725	100.14	-95.23	4.91	5	Pass
179	6845	100.17	-95.23	4.94	5	Pass
187	6885	100.15	-95.23	4.92	5	Pass
211	7005	100.19	-95.23	4.96	5	Pass
227	7085	100.16	-95.23	4.93	5	Pass

### 802.11be (EHT80) Beamforming

Chan.	Chan. Freq. (MHz)	Field Strength (dBuV/m)	Correction Factor (dB)	EIRP PSD (dBm/MHz)	EIRP PSD Limit (dBm/MHz)	Test Result
39	6145	100.18	-95.23	4.95	5	Pass
55	6225	100.15	-95.23	4.92	5	Pass
87	6385	100.14	-95.23	4.91	5	Pass
103	6465	100.17	-95.23	4.94	5	Pass
119	6545	100.19	-95.23	4.96	5	Pass
135	6625	100.20	-95.23	4.97	5	Pass
151	6705	100.20	-95.23	4.97	5	Pass
167	6785	100.16	-95.23	4.93	5	Pass
183	6865	100.19	-95.23	4.96	5	Pass
199	6945	100.17	-95.23	4.94	5	Pass
215	7025	100.19	-95.23	4.96	5	Pass

### 802.11be (EHT160) Beamforming

Chan.	Chan. Freq. (MHz)	Field Strength (dBuV/m)	Correction Factor (dB)	EIRP PSD (dBm/MHz)	EIRP PSD Limit (dBm/MHz)	Test Result
47	6185	100.15	-95.23	4.92	5	Pass
79	6345	100.19	-95.23	4.96	5	Pass
111	6505	100.19	-95.23	4.96	5	Pass
143	6665	100.20	-95.23	4.97	5	Pass
175	6825	100.18	-95.23	4.95	5	Pass
207	6985	100.14	-95.23	4.91	5	Pass

### 802.11be (EHT320) Beamforming

Chan.	Chan. Freq. (MHz)	Field Strength (dBuV/m)	Correction Factor (dB)	EIRP PSD (dBm/MHz)	EIRP PSD Limit (dBm/MHz)	Test Result
63	6265	100.20	-95.23	4.97	5	Pass
95	6425	100.16	-95.23	4.93	5	Pass
127	6585	100.17	-95.23	4.94	5	Pass
159	6745	100.20	-95.23	4.97	5	Pass
191	6905	100.18	-95.23	4.95	5	Pass

### Spectrum Plot of Maximum Value

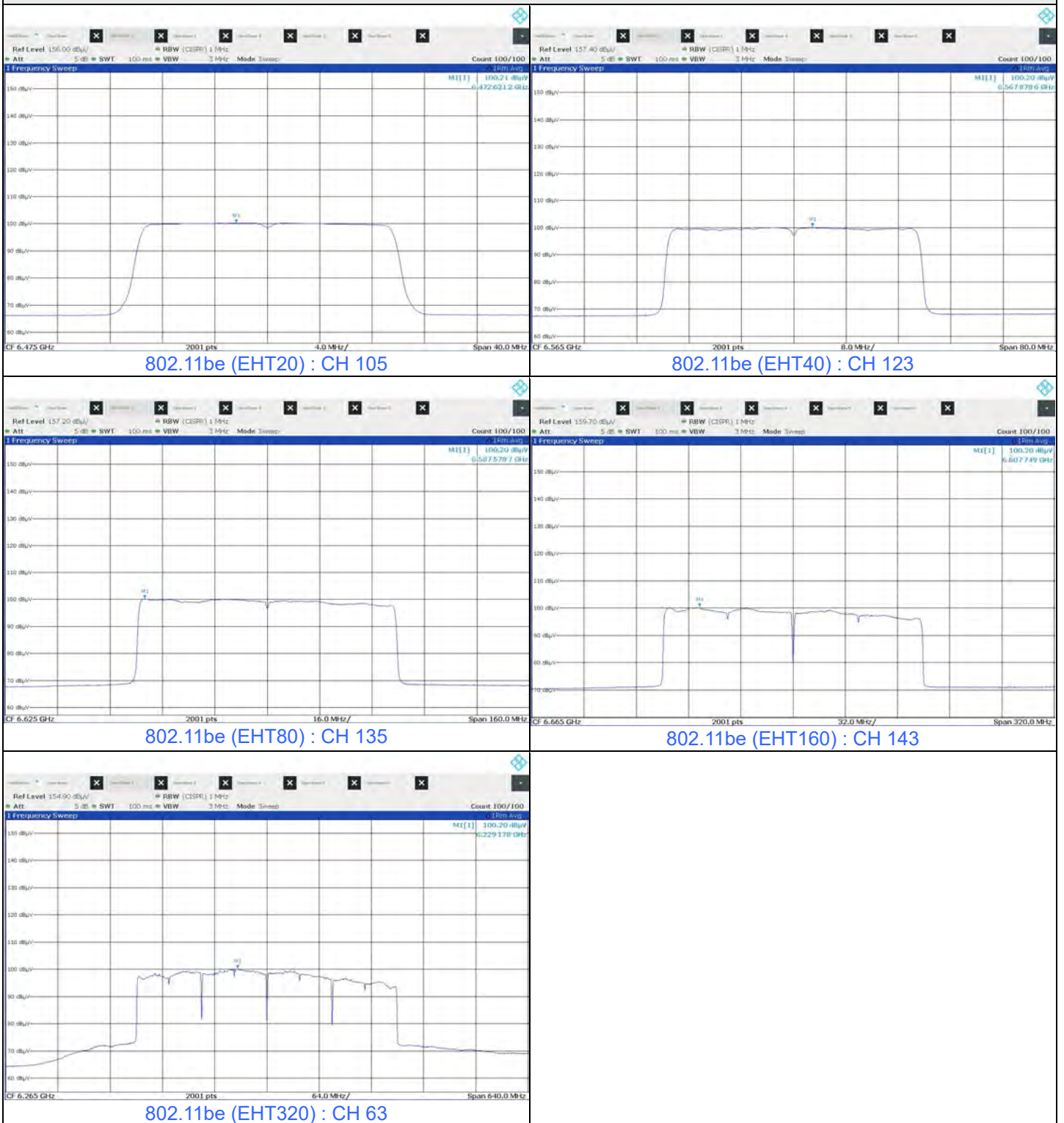

## Beamforming (4T4S)

### 802.11be (EHT20) Beamforming

Chan.	Chan. Freq. (MHz)	Field Strength (dBuV/m)	Correction Factor (dB)	EIRP PSD (dBm/MHz)	EIRP PSD Limit (dBm/MHz)	Test Result
33	6115	100.21	-95.23	4.98	5	Pass
61	6255	100.09	-95.23	4.86	5	Pass
93	6415	100.10	-95.23	4.87	5	Pass
97	6435	100.05	-95.23	4.82	5	Pass
105	6475	100.21	-95.23	4.98	5	Pass
113	6515	100.08	-95.23	4.85	5	Pass
117	6535	100.04	-95.23	4.81	5	Pass
149	6695	100.18	-95.23	4.95	5	Pass
181	6855	100.21	-95.23	4.98	5	Pass
185	6875	100.09	-95.23	4.86	5	Pass
209	6995	100.16	-95.23	4.93	5	Pass
229	7095	100.08	-95.23	4.85	5	Pass
233	7115	83.25	-95.23	-11.98	5	Pass

### 802.11be (EHT40) Beamforming

Chan.	Chan. Freq. (MHz)	Field Strength (dBuV/m)	Correction Factor (dB)	EIRP PSD (dBm/MHz)	EIRP PSD Limit (dBm/MHz)	Test Result
35	6125	100.18	-95.23	4.95	5	Pass
59	6245	100.11	-95.23	4.88	5	Pass
91	6405	100.03	-95.23	4.80	5	Pass
99	6445	100.18	-95.23	4.95	5	Pass
107	6485	100.13	-95.23	4.90	5	Pass
115	6525	100.12	-95.23	4.89	5	Pass
123	6565	100.19	-95.23	4.96	5	Pass
155	6725	100.18	-95.23	4.95	5	Pass
179	6845	100.14	-95.23	4.91	5	Pass
187	6885	100.09	-95.23	4.86	5	Pass
211	7005	100.11	-95.23	4.88	5	Pass
227	7085	100.17	-95.23	4.94	5	Pass

### 802.11be (EHT80) Beamforming

Chan.	Chan. Freq. (MHz)	Field Strength (dBuV/m)	Correction Factor (dB)	EIRP PSD (dBm/MHz)	EIRP PSD Limit (dBm/MHz)	Test Result
39	6145	100.04	-95.23	4.81	5	Pass
55	6225	100.07	-95.23	4.84	5	Pass
87	6385	100.05	-95.23	4.82	5	Pass
103	6465	100.11	-95.23	4.88	5	Pass
119	6545	100.12	-95.23	4.89	5	Pass
135	6625	100.20	-95.23	4.97	5	Pass
151	6705	100.04	-95.23	4.81	5	Pass
167	6785	100.04	-95.23	4.81	5	Pass
183	6865	100.10	-95.23	4.87	5	Pass
199	6945	100.12	-95.23	4.89	5	Pass
215	7025	100.19	-95.23	4.96	5	Pass

### 802.11be (EHT160) Beamforming

Chan.	Chan. Freq. (MHz)	Field Strength (dBuV/m)	Correction Factor (dB)	EIRP PSD (dBm/MHz)	EIRP PSD Limit (dBm/MHz)	Test Result
47	6185	100.14	-95.23	4.91	5	Pass
79	6345	100.07	-95.23	4.84	5	Pass
111	6505	100.17	-95.23	4.94	5	Pass
143	6665	100.18	-95.23	4.95	5	Pass
175	6825	100.16	-95.23	4.93	5	Pass
207	6985	100.08	-95.23	4.85	5	Pass

### 802.11be (EHT320) Beamforming

Chan.	Chan. Freq. (MHz)	Field Strength (dBuV/m)	Correction Factor (dB)	EIRP PSD (dBm/MHz)	EIRP PSD Limit (dBm/MHz)	Test Result
63	6265	99.36	-95.23	4.13	5	Pass
95	6425	99.30	-95.23	4.07	5	Pass
127	6585	99.35	-95.23	4.12	5	Pass
159	6745	99.27	-95.23	4.04	5	Pass
191	6905	99.38	-95.23	4.15	5	Pass





### Spectrum Plot of Maximum Value

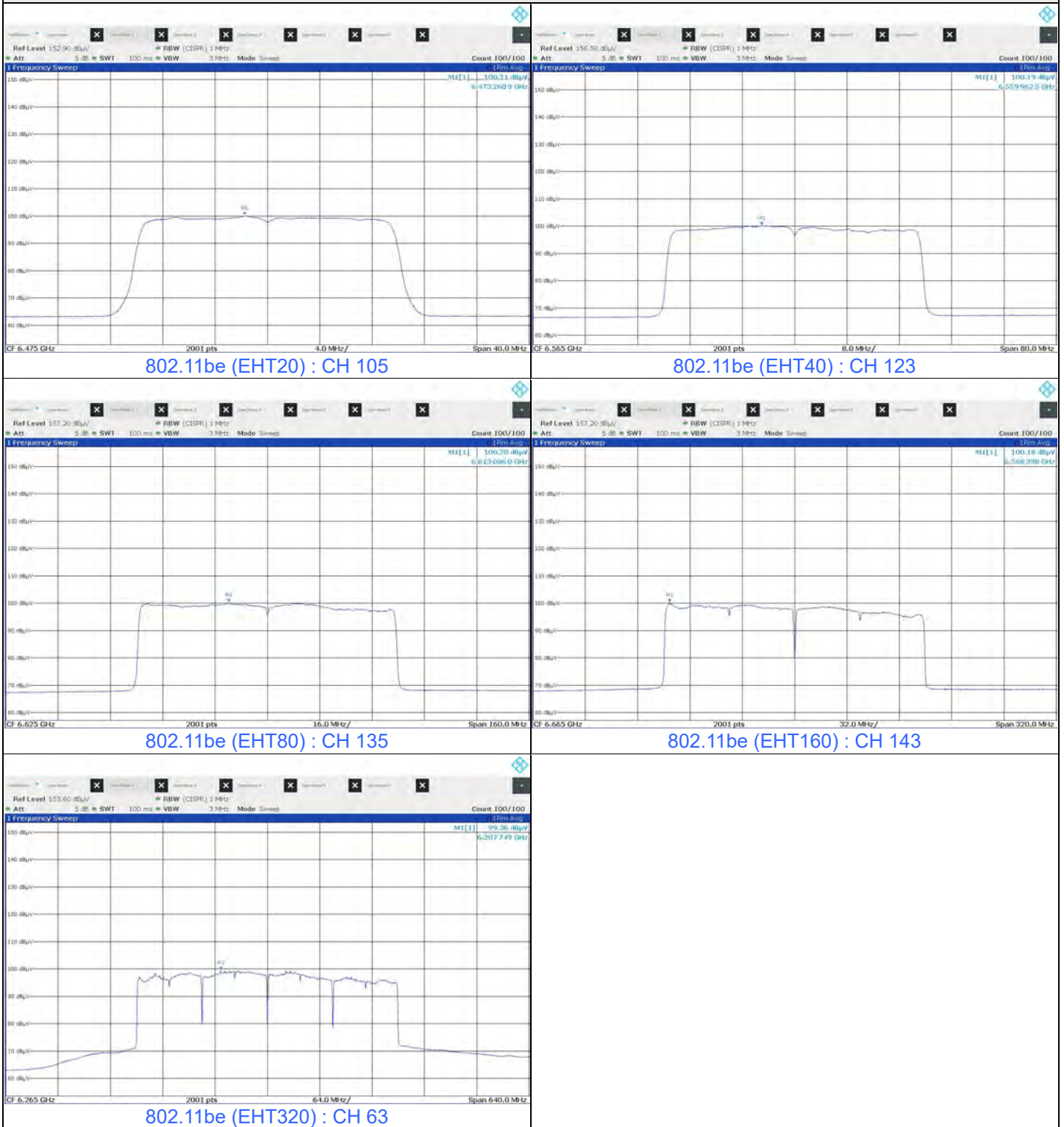

### 7.3 Emission Bandwidth

Input Power:	120 Vac, 60 Hz	Environmental Conditions:	25°C, 60% RH	Tested By:	Alan Wu
--------------	----------------	---------------------------	--------------	------------	---------

#### 802.11a

Channel	Frequency (MHz)	26dB Bandwidth (MHz)			
		Chain 0	Chain 1	Chain 2	Chain 3
33	6115	21.81	21.82	21.98	21.86
61	6255	22.38	21.98	21.93	22.84
93	6415	22.02	22.11	22.41	22.18
97	6435	21.93	22.10	22.12	22.40
105	6475	22.01	21.86	22.03	21.98
113	6515	21.91	22.05	21.96	22.08
117	6535	21.99	22.19	21.96	22.05
149	6695	21.90	21.92	21.93	21.94
181	6855	21.85	21.95	21.93	22.09
185	6875	21.88	21.94	22.01	21.97
209	6995	21.88	22.05	22.07	21.85
229	7095	22.22	21.87	22.22	21.82
233	7115	21.75	21.93	21.97	22.11

Spectrum Plot of Maximum Value

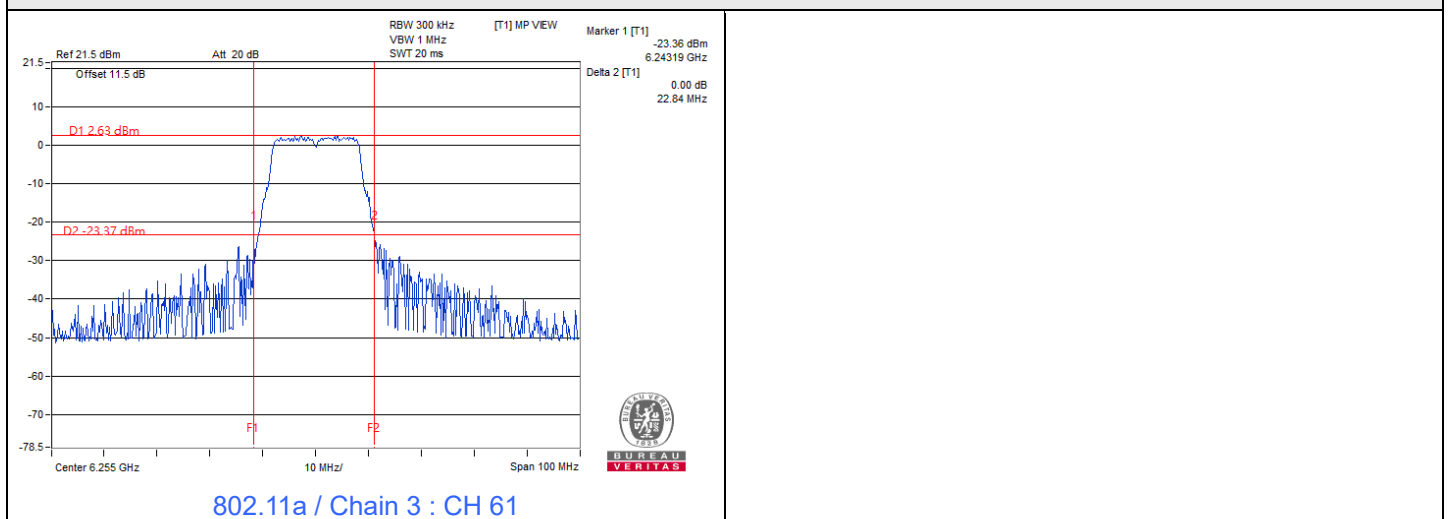

## Beamforming (4T1S)

### 802.11be (EHT20) Beamforming

Channel	Frequency (MHz)	26dB Bandwidth (MHz)			
		Chain 0	Chain 1	Chain 2	Chain 3
33	6115	21.75	21.90	21.97	22.01
61	6255	21.97	22.01	21.81	22.03
93	6415	22.08	22.09	21.93	22.10
97	6435	22.25	22.05	21.96	22.12
105	6475	22.01	21.97	21.95	22.05
113	6515	22.17	22.09	22.04	21.97
117	6535	22.20	21.97	21.96	22.29
149	6695	22.11	22.03	22.03	22.01
181	6855	21.91	21.99	21.86	22.05
185	6875	21.99	22.13	22.05	21.95
209	6995	22.10	21.92	22.02	22.05
229	7095	21.97	21.93	22.17	21.94
233	7115	22.17	22.18	22.06	21.98

### 802.11be (EHT40) Beamforming

Channel	Frequency (MHz)	26dB Bandwidth (MHz)			
		Chain 0	Chain 1	Chain 2	Chain 3
35	6125	41.58	41.91	41.65	41.55
59	6245	42.04	42.06	41.80	42.01
91	6405	41.87	42.12	41.94	41.74
99	6445	41.92	42.11	42.16	42.00
107	6485	42.11	41.87	41.87	41.97
115	6525	41.89	42.18	41.87	42.12
123	6565	42.18	41.82	41.91	41.91
155	6725	41.88	42.17	42.08	42.04
179	6845	42.00	42.09	42.07	41.89
187	6885	41.99	41.84	41.97	41.88
211	7005	42.07	41.71	41.92	41.90
227	7085	42.11	42.21	41.81	42.09

### 802.11be (EHT80) Beamforming

Channel	Frequency (MHz)	26dB Bandwidth (MHz)			
		Chain 0	Chain 1	Chain 2	Chain 3
39	6145	82.40	82.34	82.46	82.19
55	6225	82.96	82.79	82.73	82.86
87	6385	82.73	83.22	82.78	82.89
103	6465	82.88	82.87	83.04	83.01
119	6545	82.97	82.87	83.09	82.90
135	6625	83.06	82.39	82.91	82.27
151	6705	82.95	83.08	82.76	82.85
167	6785	83.20	82.69	82.78	82.67
183	6865	82.77	82.46	82.97	82.93
199	6945	82.91	83.02	83.11	83.23
215	7025	82.85	82.99	83.22	82.92

### 802.11be (EHT160) Beamforming

Channel	Frequency (MHz)	26dB Bandwidth (MHz)			
		Chain 0	Chain 1	Chain 2	Chain 3
47	6185	167.63	167.61	167.56	167.29
79	6345	167.85	168.00	168.52	168.59
111	6505	168.26	168.70	168.34	168.45
143	6665	167.95	168.08	167.76	168.00
175	6825	169.04	168.51	168.06	168.20
207	6985	167.66	168.69	168.72	168.00

### 802.11be (EHT320) Beamforming

Channel	Frequency (MHz)	26dB Bandwidth (MHz)			
		Chain 0	Chain 1	Chain 2	Chain 3
63	6265	331.60	331.42	332.12	330.90
95	6425	334.48	334.06	334.86	334.69
127	6585	333.68	333.16	333.48	333.98
159	6745	333.64	333.50	334.17	333.55
191	6905	332.11	333.25	333.13	333.61

### Spectrum Plot of Maximum Value

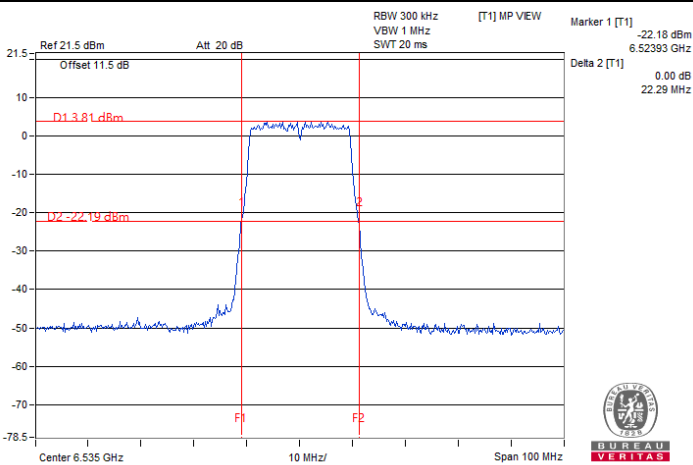

802.11be (EHT20) Beamforming / Chain 3 : CH 117

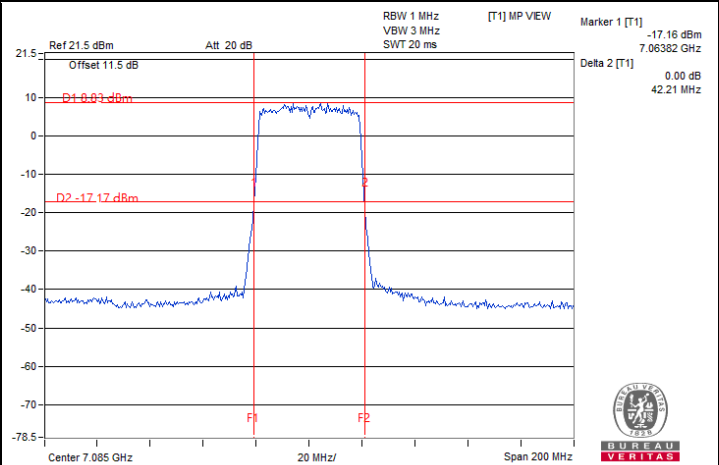

802.11be (EHT40) Beamforming / Chain 1 : CH 227

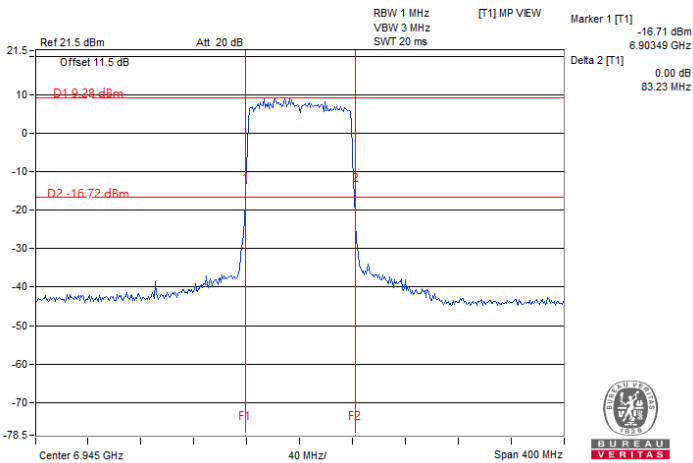

802.11be (EHT80) Beamforming / Chain 3 : CH 199

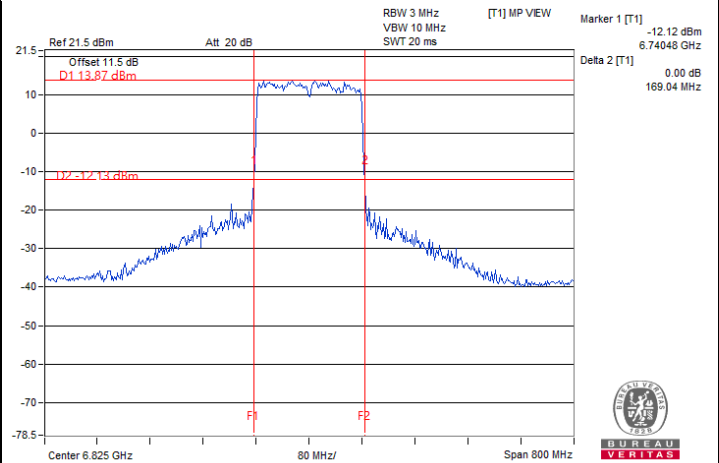

802.11be (EHT160) Beamforming / Chain 0 : CH 175

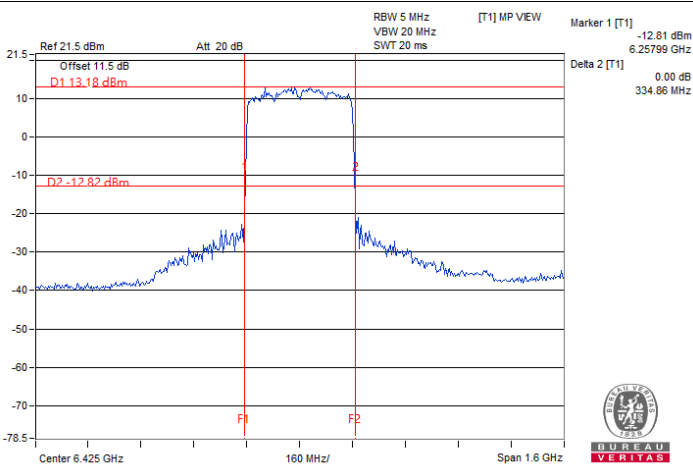

802.11be (EHT320) Beamforming / Chain 2 : CH 95

## Beamforming (4T4S)

### 802.11be (EHT20) Beamforming

Channel	Frequency (MHz)	26dB Bandwidth (MHz)			
		Chain 0	Chain 1	Chain 2	Chain 3
33	6115	22.10	22.07	21.93	21.94
61	6255	22.27	22.02	22.08	22.00
93	6415	22.11	22.05	22.12	21.96
97	6435	22.18	22.12	22.05	22.01
105	6475	22.05	22.16	21.97	22.03
113	6515	22.02	21.83	22.06	21.92
117	6535	22.07	22.07	22.21	21.95
149	6695	22.25	22.06	22.08	22.11
181	6855	22.13	22.04	22.00	21.98
185	6875	22.09	21.94	22.04	22.12
209	6995	21.88	21.85	21.95	21.88
229	7095	22.01	21.76	22.08	21.99
233	7115	22.10	21.93	21.98	22.10

### 802.11be (EHT40) Beamforming

Channel	Frequency (MHz)	26dB Bandwidth (MHz)			
		Chain 0	Chain 1	Chain 2	Chain 3
35	6125	41.73	41.83	41.85	41.86
59	6245	41.90	41.99	41.93	42.17
91	6405	42.04	41.85	42.05	41.95
99	6445	41.70	41.88	41.96	41.63
107	6485	42.05	41.92	41.90	41.97
115	6525	41.81	42.14	41.88	41.86
123	6565	41.92	41.88	41.58	41.83
155	6725	41.94	41.99	41.91	41.91
179	6845	41.84	41.92	41.78	42.09
187	6885	42.09	41.95	41.81	42.18
211	7005	41.60	41.59	41.63	41.71
227	7085	41.78	41.58	41.98	41.62

### 802.11be (EHT80) Beamforming

Channel	Frequency (MHz)	26dB Bandwidth (MHz)			
		Chain 0	Chain 1	Chain 2	Chain 3
39	6145	82.88	82.77	82.48	82.82
55	6225	82.43	82.74	82.79	82.28
87	6385	82.64	82.71	82.39	82.38
103	6465	82.66	82.52	82.14	82.63
119	6545	82.59	82.47	82.60	82.56
135	6625	82.43	82.66	82.29	82.32
151	6705	82.64	82.36	82.22	82.82
167	6785	82.45	82.45	82.64	82.64
183	6865	82.71	82.45	82.11	82.49
199	6945	82.45	82.32	82.51	82.13
215	7025	82.12	82.24	82.27	82.27

### 802.11be (EHT160) Beamforming

Channel	Frequency (MHz)	26dB Bandwidth (MHz)			
		Chain 0	Chain 1	Chain 2	Chain 3
47	6185	167.27	166.89	167.00	167.25
79	6345	167.12	167.23	169.21	168.01
111	6505	167.42	168.39	168.28	167.35
143	6665	166.88	168.26	167.38	167.52
175	6825	176.63	191.33	168.24	168.25
207	6985	167.10	167.13	168.79	166.88

### 802.11be (EHT320) Beamforming

Channel	Frequency (MHz)	26dB Bandwidth (MHz)			
		Chain 0	Chain 1	Chain 2	Chain 3
63	6265	332.16	331.91	331.35	332.27
95	6425	332.73	332.44	332.11	332.40
127	6585	331.90	331.96	331.27	331.85
159	6745	332.53	332.71	332.57	332.61
191	6905	331.93	332.29	331.64	333.04



### Spectrum Plot of Maximum Value

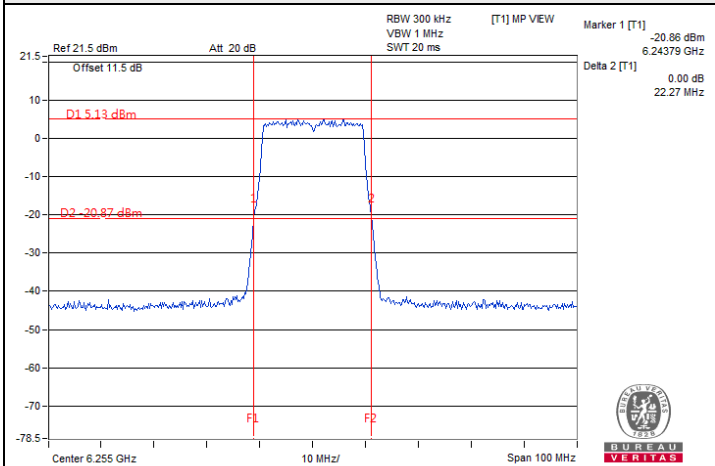

802.11be (EHT20) Beamforming / Chain 0 : CH 61

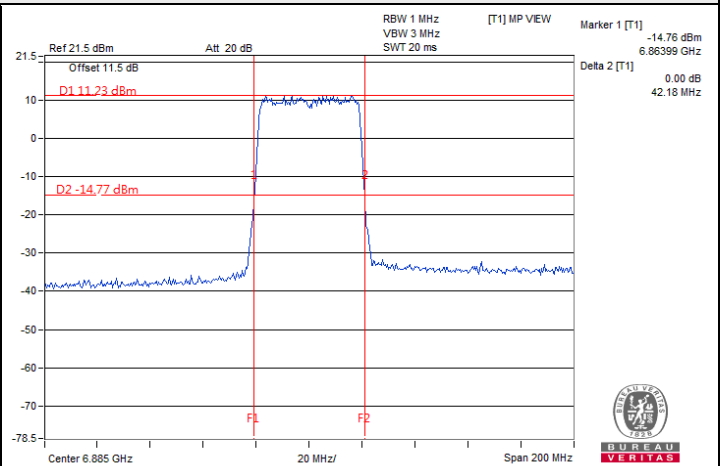

802.11be (EHT40) Beamforming / Chain 3 : CH 187

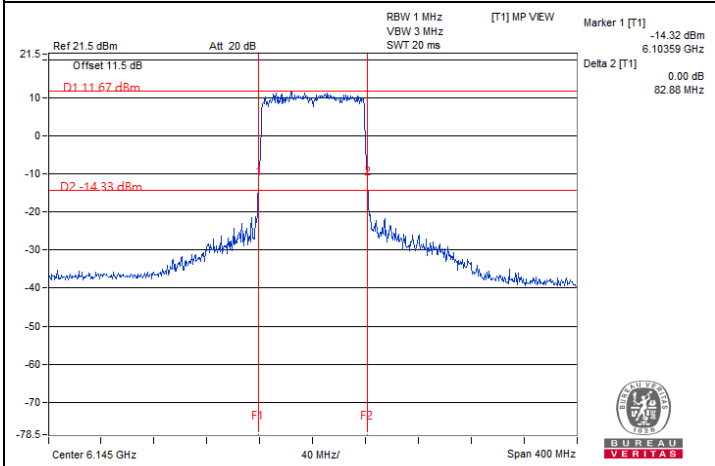

802.11be (EHT80) Beamforming / Chain 0 : CH 39

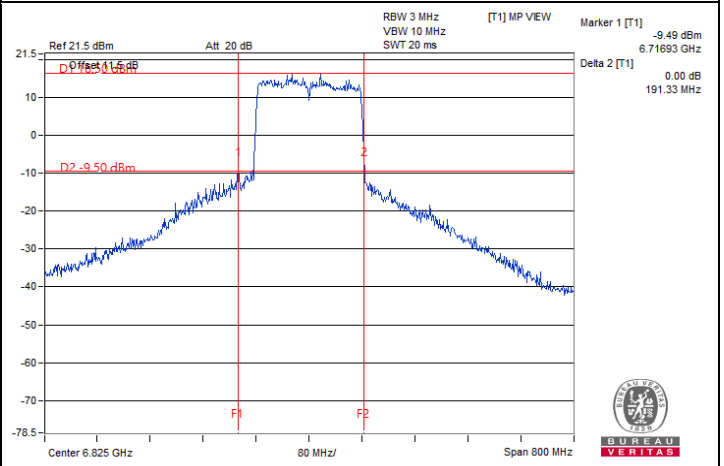

802.11be (EHT160) Beamforming / Chain 1 : CH 175

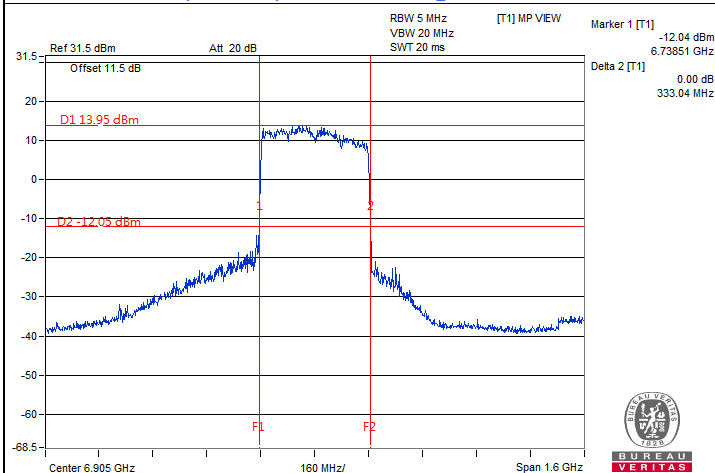

802.11be (EHT320) Beamforming / Chain 3 : CH 191



### 7.4 In-Band Emission Mask

Input Power:	120 Vac, 60 Hz	Environmental Conditions:	25°C, 60% RH	Tested By:	Alan Wu
--------------	----------------	---------------------------	--------------	------------	---------

#### 802.11a

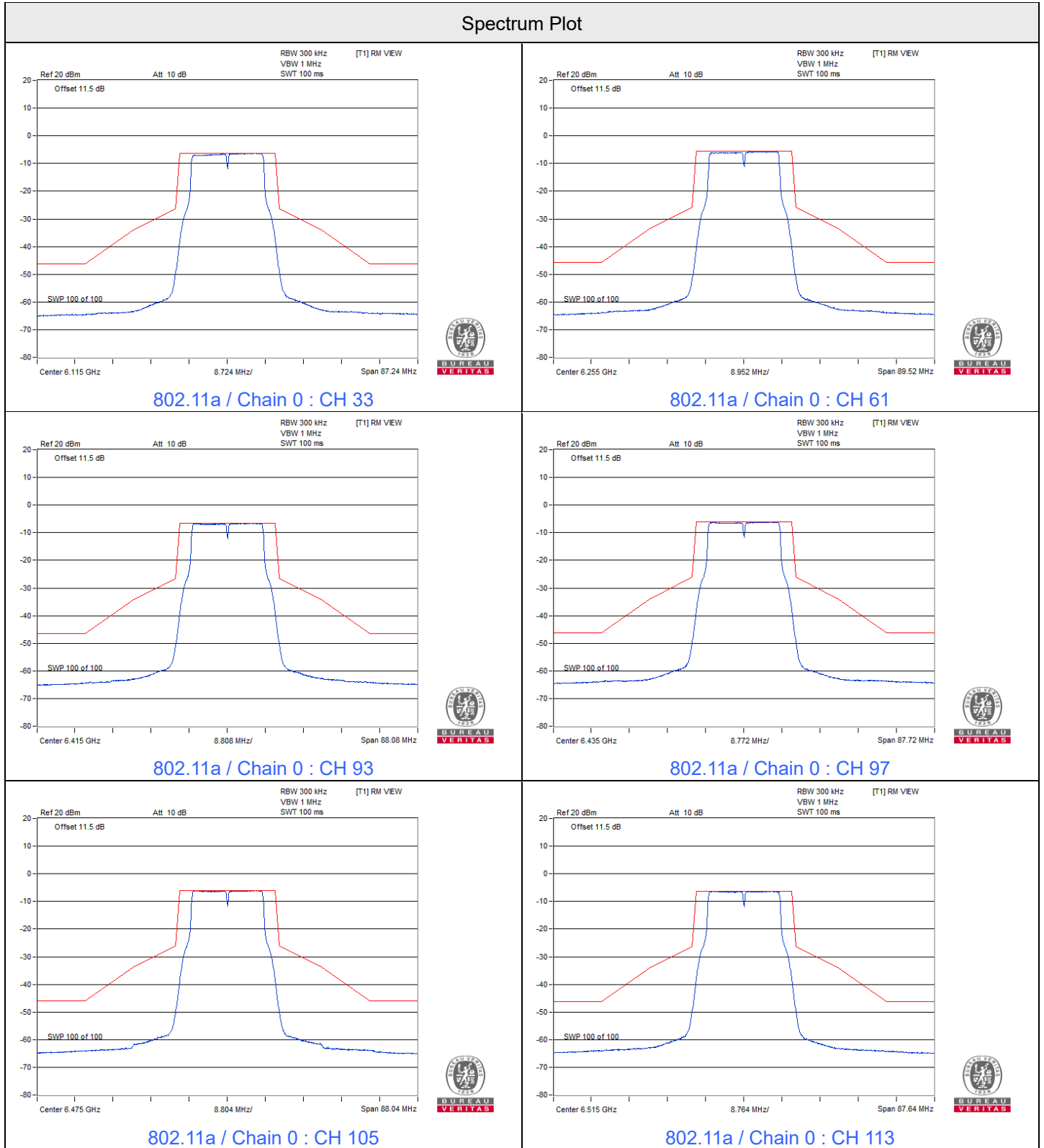

### Spectrum Plot

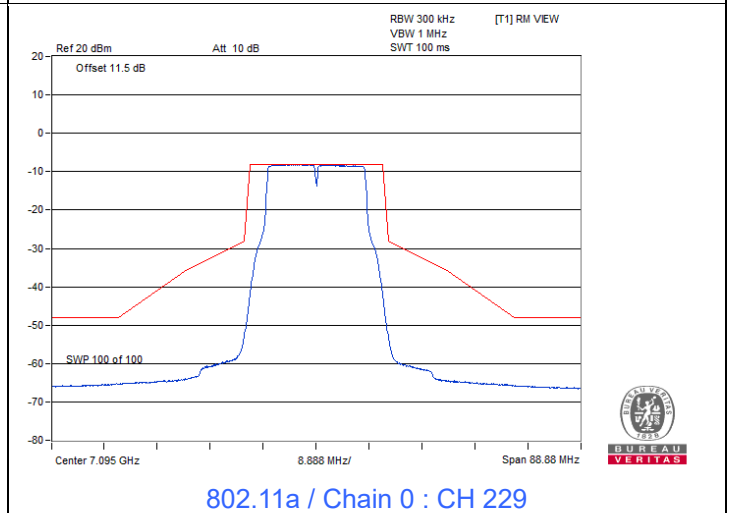
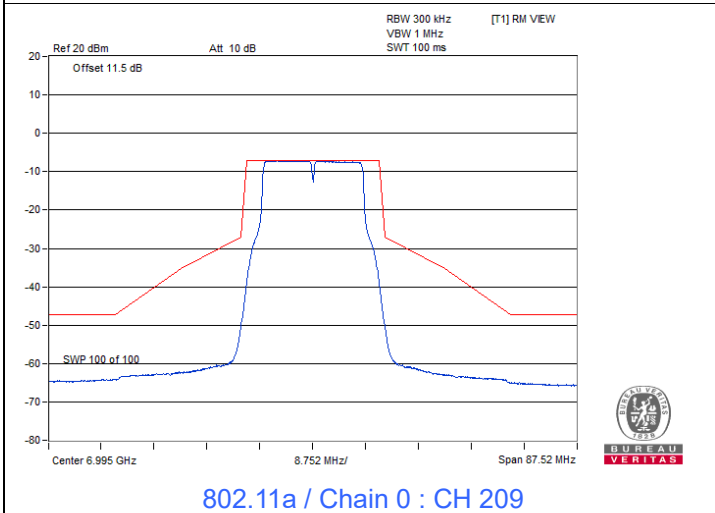
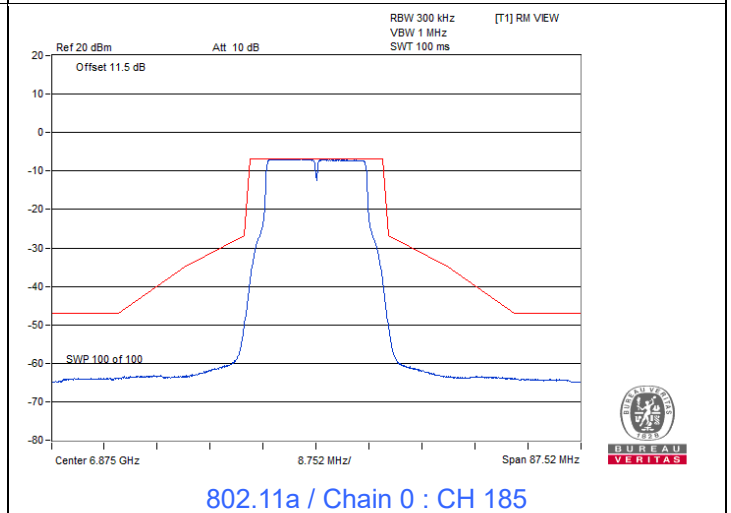
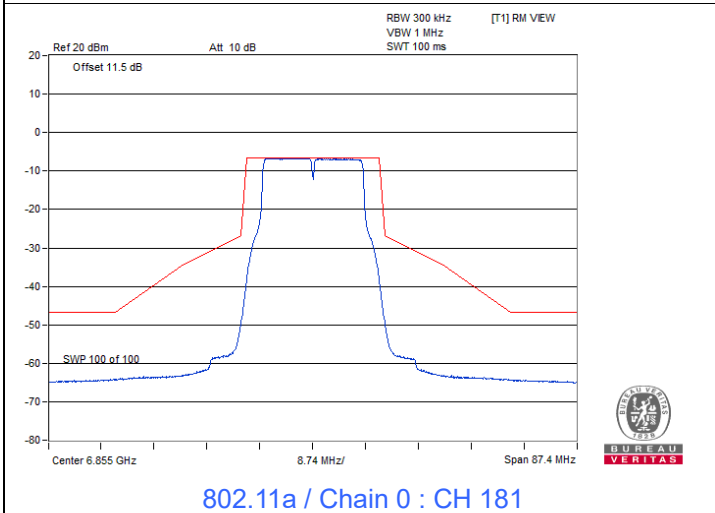
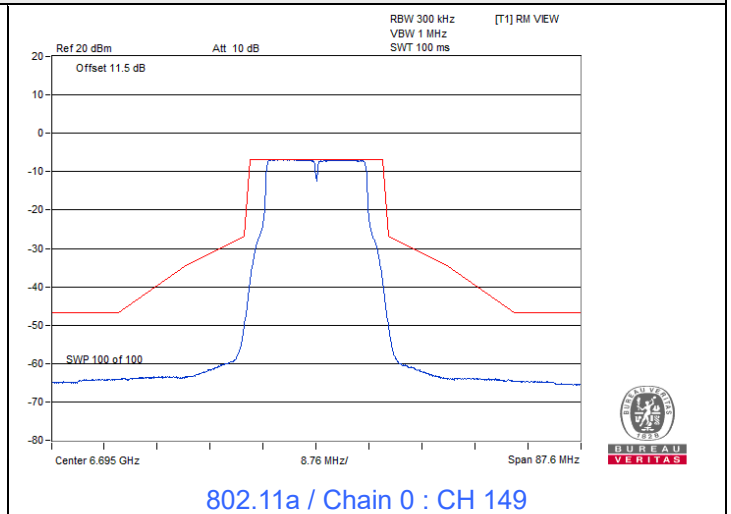
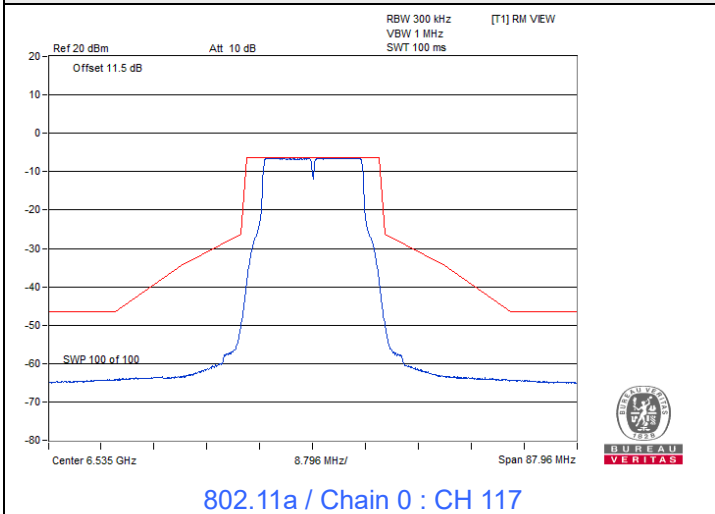

### Spectrum Plot

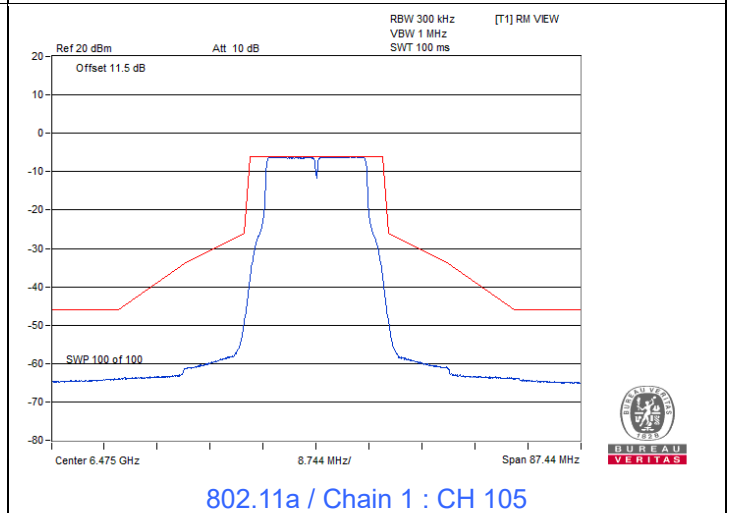
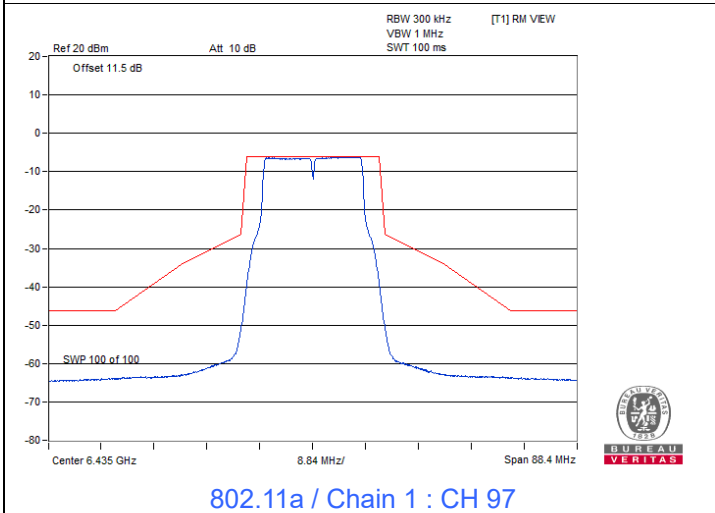
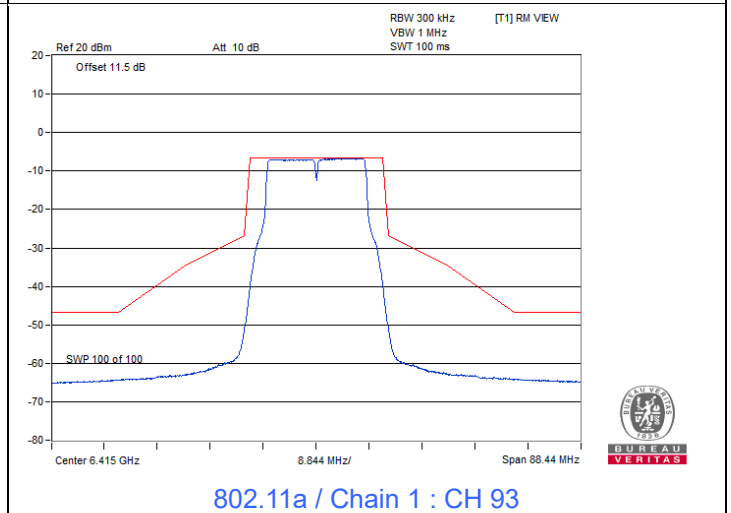
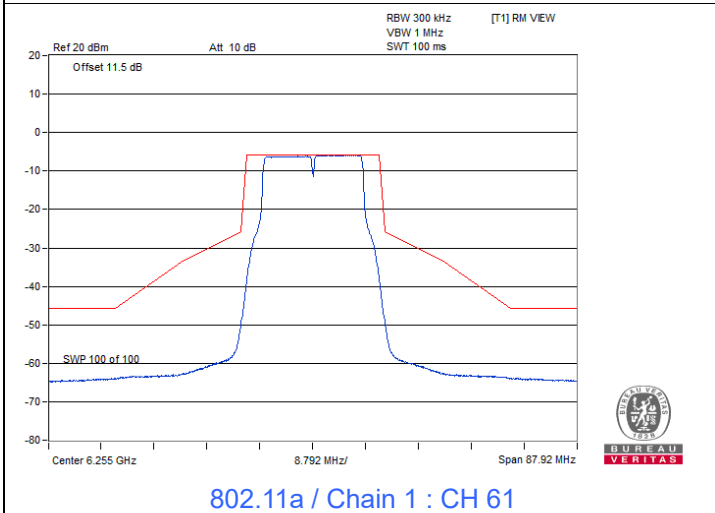
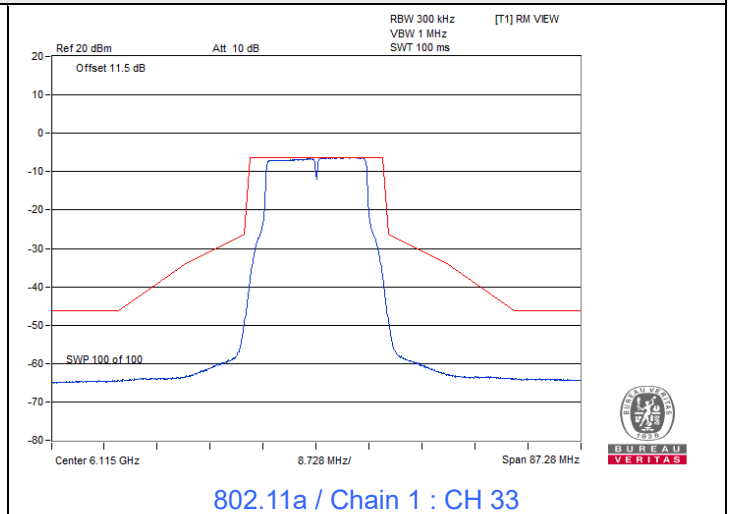
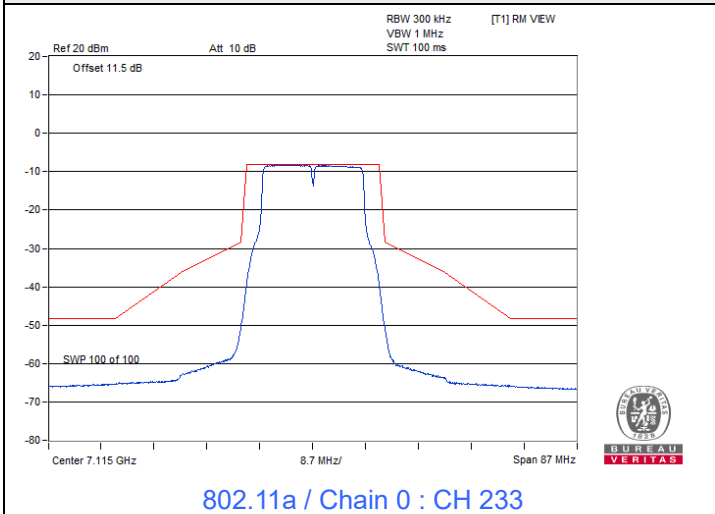

### Spectrum Plot

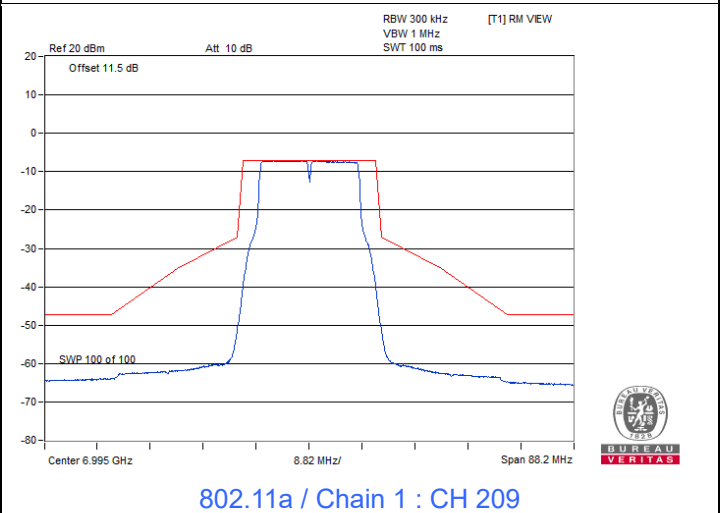
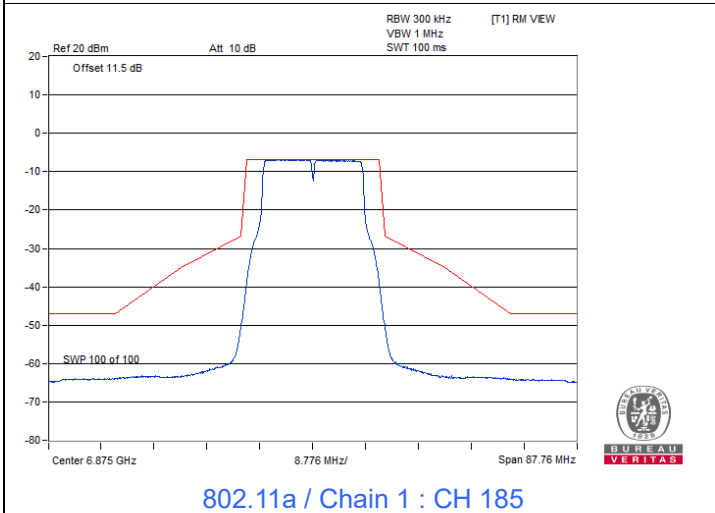
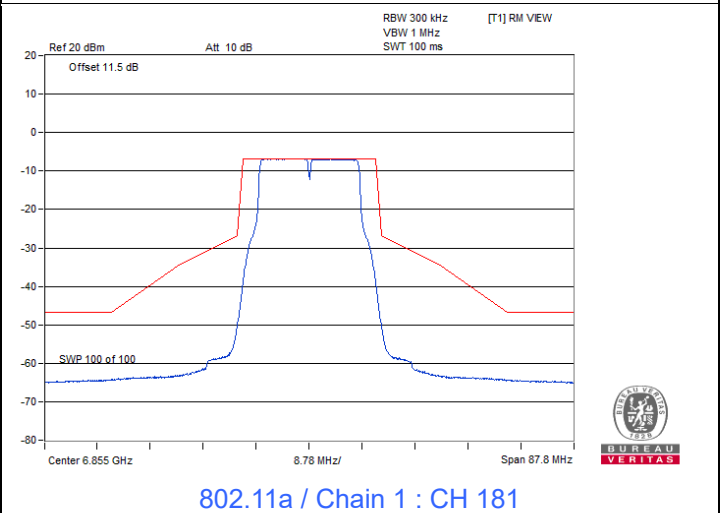
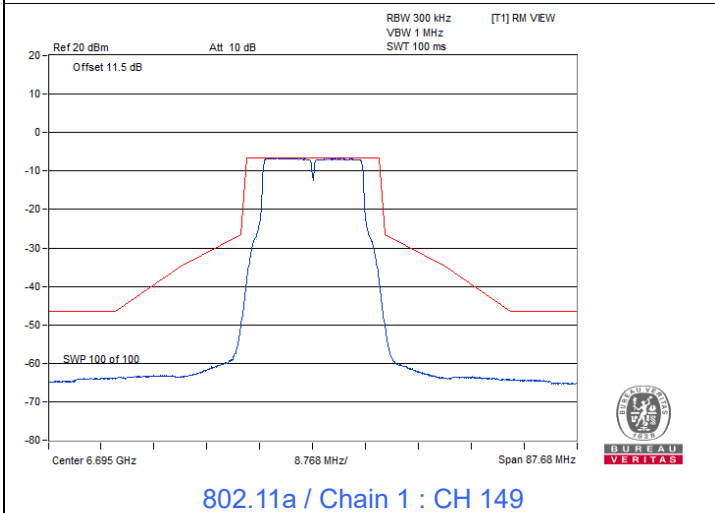
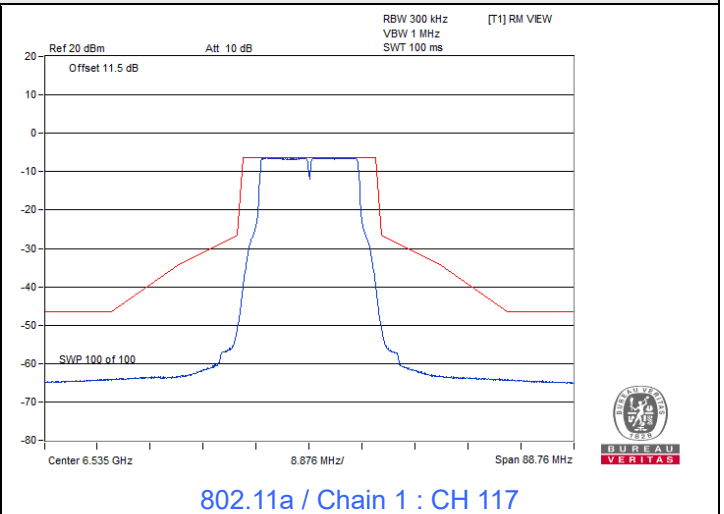
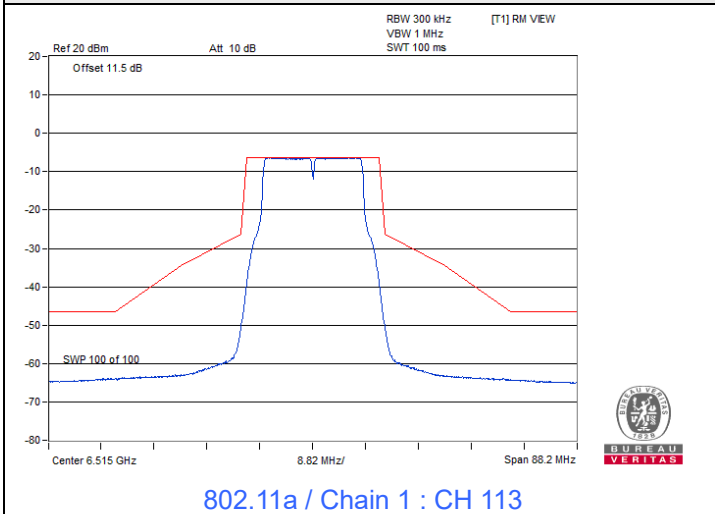

### Spectrum Plot

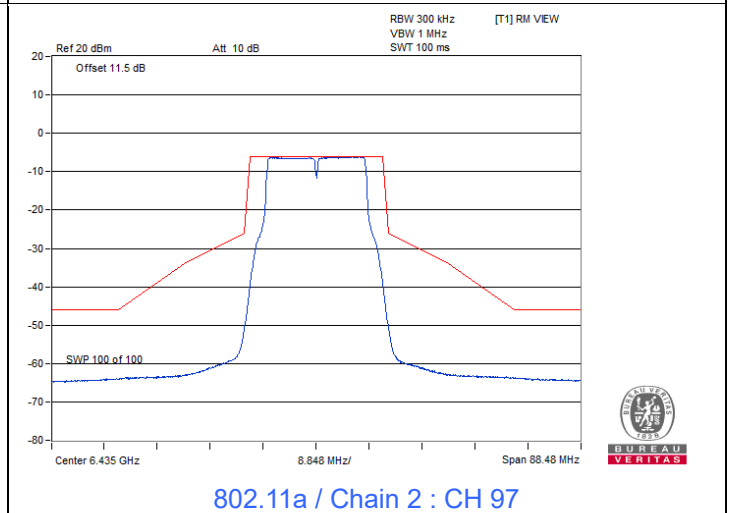
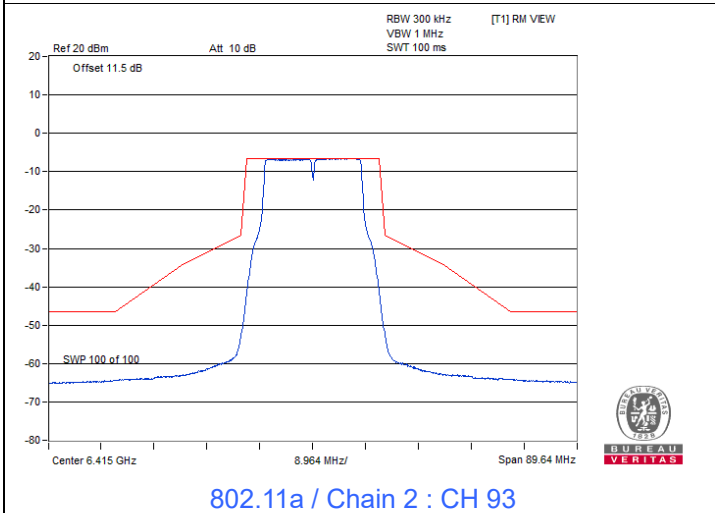
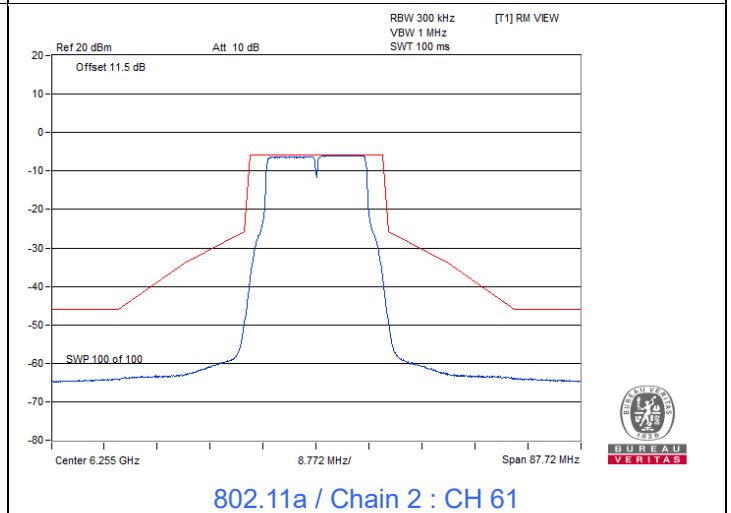
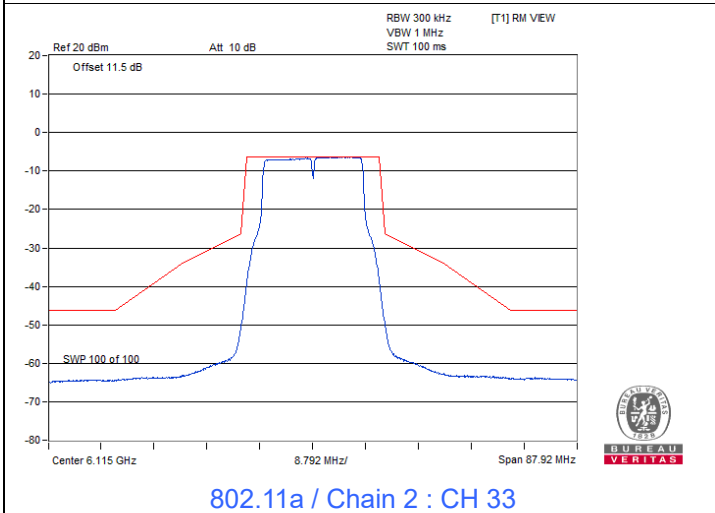
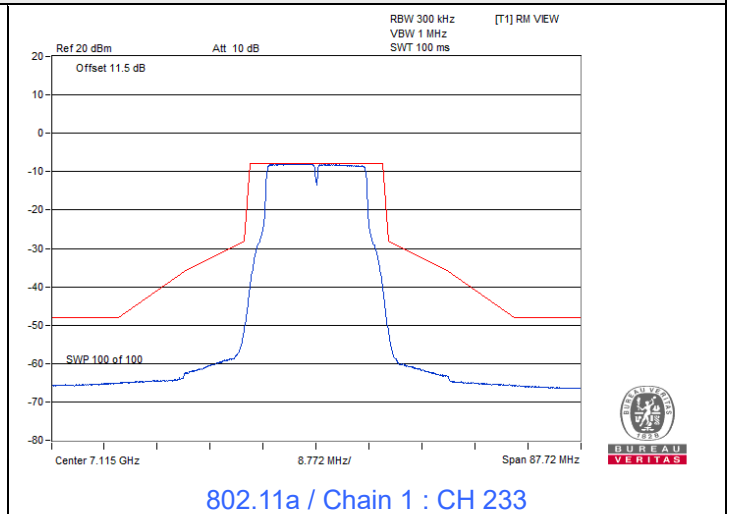
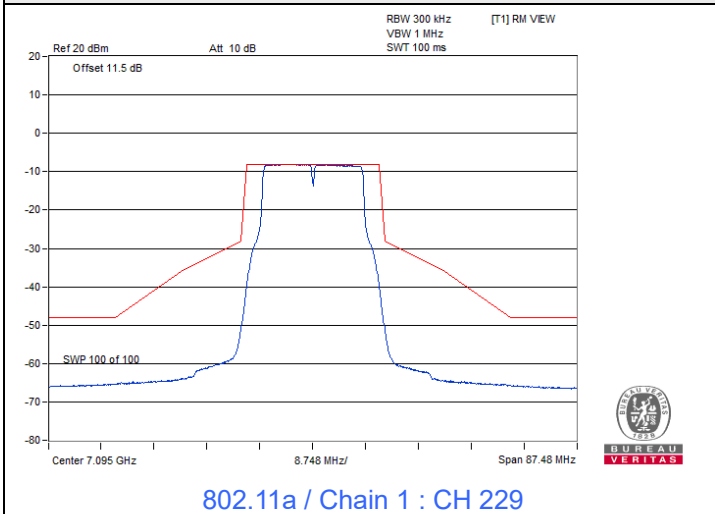

### Spectrum Plot

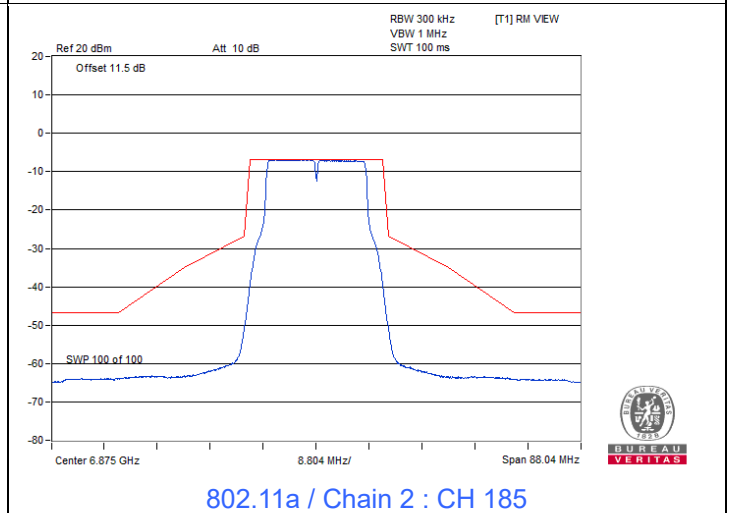
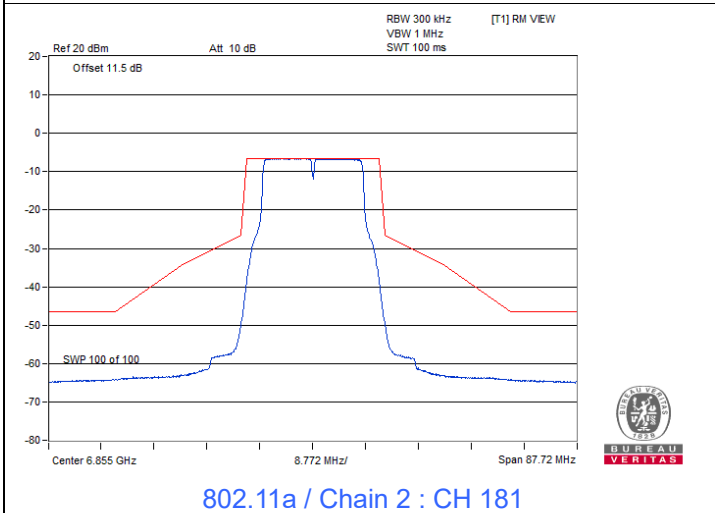
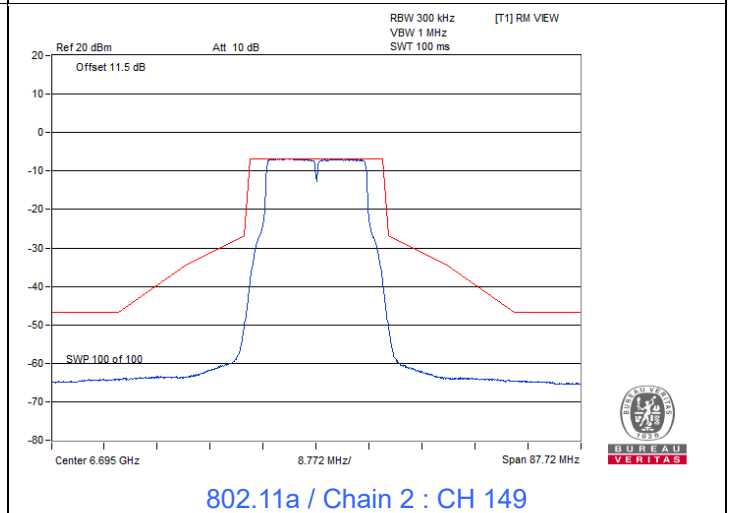
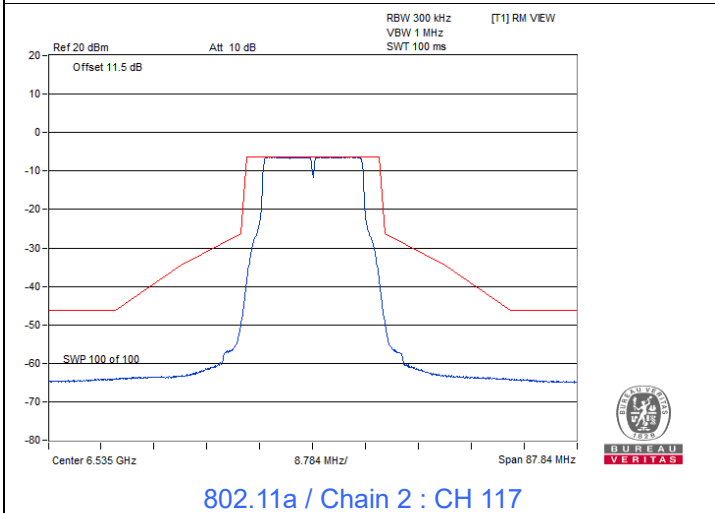
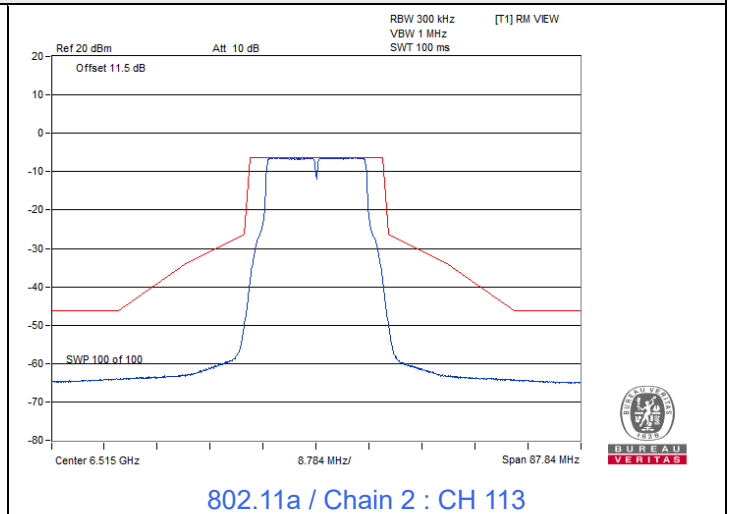
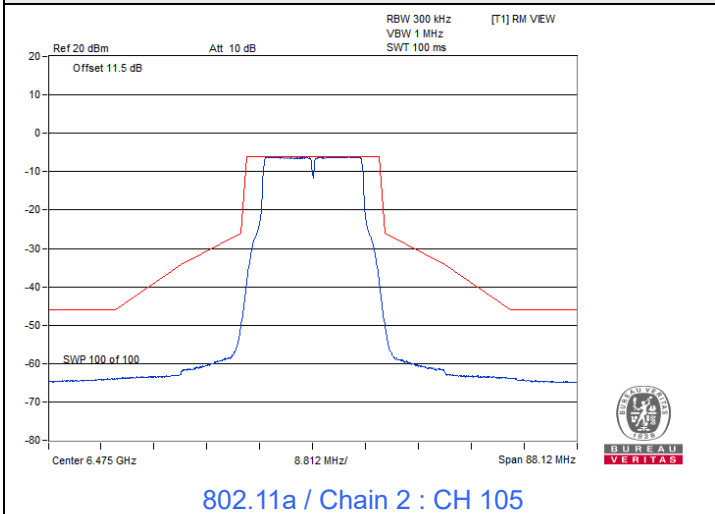

### Spectrum Plot

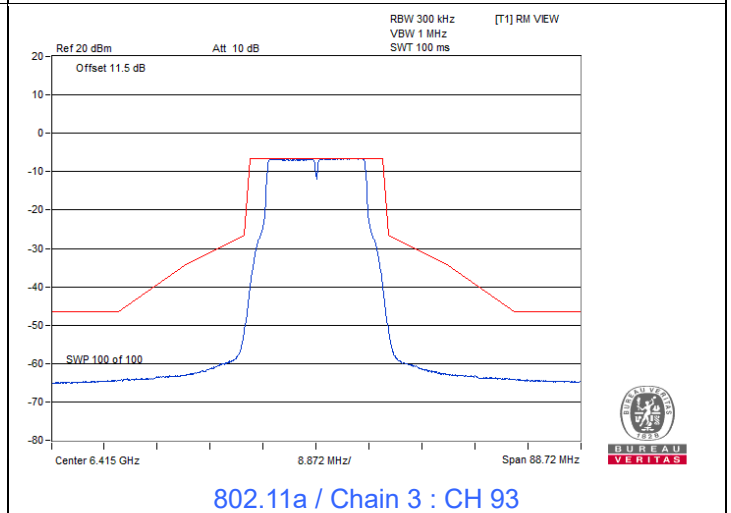
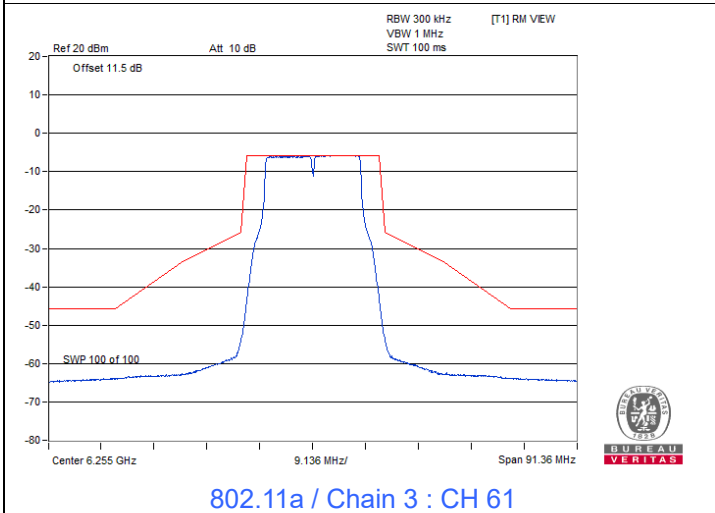
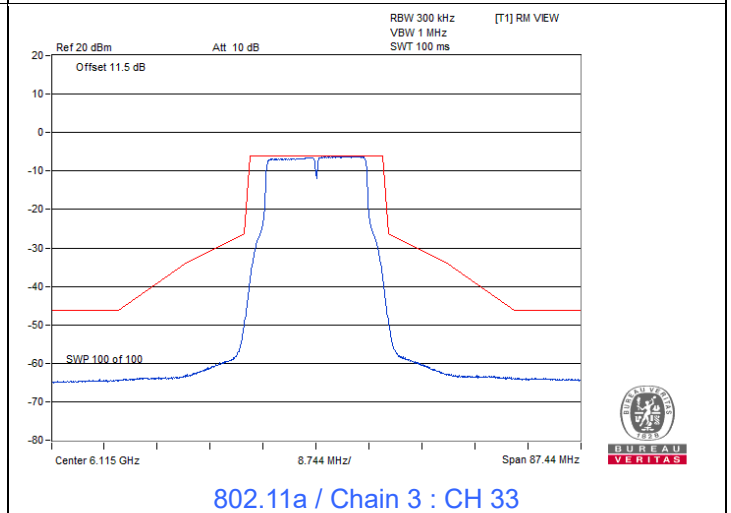
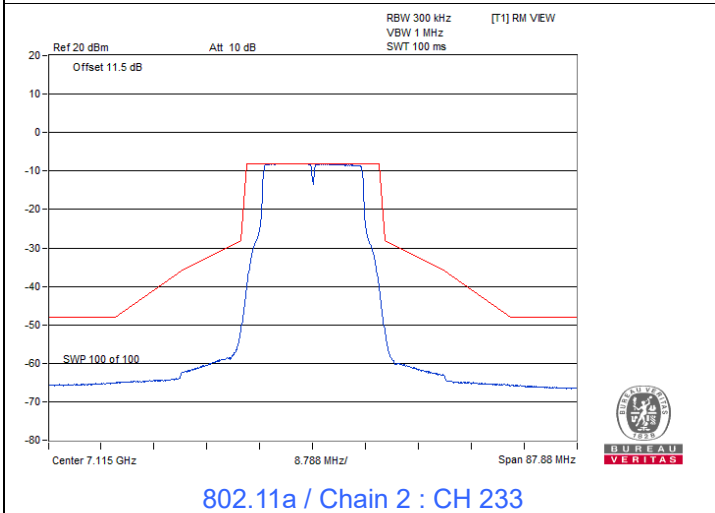
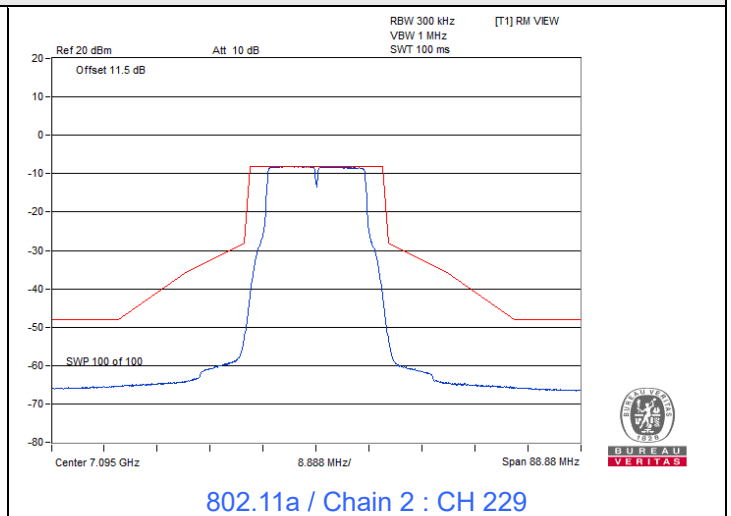
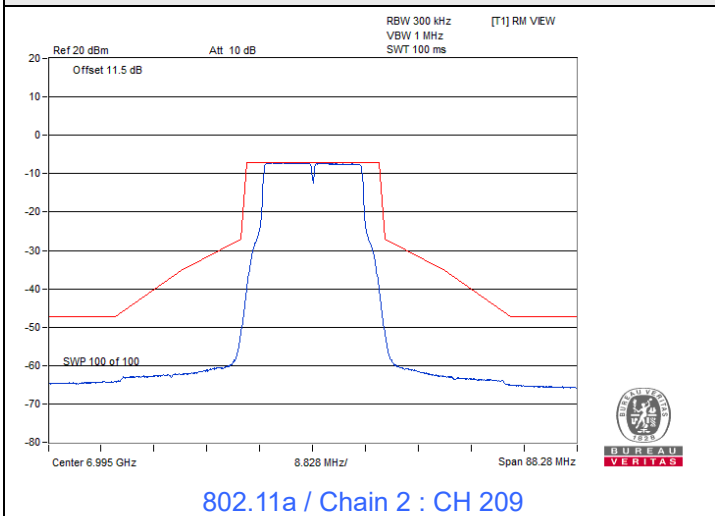

### Spectrum Plot

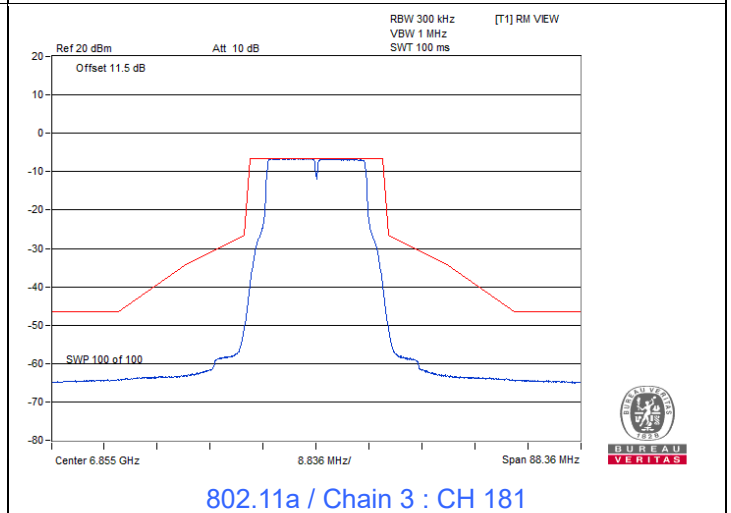
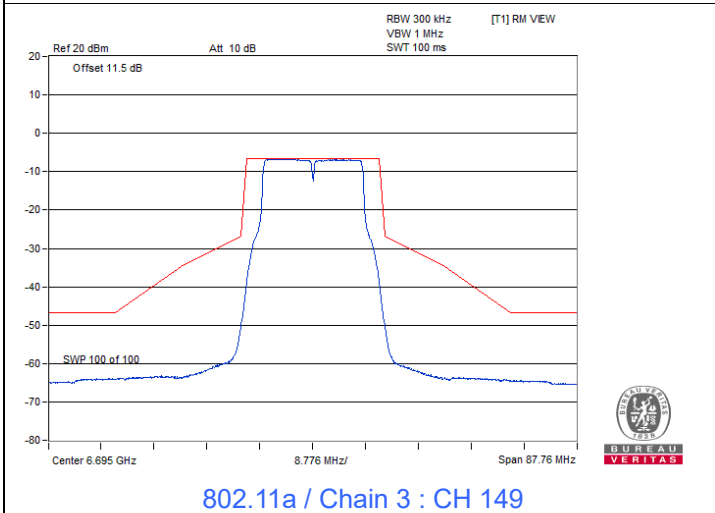
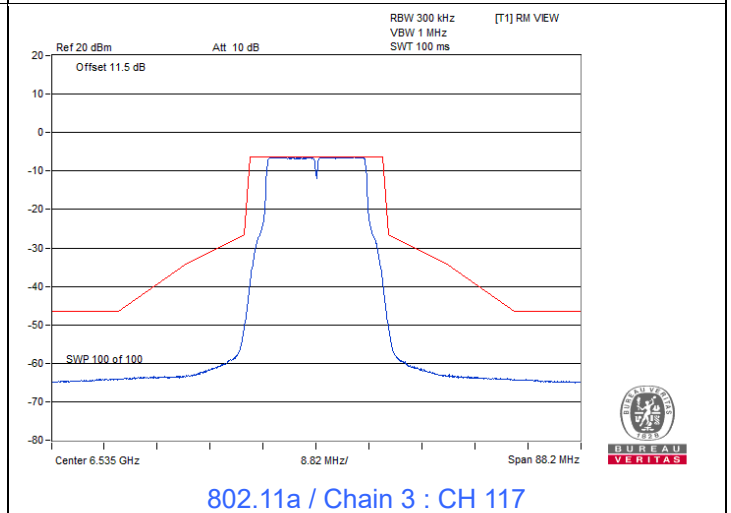
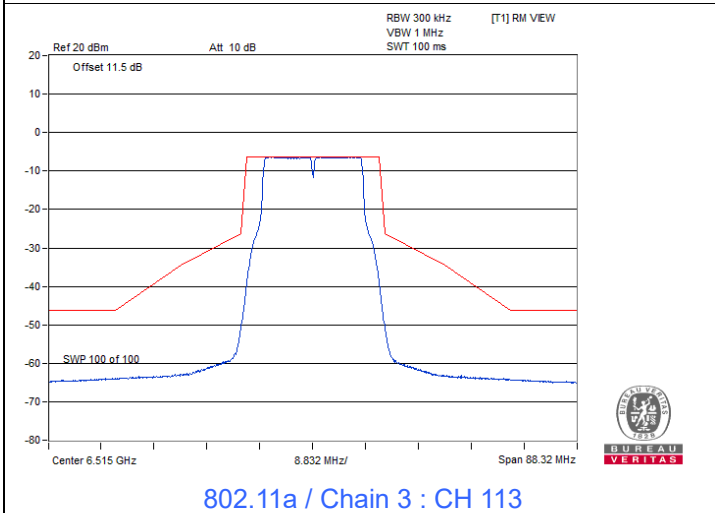
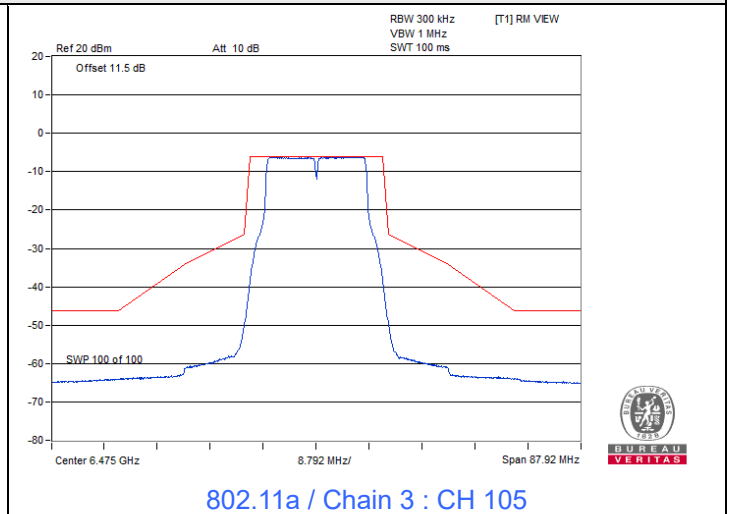
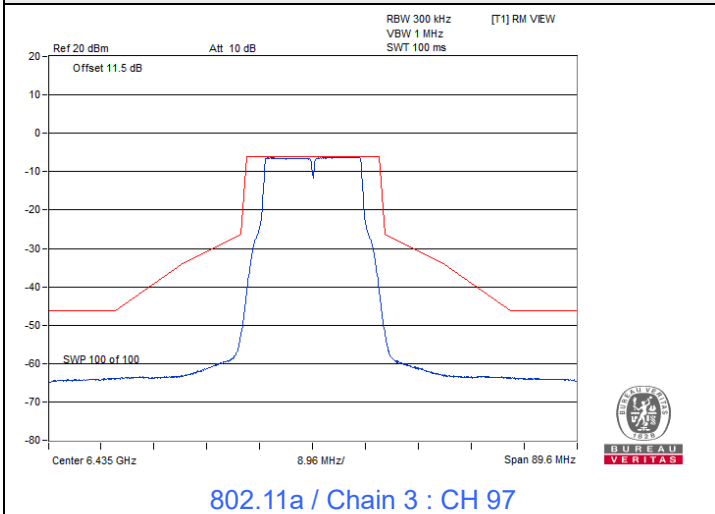



### Spectrum Plot

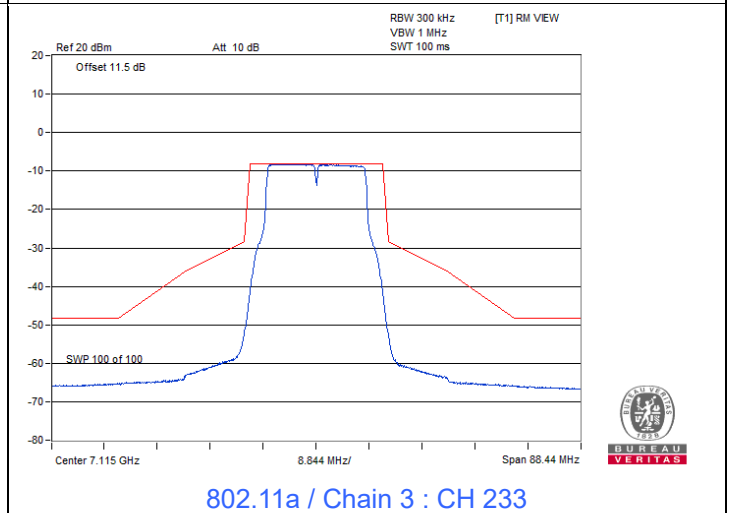
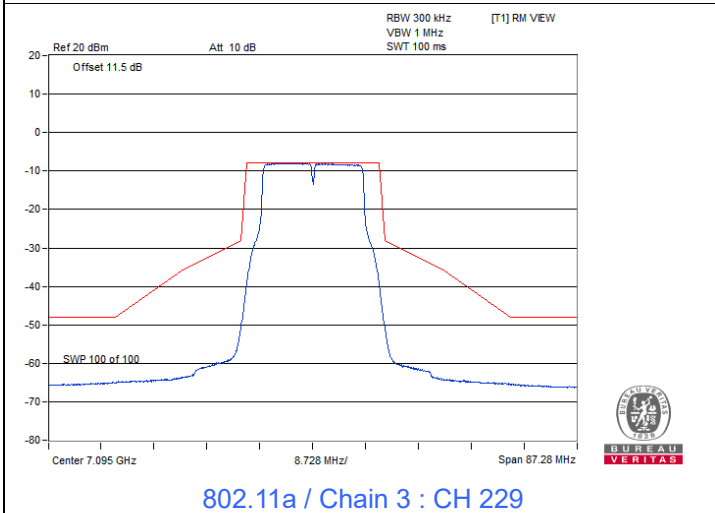
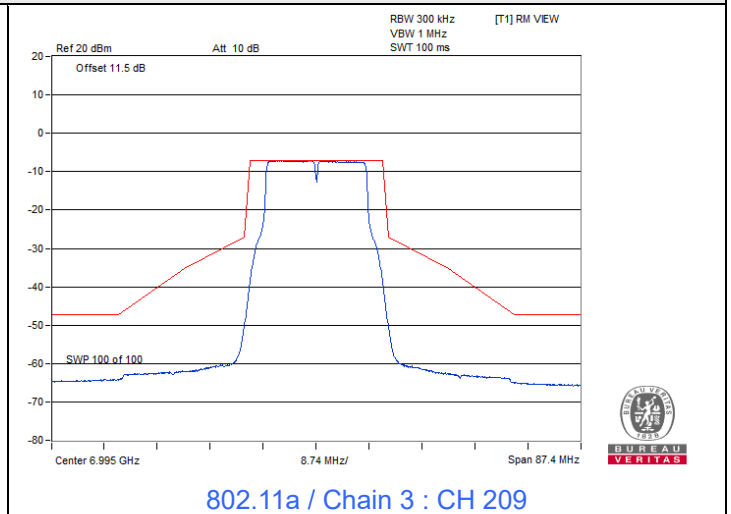
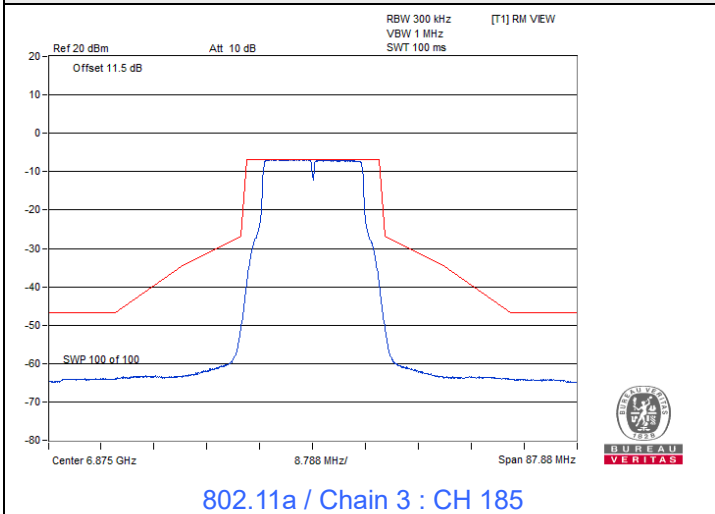

# Beamforming (4T1S)

## 802.11be (EHT20) Beamforming

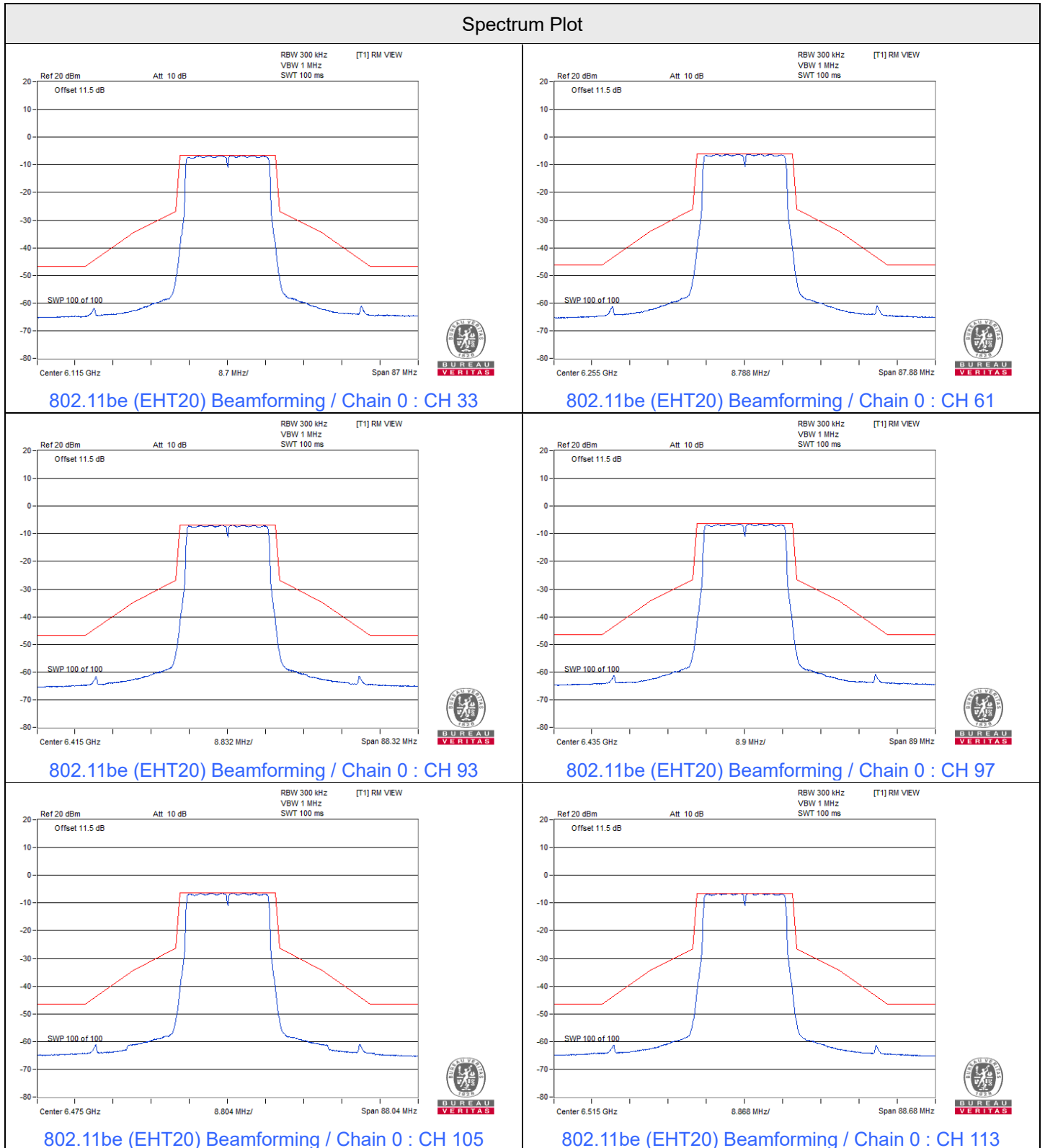

### Spectrum Plot

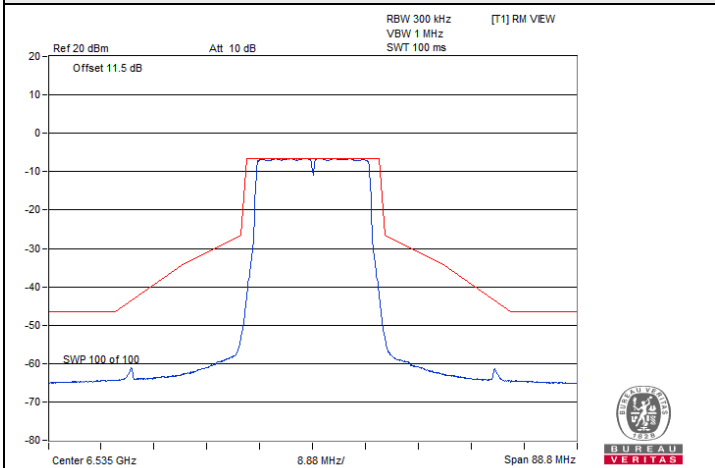

802.11be (EHT20) Beamforming / Chain 0 : CH 117

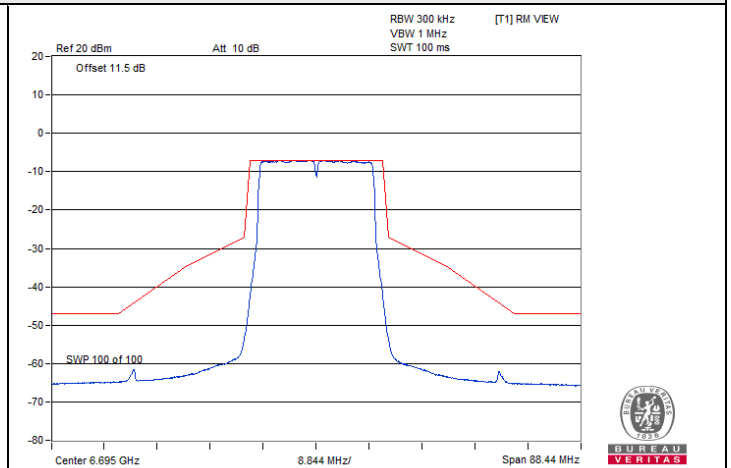

802.11be (EHT20) Beamforming / Chain 0 : CH 149

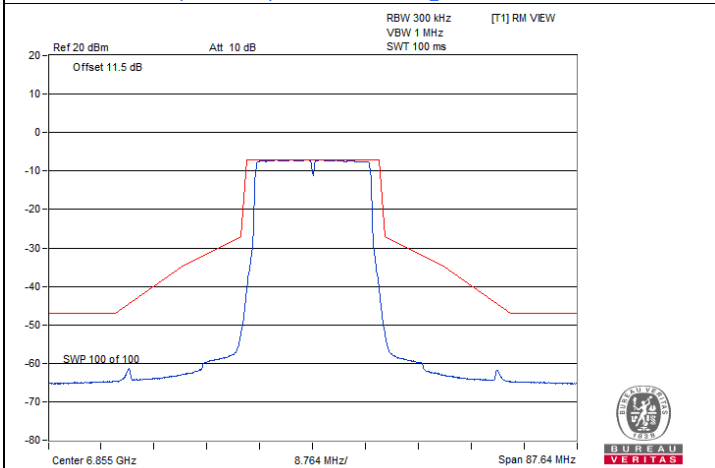

802.11be (EHT20) Beamforming / Chain 0 : CH 181

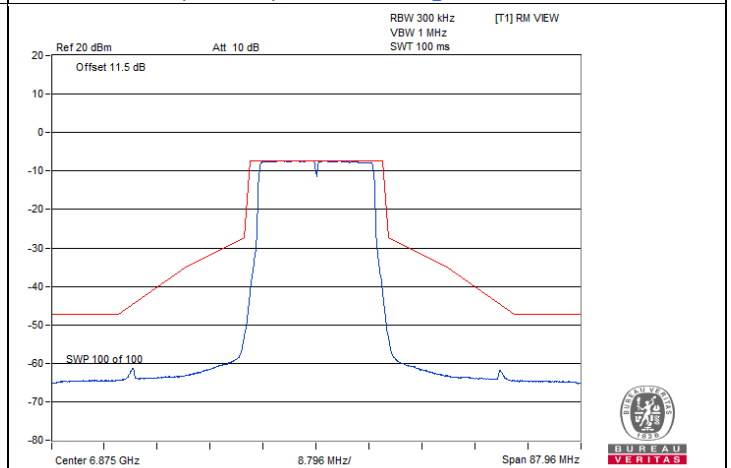

802.11be (EHT20) Beamforming / Chain 0 : CH 185

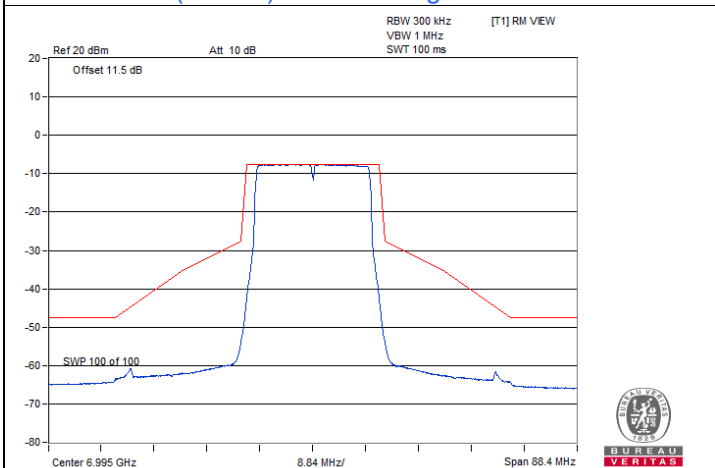

802.11be (EHT20) Beamforming / Chain 0 : CH 209

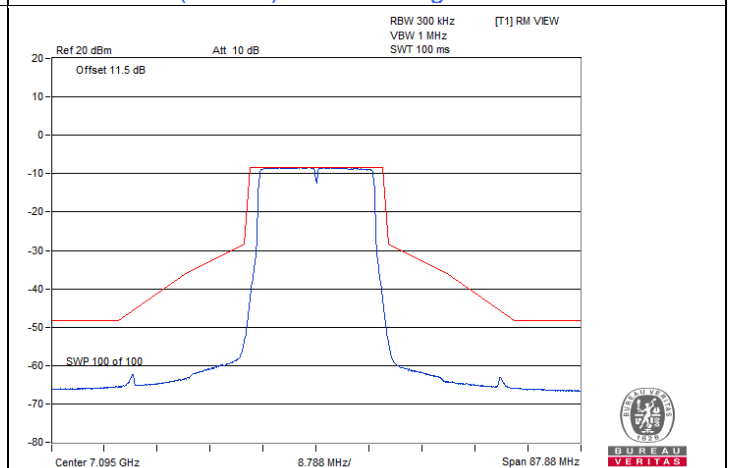

802.11be (EHT20) Beamforming / Chain 0 : CH 229

### Spectrum Plot

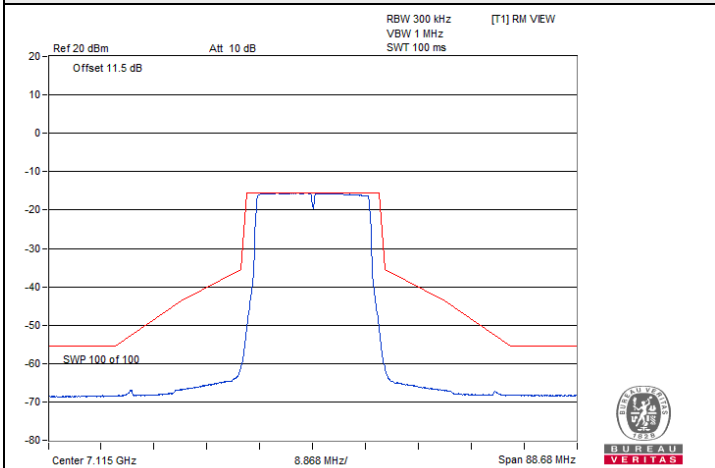

802.11be (EHT20) Beamforming / Chain 0 : CH 233

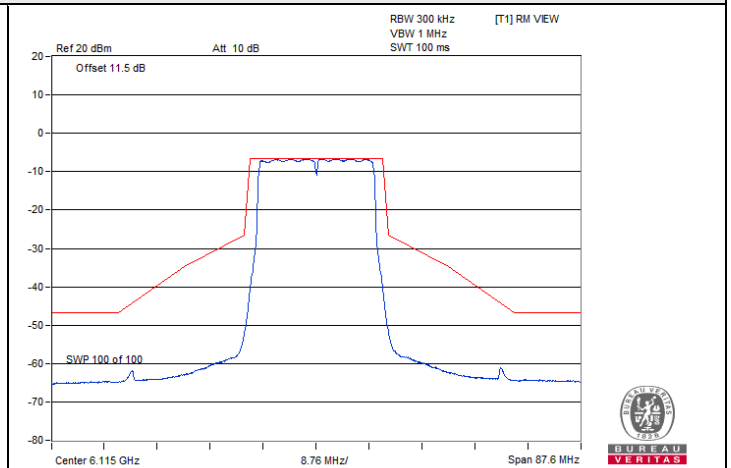

802.11be (EHT20) Beamforming / Chain 1 : CH 33

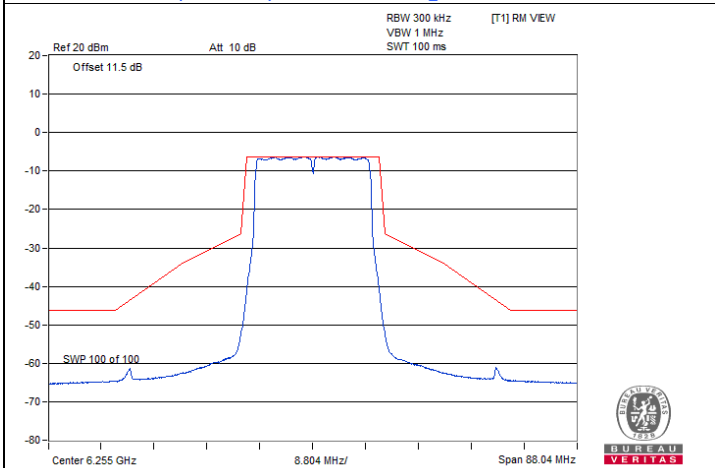

802.11be (EHT20) Beamforming / Chain 1 : CH 61

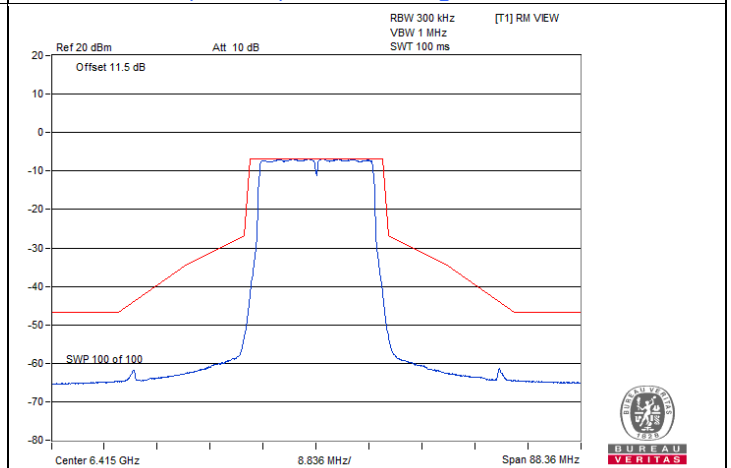

802.11be (EHT20) Beamforming / Chain 1 : CH 93

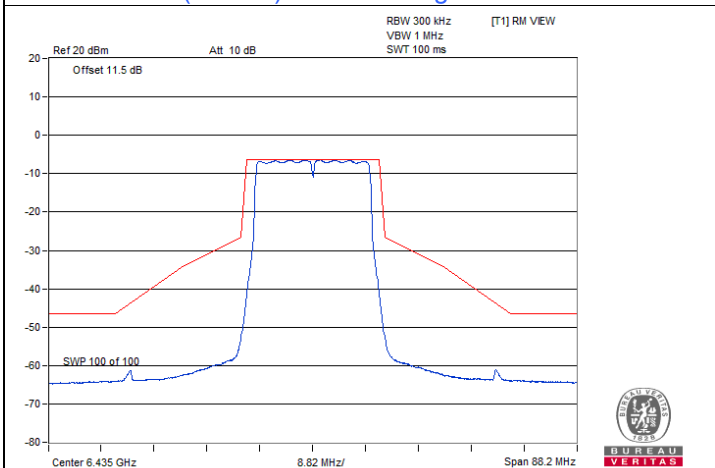

802.11be (EHT20) Beamforming / Chain 1 : CH 97

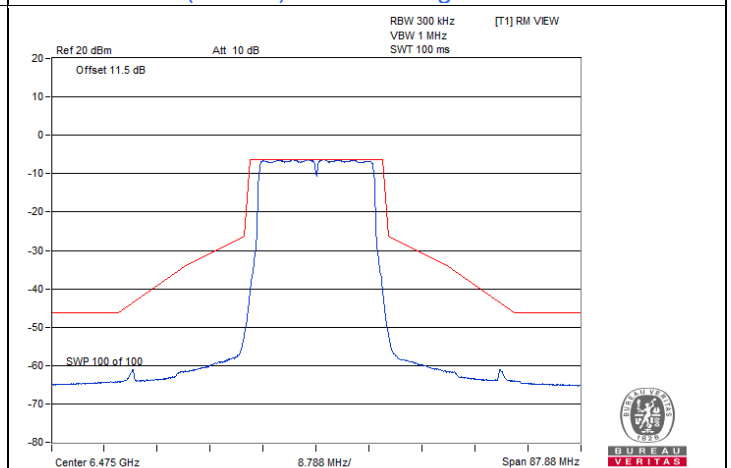

802.11be (EHT20) Beamforming / Chain 1 : CH 105

### Spectrum Plot

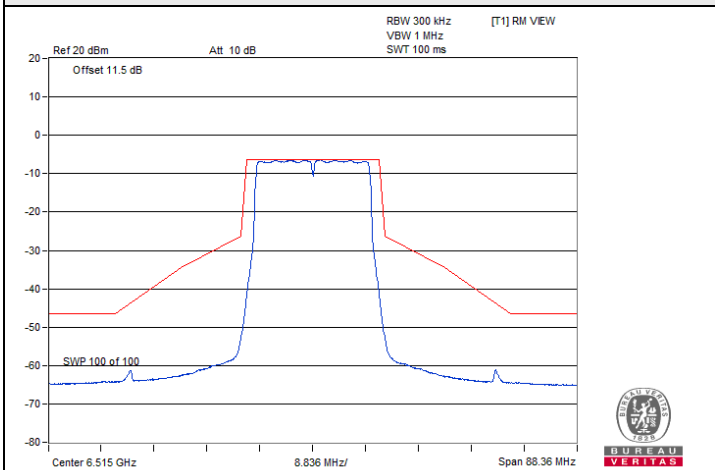

802.11be (EHT20) Beamforming / Chain 1 : CH 113

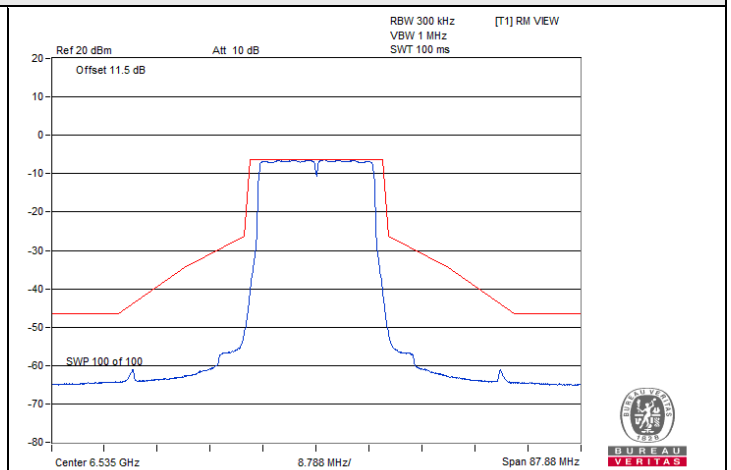

802.11be (EHT20) Beamforming / Chain 1 : CH 117

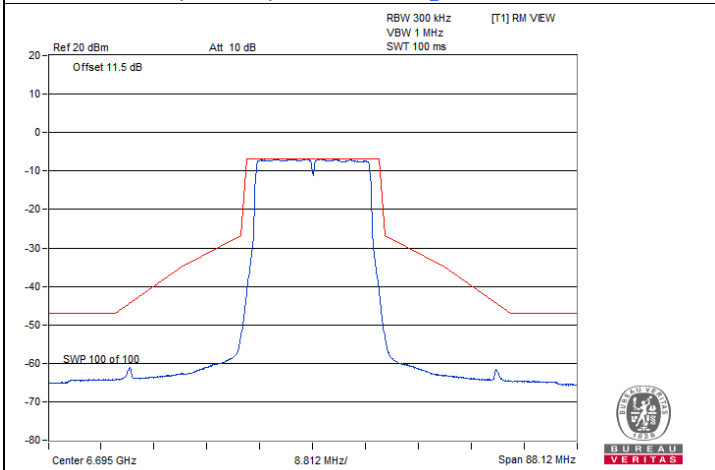

802.11be (EHT20) Beamforming / Chain 1 : CH 149

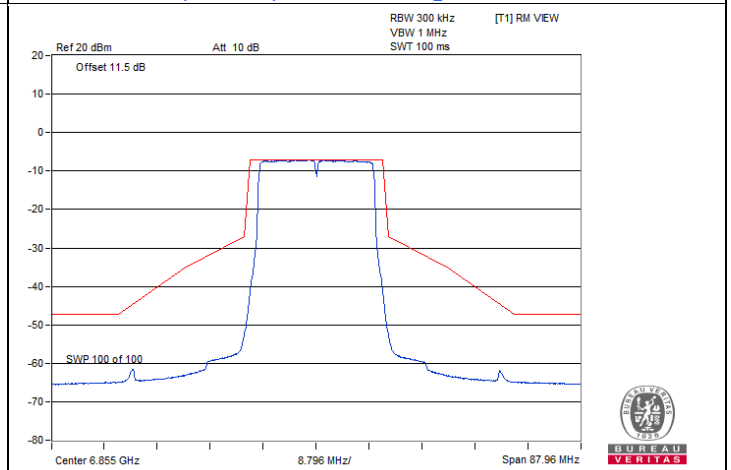

802.11be (EHT20) Beamforming / Chain 1 : CH 181

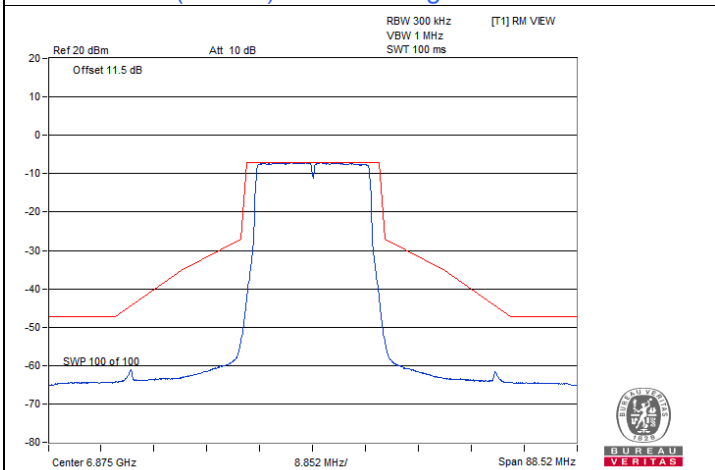

802.11be (EHT20) Beamforming / Chain 1 : CH 185

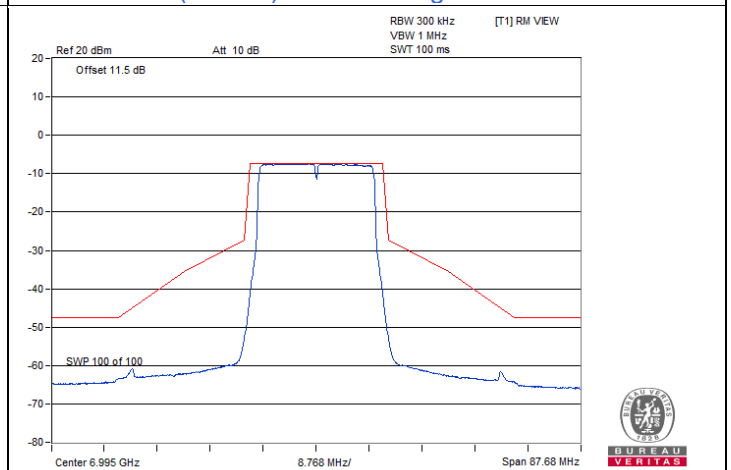

802.11be (EHT20) Beamforming / Chain 1 : CH 209

### Spectrum Plot

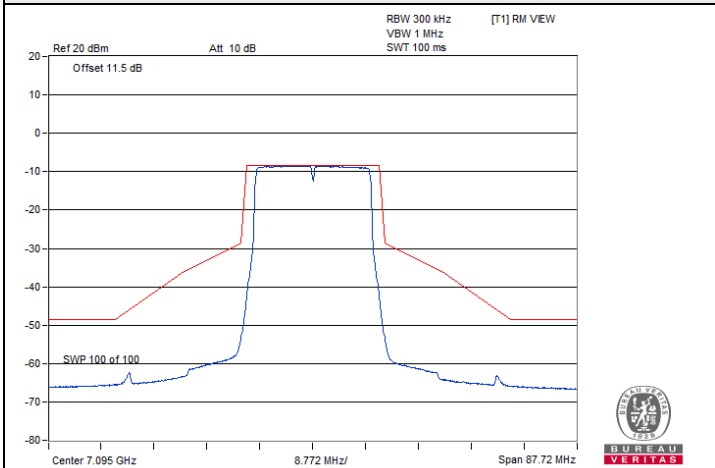

802.11be (EHT20) Beamforming / Chain 1 : CH 229

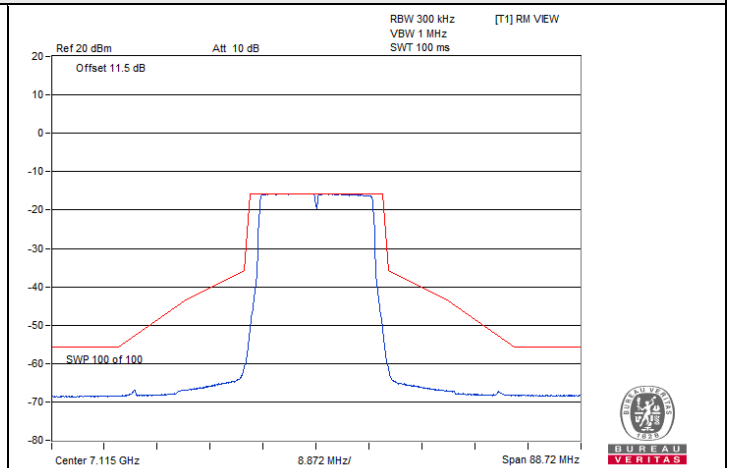

802.11be (EHT20) Beamforming / Chain 1 : CH 233

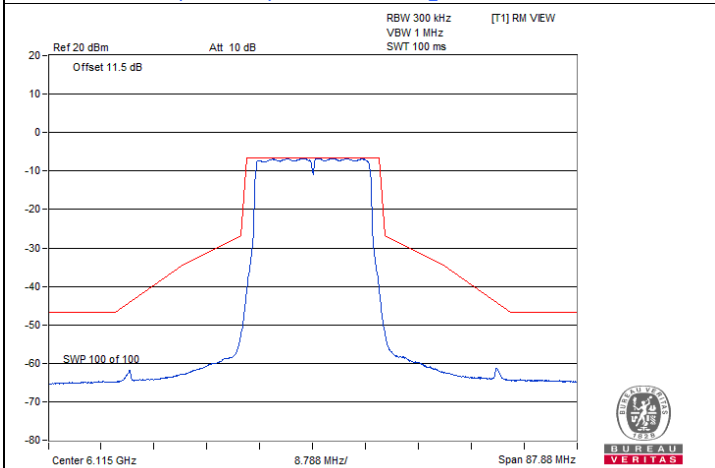

802.11be (EHT20) Beamforming / Chain 2 : CH 33

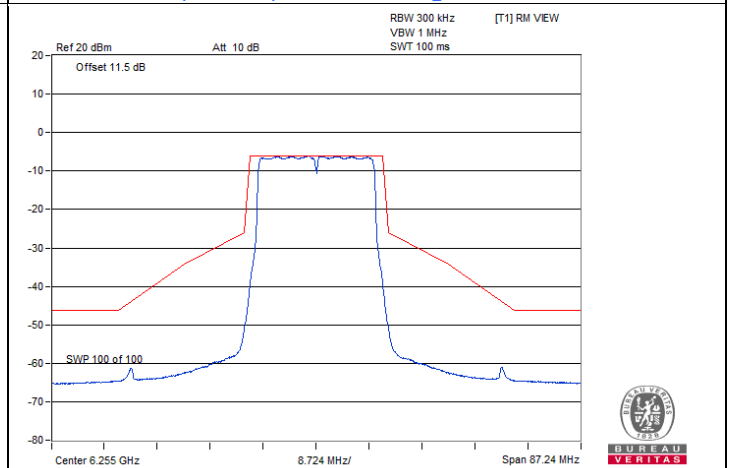

802.11be (EHT20) Beamforming / Chain 2 : CH 61

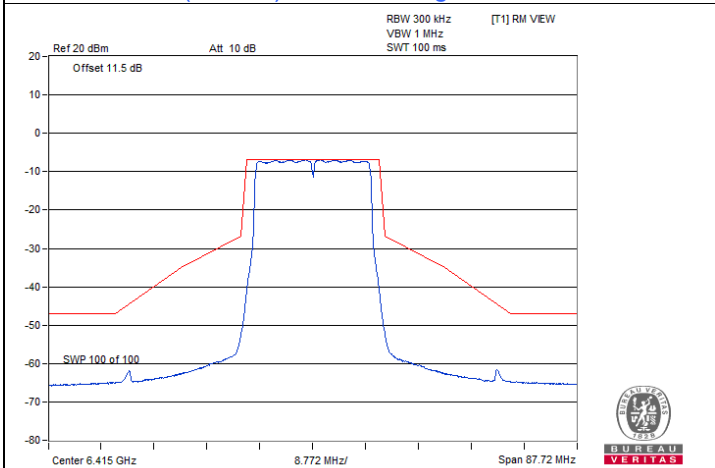

802.11be (EHT20) Beamforming / Chain 2 : CH 93

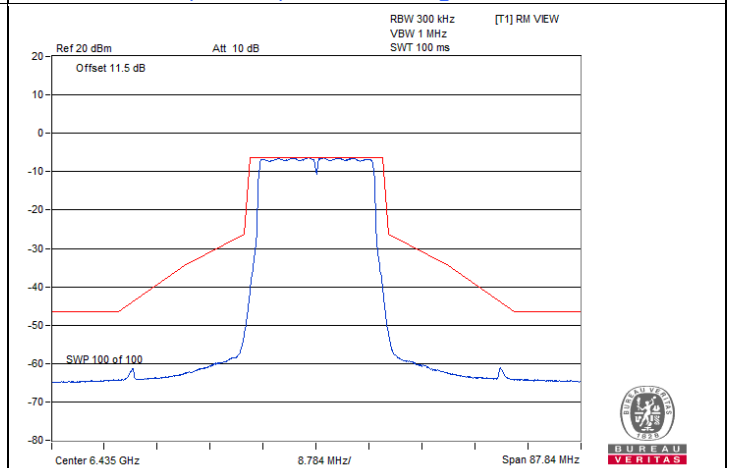

802.11be (EHT20) Beamforming / Chain 2 : CH 97

### Spectrum Plot

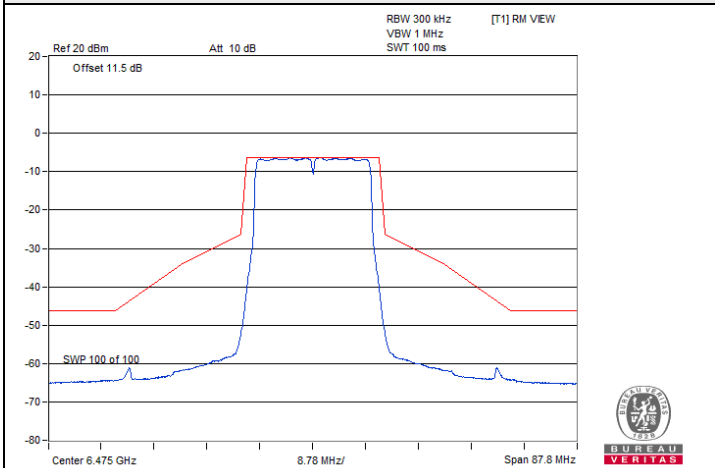

802.11be (EHT20) Beamforming / Chain 2 : CH 105

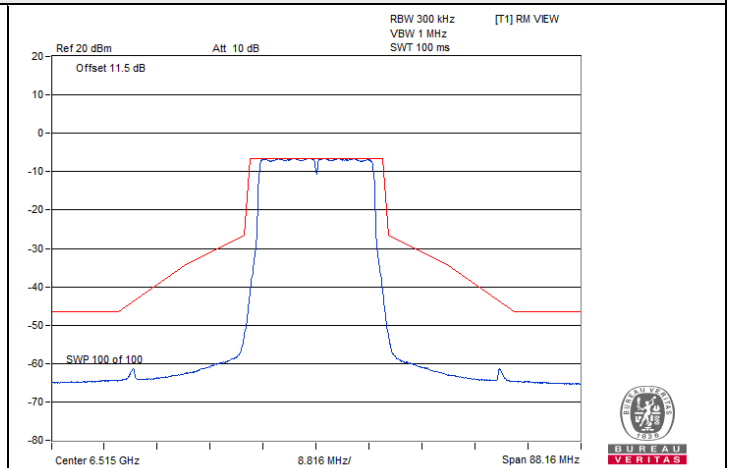

802.11be (EHT20) Beamforming / Chain 2 : CH 113

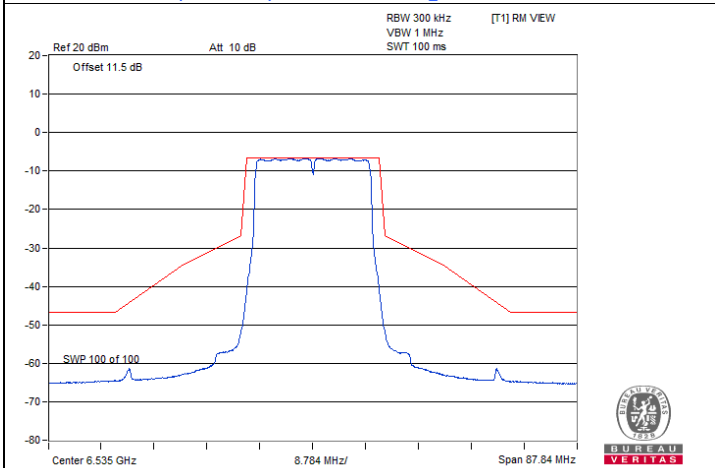

802.11be (EHT20) Beamforming / Chain 2 : CH 117

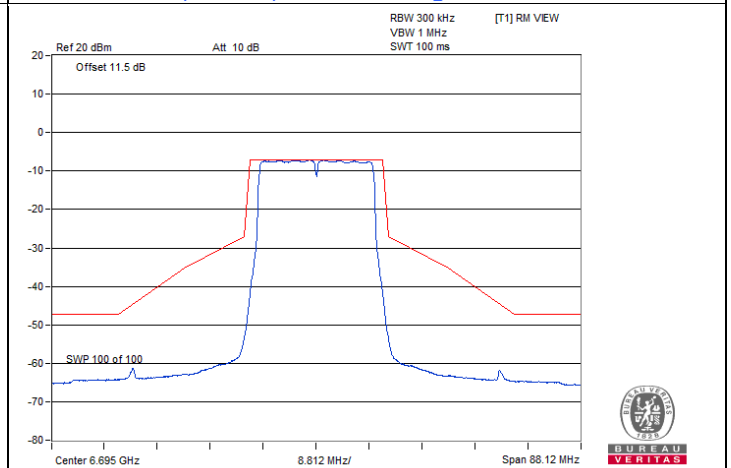

802.11be (EHT20) Beamforming / Chain 2 : CH 149

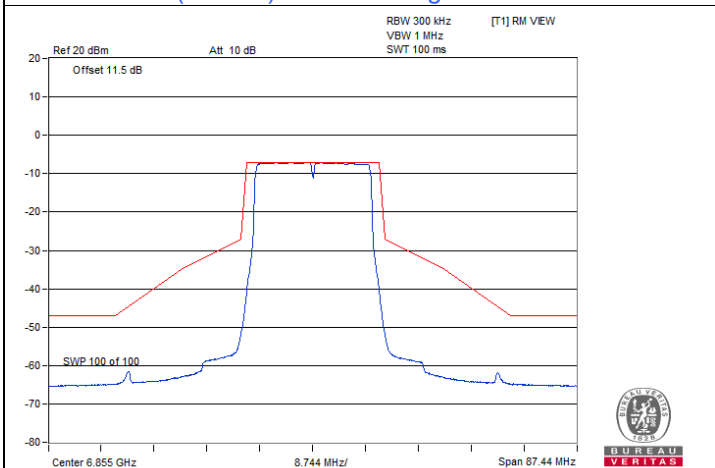

802.11be (EHT20) Beamforming / Chain 2 : CH 181

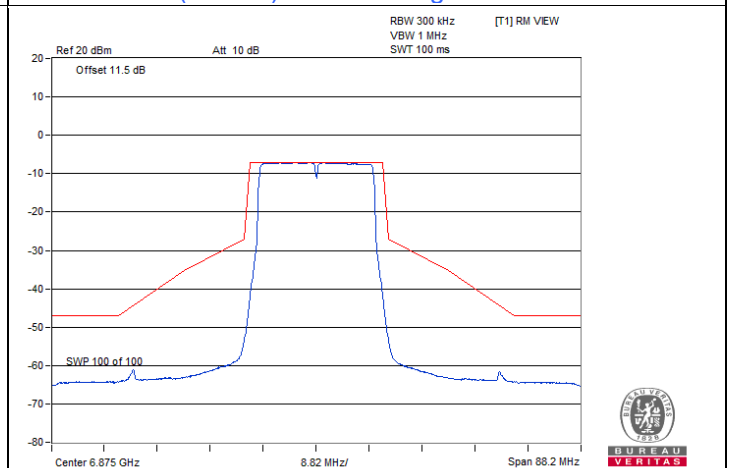

802.11be (EHT20) Beamforming / Chain 2 : CH 185

### Spectrum Plot

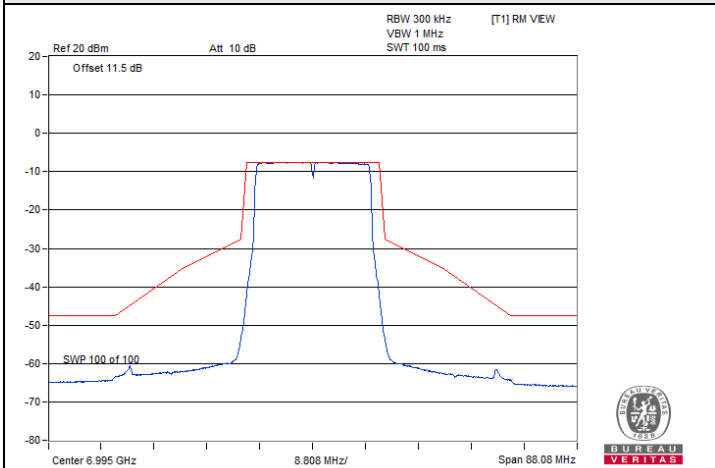

802.11be (EHT20) Beamforming / Chain 2 : CH 209

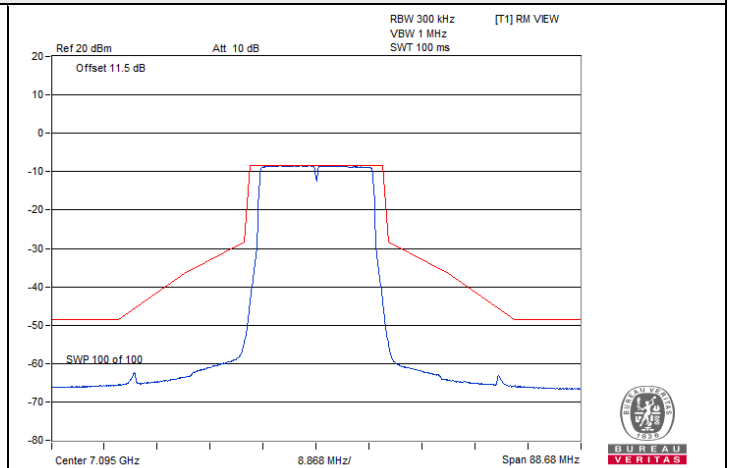

802.11be (EHT20) Beamforming / Chain 2 : CH 229

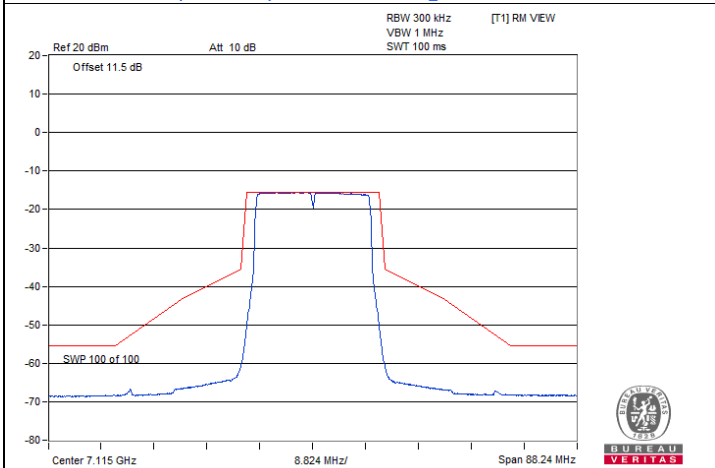

802.11be (EHT20) Beamforming / Chain 2 : CH 233

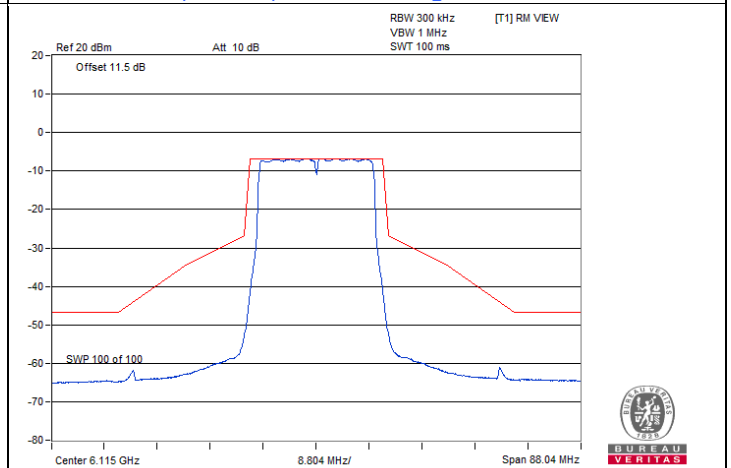

802.11be (EHT20) Beamforming / Chain 3 : CH 33

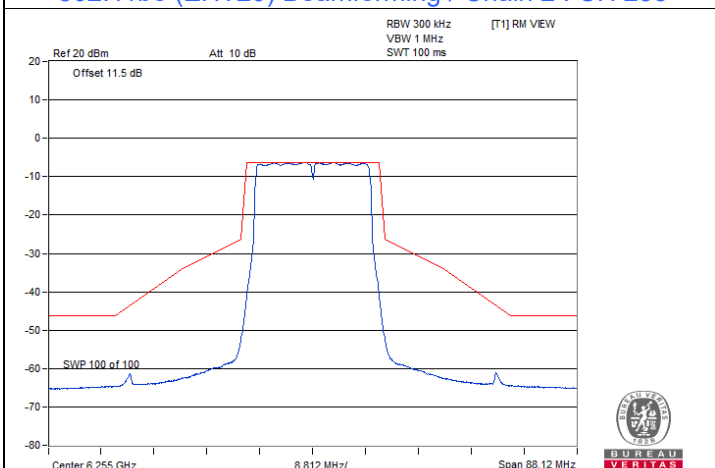

802.11be (EHT20) Beamforming / Chain 3 : CH 61

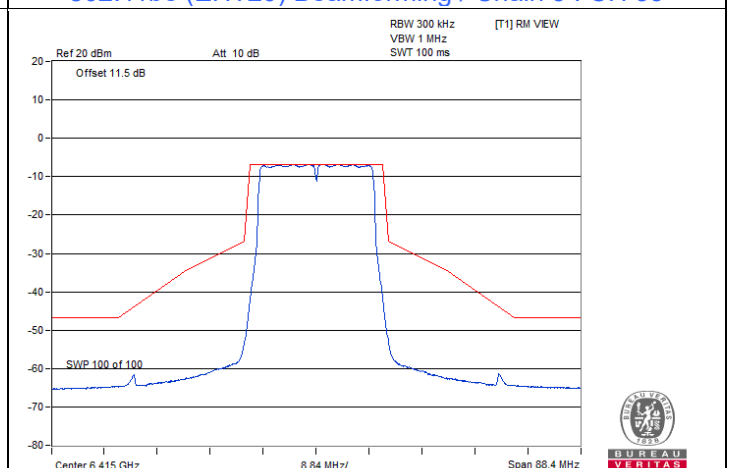

802.11be (EHT20) Beamforming / Chain 3 : CH 93



### Spectrum Plot

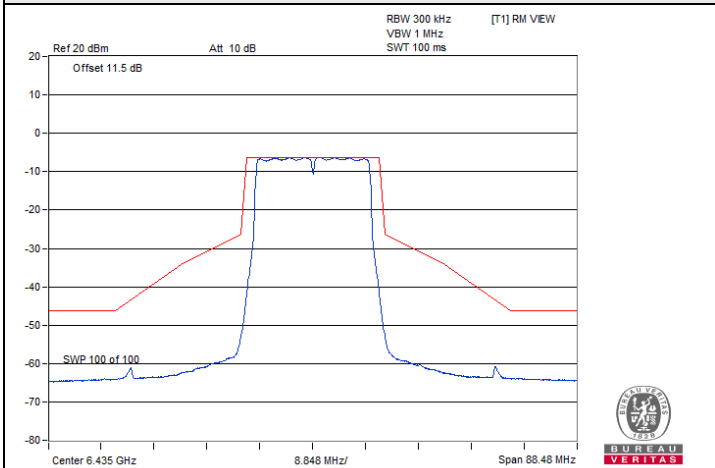

802.11be (EHT20) Beamforming / Chain 3 : CH 97

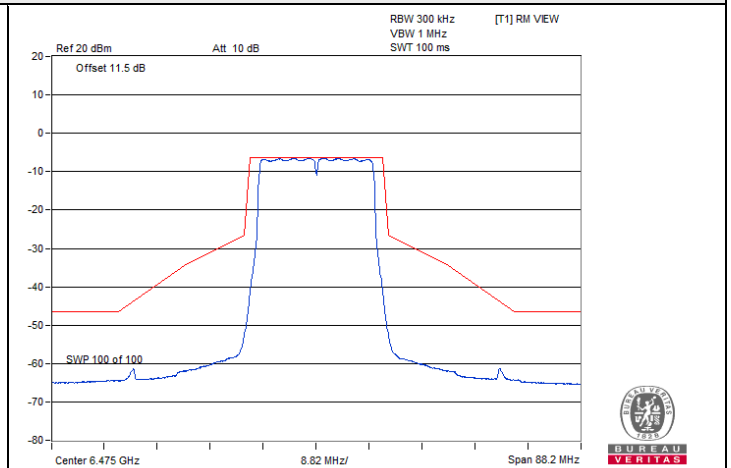

802.11be (EHT20) Beamforming / Chain 3 : CH 105

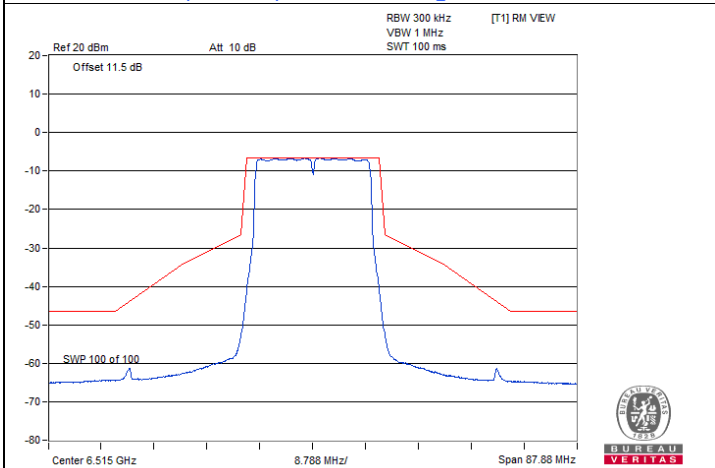

802.11be (EHT20) Beamforming / Chain 3 : CH 113

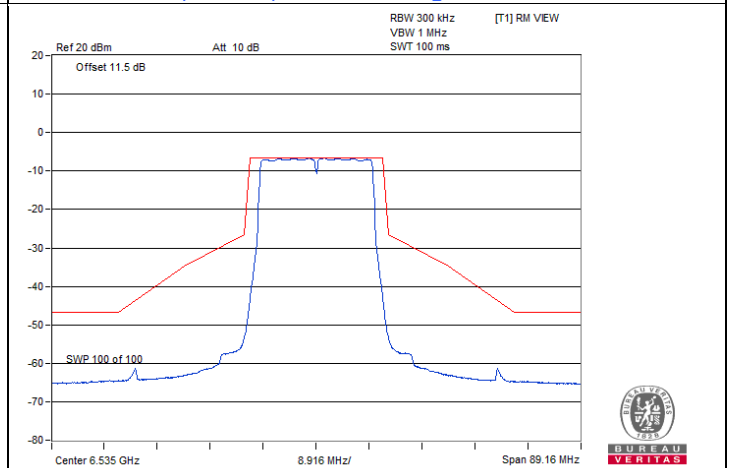

802.11be (EHT20) Beamforming / Chain 3 : CH 117

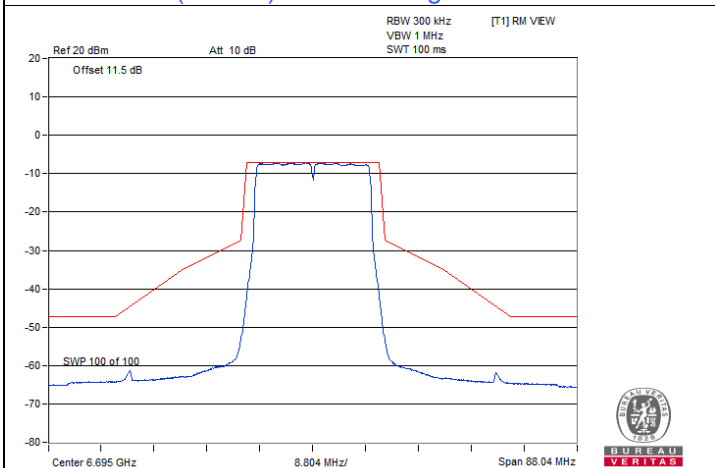

802.11be (EHT20) Beamforming / Chain 3 : CH 149

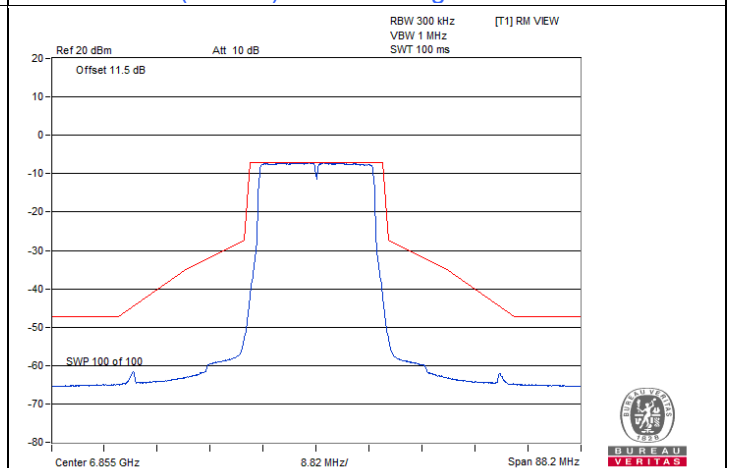

802.11be (EHT20) Beamforming / Chain 3 : CH 181

### Spectrum Plot

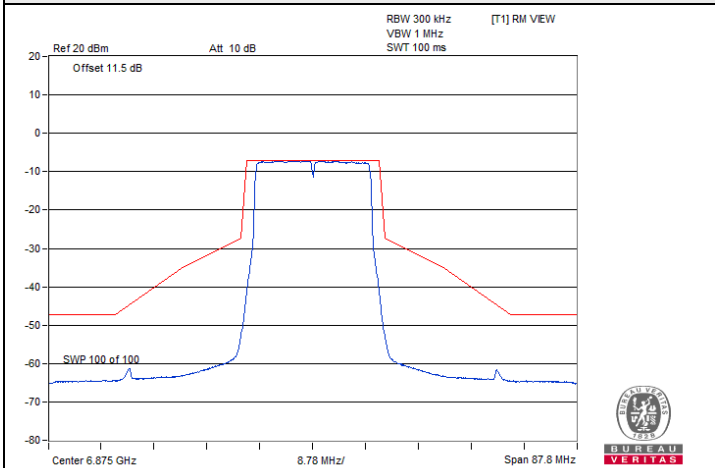

802.11be (EHT20) Beamforming / Chain 3 : CH 185

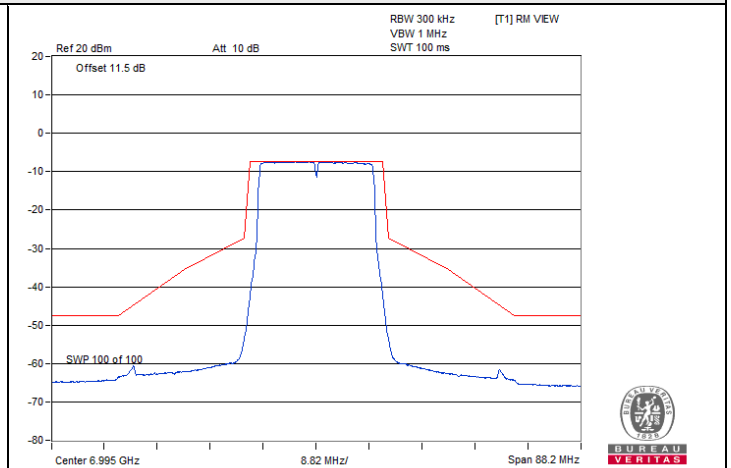

802.11be (EHT20) Beamforming / Chain 3 : CH 209

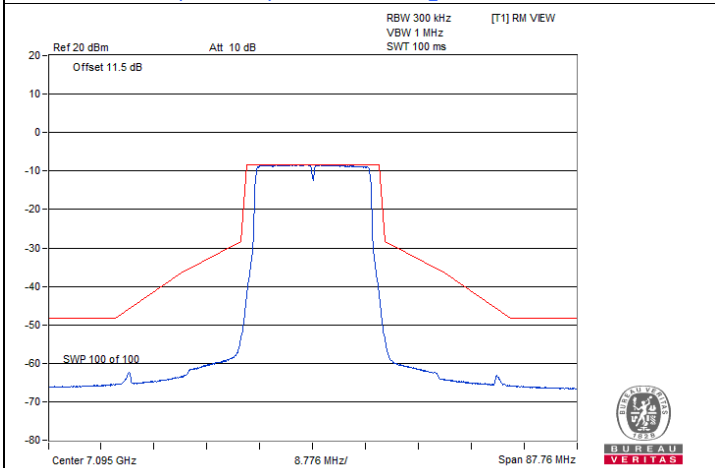

802.11be (EHT20) Beamforming / Chain 3 : CH 229

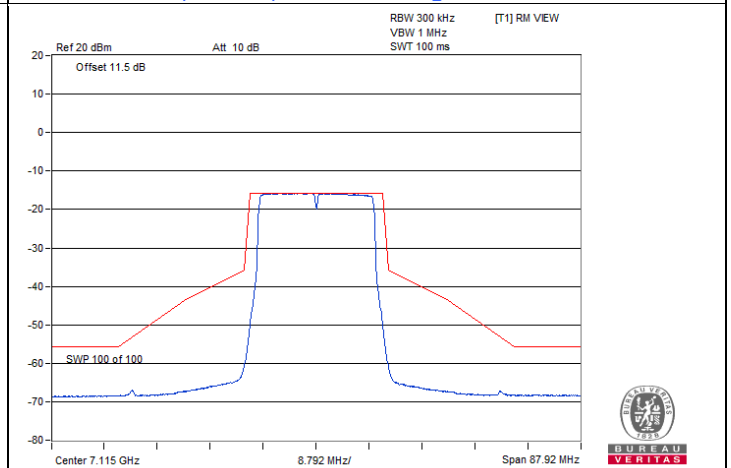

802.11be (EHT20) Beamforming / Chain 3 : CH 233

# 802.11be (EHT40) Beamforming

## Spectrum Plot

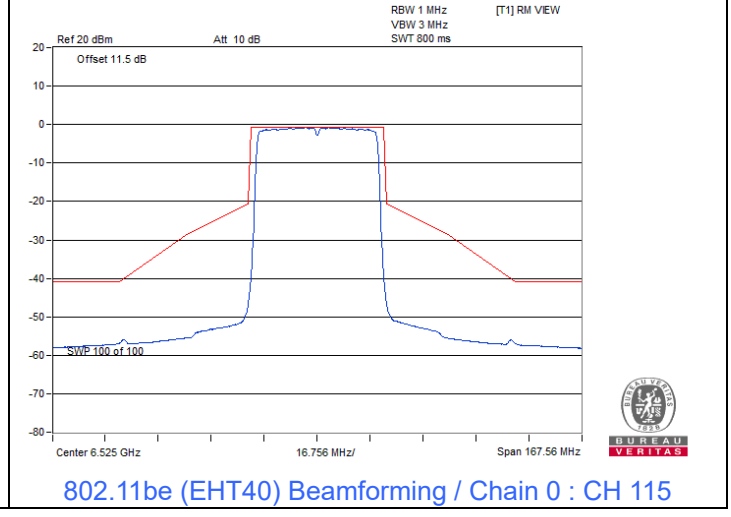
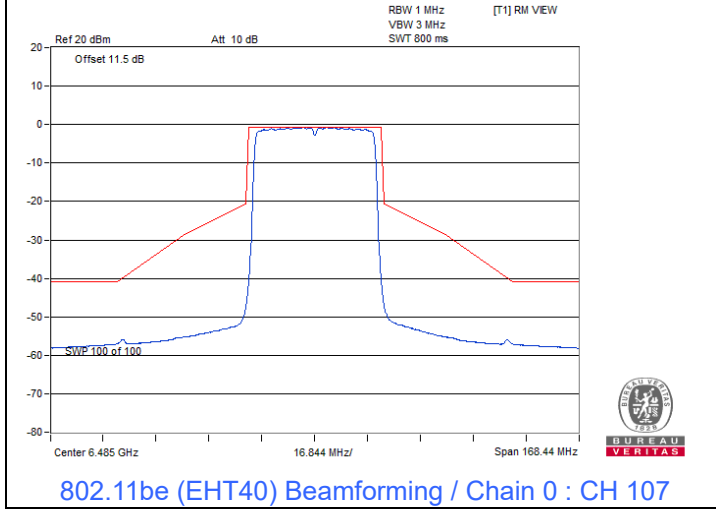
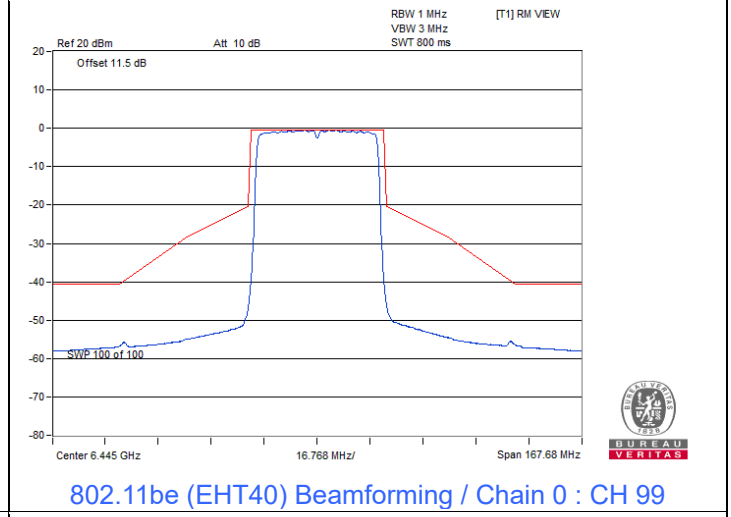
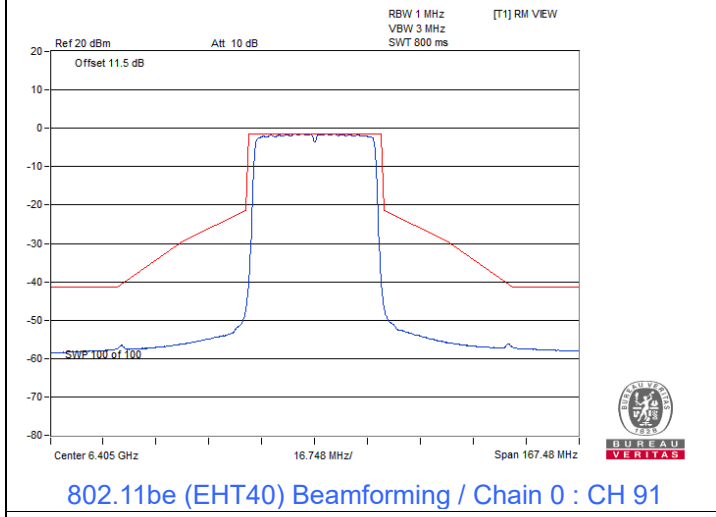
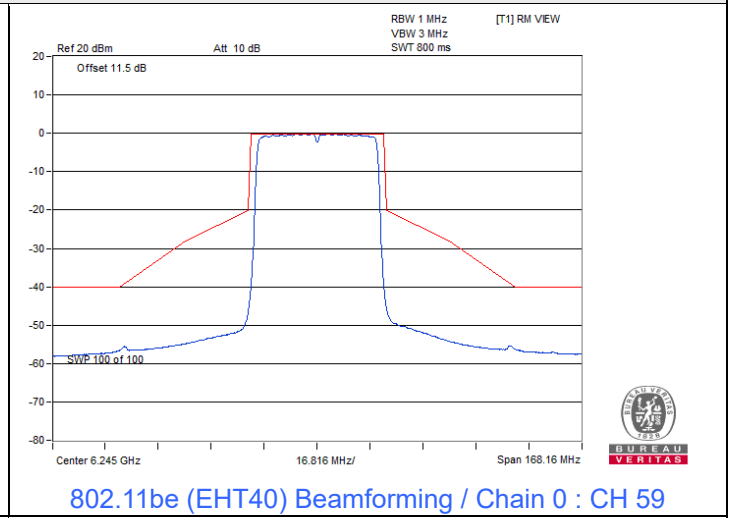
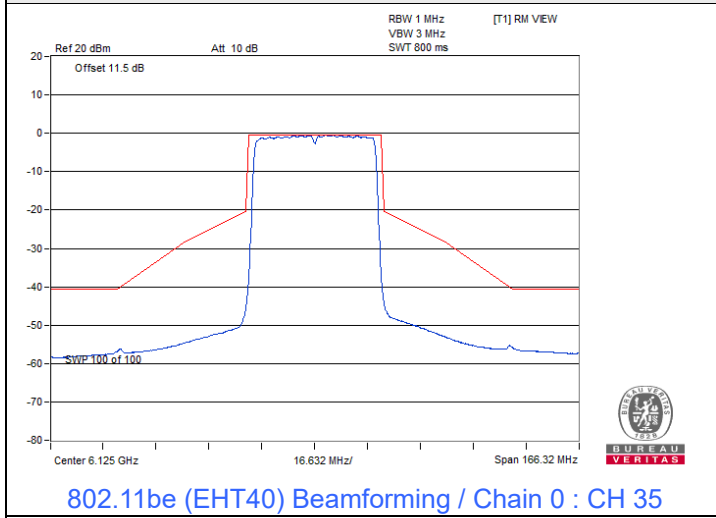

### Spectrum Plot

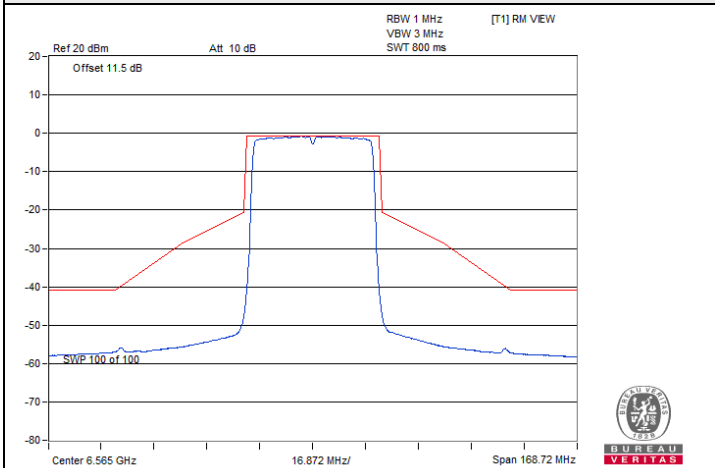

802.11be (EHT40) Beamforming / Chain 0 : CH 123

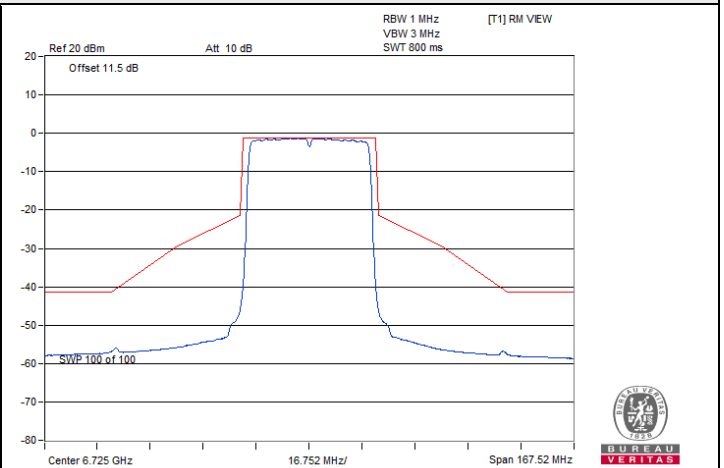

802.11be (EHT40) Beamforming / Chain 0 : CH 155

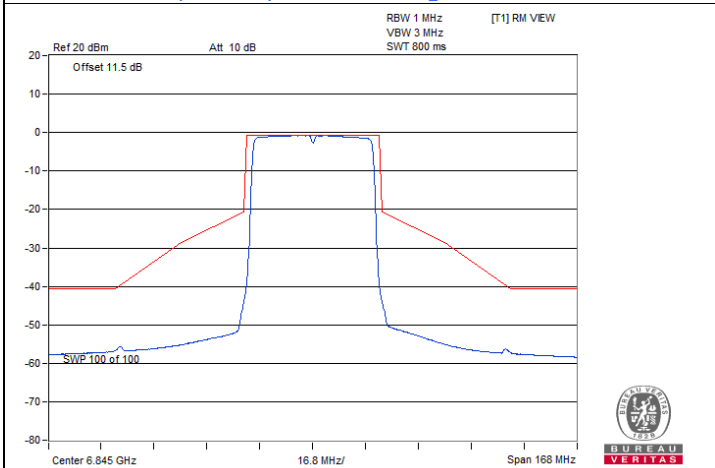

802.11be (EHT40) Beamforming / Chain 0 : CH 179

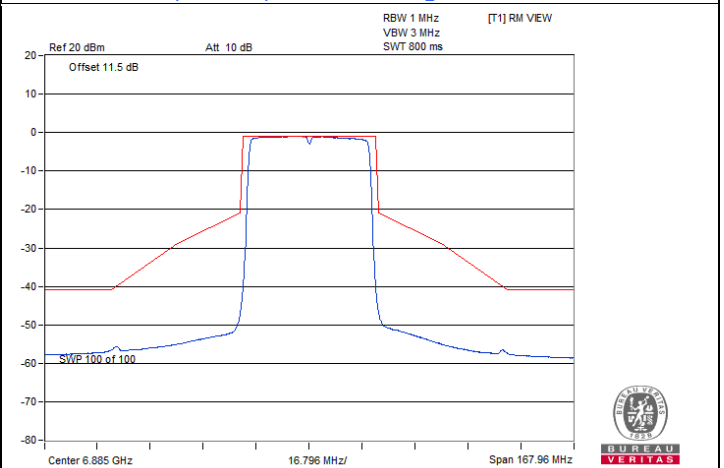

802.11be (EHT40) Beamforming / Chain 0 : CH 187

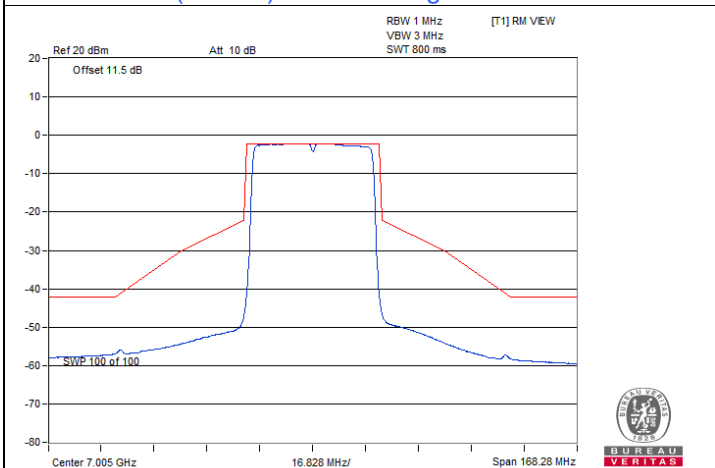

802.11be (EHT40) Beamforming / Chain 0 : CH 211

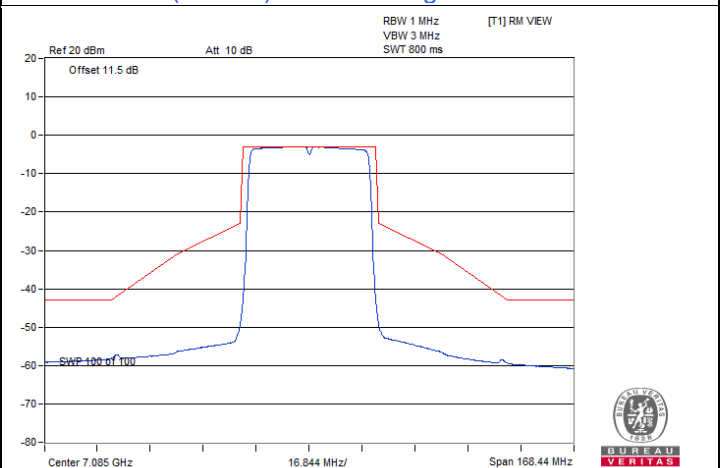

802.11be (EHT40) Beamforming / Chain 0 : CH 227

### Spectrum Plot

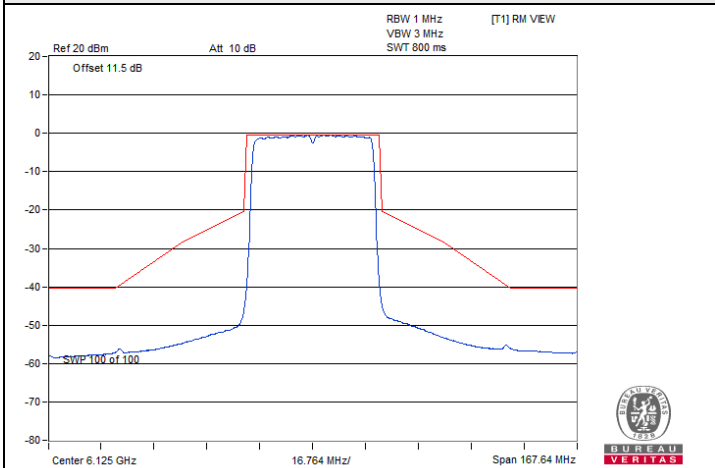

802.11be (EHT40) Beamforming / Chain 1 : CH 35

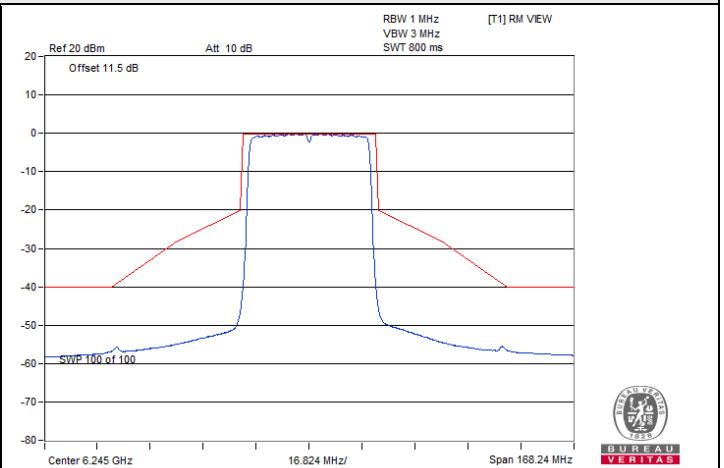

802.11be (EHT40) Beamforming / Chain 1 : CH 59

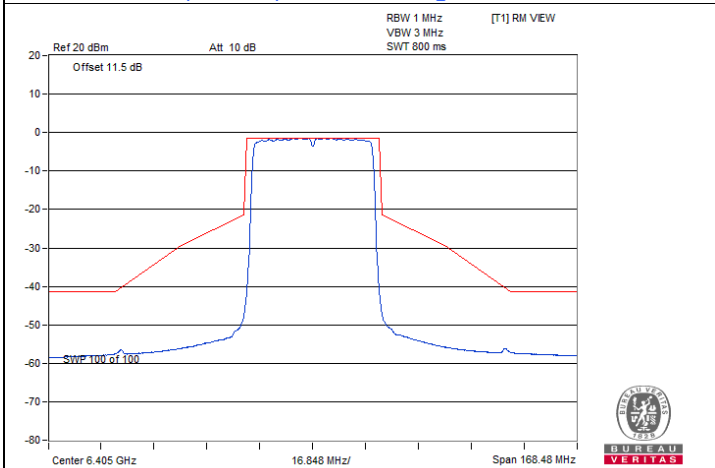

802.11be (EHT40) Beamforming / Chain 1 : CH 91

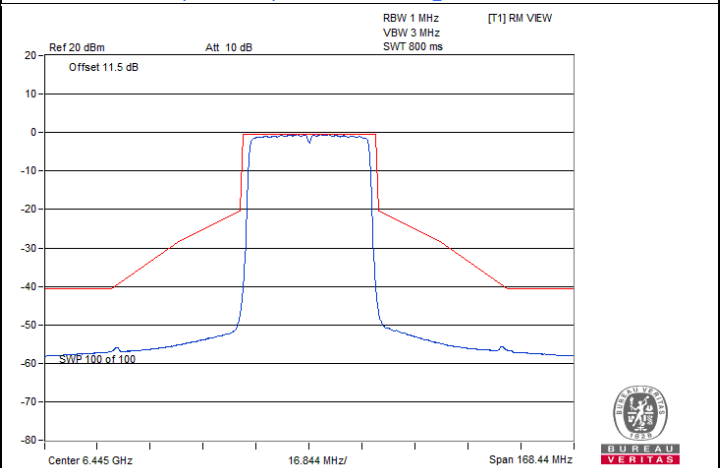

802.11be (EHT40) Beamforming / Chain 1 : CH 99

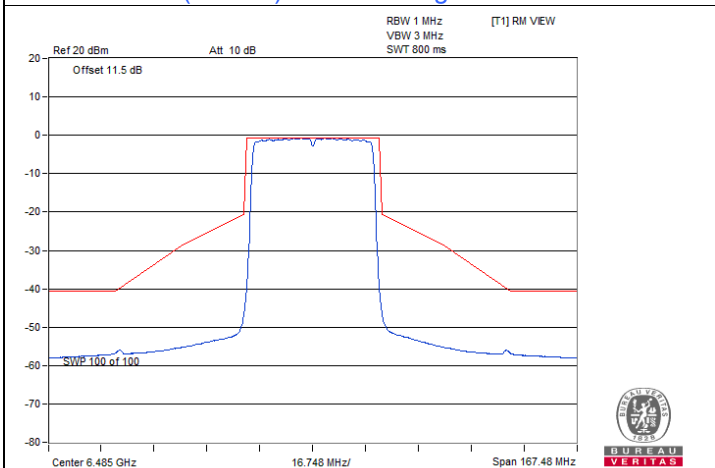

802.11be (EHT40) Beamforming / Chain 1 : CH 107

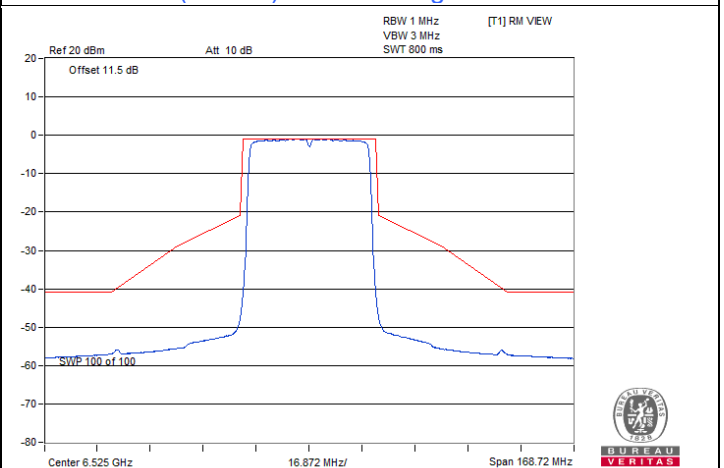

802.11be (EHT40) Beamforming / Chain 1 : CH 115

### Spectrum Plot

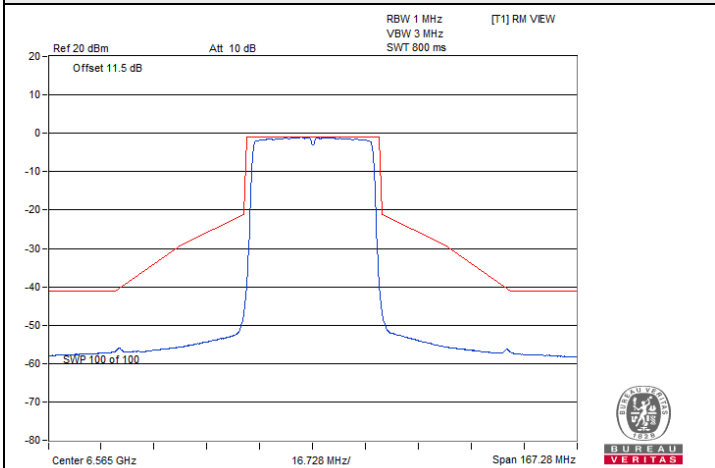

802.11be (EHT40) Beamforming / Chain 1 : CH 123

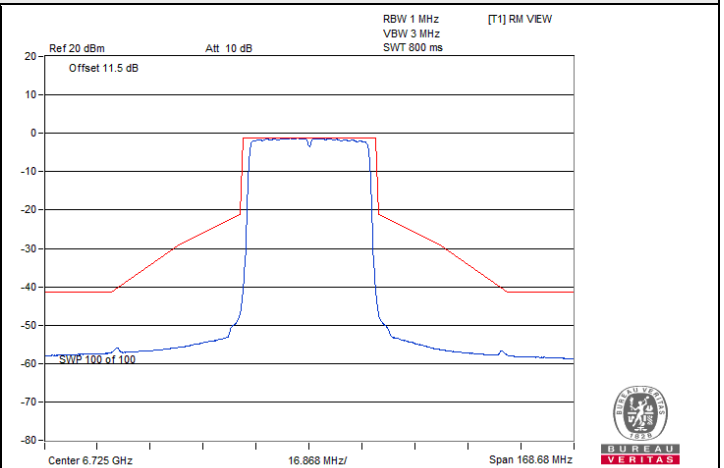

802.11be (EHT40) Beamforming / Chain 1 : CH 155

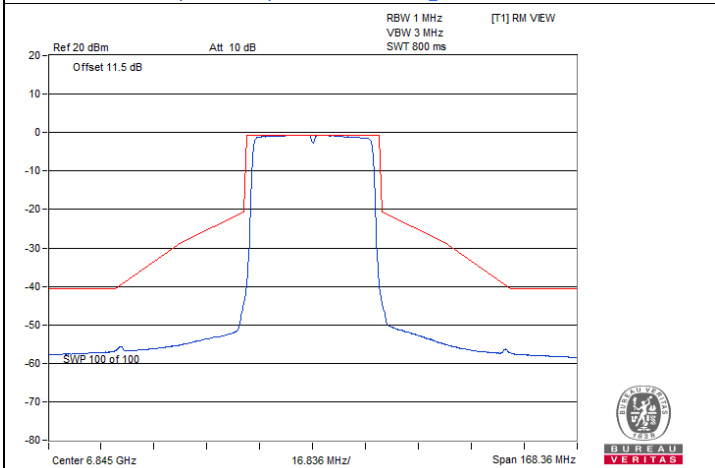

802.11be (EHT40) Beamforming / Chain 1 : CH 179

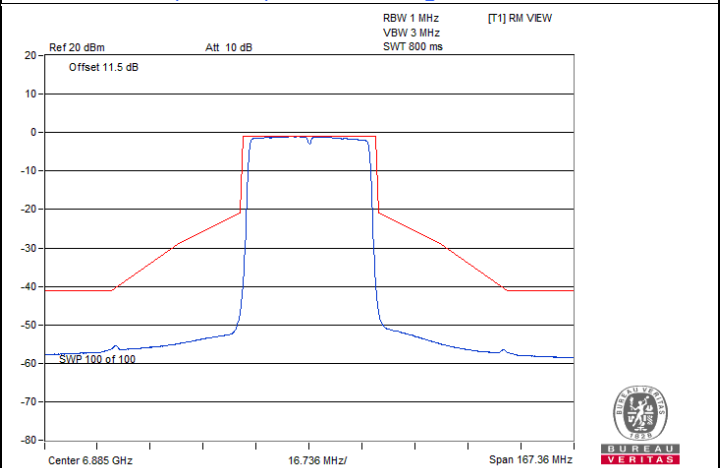

802.11be (EHT40) Beamforming / Chain 1 : CH 187

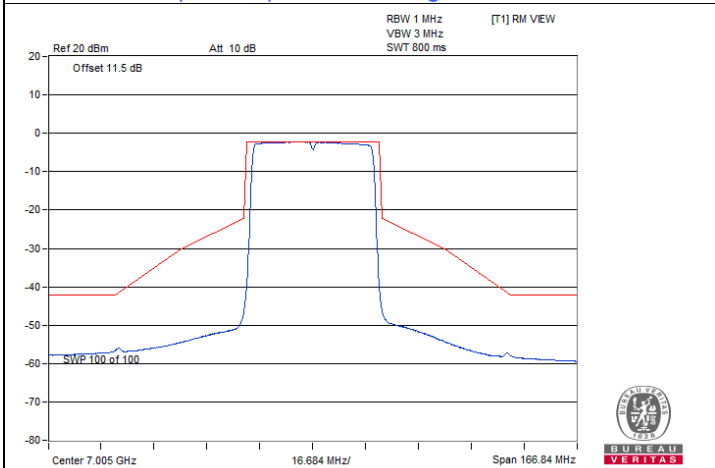

802.11be (EHT40) Beamforming / Chain 1 : CH 211

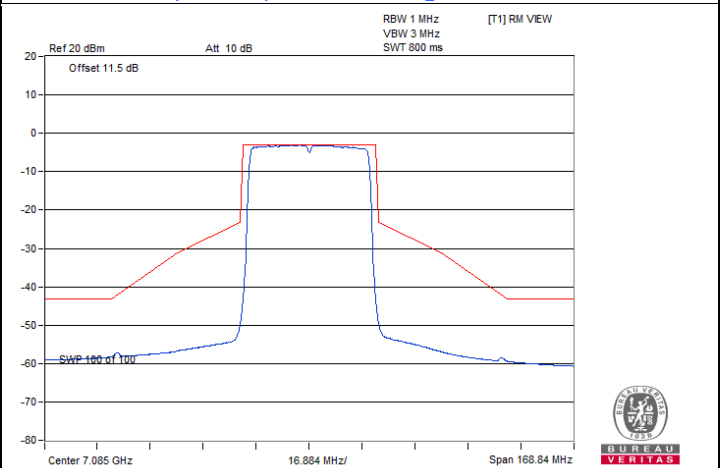

802.11be (EHT40) Beamforming / Chain 1 : CH 227

### Spectrum Plot

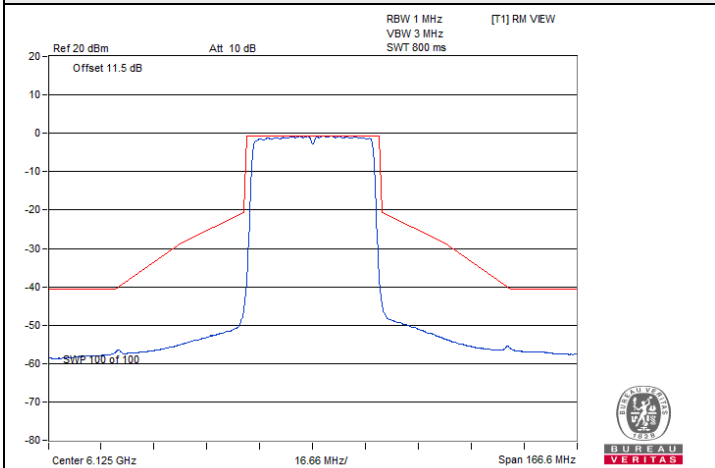

802.11be (EHT40) Beamforming / Chain 2 : CH 35

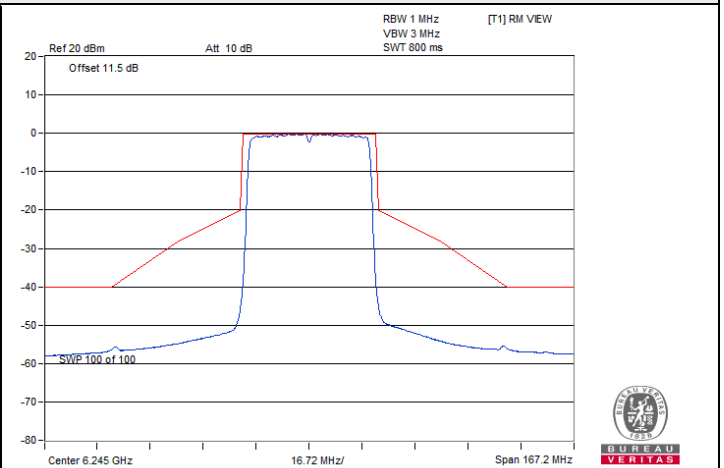

802.11be (EHT40) Beamforming / Chain 2 : CH 59

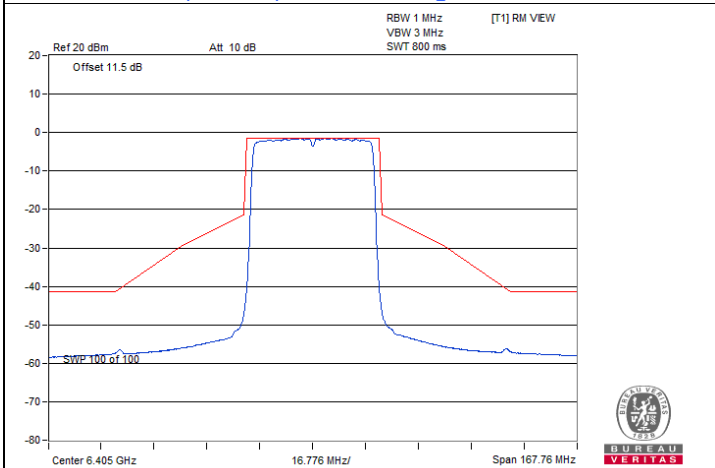

802.11be (EHT40) Beamforming / Chain 2 : CH 91

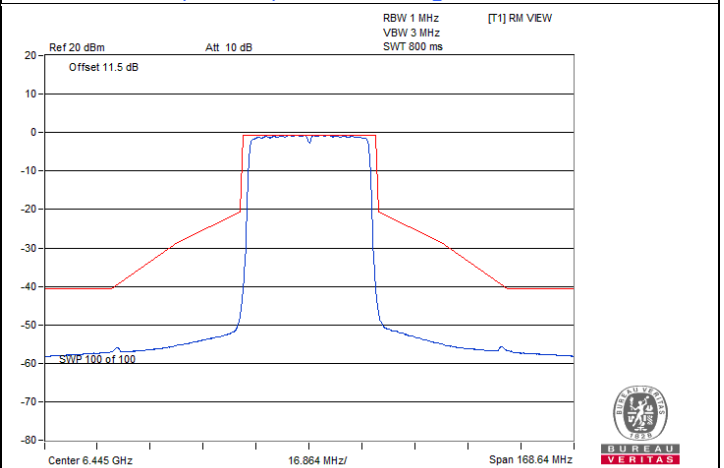

802.11be (EHT40) Beamforming / Chain 2 : CH 99

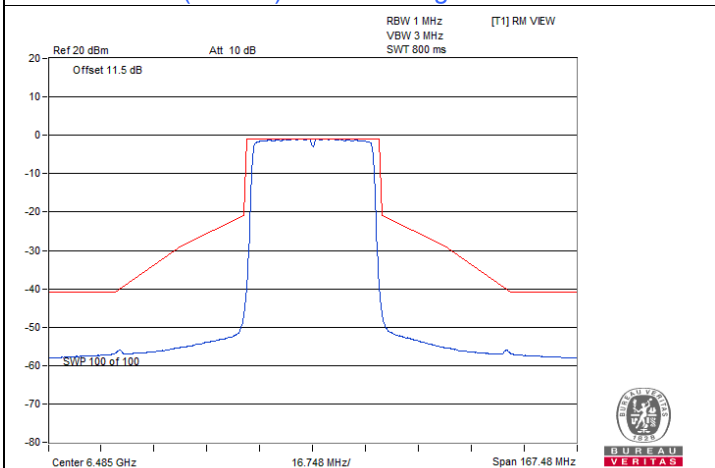

802.11be (EHT40) Beamforming / Chain 2 : CH 107

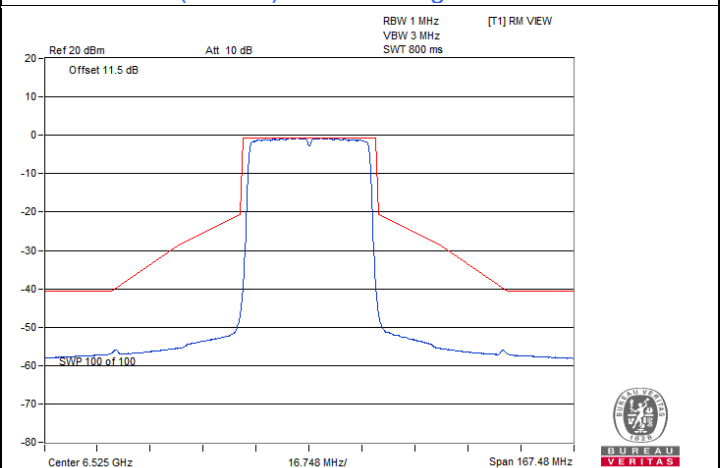

802.11be (EHT40) Beamforming / Chain 2 : CH 115

### Spectrum Plot

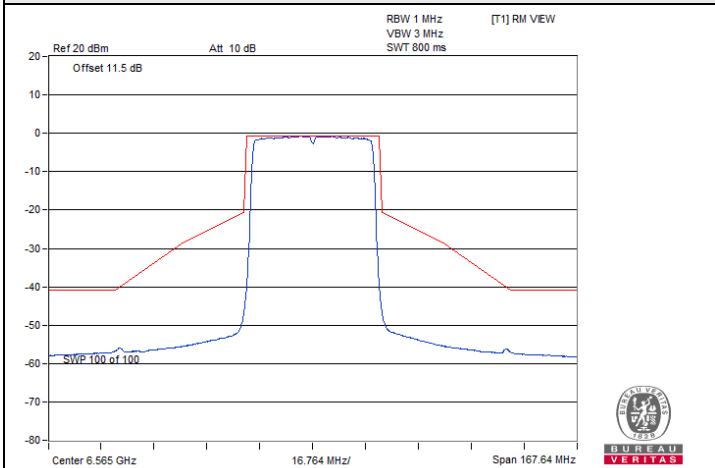

802.11be (EHT40) Beamforming / Chain 2 : CH 123

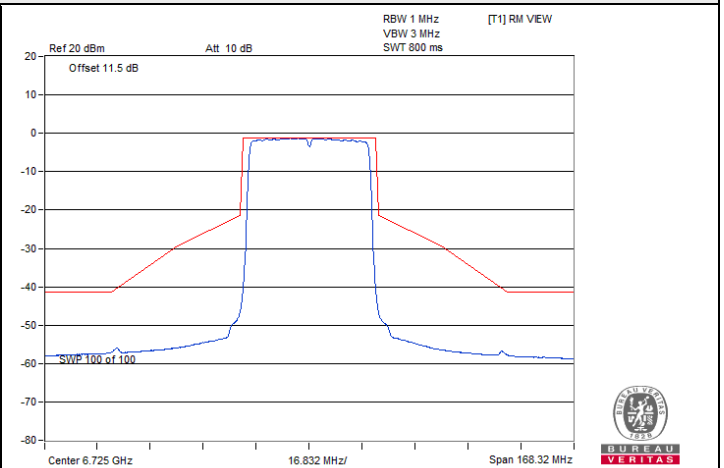

802.11be (EHT40) Beamforming / Chain 2 : CH 155

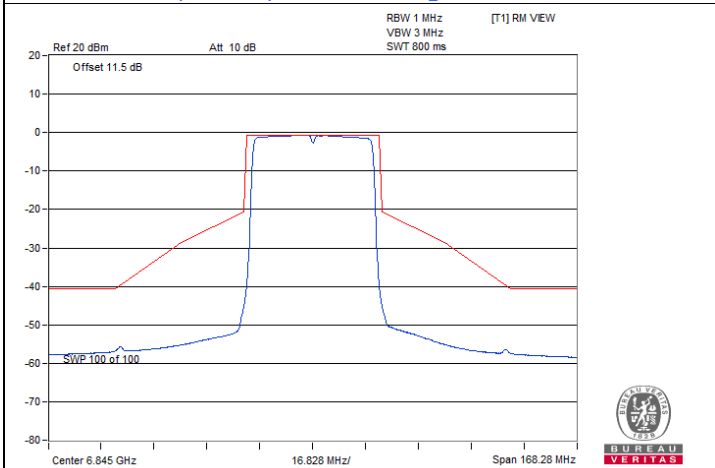

802.11be (EHT40) Beamforming / Chain 2 : CH 179

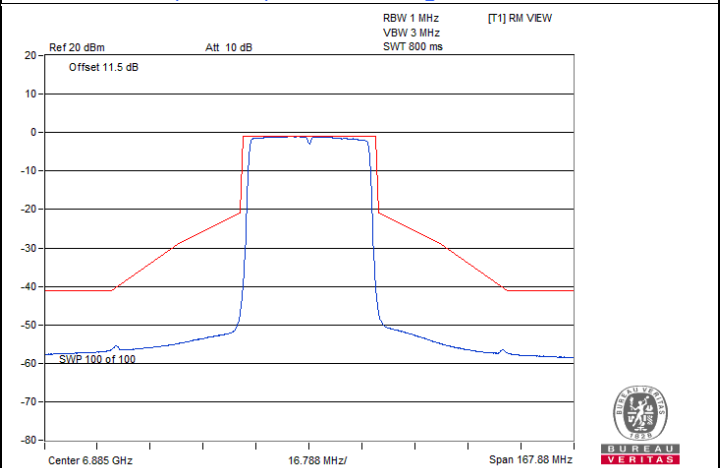

802.11be (EHT40) Beamforming / Chain 2 : CH 187

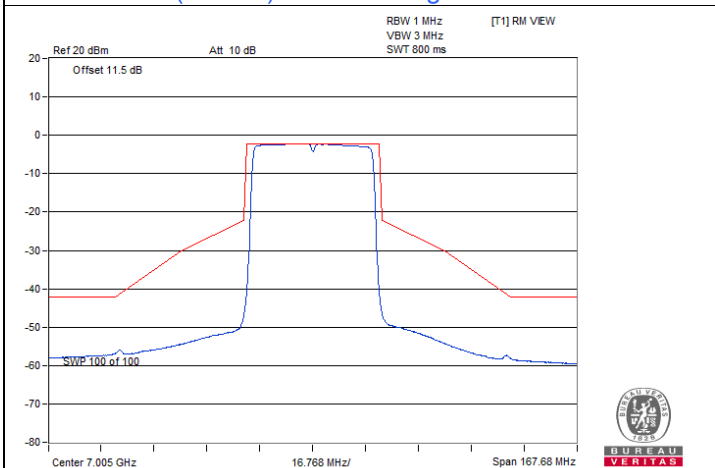

802.11be (EHT40) Beamforming / Chain 2 : CH 211

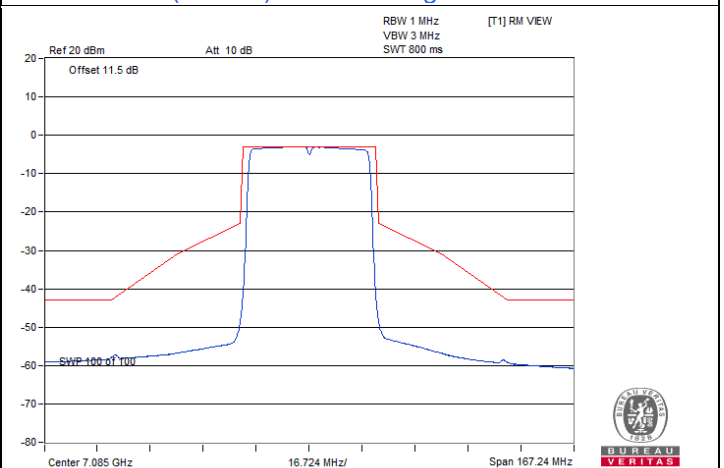

802.11be (EHT40) Beamforming / Chain 2 : CH 227



### Spectrum Plot

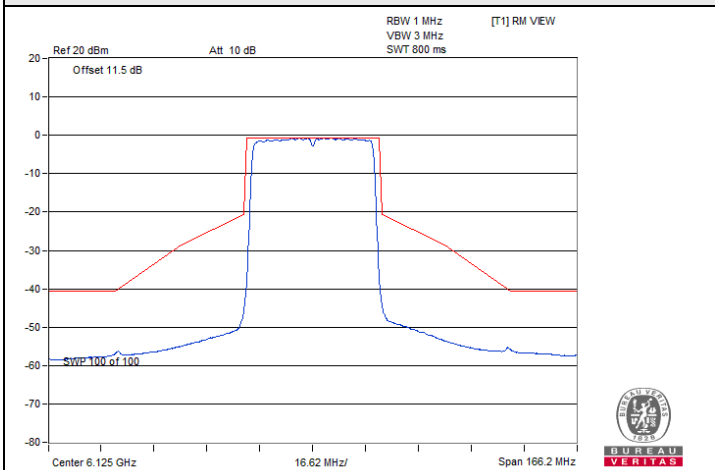

802.11be (EHT40) Beamforming / Chain 3 : CH 35

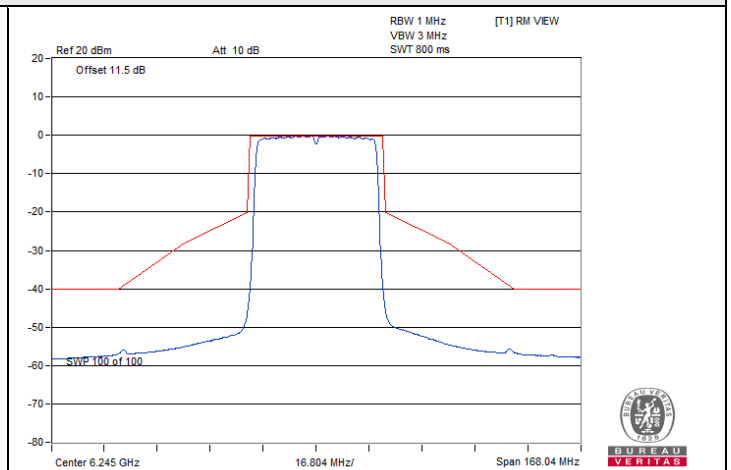

802.11be (EHT40) Beamforming / Chain 3 : CH 59

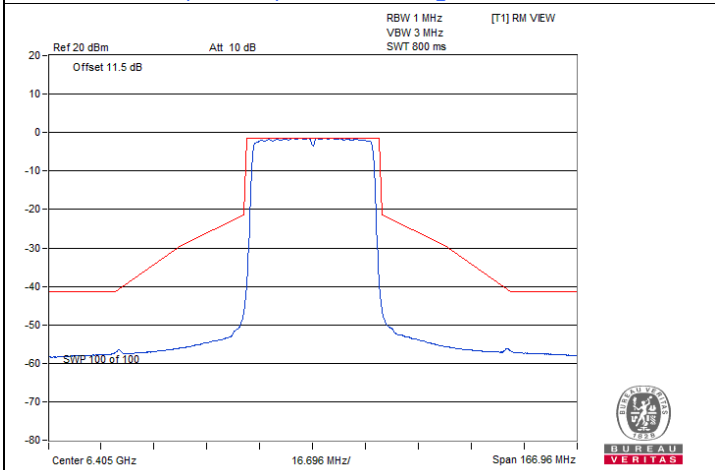

802.11be (EHT40) Beamforming / Chain 3 : CH 91

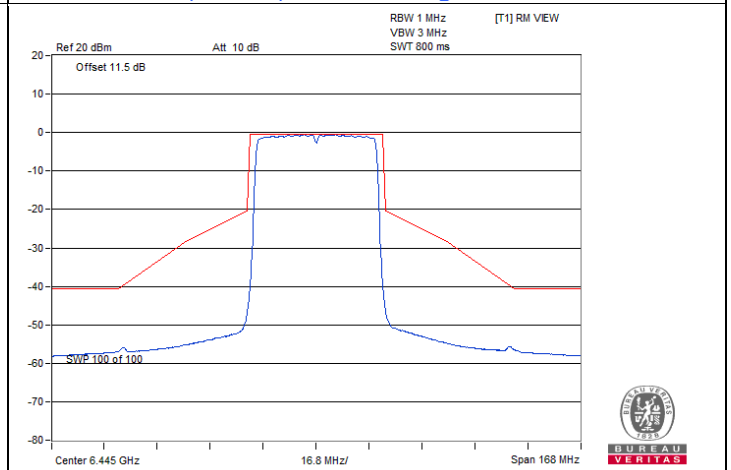

802.11be (EHT40) Beamforming / Chain 3 : CH 99

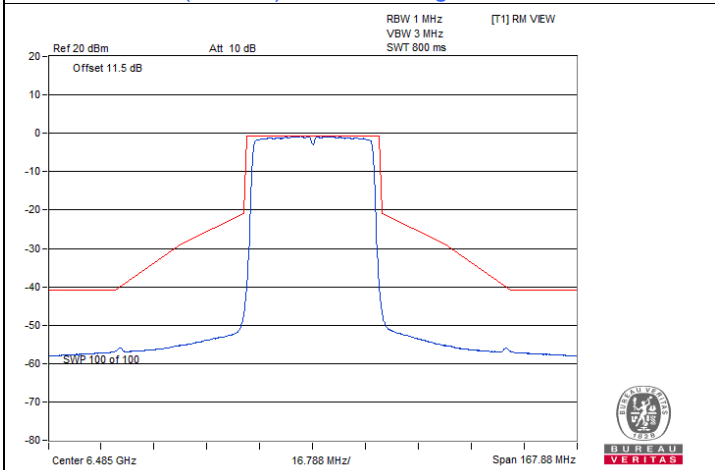

802.11be (EHT40) Beamforming / Chain 3 : CH 107

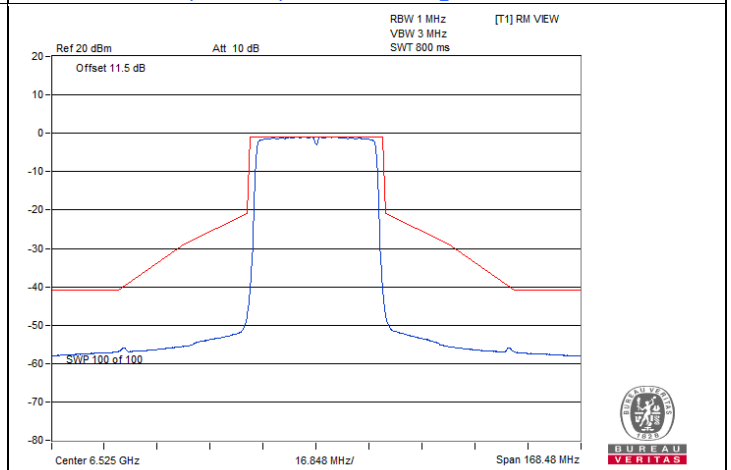

802.11be (EHT40) Beamforming / Chain 3 : CH 115

### Spectrum Plot

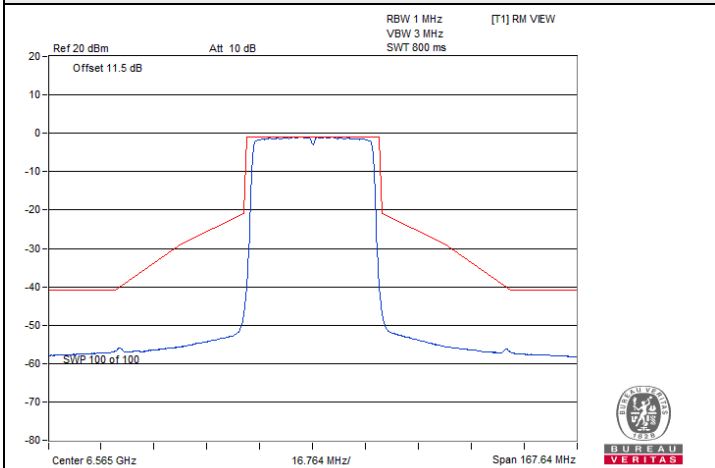

802.11be (EHT40) Beamforming / Chain 3 : CH 123

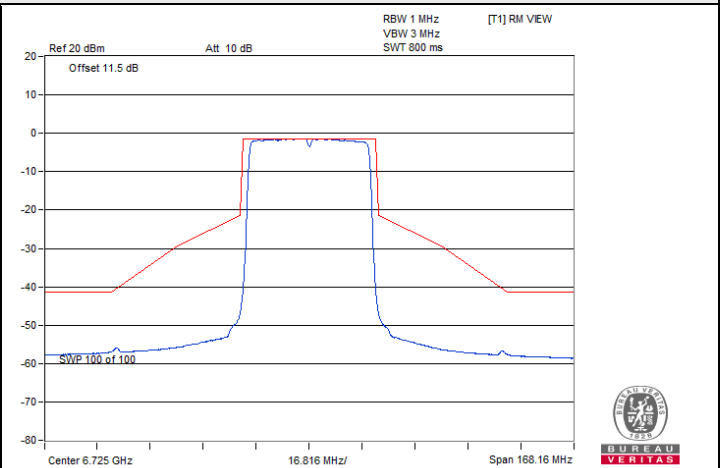

802.11be (EHT40) Beamforming / Chain 3 : CH 155

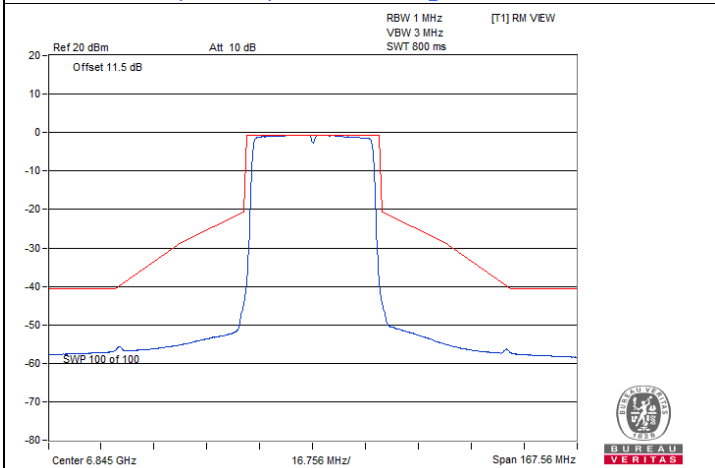

802.11be (EHT40) Beamforming / Chain 3 : CH 179

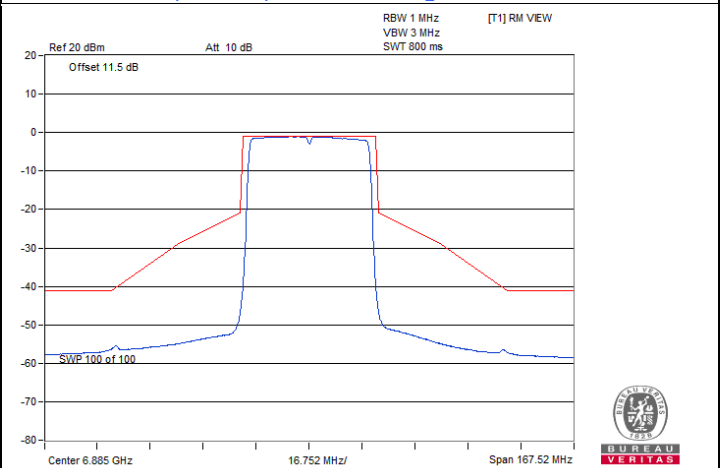

802.11be (EHT40) Beamforming / Chain 3 : CH 187

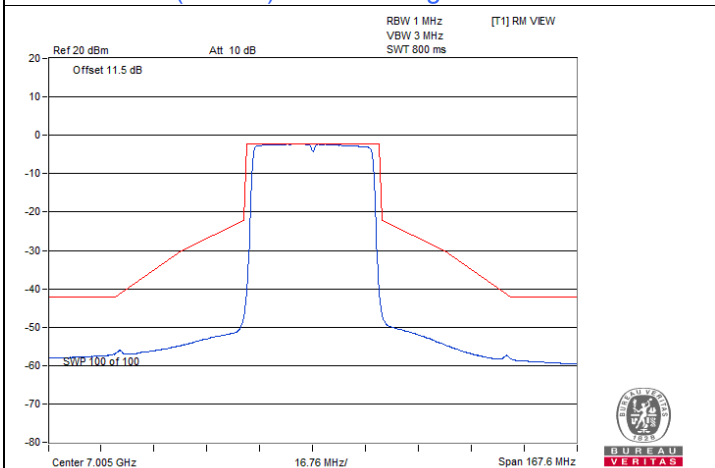

802.11be (EHT40) Beamforming / Chain 3 : CH 211

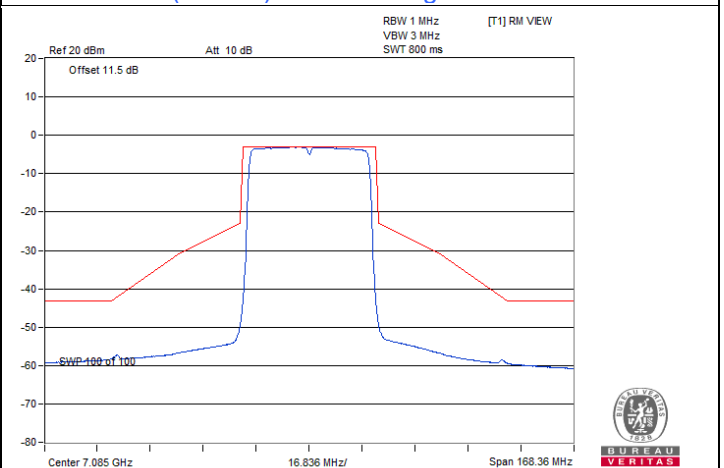

802.11be (EHT40) Beamforming / Chain 3 : CH 227

### 802.11be (EHT80) Beamforming

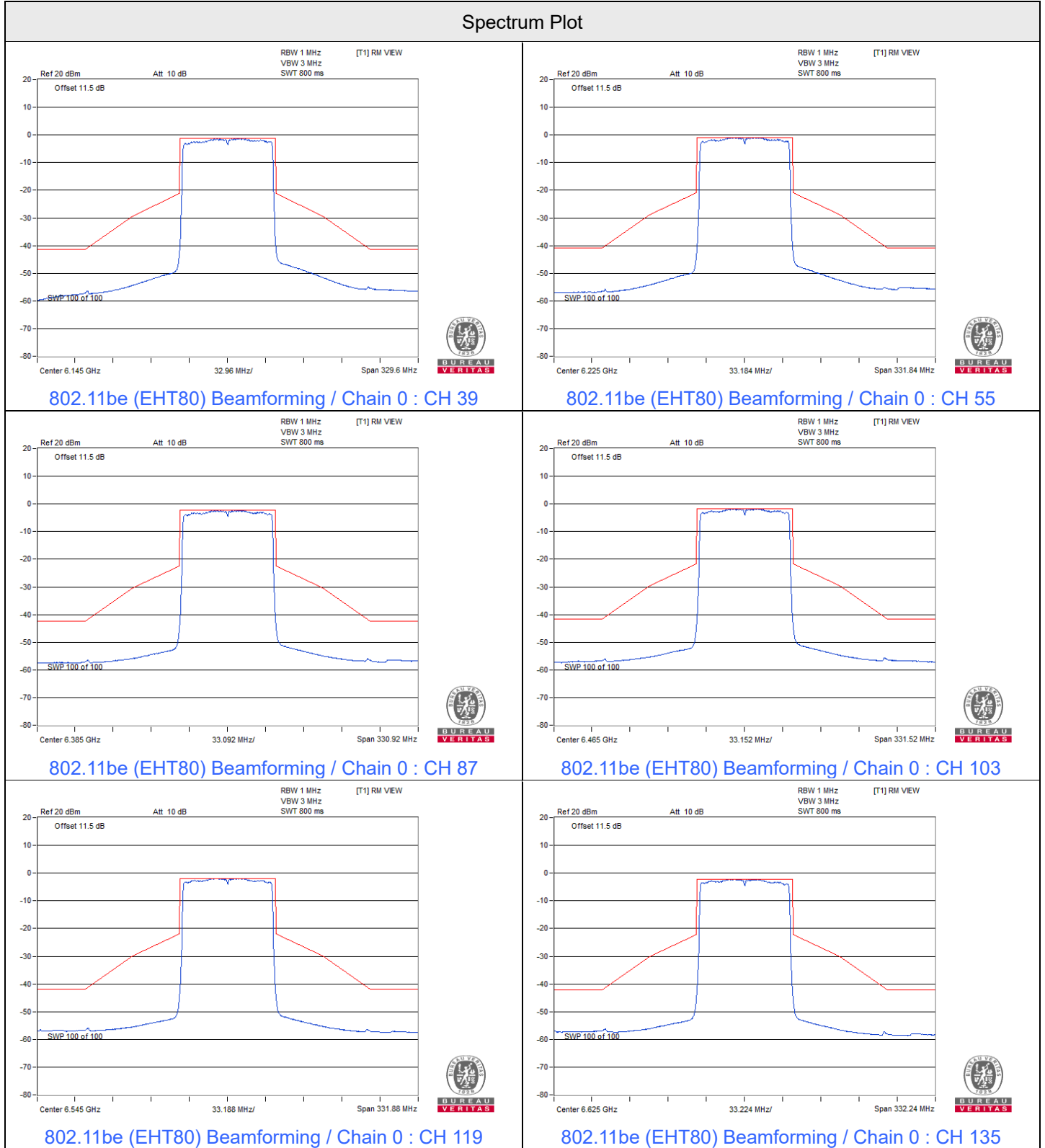

### Spectrum Plot

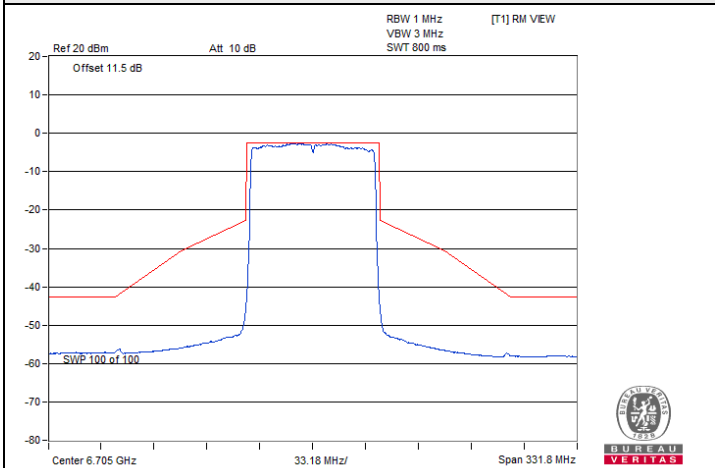

802.11be (EHT80) Beamforming / Chain 0 : CH 151

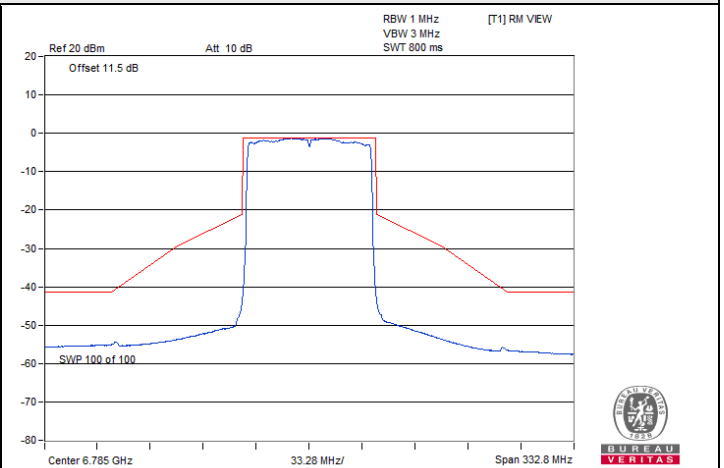

802.11be (EHT80) Beamforming / Chain 0 : CH 167

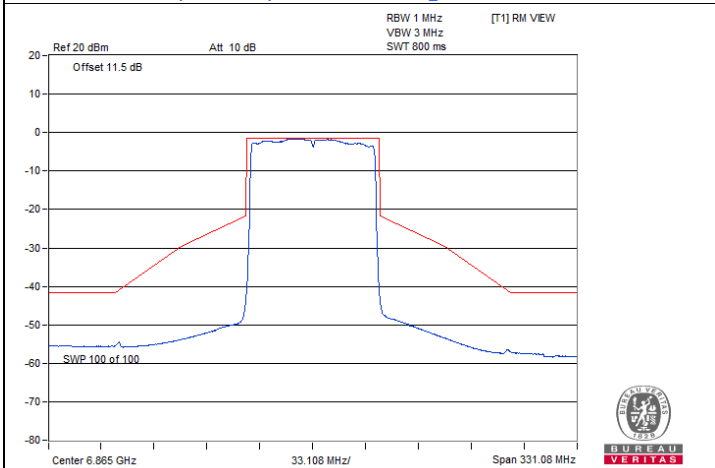

802.11be (EHT80) Beamforming / Chain 0 : CH 183

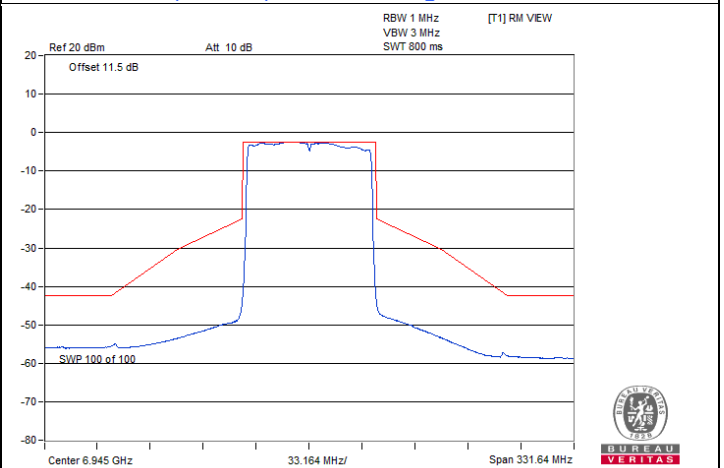

802.11be (EHT80) Beamforming / Chain 0 : CH 199

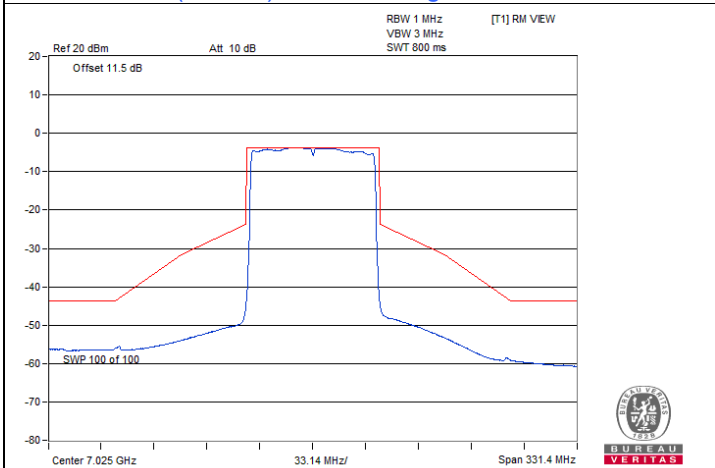

802.11be (EHT80) Beamforming / Chain 0 : CH 215

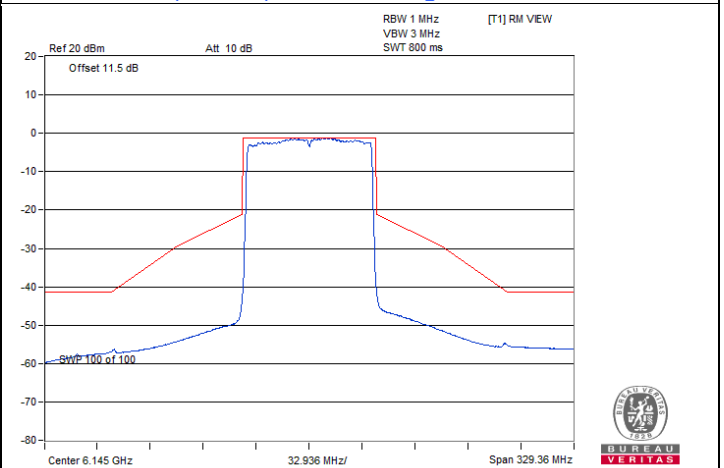

802.11be (EHT80) Beamforming / Chain 1 : CH 39

### Spectrum Plot

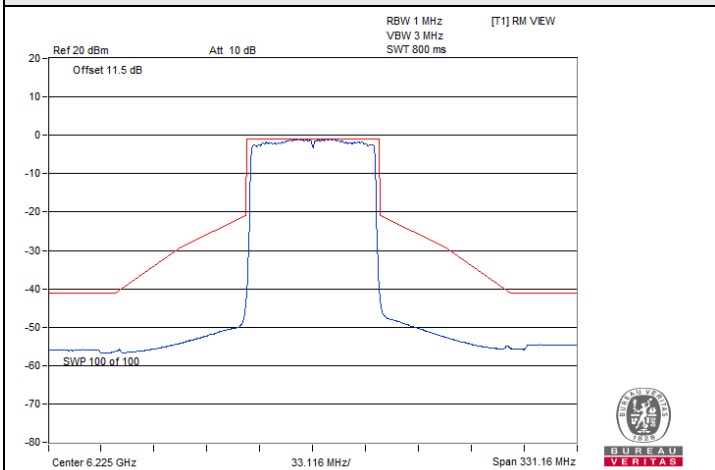

802.11be (EHT80) Beamforming / Chain 1 : CH 55

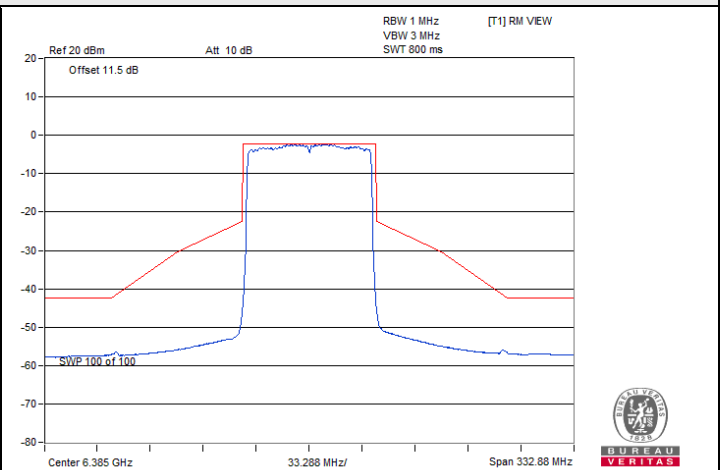

802.11be (EHT80) Beamforming / Chain 1 : CH 87

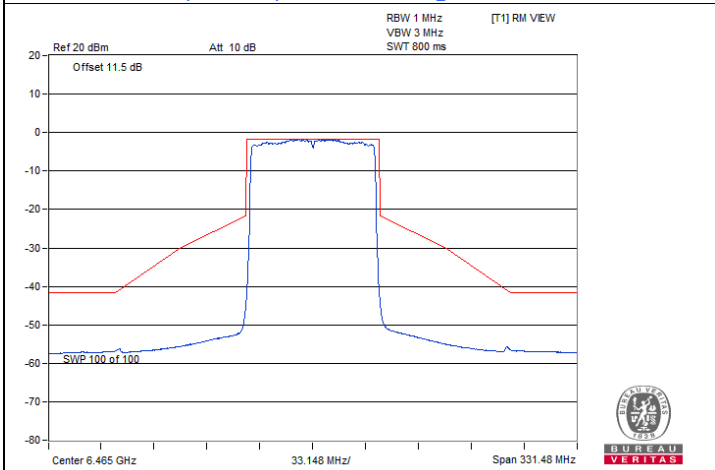

802.11be (EHT80) Beamforming / Chain 1 : CH 103

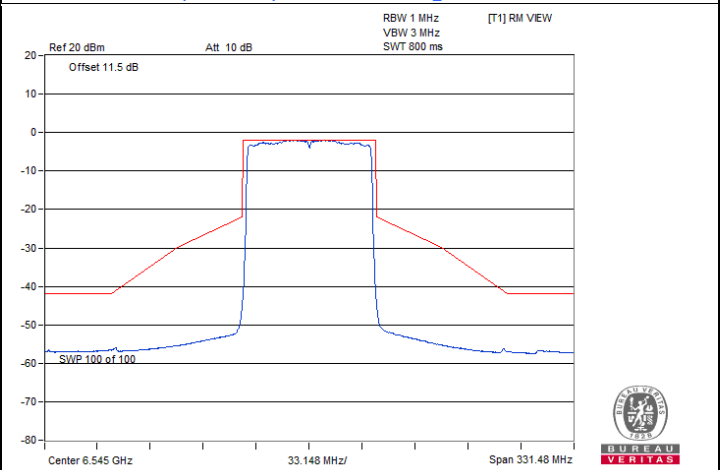

802.11be (EHT80) Beamforming / Chain 1 : CH 119

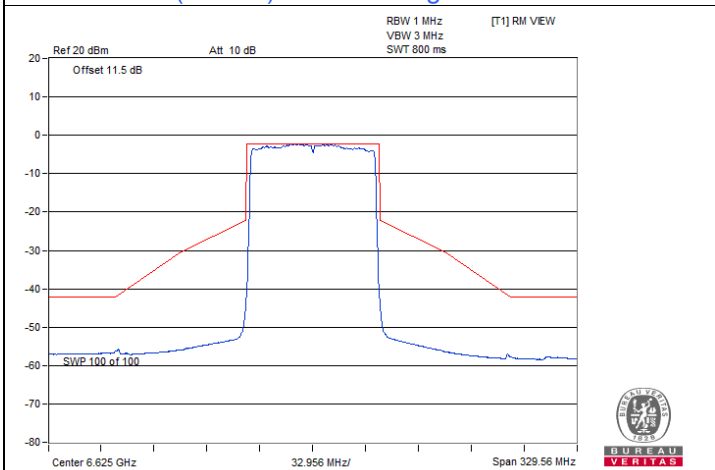

802.11be (EHT80) Beamforming / Chain 1 : CH 135

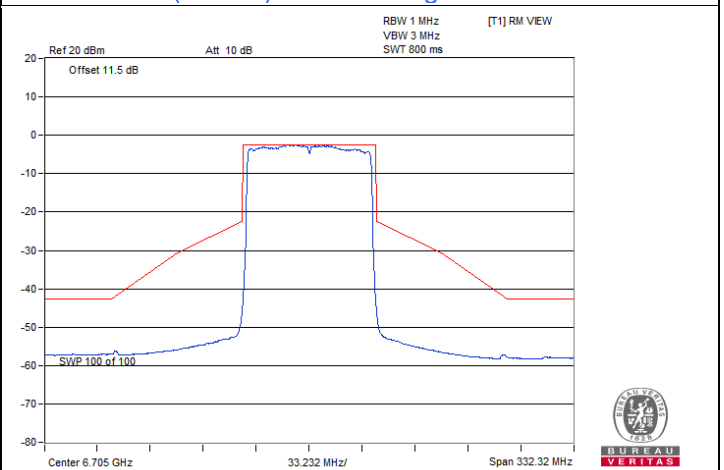

802.11be (EHT80) Beamforming / Chain 1 : CH 151

### Spectrum Plot

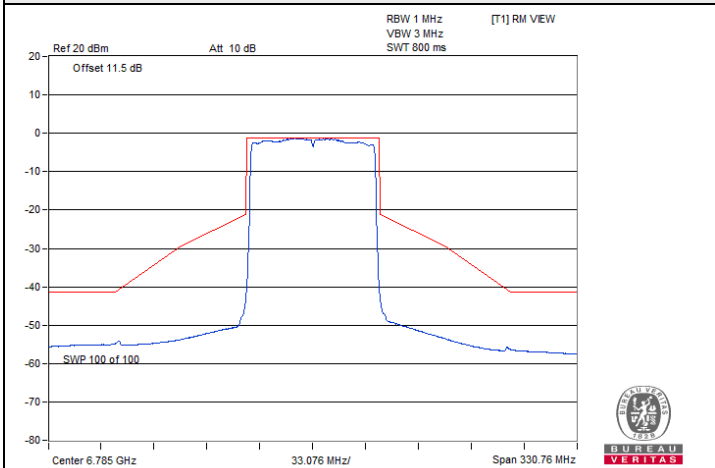

802.11be (EHT80) Beamforming / Chain 1 : CH 167

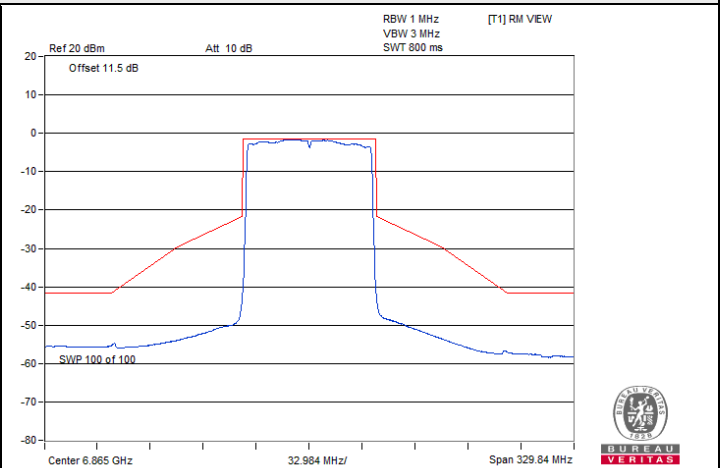

802.11be (EHT80) Beamforming / Chain 1 : CH 183

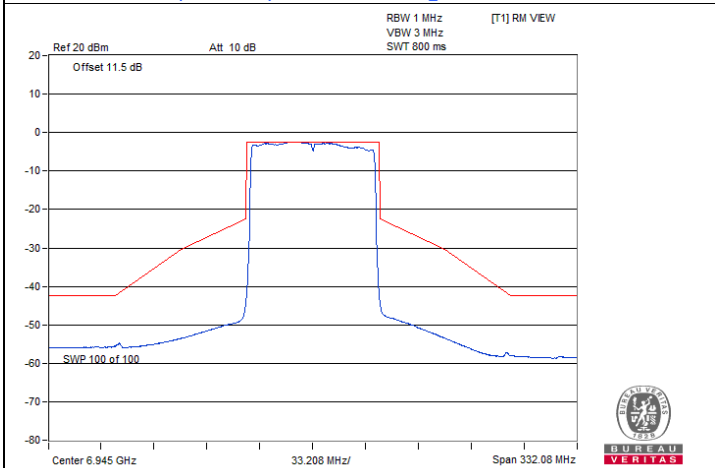

802.11be (EHT80) Beamforming / Chain 1 : CH 199

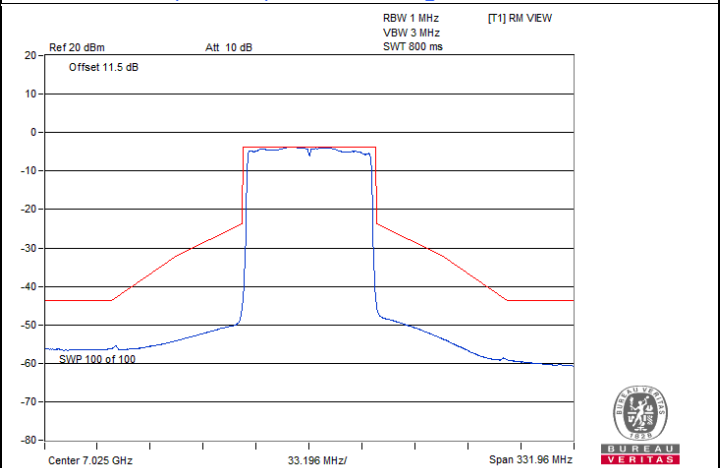

802.11be (EHT80) Beamforming / Chain 1 : CH 215

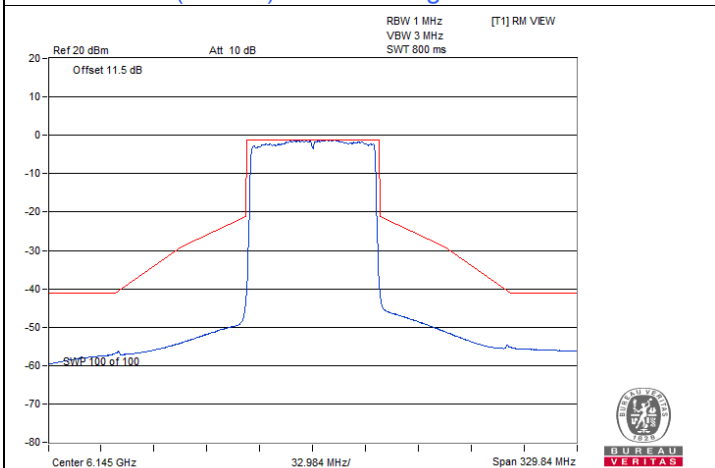

802.11be (EHT80) Beamforming / Chain 2 : CH 39

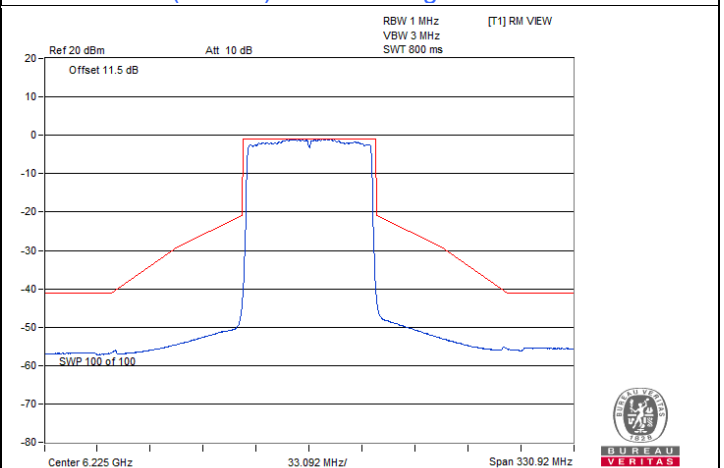

802.11be (EHT80) Beamforming / Chain 2 : CH 55

### Spectrum Plot

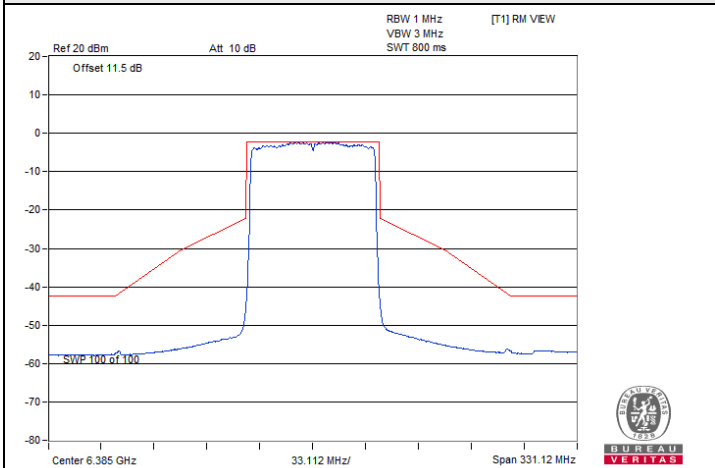

802.11be (EHT80) Beamforming / Chain 2 : CH 87

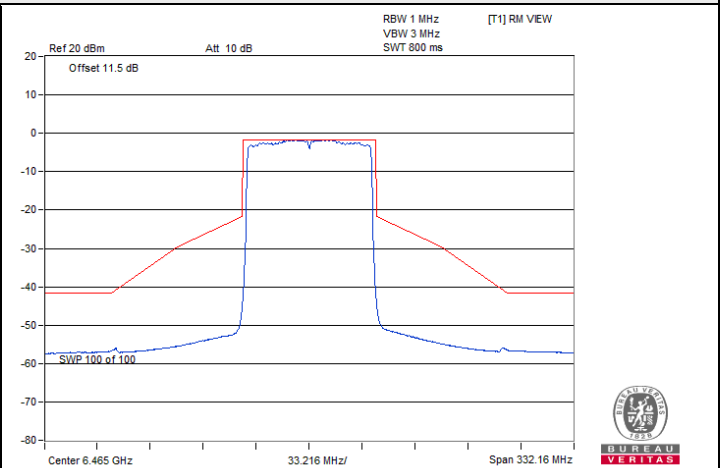

802.11be (EHT80) Beamforming / Chain 2 : CH 103

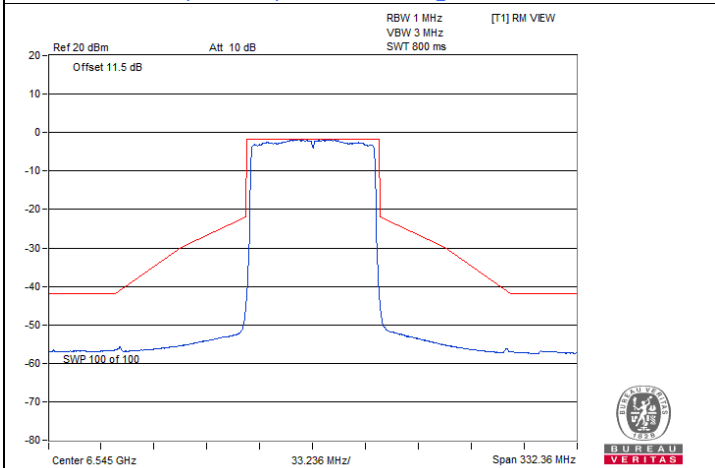

802.11be (EHT80) Beamforming / Chain 2 : CH 119

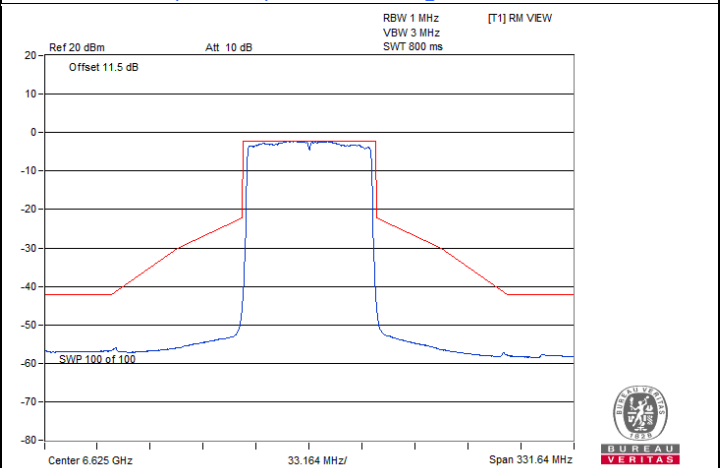

802.11be (EHT80) Beamforming / Chain 2 : CH 135

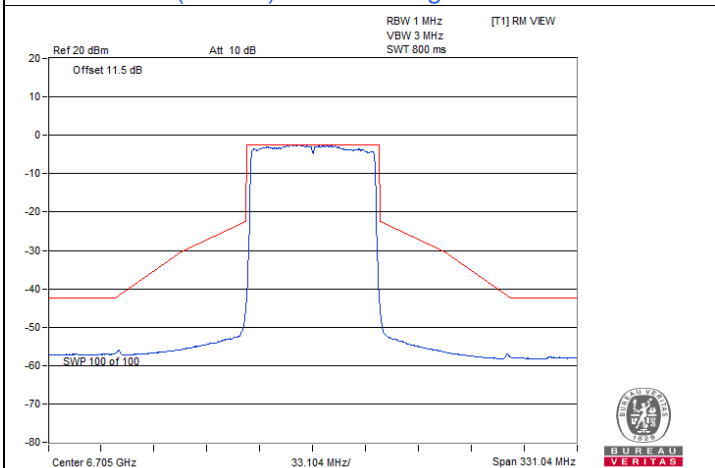

802.11be (EHT80) Beamforming / Chain 2 : CH 151

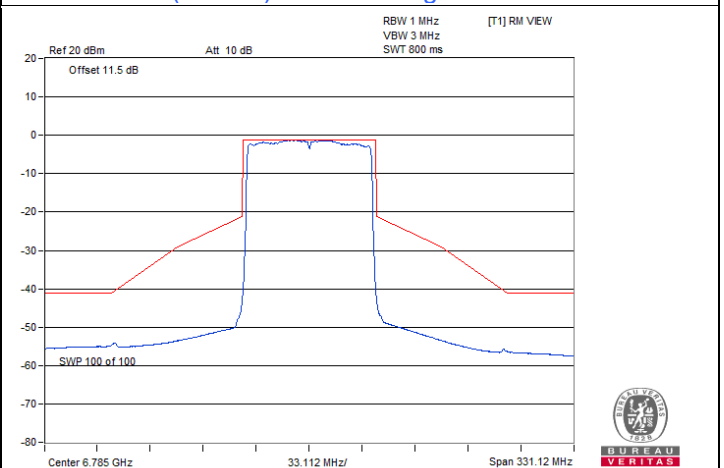

802.11be (EHT80) Beamforming / Chain 2 : CH 167

### Spectrum Plot

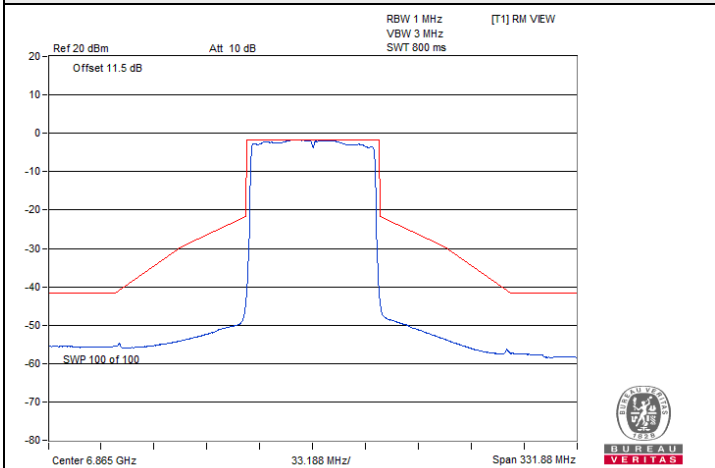

802.11be (EHT80) Beamforming / Chain 2 : CH 183

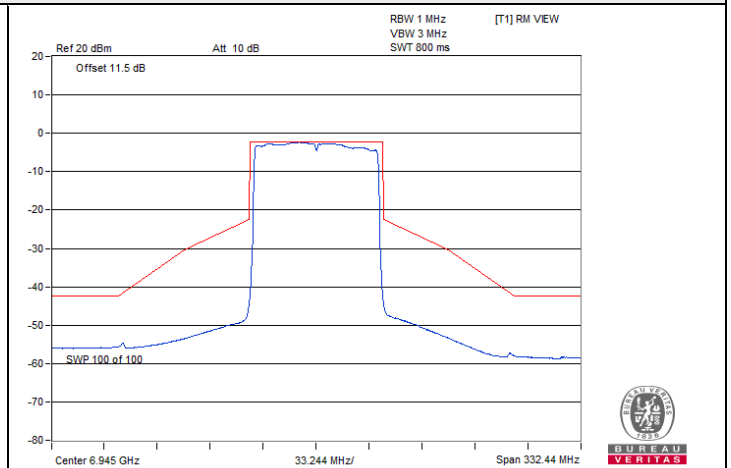

802.11be (EHT80) Beamforming / Chain 2 : CH 199

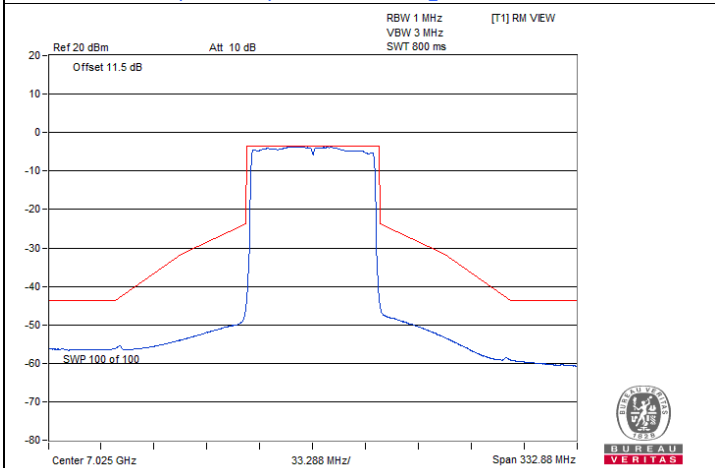

802.11be (EHT80) Beamforming / Chain 2 : CH 215

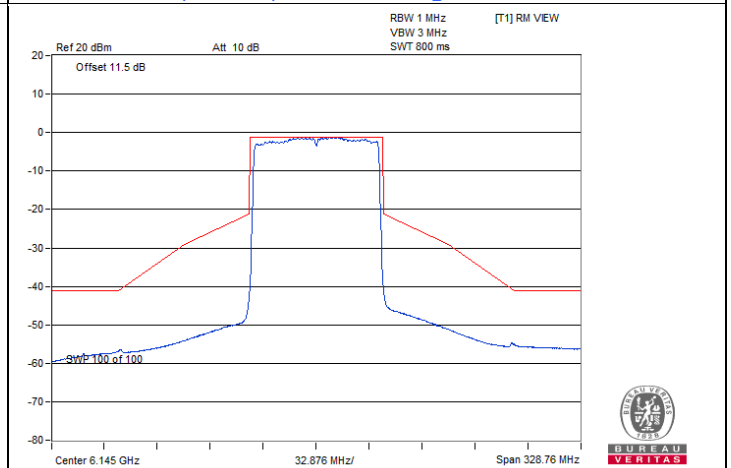

802.11be (EHT80) Beamforming / Chain 3 : CH 39

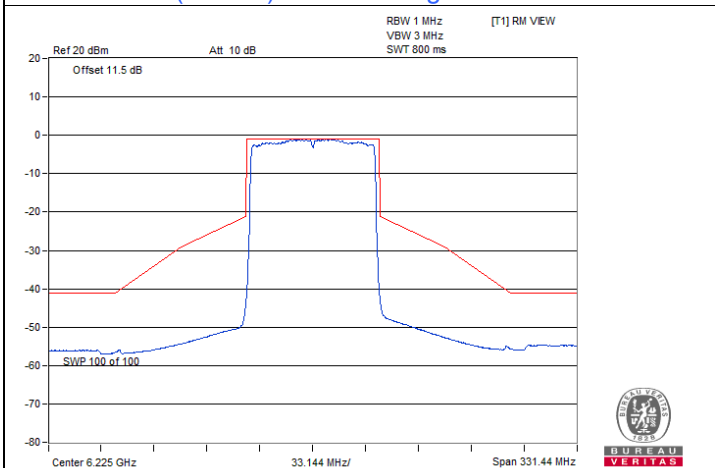

802.11be (EHT80) Beamforming / Chain 3 : CH 55

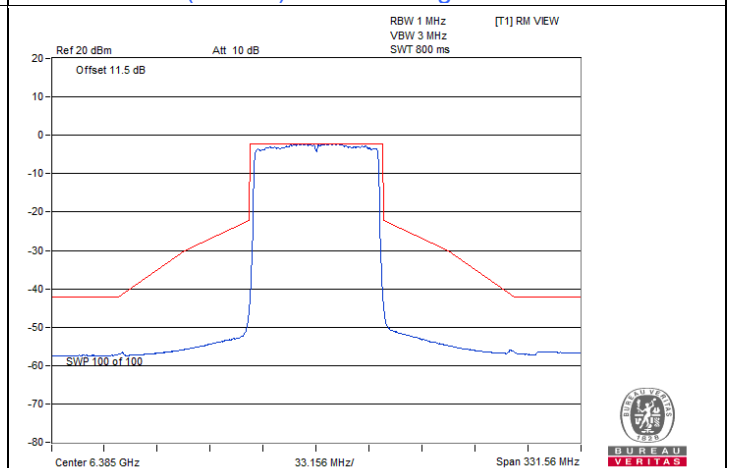

802.11be (EHT80) Beamforming / Chain 3 : CH 87



### Spectrum Plot

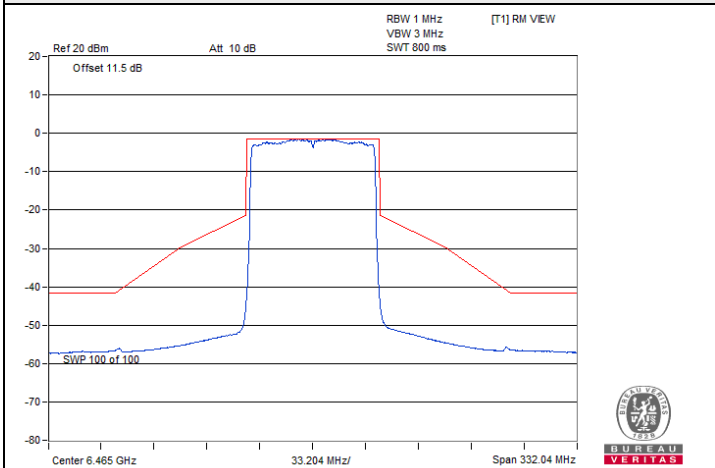

802.11be (EHT80) Beamforming / Chain 3 : CH 103

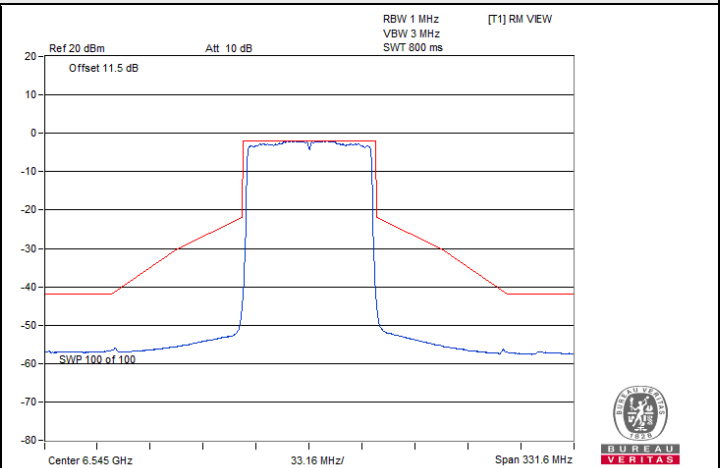

802.11be (EHT80) Beamforming / Chain 3 : CH 119

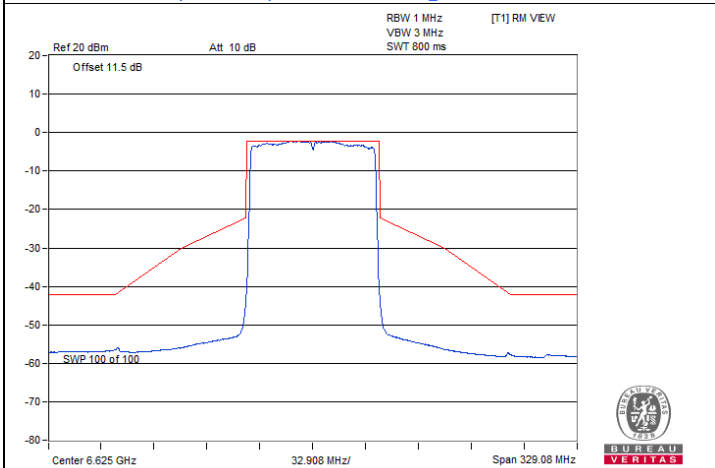

802.11be (EHT80) Beamforming / Chain 3 : CH 135

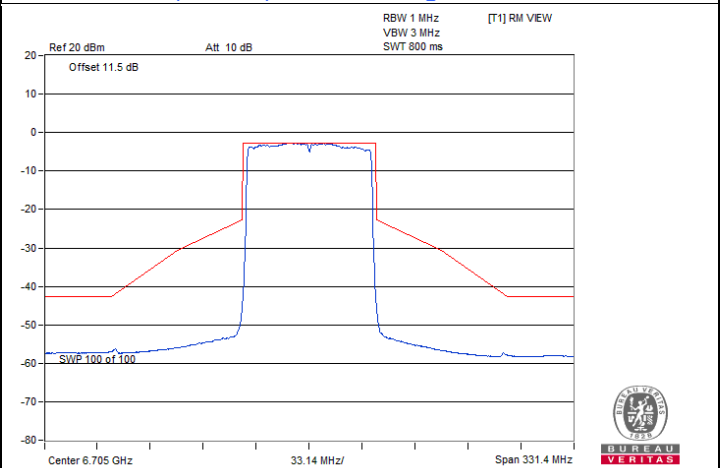

802.11be (EHT80) Beamforming / Chain 3 : CH 151

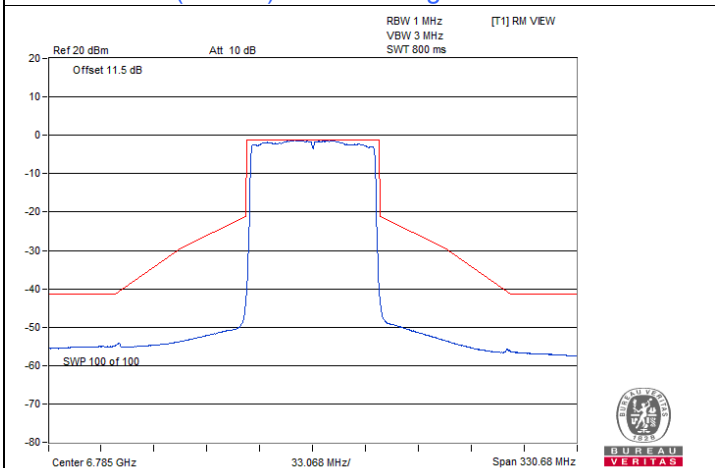

802.11be (EHT80) Beamforming / Chain 3 : CH 167

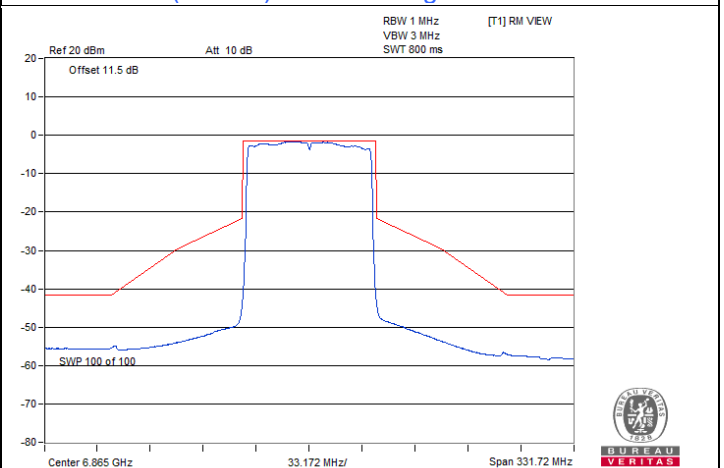

802.11be (EHT80) Beamforming / Chain 3 : CH 183

### Spectrum Plot

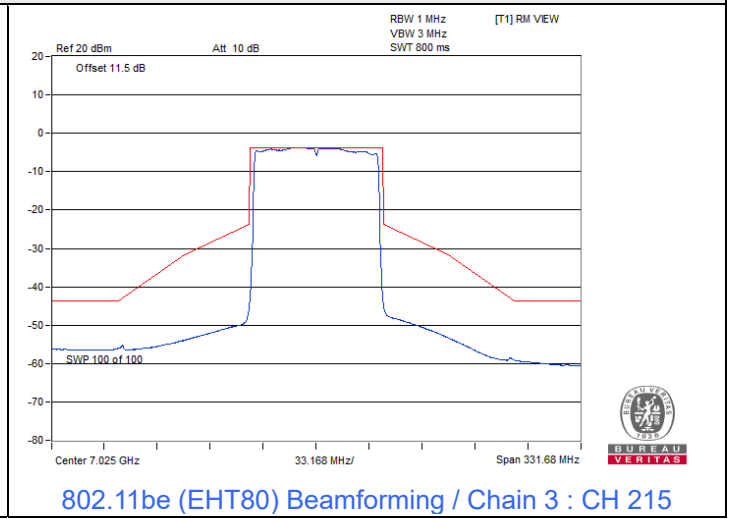
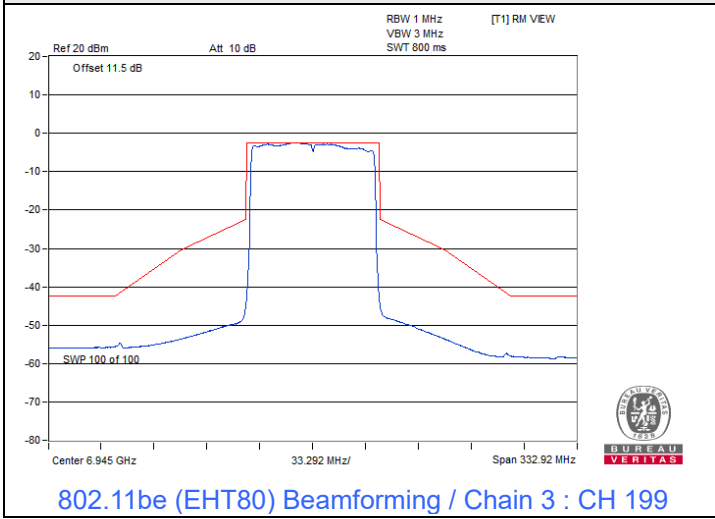

## 802.11be (EHT160) Beamforming



### Spectrum Plot

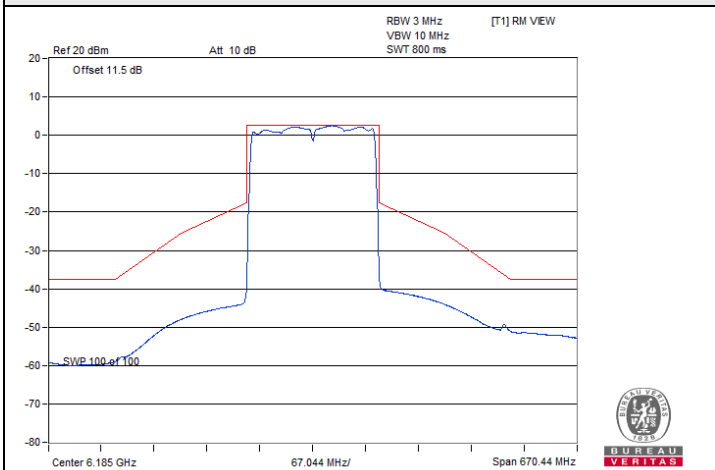

802.11be (EHT160) Beamforming / Chain 1 : CH 47

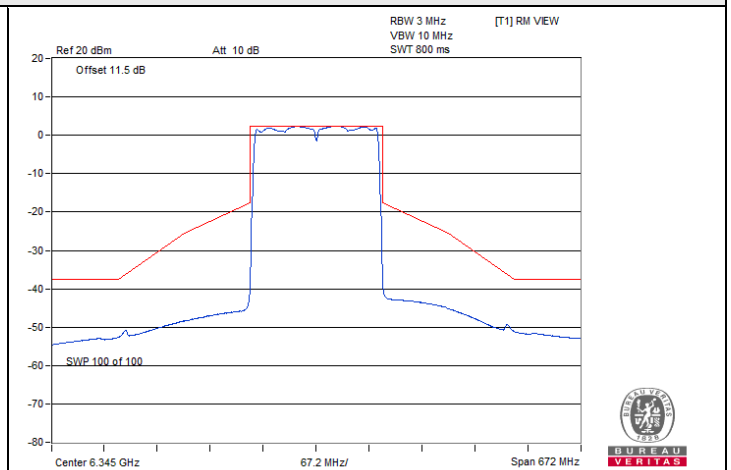

802.11be (EHT160) Beamforming / Chain 1 : CH 79

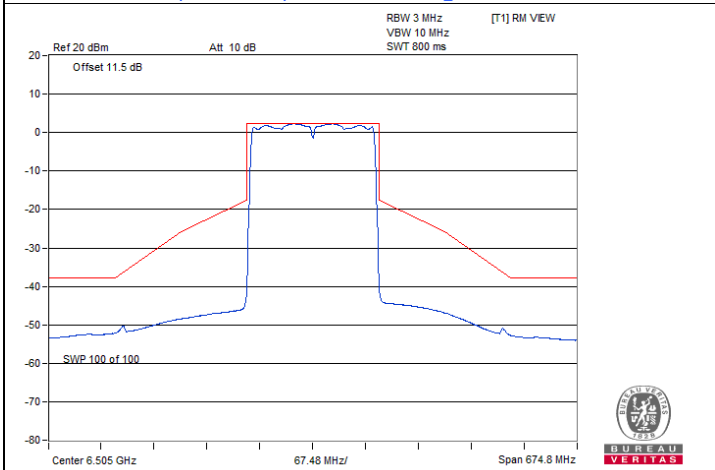

802.11be (EHT160) Beamforming / Chain 1 : CH 111

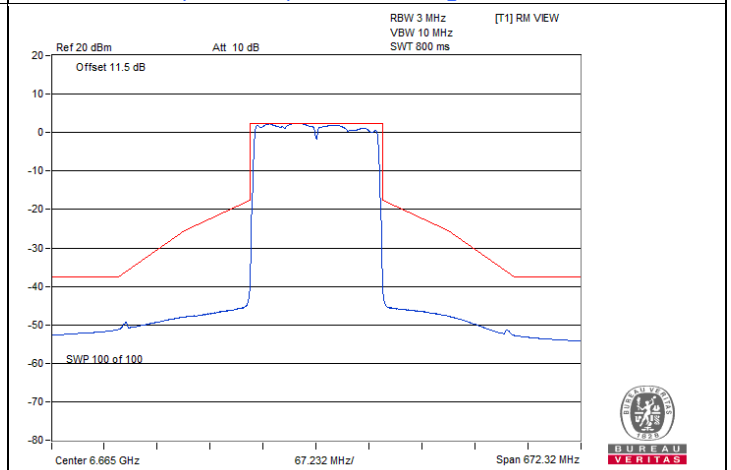

802.11be (EHT160) Beamforming / Chain 1 : CH 143

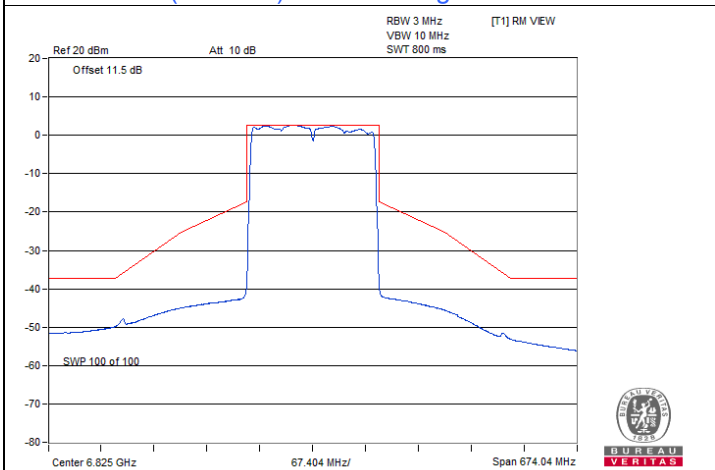

802.11be (EHT160) Beamforming / Chain 1 : CH 175

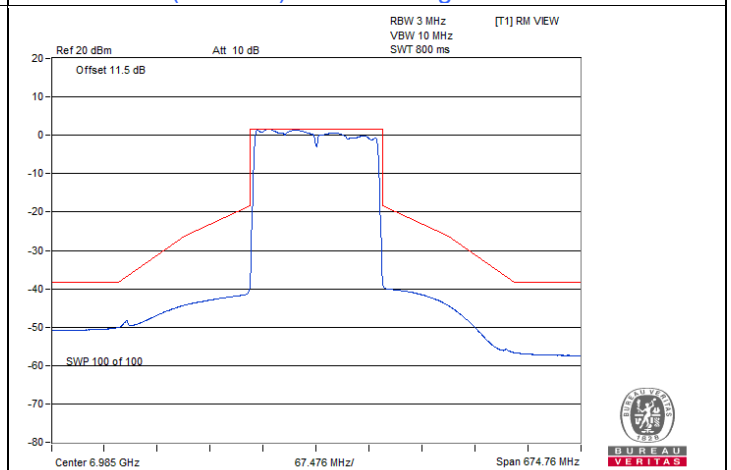

802.11be (EHT160) Beamforming / Chain 1 : CH 207

### Spectrum Plot

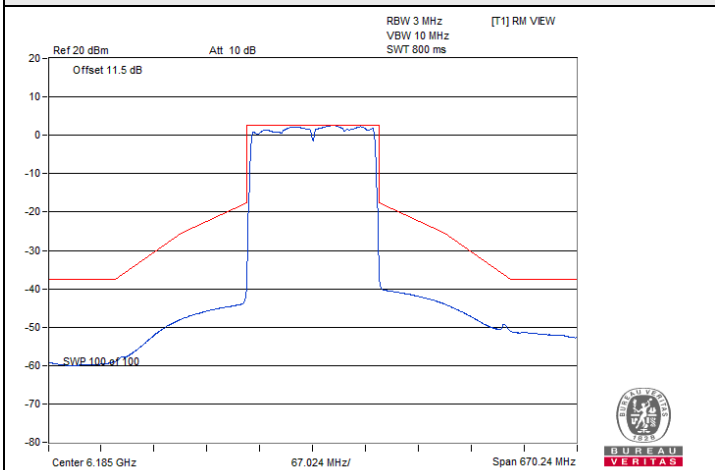

802.11be (EHT160) Beamforming / Chain 2 : CH 47

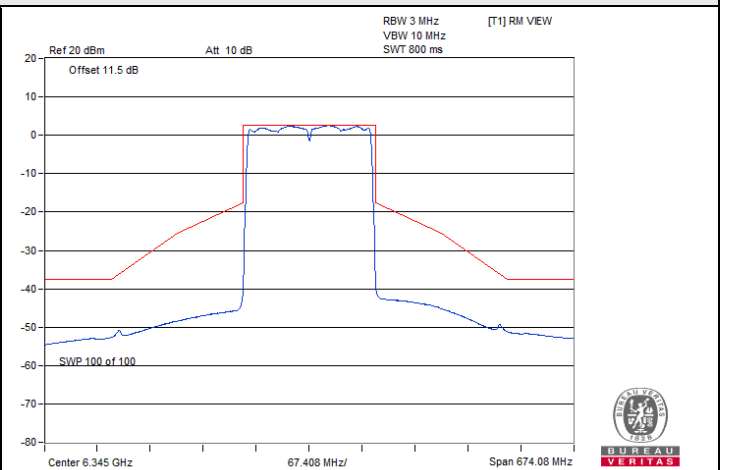

802.11be (EHT160) Beamforming / Chain 2 : CH 79

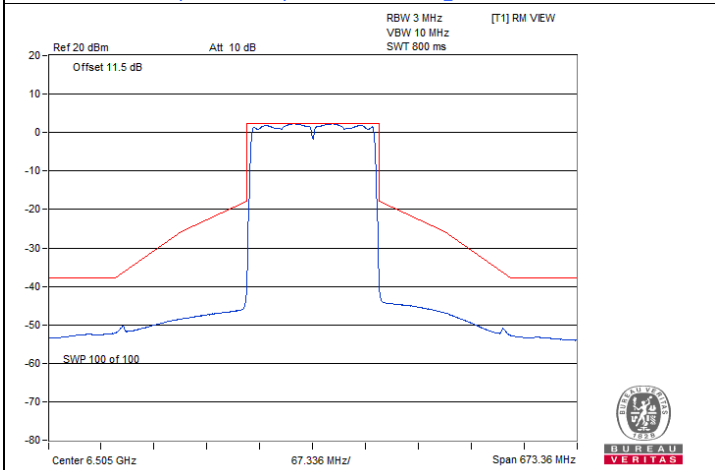

802.11be (EHT160) Beamforming / Chain 2 : CH 111

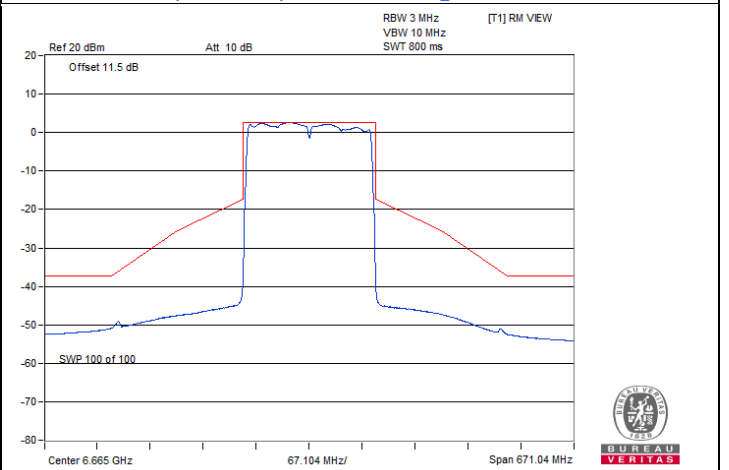

802.11be (EHT160) Beamforming / Chain 2 : CH 143

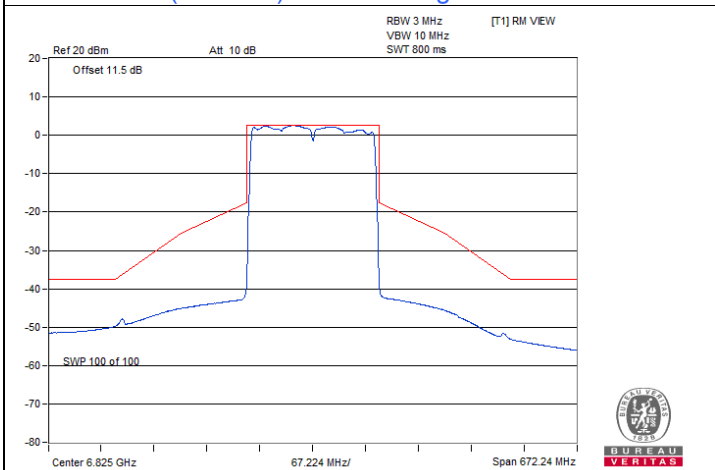

802.11be (EHT160) Beamforming / Chain 2 : CH 175

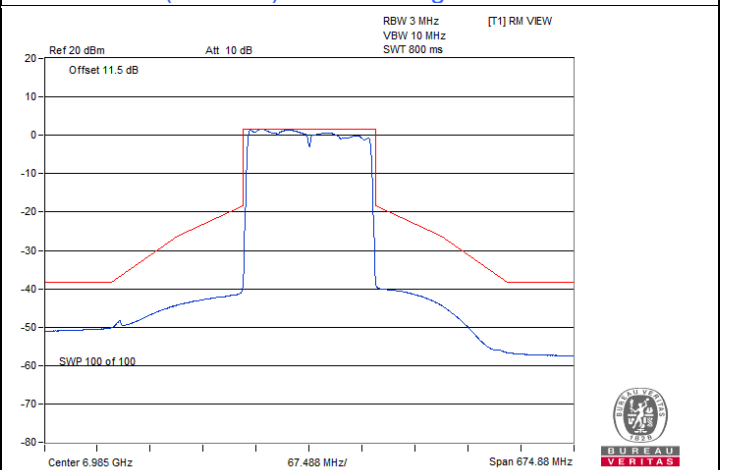

802.11be (EHT160) Beamforming / Chain 2 : CH 207

### Spectrum Plot

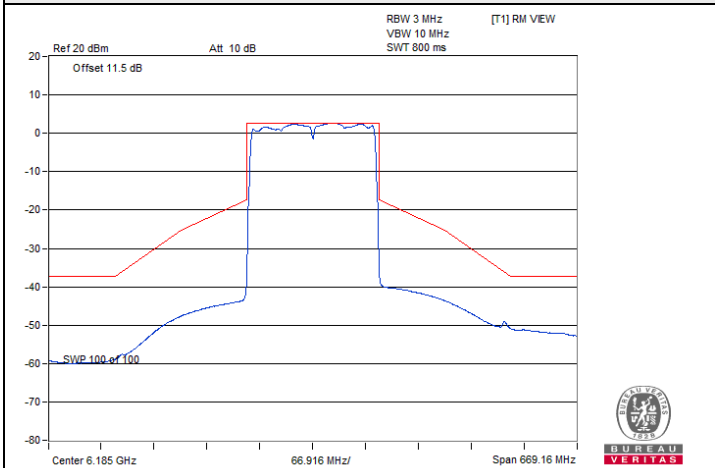

802.11be (EHT160) Beamforming / Chain 3 : CH 47

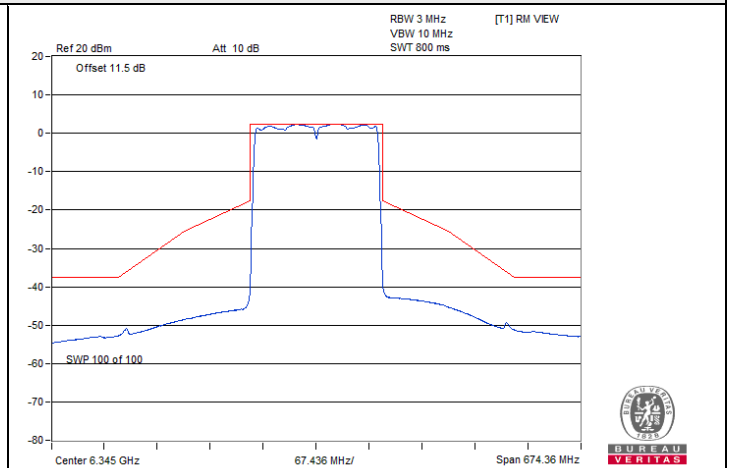

802.11be (EHT160) Beamforming / Chain 3 : CH 79

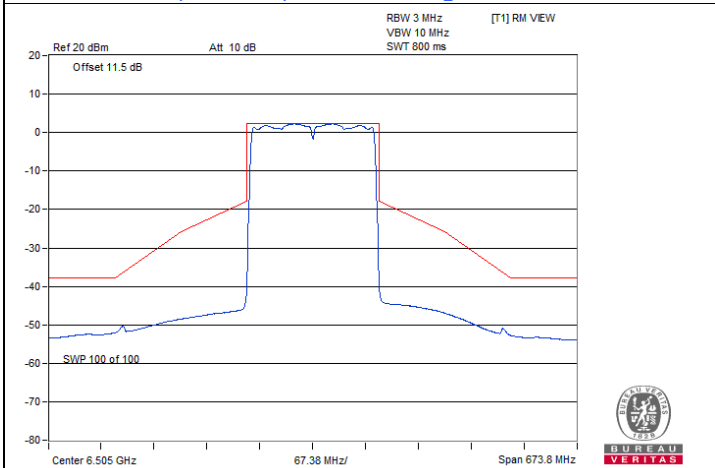

802.11be (EHT160) Beamforming / Chain 3 : CH 111

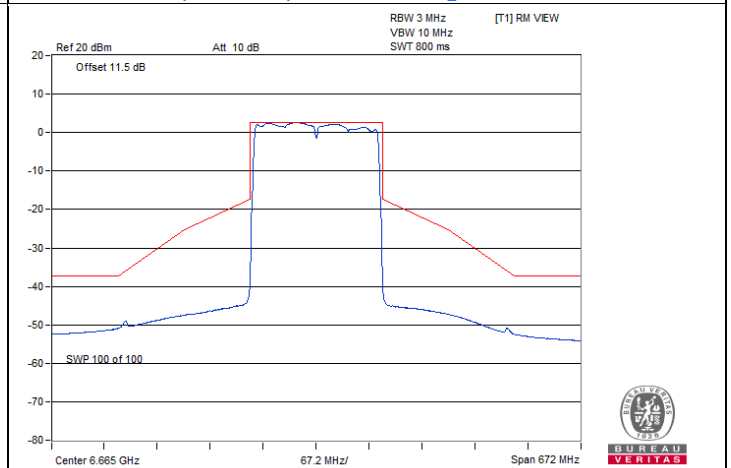

802.11be (EHT160) Beamforming / Chain 3 : CH 143

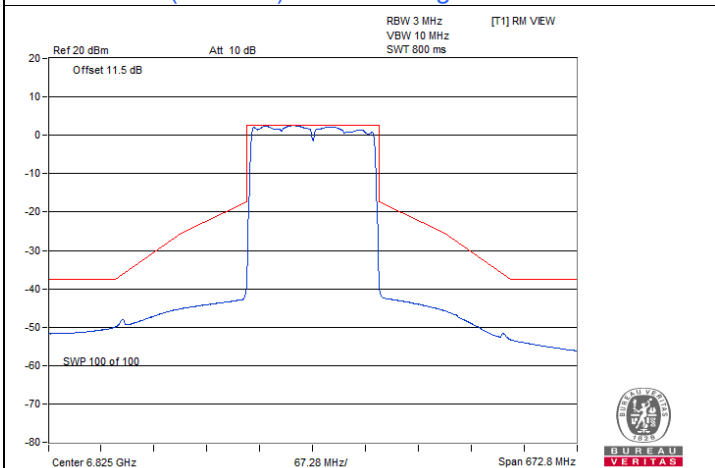

802.11be (EHT160) Beamforming / Chain 3 : CH 175

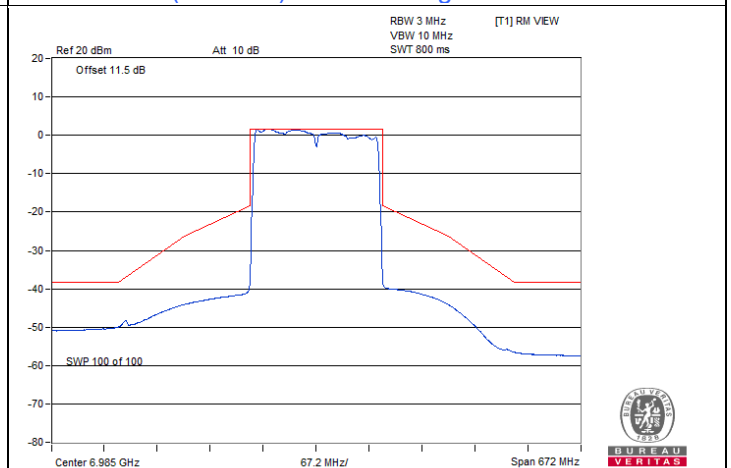

802.11be (EHT160) Beamforming / Chain 3 : CH 207

### 802.11be (EHT320) Beamforming

#### Spectrum Plot

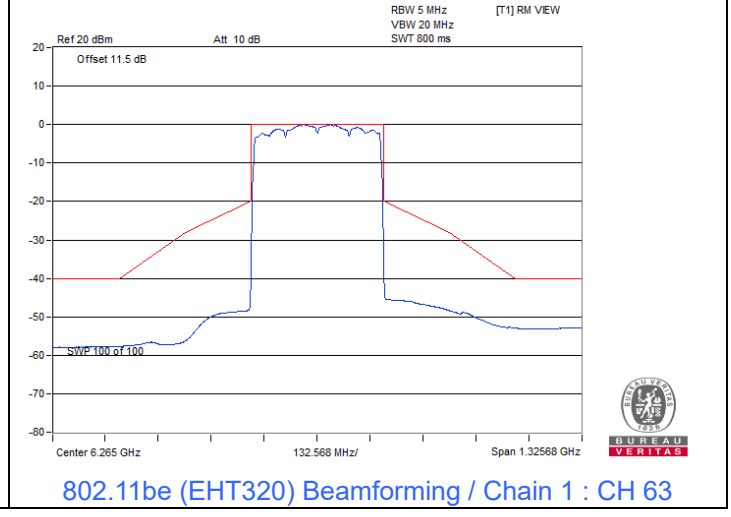
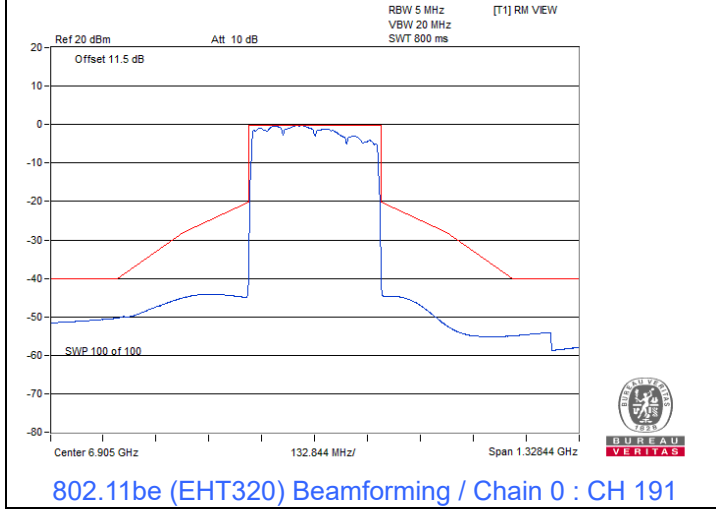
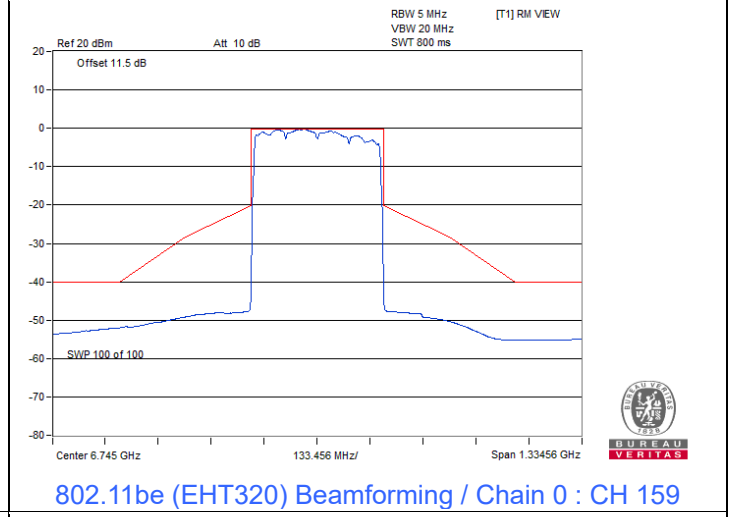
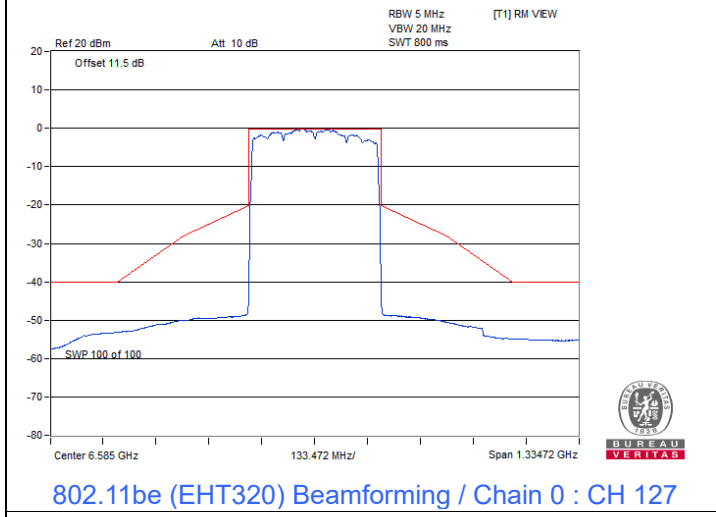
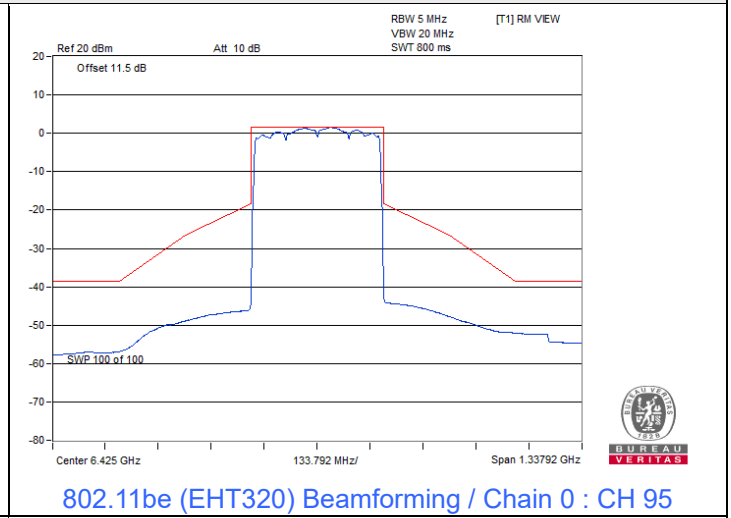
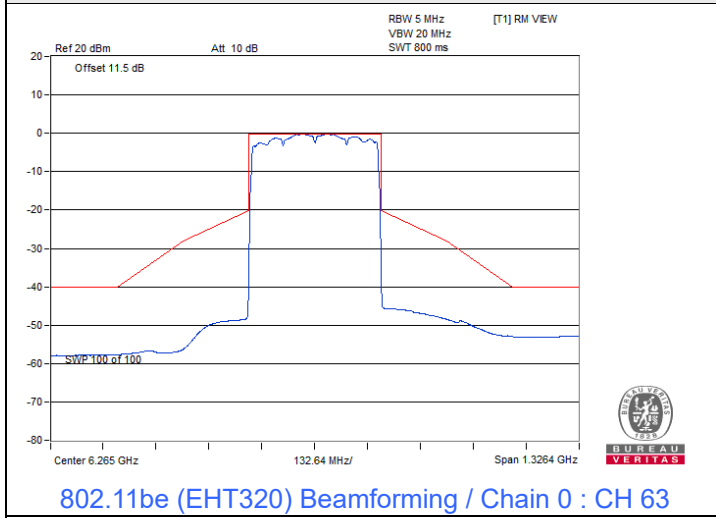

### Spectrum Plot

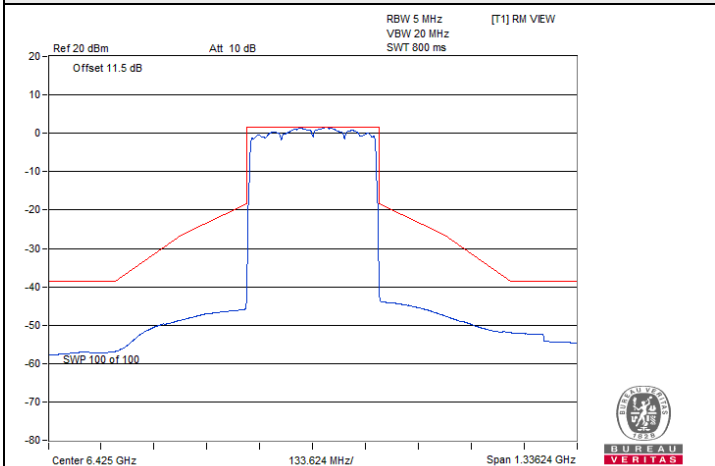

802.11be (EHT320) Beamforming / Chain 1 : CH 95

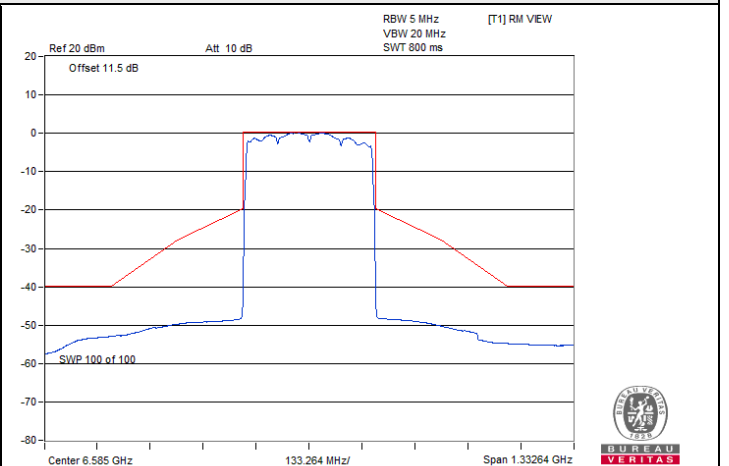

802.11be (EHT320) Beamforming / Chain 1 : CH 127

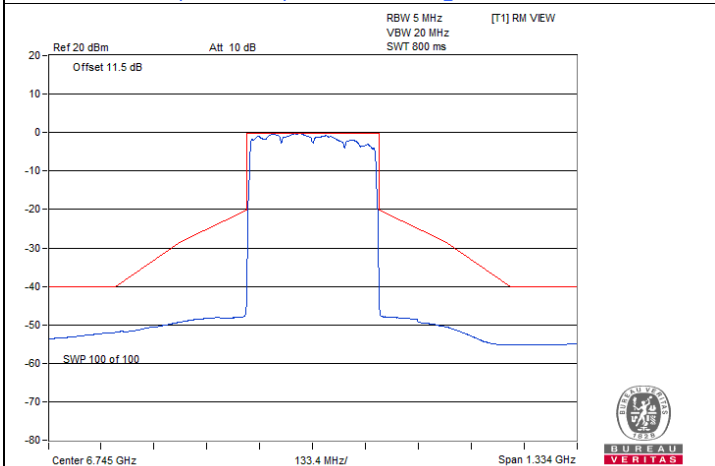

802.11be (EHT320) Beamforming / Chain 1 : CH 159

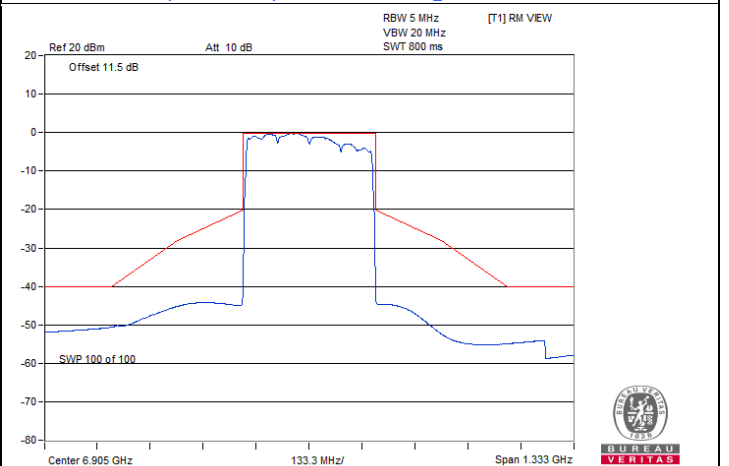

802.11be (EHT320) Beamforming / Chain 1 : CH 191

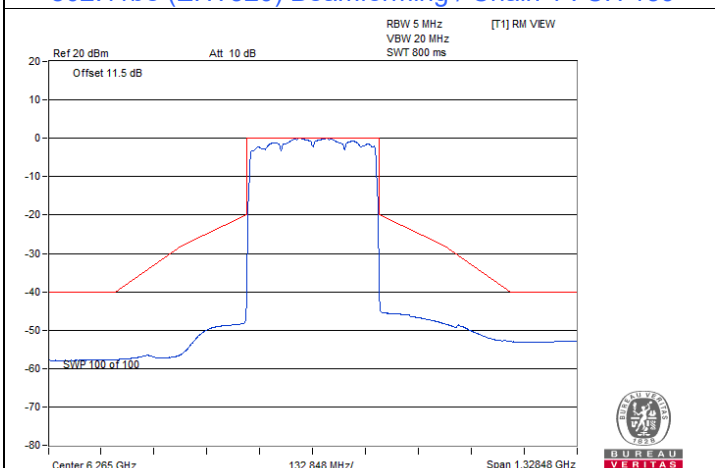

802.11be (EHT320) Beamforming / Chain 2 : CH 63

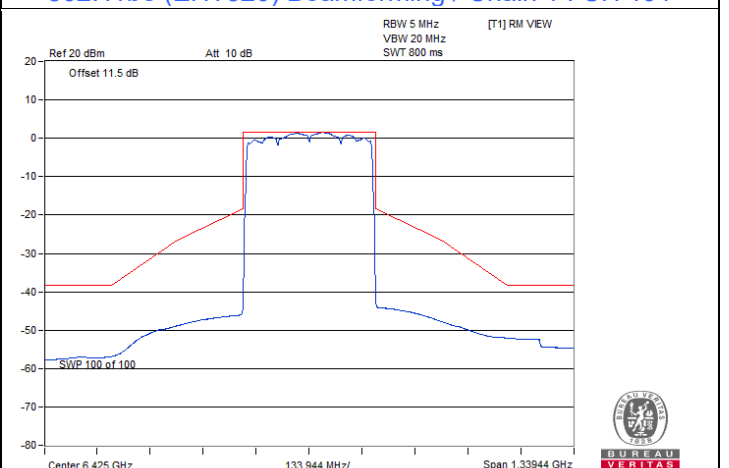

802.11be (EHT320) Beamforming / Chain 2 : CH 95



### Spectrum Plot

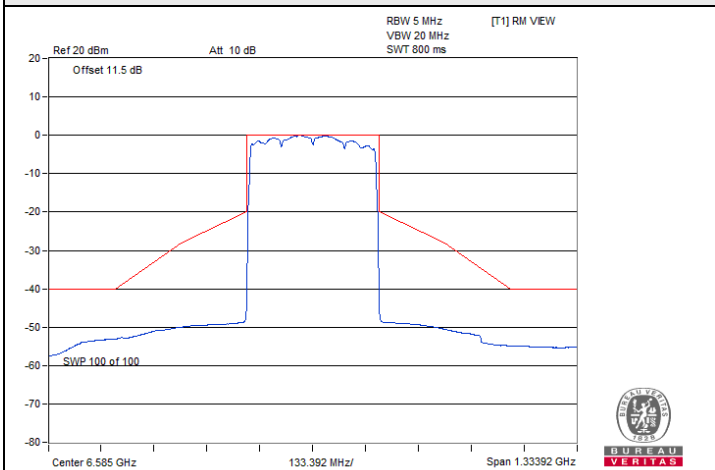

802.11be (EHT320) Beamforming / Chain 2 : CH 127

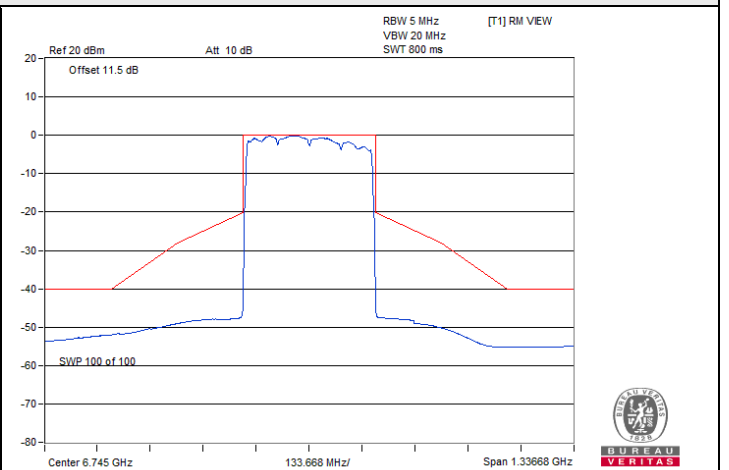

802.11be (EHT320) Beamforming / Chain 2 : CH 159

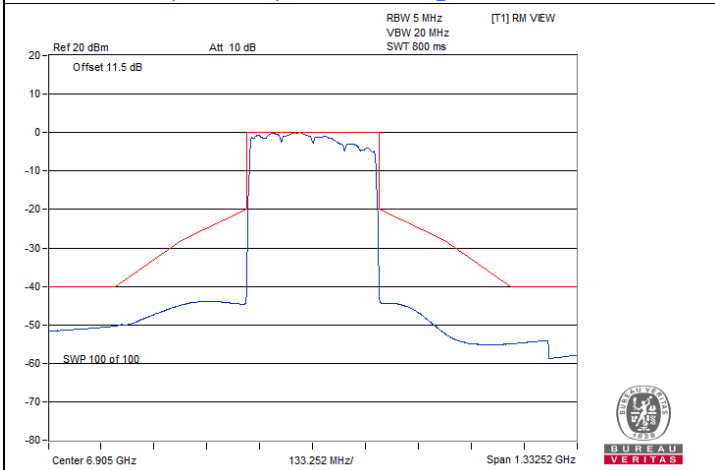

802.11be (EHT320) Beamforming / Chain 2 : CH 191

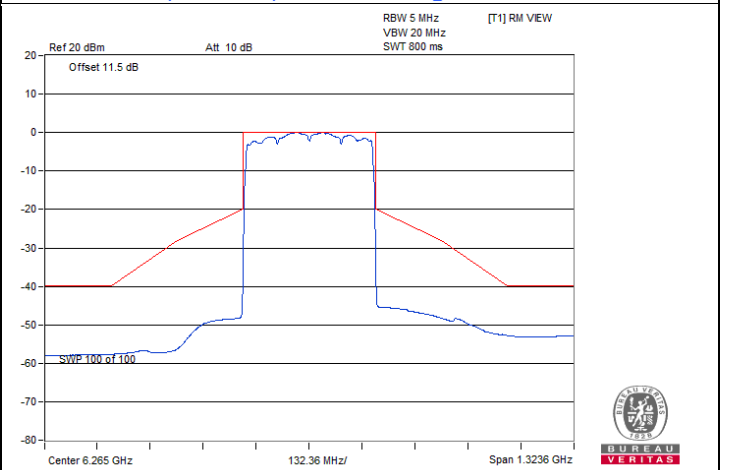

802.11be (EHT320) Beamforming / Chain 3 : CH 63

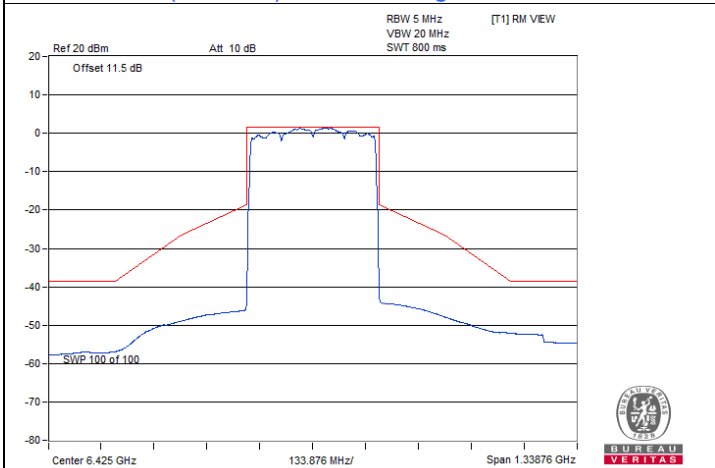

802.11be (EHT320) Beamforming / Chain 3 : CH 95

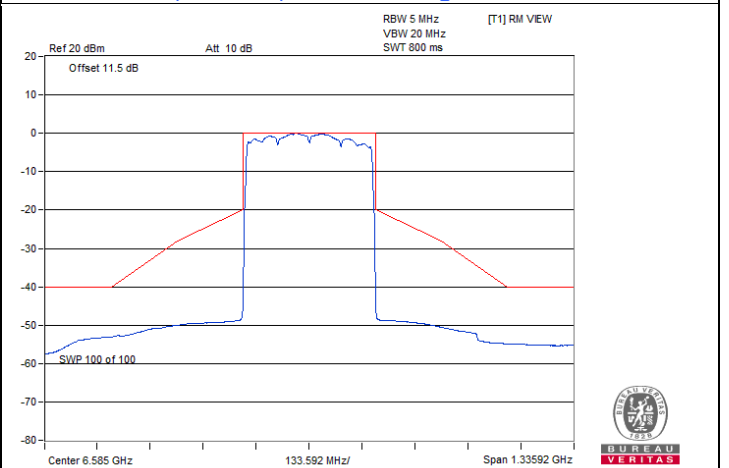

802.11be (EHT320) Beamforming / Chain 3 : CH 127

### Spectrum Plot

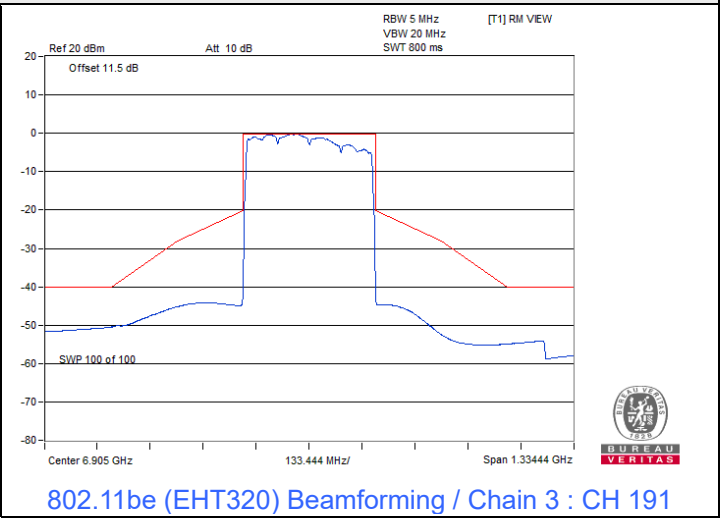
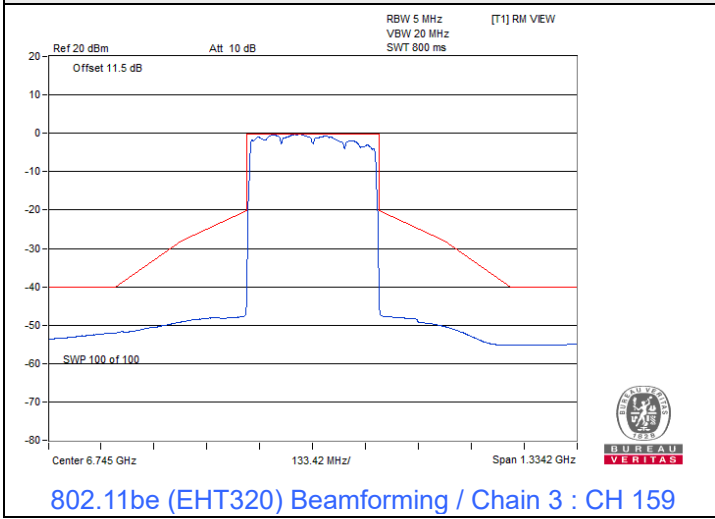

# Beamforming (4T4S)

## 802.11be (EHT20) Beamforming

### Spectrum Plot

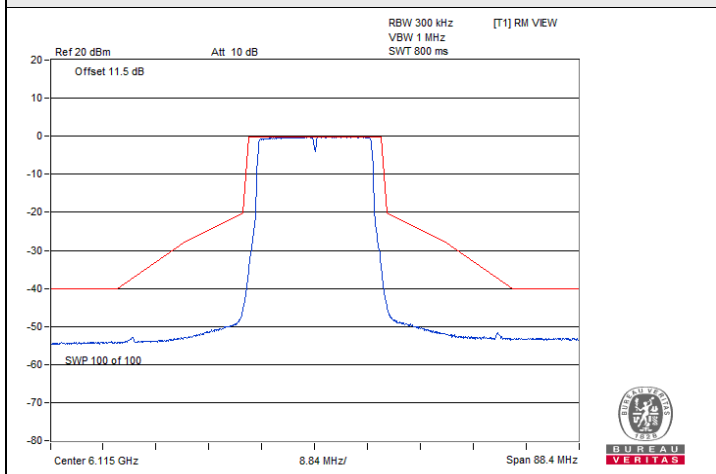

802.11be (EHT20) Beamforming / Chain 0 : CH 33

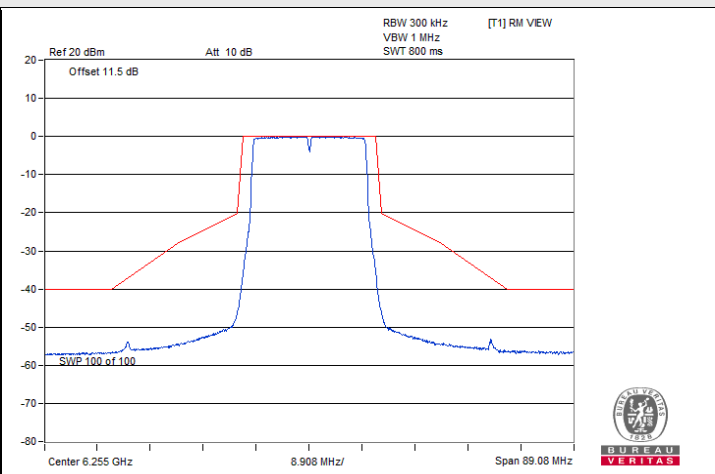

802.11be (EHT20) Beamforming / Chain 0 : CH 61

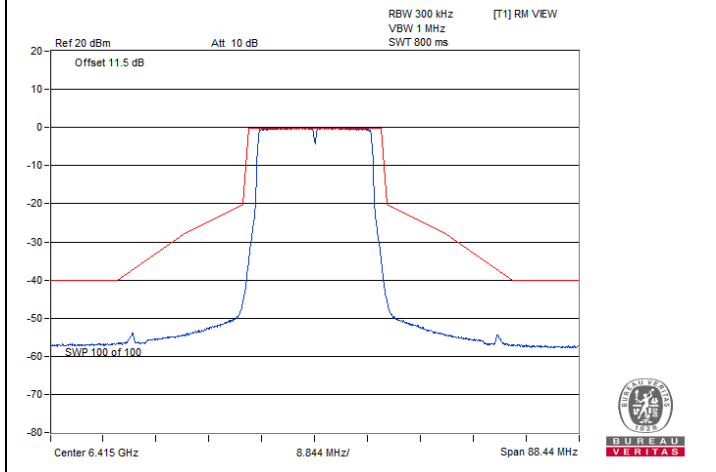

802.11be (EHT20) Beamforming / Chain 0 : CH 93

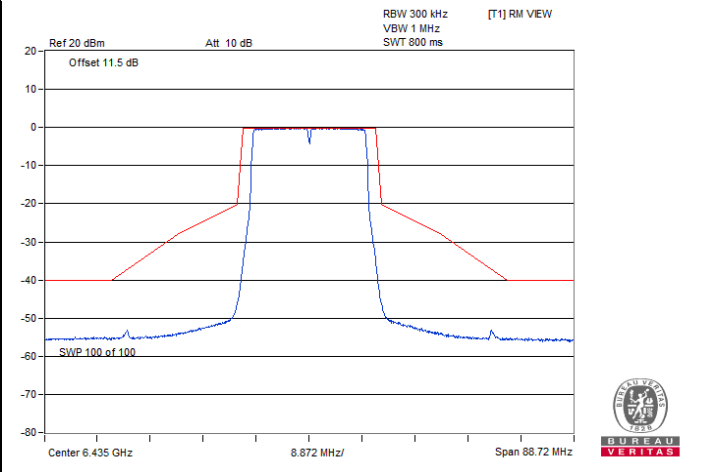

802.11be (EHT20) Beamforming / Chain 0 : CH 97

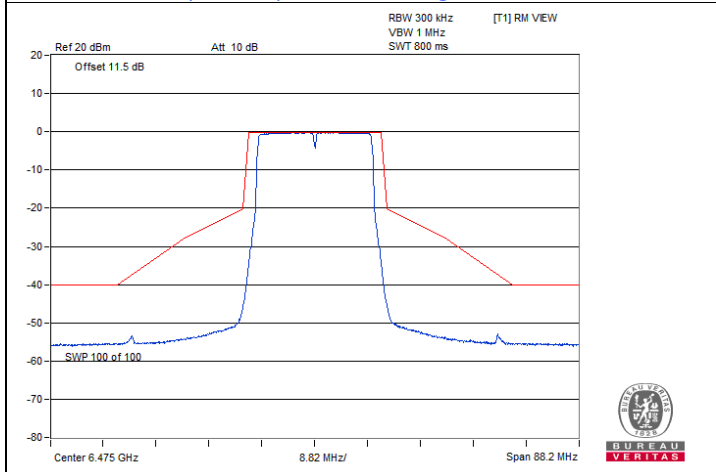

802.11be (EHT20) Beamforming / Chain 0 : CH 105

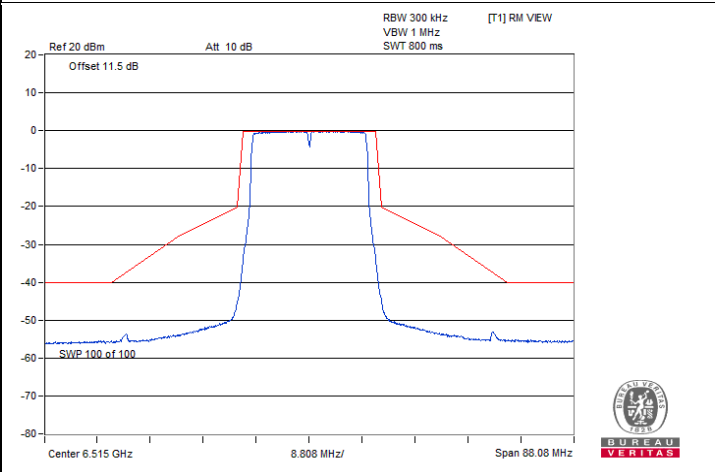

802.11be (EHT20) Beamforming / Chain 0 : CH 113

### Spectrum Plot

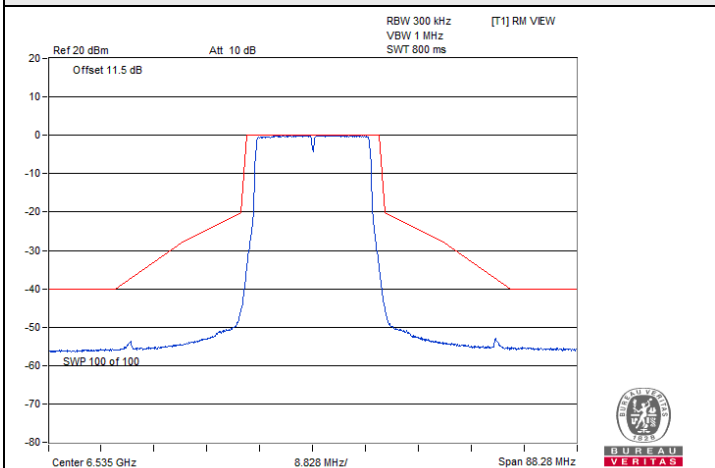

802.11be (EHT20) Beamforming / Chain 0 : CH 117

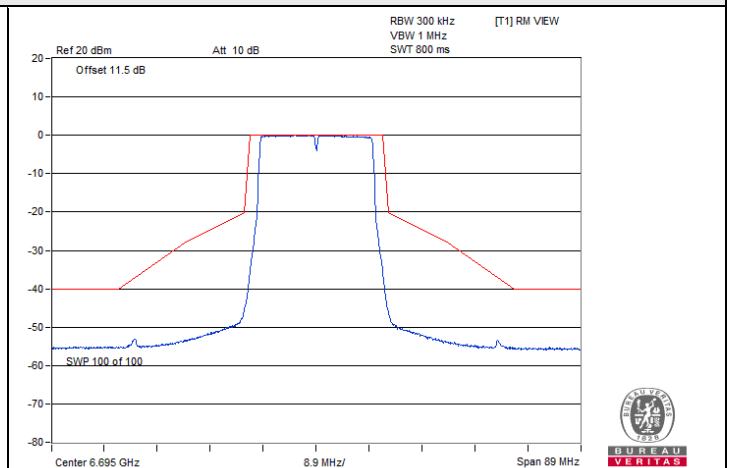

802.11be (EHT20) Beamforming / Chain 0 : CH 149

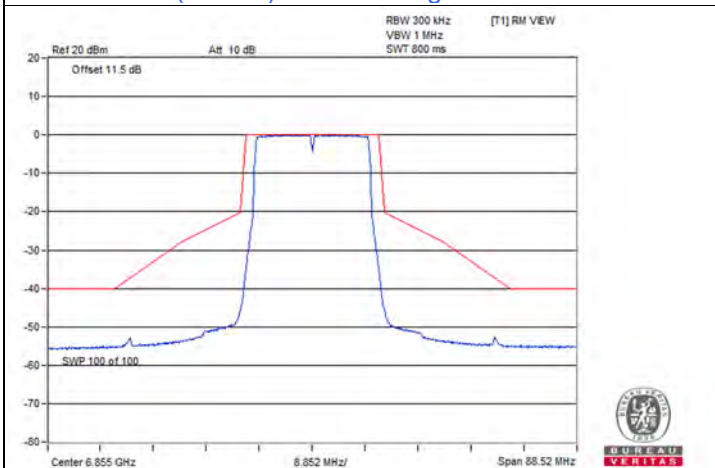

802.11be (EHT20) Beamforming / Chain 0 : CH 181

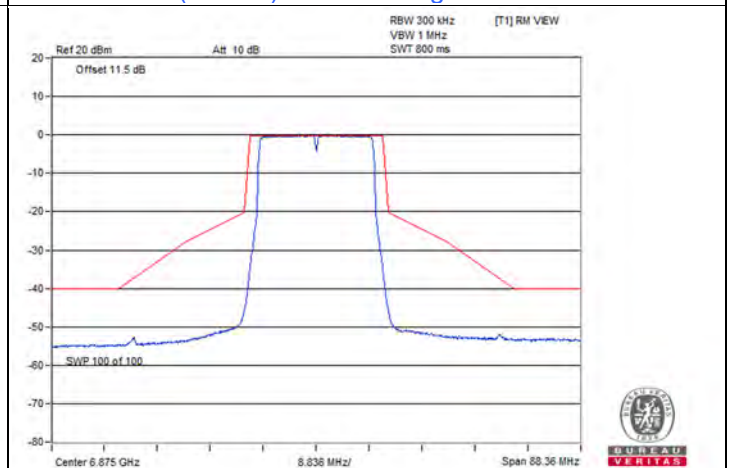

802.11be (EHT20) Beamforming / Chain 0 : CH 185

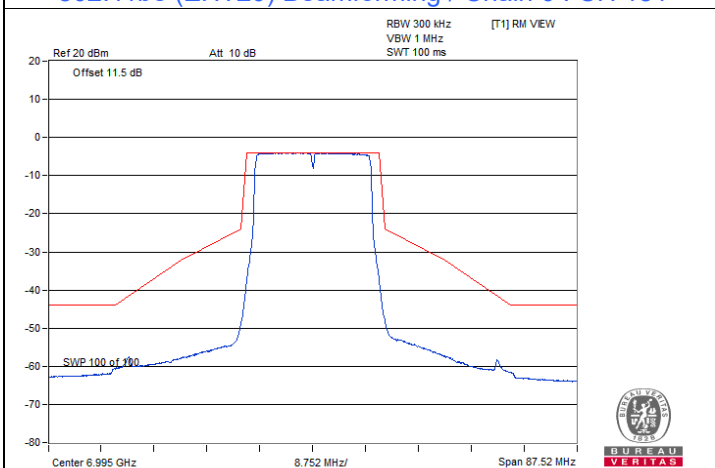

802.11be (EHT20) Beamforming / Chain 0 : CH 209

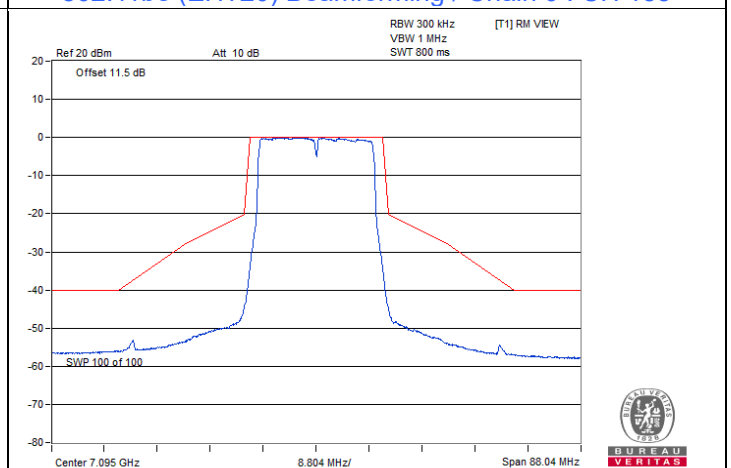

802.11be (EHT20) Beamforming / Chain 0 : CH 229

### Spectrum Plot

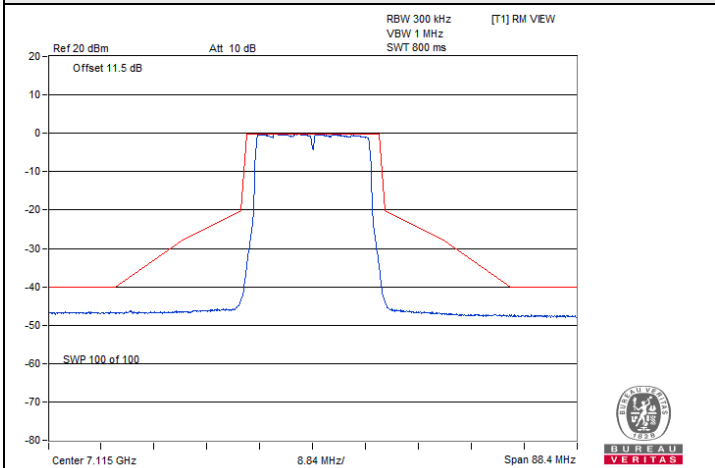

802.11be (EHT20) Beamforming / Chain 0 : CH 233

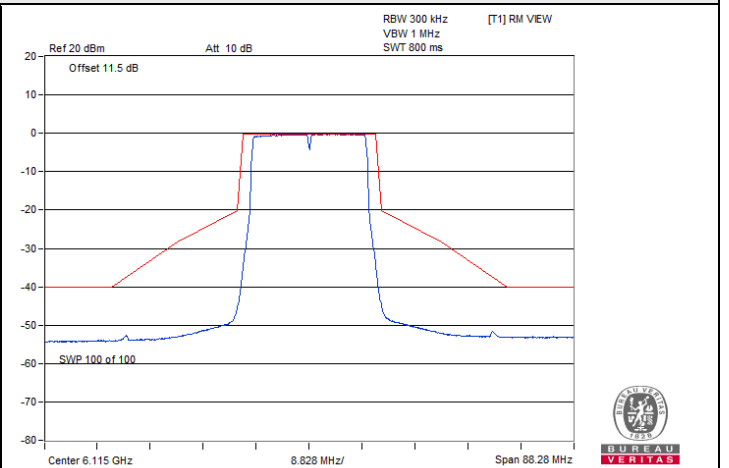

802.11be (EHT20) Beamforming / Chain 1 : CH 33

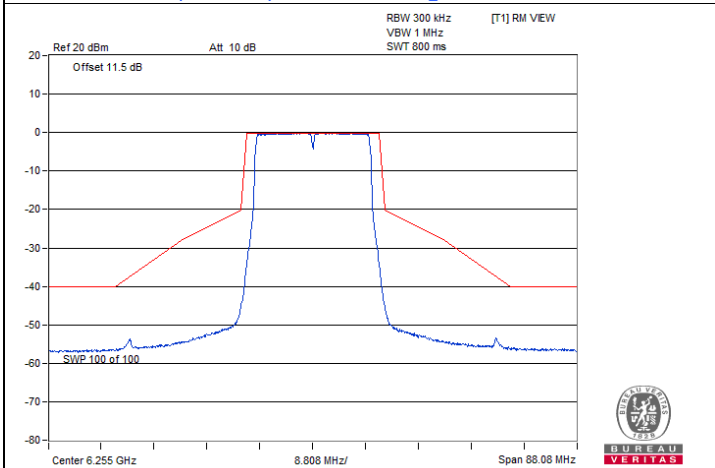

802.11be (EHT20) Beamforming / Chain 1 : CH 61

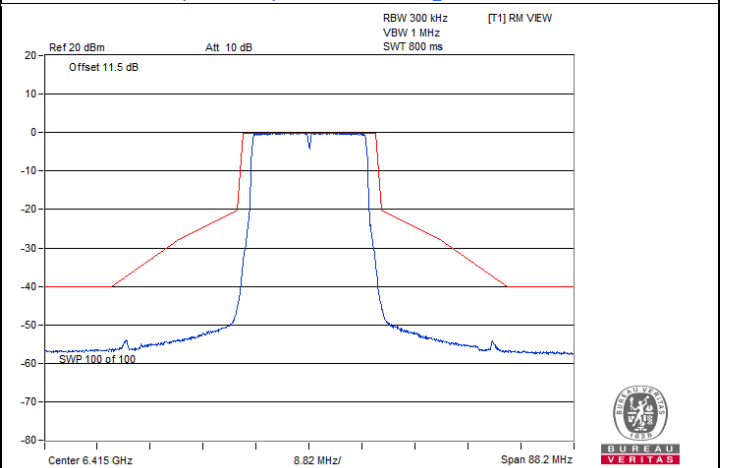

802.11be (EHT20) Beamforming / Chain 1 : CH 93

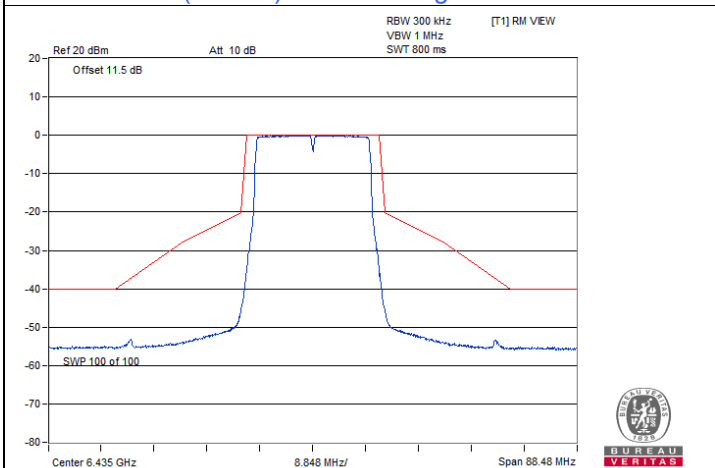

802.11be (EHT20) Beamforming / Chain 1 : CH 97

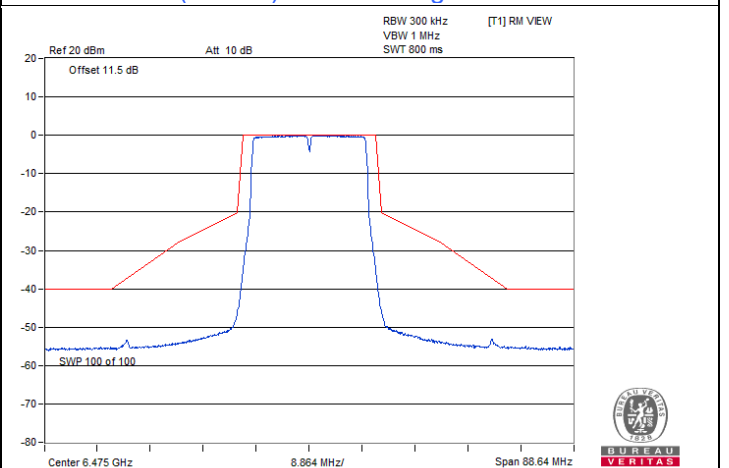

802.11be (EHT20) Beamforming / Chain 1 : CH 105

### Spectrum Plot

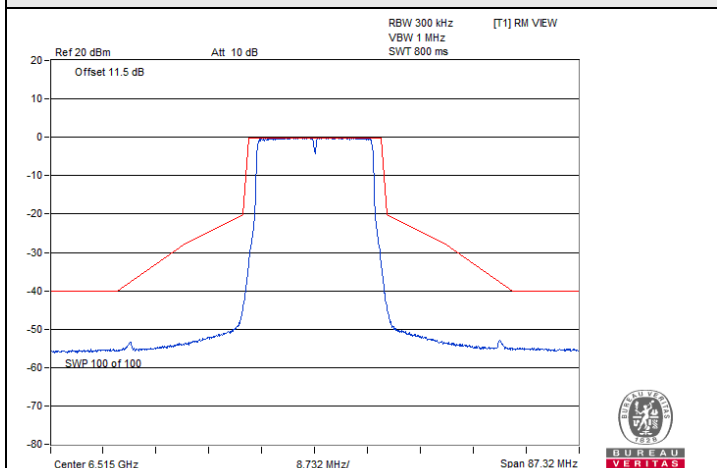

802.11be (EHT20) Beamforming / Chain 1 : CH 113

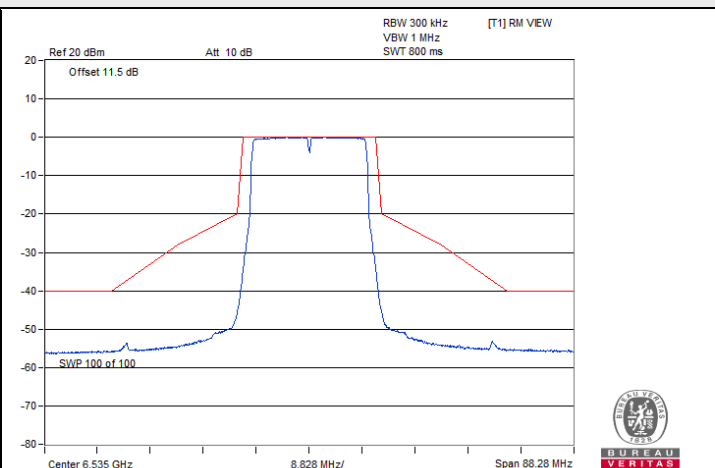

802.11be (EHT20) Beamforming / Chain 1 : CH 117

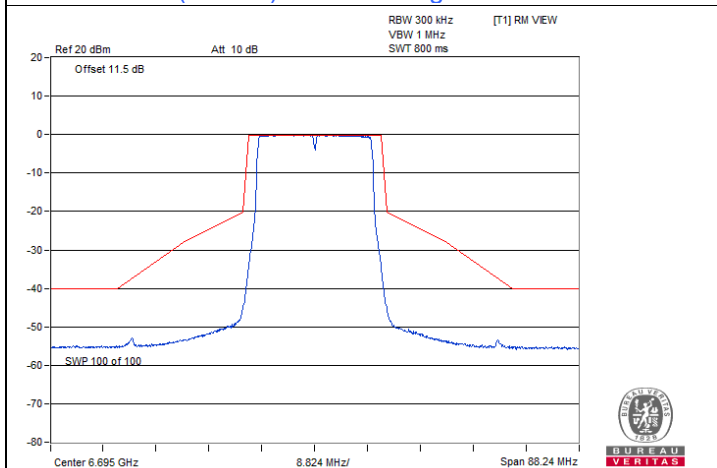

802.11be (EHT20) Beamforming / Chain 1 : CH 149

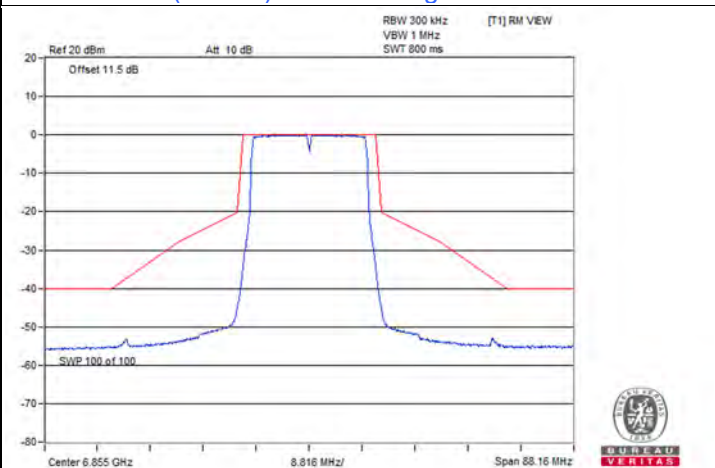

802.11be (EHT20) Beamforming / Chain 1 : CH 181

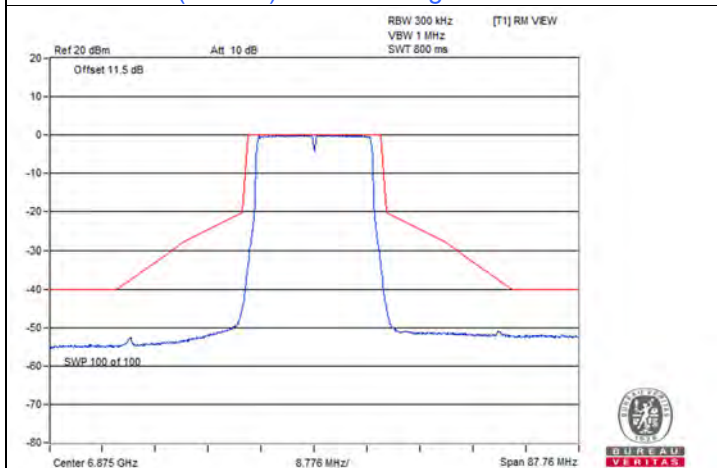

802.11be (EHT20) Beamforming / Chain 1 : CH 185

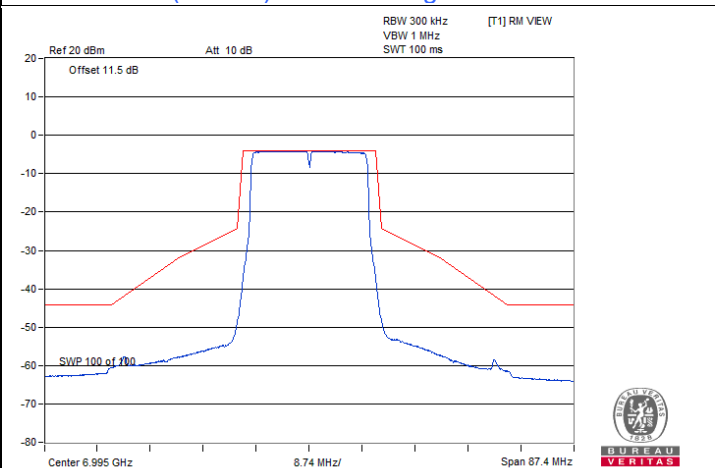

802.11be (EHT20) Beamforming / Chain 1 : CH 209

### Spectrum Plot

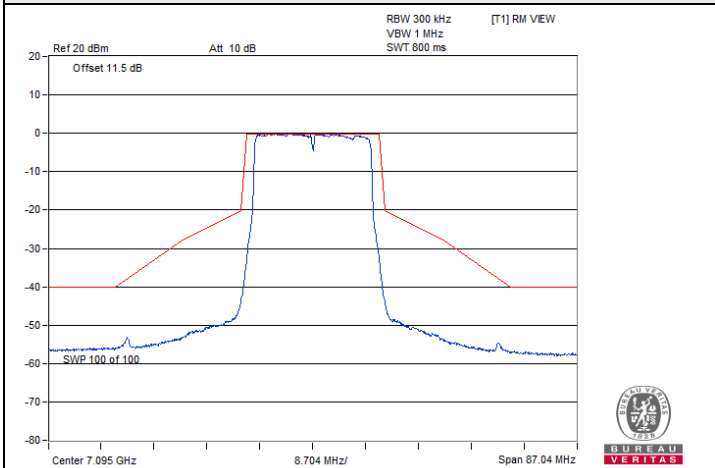

802.11be (EHT20) Beamforming / Chain 1 : CH 229

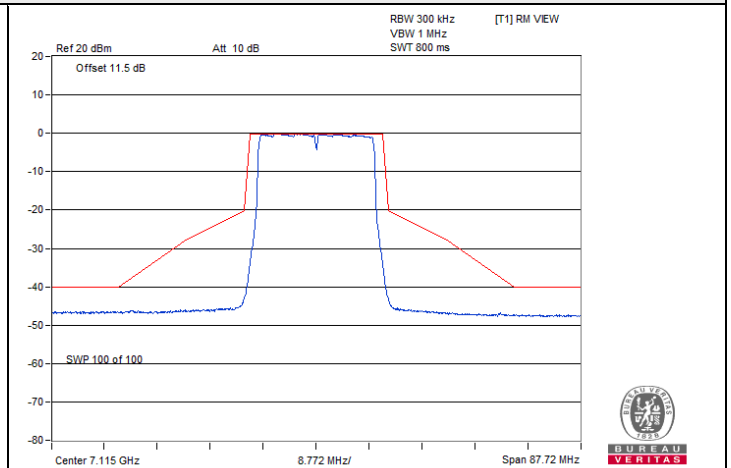

802.11be (EHT20) Beamforming / Chain 1 : CH 233

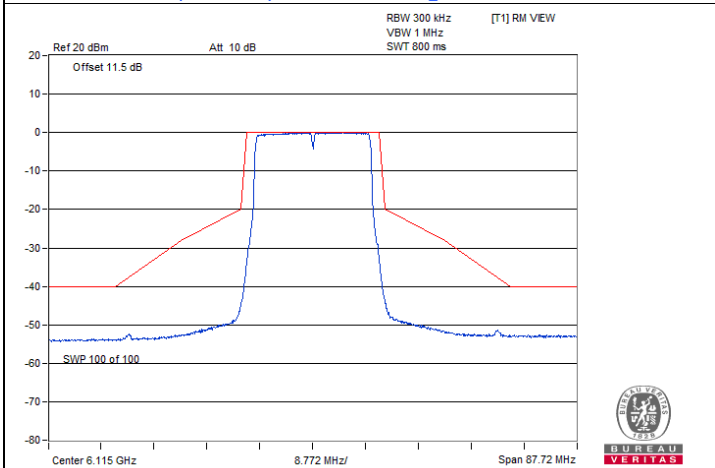

802.11be (EHT20) Beamforming / Chain 2 : CH 33

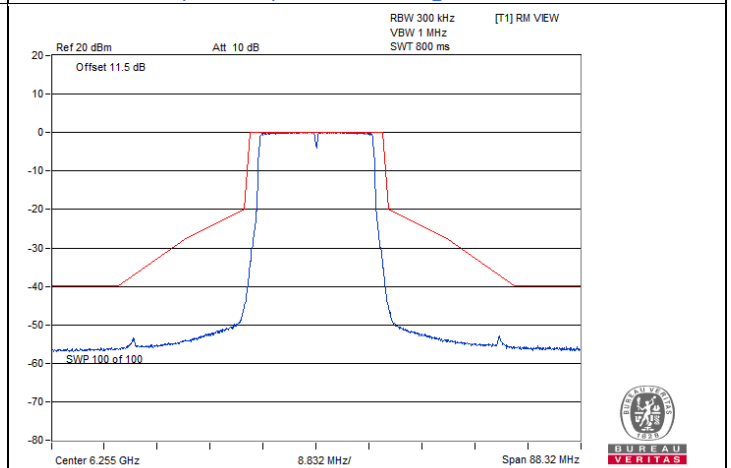

802.11be (EHT20) Beamforming / Chain 2 : CH 61

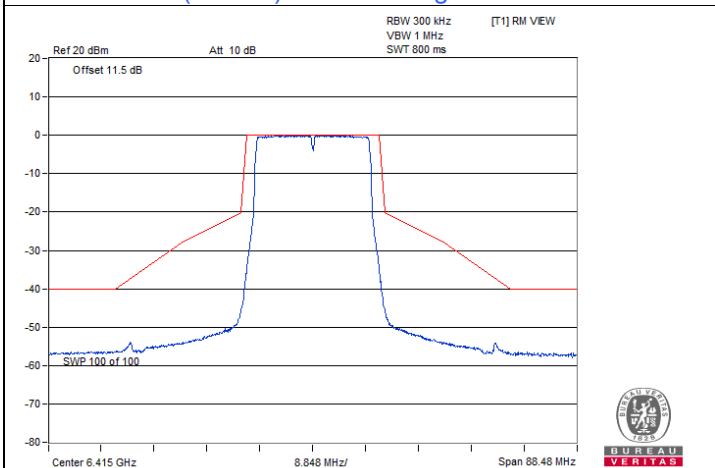

802.11be (EHT20) Beamforming / Chain 2 : CH 93

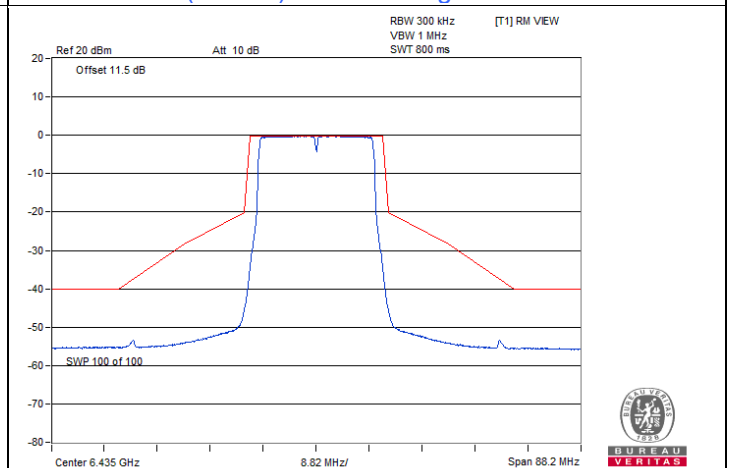

802.11be (EHT20) Beamforming / Chain 2 : CH 97

### Spectrum Plot

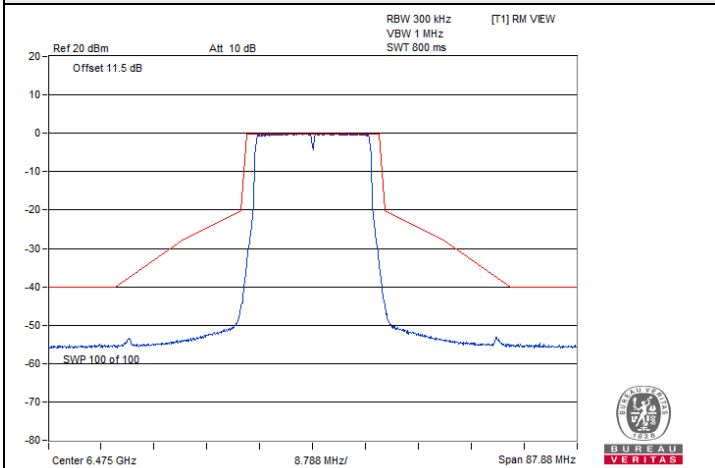

802.11be (EHT20) Beamforming / Chain 2 : CH 105

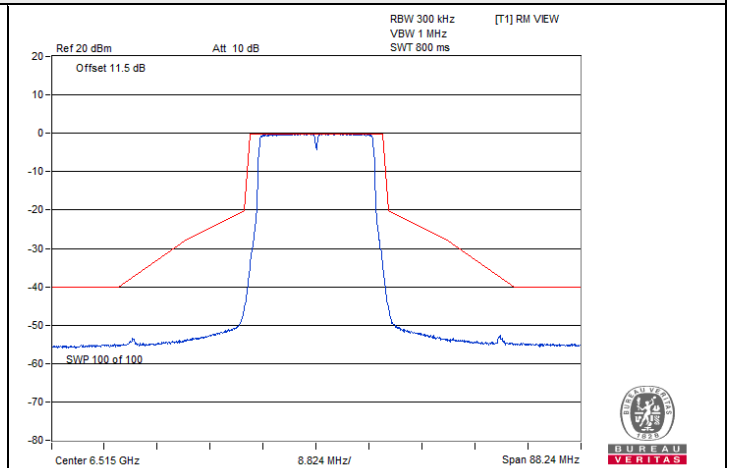

802.11be (EHT20) Beamforming / Chain 2 : CH 113

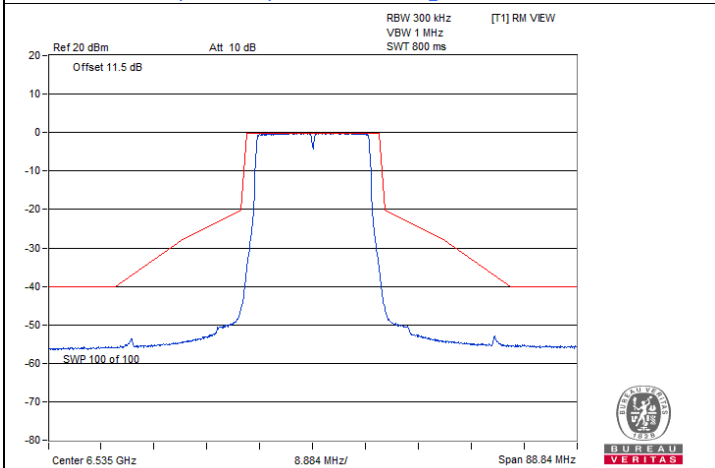

802.11be (EHT20) Beamforming / Chain 2 : CH 117

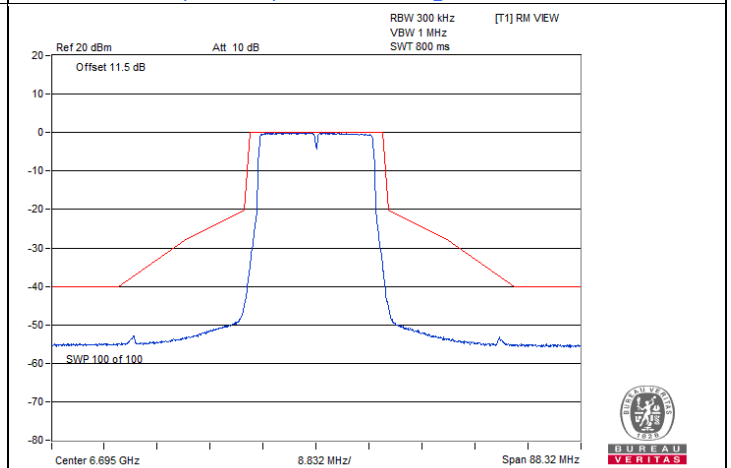

802.11be (EHT20) Beamforming / Chain 2 : CH 149

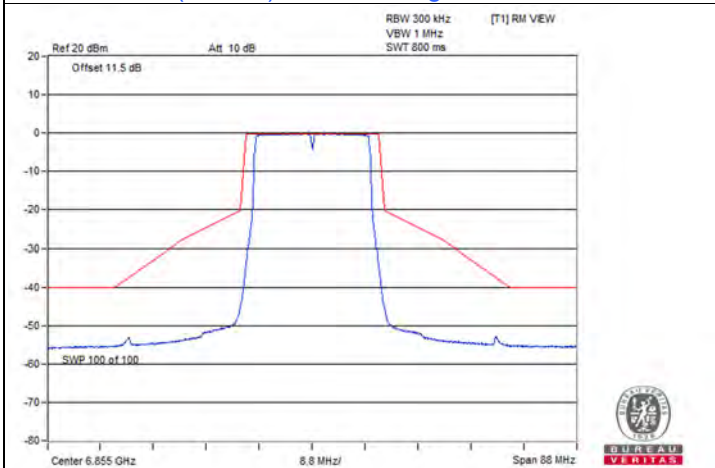

802.11be (EHT20) Beamforming / Chain 2 : CH 181

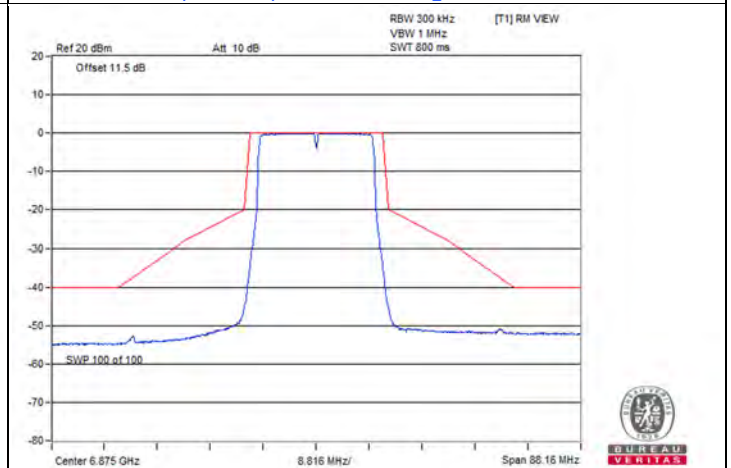

802.11be (EHT20) Beamforming / Chain 2 : CH 185



### Spectrum Plot

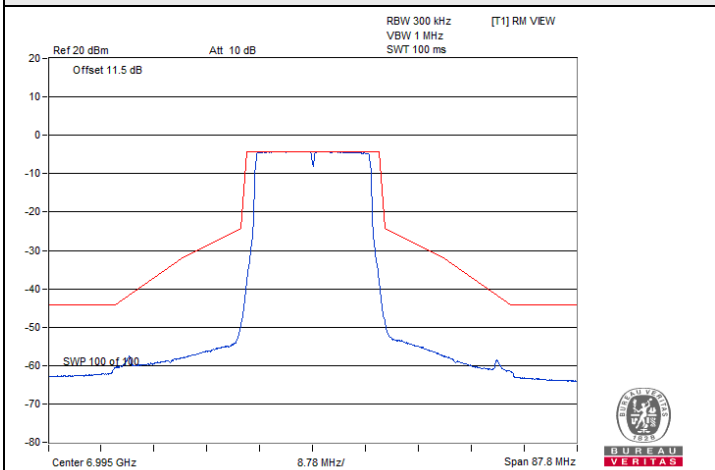

802.11be (EHT20) Beamforming / Chain 2 : CH 209

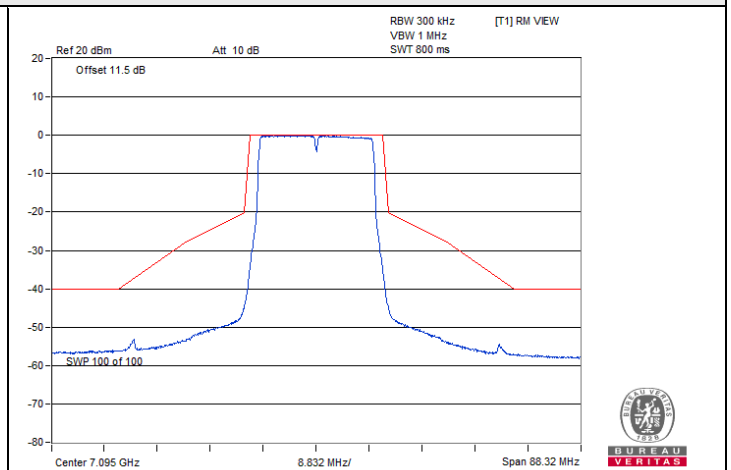

802.11be (EHT20) Beamforming / Chain 2 : CH 229

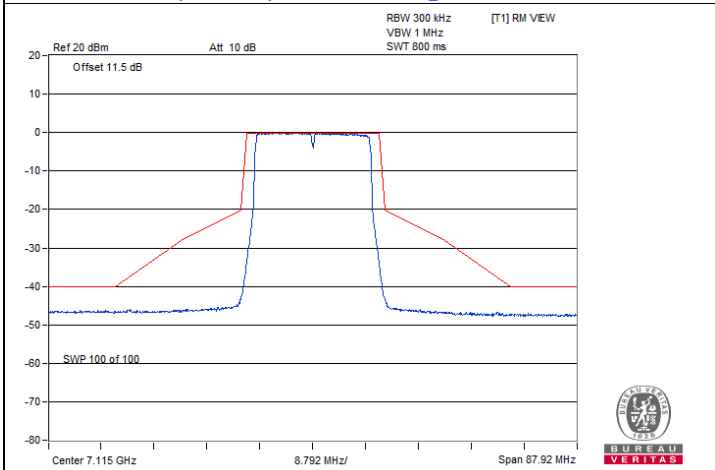

802.11be (EHT20) Beamforming / Chain 2 : CH 233

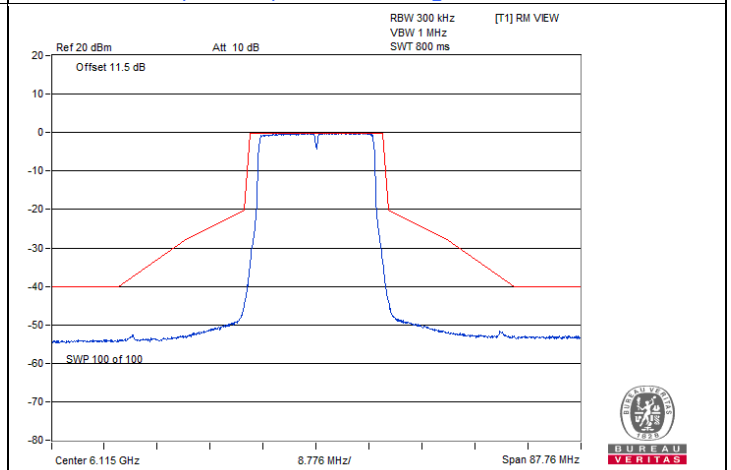

802.11be (EHT20) Beamforming / Chain 3 : CH 33

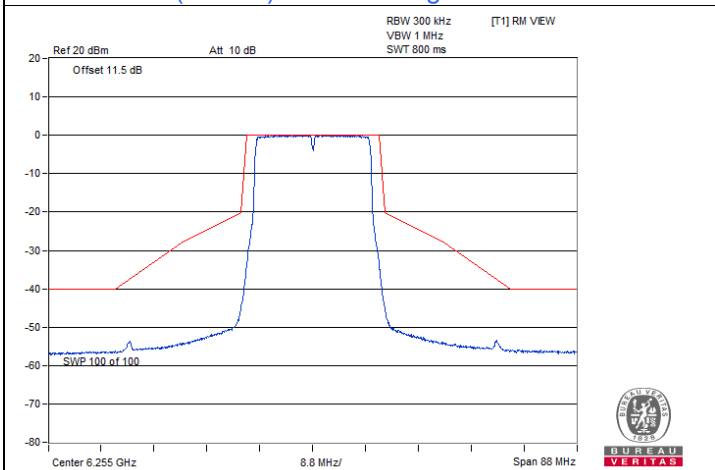

802.11be (EHT20) Beamforming / Chain 3 : CH 61

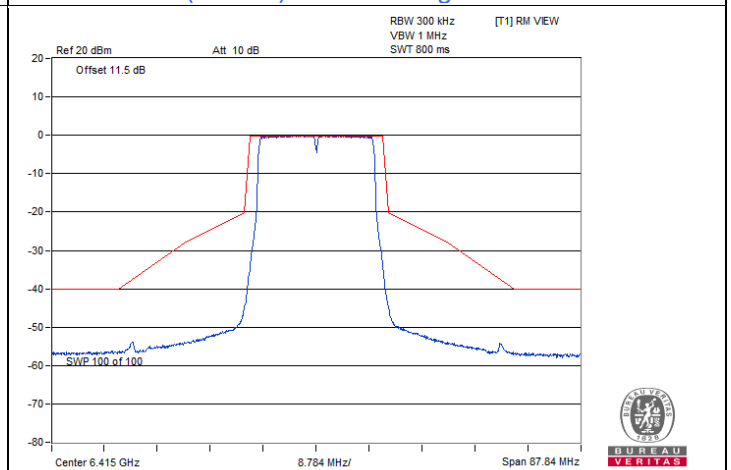

802.11be (EHT20) Beamforming / Chain 3 : CH 93

### Spectrum Plot

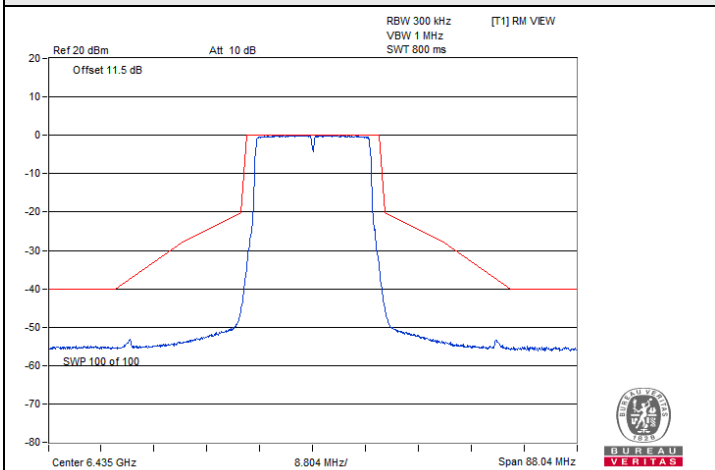

802.11be (EHT20) Beamforming / Chain 3 : CH 97

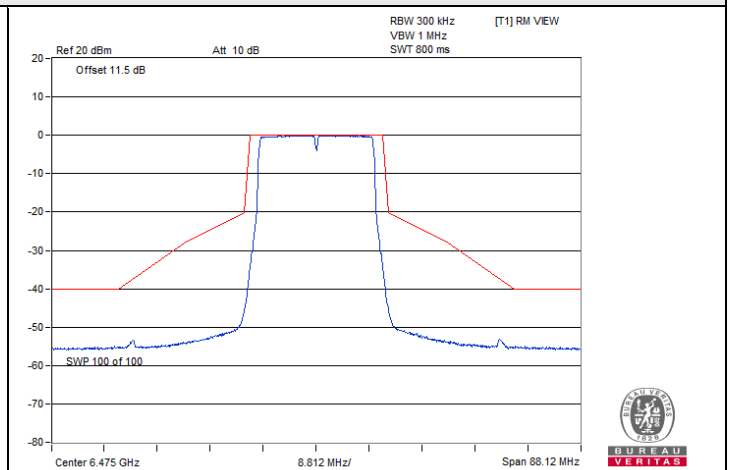

802.11be (EHT20) Beamforming / Chain 3 : CH 105

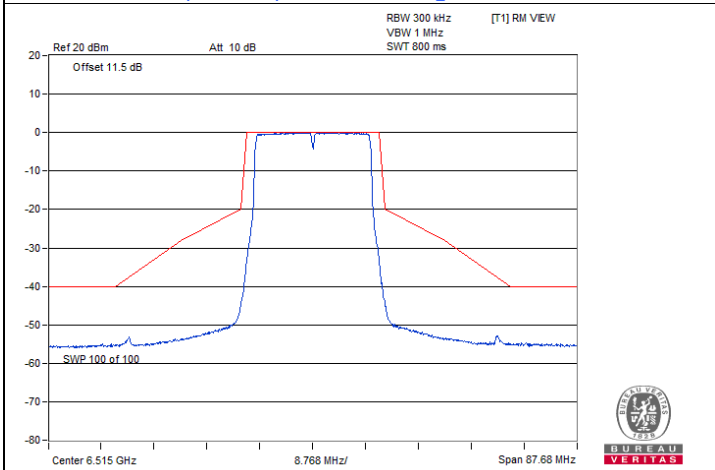

802.11be (EHT20) Beamforming / Chain 3 : CH 113

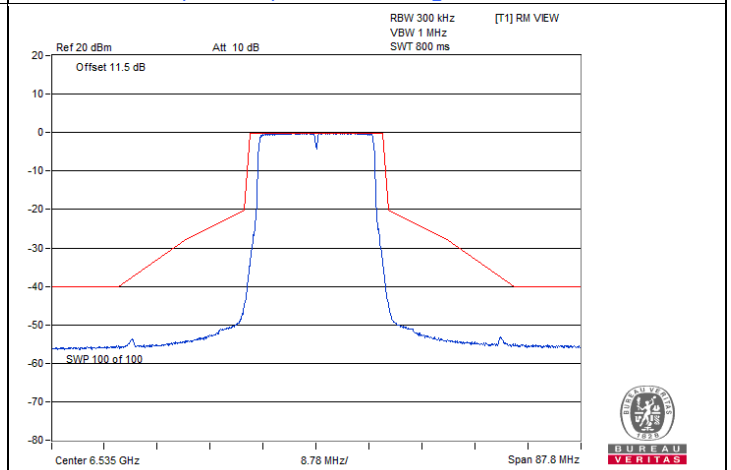

802.11be (EHT20) Beamforming / Chain 3 : CH 117

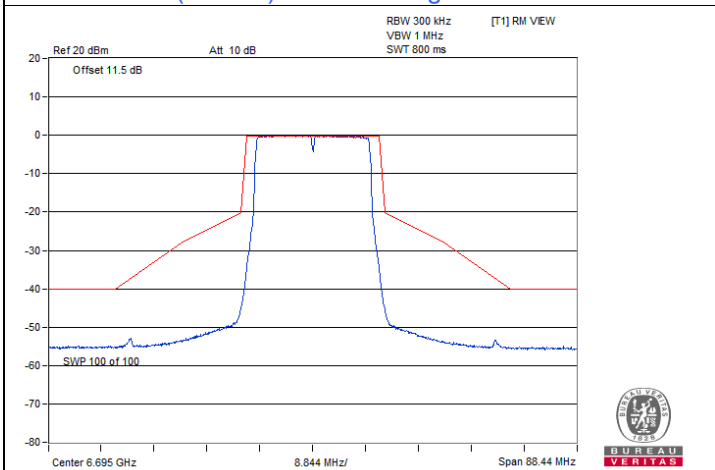

802.11be (EHT20) Beamforming / Chain 3 : CH 149

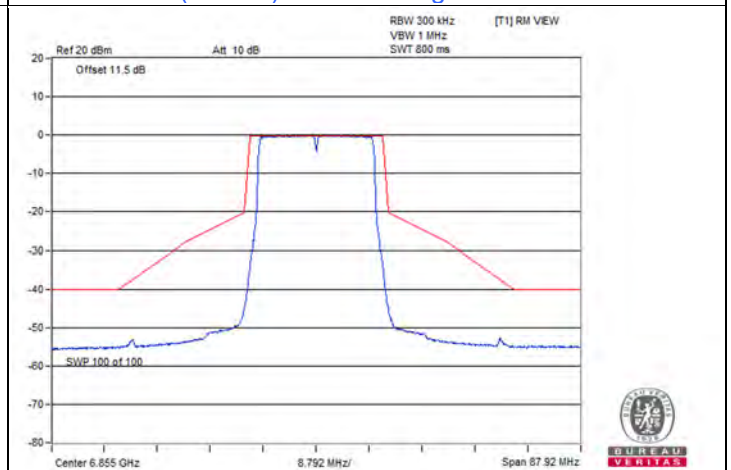

802.11be (EHT20) Beamforming / Chain 3 : CH 181

### Spectrum Plot

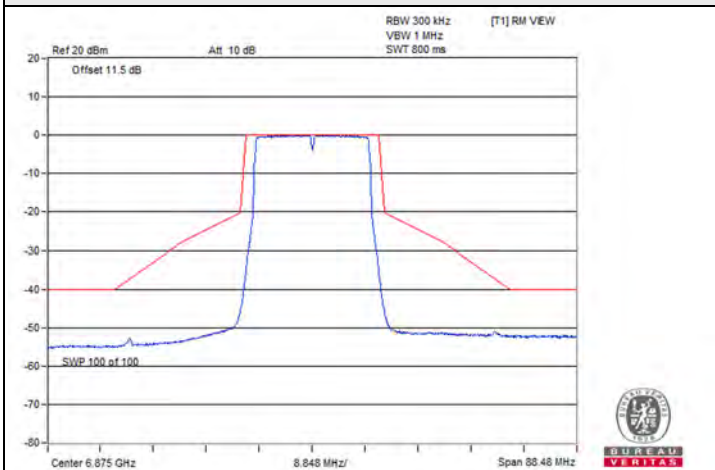

802.11be (EHT20) Beamforming / Chain 3 : CH 185

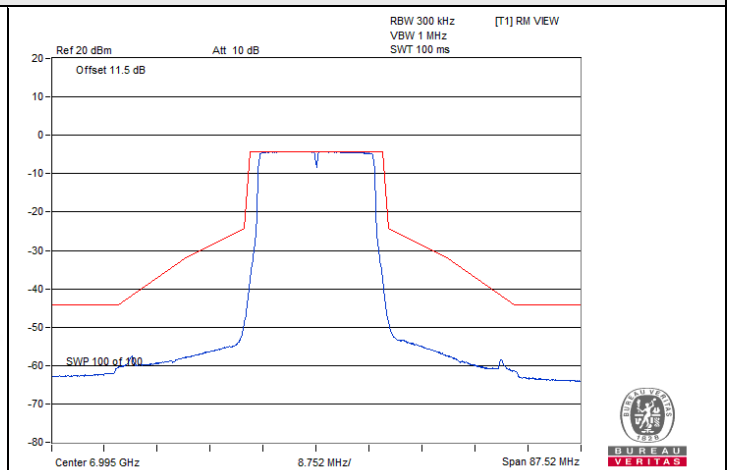

802.11be (EHT20) Beamforming / Chain 3 : CH 209

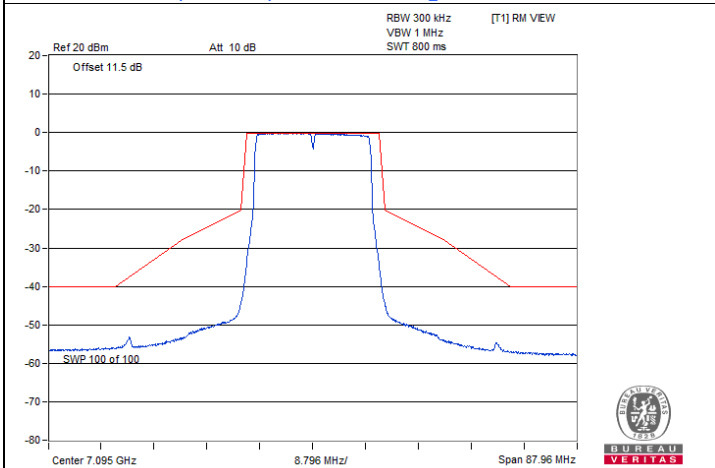

802.11be (EHT20) Beamforming / Chain 3 : CH 229

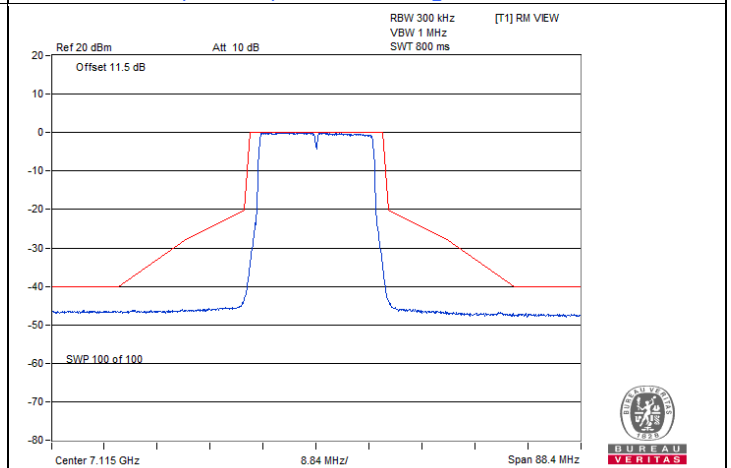

802.11be (EHT20) Beamforming / Chain 3 : CH 233

802.11be (EHT40) Beamforming

Spectrum Plot

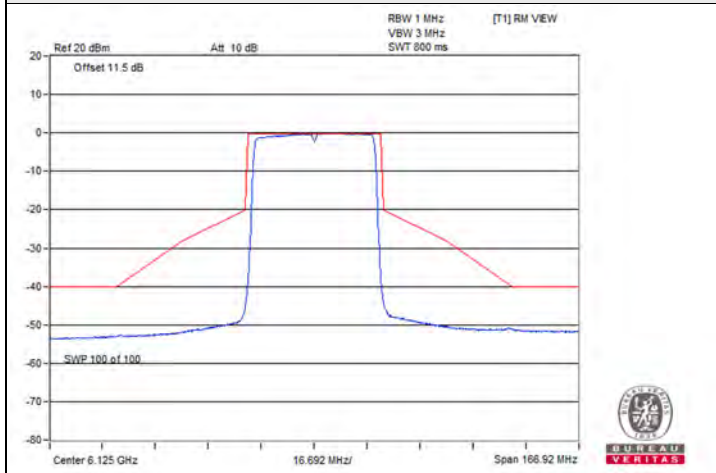

802.11be (EHT40) Beamforming / Chain 0 : CH 35

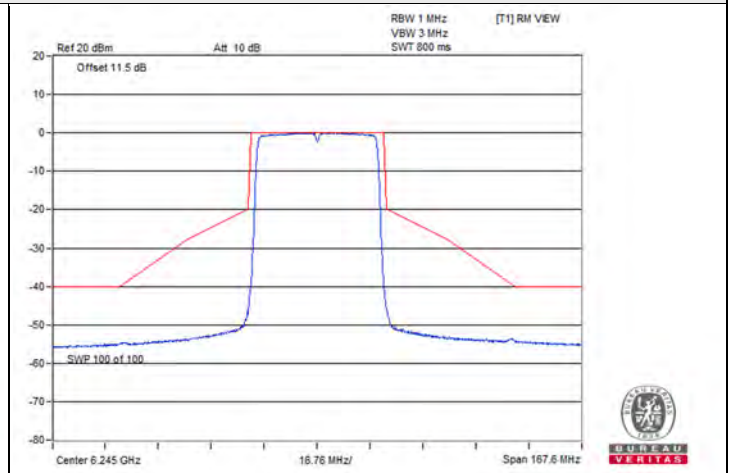

802.11be (EHT40) Beamforming / Chain 0 : CH 59

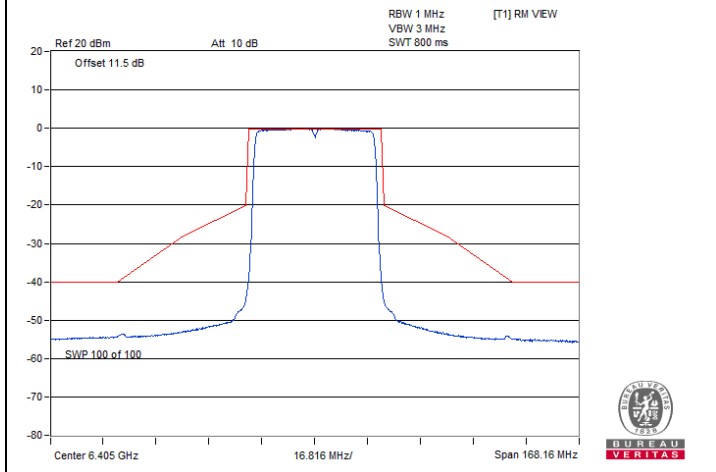

802.11be (EHT40) Beamforming / Chain 0 : CH 91

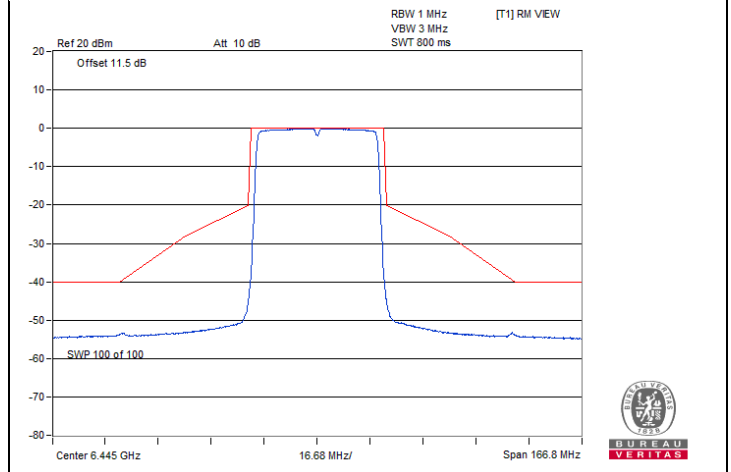

802.11be (EHT40) Beamforming / Chain 0 : CH 99

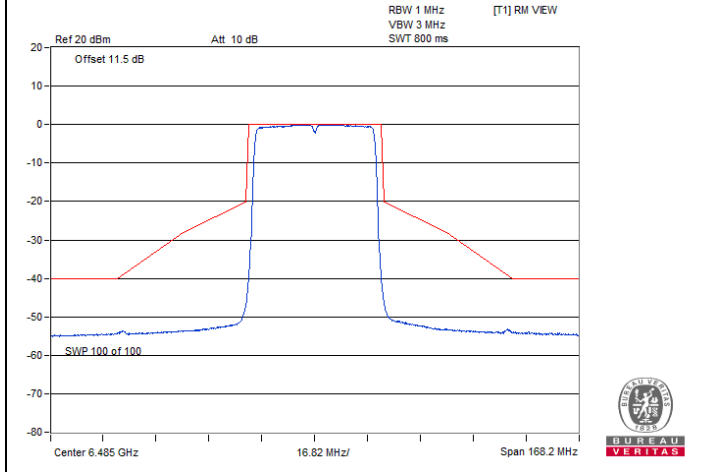

802.11be (EHT40) Beamforming / Chain 0 : CH 107

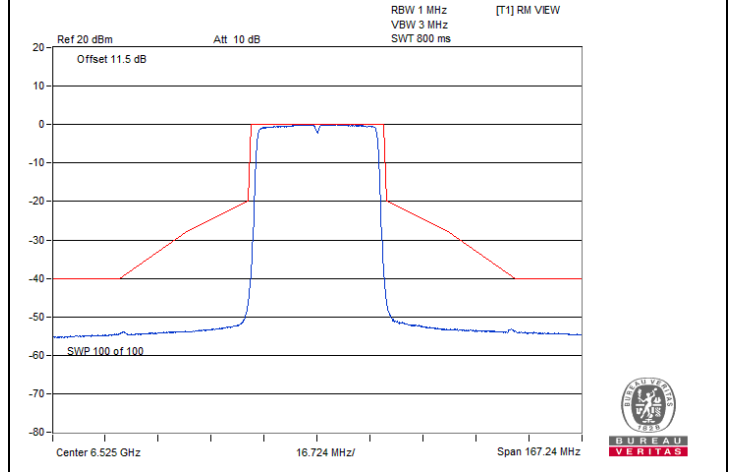

802.11be (EHT40) Beamforming / Chain 0 : CH 115

### Spectrum Plot

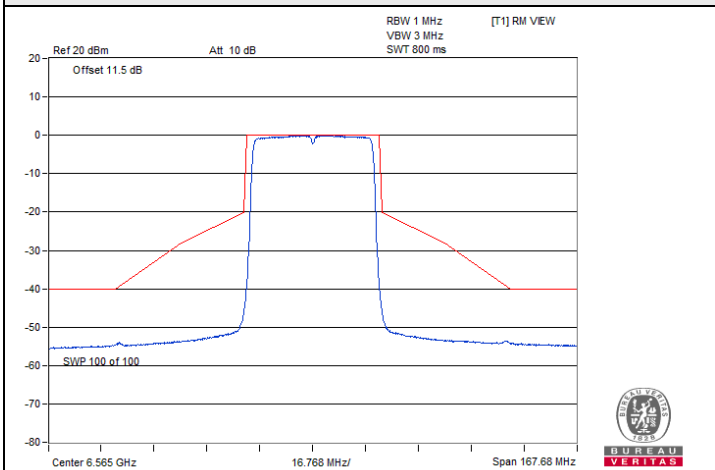

802.11be (EHT40) Beamforming / Chain 0 : CH 123

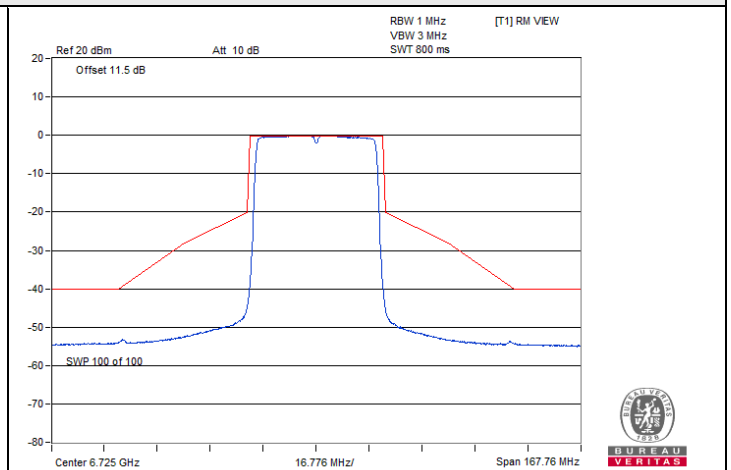

802.11be (EHT40) Beamforming / Chain 0 : CH 155

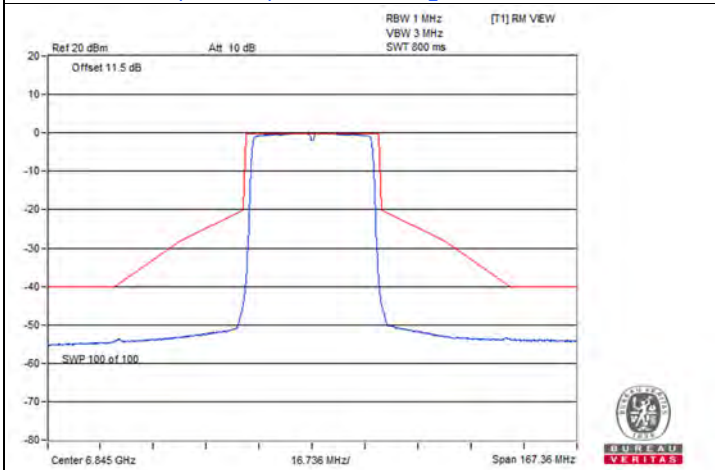

802.11be (EHT40) Beamforming / Chain 0 : CH 179

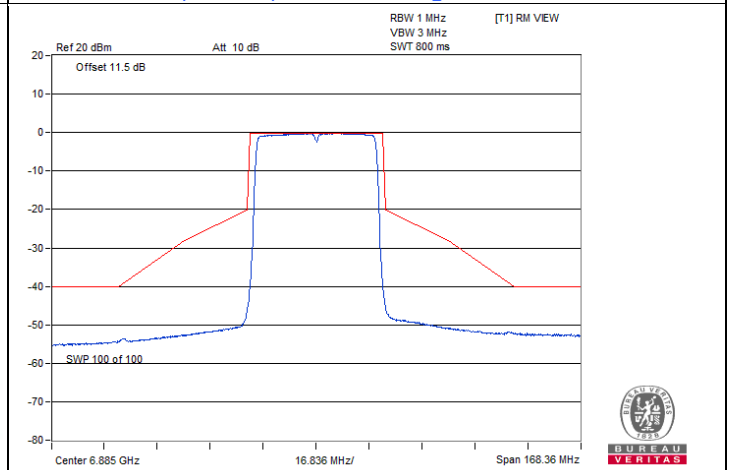

802.11be (EHT40) Beamforming / Chain 0 : CH 187

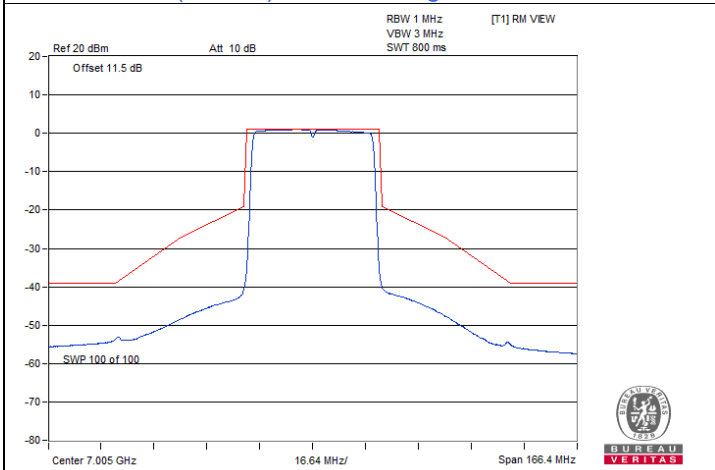

802.11be (EHT40) Beamforming / Chain 0 : CH 211

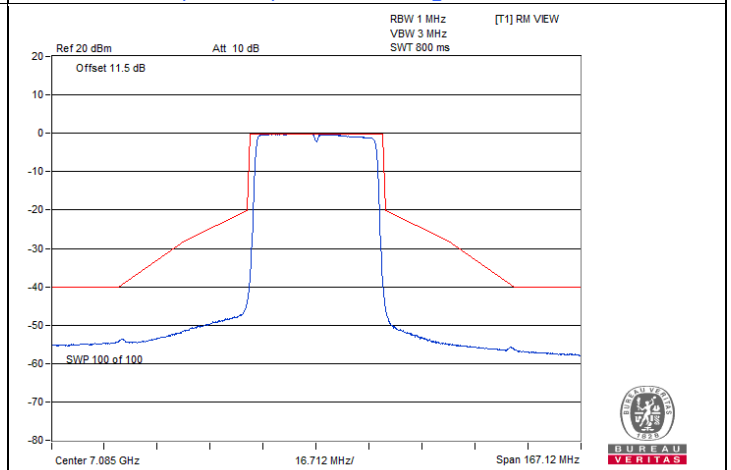

802.11be (EHT40) Beamforming / Chain 0 : CH 227