

# TEST REPORT

## CERTIFICATE OF CONFORMITY

**Standard:** 47 CFR FCC Part 15, Subpart C (Section 15.247)

**Report No.:** RFBBQZ-WTW-P22110099

**FCC ID:** PY323100586

**Product:** BE19000 WiFi 7 Router

**Brand:** NETGEAR

**Model No.:** RS700

**Received Date:** 2023/2/14

**Test Date:** 2023/3/2 ~ 2023/5/5

**Issued Date:** 2023/5/24

**Applicant and Manufacturer:** NETGEAR, Inc.

**Address:** 350 East Plumeria Drive San Jose, CA 95134

**Issued By:** Bureau Veritas Consumer Products Services (H.K.) Ltd., Taoyuan Branch  
Lin Kou Laboratories

**Lab Address:** No. 47-2, 14th Ling, Chia Pau Vil., Lin Kou Dist., New Taipei City, Taiwan

**Test Location:** No. 19, Hwa Ya 2nd Rd., Wen Hwa Vil., Kewi Shan Dist., Taoyuan City 33383, Taiwan

**FCC Registration /** 788550 / TW0003

**Designation Number:**

**Approved by:** Jeremy Lin, **Date:** 2023/5/24  
Jeremy Lin / Project Engineer

This test report consists of 74 pages in total. It may be duplicated completely for legal use with the approval of the applicant. It should not be reproduced except in full, without the written approval of our laboratory. The test results in the report only apply to the tested sample. The test results in this report are traceable to the national or international standards.

Prepared by : Celine Chou / Senior Specialist



This report is governed by, and incorporates by reference, the Conditions of Testing as posted at the date of issuance of this report at <http://www.bureauveritas.com/home/about-us/our-business/cps/about-us/terms-conditions/> and is intended for your exclusive use. Any copying or replication of this report to or for any other person or entity, or use of our name or trademark, is permitted only with our prior written permission. This report sets forth our findings solely with respect to the test samples identified herein. The results set forth in this report are not indicative or representative of the quality or characteristics of the lot from which a test sample was taken or any similar or identical product unless specifically and expressly noted. Our report includes all of the tests requested by you and the results thereof based upon the information that you provided to us. Measurement uncertainty is only provided upon request for accredited tests. Statements of conformity are based on simple acceptance criteria without taking measurement uncertainty into account, unless otherwise requested in writing. You have 60 days from date of issuance of this report to notify us of any material error or omission caused by our negligence or if you require measurement uncertainty; provided, however, that such notice shall be in writing and shall specifically address the issue you wish to raise. A failure to raise such issue within the prescribed time shall constitute your unqualified acceptance of the completeness of this report, the tests conducted and the correctness of the report contents.

## Table of Contents

|   |           |
|---|-----------|
| <b>Release Control Record</b> .....                                 | <b>4</b>  |
| <b>1 Certificate</b> .....  | <b>5</b>  |
| <b>2 Summary of Test Results</b> .....                              | <b>6</b>  |
| 2.1 Measurement Uncertainty .....                                   | 6         |
| 2.2 Supplementary Information .....                                 | 6         |
| <b>3 General Information</b> .....                                  | <b>7</b>  |
| 3.1 General Description .....                                       | 7         |
| 3.2 Antenna Description of EUT .....                                | 8         |
| 3.3 Channel List .....  | 9         |
| 3.4 Test Mode Applicability and Tested Channel Detail .....         | 10        |
| 3.5 Duty Cycle of Test Signal .....                                 | 11        |
| 3.6 Test Program Used and Operation Descriptions .....              | 13        |
| 3.7 Connection Diagram of EUT and Peripheral Devices .....          | 13        |
| 3.8 Configuration of Peripheral Devices and Cable Connections ..... | 13        |
| <b>4 Test Instruments</b> .....                                     | <b>14</b> |
| 4.1 RF Output Power .....   | 14        |
| 4.2 Power Spectral Density .....                                    | 14        |
| 4.3 6 dB Bandwidth .....  | 14        |
| 4.4 Conducted Out of Band Emissions .....                           | 14        |
| 4.5 AC Power Conducted Emissions .....                              | 14        |
| 4.6 Unwanted Emissions below 1 GHz .....                            | 15        |
| 4.7 Unwanted Emissions above 1 GHz .....                            | 16        |
| <b>5 Limits of Test Items</b> .....                                 | <b>17</b> |
| 5.1 RF Output Power .....   | 17        |
| 5.2 Power Spectral Density .....                                    | 17        |
| 5.3 6 dB Bandwidth .....  | 17        |
| 5.4 Conducted Out of Band Emissions .....                           | 17        |
| 5.5 AC Power Conducted Emissions .....                              | 17        |
| 5.6 Unwanted Emissions below 1 GHz .....                            | 18        |
| 5.7 Unwanted Emissions above 1 GHz .....                            | 18        |
| <b>6 Test Arrangements</b> .....                                    | <b>19</b> |
| 6.1 RF Output Power .....   | 19        |
| 6.1.1 Test Setup .....  | 19        |
| 6.1.2 Test Procedure .....  | 19        |
| 6.2 Power Spectral Density .....                                    | 19        |
| 6.2.1 Test Setup .....  | 19        |
| 6.2.2 Test Procedure .....  | 19        |
| 6.3 6 dB Bandwidth .....  | 20        |
| 6.3.1 Test Setup .....  | 20        |
| 6.3.2 Test Procedure .....  | 20        |
| 6.4 Conducted Out of Band Emissions .....                           | 20        |
| 6.4.1 Test Setup .....  | 20        |
| 6.4.2 Test Procedure .....  | 20        |
| 6.5 AC Power Conducted Emissions .....                              | 21        |
| 6.5.1 Test Setup .....  | 21        |
| 6.5.2 Test Procedure .....  | 21        |
| 6.6 Unwanted Emissions below 1 GHz .....                            | 22        |
| 6.6.1 Test Setup .....  | 22        |
| 6.6.2 Test Procedure .....  | 23        |
| 6.7 Unwanted Emissions above 1 GHz .....                            | 24        |
| 6.7.1 Test Setup .....  | 24        |
| 6.7.2 Test Procedure .....  | 24        |
| <b>7 Test Results of Test Item</b> .....                            | <b>25</b> |



|          |   |           |
|----------|---|-----------|
| 7.1      | RF Output Power.....                                | 25        |
| 7.2      | Power Spectral Density.....                         | 28        |
| 7.3      | 6 dB Bandwidth.....                                 | 31        |
| 7.4      | Conducted Out of Band Emissions.....                | 33        |
| 7.5      | AC Power Conducted Emissions.....                   | 49        |
| 7.6      | Unwanted Emissions below 1 GHz.....                 | 53        |
| 7.7      | Unwanted Emissions above 1 GHz.....                 | 57        |
| <b>8</b> | <b>Pictures of Test Arrangements.....</b>           | <b>73</b> |
| <b>9</b> | <b>Information of the Testing Laboratories.....</b> | <b>74</b> |



## Release Control Record

| Issue No.            | Description       | Date Issued |
|----------------------|-------------------|-------------|
| RFBBQZ-WTW-P22110099 | Original release. | 2023/5/24   |

## 1 Certificate

**Product:** BE19000 WiFi 7 Router

**Brand:** NETGEAR

**Test Model:** RS700

**Sample Status:** Engineering sample

**Applicant:** NETGEAR, Inc.

**Test Date:** 2023/3/2 ~ 2023/5/5

**Standard:** 47 CFR FCC Part 15, Subpart C (Section 15.247)

**Measurement** ANSI C63.10-2013

**procedure:**

KDB 558074 D01 15.247 Meas Guidance v05r02

KDB 662911 D01 Multiple Transmitter Output v02r01

KDB 662911 D03 MIMO Antenna Gain Measurement v01

The above equipment has been tested by **Bureau Veritas Consumer Products Services (H.K.) Ltd., Taoyuan Branch**, and found compliance with the requirement of the above standards. The test record, data evaluation & Equipment Under Test (EUT) configurations represented herein are true and accurate accounts of the measurements of the sample's RF characteristics under the conditions specified in this report.

## 2 Summary of Test Results

| 47 CFR FCC Part 15, Subpart C (Section 15.247) |                                 |        |  |
|--|---------------------------------|--------|--|
| Standard / Clause                              | Test Item                       | Result | Remark   |
| 15.247(b)                                      | RF Output Power                 | Pass   | Meet the requirement of limit.                           |
| 15.247(e)                                      | Power Spectral Density          | Pass   | Meet the requirement of limit.                           |
| 15.247(a)(2)                                   | 6 dB Bandwidth                  | Pass   | Meet the requirement of limit.                           |
| 15.247(d)                                      | Conducted Out of Band Emissions | Pass   | Meet the requirement of limit.                           |
| 15.207   | AC Power Conducted Emissions    | Pass   | Minimum passing margin is -9.19 dB at 0.47400 MHz        |
| 15.205 /<br>15.209 /<br>15.247(d)              | Unwanted Emissions below 1 GHz  | Pass   | Minimum passing margin is -3.1 dB at 52.49 MHz           |
| 15.205 /<br>15.209 /<br>15.247(d)              | Unwanted Emissions above 1 GHz  | Pass   | Minimum passing margin is -0.1 dB at 2483.50 MHz         |
| 15.203   | Antenna Requirement             | Pass   | Antenna connector is ipex(MHF) not a standard connector. |

Note: Determining compliance based on the results of the compliance measurement, not taking into account measurement instrumentation uncertainty.

### 2.1 Measurement Uncertainty

Where relevant, the following measurement uncertainty levels have been estimated for tests performed on the EUT as specified in CISPR 16-4-2:

| Measurement                    | Specification   | Expanded Uncertainty (k=2)<br>(±) |
|--------------------------------|-----------------|-----------------------------------|
| AC Power Conducted Emissions   | 9 kHz ~ 30 MHz  | 2.99 dB                           |
| Unwanted Emissions below 1 GHz | 9 kHz ~ 30 MHz  | 3.59 dB                           |
|                                | 30 MHz ~ 1 GHz  | 3.64 dB                           |
| Unwanted Emissions above 1 GHz | 1 GHz ~ 18 GHz  | 2.29 dB                           |
|                                | 18 GHz ~ 40 GHz | 2.29 dB                           |

The other instruments specified are routine verified to remain within the calibrated levels, no measurement uncertainty is required to be calculated.

### 2.2 Supplementary Information

There is not any deviation from the test standards for the test method, and no modifications required for compliance.

### 3 General Information

#### 3.1 General Description

|                       |   |
|-----------------------|---|
| Product               | BE19000 WiFi 7 Router   |
| Brand                 | NETGEAR   |
| Test Model            | RS700   |
| Status of EUT         | Engineering sample  |
| Power Supply Rating   | 19 Vdc from adapter   |
| Modulation Type       | CCK, DQPSK, DBPSK for DSSS<br>64QAM, 16QAM, QPSK, BPSK for OFDM<br>256QAM for OFDM in VHT mode<br>1024QAM for OFDMA in 11ax mode only<br>4096QAM for OFDMA in 11be EHT mode |
| Modulation Technology | DSSS, OFDM, OFDMA   |
| Transfer Rate         | 802.11b: up to 11 Mbps<br>802.11g: up to 54 Mbps<br>802.11n: up to 600 Mbps<br>VHT: up to 800 Mbps<br>802.11ax: up to 1147.1 Mbps<br>802.11be: up to 1376.4 Mbps            |
| Operating Frequency   | 2412 ~ 2462 MHz   |
| Number of Channel     | 802.11b, 802.11g, 802.11n (HT20), VHT20, 802.11ax (HE20), 802.11be (EHT20): 11<br>802.11n (HT40), VHT40, 802.11ax (HE40), 802.11be (EHT40): 7                               |
| Output Power          | CDD Mode: 29.55 dBm (902.379 mW)<br>Beamforming Mode: 29.55 dBm (902.379 mW)  |

Note:

1. The EUT uses following accessories.

| Item           | Brand   | Model        | Part Number  | Specification  |
|----------------|---------|--------------|--------------|--|
| Adapter 1      | NETGEAR | AD200F10     | 332-11480-02 | AC Input : 100-120 Vac, 50/60 Hz, 1.7 A<br>DC Output : 19 Vdc, 3.16 A, 60 W<br>DC Output Cable : 1.8 m non-shielded and without core |
| Adapter 2      | NETGEAR | 2AEC060K 1   | 332-11578-01 | AC Input : 100-120 Vac, 50/60 Hz, 1.7 A<br>DC Output : 19 Vdc, 3.16 A, 60 W<br>DC Output Cable : 1.8 m non-shielded and without core |
| Ethernet Cable | NETGEAR | 312-10147-01 | -            | 2m non-shielded and without core   |

2. Simultaneously transmission condition.

| Condition | Technology    |             |             |
|-----------|---------------|-------------|-------------|
|           | WLAN (2.4GHz) | WLAN (5GHz) | WLAN (6GHz) |
| 1         |               |             |             |

Note: The emission of the simultaneous operation has been evaluated and no non-compliance was found.

3. The above EUT information is declared by manufacturer and for more detailed features description, please refer to the manufacturer's specifications or user's manual.

### 3.2 Antenna Description of EUT

1. The antenna information is listed as below.

|                 |                        |
|-----------------|------------------------|
| Antenna Type    | Dipole                 |
| Connector Type  | ipex(MHF)              |
| Antenna Gain    | Directional Gain (dBi) |
| 2400~2483.5 MHz | 6.06                   |
| 5150~5250 MHz   | 5.99                   |
| 5250~5350 MHz   | 6.05                   |
| 5470~5725 MHz   | 6.03                   |
| 5725~5850 MHz   | 6.06                   |

\* The detailed antenna information, please refer to the BV CPS report no.: RFBBQZ-WTW-P22110099-6.

2. The EUT incorporates a MIMO function:

| Modulation Mode  | Beamforming Mode | Tx & Rx Configuration |     |
|------------------|------------------|-----------------------|-----|
| 802.11b          | Not Support      | 4TX                   | 4RX |
| 802.11g          | Not Support      | 4TX                   | 4RX |
| 802.11n (HT20)   | Support          | 4TX                   | 4RX |
| 802.11n (HT40)   | Support          | 4TX                   | 4RX |
| VHT20            | Support          | 4TX                   | 4RX |
| VHT40            | Support          | 4TX                   | 4RX |
| 802.11ax (HE20)  | Support          | 4TX                   | 4RX |
| 802.11ax (HE40)  | Support          | 4TX                   | 4RX |
| 802.11be (EHT20) | Support          | 4TX                   | 4RX |
| 802.11be (EHT40) | Support          | 4TX                   | 4RX |

Note:

1. The EUT support Beamforming and CDD mode, therefore both mode were investigated and the worst case scenario was identified. The worst case data were presented in test report.
2. The modulation and bandwidth are similar for 802.11n mode for 20 MHz (40 MHz), VHT mode for 20 MHz (40 MHz), 802.11ax mode for 20 MHz (40 MHz), and 802.11be mode for 20 MHz (40 MHz), therefore the manufacturer will control the power for 802.11n/VHT/ax mode is the same as the 802.11be or more lower than it and investigated worst case to representative mode in test report.
3. For 802.11ax and 802.11be, the EUT not support Partial RU.



### 3.3 Channel List

11 channels are provided for 802.11b, 802.11g, 802.11n (HT20), VHT20, 802.11ax (HE20), 802.11be (EHT20):

| Channel | Frequency | Channel | Frequency |
|---------|-----------|---------|-----------|
| 1       | 2412 MHz  | 7       | 2442 MHz  |
| 2       | 2417 MHz  | 8       | 2447 MHz  |
| 3       | 2422 MHz  | 9       | 2452 MHz  |
| 4       | 2427 MHz  | 10      | 2457 MHz  |
| 5       | 2432 MHz  | 11      | 2462 MHz  |
| 6       | 2437 MHz  |         |           |

7 channels are provided for 802.11n (HT40), VHT40, 802.11ax (HE40), 802.11be (EHT40):

| Channel | Frequency | Channel | Frequency |
|---------|-----------|---------|-----------|
| 3       | 2422 MHz  | 7       | 2442 MHz  |
| 4       | 2427 MHz  | 8       | 2447 MHz  |
| 5       | 2432 MHz  | 9       | 2452 MHz  |
| 6       | 2437 MHz  |         |           |

### 3.4 Test Mode Applicability and Tested Channel Detail

|             |   |
|-------------|---|
| Pre-Scan:   | EUT can be used in the following ways: XYZ 3-axis. Pre-scan in these ways and find the worst case as a representative test condition. |
| Worst Case: | X / Y / Z Worst Condition: Z Axis.  |

Following channel(s) was (were) selected for the final test as listed below:

| Test Item   | EUT Configure Mode | Mode                     | Signal Mode       | Tested Channel | Modulation | Data Rate Parameter |
|---|--------------------|--------------------------|-------------------|----------------|------------|---------------------|
| RF Output Power   | B                  | 802.11b                  | CDD               | 1, 6, 11       | DBPSK      | 1Mb/s               |
|   |                    | 802.11g                  |                   | 1, 6, 11       | BPSK       | 6Mb/s               |
|   |                    | 802.11be (EHT20)         | CDD & Beamforming | 1, 6, 11       | BPSK       | MCS0                |
|   |                    | 802.11be (EHT40)         |                   | 3, 6, 9        | BPSK       | MCS0                |
| Power Spectral Density / 6 dB Bandwidth / Conducted Out of Band Emissions | B                  | 802.11b                  | CDD               | 1, 6, 11       | DBPSK      | 1Mb/s               |
|   |                    | 802.11g                  |                   | 1, 6, 11       | BPSK       | 6Mb/s               |
|   |                    | 802.11be (EHT20)         |                   | 1, 6, 11       | BPSK       | MCS0                |
|   |                    | 802.11be (EHT40)         |                   | 3, 6, 9        | BPSK       | MCS0                |
| AC Power Conducted Emissions  | A, B               | 802.11be (EHT20)         | CDD               | 6              | BPSK       | 6Mb/s               |
| Unwanted Emissions below 1 GHz  | A, B               | 802.11be (EHT20)         | CDD               | 6              | BPSK       | 6Mb/s               |
| Unwanted Emissions above 1 GHz  | B                  | 802.11b                  | CDD               | 1, 6, 11       | DBPSK      | 1Mb/s               |
|   |                    | 802.11g                  |                   | 1, 6, 11       | BPSK       | 6Mb/s               |
|   |                    | 802.11be (EHT20)         |                   | 1, 6, 11       | BPSK       | MCS0                |
|   |                    | 802.11be (EHT40)         |                   | 3, 6, 9        | BPSK       | MCS0                |
| EUT Configure Mode:   | A                  | EUT powered by adapter 1 |                   |                |            |                     |
|   | B                  | EUT powered by adapter 2 |                   |                |            |                     |

### 3.5 Duty Cycle of Test Signal

**802.11b:** Duty cycle = 3.205 ms / 3.225 ms x 100% = 99.4%

**802.11g:** Duty cycle = 3.015 ms / 3.035 ms x 100% = 99.3%

**802.11be (EHT20):** Duty cycle = 2.875 ms / 2.895 ms x 100% = 99.3%

**802.11be (EHT40):** Duty cycle = 2.855 ms / 2.875 ms x 100% = 99.3%

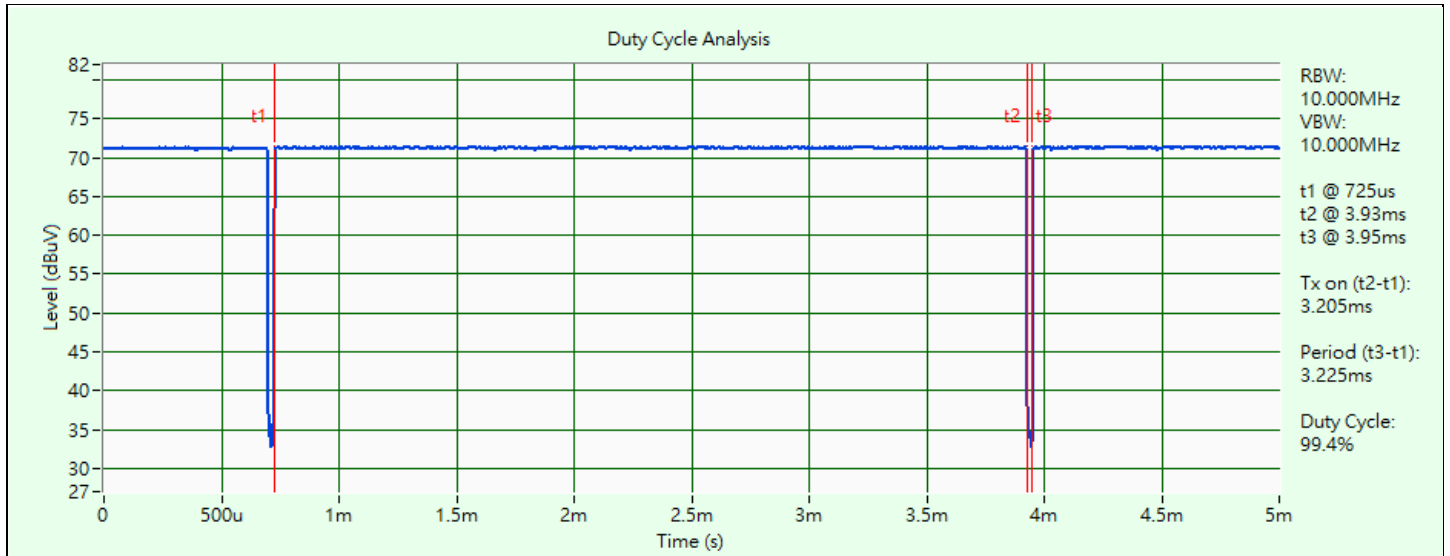

802.11b

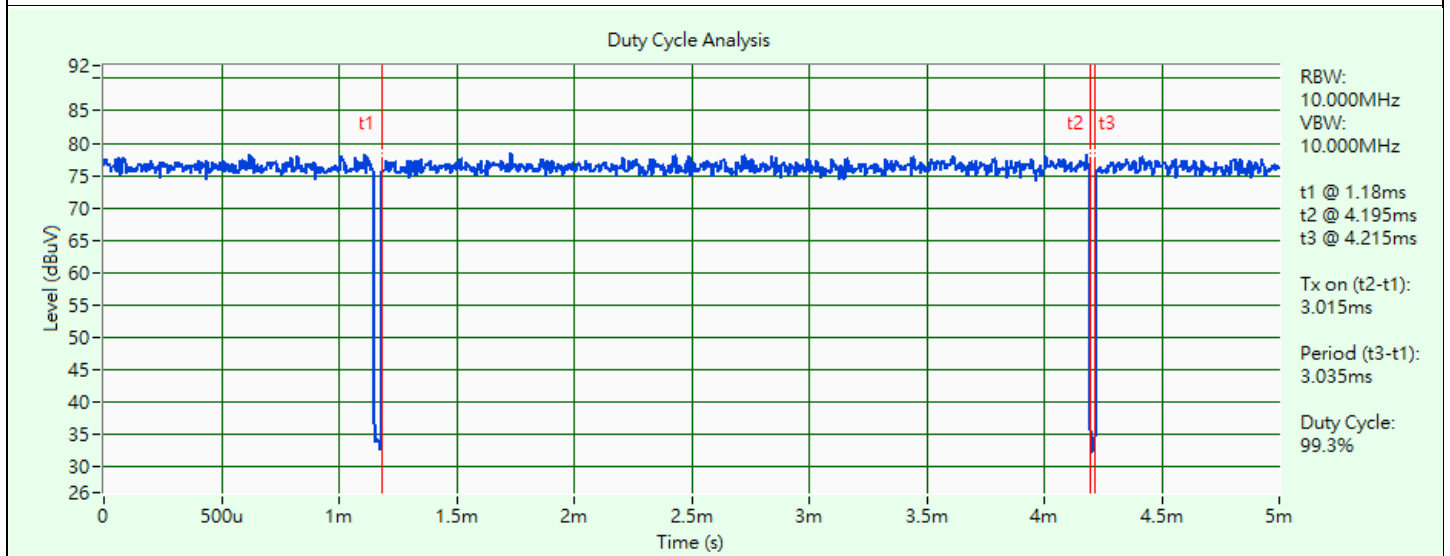

802.11g

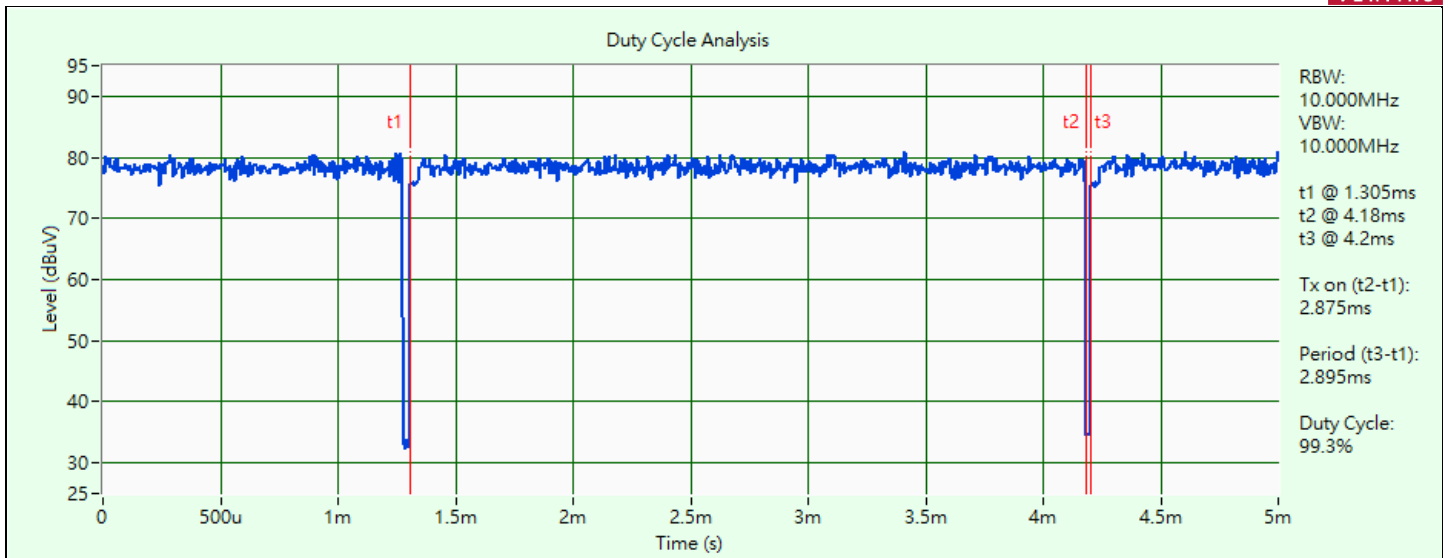

802.11be (EHT20)

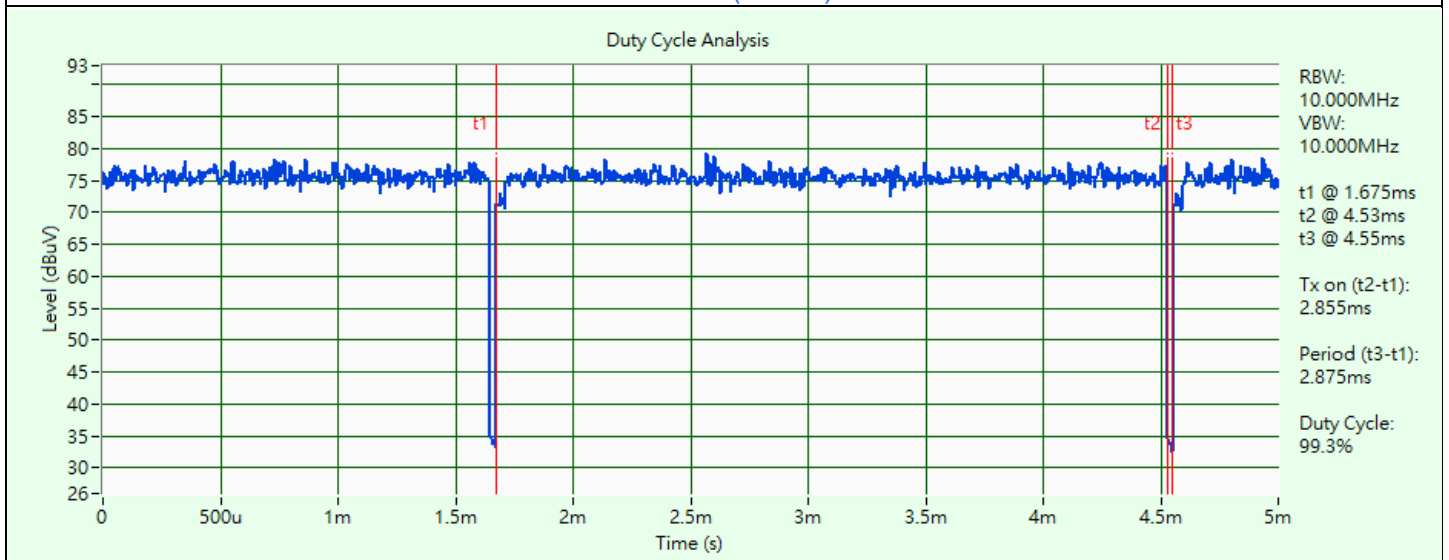

802.11be (EHT40)

### 3.6 Test Program Used and Operation Descriptions

Controlling software accessMTool\_REL\_3\_2\_1\_5 has been activated to set the EUT under transmission condition continuously at specific channel frequency.

### 3.7 Connection Diagram of EUT and Peripheral Devices

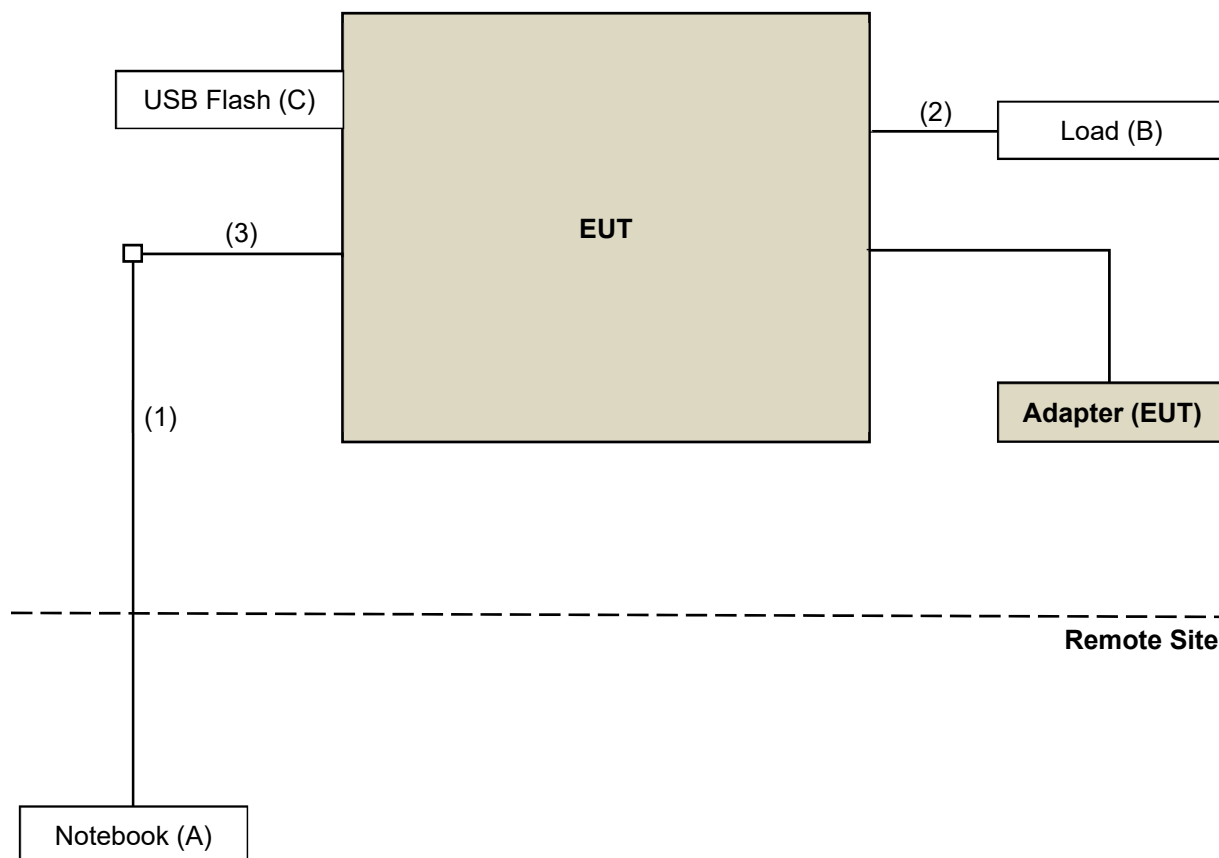

### 3.8 Configuration of Peripheral Devices and Cable Connections

| ID | Product   | Brand   | Model No.   | Serial No. | FCC ID | Remarks         |
|----|-----------|---------|-------------|------------|--------|-----------------|
| A  | Notebook  | DELL    | E5430       | 2RL3YW1    | N/A    | Provided by Lab |
| B  | Load      | N/A     | N/A         | N/A        | N/A    | Provided by Lab |
| C  | USB Flash | SanDisk | SDDDC3-032G | N/A        | N/A    | Provided by Lab |

| ID | Cable Descriptions | Qty. | Length (m) | Shielding (Yes/No) | Cores (Qty.) | Remarks          |
|----|--------------------|------|------------|--------------------|--------------|------------------|
| 1  | LAN Cable          | 1    | 10         | N                  | N            | Provided by Lab  |
| 2  | LAN Cable          | 5    | 1.5        | N                  | N            | Provided by Lab  |
| 3  | Ethernet Cable     | 1    | 2.0        | N                  | N            | Accessory of EUT |

## 4 Test Instruments

The calibration interval of the all test instruments are 12 months and the calibrations are traceable to NML/ROC and NIST/USA.

### 4.1 RF Output Power

| Description<br>Manufacturer              | Model No. | Serial No.                                  | Calibrated<br>Date | Calibrated<br>Until |
|--|-----------|---|--------------------|---------------------|
| USB Wideband Power<br>Sensor<br>KEYSIGHT | U2021XA   | MY55050005/MY55190004/MY55190007/MY55210005 | 2022/7/13          | 2023/7/12           |

Notes:

1. The test was performed in Oven room.
2. Tested Date: 2023/4/20

### 4.2 Power Spectral Density

| Description<br>Manufacturer         | Model No.                        | Serial No. | Calibrated<br>Date | Calibrated<br>Until |
|-------------------------------------|----------------------------------|------------|--------------------|---------------------|
| Signal and spectrum analyzer<br>R&S | FSV3044                          | 101105     | 2023/2/22          | 2024/2/21           |
| Software<br>BV                      | ADT_RF Test Software<br>V6.6.5.4 | N/A        | N/A                | N/A                 |

Notes:

1. The test was performed in Oven room.
2. Tested Date: 2023/4/20

### 4.3 6 dB Bandwidth

Refer to section 4.2 to get information of the instruments.

### 4.4 Conducted Out of Band Emissions

Refer to section 4.2 to get information of the instruments.

### 4.5 AC Power Conducted Emissions

| Description<br>Manufacturer    | Model No.               | Serial No.     | Calibrated<br>Date | Calibrated<br>Until |
|--------------------------------|-------------------------|----------------|--------------------|---------------------|
| LISN<br>R&S                    | ESH3-Z5                 | 100311         | 2022/9/12          | 2023/9/11           |
| LISN<br>ROHDE & SCHWARZ        | ENV216                  | 101826         | 2023/3/23          | 2024/3/22           |
| RF Coaxial Cable<br>WOKEN      | 5D-FB                   | Cable-cond1-01 | 2023/1/7           | 2024/1/6            |
| Software<br>BVADT              | BVADT_Cond_<br>V7.3.7.4 | N/A            | N/A                | N/A                 |
| Test Receiver<br>Rohde&Schwarz | ESCI                    | 100613         | 2022/12/5          | 2023/12/4           |
| V-LISN<br>Schwarzbeck          | NNBL 8226-2             | 8226-142       | 2022/8/31          | 2023/8/30           |

Notes:

1. The test was performed in HY - Conduction 1.
2. Tested Date: 2023/4/25 ~ 2023/5/5

#### 4.6 Unwanted Emissions below 1 GHz

| Description<br>Manufacturer     | Model No.                    | Serial No.    | Calibrated<br>Date | Calibrated<br>Until |
|---------------------------------|------------------------------|---------------|--------------------|---------------------|
| Antenna Tower<br>inn-co GmbH    | MA 4000                      | 010303        | N/A                | N/A                 |
| Bi_Log Antenna<br>Schwarbeck    | VULB9168                     | 9168-155      | 2022/10/21         | 2023/10/20          |
| Loop Antenna<br>EMCI            | EM-6879                      | 269           | 2022/9/19          | 2023/9/18           |
| Loop Antenna<br>TESEQ           | HLA 6121                     | 45745         | 2022/7/27          | 2023/7/26           |
| Pre-amplifier<br>EMCI           | EMC001340                    | 980201        | 2022/9/23          | 2023/9/22           |
| Pre_Amplifier<br>Agilent        | 8447D                        | 2944A10631    | 2022/5/14          | 2023/5/13           |
| RF Coaxial Cable<br>EMCI        | 5D-NM-BM                     | 140903+140902 | 2023/1/7           | 2024/1/6            |
| RF Coaxial Cable<br>WOKEN       | 8D-FB                        | Cable-CH4-01  | 2022/7/9           | 2023/7/8            |
| Software<br>BV ADT              | ADT_Radiated_<br>V7.6.15.9.5 | N/A           | N/A                | N/A                 |
| Spectrum Analyzer<br>R&S        | FSW43                        | 101866        | 2023/1/10          | 2024/1/9            |
| Test Receiver<br>R&S            | ESR3+                        | 102782        | 2022/12/12         | 2023/12/11          |
| Turn Table<br>BV ADT            | TT100                        | TT93021705    | N/A                | N/A                 |
| Turn Table Controller<br>BV ADT | SC100                        | SC93021705    | N/A                | N/A                 |

Notes:

1. The test was performed in HY - 966 chamber 3.
2. Tested Date: 2023/5/5

#### 4.7 Unwanted Emissions above 1 GHz

| Description<br>Manufacturer           | Model No.                    | Serial No.           | Calibrated<br>Date | Calibrated<br>Until |
|---------------------------------------|------------------------------|----------------------|--------------------|---------------------|
| Antenna Tower<br>inn-co GmbH          | MA 4000                      | 010303               | N/A                | N/A                 |
| Boresight antenna tower fixture<br>BV | BAF-02                       | 5                    | N/A                | N/A                 |
| Horn Antenna<br>Schwarzbeck           | 9120D                        | 9120D-408            | 2022/11/13         | 2023/11/12          |
|                                       | BBHA 9170                    | 9170-480             | 2022/11/13         | 2023/11/12          |
|                                       |                              | BBHA9170241          | 2022/10/20         | 2023/10/19          |
|                                       |                              | BBHA9170243          | 2022/11/13         | 2023/11/12          |
| Pre-Amplifier<br>EMCI                 | EMC 184045                   | 980116               | 2022/10/1          | 2023/9/30           |
| Pre_Amplifier<br>KEYSIGHT             | 83017A                       | MY53270295           | 2022/5/14          | 2023/5/13           |
| RF cable<br>HUBER+SUHNER              | Sucoflex 104                 | MY 13380+295012/04   | 2022/5/14          | 2023/5/13           |
| RF Coaxial Cable<br>EMCI              | EMC102-KM-KM-600             | 150928               | 2022/7/9           | 2023/7/8            |
|                                       | EMC102-KM-KM-3000            | 150929               | 2022/7/9           | 2023/7/8            |
| RF Coaxial Cable<br>HUBER+SUHNER      | SUCOFLEX 104                 | Cable-CH4-03(250724) | 2022/5/14          | 2023/5/13           |
| Software<br>BV ADT                    | ADT_Radiated_<br>V7.6.15.9.5 | N/A                  | N/A                | N/A                 |
| Spectrum Analyzer<br>R&S              | FSW43                        | 101866               | 2023/1/10          | 2024/1/9            |
| Test Receiver<br>R&S                  | ESR3+                        | 102782               | 2022/12/12         | 2023/12/11          |
| Turn Table<br>BV ADT                  | TT100                        | TT93021705           | N/A                | N/A                 |
| Turn Table Controller<br>BV ADT       | SC100                        | SC93021705           | N/A                | N/A                 |

Notes:

1. The test was performed in HY - 966 chamber 3.
2. Tested Date: 2023/3/2 ~ 2023/4/20



## 5 Limits of Test Items

### 5.1 RF Output Power

For systems using digital modulation in the 2400–2483.5 MHz bands: 1 Watt (30 dBm)

Per KDB 662911 D01 Multiple Transmitter Output Method of conducted output power measurement on IEEE 802.11 devices,

Array Gain = 0 dB (i.e., no array gain) for  $N_{ANT} \leq 4$ ;

Array Gain = 0 dB (i.e., no array gain) for channel widths  $\geq 40$  MHz for any  $N_{ANT}$ ;

Array Gain =  $5 \log(N_{ANT}/N_{SS})$  dB or 3 dB, whichever is less, for 20-MHz channel widths with  $N_{ANT} \geq 5$ .

For power measurements on all other devices: Array Gain =  $10 \log(N_{ANT}/N_{SS})$  dB.

### 5.2 Power Spectral Density

The Maximum of Power Spectral Density Measurement is 8 dBm in any 3 kHz.

### 5.3 6 dB Bandwidth

The minimum of 6 dB Bandwidth Measurement is 0.5 MHz.

### 5.4 Conducted Out of Band Emissions

Below 30 dB of the highest emission level of operating band (in 100 kHz Resolution Bandwidth).

### 5.5 AC Power Conducted Emissions

| Frequency (MHz) | Conducted Limit (dBuV) |         |
|-----------------|------------------------|---------|
|                 | Quasi-peak             | Average |
| 0.15 - 0.5      | 66 - 56                | 56 - 46 |
| 0.50 - 5.0      | 56                     | 46      |
| 5.0 - 30.0      | 60                     | 50      |

Notes:

1. The lower limit shall apply at the transition frequencies.
2. The limit decreases in line with the logarithm of the frequency in the range of 0.15 to 0.50 MHz.

## 5.6 Unwanted Emissions below 1 GHz

Radiated emissions up to 1 GHz which fall in the restricted bands must comply with the radiated emission limits specified as below table. Other emissions shall be at least 30 dB below the highest level of the desired power:

| Frequencies (MHz) | Field Strength (microvolts/meter) | Measurement Distance (meters) |
|-------------------|-----------------------------------|-------------------------------|
| 0.009 ~ 0.490     | 2400/F(kHz)                       | 300                           |
| 0.490 ~ 1.705     | 24000/F(kHz)                      | 30                            |
| 1.705 ~ 30.0      | 30                                | 30                            |
| 30 ~ 88           | 100                               | 3                             |
| 88 ~ 216          | 150                               | 3                             |
| 216 ~ 960         | 200                               | 3                             |
| Above 960         | 500                               | 3                             |

Notes:

1. The lower limit shall apply at the transition frequencies.
2. Emission level (dBuV/m) = 20 log Emission level (uV/m).

## 5.7 Unwanted Emissions above 1 GHz

Radiated emissions above 1 GHz which fall in the restricted bands must comply with the radiated emission limits specified as below table. Other emissions shall be at least 30 dB below the highest level of the desired power:

| Frequencies (MHz) | Field Strength (microvolts/meter) | Measurement Distance (meters) |
|-------------------|-----------------------------------|-------------------------------|
| Above 960         | 500                               | 3                             |

Notes:

1. The lower limit shall apply at the transition frequencies.
2. Emission level (dBuV/m) = 20 log Emission level (uV/m).
3. For frequencies above 1000 MHz, the field strength limits are based on average detector, however, the peak field strength of any emission shall not exceed the maximum permitted average limits, specified above by more than 20 dB under any condition of modulation.

## 6 Test Arrangements

### 6.1 RF Output Power

#### 6.1.1 Test Setup

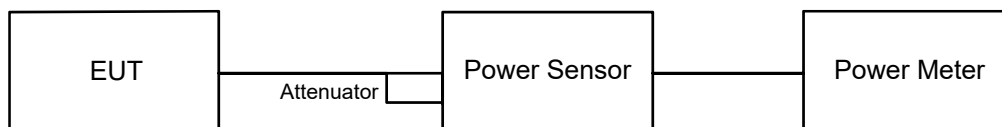

#### 6.1.2 Test Procedure

Average Power:

Average power sensor was used to perform output power measurement, trigger and gating function of wide band power meter is enabled to measure max output power of TX on burst. Duty factor is not added to measured value.

### 6.2 Power Spectral Density

#### 6.2.1 Test Setup

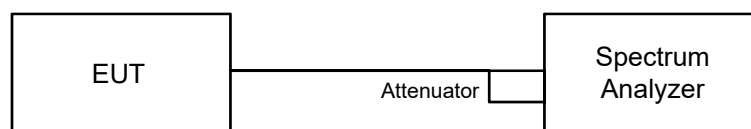

#### 6.2.2 Test Procedure

- a. Measure the duty cycle (x).
- b. Set instrument center frequency to DTS channel center frequency.
- c. Set span to at least 1.5 times the OBW.
- d. Set RBW to: 3 kHz.
- e. Set VBW  $\geq 3 \times$  RBW.
- f. Detector = power averaging (RMS) or sample detector (when RMS not available).
- g. Ensure that the number of measurement points in the sweep  $\geq 2 \times$  span/RBW.
- h. Sweep time = auto couple.
- i. Do not use sweep triggering. Allow sweep to "free run".
- j. Employ trace averaging (RMS) mode over a minimum of 100 traces.
- k. Use the peak marker function to determine the maximum amplitude level.
- l. Note: If Duty cycle < 98%, Add  $10 \log (1/x)$ , where x is the duty cycle measured in step (a), to the measured PSD to compute the average PSD during the actual transmission time.

## 6.3 6 dB Bandwidth

### 6.3.1 Test Setup

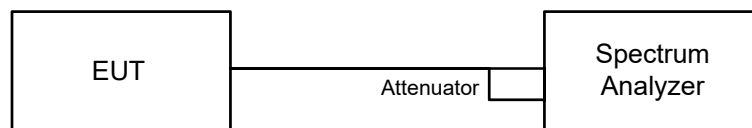

### 6.3.2 Test Procedure

- Set resolution bandwidth (RBW) = 100 kHz.
- Set the video bandwidth (VBW)  $\geq 3 \times$  RBW, Detector = Peak.
- Trace mode = max hold.
- Sweep = auto couple.
- Measure the maximum width of the emission that is constrained by the frequencies associated with the two amplitude points (upper and lower) that are attenuated by 6 dB relative to the maximum level measured in the fundamental emission.

## 6.4 Conducted Out of Band Emissions

### 6.4.1 Test Setup

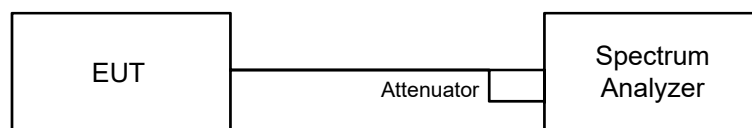

### 6.4.2 Test Procedure

#### MEASUREMENT PROCEDURE REF

- Set the RBW = 100 kHz.
- Set the VBW  $\geq 300$  kHz.
- Detector = peak.
- Sweep time = auto couple.
- Trace mode = max hold.
- Allow trace to fully stabilize.
- Use the peak marker function to determine the maximum power level in any 100 kHz band segment within the fundamental EBW.

#### MEASUREMENT PROCEDURE OOB

- Set RBW = 100 kHz.
- Set VBW  $\geq 300$  kHz.
- Detector = peak.
- Sweep = auto couple.
- Trace Mode = max hold.
- Allow trace to fully stabilize.
- Use the peak marker function to determine the maximum amplitude level.

## 6.5 AC Power Conducted Emissions

### 6.5.1 Test Setup

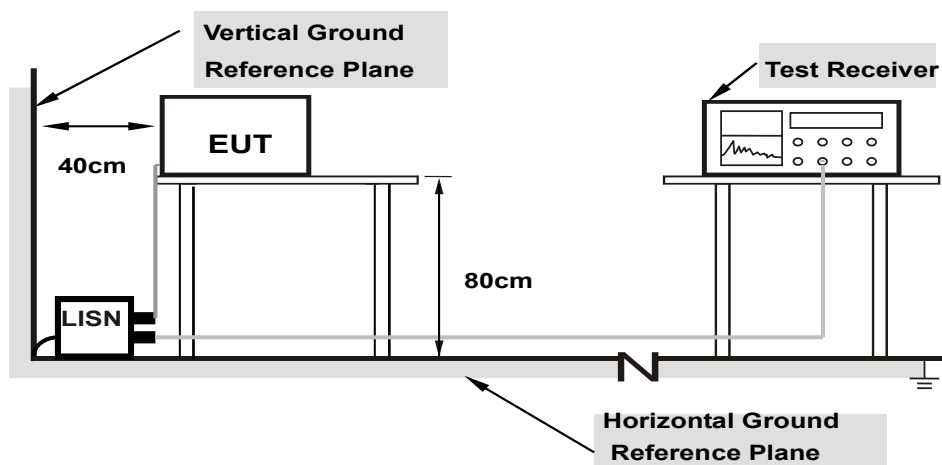

**Note: 1.Support units were connected to second LISN.**

For the actual test configuration, please refer to the attached file (Test Setup Photo).

### 6.5.2 Test Procedure

- The EUT was placed on a 0.8 meter to the top of table and placed 0.4 meters from the conducting wall of the shielded room with EUT being connected to the power mains through a line impedance stabilization network (LISN). Other support units were connected to the power mains through another LISN. The two LISNs provide 50 ohm/ 50 uH of coupling impedance for the measuring instrument.
- Both lines of the power mains connected to the EUT were checked for maximum conducted interference.
- The frequency range from 150 kHz to 30 MHz was searched. Emission levels under (Limit – 20 dB) was not recorded.

Note: The resolution bandwidth and video bandwidth of test receiver is 9 kHz for quasi-peak detection (QP) and average detection (AV) at frequency 0.15 MHz-30 MHz.

## 6.6 Unwanted Emissions below 1 GHz

### 6.6.1 Test Setup

#### For Radiated emission below 30 MHz

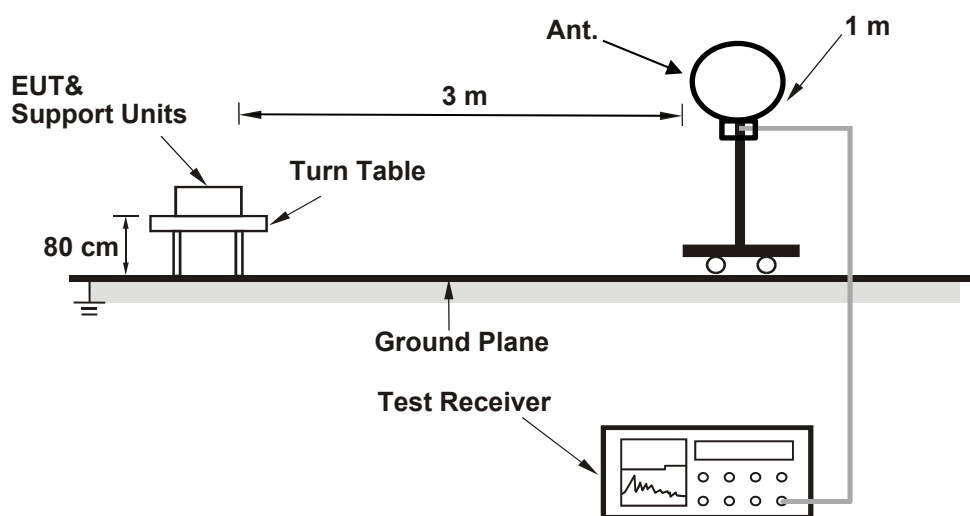

#### For Radiated emission above 30 MHz

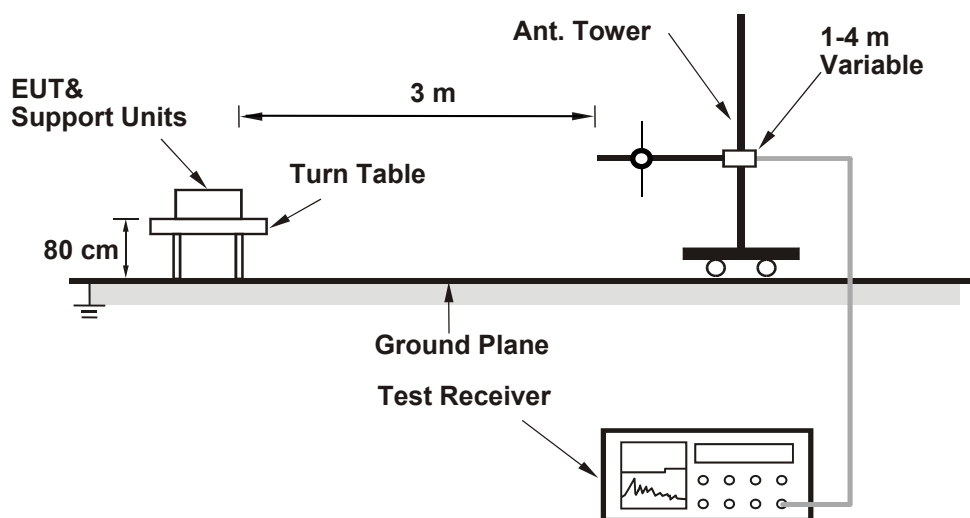

For the actual test configuration, please refer to the attached file (Test Setup Photo).

## 6.6.2 Test Procedure

### For Radiated emission below 30 MHz

- a. The EUT was placed on the top of a rotating table 0.8 meters above the ground at 3 meter chamber room for test. The table was rotated 360 degrees to determine the position of the highest radiation.
- b. The EUT was set 3 meters away from the interference-receiving antenna, which was mounted on the top of a variable-height antenna tower.
- c. Parallel, perpendicular, and ground-parallel orientations of the antenna are set to make the measurement.
- d. For each suspected emission, the EUT was arranged to its worst case and the rotatable table was turned from 0 degrees to 360 degrees to find the maximum reading.
- e. The test-receiver system was set to Quasi-Peak Detect Function and Specified Bandwidth with Maximum Hold Mode, except for the frequency band (9 kHz to 90 kHz and 110 kHz to 490 kHz) set to average detect function and peak detect function.

#### Notes:

1. The resolution bandwidth and video bandwidth of test receiver/spectrum analyzer is 200 Hz at frequency below 150 kHz.
2. The resolution bandwidth and video bandwidth of test receiver/spectrum analyzer is 9 kHz or 10 kHz at frequency (150 kHz to 30 MHz).
3. All modes of operation were investigated and the worst-case emissions are reported.

### For Radiated emission above 30 MHz

- a. The EUT was placed on the top of a rotating table 0.8 meters above the ground at 3 meter chamber room for test. The table was rotated 360 degrees to determine the position of the highest radiation.
- b. The EUT was set 3 meters away from the interference-receiving antenna, which was mounted on the top of a variable-height antenna tower.
- c. The height of antenna is varied from one meter to four meters above the ground to determine the maximum value of the field strength. Both horizontal and vertical polarizations of the antenna are set to make the measurement.
- d. For each suspected emission, the EUT was arranged to its worst case and then the antenna was tuned to heights from 1 meter to 4 meters and the rotatable table was turned from 0 degrees to 360 degrees to find the maximum reading.
- e. The test-receiver system was set to quasi-peak detect function and specified bandwidth with maximum hold mode when the test frequency is below 1 GHz.

#### Notes:

1. The resolution bandwidth and video bandwidth of test receiver/spectrum analyzer is 120 kHz for Quasi-peak detection (QP) at frequency below 1 GHz.
2. All modes of operation were investigated and the worst-case emissions are reported.

## 6.7 Unwanted Emissions above 1 GHz

### 6.7.1 Test Setup

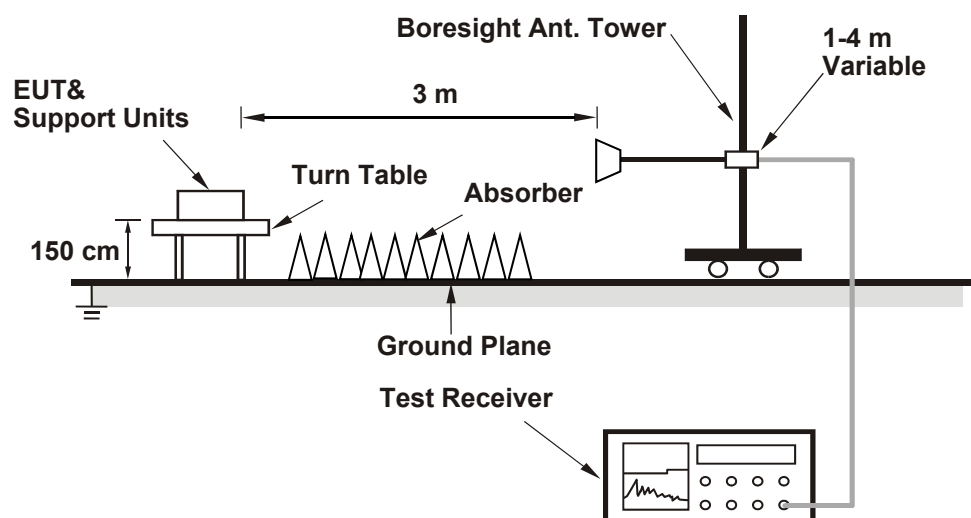

For the actual test configuration, please refer to the attached file (Test Setup Photo).

### 6.7.2 Test Procedure

- The EUT was placed on the top of a rotating table 1.5 meters above the ground at 3 meter chamber room for test. The table was rotated 360 degrees to determine the position of the highest radiation.
- The EUT was set 3 meters away from the interference-receiving antenna, which was mounted on the top of a variable-height antenna tower.
- The height of antenna is varied from one meter to four meters above the ground to determine the maximum value of the field strength. Both horizontal and vertical polarizations of the antenna are set to make the measurement.
- For each suspected emission, the EUT was arranged to its worst case and then the antenna was tuned to heights from 1 meter to 4 meters and the rotatable table was turned from 0 degrees to 360 degrees to find the maximum reading.
- The test-receiver system was set to peak and average detects function and specified bandwidth with maximum hold mode when the test frequency is above 1 GHz. If the peak reading value also meets average limit, measurement with the average detector is unnecessary.

#### Notes:

- The resolution bandwidth of test receiver/spectrum analyzer is 1 MHz and the video bandwidth is 3 MHz for Peak detection (PK) and Average detection (AV) at frequency above 1 GHz.
- For fundamental and harmonic signal measurement, the resolution bandwidth of test receiver/spectrum analyzer is 1 MHz and the video bandwidth is  $\geq 1/T$  (Duty cycle  $< 98\%$ ) or 10 Hz (Duty cycle  $\geq 98\%$ ) for Average detection (AV) at frequency above 1 GHz.
- All modes of operation were investigated and the worst-case emissions are reported.



## 7 Test Results of Test Item

### 7.1 RF Output Power

|              |                |                           |              |            |              |
|--------------|----------------|---------------------------|--------------|------------|--------------|
| Input Power: | 120 Vac, 60 Hz | Environmental Conditions: | 25°C, 60% RH | Tested By: | Jisyong Wang |
|--------------|----------------|---------------------------|--------------|------------|--------------|

#### 802.11b

| Chan. | Chan. Freq. (MHz) | Average Power (dBm) |         |         |         | Total Power (mW) | Total Power (dBm) | Power Limit (dBm) | Test Result |
|-------|-------------------|---------------------|---------|---------|---------|------------------|-------------------|-------------------|-------------|
|       |                   | Chain 0             | Chain 1 | Chain 2 | Chain 3 |                  |                   |                   |             |
| 1     | 2412              | 23.29               | 23.52   | 23.02   | 23.23   | 849.035          | 29.29             | 30                | Pass        |
| 6     | 2437              | 23.02               | 23.39   | 22.85   | 23.45   | 832.782          | 29.21             | 30                | Pass        |
| 11    | 2462              | 23.05               | 23.45   | 22.78   | 23.02   | 813.264          | 29.10             | 30                | Pass        |

Notes:

1. Directional gain is the maximum gain of antennas.
2. The maximum gain is 2 dBi < 6 dBi, so the output power limit shall not be reduced.

#### 802.11g

| Chan. | Chan. Freq. (MHz) | Average Power (dBm) |         |         |         | Total Power (mW) | Total Power (dBm) | Power Limit (dBm) | Test Result |
|-------|-------------------|---------------------|---------|---------|---------|------------------|-------------------|-------------------|-------------|
|       |                   | Chain 0             | Chain 1 | Chain 2 | Chain 3 |                  |                   |                   |             |
| 1     | 2412              | 22.85               | 23.35   | 22.87   | 23.12   | 807.783          | 29.07             | 30                | Pass        |
| 6     | 2437              | 22.87               | 23.45   | 22.91   | 23.22   | 820.28           | 29.14             | 30                | Pass        |
| 11    | 2462              | 21.05               | 21.69   | 20.77   | 21.12   | 523.739          | 27.19             | 30                | Pass        |

Notes:

1. Directional gain is the maximum gain of antennas.
2. The maximum gain is 2 dBi < 6 dBi, so the output power limit shall not be reduced.

### 802.11be (EHT20)

| Chan. | Chan. Freq. (MHz) | Average Power (dBm) |         |         |         | Total Power (mW) | Total Power (dBm) | Power Limit (dBm) | Test Result |
|-------|-------------------|---------------------|---------|---------|---------|------------------|-------------------|-------------------|-------------|
|       |                   | Chain 0             | Chain 1 | Chain 2 | Chain 3 |                  |                   |                   |             |
| 1     | 2412              | 22.87               | 23.32   | 22.95   | 22.98   | 804.277          | 29.05             | 30                | Pass        |
| 6     | 2437              | 23.62               | 23.44   | 23.46   | 23.61   | 902.379          | 29.55             | 30                | Pass        |
| 11    | 2462              | 19.82               | 20.08   | 19.54   | 19.78   | 382.809          | 25.83             | 30                | Pass        |

Notes:

1. Directional gain is the maximum gain of antennas.
2. The maximum gain is 2 dBi < 6 dBi, so the output power limit shall not be reduced.

### 802.11be (EHT40)

| Chan. | Chan. Freq. (MHz) | Average Power (dBm) |         |         |         | Total Power (mW) | Total Power (dBm) | Power Limit (dBm) | Test Result |
|-------|-------------------|---------------------|---------|---------|---------|------------------|-------------------|-------------------|-------------|
|       |                   | Chain 0             | Chain 1 | Chain 2 | Chain 3 |                  |                   |                   |             |
| 3     | 2422              | 22.82               | 23.42   | 22.72   | 23.02   | 798.727          | 29.02             | 30                | Pass        |
| 6     | 2437              | 21.09               | 20.97   | 21.02   | 21.07   | 507.966          | 27.06             | 30                | Pass        |
| 9     | 2452              | 17.45               | 17.85   | 16.72   | 19.92   | 261.708          | 24.18             | 30                | Pass        |

Notes:

1. Directional gain is the maximum gain of antennas.
2. The maximum gain is 2 dBi < 6 dBi, so the output power limit shall not be reduced.

### 802.11be (EHT20) Beamforming

| Chan. | Chan. Freq. (MHz) | Average Power (dBm) |         |         |         | Total Power (mW) | Total Power (dBm) | Power Limit (dBm) | Test Result |
|-------|-------------------|---------------------|---------|---------|---------|------------------|-------------------|-------------------|-------------|
|       |                   | Chain 0             | Chain 1 | Chain 2 | Chain 3 |                  |                   |                   |             |
| 1     | 2412              | 22.87               | 23.32   | 22.95   | 22.98   | 804.277          | 29.05             | 29.94             | Pass        |
| 6     | 2437              | 23.62               | 23.44   | 23.46   | 23.61   | 902.379          | 29.55             | 29.94             | Pass        |
| 11    | 2462              | 19.82               | 20.08   | 19.54   | 19.78   | 382.809          | 25.83             | 29.94             | Pass        |

**Notes:**

1. Directional gain is the measured value according to KDB 662911 D03 Method of MIMO Antenna Gain Measurement.
2. The directional gain is 6.06 dBi > 6 dBi, so the output power limit shall be reduced to  $30-(6.06-6) = 29.94$  dBm.

### 802.11be (EHT40) Beamforming

| Chan. | Chan. Freq. (MHz) | Average Power (dBm) |         |         |         | Total Power (mW) | Total Power (dBm) | Power Limit (dBm) | Test Result |
|-------|-------------------|---------------------|---------|---------|---------|------------------|-------------------|-------------------|-------------|
|       |                   | Chain 0             | Chain 1 | Chain 2 | Chain 3 |                  |                   |                   |             |
| 3     | 2422              | 22.82               | 23.42   | 22.72   | 23.02   | 798.727          | 29.02             | 29.94             | Pass        |
| 6     | 2437              | 21.09               | 20.97   | 21.02   | 21.07   | 507.966          | 27.06             | 29.94             | Pass        |
| 9     | 2452              | 17.45               | 17.85   | 16.72   | 19.92   | 261.708          | 24.18             | 29.94             | Pass        |

**Notes:**

1. Directional gain is the measured value according to KDB 662911 D03 Method of MIMO Antenna Gain Measurement.
2. The directional gain is 6.06 dBi > 6 dBi, so the output power limit shall be reduced to  $30-(6.06-6) = 29.94$  dBm.

## 7.2 Power Spectral Density

|              |                |                           |              |            |              |
|--------------|----------------|---------------------------|--------------|------------|--------------|
| Input Power: | 120 Vac, 60 Hz | Environmental Conditions: | 25°C, 60% RH | Tested By: | Jisyong Wang |
|--------------|----------------|---------------------------|--------------|------------|--------------|

### 802.11b

| Chan. | Chan. Freq. (MHz) | PSD (dBm/3kHz) |         |         |         | Total PSD (dBm/3kHz) | PSD Limit (dBm/3kHz) | Test Result |
|-------|-------------------|----------------|---------|---------|---------|----------------------|----------------------|-------------|
|       |                   | Chain 0        | Chain 1 | Chain 2 | Chain 3 |                      |                      |             |
| 1     | 2412              | -7.54          | -7.53   | -7.80   | -7.56   | -1.59                | 7.94                 | Pass        |
| 6     | 2437              | -7.86          | -7.87   | -8.06   | -8.05   | -1.94                | 7.94                 | Pass        |
| 11    | 2462              | -8.65          | -8.16   | -8.45   | -7.47   | -2.14                | 7.94                 | Pass        |

#### Notes:

- Method E) 2) b) Measure and sum spectral maxima across the outputs of KDB 662911 is using for calculating total power density.
- Directional gain is the measured value according to KDB 662911 D03 Method of MIMO Antenna Gain Measurement.
- The directional gain is 6.06 dBi > 6 dBi, so the power density limit shall be reduced to  $8-(6.06-6) = 7.94$  dBm/3kHz.

### 802.11g

| Chan. | Chan. Freq. (MHz) | PSD (dBm/3kHz) |         |         |         | Total PSD (dBm/3kHz) | PSD Limit (dBm/3kHz) | Test Result |
|-------|-------------------|----------------|---------|---------|---------|----------------------|----------------------|-------------|
|       |                   | Chain 0        | Chain 1 | Chain 2 | Chain 3 |                      |                      |             |
| 1     | 2412              | -13.12         | -12.93  | -13.28  | -12.92  | -7.04                | 7.94                 | Pass        |
| 6     | 2437              | -13.17         | -13.01  | -12.79  | -12.99  | -6.97                | 7.94                 | Pass        |
| 11    | 2462              | -15.28         | -15.31  | -15.19  | -14.90  | -9.15                | 7.94                 | Pass        |

#### Notes:

- Method E) 2) b) Measure and sum spectral maxima across the outputs of KDB 662911 is using for calculating total power density.
- Directional gain is the measured value according to KDB 662911 D03 Method of MIMO Antenna Gain Measurement.
- The directional gain is 6.06 dBi > 6 dBi, so the power density limit shall be reduced to  $8-(6.06-6) = 7.94$  dBm/3kHz.

### 802.11be (EHT20)

| Chan. | Chan. Freq. (MHz) | PSD (dBm/3kHz) |         |         |         | Total PSD (dBm/3kHz) | PSD Limit (dBm/3kHz) | Test Result |
|-------|-------------------|----------------|---------|---------|---------|----------------------|----------------------|-------------|
|       |                   | Chain 0        | Chain 1 | Chain 2 | Chain 3 |                      |                      |             |
| 1     | 2412              | -10.72         | -10.61  | -10.52  | -10.35  | -4.53                | 7.94                 | Pass        |
| 6     | 2437              | -10.47         | -10.56  | -10.02  | -10.07  | -4.25                | 7.94                 | Pass        |
| 11    | 2462              | -14.31         | -14.10  | -14.45  | -14.69  | -8.36                | 7.94                 | Pass        |

Notes:

1. Method E) 2) b) Measure and sum spectral maxima across the outputs of KDB 662911 is using for calculating total power density.
2. Directional gain is the measured value according to KDB 662911 D03 Method of MIMO Antenna Gain Measurement.
3. The directional gain is 6.06 dBi > 6 dBi, so the power density limit shall be reduced to  $8-(6.06-6) = 7.94$  dBm/3kHz.

### 802.11be (EHT40)

| Chan. | Chan. Freq. (MHz) | PSD (dBm/3kHz) |         |         |         | Total PSD (dBm/3kHz) | PSD Limit (dBm/3kHz) | Test Result |
|-------|-------------------|----------------|---------|---------|---------|----------------------|----------------------|-------------|
|       |                   | Chain 0        | Chain 1 | Chain 2 | Chain 3 |                      |                      |             |
| 3     | 2422              | -16.69         | -16.70  | -17.05  | -16.65  | -10.75               | 7.94                 | Pass        |
| 6     | 2437              | -20.64         | -20.74  | -20.38  | -20.70  | -14.59               | 7.94                 | Pass        |
| 9     | 2452              | -22.89         | -22.66  | -22.51  | -22.69  | -16.66               | 7.94                 | Pass        |

Notes:

1. Method E) 2) b) Measure and sum spectral maxima across the outputs of KDB 662911 is using for calculating total power density.
2. Directional gain is the measured value according to KDB 662911 D03 Method of MIMO Antenna Gain Measurement.
3. The directional gain is 6.06 dBi > 6 dBi, so the power density limit shall be reduced to  $8-(6.06-6) = 7.94$  dBm/3kHz.

### Spectrum Plot of Maximum Value

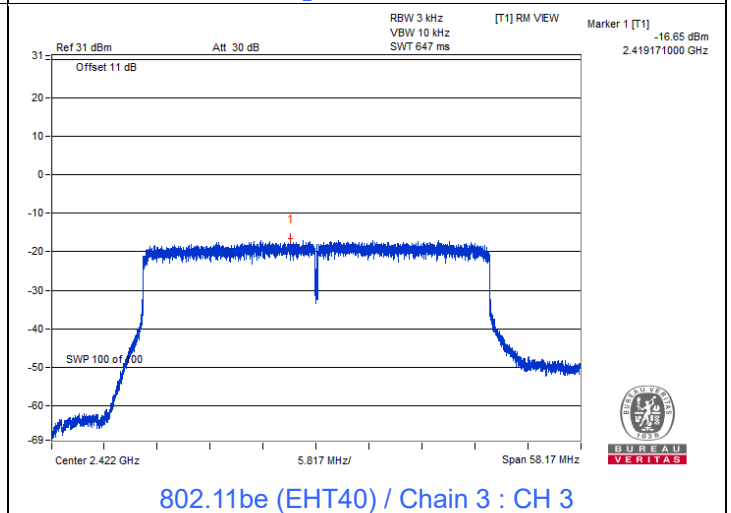
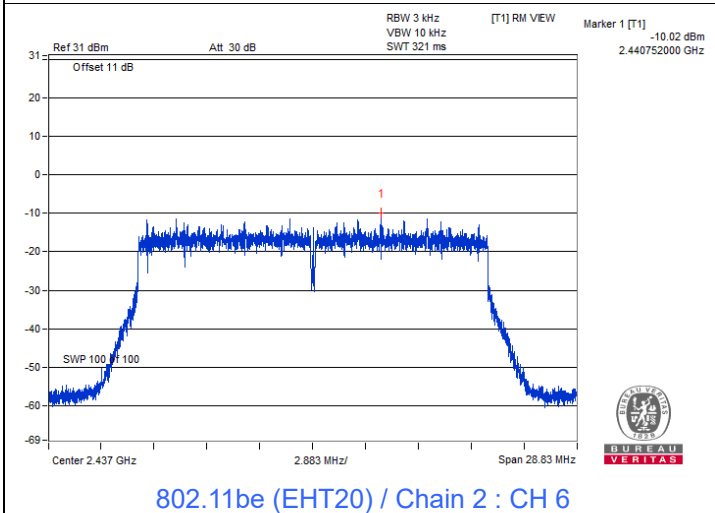
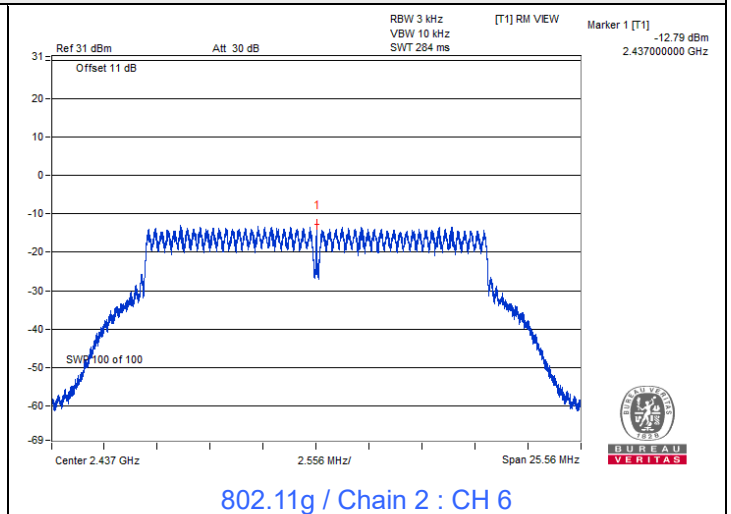
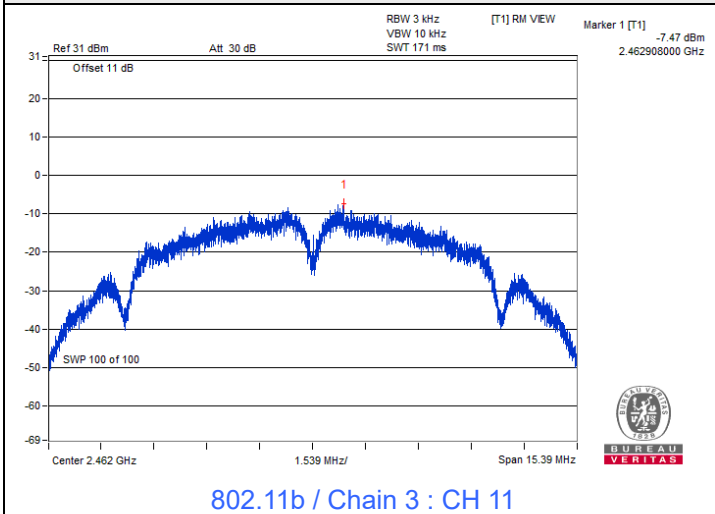

### 7.3 6 dB Bandwidth

|              |                |                           |              |            |              |
|--------------|----------------|---------------------------|--------------|------------|--------------|
| Input Power: | 120 Vac, 60 Hz | Environmental Conditions: | 25°C, 60% RH | Tested By: | Jisyong Wang |
|--------------|----------------|---------------------------|--------------|------------|--------------|

#### 802.11b

| Channel | Frequency (MHz) | 6 dB Bandwidth (MHz) |         |         |         | Minimum Limit (MHz) | Test Result |
|---------|-----------------|----------------------|---------|---------|---------|---------------------|-------------|
|         |                 | Chain 0              | Chain 1 | Chain 2 | Chain 3 |                     |             |
| 1       | 2412            | 7.15                 | 7.14    | 7.12    | 7.12    | 0.5                 | Pass        |
| 6       | 2437            | 7.11                 | 7.13    | 7.10    | 7.13    | 0.5                 | Pass        |
| 11      | 2462            | 7.12                 | 7.13    | 7.12    | 7.11    | 0.5                 | Pass        |

#### 802.11g

| Channel | Frequency (MHz) | 6 dB Bandwidth (MHz) |         |         |         | Minimum Limit (MHz) | Test Result |
|---------|-----------------|----------------------|---------|---------|---------|---------------------|-------------|
|         |                 | Chain 0              | Chain 1 | Chain 2 | Chain 3 |                     |             |
| 1       | 2412            | 16.41                | 16.40   | 16.40   | 16.39   | 0.5                 | Pass        |
| 6       | 2437            | 16.42                | 16.41   | 16.42   | 16.43   | 0.5                 | Pass        |
| 11      | 2462            | 16.41                | 16.42   | 16.42   | 16.41   | 0.5                 | Pass        |

#### 802.11be (EHT20)

| Channel | Frequency (MHz) | 6 dB Bandwidth (MHz) |         |         |         | Minimum Limit (MHz) | Test Result |
|---------|-----------------|----------------------|---------|---------|---------|---------------------|-------------|
|         |                 | Chain 0              | Chain 1 | Chain 2 | Chain 3 |                     |             |
| 1       | 2412            | 18.85                | 18.77   | 18.92   | 18.93   | 0.5                 | Pass        |
| 6       | 2437            | 18.98                | 19.00   | 18.94   | 19.05   | 0.5                 | Pass        |
| 11      | 2462            | 18.92                | 18.95   | 18.89   | 18.89   | 0.5                 | Pass        |

#### 802.11be (EHT40)

| Channel | Frequency (MHz) | 6 dB Bandwidth (MHz) |         |         |         | Minimum Limit (MHz) | Test Result |
|---------|-----------------|----------------------|---------|---------|---------|---------------------|-------------|
|         |                 | Chain 0              | Chain 1 | Chain 2 | Chain 3 |                     |             |
| 3       | 2422            | 37.83                | 37.79   | 37.90   | 37.97   | 0.5                 | Pass        |
| 6       | 2437            | 38.04                | 37.93   | 37.93   | 37.98   | 0.5                 | Pass        |
| 9       | 2452            | 37.91                | 38.07   | 37.94   | 37.86   | 0.5                 | Pass        |

### Spectrum Plot of Minimum Value

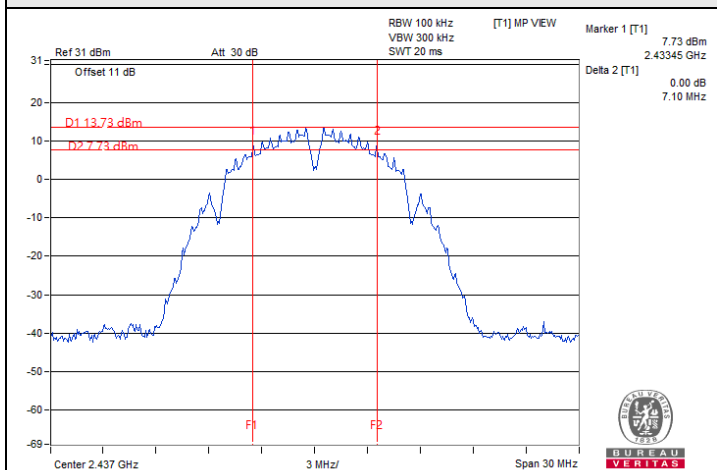

802.11b / Chain 2 : CH 6

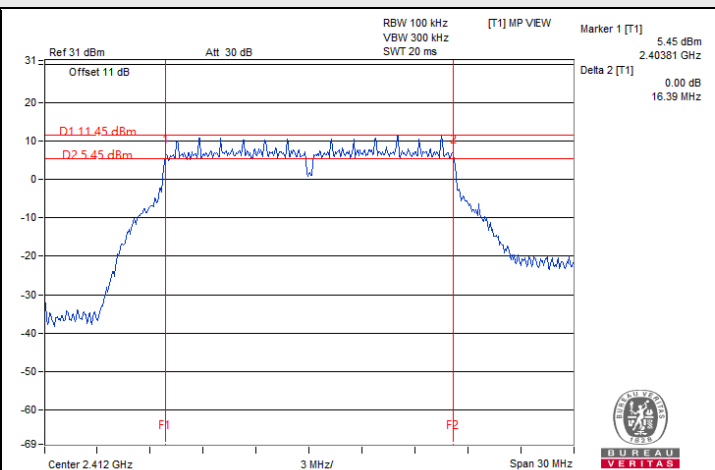

802.11g / Chain 3 : CH 1

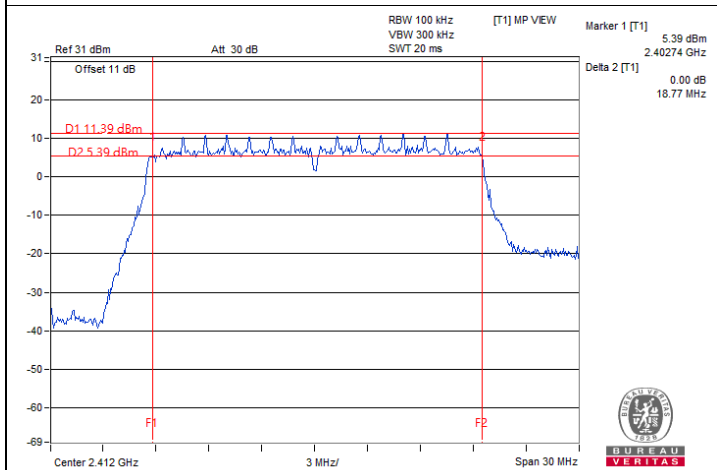

802.11be (EHT20) / Chain 1 : CH 1

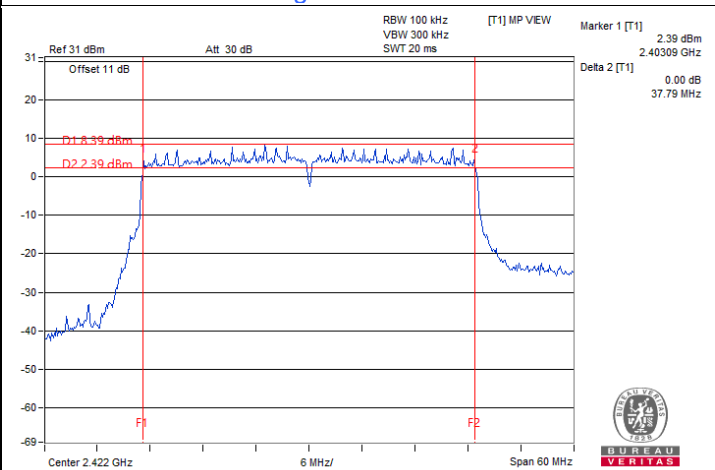

802.11be (EHT40) / Chain 1 : CH 3





### 7.4 Conducted Out of Band Emissions

|              |                |                           |              |            |              |
|--------------|----------------|---------------------------|--------------|------------|--------------|
| Input Power: | 120 Vac, 60 Hz | Environmental Conditions: | 25°C, 60% RH | Tested By: | Jisyong Wang |
|--------------|----------------|---------------------------|--------------|------------|--------------|

#### 802.11b

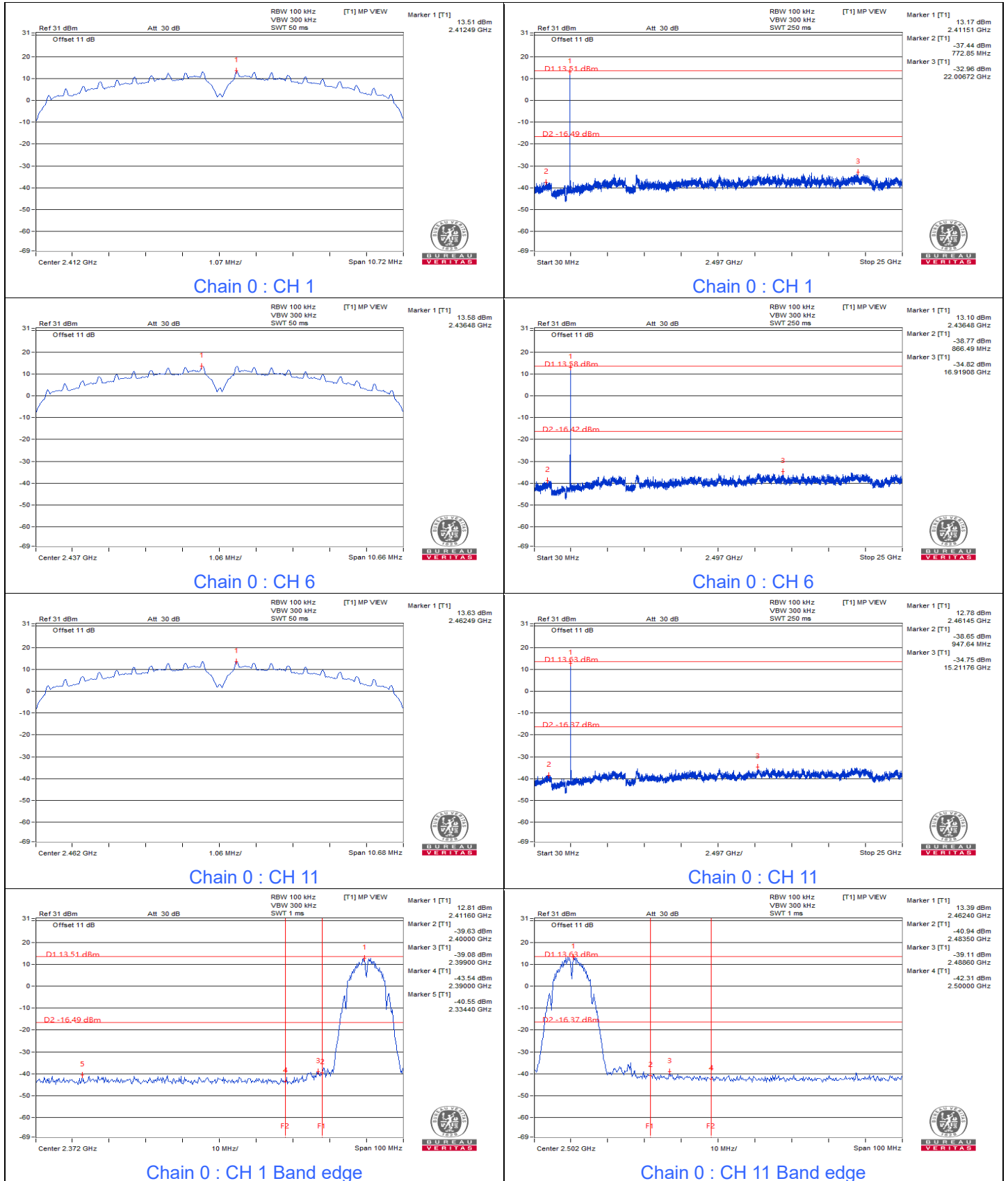

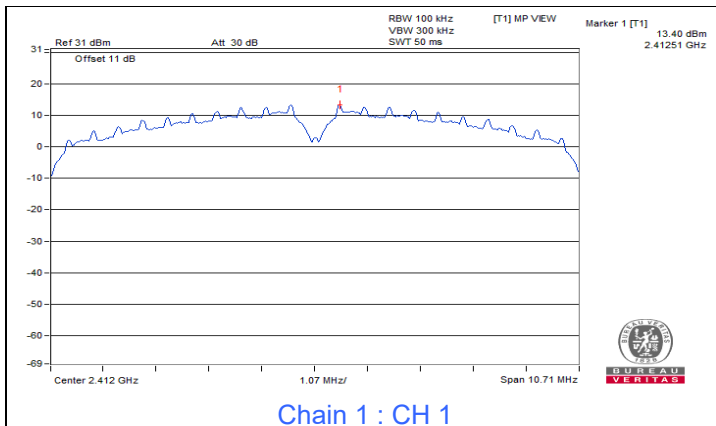

Chain 1 : CH 1

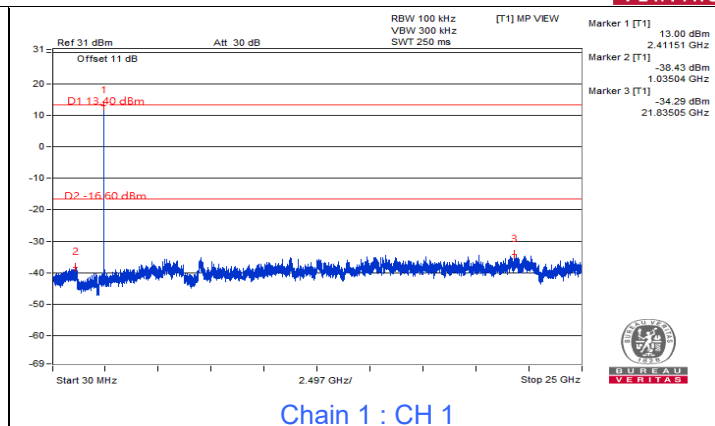

Chain 1 : CH 1

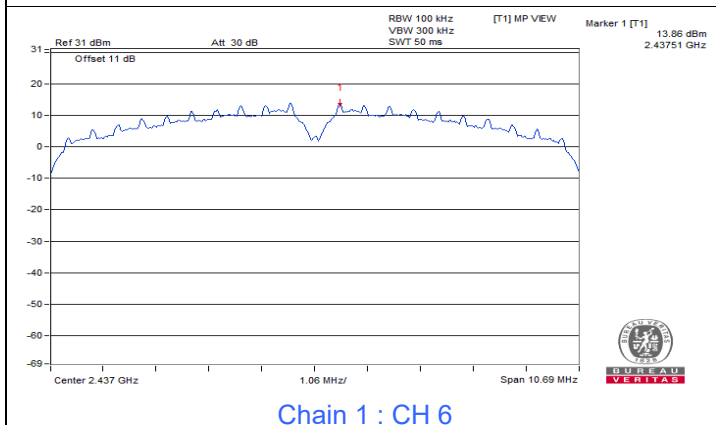

Chain 1 : CH 6

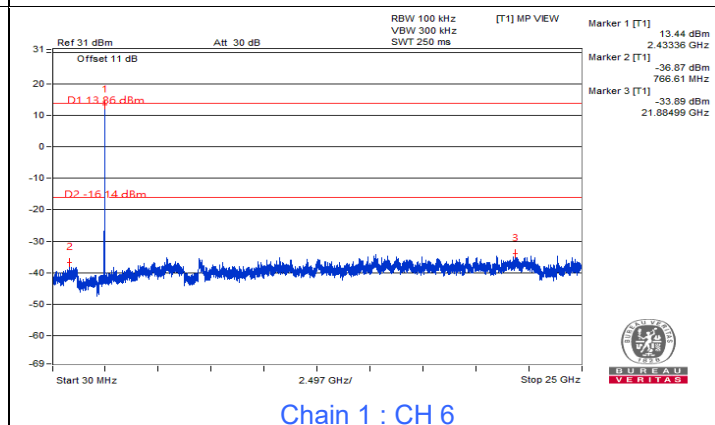

Chain 1 : CH 6

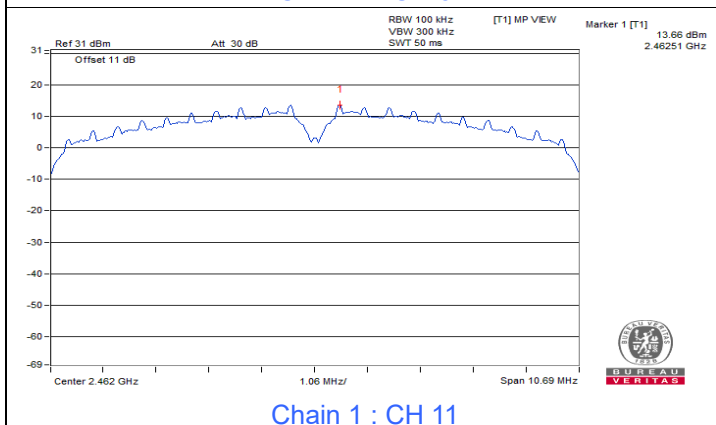

Chain 1 : CH 11

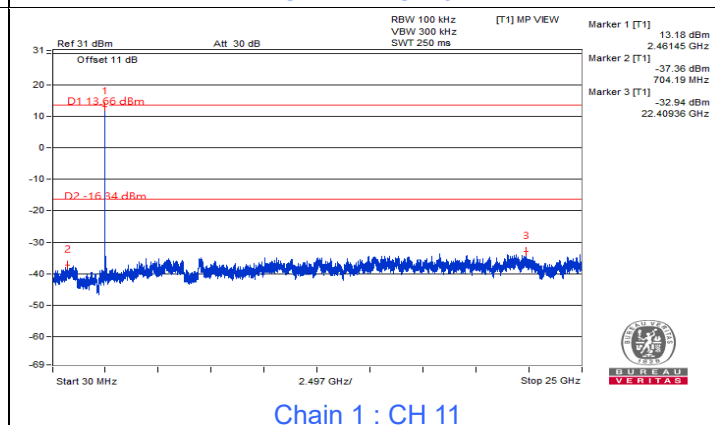

Chain 1 : CH 11

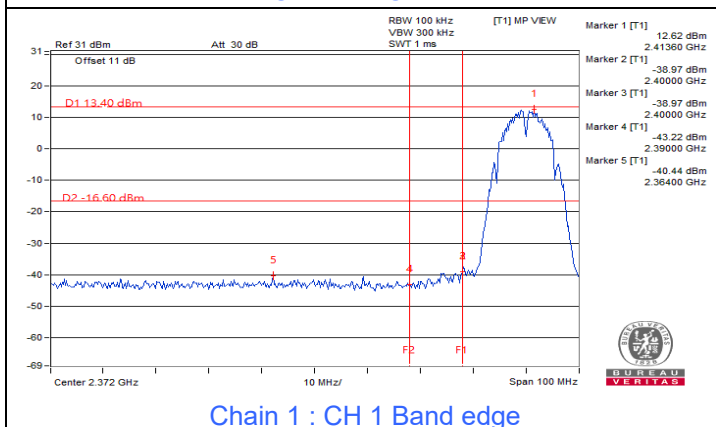

Chain 1 : CH 1 Band edge

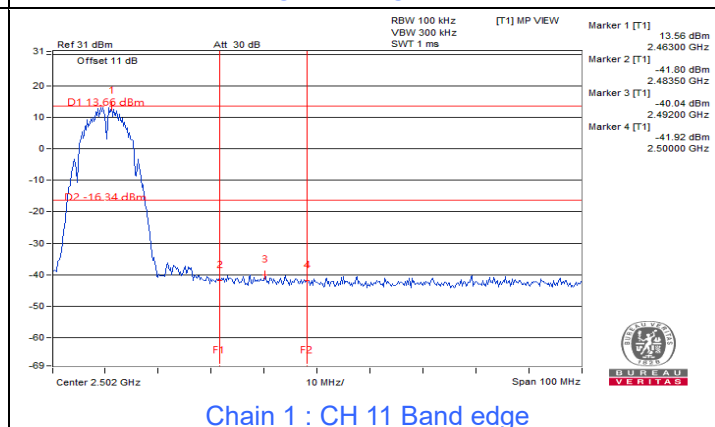

Chain 1 : CH 11 Band edge

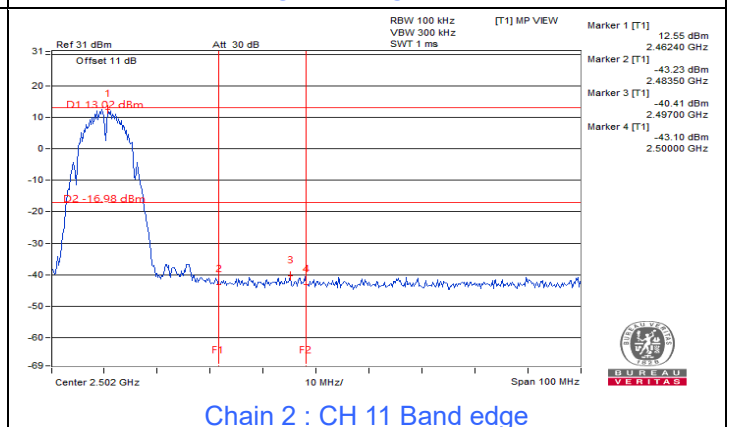
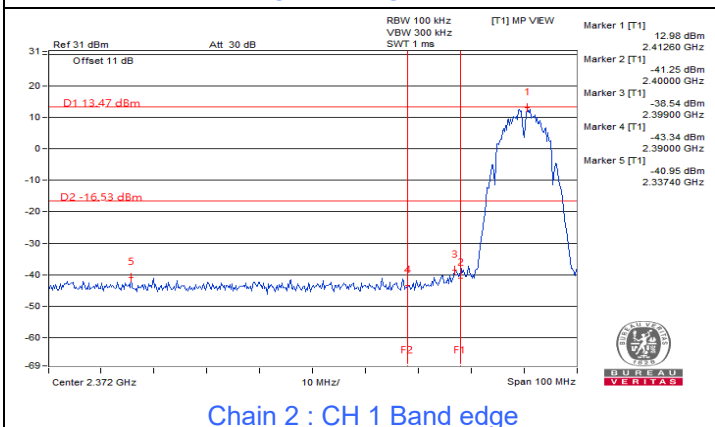
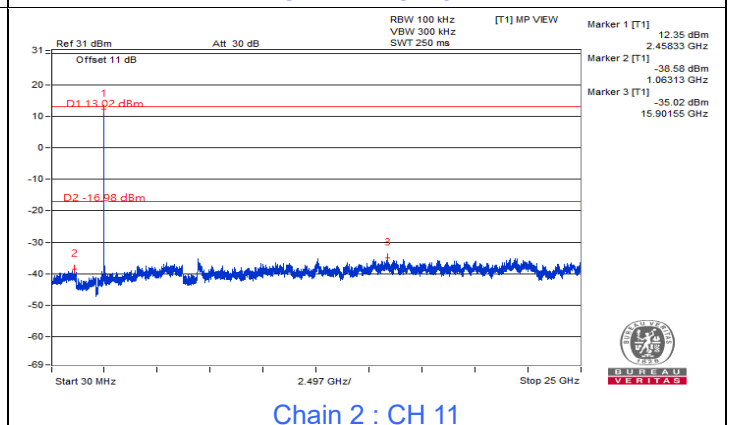
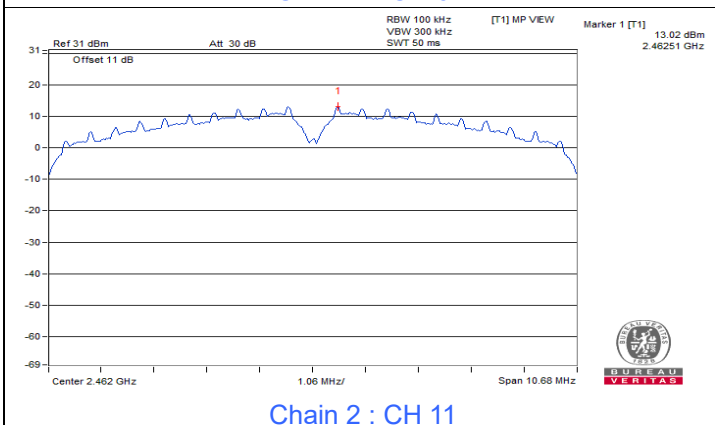
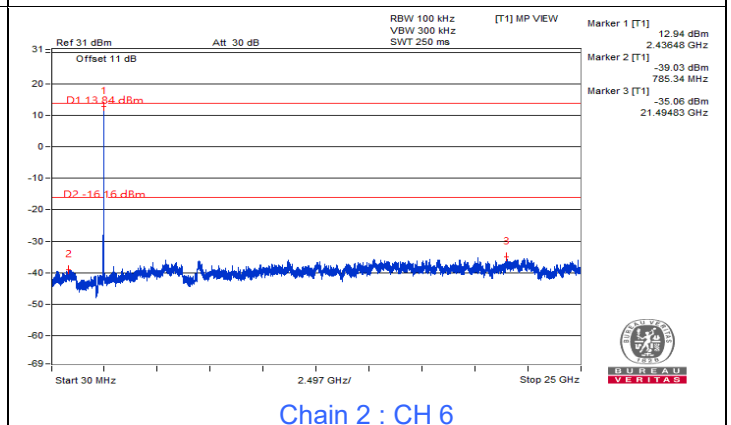
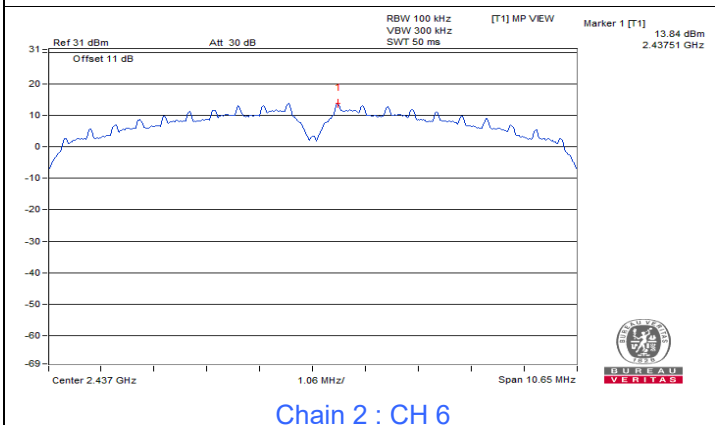
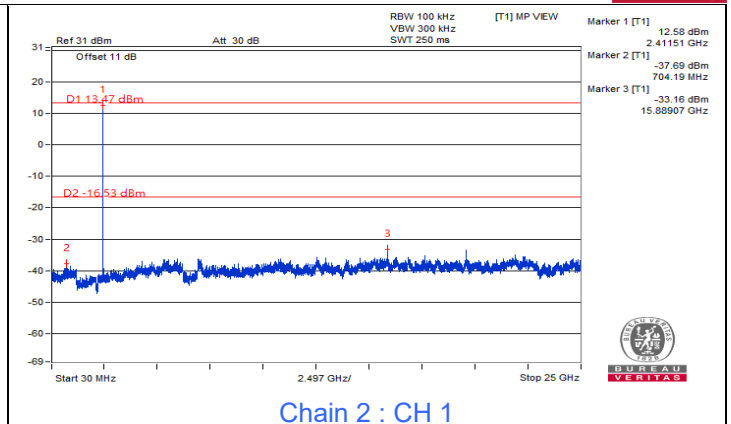
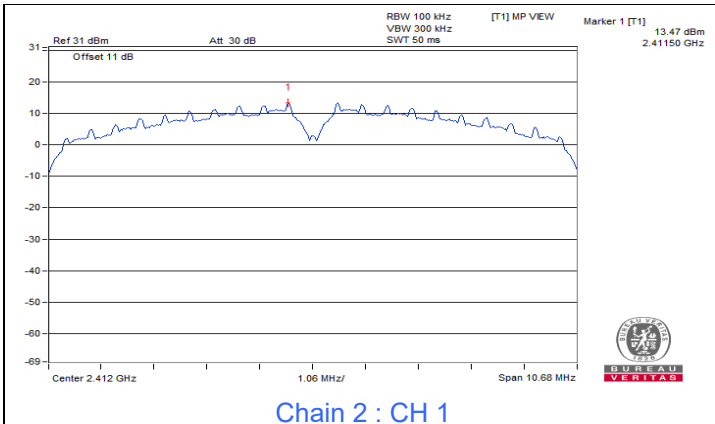

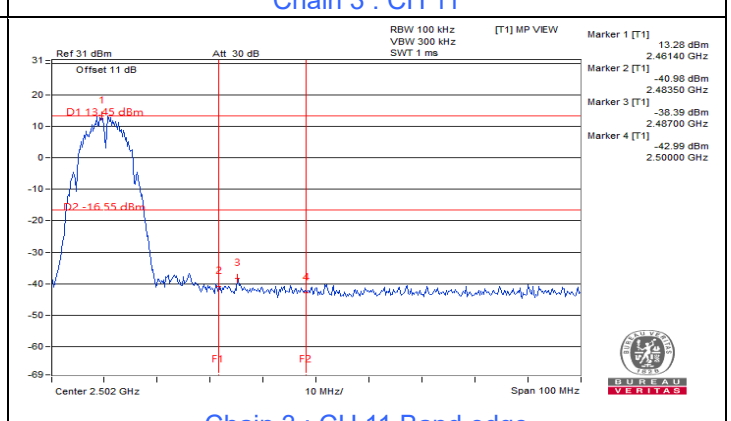
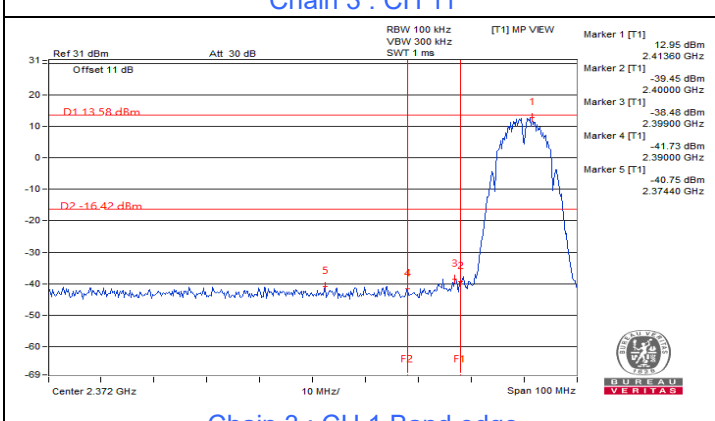
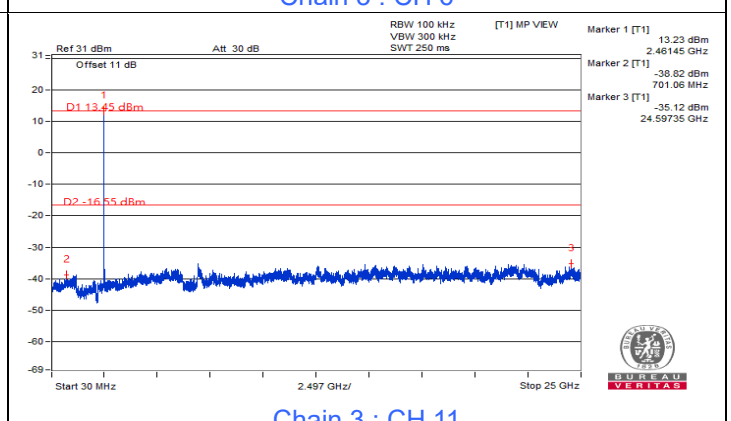
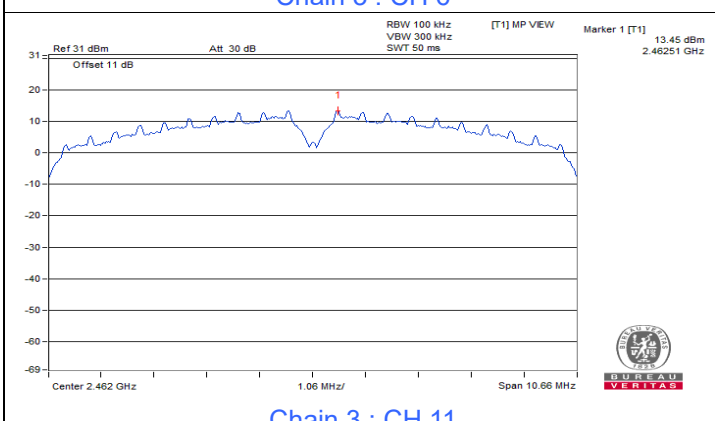
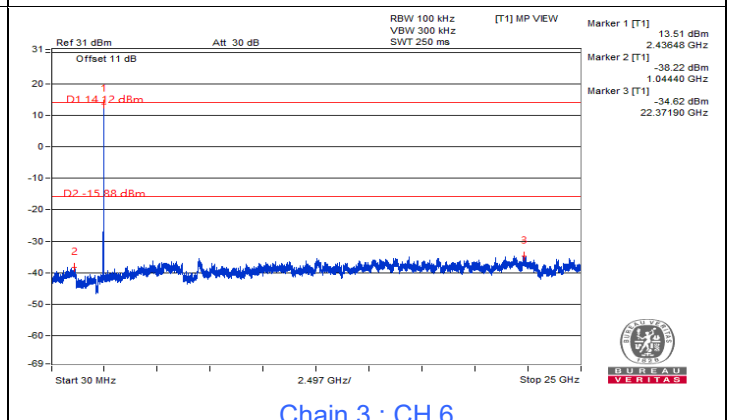
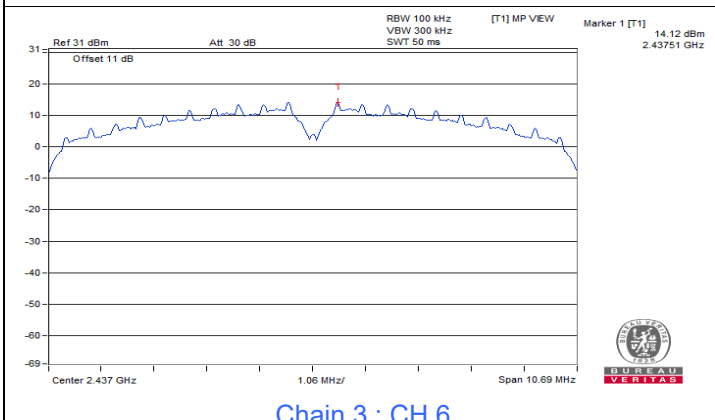
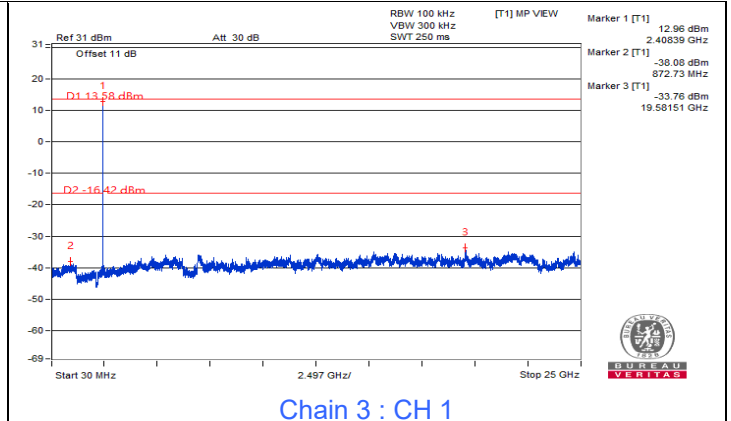
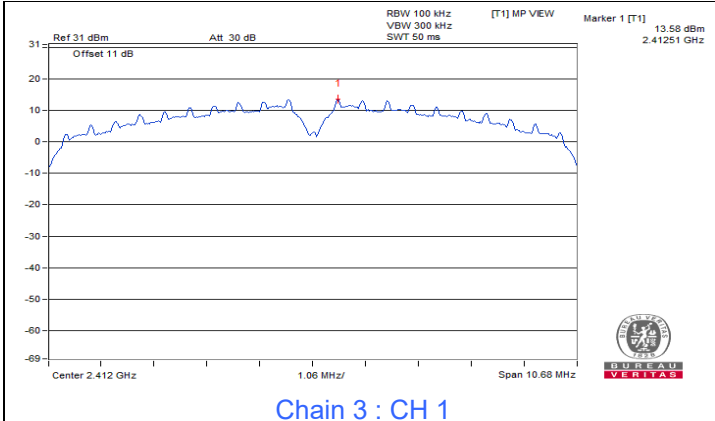

802.11g

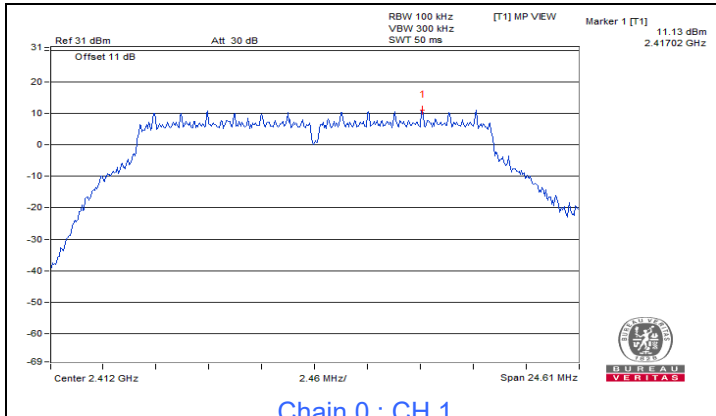

Chain 0 : CH 1

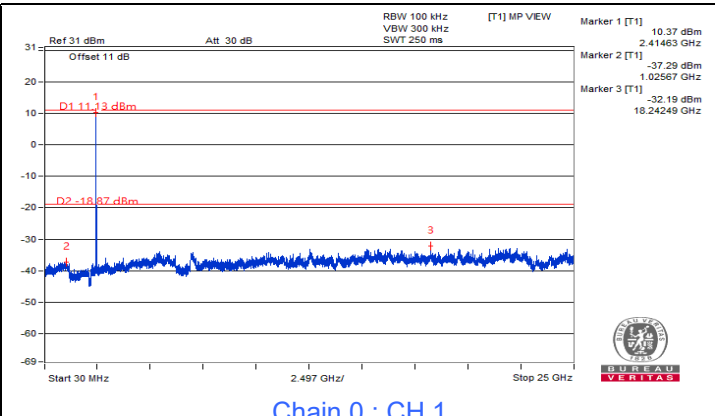

Chain 0 : CH 1

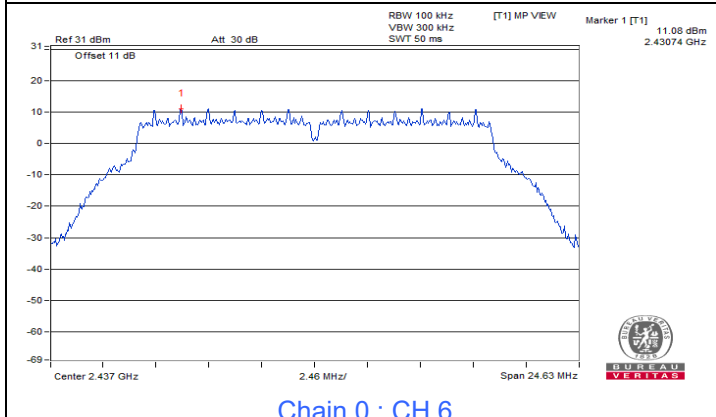

Chain 0 : CH 6

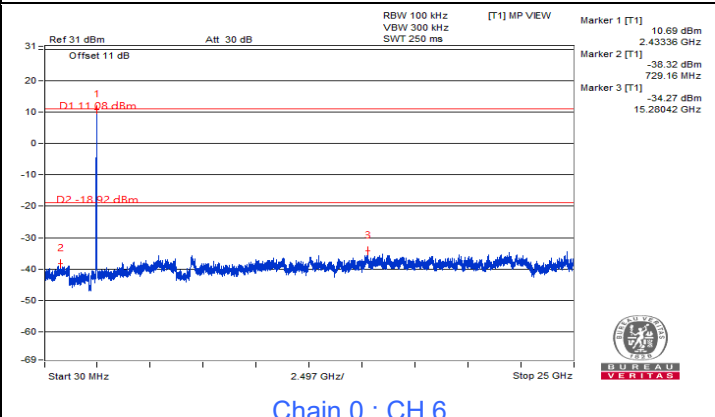

Chain 0 : CH 6

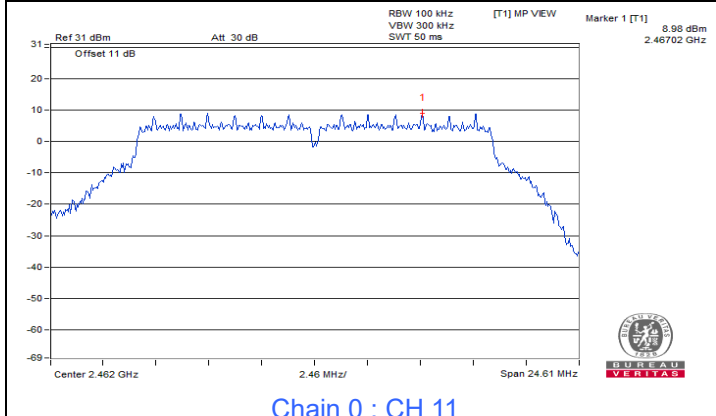

Chain 0 : CH 11

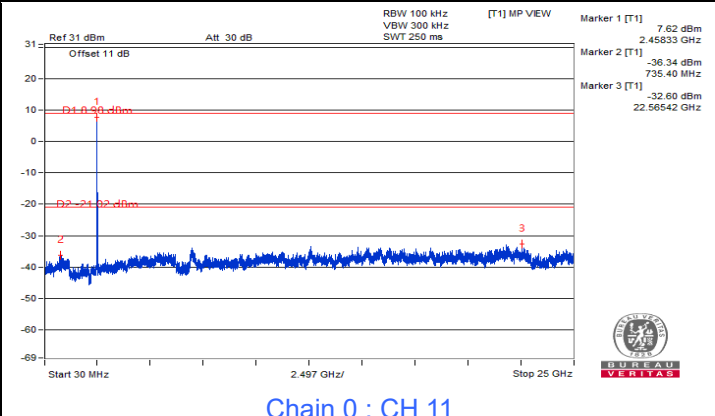

Chain 0 : CH 11

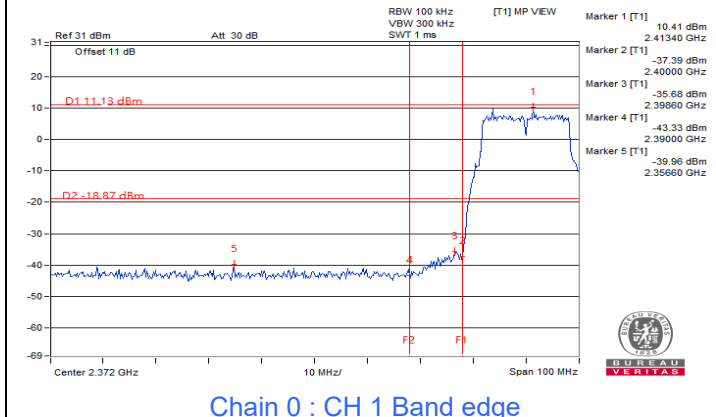

Chain 0 : CH 1 Band edge

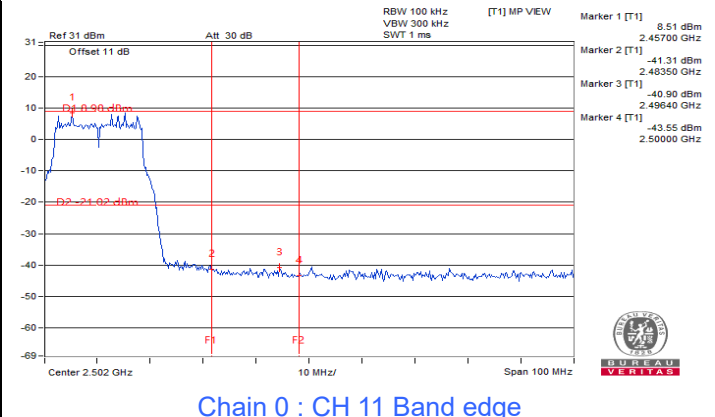

Chain 0 : CH 11 Band edge

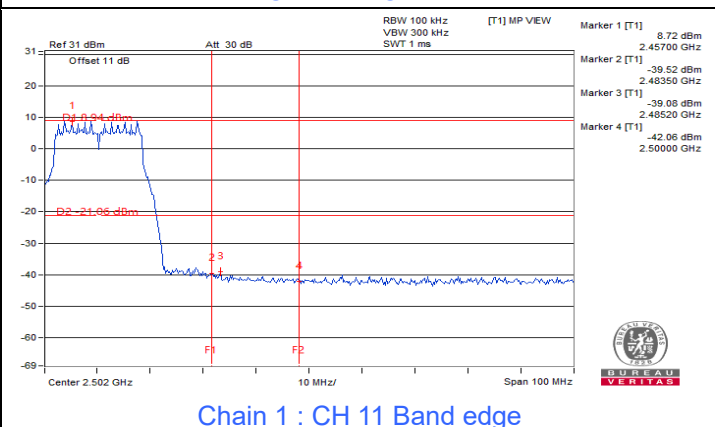
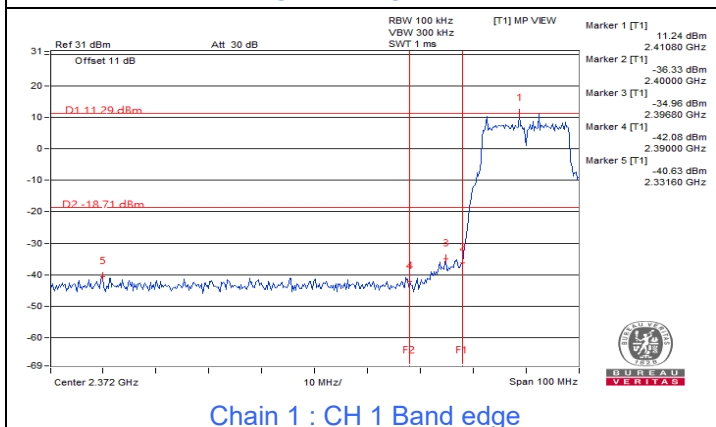
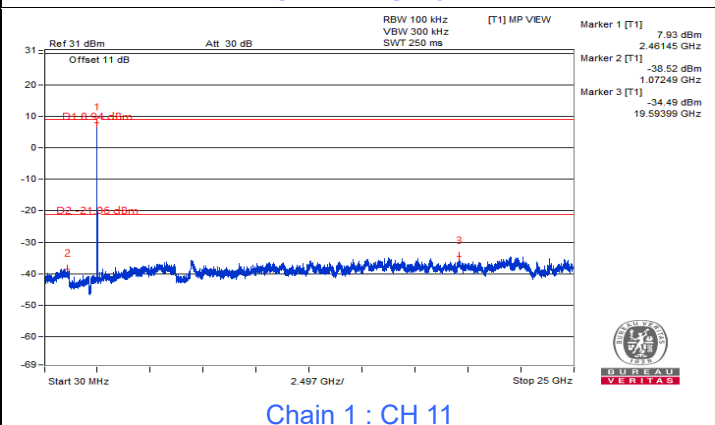
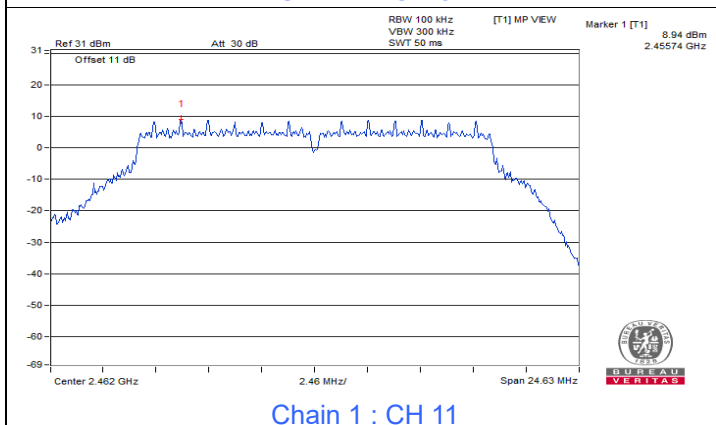
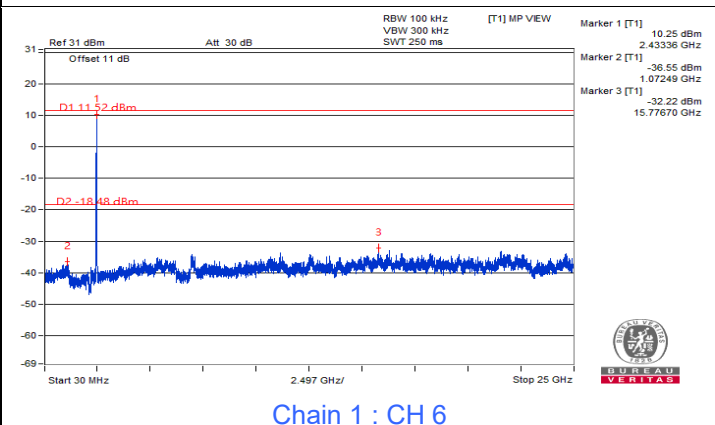
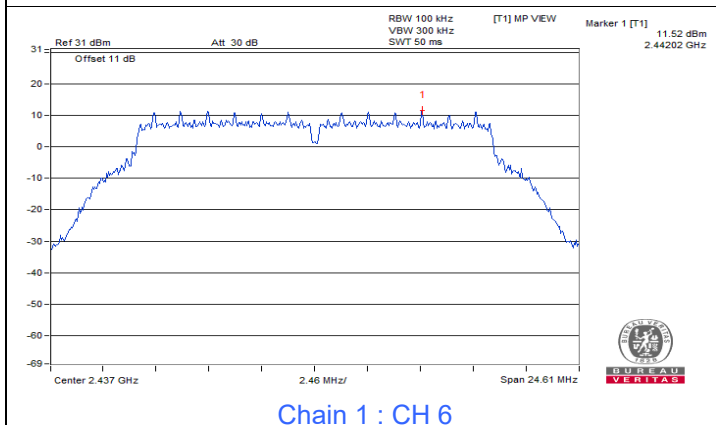
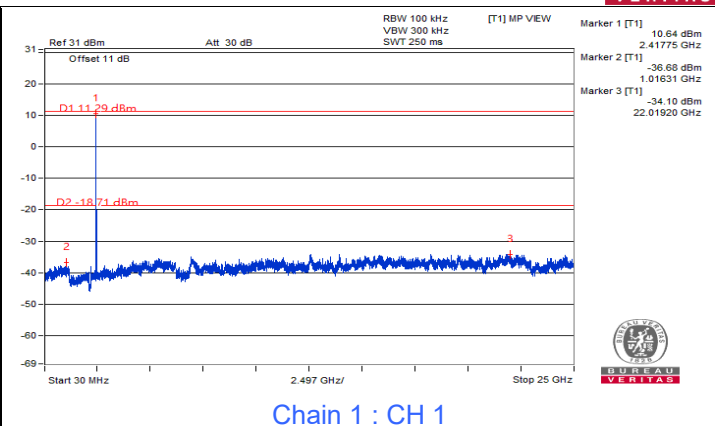
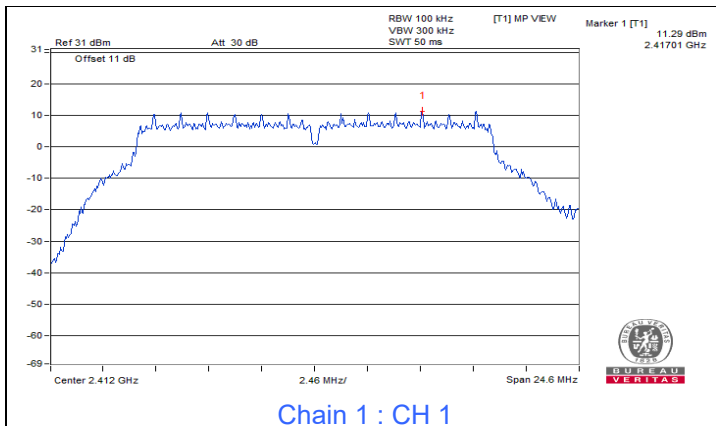

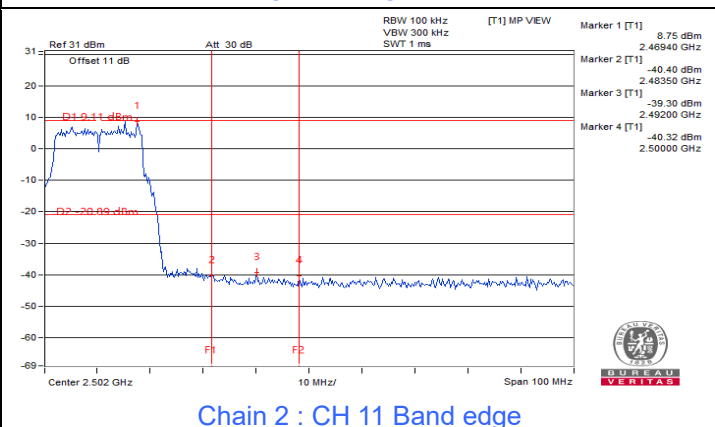
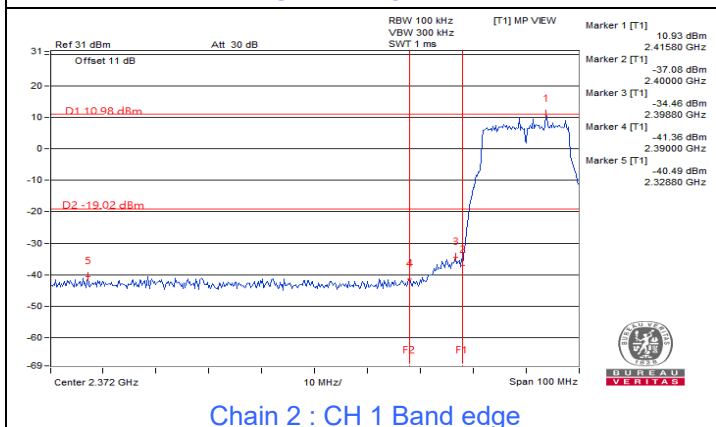
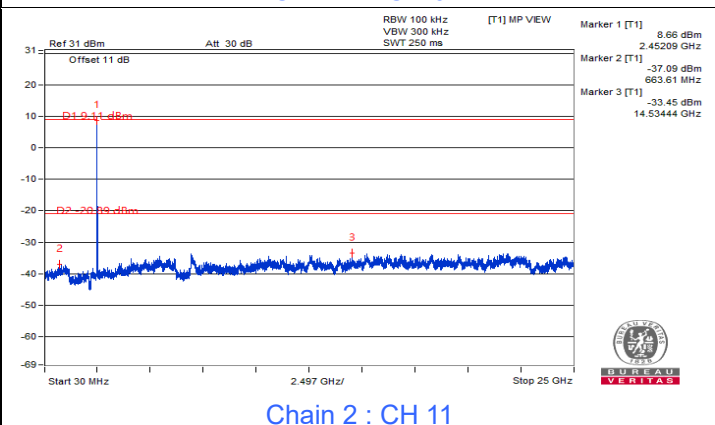
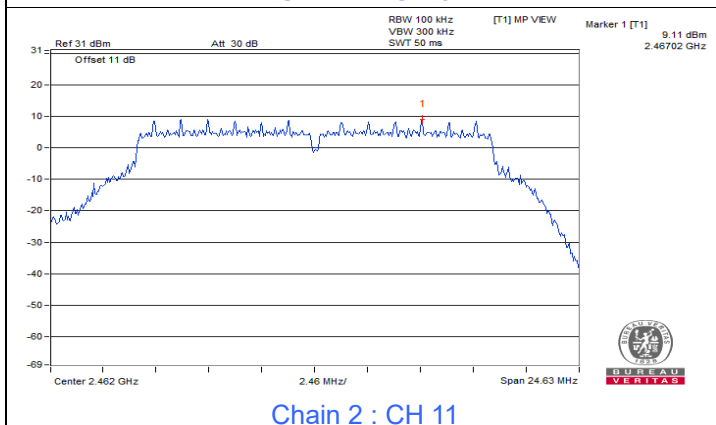
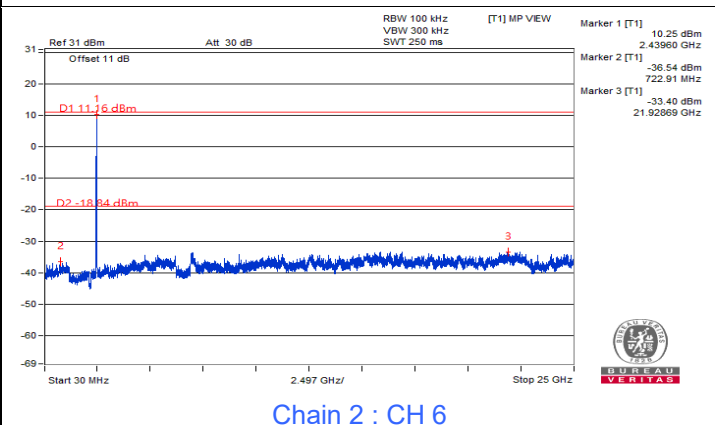
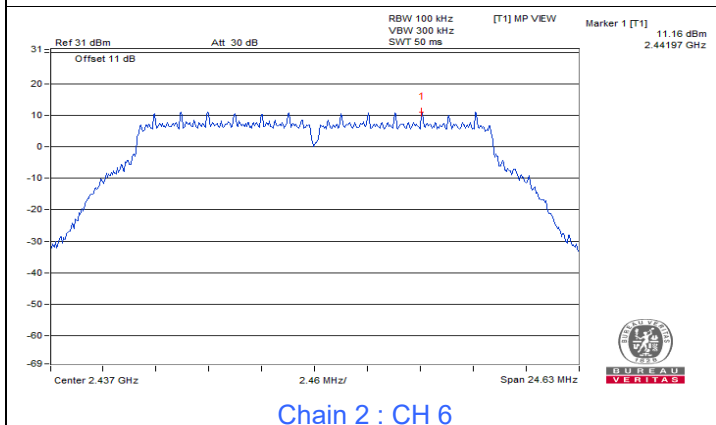
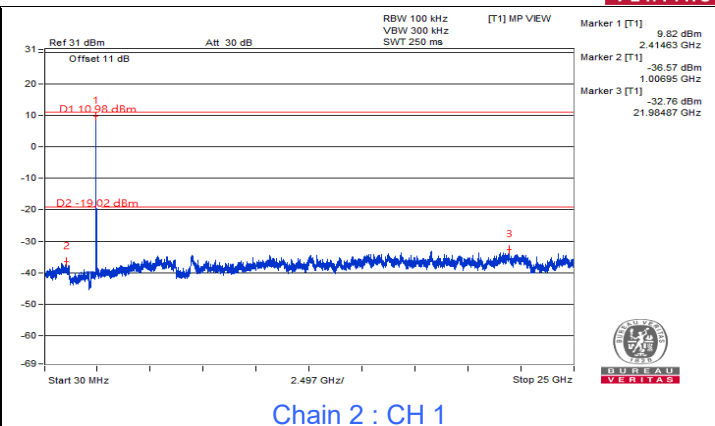
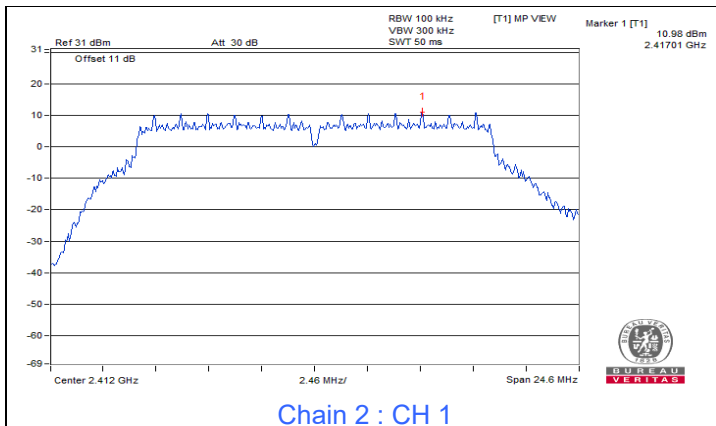

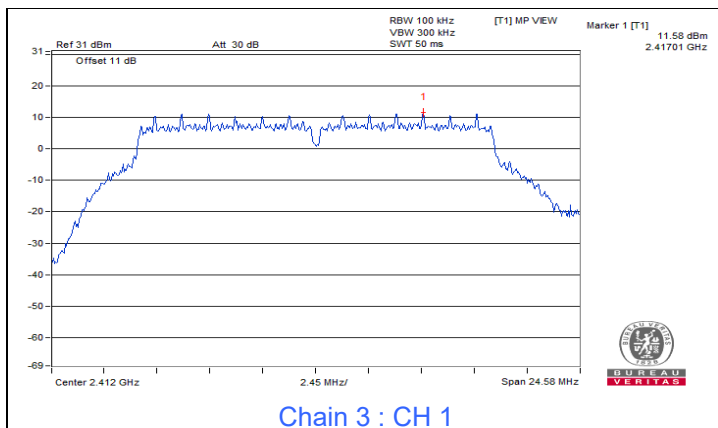

Chain 3 : CH 1

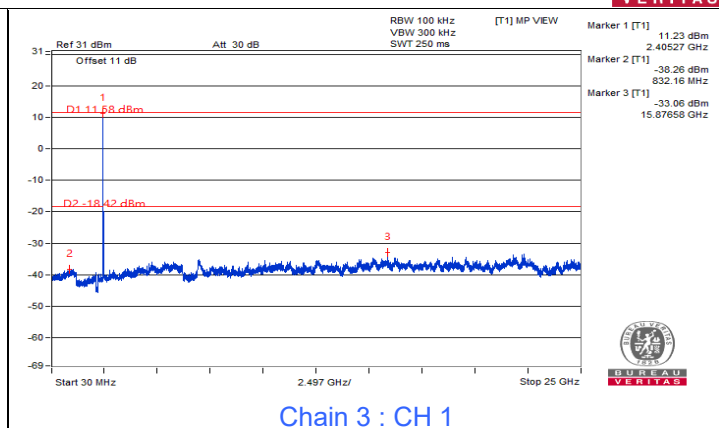

Chain 3 : CH 1

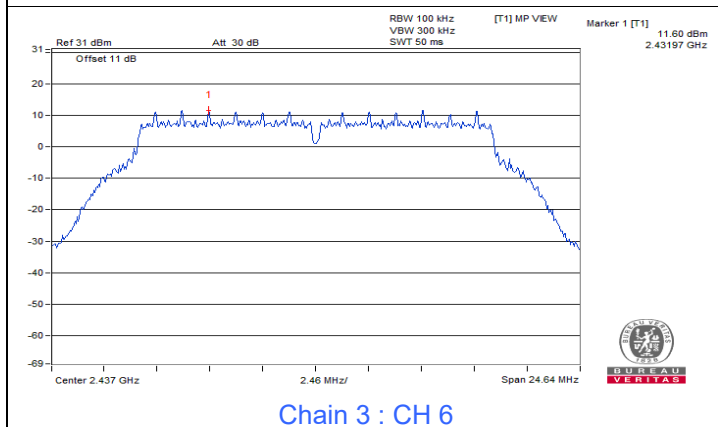

Chain 3 : CH 6

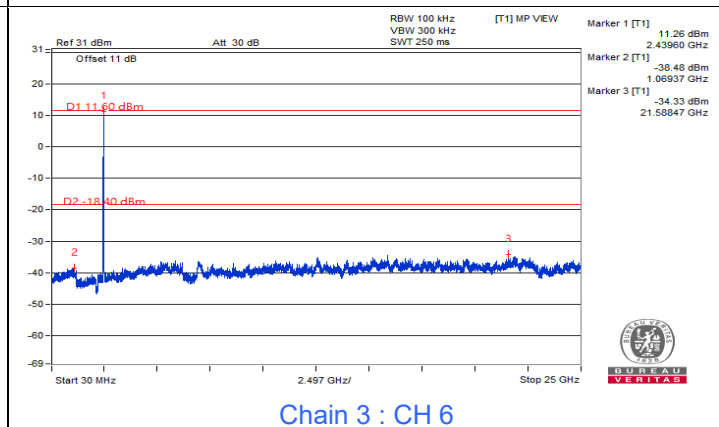

Chain 3 : CH 6

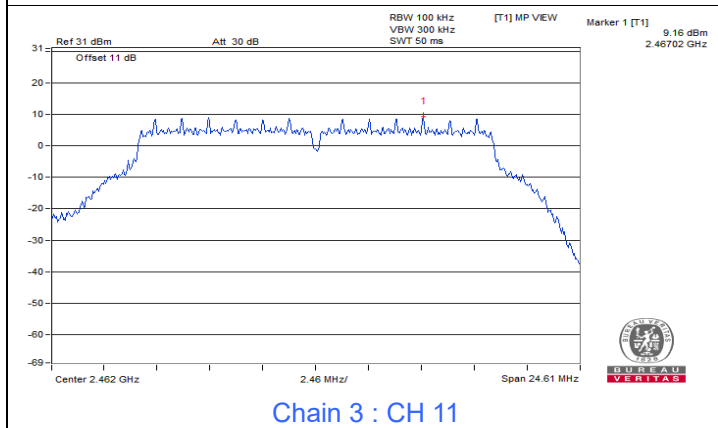

Chain 3 : CH 11

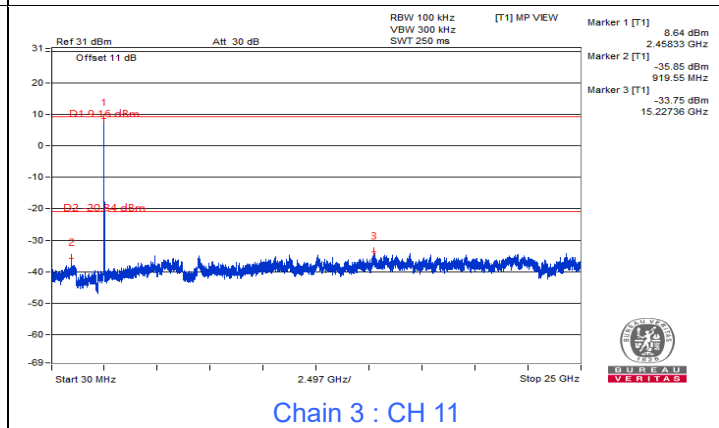

Chain 3 : CH 11

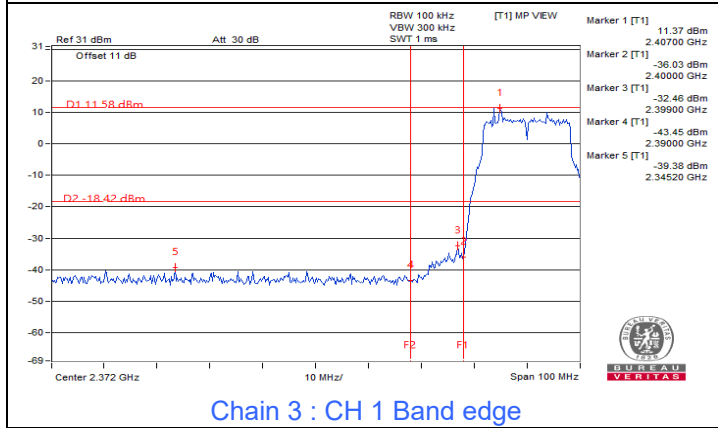

Chain 3 : CH 1 Band edge

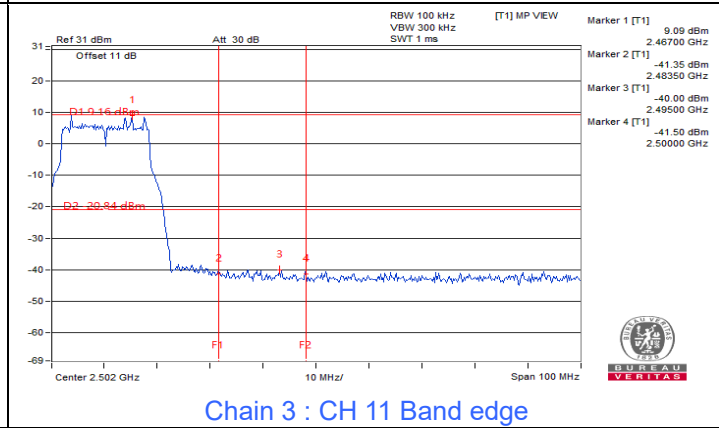

Chain 3 : CH 11 Band edge





### 802.11be (EHT20)

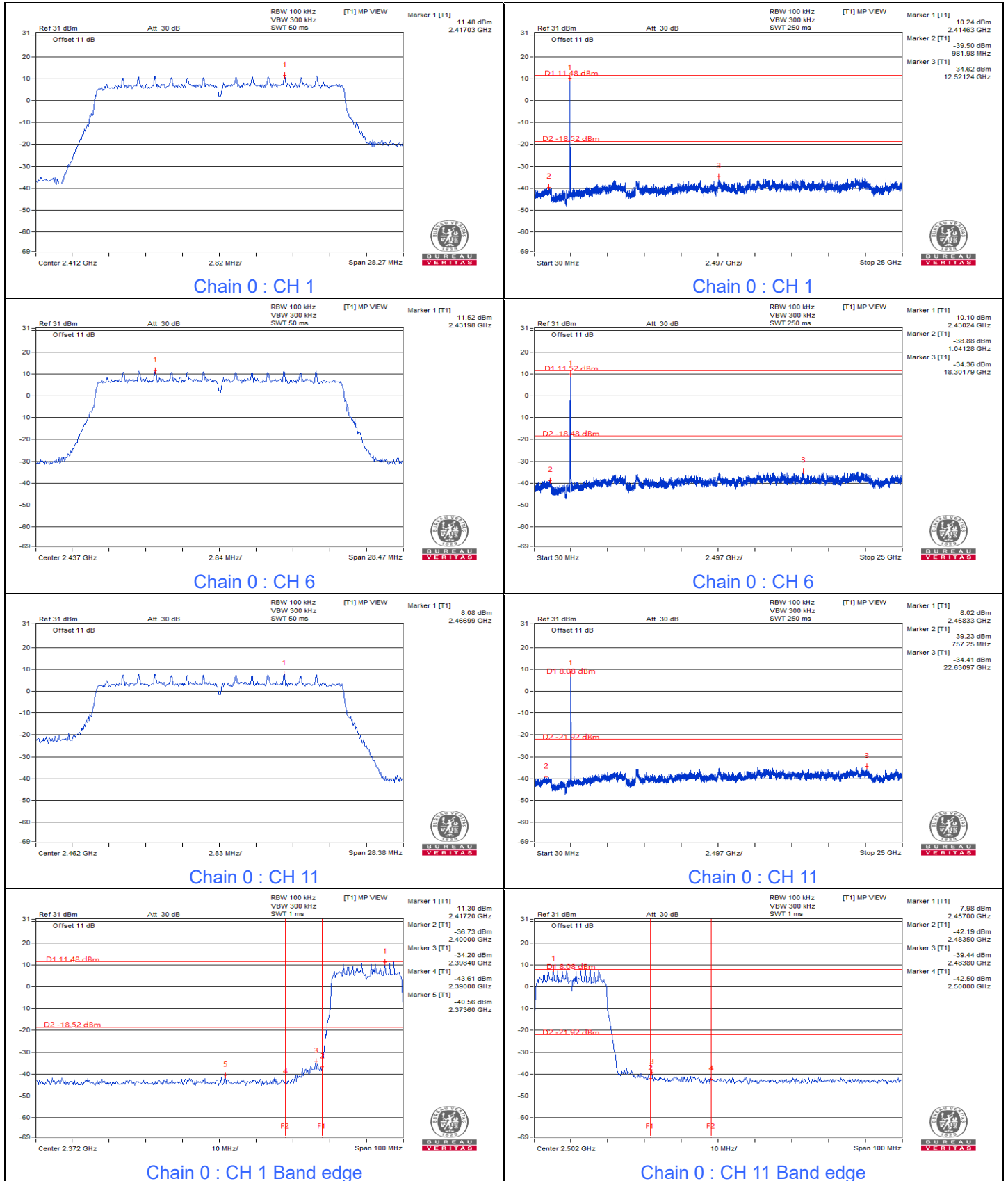

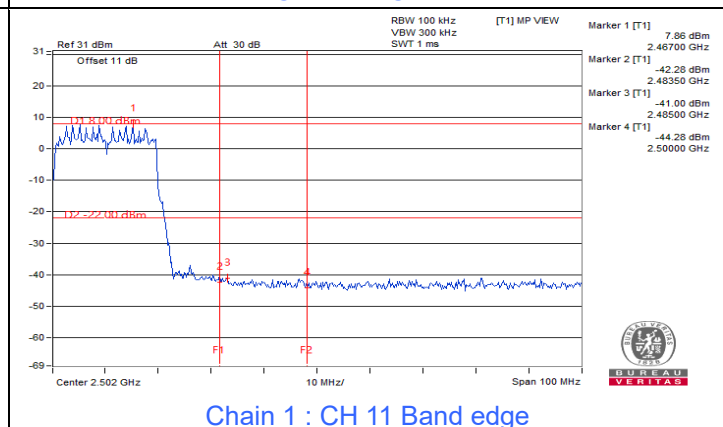
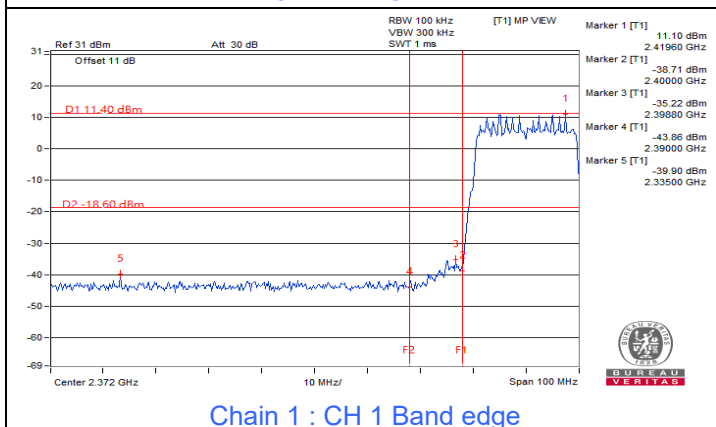
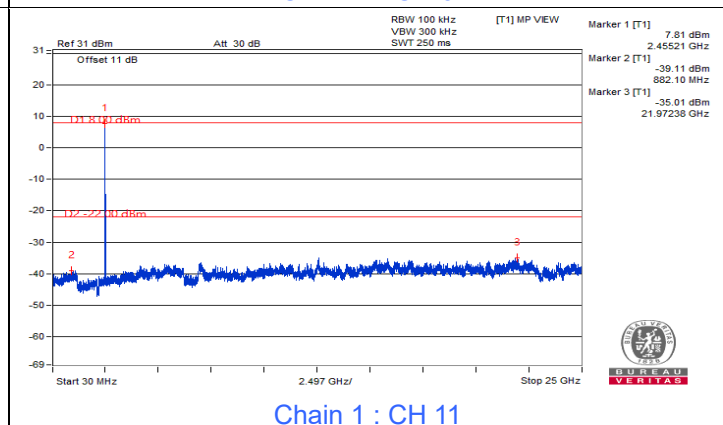
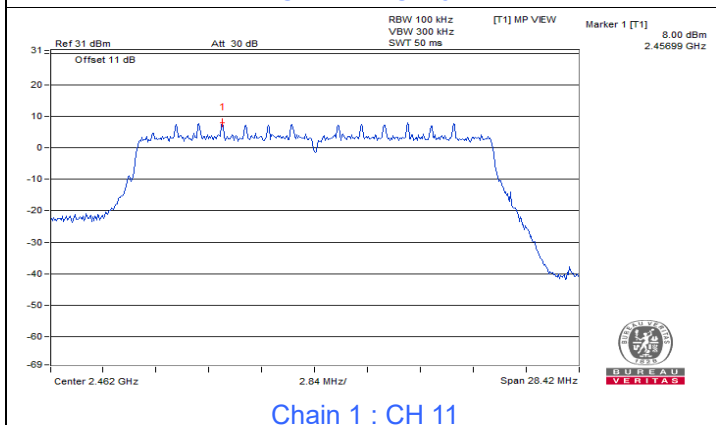
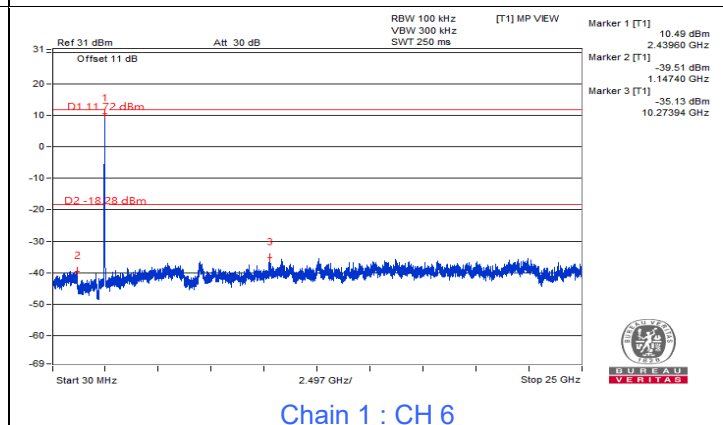
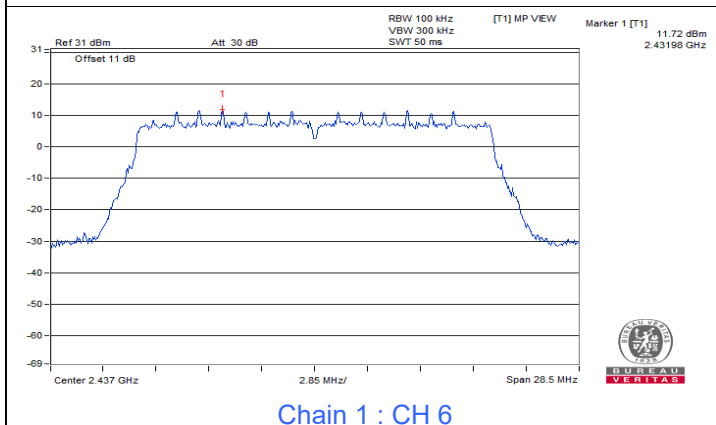
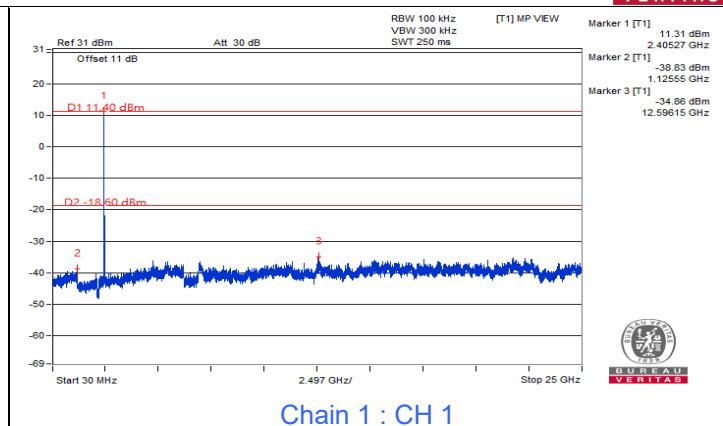
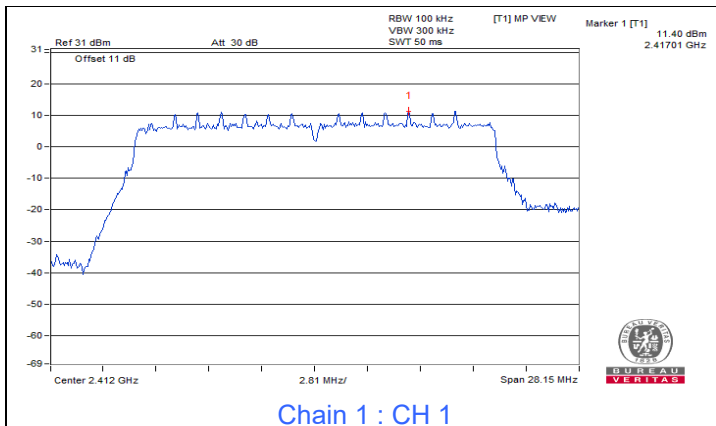

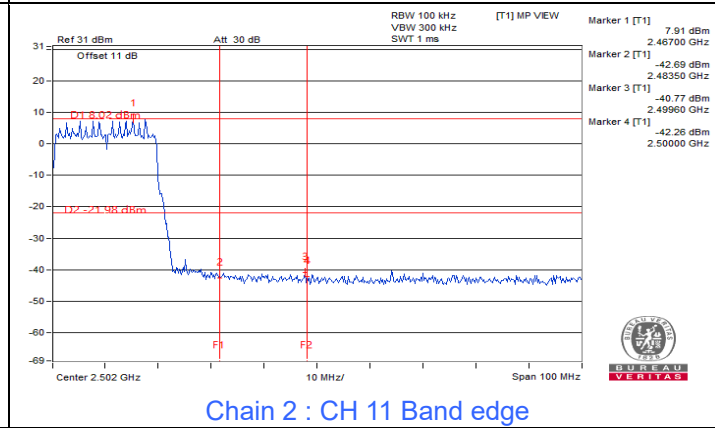
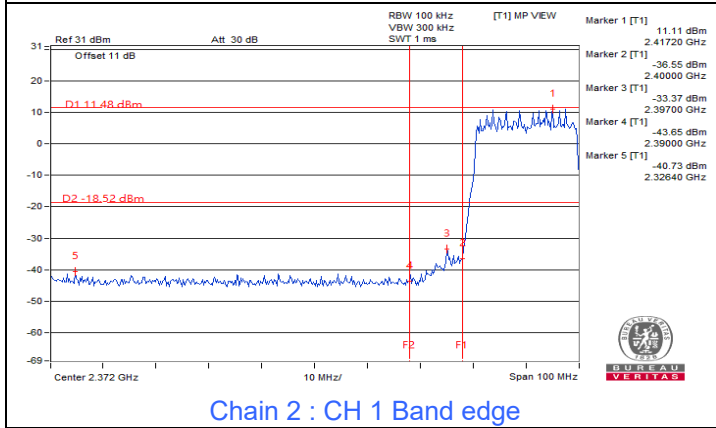
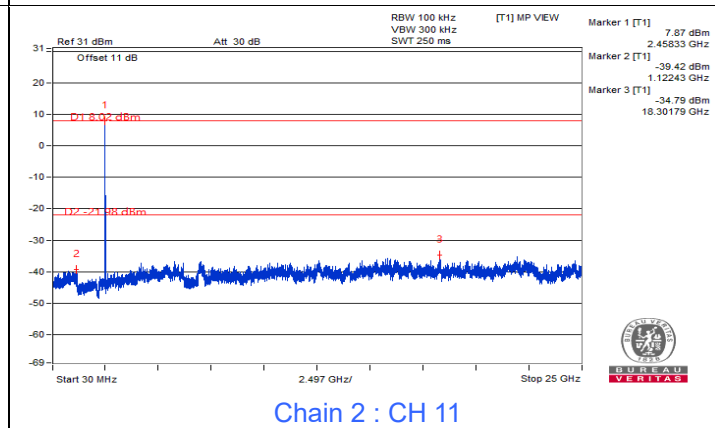
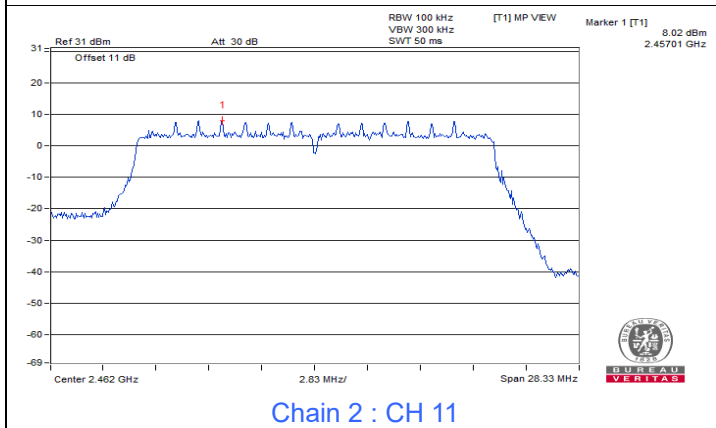
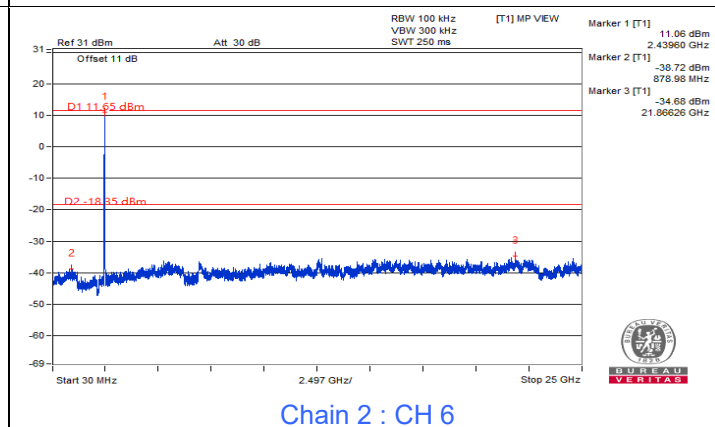
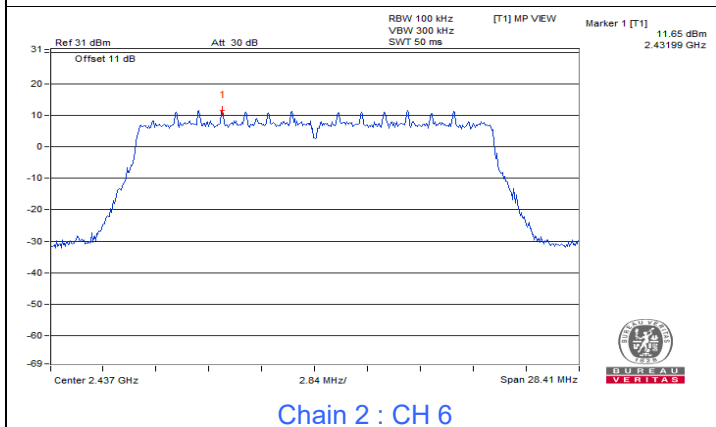
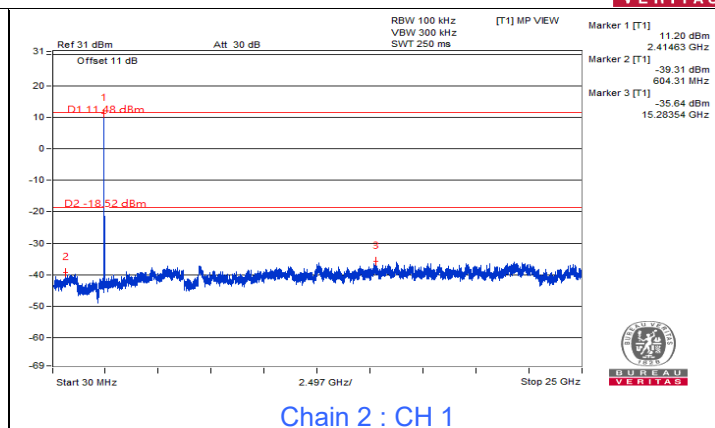
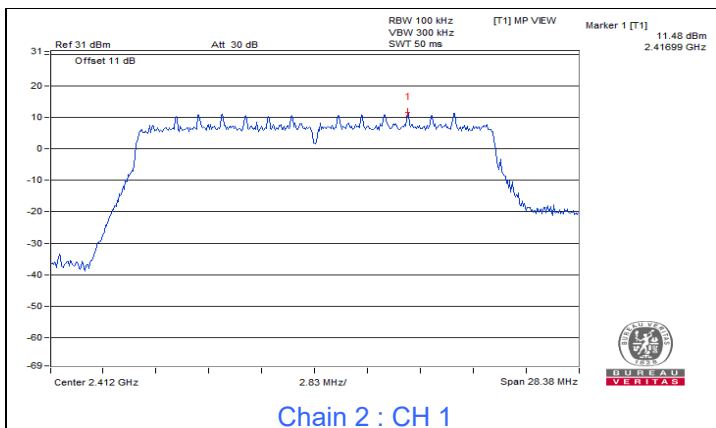

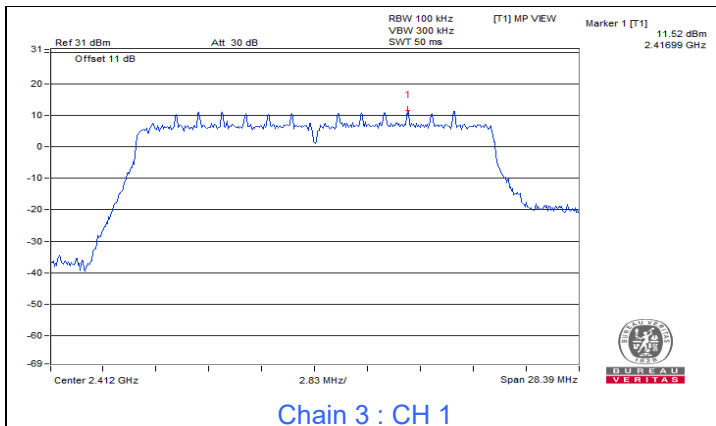

Chain 3 : CH 1

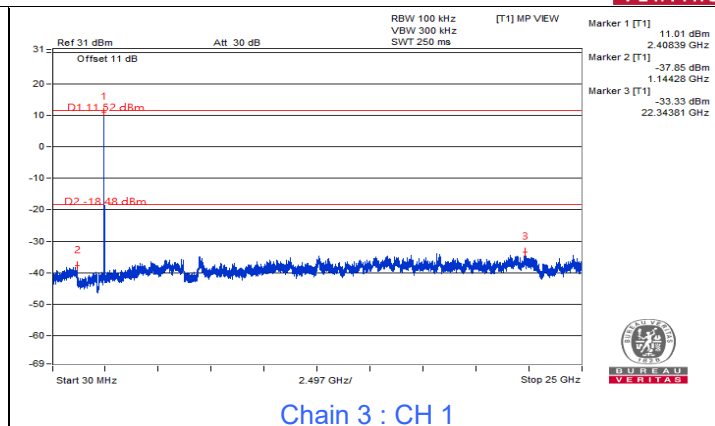

Chain 3 : CH 1

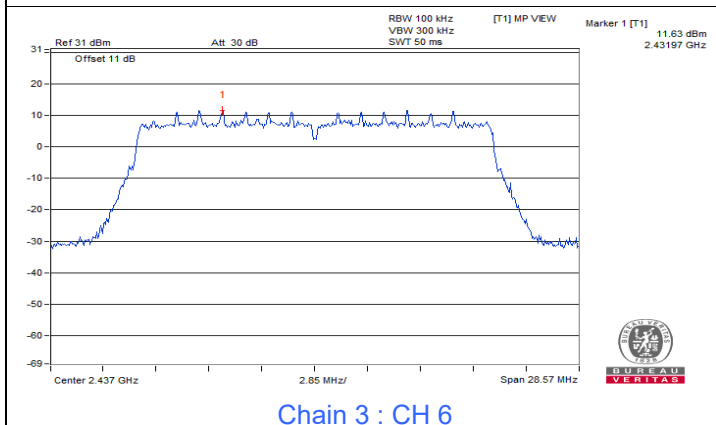

Chain 3 : CH 6

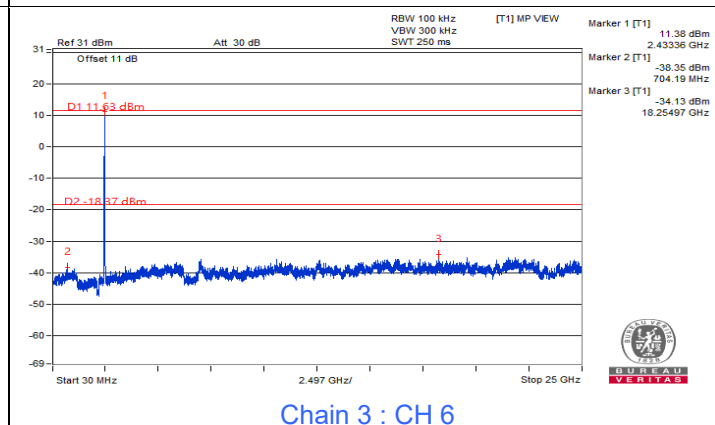

Chain 3 : CH 6

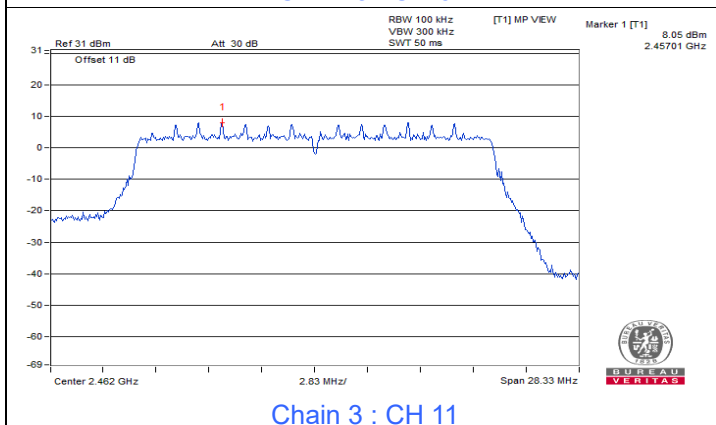

Chain 3 : CH 11

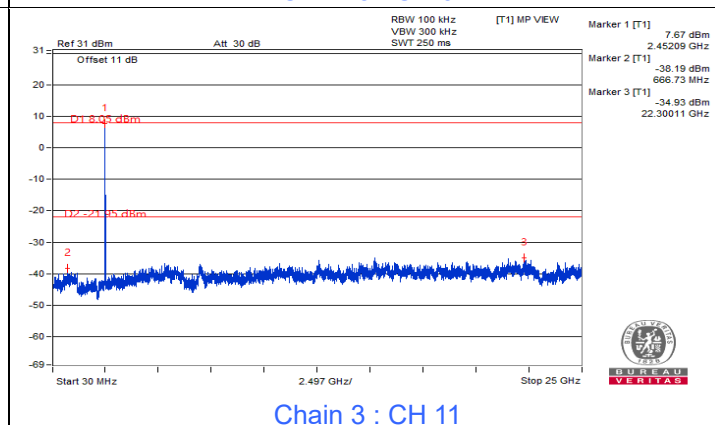

Chain 3 : CH 11

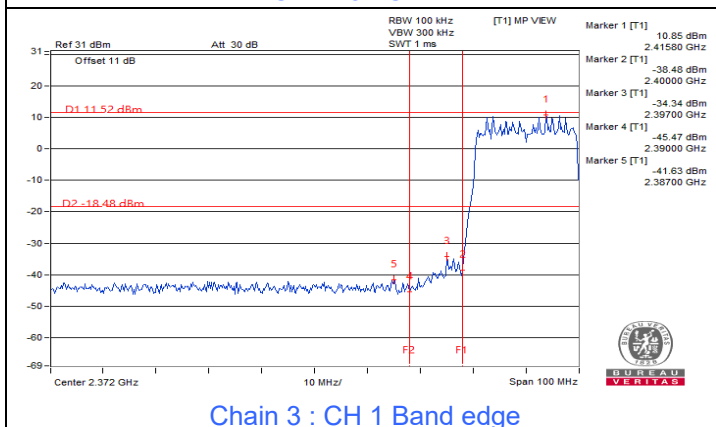

Chain 3 : CH 1 Band edge

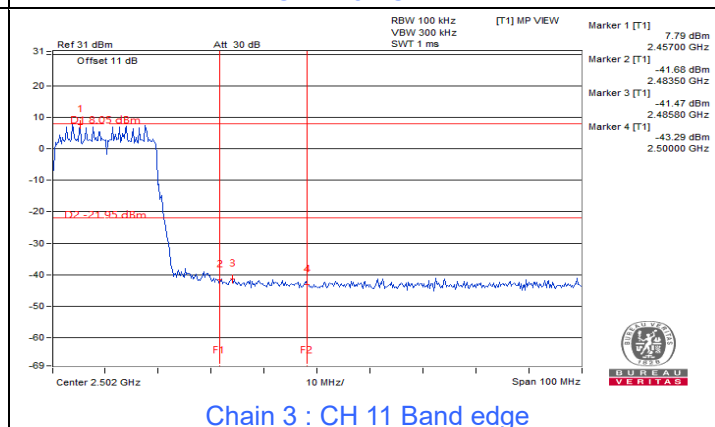

Chain 3 : CH 11 Band edge



### 802.11be (EHT40)

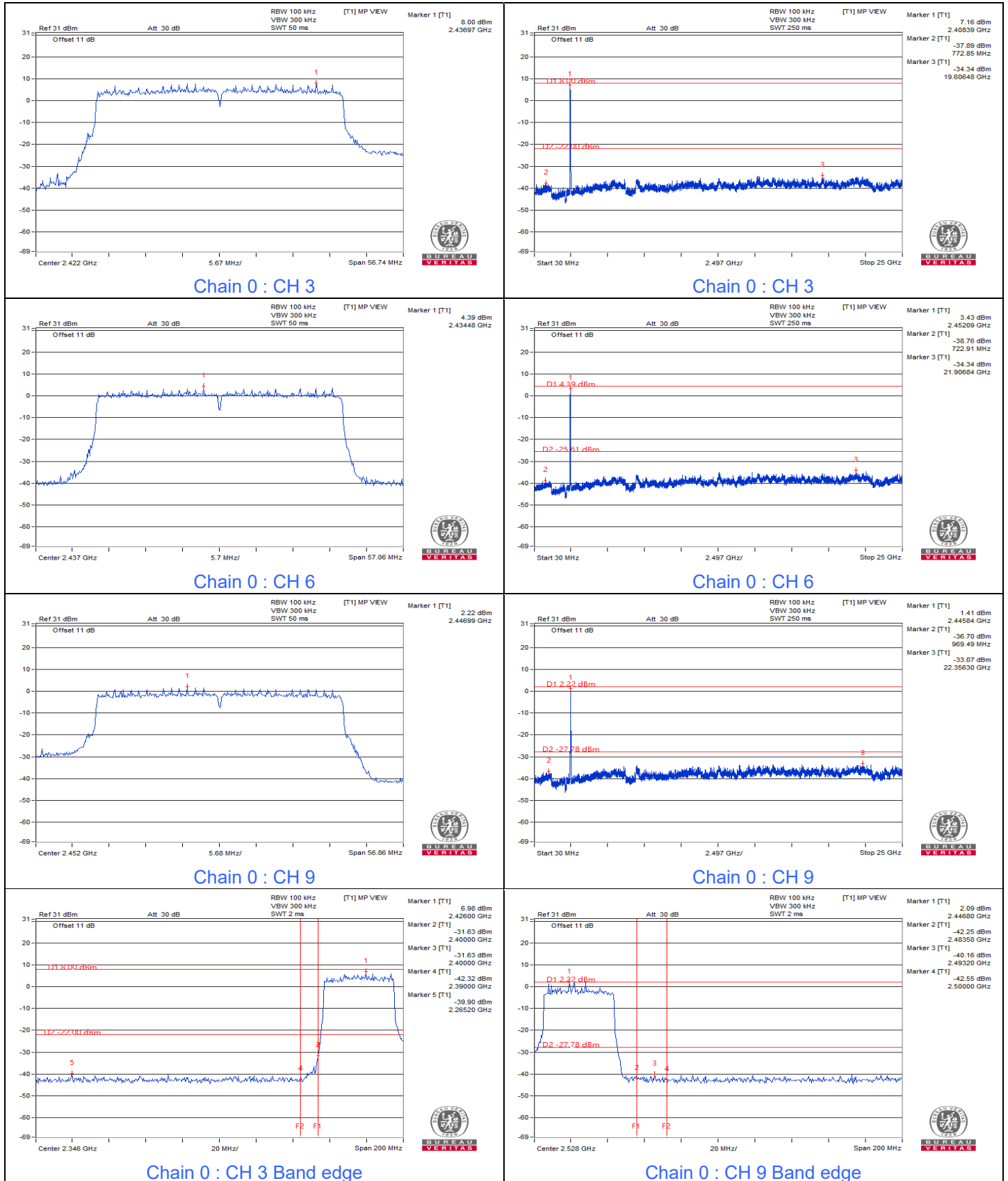

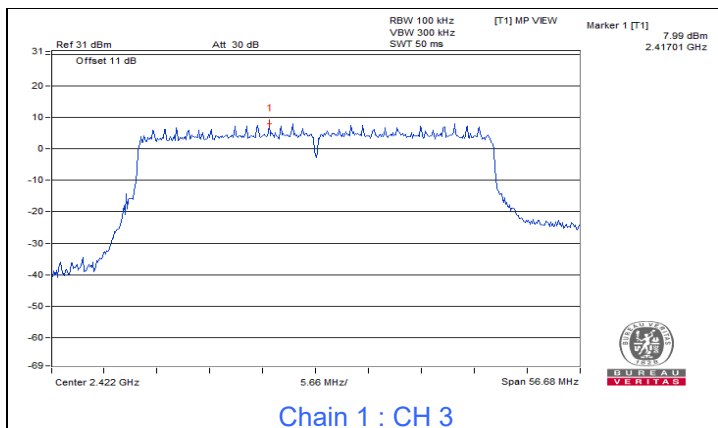

Chain 1 : CH 3

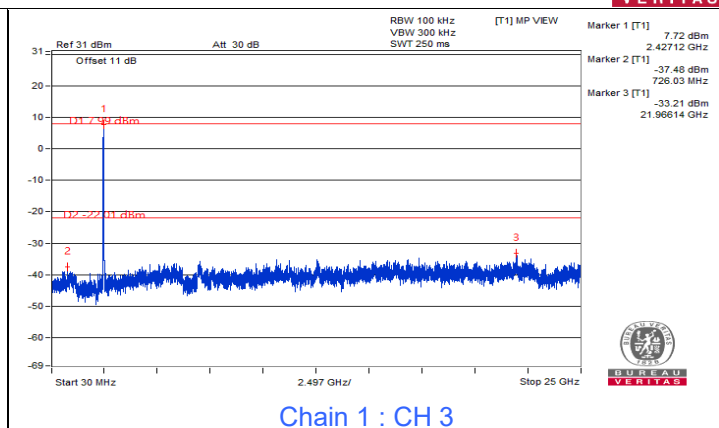

Chain 1 : CH 3

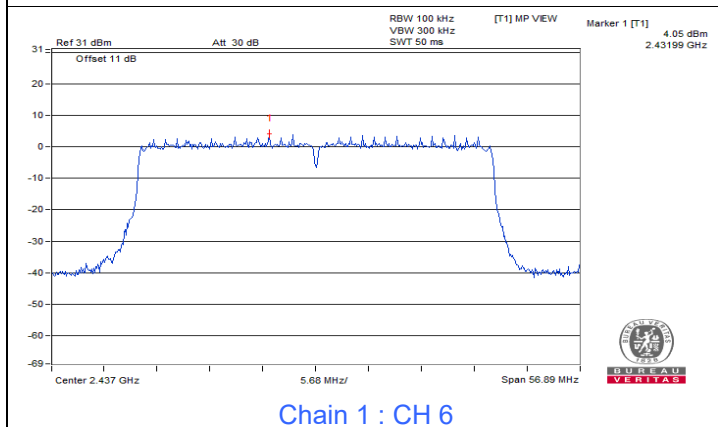

Chain 1 : CH 6

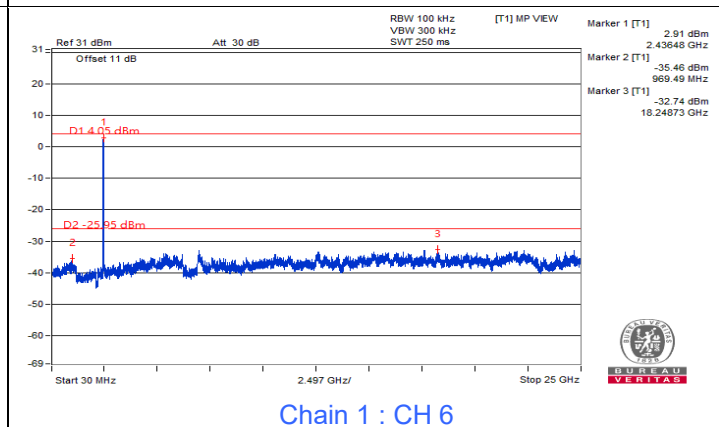

Chain 1 : CH 6

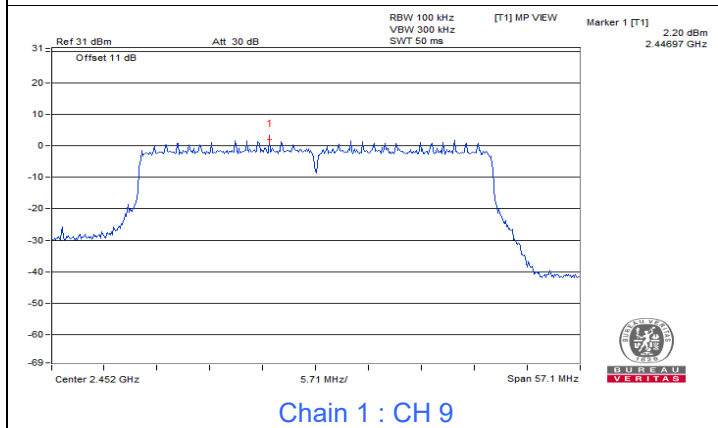

Chain 1 : CH 9

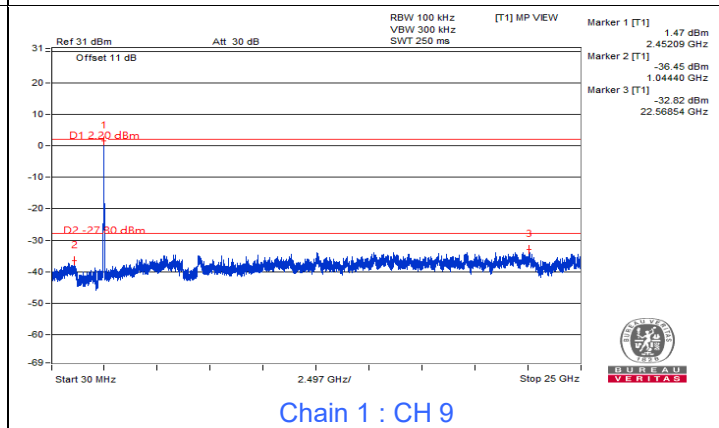

Chain 1 : CH 9

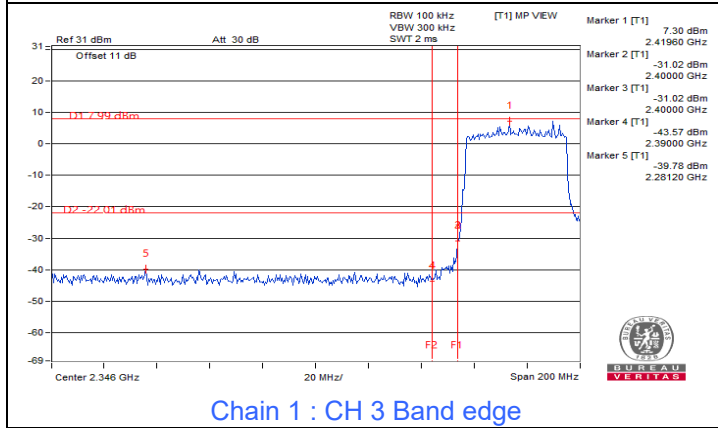

Chain 1 : CH 3 Band edge

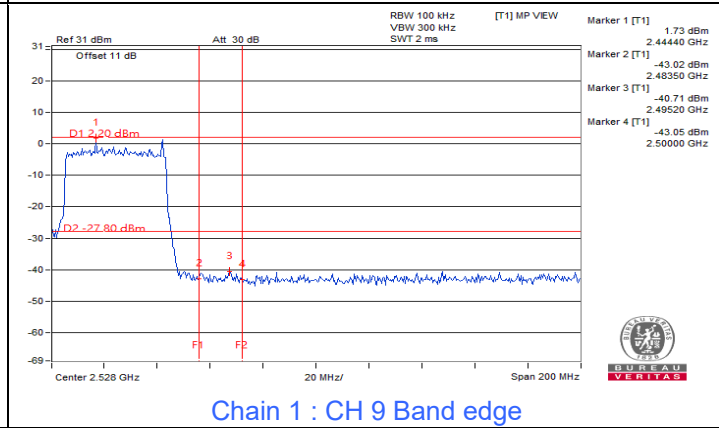

Chain 1 : CH 9 Band edge

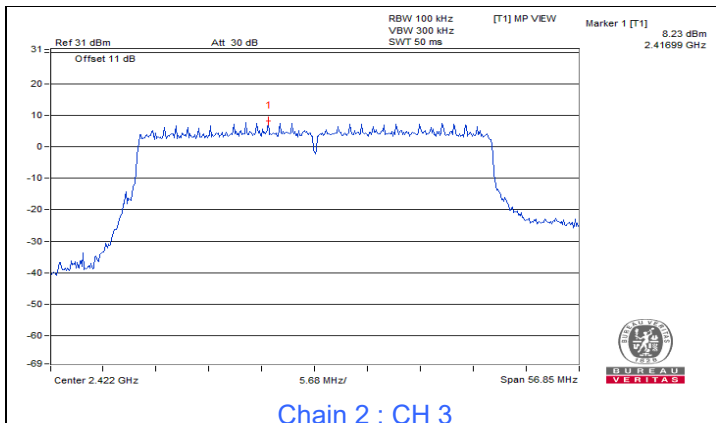

Chain 2 : CH 3

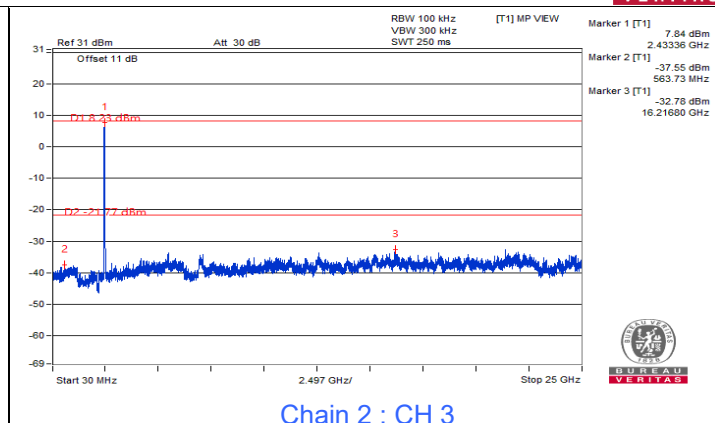

Chain 2 : CH 3

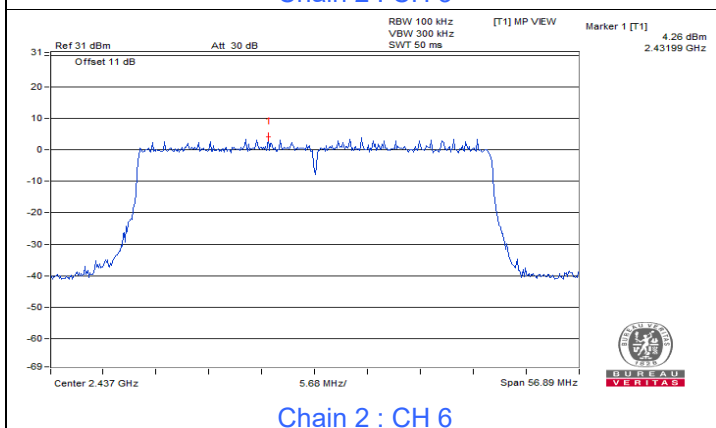

Chain 2 : CH 6

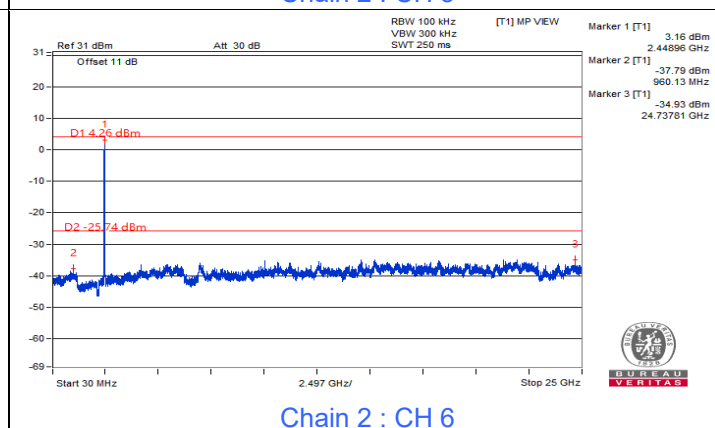

Chain 2 : CH 6

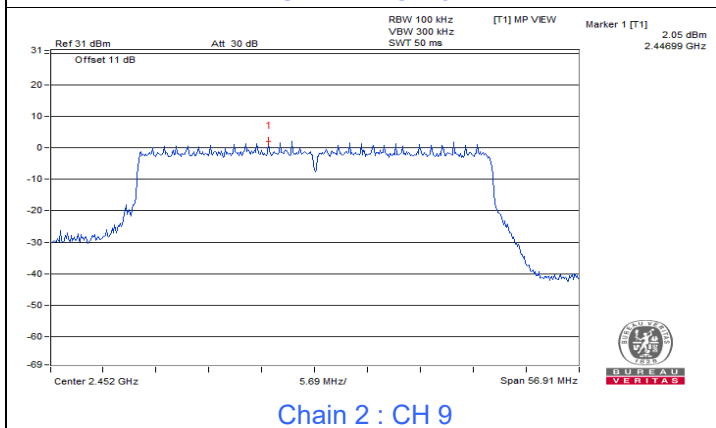

Chain 2 : CH 9

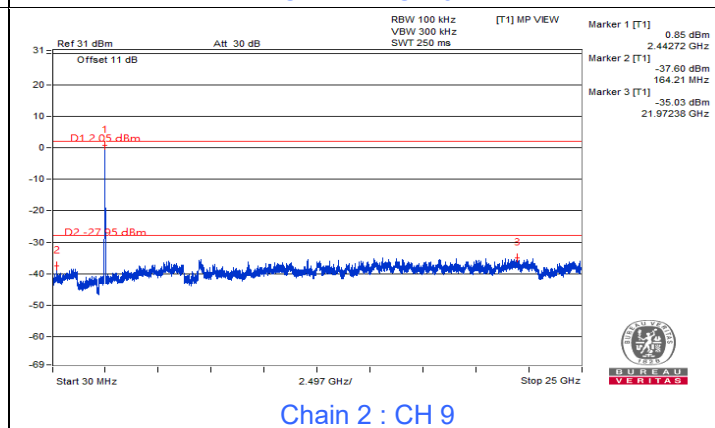

Chain 2 : CH 9

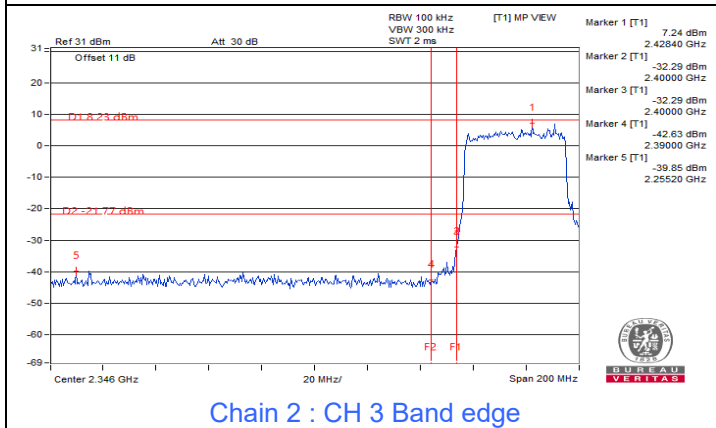

Chain 2 : CH 3 Band edge

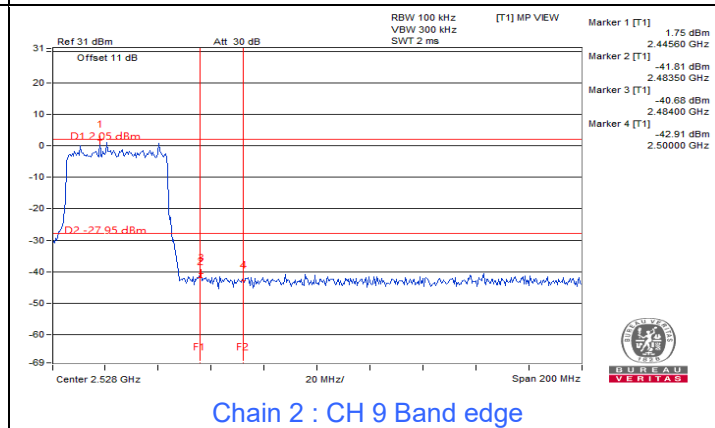

Chain 2 : CH 9 Band edge

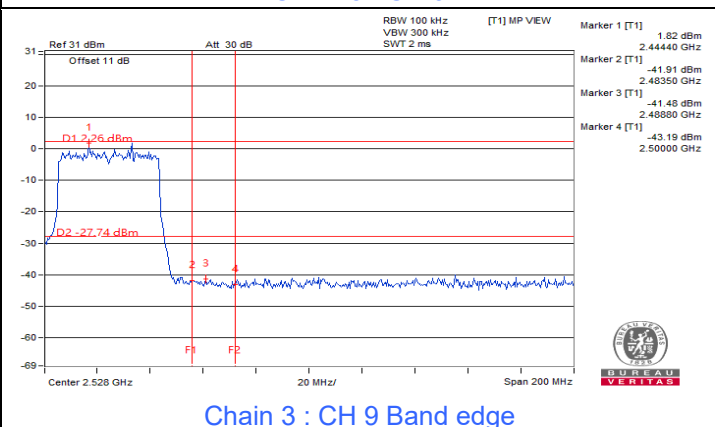
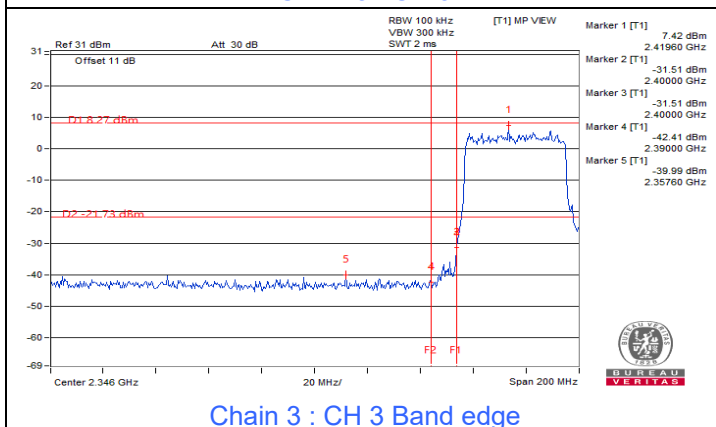
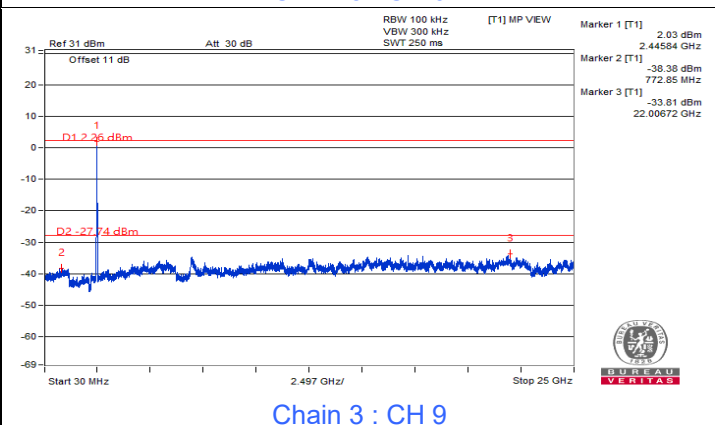
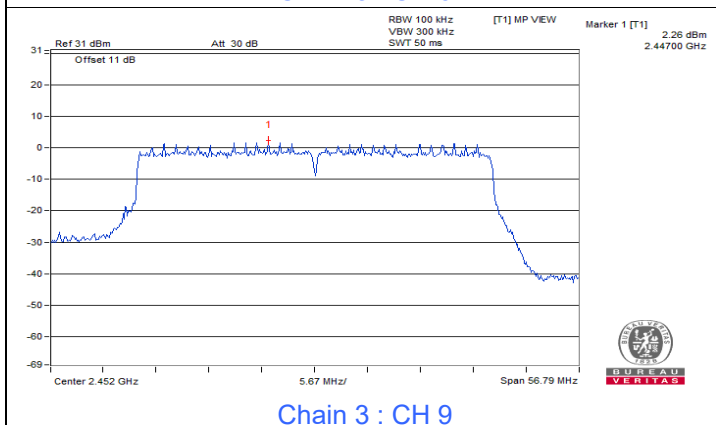
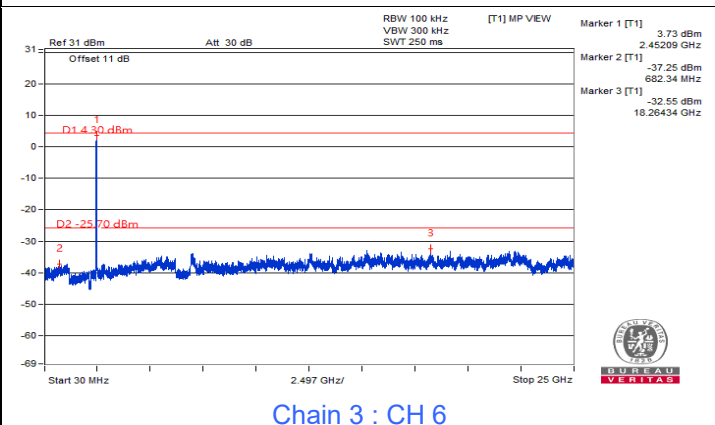
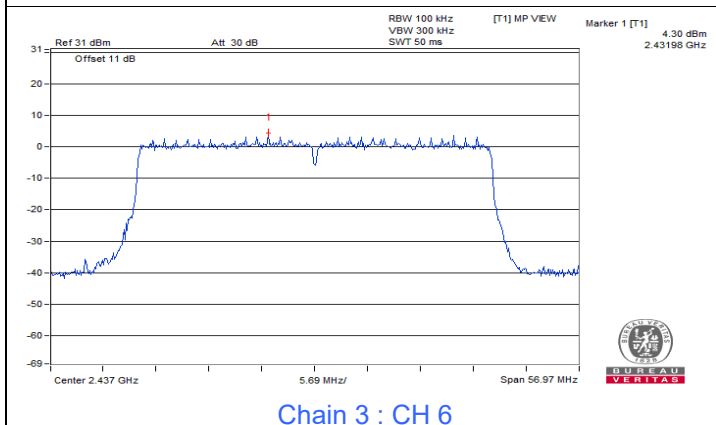
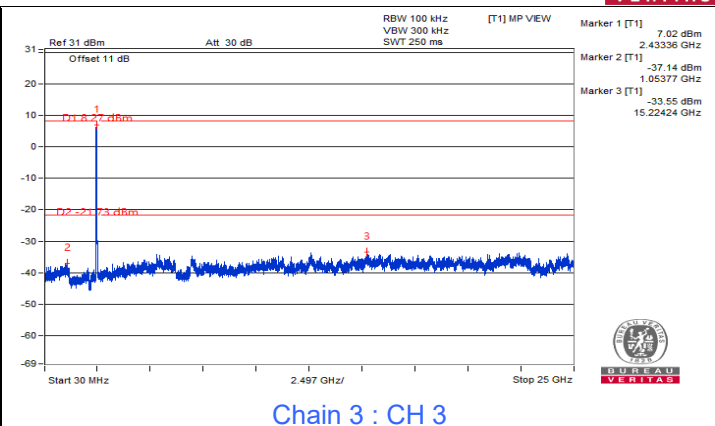
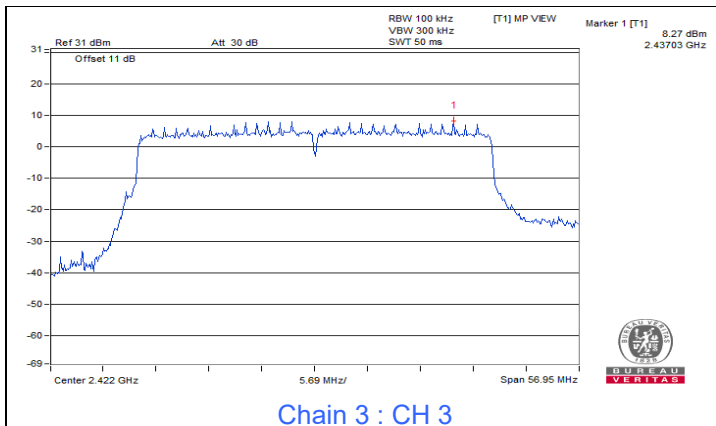



## 7.5 AC Power Conducted Emissions

### Test Mode A

|                 |                  |  |                                       |
|-----------------|------------------|--|---------------------------------------|
| RF Mode         | 802.11be (EHT20) | Channel                                  | CH 6 : 2437 MHz                       |
| Frequency Range | 150kHz ~ 30MHz   | Detector Function & Resolution Bandwidth | Quasi-Peak (QP) / Average (AV), 9 kHz |
| Input Power     | 120 Vac, 60 Hz   | Environmental Conditions                 | 25°C, 71% RH                          |
| Tested By       | Luis Lee         |  |                                       |

| Phase Of Power : Line (L) |                 |                        |                      |       |                       |       |              |       |             |        |
|---------------------------|-----------------|------------------------|----------------------|-------|-----------------------|-------|--------------|-------|-------------|--------|
| No                        | Frequency (MHz) | Correction Factor (dB) | Reading Value (dBuV) |       | Emission Level (dBuV) |       | Limit (dBuV) |       | Margin (dB) |        |
|                           |                 |                        | Q.P.                 | AV.   | Q.P.                  | AV.   | Q.P.         | AV.   | Q.P.        | AV.    |
| 1                         | 0.19800         | 9.70                   | 29.02                | 10.80 | 38.72                 | 20.50 | 63.69        | 53.69 | -24.97      | -33.19 |
| 2                         | 0.21400         | 9.71                   | 27.24                | 10.48 | 36.95                 | 20.19 | 63.05        | 53.05 | -26.10      | -32.86 |
| 3                         | 0.24600         | 9.72                   | 24.17                | 11.28 | 33.89                 | 21.00 | 61.89        | 51.89 | -28.00      | -30.89 |
| 4                         | 0.26200         | 9.73                   | 22.72                | 8.83  | 32.45                 | 18.56 | 61.37        | 51.37 | -28.92      | -32.81 |
| 5                         | 0.29400         | 9.74                   | 20.57                | 10.05 | 30.31                 | 19.79 | 60.41        | 50.41 | -30.10      | -30.62 |
| 6                         | 17.81800        | 10.06                  | 20.61                | 15.21 | 30.67                 | 25.27 | 60.00        | 50.00 | -29.33      | -24.73 |

#### Remarks:

1. Q.P. and AV. are abbreviations of quasi-peak and average individually.
2. The emission levels of other frequencies were very low against the limit.
3. Margin value = Emission level – Limit value
4. Correction factor = Insertion loss + Cable loss
5. Emission Level = Correction Factor + Reading Value

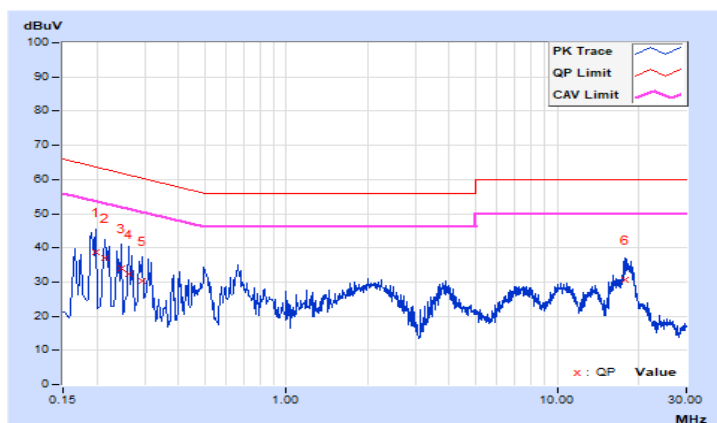

|                        |                  |   |                                       |
|------------------------|------------------|---|---------------------------------------|
| <b>RF Mode</b>         | 802.11be (EHT20) | <b>Channel</b>                                      | CH 6 : 2437 MHz                       |
| <b>Frequency Range</b> | 150kHz ~ 30MHz   | <b>Detector Function &amp; Resolution Bandwidth</b> | Quasi-Peak (QP) / Average (AV), 9 kHz |
| <b>Input Power</b>     | 120 Vac, 60 Hz   | <b>Environmental Conditions</b>                     | 25°C, 71% RH                          |
| <b>Tested By</b>       | Luis Lee         |   |                                       |

| Phase Of Power : Neutral (N) |                 |                        |                      |       |                       |       |              |       |             |        |
|------------------------------|-----------------|------------------------|----------------------|-------|-----------------------|-------|--------------|-------|-------------|--------|
| No                           | Frequency (MHz) | Correction Factor (dB) | Reading Value (dBuV) |       | Emission Level (dBuV) |       | Limit (dBuV) |       | Margin (dB) |        |
|                              |                 |                        | Q.P.                 | AV.   | Q.P.                  | AV.   | Q.P.         | AV.   | Q.P.        | AV.    |
| 1                            | 0.16200         | 9.67                   | 32.86                | 16.84 | 42.53                 | 26.51 | 65.36        | 55.36 | -22.83      | -28.85 |
| 2                            | 0.18600         | 9.69                   | 30.39                | 14.15 | 40.08                 | 23.84 | 64.21        | 54.21 | -24.13      | -30.37 |
| 3                            | 0.21000         | 9.70                   | 27.59                | 10.46 | 37.29                 | 20.16 | 63.21        | 53.21 | -25.92      | -33.05 |
| 4                            | 0.23400         | 9.71                   | 25.10                | 11.54 | 34.81                 | 21.25 | 62.31        | 52.31 | -27.50      | -31.06 |
| 5                            | 0.25800         | 9.72                   | 23.32                | 10.07 | 33.04                 | 19.79 | 61.50        | 51.50 | -28.46      | -31.71 |
| 6                            | 0.28200         | 9.73                   | 21.15                | 8.38  | 30.88                 | 18.11 | 60.76        | 50.76 | -29.88      | -32.65 |

**Remarks:**

1. Q.P. and AV. are abbreviations of quasi-peak and average individually.
2. The emission levels of other frequencies were very low against the limit.
3. Margin value = Emission level – Limit value
4. Correction factor = Insertion loss + Cable loss
5. Emission Level = Correction Factor + Reading Value

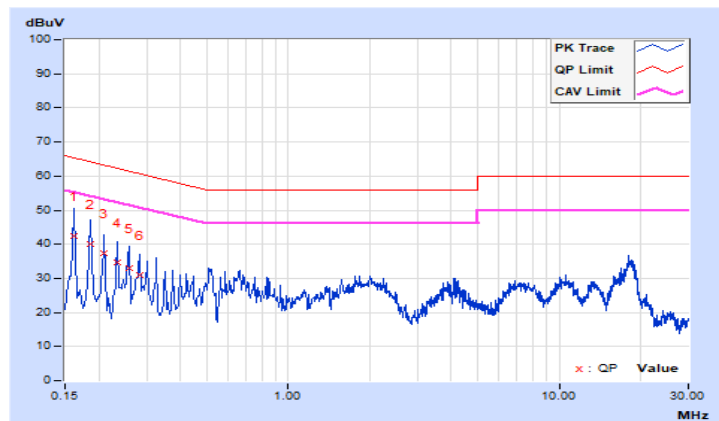

### Test Mode B

|                 |                  |  |                                       |
|-----------------|------------------|--|---------------------------------------|
| RF Mode         | 802.11be (EHT20) | Channel                                  | CH 6 : 2437 MHz                       |
| Frequency Range | 150kHz ~ 30MHz   | Detector Function & Resolution Bandwidth | Quasi-Peak (QP) / Average (AV), 9 kHz |
| Input Power     | 120 Vac, 60 Hz   | Environmental Conditions                 | 25°C, 70% RH                          |
| Tested By       | Luis Lee         |  |                                       |

#### Phase Of Power : Line (L)

| No       | Frequency (MHz) | Correction Factor (dB) | Reading Value (dBuV) |              | Emission Level (dBuV) |              | Limit (dBuV) |              | Margin (dB)   |              |
|----------|-----------------|------------------------|----------------------|--------------|-----------------------|--------------|--------------|--------------|---------------|--------------|
|          |                 |                        | Q.P.                 | AV.          | Q.P.                  | AV.          | Q.P.         | AV.          | Q.P.          | AV.          |
| 1        | 0.15800         | 9.67                   | 37.44                | 21.38        | 47.11                 | 31.05        | 65.57        | 55.57        | -18.46        | -24.52       |
| 2        | 0.16600         | 9.67                   | 34.14                | 19.42        | 43.81                 | 29.09        | 65.16        | 55.16        | -21.35        | -26.07       |
| 3        | 0.20600         | 9.70                   | 29.18                | 19.19        | 38.88                 | 28.89        | 63.37        | 53.37        | -24.49        | -24.48       |
| 4        | 0.31800         | 9.75                   | 29.48                | 22.11        | 39.23                 | 31.86        | 59.76        | 49.76        | -20.53        | -17.90       |
| <b>5</b> | <b>0.47400</b>  | <b>9.80</b>            | <b>35.06</b>         | <b>27.45</b> | <b>44.86</b>          | <b>37.25</b> | <b>56.44</b> | <b>46.44</b> | <b>-11.58</b> | <b>-9.19</b> |
| 6        | 0.61800         | 9.81                   | 24.47                | 17.88        | 34.28                 | 27.69        | 56.00        | 46.00        | -21.72        | -18.31       |

#### Remarks:

1. Q.P. and AV. are abbreviations of quasi-peak and average individually.
2. The emission levels of other frequencies were very low against the limit.
3. Margin value = Emission level – Limit value
4. Correction factor = Insertion loss + Cable loss
5. Emission Level = Correction Factor + Reading Value

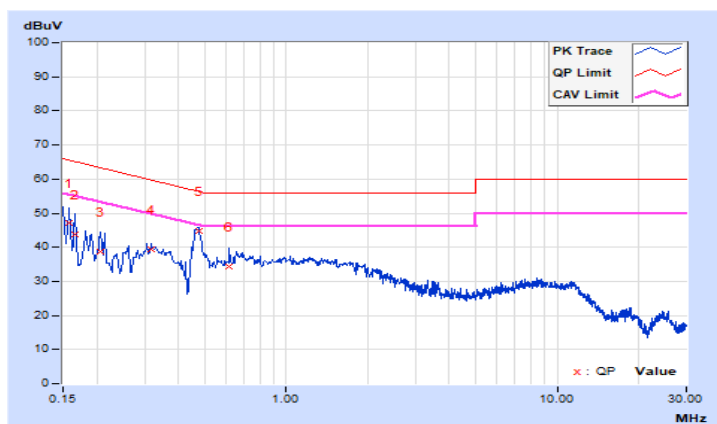

|                        |                  |   |                                       |
|------------------------|------------------|---|---------------------------------------|
| <b>RF Mode</b>         | 802.11be (EHT20) | <b>Channel</b>                                      | CH 6 : 2437 MHz                       |
| <b>Frequency Range</b> | 150kHz ~ 30MHz   | <b>Detector Function &amp; Resolution Bandwidth</b> | Quasi-Peak (QP) / Average (AV), 9 kHz |
| <b>Input Power</b>     | 120 Vac, 60 Hz   | <b>Environmental Conditions</b>                     | 25°C, 70% RH                          |
| <b>Tested By</b>       | Luis Lee         |   |                                       |

| Phase Of Power : Neutral (N) |                 |                        |                      |       |                       |       |              |       |             |        |
|------------------------------|-----------------|------------------------|----------------------|-------|-----------------------|-------|--------------|-------|-------------|--------|
| No                           | Frequency (MHz) | Correction Factor (dB) | Reading Value (dBuV) |       | Emission Level (dBuV) |       | Limit (dBuV) |       | Margin (dB) |        |
|                              |                 |                        | Q.P.                 | AV.   | Q.P.                  | AV.   | Q.P.         | AV.   | Q.P.        | AV.    |
| 1                            | 0.16200         | 9.67                   | 36.33                | 23.99 | 46.00                 | 33.66 | 65.36        | 55.36 | -19.36      | -21.70 |
| 2                            | 0.18519         | 9.69                   | 33.62                | 23.96 | 43.31                 | 33.65 | 64.25        | 54.25 | -20.94      | -20.60 |
| 3                            | 0.21400         | 9.70                   | 30.68                | 22.47 | 40.38                 | 32.17 | 63.05        | 53.05 | -22.67      | -20.88 |
| 4                            | 0.28982         | 9.73                   | 30.60                | 24.21 | 40.33                 | 33.94 | 60.53        | 50.53 | -20.20      | -16.59 |
| 5                            | 0.45400         | 9.78                   | 35.04                | 26.03 | 44.82                 | 35.81 | 56.80        | 46.80 | -11.98      | -10.99 |
| 6                            | 1.29400         | 9.85                   | 27.55                | 22.01 | 37.40                 | 31.86 | 56.00        | 46.00 | -18.60      | -14.14 |

**Remarks:**

1. Q.P. and AV. are abbreviations of quasi-peak and average individually.
2. The emission levels of other frequencies were very low against the limit.
3. Margin value = Emission level – Limit value
4. Correction factor = Insertion loss + Cable loss
5. Emission Level = Correction Factor + Reading Value

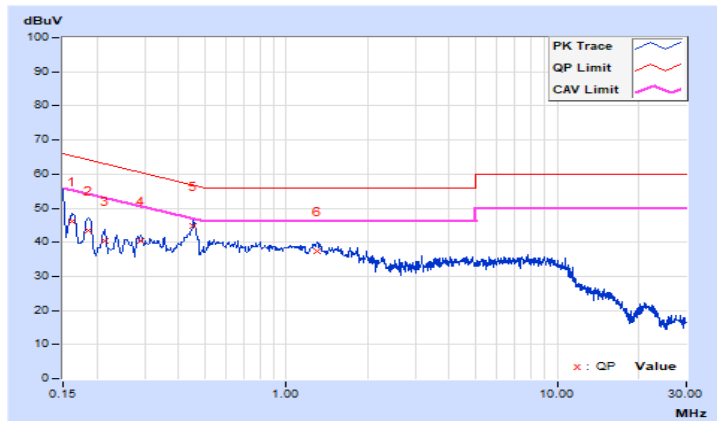

## 7.6 Unwanted Emissions below 1 GHz

### Test Mode A

|                        |                  |  |                  |
|------------------------|------------------|--|------------------|
| <b>RF Mode</b>         | 802.11be (EHT20) | <b>Channel</b>                           | CH 6 : 2437 MHz  |
| <b>Frequency Range</b> | 30 MHz ~ 1 GHz   | <b>Detector Function &amp; Bandwidth</b> | (QP) RB = 120kHz |
| <b>Input Power</b>     | 120 Vac, 60 Hz   | <b>Environmental Conditions</b>          | 23°C, 66% RH     |
| <b>Tested By</b>       | Luis Lee         |  |                  |

#### Antenna Polarity & Test Distance : Horizontal at 3 m

| No | Frequency (MHz) | Emission Level (dBuV/m) | Limit (dBuV/m) | Margin (dB) | Antenna Height (m) | Table Angle (Degree) | Raw Value (dBuV) | Correction Factor (dB/m) |
|----|-----------------|-------------------------|----------------|-------------|--------------------|----------------------|------------------|--------------------------|
| 1  | 38.43           | 30.7 QP                 | 40.0           | -9.3        | 1.01 H             | 157                  | 40.3             | -9.6                     |
| 2  | 91.86           | 25.9 QP                 | 43.5           | -17.6       | 1.01 H             | 101                  | 40.1             | -14.2                    |
| 3  | 257.74          | 36.3 QP                 | 46.0           | -9.7        | 1.50 H             | 324                  | 45.2             | -8.9                     |
| 4  | 284.45          | 35.0 QP                 | 46.0           | -11.0       | 1.50 H             | 251                  | 42.7             | -7.7                     |
| 5  | 305.54          | 33.6 QP                 | 46.0           | -12.4       | 1.50 H             | 167                  | 40.8             | -7.2                     |
| 6  | 464.39          | 27.6 QP                 | 46.0           | -18.4       | 1.01 H             | 283                  | 32.1             | -4.5                     |

#### Remarks:

1. Emission Level(dBuV/m) = Raw Value(dBuV) + Correction Factor(dB/m)
2. Correction Factor(dB/m) = Antenna Factor(dB/m) + Cable Factor(dB) – Pre-Amplifier Factor(dB)
3. Margin value = Emission Level – Limit value
4. The other emission levels were very low against the limit of frequency range 30 MHz ~ 1 GHz.
5. The emission levels were very low against the limit of frequency range 9 kHz ~ 30 MHz: the amplitude of spurious emissions attenuated more than 20 dB below the permissible value to be report.

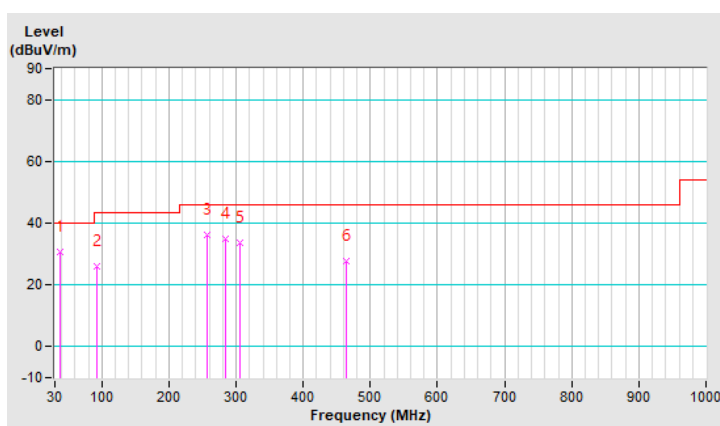

|                        |                  |  |                  |
|------------------------|------------------|--|------------------|
| <b>RF Mode</b>         | 802.11be (EHT20) | <b>Channel</b>                           | CH 6 : 2437 MHz  |
| <b>Frequency Range</b> | 30 MHz ~ 1 GHz   | <b>Detector Function &amp; Bandwidth</b> | (QP) RB = 120kHz |
| <b>Input Power</b>     | 120 Vac, 60 Hz   | <b>Environmental Conditions</b>          | 23°C, 66% RH     |
| <b>Tested By</b>       | Luis Lee         |  |                  |

**Antenna Polarity & Test Distance : Vertical at 3 m**

| No | Frequency (MHz) | Emission Level (dBUV/m) | Limit (dBUV/m) | Margin (dB) | Antenna Height (m) | Table Angle (Degree) | Raw Value (dBUV) | Correction Factor (dB/m) |
|----|-----------------|-------------------------|----------------|-------------|--------------------|----------------------|------------------|--------------------------|
| 1  | 91.86           | 26.2 QP                 | 43.5           | -17.3       | 1.00 V             | 114                  | 40.4             | -14.2                    |
| 2  | 207.13          | 18.2 QP                 | 43.5           | -25.3       | 1.49 V             | 0                    | 29.5             | -11.3                    |
| 3  | 284.45          | 35.1 QP                 | 46.0           | -10.9       | 1.49 V             | 261                  | 42.8             | -7.7                     |
| 4  | 346.30          | 25.4 QP                 | 46.0           | -20.6       | 1.49 V             | 89                   | 32.2             | -6.8                     |
| 5  | 502.35          | 28.3 QP                 | 46.0           | -17.7       | 1.00 V             | 351                  | 32.4             | -4.1                     |
| 6  | 519.22          | 26.0 QP                 | 46.0           | -20.0       | 1.00 V             | 4                    | 29.7             | -3.7                     |

**Remarks:**

1. Emission Level(dBUV/m) = Raw Value(dBUV) + Correction Factor(dB/m)
2. Correction Factor(dB/m) = Antenna Factor(dB/m) + Cable Factor(dB) – Pre-Amplifier Factor(dB)
3. Margin value = Emission Level – Limit value
4. The other emission levels were very low against the limit of frequency range 30 MHz ~ 1 GHz.
5. The emission levels were very low against the limit of frequency range 9 kHz ~ 30 MHz: the amplitude of spurious emissions attenuated more than 20 dB below the permissible value to be report.

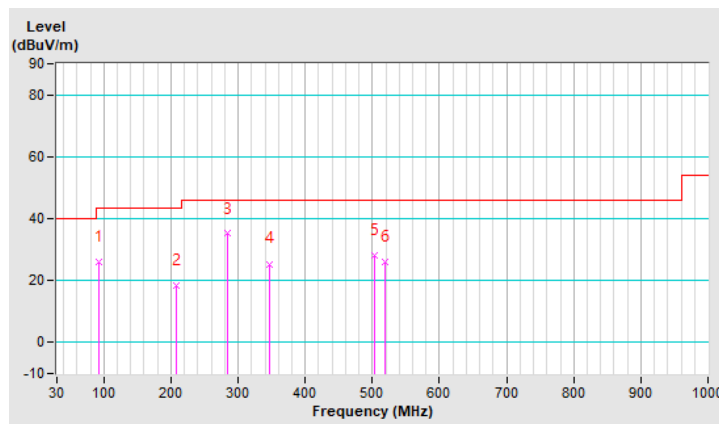

### Test Mode B

|                        |                  |  |                  |
|------------------------|------------------|--|------------------|
| <b>RF Mode</b>         | 802.11be (EHT20) | <b>Channel</b>                           | CH 6 : 2437 MHz  |
| <b>Frequency Range</b> | 30 MHz ~ 1 GHz   | <b>Detector Function &amp; Bandwidth</b> | (QP) RB = 120kHz |
| <b>Input Power</b>     | 120 Vac, 60 Hz   | <b>Environmental Conditions</b>          | 23°C, 66% RH     |
| <b>Tested By</b>       | Luis Lee         |  |                  |

#### Antenna Polarity & Test Distance : Horizontal at 3 m

| No | Frequency (MHz) | Emission Level (dBuV/m) | Limit (dBuV/m) | Margin (dB) | Antenna Height (m) | Table Angle (Degree) | Raw Value (dBuV) | Correction Factor (dB/m) |
|----|-----------------|-------------------------|----------------|-------------|--------------------|----------------------|------------------|--------------------------|
| 1  | 46.87           | 32.7 QP                 | 40.0           | -7.3        | 1.49 H             | 94                   | 41.6             | -8.9                     |
| 2  | 73.58           | 31.6 QP                 | 40.0           | -8.4        | 2.00 H             | 333                  | 43.0             | -11.4                    |
| 3  | 170.58          | 28.2 QP                 | 43.5           | -15.3       | 2.00 H             | 238                  | 37.2             | -9.0                     |
| 4  | 257.74          | 42.8 QP                 | 46.0           | -3.2        | 1.00 H             | 77                   | 51.7             | -8.9                     |
| 5  | 287.26          | 34.2 QP                 | 46.0           | -11.8       | 1.00 H             | 323                  | 41.9             | -7.7                     |
| 6  | 415.19          | 24.3 QP                 | 46.0           | -21.7       | 2.00 H             | 304                  | 29.9             | -5.6                     |

#### Remarks:

1. Emission Level(dBuV/m) = Raw Value(dBuV) + Correction Factor(dB/m)
2. Correction Factor(dB/m) = Antenna Factor(dB/m) + Cable Factor(dB) – Pre-Amplifier Factor(dB)
3. Margin value = Emission Level – Limit value
4. The other emission levels were very low against the limit of frequency range 30 MHz ~ 1 GHz.
5. The emission levels were very low against the limit of frequency range 9 kHz ~ 30 MHz: the amplitude of spurious emissions attenuated more than 20 dB below the permissible value to be report.

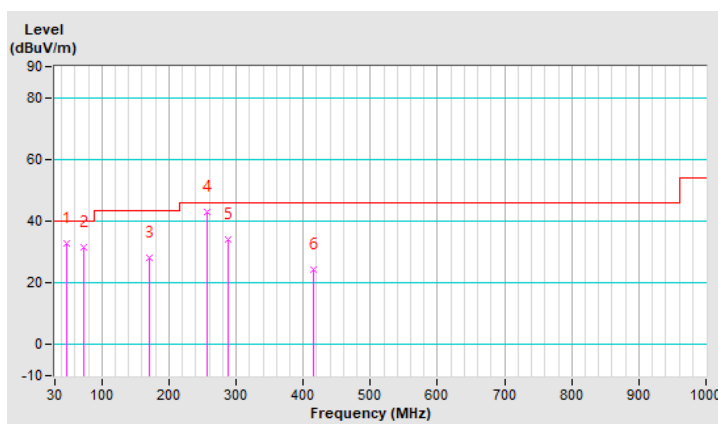

|                        |                  |  |                  |
|------------------------|------------------|--|------------------|
| <b>RF Mode</b>         | 802.11be (EHT20) | <b>Channel</b>                           | CH 6 : 2437 MHz  |
| <b>Frequency Range</b> | 30 MHz ~ 1 GHz   | <b>Detector Function &amp; Bandwidth</b> | (QP) RB = 120kHz |
| <b>Input Power</b>     | 120 Vac, 60 Hz   | <b>Environmental Conditions</b>          | 23°C, 66% RH     |
| <b>Tested By</b>       | Luis Lee         |  |                  |

| Antenna Polarity & Test Distance : Vertical at 3 m |                 |                         |                |             |                    |                      |                  |                          |
|--|-----------------|-------------------------|----------------|-------------|--------------------|----------------------|------------------|--------------------------|
| No   | Frequency (MHz) | Emission Level (dBuV/m) | Limit (dBuV/m) | Margin (dB) | Antenna Height (m) | Table Angle (Degree) | Raw Value (dBuV) | Correction Factor (dB/m) |
| 1  | 52.49           | 36.9 QP                 | 40.0           | -3.1        | 1.01 V             | 331                  | 45.7             | -8.8                     |
| 2  | 73.58           | 34.3 QP                 | 40.0           | -5.7        | 1.01 V             | 6                    | 45.7             | -11.4                    |
| 3  | 256.33          | 40.6 QP                 | 46.0           | -5.4        | 1.51 V             | 16                   | 49.6             | -9.0                     |
| 4  | 257.74          | 40.2 QP                 | 46.0           | -5.8        | 2.00 V             | 359                  | 49.1             | -8.9                     |
| 5  | 283.04          | 38.3 QP                 | 46.0           | -7.7        | 1.51 V             | 155                  | 46.1             | -7.8                     |
| 6  | 305.54          | 35.6 QP                 | 46.0           | -10.4       | 1.51 V             | 227                  | 42.8             | -7.2                     |

**Remarks:**

1. Emission Level(dBuV/m) = Raw Value(dBuV) + Correction Factor(dB/m)
2. Correction Factor(dB/m) = Antenna Factor(dB/m) + Cable Factor(dB) – Pre-Amplifier Factor(dB)
3. Margin value = Emission Level – Limit value
4. The other emission levels were very low against the limit of frequency range 30 MHz ~ 1 GHz.
5. The emission levels were very low against the limit of frequency range 9 kHz ~ 30 MHz: the amplitude of spurious emissions attenuated more than 20 dB below the permissible value to be report.

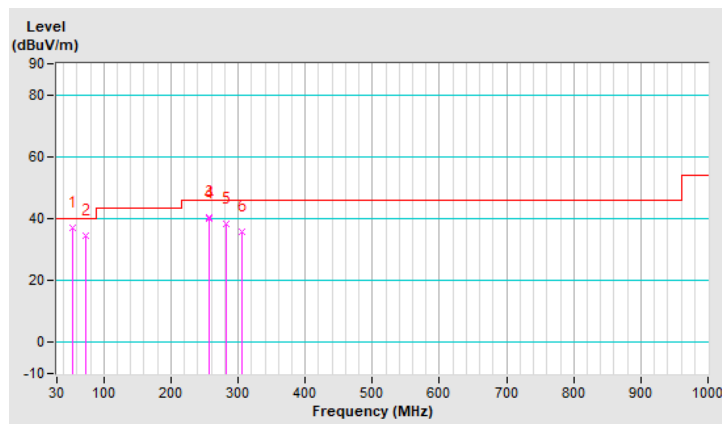



## 7.7 Unwanted Emissions above 1 GHz

|                        |                |  |  |
|------------------------|----------------|--|--|
| <b>RF Mode</b>         | 802.11b        | <b>Channel</b>                           | CH 1 : 2412 MHz  |
| <b>Frequency Range</b> | 1 GHz ~ 25 GHz | <b>Detector Function &amp; Bandwidth</b> | (PK) RB = 1 MHz, VB = 3 MHz<br>(AV) RB = 1 MHz, VB = 10 Hz |
| <b>Input Power</b>     | 120 Vac, 60 Hz | <b>Environmental Conditions</b>          | 23°C, 66% RH   |
| <b>Tested By</b>       | Titan Hsu      |  |  |

| Antenna Polarity & Test Distance : Horizontal at 3 m |                 |                         |                |             |                    |                      |                  |                          |
|--|-----------------|-------------------------|----------------|-------------|--------------------|----------------------|------------------|--------------------------|
| No   | Frequency (MHz) | Emission Level (dBuV/m) | Limit (dBuV/m) | Margin (dB) | Antenna Height (m) | Table Angle (Degree) | Raw Value (dBuV) | Correction Factor (dB/m) |
| 1  | 2390.00         | 59.6 PK                 | 74.0           | -14.4       | 2.87 H             | 346                  | 24.7             | 34.9                     |
| 2  | 2390.00         | 47.4 AV                 | 54.0           | -6.6        | 2.87 H             | 346                  | 12.5             | 34.9                     |
| 3  | *2412.00        | 121.2 PK                |                |             | 2.87 H             | 346                  | 86.3             | 34.9                     |
| 4  | *2412.00        | 118.7 AV                |                |             | 2.87 H             | 346                  | 83.8             | 34.9                     |
| 5  | 4824.00         | 51.5 PK                 | 74.0           | -22.5       | 1.29 H             | 317                  | 38.0             | 13.5                     |
| 6  | 4824.00         | 41.0 AV                 | 54.0           | -13.0       | 1.29 H             | 317                  | 27.5             | 13.5                     |
| Antenna Polarity & Test Distance : Vertical at 3 m   |                 |                         |                |             |                    |                      |                  |                          |
| No   | Frequency (MHz) | Emission Level (dBuV/m) | Limit (dBuV/m) | Margin (dB) | Antenna Height (m) | Table Angle (Degree) | Raw Value (dBuV) | Correction Factor (dB/m) |
| 1  | 2390.00         | 59.9 PK                 | 74.0           | -14.1       | 3.00 V             | 120                  | 25.0             | 34.9                     |
| 2  | 2390.00         | 47.8 AV                 | 54.0           | -6.2        | 3.00 V             | 120                  | 12.9             | 34.9                     |
| 3  | *2412.00        | 121.4 PK                |                |             | 3.00 V             | 120                  | 86.5             | 34.9                     |
| 4  | *2412.00        | 118.9 AV                |                |             | 3.00 V             | 120                  | 84.0             | 34.9                     |
| 5  | 4824.00         | 51.7 PK                 | 74.0           | -22.3       | 1.54 V             | 272                  | 38.2             | 13.5                     |
| 6  | 4824.00         | 42.6 AV                 | 54.0           | -11.4       | 1.54 V             | 272                  | 29.1             | 13.5                     |

### Remarks:

1. Emission Level(dBuV/m) = Raw Value(dBuV) + Correction Factor(dB/m)
2. Correction Factor(dB/m) = Antenna Factor(dB/m) + Cable Factor(dB) – Pre-Amplifier Factor(dB)
3. Margin value = Emission Level – Limit value
4. The other emission levels were very low against the limit.
5. " \* ": Fundamental frequency, the limit was restricted at the RF Output Power.

|                        |                |  |  |
|------------------------|----------------|--|--|
| <b>RF Mode</b>         | 802.11b        | <b>Channel</b>                           | CH 6 : 2437 MHz  |
| <b>Frequency Range</b> | 1 GHz ~ 25 GHz | <b>Detector Function &amp; Bandwidth</b> | (PK) RB = 1 MHz, VB = 3 MHz<br>(AV) RB = 1 MHz, VB = 10 Hz |
| <b>Input Power</b>     | 120 Vac, 60 Hz | <b>Environmental Conditions</b>          | 23°C, 66% RH   |
| <b>Tested By</b>       | Titan Hsu      |  |  |

| Antenna Polarity & Test Distance : Horizontal at 3 m |                 |                         |                |             |                    |                      |                  |                          |
|--|-----------------|-------------------------|----------------|-------------|--------------------|----------------------|------------------|--------------------------|
| No   | Frequency (MHz) | Emission Level (dBuV/m) | Limit (dBuV/m) | Margin (dB) | Antenna Height (m) | Table Angle (Degree) | Raw Value (dBuV) | Correction Factor (dB/m) |
| 1  | *2437.00        | 121.2 PK                |                |             | 2.92 H             | 346                  | 86.5             | 34.7                     |
| 2  | *2437.00        | 118.7 AV                |                |             | 2.92 H             | 346                  | 84.0             | 34.7                     |
| 3  | 2483.50         | 62.9 PK                 | 74.0           | -11.1       | 2.92 H             | 346                  | 28.2             | 34.7                     |
| 4  | 2483.50         | 52.1 AV                 | 54.0           | -1.9        | 2.92 H             | 346                  | 17.4             | 34.7                     |
| 5  | 4874.00         | 51.1 PK                 | 74.0           | -22.9       | 1.22 H             | 320                  | 37.8             | 13.3                     |
| 6  | 4874.00         | 39.8 AV                 | 54.0           | -14.2       | 1.22 H             | 320                  | 26.5             | 13.3                     |
| Antenna Polarity & Test Distance : Vertical at 3 m   |                 |                         |                |             |                    |                      |                  |                          |
| No   | Frequency (MHz) | Emission Level (dBuV/m) | Limit (dBuV/m) | Margin (dB) | Antenna Height (m) | Table Angle (Degree) | Raw Value (dBuV) | Correction Factor (dB/m) |
| 1  | *2437.00        | 121.6 PK                |                |             | 3.16 V             | 119                  | 86.9             | 34.7                     |
| 2  | *2437.00        | 119.2 AV                |                |             | 3.16 V             | 119                  | 84.5             | 34.7                     |
| 3  | 2483.50         | 64.8 PK                 | 74.0           | -9.2        | 3.16 V             | 119                  | 30.1             | 34.7                     |
| 4  | 2483.50         | 53.3 AV                 | 54.0           | -0.7        | 3.16 V             | 119                  | 18.6             | 34.7                     |
| 5  | 4874.00         | 51.3 PK                 | 74.0           | -22.7       | 1.59 V             | 210                  | 38.0             | 13.3                     |
| 6  | 4874.00         | 40.8 AV                 | 54.0           | -13.2       | 1.59 V             | 210                  | 27.5             | 13.3                     |

**Remarks:**

1. Emission Level(dBuV/m) = Raw Value(dBuV) + Correction Factor(dB/m)
2. Correction Factor(dB/m) = Antenna Factor(dB/m) + Cable Factor(dB) – Pre-Amplifier Factor(dB)
3. Margin value = Emission Level – Limit value
4. The other emission levels were very low against the limit.
5. " \* " : Fundamental frequency, the limit was restricted at the RF Output Power.



|                        |                |  |  |
|------------------------|----------------|--|--|
| <b>RF Mode</b>         | 802.11b        | <b>Channel</b>                           | CH 11 : 2462 MHz   |
| <b>Frequency Range</b> | 1 GHz ~ 25 GHz | <b>Detector Function &amp; Bandwidth</b> | (PK) RB = 1 MHz, VB = 3 MHz<br>(AV) RB = 1 MHz, VB = 10 Hz |
| <b>Input Power</b>     | 120 Vac, 60 Hz | <b>Environmental Conditions</b>          | 23°C, 66% RH   |
| <b>Tested By</b>       | Titan Hsu      |  |  |

**Antenna Polarity & Test Distance : Horizontal at 3 m**

| No | Frequency (MHz) | Emission Level (dBuV/m) | Limit (dBuV/m) | Margin (dB) | Antenna Height (m) | Table Angle (Degree) | Raw Value (dBuV) | Correction Factor (dB/m) |
|----|-----------------|-------------------------|----------------|-------------|--------------------|----------------------|------------------|--------------------------|
| 1  | *2462.00        | 120.0 PK                |                |             | 2.82 H             | 341                  | 85.3             | 34.7                     |
| 2  | *2462.00        | 117.5 AV                |                |             | 2.82 H             | 341                  | 82.8             | 34.7                     |
| 3  | 2483.50         | 64.7 PK                 | 74.0           | -9.3        | 2.82 H             | 341                  | 30.0             | 34.7                     |
| 4  | 2483.50         | 52.7 AV                 | 54.0           | -1.3        | 2.82 H             | 341                  | 18.0             | 34.7                     |
| 5  | 4924.00         | 50.8 PK                 | 74.0           | -23.2       | 1.15 H             | 309                  | 37.7             | 13.1                     |
| 6  | 4924.00         | 37.3 AV                 | 54.0           | -16.7       | 1.15 H             | 309                  | 24.2             | 13.1                     |

**Antenna Polarity & Test Distance : Vertical at 3 m**

| No       | Frequency (MHz) | Emission Level (dBuV/m) | Limit (dBuV/m) | Margin (dB) | Antenna Height (m) | Table Angle (Degree) | Raw Value (dBuV) | Correction Factor (dB/m) |
|----------|-----------------|-------------------------|----------------|-------------|--------------------|----------------------|------------------|--------------------------|
| 1        | *2462.00        | 121.3 PK                |                |             | 3.17 V             | 201                  | 86.6             | 34.7                     |
| 2        | *2462.00        | 119.0 AV                |                |             | 3.17 V             | 201                  | 84.3             | 34.7                     |
| 3        | 2483.50         | 65.1 PK                 | 74.0           | -8.9        | 3.17 V             | 201                  | 30.4             | 34.7                     |
| <b>4</b> | <b>2483.50</b>  | <b>53.9 AV</b>          | <b>54.0</b>    | <b>-0.1</b> | <b>3.17 V</b>      | <b>201</b>           | <b>19.2</b>      | <b>34.7</b>              |
| 5        | 4924.00         | 51.1 PK                 | 74.0           | -22.9       | 1.55 V             | 211                  | 38.0             | 13.1                     |
| 6        | 4924.00         | 37.8 AV                 | 54.0           | -16.2       | 1.55 V             | 211                  | 24.7             | 13.1                     |

**Remarks:**

1. Emission Level(dBuV/m) = Raw Value(dBuV) + Correction Factor(dB/m)
2. Correction Factor(dB/m) = Antenna Factor(dB/m) + Cable Factor(dB) – Pre-Amplifier Factor(dB)
3. Margin value = Emission Level – Limit value
4. The other emission levels were very low against the limit.
5. " \* " : Fundamental frequency, the limit was restricted at the RF Output Power.



|                        |                |  |  |
|------------------------|----------------|--|--|
| <b>RF Mode</b>         | 802.11g        | <b>Channel</b>                           | CH 1 : 2412 MHz  |
| <b>Frequency Range</b> | 1 GHz ~ 25 GHz | <b>Detector Function &amp; Bandwidth</b> | (PK) RB = 1 MHz, VB = 3 MHz<br>(AV) RB = 1 MHz, VB = 10 Hz |
| <b>Input Power</b>     | 120 Vac, 60 Hz | <b>Environmental Conditions</b>          | 23°C, 66% RH   |
| <b>Tested By</b>       | Titan Hsu      |  |  |

**Antenna Polarity & Test Distance : Horizontal at 3 m**

| No | Frequency (MHz) | Emission Level (dBuV/m) | Limit (dBuV/m) | Margin (dB) | Antenna Height (m) | Table Angle (Degree) | Raw Value (dBuV) | Correction Factor (dB/m) |
|----|-----------------|-------------------------|----------------|-------------|--------------------|----------------------|------------------|--------------------------|
| 1  | 2390.00         | 62.2 PK                 | 74.0           | -11.8       | 1.96 H             | 153                  | 27.3             | 34.9                     |
| 2  | 2390.00         | 48.9 AV                 | 54.0           | -5.1        | 1.96 H             | 153                  | 14.0             | 34.9                     |
| 3  | *2412.00        | 122.9 PK                |                |             | 1.96 H             | 153                  | 88.0             | 34.9                     |
| 4  | *2412.00        | 113.3 AV                |                |             | 1.96 H             | 153                  | 78.4             | 34.9                     |
| 5  | 4824.00         | 51.0 PK                 | 74.0           | -23.0       | 1.15 H             | 308                  | 37.5             | 13.5                     |
| 6  | 4824.00         | 38.0 AV                 | 54.0           | -16.0       | 1.15 H             | 308                  | 24.5             | 13.5                     |

**Antenna Polarity & Test Distance : Vertical at 3 m**

| No | Frequency (MHz) | Emission Level (dBuV/m) | Limit (dBuV/m) | Margin (dB) | Antenna Height (m) | Table Angle (Degree) | Raw Value (dBuV) | Correction Factor (dB/m) |
|----|-----------------|-------------------------|----------------|-------------|--------------------|----------------------|------------------|--------------------------|
| 1  | 2390.00         | 71.2 PK                 | 74.0           | -2.8        | 2.00 V             | 54                   | 36.3             | 34.9                     |
| 2  | 2390.00         | 53.4 AV                 | 54.0           | -0.6        | 2.00 V             | 54                   | 18.5             | 34.9                     |
| 3  | *2412.00        | 123.4 PK                |                |             | 2.00 V             | 54                   | 88.5             | 34.9                     |
| 4  | *2412.00        | 114.0 AV                |                |             | 2.00 V             | 54                   | 79.1             | 34.9                     |
| 5  | 4824.00         | 51.3 PK                 | 74.0           | -22.7       | 1.55 V             | 275                  | 37.8             | 13.5                     |
| 6  | 4824.00         | 38.5 AV                 | 54.0           | -15.5       | 1.55 V             | 275                  | 25.0             | 13.5                     |

**Remarks:**

1. Emission Level(dBuV/m) = Raw Value(dBuV) + Correction Factor(dB/m)
2. Correction Factor(dB/m) = Antenna Factor(dB/m) + Cable Factor(dB) – Pre-Amplifier Factor(dB)
3. Margin value = Emission Level – Limit value
4. The other emission levels were very low against the limit.
5. " \* ": Fundamental frequency, the limit was restricted at the RF Output Power.



|                        |                |  |  |
|------------------------|----------------|--|--|
| <b>RF Mode</b>         | 802.11g        | <b>Channel</b>                           | CH 6 : 2437 MHz  |
| <b>Frequency Range</b> | 1 GHz ~ 25 GHz | <b>Detector Function &amp; Bandwidth</b> | (PK) RB = 1 MHz, VB = 3 MHz<br>(AV) RB = 1 MHz, VB = 10 Hz |
| <b>Input Power</b>     | 120 Vac, 60 Hz | <b>Environmental Conditions</b>          | 23°C, 66% RH   |
| <b>Tested By</b>       | Titan Hsu      |  |  |

**Antenna Polarity & Test Distance : Horizontal at 3 m**

| No | Frequency (MHz) | Emission Level (dBuV/m) | Limit (dBuV/m) | Margin (dB) | Antenna Height (m) | Table Angle (Degree) | Raw Value (dBuV) | Correction Factor (dB/m) |
|----|-----------------|-------------------------|----------------|-------------|--------------------|----------------------|------------------|--------------------------|
| 1  | *2437.00        | 122.0 PK                |                |             | 1.88 H             | 345                  | 87.3             | 34.7                     |
| 2  | *2437.00        | 112.5 AV                |                |             | 1.88 H             | 345                  | 77.8             | 34.7                     |
| 3  | 2483.50         | 67.0 PK                 | 74.0           | -7.0        | 1.88 H             | 345                  | 32.3             | 34.7                     |
| 4  | 2483.50         | 52.4 AV                 | 54.0           | -1.6        | 1.88 H             | 345                  | 17.7             | 34.7                     |
| 5  | 4874.00         | 50.8 PK                 | 74.0           | -23.2       | 1.19 H             | 311                  | 37.5             | 13.3                     |
| 6  | 4874.00         | 37.9 AV                 | 54.0           | -16.1       | 1.19 H             | 311                  | 24.6             | 13.3                     |

**Antenna Polarity & Test Distance : Vertical at 3 m**

| No | Frequency (MHz) | Emission Level (dBuV/m) | Limit (dBuV/m) | Margin (dB) | Antenna Height (m) | Table Angle (Degree) | Raw Value (dBuV) | Correction Factor (dB/m) |
|----|-----------------|-------------------------|----------------|-------------|--------------------|----------------------|------------------|--------------------------|
| 1  | *2437.00        | 123.0 PK                |                |             | 2.29 V             | 54                   | 88.3             | 34.7                     |
| 2  | *2437.00        | 113.7 AV                |                |             | 2.29 V             | 54                   | 79.0             | 34.7                     |
| 3  | 2483.50         | 72.9 PK                 | 74.0           | -1.1        | 2.29 V             | 54                   | 38.2             | 34.7                     |
| 4  | 2483.50         | 53.7 AV                 | 54.0           | -0.3        | 2.29 V             | 54                   | 19.0             | 34.7                     |
| 5  | 4874.00         | 50.9 PK                 | 74.0           | -23.1       | 1.59 V             | 271                  | 37.6             | 13.3                     |
| 6  | 4874.00         | 38.1 AV                 | 54.0           | -15.9       | 1.59 V             | 271                  | 24.8             | 13.3                     |

**Remarks:**

1. Emission Level(dBuV/m) = Raw Value(dBuV) + Correction Factor(dB/m)
2. Correction Factor(dB/m) = Antenna Factor(dB/m) + Cable Factor(dB) – Pre-Amplifier Factor(dB)
3. Margin value = Emission Level – Limit value
4. The other emission levels were very low against the limit.
5. " \* ": Fundamental frequency, the limit was restricted at the RF Output Power.



|                        |                |  |  |
|------------------------|----------------|--|--|
| <b>RF Mode</b>         | 802.11g        | <b>Channel</b>                           | CH 11 : 2462 MHz   |
| <b>Frequency Range</b> | 1 GHz ~ 25 GHz | <b>Detector Function &amp; Bandwidth</b> | (PK) RB = 1 MHz, VB = 3 MHz<br>(AV) RB = 1 MHz, VB = 10 Hz |
| <b>Input Power</b>     | 120 Vac, 60 Hz | <b>Environmental Conditions</b>          | 23°C, 66% RH   |
| <b>Tested By</b>       | Titan Hsu      |  |  |

**Antenna Polarity & Test Distance : Horizontal at 3 m**

| No | Frequency (MHz) | Emission Level (dBuV/m) | Limit (dBuV/m) | Margin (dB) | Antenna Height (m) | Table Angle (Degree) | Raw Value (dBuV) | Correction Factor (dB/m) |
|----|-----------------|-------------------------|----------------|-------------|--------------------|----------------------|------------------|--------------------------|
| 1  | *2462.00        | 117.9 PK                |                |             | 1.85 H             | 319                  | 83.2             | 34.7                     |
| 2  | *2462.00        | 108.7 AV                |                |             | 1.85 H             | 319                  | 74.0             | 34.7                     |
| 3  | 2483.50         | 64.6 PK                 | 74.0           | -9.4        | 1.85 H             | 319                  | 29.9             | 34.7                     |
| 4  | 2483.50         | 52.3 AV                 | 54.0           | -1.7        | 1.85 H             | 319                  | 17.6             | 34.7                     |
| 5  | 4924.00         | 50.4 PK                 | 74.0           | -23.6       | 1.19 H             | 316                  | 37.3             | 13.1                     |
| 6  | 4924.00         | 37.3 AV                 | 54.0           | -16.7       | 1.19 H             | 316                  | 24.2             | 13.1                     |

**Antenna Polarity & Test Distance : Vertical at 3 m**

| No | Frequency (MHz) | Emission Level (dBuV/m) | Limit (dBuV/m) | Margin (dB) | Antenna Height (m) | Table Angle (Degree) | Raw Value (dBuV) | Correction Factor (dB/m) |
|----|-----------------|-------------------------|----------------|-------------|--------------------|----------------------|------------------|--------------------------|
| 1  | *2462.00        | 119.6 PK                |                |             | 2.28 V             | 56                   | 84.9             | 34.7                     |
| 2  | *2462.00        | 110.0 AV                |                |             | 2.28 V             | 56                   | 75.3             | 34.7                     |
| 3  | 2483.50         | 67.2 PK                 | 74.0           | -6.8        | 2.28 V             | 56                   | 32.5             | 34.7                     |
| 4  | 2483.50         | 53.7 AV                 | 54.0           | -0.3        | 2.28 V             | 56                   | 19.0             | 34.7                     |
| 5  | 4924.00         | 50.6 PK                 | 74.0           | -23.4       | 1.58 V             | 205                  | 37.5             | 13.1                     |
| 6  | 4924.00         | 37.6 AV                 | 54.0           | -16.4       | 1.58 V             | 205                  | 24.5             | 13.1                     |

**Remarks:**

1. Emission Level(dBuV/m) = Raw Value(dBuV) + Correction Factor(dB/m)
2. Correction Factor(dB/m) = Antenna Factor(dB/m) + Cable Factor(dB) – Pre-Amplifier Factor(dB)
3. Margin value = Emission Level – Limit value
4. The other emission levels were very low against the limit.
5. " \* " : Fundamental frequency, the limit was restricted at the RF Output Power.



|                        |                  |  |  |
|------------------------|------------------|--|--|
| <b>RF Mode</b>         | 802.11be (EHT20) | <b>Channel</b>                           | CH 1 : 2412 MHz  |
| <b>Frequency Range</b> | 1 GHz ~ 25 GHz   | <b>Detector Function &amp; Bandwidth</b> | (PK) RB = 1 MHz, VB = 3 MHz<br>(AV) RB = 1 MHz, VB = 10 Hz |
| <b>Input Power</b>     | 120 Vac, 60 Hz   | <b>Environmental Conditions</b>          | 23°C, 66% RH   |
| <b>Tested By</b>       | Titan Hsu        |  |  |

**Antenna Polarity & Test Distance : Horizontal at 3 m**

| No | Frequency (MHz) | Emission Level (dBuV/m) | Limit (dBuV/m) | Margin (dB) | Antenna Height (m) | Table Angle (Degree) | Raw Value (dBuV) | Correction Factor (dB/m) |
|----|-----------------|-------------------------|----------------|-------------|--------------------|----------------------|------------------|--------------------------|
| 1  | 2390.00         | 65.6 PK                 | 74.0           | -8.4        | 1.85 H             | 308                  | 30.7             | 34.9                     |
| 2  | 2390.00         | 52.1 AV                 | 54.0           | -1.9        | 1.85 H             | 308                  | 17.2             | 34.9                     |
| 3  | *2412.00        | 124.9 PK                |                |             | 1.85 H             | 308                  | 90.0             | 34.9                     |
| 4  | *2412.00        | 112.7 AV                |                |             | 1.85 H             | 308                  | 77.8             | 34.9                     |
| 5  | 4824.00         | 51.0 PK                 | 74.0           | -23.0       | 1.13 H             | 305                  | 37.5             | 13.5                     |
| 6  | 4824.00         | 38.0 AV                 | 54.0           | -16.0       | 1.13 H             | 305                  | 24.5             | 13.5                     |

**Antenna Polarity & Test Distance : Vertical at 3 m**

| No | Frequency (MHz) | Emission Level (dBuV/m) | Limit (dBuV/m) | Margin (dB) | Antenna Height (m) | Table Angle (Degree) | Raw Value (dBuV) | Correction Factor (dB/m) |
|----|-----------------|-------------------------|----------------|-------------|--------------------|----------------------|------------------|--------------------------|
| 1  | 2390.00         | 65.8 PK                 | 74.0           | -8.2        | 2.35 V             | 44                   | 30.9             | 34.9                     |
| 2  | 2390.00         | 53.4 AV                 | 54.0           | -0.6        | 2.35 V             | 44                   | 18.5             | 34.9                     |
| 3  | *2412.00        | 126.2 PK                |                |             | 2.35 V             | 44                   | 91.3             | 34.9                     |
| 4  | *2412.00        | 113.8 AV                |                |             | 2.35 V             | 44                   | 78.9             | 34.9                     |
| 5  | 4824.00         | 51.1 PK                 | 74.0           | -22.9       | 1.59 V             | 278                  | 37.6             | 13.5                     |
| 6  | 4824.00         | 38.1 AV                 | 54.0           | -15.9       | 1.59 V             | 278                  | 24.6             | 13.5                     |

**Remarks:**

1. Emission Level(dBuV/m) = Raw Value(dBuV) + Correction Factor(dB/m)
2. Correction Factor(dB/m) = Antenna Factor(dB/m) + Cable Factor(dB) – Pre-Amplifier Factor(dB)
3. Margin value = Emission Level – Limit value
4. The other emission levels were very low against the limit.
5. " \* ": Fundamental frequency, the limit was restricted at the RF Output Power.



|                        |                  |  |  |
|------------------------|------------------|--|--|
| <b>RF Mode</b>         | 802.11be (EHT20) | <b>Channel</b>                           | CH 6 : 2437 MHz  |
| <b>Frequency Range</b> | 1 GHz ~ 25 GHz   | <b>Detector Function &amp; Bandwidth</b> | (PK) RB = 1 MHz, VB = 3 MHz<br>(AV) RB = 1 MHz, VB = 10 Hz |
| <b>Input Power</b>     | 120 Vac, 60 Hz   | <b>Environmental Conditions</b>          | 23°C, 66% RH   |
| <b>Tested By</b>       | Titan Hsu        |  |  |

**Antenna Polarity & Test Distance : Horizontal at 3 m**

| No | Frequency (MHz) | Emission Level (dBuV/m) | Limit (dBuV/m) | Margin (dB) | Antenna Height (m) | Table Angle (Degree) | Raw Value (dBuV) | Correction Factor (dB/m) |
|----|-----------------|-------------------------|----------------|-------------|--------------------|----------------------|------------------|--------------------------|
| 1  | *2437.00        | 121.7 PK                |                |             | 2.09 H             | 108                  | 87.0             | 34.7                     |
| 2  | *2437.00        | 110.2 AV                |                |             | 2.09 H             | 108                  | 75.5             | 34.7                     |
| 3  | 2483.50         | 66.0 PK                 | 74.0           | -8.0        | 2.09 H             | 108                  | 31.3             | 34.7                     |
| 4  | 2483.50         | 52.4 AV                 | 54.0           | -1.6        | 2.09 H             | 108                  | 17.7             | 34.7                     |
| 5  | 4874.00         | 50.6 PK                 | 74.0           | -23.4       | 1.18 H             | 321                  | 37.3             | 13.3                     |
| 6  | 4874.00         | 37.6 AV                 | 54.0           | -16.4       | 1.18 H             | 321                  | 24.3             | 13.3                     |

**Antenna Polarity & Test Distance : Vertical at 3 m**

| No | Frequency (MHz) | Emission Level (dBuV/m) | Limit (dBuV/m) | Margin (dB) | Antenna Height (m) | Table Angle (Degree) | Raw Value (dBuV) | Correction Factor (dB/m) |
|----|-----------------|-------------------------|----------------|-------------|--------------------|----------------------|------------------|--------------------------|
| 1  | *2437.00        | 122.9 PK                |                |             | 2.13 V             | 48                   | 88.2             | 34.7                     |
| 2  | *2437.00        | 111.5 AV                |                |             | 2.13 V             | 48                   | 76.8             | 34.7                     |
| 3  | 2483.50         | 70.5 PK                 | 74.0           | -3.5        | 2.13 V             | 48                   | 35.8             | 34.7                     |
| 4  | 2483.50         | 53.8 AV                 | 54.0           | -0.2        | 2.13 V             | 48                   | 19.1             | 34.7                     |
| 5  | 4874.00         | 50.8 PK                 | 74.0           | -23.2       | 1.52 V             | 282                  | 37.5             | 13.3                     |
| 6  | 4874.00         | 37.8 AV                 | 54.0           | -16.2       | 1.52 V             | 282                  | 24.5             | 13.3                     |

**Remarks:**

1. Emission Level(dBuV/m) = Raw Value(dBuV) + Correction Factor(dB/m)
2. Correction Factor(dB/m) = Antenna Factor(dB/m) + Cable Factor(dB) – Pre-Amplifier Factor(dB)
3. Margin value = Emission Level – Limit value
4. The other emission levels were very low against the limit.
5. " \* " : Fundamental frequency, the limit was restricted at the RF Output Power.





|                        |                  |  |  |
|------------------------|------------------|--|--|
| <b>RF Mode</b>         | 802.11be (EHT20) | <b>Channel</b>                           | CH 11 : 2462 MHz   |
| <b>Frequency Range</b> | 1 GHz ~ 25 GHz   | <b>Detector Function &amp; Bandwidth</b> | (PK) RB = 1 MHz, VB = 3 MHz<br>(AV) RB = 1 MHz, VB = 10 Hz |
| <b>Input Power</b>     | 120 Vac, 60 Hz   | <b>Environmental Conditions</b>          | 23°C, 66% RH   |
| <b>Tested By</b>       | Titan Hsu        |  |  |

**Antenna Polarity & Test Distance : Horizontal at 3 m**

| No | Frequency (MHz) | Emission Level (dBuV/m) | Limit (dBuV/m) | Margin (dB) | Antenna Height (m) | Table Angle (Degree) | Raw Value (dBuV) | Correction Factor (dB/m) |
|----|-----------------|-------------------------|----------------|-------------|--------------------|----------------------|------------------|--------------------------|
| 1  | *2462.00        | 119.7 PK                |                |             | 2.41 H             | 113                  | 85.0             | 34.7                     |
| 2  | *2462.00        | 107.9 AV                |                |             | 2.41 H             | 113                  | 73.2             | 34.7                     |
| 3  | 2483.50         | 65.7 PK                 | 74.0           | -8.3        | 2.41 H             | 113                  | 31.0             | 34.7                     |
| 4  | 2483.50         | 52.3 AV                 | 54.0           | -1.7        | 2.41 H             | 113                  | 17.6             | 34.7                     |
| 5  | 4924.00         | 50.3 PK                 | 74.0           | -23.7       | 1.08 H             | 315                  | 37.2             | 13.1                     |
| 6  | 4924.00         | 37.3 AV                 | 54.0           | -16.7       | 1.08 H             | 315                  | 24.2             | 13.1                     |

**Antenna Polarity & Test Distance : Vertical at 3 m**

| No | Frequency (MHz) | Emission Level (dBuV/m) | Limit (dBuV/m) | Margin (dB) | Antenna Height (m) | Table Angle (Degree) | Raw Value (dBuV) | Correction Factor (dB/m) |
|----|-----------------|-------------------------|----------------|-------------|--------------------|----------------------|------------------|--------------------------|
| 1  | *2462.00        | 121.3 PK                |                |             | 2.33 V             | 42                   | 86.6             | 34.7                     |
| 2  | *2462.00        | 109.5 AV                |                |             | 2.33 V             | 42                   | 74.8             | 34.7                     |
| 3  | 2483.50         | 67.8 PK                 | 74.0           | -6.2        | 2.33 V             | 42                   | 33.1             | 34.7                     |
| 4  | 2483.50         | 53.7 AV                 | 54.0           | -0.3        | 2.33 V             | 42                   | 19.0             | 34.7                     |
| 5  | 4924.00         | 50.6 PK                 | 74.0           | -23.4       | 1.52 V             | 275                  | 37.5             | 13.1                     |
| 6  | 4924.00         | 37.6 AV                 | 54.0           | -16.4       | 1.52 V             | 275                  | 24.5             | 13.1                     |

**Remarks:**

1. Emission Level(dBuV/m) = Raw Value(dBuV) + Correction Factor(dB/m)
2. Correction Factor(dB/m) = Antenna Factor(dB/m) + Cable Factor(dB) – Pre-Amplifier Factor(dB)
3. Margin value = Emission Level – Limit value
4. The other emission levels were very low against the limit.
5. " \* " : Fundamental frequency, the limit was restricted at the RF Output Power.



|                        |                  |  |  |
|------------------------|------------------|--|--|
| <b>RF Mode</b>         | 802.11be (EHT40) | <b>Channel</b>                           | CH 3 : 2422 MHz  |
| <b>Frequency Range</b> | 1 GHz ~ 25 GHz   | <b>Detector Function &amp; Bandwidth</b> | (PK) RB = 1 MHz, VB = 3 MHz<br>(AV) RB = 1 MHz, VB = 10 Hz |
| <b>Input Power</b>     | 120 Vac, 60 Hz   | <b>Environmental Conditions</b>          | 23°C, 66% RH   |
| <b>Tested By</b>       | Titan Hsu        |  |  |

**Antenna Polarity & Test Distance : Horizontal at 3 m**

| No | Frequency (MHz) | Emission Level (dBuV/m) | Limit (dBuV/m) | Margin (dB) | Antenna Height (m) | Table Angle (Degree) | Raw Value (dBuV) | Correction Factor (dB/m) |
|----|-----------------|-------------------------|----------------|-------------|--------------------|----------------------|------------------|--------------------------|
| 1  | 2390.00         | 59.9 PK                 | 74.0           | -14.1       | 2.40 H             | 350                  | 25.0             | 34.9                     |
| 2  | 2390.00         | 47.4 AV                 | 54.0           | -6.6        | 2.40 H             | 350                  | 12.5             | 34.9                     |
| 3  | *2422.00        | 119.9 PK                |                |             | 2.40 H             | 350                  | 85.0             | 34.9                     |
| 4  | *2422.00        | 107.9 AV                |                |             | 2.40 H             | 350                  | 73.0             | 34.9                     |
| 5  | 2483.50         | 64.7 PK                 | 74.0           | -9.3        | 2.40 H             | 350                  | 30.0             | 34.7                     |
| 6  | 2483.50         | 51.9 AV                 | 54.0           | -2.1        | 2.40 H             | 350                  | 17.2             | 34.7                     |
| 7  | 4844.00         | 50.6 PK                 | 74.0           | -23.4       | 1.15 H             | 302                  | 37.2             | 13.4                     |
| 8  | 4844.00         | 37.5 AV                 | 54.0           | -16.5       | 1.15 H             | 302                  | 24.1             | 13.4                     |

**Antenna Polarity & Test Distance : Vertical at 3 m**

| No | Frequency (MHz) | Emission Level (dBuV/m) | Limit (dBuV/m) | Margin (dB) | Antenna Height (m) | Table Angle (Degree) | Raw Value (dBuV) | Correction Factor (dB/m) |
|----|-----------------|-------------------------|----------------|-------------|--------------------|----------------------|------------------|--------------------------|
| 1  | 2390.00         | 60.2 PK                 | 74.0           | -13.8       | 2.46 V             | 42                   | 25.3             | 34.9                     |
| 2  | 2390.00         | 48.3 AV                 | 54.0           | -5.7        | 2.46 V             | 42                   | 13.4             | 34.9                     |
| 3  | *2422.00        | 121.7 PK                |                |             | 2.46 V             | 42                   | 86.8             | 34.9                     |
| 4  | *2422.00        | 109.3 AV                |                |             | 2.46 V             | 42                   | 74.4             | 34.9                     |
| 5  | 2483.50         | 66.6 PK                 | 74.0           | -7.4        | 2.46 V             | 42                   | 31.9             | 34.7                     |
| 6  | 2483.50         | 53.8 AV                 | 54.0           | -0.2        | 2.46 V             | 42                   | 19.1             | 34.7                     |
| 7  | 4844.00         | 50.9 PK                 | 74.0           | -23.1       | 1.59 V             | 277                  | 37.5             | 13.4                     |
| 8  | 4844.00         | 37.8 AV                 | 54.0           | -16.2       | 1.59 V             | 277                  | 24.4             | 13.4                     |

**Remarks:**

1. Emission Level(dBuV/m) = Raw Value(dBuV) + Correction Factor(dB/m)
2. Correction Factor(dB/m) = Antenna Factor(dB/m) + Cable Factor(dB) – Pre-Amplifier Factor(dB)
3. Margin value = Emission Level – Limit value
4. The other emission levels were very low against the limit.
5. " \* " : Fundamental frequency, the limit was restricted at the RF Output Power.



|                        |                  |  |  |
|------------------------|------------------|--|--|
| <b>RF Mode</b>         | 802.11be (EHT40) | <b>Channel</b>                           | CH 6 : 2437 MHz  |
| <b>Frequency Range</b> | 1 GHz ~ 25 GHz   | <b>Detector Function &amp; Bandwidth</b> | (PK) RB = 1 MHz, VB = 3 MHz<br>(AV) RB = 1 MHz, VB = 10 Hz |
| <b>Input Power</b>     | 120 Vac, 60 Hz   | <b>Environmental Conditions</b>          | 23°C, 66% RH   |
| <b>Tested By</b>       | Titan Hsu        |  |  |

**Antenna Polarity & Test Distance : Horizontal at 3 m**

| No | Frequency (MHz) | Emission Level (dBuV/m) | Limit (dBuV/m) | Margin (dB) | Antenna Height (m) | Table Angle (Degree) | Raw Value (dBuV) | Correction Factor (dB/m) |
|----|-----------------|-------------------------|----------------|-------------|--------------------|----------------------|------------------|--------------------------|
| 1  | *2437.00        | 117.7 PK                |                |             | 2.36 H             | 123                  | 83.0             | 34.7                     |
| 2  | *2437.00        | 104.9 AV                |                |             | 2.36 H             | 123                  | 70.2             | 34.7                     |
| 3  | 2483.50         | 35.4 PK                 | 74.0           | -38.6       | 2.36 H             | 123                  | 32.2             | 3.2                      |
| 4  | 2483.50         | 21.2 AV                 | 54.0           | -32.8       | 2.36 H             | 123                  | 18.0             | 3.2                      |
| 5  | 4874.00         | 50.5 PK                 | 74.0           | -23.5       | 1.32 H             | 315                  | 37.2             | 13.3                     |
| 6  | 4874.00         | 37.8 AV                 | 54.0           | -16.2       | 1.32 H             | 315                  | 24.5             | 13.3                     |

**Antenna Polarity & Test Distance : Vertical at 3 m**

| No | Frequency (MHz) | Emission Level (dBuV/m) | Limit (dBuV/m) | Margin (dB) | Antenna Height (m) | Table Angle (Degree) | Raw Value (dBuV) | Correction Factor (dB/m) |
|----|-----------------|-------------------------|----------------|-------------|--------------------|----------------------|------------------|--------------------------|
| 1  | *2437.00        | 119.5 PK                |                |             | 1.89 V             | 73                   | 84.8             | 34.7                     |
| 2  | *2437.00        | 106.2 AV                |                |             | 1.89 V             | 73                   | 71.5             | 34.7                     |
| 3  | 2484.90         | 70.9 PK                 | 74.0           | -3.1        | 1.89 V             | 73                   | 36.2             | 34.7                     |
| 4  | 2484.90         | 53.6 AV                 | 54.0           | -0.4        | 1.89 V             | 73                   | 18.9             | 34.7                     |
| 5  | 4874.00         | 50.8 PK                 | 74.0           | -23.2       | 1.62 V             | 249                  | 37.5             | 13.3                     |
| 6  | 4874.00         | 38.0 AV                 | 54.0           | -16.0       | 1.62 V             | 249                  | 24.7             | 13.3                     |

**Remarks:**

1. Emission Level(dBuV/m) = Raw Value(dBuV) + Correction Factor(dB/m)
2. Correction Factor(dB/m) = Antenna Factor(dB/m) + Cable Factor(dB) – Pre-Amplifier Factor(dB)
3. Margin value = Emission Level – Limit value
4. The other emission levels were very low against the limit.
5. " \* ": Fundamental frequency, the limit was restricted at the RF Output Power.

|                        |                  |  |  |
|------------------------|------------------|--|--|
| <b>RF Mode</b>         | 802.11be (EHT40) | <b>Channel</b>                           | CH 9 : 2452 MHz  |
| <b>Frequency Range</b> | 1 GHz ~ 25 GHz   | <b>Detector Function &amp; Bandwidth</b> | (PK) RB = 1 MHz, VB = 3 MHz<br>(AV) RB = 1 MHz, VB = 10 Hz |
| <b>Input Power</b>     | 120 Vac, 60 Hz   | <b>Environmental Conditions</b>          | 23°C, 66% RH   |
| <b>Tested By</b>       | Titan Hsu        |  |  |

**Antenna Polarity & Test Distance : Horizontal at 3 m**

| No | Frequency (MHz) | Emission Level (dBuV/m) | Limit (dBuV/m) | Margin (dB) | Antenna Height (m) | Table Angle (Degree) | Raw Value (dBuV) | Correction Factor (dB/m) |
|----|-----------------|-------------------------|----------------|-------------|--------------------|----------------------|------------------|--------------------------|
| 1  | *2452.00        | 114.9 PK                |                |             | 2.73 H             | 129                  | 80.2             | 34.7                     |
| 2  | *2452.00        | 102.7 AV                |                |             | 2.73 H             | 129                  | 68.0             | 34.7                     |
| 3  | 2483.50         | 64.2 PK                 | 74.0           | -9.8        | 2.73 H             | 129                  | 29.5             | 34.7                     |
| 4  | 2483.50         | 52.3 AV                 | 54.0           | -1.7        | 2.73 H             | 129                  | 17.6             | 34.7                     |
| 5  | 4904.00         | 50.6 PK                 | 74.0           | -23.4       | 1.22 H             | 311                  | 37.3             | 13.3                     |
| 6  | 4904.00         | 37.5 AV                 | 54.0           | -16.5       | 1.22 H             | 311                  | 24.2             | 13.3                     |

**Antenna Polarity & Test Distance : Vertical at 3 m**

| No | Frequency (MHz) | Emission Level (dBuV/m) | Limit (dBuV/m) | Margin (dB) | Antenna Height (m) | Table Angle (Degree) | Raw Value (dBuV) | Correction Factor (dB/m) |
|----|-----------------|-------------------------|----------------|-------------|--------------------|----------------------|------------------|--------------------------|
| 1  | *2452.00        | 116.7 PK                |                |             | 2.28 V             | 40                   | 82.0             | 34.7                     |
| 2  | *2452.00        | 103.7 AV                |                |             | 2.28 V             | 40                   | 69.0             | 34.7                     |
| 3  | 2483.50         | 66.6 PK                 | 74.0           | -7.4        | 2.28 V             | 40                   | 31.9             | 34.7                     |
| 4  | 2483.50         | 53.8 AV                 | 54.0           | -0.2        | 2.28 V             | 40                   | 19.1             | 34.7                     |
| 5  | 4904.00         | 50.9 PK                 | 74.0           | -23.1       | 1.58 V             | 278                  | 37.6             | 13.3                     |
| 6  | 4904.00         | 37.7 AV                 | 54.0           | -16.3       | 1.58 V             | 278                  | 24.4             | 13.3                     |

**Remarks:**

1. Emission Level(dBuV/m) = Raw Value(dBuV) + Correction Factor(dB/m)
2. Correction Factor(dB/m) = Antenna Factor(dB/m) + Cable Factor(dB) – Pre-Amplifier Factor(dB)
3. Margin value = Emission Level – Limit value
4. The other emission levels were very low against the limit.
5. " \* " : Fundamental frequency, the limit was restricted at the RF Output Power.



### Plot of Band Edge

#### 802.11b Channel 1

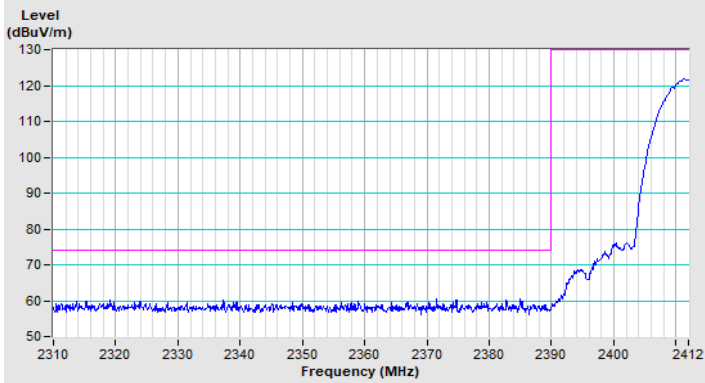

Horizontal (Peak)

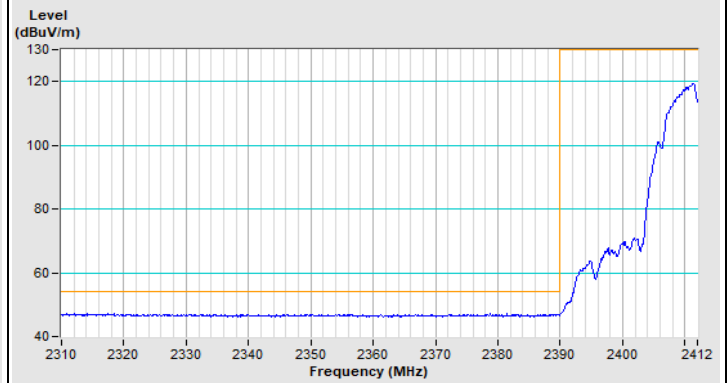

Horizontal (Average)

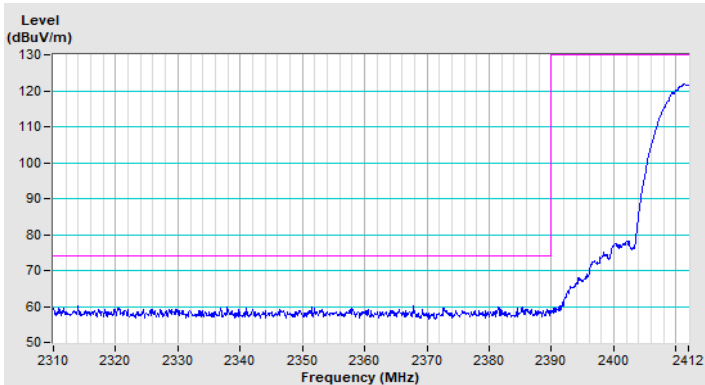

Vertical (Peak)

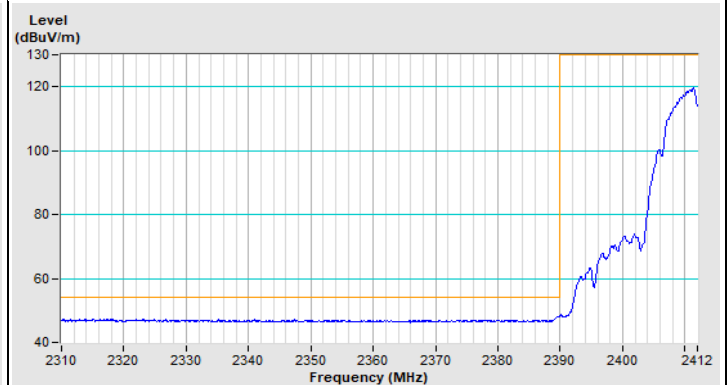

Vertical (Average)

#### 802.11b Channel 11

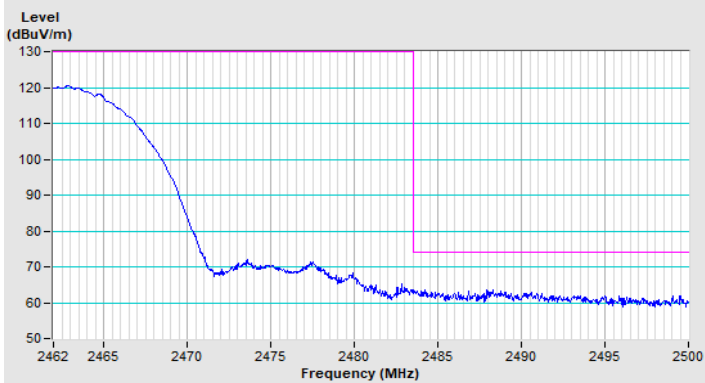

Horizontal (Peak)

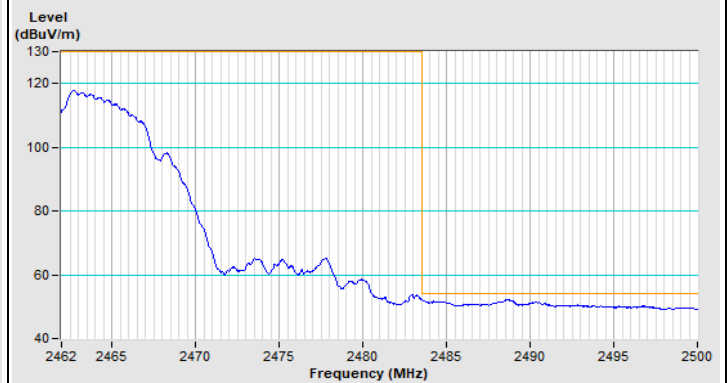

Horizontal (Average)

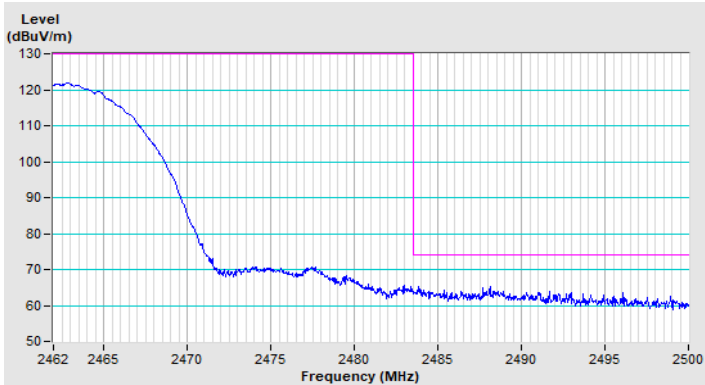

Vertical (Peak)

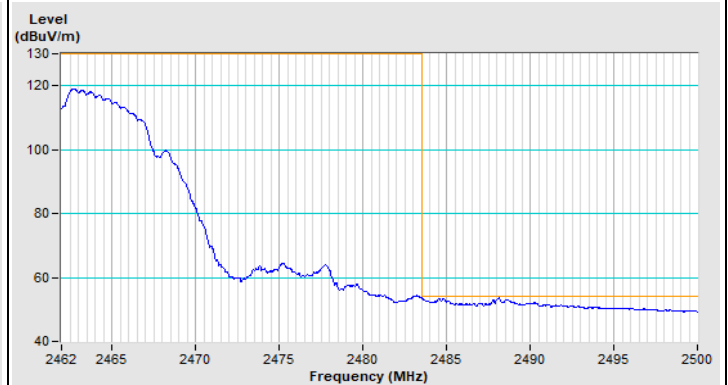

Vertical (Average)

### 802.11g Channel 1

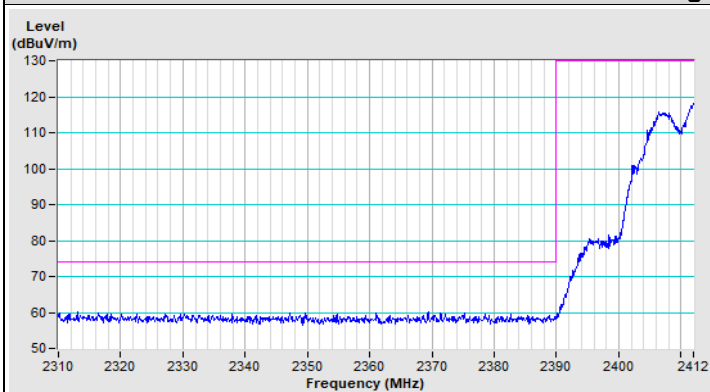

Horizontal (Peak)

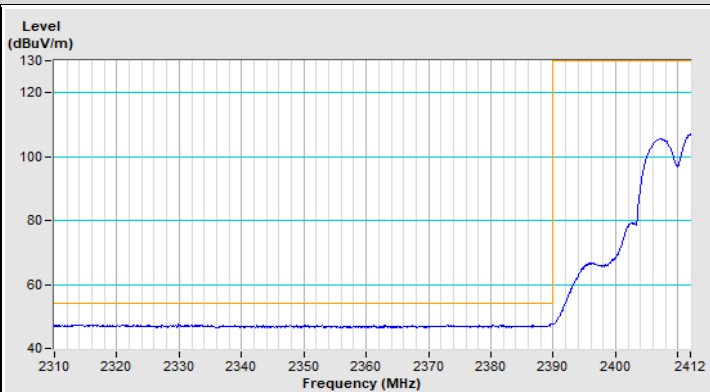

Horizontal (Average)

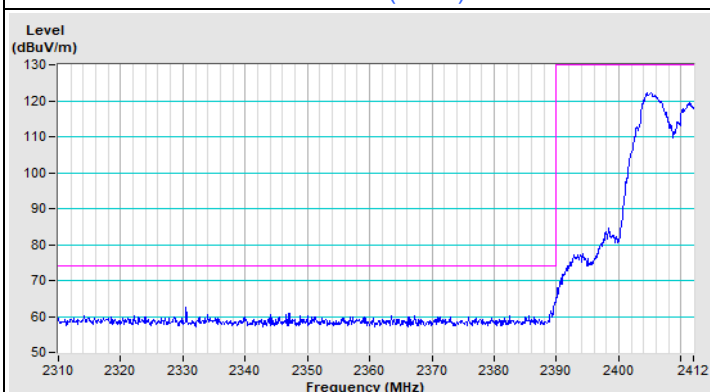

Vertical (Peak)

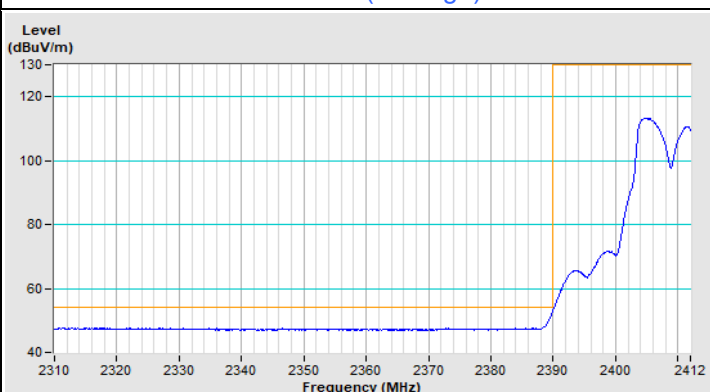

Vertical (Average)

### 802.11g Channel 11

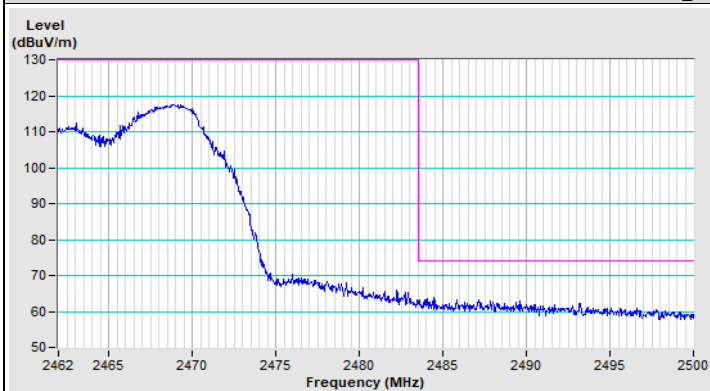

Horizontal (Peak)

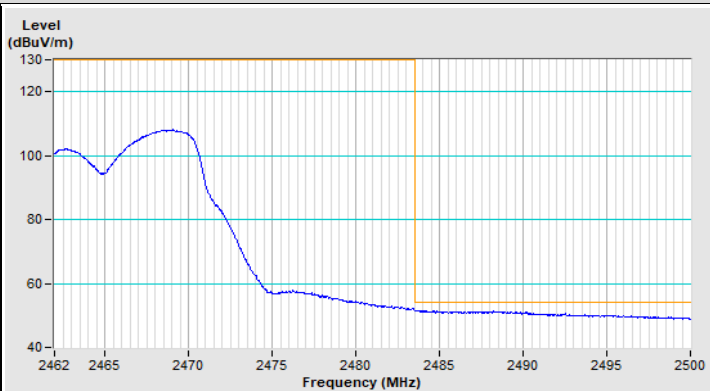

Horizontal (Average)

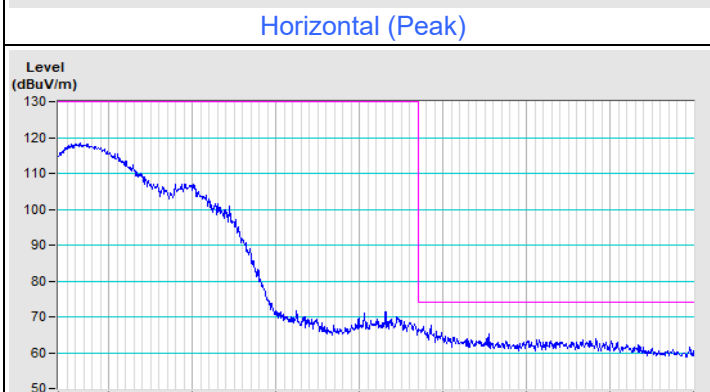

Vertical (Peak)

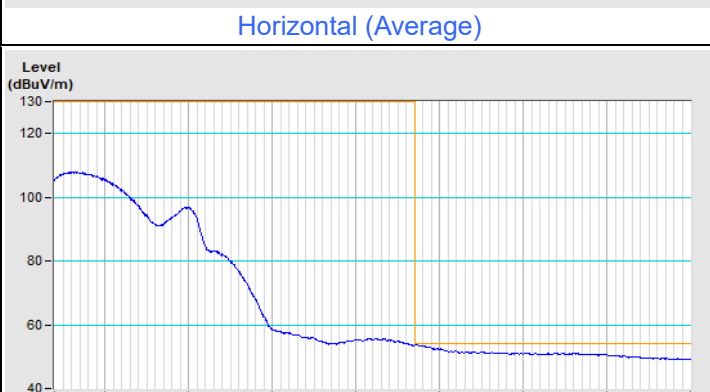

Vertical (Average)

### 802.11be (EHT20) Channel 1

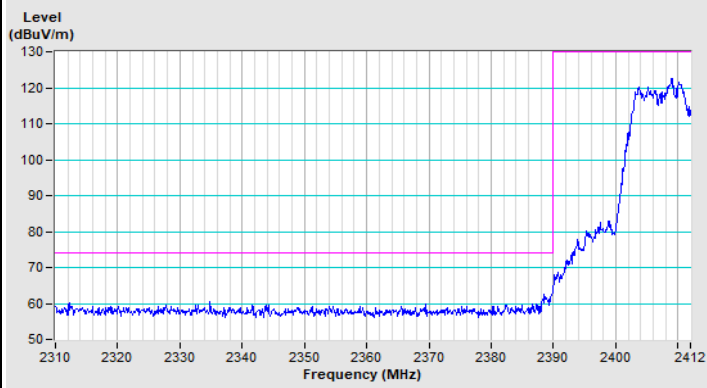

Horizontal (Peak)

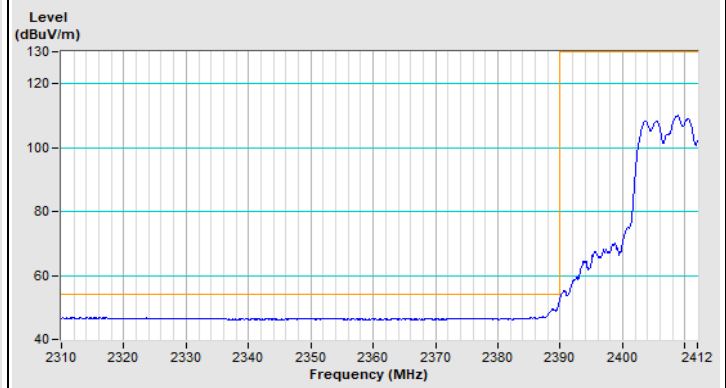

Horizontal (Average)

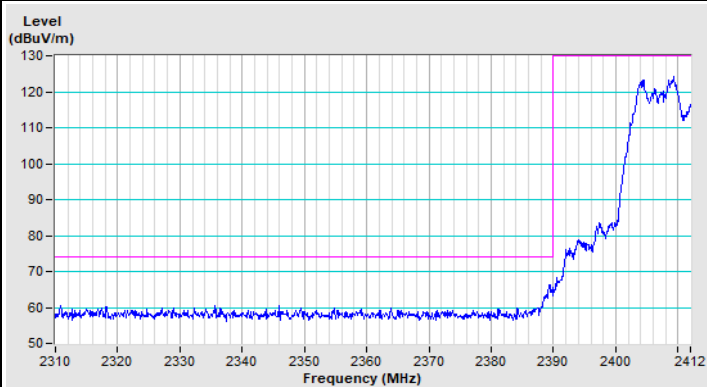

Vertical (Peak)

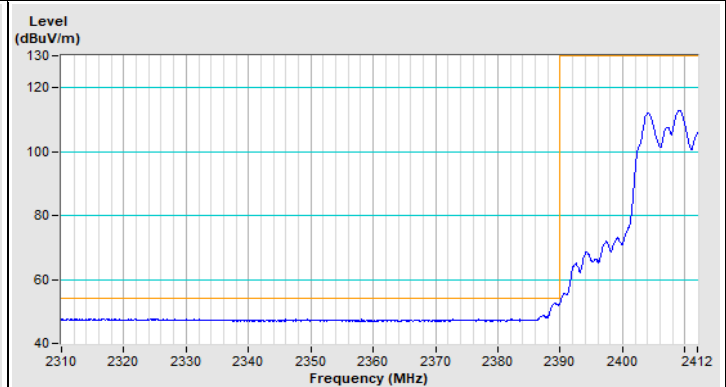

Vertical (Average)

### 802.11be (EHT20) Channel 11

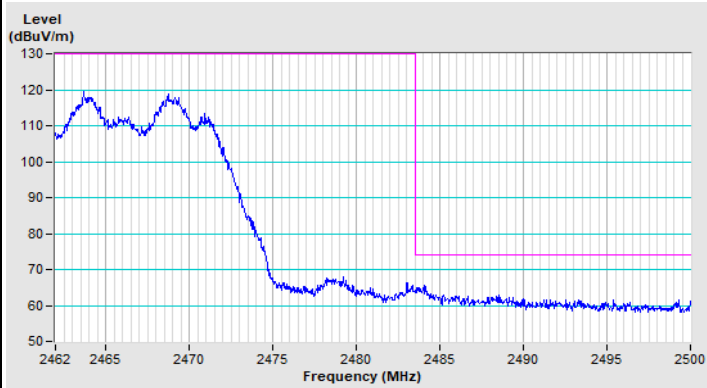

Horizontal (Peak)

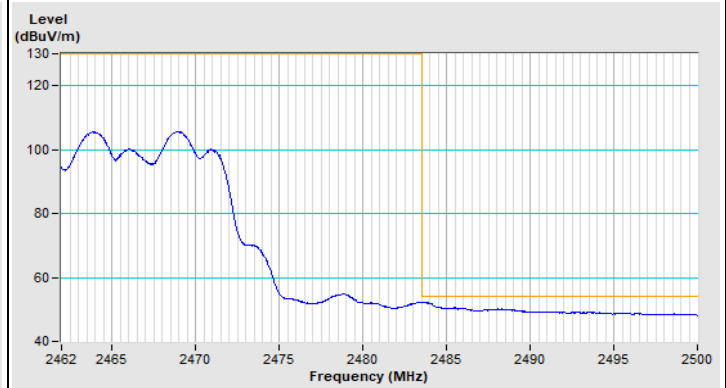

Horizontal (Average)

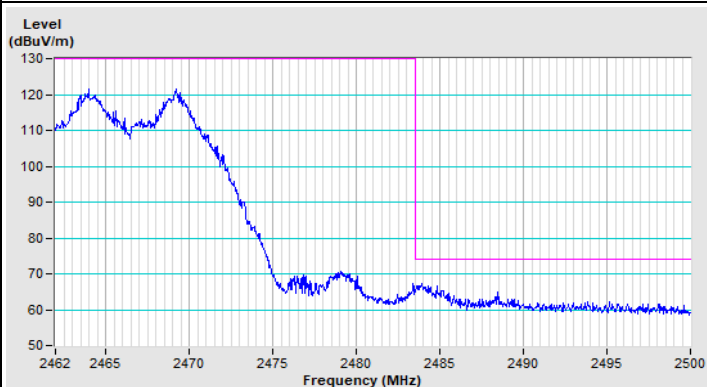

Vertical (Peak)

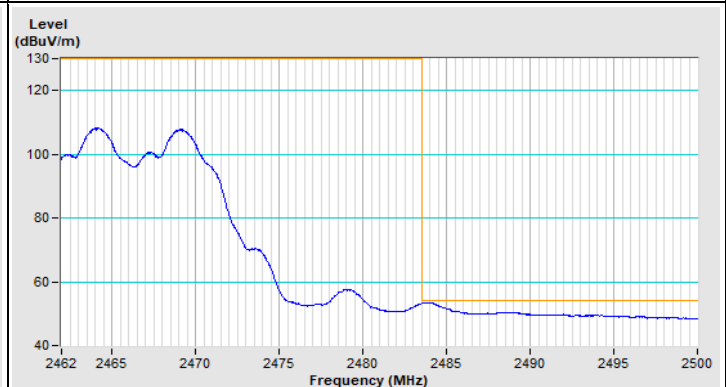

Vertical (Average)

### 802.11be (EHT40) Channel 3

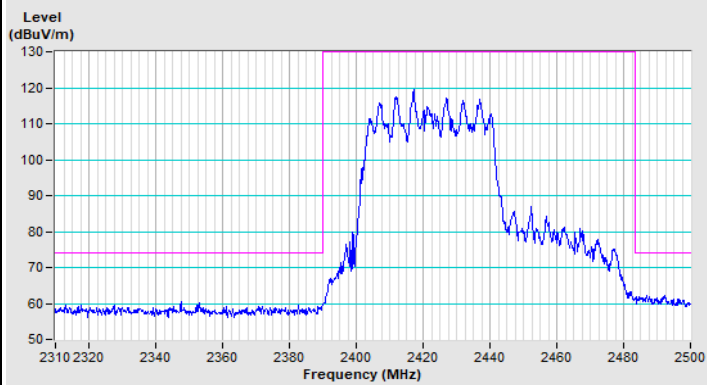

Horizontal (Peak)

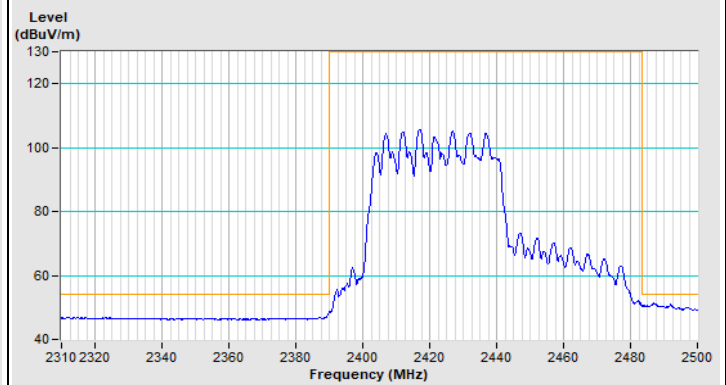

Horizontal (Average)

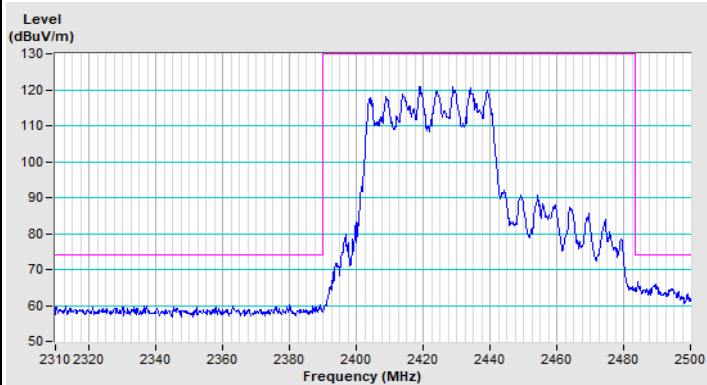

Vertical (Peak)

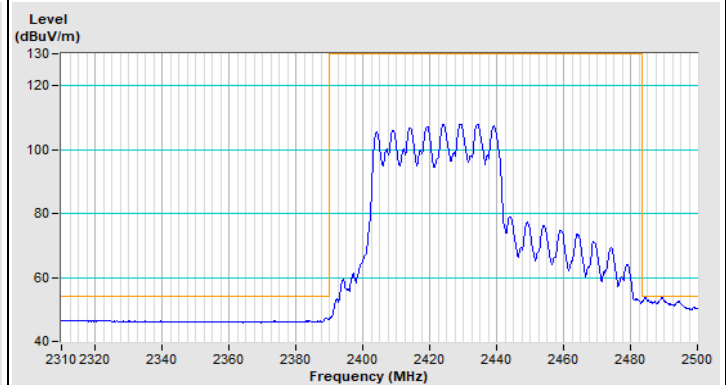

Vertical (Average)

### 802.11be (EHT40) Channel 9

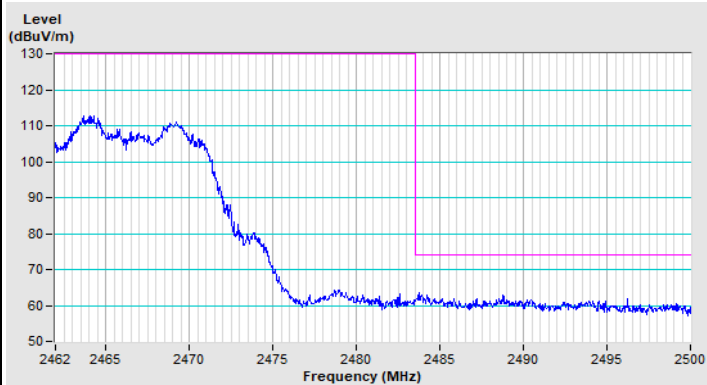

Horizontal (Peak)

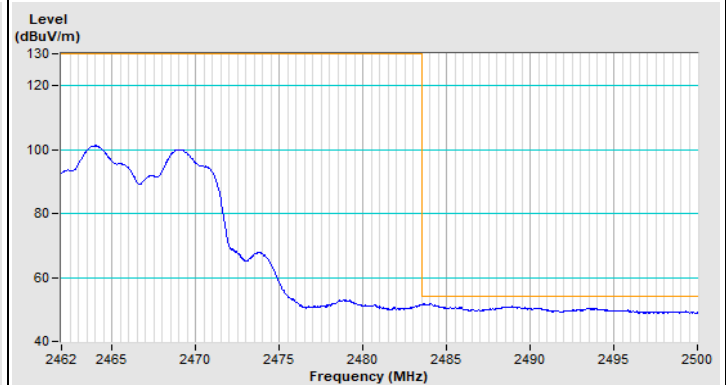

Horizontal (Average)

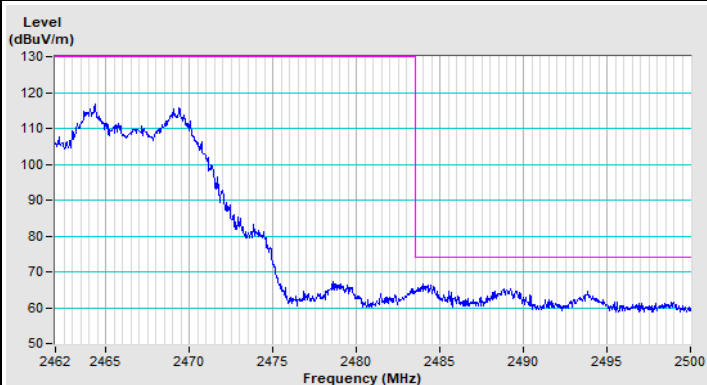

Vertical (Peak)

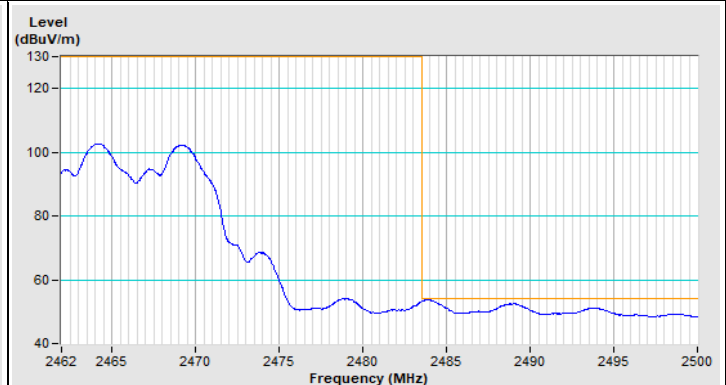

Vertical (Average)



## 8 Pictures of Test Arrangements

Please refer to the attached file (Test Setup Photo)



## 9 Information of the Testing Laboratories

We, Bureau Veritas Consumer Products Services (H.K.) Ltd., Taoyuan Branch, were founded in 1988 to provide our best service in EMC, Radio, Telecom and Safety consultation. Our laboratories are FCC recognized accredited test firms and accredited according to ISO/IEC 17025.

If you have any comments, please feel free to contact us at the following:

**Lin Kou EMC/RF Lab**

Tel: 886-2-26052180

Fax: 886-2-26051924

**Hsin Chu EMC/RF/Telecom Lab**

Tel: 886-3-6668565

Fax: 886-3-6668323

**Hwa Ya EMC/RF/Safety Lab**

Tel: 886-3-3183232

Fax: 886-3-3270892

**Email:** [service.adt@bureauveritas.com](mailto:service.adt@bureauveritas.com)

**Web Site:** <http://ee.bureauveritas.com.tw>

The address and road map of all our labs can be found in our web site also.

--- END ---