

TEST REPORT

CERTIFICATE OF CONFORMITY

Standard: 47 CFR FCC Part 15, Subpart E (Section 15.407)

Report No.: RFBBQZ-WTW-P22100778-4

FCC ID: PY323100585

Product: Quad-band WiFi 7 Orbi 9 Router & Quad-band WiFi 7 Orbi 9 Satellite

Brand: NETGEAR

Model No.: RBE971

Series Model: RBE970

Received Date: 2022/11/2

Test Date: 2023/2/14 ~ 2023/5/17

Issued Date: 2023/5/29

Applicant and Manufacturer: NETGEAR, Inc.

Address: 350 East Plumeria Drive San Jose, CA 95134

Issued By: Bureau Veritas Consumer Products Services (H.K.) Ltd., Taoyuan Branch
Lin Kou Laboratories

Lab Address: No. 47-2, 14th Ling, Chia Pau Vil., Lin Kou Dist., New Taipei City, Taiwan

Test Location: No. 19, Hwa Ya 2nd Rd., Wen Hwa Vil., Kewi Shan Dist., Taoyuan City 33383, Taiwan

FCC Registration / Designation Number: 788550 / TW0003

Approved by: Jeremy Lin , **Date:** 2023/5/29
Jeremy Lin / Project Engineer

This test report consists of 66 pages in total. It may be duplicated completely for legal use with the approval of the applicant. It should not be reproduced except in full, without the written approval of our laboratory. The test results in the report only apply to the tested sample. The test results in this report are traceable to the national or international standards.



Prepared by : Lena Wang / Specialist

This report is governed by, and incorporates by reference, the Conditions of Testing as posted at the date of issuance of this report at <http://www.bureauveritas.com/home/about-us/our-business/cps/about-us/terms-conditions/> and is intended for your exclusive use. Any copying or replication of this report to or for any other person or entity, or use of our name or trademark, is permitted only with our prior written permission. This report sets forth our findings solely with respect to the test samples identified herein. The results set forth in this report are not indicative or representative of the quality or characteristics of the lot from which a test sample was taken or any similar or identical product unless specifically and expressly noted. Our report includes all of the tests requested by you and the results thereof based upon the information that you provided to us. Measurement uncertainty is only provided upon request for accredited tests. Statements of conformity are based on simple acceptance criteria without taking measurement uncertainty into account, unless otherwise requested in writing. You have 60 days from date of issuance of this report to notify us of any material error or omission caused by our negligence or if you require measurement uncertainty; provided, however, that such notice shall be in writing and shall specifically address the issue you wish to raise. A failure to raise such issue within the prescribed time shall constitute your unqualified acceptance of the completeness of this report, the tests conducted and the correctness of the report contents.

Table of Contents

Release Control Record	4
1 Certificate.....	5
2 Summary of Test Results	6
2.1 Measurement Uncertainty	6
2.2 Supplementary Information	6
3 General Information	7
3.1 General Description of EUT	7
3.2 Antenna Description of EUT	9
3.3 Channel List.....	10
3.4 Test Mode Applicability and Tested Channel Detail.....	11
3.5 Duty Cycle of Test Signal.....	12
3.6 Test Program Used and Operation Descriptions	15
3.7 Connection Diagram of EUT and Peripheral Devices	15
3.8 Configuration of Peripheral Devices and Cable Connections	16
4 Test Instruments	17
4.1 RF Output Power.....	17
4.2 Power Spectral Density	17
4.3 6 dB Bandwidth	18
4.4 Frequency Stability	18
4.5 AC Power Conducted Emissions	18
4.6 Unwanted Emissions below 1 GHz	19
4.7 Unwanted Emissions above 1 GHz.....	20
5 Limits of Test Items.....	21
5.1 RF Output Power.....	21
5.2 Power Spectral Density	21
5.3 6 dB Bandwidth	21
5.4 Frequency Stability	21
5.5 AC Power Conducted Emissions	21
5.6 Unwanted Emissions below 1 GHz	22
5.7 Unwanted Emissions above 1 GHz.....	22
6 Test Arrangements.....	23
6.1 RF Output Power.....	23
6.1.1 Test Setup	23
6.1.2 Test Procedure.....	23
6.2 Power Spectral Density	24
6.2.1 Test Setup	24
6.2.2 Test Procedure.....	24
6.3 6 dB Bandwidth	25
6.3.1 Test Setup	25
6.3.2 Test Procedure.....	25
6.4 Frequency Stability	25
6.4.1 Test Setup	25
6.4.2 Test Procedure.....	25
6.5 AC Power Conducted Emissions	26
6.5.1 Test Setup	26
6.5.2 Test Procedure.....	26
6.6 Unwanted Emissions below 1 GHz	27
6.6.1 Test Setup	27
6.6.2 Test Procedure.....	28
6.7 Unwanted Emissions above 1 GHz.....	29
6.7.1 Test Setup	29
6.7.2 Test Procedure.....	29
7 Test Results of Test Item	30



7.1	RF Output Power	30
7.2	Power Spectral Density	34
7.3	6 dB Bandwidth	39
7.4	Frequency Stability	41
7.5	AC Power Conducted Emissions	42
7.6	Unwanted Emissions below 1 GHz	46
7.7	Unwanted Emissions above 1 GHz.....	50
8	Operational Restrictions for 5.85-5.895 GHz U-NII Devices.....	64
9	Pictures of Test Arrangements	65
10	Information of the Testing Laboratories	66



Release Control Record

Issue No.	Description	Date Issued
RFBBQZ-WTW-P22100778-4	Original Release	2023/5/29

1 Certificate

Product: Quad-band WiFi 7 Orbi 9 Router & Quad-band WiFi 7 Orbi 9 Satellite

Brand: NETGEAR

Test Model: RBE971

Series Model: RBE970

Sample Status: Engineering Sample

**Applicant and
Manufacturer:** NETGEAR, Inc.

Test Date: 2023/2/14 ~ 2023/5/17

Standard: 47 CFR FCC Part 15, Subpart E (Section 15.407)

Measurement ANSI C63.10-2013

procedure:

KDB 291074 D02 EMC Measurement v01

KDB 789033 D02 General UNII Test Procedure New Rules v02r01

KDB 662911 D01 Multiple Transmitter Output v02r01

The above equipment has been tested by **Bureau Veritas Consumer Products Services (H.K.) Ltd., Taoyuan Branch**, and found compliance with the requirement of the above standards. The test record, data evaluation & Equipment Under Test (EUT) configurations represented herein are true and accurate accounts of the measurements of the sample's RF characteristics under the conditions specified in this report.

2 Summary of Test Results

47 CFR FCC Part 15, Subpart E (Section 15.407)			
Clause	Test Item	Result	Remark
15.407(a)(3)	RF Output Power	Pass	Meet the requirement of limit.
15.407(a)(3)	Power Spectral Density	Pass	Meet the requirement of limit.
15.407(b)(9)	AC Power Conducted Emissions	Pass	Minimum passing margin is -21.52 dB at 15.25800 MHz
15.407(b)(9)	Unwanted Emissions below 1 GHz	Pass	Minimum passing margin is -5.0 dB at 43.58 MHz
15.407(b)(5) 15.407(b)(10)	Unwanted Emissions above 1 GHz	Pass	Minimum passing margin is -0.1 dB at 5618.80, 5650.00 MHz
15.407(e)	6 dB Bandwidth	Pass	Meet the requirement of limit.
15.407(g)	Frequency Stability	Pass	Meet the requirement of limit.
15.403	Operational restrictions U-NII 4 devices	-	Declaration by applicant.
15.203	Antenna Requirement	Pass	Antenna connector is ipex(MHF).

Note: Determining compliance based on the results of the compliance measurement, not taking into account measurement instrumentation uncertainty.

2.1 Measurement Uncertainty

Where relevant, the following measurement uncertainty levels have been estimated for tests performed on the EUT as specified in CISPR 16-4-2:

Measurement	Specification	Expanded Uncertainty (k=2) (±)
AC Power Conducted Emissions	9 kHz ~ 30 MHz	2.99 dB
Unwanted Emissions below 1 GHz	9 kHz ~ 30 MHz	3.59 dB
	30 MHz ~ 1 GHz	3.64 dB
Unwanted Emissions above 1 GHz	1 GHz ~ 18 GHz	2.29 dB
	18 GHz ~ 40 GHz	2.29 dB

The other instruments specified are routine verified to remain within the calibrated levels, no measurement uncertainty is required to be calculated.

2.2 Supplementary Information

There is not any deviation from the test standards for the test method, and no modifications required for compliance.

3 General Information

3.1 General Description of EUT

Product	Quad-band WiFi 7 Orbi 9 Router & Quad-band WiFi 7 Orbi 9 Satellite
Brand	NETGEAR
Test Model	RBE971
Series Model	RBE970
Model Difference	Refer to Note as below
Status of EUT	Engineering Sample
Power Supply Rating	Refer to Note as below
Modulation Type	64QAM, 16QAM, QPSK, BPSK for OFDM 256QAM for OFDM in 11ac mode only 1024QAM for OFDMA in 11ax mode only 4096QAM for OFDMA in 11be EHT mode
Modulation Technology	OFDM, OFDMA
Transfer Rate	802.11a: up to 54 Mbps 802.11n: up to 600 Mbps 802.11ac: up to 3466.7 Mbps 802.11ax: up to 4803.9 Mbps 802.11be: up to 5764.8 Mbps
Operating Frequency	5815 ~ 5885 MHz
Number of Channel	802.11a, 802.11n (HT20), 802.11ac (VHT20), 802.11ax (HE20), 802.11be (EHT20): 3 802.11n (HT40), 802.11ac (VHT40), 802.11ax (HE40), 802.11be (EHT40): 2 802.11ac (VHT80), 802.11ax (HE80), 802.11be (EHT80): 1 802.11ac (VHT160), 802.11ax (HE160), 802.11be (EHT160): 1
Output Power	CDD Mode: EIRP: 1032.761 mW (30.14 dBm) Beamforming Mode: EIRP: 2654.606 mW (34.24 dBm)
EUT Category	indoor AP + subordinate for unii-4

Note:

1. All models are listed as below.

Brand	Product	Model	Difference
NETGEAR	Quad-band WiFi 7 Orbi 9 Router	RBE971	DFS Function: Master With 10G Internet port*1, 10G Ethernet port*1, Lan port*4
	Quad-band WiFi 7 Orbi 9 Satellite	RBE970	DFS Function: Master & Client (Easy Mech) With 10G Ethernet port*1, Lan port*2

*This product have two different colors of housing (black & white) for marketing purpose

2. The EUT uses following accessories.

AC Adapter 1			
Brand	Model	Part Number	Specification
NETGEAR	2AEC060K 1	332-11586-01	AC Input : 100-240V ~ 50/60Hz 1.7A DC Output : 19.0V, 3.16A 60.0W DC Output Cable : 1.8m non-shielded and without core Plug : US/ISED Color: White

AC Adapter 2			
Brand	Model	Part Number	Specification
NETGEAR	AD2003F10	332-11488-02	AC Input : 100-240V ~ 50/60Hz 1.5A DC Output : 19.0V, 3.16A 60.0W DC Output Cable : 1.8m non-shielded and without core Plug : US/ISED Color: White
AC Adapter 3			
Brand	Model	Part Number	Specification
NETGEAR	2AEC060K 1	332-11578-01	AC Input : 100-240V ~ 50/60Hz 1.7A DC Output : 19.0V, 3.16A 60.0W DC Output Cable : 1.8m non-shielded and without core Plug : US/ISED Color: Black
AC Adapter 4			
Brand	Model	Part Number	Specification
NETGEAR	AD2003F10	332-11480-02	AC Input : 100-240V ~ 50/60Hz 1.5A DC Output : 19.0V, 3.16A 60.0W DC Output Cable : 1.8m non-shielded and without core Plug : US/ISED Color: Black
Ethernet Cable			
Brand	Model	Specification	
NETGEAR	312-10146-01	Signal Line : 2m, Unshielded	

* Adapter 1 & 3, 2 & 4 are same PA vendor with same category, the design is the same, only difference is color.

3. Simultaneously transmission condition.

Condition	Technology			
	1	WLAN (2.4GHz)	WLAN (5GHz Radio 1)	WLAN (5GHz Radio 2)
2	WLAN (2.4GHz)	WLAN (5GHz Radio 1)	WLAN (5.9GHz Radio 2)	WLAN (6GHz)

Note: The emission of the simultaneous operation has been evaluated and no non-compliance was found.

4. The above EUT information is declared by manufacturer and for more detailed features description, please refers to the manufacturer's specifications or user's manual.

3.2 Antenna Description of EUT

1. The antenna information is listed as below.

Type	Connector	Frequency Range	Ant 0 (dBi)	Ant 1 (dBi)	Ant 2 (dBi)	Ant 3 (dBi)
Dipole	ipex(MHF)	5850~5895 MHz	2.68	2.77	2.62	2.59

* Detail antenna specification please refer to antenna datasheet and/or antenna measurement report.

2. The EUT incorporates a MIMO function:

Modulation Mode	Beamforming Mode	Tx & Rx Configuration	
802.11a	Not Support	4TX	4RX
802.11n (HT20)	Support	4TX	4RX
802.11n (HT40)	Support	4TX	4RX
802.11ac (VHT20)	Support	4TX	4RX
802.11ac (VHT40)	Support	4TX	4RX
802.11ac (VHT80)	Support	4TX	4RX
802.11ac (VHT160)	Support	4TX	4RX
802.11ax (HE20)	Support	4TX	4RX
802.11ax (HE40)	Support	4TX	4RX
802.11ax (HE80)	Support	4TX	4RX
802.11ax (HE160)	Support	4TX	4RX
802.11be (EHT20)	Support	4TX	4RX
802.11be (EHT40)	Support	4TX	4RX
802.11be (EHT80)	Support	4TX	4RX
802.11be (EHT160)	Support	4TX	4RX

Note:

1. The EUT support Beamforming and CDD mode, therefore both mode were investigated and the worst case scenario was identified. The worst case data were presented in test report.
2. The modulation and bandwidth are similar for 802.11n mode for 20 MHz (40 MHz), 802.11ac mode for 20 MHz (40 MHz, 80 MHz, 160MHz), 802.11ax mode for 20 MHz (40 MHz, 80 MHz, 160MHz), and 802.11be mode for 20 MHz (40 MHz, 80 MHz, 160MHz), therefore the manufacturer will control the power for 802.11n/ac/ax mode is the same as the 802.11be or more lower than it and investigated worst case to representative mode in test report.
3. For 802.11ax and 802.11be, the EUT not support Partial RU.

3.3 Channel List

3 channels are provided for 802.11a, 802.11n (HT20), 802.11ac (VHT20), 802.11ax (HE20), 802.11be (EHT20):

Channel	Frequency	Channel	Frequency	Channel	Frequency
*169	5845 MHz	173	5865 MHz	177	5885 MHz

2 channels are provided for 802.11n (HT40), 802.11ac (VHT40), 802.11ax (HE40), 802.11be (EHT40):

Channel	Frequency	Channel	Frequency
*167	5835 MHz	175	5875 MHz

1 channel is provided for 802.11ac (VHT80), 802.11ax (HE80), 802.11be (EHT80):

Channel	Frequency
*171	5855 MHz

1 channel is provided for 802.11ac (VHT160), 802.11ax (HE160), 802.11be (EHT160):

Channel	Frequency
*163	5815 MHz

Note: * U-NII-3 & -4 span channels.

3.4 Test Mode Applicability and Tested Channel Detail

Pre-Scan:	1. The AC Adapter has the following models: 2AEC060K 1 / AD2003F10. Pre-scan these models of AC Adapters and find the worst case as a representative test condition.
Worst Case:	1. AC Adapter Worst Condition:AD2003F10

Following channel(s) was (were) selected for the final test as listed below:

Test Item	EUT Configure Mode	Mode	Signal Mode	Tested Channel	Modulation	Data Rate Parameter
RF Output Power	A	802.11a	CDD	169, 173, 177	BPSK	6Mb/s
		802.11be (EHT20)	CDD & Beamforming	169, 173, 177	BPSK	MCS0
		802.11be (EHT40)	CDD & Beamforming	167, 175	BPSK	MCS0
		802.11be (EHT80)	CDD & Beamforming	171	BPSK	MCS0
		802.11be (EHT160)	CDD & Beamforming	163	BPSK	MCS0
Power Spectral Density	A	802.11a	CDD	169, 173, 177	BPSK	6Mb/s
		802.11be (EHT20)	CDD & Beamforming	169, 173, 177	BPSK	MCS0
		802.11be (EHT40)	CDD & Beamforming	167, 175	BPSK	MCS0
		802.11be (EHT80)	CDD & Beamforming	171	BPSK	MCS0
		802.11be (EHT160)	CDD & Beamforming	163	BPSK	MCS0
6 dB Bandwidth	A	802.11a	CDD	169, 173, 177	BPSK	6Mb/s
		802.11be (EHT20)	CDD	169, 173, 177	BPSK	MCS0
		802.11be (EHT40)	CDD	167, 175	BPSK	MCS0
		802.11be (EHT80)	CDD	171	BPSK	MCS0
		802.11be (EHT160)	CDD	163	BPSK	MCS0
Frequency Stability	A	802.11a	-	177	un-modulation	-
AC Power Conducted Emissions	A, B	802.11a	CDD	173	BPSK	6Mb/s
Unwanted Emissions below 1 GHz	A, B	802.11a	CDD	173	BPSK	6Mb/s

Test Item	EUT Configure Mode	Mode	Signal Mode	Tested Channel	Modulation	Data Rate Parameter
Unwanted Emissions above 1 GHz	A	802.11a	CDD	169, 173, 177	BPSK	6Mb/s
		802.11be (EHT20)	CDD	169, 173, 177	BPSK	MCS0
		802.11be (EHT40)	CDD	167, 175	BPSK	MCS0
		802.11be (EHT80)	CDD	171	BPSK	MCS0
		802.11be (EHT160)	CDD	163	BPSK	MCS0
EUT Configure Mode:	A	EUT (RBE971) + AC Adapter 2 (AD2003F10)				
	B	EUT (RBE970) + AC Adapter 2 (AD2003F10)				

*The EUT is only tested while standing.

3.5 Duty Cycle of Test Signal

- 802.11a:** Duty cycle = 1.985 ms / 2.06 ms x 100% = 96.4%, duty factor = $10 \cdot \log(1/\text{Duty cycle}) = 0.16 \text{ dB}$
- 802.11be (EHT20):** Duty cycle = 5.47 ms / 6.83 ms x 100% = 80.1%, duty factor = $10 \cdot \log(1/\text{Duty cycle}) = 0.96 \text{ dB}$
- 802.11be (EHT40):** Duty cycle = 5.47 ms / 6.83 ms x 100% = 80.1%, duty factor = $10 \cdot \log(1/\text{Duty cycle}) = 0.96 \text{ dB}$
- 802.11be (EHT80):** Duty cycle = 5.47 ms / 6.83 ms x 100% = 80.1%, duty factor = $10 \cdot \log(1/\text{Duty cycle}) = 0.96 \text{ dB}$
- 802.11be (EHT160):** Duty cycle = 5.46 ms / 6.83 ms x 100% = 79.9%, duty factor = $10 \cdot \log(1/\text{Duty cycle}) = 0.97 \text{ dB}$

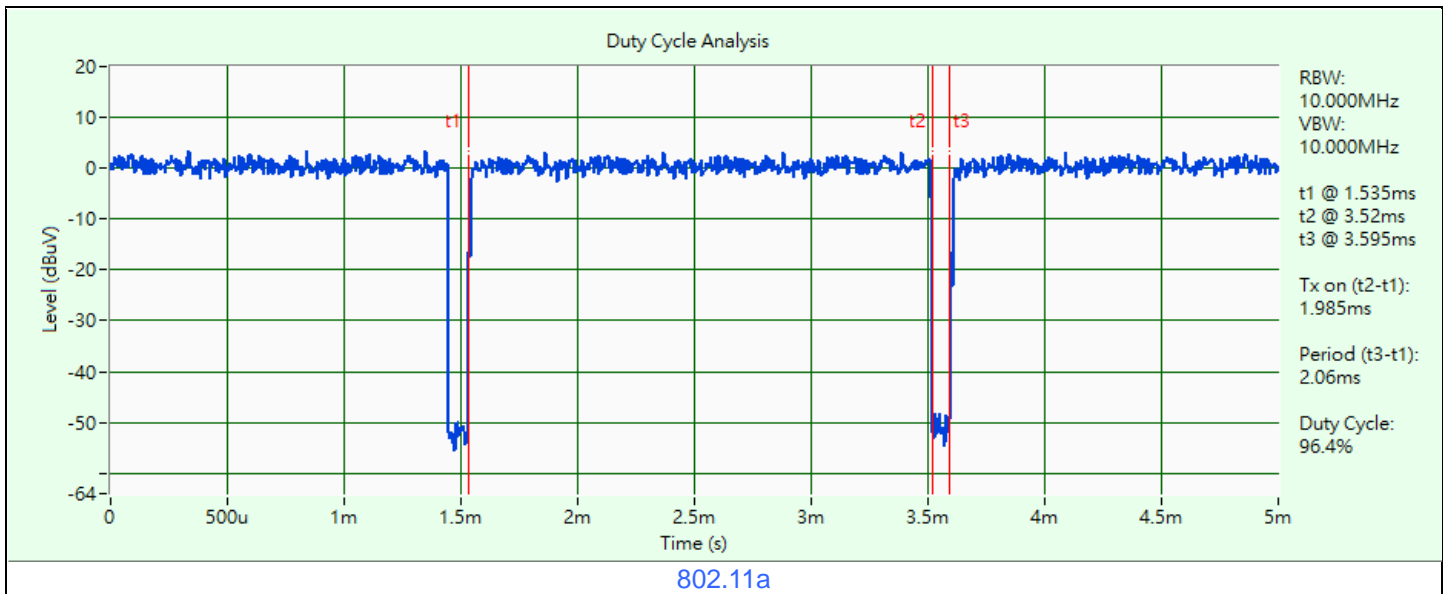

Duty Cycle Analysis

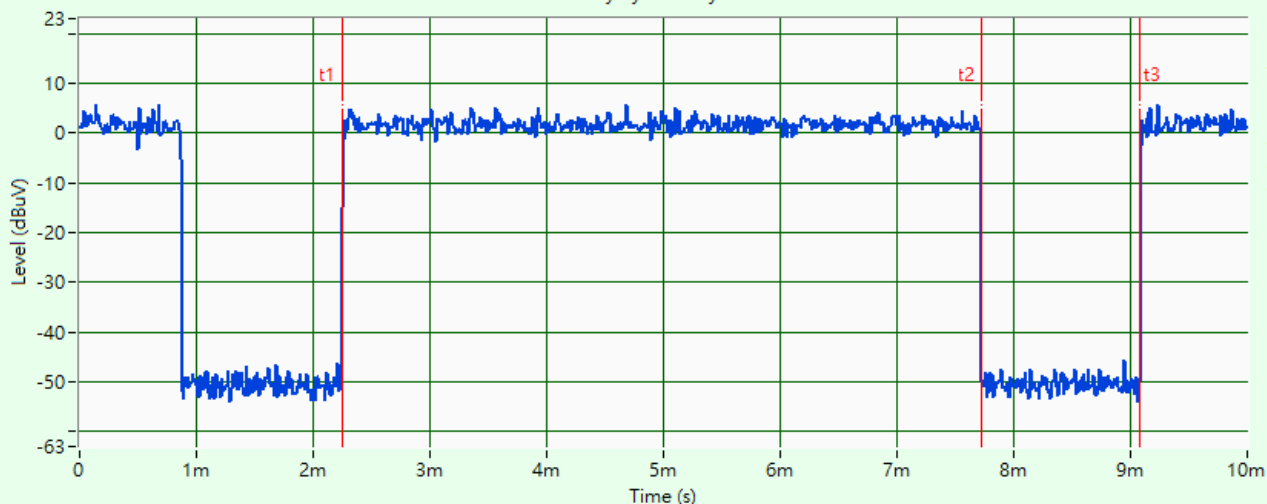

802.11be (EHT20)

Duty Cycle Analysis

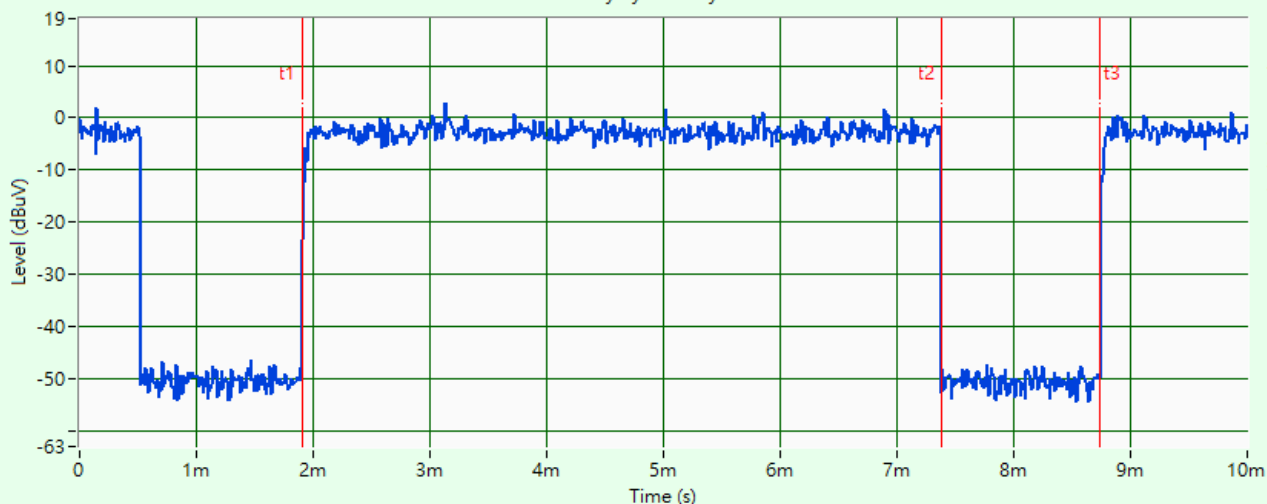

802.11be (EHT40)

Duty Cycle Analysis

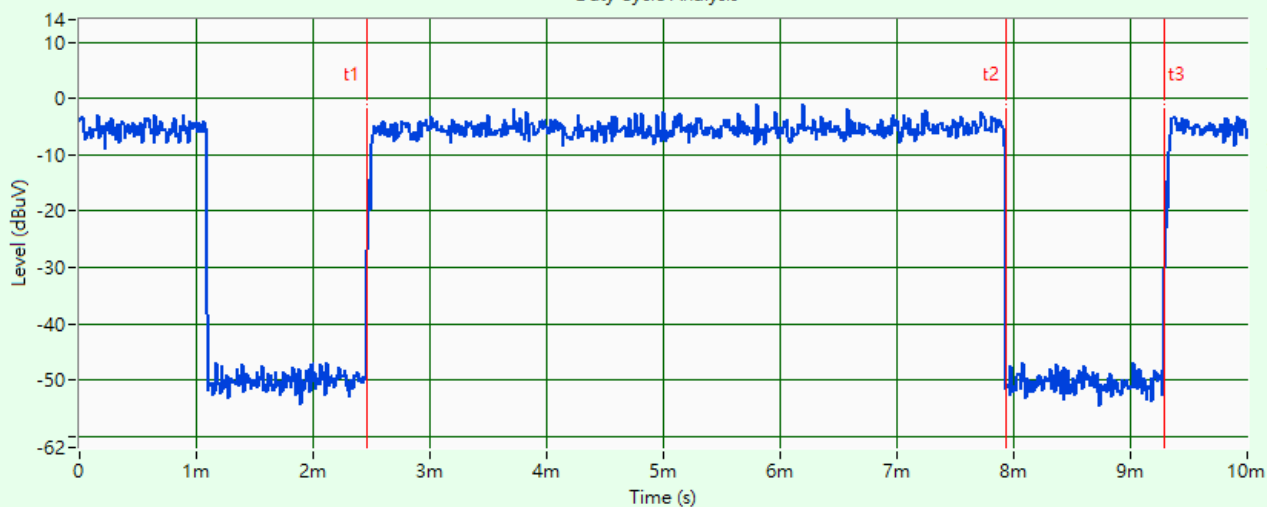

802.11be (EHT80)

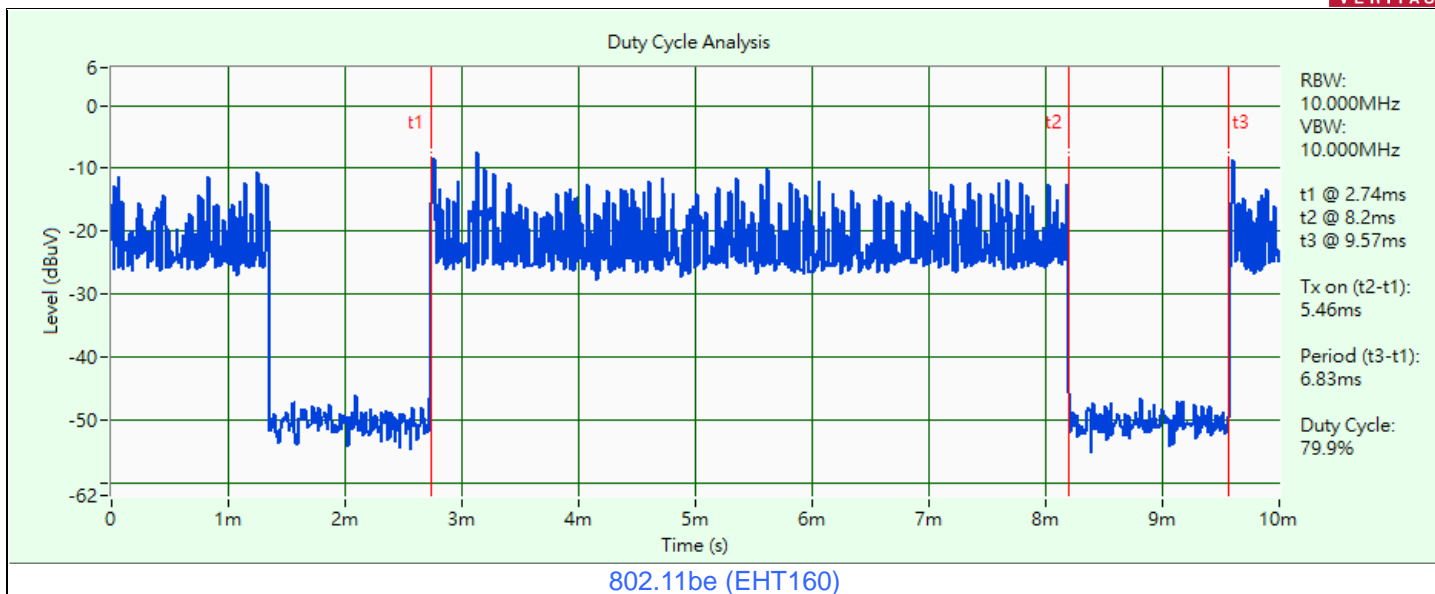

3.6 Test Program Used and Operation Descriptions

Controlling software QSPR Version 5.0-00202 has been activated to set the EUT under transmission condition continuously at specific channel frequency.

3.7 Connection Diagram of EUT and Peripheral Devices

Mode A

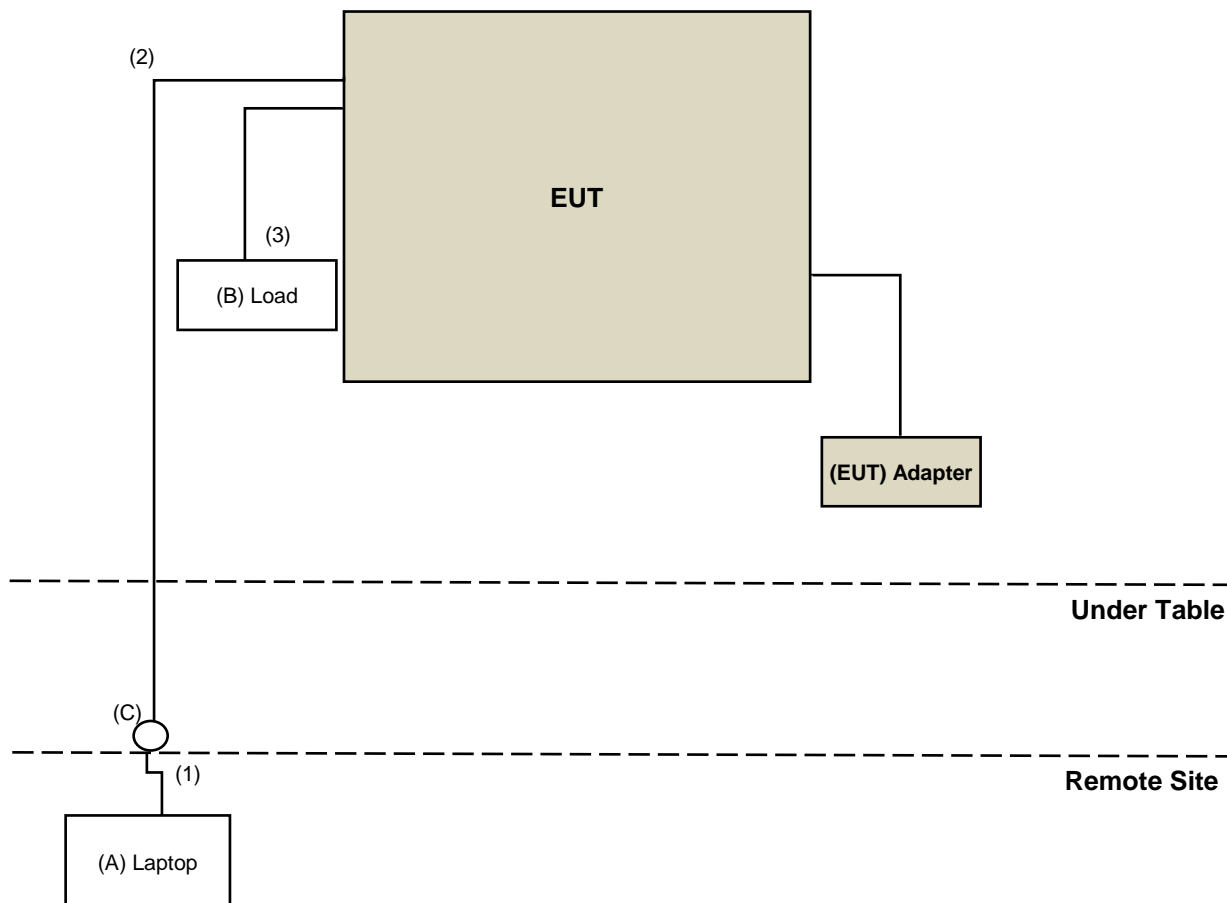

Mode B

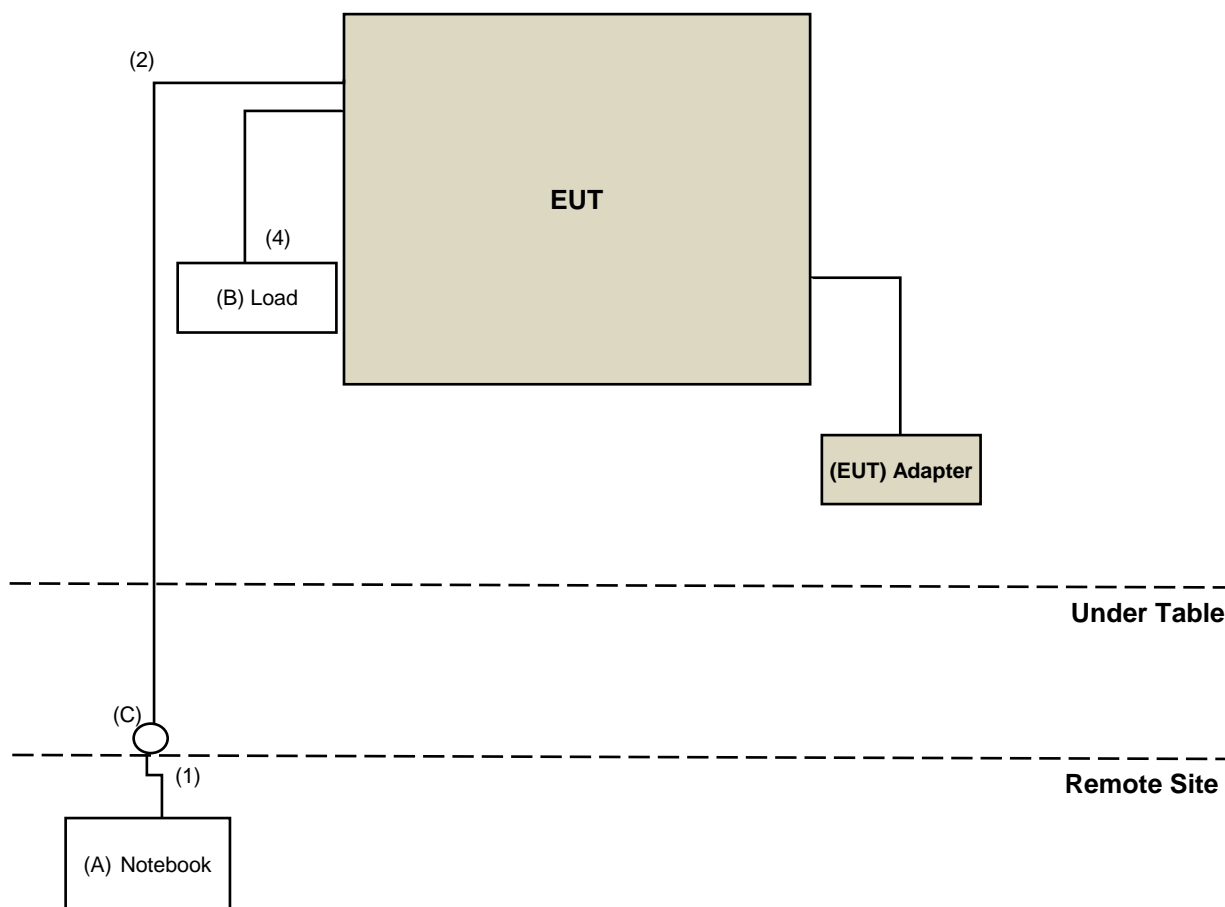

3.8 Configuration of Peripheral Devices and Cable Connections

ID	Product	Brand	Model No.	Serial No.	FCC ID	Remarks
A	Notebook	DELL	E5430	2RL3YW1	N/A	Provided by Lab
B	Load	N/A	N/A	N/A	N/A	Provided by Lab
C	Lan connector	N/A	N/A	N/A	N/A	Provided by Lab

ID	Cable Descriptions	Qty.	Length (m)	Shielding (Yes/No)	Cores (Qty.)	Remarks
1	RJ-45 Cable	1	10	N	N	Provided by Lab
2	RJ-45 Cable	1	2	N	N	Supplied by applicant
3	RJ-45 Cable	5	1.5	N	N	Provided by Lab
4	RJ-45 Cable	2	1.5	N	N	Provided by Lab

4 Test Instruments

The calibration interval of the all test instruments are 12 months and the calibrations are traceable to NML/ROC and NIST/USA.

4.1 RF Output Power

Description Manufacturer	Model No.	Serial No.	Calibrated Date	Calibrated Until
Antenna Tower inn-co GmbH	MA 4000	010303	N/A	N/A
Boresight antenna tower fixture BV	BAF-02	5	N/A	N/A
Horn Antenna Schwarzbeck	9120D	9120D-408	2022/11/13	2023/11/12
	BBHA 9170	9170-480	2022/11/13	2023/11/12
		BBHA9170241	2022/10/20	2023/10/19
		BBHA9170243	2022/11/13	2023/11/12
Pre-Amplifier EMCI	EMC 184045	980116	2022/10/1	2023/9/30
Pre_Amplifier KEYSIGHT	83017A	MY53270295	2022/5/14	2023/5/13
RF cable HUBER+SUHNER	Sucoflex 104	MY 13380+295012/04	2022/5/14	2023/5/13
RF Coaxial Cable EMCI	EMC102-KM-KM-600	150928	2022/7/9	2023/7/8
	EMC102-KM-KM-3000	150929	2022/7/9	2023/7/8
RF Coaxial Cable HUBER+SUHNER	SUCOFLEX 104	Cable-CH4-03(250724)	2022/5/14	2023/5/13
Software BV ADT	ADT_Radiated_ V7.6.15.9.5	N/A	N/A	N/A
Spectrum Analyzer R&S	FSW43	101866	2023/1/10	2024/1/9
Test Receiver R&S	ESR3+	102782	2022/12/12	2023/12/11
Turn Table BV ADT	TT100	TT93021705	N/A	N/A
Turn Table Controller BV ADT	SC100	SC93021705	N/A	N/A

Notes:

1. The test was performed in HY - 966 chamber 3.
1. Tested Date: 2023/5/10 ~ 2023/5/11

4.2 Power Spectral Density

Refer to section 4.1 to get information of the instruments.

4.3 6 dB Bandwidth

Description Manufacturer	Model No.	Serial No.	Calibrated Date	Calibrated Until
Signal and spectrum analyzer R&S	FSV3044	101105	2023/2/22	2024/2/21
Software BV	ADT_RF Test Software V6.6.5.4	N/A	N/A	N/A

Notes:

1. The test was performed in Oven room.
2. Tested Date: 2023/5/10 ~ 2023/5/11

4.4 Frequency Stability

Description Manufacturer	Model No.	Serial No.	Calibrated Date	Calibrated Until
AC power supply JIN YIH Technology	6905S	1720444	N/A	N/A
Digital Multimeter Fluke	87-III	70360742	2022/6/23	2023/6/22
Signal and spectrum analyzer R&S	FSV3044	101105	2023/2/22	2024/2/21
Software BV	ADT_RF Test Software V6.6.5.4	N/A	N/A	N/A
Temperature & Humidity Chamber TERCHY	HRM-120RF	931022	2022/12/27	2023/12/26

Notes:

1. The test was performed in Oven room.
2. Tested Date: 2023/5/10 ~ 2023/5/11

4.5 AC Power Conducted Emissions

Description Manufacturer	Model No.	Serial No.	Calibrated Date	Calibrated Until
LISN R&S	ESH3-Z5	100311	2022/9/12	2023/9/11
LISN ROHDE & SCHWARZ	ENV216	101826	2023/3/23	2024/3/22
RF Coaxial Cable WOKEN	5D-FB	Cable-cond1-01	2023/1/7	2024/1/6
Software BVADT	BVADT_Cond_ V7.3.7.4	N/A	N/A	N/A
Test Receiver Rohde&Schwarz	ESCI	100613	2022/12/5	2023/12/4
V-LISN Schwarzbeck	NNBL 8226-2	8226-142	2022/8/31	2023/8/30

Notes:

1. The test was performed in HY - Conduction 1.
2. Tested Date: 2023/5/15 ~ 2023/5/17

4.6 Unwanted Emissions below 1 GHz

Description Manufacturer	Model No.	Serial No.	Calibrated Date	Calibrated Until
Antenna Tower inn-co GmbH	MA 4000	010303	N/A	N/A
Bi_Log Antenna Schwarbeck	VULB9168	9168-155	2022/10/21	2023/10/20
Loop Antenna EMCI	EM-6879	269	2022/9/19	2023/9/18
Loop Antenna TESEQ	HLA 6121	45745	2022/7/27	2023/7/26
Pre-amplifier EMCI	EMC001340	980201	2022/9/23	2023/9/22
Pre_Amplifier Agilent	8447D	2944A10631	2022/5/14	2023/5/13
RF Coaxial Cable EMCI	5D-NM-BM	140903+140902	2023/1/7	2024/1/6
RF Coaxial Cable WOKEN	8D-FB	Cable-CH4-01	2022/7/9	2023/7/8
Software BV ADT	ADT_Radiated_ V7.6.15.9.5	N/A	N/A	N/A
Spectrum Analyzer R&S	FSW43	101866	2023/1/10	2024/1/9
Test Receiver R&S	ESR3+	102782	2022/12/12	2023/12/11
Turn Table BV ADT	TT100	TT93021705	N/A	N/A
Turn Table Controller BV ADT	SC100	SC93021705	N/A	N/A

Notes:

1. The test was performed in HY - 966 chamber 3.
2. Tested Date: 2023/3/17

4.7 Unwanted Emissions above 1 GHz

Description Manufacturer	Model No.	Serial No.	Calibrated Date	Calibrated Until
Antenna Tower inn-co GmbH	MA 4000	010303	N/A	N/A
Boresight antenna tower fixture BV	BAF-02	5	N/A	N/A
Horn Antenna Schwarzbeck	9120D	9120D-408	2022/11/13	2023/11/12
	BBHA 9170	9170-480	2022/11/13	2023/11/12
		BBHA9170241	2022/10/20	2023/10/19
		BBHA9170243	2022/11/13	2023/11/12
Pre-Amplifier EMCI	EMC 184045	980116	2022/10/1	2023/9/30
Pre_Amplifier KEYSIGHT	83017A	MY53270295	2022/5/14	2023/5/13
RF cable HUBER+SUHNER	Sucoflex 104	MY 13380+295012/04	2022/5/14	2023/5/13
RF Coaxial Cable EMCI	EMC102-KM-KM-600	150928	2022/7/9	2023/7/8
	EMC102-KM-KM-3000	150929	2022/7/9	2023/7/8
RF Coaxial Cable HUBER+SUHNER	SUCOFLEX 104	Cable-CH4-03(250724)	2022/5/14	2023/5/13
Software BV ADT	ADT_Radiated_ V7.6.15.9.5	N/A	N/A	N/A
Spectrum Analyzer R&S	FSW43	101866	2023/1/10	2024/1/9
Test Receiver R&S	ESR3+	102782	2022/12/12	2023/12/11
Turn Table BV ADT	TT100	TT93021705	N/A	N/A
Turn Table Controller BV ADT	SC100	SC93021705	N/A	N/A

Notes:

1. The test was performed in HY - 966 chamber 3.
2. Tested Date: 2023/2/14

5 Limits of Test Items

5.1 RF Output Power

Device Category	Limit (Max Average Power)
Indoor access point	EIRP 36 dBm
Subordinate device	EIRP 36 dBm
Client device	EIRP 30 dBm

Note: For all U-NII-4 and U-NII-3 & -4 span channels shall met above EIRP values.

Per KDB 662911 Method of conducted output power measurement on IEEE 802.11 devices,

Array Gain = 0 dB (i.e., no array gain) for $N_{ANT} \leq 4$;

Array Gain = 0 dB (i.e., no array gain) for channel widths ≥ 40 MHz for any N_{ANT} ;

Array Gain = $5 \log(N_{ANT}/N_{SS})$ dB or 3 dB, whichever is less for 20-MHz channel widths with $N_{ANT} \geq 5$.

For power measurements on all other devices: Array Gain = $10 \log(N_{ANT}/N_{SS})$ dB.

5.2 Power Spectral Density

Device Category	Limit
Indoor access point	EIRP 20 dBm/MHz
Subordinate device	EIRP 20 dBm/MHz
Client device	EIRP 14 dBm/MHz

Note: For all U-NII-4 and U-NII-3 & -4 span channels shall met above EIRP values.

5.3 6 dB Bandwidth

Within the 5.725-5.850 GHz and 5.850-5.895 GHz bands, the minimum 6 dB bandwidth of U-NII devices shall be at least 500 kHz.

5.4 Frequency Stability

The frequency of the carrier signal shall be maintained within band of operation.

5.5 AC Power Conducted Emissions

Frequency (MHz)	Conducted Limit (dBuV)	
	Quasi-peak	Average
0.15 - 0.5	66 - 56	56 - 46
0.50 - 5.0	56	46
5.0 - 30.0	60	50

Notes:

1. The lower limit shall apply at the transition frequencies.
2. The limit decreases in line with the logarithm of the frequency in the range of 0.15 to 0.50 MHz.

5.6 Unwanted Emissions below 1 GHz

Radiated emissions which fall in the restricted bands must comply with the radiated emission limits specified as below table.

Frequencies (MHz)	Field Strength (microvolts/meter)	Measurement Distance (meters)
0.009 ~ 0.490	2400/F(kHz)	300
0.490 ~ 1.705	24000/F(kHz)	30
1.705 ~ 30.0	30	30
30 ~ 88	100	3
88 ~ 216	150	3
216 ~ 960	200	3
Above 960	500	3

Notes:

1. The lower limit shall apply at the transition frequencies.
2. Emission level (dBuV/m) = 20 log Emission level (uV/m).

5.7 Unwanted Emissions above 1 GHz

- (i) For an indoor access point or subordinate device, all emissions at or above 5.895 GHz shall not exceed an e.i.r.p. of 15 dBm/MHz and shall decrease linearly to an e.i.r.p. of -7 dBm/MHz at or above 5.925 GHz.
- (ii) For a client device, all emissions at or above 5.895 GHz shall not exceed an e.i.r.p. of -5 dBm/MHz and shall decrease linearly to an e.i.r.p. of -27 dBm/MHz at or above 5.925 GHz.
- (iii) For a client device or indoor access point or subordinate device, all emissions below 5.725 GHz shall not exceed an e.i.r.p. of -27 dBm/MHz at 5.65 GHz increasing linearly to 10 dBm/MHz at 5.7 GHz, and from 5.7 GHz increasing linearly to a level of 15.6 dBm/MHz at 5.72 GHz, and from 5.72 GHz increasing linearly to a level of 27 dBm/MHz at 5.725 GHz.

Note:

The following formula is used to convert the equipment isotropic radiated power (eirp) to field strength:

$$E = \frac{1000000\sqrt{30P}}{3} \mu\text{V/m, where } P \text{ is the eirp (Watts).}$$

6 Test Arrangements

6.1 RF Output Power

6.1.1 Test Setup

Radiated Measurement Method

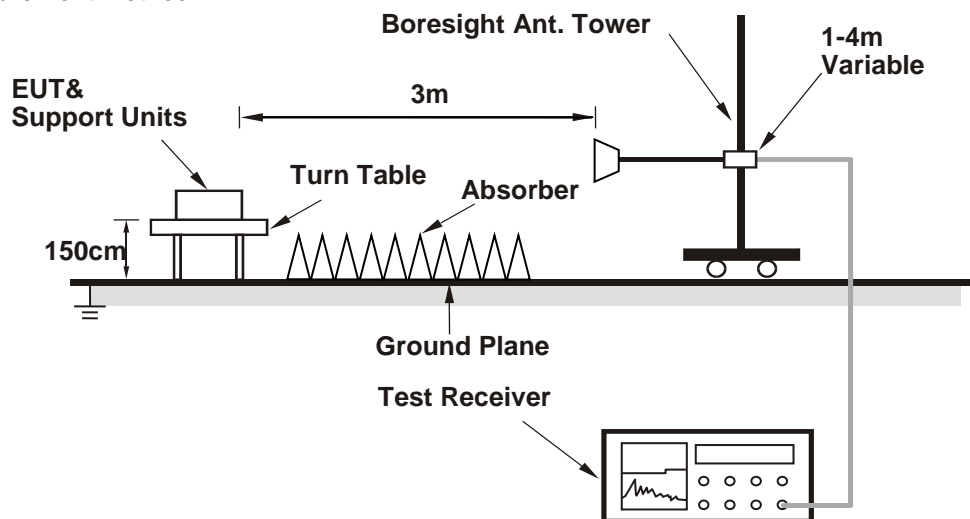

6.1.2 Test Procedure

Radiated Measurement Method

- The EUT was placed on the top of a rotating table 1.5 meters above the ground at 3 meter chamber room for test. The table was rotated 360 degrees to determine the position of the highest radiation.
- The EUT was set 3 meters away from the interference-receiving antenna, which was mounted on the top of a variable-height antenna tower.
- The height of antenna is varied from one meter to four meters above the ground to determine the maximum value of the field strength. Both horizontal and vertical polarizations of the antenna are set to make the measurement.
- Perform a field strength measurement and record the worse read value, is the field strength value via a spectrum reading obtained corrected for antenna factor, cable loss and pre-amplifier factor and then mathematically convert the measured field strength level to EIRP level.
- Follow ANSI C63.10 section 12.7.3, $EIRP \text{ Value (dBm)} = \text{Field Strength Value (dBuV/m)} + \text{Correction Factor @ 3 m}$.
- $\text{Correction Factor (dB) @ 3 m} = 20\log(D) - 104.77$; where D is the measurement distance @3 m = -95.23 dB

Spectrum analyzer setting as below:

Method SA-2A

- Set span to encompass the entire emission bandwidth (EBW) of the signal.
- Set RBW = 1 MHz, Set VBW \geq 3 MHz, Detector = RMS
- Sweep points $\geq [2 \times \text{span} / \text{RBW}]$. (This gives bin-to-bin spacing $\leq \text{RBW} / 2$, so that narrowband signals are not lost between frequency bins.)
- Manually set sweep time $\geq 10 \times (\text{number of points in sweep}) \times (\text{total on/off period of the transmitted signal})$.
- Add $10 \log (1/\text{duty cycle})$ to spectrum instrument offset.
- Perform a single sweep.
- Record the max value.

Note: When measuring power, use compute power by integrating the spectrum across the 26 dB EBW or 99% OBW of the signal using the instrument's band power measurement function, with band limits set equal to the EBW or OBW band edges. If the instrument does not have a band power function, then sum the spectrum levels (in power units) at 1 MHz intervals extending across the 26 dB EBW or 99% OBW of the spectrum.

6.2 Power Spectral Density

6.2.1 Test Setup

Radiated Measurement Method

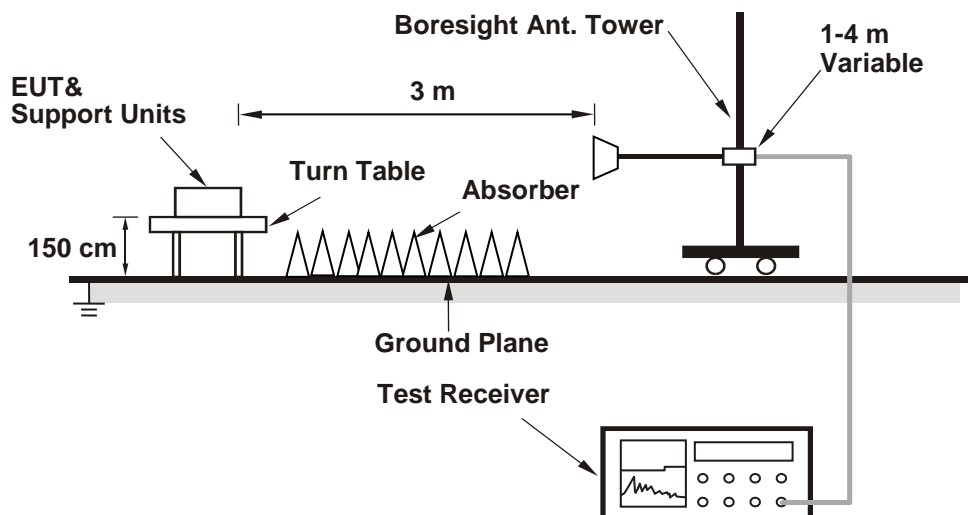

6.2.2 Test Procedure

Radiated Measurement Method

- h. The EUT was placed on the top of a rotating table 1.5 meters above the ground at 3 meter chamber room for test. The table was rotated 360 degrees to determine the position of the highest radiation.
- i. The EUT was set 3 meters away from the interference-receiving antenna, which was mounted on the top of a variable-height antenna tower.
- j. The height of antenna is varied from one meter to four meters above the ground to determine the maximum value of the field strength. Both horizontal and vertical polarizations of the antenna are set to make the measurement.
- k. Perform a field strength measurement and record the worse read value, is the field strength value via a spectrum reading obtained corrected for antenna factor, cable loss and pre-amplifier factor and then mathematically convert the measured field strength level to EIRP level.
- l. Follow ANSI C63.10 section 12.7.3, $EIRP \text{ Value (dBm)} = \text{Field Strength Value (dBuV/m)} + \text{Correction Factor @ 3 m}$.
- m. $\text{Correction Factor (dB) @ 3 m} = 20\log(D) - 104.77$; where D is the measurement distance @ 3 m = -95.23 dB

Spectrum analyzer setting as below:

Method SA-2A

- n. Set span to encompass the entire emission bandwidth (EBW) of the signal.
 - o. Set RBW = 1 MHz, Set VBW \geq 3 MHz, Detector = RMS
 - p. Sweep points $\geq [2 \times \text{span} / \text{RBW}]$. (This gives bin-to-bin spacing $\leq \text{RBW} / 2$, so that narrowband signals are not lost between frequency bins.)
 - q. Manually set sweep time $\geq 10 \times (\text{number of points in sweep}) \times (\text{total on/off period of the transmitted signal})$.
 - r. Add $10 \log (1/\text{duty cycle})$ to spectrum instrument offset.
 - s. Perform a single sweep.
- Record the max value.

6.3 6 dB Bandwidth

6.3.1 Test Setup

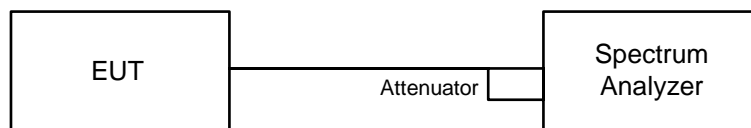

6.3.2 Test Procedure

- t. Set resolution bandwidth (RBW) = 100 kHz.
- u. Set the video bandwidth (VBW) $\geq 3 \times$ RBW, Detector = Peak.
- v. Trace mode = max hold.
- w. Sweep = auto couple.
- x. Measure the maximum width of the emission that is constrained by the frequencies associated with the two amplitude points (upper and lower) that are attenuated by 6 dB relative to the maximum level measured in the fundamental emission.

6.4 Frequency Stability

6.4.1 Test Setup

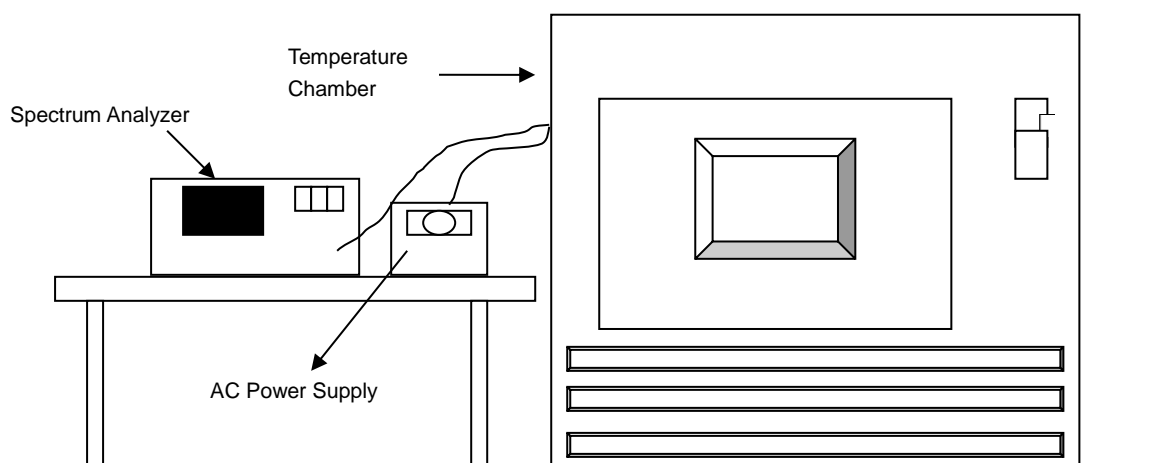

6.4.2 Test Procedure

- a. The EUT was placed inside the environmental test chamber and powered by nominal AC voltage.
- b. Turn the EUT on and couple its output to a spectrum analyzer.
- c. Turn the EUT off and set the chamber to the highest temperature specified.
- d. Allow sufficient time (approximately 30 min) for the temperature of the chamber to stabilize, turn the EUT on and measure the operating frequency after 2, 5, and 10 Minutes.
- e. Repeat step (d) with the temperature chamber set to the next desired temperature until measurements down to the lowest specified temperature have been completed.
- f. The test chamber was allowed to stabilize at +20 degree C for a minimum of 30 Minutes. The supply voltage was then adjusted on the EUT from 85% to 115% and the frequency record.

6.5 AC Power Conducted Emissions

6.5.1 Test Setup

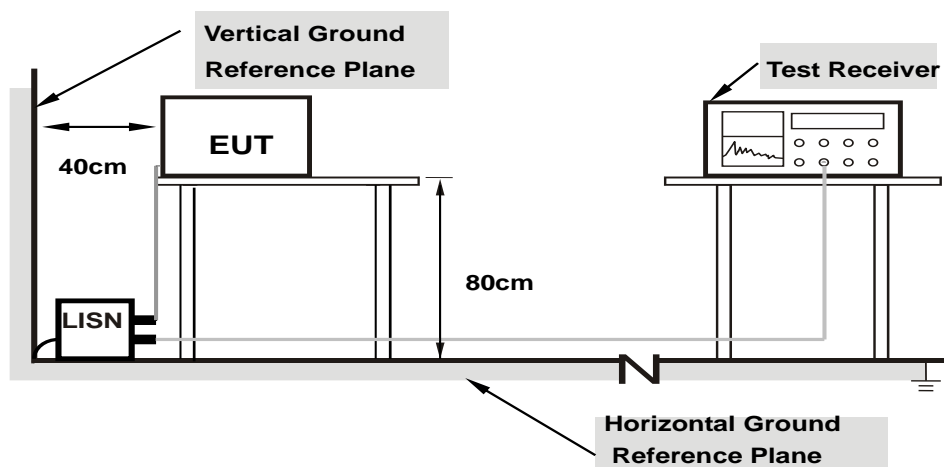

Note: 1.Support units were connected to second LISN.

For the actual test configuration, please refer to the attached file (Test Setup Photo).

6.5.2 Test Procedure

- The EUT was placed on a 0.8 meter to the top of table and placed 0.4 meters from the conducting wall of the shielded room with EUT being connected to the power mains through a line impedance stabilization network (LISN). Other support units were connected to the power mains through another LISN. The two LISNs provide 50 ohm/ 50 uH of coupling impedance for the measuring instrument.
- Both lines of the power mains connected to the EUT were checked for maximum conducted interference.
- The frequency range from 150 kHz to 30 MHz was searched. Emission levels under (Limit – 20 dB) was not recorded.

Note: The resolution bandwidth and video bandwidth of test receiver is 9 kHz for quasi-peak detection (QP) and average detection (AV) at frequency 0.15 MHz-30 MHz.

6.6 Unwanted Emissions below 1 GHz

6.6.1 Test Setup

For Radiated emission below 30 MHz

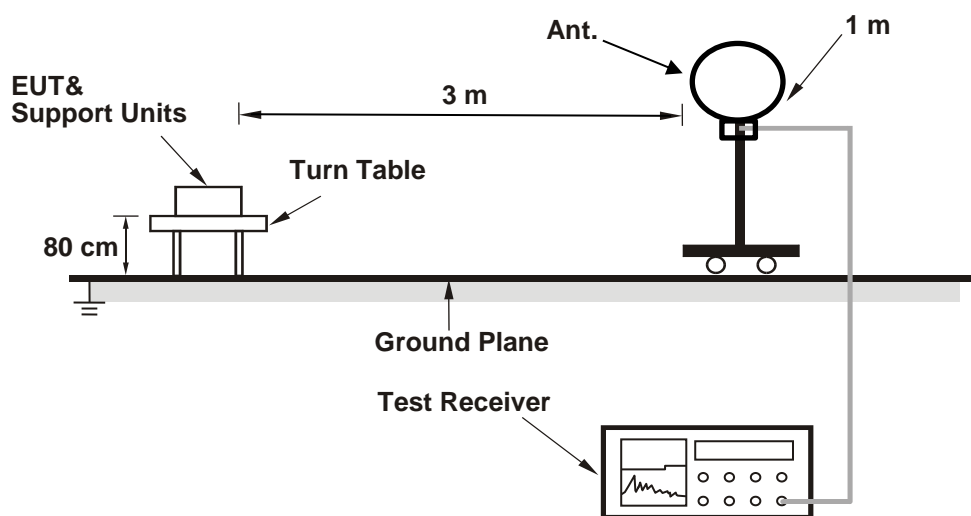

For Radiated emission above 30 MHz

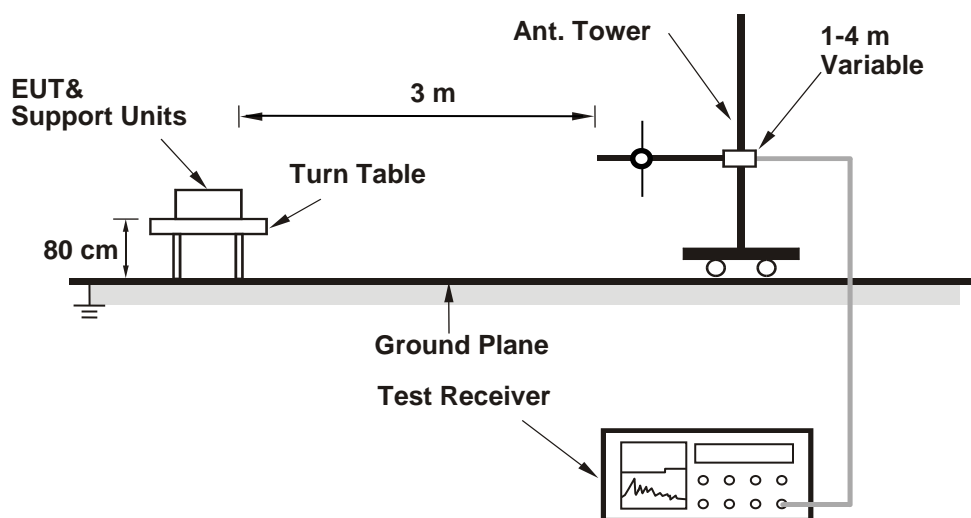

For the actual test configuration, please refer to the attached file (Test Setup Photo).

6.6.2 Test Procedure

For Radiated emission below 30 MHz

- a. The EUT was placed on the top of a rotating table 0.8 meters above the ground at 3 meter chamber room for test. The table was rotated 360 degrees to determine the position of the highest radiation.
- b. The EUT was set 3 meters away from the interference-receiving antenna, which was mounted on the top of a variable-height antenna tower.
- c. Parallel, perpendicular, and ground-parallel orientations of the antenna are set to make the measurement.
- d. For each suspected emission, the EUT was arranged to its worst case and the rotatable table was turned from 0 degrees to 360 degrees to find the maximum reading.
- e. The test-receiver system was set to Quasi-Peak Detect Function and Specified Bandwidth with Maximum Hold Mode, except for the frequency band (9 kHz to 90 kHz and 110 kHz to 490 kHz) set to average detect function and peak detect function.

Notes:

1. The resolution bandwidth and video bandwidth of test receiver/spectrum analyzer is 200 Hz at frequency below 150 kHz.
2. The resolution bandwidth and video bandwidth of test receiver/spectrum analyzer is 9 kHz or 10 kHz at frequency (150 kHz to 30 MHz).
3. All modes of operation were investigated and the worst-case emissions are reported.

For Radiated emission above 30 MHz

- a. The EUT was placed on the top of a rotating table 0.8 meters above the ground at 3 meter chamber room for test. The table was rotated 360 degrees to determine the position of the highest radiation.
- b. The EUT was set 3 meters away from the interference-receiving antenna, which was mounted on the top of a variable-height antenna tower.
- c. The height of antenna is varied from one meter to four meters above the ground to determine the maximum value of the field strength. Both horizontal and vertical polarizations of the antenna are set to make the measurement.
- d. For each suspected emission, the EUT was arranged to its worst case and then the antenna was tuned to heights from 1 meter to 4 meters and the rotatable table was turned from 0 degrees to 360 degrees to find the maximum reading.
- e. The test-receiver system was set to quasi-peak detect function and specified bandwidth with maximum hold mode when the test frequency is below 1 GHz.

Notes:

1. The resolution bandwidth and video bandwidth of test receiver/spectrum analyzer is 120 kHz for Quasi-peak detection (QP) at frequency below 1 GHz.
2. All modes of operation were investigated and the worst-case emissions are reported.

6.7 Unwanted Emissions above 1 GHz

6.7.1 Test Setup

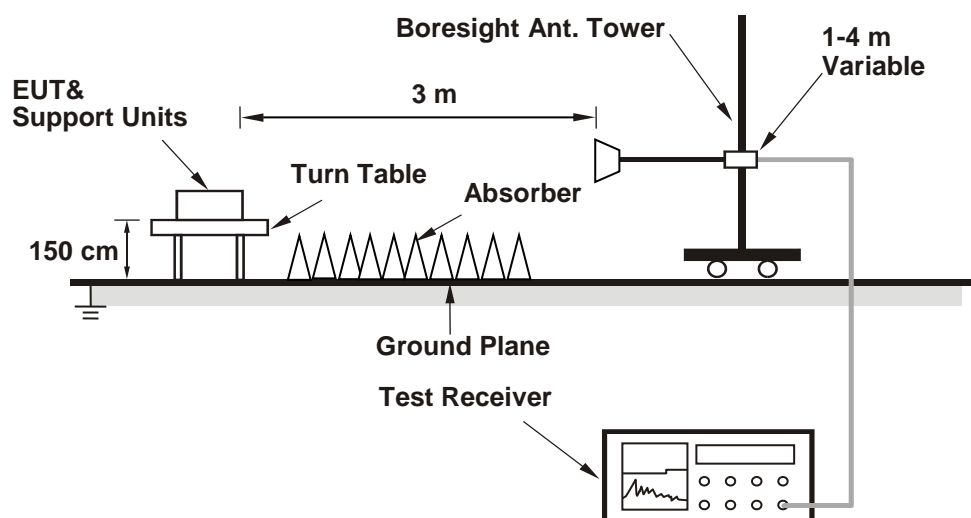

For the actual test configuration, please refer to the attached file (Test Setup Photo).

6.7.2 Test Procedure

- The EUT was placed on the top of a rotating table 1.5 meters above the ground at 3 meter chamber room for test. The table was rotated 360 degrees to determine the position of the highest radiation.
- The EUT was set 3 meters away from the interference-receiving antenna, which was mounted on the top of a variable-height antenna tower.
- The height of antenna is varied from one meter to four meters above the ground to determine the maximum value of the field strength. Both horizontal and vertical polarizations of the antenna are set to make the measurement.
- For each suspected emission, the EUT was arranged to its worst case and then the antenna was tuned to heights from 1 meter to 4 meters and the rotatable table was turned from 0 degrees to 360 degrees to find the maximum reading.
- The test-receiver system was set to peak and average detects function and specified bandwidth with maximum hold mode when the test frequency is above 1 GHz. If the peak reading value also meets average limit, measurement with the average detector is unnecessary.

Notes:

- The resolution bandwidth of test receiver/spectrum analyzer is 1 MHz and the video bandwidth is 3 MHz for Peak detection (PK) and Average detection (AV) at frequency above 1 GHz.
- For fundamental and harmonic signal measurement, the resolution bandwidth of test receiver/spectrum analyzer is 1 MHz and the video bandwidth is $\geq 1/T$ (Duty cycle $< 98\%$) or 10 Hz (Duty cycle $\geq 98\%$) for Average detection (AV) at frequency above 1 GHz.
- All modes of operation were investigated and the worst-case emissions are reported.

7 Test Results of Test Item

7.1 RF Output Power

Input Power:	120 Vac, 60 Hz	Environmental Conditions:	25°C, 60% RH	Tested By:	Wayne Lin
--------------	----------------	---------------------------	--------------	------------	-----------

CDD Mode

802.11a

Chan.	Chan. Freq. (MHz)	Field Strength (dBuV/m)	Correction Factor (dB)	EIRP (mW)	EIRP (dBm)	EIRP Limit (dBm)	Test Result
169	5845	125.34	-95.23	1025.652	30.11	36	Pass
173	5865	125.37	-95.23	1032.761	30.14	36	Pass
177	5885	121.55	-95.23	428.549	26.32	36	Pass

802.11be (EHT20)

Chan.	Chan. Freq. (MHz)	Field Strength (dBuV/m)	Correction Factor (dB)	EIRP (mW)	EIRP (dBm)	EIRP Limit (dBm)	Test Result
169	5845	125.14	-95.23	979.49	29.91	36	Pass
173	5865	125.27	-95.23	1009.253	30.04	36	Pass
177	5885	121.40	-95.23	414	26.17	36	Pass

802.11be (EHT40)

Chan.	Chan. Freq. (MHz)	Field Strength (dBuV/m)	Correction Factor (dB)	EIRP (mW)	EIRP (dBm)	EIRP Limit (dBm)	Test Result
167	5835	125.30	-95.23	1016.249	30.07	36	Pass
175	5875	122.66	-95.23	553.35	27.43	36	Pass

802.11be (EHT80)

Chan.	Chan. Freq. (MHz)	Field Strength (dBuV/m)	Correction Factor (dB)	EIRP (mW)	EIRP (dBm)	EIRP Limit (dBm)	Test Result
171	5855	123.92	-95.23	739.605	28.69	36	Pass

802.11be (EHT160)

Chan.	Chan. Freq. (MHz)	Field Strength (dBuV/m)	Correction Factor (dB)	EIRP (mW)	EIRP (dBm)	EIRP Limit (dBm)	Test Result
163	5815	121.54	-95.23	427.563	26.31	36	Pass

Spectrum Plot of Maximum Value

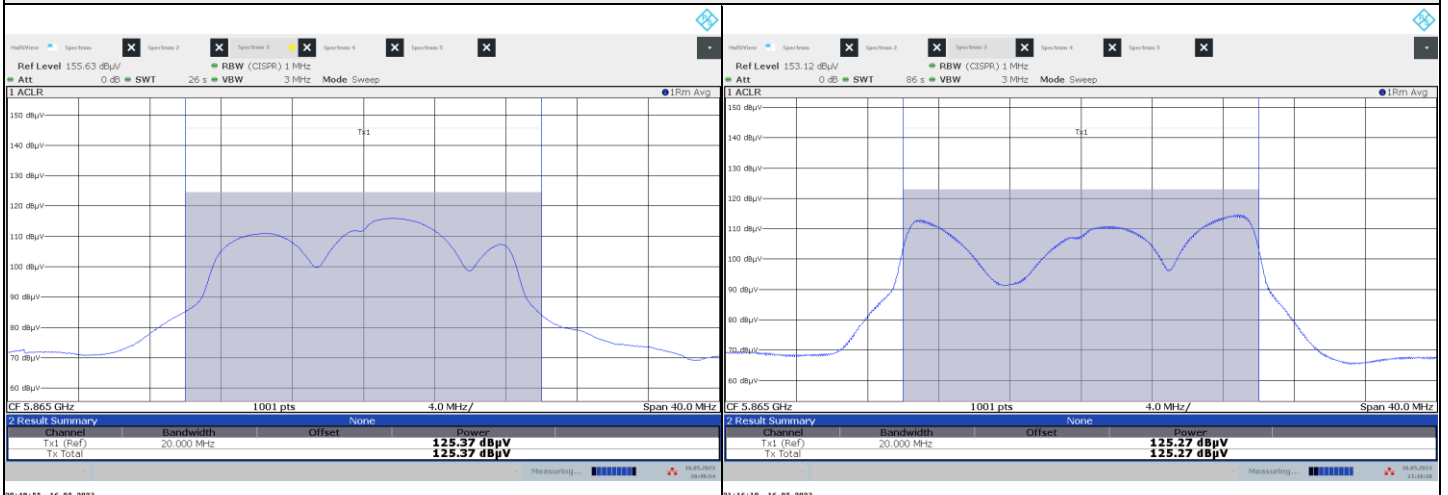

802.11a : CH 173

802.11be (EHT20) : CH 173

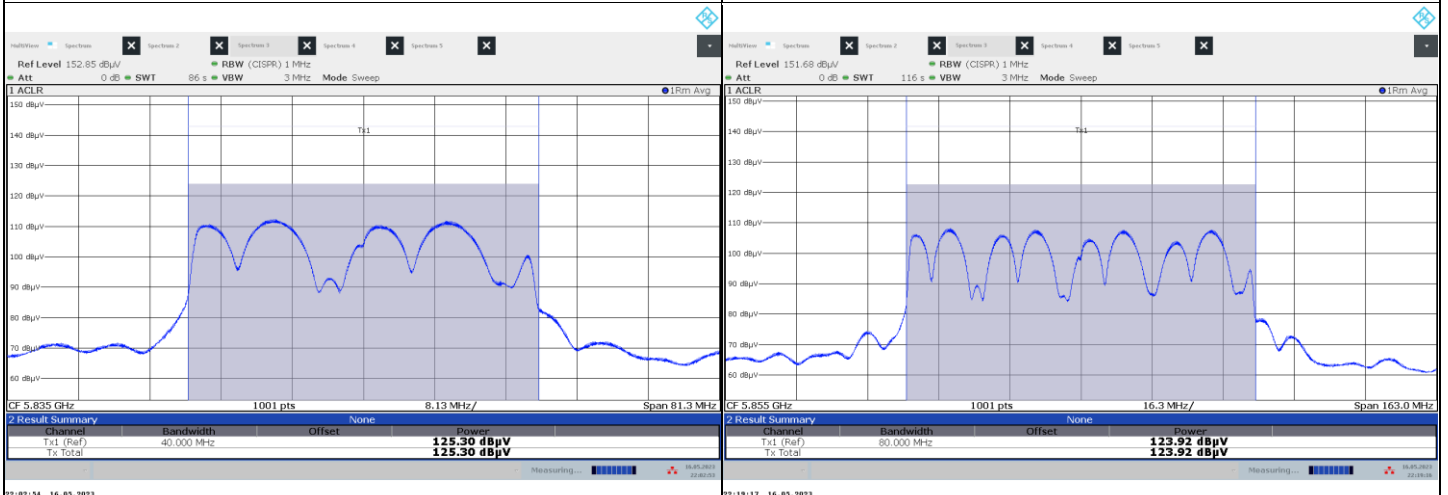

802.11be (EHT40) : CH 167

802.11be (EHT80) : CH 171

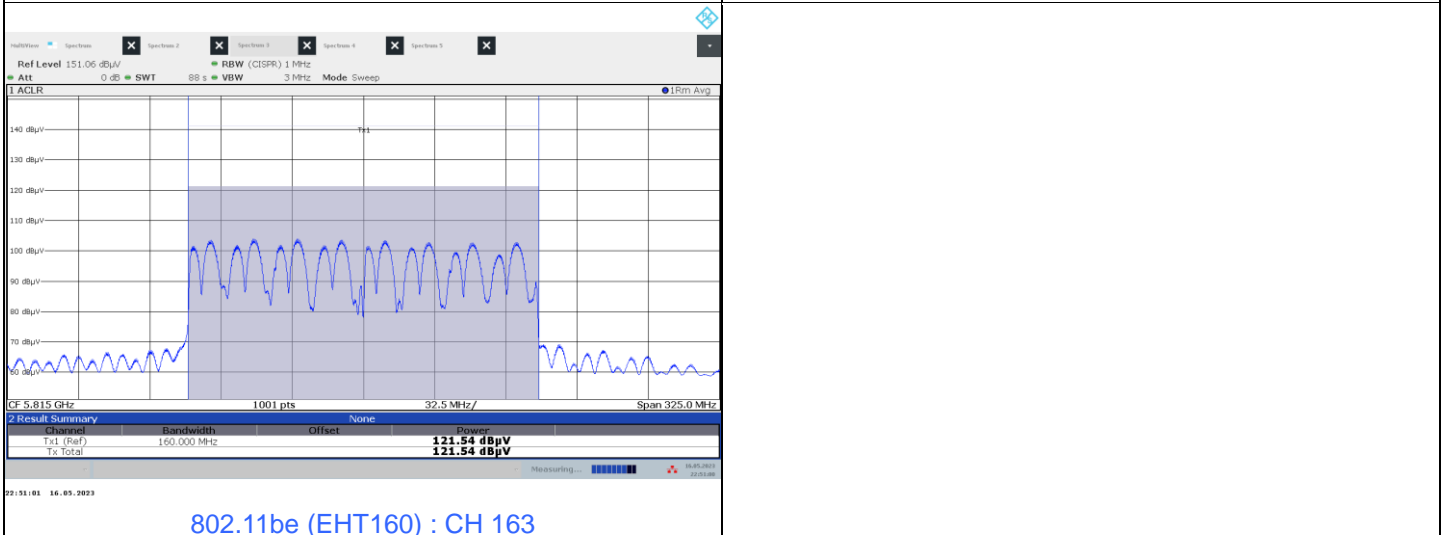

802.11be (EHT160) : CH 163

Beamforming Mode

802.11be (EHT20)

Chan.	Chan. Freq. (MHz)	Field Strength (dBuV/m)	Correction Factor (dB)	EIRP (mW)	EIRP (dBm)	EIRP Limit (dBm)	Test Result
169	5845	129.34	-95.23	2576.321	34.11	36	Pass
173	5865	129.47	-95.23	2654.606	34.24	36	Pass
177	5885	125.40	-95.23	1039.92	30.17	36	Pass

802.11be (EHT40)

Chan.	Chan. Freq. (MHz)	Field Strength (dBuV/m)	Correction Factor (dB)	EIRP (mW)	EIRP (dBm)	EIRP Limit (dBm)	Test Result
167	5835	129.42	-95.23	2624.219	34.19	36	Pass
175	5875	126.76	-95.23	1422.329	31.53	36	Pass

802.11be (EHT80)

Chan.	Chan. Freq. (MHz)	Field Strength (dBuV/m)	Correction Factor (dB)	EIRP (mW)	EIRP (dBm)	EIRP Limit (dBm)	Test Result
171	5855	128.10	-95.23	1936.422	32.87	36	Pass

802.11be (EHT160)

Chan.	Chan. Freq. (MHz)	Field Strength (dBuV/m)	Correction Factor (dB)	EIRP (mW)	EIRP (dBm)	EIRP Limit (dBm)	Test Result
163	5815	125.57	-95.23	1081.434	30.34	36	Pass

Spectrum Plot of Maximum Value

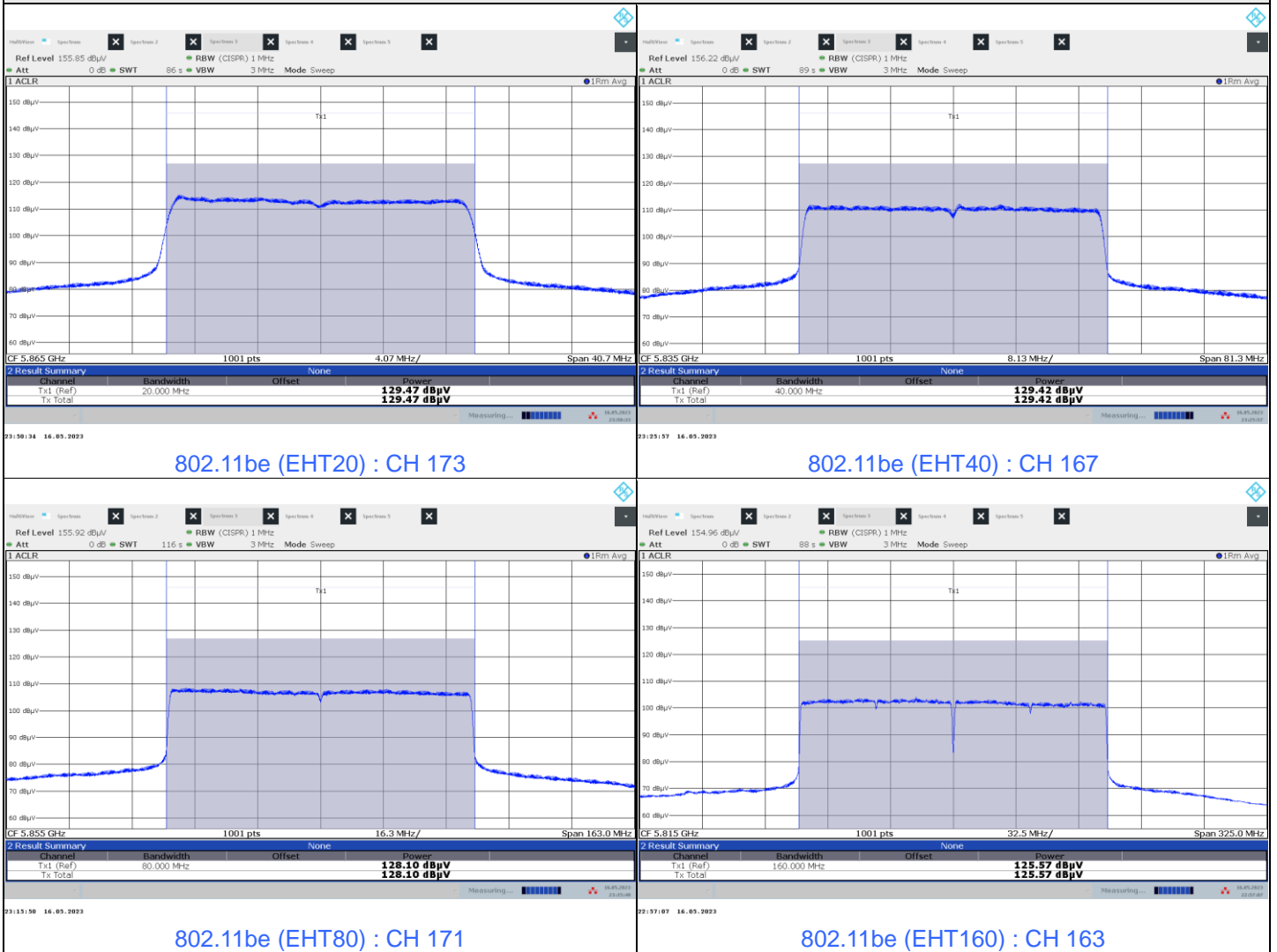

7.2 Power Spectral Density

Input Power:	120 Vac, 60 Hz	Environmental Conditions:	25°C, 60% RH	Tested By:	Wayne Lin
--------------	----------------	---------------------------	--------------	------------	-----------

802.11a

Chan.	Chan. Freq. (MHz)	Field Strength (dBuV/m)	Correction Factor (dB)	EIRP PSD (dBm/MHz)	EIRP PSD Limit (dBm/MHz)	Test Result
169	5845	115.08	-95.23	19.85	20	Pass
173	5865	115.12	-95.23	19.89	20	Pass
177	5885	111.42	-95.23	16.19	20	Pass

802.11be (EHT20)

Chan.	Chan. Freq. (MHz)	Field Strength (dBuV/m)	Correction Factor (dB)	EIRP PSD (dBm/MHz)	EIRP PSD Limit (dBm/MHz)	Test Result
169	5845	115.05	-95.23	19.82	20	Pass
173	5865	115.11	-95.23	19.88	20	Pass
177	5885	111.50	-95.23	16.27	20	Pass

802.11be (EHT40)

Chan.	Chan. Freq. (MHz)	Field Strength (dBuV/m)	Correction Factor (dB)	EIRP PSD (dBm/MHz)	EIRP PSD Limit (dBm/MHz)	Test Result
167	5835	111.98	-95.23	16.75	20	Pass
175	5875	109.59	-95.23	14.36	20	Pass

802.11be (EHT80)

Chan.	Chan. Freq. (MHz)	Field Strength (dBuV/m)	Correction Factor (dB)	EIRP PSD (dBm/MHz)	EIRP PSD Limit (dBm/MHz)	Test Result
171	5855	108.11	-95.23	12.88	20	Pass

802.11be (EHT160)

Chan.	Chan. Freq. (MHz)	Field Strength (dBuV/m)	Correction Factor (dB)	EIRP PSD (dBm/MHz)	EIRP PSD Limit (dBm/MHz)	Test Result
163	5815	103.97	-95.23	8.74	20	Pass

Spectrum Plot of Maximum Value

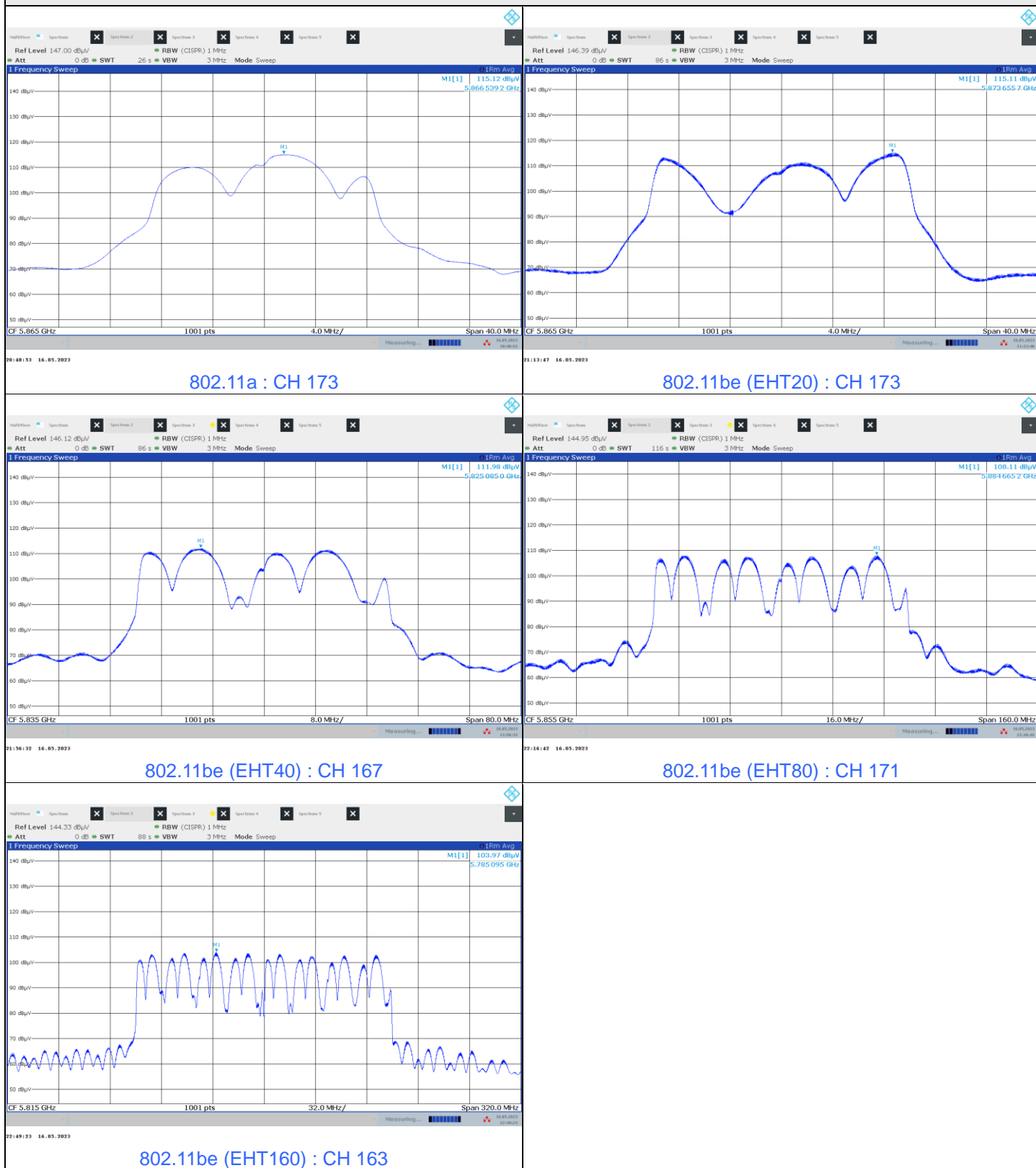

Beamforming Mode

802.11be (EHT20)

Chan.	Chan. Freq. (MHz)	Field Strength (dBuV/m)	Correction Factor (dB)	EIRP PSD (dBm/MHz)	EIRP PSD Limit (dBm/MHz)	Test Result
169	5845	115.01	-95.23	19.78	20	Pass
173	5865	115.05	-95.23	19.82	20	Pass
177	5885	111.46	-95.23	16.23	20	Pass

802.11be (EHT40)

Chan.	Chan. Freq. (MHz)	Field Strength (dBuV/m)	Correction Factor (dB)	EIRP PSD (dBm/MHz)	EIRP PSD Limit (dBm/MHz)	Test Result
167	5835	111.94	-95.23	16.71	20	Pass
175	5875	109.60	-95.23	14.37	20	Pass

802.11be (EHT80)

Chan.	Chan. Freq. (MHz)	Field Strength (dBuV/m)	Correction Factor (dB)	EIRP PSD (dBm/MHz)	EIRP PSD Limit (dBm/MHz)	Test Result
171	5855	108.08	-95.23	12.85	20	Pass

802.11be (EHT160)

Chan.	Chan. Freq. (MHz)	Field Strength (dBuV/m)	Correction Factor (dB)	EIRP PSD (dBm/MHz)	EIRP PSD Limit (dBm/MHz)	Test Result
163	5815	103.85	-95.23	8.62	20	Pass

Spectrum Plot of Maximum Value

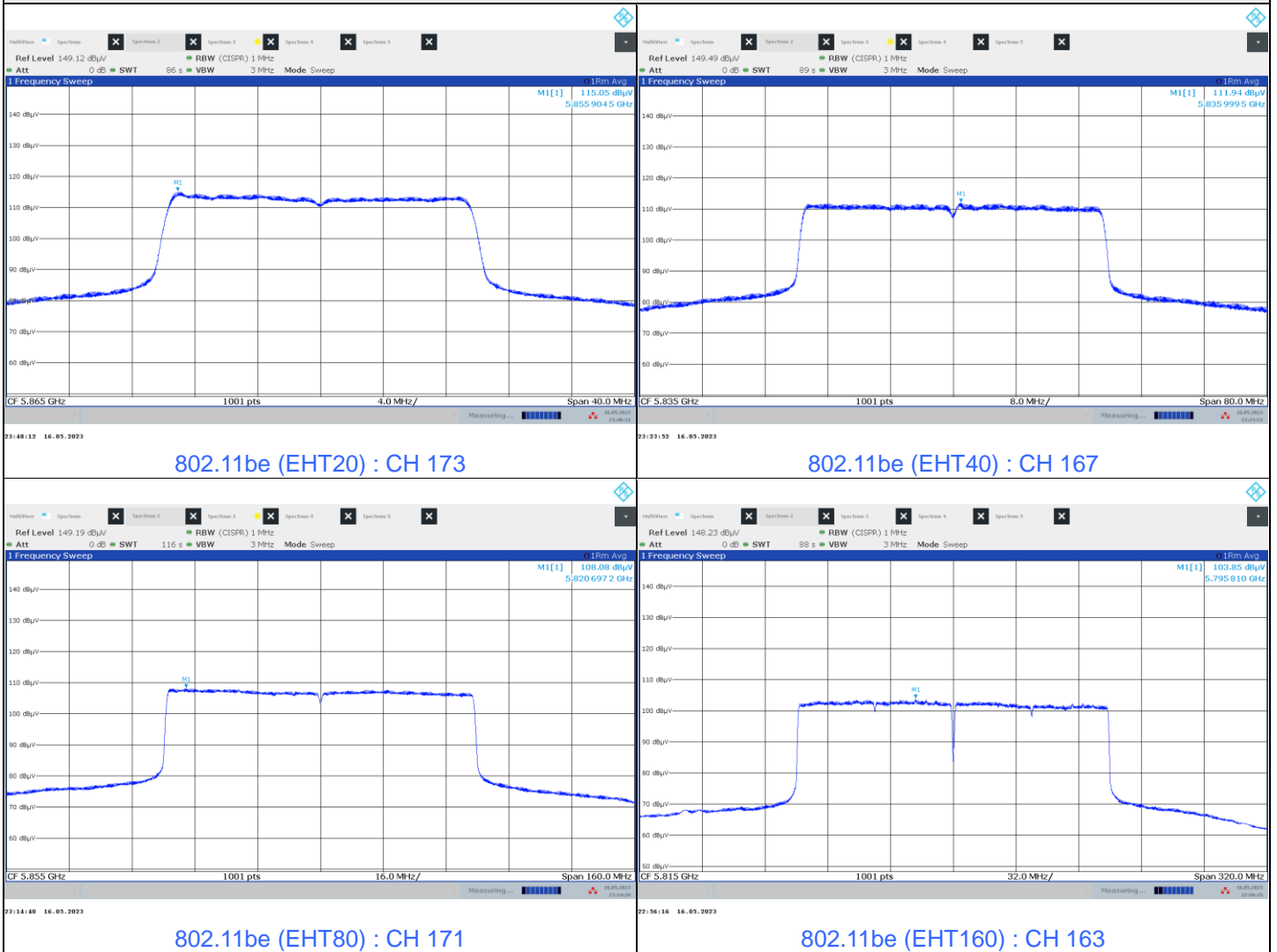

7.3 6 dB Bandwidth

Input Power:	120 Vac, 60 Hz	Environmental Conditions:	25°C, 60% RH	Tested By:	Wayne Lin
--------------	----------------	---------------------------	--------------	------------	-----------

802.11a

Channel	Frequency (MHz)	6dB Bandwidth (MHz)				Minimum Limit (MHz)	Test Result
		Chain 0	Chain 1	Chain 2	Chain 3		
169	5845	16.40	16.39	16.39	16.42	0.5	Pass
173	5865	16.41	16.40	16.40	16.41	0.5	Pass
177	5885	16.40	16.41	16.40	16.40	0.5	Pass

802.11be (EHT20)

Channel	Frequency (MHz)	6dB Bandwidth (MHz)				Minimum Limit (MHz)	Test Result
		Chain 0	Chain 1	Chain 2	Chain 3		
169	5845	19.06	19.07	19.11	19.10	0.5	Pass
173	5865	19.08	19.10	19.14	19.13	0.5	Pass
177	5885	19.08	19.15	19.08	19.11	0.5	Pass

802.11be (EHT40)

Channel	Frequency (MHz)	6dB Bandwidth (MHz)				Minimum Limit (MHz)	Test Result
		Chain 0	Chain 1	Chain 2	Chain 3		
167	5835	38.26	38.27	38.22	38.20	0.5	Pass
175	5875	38.24	38.28	38.24	38.26	0.5	Pass

802.11be (EHT80)

Channel	Frequency (MHz)	6dB Bandwidth (MHz)				Minimum Limit (MHz)	Test Result
		Chain 0	Chain 1	Chain 2	Chain 3		
171	5855	78.25	78.33	78.24	78.28	0.5	Pass

802.11be (EHT160)

Channel	Frequency (MHz)	6dB Bandwidth (MHz)				Minimum Limit (MHz)	Test Result
		Chain 0	Chain 1	Chain 2	Chain 3		
163	5815	158.37	158.34	158.39	158.10	0.5	Pass



Spectrum Plot of Minimum Value

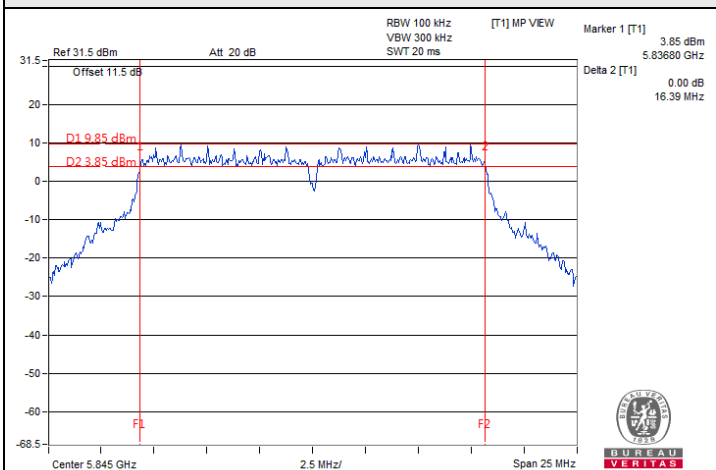

802.11a / Chain 1 : CH 169

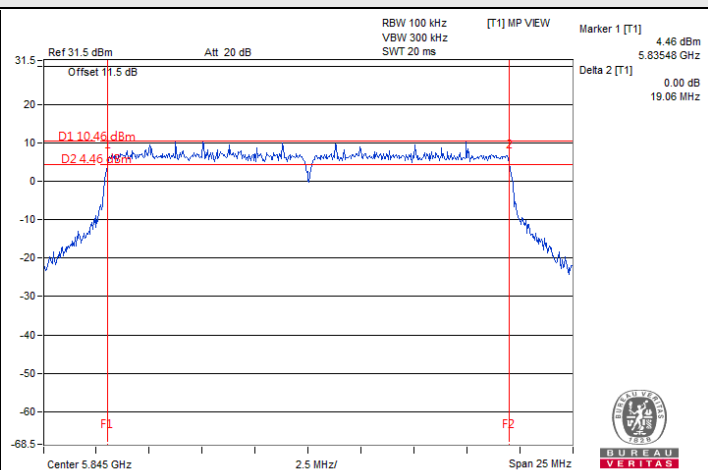

802.11be (EHT20) / Chain 0 : CH 169

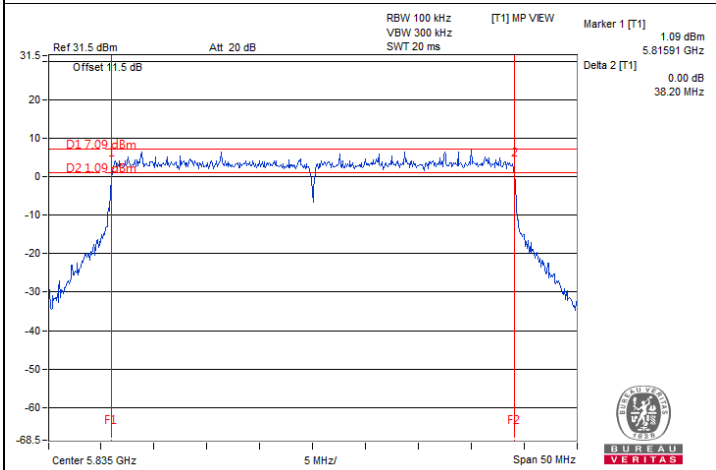

802.11be (EHT40) / Chain 3 : CH 167

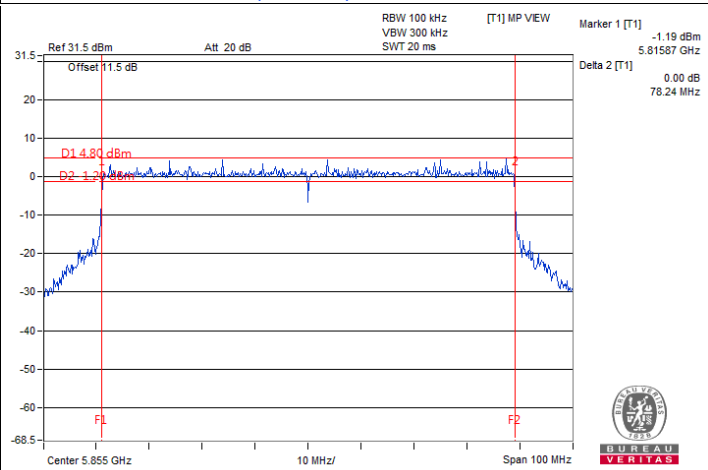

802.11be (EHT80) / Chain 2 : CH 171

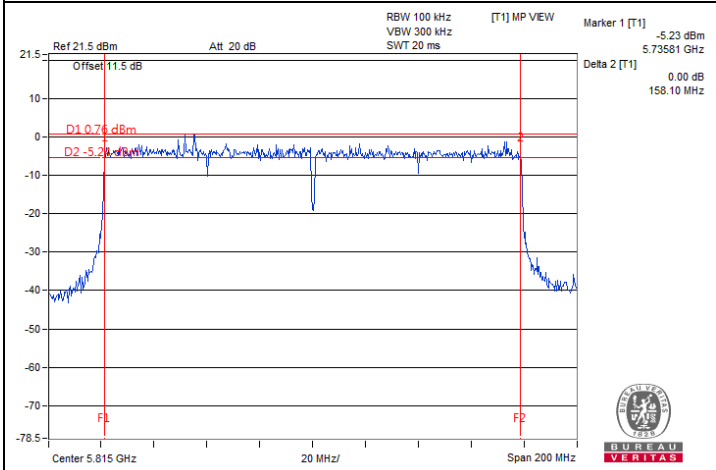

802.11be (EHT160) / Chain 3 : CH 163

7.4 Frequency Stability

Input Power:	120 Vac, 60 Hz	Environmental Conditions:	25°C, 60% RH	Tested By:	Wayne Lin
--------------	----------------	---------------------------	--------------	------------	-----------

802.11a

Frequency Stability Versus Temperature									
Operating Frequency: 5885 MHz									
Temp. (°C)	Power Supply (Vac)	0 Minute		2 Minutes		5 Minutes		10 Minutes	
		Measured Frequency (MHz)	Test Result	Measured Frequency (MHz)	Test Result	Measured Frequency (MHz)	Test Result	Measured Frequency (MHz)	Test Result
40	120	5885.0058	Pass	5885.0069	Pass	5885.0063	Pass	5885.0038	Pass
30	120	5885.01	Pass	5885.0123	Pass	5885.0144	Pass	5885.0138	Pass
20	120	5884.9988	Pass	5884.9998	Pass	5884.9999	Pass	5884.9997	Pass
10	120	5884.9902	Pass	5884.9953	Pass	5884.9902	Pass	5884.9936	Pass
0	120	5885.0273	Pass	5885.0232	Pass	5885.0237	Pass	5885.024	Pass

Frequency Stability Versus Voltage									
Operating Frequency: 5885 MHz									
Temp. (°C)	Power Supply (Vac)	0 Minute		2 Minutes		5 Minutes		10 Minutes	
		Measured Frequency (MHz)	Test Result	Measured Frequency (MHz)	Test Result	Measured Frequency (MHz)	Test Result	Measured Frequency (MHz)	Test Result
20	138	5884.9923	Pass	5884.994	Pass	5884.9931	Pass	5884.9913	Pass
	120	5884.9988	Pass	5884.9998	Pass	5884.9999	Pass	5884.9997	Pass
	102	5884.989	Pass	5884.9913	Pass	5884.9886	Pass	5884.9891	Pass

7.5 AC Power Conducted Emissions

Mode A

RF Mode	802.11a	Channel	CH 173 : 5865 MHz
Frequency Range	150kHz ~ 30MHz	Detector Function & Resolution Bandwidth	Quasi-Peak (QP) / Average (AV), 9 kHz
Input Power	120 Vac, 60 Hz	Environmental Conditions	25°C, 70% RH
Tested By	Luis Lee		

Phase Of Power : Line (L)										
No	Frequency (MHz)	Correction Factor (dB)	Reading Value (dBuV)		Emission Level (dBuV)		Limit (dBuV)		Margin (dB)	
			Q.P.	AV.	Q.P.	AV.	Q.P.	AV.	Q.P.	AV.
1	0.17400	0.21	34.19	22.52	34.40	22.73	64.77	54.77	-30.37	-32.04
2	0.19400	0.23	30.97	12.24	31.20	12.47	63.86	53.86	-32.66	-41.39
3	0.22152	0.24	28.31	15.13	28.55	15.37	62.76	52.76	-34.21	-37.39
4	0.24200	0.25	26.17	13.11	26.42	13.36	62.03	52.03	-35.61	-38.67
5	0.26921	0.26	24.05	10.58	24.31	10.84	61.14	51.14	-36.83	-40.30
6	14.87000	1.08	25.76	20.27	26.84	21.35	60.00	50.00	-33.16	-28.65

Remarks:

1. Q.P. and AV. are abbreviations of quasi-peak and average individually.
2. The emission levels of other frequencies were very low against the limit.
3. Margin value = Emission level – Limit value
4. Correction factor = Insertion loss + Cable loss
5. Emission Level = Correction Factor + Reading Value

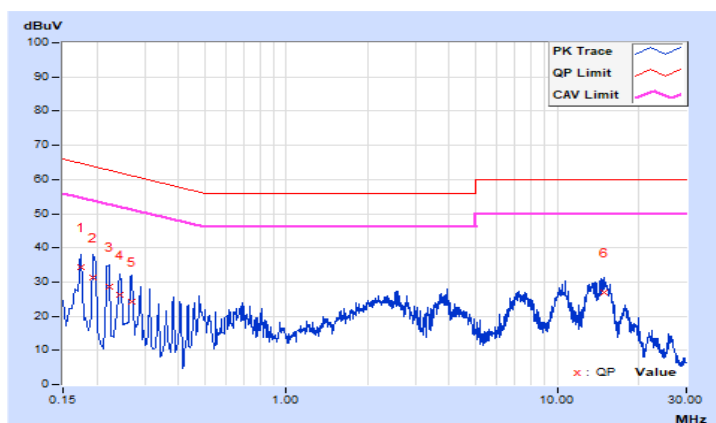

RF Mode	802.11a	Channel	CH 173 : 5865 MHz
Frequency Range	150kHz ~ 30MHz	Detector Function & Resolution Bandwidth	Quasi-Peak (QP) / Average (AV), 9 kHz
Input Power	120 Vac, 60 Hz	Environmental Conditions	25°C, 70% RH
Tested By	Luis Lee		

Phase Of Power : Neutral (N)										
No	Frequency (MHz)	Correction Factor (dB)	Reading Value (dBuV)		Emission Level (dBuV)		Limit (dBuV)		Margin (dB)	
			Q.P.	AV.	Q.P.	AV.	Q.P.	AV.	Q.P.	AV.
1	0.15800	0.23	36.62	24.65	36.85	24.88	65.57	55.57	-28.72	-30.69
2	0.18200	0.25	32.89	15.85	33.14	16.10	64.39	54.39	-31.25	-38.29
3	0.20600	0.26	30.15	11.38	30.41	11.64	63.37	53.37	-32.96	-41.73
4	0.22600	0.27	28.39	11.41	28.66	11.68	62.60	52.60	-33.94	-40.92
5	0.27400	0.29	24.11	10.75	24.40	11.04	61.00	51.00	-36.60	-39.96
6	0.29800	0.30	22.27	9.52	22.57	9.82	60.30	50.30	-37.73	-40.48

Remarks:

1. Q.P. and AV. are abbreviations of quasi-peak and average individually.
2. The emission levels of other frequencies were very low against the limit.
3. Margin value = Emission level – Limit value
4. Correction factor = Insertion loss + Cable loss
5. Emission Level = Correction Factor + Reading Value

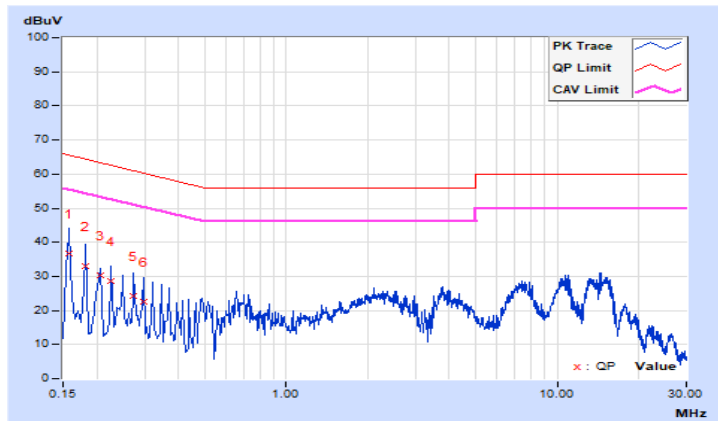

Mode B

RF Mode	802.11a	Channel	CH 173 : 5865 MHz
Frequency Range	150kHz ~ 30MHz	Detector Function & Resolution Bandwidth	Quasi-Peak (QP) / Average (AV), 9 kHz
Input Power	120 Vac, 60 Hz	Environmental Conditions	23°C, 67% RH
Tested By	Luis Lee		

Phase Of Power : Line (L)

No	Frequency (MHz)	Correction Factor (dB)	Reading Value (dBuV)		Emission Level (dBuV)		Limit (dBuV)		Margin (dB)	
			Q.P.	AV.	Q.P.	AV.	Q.P.	AV.	Q.P.	AV.
1	0.15800	9.67	32.95	10.82	42.62	20.49	65.57	55.57	-22.95	-35.08
2	0.18200	9.69	30.64	16.54	40.33	26.23	64.39	54.39	-24.06	-28.16
3	0.20600	9.70	27.10	7.56	36.80	17.26	63.37	53.37	-26.57	-36.11
4	0.22985	9.71	25.25	12.02	34.96	21.73	62.46	52.46	-27.50	-30.73
5	0.25400	9.72	23.44	11.37	33.16	21.09	61.63	51.63	-28.47	-30.54
6	15.25800	10.06	23.46	18.42	33.52	28.48	60.00	50.00	-26.48	-21.52

Remarks:

1. Q.P. and AV. are abbreviations of quasi-peak and average individually.
2. The emission levels of other frequencies were very low against the limit.
3. Margin value = Emission level – Limit value
4. Correction factor = Insertion loss + Cable loss
5. Emission Level = Correction Factor + Reading Value

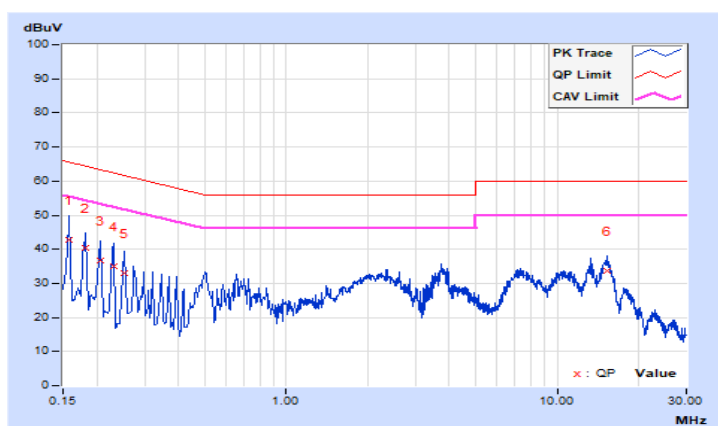

RF Mode	802.11a	Channel	CH 173 : 5865 MHz
Frequency Range	150kHz ~ 30MHz	Detector Function & Resolution Bandwidth	Quasi-Peak (QP) / Average (AV), 9 kHz
Input Power	120 Vac, 60 Hz	Environmental Conditions	23°C, 67% RH
Tested By	Luis Lee		

Phase Of Power : Neutral (N)										
No	Frequency (MHz)	Correction Factor (dB)	Reading Value (dBuV)		Emission Level (dBuV)		Limit (dBuV)		Margin (dB)	
			Q.P.	AV.	Q.P.	AV.	Q.P.	AV.	Q.P.	AV.
1	0.16600	9.67	33.44	22.53	43.11	32.20	65.16	55.16	-22.05	-22.96
2	0.21000	9.70	27.74	16.57	37.44	26.27	63.21	53.21	-25.77	-26.94
3	0.23400	9.71	25.52	13.66	35.23	23.37	62.31	52.31	-27.08	-28.94
4	0.25800	9.72	23.29	8.47	33.01	18.19	61.50	51.50	-28.49	-33.31
5	0.28200	9.73	21.75	11.17	31.48	20.90	60.76	50.76	-29.28	-29.86
6	0.30600	9.74	20.57	11.65	30.31	21.39	60.08	50.08	-29.77	-28.69

Remarks:

1. Q.P. and AV. are abbreviations of quasi-peak and average individually.
2. The emission levels of other frequencies were very low against the limit.
3. Margin value = Emission level – Limit value
4. Correction factor = Insertion loss + Cable loss
5. Emission Level = Correction Factor + Reading Value

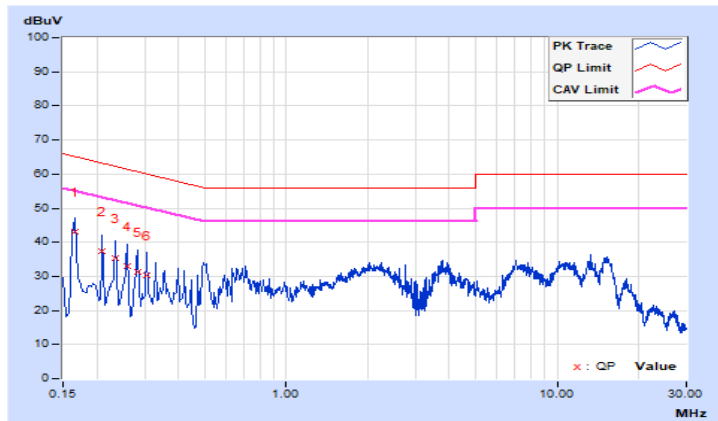

7.6 Unwanted Emissions below 1 GHz

Mode A

RF Mode	802.11a	Channel	CH 173 : 5865 MHz
Frequency Range	9 kHz ~ 1 GHz	Detector Function & Bandwidth	(QP) RB = 120kHz
Input Power	120 Vac, 60 Hz	Environmental Conditions	24°C, 70% RH
Tested By	Luis Lee		

Antenna Polarity & Test Distance : Horizontal at 3 m

No	Frequency (MHz)	Emission Level (dBuV/m)	Limit (dBuV/m)	Margin (dB)	Antenna Height (m)	Table Angle (Degree)	Raw Value (dBuV)	Correction Factor (dB/m)
1	118.27	30.6 QP	43.5	-12.9	1.49 H	291	41.7	-11.1
2	159.98	29.2 QP	43.5	-14.3	1.00 H	258	37.8	-8.6
3	256.01	30.2 QP	46.0	-15.8	1.00 H	249	39.2	-9.0
4	399.57	33.9 QP	46.0	-12.1	1.00 H	173	39.8	-5.9
5	483.96	35.7 QP	46.0	-10.3	1.49 H	16	40.2	-4.5
6	566.41	29.2 QP	46.0	-16.8	1.49 H	2	32.2	-3.0

Remarks:

1. Emission Level(dBuV/m) = Raw Value(dBuV) + Correction Factor(dB/m)
2. Correction Factor(dB/m) = Antenna Factor(dB/m) + Cable Factor(dB) – Pre-Amplifier Factor(dB)
3. Margin value = Emission Level – Limit value
4. The other emission levels were very low against the limit of frequency range 30 MHz ~ 1 GHz.
5. The emission levels were very low against the limit of frequency range 9 kHz ~ 30 MHz: the amplitude of spurious emissions attenuated more than 20 dB below the permissible value to be report.

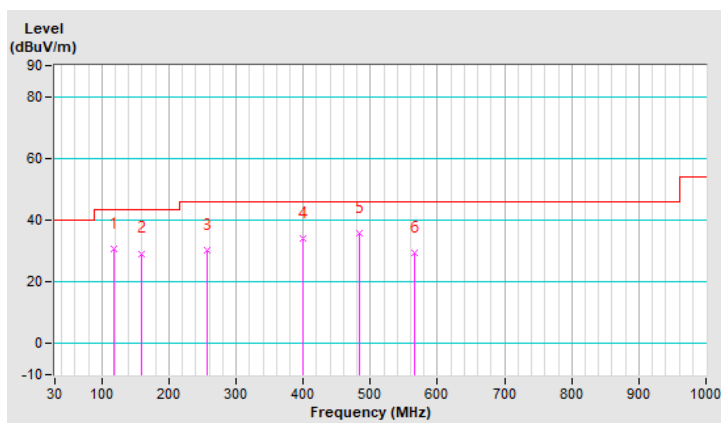

RF Mode	802.11a	Channel	CH 173 : 5865 MHz
Frequency Range	9 kHz ~ 1 GHz	Detector Function & Bandwidth	(QP) RB = 120kHz
Input Power	120 Vac, 60 Hz	Environmental Conditions	24°C, 70% RH
Tested By	Luis Lee		

Antenna Polarity & Test Distance : Vertical at 3 m								
No	Frequency (MHz)	Emission Level (dBuV/m)	Limit (dBuV/m)	Margin (dB)	Antenna Height (m)	Table Angle (Degree)	Raw Value (dBuV)	Correction Factor (dB/m)
1	43.58	35.0 QP	40.0	-5.0	1.01 V	245	44.2	-9.2
2	122.15	27.7 QP	43.5	-15.8	1.01 V	16	38.4	-10.7
3	159.01	35.3 QP	43.5	-8.2	1.01 V	243	43.8	-8.5
4	250.19	32.5 QP	46.0	-13.5	1.01 V	45	41.7	-9.2
5	420.91	31.9 QP	46.0	-14.1	1.01 V	119	37.3	-5.4
6	500.45	35.5 QP	46.0	-10.5	1.01 V	113	39.6	-4.1

Remarks:

1. Emission Level(dBuV/m) = Raw Value(dBuV) + Correction Factor(dB/m)
2. Correction Factor(dB/m) = Antenna Factor(dB/m) + Cable Factor(dB) – Pre-Amplifier Factor(dB)
3. Margin value = Emission Level – Limit value
4. The other emission levels were very low against the limit of frequency range 30 MHz ~ 1 GHz.
5. The emission levels were very low against the limit of frequency range 9 kHz ~ 30 MHz: the amplitude of spurious emissions attenuated more than 20 dB below the permissible value to be report.

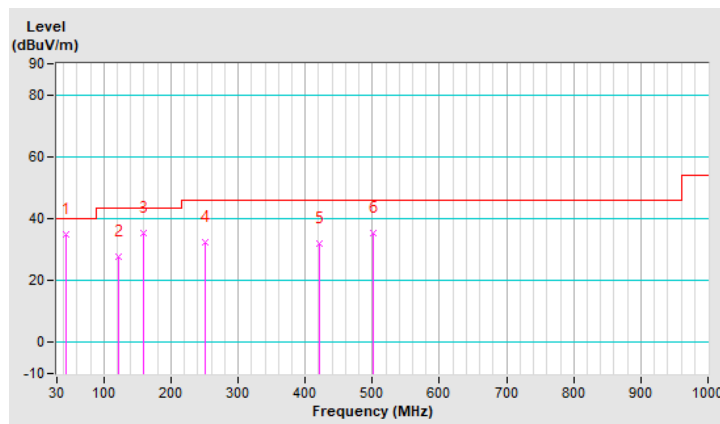

Mode B

RF Mode	802.11a	Channel	CH 173 : 5865 MHz
Frequency Range	9 kHz ~ 1 GHz	Detector Function & Bandwidth	(QP) RB = 120kHz
Input Power	120 Vac, 60 Hz	Environmental Conditions	24°C, 70% RH
Tested By	Luis Lee		

Antenna Polarity & Test Distance : Horizontal at 3 m

No	Frequency (MHz)	Emission Level (dBuV/m)	Limit (dBuV/m)	Margin (dB)	Antenna Height (m)	Table Angle (Degree)	Raw Value (dBuV)	Correction Factor (dB/m)
1	43.58	23.2 QP	40.0	-16.8	1.49 H	3	32.4	-9.2
2	69.77	24.7 QP	40.0	-15.3	1.00 H	98	35.5	-10.8
3	128.94	24.6 QP	43.5	-18.9	1.49 H	264	34.7	-10.1
4	171.62	25.6 QP	43.5	-17.9	1.49 H	287	34.7	-9.1
5	428.67	29.1 QP	46.0	-16.9	1.49 H	182	34.3	-5.2
6	637.22	29.8 QP	46.0	-16.2	1.49 H	60	30.8	-1.0

Remarks:

1. Emission Level(dBuV/m) = Raw Value(dBuV) + Correction Factor(dB/m)
2. Correction Factor(dB/m) = Antenna Factor(dB/m) + Cable Factor(dB) – Pre-Amplifier Factor(dB)
3. Margin value = Emission Level – Limit value
4. The other emission levels were very low against the limit of frequency range 30 MHz ~ 1 GHz.
5. The emission levels were very low against the limit of frequency range 9 kHz ~ 30 MHz: the amplitude of spurious emissions attenuated more than 20 dB below the permissible value to be report.

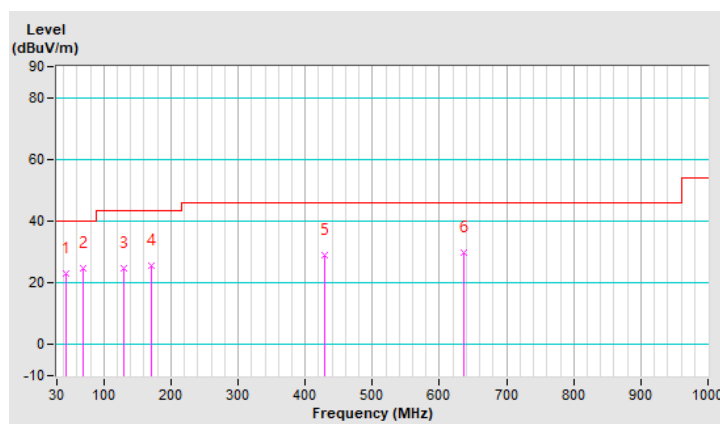

RF Mode	802.11a	Channel	CH 173 : 5865 MHz
Frequency Range	9 kHz ~ 1 GHz	Detector Function & Bandwidth	(QP) RB = 120kHz
Input Power	120 Vac, 60 Hz	Environmental Conditions	24°C, 70% RH
Tested By	Luis Lee		

Antenna Polarity & Test Distance : Vertical at 3 m								
No	Frequency (MHz)	Emission Level (dBuV/m)	Limit (dBuV/m)	Margin (dB)	Antenna Height (m)	Table Angle (Degree)	Raw Value (dBuV)	Correction Factor (dB/m)
1	97.90	23.9 QP	43.5	-19.6	1.49 V	300	37.6	-13.7
2	166.77	24.9 QP	43.5	-18.6	1.01 V	267	33.6	-8.7
3	317.12	26.2 QP	46.0	-19.8	1.49 V	98	33.2	-7.0
4	399.57	28.9 QP	46.0	-17.1	1.49 V	133	34.8	-5.9
5	614.91	31.6 QP	46.0	-14.4	1.49 V	96	32.9	-1.3
6	688.63	30.3 QP	46.0	-15.7	1.01 V	55	30.7	-0.4

Remarks:

1. Emission Level(dBuV/m) = Raw Value(dBuV) + Correction Factor(dB/m)
2. Correction Factor(dB/m) = Antenna Factor(dB/m) + Cable Factor(dB) – Pre-Amplifier Factor(dB)
3. Margin value = Emission Level – Limit value
4. The other emission levels were very low against the limit of frequency range 30 MHz ~ 1 GHz.
5. The emission levels were very low against the limit of frequency range 9 kHz ~ 30 MHz: the amplitude of spurious emissions attenuated more than 20 dB below the permissible value to be report.

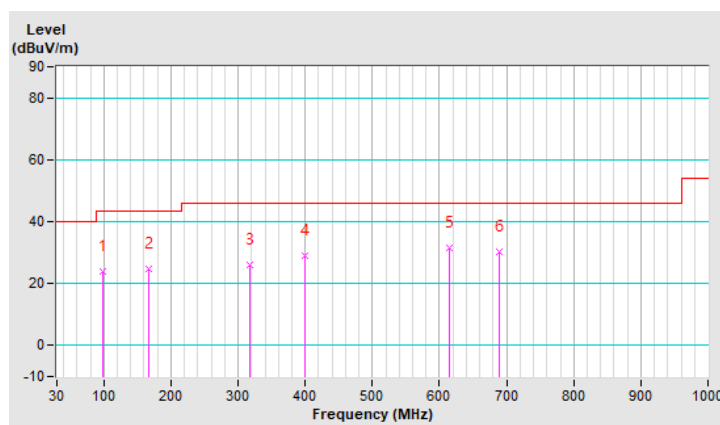

7.7 Unwanted Emissions above 1 GHz

RF Mode	802.11a	Channel	CH 169 : 5845 MHz
Frequency Range	1 GHz ~ 40 GHz	Detector Function & Bandwidth	(PK) RB = 1 MHz, VB = 3 MHz (AV) RB = 1 MHz, VB = 1 kHz
Input Power	120 Vac, 60 Hz	Environmental Conditions	23°C, 66% RH
Tested By	Luis Lee/TitanHSU		

Antenna Polarity & Test Distance : Horizontal at 3 m								
No	Frequency (MHz)	Emission Level (dBuV/m)	Limit (dBuV/m)	Margin (dB)	Antenna Height (m)	Table Angle (Degree)	Raw Value (dBuV)	Correction Factor (dB/m)
1	#5650.00	60.2 PK	68.2	-8.0	1.68 H	140	47.5	12.7
2	*5845.00	118.2 PK			1.68 H	140	74.4	43.8
3	*5845.00	108.3 AV			1.68 H	140	64.5	43.8
4	#5925.00	62.0 PK	88.2	-26.2	1.68 H	140	48.4	13.6
5	11690.00	62.5 PK	74.0	-11.5	1.99 H	206	39.4	23.1
6	11690.00	49.4 AV	54.0	-4.6	1.99 H	206	26.3	23.1
Antenna Polarity & Test Distance : Vertical at 3 m								
No	Frequency (MHz)	Emission Level (dBuV/m)	Limit (dBuV/m)	Margin (dB)	Antenna Height (m)	Table Angle (Degree)	Raw Value (dBuV)	Correction Factor (dB/m)
1	#5650.00	60.7 PK	68.2	-7.5	1.62 V	222	48.0	12.7
2	*5845.00	119.0 PK			1.62 V	222	75.2	43.8
3	*5845.00	110.2 AV			1.62 V	222	66.4	43.8
4	#5925.00	62.3 PK	88.2	-25.9	1.62 V	222	48.7	13.6
5	11690.00	62.6 PK	74.0	-11.4	1.65 V	175	39.5	23.1
6	11690.00	49.6 AV	54.0	-4.4	1.65 V	175	26.5	23.1

Remarks:

1. Emission Level(dBuV/m) = Raw Value(dBuV) + Correction Factor(dB/m)
2. Correction Factor(dB/m) = Antenna Factor(dB/m) + Cable Factor(dB) – Pre-Amplifier Factor(dB)
3. Margin value = Emission Level – Limit value
4. The other emission levels were very low against the limit.
5. " * " : Fundamental frequency, the limit was restricted at the RF Output Power.
6. " # " : The radiated frequency is out of the restricted band.



RF Mode	802.11a	Channel	CH 173 : 5865 MHz
Frequency Range	1 GHz ~ 40 GHz	Detector Function & Bandwidth	(PK) RB = 1 MHz, VB = 3 MHz (AV) RB = 1 MHz, VB = 1 kHz
Input Power	120 Vac, 60 Hz	Environmental Conditions	23°C, 66% RH
Tested By	Luis Lee/TitanHSU		

Antenna Polarity & Test Distance : Horizontal at 3 m

No	Frequency (MHz)	Emission Level (dBuV/m)	Limit (dBuV/m)	Margin (dB)	Antenna Height (m)	Table Angle (Degree)	Raw Value (dBuV)	Correction Factor (dB/m)
1	#5650.00	60.7 PK	68.2	-7.5	1.68 H	138	48.0	12.7
2	*5865.00	117.2 PK			1.68 H	138	73.4	43.8
3	*5865.00	107.3 AV			1.68 H	138	63.5	43.8
4	#5925.00	60.9 PK	88.2	-27.3	1.68 H	138	47.3	13.6
5	11730.00	61.9 PK	74.0	-12.1	1.94 H	203	39.0	22.9
6	11730.00	49.2 AV	54.0	-4.8	1.94 H	203	26.3	22.9

Antenna Polarity & Test Distance : Vertical at 3 m

No	Frequency (MHz)	Emission Level (dBuV/m)	Limit (dBuV/m)	Margin (dB)	Antenna Height (m)	Table Angle (Degree)	Raw Value (dBuV)	Correction Factor (dB/m)
1	#5650.00	61.0 PK	68.2	-7.2	1.82 V	202	48.3	12.7
2	*5865.00	119.1 PK			1.82 V	202	75.3	43.8
3	*5865.00	109.9 AV			1.82 V	202	66.1	43.8
4	#5925.00	61.6 PK	88.2	-26.6	1.82 V	202	48.0	13.6
5	11730.00	62.5 PK	74.0	-11.5	1.58 V	165	39.6	22.9
6	11730.00	49.4 AV	54.0	-4.6	1.58 V	165	26.5	22.9

Remarks:

1. Emission Level(dBuV/m) = Raw Value(dBuV) + Correction Factor(dB/m)
2. Correction Factor(dB/m) = Antenna Factor(dB/m) + Cable Factor(dB) – Pre-Amplifier Factor(dB)
3. Margin value = Emission Level – Limit value
4. The other emission levels were very low against the limit.
5. " * ": Fundamental frequency, the limit was restricted at the RF Output Power.
6. " # ": The radiated frequency is out of the restricted band.



RF Mode	802.11a	Channel	CH 177 : 5885 MHz
Frequency Range	1 GHz ~ 40 GHz	Detector Function & Bandwidth	(PK) RB = 1 MHz, VB = 3 MHz (AV) RB = 1 MHz, VB = 1 kHz
Input Power	120 Vac, 60 Hz	Environmental Conditions	23°C, 66% RH
Tested By	Luis Lee/TitanHSU		

Antenna Polarity & Test Distance : Horizontal at 3 m

No	Frequency (MHz)	Emission Level (dBuV/m)	Limit (dBuV/m)	Margin (dB)	Antenna Height (m)	Table Angle (Degree)	Raw Value (dBuV)	Correction Factor (dB/m)
1	#5650.00	60.2 PK	68.2	-8.0	1.68 H	135	47.5	12.7
2	*5885.00	116.5 PK			1.68 H	135	72.6	43.9
3	*5885.00	106.8 AV			1.68 H	135	62.9	43.9
4	#5925.00	61.6 PK	88.2	-26.6	1.68 H	135	48.0	13.6
5	11770.00	61.8 PK	74.0	-12.2	1.99 H	227	39.2	22.6
6	11770.00	48.9 AV	54.0	-5.1	1.99 H	227	26.3	22.6

Antenna Polarity & Test Distance : Vertical at 3 m

No	Frequency (MHz)	Emission Level (dBuV/m)	Limit (dBuV/m)	Margin (dB)	Antenna Height (m)	Table Angle (Degree)	Raw Value (dBuV)	Correction Factor (dB/m)
1	#5650.00	60.6 PK	68.2	-7.6	1.64 V	201	47.9	12.7
2	*5885.00	119.1 PK			1.64 V	201	75.2	43.9
3	*5885.00	109.8 AV			1.64 V	201	65.9	43.9
4	#5925.00	61.8 PK	88.2	-26.4	1.64 V	201	48.2	13.6
5	11770.00	62.1 PK	74.0	-11.9	1.59 V	165	39.5	22.6
6	11770.00	49.1 AV	54.0	-4.9	1.59 V	165	26.5	22.6

Remarks:

1. Emission Level(dBuV/m) = Raw Value(dBuV) + Correction Factor(dB/m)
2. Correction Factor(dB/m) = Antenna Factor(dB/m) + Cable Factor(dB) – Pre-Amplifier Factor(dB)
3. Margin value = Emission Level – Limit value
4. The other emission levels were very low against the limit.
5. " * " : Fundamental frequency, the limit was restricted at the RF Output Power.
6. " # " : The radiated frequency is out of the restricted band.



RF Mode	802.11be (EHT20)	Channel	CH 169 : 5845 MHz
Frequency Range	1 GHz ~ 40 GHz	Detector Function & Bandwidth	(PK) RB = 1 MHz, VB = 3 MHz (AV) RB = 1 MHz, VB = 1 kHz
Input Power	120 Vac, 60 Hz	Environmental Conditions	23°C, 66% RH
Tested By	Luis Lee/TitanHSU		

Antenna Polarity & Test Distance : Horizontal at 3 m

No	Frequency (MHz)	Emission Level (dBUV/m)	Limit (dBUV/m)	Margin (dB)	Antenna Height (m)	Table Angle (Degree)	Raw Value (dBUV)	Correction Factor (dB/m)
1	#5650.00	60.9 PK	68.2	-7.3	1.68 H	134	48.2	12.7
2	*5845.00	119.8 PK			1.68 H	134	76.0	43.8
3	*5845.00	107.6 AV			1.68 H	134	63.8	43.8
4	#5925.00	61.6 PK	88.2	-26.6	1.68 H	134	48.0	13.6
5	11690.00	62.5 PK	74.0	-11.5	1.93 H	214	39.4	23.1
6	11690.00	49.4 AV	54.0	-4.6	1.93 H	214	26.3	23.1

Antenna Polarity & Test Distance : Vertical at 3 m

No	Frequency (MHz)	Emission Level (dBUV/m)	Limit (dBUV/m)	Margin (dB)	Antenna Height (m)	Table Angle (Degree)	Raw Value (dBUV)	Correction Factor (dB/m)
1	#5650.00	61.3 PK	68.2	-6.9	1.69 V	200	48.6	12.7
2	*5845.00	121.8 PK			1.69 V	200	78.0	43.8
3	*5845.00	109.4 AV			1.69 V	200	65.6	43.8
4	#5925.00	62.0 PK	88.2	-26.2	1.69 V	200	48.4	13.6
5	11690.00	62.6 PK	74.0	-11.4	1.58 V	165	39.5	23.1
6	11690.00	49.5 AV	54.0	-4.5	1.58 V	165	26.4	23.1

Remarks:

1. Emission Level(dBUV/m) = Raw Value(dBUV) + Correction Factor(dB/m)
2. Correction Factor(dB/m) = Antenna Factor(dB/m) + Cable Factor(dB) – Pre-Amplifier Factor(dB)
3. Margin value = Emission Level – Limit value
4. The other emission levels were very low against the limit.
5. " * ": Fundamental frequency, the limit was restricted at the RF Output Power.
6. " # ": The radiated frequency is out of the restricted band.



RF Mode	802.11be (EHT20)	Channel	CH 173 : 5865 MHz
Frequency Range	1 GHz ~ 40 GHz	Detector Function & Bandwidth	(PK) RB = 1 MHz, VB = 3 MHz (AV) RB = 1 MHz, VB = 1 kHz
Input Power	120 Vac, 60 Hz	Environmental Conditions	23°C, 66% RH
Tested By	Luis Lee/TitanHSU		

Antenna Polarity & Test Distance : Horizontal at 3 m

No	Frequency (MHz)	Emission Level (dBuV/m)	Limit (dBuV/m)	Margin (dB)	Antenna Height (m)	Table Angle (Degree)	Raw Value (dBuV)	Correction Factor (dB/m)
1	#5650.00	60.7 PK	68.2	-7.5	1.68 H	134	48.0	12.7
2	*5865.00	119.7 PK			1.68 H	134	75.9	43.8
3	*5865.00	107.4 AV			1.68 H	134	63.6	43.8
4	#5925.00	61.0 PK	88.2	-27.2	1.68 H	134	47.4	13.6
5	11730.00	62.1 PK	74.0	-11.9	1.83 H	205	39.2	22.9
6	11730.00	49.0 AV	54.0	-5.0	1.83 H	205	26.1	22.9

Antenna Polarity & Test Distance : Vertical at 3 m

No	Frequency (MHz)	Emission Level (dBuV/m)	Limit (dBuV/m)	Margin (dB)	Antenna Height (m)	Table Angle (Degree)	Raw Value (dBuV)	Correction Factor (dB/m)
1	#5650.00	60.9 PK	68.2	-7.3	1.81 V	197	48.2	12.7
2	*5865.00	121.4 PK			1.81 V	197	77.6	43.8
3	*5865.00	109.1 AV			1.81 V	197	65.3	43.8
4	#5925.00	61.5 PK	88.2	-26.7	1.81 V	197	47.9	13.6
5	11730.00	62.4 PK	74.0	-11.6	1.59 V	175	39.5	22.9
6	11730.00	49.3 AV	54.0	-4.7	1.59 V	175	26.4	22.9

Remarks:

1. Emission Level(dBuV/m) = Raw Value(dBuV) + Correction Factor(dB/m)
2. Correction Factor(dB/m) = Antenna Factor(dB/m) + Cable Factor(dB) – Pre-Amplifier Factor(dB)
3. Margin value = Emission Level – Limit value
4. The other emission levels were very low against the limit.
5. " * ": Fundamental frequency, the limit was restricted at the RF Output Power.
6. " # ": The radiated frequency is out of the restricted band.



RF Mode	802.11be (EHT20)	Channel	CH 177 : 5885 MHz
Frequency Range	1 GHz ~ 40 GHz	Detector Function & Bandwidth	(PK) RB = 1 MHz, VB = 3 MHz (AV) RB = 1 MHz, VB = 1 kHz
Input Power	120 Vac, 60 Hz	Environmental Conditions	23°C, 66% RH
Tested By	Luis Lee/TitanHSU		

Antenna Polarity & Test Distance : Horizontal at 3 m

No	Frequency (MHz)	Emission Level (dBUV/m)	Limit (dBUV/m)	Margin (dB)	Antenna Height (m)	Table Angle (Degree)	Raw Value (dBUV)	Correction Factor (dB/m)
1	#5650.00	61.1 PK	68.2	-7.1	1.68 H	143	48.4	12.7
2	*5885.00	119.2 PK			1.68 H	143	75.3	43.9
3	*5885.00	106.5 AV			1.68 H	143	62.6	43.9
4	#5925.00	62.6 PK	88.2	-25.6	1.68 H	143	49.0	13.6
5	11770.00	62.0 PK	74.0	-12.0	1.85 H	193	39.4	22.6
6	11770.00	48.9 AV	54.0	-5.1	1.85 H	193	26.3	22.6

Antenna Polarity & Test Distance : Vertical at 3 m

No	Frequency (MHz)	Emission Level (dBUV/m)	Limit (dBUV/m)	Margin (dB)	Antenna Height (m)	Table Angle (Degree)	Raw Value (dBUV)	Correction Factor (dB/m)
1	#5650.00	61.3 PK	68.2	-6.9	1.80 V	200	48.6	12.7
2	*5885.00	121.6 PK			1.80 V	200	77.7	43.9
3	*5885.00	108.6 AV			1.80 V	200	64.7	43.9
4	#5925.00	63.0 PK	88.2	-25.2	1.80 V	200	49.4	13.6
5	11770.00	62.2 PK	74.0	-11.8	1.49 V	175	39.6	22.6
6	11770.00	49.1 AV	54.0	-4.9	1.49 V	175	26.5	22.6

Remarks:

1. Emission Level(dBUV/m) = Raw Value(dBUV) + Correction Factor(dB/m)
2. Correction Factor(dB/m) = Antenna Factor(dB/m) + Cable Factor(dB) – Pre-Amplifier Factor(dB)
3. Margin value = Emission Level – Limit value
4. The other emission levels were very low against the limit.
5. " * ": Fundamental frequency, the limit was restricted at the RF Output Power.
6. " # ": The radiated frequency is out of the restricted band.



RF Mode	802.11be (EHT40)	Channel	CH 167 : 5835 MHz
Frequency Range	1 GHz ~ 40 GHz	Detector Function & Bandwidth	(PK) RB = 1 MHz, VB = 3 MHz (AV) RB = 1 MHz, VB = 1 kHz
Input Power	120 Vac, 60 Hz	Environmental Conditions	23°C, 66% RH
Tested By	Luis Lee/TitanHSU		

Antenna Polarity & Test Distance : Horizontal at 3 m

No	Frequency (MHz)	Emission Level (dBUV/m)	Limit (dBUV/m)	Margin (dB)	Antenna Height (m)	Table Angle (Degree)	Raw Value (dBUV)	Correction Factor (dB/m)
1	#5650.00	60.2 PK	68.2	-8.0	1.63 H	139	47.5	12.7
2	*5835.00	115.8 PK			1.63 H	139	72.0	43.8
3	*5835.00	104.3 AV			1.63 H	139	60.5	43.8
4	#5925.00	61.7 PK	88.2	-26.5	1.68 H	139	48.1	13.6
5	11670.00	62.2 PK	74.0	-11.8	1.97 H	216	39.0	23.2
6	11670.00	49.2 AV	54.0	-4.8	1.97 H	216	26.0	23.2

Antenna Polarity & Test Distance : Vertical at 3 m

No	Frequency (MHz)	Emission Level (dBUV/m)	Limit (dBUV/m)	Margin (dB)	Antenna Height (m)	Table Angle (Degree)	Raw Value (dBUV)	Correction Factor (dB/m)
1	#5650.00	60.5 PK	68.2	-7.7	1.84 V	200	47.8	12.7
2	*5835.00	120.0 PK			1.84 V	200	76.2	43.8
3	*5835.00	108.3 AV			1.84 V	200	64.5	43.8
4	#5925.00	61.9 PK	88.2	-26.3	1.84 V	200	48.3	13.6
5	11670.00	62.4 PK	74.0	-11.6	1.59 V	169	39.2	23.2
6	11670.00	49.4 AV	54.0	-4.6	1.59 V	169	26.2	23.2

Remarks:

1. Emission Level(dBUV/m) = Raw Value(dBUV) + Correction Factor(dB/m)
2. Correction Factor(dB/m) = Antenna Factor(dB/m) + Cable Factor(dB) – Pre-Amplifier Factor(dB)
3. Margin value = Emission Level – Limit value
4. The other emission levels were very low against the limit.
5. " * " : Fundamental frequency, the limit was restricted at the RF Output Power.
6. " # " : The radiated frequency is out of the restricted band.



RF Mode	802.11be (EHT40)	Channel	CH 175 : 5875 MHz
Frequency Range	1 GHz ~ 40 GHz	Detector Function & Bandwidth	(PK) RB = 1 MHz, VB = 3 MHz (AV) RB = 1 MHz, VB = 1 kHz
Input Power	120 Vac, 60 Hz	Environmental Conditions	23°C, 66% RH
Tested By	Luis Lee/TitanHSU		

Antenna Polarity & Test Distance : Horizontal at 3 m

No	Frequency (MHz)	Emission Level (dBUV/m)	Limit (dBUV/m)	Margin (dB)	Antenna Height (m)	Table Angle (Degree)	Raw Value (dBUV)	Correction Factor (dB/m)
1	#5650.00	60.3 PK	68.2	-7.9	1.63 H	135	47.6	12.7
2	*5875.00	115.9 PK			1.63 H	135	72.1	43.8
3	*5875.00	103.3 AV			1.63 H	135	59.5	43.8
4	#5925.00	72.9 PK	88.2	-15.3	1.63 H	135	59.3	13.6
5	11750.00	61.1 PK	74.0	-12.9	1.99 H	205	38.4	22.7
6	11750.00	48.0 AV	54.0	-6.0	1.99 H	205	25.3	22.7

Antenna Polarity & Test Distance : Vertical at 3 m

No	Frequency (MHz)	Emission Level (dBUV/m)	Limit (dBUV/m)	Margin (dB)	Antenna Height (m)	Table Angle (Degree)	Raw Value (dBUV)	Correction Factor (dB/m)
1	#5650.00	60.6 PK	68.2	-7.6	1.45 V	219	47.9	12.7
2	*5875.00	119.8 PK			1.45 V	219	76.0	43.8
3	*5875.00	106.1 AV			1.45 V	219	62.3	43.8
4	#5925.00	64.2 PK	88.2	-24.0	1.45 V	219	50.6	13.6
5	11750.00	61.7 PK	74.0	-12.3	1.59 V	185	39.0	22.7
6	11750.00	48.5 AV	54.0	-5.5	1.59 V	185	25.8	22.7

Remarks:

1. Emission Level(dBUV/m) = Raw Value(dBUV) + Correction Factor(dB/m)
2. Correction Factor(dB/m) = Antenna Factor(dB/m) + Cable Factor(dB) – Pre-Amplifier Factor(dB)
3. Margin value = Emission Level – Limit value
4. The other emission levels were very low against the limit.
5. " * ": Fundamental frequency, the limit was restricted at the RF Output Power.
6. " # ": The radiated frequency is out of the restricted band.



RF Mode	802.11be (EHT80)	Channel	CH 171 : 5855 MHz
Frequency Range	1 GHz ~ 40 GHz	Detector Function & Bandwidth	(PK) RB = 1 MHz, VB = 3 MHz (AV) RB = 1 MHz, VB = 1 kHz
Input Power	120 Vac, 60 Hz	Environmental Conditions	23°C, 66% RH
Tested By	Luis Lee/TitanHSU		

Antenna Polarity & Test Distance : Horizontal at 3 m

No	Frequency (MHz)	Emission Level (dBuV/m)	Limit (dBuV/m)	Margin (dB)	Antenna Height (m)	Table Angle (Degree)	Raw Value (dBuV)	Correction Factor (dB/m)
1	#5650.00	60.9 PK	68.2	-7.3	1.63 H	133	48.2	12.7
2	*5855.00	113.4 PK			1.63 H	133	69.6	43.8
3	*5855.00	100.7 AV			1.63 H	133	56.9	43.8
4	#5928.50	75.1 PK	88.2	-13.1	1.63 H	133	61.5	13.6
5	11710.00	61.9 PK	74.0	-12.1	1.86 H	214	39.0	22.9
6	11710.00	48.4 AV	54.0	-5.6	1.86 H	214	25.5	22.9

Antenna Polarity & Test Distance : Vertical at 3 m

No	Frequency (MHz)	Emission Level (dBuV/m)	Limit (dBuV/m)	Margin (dB)	Antenna Height (m)	Table Angle (Degree)	Raw Value (dBuV)	Correction Factor (dB/m)
1	#5650.00	68.1 PK	68.2	-0.1	1.57 V	197	55.4	12.7
2	*5855.00	117.5 PK			1.57 V	197	73.7	43.8
3	*5855.00	106.6 AV			1.57 V	197	62.8	43.8
4	#5925.00	83.9 PK	88.2	-4.3	1.57 V	197	70.3	13.6
5	11710.00	62.1 PK	74.0	-11.9	1.55 V	178	39.2	22.9
6	11710.00	48.8 AV	54.0	-5.2	1.55 V	178	25.9	22.9

Remarks:

1. Emission Level(dBuV/m) = Raw Value(dBuV) + Correction Factor(dB/m)
2. Correction Factor(dB/m) = Antenna Factor(dB/m) + Cable Factor(dB) – Pre-Amplifier Factor(dB)
3. Margin value = Emission Level – Limit value
4. The other emission levels were very low against the limit.
5. " * ": Fundamental frequency, the limit was restricted at the RF Output Power.
6. " # ": The radiated frequency is out of the restricted band.



RF Mode	802.11be (EHT160)	Channel	CH 163 : 5815 MHz
Frequency Range	1 GHz ~ 40 GHz	Detector Function & Bandwidth	(PK) RB = 1 MHz, VB = 3 MHz (AV) RB = 1 MHz, VB = 1 kHz
Input Power	120 Vac, 60 Hz	Environmental Conditions	23°C, 66% RH
Tested By	Luis Lee/TitanHSU		

Antenna Polarity & Test Distance : Horizontal at 3 m

No	Frequency (MHz)	Emission Level (dBuV/m)	Limit (dBuV/m)	Margin (dB)	Antenna Height (m)	Table Angle (Degree)	Raw Value (dBuV)	Correction Factor (dB/m)
1	#5650.00	63.8 PK	68.2	-4.4	1.82 H	142	51.1	12.7
2	*5815.00	109.5 PK			1.82 H	142	65.8	43.7
3	*5815.00	97.5 AV			1.82 H	142	53.8	43.7
4	#5930.00	68.9 PK	88.2	-19.3	1.82 H	142	55.3	13.6
5	11630.00	62.7 PK	74.0	-11.3	1.97 H	214	39.1	23.6
6	11630.00	49.3 AV	54.0	-4.7	1.97 H	214	25.7	23.6

Antenna Polarity & Test Distance : Vertical at 3 m

No	Frequency (MHz)	Emission Level (dBuV/m)	Limit (dBuV/m)	Margin (dB)	Antenna Height (m)	Table Angle (Degree)	Raw Value (dBuV)	Correction Factor (dB/m)
1	#5618.80	68.1 PK	68.2	-0.1	1.69 V	196	55.6	12.5
2	*5815.00	113.7 PK			1.69 V	196	70.0	43.7
3	*5815.00	101.2 AV			1.69 V	196	57.5	43.7
4	#5925.00	69.7 PK	88.2	-18.5	1.69 V	196	56.1	13.6
5	11630.00	62.8 PK	74.0	-11.2	1.61 V	183	39.2	23.6
6	11630.00	49.5 AV	54.0	-4.5	1.61 V	183	25.9	23.6

Remarks:

1. Emission Level(dBuV/m) = Raw Value(dBuV) + Correction Factor(dB/m)
2. Correction Factor(dB/m) = Antenna Factor(dB/m) + Cable Factor(dB) – Pre-Amplifier Factor(dB)
3. Margin value = Emission Level – Limit value
4. The other emission levels were very low against the limit.
5. " * " : Fundamental frequency, the limit was restricted at the RF Output Power.
6. " # " : The radiated frequency is out of the restricted band.

Plot of Band Edge

Detector Function & Bandwidth	(PK) RB = 1 MHz, VB = 3 MHz
--	-----------------------------

802.11a Channel 169

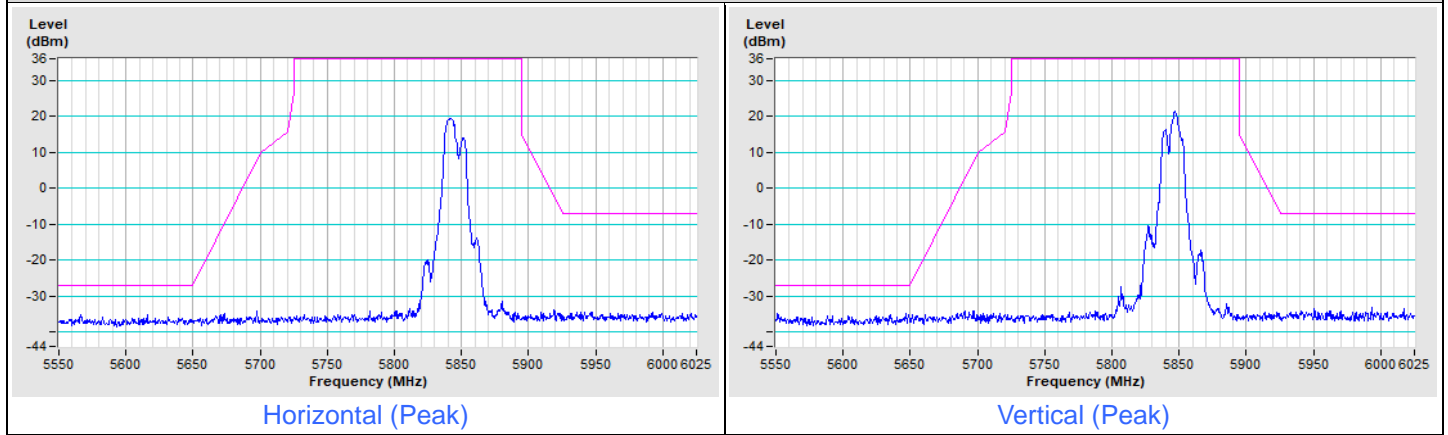

802.11a Channel 173

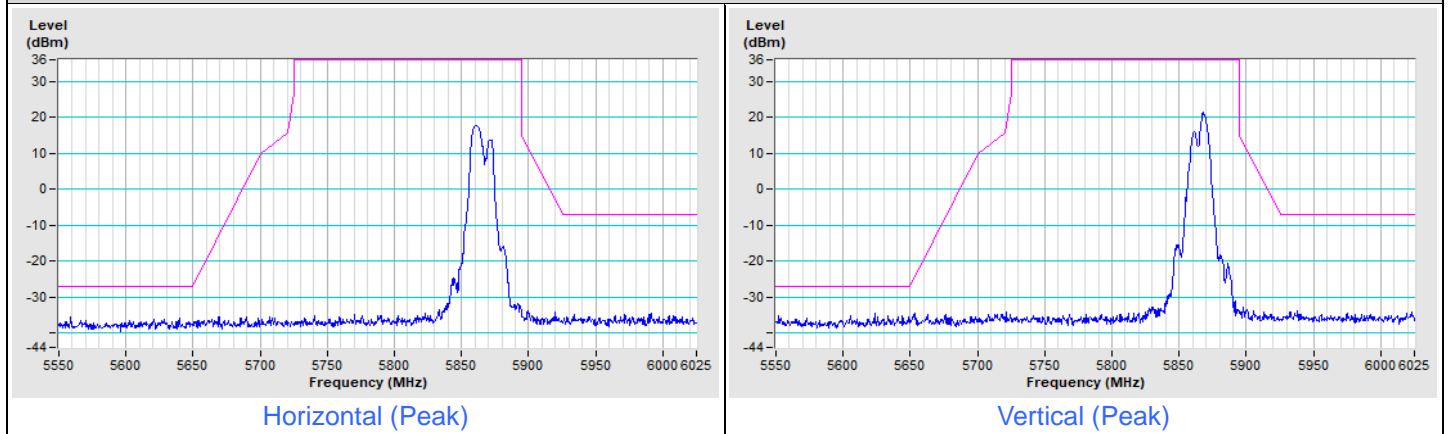

802.11a Channel 177

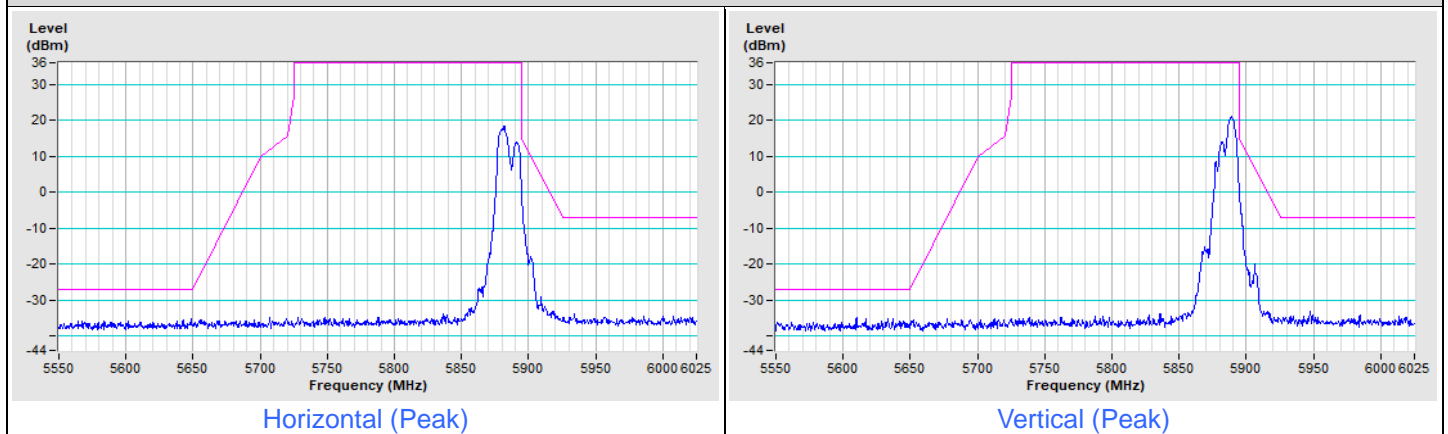

802.11be (EHT20) Channel 169

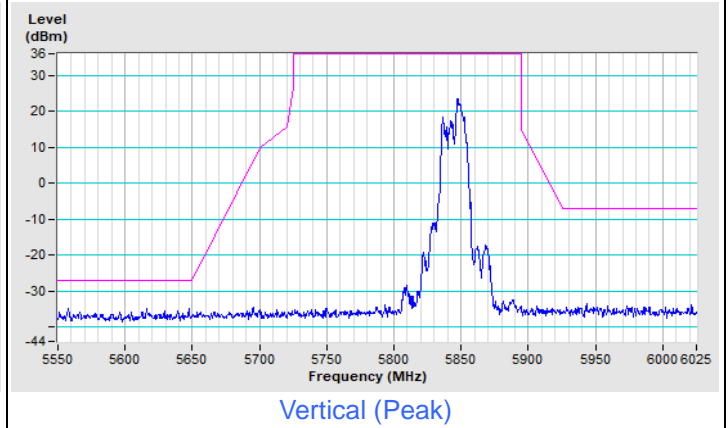
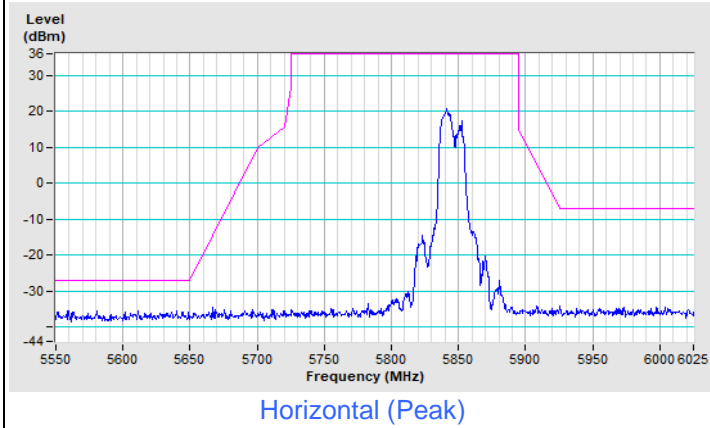

802.11be (EHT20) Channel 173

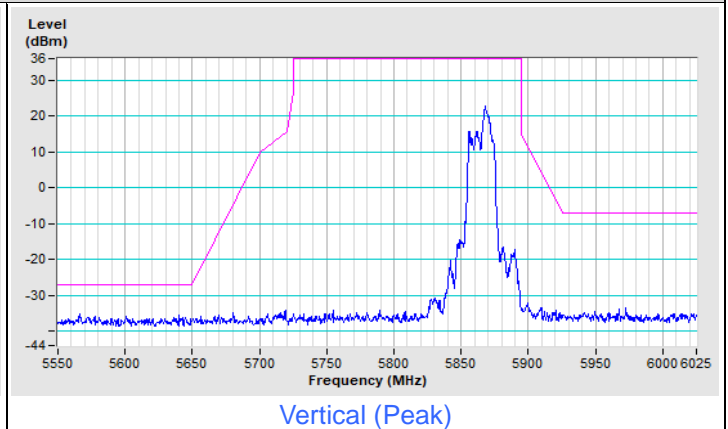
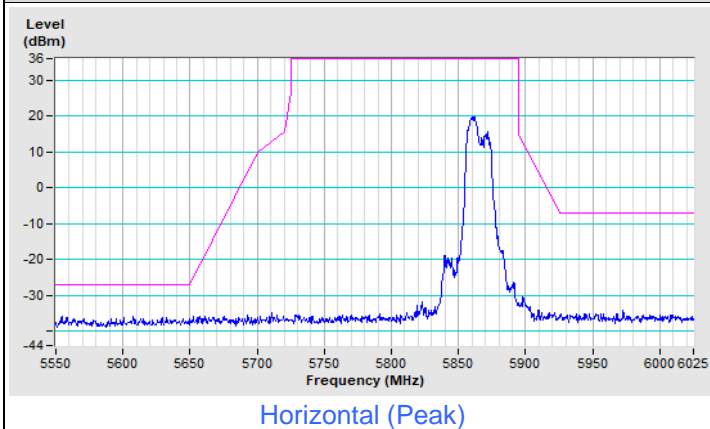

802.11be (EHT20) Channel 177

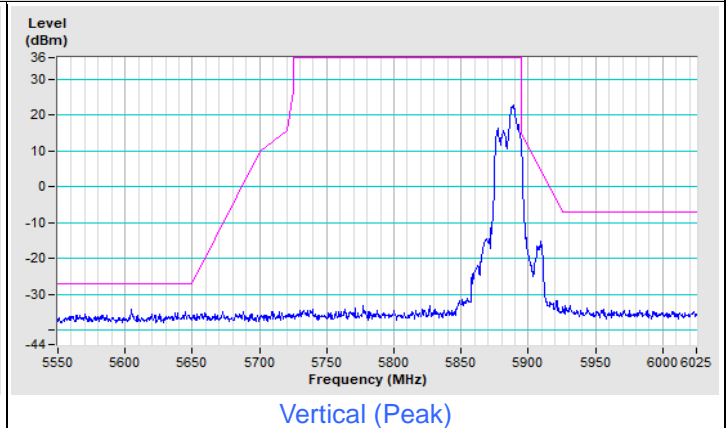
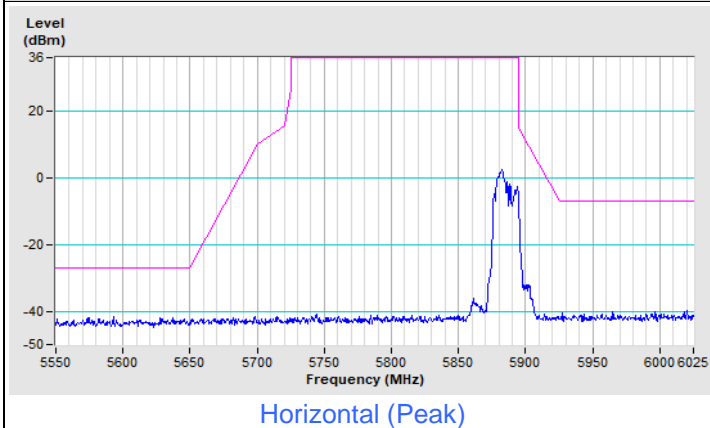

802.11be (EHT40) Channel 167

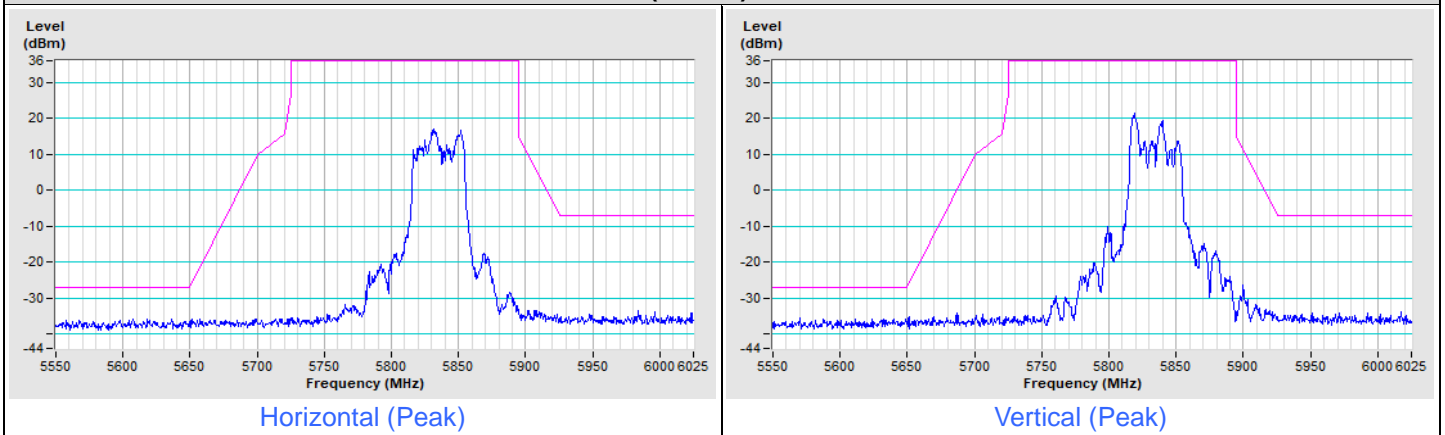

802.11be (EHT40) Channel 175

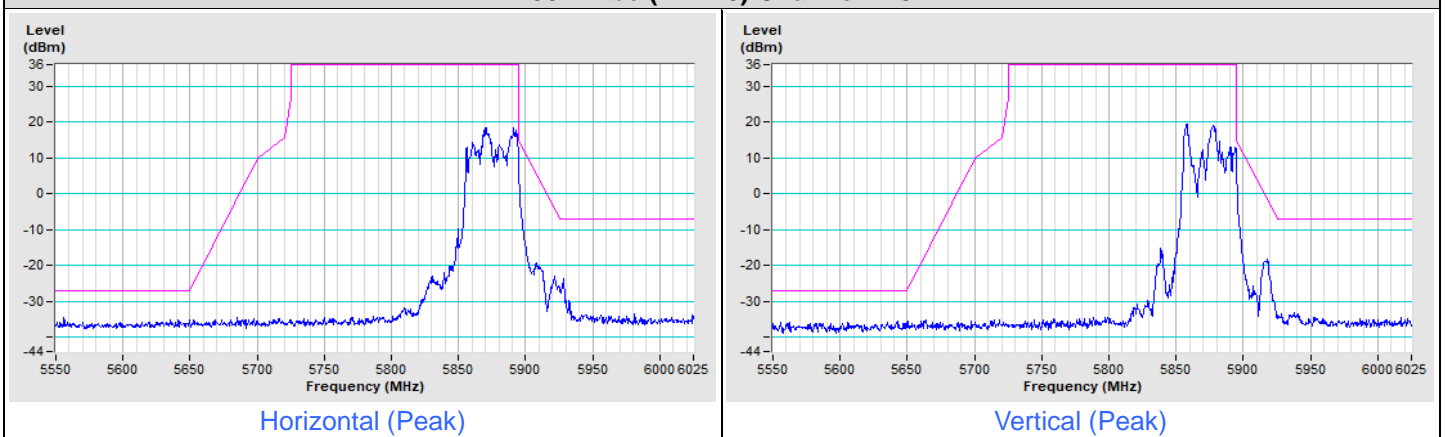

802.11be (EHT80) Channel 171

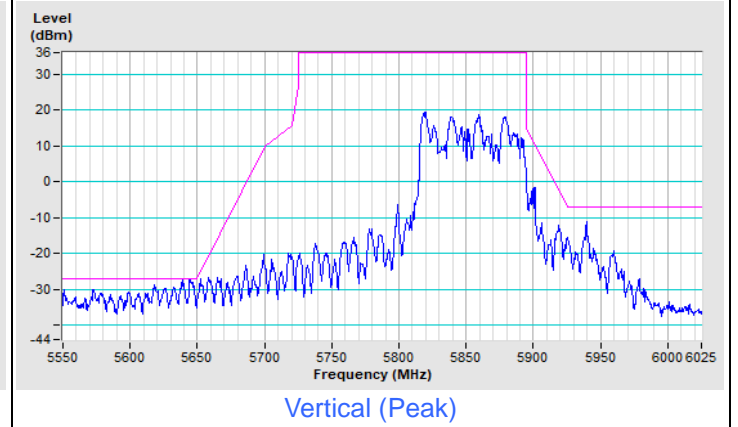
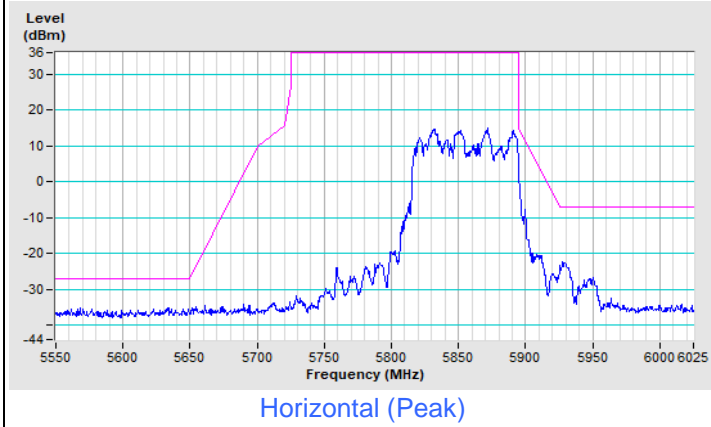

802.11be (EHT160) Channel 163

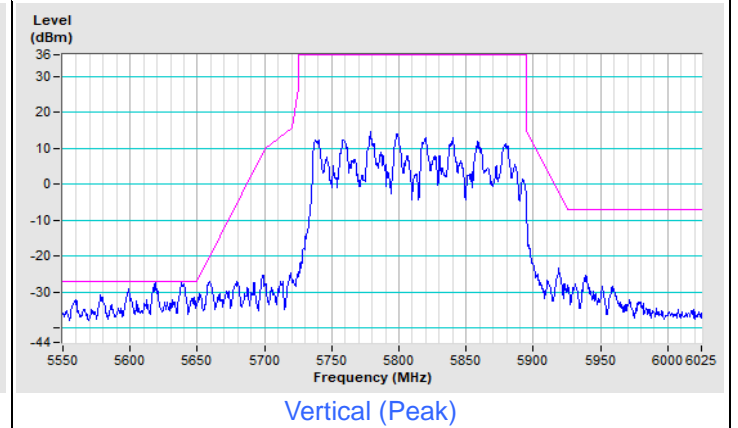
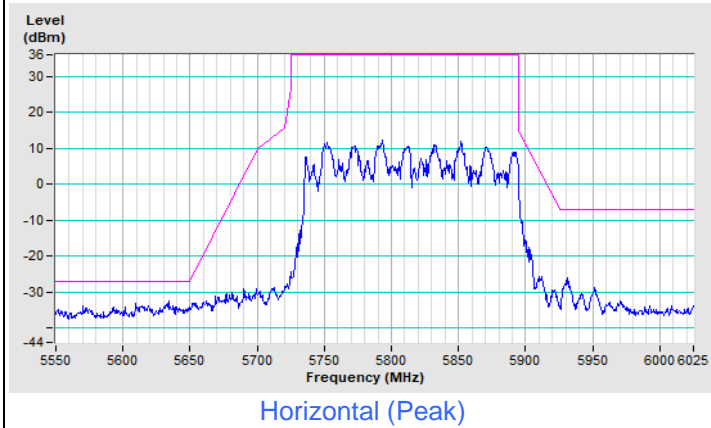

8 Operational Restrictions for 5.85-5.895GHz U-NII Devices

For Indoor Access Point operates in the 5.850-5.895 GHz band, is supplied power from a wired connection, has an integrated antenna, is not battery powered, and does not have a weatherized enclosure. Indoor access point devices must bear the following statement in a conspicuous location on the device and in the user's manual: FCC regulations restrict operation of this device to indoor use only.

Device is a Indoor access point / indoor subordinate, all restrictions are meet the §15.403 requirements. Please refer to the Attestation letter exhibit supplied within this application.

9 Pictures of Test Arrangements

Please refer to the attached file (Test Setup Photo)

10 Information of the Testing Laboratories

We, Bureau Veritas Consumer Products Services (H.K.) Ltd., Taoyuan Branch, were founded in 1988 to provide our best service in EMC, Radio, Telecom and Safety consultation. Our laboratories are FCC recognized accredited test firms and accredited according to ISO/IEC 17025.

If you have any comments, please feel free to contact us at the following:

Lin Kou EMC/RF Lab

Tel: 886-2-26052180

Fax: 886-2-26051924

Hsin Chu EMC/RF/Telecom Lab

Tel: 886-3-6668565

Fax: 886-3-6668323

Hwa Ya EMC/RF/Safety Lab

Tel: 886-3-3183232

Fax: 886-3-3270892

Email: service.adt@bureauveritas.com

Web Site: <http://ee.bureauveritas.com.tw>

The address and road map of all our labs can be found in our web site also.

--- END ---