

TEST REPORT

CERTIFICATE OF CONFORMITY

Standard: 47 CFR FCC Part 15, Subpart E (Section 15.407)
Report No.: RFBBQZ-WTW-P23020336-4
FCC ID: PY322400578
Product: Mesh WiFi 6E Satellite
Brand: NETGEAR
Model No.: MS90
Received Date: 2023/1/31
Test Date: 2023/3/13 ~ 2023/4/3
Issued Date: 2023/6/1

Applicant: NETGEAR, Inc.
Address: 350 East Plumeria Drive San Jose, CA 95134
Issued By: Bureau Veritas Consumer Products Services (H.K.) Ltd., Taoyuan Branch
Hsin Chu Laboratory
Lab Address: E-2, No.1, Li Hsin 1st Road, Hsinchu Science Park, Hsinchu City 300, Taiwan
Test Location: E-2, No.1, Li Hsin 1st Road, Hsinchu Science Park, Hsinchu City 300, Taiwan
FCC Registration / 723255 / TW2022
Designation Number:

Approved by: _____, **Date:** 2023/6/1
May Chen / Manager

This test report consists of 71 pages in total. It may be duplicated completely for legal use with the approval of the applicant. It should not be reproduced except in full, without the written approval of our laboratory. The test results in the report only apply to the tested sample. The test results in this report are traceable to the national or international standards.

Prepared by : Claire Kuan / Specialist



This report is governed by, and incorporates by reference, the Conditions of Testing as posted at the date of issuance of this report at <http://www.bureauveritas.com/home/about-us/our-business/cps/about-us/terms-conditions/> and is intended for your exclusive use. Any copying or replication of this report to or for any other person or entity, or use of our name or trademark, is permitted only with our prior written permission. This report sets forth our findings solely with respect to the test samples identified herein. The results set forth in this report are not indicative or representative of the quality or characteristics of the lot from which a test sample was taken or any similar or identical product unless specifically and expressly noted. Our report includes all of the tests requested by you and the results thereof based upon the information that you provided to us. Measurement uncertainty is only provided upon request for accredited tests. Statements of conformity are based on simple acceptance criteria without taking measurement uncertainty into account, unless otherwise requested in writing. You have 60 days from date of issuance of this report to notify us of any material error or omission caused by our negligence or if you require measurement uncertainty; provided, however, that such notice shall be in writing and shall specifically address the issue you wish to raise. A failure to raise such issue within the prescribed time shall constitute your unqualified acceptance of the completeness of this report, the tests conducted and the correctness of the report contents.

Table of Contents

Release Control Record	4
1 Certificate	5
2 Summary of Test Results	6
2.1 Measurement Uncertainty	6
2.2 Supplementary Information	6
3 General Information	7
3.1 General Description of EUT	7
3.2 Antenna Description of EUT	8
3.3 Channel List	9
3.4 Test Mode Applicability and Tested Channel Detail	10
3.5 Duty Cycle of Test Signal	11
3.6 Test Program Used and Operation Descriptions	13
3.7 Connection Diagram of EUT and Peripheral Devices	13
3.8 Configuration of Peripheral Devices and Cable Connections	14
4 Test Instruments	15
4.1 RF Output Power	15
4.2 Power Spectral Density	15
4.3 6 dB Bandwidth	15
4.4 Frequency Stability	15
4.5 AC Power Conducted Emissions	16
4.6 Unwanted Emissions below 1 GHz	16
4.7 Unwanted Emissions above 1 GHz	17
5 Limits of Test Items	18
5.1 RF Output Power	18
5.2 Power Spectral Density	18
5.3 6 dB Bandwidth	18
5.4 Frequency Stability	18
5.5 AC Power Conducted Emissions	18
5.6 Unwanted Emissions below 1 GHz	19
5.7 Unwanted Emissions above 1 GHz	19
6 Test Arrangements	20
6.1 RF Output Power	20
6.1.1 Test Setup	20
6.1.2 Test Procedure	20
6.2 Power Spectral Density	21
6.2.1 Test Setup	21
6.2.2 Test Procedure	21
6.3 6 dB Bandwidth	22
6.3.1 Test Setup	22
6.3.2 Test Procedure	22
6.4 Frequency Stability	22
6.4.1 Test Setup	22
6.4.2 Test Procedure	22
6.5 AC Power Conducted Emissions	23
6.5.1 Test Setup	23
6.5.2 Test Procedure	23
6.6 Unwanted Emissions below 1 GHz	24
6.6.1 Test Setup	24
6.6.2 Test Procedure	25
6.7 Unwanted Emissions above 1 GHz	26
6.7.1 Test Setup	26
6.7.2 Test Procedure	26
7 Test Results of Test Item	27



7.1	RF Output Power.....	27
7.2	Power Spectral Density	31
7.3	6 dB Bandwidth	35
7.4	Frequency Stability	37
7.5	AC Power Conducted Emissions	38
7.6	Unwanted Emissions below 1 GHz	40
7.7	Unwanted Emissions above 1 GHz.....	42
8	Operational Restrictions for 5.85-5.895 GHz U-NII Devices.....	69
9	Pictures of Test Arrangements	70
10	Information of the Testing Laboratories	71



Release Control Record

Issue No.	Description	Date Issued
RFBBQZ-WTW-P23020336-4	Original release.	2023/6/1

1 Certificate

Product: Mesh WiFi 6E Satellite

Brand: NETGEAR

Test Model: MS90

Sample Status: Engineering sample

Applicant: NETGEAR, Inc.

Test Date: 2023/3/13 ~ 2023/4/3

Standard: 47 CFR FCC Part 15, Subpart E (Section 15.407)

Measurement ANSI C63.10-2013

procedure: KDB 291074 D02 EMC Measurement v01

KDB 789033 D02 General UNII Test Procedure New Rules v02r01

KDB 662911 D01 Multiple Transmitter Output v02r01

The above equipment has been tested by **Bureau Veritas Consumer Products Services (H.K.) Ltd., Taoyuan Branch**, and found compliance with the requirement of the above standards. The test record, data evaluation & Equipment Under Test (EUT) configurations represented herein are true and accurate accounts of the measurements of the sample's RF characteristics under the conditions specified in this report.

2 Summary of Test Results

47 CFR FCC Part 15, Subpart E (Section 15.407)			
Clause	Test Item	Result	Remark
15.407(a)(3)	RF Output Power	Pass	Meet the requirement of limit.
15.407(a)(3)	Power Spectral Density	Pass	Meet the requirement of limit.
15.407(b)(9)	AC Power Conducted Emissions	Pass	Minimum passing margin is -6.59 dB at 0.35063 MHz
15.407(b)(9)	Unwanted Emissions below 1 GHz	Pass	Minimum passing margin is -5.9 dB at 63.46 MHz
15.407(b)(5) 15.407(b)(10)	Unwanted Emissions above 1 GHz	Pass	Minimum passing margin is -0.5 dB at 5639.93, 5646.42 MHz
15.407(e)	6 dB Bandwidth	Pass	Meet the requirement of limit.
15.407(g)	Frequency Stability	Pass	Meet the requirement of limit.
15.403	Operational restrictions U-NII 4 devices	-	Declaration by applicant.
15.203	Antenna Requirement	Pass	Antenna connector is ipex(MHF) not a standard connector.

Note: Determining compliance based on the results of the compliance measurement, not taking into account measurement instrumentation uncertainty.

2.1 Measurement Uncertainty

Where relevant, the following measurement uncertainty levels have been estimated for tests performed on the EUT as specified in CISPR 16-4-2:

Measurement	Specification	Expanded Uncertainty (k=2) (±)
AC Power Conducted Emissions	150 kHz ~ 30 MHz	1.9 dB
Unwanted Emissions below 1 GHz	9 kHz ~ 30 MHz	3.1 dB
	30 MHz ~ 1 GHz	5.5 dB
Unwanted Emissions above 1 GHz	1 GHz ~ 18 GHz	5.1 dB
	18 GHz ~ 40 GHz	5.3 dB

The other instruments specified are routine verified to remain within the calibrated levels, no measurement uncertainty is required to be calculated.

2.2 Supplementary Information

There is not any deviation from the test standards for the test method, and no modifications required for compliance.

3 General Information

3.1 General Description of EUT

Product	Mesh WiFi 6E Satellite
Brand	NETGEAR
Test Model	MS90
Status of EUT	Engineering sample
Power Supply Rating	Refer to Note
Modulation Type	64QAM, 16QAM, QPSK, BPSK for OFDM 256QAM for OFDM in 11ac mode 1024QAM for OFDMA in 11ax HE mode
Modulation Technology	OFDM, OFDMA
Transfer Rate	802.11a: up to 54 Mbps 802.11n: up to 300 Mbps 802.11ac: up to 1733.3 Mbps 802.11ax: up to 2401.9 Mbps
Operating Frequency	5.835 GHz ~ 5.885 GHz
Number of Channel	802.11a, 802.11n (HT20), 802.11ac (VHT20), 802.11ax (HE20): 3 802.11n (HT40), 802.11ac (VHT40), 802.11ax (HE40): 2 802.11ac (VHT80), 802.11ax (HE80): 1 802.11ac (VHT160), 802.11ax (HE160): 1
Output Power	CDD Mode: EIRP: 1435.489 mW (31.57 dBm) Beamforming Mode: EIRP: 2074.914 mW (33.17 dBm)
EUT Category	Indoor subordinate device only

Note:

1. The EUT has below radios as following table:

Radio 1	Radio 2
WLAN 2.4GHz	WLAN 5GHz + 6GHz

2. Simultaneously transmission condition.

Condition	Technology		
1	WLAN (2.4 GHz)	WLAN (5 GHz)	WLAN (6 GHz)

Note: The emission of the simultaneous operation has been evaluated and no non-compliance was found.

3. The EUT must be supplied with a power adapter as the following table:

AC Adapter 1		
Brand	Model	Specification
NETGEAR	2AED030FC	Part Number: 332-11595-01 AC Input: 100-120V~60Hz Max 1.0A DC Output: 12V, 2.5A DC Output Cable: unshielded, 1.8m without core
AC Adapter 2		
Brand	Model	Specification
NETGEAR	ADS-40FPC-12 12030E	Part Number: 332-11585-02 AC Input: 100-120V~50/60Hz 1.0A DC Output: 12V, 2.5A DC Output Cable: unshielded, 1.8m without core
Ethernet Cable		
Brand	Model	Specification
NETGEAR	312-10138-01	Signal Line : 2m, Unshielded

4. The above EUT information is declared by manufacturer and for more detailed features description, please refers to the manufacturer's specifications or user's manual.

3.2 Antenna Description of EUT

1. The antenna information is listed as below.

Antenna NO.	RF Chain NO.	Antenna Net Gain(dBi)	Frequency range (GHz)	Antenna Type	Connector Type
2G	2G-0	2.15	2.4~2.4835	PIFA	ipex(MHF)
DB1	2G-1	2.21	2.4~2.4835	PIFA	ipex(MHF)
DB2	2G-2	2.29	2.4~2.4835	PIFA	ipex(MHF)
5G1	5G-0	2.38	5.15~5.25	PIFA	ipex(MHF)
		2.38	5.25~5.35		
		2.65	5.47~5.725		
		2.69	5.725~5.85		
		2.69	5.85~5.895		
5G2	5G-1	2.49	5.15~5.25	PIFA	ipex(MHF)
		2.49	5.25~5.35		
		2.81	5.47~5.725		
		2.54	5.725~5.85		
		2.54	5.85~5.895		
DB1	6G-0	2.85	5.925~6.425	PIFA	ipex(MHF)
		2.89	6.425~6.525		
		2.89	6.525~6.875		
		2.93	6.875~7.125		
DB2	6G-1	2.98	5.925~6.425	PIFA	ipex(MHF)
		2.87	6.425~6.525		
		2.87	6.525~6.875		
		2.99	6.875~7.125		

* Detail antenna specification please refer to antenna datasheet and/or antenna measurement report.

2. The EUT incorporates a MIMO function:

5 GHz Band		
Modulation Mode	TX & RX Configuration	
802.11a	2TX	2RX
802.11n (HT20)	2TX	2RX
802.11n (HT40)	2TX	2RX
802.11ac (VHT20)	2TX	2RX
802.11ac (VHT40)	2TX	2RX
802.11ac (VHT80)	2TX	2RX
802.11ac (VHT160)	2TX	2RX
802.11ax (HE20)	2TX	2RX
802.11ax (HE40)	2TX	2RX
802.11ax (HE80)	2TX	2RX
802.11ax (HE160)	2TX	2RX

Note:

- All of modulation mode support beamforming function except 802.11a modulation mode.
- The EUT support Beamforming and CDD mode, therefore both mode were investigated and the worst case scenario was identified. The worst case data were presented in test report.
- The modulation and bandwidth are similar for 802.11n mode for 20 MHz (40 MHz), 802.11ac mode for 20 MHz (40 MHz, 80 MHz) and 802.11ax mode for 20 MHz (40 MHz, 80 MHz, 160 MHz), therefore the manufacturer will control the power for 802.11n/ac mode is the same as the 802.11ax or more lower than it and investigated worst case to representative mode in test report.

3.3 Channel List

For U-NII-4

3 channels are provided for 802.11a, 802.11n (HT20), 802.11ac (VHT20), 802.11ax (HE20):

Channel	Frequency	Channel	Frequency	Channel	Frequency
*169	5845 MHz	173	5865 MHz	177	5885 MHz

2 channels are provided for 802.11n (HT40), 802.11ac (VHT40), 802.11ax (HE40):

Channel	Frequency	Channel	Frequency
*167	5835 MHz	175	5875 MHz

1 channel is provided for 802.11ac (VHT80), 802.11ax (HE80):

Channel	Frequency
*171	5855 MHz

1 channel is provided for 802.11ac (VHT160), 802.11ax (HE160):

Channel	Frequency
*163	5815 MHz

Note: * U-NII-3 & -4 span channels.

3.4 Test Mode Applicability and Tested Channel Detail

Pre-Scan:	1.The AC Adapter has the following models: Adapter 1 : 2AED030FC / Adapter 2 : ADS-40FPC-12 12030E. Pre-scan these models of AC Adapters and find the worst case as a representative test condition. 2.Pre-Scan has been conducted to determine the worst-case mode from all possible combinations between available modulations, data rates and antenna ports (if EUT with antenna diversity architecture).
Worst Case:	1. AC Adapter Worst Condition: Adapter1: 2AED030FC 2. The EUT is usually used lying flat and was therefore chosen for Unwanted Emission testing.

Following channel(s) was (were) selected for the final test as listed below:

Test Item	Mode	Signal Mode	Tested Channel	Modulation	Data Rate Parameter
RF Output Power / Power Spectral Density	802.11a	CDD	169, 173, 177	BPSK	6Mb/s
	802.11ax (HE20)	CDD & Beamforming	169, 173, 177	BPSK	MCS0
	802.11ax (HE40)	CDD & Beamforming	167, 175	BPSK	MCS0
	802.11ax (HE80)	CDD & Beamforming	171	BPSK	MCS0
	802.11ax (HE160)	CDD & Beamforming	163	BPSK	MCS0
6 dB Bandwidth	802.11a	CDD	169, 173, 177	BPSK	6Mb/s
	802.11ax (HE20)	CDD	169, 173, 177	BPSK	MCS0
	802.11ax (HE40)	CDD	167, 175	BPSK	MCS0
	802.11ax (HE80)	CDD	171	BPSK	MCS0
	802.11ax (HE160)	CDD	163	BPSK	MCS0
Frequency Stability	802.11a	-	169	un-modulation	-
AC Power Conducted Emissions	802.11ax (HE20)	CDD	173	BPSK	MCS0
Unwanted Emissions below 1 GHz	802.11ax (HE20)	CDD	173	BPSK	MCS0
Unwanted Emissions above 1 GHz	802.11a	CDD	169, 173, 177	BPSK	6Mb/s
	802.11ax (HE20)	CDD	169, 173, 177	BPSK	MCS0
	802.11ax (HE40)	CDD	167, 175	BPSK	MCS0
	802.11ax (HE80)	CDD	171	BPSK	MCS0
	802.11ax (HE160)	CDD	163	BPSK	MCS0

3.5 Duty Cycle of Test Signal

802.11a: Duty cycle = 3.01 ms / 3.036 ms x 100% = 99.1%

802.11ax (HE20): Duty cycle = 3.025 ms / 3.053 ms x 100% = 99.1%

802.11ax (HE40): Duty cycle = 3.011 ms / 3.039 ms x 100% = 99.1%

802.11ax (HE80): Duty cycle = 2.999 ms / 3.025 ms x 100% = 99.1%

802.11ax (HE160): Duty cycle = 2.999 ms / 3.025 ms x 100% = 99.1%

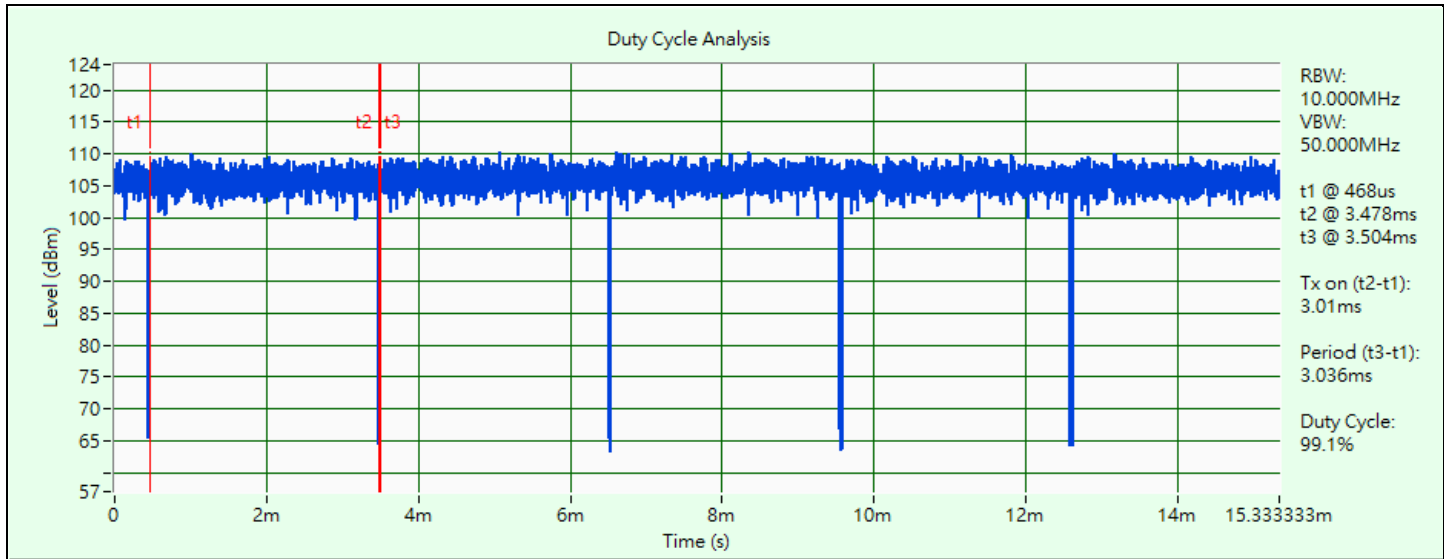

802.11a

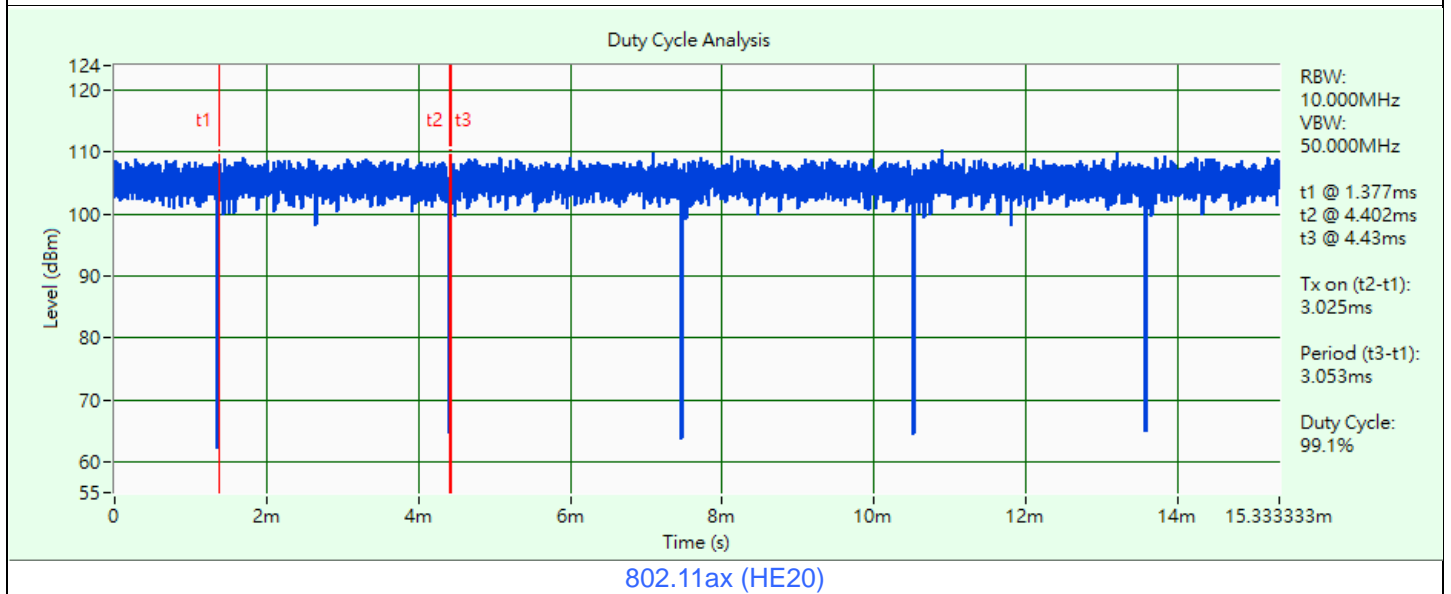

802.11ax (HE20)

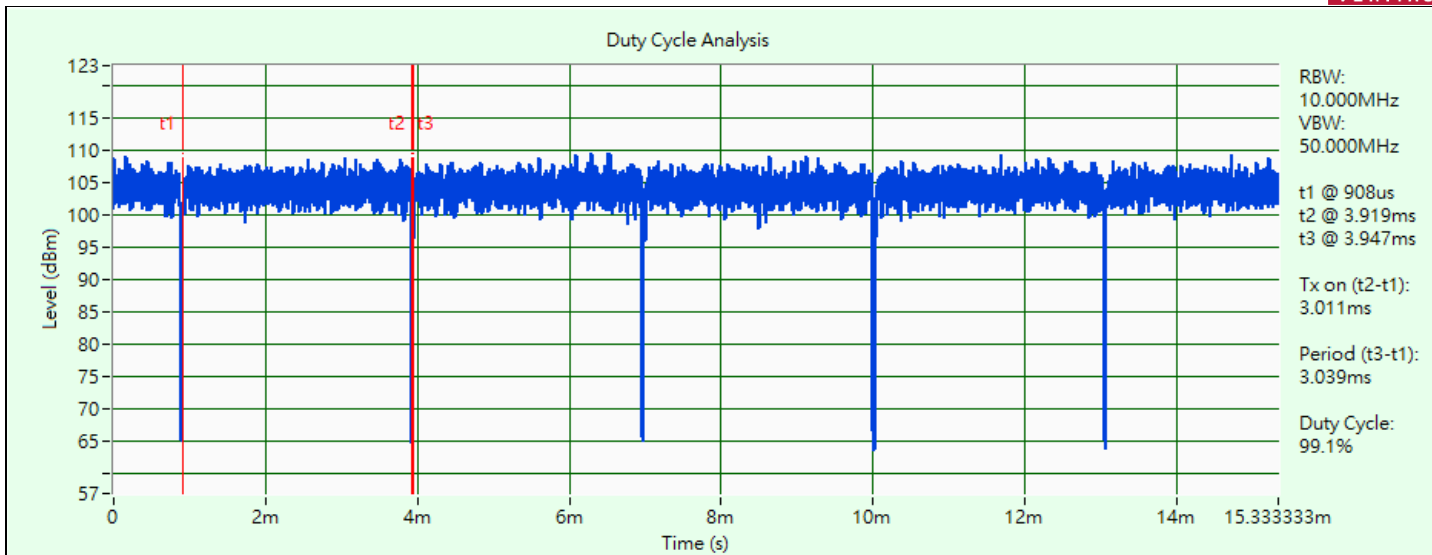

802.11ax (HE40)

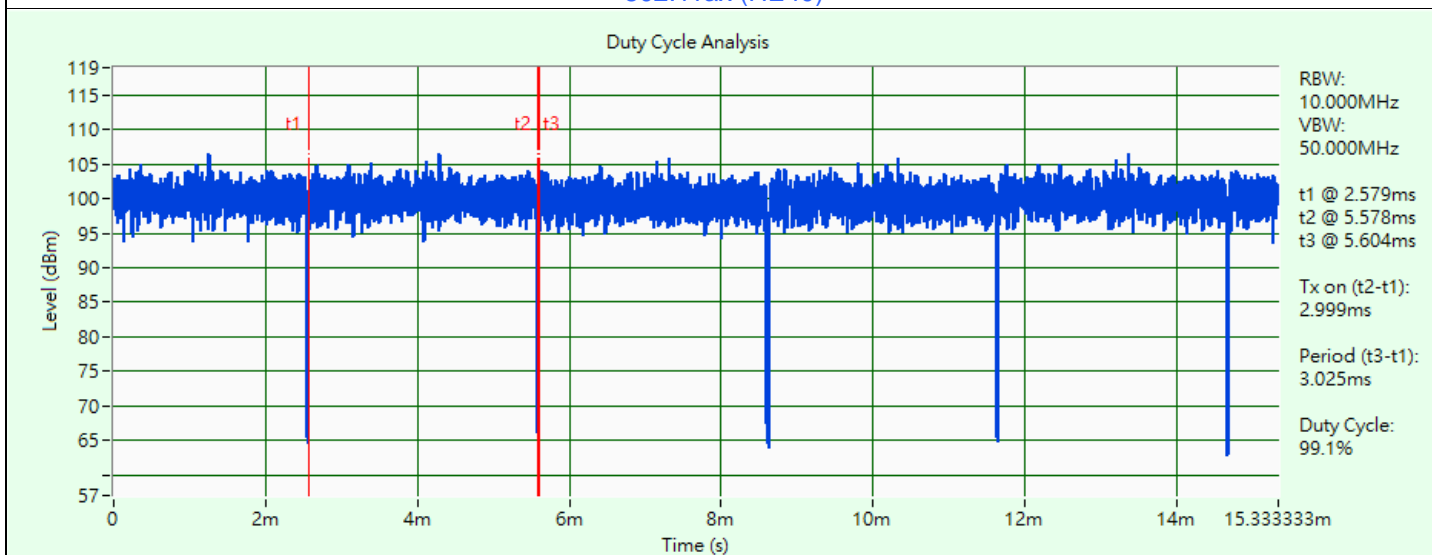

802.11ax (HE80)

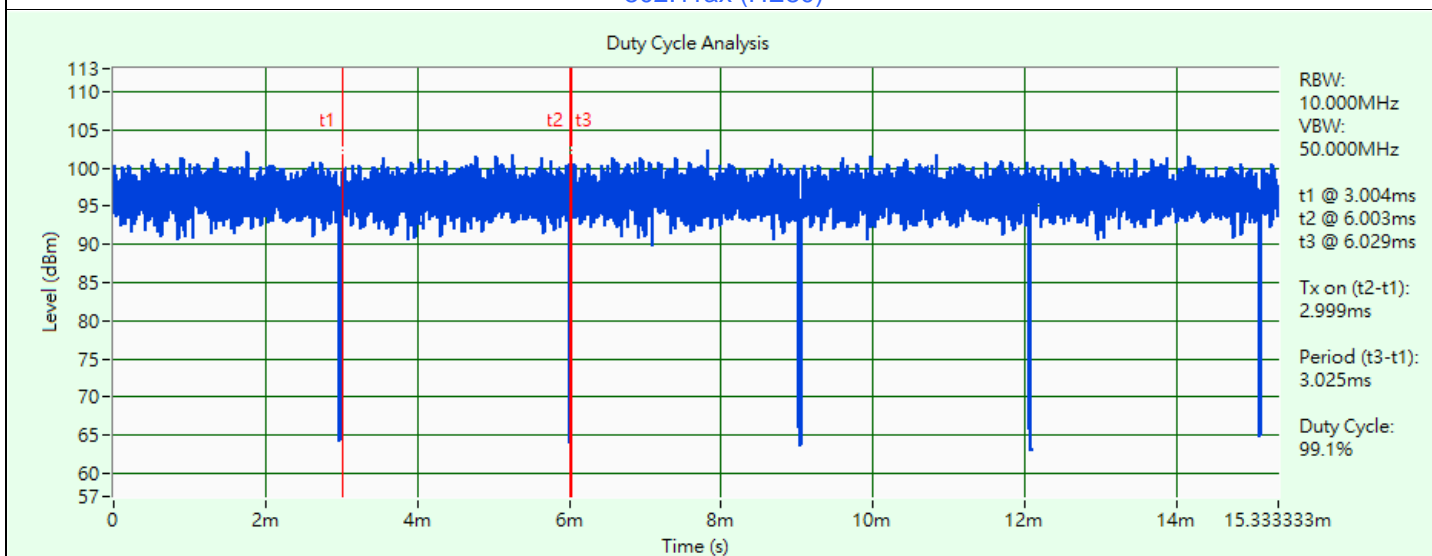

802.11ax (HE160)

3.6 Test Program Used and Operation Descriptions

Controlling software (AccessMTool_REL_3_3_0_1) has been activated to set the EUT under transmission condition continuously at specific channel frequency.

3.7 Connection Diagram of EUT and Peripheral Devices

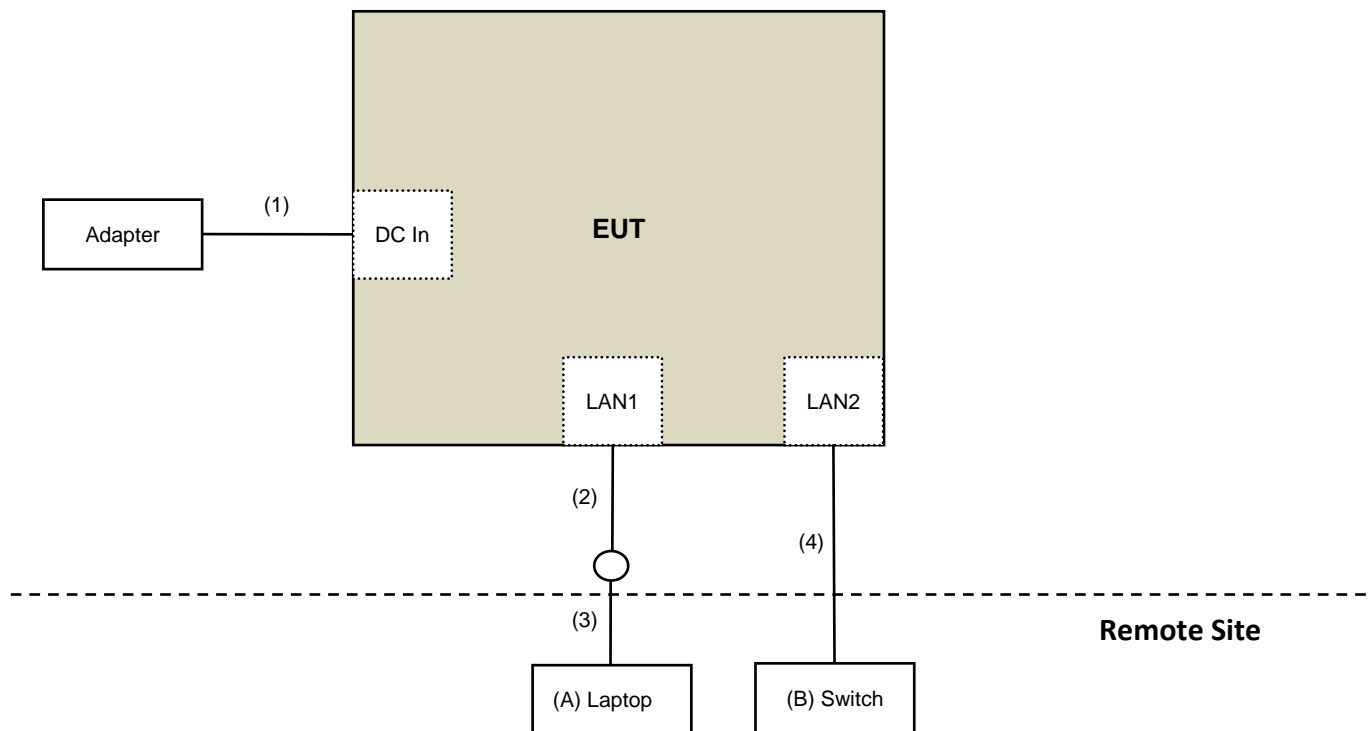

3.8 Configuration of Peripheral Devices and Cable Connections

ID	Product	Brand	Model No.	Serial No.	FCC ID	Remarks
A	Laptop	Lenovo	20U5S01X00 L14	PF-1ANPYA	N/A	Provided by Lab
B	Switch	D-Link	DGS-1005D	DR8WC92000523	N/A	Provided by Lab

ID	Cable Descriptions	Qty.	Length (m)	Shielding (Yes/No)	Cores (Qty.)	Remarks
1	DC Cable	1	1.8	No	0	Supplied by applicant
2	RJ45	1	2	No	0	Supplied by applicant
3	RJ45	1	10	No	0	Provided by Lab
4	RJ45	1	10	No	0	Provided by Lab

4 Test Instruments

The calibration interval of the all test instruments are 12 months and the calibrations are traceable to NML/ROC and NIST/USA.

4.1 RF Output Power

Description Manufacturer	Model No.	Serial No.	Calibrated Date	Calibrated Until
Power Meter Anritsu	ML2495A	1529002	2022/6/22	2023/6/21
Pulse Power Sensor Anritsu	MA2411B	1726434	2022/6/22	2023/6/21

Notes:

1. The test was performed in Oven room 2.
2. Tested Date: 2023/4/2 ~ 2023/4/3

4.2 Power Spectral Density

Description Manufacturer	Model No.	Serial No.	Calibrated Date	Calibrated Until
Attenuator WOKEN	MDCS18N-10	MDCS18N-10-01	2022/4/5	2023/4/4
Software	ADT_RF Test Software V6.6.5.4	N/A	N/A	N/A
Spectrum Analyzer Keysight	N9020B	MY60112409	2023/2/18	2024/2/17

Notes:

1. The test was performed in Oven room 2.
2. Tested Date: 2023/4/2 ~ 2023/4/3

4.3 6 dB Bandwidth

Refer to section 4.2 to get information of the instruments.

4.4 Frequency Stability

Description Manufacturer	Model No.	Serial No.	Calibrated Date	Calibrated Until
AC Power Source GOOD WILL	6905S	1991551	N/A	N/A
Attenuator WOKEN	MDCS18N-10	MDCS18N-10-01	2022/4/5	2023/4/4
Software	ADT_RF Test Software V6.6.5.4	N/A	N/A	N/A
Spectrum Analyzer Keysight	N9020B	MY60112409	2023/2/18	2024/2/17
Temperature & Humidity Chamber Giant Force	GTH-150-40-SP-AR	MAA0812-008	2022/12/26	2023/12/25
True RMS Clamp Meter Fluke	325	31130711WS	2022/6/9	2023/6/8

Notes:

1. The test was performed in Oven room 2.
2. Tested Date: 2023/4/2

4.5 AC Power Conducted Emissions

Description Manufacturer	Model No.	Serial No.	Calibrated Date	Calibrated Until
50 ohm terminal resistance	N/A	EMC-01	2022/9/27	2023/9/26
Fixed attenuator STI	STI02-2200-10	005	2022/8/24	2023/8/23
LISN R&S	ESH3-Z5	848773/004	2022/10/18	2023/10/17
RF Coaxial Cable JYEBO	5D-FB	COCCAB-001	2022/8/24	2023/8/23
Software BVADT	BVADT_Cond_V7.3.7.4	N/A	N/A	N/A
TEST RECEIVER R&S	ESCS 30	847124/029	2022/10/14	2023/10/13

Notes:

1. The test was performed in Conduction 1
2. Tested Date: 2023/3/13

4.6 Unwanted Emissions below 1 GHz

Description Manufacturer	Model No.	Serial No.	Calibrated Date	Calibrated Until
Boresight Antenna Tower & Turn Table Max-Full	MF-7802BS	MF780208530	N/A	N/A
Fixed attenuator Mini-Circuits	UNAT-5+	PAD-ATT5-03	2022/12/28	2023/12/27
LOOP ANTENNA Electro-Metrics	EM-6879	264	2023/2/21	2024/2/20
Pre_Amplifier Agilent	8447D	2944A10636	2023/3/12	2024/3/11
Pre_Amplifier EMCI	EMC330N	980701	2023/2/18	2024/2/17
RF Coaxial Cable COMMATE/PEWC	8D	966-4-1	2023/2/18	2024/2/17
		966-4-2	2023/2/18	2024/2/17
		966-4-3	2023/2/18	2024/2/17
RF Coaxial Cable JYEBO	5D-FB	LOOPCAB-001	2022/12/19	2023/12/18
		LOOPCAB-002	2022/12/19	2023/12/18
Software	ADT_Radiated_V8.7.08	N/A	N/A	N/A
Spectrum Analyzer KEYSIGHT	N9030B	MY57142938	2022/4/26	2023/4/25
Trilog Broadband Antenna Schwarzbeck	VULB 9168	9168-406	2022/10/21	2023/10/20

Notes:

1. The test was performed in 966 Chamber No. 4.
2. Tested Date: 2023/3/15

4.7 Unwanted Emissions above 1 GHz

Description Manufacturer	Model No.	Serial No.	Calibrated Date	Calibrated Until
Boresight Antenna Tower & Turn Table Max-Full	MF-7802BS	MF780208530	N/A	N/A
Horn Antenna Schwarzbeck	BBHA 9120D	9120D-783	2022/11/13	2023/11/12
	BBHA 9170	9170-739	2022/11/13	2023/11/12
Pre_Amplifier EMCI	EMC12630SE	980688	2022/10/4	2023/10/3
	EMC184045SE	980387	2022/12/28	2023/12/27
RF Cable-Frequency Range : 1- 26.5GHz EMCI	EMC104-SM-SM-1200	160922	2022/12/15	2023/12/14
RF Cable-Frequency range: 1- 40GHz EMCI	EMC102-KM-KM-1200	160924	2022/12/28	2023/12/27
RF Coaxial Cable EMCI	EMC-KM-KM-4000	200214	2023/2/20	2024/2/19
	EMC104-SM-SM-2000	180502	2022/4/25	2023/4/24
	EMC104-SM-SM-6000	210704	2022/11/4	2023/11/3
Software	ADT_Radiated_V8.7.08	N/A	N/A	N/A
Spectrum Analyzer KEYSIGHT	N9030B	MY57142938	2022/4/26	2023/4/25

Notes:

1. The test was performed in 966 Chamber No. 4.
2. Tested Date: 2023/3/14 ~ 2023/3/15

5 Limits of Test Items

5.1 RF Output Power

Device Category	Limit (Max Average Power)
Indoor access point	EIRP 36 dBm
Subordinate device	EIRP 36 dBm
Client device	EIRP 30 dBm

Note: For all U-NII-4 and U-NII-3 & -4 span channels shall met above EIRP values.

Per KDB 662911 Method of conducted output power measurement on IEEE 802.11 devices,

Array Gain = 0 dB (i.e., no array gain) for $N_{ANT} \leq 4$;

Array Gain = 0 dB (i.e., no array gain) for channel widths ≥ 40 MHz for any N_{ANT} ;

Array Gain = $5 \log(N_{ANT}/N_{SS})$ dB or 3 dB, whichever is less for 20-MHz channel widths with $N_{ANT} \geq 5$.

For power measurements on all other devices: Array Gain = $10 \log(N_{ANT}/N_{SS})$ dB.

5.2 Power Spectral Density

Device Category	Limit
Indoor access point	EIRP 20 dBm/MHz
Subordinate device	EIRP 20 dBm/MHz
Client device	EIRP 14 dBm/MHz

Note: For all U-NII-4 and U-NII-3 & -4 span channels shall met above EIRP values.

5.3 6 dB Bandwidth

Within the 5.725-5.850 GHz and 5.850-5.895 GHz bands, the minimum 6 dB bandwidth of U-NII devices shall be at least 500 kHz.

5.4 Frequency Stability

The frequency of the carrier signal shall be maintained within band of operation.

5.5 AC Power Conducted Emissions

Frequency (MHz)	Conducted Limit (dBuV)	
	Quasi-peak	Average
0.15 - 0.5	66 - 56	56 - 46
0.50 - 5.0	56	46
5.0 - 30.0	60	50

Notes:

1. The lower limit shall apply at the transition frequencies.
2. The limit decreases in line with the logarithm of the frequency in the range of 0.15 to 0.50 MHz.

5.6 Unwanted Emissions below 1 GHz

Radiated emissions which fall in the restricted bands must comply with the radiated emission limits specified as below table.

Frequencies (MHz)	Field Strength (microvolts/meter)	Measurement Distance (meters)
0.009 ~ 0.490	2400/F(kHz)	300
0.490 ~ 1.705	24000/F(kHz)	30
1.705 ~ 30.0	30	30
30 ~ 88	100	3
88 ~ 216	150	3
216 ~ 960	200	3
Above 960	500	3

Notes:

1. The lower limit shall apply at the transition frequencies.
2. Emission level (dBuV/m) = 20 log Emission level (uV/m).

5.7 Unwanted Emissions above 1 GHz

- (i) For an indoor access point or subordinate device, all emissions at or above 5.895 GHz shall not exceed an e.i.r.p. of 15 dBm/MHz and shall decrease linearly to an e.i.r.p. of -7 dBm/MHz at or above 5.925 GHz.
- (ii) For a client device, all emissions at or above 5.895 GHz shall not exceed an e.i.r.p. of -5 dBm/MHz and shall decrease linearly to an e.i.r.p. of -27 dBm/MHz at or above 5.925 GHz.
- (iii) For a client device or indoor access point or subordinate device, all emissions below 5.725 GHz shall not exceed an e.i.r.p. of -27 dBm/MHz at 5.65 GHz increasing linearly to 10 dBm/MHz at 5.7 GHz, and from 5.7 GHz increasing linearly to a level of 15.6 dBm/MHz at 5.72 GHz, and from 5.72 GHz increasing linearly to a level of 27 dBm/MHz at 5.725 GHz.

Note:

The following formula is used to convert the equipment isotropic radiated power (eirp) to field strength:

$$E = \frac{1000000\sqrt{30P}}{3} \mu\text{V/m, where } P \text{ is the eirp (Watts).}$$

6 Test Arrangements

6.1 RF Output Power

6.1.1 Test Setup

Radiated Measurement Method

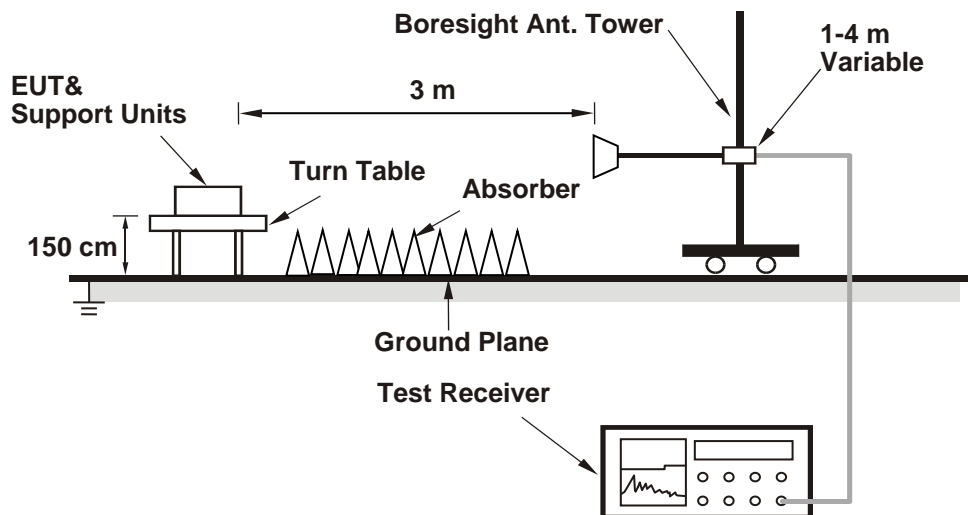

6.1.2 Test Procedure

Radiated Measurement Method

- The EUT was placed on the top of a rotating table 1.5 meters above the ground at 3 meter chamber room for test. The table was rotated 360 degrees to determine the position of the highest radiation.
- The EUT was set 3 meters away from the interference-receiving antenna, which was mounted on the top of a variable-height antenna tower.
- The height of antenna is varied from one meter to four meters above the ground to determine the maximum value of the field strength. Both horizontal and vertical polarizations of the antenna are set to make the measurement.
- Perform a field strength measurement and record the worse read value, is the field strength value via a spectrum reading obtained corrected for antenna factor, cable loss and pre-amplifier factor and then mathematically convert the measured field strength level to EIRP level.
- Follow ANSI C63.10 section 12.7.3, $EIRP \text{ Value (dBm)} = \text{Field Strength Value (dBuV / m)} + \text{Correction Factor @ 3 m}$.
- $\text{Correction Factor (dB) @ 3 m} = 20\log(D) - 104.77 = -95.23 \text{ dB}$; where D is the measurement distance @3 m.

Spectrum analyzer setting as below:

Method SA-1

- Set span to encompass the entire emission bandwidth (EBW) of the signal.
- Set RBW = 1 MHz, Set VBW \geq 3 MHz, Detector = RMS
- Sweep points $\geq [2 \times \text{span} / \text{RBW}]$. (This gives bin-to-bin spacing $\leq \text{RBW} / 2$, so that narrowband signals are not lost between frequency bins.)
- Sweep time = auto, trigger set to "free run".
- Trace average at least 100 traces in power averaging mode.
- Record the max value

Note: When measuring power, use compute power by integrating the spectrum across the 26 dB EBW or 99% OBW of the signal using the instrument's band power measurement function, with band limits set equal to the EBW or OBW band edges. If the instrument does not have a band power function, then sum the spectrum levels (in power units) at 1 MHz intervals extending across the 26 dB EBW or 99% OBW of the spectrum.

6.2 Power Spectral Density

6.2.1 Test Setup

Radiated Measurement Method

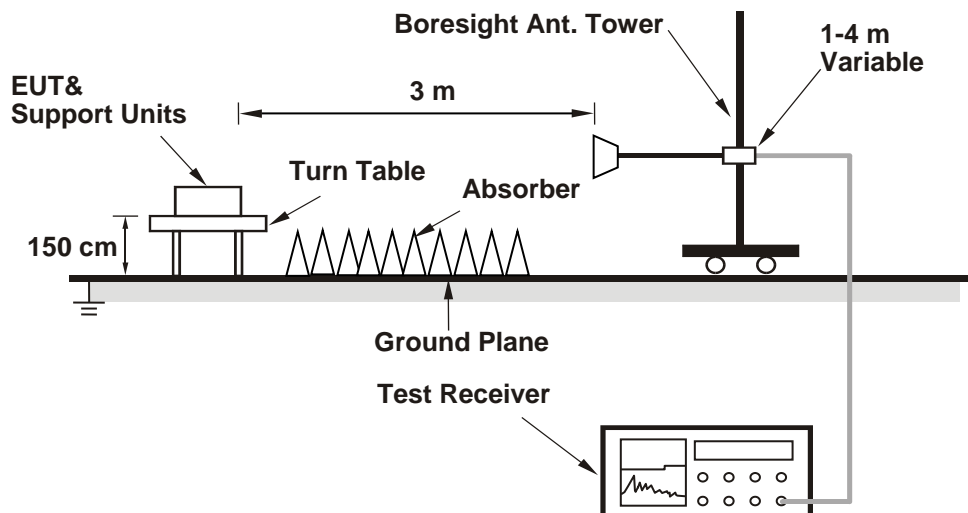

6.2.2 Test Procedure

Radiated Measurement Method

- g. The EUT was placed on the top of a rotating table 1.5 meters above the ground at 3 meter chamber room for test. The table was rotated 360 degrees to determine the position of the highest radiation.
- h. The EUT was set 3 meters away from the interference-receiving antenna, which was mounted on the top of a variable-height antenna tower.
- i. The height of antenna is varied from one meter to four meters above the ground to determine the maximum value of the field strength. Both horizontal and vertical polarizations of the antenna are set to make the measurement.
- j. Perform a field strength measurement and record the worse read value, is the field strength value via a spectrum reading obtained corrected for antenna factor, cable loss and pre-amplifier factor and then mathematically convert the measured field strength level to EIRP level.
- k. Follow ANSI C63.10 section 12.7.3, $EIRP \text{ Value (dBm)} = \text{Field Strength Value (dBuV/m)} + \text{Correction Factor @ 3 m}$.
- l. $\text{Correction Factor (dB) @ 3 m} = 20\log(D) - 104.77 = -95.23 \text{ dB}$; where D is the measurement distance @3 m.

Spectrum analyzer setting as below:

Method SA-1

- m. Set span to encompass the entire emission bandwidth (EBW) of the signal.
- n. Set RBW = 300 kHz, Set VBW \geq 1 MHz, Detector = RMS
- o. Scale the observed power level to an equivalent value in 1 MHz by adjusting (increasing) the measured power by a bandwidth correction factor (BWCF) where $BWCF = 10\log(1 \text{ MHz}/300 \text{ kHz})$
- p. Sweep points $\geq [2 \times \text{span} / \text{RBW}]$. (This gives bin-to-bin spacing $\leq \text{RBW} / 2$, so that narrowband signals are not lost between frequency bins.)
- q. Sweep time = auto, trigger set to "free run".
- r. Trace average at least 100 traces in power averaging mode.
- s. Record the max value

6.3 6 dB Bandwidth

6.3.1 Test Setup

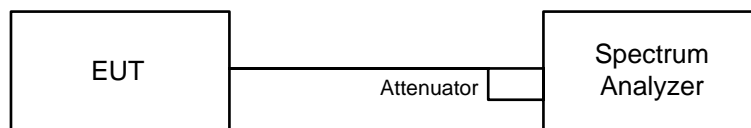

6.3.2 Test Procedure

- Set resolution bandwidth (RBW) = 100 kHz.
- Set the video bandwidth (VBW) $\geq 3 \times$ RBW, Detector = Peak.
- Trace mode = max hold.
- Sweep = auto couple.
- Measure the maximum width of the emission that is constrained by the frequencies associated with the two amplitude points (upper and lower) that are attenuated by 6 dB relative to the maximum level measured in the fundamental emission.

6.4 Frequency Stability

6.4.1 Test Setup

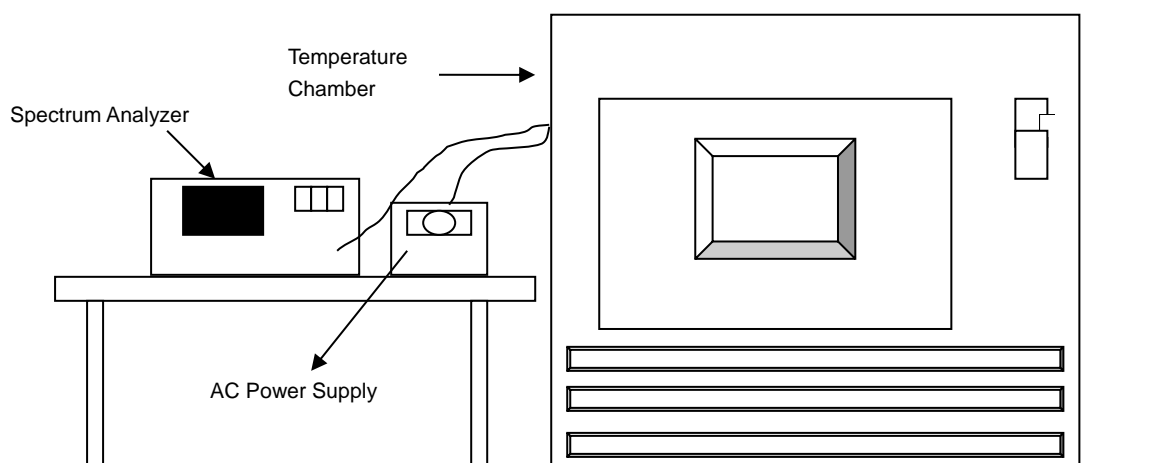

6.4.2 Test Procedure

- The EUT was placed inside the environmental test chamber and powered by nominal AC voltage.
- Turn the EUT on and couple its output to a spectrum analyzer.
- Turn the EUT off and set the chamber to the highest temperature specified.
- Allow sufficient time (approximately 30 min) for the temperature of the chamber to stabilize, turn the EUT on and measure the operating frequency after 2, 5, and 10 Minutes.
- Repeat step (d) with the temperature chamber set to the next desired temperature until measurements down to the lowest specified temperature have been completed.
- The test chamber was allowed to stabilize at +20 degree C for a minimum of 30 Minutes. The supply voltage was then adjusted on the EUT from 85% to 115% and the frequency record.

6.5 AC Power Conducted Emissions

6.5.1 Test Setup

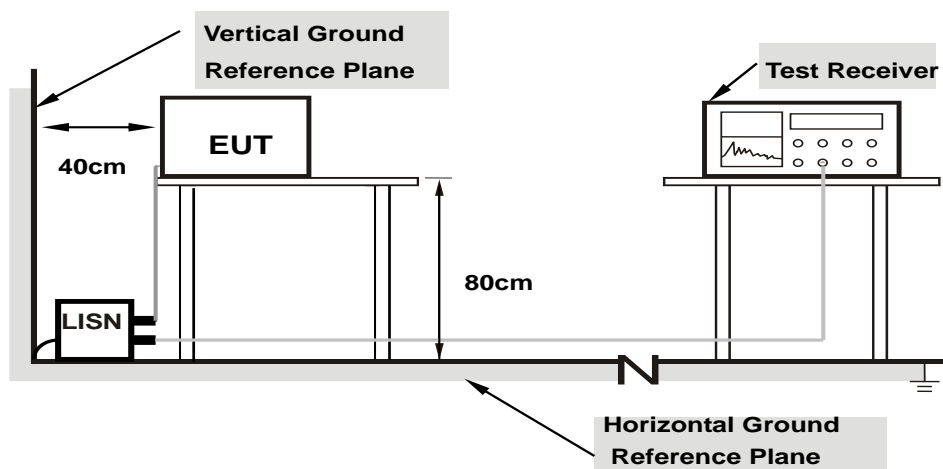

Note: 1.Support units were connected to second LISN.

For the actual test configuration, please refer to the attached file (Test Setup Photo).

6.5.2 Test Procedure

- The EUT was placed on a 0.8 meter to the top of table and placed 0.4 meters from the conducting wall of the shielded room with EUT being connected to the power mains through a line impedance stabilization network (LISN). Other support units were connected to the power mains through another LISN. The two LISNs provide 50 ohm/ 50 uH of coupling impedance for the measuring instrument.
- Both lines of the power mains connected to the EUT were checked for maximum conducted interference.
- The frequency range from 150 kHz to 30 MHz was searched. Emission levels under (Limit – 20 dB) was not recorded.

Note: The resolution bandwidth and video bandwidth of test receiver is 9 kHz for quasi-peak detection (QP) and average detection (AV) at frequency 0.15 MHz-30 MHz.

6.6 Unwanted Emissions below 1 GHz

6.6.1 Test Setup

For Radiated emission below 30 MHz

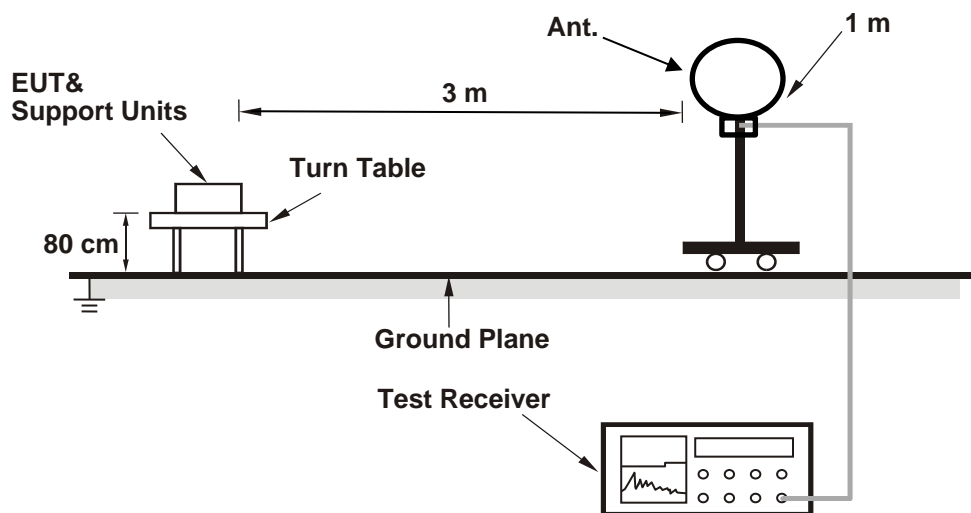

For Radiated emission above 30 MHz

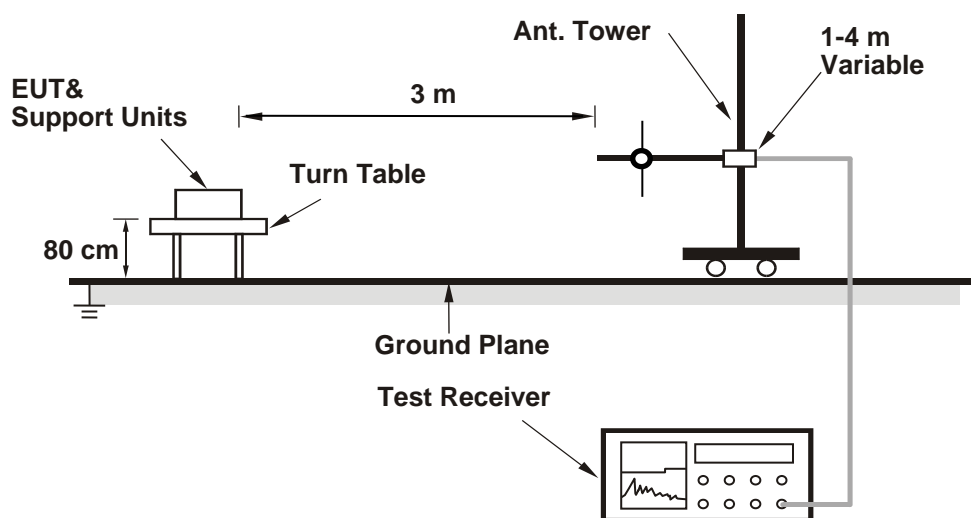

For the actual test configuration, please refer to the attached file (Test Setup Photo).

6.6.2 Test Procedure

For Radiated emission below 30 MHz

- a. The EUT was placed on the top of a rotating table 0.8 meters above the ground at 3 meter chamber room for test. The table was rotated 360 degrees to determine the position of the highest radiation.
- b. The EUT was set 3 meters away from the interference-receiving antenna, which was mounted on the top of a variable-height antenna tower.
- c. Parallel, perpendicular, and ground-parallel orientations of the antenna are set to make the measurement.
- d. For each suspected emission, the EUT was arranged to its worst case and the rotatable table was turned from 0 degrees to 360 degrees to find the maximum reading.
- e. The test-receiver system was set to Quasi-Peak Detect Function and Specified Bandwidth with Maximum Hold Mode, except for the frequency band (9 kHz to 90 kHz and 110 kHz to 490 kHz) set to average detect function and peak detect function.

Notes:

1. The resolution bandwidth and video bandwidth of test receiver/spectrum analyzer is 200 Hz at frequency below 150 kHz.
2. The resolution bandwidth and video bandwidth of test receiver/spectrum analyzer is 9 kHz or 10 kHz at frequency (150 kHz to 30 MHz).
3. All modes of operation were investigated and the worst-case emissions are reported.

For Radiated emission above 30 MHz

- a. The EUT was placed on the top of a rotating table 0.8 meters above the ground at 3 meter chamber room for test. The table was rotated 360 degrees to determine the position of the highest radiation.
- b. The EUT was set 3 meters away from the interference-receiving antenna, which was mounted on the top of a variable-height antenna tower.
- c. The height of antenna is varied from one meter to four meters above the ground to determine the maximum value of the field strength. Both horizontal and vertical polarizations of the antenna are set to make the measurement.
- d. For each suspected emission, the EUT was arranged to its worst case and then the antenna was tuned to heights from 1 meter to 4 meters and the rotatable table was turned from 0 degrees to 360 degrees to find the maximum reading.
- e. The test-receiver system was set to quasi-peak detect function and specified bandwidth with maximum hold mode when the test frequency is below 1 GHz.

Notes:

1. The resolution bandwidth and video bandwidth of test receiver/spectrum analyzer is 120 kHz for Quasi-peak detection (QP) at frequency below 1 GHz.
2. All modes of operation were investigated and the worst-case emissions are reported.

6.7 Unwanted Emissions above 1 GHz

6.7.1 Test Setup

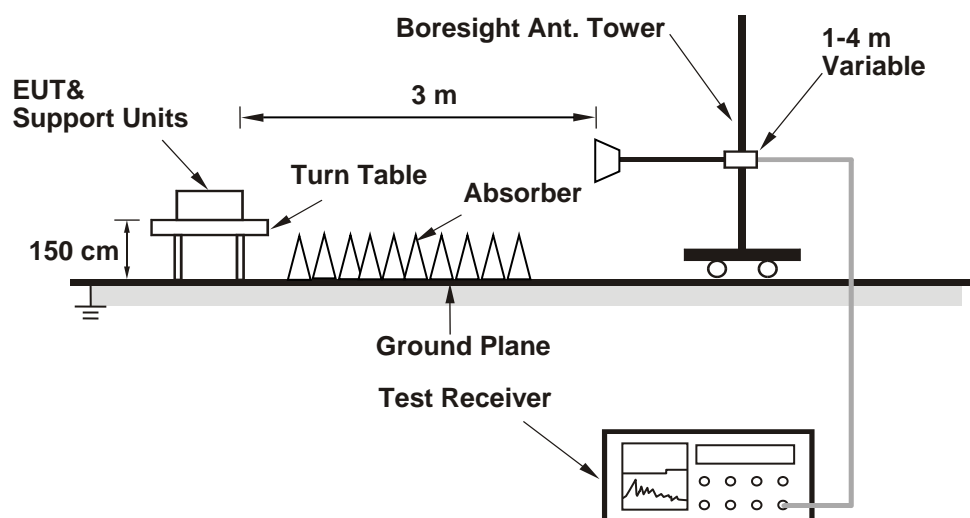

For the actual test configuration, please refer to the attached file (Test Setup Photo).

6.7.2 Test Procedure

- The EUT was placed on the top of a rotating table 1.5 meters above the ground at 3 meter chamber room for test. The table was rotated 360 degrees to determine the position of the highest radiation.
- The EUT was set 3 meters away from the interference-receiving antenna, which was mounted on the top of a variable-height antenna tower.
- The height of antenna is varied from one meter to four meters above the ground to determine the maximum value of the field strength. Both horizontal and vertical polarizations of the antenna are set to make the measurement.
- For each suspected emission, the EUT was arranged to its worst case and then the antenna was tuned to heights from 1 meter to 4 meters and the rotatable table was turned from 0 degrees to 360 degrees to find the maximum reading.
- The test-receiver system was set to peak and average detects function and specified bandwidth with maximum hold mode when the test frequency is above 1 GHz. If the peak reading value also meets average limit, measurement with the average detector is unnecessary.

Notes:

- The resolution bandwidth of test receiver/spectrum analyzer is 1 MHz and the video bandwidth is 3 MHz for Peak detection (PK) and Average detection (AV) at frequency above 1 GHz.
- For fundamental and harmonic signal measurement, the resolution bandwidth of test receiver/spectrum analyzer is 1 MHz and the video bandwidth is $\geq 1/T$ (Duty cycle $< 98\%$) or 10 Hz (Duty cycle $\geq 98\%$) for Average detection (AV) at frequency above 1 GHz.
- All modes of operation were investigated and the worst-case emissions are reported.

7 Test Results of Test Item

7.1 RF Output Power

Input Power:	120 Vac, 60 Hz	Environmental Conditions:	25°C, 65% RH	Tested By:	Katina Lu
--------------	----------------	---------------------------	--------------	------------	-----------

802.11a CDD

Chan.	Chan. Freq. (MHz)	Field Strength (dBuV/m)	Correction Factor (dB)	EIRP (mW)	EIRP (dBm)	EIRP Limit (dBm)	Test Result
169	5845	125.10	-95.23	970.51	29.87	36	Pass
173	5865	125.40	-95.23	1039.92	30.17	36	Pass
177	5885	125.20	-95.23	993.116	29.97	36	Pass

802.11ax (HE20) CDD

Chan.	Chan. Freq. (MHz)	Field Strength (dBuV/m)	Correction Factor (dB)	EIRP (mW)	EIRP (dBm)	EIRP Limit (dBm)	Test Result
169	5845	125.30	-95.23	1016.249	30.07	36	Pass
173	5865	125.40	-95.23	1039.92	30.17	36	Pass
177	5885	125.00	-95.23	948.418	29.77	36	Pass

802.11ax (HE40) CDD

Chan.	Chan. Freq. (MHz)	Field Strength (dBuV/m)	Correction Factor (dB)	EIRP (mW)	EIRP (dBm)	EIRP Limit (dBm)	Test Result
167	5835	126.70	-95.23	1402.814	31.47	36	Pass
175	5875	126.80	-95.23	1435.489	31.57	36	Pass

802.11ax (HE80) CDD

Chan.	Chan. Freq. (MHz)	Field Strength (dBuV/m)	Correction Factor (dB)	EIRP (mW)	EIRP (dBm)	EIRP Limit (dBm)	Test Result
171	5855	126.70	-95.23	1402.814	31.47	36	Pass

802.11ax (HE160) CDD

Chan.	Chan. Freq. (MHz)	Field Strength (dBuV/m)	Correction Factor (dB)	EIRP (mW)	EIRP (dBm)	EIRP Limit (dBm)	Test Result
163	5815	121.60	-95.23	433.511	26.37	36	Pass

802.11ax (HE20) Beamforming

Chan.	Chan. Freq. (MHz)	Field Strength (dBuV/m)	Correction Factor (dB)	EIRP (mW)	EIRP (dBm)	EIRP Limit (dBm)	Test Result
169	5845	126.90	-95.23	1468.926	31.67	36	Pass
173	5865	127.00	-95.23	1503.142	31.77	36	Pass
177	5885	126.50	-95.23	1339.677	31.27	36	Pass

802.11ax (HE40) Beamforming

Chan.	Chan. Freq. (MHz)	Field Strength (dBuV/m)	Correction Factor (dB)	EIRP (mW)	EIRP (dBm)	EIRP Limit (dBm)	Test Result
167	5835	128.40	-95.23	2074.914	33.17	36	Pass
175	5875	128.40	-95.23	2074.914	33.17	36	Pass

802.11ax (HE80) Beamforming

Chan.	Chan. Freq. (MHz)	Field Strength (dBuV/m)	Correction Factor (dB)	EIRP (mW)	EIRP (dBm)	EIRP Limit (dBm)	Test Result
171	5855	128.40	-95.23	2074.914	33.17	36	Pass

802.11ax (HE160) Beamforming

Chan.	Chan. Freq. (MHz)	Field Strength (dBuV/m)	Correction Factor (dB)	EIRP (mW)	EIRP (dBm)	EIRP Limit (dBm)	Test Result
163	5815	123.20	-95.23	626.614	27.97	36	Pass

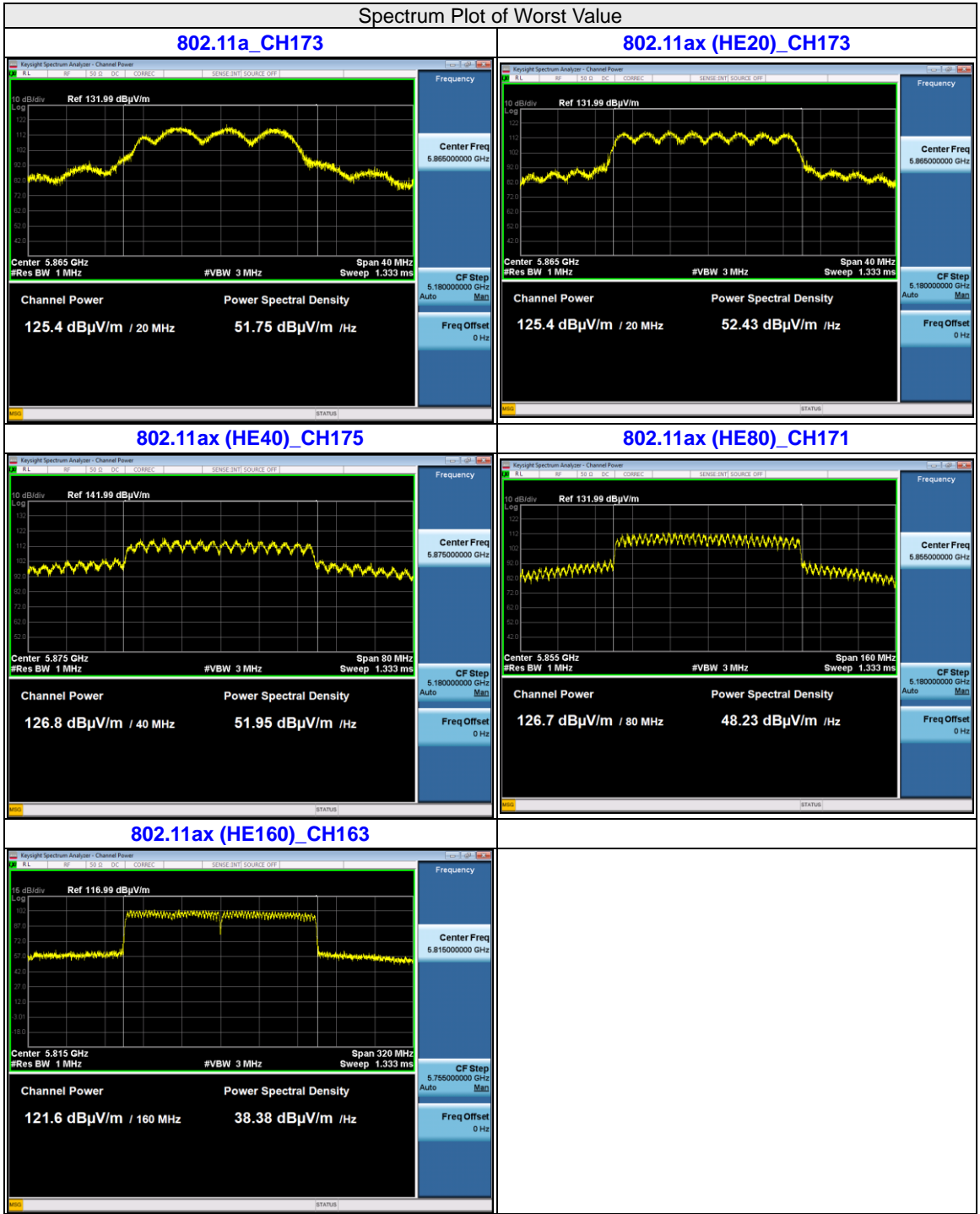

Beamforming

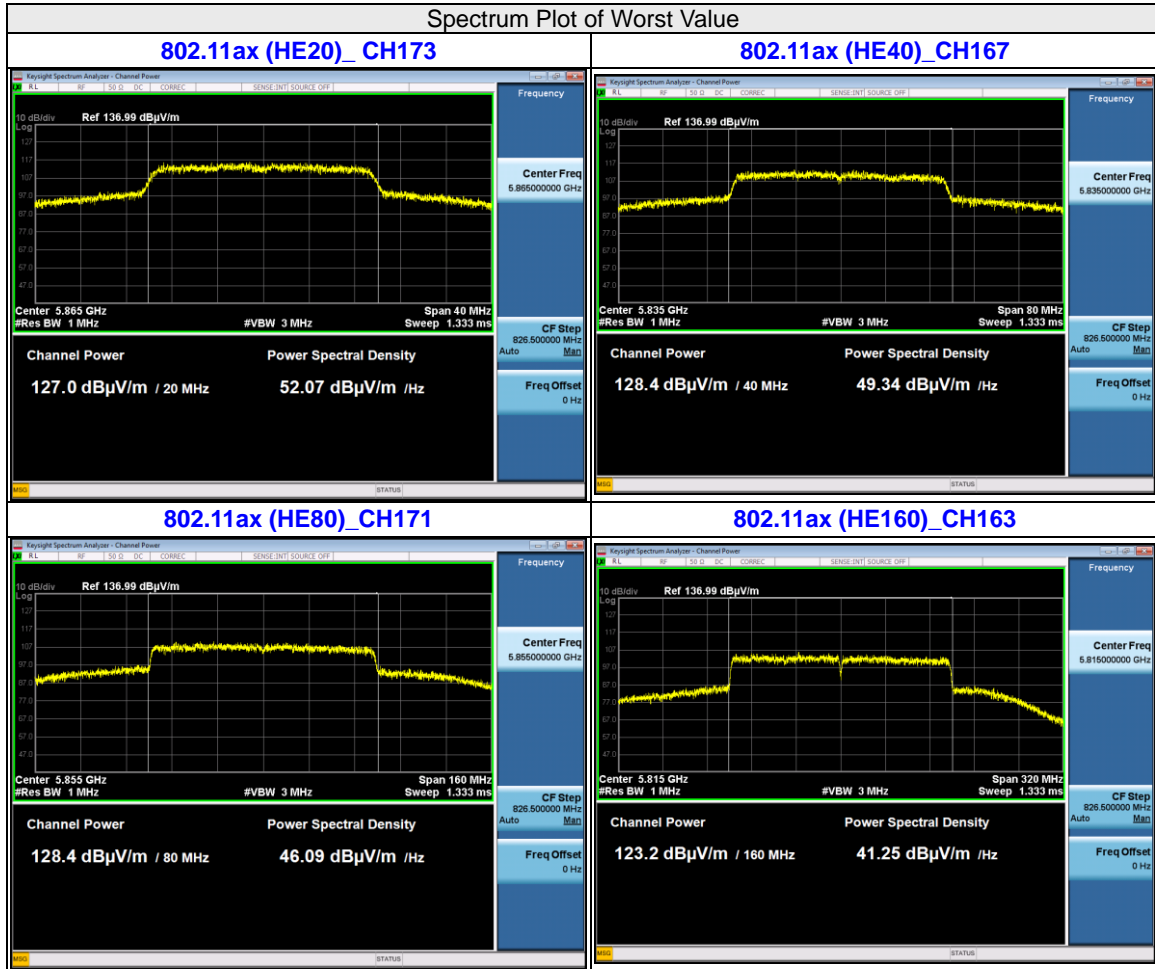

7.2 Power Spectral Density

Input Power:	120 Vac, 60 Hz	Environmental Conditions:	25°C, 65% RH	Tested By:	Katina Lu
--------------	----------------	---------------------------	--------------	------------	-----------

802.11a CDD

Chan.	Chan. Freq. (MHz)	Field Strength (dBuV/m)	Correction Factor (dB)	EIRP PSD (dBm/300kHz)	EIRP PSD (dBm/MHz)	EIRP PSD Limit (dBm/MHz)	Test Result
169	5845	109.04	-95.23	13.81	19.04	20	Pass
173	5865	109.34	-95.23	14.11	19.34	20	Pass
177	5885	109.33	-95.23	14.10	19.33	20	Pass

802.11ax (HE20) CDD

Chan.	Chan. Freq. (MHz)	Field Strength (dBuV/m)	Correction Factor (dB)	EIRP PSD (dBm/300kHz)	EIRP PSD (dBm/MHz)	EIRP PSD Limit (dBm/MHz)	Test Result
169	5845	108.98	-95.23	13.75	18.98	20	Pass
173	5865	109.34	-95.23	14.11	19.34	20	Pass
177	5885	109.00	-95.23	13.77	19.00	20	Pass

802.11ax (HE40) CDD

Chan.	Chan. Freq. (MHz)	Field Strength (dBuV/m)	Correction Factor (dB)	EIRP PSD (dBm/300kHz)	EIRP PSD (dBm/MHz)	EIRP PSD Limit (dBm/MHz)	Test Result
167	5835	109.27	-95.23	14.04	19.27	20	Pass
175	5875	109.28	-95.23	14.05	19.28	20	Pass

802.11ax (HE80) CDD

Chan.	Chan. Freq. (MHz)	Field Strength (dBuV/m)	Correction Factor (dB)	EIRP PSD (dBm/300kHz)	EIRP PSD (dBm/MHz)	EIRP PSD Limit (dBm/MHz)	Test Result
171	5855	106.84	-95.23	11.61	16.84	20	Pass

802.11ax (HE160) CDD

Chan.	Chan. Freq. (MHz)	Field Strength (dBuV/m)	Correction Factor (dB)	EIRP PSD (dBm/300kHz)	EIRP PSD (dBm/MHz)	EIRP PSD Limit (dBm/MHz)	Test Result
163	5815	96.92	-95.23	1.69	6.92	20	Pass

802.11ax (HE20) Beamforming

Chan.	Chan. Freq. (MHz)	Field Strength (dBuV/m)	Correction Factor (dB)	EIRP PSD (dBm/300kHz)	EIRP PSD (dBm/MHz)	EIRP PSD Limit (dBm/MHz)	Test Result
169	5845	108.91	-95.23	13.68	18.91	20	Pass
173	5865	109.23	-95.23	14.00	19.23	20	Pass
177	5885	108.97	-95.23	13.74	18.97	20	Pass

802.11ax (HE40) Beamforming

Chan.	Chan. Freq. (MHz)	Field Strength (dBuV/m)	Correction Factor (dB)	EIRP PSD (dBm/300kHz)	EIRP PSD (dBm/MHz)	EIRP PSD Limit (dBm/MHz)	Test Result
167	5835	109.22	-95.23	13.99	19.22	20	Pass
175	5875	109.17	-95.23	13.94	19.17	20	Pass

802.11ax (HE80) Beamforming

Chan.	Chan. Freq. (MHz)	Field Strength (dBuV/m)	Correction Factor (dB)	EIRP PSD (dBm/300kHz)	EIRP PSD (dBm/MHz)	EIRP PSD Limit (dBm/MHz)	Test Result
171	5855	106.84	-95.23	11.61	16.84	20	Pass

802.11ax (HE160) Beamforming

Chan.	Chan. Freq. (MHz)	Field Strength (dBuV/m)	Correction Factor (dB)	EIRP PSD (dBm/300kHz)	EIRP PSD (dBm/MHz)	EIRP PSD Limit (dBm/MHz)	Test Result
163	5815	96.76	-95.23	1.53	6.76	20	Pass

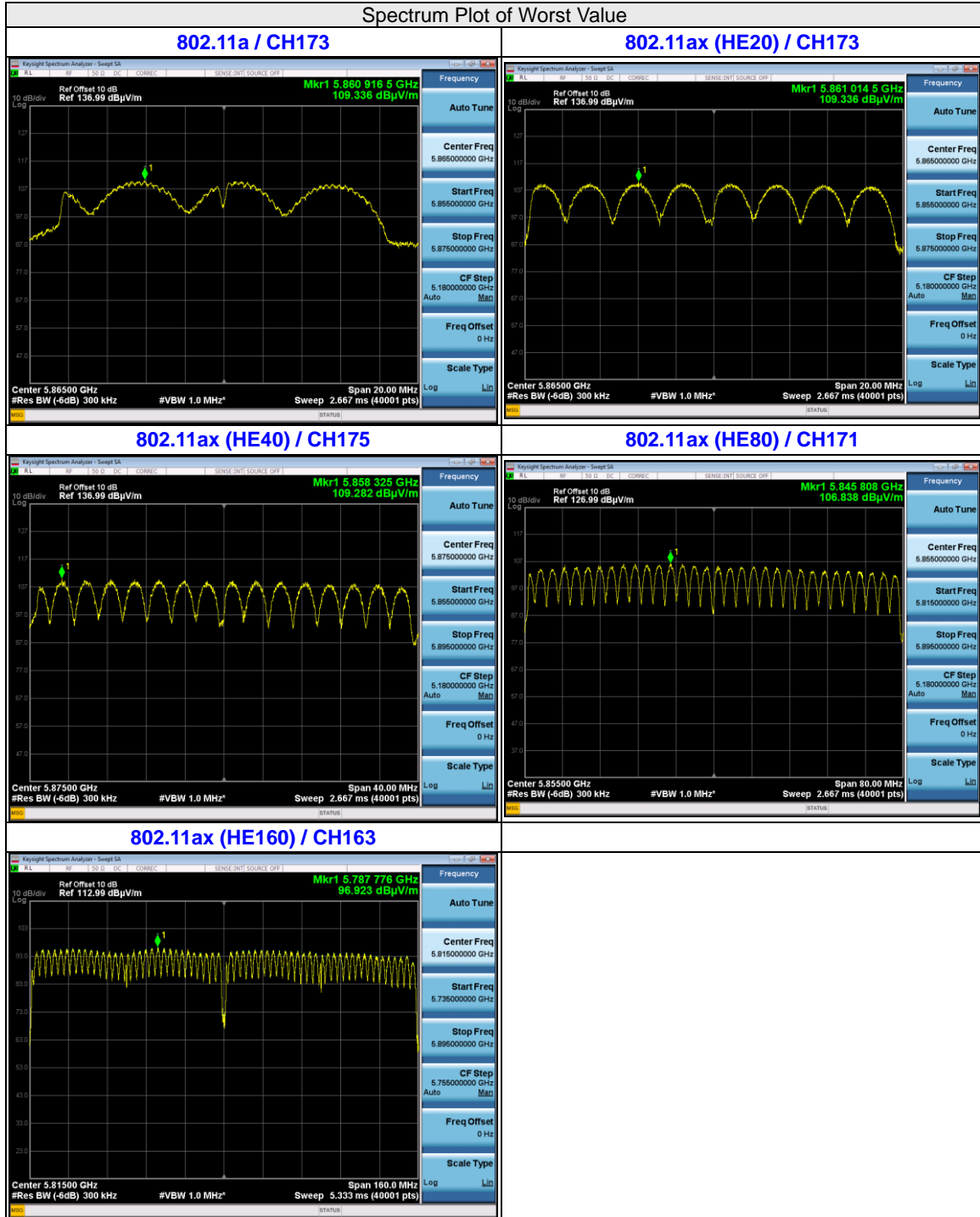



Beamforming

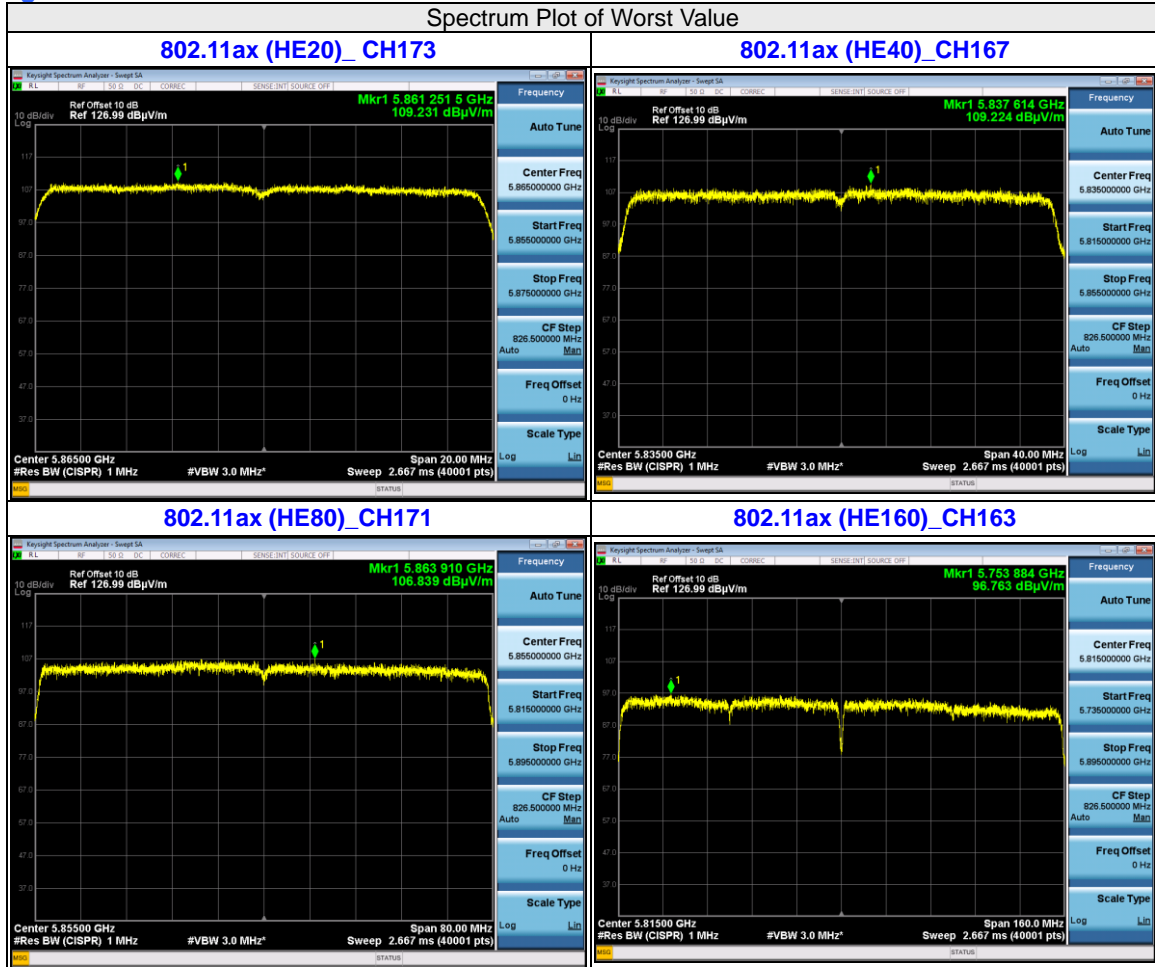

7.3 6 dB Bandwidth

Input Power:	120 Vac, 60 Hz	Environmental Conditions:	25°C, 65% RH	Tested By:	Katina Lu
--------------	----------------	---------------------------	--------------	------------	-----------

802.11a

Channel	Frequency (MHz)	6dB Bandwidth (MHz)		Minimum Limit (MHz)	Test Result
		Chain 0	Chain 1		
169	5845	16.37	16.33	0.5	Pass
173	5865	16.38	16.38	0.5	Pass
177	5885	16.36	16.37	0.5	Pass

802.11ax (HE20)

Channel	Frequency (MHz)	6dB Bandwidth (MHz)		Minimum Limit (MHz)	Test Result
		Chain 0	Chain 1		
169	5845	18.76	18.74	0.5	Pass
173	5865	18.83	18.80	0.5	Pass
177	5885	18.76	18.87	0.5	Pass

802.11ax (HE40)

Channel	Frequency (MHz)	6dB Bandwidth (MHz)		Minimum Limit (MHz)	Test Result
		Chain 0	Chain 1		
167	5835	37.13	36.21	0.5	Pass
175	5875	36.89	36.50	0.5	Pass

802.11ax (HE80)

Channel	Frequency (MHz)	6dB Bandwidth (MHz)		Minimum Limit (MHz)	Test Result
		Chain 0	Chain 1		
171	5855	75.41	75.39	0.5	Pass

802.11ax (HE160)

Channel	Frequency (MHz)	6dB Bandwidth (MHz)		Minimum Limit (MHz)	Test Result
		Chain 0	Chain 1		
163	5815	155.91	155.81	0.5	Pass



Spectrum Plot of Minimum Value

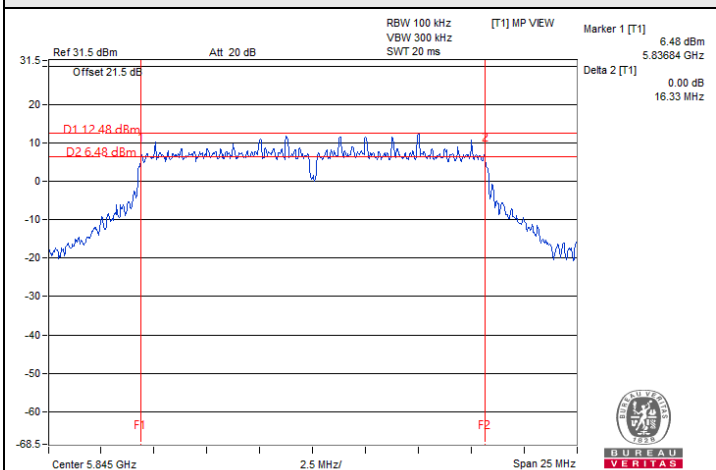

802.11a / Chain 1 : CH 169

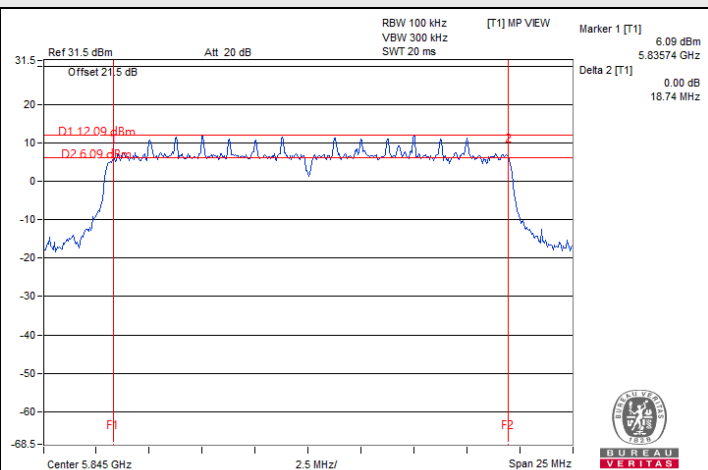

802.11ax (HE20) / Chain 1 : CH 169

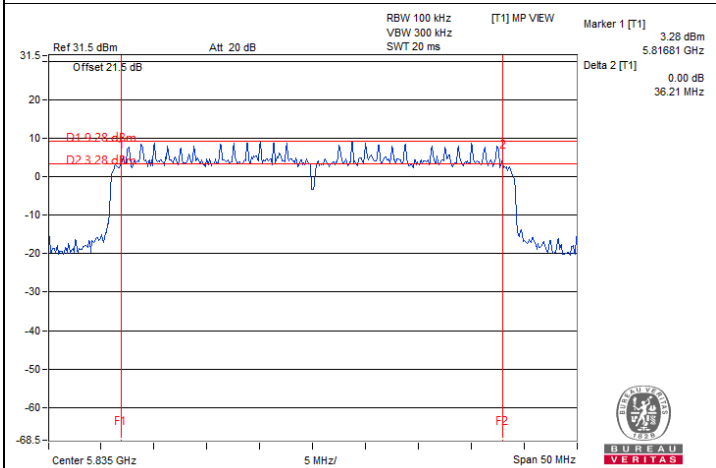

802.11ax (HE40) / Chain 1 : CH 167

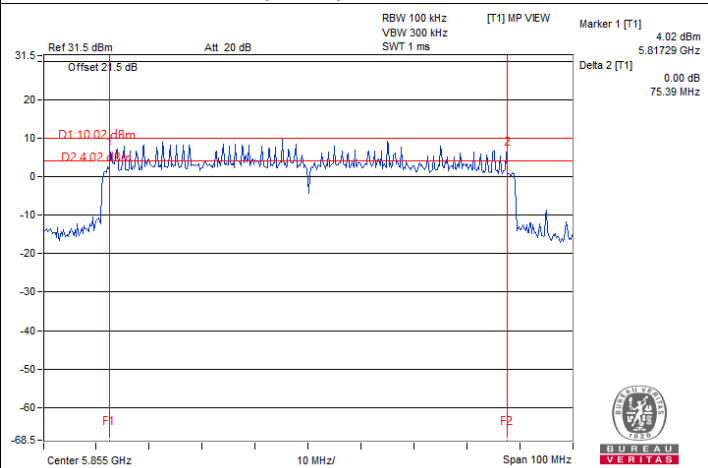

802.11ax (HE80) / Chain 1 : CH 171

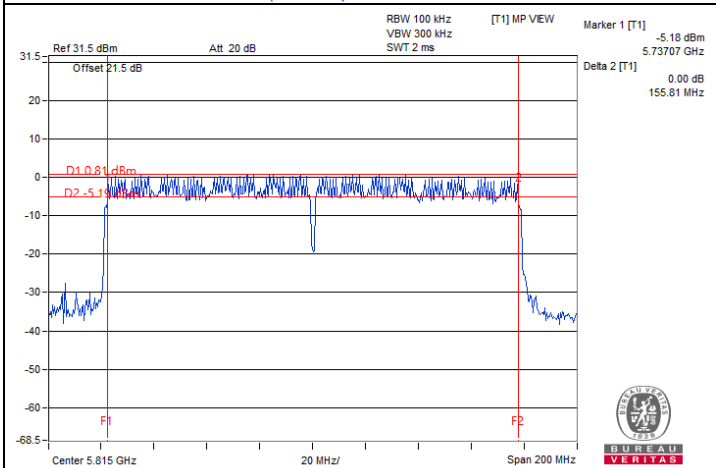

802.11ax (HE160) / Chain 1 : CH 163

7.4 Frequency Stability

Input Power:	120 Vac, 60 Hz	Environmental Conditions:	25°C, 65% RH	Tested By:	Katina Lu
--------------	----------------	---------------------------	--------------	------------	-----------

802.11a

Frequency Stability Versus Temperature									
Operating Frequency: 5865 MHz									
Temp. (°C)	Power Supply (Vac)	0 Minute		2 Minutes		5 Minutes		10 Minutes	
		Measured Frequency (MHz)	Test Result	Measured Frequency (MHz)	Test Result	Measured Frequency (MHz)	Test Result	Measured Frequency (MHz)	Test Result
40	120	5864.995	Pass	5864.9901	Pass	5864.9902	Pass	5864.99	Pass
30	120	5864.9848	Pass	5864.9856	Pass	5864.9864	Pass	5864.9839	Pass
20	120	5865.0175	Pass	5865.0135	Pass	5865.0139	Pass	5865.0142	Pass
10	120	5864.9727	Pass	5864.9744	Pass	5864.9736	Pass	5864.9718	Pass
0	120	5864.9686	Pass	5864.9709	Pass	5864.9741	Pass	5864.9688	Pass

Frequency Stability Versus Voltage									
Operating Frequency: 5865 MHz									
Temp. (°C)	Power Supply (Vac)	0 Minute		2 Minutes		5 Minutes		10 Minutes	
		Measured Frequency (MHz)	Test Result	Measured Frequency (MHz)	Test Result	Measured Frequency (MHz)	Test Result	Measured Frequency (MHz)	Test Result
20	138	5865.0127	Pass	5865.0167	Pass	5865.0123	Pass	5865.0152	Pass
	120	5865.0175	Pass	5865.0135	Pass	5865.0139	Pass	5865.0142	Pass
	102	5865.0207	Pass	5865.0225	Pass	5865.0239	Pass	5865.0212	Pass

7.5 AC Power Conducted Emissions

RF Mode	802.11ax (HE20)	Channel	CH 173 : 5865 MHz
Frequency Range	150kHz ~ 30MHz	Detector Function & Resolution Bandwidth	Quasi-Peak (QP) / Average (AV), 9 kHz
Input Power	120 Vac, 60 Hz	Environmental Conditions	25°C, 75% RH
Tested By	Carter Lin		

Phase Of Power : Line (L)										
No	Frequency (MHz)	Correction Factor (dB)	Reading Value (dBuV)		Emission Level (dBuV)		Limit (dBuV)		Margin (dB)	
			Q.P.	AV.	Q.P.	AV.	Q.P.	AV.	Q.P.	AV.
1	0.16175	9.96	37.21	21.64	47.17	31.60	65.37	55.37	-18.20	-23.77
2	0.35063	9.97	32.46	32.39	42.43	42.36	58.95	48.95	-16.52	-6.59
3	0.56796	9.98	14.58	7.39	24.56	17.37	56.00	46.00	-31.44	-28.63
4	1.07422	10.00	14.31	10.27	24.31	20.27	56.00	46.00	-31.69	-25.73
5	2.06647	10.05	14.76	7.39	24.81	17.44	56.00	46.00	-31.19	-28.56
6	26.74606	11.21	20.21	18.36	31.42	29.57	60.00	50.00	-28.58	-20.43

Remarks:

1. Q.P. and AV. are abbreviations of quasi-peak and average individually.
2. The emission levels of other frequencies were very low against the limit.
3. Margin value = Emission level – Limit value
4. Correction factor = Insertion loss + Cable loss
5. Emission Level = Correction Factor + Reading Value

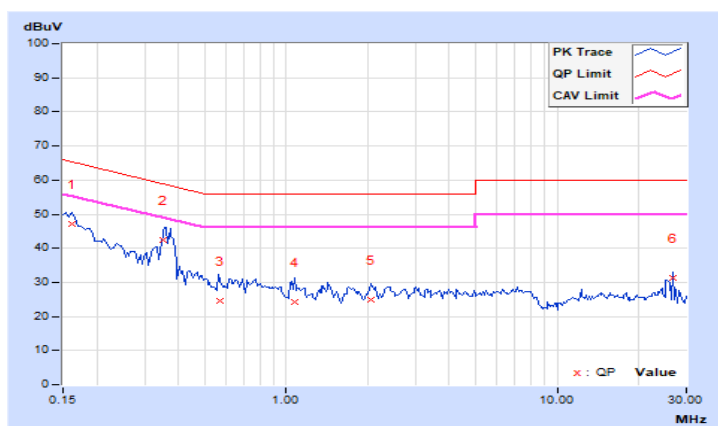

RF Mode	802.11ax (HE20)	Channel	CH 173 : 5865 MHz
Frequency Range	150kHz ~ 30MHz	Detector Function & Resolution Bandwidth	Quasi-Peak (QP) / Average (AV), 9 kHz
Input Power	120 Vac, 60 Hz	Environmental Conditions	25°C, 75% RH
Tested By	Carter Lin		

Phase Of Power : Neutral (N)										
No	Frequency (MHz)	Correction Factor (dB)	Reading Value (dBuV)		Emission Level (dBuV)		Limit (dBuV)		Margin (dB)	
			Q.P.	AV.	Q.P.	AV.	Q.P.	AV.	Q.P.	AV.
1	0.15785	9.93	36.36	21.61	46.29	31.54	65.58	55.58	-19.29	-24.04
2	0.22814	9.94	24.46	11.90	34.40	21.84	62.52	52.52	-28.12	-30.68
3	0.34936	9.94	33.67	31.54	43.61	41.48	58.98	48.98	-15.37	-7.50
4	0.72817	9.96	16.96	14.83	26.92	24.79	56.00	46.00	-29.08	-21.21
5	0.98205	9.97	15.88	12.43	25.85	22.40	56.00	46.00	-30.15	-23.60
6	25.98043	10.86	15.72	11.08	26.58	21.94	60.00	50.00	-33.42	-28.06

Remarks:

1. Q.P. and AV. are abbreviations of quasi-peak and average individually.
2. The emission levels of other frequencies were very low against the limit.
3. Margin value = Emission level – Limit value
4. Correction factor = Insertion loss + Cable loss
5. Emission Level = Correction Factor + Reading Value

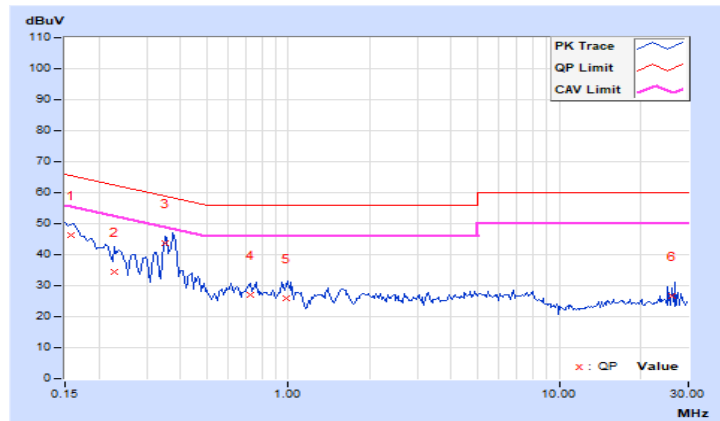

7.6 Unwanted Emissions below 1 GHz

RF Mode	802.11ax (HE20)	Channel	CH 173 : 5865 MHz
Frequency Range	30 MHz ~ 1 GHz	Detector Function & Bandwidth	(QP) RB = 120kHz
Input Power	120 Vac, 60 Hz	Environmental Conditions	20°C, 70% RH
Tested By	Ryan Du		

Antenna Polarity & Test Distance : Horizontal at 3 m								
No	Frequency (MHz)	Emission Level (dBuV/m)	Limit (dBuV/m)	Margin (dB)	Antenna Height (m)	Table Angle (Degree)	Raw Value (dBuV)	Correction Factor (dB/m)
1	63.29	31.3 QP	40.0	-8.7	1.50 H	334	44.3	-13.0
2	94.53	33.6 QP	43.5	-9.9	1.00 H	35	50.8	-17.2
3	173.54	32.1 QP	43.5	-11.4	1.50 H	274	44.4	-12.3
4	261.97	33.3 QP	46.0	-12.7	1.00 H	259	45.2	-11.9
5	462.99	38.8 QP	46.0	-7.2	2.00 H	342	44.2	-5.4
6	719.23	39.0 QP	46.0	-7.0	1.00 H	21	39.1	-0.1

Remarks:

1. Emission Level(dBuV/m) = Raw Value(dBuV) + Correction Factor(dB/m)
2. Correction Factor(dB/m) = Antenna Factor(dB/m) + Cable Factor(dB) – Pre-Amplifier Factor(dB)
3. Margin value = Emission Level – Limit value
4. The other emission levels were very low against the limit of frequency range 30 MHz ~ 1 GHz.
5. The emission levels were very low against the limit of frequency range 9 kHz ~ 30 MHz: the amplitude of spurious emissions attenuated more than 20 dB below the permissible value to be report.

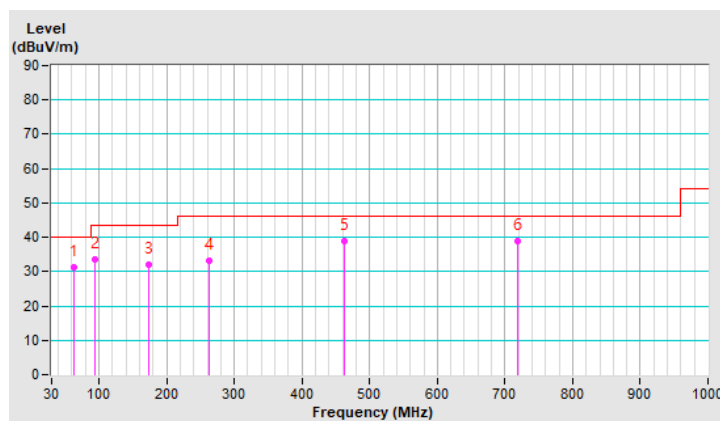

RF Mode	802.11ax (HE20)	Channel	CH 173 : 5865 MHz
Frequency Range	30 MHz ~ 1 GHz	Detector Function & Bandwidth	(QP) RB = 120kHz
Input Power	120 Vac, 60 Hz	Environmental Conditions	20°C, 70% RH
Tested By	Ryan Du		

Antenna Polarity & Test Distance : Vertical at 3 m								
No	Frequency (MHz)	Emission Level (dBuV/m)	Limit (dBuV/m)	Margin (dB)	Antenna Height (m)	Table Angle (Degree)	Raw Value (dBuV)	Correction Factor (dB/m)
1	46.39	32.5 QP	40.0	-7.5	1.00 V	24	44.6	-12.1
2	63.46	34.1 QP	40.0	-5.9	1.50 V	347	47.2	-13.1
3	108.45	35.7 QP	43.5	-7.8	1.00 V	142	50.4	-14.7
4	174.80	30.1 QP	43.5	-13.4	2.00 V	165	42.6	-12.5
5	466.41	40.0 QP	46.0	-6.0	1.00 V	326	45.4	-5.4
6	697.27	35.9 QP	46.0	-10.1	1.50 V	42	36.2	-0.3

Remarks:

1. Emission Level(dBuV/m) = Raw Value(dBuV) + Correction Factor(dB/m)
2. Correction Factor(dB/m) = Antenna Factor(dB/m) + Cable Factor(dB) – Pre-Amplifier Factor(dB)
3. Margin value = Emission Level – Limit value
4. The other emission levels were very low against the limit of frequency range 30 MHz ~ 1 GHz.
5. The emission levels were very low against the limit of frequency range 9 kHz ~ 30 MHz: the amplitude of spurious emissions attenuated more than 20 dB below the permissible value to be report.

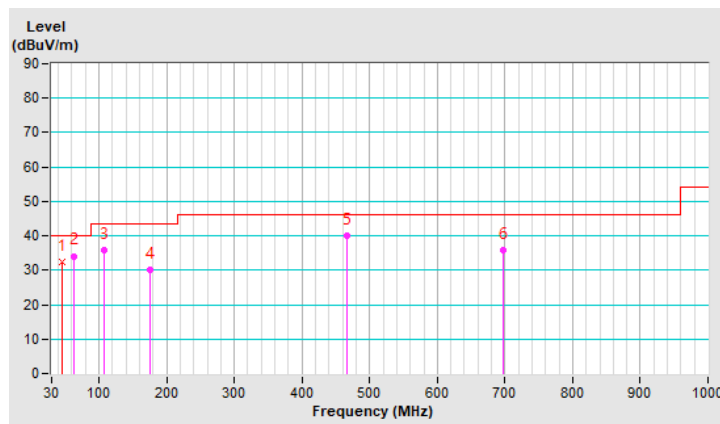

7.7 Unwanted Emissions above 1 GHz

RF Mode	802.11a	Channel	CH 169 : 5845 MHz
Frequency Range	1 GHz ~ 40 GHz	Detector Function & Bandwidth	(PK) RB = 1 MHz, VB = 3 MHz (AV) RB = 1 MHz, VB = 10 Hz
Input Power	120 Vac, 60 Hz	Environmental Conditions	20°C, 70% RH
Tested By	Ryan Du		

Antenna Polarity & Test Distance : Horizontal at 3 m								
No	Frequency (MHz)	Emission Level (dBuV/m)	Limit (dBuV/m)	Margin (dB)	Antenna Height (m)	Table Angle (Degree)	Raw Value (dBuV)	Correction Factor (dB/m)
1	#5650.00	57.5 PK	68.2	-10.7	2.33 H	92	52.8	4.7
2	*5845.00	119.2 PK			2.33 H	92	114.1	5.1
3	*5845.00	110.3 AV			2.33 H	92	105.2	5.1
4	#5895.00	79.0 PK	130.2	-51.2	2.33 H	92	74.1	4.9
5	#5895.00	49.7 AV	110.2	-60.5	2.33 H	92	44.8	4.9
6	11690.00	47.3 PK	74.0	-26.7	1.78 H	225	32.7	14.6
7	11690.00	36.3 AV	54.0	-17.7	1.78 H	225	21.7	14.6
8	#17535.00	58.4 PK	88.2	-29.8	1.68 H	66	38.6	19.8

Remarks:

1. Emission Level(dBuV/m) = Raw Value(dBuV) + Correction Factor(dB/m)
2. Correction Factor(dB/m) = Antenna Factor(dB/m) + Cable Factor(dB) – Pre-Amplifier Factor(dB)
3. Margin value = Emission Level – Limit value
4. The other emission levels were very low against the limit.
5. " * ": Fundamental frequency, the limit was restricted at the RF Output Power.
6. " # ": The radiated frequency is out of the restricted band.

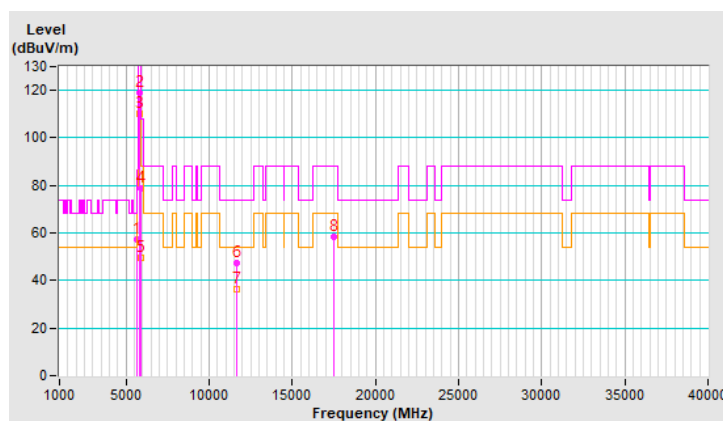

RF Mode	802.11a	Channel	CH 169 : 5845 MHz
Frequency Range	1 GHz ~ 40 GHz	Detector Function & Bandwidth	(PK) RB = 1 MHz, VB = 3 MHz (AV) RB = 1 MHz, VB = 10 Hz
Input Power	120 Vac, 60 Hz	Environmental Conditions	20°C, 70% RH
Tested By	Ryan Du		

Antenna Polarity & Test Distance : Vertical at 3 m								
No	Frequency (MHz)	Emission Level (dBuV/m)	Limit (dBuV/m)	Margin (dB)	Antenna Height (m)	Table Angle (Degree)	Raw Value (dBuV)	Correction Factor (dB/m)
1	#5650.00	59.5 PK	68.2	-8.7	1.79 V	22	54.8	4.7
2	*5845.00	122.1 PK			1.79 V	22	117.0	5.1
3	*5845.00	113.4 AV			1.79 V	22	108.3	5.1
4	#5895.00	63.8 PK	130.2	-66.4	1.79 V	22	58.9	4.9
5	#5895.00	51.7 AV	110.2	-58.5	1.79 V	22	46.8	4.9
6	11690.00	47.6 PK	74.0	-26.4	1.86 V	213	33.0	14.6
7	11690.00	36.1 AV	54.0	-17.9	1.86 V	213	21.5	14.6
8	#17535.00	58.3 PK	88.2	-29.9	1.52 V	201	38.5	19.8

Remarks:

1. Emission Level(dBuV/m) = Raw Value(dBuV) + Correction Factor(dB/m)
2. Correction Factor(dB/m) = Antenna Factor(dB/m) + Cable Factor(dB) – Pre-Amplifier Factor(dB)
3. Margin value = Emission Level – Limit value
4. The other emission levels were very low against the limit.
5. " * ": Fundamental frequency, the limit was restricted at the RF Output Power.
6. " # ": The radiated frequency is out of the restricted band.

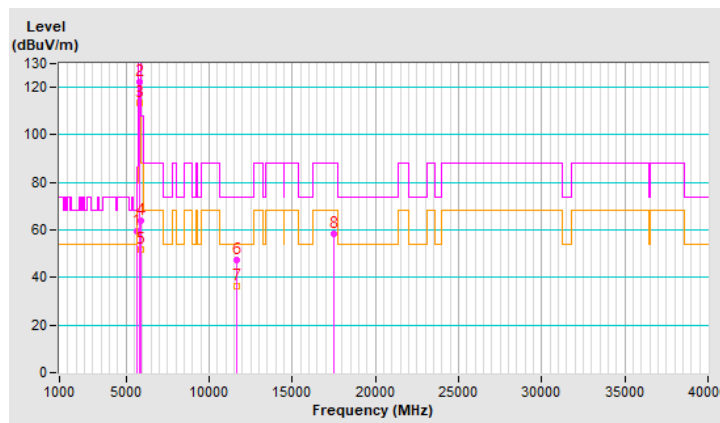

RF Mode	802.11a	Channel	CH 173 : 5865 MHz
Frequency Range	1 GHz ~ 40 GHz	Detector Function & Bandwidth	(PK) RB = 1 MHz, VB = 3 MHz (AV) RB = 1 MHz, VB = 10 Hz
Input Power	120 Vac, 60 Hz	Environmental Conditions	20°C, 70% RH
Tested By	Ryan Du		

Antenna Polarity & Test Distance : Horizontal at 3 m

No	Frequency (MHz)	Emission Level (dBuV/m)	Limit (dBuV/m)	Margin (dB)	Antenna Height (m)	Table Angle (Degree)	Raw Value (dBuV)	Correction Factor (dB/m)
1	#5650.00	56.5 PK	68.2	-11.7	2.29 H	92	51.8	4.7
2	*5865.00	118.8 PK			2.29 H	92	113.8	5.0
3	*5865.00	110.1 AV			2.29 H	92	105.1	5.0
4	#5895.00	63.1 PK	130.2	-67.1	2.29 H	92	58.2	4.9
5	#5895.00	52.5 AV	110.2	-57.7	2.29 H	92	47.6	4.9
6	11730.00	46.9 PK	74.0	-27.1	1.76 H	209	32.5	14.4
7	11730.00	36.1 AV	54.0	-17.9	1.76 H	209	21.7	14.4
8	#17595.00	58.8 PK	88.2	-29.4	1.71 H	66	38.8	20.0

Remarks:

1. Emission Level(dBuV/m) = Raw Value(dBuV) + Correction Factor(dB/m)
2. Correction Factor(dB/m) = Antenna Factor(dB/m) + Cable Factor(dB) – Pre-Amplifier Factor(dB)
3. Margin value = Emission Level – Limit value
4. The other emission levels were very low against the limit.
5. " * ": Fundamental frequency, the limit was restricted at the RF Output Power.
6. " # ": The radiated frequency is out of the restricted band.

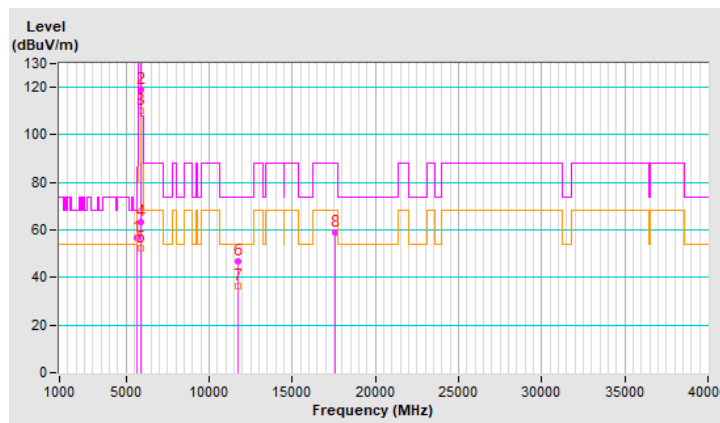

RF Mode	802.11a	Channel	CH 173 : 5865 MHz
Frequency Range	1 GHz ~ 40 GHz	Detector Function & Bandwidth	(PK) RB = 1 MHz, VB = 3 MHz (AV) RB = 1 MHz, VB = 10 Hz
Input Power	120 Vac, 60 Hz	Environmental Conditions	20°C, 70% RH
Tested By	Ryan Du		

Antenna Polarity & Test Distance : Vertical at 3 m								
No	Frequency (MHz)	Emission Level (dBuV/m)	Limit (dBuV/m)	Margin (dB)	Antenna Height (m)	Table Angle (Degree)	Raw Value (dBuV)	Correction Factor (dB/m)
1	#5650.00	58.7 PK	68.2	-9.5	1.75 V	16	54.0	4.7
2	*5865.00	121.7 PK			1.75 V	16	116.7	5.0
3	*5865.00	113.1 AV			1.75 V	16	108.1	5.0
4	#5895.00	69.3 PK	130.2	-60.9	1.75 V	16	64.4	4.9
5	#5895.00	59.0 AV	110.2	-51.2	1.75 V	16	54.1	4.9
6	11730.00	47.6 PK	74.0	-26.4	1.88 V	224	33.2	14.4
7	11730.00	36.0 AV	54.0	-18.0	1.88 V	224	21.6	14.4
8	#17595.00	58.6 PK	88.2	-29.6	1.48 V	209	38.6	20.0

Remarks:

1. Emission Level(dBuV/m) = Raw Value(dBuV) + Correction Factor(dB/m)
2. Correction Factor(dB/m) = Antenna Factor(dB/m) + Cable Factor(dB) – Pre-Amplifier Factor(dB)
3. Margin value = Emission Level – Limit value
4. The other emission levels were very low against the limit.
5. " * ": Fundamental frequency, the limit was restricted at the RF Output Power.
6. " # ": The radiated frequency is out of the restricted band.

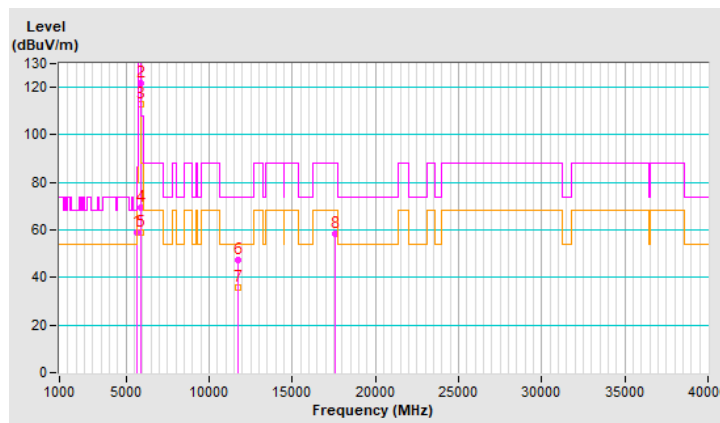

RF Mode	802.11a	Channel	CH 177 : 5885 MHz
Frequency Range	1 GHz ~ 40 GHz	Detector Function & Bandwidth	(PK) RB = 1 MHz, VB = 3 MHz (AV) RB = 1 MHz, VB = 10 Hz
Input Power	120 Vac, 60 Hz	Environmental Conditions	20°C, 70% RH
Tested By	Ryan Du		

Antenna Polarity & Test Distance : Horizontal at 3 m								
No	Frequency (MHz)	Emission Level (dBuV/m)	Limit (dBuV/m)	Margin (dB)	Antenna Height (m)	Table Angle (Degree)	Raw Value (dBuV)	Correction Factor (dB/m)
1	#5650.00	57.1 PK	68.2	-11.1	2.29 H	99	52.4	4.7
2	*5885.00	119.7 PK			2.29 H	99	114.8	4.9
3	*5885.00	110.7 AV			2.29 H	99	105.8	4.9
4	#5895.00	94.8 PK	130.2	-35.4	2.29 H	99	89.9	4.9
5	#5895.00	72.0 AV	110.2	-38.2	2.29 H	99	67.1	4.9
6	11770.00	47.7 PK	74.0	-26.3	1.74 H	215	33.4	14.3
7	11770.00	36.5 AV	54.0	-17.5	1.74 H	215	22.2	14.3
8	#17655.00	58.4 PK	88.2	-29.8	1.64 H	54	38.1	20.3

Remarks:

1. Emission Level(dBuV/m) = Raw Value(dBuV) + Correction Factor(dB/m)
2. Correction Factor(dB/m) = Antenna Factor(dB/m) + Cable Factor(dB) – Pre-Amplifier Factor(dB)
3. Margin value = Emission Level – Limit value
4. The other emission levels were very low against the limit.
5. " * ": Fundamental frequency, the limit was restricted at the RF Output Power.
6. " # ": The radiated frequency is out of the restricted band.

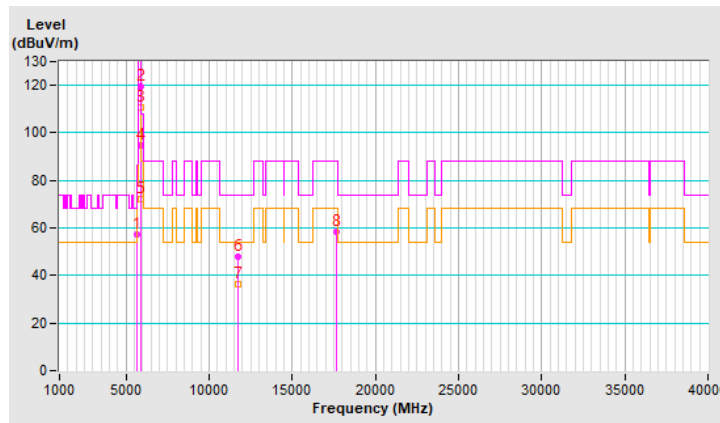

RF Mode	802.11a	Channel	CH 177 : 5885 MHz
Frequency Range	1 GHz ~ 40 GHz	Detector Function & Bandwidth	(PK) RB = 1 MHz, VB = 3 MHz (AV) RB = 1 MHz, VB = 10 Hz
Input Power	120 Vac, 60 Hz	Environmental Conditions	20°C, 70% RH
Tested By	Ryan Du		

Antenna Polarity & Test Distance : Vertical at 3 m								
No	Frequency (MHz)	Emission Level (dBuV/m)	Limit (dBuV/m)	Margin (dB)	Antenna Height (m)	Table Angle (Degree)	Raw Value (dBuV)	Correction Factor (dB/m)
1	#5650.00	60.3 PK	68.2	-7.9	1.75 V	33	55.6	4.7
2	*5885.00	121.8 PK			1.75 V	33	116.9	4.9
3	*5885.00	113.1 AV			1.75 V	33	108.2	4.9
4	#5895.00	99.0 PK	130.2	-31.2	1.75 V	33	94.1	4.9
5	#5895.00	86.9 AV	110.2	-23.3	1.75 V	33	82.0	4.9
6	11770.00	47.4 PK	74.0	-26.6	1.91 V	221	33.1	14.3
7	11770.00	36.1 AV	54.0	-17.9	1.91 V	221	21.8	14.3
8	#17655.00	58.4 PK	88.2	-29.8	1.50 V	195	38.1	20.3

Remarks:

1. Emission Level(dBuV/m) = Raw Value(dBuV) + Correction Factor(dB/m)
2. Correction Factor(dB/m) = Antenna Factor(dB/m) + Cable Factor(dB) – Pre-Amplifier Factor(dB)
3. Margin value = Emission Level – Limit value
4. The other emission levels were very low against the limit.
5. " * ": Fundamental frequency, the limit was restricted at the RF Output Power.
6. " # ": The radiated frequency is out of the restricted band.

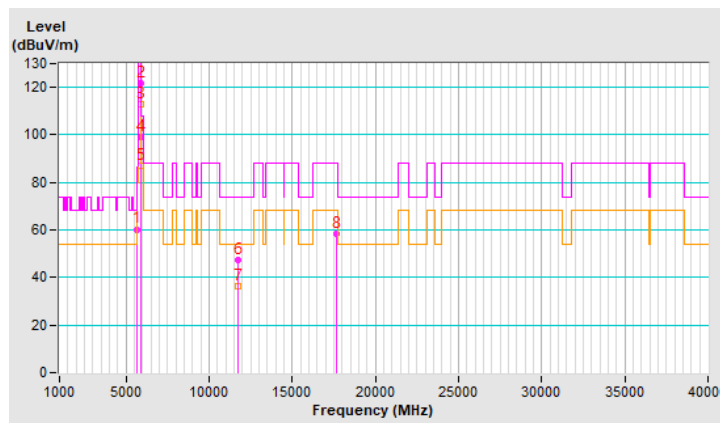

RF Mode	802.11ax (HE20)	Channel	CH 169 : 5845 MHz
Frequency Range	1 GHz ~ 40 GHz	Detector Function & Bandwidth	(PK) RB = 1 MHz, VB = 3 MHz (AV) RB = 1 MHz, VB = 10 Hz
Input Power	120 Vac, 60 Hz	Environmental Conditions	20°C, 70% RH
Tested By	Ryan Du		

Antenna Polarity & Test Distance : Horizontal at 3 m

No	Frequency (MHz)	Emission Level (dBuV/m)	Limit (dBuV/m)	Margin (dB)	Antenna Height (m)	Table Angle (Degree)	Raw Value (dBuV)	Correction Factor (dB/m)
1	#5650.00	57.7 PK	68.2	-10.5	2.34 H	79	53.0	4.7
2	*5845.00	118.9 PK			2.34 H	79	113.8	5.1
3	*5845.00	110.0 AV			2.34 H	79	104.9	5.1
4	#5895.00	62.8 PK	130.2	-67.4	2.34 H	79	57.9	4.9
5	#5895.00	50.0 AV	110.2	-60.2	2.34 H	79	45.1	4.9
6	11690.00	47.1 PK	74.0	-26.9	1.72 H	215	32.5	14.6
7	11690.00	36.3 AV	54.0	-17.7	1.72 H	215	21.7	14.6
8	#17535.00	58.0 PK	88.2	-30.2	1.64 H	76	38.2	19.8

Remarks:

1. Emission Level(dBuV/m) = Raw Value(dBuV) + Correction Factor(dB/m)
2. Correction Factor(dB/m) = Antenna Factor(dB/m) + Cable Factor(dB) – Pre-Amplifier Factor(dB)
3. Margin value = Emission Level – Limit value
4. The other emission levels were very low against the limit.
5. " * ": Fundamental frequency, the limit was restricted at the RF Output Power.
6. " # ": The radiated frequency is out of the restricted band.

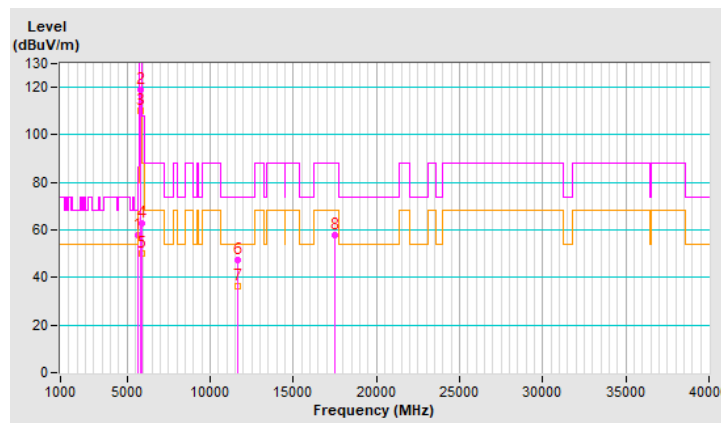

RF Mode	802.11ax (HE20)	Channel	CH 169 : 5845 MHz
Frequency Range	1 GHz ~ 40 GHz	Detector Function & Bandwidth	(PK) RB = 1 MHz, VB = 3 MHz (AV) RB = 1 MHz, VB = 10 Hz
Input Power	120 Vac, 60 Hz	Environmental Conditions	20°C, 70% RH
Tested By	Ryan Du		

Antenna Polarity & Test Distance : Vertical at 3 m								
No	Frequency (MHz)	Emission Level (dBuV/m)	Limit (dBuV/m)	Margin (dB)	Antenna Height (m)	Table Angle (Degree)	Raw Value (dBuV)	Correction Factor (dB/m)
1	#5650.00	59.2 PK	68.2	-9.0	1.76 V	27	54.5	4.7
2	*5845.00	123.8 PK			1.76 V	27	118.7	5.1
3	*5845.00	112.9 AV			1.76 V	27	107.8	5.1
4	#5895.00	61.7 PK	130.2	-68.5	1.76 V	27	56.8	4.9
5	#5895.00	50.2 AV	110.2	-60.0	1.76 V	27	45.3	4.9
6	11690.00	47.6 PK	74.0	-26.4	1.81 V	219	33.0	14.6
7	11690.00	36.3 AV	54.0	-17.7	1.81 V	219	21.7	14.6
8	#17535.00	58.7 PK	88.2	-29.5	1.55 V	195	38.9	19.8

Remarks:

1. Emission Level(dBuV/m) = Raw Value(dBuV) + Correction Factor(dB/m)
2. Correction Factor(dB/m) = Antenna Factor(dB/m) + Cable Factor(dB) – Pre-Amplifier Factor(dB)
3. Margin value = Emission Level – Limit value
4. The other emission levels were very low against the limit.
5. " * ": Fundamental frequency, the limit was restricted at the RF Output Power.
6. " # ": The radiated frequency is out of the restricted band.

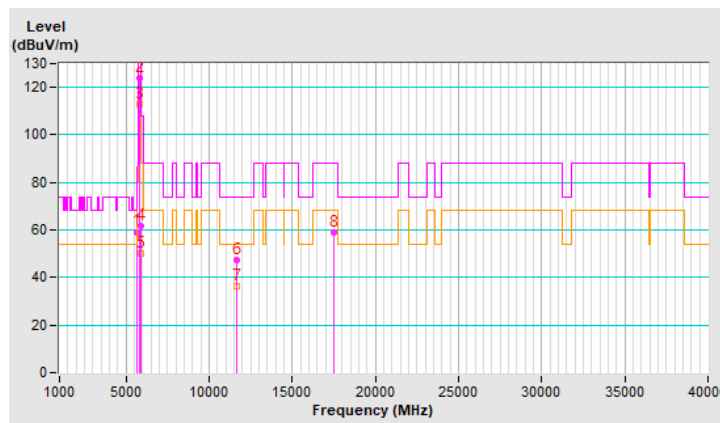

RF Mode	802.11ax (HE20)	Channel	CH 173 : 5865 MHz
Frequency Range	1 GHz ~ 40 GHz	Detector Function & Bandwidth	(PK) RB = 1 MHz, VB = 3 MHz (AV) RB = 1 MHz, VB = 10 Hz
Input Power	120 Vac, 60 Hz	Environmental Conditions	20°C, 70% RH
Tested By	Ryan Du		

Antenna Polarity & Test Distance : Horizontal at 3 m								
No	Frequency (MHz)	Emission Level (dBuV/m)	Limit (dBuV/m)	Margin (dB)	Antenna Height (m)	Table Angle (Degree)	Raw Value (dBuV)	Correction Factor (dB/m)
1	#5650.00	57.4 PK	68.2	-10.8	2.32 H	95	52.7	4.7
2	*5865.00	118.4 PK			2.32 H	95	113.4	5.0
3	*5865.00	110.0 AV			2.32 H	95	105.0	5.0
4	#5895.00	62.2 PK	130.2	-68.0	2.32 H	95	57.3	4.9
5	#5895.00	53.0 AV	110.2	-57.2	2.32 H	95	48.1	4.9
6	11730.00	46.8 PK	74.0	-27.2	1.82 H	216	32.4	14.4
7	11730.00	36.0 AV	54.0	-18.0	1.82 H	216	21.6	14.4
8	#17595.00	59.0 PK	88.2	-29.2	1.65 H	64	39.0	20.0

Remarks:

1. Emission Level(dBuV/m) = Raw Value(dBuV) + Correction Factor(dB/m)
2. Correction Factor(dB/m) = Antenna Factor(dB/m) + Cable Factor(dB) – Pre-Amplifier Factor(dB)
3. Margin value = Emission Level – Limit value
4. The other emission levels were very low against the limit.
5. " * ": Fundamental frequency, the limit was restricted at the RF Output Power.
6. " # ": The radiated frequency is out of the restricted band.

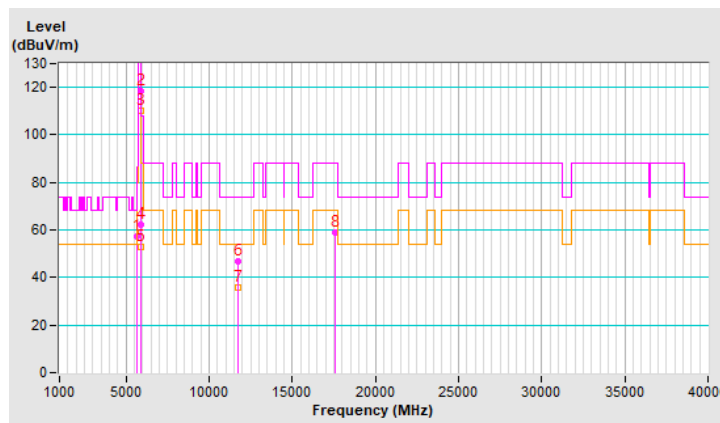

RF Mode	802.11ax (HE20)	Channel	CH 173 : 5865 MHz
Frequency Range	1 GHz ~ 40 GHz	Detector Function & Bandwidth	(PK) RB = 1 MHz, VB = 3 MHz (AV) RB = 1 MHz, VB = 10 Hz
Input Power	120 Vac, 60 Hz	Environmental Conditions	20°C, 70% RH
Tested By	Ryan Du		

Antenna Polarity & Test Distance : Vertical at 3 m								
No	Frequency (MHz)	Emission Level (dBuV/m)	Limit (dBuV/m)	Margin (dB)	Antenna Height (m)	Table Angle (Degree)	Raw Value (dBuV)	Correction Factor (dB/m)
1	#5650.00	58.1 PK	68.2	-10.1	1.74 V	12	53.4	4.7
2	*5865.00	123.6 PK			1.74 V	12	118.6	5.0
3	*5865.00	112.2 AV			1.74 V	12	107.2	5.0
4	#5895.00	68.7 PK	130.2	-61.5	1.74 V	12	63.8	4.9
5	#5895.00	53.6 AV	110.2	-56.6	1.74 V	12	48.7	4.9
6	11730.00	47.5 PK	74.0	-26.5	1.89 V	216	33.1	14.4
7	11730.00	36.0 AV	54.0	-18.0	1.89 V	216	21.6	14.4
8	#17595.00	58.8 PK	88.2	-29.4	1.51 V	200	38.8	20.0

Remarks:

1. Emission Level(dBuV/m) = Raw Value(dBuV) + Correction Factor(dB/m)
2. Correction Factor(dB/m) = Antenna Factor(dB/m) + Cable Factor(dB) – Pre-Amplifier Factor(dB)
3. Margin value = Emission Level – Limit value
4. The other emission levels were very low against the limit.
5. " * ": Fundamental frequency, the limit was restricted at the RF Output Power.
6. " # ": The radiated frequency is out of the restricted band.

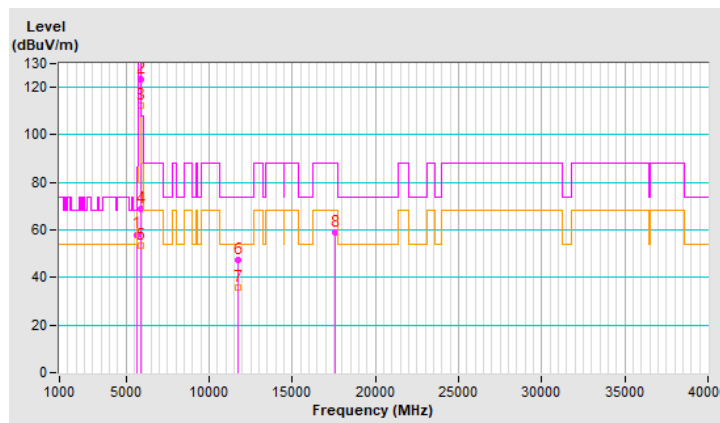

RF Mode	802.11ax (HE20)	Channel	CH 177 : 5885 MHz
Frequency Range	1 GHz ~ 40 GHz	Detector Function & Bandwidth	(PK) RB = 1 MHz, VB = 3 MHz (AV) RB = 1 MHz, VB = 10 Hz
Input Power	120 Vac, 60 Hz	Environmental Conditions	20°C, 70% RH
Tested By	Ryan Du		

Antenna Polarity & Test Distance : Horizontal at 3 m								
No	Frequency (MHz)	Emission Level (dBuV/m)	Limit (dBuV/m)	Margin (dB)	Antenna Height (m)	Table Angle (Degree)	Raw Value (dBuV)	Correction Factor (dB/m)
1	#5596.34	57.3 PK	68.2	-10.9	2.34 H	107	53.0	4.3
2	*5885.00	119.1 PK			2.34 H	107	114.2	4.9
3	*5885.00	110.5 AV			2.34 H	107	105.6	4.9
4	#5895.00	88.6 PK	130.2	-41.6	2.34 H	107	83.7	4.9
5	#5895.00	81.0 AV	110.2	-29.2	2.34 H	107	76.1	4.9
6	11770.00	47.4 PK	74.0	-26.6	1.74 H	216	33.1	14.3
7	11770.00	36.5 AV	54.0	-17.5	1.74 H	216	22.2	14.3
8	#17655.00	58.6 PK	88.2	-29.6	1.63 H	71	38.3	20.3

Remarks:

1. Emission Level(dBuV/m) = Raw Value(dBuV) + Correction Factor(dB/m)
2. Correction Factor(dB/m) = Antenna Factor(dB/m) + Cable Factor(dB) – Pre-Amplifier Factor(dB)
3. Margin value = Emission Level – Limit value
4. The other emission levels were very low against the limit.
5. " * ": Fundamental frequency, the limit was restricted at the RF Output Power.
6. " # ": The radiated frequency is out of the restricted band.

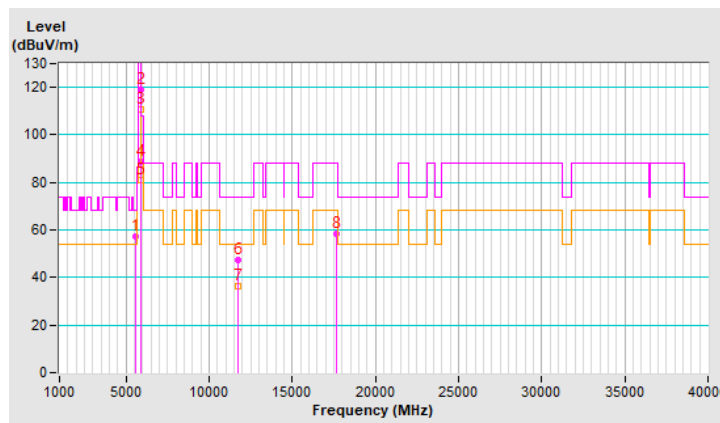

RF Mode	802.11ax (HE20)	Channel	CH 177 : 5885 MHz
Frequency Range	1 GHz ~ 40 GHz	Detector Function & Bandwidth	(PK) RB = 1 MHz, VB = 3 MHz (AV) RB = 1 MHz, VB = 10 Hz
Input Power	120 Vac, 60 Hz	Environmental Conditions	20°C, 70% RH
Tested By	Ryan Du		

Antenna Polarity & Test Distance : Vertical at 3 m								
No	Frequency (MHz)	Emission Level (dBuV/m)	Limit (dBuV/m)	Margin (dB)	Antenna Height (m)	Table Angle (Degree)	Raw Value (dBuV)	Correction Factor (dB/m)
1	#5600.79	58.8 PK	68.2	-9.4	1.80 V	13	54.4	4.4
2	*5885.00	123.5 PK			1.80 V	13	118.6	4.9
3	*5885.00	111.9 AV			1.80 V	13	107.0	4.9
4	#5895.00	107.6 PK	130.2	-22.6	1.80 V	13	102.7	4.9
5	#5895.00	99.0 AV	110.2	-11.2	1.80 V	13	94.1	4.9
6	11770.00	47.9 PK	74.0	-26.1	1.88 V	228	33.6	14.3
7	11770.00	36.3 AV	54.0	-17.7	1.88 V	228	22.0	14.3
8	#17655.00	57.9 PK	88.2	-30.3	1.57 V	205	37.6	20.3

Remarks:

1. Emission Level(dBuV/m) = Raw Value(dBuV) + Correction Factor(dB/m)
2. Correction Factor(dB/m) = Antenna Factor(dB/m) + Cable Factor(dB) – Pre-Amplifier Factor(dB)
3. Margin value = Emission Level – Limit value
4. The other emission levels were very low against the limit.
5. " * ": Fundamental frequency, the limit was restricted at the RF Output Power.
6. " # ": The radiated frequency is out of the restricted band.

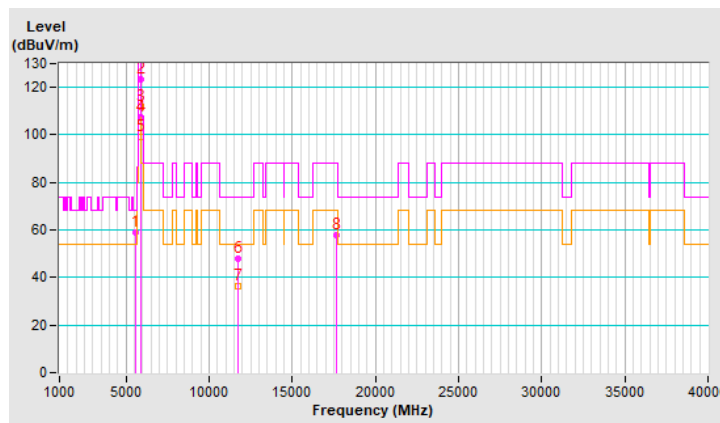

RF Mode	802.11ax (HE40)	Channel	CH 167 : 5835 MHz
Frequency Range	1 GHz ~ 40 GHz	Detector Function & Bandwidth	(PK) RB = 1 MHz, VB = 3 MHz (AV) RB = 1 MHz, VB = 10 Hz
Input Power	120 Vac, 60 Hz	Environmental Conditions	20°C, 70% RH
Tested By	Ryan Du		

Antenna Polarity & Test Distance : Horizontal at 3 m

No	Frequency (MHz)	Emission Level (dBuV/m)	Limit (dBuV/m)	Margin (dB)	Antenna Height (m)	Table Angle (Degree)	Raw Value (dBuV)	Correction Factor (dB/m)
1	#5650.00	58.2 PK	68.2	-10.0	2.31 H	95	53.5	4.7
2	*5835.00	120.3 PK			2.31 H	95	115.3	5.0
3	*5835.00	109.1 AV			2.31 H	95	104.1	5.0
4	#5895.00	72.0 PK	130.2	-58.2	2.31 H	95	67.1	4.9
5	#5895.00	61.3 AV	110.2	-48.9	2.31 H	95	56.4	4.9
6	11670.00	47.7 PK	74.0	-26.3	1.75 H	234	33.2	14.5
7	11670.00	36.4 AV	54.0	-17.6	1.75 H	234	21.9	14.5
8	#17505.00	58.8 PK	88.2	-29.4	1.66 H	72	39.2	19.6

Remarks:

1. Emission Level(dBuV/m) = Raw Value(dBuV) + Correction Factor(dB/m)
2. Correction Factor(dB/m) = Antenna Factor(dB/m) + Cable Factor(dB) – Pre-Amplifier Factor(dB)
3. Margin value = Emission Level – Limit value
4. The other emission levels were very low against the limit.
5. " * ": Fundamental frequency, the limit was restricted at the RF Output Power.
6. " # ": The radiated frequency is out of the restricted band.

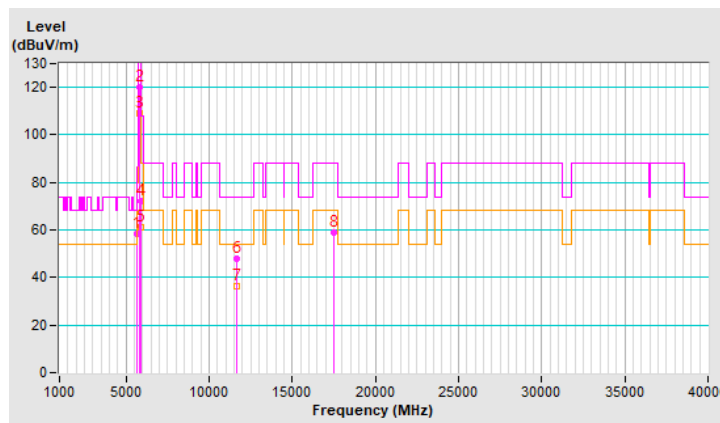

RF Mode	802.11ax (HE40)	Channel	CH 167 : 5835 MHz
Frequency Range	1 GHz ~ 40 GHz	Detector Function & Bandwidth	(PK) RB = 1 MHz, VB = 3 MHz (AV) RB = 1 MHz, VB = 10 Hz
Input Power	120 Vac, 60 Hz	Environmental Conditions	20°C, 70% RH
Tested By	Ryan Du		

Antenna Polarity & Test Distance : Vertical at 3 m								
No	Frequency (MHz)	Emission Level (dBuV/m)	Limit (dBuV/m)	Margin (dB)	Antenna Height (m)	Table Angle (Degree)	Raw Value (dBuV)	Correction Factor (dB/m)
1	#5639.93	67.7 PK	68.2	-0.5	1.82 V	16	63.1	4.6
2	*5835.00	123.2 PK			1.82 V	16	118.2	5.0
3	*5835.00	112.0 AV			1.82 V	16	107.0	5.0
4	#5895.00	90.3 PK	130.2	-39.9	1.82 V	16	85.4	4.9
5	#5895.00	81.4 AV	110.2	-28.8	1.82 V	16	76.5	4.9
6	11670.00	48.0 PK	74.0	-26.0	1.82 V	207	33.5	14.5
7	11670.00	36.5 AV	54.0	-17.5	1.82 V	207	22.0	14.5
8	#17505.00	58.3 PK	88.2	-29.9	1.51 V	190	38.7	19.6

Remarks:

1. Emission Level(dBuV/m) = Raw Value(dBuV) + Correction Factor(dB/m)
2. Correction Factor(dB/m) = Antenna Factor(dB/m) + Cable Factor(dB) – Pre-Amplifier Factor(dB)
3. Margin value = Emission Level – Limit value
4. The other emission levels were very low against the limit.
5. " * ": Fundamental frequency, the limit was restricted at the RF Output Power.
6. " # ": The radiated frequency is out of the restricted band.

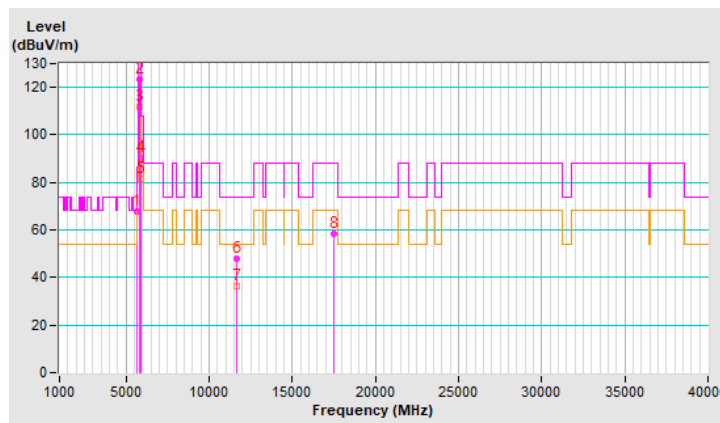

RF Mode	802.11ax (HE40)	Channel	CH 175 : 5875 MHz
Frequency Range	1 GHz ~ 40 GHz	Detector Function & Bandwidth	(PK) RB = 1 MHz, VB = 3 MHz (AV) RB = 1 MHz, VB = 10 Hz
Input Power	120 Vac, 60 Hz	Environmental Conditions	20°C, 70% RH
Tested By	Ryan Du		

Antenna Polarity & Test Distance : Horizontal at 3 m								
No	Frequency (MHz)	Emission Level (dBuV/m)	Limit (dBuV/m)	Margin (dB)	Antenna Height (m)	Table Angle (Degree)	Raw Value (dBuV)	Correction Factor (dB/m)
1	#5650.00	58.8 PK	68.2	-9.4	2.32 H	80	54.1	4.7
2	*5875.00	120.0 PK			2.32 H	80	115.0	5.0
3	*5875.00	108.9 AV			2.32 H	80	103.9	5.0
4	#5895.00	93.0 PK	130.2	-37.2	2.32 H	80	88.1	4.9
5	#5895.00	84.0 AV	110.2	-26.2	2.32 H	80	79.1	4.9
6	11750.00	46.9 PK	74.0	-27.1	1.84 H	237	32.5	14.4
7	11750.00	35.9 AV	54.0	-18.1	1.84 H	237	21.5	14.4
8	#17625.00	58.0 PK	88.2	-30.2	1.63 H	69	37.8	20.2

Remarks:

1. Emission Level(dBuV/m) = Raw Value(dBuV) + Correction Factor(dB/m)
2. Correction Factor(dB/m) = Antenna Factor(dB/m) + Cable Factor(dB) – Pre-Amplifier Factor(dB)
3. Margin value = Emission Level – Limit value
4. The other emission levels were very low against the limit.
5. " * ": Fundamental frequency, the limit was restricted at the RF Output Power.
6. " # ": The radiated frequency is out of the restricted band.

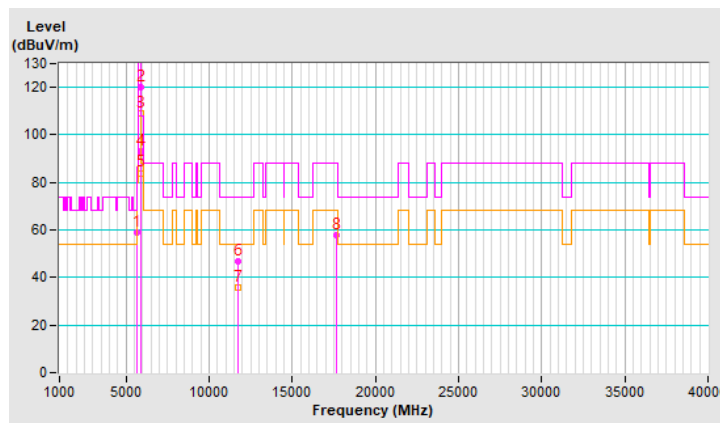

RF Mode	802.11ax (HE40)	Channel	CH 175 : 5875 MHz
Frequency Range	1 GHz ~ 40 GHz	Detector Function & Bandwidth	(PK) RB = 1 MHz, VB = 3 MHz (AV) RB = 1 MHz, VB = 10 Hz
Input Power	120 Vac, 60 Hz	Environmental Conditions	20°C, 70% RH
Tested By	Ryan Du		

Antenna Polarity & Test Distance : Vertical at 3 m								
No	Frequency (MHz)	Emission Level (dBuV/m)	Limit (dBuV/m)	Margin (dB)	Antenna Height (m)	Table Angle (Degree)	Raw Value (dBuV)	Correction Factor (dB/m)
1	#5649.25	65.8 PK	68.2	-2.4	1.79 V	38	61.1	4.7
2	*5875.00	123.0 PK			1.79 V	38	118.0	5.0
3	*5875.00	111.6 AV			1.79 V	38	106.6	5.0
4	#5895.00	107.1 PK	130.2	-23.1	1.79 V	38	102.2	4.9
5	#5895.00	98.0 AV	110.2	-12.2	1.79 V	38	93.1	4.9
6	11750.00	47.7 PK	74.0	-26.3	1.82 V	203	33.3	14.4
7	11750.00	36.4 AV	54.0	-17.6	1.82 V	203	22.0	14.4
8	#17625.00	58.4 PK	88.2	-29.8	1.53 V	214	38.2	20.2

Remarks:

1. Emission Level(dBuV/m) = Raw Value(dBuV) + Correction Factor(dB/m)
2. Correction Factor(dB/m) = Antenna Factor(dB/m) + Cable Factor(dB) – Pre-Amplifier Factor(dB)
3. Margin value = Emission Level – Limit value
4. The other emission levels were very low against the limit.
5. " * ": Fundamental frequency, the limit was restricted at the RF Output Power.
6. " # ": The radiated frequency is out of the restricted band.

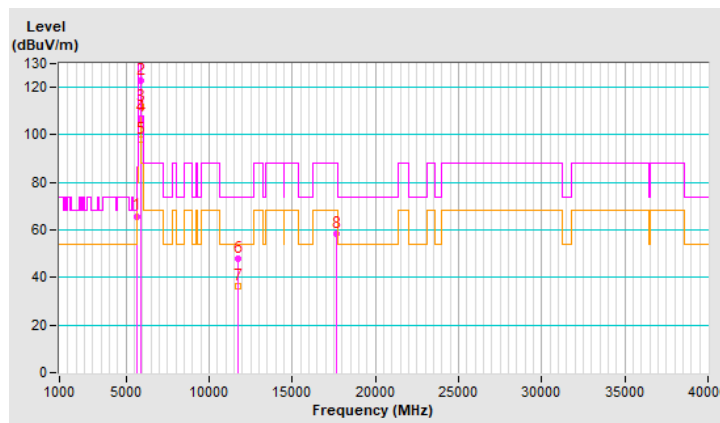

RF Mode	802.11ax (HE80)	Channel	CH 171 : 5855 MHz
Frequency Range	1 GHz ~ 40 GHz	Detector Function & Bandwidth	(PK) RB = 1 MHz, VB = 3 MHz (AV) RB = 1 MHz, VB = 10 Hz
Input Power	120 Vac, 60 Hz	Environmental Conditions	20°C, 70% RH
Tested By	Ryan Du		

Antenna Polarity & Test Distance : Horizontal at 3 m

No	Frequency (MHz)	Emission Level (dBuV/m)	Limit (dBuV/m)	Margin (dB)	Antenna Height (m)	Table Angle (Degree)	Raw Value (dBuV)	Correction Factor (dB/m)
1	#5650.00	60.8 PK	68.2	-7.4	2.30 H	87	56.1	4.7
2	*5855.00	116.2 PK			2.30 H	87	111.1	5.1
3	*5855.00	105.5 AV			2.30 H	87	100.4	5.1
4	#5895.00	89.5 PK	130.2	-40.7	2.30 H	87	84.6	4.9
5	#5895.00	80.1 AV	110.2	-30.1	2.30 H	87	75.2	4.9
6	11710.00	46.8 PK	74.0	-27.2	1.83 H	228	32.3	14.5
7	11710.00	36.0 AV	54.0	-18.0	1.83 H	228	21.5	14.5
8	#17565.00	58.8 PK	88.2	-29.4	1.64 H	65	38.9	19.9

Remarks:

1. Emission Level(dBuV/m) = Raw Value(dBuV) + Correction Factor(dB/m)
2. Correction Factor(dB/m) = Antenna Factor(dB/m) + Cable Factor(dB) – Pre-Amplifier Factor(dB)
3. Margin value = Emission Level – Limit value
4. The other emission levels were very low against the limit.
5. " * ": Fundamental frequency, the limit was restricted at the RF Output Power.
6. " # ": The radiated frequency is out of the restricted band.

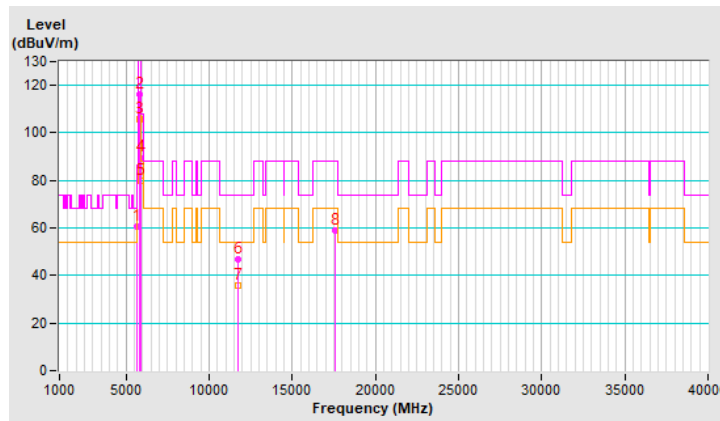

RF Mode	802.11ax (HE80)	Channel	CH 171 : 5855 MHz
Frequency Range	1 GHz ~ 40 GHz	Detector Function & Bandwidth	(PK) RB = 1 MHz, VB = 3 MHz (AV) RB = 1 MHz, VB = 10 Hz
Input Power	120 Vac, 60 Hz	Environmental Conditions	20°C, 70% RH
Tested By	Ryan Du		

Antenna Polarity & Test Distance : Vertical at 3 m								
No	Frequency (MHz)	Emission Level (dBuV/m)	Limit (dBuV/m)	Margin (dB)	Antenna Height (m)	Table Angle (Degree)	Raw Value (dBuV)	Correction Factor (dB/m)
1	#5647.72	67.6 PK	68.2	-0.6	1.85 V	14	62.9	4.7
2	*5855.00	119.4 PK			1.85 V	14	114.3	5.1
3	*5855.00	108.6 AV			1.85 V	14	103.5	5.1
4	#5895.00	97.7 PK	130.2	-32.5	1.85 V	14	92.8	4.9
5	#5895.00	90.6 AV	110.2	-19.6	1.85 V	14	85.7	4.9
6	11710.00	47.6 PK	74.0	-26.4	1.88 V	210	33.1	14.5
7	11710.00	36.3 AV	54.0	-17.7	1.88 V	210	21.8	14.5
8	#17565.00	58.3 PK	88.2	-29.9	1.53 V	202	38.4	19.9

Remarks:

1. Emission Level(dBuV/m) = Raw Value(dBuV) + Correction Factor(dB/m)
2. Correction Factor(dB/m) = Antenna Factor(dB/m) + Cable Factor(dB) – Pre-Amplifier Factor(dB)
3. Margin value = Emission Level – Limit value
4. The other emission levels were very low against the limit.
5. " * ": Fundamental frequency, the limit was restricted at the RF Output Power.
6. " # ": The radiated frequency is out of the restricted band.

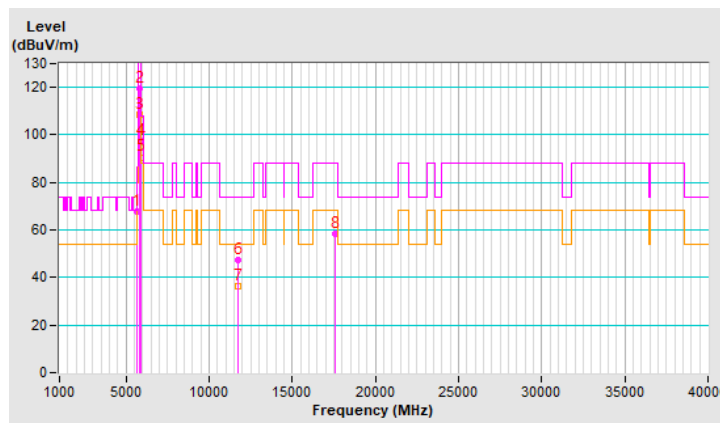

RF Mode	802.11ax (HE160)	Channel	CH 163 : 5815 MHz
Frequency Range	1 GHz ~ 40 GHz	Detector Function & Bandwidth	(PK) RB = 1 MHz, VB = 3 MHz (AV) RB = 1 MHz, VB = 10 Hz
Input Power	120 Vac, 60 Hz	Environmental Conditions	20°C, 70% RH
Tested By	Ryan Du		

Antenna Polarity & Test Distance : Horizontal at 3 m

No	Frequency (MHz)	Emission Level (dBuV/m)	Limit (dBuV/m)	Margin (dB)	Antenna Height (m)	Table Angle (Degree)	Raw Value (dBuV)	Correction Factor (dB/m)
1	#5616.58	66.1 PK	68.2	-2.1	2.29 H	94	61.6	4.5
2	*5815.00	101.3 PK			2.29 H	94	96.3	5.0
3	*5815.00	90.6 AV			2.29 H	94	85.6	5.0
4	#5895.00	79.5 PK	130.2	-50.7	2.29 H	94	74.6	4.9
5	#5895.00	61.5 AV	110.2	-48.7	2.29 H	94	56.6	4.9
6	11630.00	47.4 PK	74.0	-26.6	1.81 H	235	32.8	14.6
7	11630.00	36.2 AV	54.0	-17.8	1.81 H	235	21.6	14.6
8	#17445.00	58.5 PK	88.2	-29.7	1.72 H	78	39.3	19.2

Remarks:

1. Emission Level(dBuV/m) = Raw Value(dBuV) + Correction Factor(dB/m)
2. Correction Factor(dB/m) = Antenna Factor(dB/m) + Cable Factor(dB) – Pre-Amplifier Factor(dB)
3. Margin value = Emission Level – Limit value
4. The other emission levels were very low against the limit.
5. " * ": Fundamental frequency, the limit was restricted at the RF Output Power.
6. " # ": The radiated frequency is out of the restricted band.

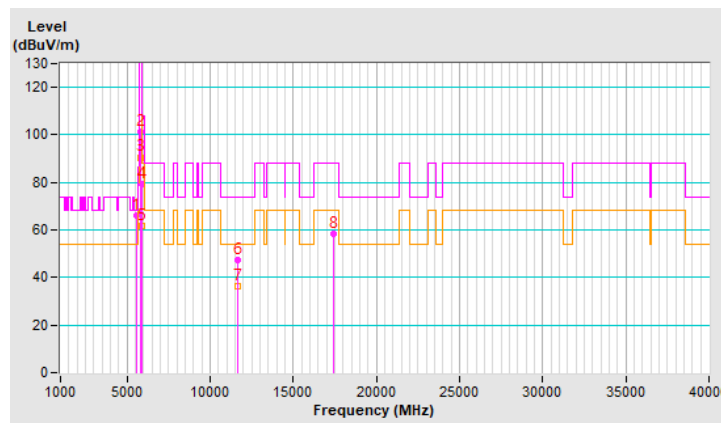

RF Mode	802.11ax (HE160)	Channel	CH 163 : 5815 MHz
Frequency Range	1 GHz ~ 40 GHz	Detector Function & Bandwidth	(PK) RB = 1 MHz, VB = 3 MHz (AV) RB = 1 MHz, VB = 10 Hz
Input Power	120 Vac, 60 Hz	Environmental Conditions	20°C, 70% RH
Tested By	Ryan Du		

Antenna Polarity & Test Distance : Vertical at 3 m								
No	Frequency (MHz)	Emission Level (dBuV/m)	Limit (dBuV/m)	Margin (dB)	Antenna Height (m)	Table Angle (Degree)	Raw Value (dBuV)	Correction Factor (dB/m)
1	#5646.42	67.7 PK	68.2	-0.5	1.76 V	28	63.0	4.7
2	*5815.00	104.4 PK			1.76 V	28	99.4	5.0
3	*5815.00	93.6 AV			1.76 V	28	88.6	5.0
4	#5895.00	82.0 PK	130.2	-48.2	1.76 V	28	77.1	4.9
5	#5895.00	66.7 AV	110.2	-43.5	1.76 V	28	61.8	4.9
6	11630.00	47.4 PK	74.0	-26.6	1.89 V	215	32.8	14.6
7	11630.00	36.0 AV	54.0	-18.0	1.89 V	215	21.4	14.6
8	#17445.00	58.8 PK	88.2	-29.4	1.53 V	203	39.6	19.2

Remarks:

1. Emission Level(dBuV/m) = Raw Value(dBuV) + Correction Factor(dB/m)
2. Correction Factor(dB/m) = Antenna Factor(dB/m) + Cable Factor(dB) – Pre-Amplifier Factor(dB)
3. Margin value = Emission Level – Limit value
4. The other emission levels were very low against the limit.
5. " * ": Fundamental frequency, the limit was restricted at the RF Output Power.
6. " # ": The radiated frequency is out of the restricted band.

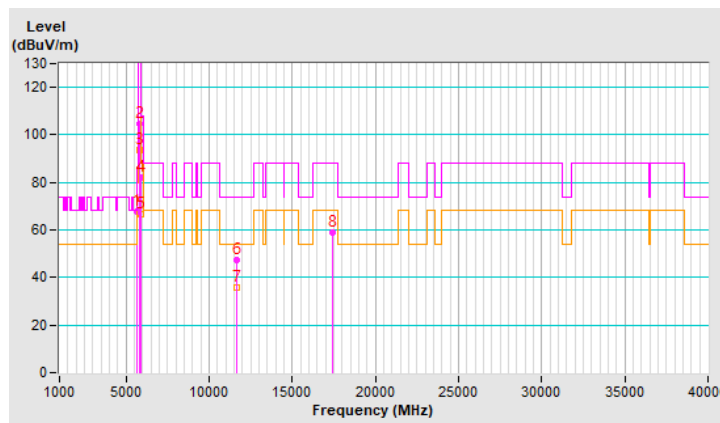

802.11a Channel 169

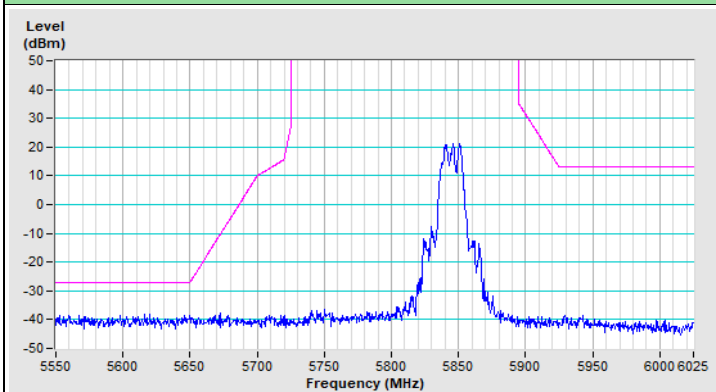

Horizontal (Peak)

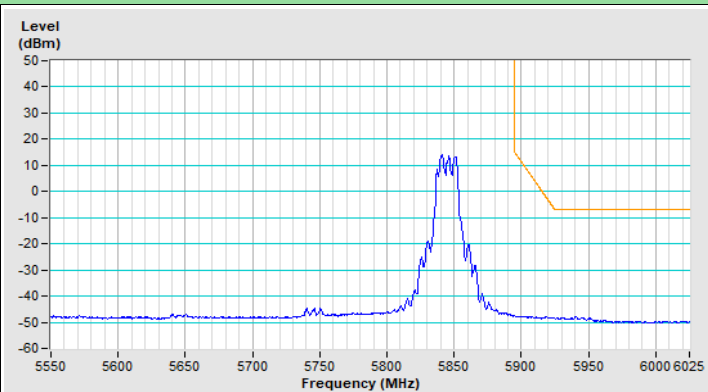

Horizontal (Average)

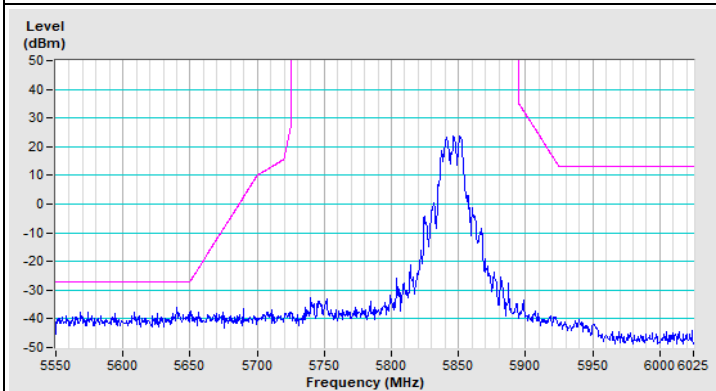

Vertical (Peak)

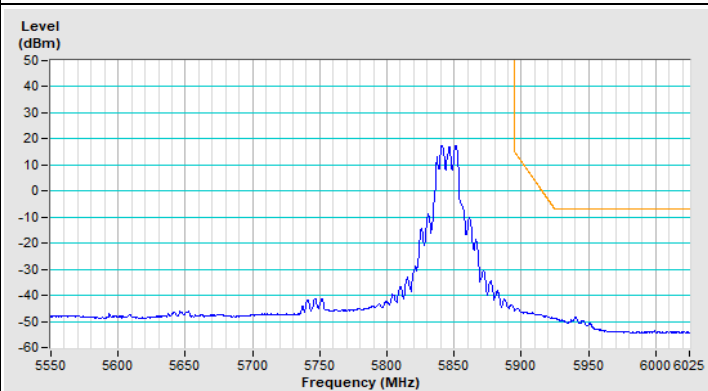

Vertical (Average)

802.11a Channel 173

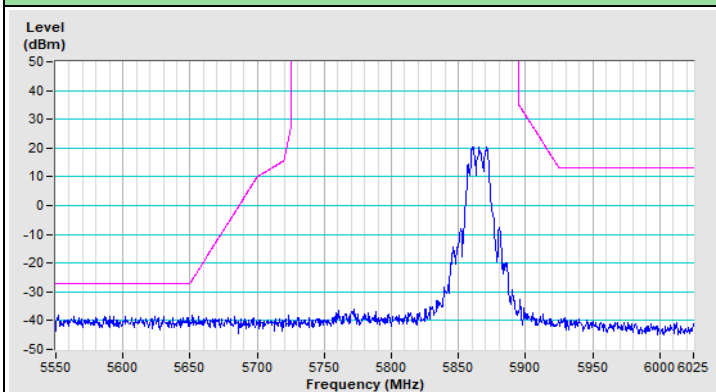

Horizontal (Peak)

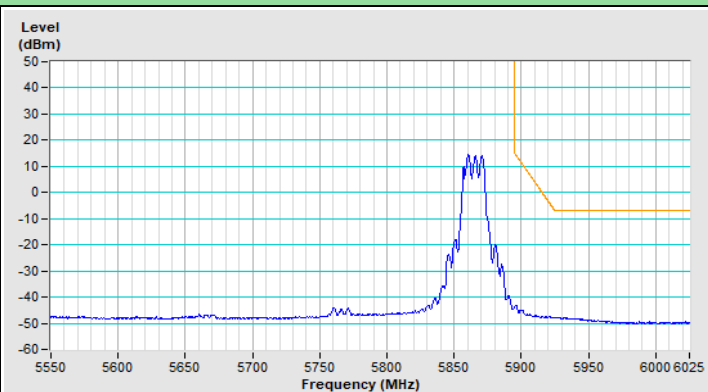

Horizontal (Average)

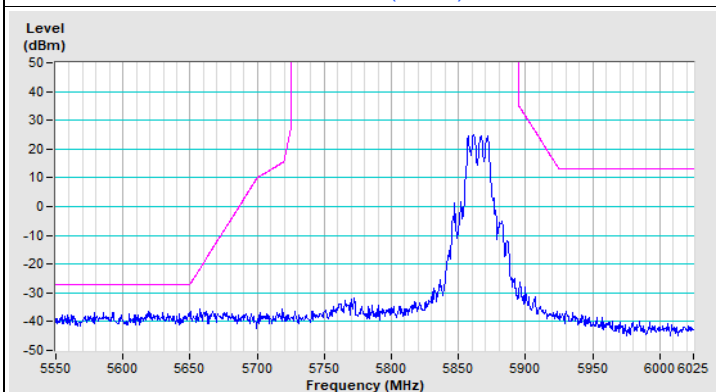

Vertical (Peak)

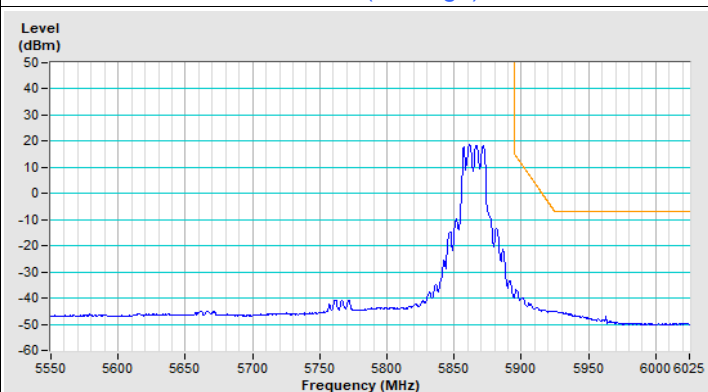

Vertical (Average)

802.11a Channel 177

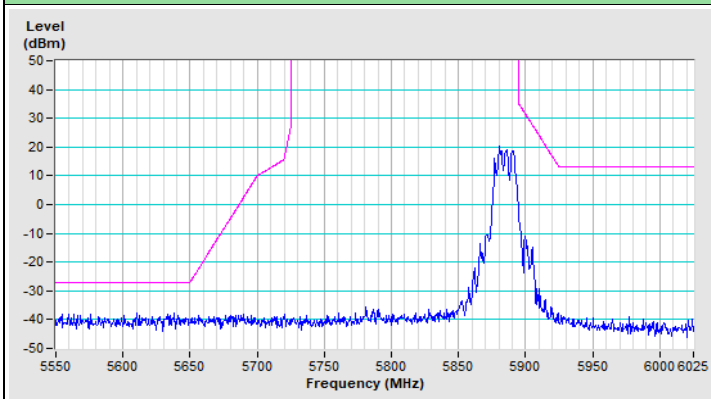

Horizontal (Peak)

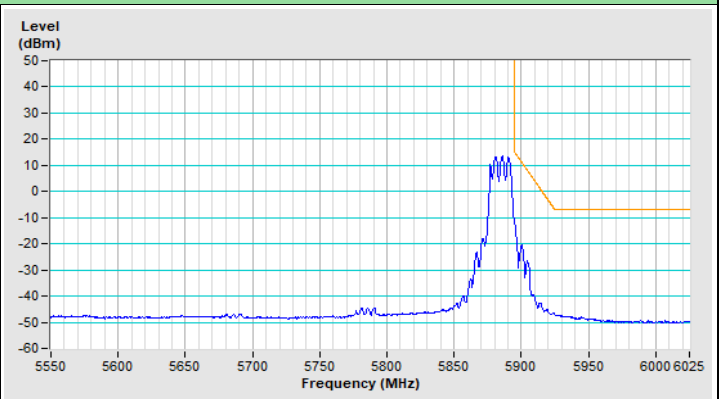

Horizontal (Average)

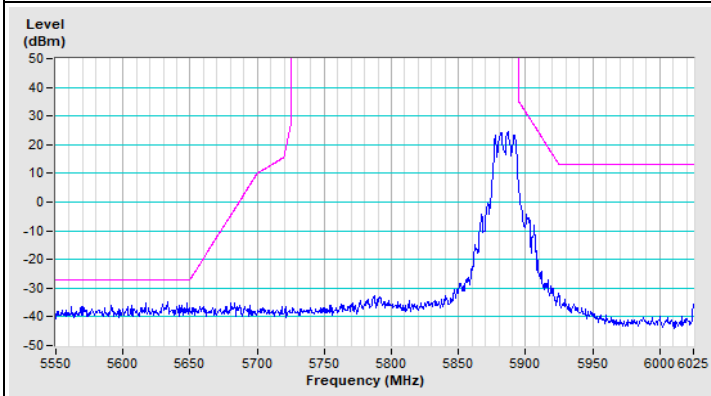

Vertical (Peak)

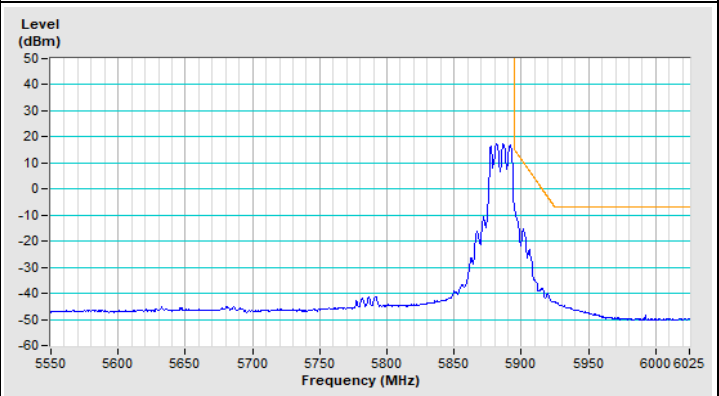

Vertical (Average)

802.11ax (HE20) Channel 169

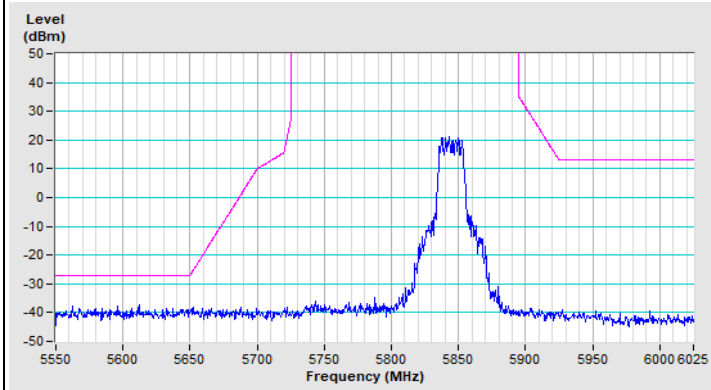

Horizontal (Peak)

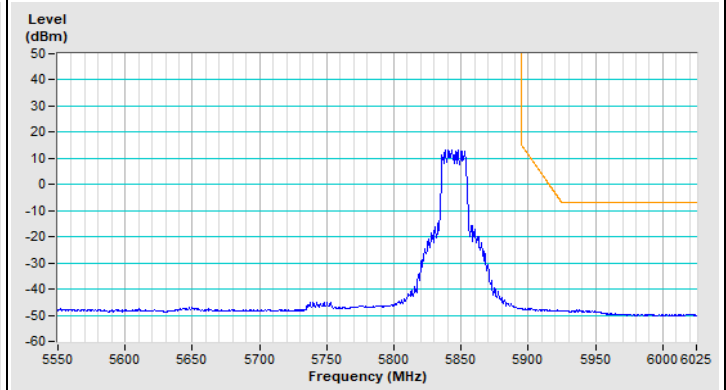

Horizontal (Average)

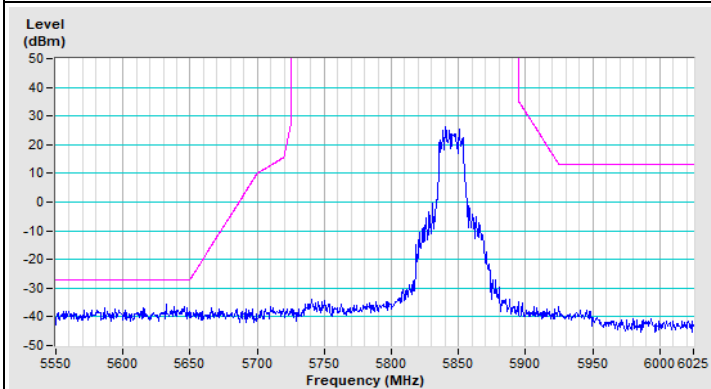

Vertical (Peak)

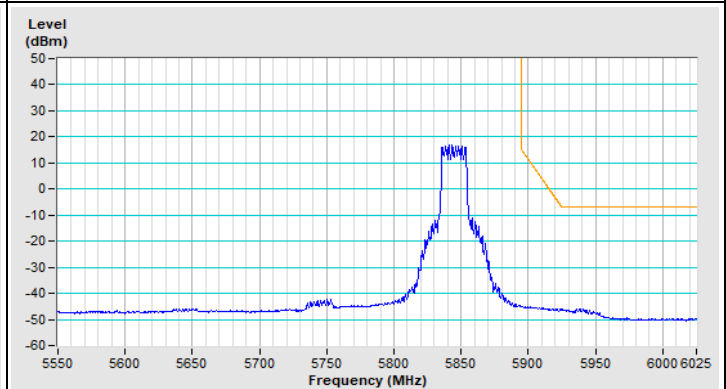

Vertical (Average)

802.11ax (HE20) Channel 173

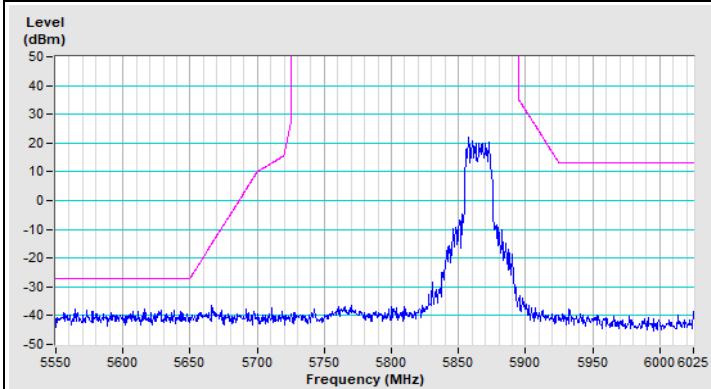

Horizontal (Peak)

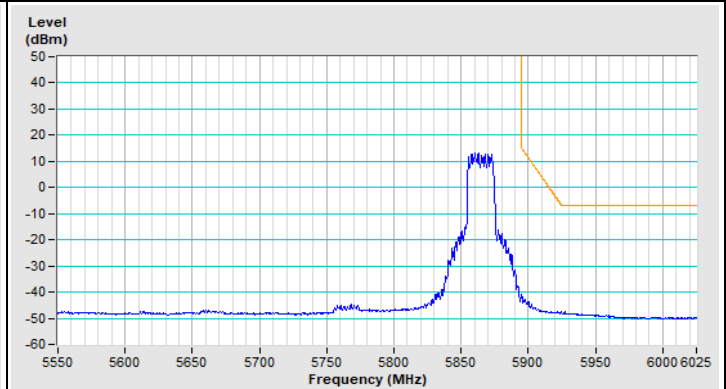

Horizontal (Average)

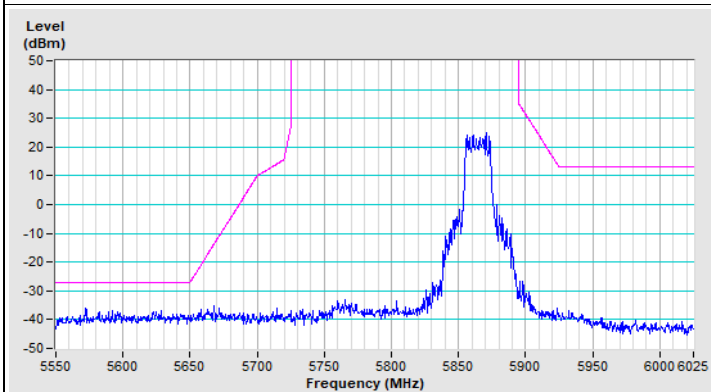

Vertical (Peak)

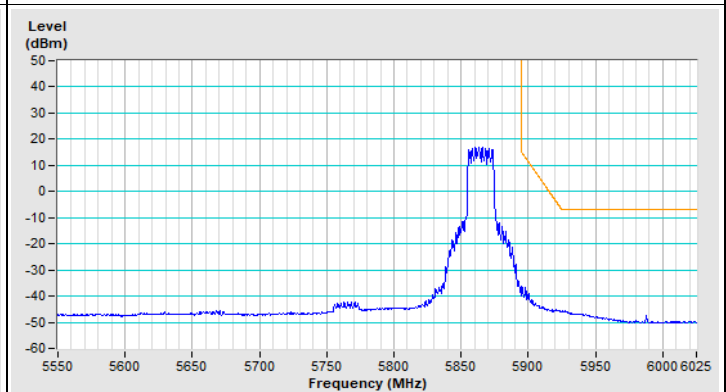

Vertical (Average)

802.11ax (HE20) Channel 177

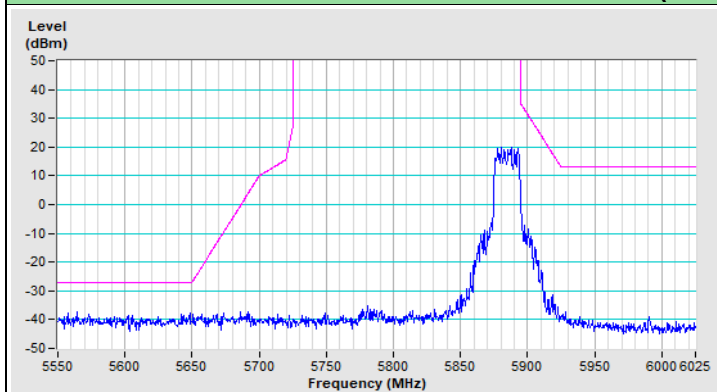

Horizontal (Peak)

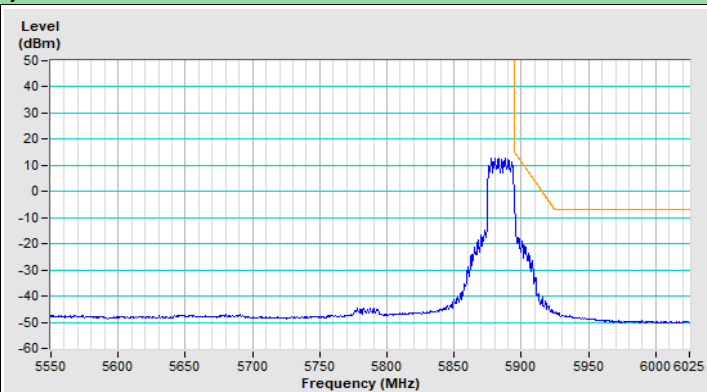

Horizontal (Average)

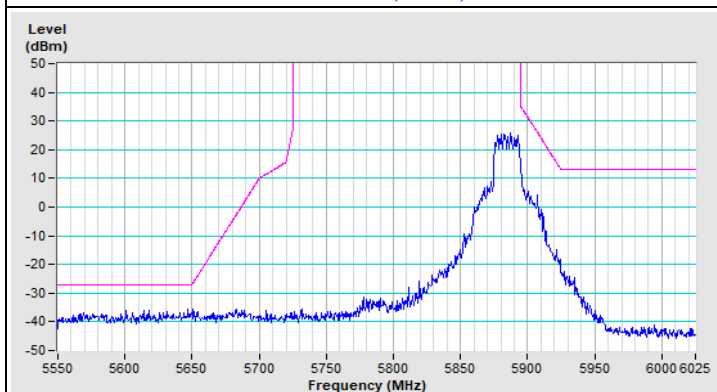

Vertical (Peak)

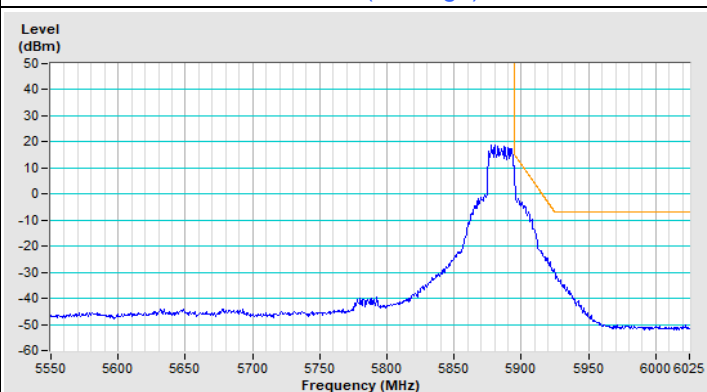

Vertical (Average)

802.11ax (HE40) Channel 167

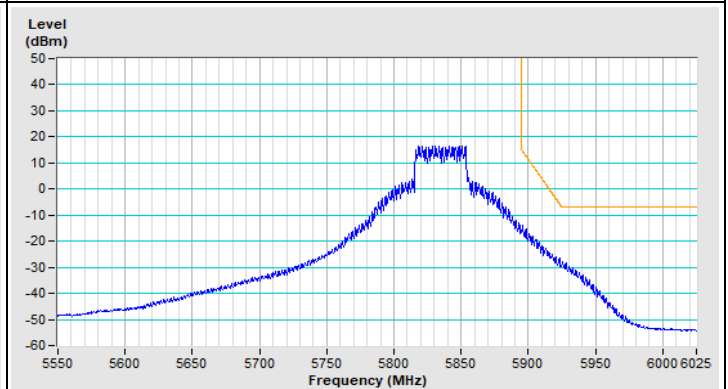
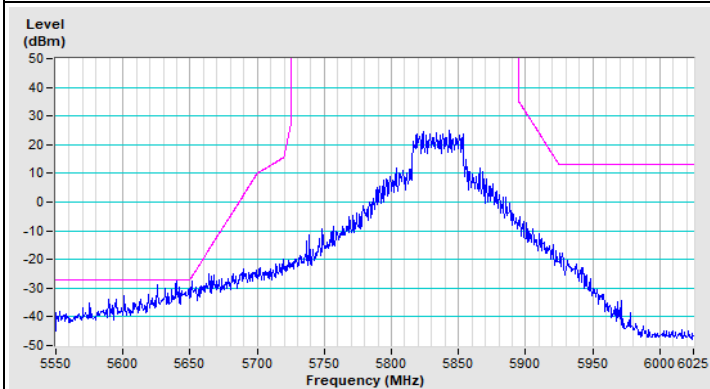
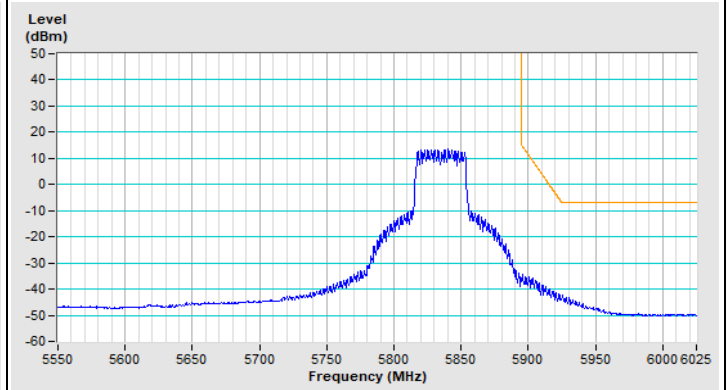
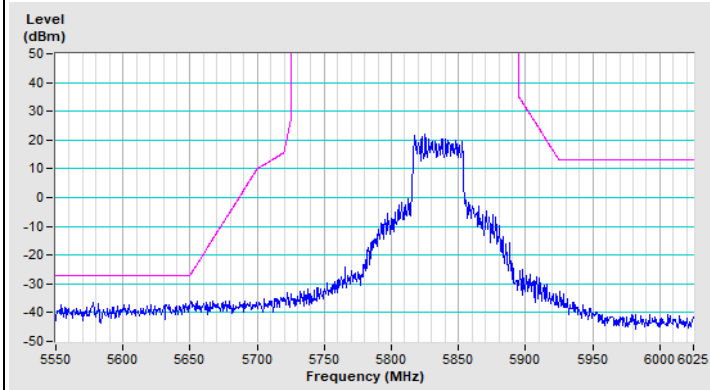

802.11ax (HE40) Channel 175

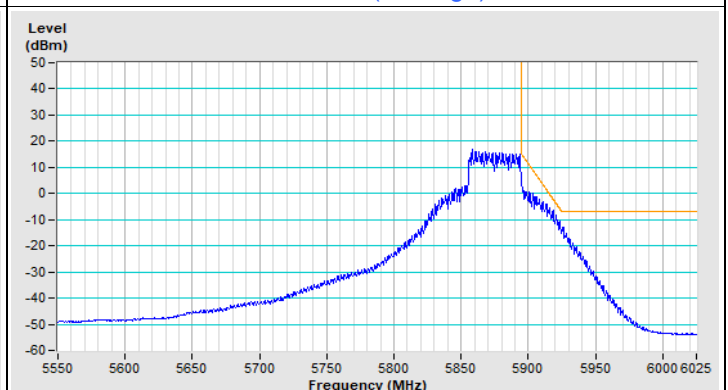
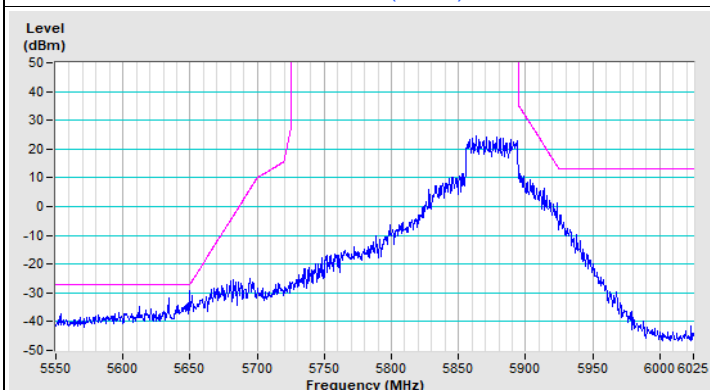
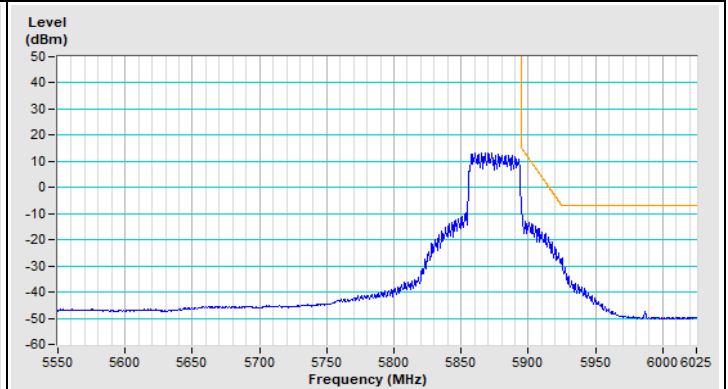
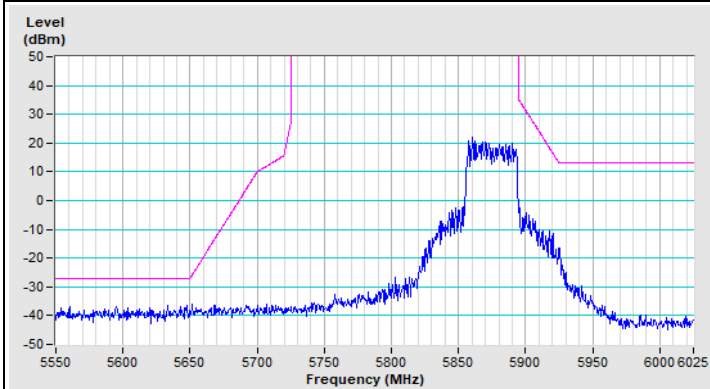

802.11ax (HE80) Channel 171

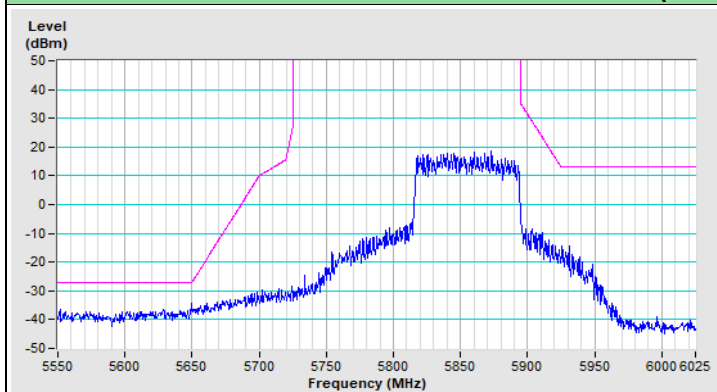

Horizontal (Peak)

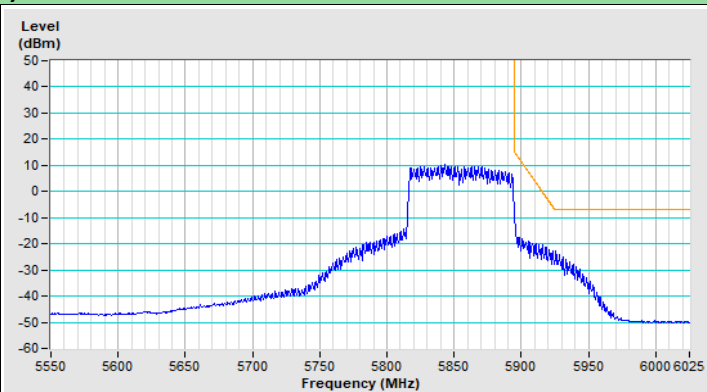

Horizontal (Average)

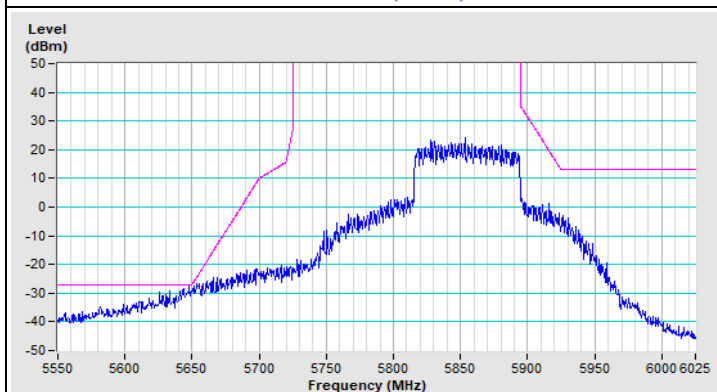

Vertical (Peak)

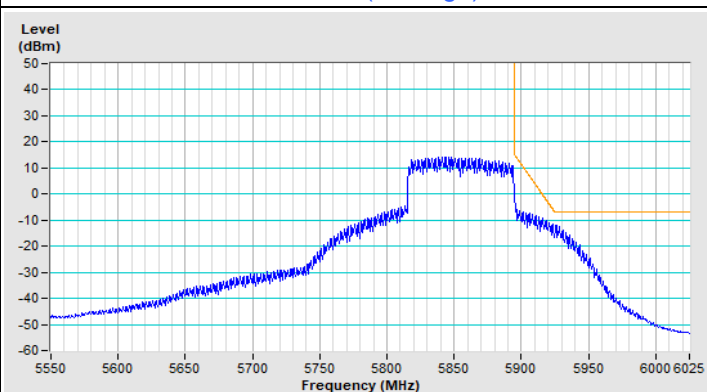

Vertical (Average)

802.11ax (HE160) Channel 163

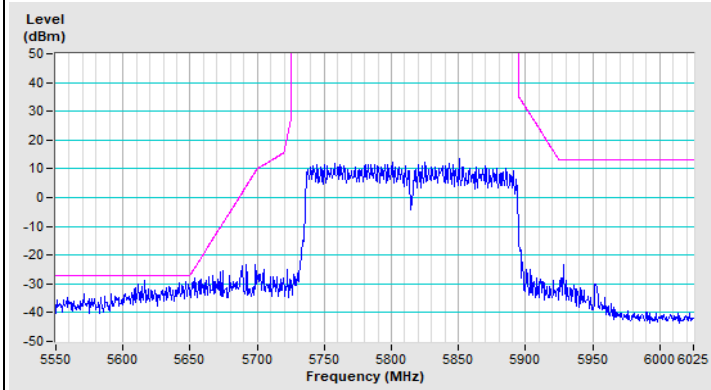

Horizontal (Peak)

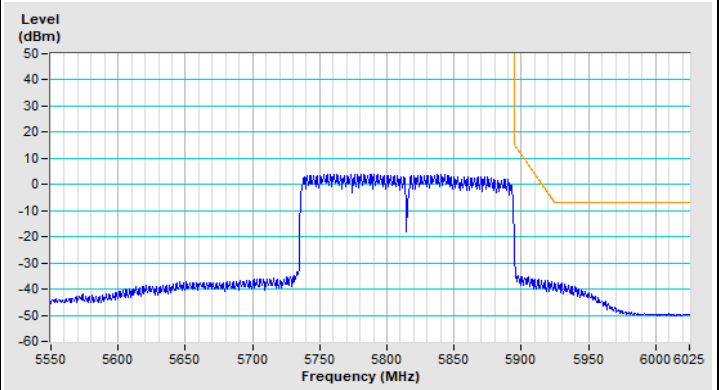

Horizontal (Average)

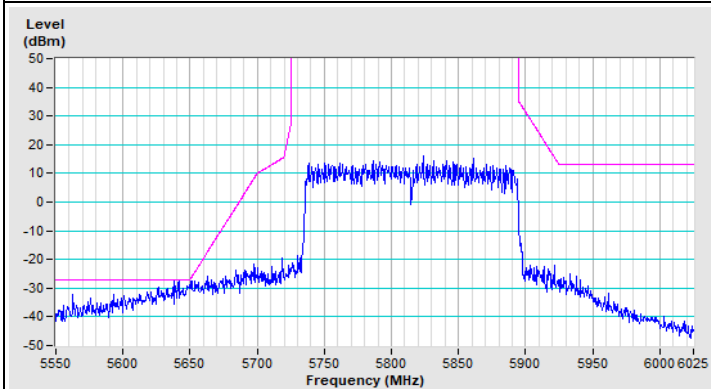

Vertical (Peak)

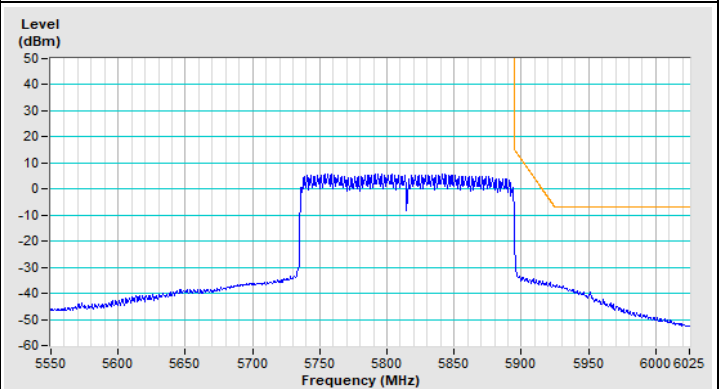

Vertical (Average)

8 Operational Restrictions for 5.85-5.895GHz U-NII Devices

For Subordinate Device operates in the 5.850-5.895 GHz band under the control of an Indoor Access Point, is supplied power from a wired connection, has an integrated antenna, is not battery powered, does not have a weatherized enclosure, and does not have a direct connection to the internet.

Subordinate devices must not be used to connect devices between separate buildings or structures. Subordinate devices must be authorized under certification procedures in part 2 of this chapter. Modules may not be certified as subordinate devices.

9 Pictures of Test Arrangements

Please refer to the attached file (Test Setup Photo)

10 Information of the Testing Laboratories

We, Bureau Veritas Consumer Products Services (H.K.) Ltd., Taoyuan Branch, were founded in 1988 to provide our best service in EMC, Radio, Telecom and Safety consultation. Our laboratories are FCC recognized accredited test firms and accredited according to ISO/IEC 17025.

If you have any comments, please feel free to contact us at the following:

Lin Kou EMC/RF Lab

Tel: 886-2-26052180

Fax: 886-2-26051924

Hsin Chu EMC/RF/Telecom Lab

Tel: 886-3-6668565

Fax: 886-3-6668323

Hwa Ya EMC/RF/Safety Lab

Tel: 886-3-3183232

Fax: 886-3-3270892

Email: service.adt@bureauveritas.com

Web Site: <http://ee.bureauveritas.com.tw>

The address and road map of all our labs can be found in our web site also.

--- END ---