



FCC RADIO TEST REPORT

FCC ID : PY322300575
Equipment : NightHawk M6 5G Mobile Hotspot
Brand Name : Netgear
Model Name : MR6550
Applicant : Netgear Inc
350 E. Plumeria Drive, San Jose, CA
95134, United States
Manufacturer : Netgear Inc
350 E. Plumeria Drive, San Jose, CA
95134, United States
Standard : FCC 47 CFR Part 2, 27

The product was received on Dec. 26, 2022 and testing was performed from Jun. 06, 2023 to Mar. 03, 2023. We, Sporton International Inc. EMC & Wireless Communications Laboratory, would like to declare that the tested sample has been evaluated in accordance with the test procedures given in ANSI / TIA-603-E and has been in compliance with the applicable technical standards.

The test results in this variant report apply exclusively to the tested model / sample. Without written approval of Sporton International Inc. EMC & Wireless Communications Laboratory, the test report shall not be reproduced except in full.

Louis Wu

Approved by: Louis Wu

Sporton International Inc. EMC & Wireless Communications Laboratory

No. 52, Huaya 1st Rd., Guishan Dist., Taoyuan City 333, Taiwan (R.O.C.)



Table of Contents

History of this test report.....	3
Summary of Test Result.....	4
1 General Description	5
1.1 Product Feature of Equipment Under Test.....	5
1.2 Modification of EUT	5
1.3 Testing Location	6
1.4 Applicable Standards.....	6
2 Test Configuration of Equipment Under Test	7
2.1 Test Mode.....	7
2.2 Connection Diagram of Test System.....	9
2.3 Support Unit used in test configuration and system	9
2.4 Measurement Results Explanation Example.....	9
2.5 Frequency List of Low/Middle/High Channels	10
3 Conducted Test Items.....	12
3.1 Measuring Instruments	12
3.2 Conducted Output Power and EIRP	13
3.3 Peak-to-Average Ratio	14
3.4 Occupied Bandwidth.....	15
3.5 Conducted Band Edge	16
3.6 Conducted Spurious Emission	17
3.7 Frequency Stability	18
4 Radiated Test Items	19
4.1 Measuring Instruments	19
4.2 Radiated Spurious Emission Measurement	21
5 List of Measuring Equipment.....	22
6 Uncertainty of Evaluation.....	24
Appendix A. Test Results of Conducted Test	
Appendix B. Test Results of Radiated Test	
Appendix C. Test Setup Photographs	



History of this test report

Report No.	Version	Description	Issue Date
FG190614-07B	01	Initial issue of report	Mar. 24, 2023



Summary of Test Result

Report Clause	Ref Std. Clause	Test Items	Result (PASS/FAIL)	Remark
3.2	§2.1046	Conducted Output Power	Reporting only	-
	§27.50 (j)(3)	Equivalent Isotropic Radiated Power (n77) (n78)	Pass	
3.3	§27.50 (j)(4)	Peak-to-Average Ratio	Reporting only	-
3.4	§2.1049	Occupied Bandwidth	Reporting only	-
3.5	§2.1051 §27.53 (l)(2)	Conducted Band Edge Measurement (n77) (n78)	Pass	-
3.6	§2.1051 §27.53 (l)(2)	Conducted Spurious Emission (n77) (n78)	Pass	-
3.7	§2.1055 §27.54	Frequency Stability Temperature & Voltage	Pass	-
4.2	§2.1051 §27.53 (l)(2)	Radiated Spurious Emission (n77) (n78)	Pass	-14.93 dB under the limit at 14965.000 MHz

Remark: This is a variant report by changing Equipment Name and adding 5G NR n78_HPUE, n77 MIMO, n78 MIMO band via software. All the test cases were performed on original report which can be referred to Sporton Report Number 190614-06. Based on the original report, the test cases were verified.

Conformity Assessment Condition:

1. The test results (PASS/FAIL) with all measurement uncertainty excluded are presented against the regulation limits or in accordance with the requirements stipulated by the applicant/manufacturer who shall bear all the risks of non-compliance that may potentially occur if measurement uncertainty is taken into account.
2. Please refer to the section " Uncertainty of Evaluation " for measurement uncertainty.

Disclaimer:

The product specifications of the EUT presented in the test report that may affect the test assessments are declared by the manufacturer who shall take full responsibility for the authenticity.

Reviewed by: Avis Chuang

Report Producer: Rachel Hsieh



1 General Description

1.1 Product Feature of Equipment Under Test

LTE/5G NR, Wi-Fi 2.4GHz 802.11b/g/n/ac/ax, Wi-Fi 5GHz 802.11a/n/ac/ax, Wi-Fi 6GHz 802.11a/ax, and GPS

Product Feature	
Antenna Type	WWAN: <Ant. 1>: Monopole Antenna <Ant. 2>: Monopole Antenna WLAN: <Ant. 3>: Monopole Antenna <Ant. 4>: Monopole Antenna GPS: PIFA Antenna

Remark: The above EUT's information was declared by manufacturer. Please refer to Disclaimer in report summary.

Antenna Information	
Internal Antenna Gain	<Ant. 1>: 0.17 dBi <Ant. 2>: 1.66 dBi <Ant. 5 (SRS)>: 0.98 dBi (Rx only) <Ant. 6 (SRS)>: 3.31 dBi (Rx only)
External Antenna Gain	<Ant. 1>: 0.17 dBi <Ant. 2>: 0.17 dBi
External Connector	TS9

Remark:

1. TS9 connector is for the external antennas, while the external antennas are connected, RF outputs are switched from internal antenna 1/2 to the external one.
2. The maximum antenna gain allowed for the external antenna is limited by the numbers in the table, and also illustrated in the user manual.

1.2 Modification of EUT

No modifications are made to the EUT during all test items.



1.3 Testing Location

Test Site	Sporton International Inc. EMC & Wireless Communications Laboratory
Test Site Location	No.52, Huaya 1st Rd., Guishan Dist., Taoyuan City 333, Taiwan (R.O.C.) TEL: +886-3-327-3456 FAX: +886-3-328-4978
Test Site No.	Sporton Site No. TH03-HY
Test Engineer	Luffy Lin and Ivy Yeh
Temperature (°C)	23.5~24.1°C
Relative Humidity (%)	48~52%

Test Site	Sporton International Inc. Wensan Laboratory
Test Site Location	No.58, Huaya 1st Rd., Guishan Dist., Taoyuan City 333010, Taiwan (R.O.C.) TEL: +886-3-327-3456 FAX: +886-3-328-4978
Test Site No.	Sporton Site No. 03CH12-HY (TAF Code: 3786)
Test Engineer	Jack Cheng, Wilson Wu, Jesse Fan and Tim Lee
Temperature (°C)	20~25°C
Relative Humidity (%)	50~60%
Remark	The Radiated Spurious Emission test item subcontracted to Sporton International Inc. Wensan Laboratory.

Note: The test site complies with ANSI C63.4 2014 requirement.

FCC Designation No.: TW1190 and TW3786

1.4 Applicable Standards

According to the specifications of the manufacturer, the EUT must comply with the requirements of the following standards:

- ♦ ANSI C63.26-2015
- ♦ ANSI / TIA-603-E
- ♦ FCC 47 CFR Part 2, 27
- ♦ FCC KDB 971168 D01 Power Meas. License Digital Systems v03r01
- ♦ FCC KDB 412172 D01 Determining ERP and EIRP v01r01
- ♦ FCC KDB 414788 D01 Radiated Test Site v01r01
- ♦ FCC KDB 662911 D01 Multiple Transmitter Output v02r01.

Remark:

1. All test items were verified and recorded according to the standards and without any deviation during the test.
2. The TAF code is not including all the FCC KDB listed without accreditation.



Test Items	NR Band	Bandwidth (MHz)											Modulation				RB #			Test Channel			
		10	15	20	30	40	50	60	70	80	90	100	PI/2 BPSK	QPSK	16QAM	64QAM	256QAM	1	Half	Full	L	M	H
E.I.R.P	n77_HPUE	v	v	v	v	v	v	v	v	v	v	v	v	v	v	v	v	Max. Power					
	n78_HPUE	v	v	v	v	v	v	v	v	v	v	v	v	v	v	v	v						
Radiated Spurious Emission	n77_HPUE	Worst Case																v	v	v			
	n78_HPUE	Covered by 5G NR n77																					
Remark	<ol style="list-style-type: none"> The mark "v" means that this configuration is chosen for testing The mark "-" means that this bandwidth is not supported. The device is investigated from 30MHz to 10 times of fundamental signal for radiated spurious emission test under different RB size/offset and modulations in exploratory test. Subsequently, only the worst case emissions are reported. Test combination are EN-DC 4A_n78A_HPUE, EN-DC 7A_n78A_HPUE, EN-DC 25A_n78A_HPUE, EN-DC 13A_n78A_HPUE, EN-DC 26A_n78A_HPUE, EN-DC 71A_n78A_HPUE. For radiated measurement, pre-scanned in two modes, DFT-s OFDM and CP OFDM. The worst cases (DFT-s OFDM) were recorded in this report, and the worst modes of FR1 and LTE for simultaneous transmission were verified and compliant. The SRS operation is controlled via software tool QRCT FTM mode under 100% duty cycle transmission. One representative bandwidth is selected to perform PAR and frequency stability. 																						

2.2 Connection Diagram of Test System

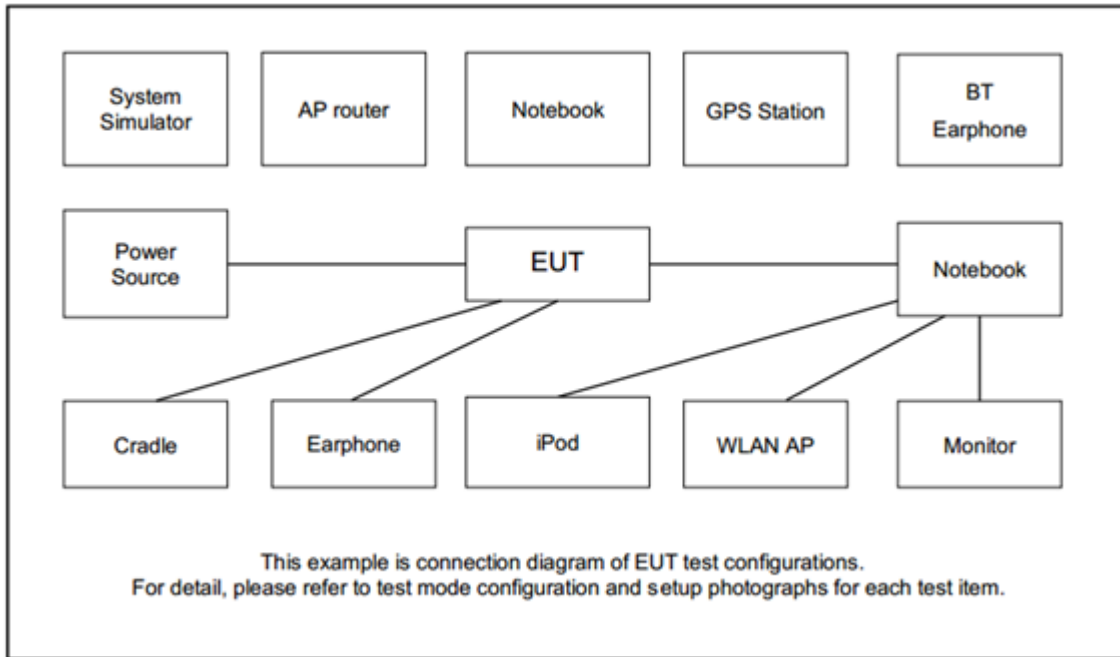

2.3 Support Unit used in test configuration and system

Item	Equipment	Brand Name	Model No.	FCC ID	Data Cable	Power Cord
1.	System Simulator	Anritsu	MT8821C	N/A	N/A	Unshielded, 1.8 m
2.	System Simulator	Anritsu	MT8000A	N/A	N/A	Unshielded, 1.8 m

2.4 Measurement Results Explanation Example

For all conducted test items:

The offset level is set in the spectrum analyzer to compensate the RF cable loss and attenuator factor between EUT conducted output port and spectrum analyzer. With the offset compensation, the spectrum analyzer reading level is exactly the EUT RF output level.

The spectrum analyzer offset is derived from RF cable loss and attenuator factor.

Offset = RF cable loss + attenuator factor.

Following shows an offset computation example with cable loss 4.2 dB and 10dB attenuator.

Example :

$$\begin{aligned} \text{Offset(dB)} &= \text{RF cable loss(dB)} + \text{attenuator factor(dB)}. \\ &= 4.2 + 10 = 14.2 \text{ (dB)} \end{aligned}$$



2.5 Frequency List of Low/Middle/High Channels

5G NR Band n77_HPUE Channel and Frequency List				
BW [MHz]	Channel/Frequency(MHz)	Lowest	Middle	Highest
100	Channel	650000	656000	662000
	Frequency	3750	3840	3930
90	Channel	649668	656000	662332
	Frequency	3745.02	3840	3934.98
80	Channel	649334	656000	662666
	Frequency	3740.01	3840	3939.99
70	Channel	649000	656000	663000
	Frequency	3735	3840	3945
60	Channel	648668	656000	663332
	Frequency	3730.02	3840	3949.98
50	Channel	648334	656000	663666
	Frequency	3725.01	3840	3954.99
40	Channel	648000	656000	664000
	Frequency	3720	3840	3960
30	Channel	647668	656000	664332
	Frequency	3715.02	3840	3965
20	Channel	647334	656000	664666
	Frequency	3710.01	3840	3969.99
15	Channel	647168	656000	664832
	Frequency	3707.52	3840	3972.48
10	Channel	647000	656000	665000
	Frequency	3705	3840	3975



5G NR Band n78_HPUE Channel and Frequency List				
BW [MHz]	Channel/Frequency(MHz)	Lowest	Middle	Highest
100	Channel	-	650000	-
	Frequency	-	3750	-
90	Channel	649668	650000	650332
	Frequency	3745.02	3750	3754.98
80	Channel	649334	650000	650666
	Frequency	3740.01	3750	3759.99
70	Channel	649000	650000	651000
	Frequency	3735	3750	3765
60	Channel	648668	650000	651332
	Frequency	3730.02	3750	3769.98
50	Channel	648334	650000	651666
	Frequency	3725.01	3750	3774.99
40	Channel	648000	650000	652000
	Frequency	3720	3750	3780
30	Channel	647668	650000	652332
	Frequency	3715.02	3750	3784.98
20	Channel	647334	650000	652666
	Frequency	3710.01	3750	3789.99
15	Channel	647168	650000	652832
	Frequency	3707.52	3750	3792.48
10	Channel	647000	650000	653000
	Frequency	3705	3750	3795

3 Conducted Test Items

3.1 Measuring Instruments

See list of measuring instruments of this test report.

3.1.1 Test Setup

3.1.2 Conducted Output Power



3.1.3 Peak-to-Average Ratio, Occupied Bandwidth ,Conducted Band-Edge and Conducted Spurious Emission

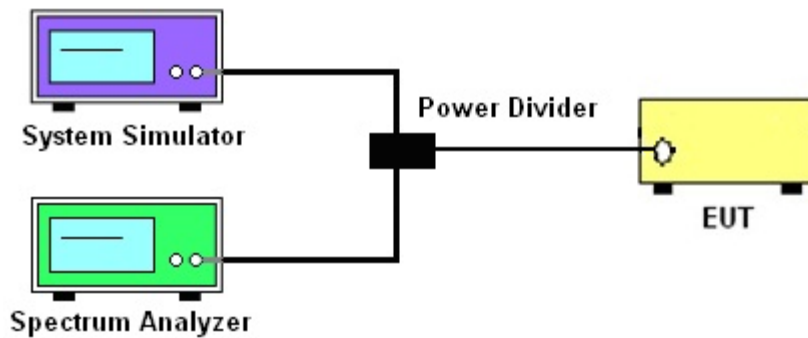

3.1.4 Frequency Stability

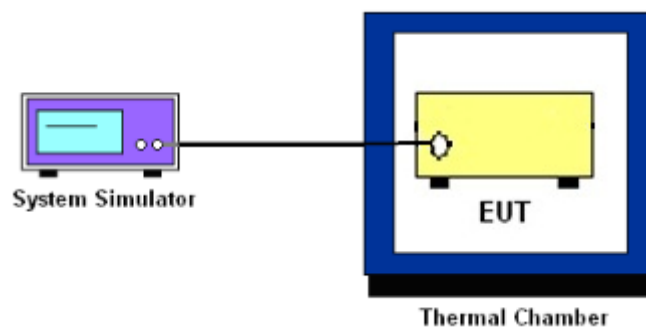

3.1.5 Test Result of Conducted Test

Please refer to Appendix A.



3.2 Conducted Output Power and EIRP

3.2.1 Description of the Conducted Output Power Measurement and EIRP Measurement

A system simulator was used to establish communication with the EUT. Its parameters were set to force the EUT transmitting at maximum output power. The measured power in the radio frequency on the transmitter output terminals shall be reported.

The EIRP of mobile transmitters must not exceed 1 Watts for 5G NR n77 and n78.

According to KDB 412172 D01 Power Approach,

$EIRP = P_T + G_T - L_C$, $ERP = EIRP - 2.15$, where

P_T = transmitter output power in dBm

G_T = gain of the transmitting antenna in dBi

L_C = signal attenuation in the connecting cable between the transmitter and antenna in dB

3.2.2 Test Procedures

1. The transmitter output port was connected to the system simulator.
2. Set EUT at maximum power through the system simulator.
3. Select lowest, middle, and highest channels for each band and different modulation.
4. Measure and record the power level from the system simulator.
5. The MIMO mode is completely uncorrelated, so the directional gain is selected the maximum gain among all antennas.



3.3 Peak-to-Average Ratio

3.3.1 Description of the PAR Measurement

Power Complementary Cumulative Distribution Function (CCDF) curves provide a means for characterizing the power peaks of a digitally modulated signal on a statistical basis. A CCDF curve depicts the probability of the peak signal amplitude exceeding the average power level. Most contemporary measurement instrumentation include the capability to produce CCDF curves for an input signal provided that the instrument's resolution bandwidth can be set wide enough to accommodate the entire input signal bandwidth. In measuring transmissions in this band using an average power technique, the peak-to-average ratio (PAR) of the transmission may not exceed 13 dB.

3.3.2 Test Procedures

The testing follows ANSI C63.26-2015 Section 5.2.6

1. The EUT was connected to spectrum and system simulator via a power divider.
2. Set the CCDF (Complementary Cumulative Distribution Function) option in spectrum analyzer.
3. The highest RF powers were measured and recorded the maximum PAPR level associated with a probability of 0.1 %.
4. Record the deviation as Peak to Average Ratio.



3.4 Occupied Bandwidth

3.4.1 Description of Occupied Bandwidth Measurement

The occupied bandwidth is the width of a frequency band such that, below the lower and above the upper frequency limits, the mean powers emitted are each equal to a specified percentage 0.5% of the total mean transmitted power.

The 26 dB emission bandwidth is defined as the frequency range between two points, one above and one below the carrier frequency, at which the spectral density of the emission is attenuated 26 dB below the maximum in-band spectral density of the modulated signal. Spectral density (power per unit bandwidth) is to be measured with a detector of resolution bandwidth equal to approximately 1.0% of the emission bandwidth.

3.4.2 Test Procedures

The testing follows ANSI C63.26-2015 Section 5.4.3 (26dB) and Section 5.4.4 (99OB)

1. The EUT was connected to spectrum analyzer and system simulator via a power divider.
2. The spectrum analyzer center frequency is set to the nominal EUT channel center frequency. The span range for the spectrum analyzer shall be between two and five times the anticipated OBW.
3. The nominal resolution bandwidth (RBW) shall be in the range of 1 to 5 % of the anticipated OBW, and the VBW shall be at least 3 times the RBW.
4. Set the detection mode to peak, and the trace mode to max hold.
5. Determine the reference value: Set the EUT to transmit a modulated signal. Allow the trace to stabilize. Set the spectrum analyzer marker to the highest level of the displayed trace.
(this is the reference value)
6. Determine the “-26 dB down amplitude” as equal to (Reference Value – X).
7. Place two markers, one at the lowest and the other at the highest frequency of the envelope of the spectral display such that each marker is at or slightly below the “-X dB down amplitude” determined in step 6. If a marker is below this “-X dB down amplitude” value it shall be placed as close as possible to this value. The OBW is the positive frequency difference between the two markers.
8. Use the 99 % power bandwidth function of the spectrum analyzer and report the measured bandwidth.



3.5 Conducted Band Edge

3.5.1 Description of Conducted Band Edge Measurement

27.53 (l)(2)

For mobile operations in the 3700-3980 MHz band, the conducted power of any emission outside the licensee's authorized bandwidth shall not exceed -13 dBm/MHz. Compliance with this paragraph (l)(2) is based on the use of measurement instrumentation employing a resolution bandwidth of 1 megahertz or greater. However, in the 1 megahertz bands immediately outside and adjacent to the licensee's frequency block, the minimum resolution bandwidth for the measurement shall be either one percent of the emission bandwidth of the fundamental emission of the transmitter or 350 kHz. In the bands between 1 and 5 MHz removed from the licensee's frequency block, the minimum resolution bandwidth for the measurement shall be 500 kHz. The emission bandwidth is defined as the width of the signal between two points, one below the carrier center frequency and one above the carrier center frequency, outside of which all emissions are attenuated at least 26 dB below the transmitter power.

3.5.2 Test Procedures

The testing follows FCC KDB 971168 D01 v03r01 Section 6.1.

1. The EUT was connected to spectrum analyzer and system simulator via a power divider.
2. The band edges of low and high channels for the highest RF powers were measured.
3. Set RBW $\geq 1\%$ EBW in the 1MHz band immediately outside and adjacent to the band edge.
4. Beyond the 1 MHz band from the band edge, RBW=1MHz was used.
5. Set spectrum analyzer with RMS detector.
6. The RF fundamental frequency should be excluded against the limit line in the operating frequency band.
7. Checked that all the results comply with the emission limit line.

The limit line is derived from $43 + 10\log(P)$ dB below the transmitter power P(Watts)

8. For MIMO mode, add additional MIMO factor $10\log(\text{NTX}=2) = 3.01$ dB into the spectrum analyzer offset.



3.6 Conducted Spurious Emission

3.6.1 Description of Conducted Spurious Emission Measurement

The power of any emission outside of the authorized operating frequency ranges must be lower than the transmitter power (P) by a factor of at least $43 + 10 \log (P)$ dB.

3.6.2 Test Procedures

The testing follows FCC KDB 971168 D01 v03r01 Section 6.1.

1. The EUT was connected to spectrum analyzer and system simulator via a power divider.
2. The RF output of EUT was connected to the spectrum analyzer by RF cable and attenuator. The path loss was compensated to the results for each measurement.
3. The middle channel for the highest RF power within the transmitting frequency was measured.
4. The conducted spurious emission for the whole frequency range was taken.
5. Make the measurement with the spectrum analyzer's RBW = 1MHz, VBW = 3MHz.
6. Set spectrum analyzer with RMS detector.
7. Taking the record of maximum spurious emission.
8. The RF fundamental frequency should be excluded against the limit line in the operating frequency band.
9. The limit line is derived from $43 + 10\log(P)$ dB below the transmitter power P(Watts)
10. For MIMO mode, add additional MIMO factor $10\log(NTX=2) = 3.01$ dB into the spectrum analyzer offset.



3.7 Frequency Stability

3.7.1 Description of Frequency Stability Measurement

27.54

The frequency stability shall be sufficient to ensure that the fundamental emission stays within the authorized frequency block.

3.7.2 Test Procedures for Temperature Variation

The testing follows FCC KDB 971168 D01 v03r01 Section 9.0.

1. The EUT was set up in the thermal chamber and connected with the system simulator.
2. With power OFF, the temperature was decreased to -30°C and the EUT was stabilized before testing. Power was applied and the maximum change in frequency was recorded within one minute.
3. With power OFF, the temperature was raised in 10°C step up to 50°C . The EUT was stabilized at each step for at least half an hour. Power was applied and the maximum frequency change was recorded within one minute.

3.7.3 Test Procedures for Voltage Variation

The testing follows FCC KDB 971168 D01 v03r01 Section 9.0.

1. The EUT was placed in a temperature chamber at $20\pm 5^{\circ}\text{C}$ and connected with the system simulator.
2. The power supply voltage to the EUT was varied from 85% to 115% of the nominal value measured at the input to the EUT.
3. The variation in frequency was measured for the worst case.

4 Radiated Test Items

4.1 Measuring Instruments

See list of measuring instruments of this test report.

4.1.1 Test Setup

For radiated emissions below 30MHz



For radiated test from 30MHz to 1GHz



For radiated test from 1GHz to 18GHz

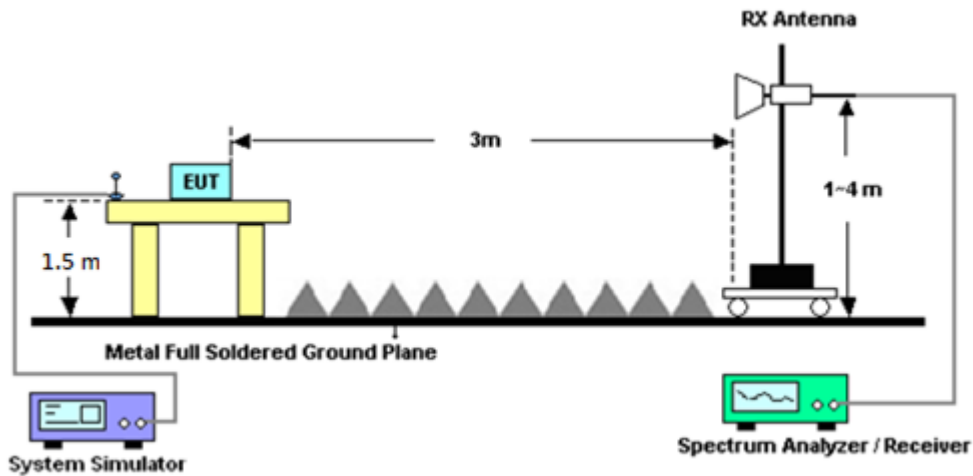

For radiated test above 18GHz

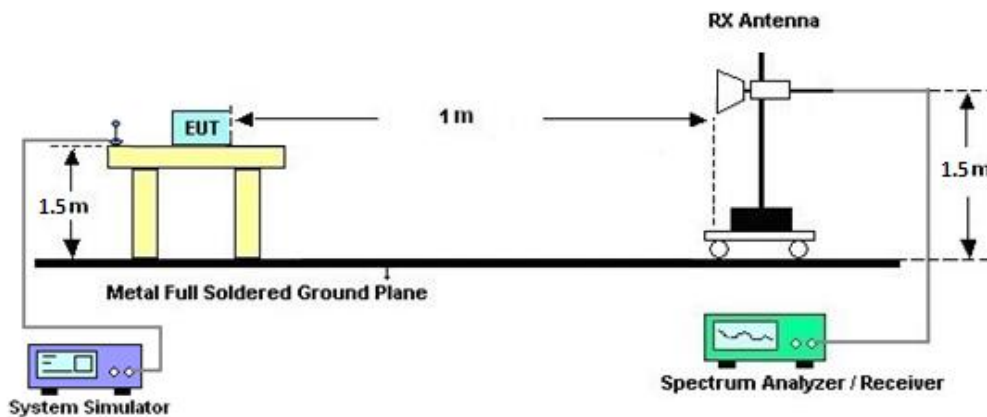

4.1.2 Test Result of Radiated Test

Please refer to Appendix B.

Note:

The low frequency, which started from 9 kHz to 30MHz, was pre-scanned and the result which was 20dB lower than the limit line was not reported.

There is adequate comparison measurement of both open-field test site and alternative test site - semi-Anechoic chamber according to 414788 D01 Radiated Test Site v01r01, and the result came out very similar.



4.2 Radiated Spurious Emission Measurement

4.2.1 Description of Radiated Spurious Emission Measurement

The radiated spurious emission was measured by substitution method according to ANSI / TIA-603-E. The power of any emission outside of the authorized operating frequency ranges must be attenuated below the transmitter power (P) by a factor of at least $43 + 10 \log (P)$ dB.

4.2.2 Test Procedures

The testing follows FCC KDB 971168 D01 v03r01 Section 7 and ANSI / TIA-603-E Section 2.2.12.

1. The EUT was placed on a turntable with 0.8 meter for frequency below 1GHz and 1.5 meter for frequency above 1GHz respectively above ground.
2. The EUT was set 3 meters from the receiving antenna, which was mounted on the antenna tower.
3. The table was rotated 360 degrees to determine the position of the highest spurious emission.
4. The height of the receiving antenna is varied between one meter and four meters to search the maximum spurious emission for both horizontal and vertical polarizations.
5. Make the measurement with the spectrum analyzer's RBW = 1MHz, VBW = 3MHz, taking the record of maximum spurious emission.
6. A horn antenna was substituted in place of the EUT and was driven by a signal generator.
7. Tune the output power of signal generator to the same emission level with EUT maximum spurious emission.
8. Taking the record of output power at antenna port.
9. Repeat step 7 to step 8 for another polarization.
10. The RF fundamental frequency should be excluded against the limit line in the operating frequency band.

The limit line is derived from $43 + 10\log(P)$ dB below the transmitter power P(Watts)



5 List of Measuring Equipment

Instrument	Brand Name	Model No.	Serial No.	Characteristics	Calibration Date	Test Date	Due Date	Remark
Loop Antenna	Rohde & Schwarz	HFH2-Z2	100488	9 kHz~30 MHz	Sep. 20, 2022	Jan. 08, 2023~ Mar. 03, 2023	Sep. 19, 2023	Radiation (03CH12-HY)
Horn Antenna	SCHWARZBECK	BBHA 9120 D	9120D-02114	1GHz~18GHz	Aug. 09, 2022	Jan. 08, 2023~ Mar. 03, 2023	Aug. 08, 2023	Radiation (03CH12-HY)
Bilog Antenna	TESEQ	CBL 6111D & 00800N1D01N-06	40103 & 07	30MHz~1GHz	Apr. 24, 2022	Jan. 08, 2023~ Mar. 03, 2023	Apr. 23, 2023	Radiation (03CH12-HY)
Bilog Antenna	TESEQ	CBL 6111D & N-6-06	35414 & AT-N0602	30MHz~1GHz	Oct. 08, 2022	Jan. 08, 2023~ Mar. 03, 2023	Oct. 07, 2023	Radiation (03CH12-HY)
Horn Antenna	SCHWARZBECK	BBHA 9120 D	9120D-1212	1GHz~18GHz	Mar. 10, 2022	Jan. 08, 2023~ Mar. 03, 2023	Mar. 09, 2023	Radiation (03CH12-HY)
SHF-EHF Horn Antenna	SCHWARZBECK	BBHA 9170	BBHA9170251	18GHz~40GHz	Nov. 24, 2022	Jan. 08, 2023~ Mar. 03, 2023	Nov. 23, 2023	Radiation (03CH12-HY)
SHF-EHF Horn Antenna	SCHWARZBECK	BBHA 9170	BBHA9170576	18GHz~40GHz	May 14, 2022	Jan. 08, 2023~ Mar. 03, 2023	May 13, 2023	Radiation (03CH12-HY)
Preamplifier	COM-POWER	PA-103	161075	10MHz~1GHz	Mar. 23, 2022	Jan. 08, 2023~ Mar. 03, 2023	Mar. 22, 2023	Radiation (03CH12-HY)
Preamplifier	Aglient	8449B	3008A02375	1GHz~26.5GHz	May 24, 2022	Jan. 08, 2023~ Mar. 03, 2023	May 23, 2023	Radiation (03CH12-HY)
Preamplifier	E-INSTRUMENT TECH LTD.	ERA-100M-18 G-56-01-A70	EC1900249	1GHz-18GHz	Dec. 21, 2022	Jan. 08, 2023~ Mar. 03, 2023	Dec. 20, 2023	Radiation (03CH12-HY)
Preamplifier	EMEC	EM18G40G	060715	18GHz~40GHz	Dec. 07, 2022	Jan. 08, 2023~ Mar. 03, 2023	Dec. 06, 2023	Radiation (03CH12-HY)
Signal Analyzer	Keysight	N9010B	MY60241055	10Hz~44GHz	Jul. 22, 2022	Jan. 08, 2023~ Mar. 03, 2023	Jul. 21, 2023	Radiation (03CH12-HY)
RF Cable	HUBER + SUHNER	SUCOFLEX 104	MY9837/4PE	9kHz~30MHz	Mar. 10, 2022	Jan. 08, 2023~ Mar. 03, 2023	Mar. 09, 2023	Radiation (03CH12-HY)
RF Cable	HUBER + SUHNER	SUCOFLEX 104	MY15539/4	30MHz~18GHz	Dec. 20, 2022	Jan. 08, 2023~ Mar. 03, 2023	Dec. 19, 2023	Radiation (03CH12-HY)
RF Cable	HUBER + SUHNER	SUCOFLEX 126E	0058/126E	30MHz~18GHz	Dec. 20, 2022	Jan. 08, 2023~ Mar. 03, 2023	Dec. 19, 2023	Radiation (03CH12-HY)
RF Cable	HUBER + SUHNER	SUCOFLEX 102	505134/2	30MHz~40GHz	Dec. 20, 2022	Jan. 08, 2023~ Mar. 03, 2023	Dec. 19, 2023	Radiation (03CH12-HY)
RF Cable	HUBER + SUHNER	SUCOFLEX 102	803953/2	30MHz~40GHz	Dec. 20, 2022	Jan. 08, 2023~ Mar. 03, 2023	Dec. 19, 2023	Radiation (03CH12-HY)
Filter	Wainwright	WHKX8-5872. 5-6750-18000-40ST	SN2	6.75GHz High Pass Filter	Mar. 15, 2022	Jan. 08, 2023~ Mar. 03, 2023	Mar. 14, 2023	Radiation (03CH12-HY)
Filter	Wainwright	WHKX12-2700 -3000-18000-60ST	SN2	3GHz High Pass Filter	Jul. 11, 2022	Jan. 08, 2023~ Mar. 03, 2023	Jul. 10, 2023	Radiation (03CH12-HY)
Hygrometer	TECPEL	DTM-303B	TP140325	N/A	Nov. 07, 2022	Jan. 08, 2023~ Mar. 03, 2023	Nov. 06, 2023	Radiation (03CH12-HY)
Controller	EMEC	EM1000	N/A	Control Turn table & Ant Mast	N/A	Jan. 08, 2023~ Mar. 03, 2023	N/A	Radiation (03CH12-HY)
Antenna Mast	EMEC	AM-BS-4500-B	N/A	1m~4m	N/A	Jan. 08, 2023~ Mar. 03, 2023	N/A	Radiation (03CH12-HY)
Turn Table	EMEC	TT2000	N/A	0~360 Degree	N/A	Jan. 08, 2023~ Mar. 03, 2023	N/A	Radiation (03CH12-HY)
Software	Audix	E3 6.2009-8-24	RK-000989	N/A	N/A	Jan. 08, 2023~ Mar. 03, 2023	N/A	Radiation (03CH12-HY)



Instrument	Brand Name	Model No.	Serial No.	Characteristics	Calibration Date	Test Date	Due Date	Remark
Programmable Power Supply	GW Instek	PSS-2005	EL890001	0V~64V ;0A~6A	Sep. 29, 2022	Jan. 06, 2023~ Feb. 23, 2023	Sep. 28, 2023	Conducted (TH03-HY)
Hygrometer	Testo	608-H11	34893241	NA	Mar. 18, 2022	Jan. 06, 2023~ Feb. 23, 2023	Mar. 17, 2023	Conducted (TH03-HY)
Signal Analyzer	Rohde & Schwarz	FSV3044	101048	10Hz~44GHz	May 05, 2022	Jan. 06, 2023~ Feb. 23, 2023	May 04, 2023	Conducted (TH03-HY)
Temperature Chamber	ESPEC	SH-641	92013720	-40°C ~90°C	Sep. 07, 2022	Jan. 06, 2023~ Feb. 23, 2023	Sep. 06, 2023	Conducted (TH03-HY)
Base Station (Measure)	Anritsu	MT8821C	6262116730	LTE	Jun. 15, 2022	Jan. 06, 2023~ Feb. 23, 2023	Jun. 14, 2023	Conducted (TH03-HY)
Base Station (Measure)	Anritsu	MT8000A	6262134933	FR1	Jun. 13, 2022	Jan. 06, 2023~ Feb. 23, 2023	Jun. 12, 2023	Conducted (TH03-HY)



6 Uncertainty of Evaluation

Uncertainty of Radiated Emission Measurement (30 MHz ~ 1000 MHz)

Measuring Uncertainty for a Level of Confidence of 95% ($U = 2Uc(y)$)	3.31 dB
---	---------

Uncertainty of Radiated Emission Measurement (1 GHz ~ 18 GHz)

Measuring Uncertainty for a Level of Confidence of 95% ($U = 2Uc(y)$)	3.25 dB
---	---------

Uncertainty of Radiated Emission Measurement (18 GHz ~ 40 GHz)

Measuring Uncertainty for a Level of Confidence of 95% ($U = 2Uc(y)$)	3.81 dB
---	---------



Appendix A. Test Results of Conducted Test

Conducted Output Power(Average power) and EIRP

<SISO Mode>

NR n78_HPUE Maximum Average Power [dBm] (GT - LC = 1.66 dB)								
BW [MHz]	RB Size	RB Offset	Mod	Lowest	Middle	Highest	EIRP (dBm)	EIRP(W)
10	1	1	PI/2 BPSK	24.59	24.78	23.94	26.50	0.4467
10	1	22		24.55	24.76	24.09		
10	12	6		24.64	24.83	23.94		
10	1	0		21.05	21.27	20.52		
10	1	23		21.01	21.24	20.51		
10	24	0		24.09	24.34	23.54		
10	1	1	QPSK	24.58	24.78	23.87		
10	1	22		24.59	24.81	23.92		
10	12	6		24.66	24.84	24.02		
10	1	0		21.14	21.23	20.42		
10	1	23		21.05	21.25	20.46		
10	24	0		23.65	23.86	23.07		
10	1	1	16-QAM	23.56	23.71	22.72	25.37	0.3443
10	1	1	64-QAM	22.05	22.34	21.51		
10	1	1	256-QAM	20.18	20.27	19.50		
Limit	EIRP < 1W			Result			Pass	

NR n78_HPUE Maximum Average Power [dBm] (GT - LC = 1.66 dB)								
BW [MHz]	RB Size	RB Offset	Mod	Lowest	Middle	Highest	EIRP (dBm)	EIRP(W)
15	1	1	PI/2 BPSK	24.70	24.97	24.36	26.70	0.4677
15	1	36		24.85	24.84	24.28		
15	18	9		24.81	25.04	24.23		
15	1	0		21.25	21.59	20.76		
15	1	37		21.26	21.32	20.73		
15	36	0		24.27	24.43	23.74		
15	1	1	QPSK	24.72	25.00	24.37		
15	1	36		24.71	24.82	24.26		
15	18	9		24.78	24.99	24.19		
15	1	0		21.25	21.47	20.72		
15	1	37		21.22	21.33	20.69		
15	36	0		23.78	23.99	23.25		
15	1	1	16-QAM	23.64	23.82	23.25	25.48	0.3532
15	1	1	64-QAM	22.34	22.43	21.89		
15	1	1	256-QAM	20.19	20.39	19.84		
Limit	EIRP < 1W			Result			Pass	



NR n78_HPUE Maximum Average Power [dBm] (GT - LC = 1.66 dB)								
BW [MHz]	RB Size	RB Offset	Mod	Lowest	Middle	Highest	EIRP (dBm)	EIRP(W)
20	1	1	PI/2 BPSK	24.69	24.89	24.28	26.62	0.4592
20	1	49		24.88	24.71	24.21		
20	25	12		24.87	24.96	24.25		
20	1	0		21.34	21.48	20.69		
20	1	50		21.38	21.34	20.64		
20	50	0		24.30	24.50	23.84		
20	1	1	QPSK	24.63	24.77	24.29	25.39	0.3459
20	1	49		24.81	24.79	24.14		
20	25	12		24.78	24.90	24.25		
20	1	0		21.24	21.40	20.67		
20	1	50		21.38	21.24	20.62		
20	50	0		23.88	23.94	23.30		
20	1	1	16-QAM	23.60	23.73	23.11	25.39	0.3459
20	1	1	64-QAM	22.36	22.40	21.87		
20	1	1	256-QAM	20.26	20.36	19.85		
Limit	EIRP < 1W			Result			Pass	



NR n78_HPUE Maximum Average Power [dBm] (GT - LC = 1.66 dB)								
BW [MHz]	RB Size	RB Offset	Mod	Lowest	Middle	Highest	EIRP (dBm)	EIRP(W)
30	1	1	PI/2 BPSK	24.76	24.99	24.69	26.70	0.4677
30	1	76		24.90	24.80	24.28		
30	36	18		24.81	25.04	24.46		
30	1	0		21.43	21.58	20.97		
30	1	77		21.37	21.29	20.79		
30	75	0		24.35	24.38	24.01		
30	1	1	QPSK	24.74	24.95	24.66		
30	1	76		24.85	24.74	24.30		
30	36	18		24.81	24.90	24.43		
30	1	0		21.33	21.54	21.01		
30	1	77		21.31	21.28	20.77		
30	75	0		23.86	23.98	23.54		
30	1	1	16-QAM	23.54	23.86	23.57	25.52	0.3565
30	1	1	64-QAM	22.21	22.51	21.98		
30	1	1	256-QAM	20.26	20.49	20.19		
Limit	EIRP < 1W			Result			Pass	

NR n78_HPUE Maximum Average Power [dBm] (GT - LC = 1.66 dB)								
BW [MHz]	RB Size	RB Offset	Mod	Lowest	Middle	Highest	EIRP (dBm)	EIRP(W)
40	1	1	PI/2 BPSK	24.97	25.19	24.93	26.85	0.4842
40	1	104		25.07	24.79	24.39		
40	50	25		24.95	25.00	24.57		
40	1	0		21.57	21.71	21.18		
40	1	105		21.54	21.23	20.90		
40	100	0		24.47	24.51	24.08		
40	1	1	QPSK	24.86	25.06	24.86		
40	1	104		24.97	24.76	24.39		
40	50	25		24.93	24.95	24.55		
40	1	0		21.54	21.76	21.11		
40	1	105		21.52	21.25	20.85		
40	100	0		23.97	24.07	23.57		
40	1	1	16-QAM	23.73	23.94	23.71	25.60	0.3631
40	1	1	64-QAM	22.36	22.57	22.46		
40	1	1	256-QAM	20.44	20.62	20.42		
Limit	EIRP < 1W			Result			Pass	



NR n78_HPUE Maximum Average Power [dBm] (GT - LC = 1.66 dB)								
BW [MHz]	RB Size	RB Offset	Mod	Lowest	Middle	Highest	EIRP (dBm)	EIRP(W)
50	1	1	PI/2 BPSK	24.54	24.72	24.76	26.44	0.4406
50	1	131		24.62	24.27	24.04		
50	64	32		24.61	24.77	24.47		
50	1	0		21.24	21.31	20.94		
50	1	132		21.10	20.74	20.53		
50	128	0		24.06	24.13	23.88		
50	1	1	QPSK	24.52	24.66	24.78		
50	1	131		24.60	24.23	23.99		
50	64	32		24.63	24.76	24.42		
50	1	0		21.07	21.25	20.83		
50	1	132		21.04	20.71	20.49		
50	128	0		23.58	23.67	23.43		
50	1	1	16-QAM	23.36	23.54	23.53	25.20	0.3311
50	1	1	64-QAM	22.07	22.20	22.26		
50	1	1	256-QAM	20.03	20.16	20.26		
Limit	EIRP < 1W			Result			Pass	

NR n78_HPUE Maximum Average Power [dBm] (GT - LC = 1.66 dB)								
BW [MHz]	RB Size	RB Offset	Mod	Lowest	Middle	Highest	EIRP (dBm)	EIRP(W)
60	1	1	PI/2 BPSK	24.51	24.56	24.72	26.42	0.4385
60	1	160		24.55	24.26	24.07		
60	81	40		24.76	24.70	24.38		
60	1	0		21.23	21.22	20.87		
60	1	161		21.01	20.70	20.55		
60	162	0		24.11	24.01	23.91		
60	1	1	QPSK	24.50	24.57	24.63		
60	1	160		24.58	24.20	24.04		
60	81	40		24.74	24.68	24.39		
60	1	0		21.17	21.27	20.92		
60	1	161		21.00	20.69	20.53		
60	162	0		23.69	23.68	23.39		
60	1	1	16-QAM	23.33	23.39	23.51	25.17	0.3289
60	1	1	64-QAM	22.06	22.08	22.19		
60	1	1	256-QAM	20.02	20.05	20.16		
Limit	EIRP < 1W			Result			Pass	



NR n78_HPUE Maximum Average Power [dBm] (GT - LC = 1.66 dB)										
BW [MHz]	RB Size	RB Offset	Mod	Lowest	Middle	Highest	EIRP (dBm)	EIRP(W)		
70	1	1	PI/2 BPSK	24.56	24.64	24.65	26.32	0.4285		
70	1	187		24.30	24.04	23.91				
70	90	45		24.63	24.62	24.38				
70	1	0		21.22	21.20	20.99				
70	1	188		20.71	20.47	20.43				
70	180	0		24.15	24.02	23.89				
70	1	1	QPSK	24.48	24.62	24.58			25.14	0.3266
70	1	187		24.19	23.99	23.94				
70	90	45		24.66	24.65	24.40				
70	1	0		21.20	21.21	21.01				
70	1	188		20.72	20.48	20.43				
70	180	0		23.54	23.51	23.41				
70	1	1	16-QAM	23.48	23.43	23.48	25.14	0.3266		
70	1	1	64-QAM	22.02	22.21	22.13				
70	1	1	256-QAM	20.05	20.15	20.19				
Limit	EIRP < 1W			Result			Pass			

NR n78_HPUE Maximum Average Power [dBm] (GT - LC = 1.66 dB)										
BW [MHz]	RB Size	RB Offset	Mod	Lowest	Middle	Highest	EIRP (dBm)	EIRP(W)		
80	1	1	PI/2 BPSK	24.53	24.52	24.59	26.31	0.4276		
80	1	215		24.15	24.05	23.90				
80	108	54		24.64	24.63	24.52				
80	1	0		21.30	21.25	21.16				
80	1	216		20.66	20.46	20.45				
80	216	0		23.51	23.98	24.00				
80	1	1	QPSK	24.53	24.46	24.53			25.03	0.3184
80	1	215		24.10	23.93	23.98				
80	108	54		24.65	24.61	24.58				
80	1	0		21.24	21.18	21.13				
80	1	216		20.63	20.39	20.50				
80	216	0		23.54	23.55	23.50				
80	1	1	16-QAM	23.21	23.34	23.37	25.03	0.3184		
80	1	1	64-QAM	22.09	22.10	22.03				
80	1	1	256-QAM	20.07	20.00	20.06				
Limit	EIRP < 1W			Result			Pass			



NR n78_HPUE Maximum Average Power [dBm] (GT - LC = 1.66 dB)										
BW [MHz]	RB Size	RB Offset	Mod	Lowest	Middle	Highest	EIRP (dBm)	EIRP(W)		
90	1	1	PI/2 BPSK	24.50	24.53	24.51	26.32	0.4285		
90	1	243		24.11	23.95	24.02				
90	120	60		24.62	24.63	24.65				
90	1	0		21.15	21.22	21.22				
90	1	244		20.58	20.44	20.50				
90	243	0		23.96	24.07	24.08				
90	1	1	QPSK	24.51	24.52	24.49			25.04	0.3192
90	1	243		24.02	23.92	23.86				
90	120	60		24.59	24.65	24.66				
90	1	0		21.17	21.24	21.23				
90	1	244		20.42	20.42	20.48				
90	243	0		23.50	23.55	23.55				
90	1	1	16-QAM	23.28	23.38	23.37	25.04	0.3192		
90	1	1	64-QAM	22.11	22.06	22.15				
90	1	1	256-QAM	20.06	20.02	20.01				
Limit	EIRP < 1W			Result			Pass			

NR n78_HPUE Maximum Average Power [dBm] (GT - LC = 1.66 dB)										
BW [MHz]	RB Size	RB Offset	Mod	Lowest	Middle	Highest	EIRP (dBm)	EIRP(W)		
100	1	1	PI/2 BPSK	-	24.56	-	26.35	0.4315		
100	1	271		-	24.09	-				
100	135	67		-	24.69	-				
100	1	0		-	21.21	-				
100	1	272		-	20.57	-				
100	270	0		-	24.02	-				
100	1	1	QPSK	-	24.56	-			25.05	0.3199
100	1	271		-	24.05	-				
100	135	67		-	24.68	-				
100	1	0		-	21.22	-				
100	1	272		-	20.55	-				
100	270	0		-	23.51	-				
100	1	1	16-QAM	-	23.39	-	25.05	0.3199		
100	1	1	64-QAM	-	22.06	-				
100	1	1	256-QAM	-	20.03	-				
Limit	EIRP < 1W			Result			Pass			



<MIMO Mode>

NR n77_HPUE Maximum Average Power [dBm], DG = 1.66 dBi														
BW	RB	RB	Mod	Antenna 1			Antenna 2			Combine			EIRP	EIRP
(MHz)	Size	Offset		Lowest	Middle	Highest	Lowest	Middle	Highest	Lowest	Middle	Highest	(dBm)	(W)
10	1	1	QPSK	19.92	19.87	19.54	19.58	20.06	19.47	22.76	22.98	22.52	24.66	0.2924
10	1	22		19.93	19.90	19.76	19.65	20.07	19.64	22.80	23.00	22.71		
10	12	6		20.08	19.90	19.76	19.70	19.94	19.64	22.90	22.93	22.71		
10	1	0		17.93	17.90	17.67	17.66	19.95	17.70	20.81	22.06	20.70		
10	1	23		18.05	17.84	17.73	17.80	18.09	17.56	20.94	20.98	20.66		
10	24	0		18.58	18.46	18.28	18.18	18.45	18.16	21.39	21.47	21.23		
10	1	1	16-QAM	19.38	19.33	19.08	19.21	19.52	19.00	22.31	22.44	22.05	24.10	0.2570
10	1	1	64-QAM	17.97	17.81	17.62	17.32	17.80	17.29	20.67	20.82	20.47		
10	1	1	256-QAM	14.92	14.99	14.68	14.57	15.27	14.54	17.76	18.14	17.62		
Limit	EIRP < 1W			Result									Pass	

NR n77_HPUE Maximum Average Power [dBm], DG = 1.66 dBi														
BW	RB	RB	Mod	Antenna 1			Antenna 2			Combine			EIRP	EIRP
(MHz)	Size	Offset		Lowest	Middle	Highest	Lowest	Middle	Highest	Lowest	Middle	Highest	(dBm)	(W)
15	1	1	QPSK	20.05	19.87	19.84	19.78	20.25	19.71	22.93	23.07	22.79	24.86	0.3062
15	1	36		20.30	20.00	19.92	20.07	20.13	19.61	23.20	23.08	22.78		
15	19	9		20.22	20.02	19.93	19.83	20.12	19.64	23.04	23.08	22.80		
15	1	0		18.05	17.95	17.83	18.03	18.23	17.91	21.05	21.10	20.88		
15	1	37		18.22	17.96	17.84	18.09	18.26	17.90	21.17	21.12	20.88		
15	38	0		18.78	18.60	18.40	18.29	18.70	18.15	21.55	21.66	21.29		
15	1	1	16-QAM	19.61	19.42	19.40	19.40	19.82	19.35	22.52	22.63	22.39	24.29	0.2685
15	1	1	64-QAM	18.10	17.89	17.86	17.65	18.02	17.48	20.89	20.97	20.68		
15	1	1	256-QAM	15.23	15.01	14.89	14.89	15.32	14.76	18.07	18.18	17.84		
Limit	EIRP < 1W			Result									Pass	



NR n77_HPUE Maximum Average Power [dBm], DG = 1.66 dBi														
BW (MHz)	RB Size	RB Offset	Mod	Antenna 1			Antenna 2			Combine			EIRP (dBm)	EIRP (W)
				Lowest	Middle	Highest	Lowest	Middle	Highest	Lowest	Middle	Highest		
20	1	1	QPSK	20.09	19.95	19.72	19.72	20.02	19.60	22.92	23.00	22.67	24.80	0.3020
20	1	49		20.26	20.00	19.76	19.93	20.15	18.74	23.11	23.09	22.29		
20	25	12		20.21	20.09	19.99	20.05	20.15	19.66	23.14	23.13	22.84		
20	1	0		18.01	17.98	17.82	18.00	18.24	17.85	21.02	21.12	20.85		
20	1	50		18.28	17.92	17.81	17.93	18.15	17.89	21.12	21.05	20.86		
20	51	0		18.70	18.57	18.44	18.45	18.67	18.12	21.59	21.63	21.29		
20	1	1	16-QAM	19.58	19.56	19.37	19.49	19.62	19.32	22.55	22.60	22.36	24.26	0.2667
20	1	1	64-QAM	18.14	17.98	17.85	17.66	17.89	17.54	20.92	20.95	20.71		
20	1	1	256-QAM	15.18	15.08	14.91	14.90	15.20	14.81	18.05	18.15	17.87		
Limit	EIRP < 1W			Result									Pass	



NR n77_HPUE Maximum Average Power [dBm], DG = 1.66 dBi														
BW (MHz)	RB Size	RB Offset	Mod	Antenna 1			Antenna 2			Combine			EIRP (dBm)	EIRP (W)
				Lowest	Middle	Highest	Lowest	Middle	Highest	Lowest	Middle	Highest		
30	1	1	QPSK	20.02	20.09	19.93	19.80	20.01	19.81	22.92	23.06	22.88	25.14	0.3266
30	1	76		20.54	20.00	19.93	20.39	20.36	19.92	23.48	23.19	22.94		
30	39	19		20.25	20.09	19.94	19.79	20.14	19.81	23.04	23.13	22.89		
30	1	0		18.03	18.13	17.88	17.90	18.26	17.93	20.98	21.21	20.92		
30	1	77		18.34	18.03	17.71	17.88	18.31	17.74	21.13	21.18	20.74		
30	78	0		18.76	18.66	18.42	18.28	18.69	18.26	21.54	21.69	21.35		
30	1	1	16-QAM	19.47	19.52	19.51	19.40	19.64	19.58	22.45	22.59	22.56	24.25	0.2661
30	1	1	64-QAM	17.94	18.10	17.95	17.55	17.94	17.71	20.76	21.03	20.84		
30	1	1	256-QAM	15.09	15.24	15.06	14.82	15.23	14.98	17.97	18.25	18.03		
Limit	EIRP < 1W			Result									Pass	

NR n77_HPUE Maximum Average Power [dBm], DG = 1.66 dBi														
BW (MHz)	RB Size	RB Offset	Mod	Antenna 1			Antenna 2			Combine			EIRP (dBm)	EIRP (W)
				Lowest	Middle	Highest	Lowest	Middle	Highest	Lowest	Middle	Highest		
40	1	1	QPSK	20.12	20.15	19.77	20.05	20.14	19.82	23.10	23.16	22.81	24.89	0.3083
40	1	104		20.41	19.94	19.80	20.02	20.30	19.77	23.23	23.13	22.80		
40	53	26		20.35	20.11	19.87	19.90	20.12	19.72	23.14	23.13	22.81		
40	1	0		18.33	18.29	17.80	18.20	18.41	17.95	21.28	21.36	20.89		
40	1	105		18.44	18.01	17.85	18.07	18.29	17.77	21.27	21.16	20.82		
40	106	0		18.90	18.66	18.49	18.49	18.74	18.25	21.71	21.71	21.38		
40	1	1	16-QAM	19.72	19.73	19.28	19.65	19.75	19.35	22.70	22.75	22.33	24.41	0.2761
40	1	1	64-QAM	18.20	18.19	17.80	17.73	17.97	17.61	20.98	21.09	20.72		
40	1	1	256-QAM	15.31	15.37	14.88	15.19	15.33	14.83	18.26	18.36	17.87		
Limit	EIRP < 1W			Result									Pass	



NR n77_HPUE Maximum Average Power [dBm], DG = 1.66 dBi														
BW (MHz)	RB Size	RB Offset	Mod	Antenna 1			Antenna 2			Combine			EIRP (dBm)	EIRP (W)
				Lowest	Middle	Highest	Lowest	Middle	Highest	Lowest	Middle	Highest		
50	1	1	QPSK	19.75	20.05	19.52	19.52	19.96	19.64	22.65	23.02	22.59	24.68	0.2938
50	1	131		20.12	19.85	19.50	19.73	20.09	19.56	22.94	22.98	22.54		
50	67	33		20.17	19.92	19.67	19.69	19.95	19.57	22.95	22.95	22.63		
50	1	0		17.94	18.04	17.72	17.76	18.03	17.62	20.86	21.05	20.68		
50	1	132		18.14	17.88	17.53	17.70	17.98	17.50	20.94	20.94	20.53		
50	133	0		18.73	18.50	18.22	18.19	18.45	18.08	21.48	21.49	21.16		
50	1	1	16-QAM	19.33	19.42	19.09	19.14	19.51	19.19	22.25	22.48	22.15	24.14	0.2594
50	1	1	64-QAM	17.74	17.98	17.52	17.34	17.63	17.50	20.55	20.82	20.52		
50	1	1	256-QAM	14.84	15.08	14.65	14.66	14.97	14.61	17.76	18.04	17.64		
Limit	EIRP < 1W			Result									Pass	

NR n77_HPUE Maximum Average Power [dBm], DG = 1.66 dBi														
BW (MHz)	RB Size	RB Offset	Mod	Antenna 1			Antenna 2			Combine			EIRP (dBm)	EIRP (W)
				Lowest	Middle	Highest	Lowest	Middle	Highest	Lowest	Middle	Highest		
60	1	1	QPSK	19.91	19.91	19.59	19.75	19.88	19.79	22.84	22.91	22.70	24.64	0.2911
60	1	160		20.06	19.75	19.39	19.65	20.00	19.58	22.87	22.89	22.50		
60	81	40		20.22	19.93	19.61	19.70	20.00	19.65	22.98	22.98	22.64		
60	1	0		18.01	18.00	17.52	17.88	18.08	17.81	20.96	21.05	20.68		
60	1	161		18.07	17.69	17.35	17.70	17.90	17.55	20.90	20.81	20.46		
60	162	0		18.62	18.45	18.10	18.20	18.43	18.16	21.43	21.45	21.14		
60	1	1	16-QAM	19.32	19.54	19.05	19.30	19.35	19.36	22.32	22.46	22.22	24.12	0.2582
60	1	1	64-QAM	17.89	17.90	17.49	17.41	17.69	17.55	20.67	20.81	20.53		
60	1	1	256-QAM	14.88	14.96	14.55	14.57	14.88	14.78	17.74	17.93	17.68		
Limit	EIRP < 1W			Result									Pass	



NR n77_HPUE Maximum Average Power [dBm], DG = 1.66 dBi														
BW (MHz)	RB Size	RB Offset	Mod	Antenna 1			Antenna 2			Combine			EIRP (dBm)	EIRP (W)
				Lowest	Middle	Highest	Lowest	Middle	Highest	Lowest	Middle	Highest		
70	1	1	QPSK	19.72	19.99	19.52	19.68	19.91	19.67	22.71	22.96	22.61	24.65	0.2917
70	1	187		20.10	19.71	19.71	19.77	19.90	19.79	22.95	22.82	22.76		
70	95	47		20.26	19.99	19.68	19.65	19.96	19.69	22.98	22.99	22.70		
70	1	0		18.00	18.00	17.63	17.72	18.16	17.75	20.87	21.09	20.70		
70	1	188		18.04	17.63	17.64	17.64	17.83	17.58	20.85	20.74	20.62		
70	189	0		18.71	18.46	18.18	18.11	18.40	18.12	21.43	21.44	21.16		
70	1	1	16-QAM	19.26	19.52	18.93	19.17	19.39	19.36	22.23	22.47	22.16	24.13	0.2588
70	1	1	64-QAM	17.70	17.92	17.50	17.40	17.70	17.44	20.56	20.82	20.48		
70	1	1	256-QAM	14.87	15.10	14.65	17.65	14.82	14.71	19.49	17.97	17.69		
Limit	EIRP < 1W			Result									Pass	

NR n77_HPUE Maximum Average Power [dBm], DG = 1.66 dBi														
BW (MHz)	RB Size	RB Offset	Mod	Antenna 1			Antenna 2			Combine			EIRP (dBm)	EIRP (W)
				Lowest	Middle	Highest	Lowest	Middle	Highest	Lowest	Middle	Highest		
80	1	1	QPSK	19.83	19.82	19.65	19.71	19.83	19.72	22.78	22.84	22.70	24.59	0.2877
80	1	215		19.77	19.63	19.64	19.60	19.66	19.53	22.70	22.66	22.60		
80	109	54		20.20	19.94	19.73	19.61	19.88	19.69	22.93	22.92	22.72		
80	1	0		18.14	17.95	17.71	17.81	18.08	17.85	20.99	21.03	20.79		
80	1	216		17.85	17.70	17.46	17.51	17.74	17.53	20.69	20.73	20.51		
80	217	0		18.62	18.44	18.22	18.15	18.41	18.20	21.40	21.44	21.22		
80	1	1	16-QAM	19.20	19.51	19.01	19.33	19.37	19.44	22.28	22.45	22.24	24.11	0.2576
80	1	1	64-QAM	17.75	17.92	17.48	17.42	17.58	17.56	20.60	20.76	20.53		
80	1	1	256-QAM	14.82	14.95	14.68	14.70	14.76	14.78	17.77	17.87	17.74		
Limit	EIRP < 1W			Result									Pass	



NR n77_HPUE Maximum Average Power [dBm], DG = 1.66 dBi														
BW (MHz)	RB Size	RB Offset	Mod	Antenna 1			Antenna 2			Combine			EIRP (dBm)	EIRP (W)
				Lowest	Middle	Highest	Lowest	Middle	Highest	Lowest	Middle	Highest		
90	1	1	QPSK	19.77	20.03	19.60	19.71	19.68	19.76	22.75	22.87	22.69	24.61	0.2891
90	1	243		19.83	19.51	19.45	19.60	19.90	19.43	22.73	22.72	22.45		
90	123	61		20.17	19.95	19.67	19.63	19.92	19.72	22.92	22.95	22.71		
90	1	0		18.04	17.93	17.74	17.84	18.17	17.84	20.95	21.06	20.80		
90	1	244		17.83	17.61	17.39	17.56	17.82	17.43	20.71	20.73	20.42		
90	245	0		18.53	18.47	18.20	18.03	18.39	18.18	21.30	21.44	21.20		
90	1	1	16-QAM	19.22	19.38	19.03	19.15	19.34	19.45	22.20	22.37	22.26	24.03	0.2529
90	1	1	64-QAM	17.67	17.87	19.55	17.37	17.55	17.72	20.53	20.72	21.74		
90	1	1	256-QAM	14.73	14.97	14.61	14.66	14.76	14.85	17.71	17.88	17.74		
Limit	EIRP < 1W			Result									Pass	

NR n77_HPUE Maximum Average Power [dBm], DG = 1.66 dBi														
BW (MHz)	RB Size	RB Offset	Mod	Antenna 1			Antenna 2			Combine			EIRP (dBm)	EIRP (W)
				Lowest	Middle	Highest	Lowest	Middle	Highest	Lowest	Middle	Highest		
100	1	1	QPSK	19.64	19.43	19.01	19.92	20.00	20.01	22.79	22.73	22.55	24.62	0.2897
100	1	271		19.24	19.09	19.02	19.70	20.16	19.84	22.49	22.67	22.46		
100	137	68		19.86	19.41	19.15	20.04	20.25	19.26	22.96	22.86	22.22		
100	1	0		17.99	17.55	17.16	18.08	18.51	18.11	21.05	21.07	20.67		
100	1	272		17.27	17.14	17.09	20.06	18.20	17.86	21.90	20.71	20.50		
100	273	0		18.26	17.96	17.68	18.37	18.71	18.48	21.33	21.36	21.11		
100	1	1	16-QAM	18.90	18.99	18.47	19.22	19.64	19.71	22.07	22.34	22.14	24.00	0.2512
100	1	1	64-QAM	19.61	17.40	17.02	17.94	17.85	17.88	21.87	20.64	20.48		
100	1	1	256-QAM	14.44	14.53	13.97	15.05	14.99	15.05	17.77	17.78	17.55		
Limit	EIRP < 1W			Result									Pass	



NR n78_HPUE Maximum Average Power [dBm], DG = 1.66 dBi														
BW (MHz)	RB Size	RB Offset	Mod	Antenna 1			Antenna 2			Combine			EIRP (dBm)	EIRP (W)
				Lowest	Middle	Highest	Lowest	Middle	Highest	Lowest	Middle	Highest		
10	1	1	QPSK	19.82	19.83	19.80	19.56	19.86	19.78	22.70	22.86	22.80	24.62	0.2897
10	1	22		19.87	19.74	19.95	19.54	19.95	19.90	22.72	22.86	22.94		
10	12	6		19.92	19.88	20.07	19.43	19.94	19.82	22.69	22.92	22.96		
10	1	0		17.81	17.81	17.88	17.61	17.99	17.90	20.72	20.91	20.90		
10	1	23		17.82	17.75	17.87	17.44	18.06	17.86	20.64	20.92	20.88		
10	24	0		18.41	18.38	18.53	17.97	18.48	18.33	21.21	21.44	21.44		
10	1	1	16-QAM	19.34	19.35	19.42	19.96	19.51	19.33	22.67	22.44	22.39	24.33	0.2710
10	1	1	64-QAM	17.79	17.86	17.97	17.27	17.67	17.54	20.55	20.78	20.77		
10	1	1	256-QAM	14.92	14.92	15.00	14.45	15.00	14.87	17.70	17.97	17.95		
Limit	EIRP < 1W			Result									Pass	

NR n78_HPUE Maximum Average Power [dBm], DG = 1.66 dBi														
BW (MHz)	RB Size	RB Offset	Mod	Antenna 1			Antenna 2			Combine			EIRP (dBm)	EIRP (W)
				Lowest	Middle	Highest	Lowest	Middle	Highest	Lowest	Middle	Highest		
15	1	1	QPSK	19.91	20.31	19.71	19.72	19.77	19.40	22.83	23.06	22.57	24.75	0.2985
15	1	36		20.19	20.24	19.50	19.96	19.79	19.76	23.09	23.03	22.64		
15	19	9		20.12	20.38	19.64	19.71	19.69	19.43	22.93	23.06	22.55		
15	1	0		18.03	18.29	17.52	17.77	18.03	17.61	20.91	21.17	20.58		
15	1	37		18.10	18.14	17.54	17.79	18.01	17.59	20.96	21.09	20.58		
15	38	0		18.55	18.86	18.14	18.17	18.20	18.01	21.37	21.55	21.09		
15	1	1	16-QAM	19.39	19.72	19.22	19.35	19.40	19.08	22.38	22.57	22.16	24.23	0.2649
15	1	1	64-QAM	17.89	18.16	17.67	17.51	17.46	17.21	20.71	20.83	20.46		
15	1	1	256-QAM	15.03	15.32	14.82	14.86	14.80	14.48	17.96	18.08	17.66		
Limit	EIRP < 1W			Result									Pass	



NR n78_HPUE Maximum Average Power [dBm], DG = 1.66 dBi														
BW (MHz)	RB Size	RB Offset	Mod	Antenna 1			Antenna 2			Combine			EIRP (dBm)	EIRP (W)
				Lowest	Middle	Highest	Lowest	Middle	Highest	Lowest	Middle	Highest		
20	1	1	QPSK	19.98	20.16	19.68	19.88	19.76	19.54	22.94	22.97	22.62	24.77	0.2999
20	1	49		20.22	20.12	19.45	19.84	19.74	19.56	23.04	22.94	22.52		
20	25	12		20.22	20.38	19.75	19.78	19.79	19.37	23.02	23.11	22.57		
20	1	0		17.96	18.19	17.56	17.69	17.94	17.47	20.84	21.08	20.53		
20	1	50		18.18	18.15	17.56	17.74	17.69	17.51	20.98	20.94	20.55		
20	51	0		18.57	18.78	18.13	18.17	18.21	17.95	21.38	21.51	21.05		
20	1	1	16-QAM	19.35	19.74	19.13	19.31	19.38	19.18	22.34	22.57	22.17	24.23	0.2649
20	1	1	64-QAM	17.92	18.16	17.64	17.50	17.52	17.28	20.73	20.86	20.47		
20	1	1	256-QAM	14.95	15.30	14.83	14.80	14.88	14.56	17.89	18.11	17.71		
Limit	EIRP < 1W			Result									Pass	



NR n78_HPUE Maximum Average Power [dBm], DG = 1.66 dBi														
BW (MHz)	RB Size	RB Offset	Mod	Antenna 1			Antenna 2			Combine			EIRP (dBm)	EIRP (W)
				Lowest	Middle	Highest	Lowest	Middle	Highest	Lowest	Middle	Highest		
30	1	1	QPSK	19.94	20.34	20.21	19.83	19.96	19.81	22.90	23.16	23.02	24.93	0.3112
30	1	76		20.45	20.37	19.68	19.88	20.15	19.67	23.18	23.27	22.69		
30	39	19		20.24	20.36	19.95	19.76	19.81	19.57	23.02	23.10	22.77		
30	1	0		18.03	18.35	17.87	17.84	18.15	17.84	20.95	21.26	20.87		
30	1	77		18.31	18.18	17.64	17.89	17.89	17.65	21.12	21.05	20.66		
30	78	0		18.77	18.88	18.44	18.23	18.34	18.21	21.52	21.63	21.34		
30	1	1	16-QAM	19.44	19.92	19.69	19.40	19.52	19.43	22.43	22.73	22.57	24.39	0.2748
30	1	1	64-QAM	17.96	18.31	18.14	17.58	17.77	17.62	20.78	21.06	20.90		
30	1	1	256-QAM	15.08	15.54	15.22	14.88	15.08	14.93	17.99	18.33	18.09		
Limit	EIRP < 1W			Result									Pass	

NR n78_HPUE Maximum Average Power [dBm], DG = 1.66 dBi														
BW (MHz)	RB Size	RB Offset	Mod	Antenna 1			Antenna 2			Combine			EIRP (dBm)	EIRP (W)
				Lowest	Middle	Highest	Lowest	Middle	Highest	Lowest	Middle	Highest		
40	1	1	QPSK	20.52	20.69	20.36	20.23	20.16	20.07	23.39	23.44	23.23	25.12	0.3251
40	1	104		20.67	20.34	19.85	20.21	20.02	19.98	23.46	23.19	22.93		
40	53	26		20.48	20.63	20.10	20.09	20.10	19.85	23.30	23.38	22.99		
40	1	0		18.54	18.78	18.25	18.33	18.24	18.13	21.45	21.53	21.20		
40	1	105		18.60	18.44	17.87	18.22	18.02	17.88	21.42	21.25	20.89		
40	106	0		18.98	19.01	18.65	18.64	18.54	18.39	21.82	21.79	21.53		
40	1	1	16-QAM	20.16	20.25	19.89	19.74	19.76	19.69	22.97	23.02	22.80	24.68	0.2938
40	1	1	64-QAM	18.44	18.72	18.30	18.22	18.15	17.88	21.34	21.45	21.11		
40	1	1	256-QAM	15.41	15.74	15.46	15.17	15.23	15.14	18.30	18.50	18.31		
Limit	EIRP < 1W			Result									Pass	



NR n78_HPUE Maximum Average Power [dBm], DG = 1.66 dBi														
BW (MHz)	RB Size	RB Offset	Mod	Antenna 1			Antenna 2			Combine			EIRP (dBm)	EIRP (W)
				Lowest	Middle	Highest	Lowest	Middle	Highest	Lowest	Middle	Highest		
50	1	1	QPSK	19.71	19.93	20.19	19.50	19.58	19.87	22.62	22.77	23.04	24.70	0.2951
50	1	131		20.15	19.67	19.30	19.74	19.47	19.27	22.96	22.58	22.30		
50	67	33		20.04	20.24	19.93	19.58	19.71	19.48	22.83	22.99	22.72		
50	1	0		17.93	18.12	17.85	17.68	17.87	17.79	20.82	21.01	20.83		
50	1	132		18.03	17.68	17.26	17.72	17.50	17.30	20.89	20.60	20.29		
50	133	0		18.59	18.61	18.34	18.07	18.11	18.02	21.35	21.38	21.19		
50	1	1	16-QAM	19.21	19.62	19.73	19.14	19.26	19.45	22.19	22.45	22.60	24.26	0.2667
50	1	1	64-QAM	17.70	18.03	18.25	17.27	17.42	17.62	20.50	20.75	20.96		
50	1	1	256-QAM	14.87	15.19	15.31	18.63	14.75	14.82	20.16	17.99	18.08		
Limit	EIRP < 1W			Result									Pass	

NR n78_HPUE Maximum Average Power [dBm], DG = 1.66 dBi														
BW (MHz)	RB Size	RB Offset	Mod	Antenna 1			Antenna 2			Combine			EIRP (dBm)	EIRP (W)
				Lowest	Middle	Highest	Lowest	Middle	Highest	Lowest	Middle	Highest		
60	1	1	QPSK	19.73	19.78	20.21	19.60	19.64	19.70	22.68	22.72	22.97	24.63	0.2904
60	1	160		20.03	19.63	19.63	19.65	19.50	19.44	22.85	22.58	22.55		
60	81	40		20.16	20.18	19.90	19.71	19.59	19.42	22.95	22.91	22.68		
60	1	0		17.90	18.10	17.86	17.78	17.84	17.61	20.85	20.98	20.75		
60	1	161		17.91	17.65	17.55	17.62	17.44	17.43	20.78	20.56	20.50		
60	162	0		18.59	18.60	18.41	18.21	18.13	17.95	21.41	21.38	21.20		
60	1	1	16-QAM	19.36	19.43	19.61	19.15	19.12	19.16	22.27	22.29	22.40	24.06	0.2547
60	1	1	64-QAM	17.75	17.83	17.96	17.32	17.31	17.34	20.55	20.59	20.67		
60	1	1	256-QAM	14.80	14.98	15.17	14.59	14.73	14.65	17.71	17.87	17.93		
Limit	EIRP < 1W			Result									Pass	



NR n78_HPUE Maximum Average Power [dBm], DG = 1.66 dBi														
BW (MHz)	RB Size	RB Offset	Mod	Antenna 1			Antenna 2			Combine			EIRP (dBm)	EIRP (W)
				Lowest	Middle	Highest	Lowest	Middle	Highest	Lowest	Middle	Highest		
70	1	1	QPSK	19.60	20.02	20.02	19.63	19.66	19.55	22.63	22.85	22.80	24.67	0.2931
70	1	187		20.02	19.80	19.48	19.73	19.40	19.42	22.89	22.61	22.46		
70	95	47		20.15	20.25	19.93	19.65	19.73	19.40	22.92	23.01	22.68		
70	1	0		18.02	18.15	17.80	17.76	17.92	17.61	20.90	21.05	20.72		
70	1	188		18.00	17.69	17.52	17.65	17.44	17.32	20.84	20.58	20.43		
70	189	0		18.62	18.64	18.31	18.11	18.09	17.91	21.38	21.38	21.12		
70	1	1	16-QAM	19.11	19.39	19.37	19.21	19.33	19.16	22.17	22.37	22.28	24.03	0.2529
70	1	1	64-QAM	17.63	17.99	17.91	17.45	17.51	17.32	20.55	20.77	20.64		
70	1	1	256-QAM	14.78	15.10	15.00	14.51	14.71	14.55	17.66	17.92	17.79		
Limit	EIRP < 1W			Result									Pass	

NR n78_HPUE Maximum Average Power [dBm], DG = 1.66 dBi														
BW (MHz)	RB Size	RB Offset	Mod	Antenna 1			Antenna 2			Combine			EIRP (dBm)	EIRP (W)
				Lowest	Middle	Highest	Lowest	Middle	Highest	Lowest	Middle	Highest		
80	1	1	QPSK	19.70	19.82	19.89	19.62	19.43	19.59	22.67	22.64	22.75	24.52	0.2831
80	1	215		19.55	19.41	19.41	19.33	19.22	19.22	22.45	22.33	22.33		
80	109	54		20.08	20.10	20.05	19.61	19.55	19.49	22.86	22.84	22.79		
80	1	0		17.85	17.95	17.97	17.70	17.76	17.82	20.79	20.87	20.91		
80	1	216		17.53	17.37	17.24	17.31	17.15	17.32	20.43	20.27	20.29		
80	217	0		18.44	18.43	18.39	18.08	18.01	17.97	21.27	21.24	21.20		
80	1	1	16-QAM	19.23	19.29	19.44	19.07	19.08	19.12	22.16	22.20	22.29	23.95	0.2483
80	1	1	64-QAM	17.65	17.85	17.85	17.28	17.51	17.33	20.48	20.69	20.61		
80	1	1	256-QAM	14.85	14.97	15.00	14.54	14.52	14.66	17.71	17.76	17.84		
Limit	EIRP < 1W			Result									Pass	



NR n78_HPUE Maximum Average Power [dBm], DG = 1.66 dBi														
BW (MHz)	RB Size	RB Offset	Mod	Antenna 1			Antenna 2			Combine			EIRP (dBm)	EIRP (W)
				Lowest	Middle	Highest	Lowest	Middle	Highest	Lowest	Middle	Highest		
90	1	1	QPSK	19.58	19.73	19.89	19.36	19.47	19.56	22.48	22.61	22.74	24.47	0.2799
90	1	243		19.62	19.41	19.34	19.50	19.35	19.30	22.57	22.39	22.33		
90	123	61		20.06	20.10	20.04	19.48	19.48	19.54	22.79	22.81	22.81		
90	1	0		17.80	17.84	17.97	17.72	17.77	18.00	20.77	20.82	21.00		
90	1	244		17.54	17.35	17.30	17.20	17.26	17.25	20.38	20.32	20.29		
90	245	0		18.40	18.41	18.43	17.94	17.98	18.02	21.19	21.21	21.24		
90	1	1	16-QAM	19.06	19.14	19.27	18.92	19.02	19.23	22.00	22.09	22.26	23.92	0.2466
90	1	1	64-QAM	17.62	17.68	18.01	17.15	17.29	17.35	20.40	20.50	20.70		
90	1	1	256-QAM	14.65	14.80	15.00	14.52	14.58	14.70	17.60	17.70	17.86		
Limit	EIRP < 1W			Result									Pass	

NR n78_HPUE Maximum Average Power [dBm], DG = 1.66 dBi														
BW (MHz)	RB Size	RB Offset	Mod	Antenna 1			Antenna 2			Combine			EIRP (dBm)	EIRP (W)
				Lowest	Middle	Highest	Lowest	Middle	Highest	Lowest	Middle	Highest		
100	1	1	QPSK	-	19.47	-	-	19.68	-	-	22.59	-	24.49	0.2812
100	1	271		-	18.97	-	-	19.54	-	-	22.27	-		
100	137	68		-	19.85	-	-	19.78	-	-	22.83	-		
100	1	0		-	17.69	-	-	18.03	-	-	20.87	-		
100	1	272		-	17.02	-	-	17.71	-	-	20.39	-		
100	273	0		-	18.03	-	-	18.33	-	-	21.19	-		
100	1	1	16-QAM	-	19.03	-	-	19.36	-	-	22.21	-	23.87	0.2438
100	1	1	64-QAM	-	17.32	-	-	17.46	-	-	20.40	-		
100	1	1	256-QAM	-	14.54	-	-	14.86	-	-	17.71	-		
Limit	EIRP < 1W			Result									Pass	



FR1 n77_HPUE_Ant. 1

Peak-to-Average Ratio

Mode	FR1 n77 / 20MHz / CP OFDM				
Mod.	QPSK	16QAM	64QAM	256QAM	Limit: 13dB
RB Size	Full RB	Full RB	Full RB	Full RB	Result
Middle CH	7.82	7.76	8.28	8.88	PASS

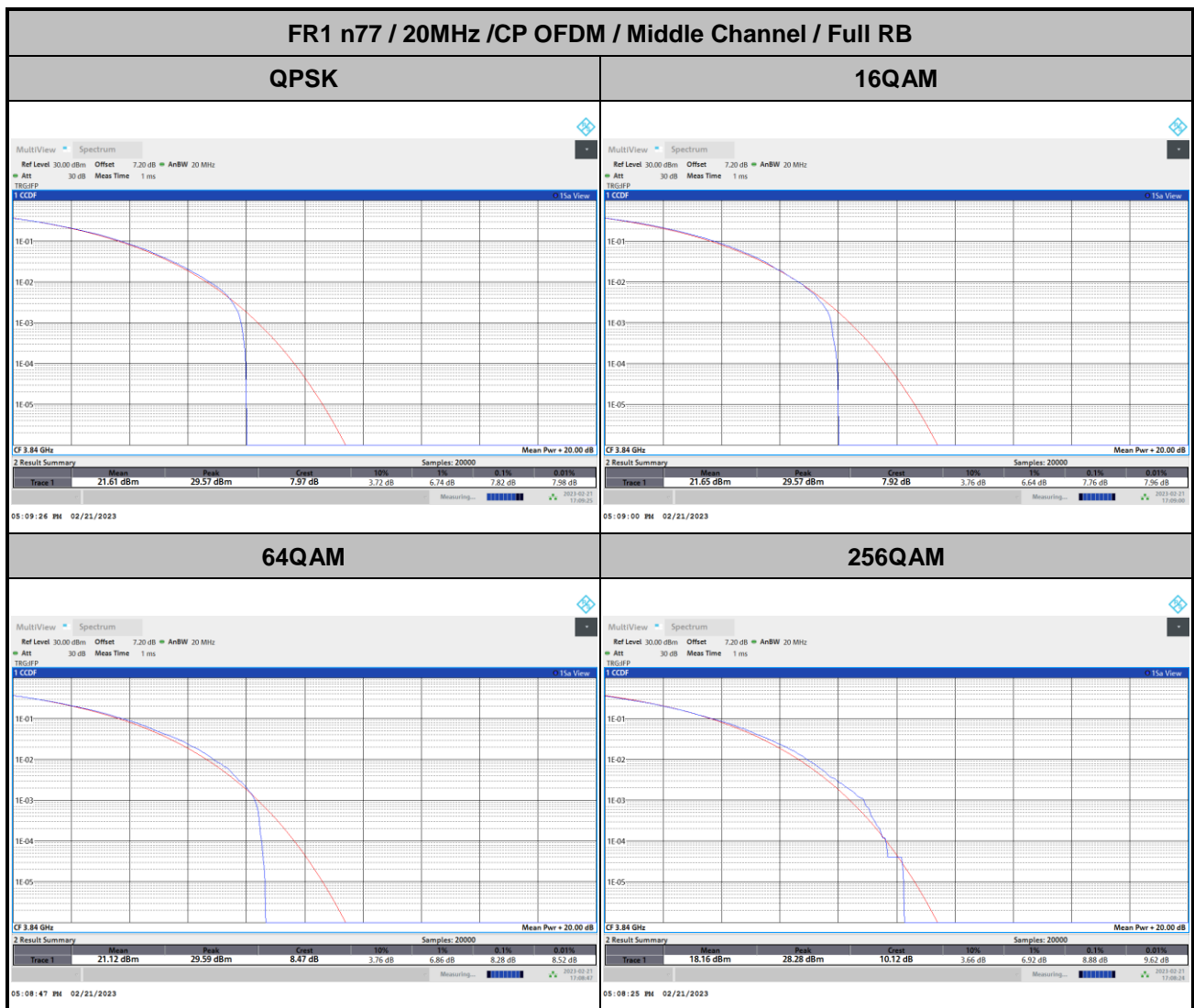



26dB Bandwidth

Mode	FR1 n77 : 26dB BW(MHz) / CP OFDM							
BW	10MHz		15MHz		20MHz		25MHz	
Mod.	QPSK	16QAM	QPSK	16QAM	QPSK	16QAM	QPSK	16QAM
Middle CH	9.77	9.79	15.23	15.35	19.82	19.98	-	-
Mod.	64QAM	256QAM	64QAM	256QAM	64QAM	256QAM	64QAM	256QAM
Middle CH	9.77	9.71	15.23	15.20	20.06	19.78	-	-
BW	30MHz		40MHz		50MHz		60MHz	
Mod.	QPSK	16QAM	QPSK	16QAM	QPSK	16QAM	QPSK	16QAM
Middle CH	29.73	29.55	40.76	40.60	50.45	50.65	61.14	61.02
Mod.	64QAM	256QAM	64QAM	256QAM	64QAM	256QAM	64QAM	256QAM
Middle CH	29.49	29.67	40.68	40.76	50.55	50.75	61.02	60.78
BW	70MHz		80MHz		90MHz		100MHz	
Mod.	QPSK	16QAM	QPSK	16QAM	QPSK	16QAM	QPSK	16QAM
Middle CH	70.63	70.77	80.72	80.72	90.99	90.99	100.90	100.70
Mod.	64QAM	256QAM	64QAM	256QAM	64QAM	256QAM	64QAM	256QAM
Middle CH	70.49	70.49	80.88	80.56	90.81	90.81	100.70	100.90



FR1 n77 / 10MHz / CP OFDM / Middle Channel / Full RB

QPSK

16QAM

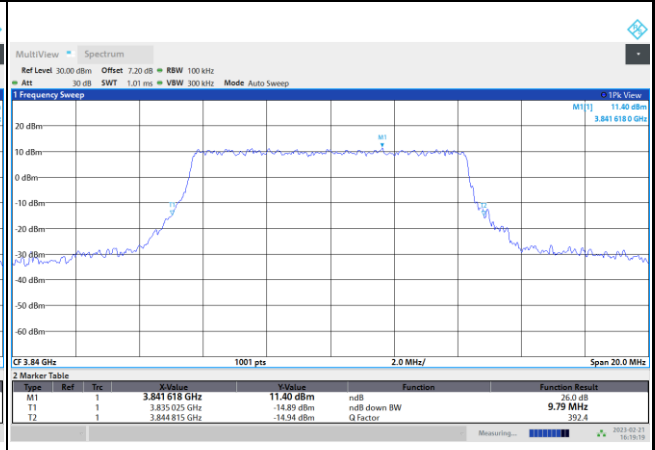
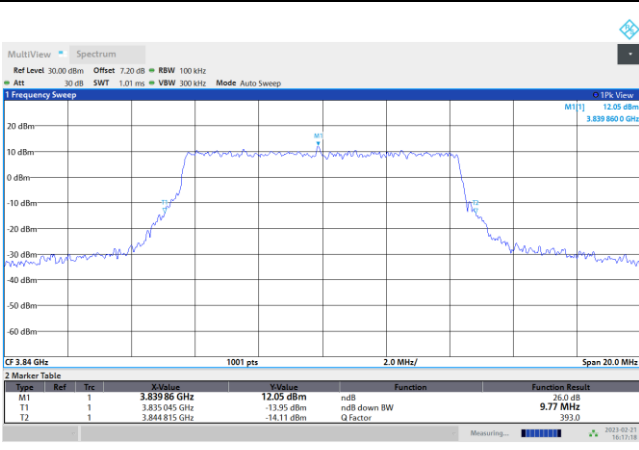

64QAM

256QAM

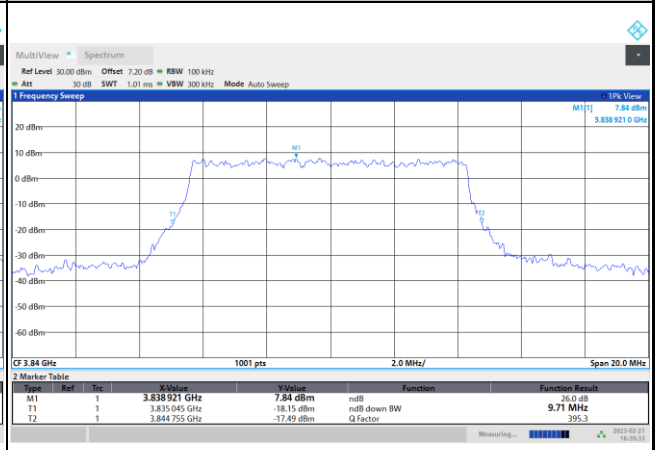
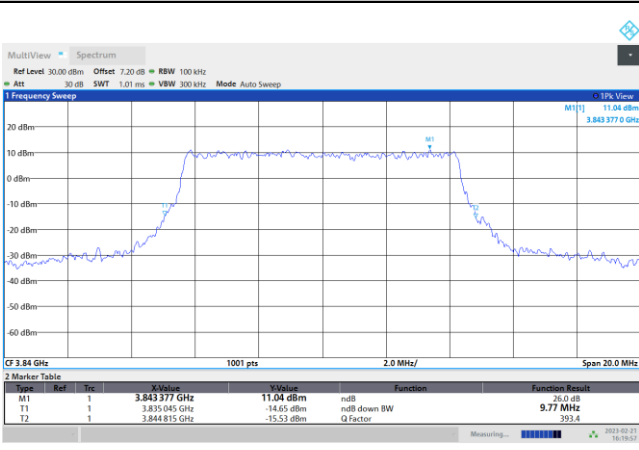



FR1 n77 / 15MHz / CP OFDM / Middle Channel / Full RB

QPSK

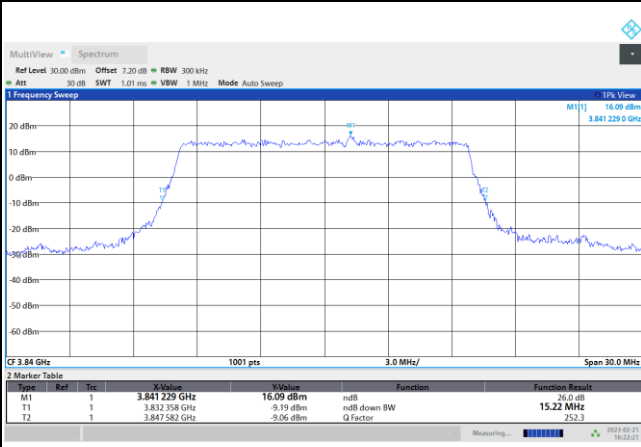

04:22:21 PM 02/21/2023

16QAM

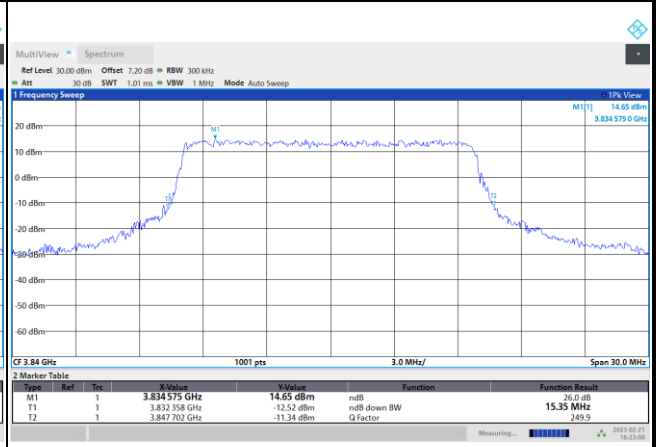

04:23:01 PM 02/21/2023

64QAM

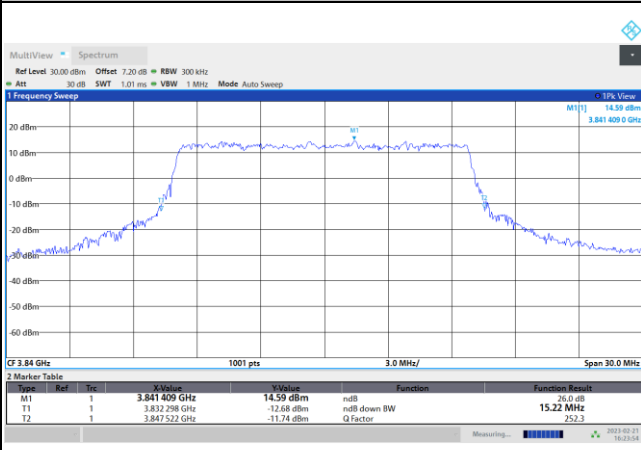

04:23:54 PM 02/21/2023

256QAM

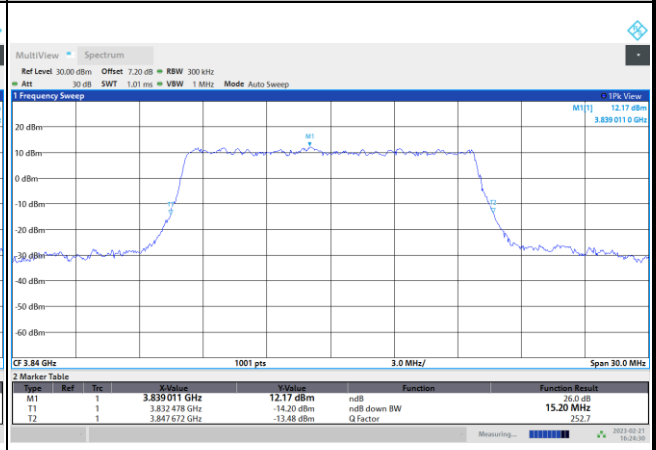

04:24:31 PM 02/21/2023



FR1 n77 / 20MHz / CP OFDM / Middle Channel / Full RB

QPSK

16QAM

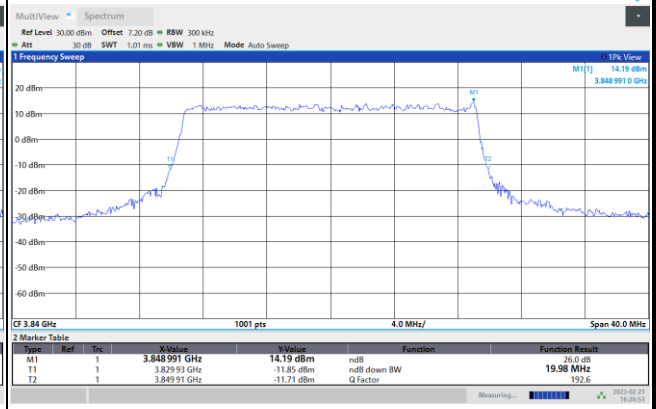
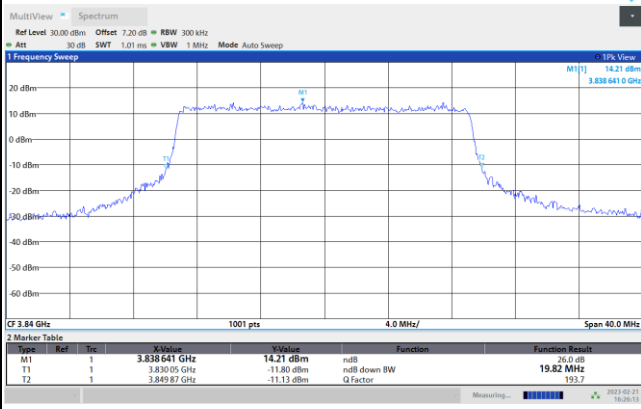

64QAM

256QAM

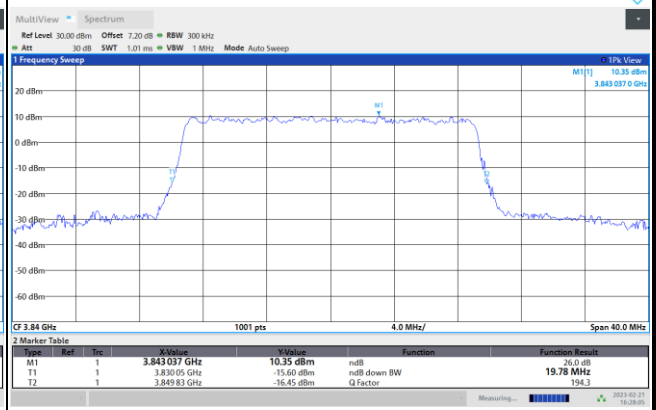
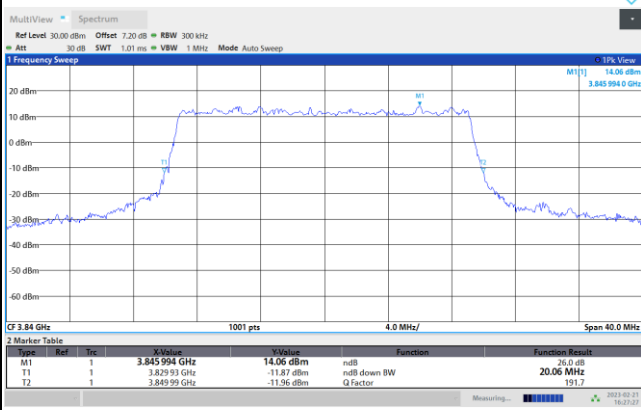



FR1 n77 / 30MHz / CP OFDM / Middle Channel / Full RB

QPSK

16QAM

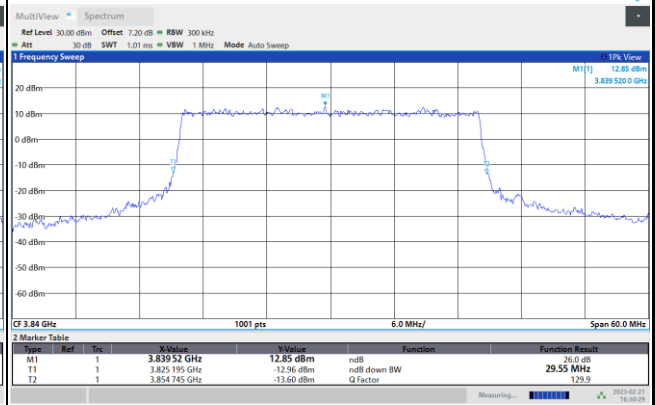
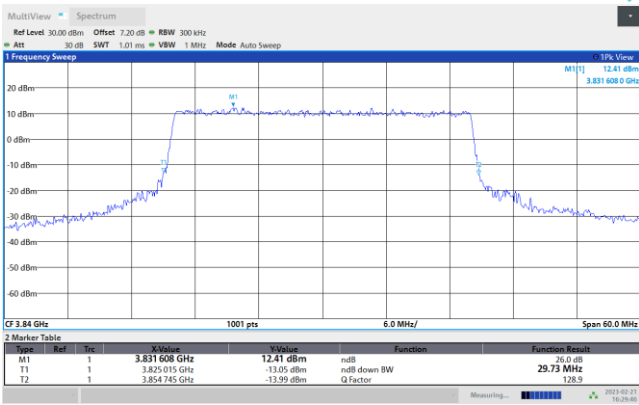

64QAM

256QAM

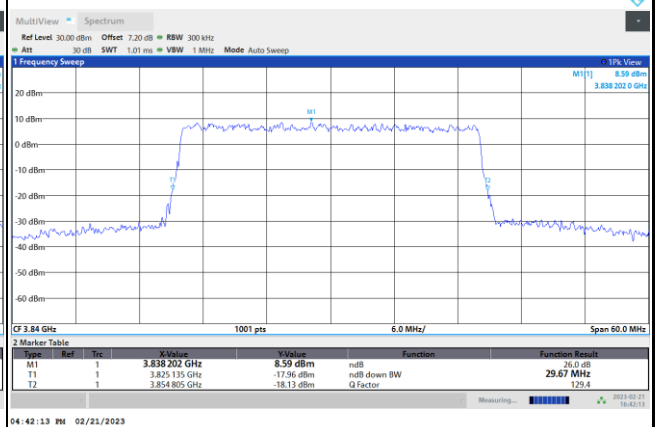
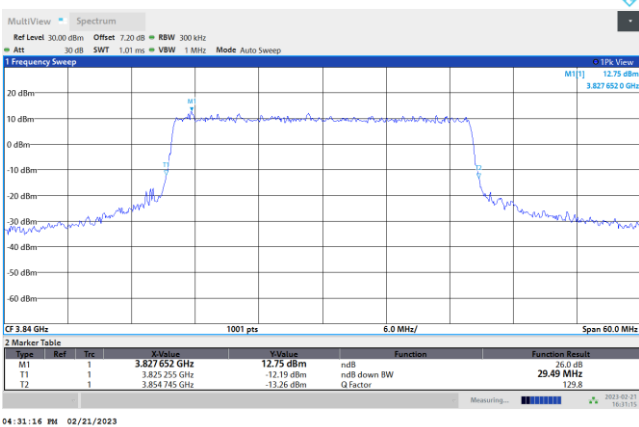



FR1 n77 / 40MHz / CP OFDM / Middle Channel / Full RB

QPSK

16QAM

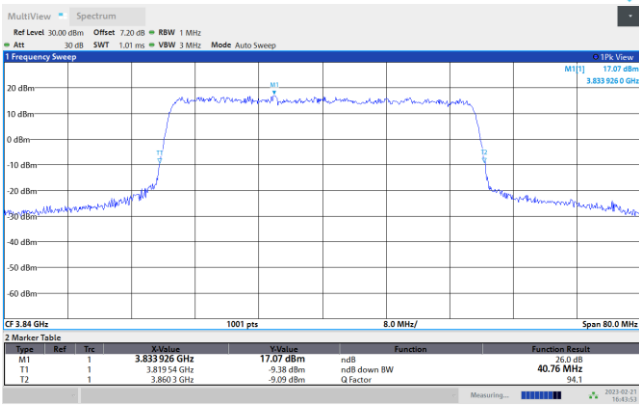

04:43:54 PM 02/21/2023

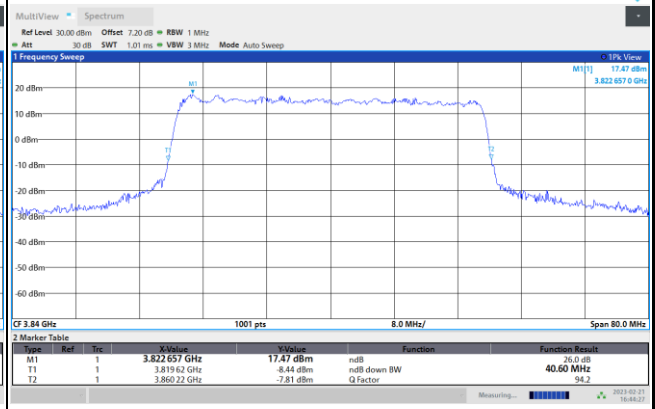

04:44:28 PM 02/21/2023

64QAM

256QAM

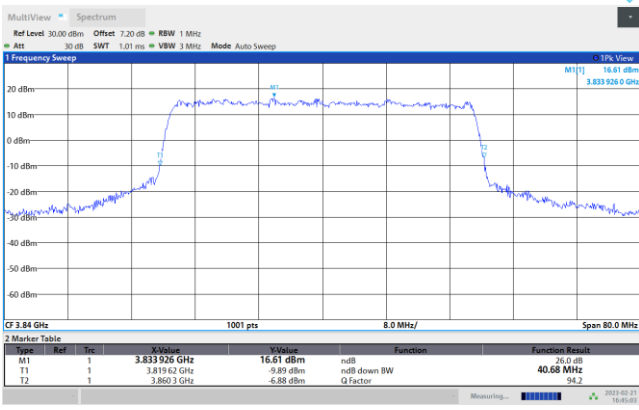

04:45:03 PM 02/21/2023

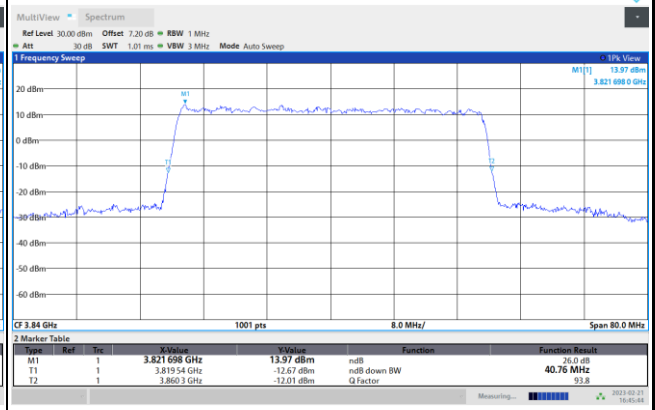

04:45:44 PM 02/21/2023



FR1 n77 / 50MHz / CP OFDM / Middle Channel / Full RB

QPSK

16QAM

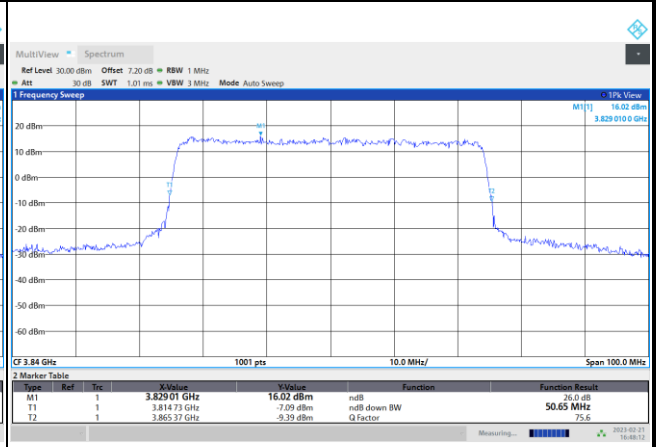
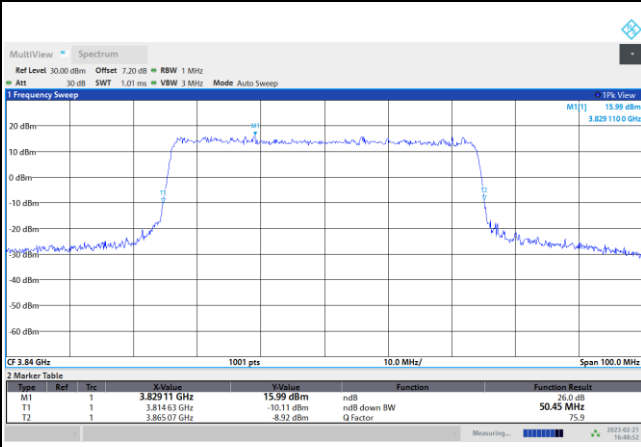

64QAM

256QAM

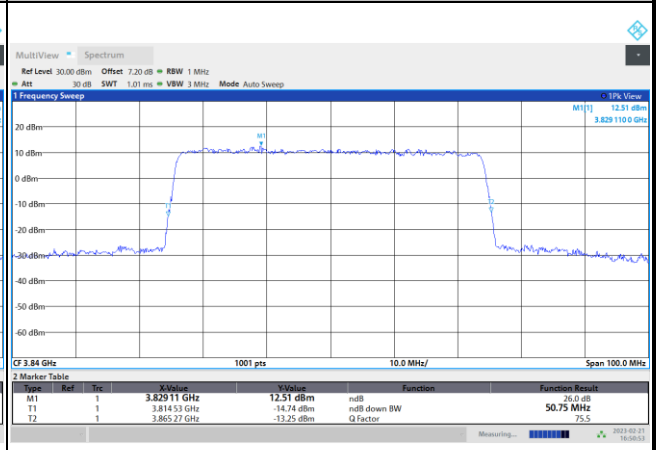
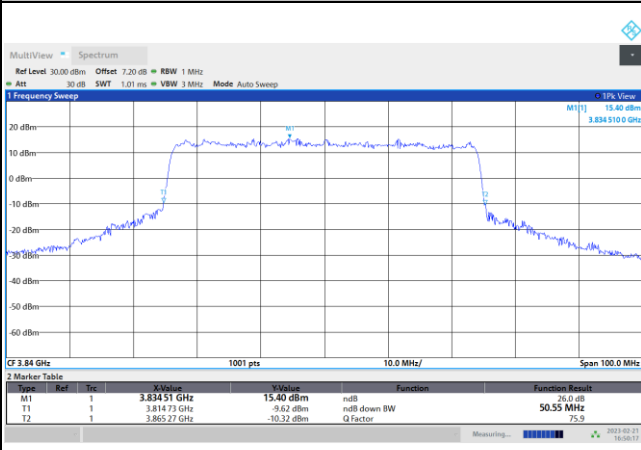



FR1 n77 / 60MHz / CP OFDM / Middle Channel / Full RB

QPSK

16QAM

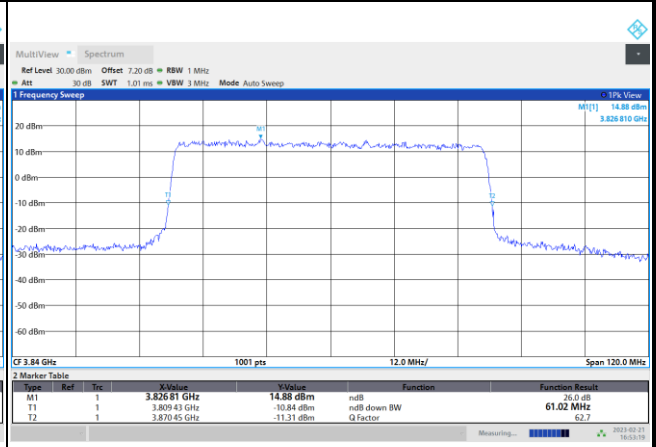
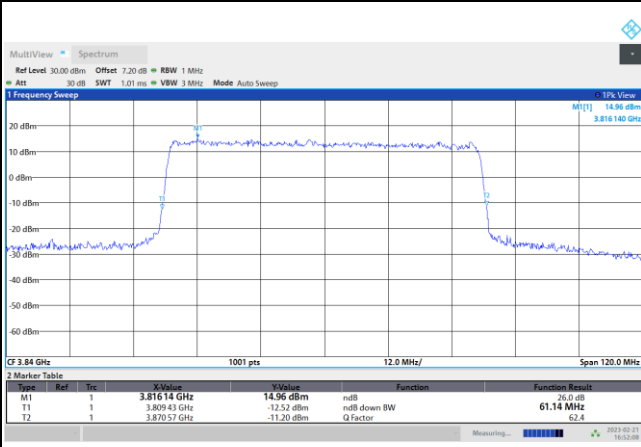

64QAM

256QAM

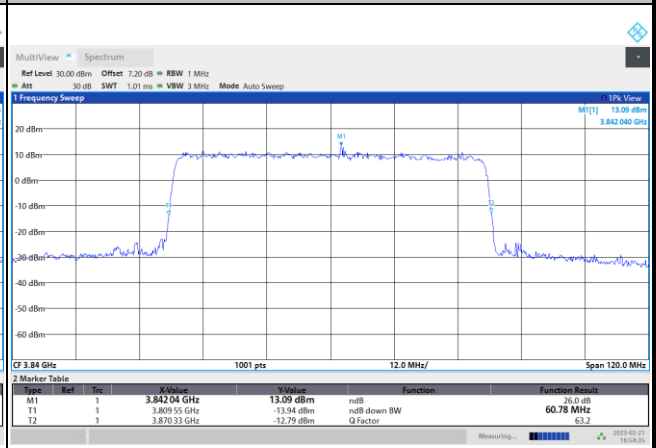
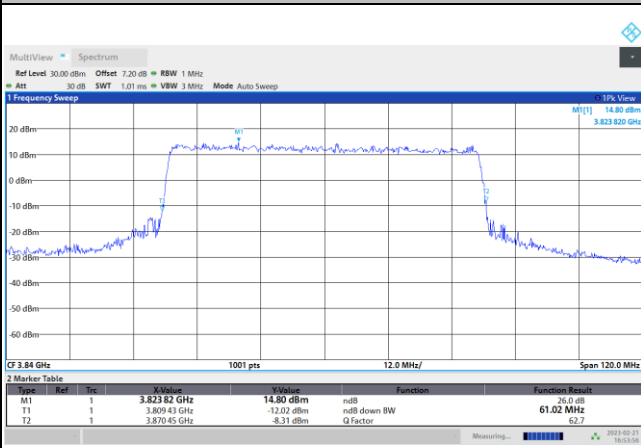



FR1 n77 / 70MHz / CP OFDM / Middle Channel / Full RB

QPSK

16QAM

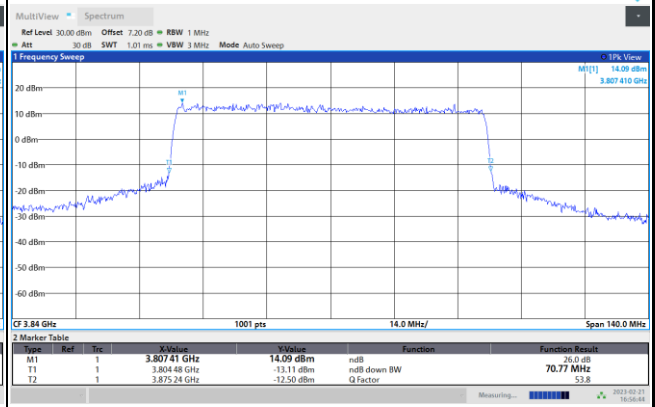
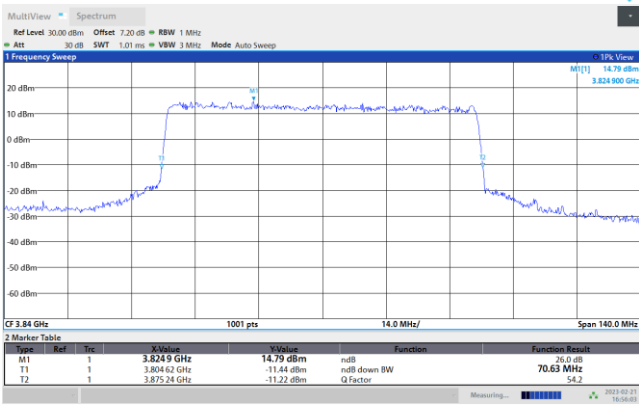

64QAM

256QAM

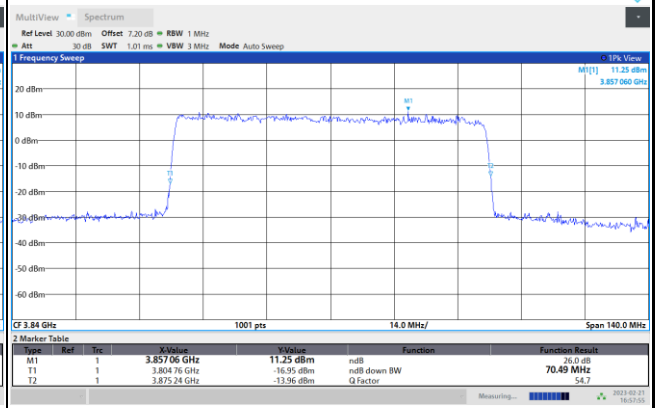
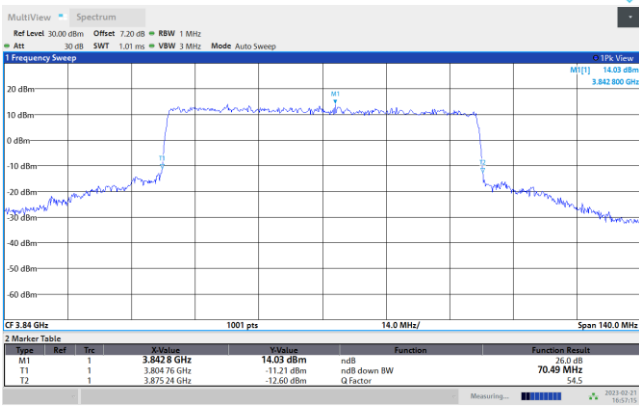



FR1 n77 / 80MHz / CP OFDM / Middle Channel / Full RB

QPSK

16QAM

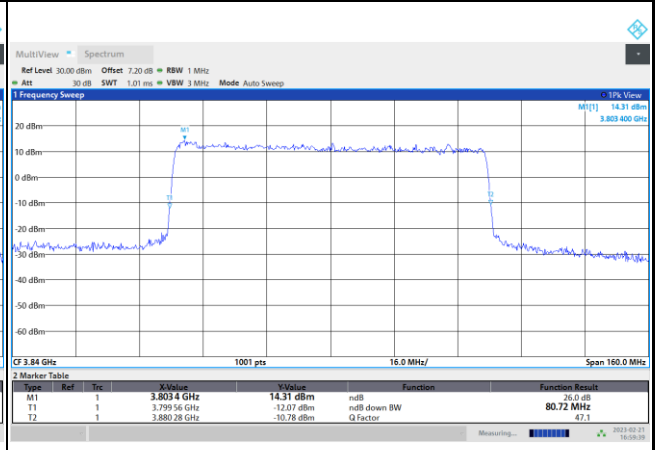
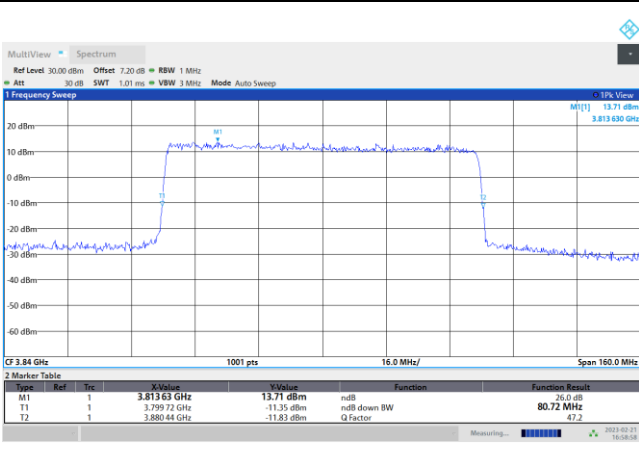

64QAM

256QAM

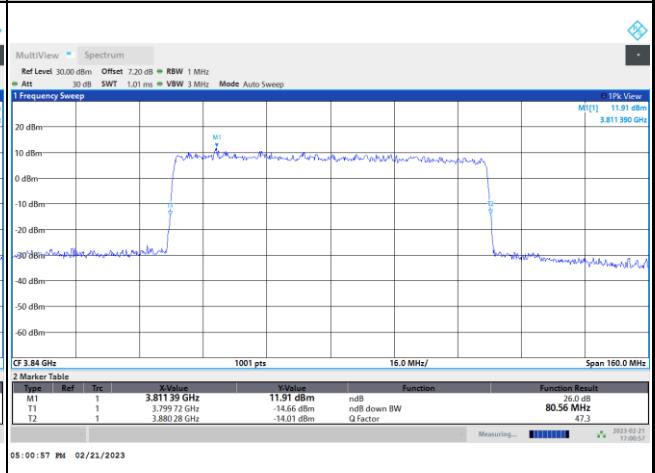
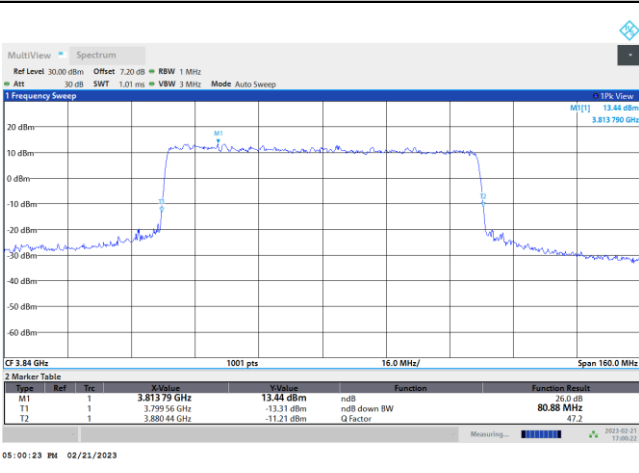



FR1 n77 / 90MHz / CP OFDM / Middle Channel / Full RB

QPSK

16QAM

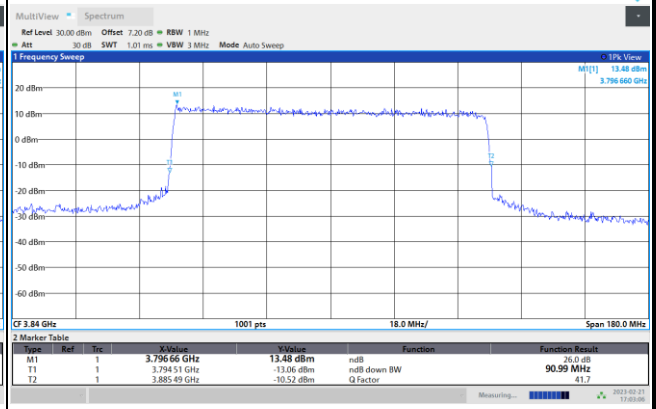
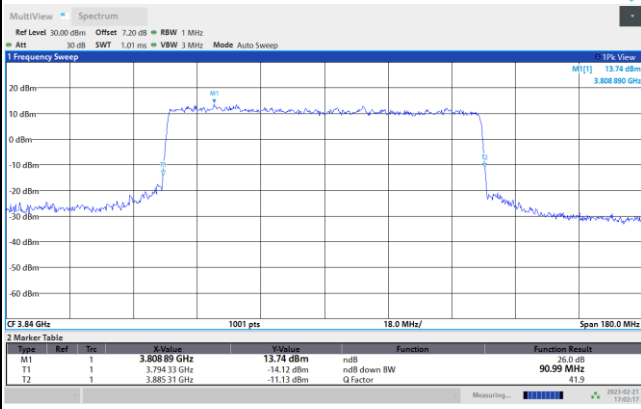

64QAM

256QAM

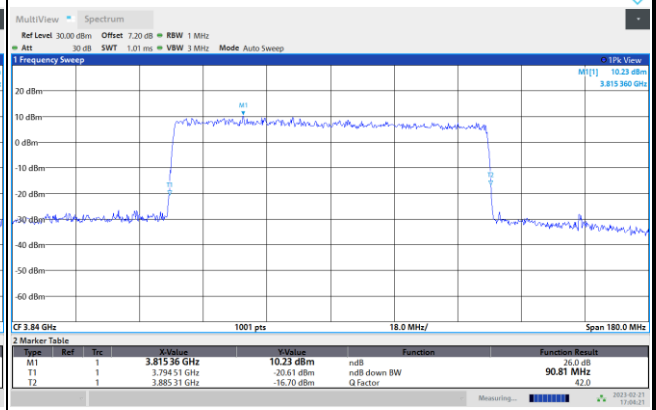
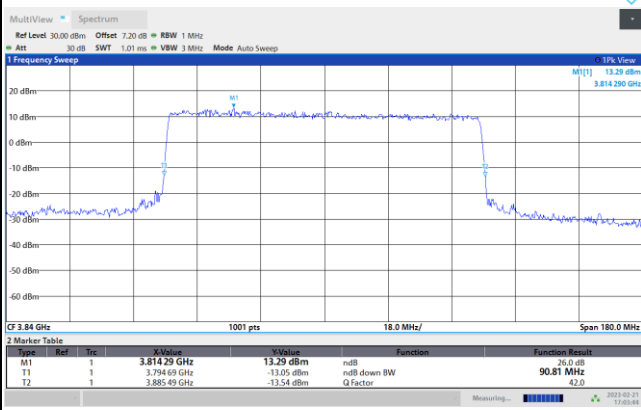



FR1 n77 / 100MHz / CP OFDM / Middle Channel / Full RB

QPSK

16QAM

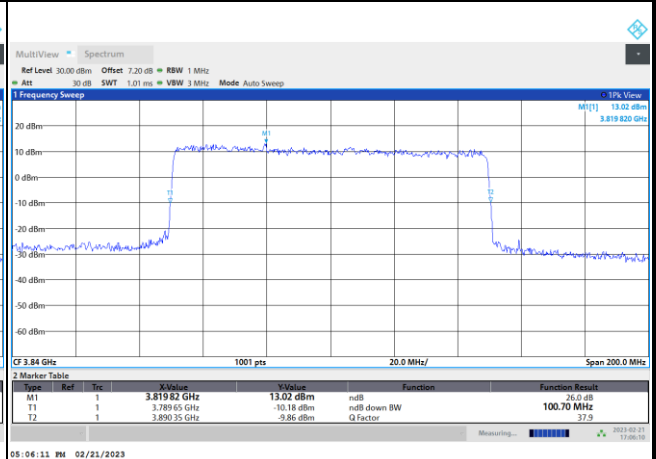
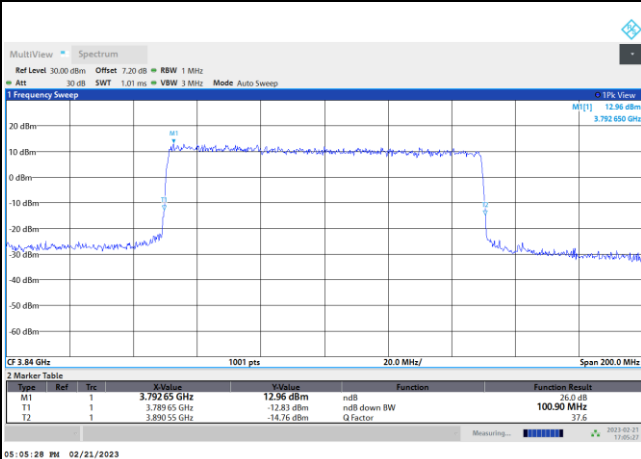

64QAM

256QAM

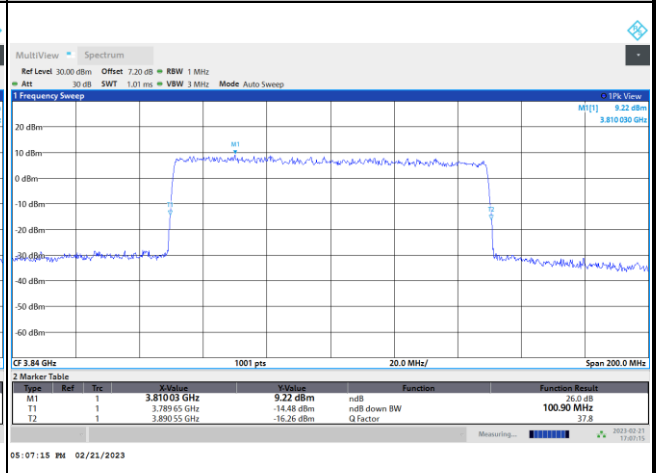
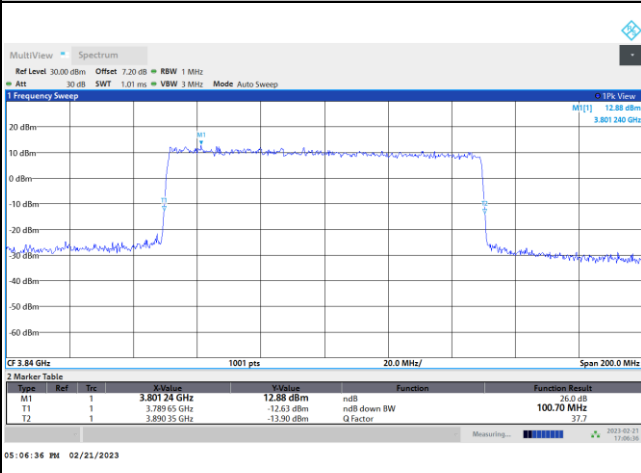



Occupied Bandwidth

Mode	FR1 n77 : OB BW(MHz) / CP OFDM							
BW	10MHz		15MHz		20MHz		25MHz	
Mod.	QPSK	16QAM	QPSK	16QAM	QPSK	16QAM	QPSK	16QAM
Middle CH	8.60	8.61	13.63	13.67	18.22	18.31	-	-
Mod.	64QAM	256QAM	64QAM	256QAM	64QAM	256QAM	64QAM	256QAM
Middle CH	8.59	8.62	13.74	13.65	18.29	18.21	-	-
BW	30MHz		40MHz		50MHz		60MHz	
Mod.	QPSK	16QAM	QPSK	16QAM	QPSK	16QAM	QPSK	16QAM
Middle CH	27.86	27.86	37.93	37.99	47.56	47.61	57.88	57.86
Mod.	64QAM	256QAM	64QAM	256QAM	64QAM	256QAM	64QAM	256QAM
Middle CH	27.78	27.86	37.96	38.23	47.57	47.55	57.85	57.75
BW	70MHz		80MHz		90MHz		100MHz	
Mod.	QPSK	16QAM	QPSK	16QAM	QPSK	16QAM	QPSK	16QAM
Middle CH	67.51	67.52	77.43	77.35	87.35	87.32	97.34	97.21
Mod.	64QAM	256QAM	64QAM	256QAM	64QAM	256QAM	64QAM	256QAM
Middle CH	67.61	67.36	77.29	77.53	87.31	87.54	97.44	97.32



FR1 n77 / 10MHz / CP OFDM / Middle Channel / Full RB

QPSK

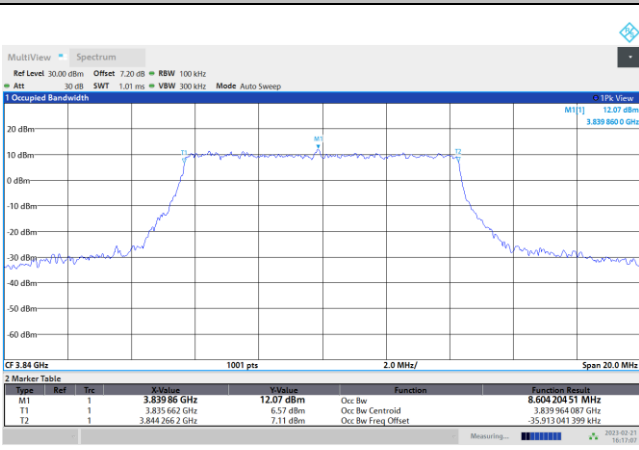

04:17:07 PM 02/21/2023

16QAM

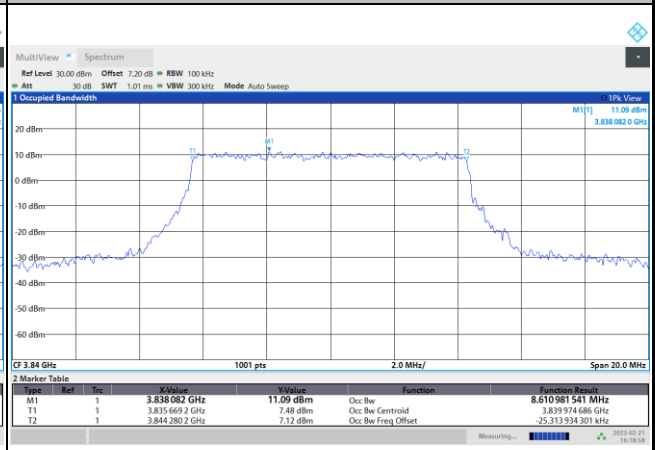

04:18:58 PM 02/21/2023

64QAM

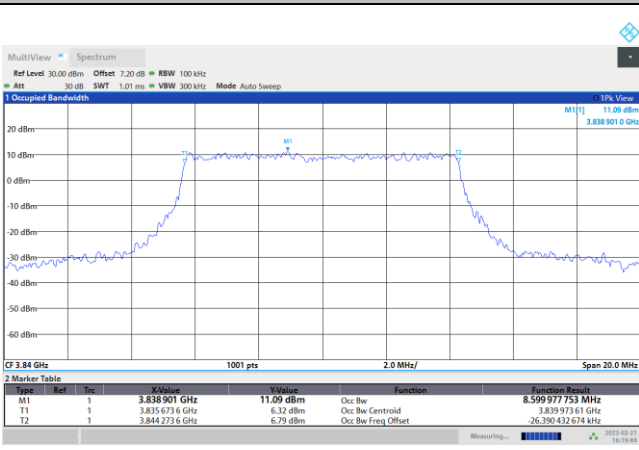

04:19:45 PM 02/21/2023

256QAM

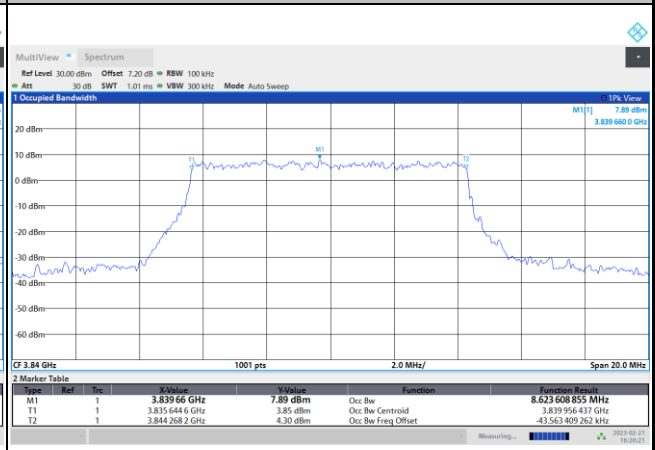

04:20:21 PM 02/21/2023



FR1 n77 / 15MHz / CP OFDM / Middle Channel / Full RB

QPSK

16QAM

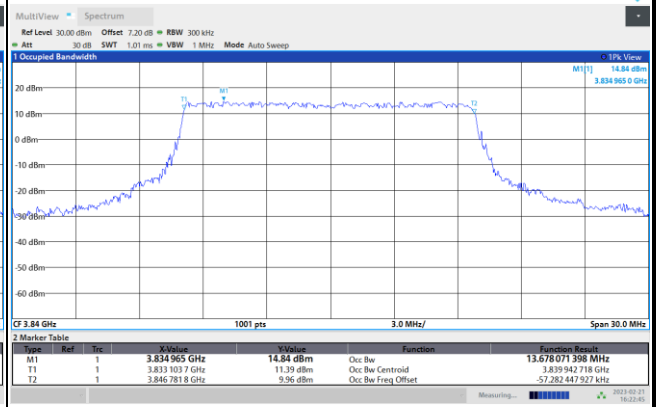
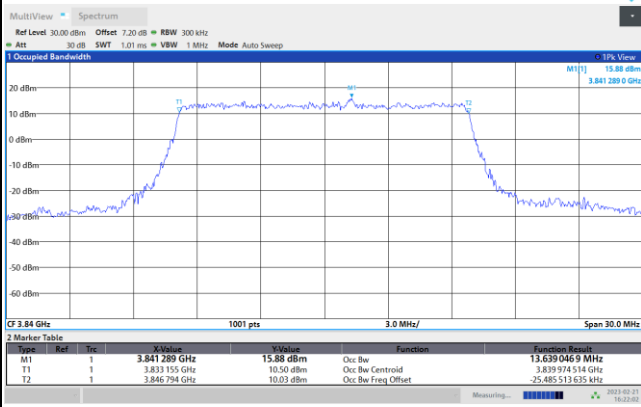

64QAM

256QAM

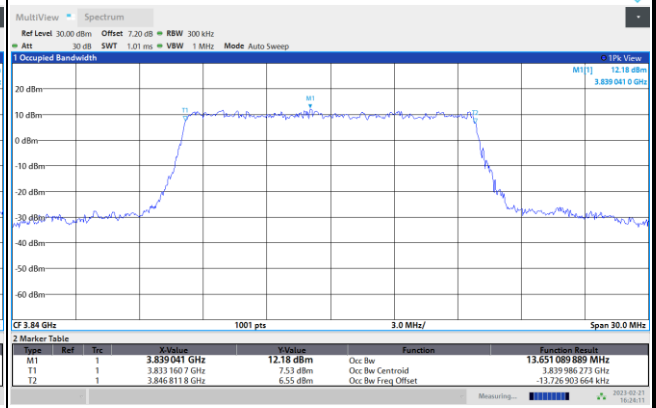
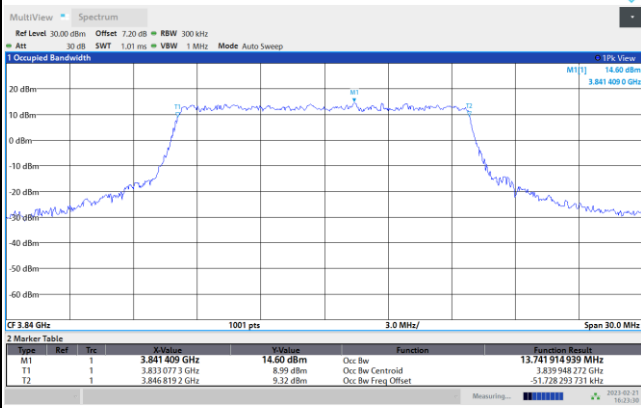



FR1 n77 / 20MHz / CP OFDM / Middle Channel / Full RB

QPSK

16QAM

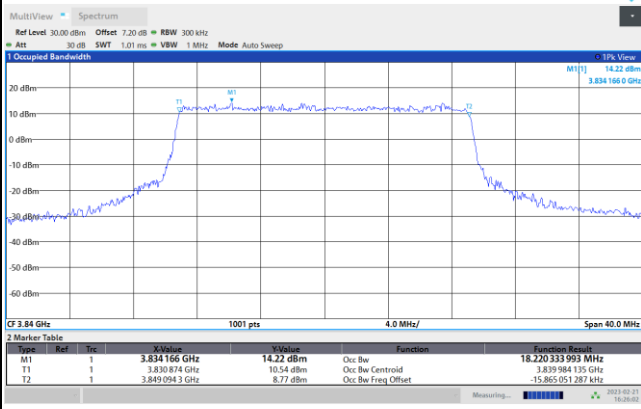

04:26:03 PM 02/21/2023

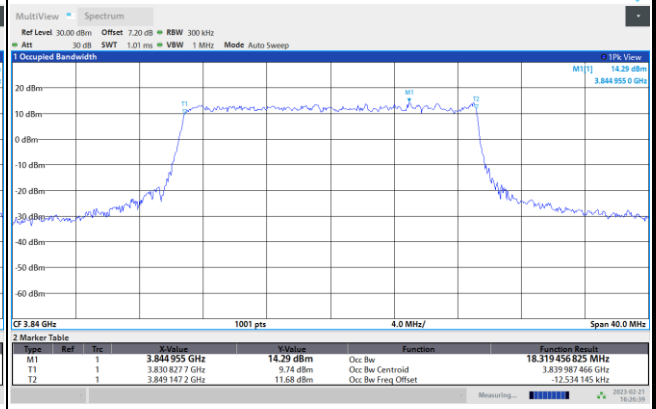

04:26:39 PM 02/21/2023

64QAM

256QAM

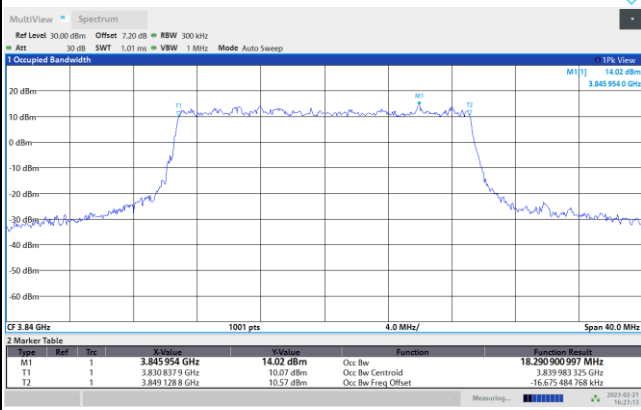

04:27:13 PM 02/21/2023

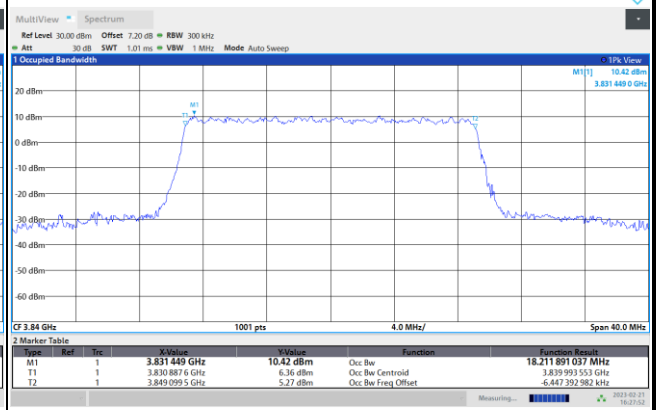

04:27:52 PM 02/21/2023



FR1 n77 / 30MHz / CP OFDM / Middle Channel / Full RB

QPSK

16QAM

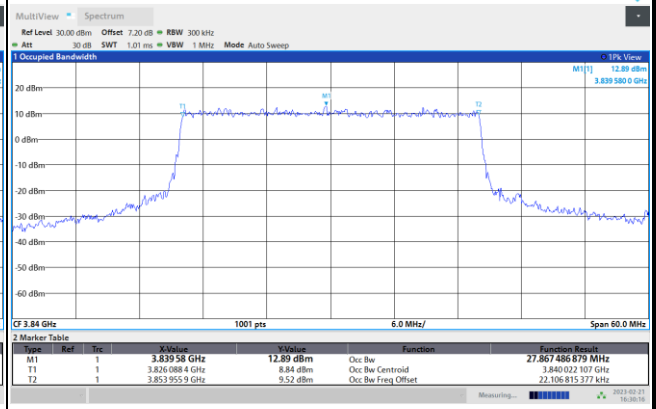
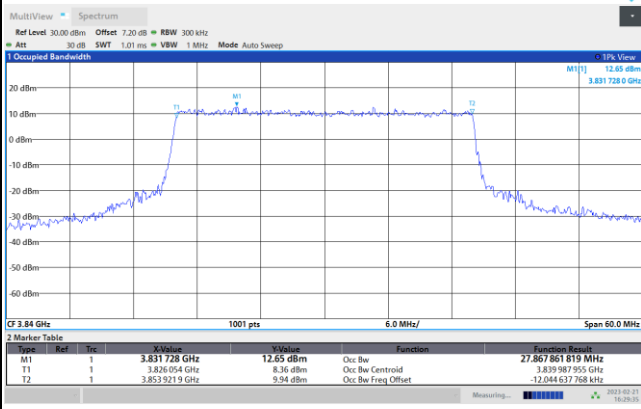

04:29:35 PM 02/21/2023

04:30:16 PM 02/21/2023

64QAM

256QAM

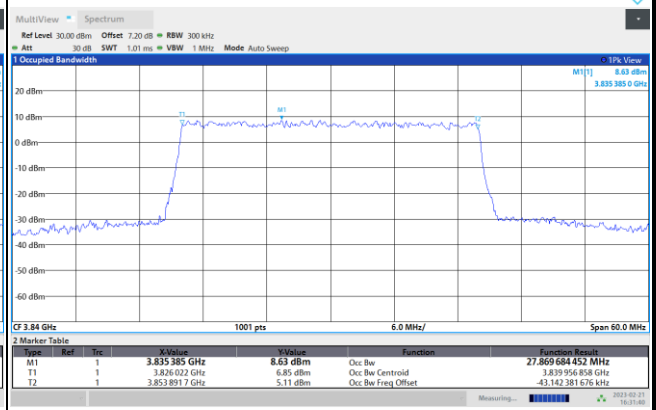
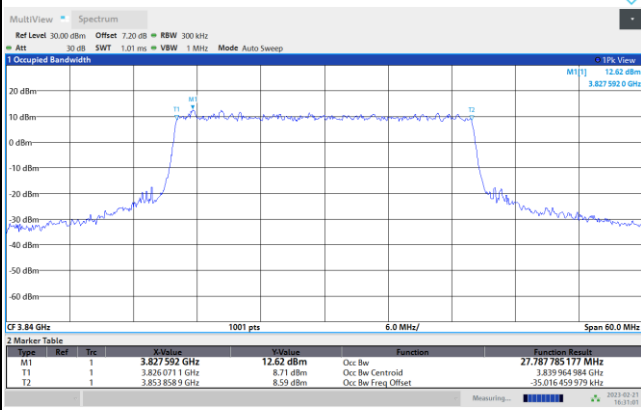

04:31:01 PM 02/21/2023

04:31:40 PM 02/21/2023



FR1 n77 / 40MHz / CP OFDM / Middle Channel / Full RB

QPSK

16QAM

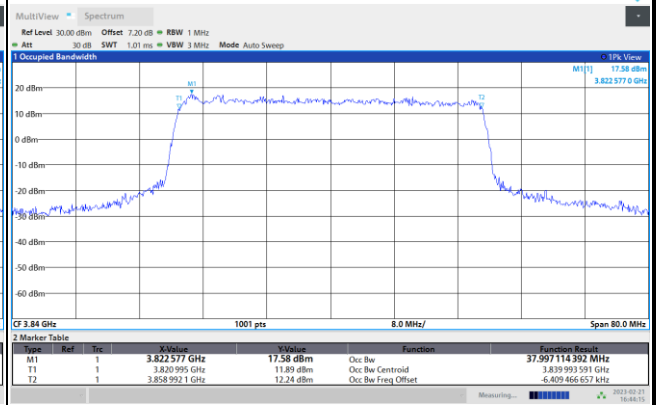
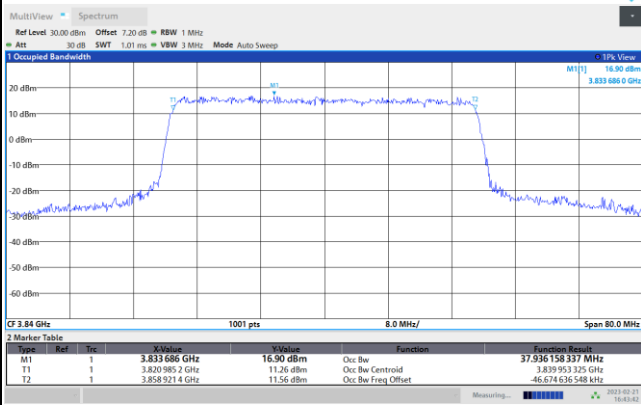

04:43:43 PM 02/21/2023

04:44:16 PM 02/21/2023

64QAM

256QAM

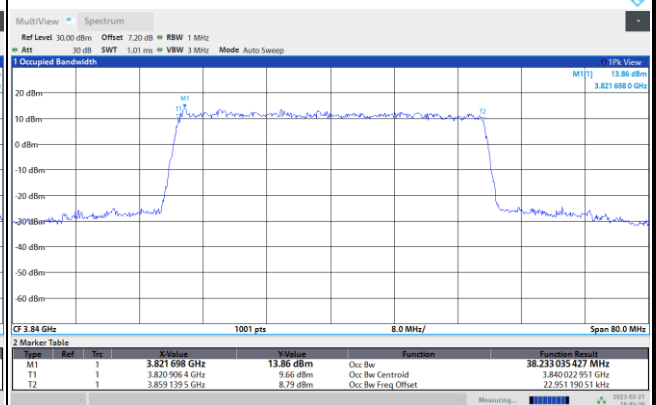
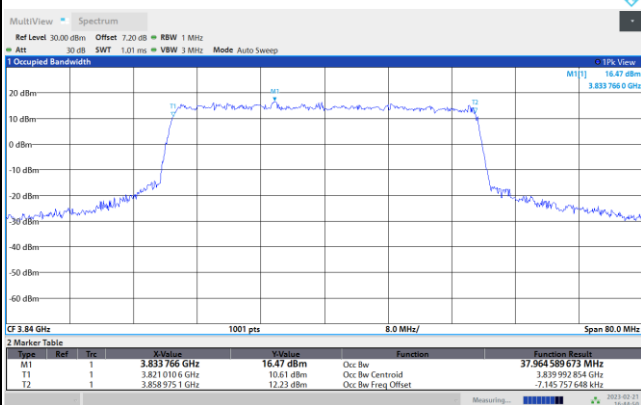

04:44:50 PM 02/21/2023

04:45:27 PM 02/21/2023



FR1 n77 / 50MHz / CP OFDM / Middle Channel / Full RB

QPSK

16QAM

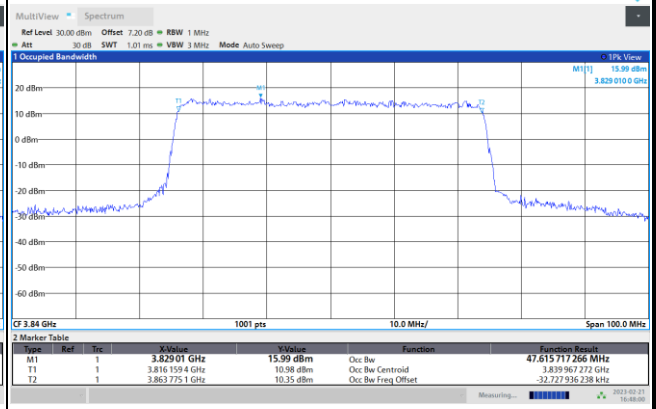
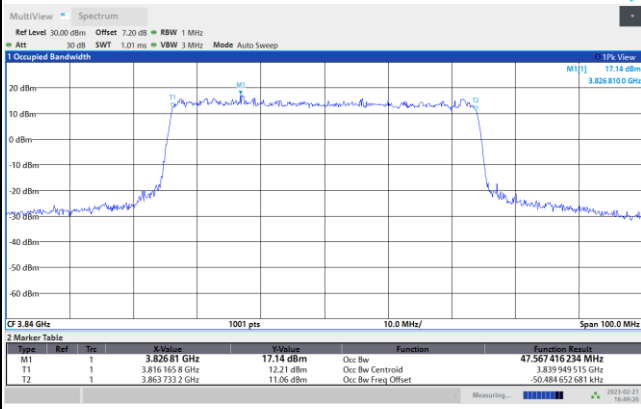

64QAM

256QAM

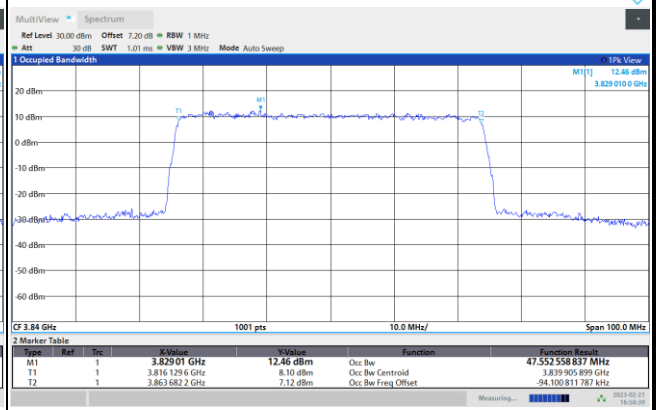
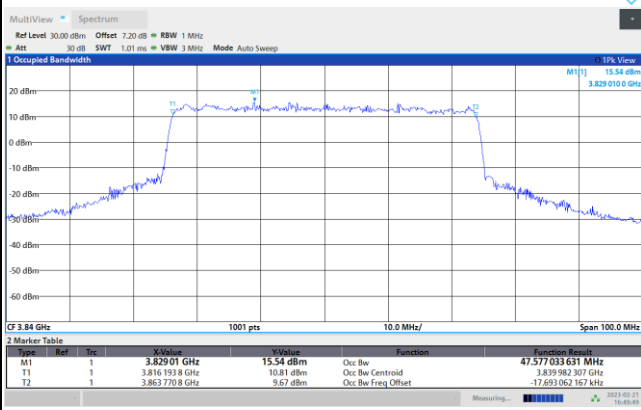



FR1 n77 / 60MHz / CP OFDM / Middle Channel / Full RB

QPSK

16QAM

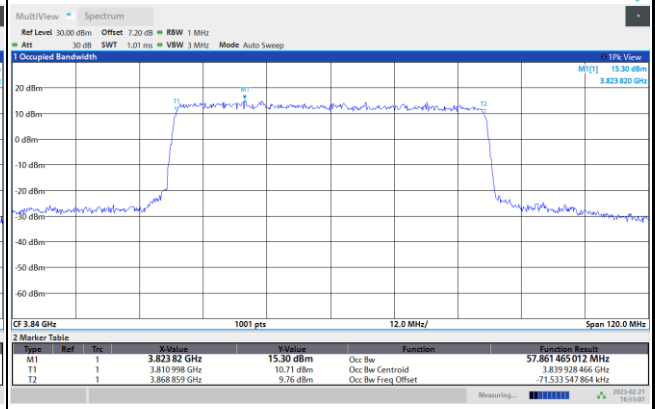
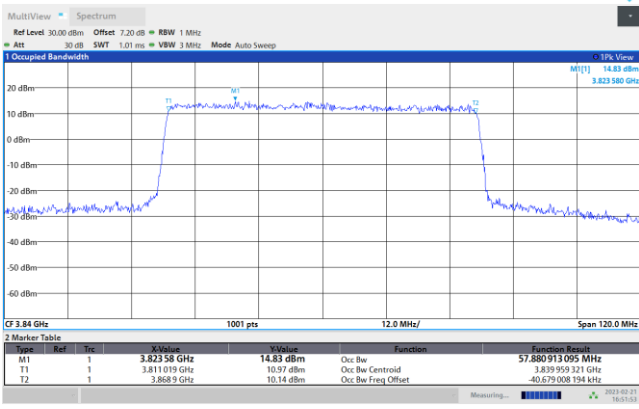

64QAM

256QAM

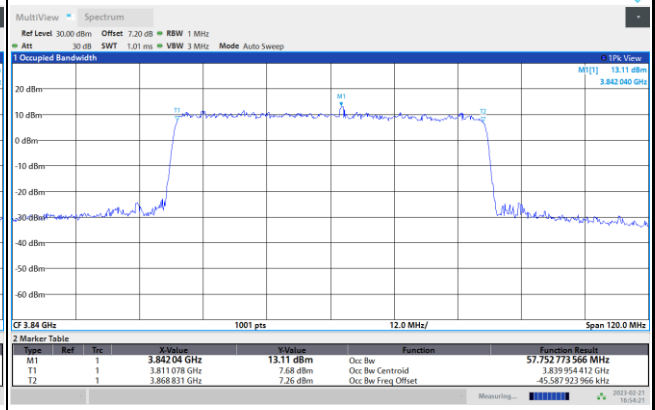
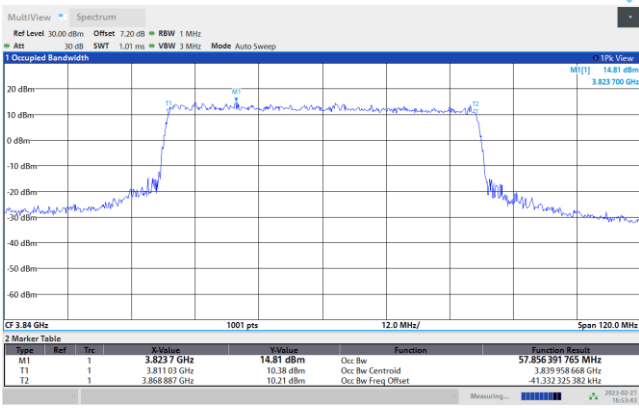



FR1 n77 / 70MHz / CP OFDM / Middle Channel / Full RB

QPSK

16QAM

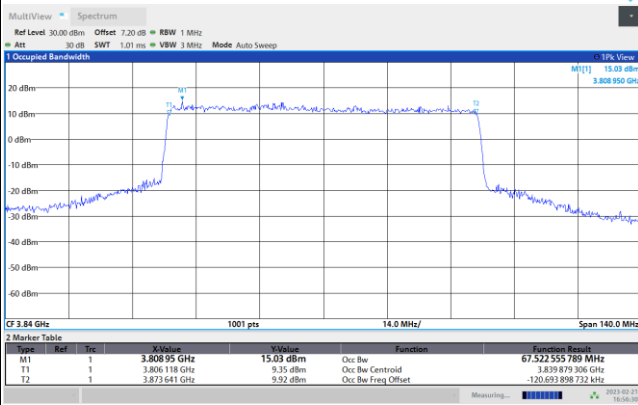
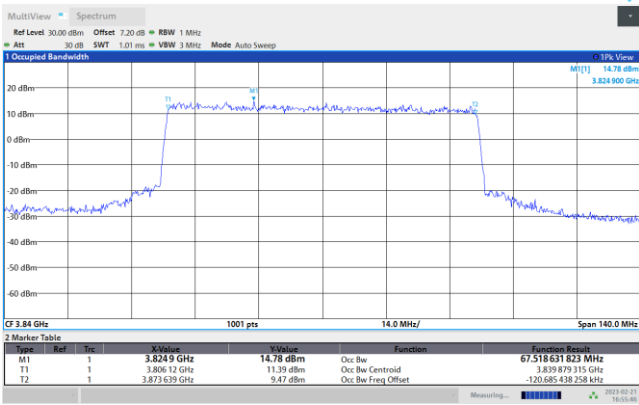

64QAM

256QAM

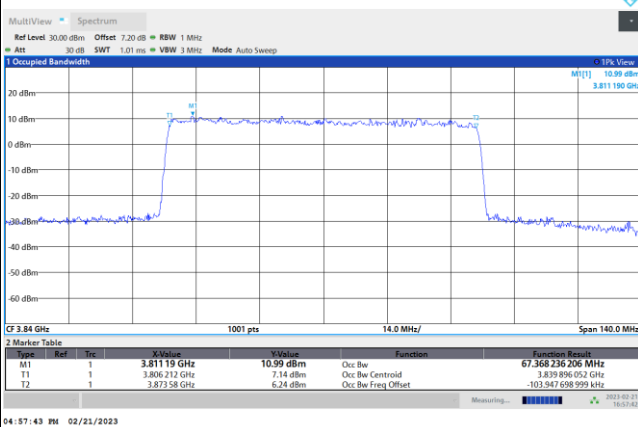
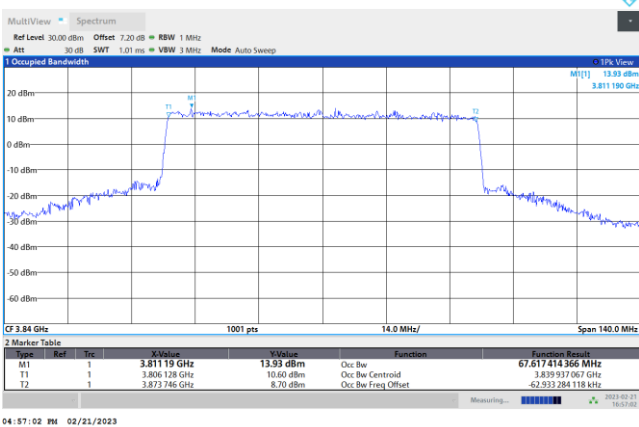



FR1 n77 / 80MHz / CP OFDM / Middle Channel / Full RB

QPSK

16QAM

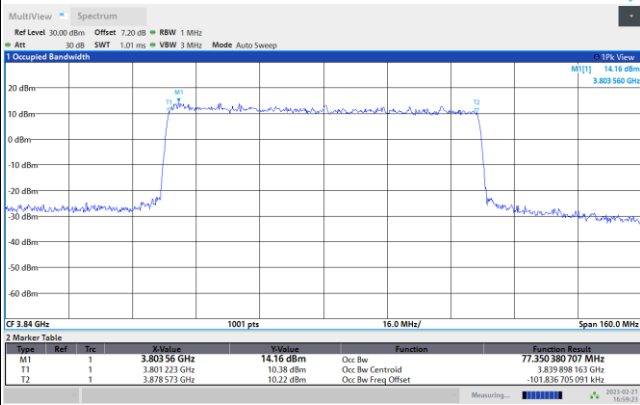
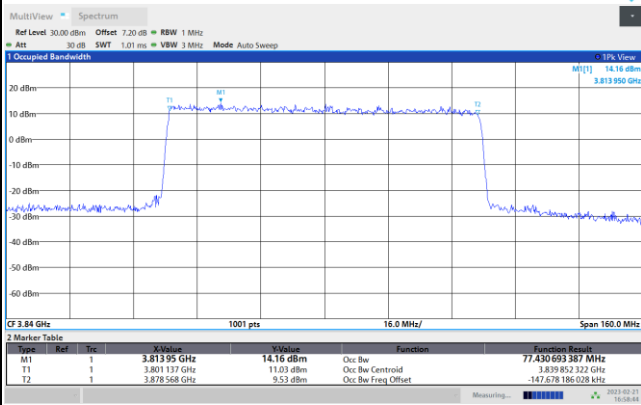

64QAM

256QAM

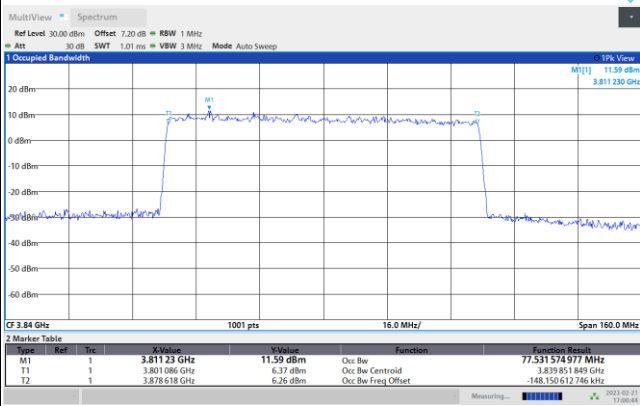
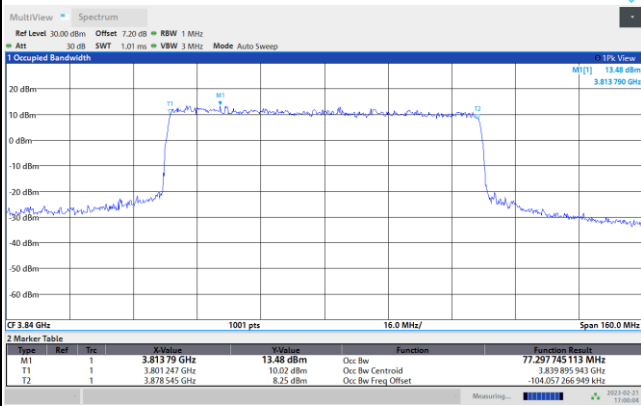



FR1 n77 / 90MHz / CP OFDM / Middle Channel / Full RB

QPSK

16QAM

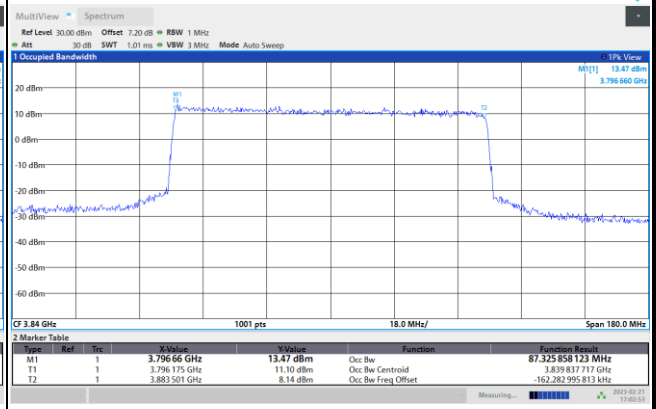
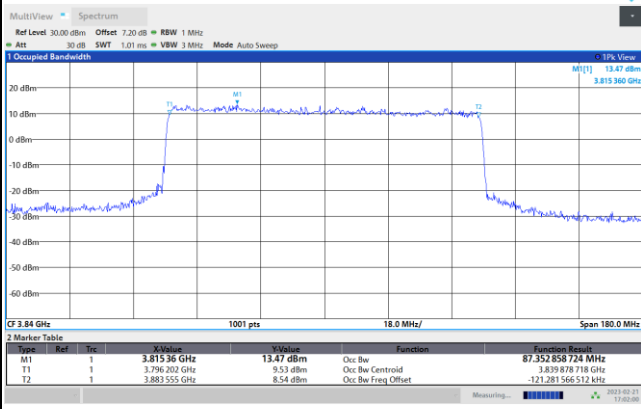

64QAM

256QAM

