

Netgear 5G MHS Travel Router
(FCC ID: PY322300575) RF
Exposure Compliance Test Report

Part 0: SAR and Power Density Characterization

10-18-2022

Table of Contents

Figures..... 2

Tables..... 2

1 Introduction 3

2. Product Description 4

3. SAR Characterization..... 5

 3.1 Worst -case SAR determination..... 5

 3.2 SAR design target 5

 3.3 SAR Char of Netgear 5G MHS Travel Router (FCC ID: PY322300575) 6

4. Power Density Characterization..... 9

 4.1 Exposure scenarios in PD evaluation 9

 4.2 PD characterization Overview..... 10

 4.3 Codebook for Netgear 5G MHS TRAVEL ROUTER (FCC ID: PY322300575) 12

 4.4 PD Simulation and Modeling validation..... 17

 4.4.1 Simulation Model..... 17

 4.4.2 Simulation Setup 17

 4.4.3 Modeling validation with PD measurements..... 20

 4.5 PD_design_target for Netgear 5G MHS Travel Router (FCC: PY322300575)..... 30

 4.6 Power Density Simulation of NETGEAR 5G TRVEL ROUTER (FCC ID: PY322300575)..... 31

 4.6.1 Simulated input power limit for single beams..... 31

 4.6.2 Simulated input power limit For dual beams..... 31

 4.7 Worst-case housing influence determination 32

 4.8 PD Char..... 37

A Worst Phase Derivation for beam Pair 45

B Scaling Factor S and 4cm²-avg PD for Netgear M6 46

C. Simulated PD Distribution Plots..... 59

D PD Char Requirements for 2nd Generation of Smart transmit (GEN 2) 60

 D.1 Verification 1 60

 D-2 Verification 2: 69

 D-3 verification 3:..... 71

Figures

Figure 3 - 1:Netgear 5G MHS Travel Router (FCC ID: PY322300575) Antenna Block Diagram..... 5

Figure 4 - 1 Device surface definition: Six surfaces of EUT 10

Figure 4 - 2: High level flow chart for power density characterization..... 11

Figure 4 - 3:Netgear 5G travel router simulation model 17

Figure 4 - 4: Simulation mesh setup 18

Figure 4 - 5:Radiation Boundary of Netgear 5G MHS Travel Router 19

Figure 4 - 6: Antenna port excitation in ANSYS EM Suite 2021R2 19

Tables

Table 3 - 1: Worst-case reported SAR 6

Table 3 - 2: SAR Char of Netgear 5G MHS Travel Router (FCC ID PY322300575) 8

Table 4 - 1: Codebook of Netgear 5G MHS Travel Router (FCC ID: PY322300575) 13

Table 4 - 2: Beams and surfaces selection for PD correlation 21

Table 4 - 3: Measured and Simulated PD distributions for selected beams at n260 and n261 bands..... 22

Table 4 - 4: Measured and simulated 4cm² averaged PD for selected beams with 6dBm input power 30

Table 4 - 5: mid channel, 4 cm²-averaged PD at sim.power_{limit} 33

Table 4 - 6: 4cm²-averaged PD of the selected beams measured on the non-selected surfaces for Δ_{min} determination 37

Table 4 - 7: input.power.limit calculation 38

Table 4 - 8: Netgear 5G MHS travel Router PD Char..... 39

Table B - 1 Netgear MHS Travel Router Sim.power.limit..... 47

Table B - 2:PD at input power of 6dBm 53

Table D - 1:Measured and simulated PD distribution for selected beams 61

Table D -2 a: Contribution factors from Qualcomm MG script and from HFSS for selected beams, and normalized combined PD verification, for EUT with 2 QTM's at n260 band 70

Table D -2 b:Contribution factors from Qualcomm MG script and from HFSS for selected beams, and normalized combined PD verification, for EUT with 2 QTM's at n261 band 70

Table D - 3 a: Measured 4cm² PD on worst surface and combined PD at worst-case location for EUT with 2 QTM's at n260 band..... 71

Table D - 3 b:Measured 4cm² PD on worst surface and combined PD at worst-case location for EUT with 2 QTM's at n261 band..... 71

1 Introduction

The equipment under test (EUT) is Netgear 5G MHS Travel Router (FCC ID: PY322300575). It contains the Qualcomm SDX65 modem supporting 4G WWAN technologies and 5G NR technology. Modem is enabled with Qualcomm Smart Transmit feature to control and manage transmitting power in real time and to always ensure the time-averaged RF exposure is compliant to the FCC requirement.

For WWAN technology, this EUT supports LTE, Sub-6 and mmW 5G NR radios. In Part 0 report, the EUT SAR and power density (PD) are characterized for WWAN radios (Sub-6 and mmW NR) to determine the power limit that corresponds to the exposure design target after accounting for all device design related uncertainties, i.e., SAR_design_target (< FCC SAR limit) for sub-6 radio and PD_design_target (< FCC PD limit) for mmW radio. The SAR characterization and PD characterization are denoted as SAR Char and PD Char in this report.

SAR Char and PD Char will be used as input for Qualcomm Smart Transmit feature to operate. Both SAR Char and PD Char will be loaded and stored in the EUT via the Embedded File System (EFS) and cannot be accessed by end users.

The EUT supports WLAN radio as well, but WLAN modem is not enabled with time-averaging algorithm. Refer to Part 1 report for WLAN SAR test report and for simultaneous transmission analysis.

2. Product Description

The equipment under test (EUT) is 5G mmW NR enabled Travel Router. The EUT is data device only, it does not support any voice functionality. This report presents the SAR and PD Char, which is used as an input parameter for enabling Qualcomm’s Smart Transmit Algorithm.

EUT	5G MHS Travel Router, data only device	
Brand name	Netgear	
Model No.	MR6550	
FCC ID.	PY322300575	
Integrated Module	WWAN	Brand name: QTI Model name: SDX65
Mode of Operation	<ul style="list-style-type: none"> • NR (mm Wave & sub6) • LTE 	
Tx frequency range (MHz)	mm NR Band 260	37000 - 40000
	Mm NR Band 261	27500 - 28350
	LTE Band 2	1850 - 1910
	LTE Band 4	1710 - 1755
	LTE Band 5	824 - 849
	LTE Band 7	2500 – 2570
	LTE Band 12	699 – 716
	LTE Band 13	777 - 787
	LTE Band 14	788 - 789
	LTE Band 25	1850 - 1915
	LTE Band 26	814 - 849
	LTE Band 30	2305 – 2315
	LTE Band 41	2496 - 2690
	LTE Band 48	3550 – 3700
	LTE Band 66	1710 - 1780
	LTE Band 71	663 - 698
	FR1 n2	1850 – 1910
	FR1 n5	824 – 849
	FR1 n12	699 – 716
	FR1 n14	788 – 798
	FR1 n25	1850 - 1915
	FR1 n30	2305 – 2315
	FR1 n41	2469 - 2690
	FR1 n48	3550 - 3700
	FR1 n66	1719 – 1780
	FR1 n71	663 - 698
	FR1 n77	3300 - 4200

3. SAR Characterization

SAR Char is generated to cover all LTE/5G Sub 6 bands and exposure scenarios that EUT supports.

3.1 Worst -case SAR determination

This EUT is a travel router. The body exposure condition is tested according to the hotspot SAR procedures specified in KDB 941225 D06. A test separation distance of 10 mm is used between the SAM flat phantom and all surfaces with a transmitting antenna within 25 mm from that surface. See Sporton SAR Report No. FA190614-06: FCC SAR Test Report for details.

The worst-case SAR for each band is determined by taking the maximum SAR value among all applicable surfaces tested. Fig.3-1 shows all device antennas 1, 2, 3, 4, 5 and 6 for LTE, Sub 6 NR, and WLAN. Only Ant 1 and 2 are transmit for LTE/Sub 6 NR, Ant 5 & 6 are only for Sound Referencing Signal (SRS) for n77 band and Ant 3 and 4 are for WLAN transmit, so ant 3 and 4 are not relevant for SAR testing.

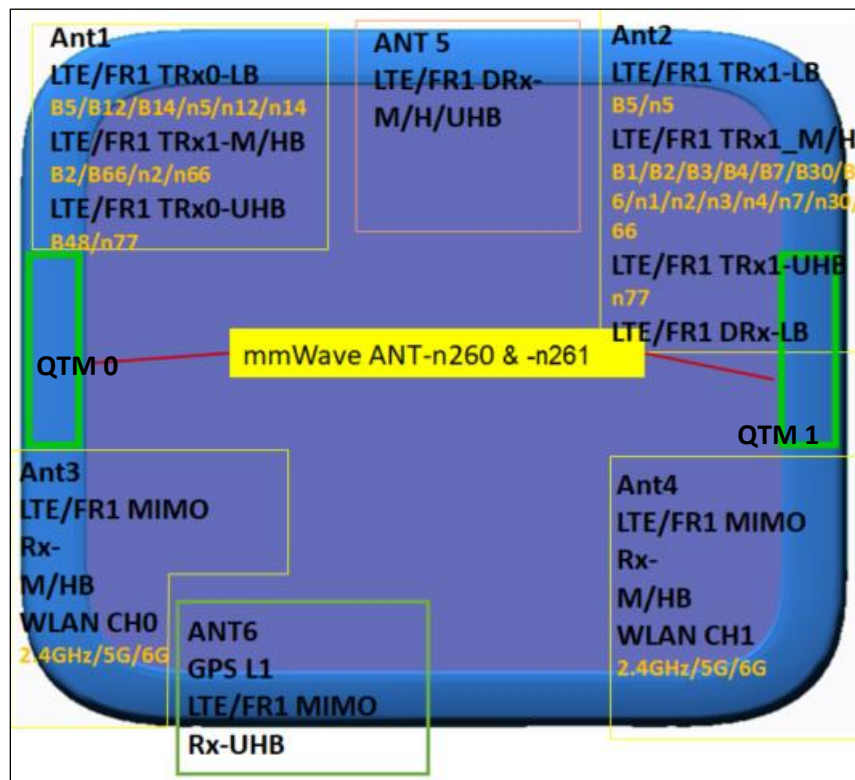


Figure 3 - 1:Netgear 5G MHS Travel Router (FCC ID: PY322300575) Antenna Block Diagram

3.2 SAR design target

The total device design related uncertainties of Netgear 5G MHS Travel Router (FCC ID: PY322300575) is 1dB (k=2), which includes TxAGC and device to device variation.

To account for total uncertainty, SAR_design_target should be determined as,

$$SAR_{design_target} < SAR_{regulatory\,limit} * 10^{\frac{-total\,uncertainty}{10}}$$

For FCC SAR requirement of 1.6 W/kg for 1gSAR, the SAR_design_target for Netgear 5G MHS Travel Router (FCC ID: PY322300575) is determined as

$$SAR_{design_target} = 1.03 \frac{W}{kg} \text{ for } 1gSAR$$

As the EUT supports WLAN radio, which is not enabled by Smart Transmit, the above value has been chosen as to keep the simultaneous transmission in compliance with regulatory limit, more detail on simultaneous transmission in Part 1 report.

3.3 SAR Char of Netgear 5G MHS Travel Router (FCC ID: PY322300575)

Table 3 - 1: Worst-case reported SAR

Band	Antenna	Pmax Max time-average Power (dBm)	Reported SAR 1g (W/kg)
LTE 2	1	23.5	0.903
LTE 2	2	24	1.168
LTE 4	2	24.0	0.993
LTE 5	1	24.0	0.718
LTE 12	1	24.0	0.712
LTE 13	1	24.0	0.714
LTE 14	1	24.0	0.779
LTE 25	2	24.0	1.113
LTE 26	1	24.0	0.837
LTE 41	2	24.0	1.173
LTE 48	1	21	0.907
LTE 66	1	24.0	0.868
LTE 7	2	23.50	1.496
LTE 30	2	23.0	1.293
LTE 66	2	24.0	0.993
LTE 71	1	24.0	0.633
N2	1	23.5	0.928
N5	1	24.0	0.755
N12	1	24.0	0.675
N14	1	24.0	0.823
N25	1	24.0	0.941
N25	2	24.0	0.966
N41	2	23.5	1.181
N48	1	23.0	1.712
N48	2	23.0	1.704
N66	1	24.0	0.922
N71	1	24.0	0.508
N2	2	24.0	1.127

N5	2	24.0	0.593
N30	2	23.0	1.183
N66	2	24.0	0.681
N77	1	23.0	4.606
N77_HPUE		26	
N77	2	23.0	4.120
N77_HPUE		26	
N77	5	21.5	4.329
N77_HPUE		26	
N77	6	20.5	5.905
N77_HPUE		26	

Table 3 - 2: SAR Char of Netgear 5G MHS Travel Router (FCC ID PY322300575)

Regulatory requirement	FCC
Reserve Power margin	3 dB
DSI	127
Tech/Band, Antenna	Plimit(dBm)
LTE_B2, 1	24
LTE_B2, 2	23.4
LTE_B4, 2	24.1
LTE_B5, 1	25.5
LTE_B7, 2	21.8
LTE_B12, 1	25.6
LTE_B13, 1	25.5
LTE_B14, 1	25.2
LTE_B25, 2	23.6
LTE_B26, 1	24.9
LTE_B41, 2	21.4
LTE_B30, 2	22
LTE_B66, 1	24.7
LTE_B66, 2	24.1
LTE_B48, 1	21.8
LTE_B71, 1	26.1
NR5G_N2, 1	23.9
NR5G_N2, 2	23.6
NR5G_N5, 1	25.3
NR5G_N5, 2	26.3
NR5G_N66, 1	24.4
NR5G_N66, 2	25.7
NR5G_N77, 1	19.4
NR5G_N77, 2	19.9
NR5G_N77, 5	19.7
NR5G_N77, 6	18.4
NR5G_N12, 1	25.8
NR5G_N14, 1	24.9
NR5G_N30, 2	22.3
NR5G_N25, 1	24.3
NR5G_N25, 2	24.2
NR5G_N41, 2	22.90
NR5G_N48, 1	20.70
NR5G_N48, 2	20.80
NR5G_N71, 1	27.0

4. Power Density Characterization

Netgear 5G MHS Travel Router (FCC ID: PY322300575) 5G mmW NR contains two Qualcomm QTM545 mmW antenna modules, denoted as QTM 0 & 1 which are installed at two different locations as shown in Figure 3-1. These are referred to as “Module” throughout this report. Total of 126 beams or antenna array configurations are supported. In this chapter, a hybrid approach using electromagnetic (EM) simulation in combination with measurement is taken to characterize power density profile efficiently and conservatively for Netgear 5G MHS Travel Router (FCC ID: PY322300575).

4.1 Exposure scenarios in PD evaluation

In general, for a device operating at frequencies > 6 GHz, the PD is required to be assessed for all antenna configurations (beams) from all mmW antenna modules that are installed inside the device. Furthermore, this PD evaluation should be performed at low, mid, and high channels for each supported mmW band.

For this EUT, the 4cm^2 spatially averaged PD is evaluated along the surfaces (Left, Top, Bottom, Right, Front and Bottom as shown in Figure 4-1) of the EUT, and the worst-case PD is determined by taking the maximum PD among all PDs at the evaluated surfaces for each beam/band.

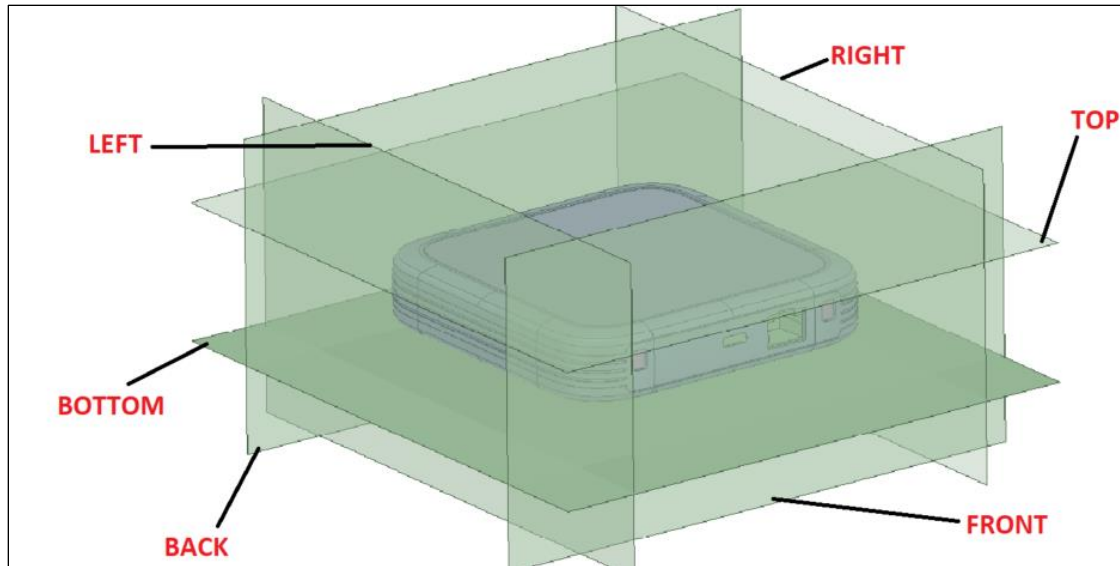


Figure 4 - 1 Device surface definition: Six surfaces of EUT

4.2 PD characterization Overview

Parameters used in PD characterization:

- The EUT supports total of 126 beams each in n260 band and n261 band, where 84 beams are single beams (SISO) and 42 are beam pairs (MIMO) where two single beams are excited at the same time for each band.
- PD_design_target: The design target for PD compliance. It should be less than FCC PD limit to account for all device design related uncertainties.
- input.power.limit: For a PD characterized wireless device, the input power level at antenna port(s) for each beam corresponding to PD_design_target.
- PD Char: the table that contains input.power.limit fed to antenna port(s) for all supported beams.

Figure 4-2 in the next page outlines the PD Char process.

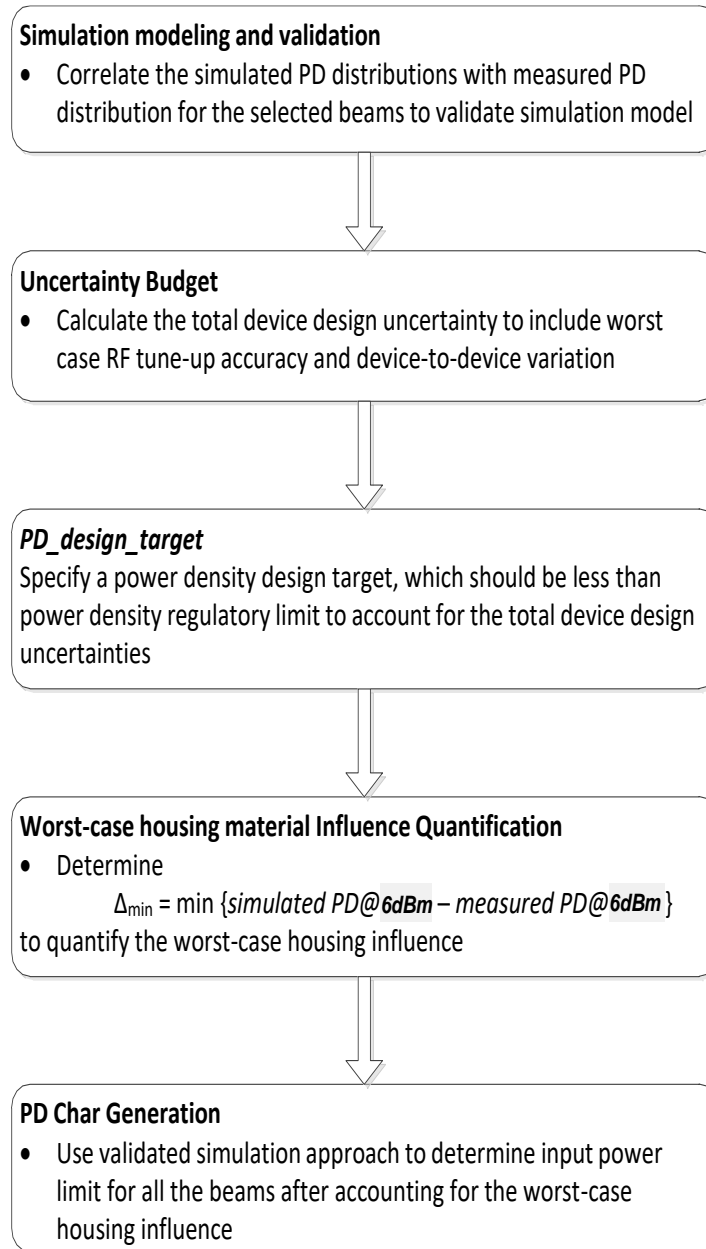


Figure 4 - 2: High level flow chart for power density characterization

For 2nd generation of Smart Transmit (Gen2), additional validation has been performed in Appendix D

4.3 Codebook for Netgear 5G MHS TRAVEL ROUTER (FCC ID: PY322300575)

In general, all the beams that the device supports are specified in the pre-defined codebook. The codebook contains a codeword for each beam in a defined set of beam pairs, which is a list of magnitude and phase weights applied to each active antenna element group's feeds to cause the desired beam to be formed. The codebook is device design specific and generated after evaluating radiation coverage from this specific device.

Table 4-1 shows all the beams and their relevant information in the codebook of Netgear 5G MHS Travel Router (FCC ID: PY322300575). There are two QTM mmW modules with module ID = 0 and 1, respectively, as shown in Figure 3-1. The PD evaluation needs to be performed for all the beams listed in Table 4-1.

Table 4 - 1: Codebook of Netgear 5G MHS Travel Router (FCC ID: PY322300575)

Band	Beam_ID	Module_ID	Ant_Type	No_active_elements	Paired_With
n260	0	1	PATCH	1	128
n260	1	0	PATCH	1	129
n260	2	1	PATCH	1	130
n260	3	0	PATCH	1	131
n260	4	1	PATCH	1	132
n260	5	0	PATCH	1	133
n260	6	1	PATCH	1	134
n260	7	0	PATCH	1	135
n260	8	1	PATCH	1	136
n260	9	0	PATCH	1	137
n260	10	1	PATCH	2	138
n260	11	1	PATCH	2	139
n260	12	1	PATCH	2	140
n260	13	1	PATCH	2	141
n260	14	0	PATCH	2	142
n260	15	0	PATCH	2	143
n260	16	0	PATCH	2	144
n260	17	0	PATCH	2	145
n260	18	1	PATCH	2	146
n260	19	1	PATCH	2	147
n260	20	1	PATCH	2	148
n260	21	0	PATCH	2	149
n260	22	0	PATCH	2	150
n260	23	0	PATCH	2	151
n260	24	1	PATCH	5	152
n260	25	1	PATCH	5	153
n260	26	1	PATCH	5	154
n260	27	1	PATCH	5	155
n260	28	1	PATCH	5	156
n260	29	0	PATCH	5	157
n260	30	0	PATCH	5	158
n260	31	0	PATCH	5	159
n260	32	0	PATCH	5	160
n260	33	0	PATCH	5	161
n260	34	1	PATCH	5	162
n260	35	1	PATCH	5	163
n260	36	1	PATCH	5	164
n260	37	1	PATCH	5	165
n260	38	0	PATCH	5	166
n260	39	0	PATCH	5	167
n260	40	0	PATCH	5	168
n260	41	0	PATCH	5	169
n260	128	1	PATCH	1	0
n260	129	0	PATCH	1	1

n260	130	1	PATCH	1	2
n260	131	0	PATCH	1	3
n260	132	1	PATCH	1	4
n260	133	0	PATCH	1	5
n260	134	1	PATCH	1	6
n260	135	0	PATCH	1	7
n260	136	1	PATCH	1	8
n260	137	0	PATCH	1	9
n260	138	1	PATCH	2	10
n260	139	1	PATCH	2	11
n260	140	1	PATCH	2	12
n260	141	1	PATCH	2	13
n260	142	0	PATCH	2	14
n260	143	0	PATCH	2	15
n260	144	0	PATCH	2	16
n260	145	0	PATCH	2	17
n260	146	1	PATCH	2	18
n260	147	1	PATCH	2	19
n260	148	1	PATCH	2	20
n260	149	0	PATCH	2	21
n260	150	0	PATCH	2	22
n260	151	0	PATCH	2	23
n260	152	1	PATCH	5	24
n260	153	1	PATCH	5	25
n260	154	1	PATCH	5	26
n260	155	1	PATCH	5	27
n260	156	1	PATCH	5	28
n260	157	0	PATCH	5	29
n260	158	0	PATCH	5	30
n260	159	0	PATCH	5	31
n260	160	0	PATCH	5	32
n260	161	0	PATCH	5	33
n260	162	1	PATCH	5	34
n260	163	1	PATCH	5	35
n260	164	1	PATCH	5	36
n260	165	1	PATCH	5	37
n260	166	0	PATCH	5	38
n260	167	0	PATCH	5	39
n260	168	0	PATCH	5	40
n260	169	0	PATCH	5	41
n261	0	1	PATCH	1	128
n261	1	0	PATCH	1	129
n261	2	1	PATCH	1	130
n261	3	0	PATCH	1	131
n261	4	1	PATCH	1	132
n261	5	0	PATCH	1	133
n261	6	1	PATCH	1	134

n261	7	0	PATCH	1	135
n261	8	1	PATCH	1	136
n261	9	0	PATCH	1	137
n261	10	1	PATCH	2	138
n261	11	1	PATCH	2	139
n261	12	1	PATCH	2	140
n261	13	1	PATCH	2	141
n261	14	0	PATCH	2	142
n261	15	0	PATCH	2	143
n261	16	0	PATCH	2	144
n261	17	0	PATCH	2	145
n261	18	1	PATCH	2	146
n261	19	1	PATCH	2	147
n261	20	1	PATCH	2	148
n261	21	0	PATCH	2	149
n261	22	0	PATCH	2	150
n261	23	0	PATCH	2	151
n261	24	1	PATCH	5	152
n261	25	1	PATCH	5	153
n261	26	1	PATCH	5	154
n261	27	1	PATCH	5	155
n261	28	1	PATCH	5	156
n261	29	0	PATCH	5	157
n261	30	0	PATCH	5	158
n261	31	0	PATCH	5	159
n261	32	0	PATCH	5	160
n261	33	0	PATCH	5	161
n261	34	1	PATCH	5	162
n261	35	1	PATCH	5	163
n261	36	1	PATCH	5	164
n261	37	1	PATCH	5	165
n261	38	0	PATCH	5	166
n261	39	0	PATCH	5	167
n261	40	0	PATCH	5	168
n261	41	0	PATCH	5	169
n261	128	1	PATCH	1	0
n261	129	0	PATCH	1	1
n261	130	1	PATCH	1	2
n261	131	0	PATCH	1	3
n261	132	1	PATCH	1	4
n261	133	0	PATCH	1	5
n261	134	1	PATCH	1	6
n261	135	0	PATCH	1	7
n261	136	1	PATCH	1	8
n261	137	0	PATCH	1	9
n261	138	1	PATCH	2	10

n261	139	1	PATCH	2	11
n261	140	1	PATCH	2	12
n261	141	1	PATCH	2	13
n261	142	0	PATCH	2	14
n261	143	0	PATCH	2	15
n261	144	0	PATCH	2	16
n261	145	0	PATCH	2	17
n261	146	1	PATCH	2	18
n261	147	1	PATCH	2	19
n261	148	1	PATCH	2	20
n261	149	0	PATCH	2	21
n261	150	0	PATCH	2	22
n261	151	0	PATCH	2	23
n261	152	1	PATCH	5	24
n261	153	1	PATCH	5	25
n261	154	1	PATCH	5	26
n261	155	1	PATCH	5	27
n261	156	1	PATCH	5	28
n261	157	0	PATCH	5	29
n261	158	0	PATCH	5	30
n261	159	0	PATCH	5	31
n261	160	0	PATCH	5	32
n261	161	0	PATCH	5	33
n261	162	1	PATCH	5	34
n261	163	1	PATCH	5	35
n261	164	1	PATCH	5	36
n261	165	1	PATCH	5	37
n261	166	0	PATCH	5	38
n261	167	0	PATCH	5	39
n261	168	0	PATCH	5	40
n261	169	0	PATCH	5	41

(The single beams selected for modeling validation are highlighted in yellow)

4.4 PD Simulation and Modeling validation

4.4.1 Simulation Model

The EUT has two QTM545 mmW modules highlighted in Figure 4-3, which contains only patch antenna arrays. The QTM545 is designed by Qualcomm, who have provided the encrypted simulation model of this module for EM simulation. The entire Netgear MHS is first modeled along with housing, mmW modules, all LTE/Sub-6 antennas, PCB, shields, LCD, flex cables, and battery etc. as shown below.

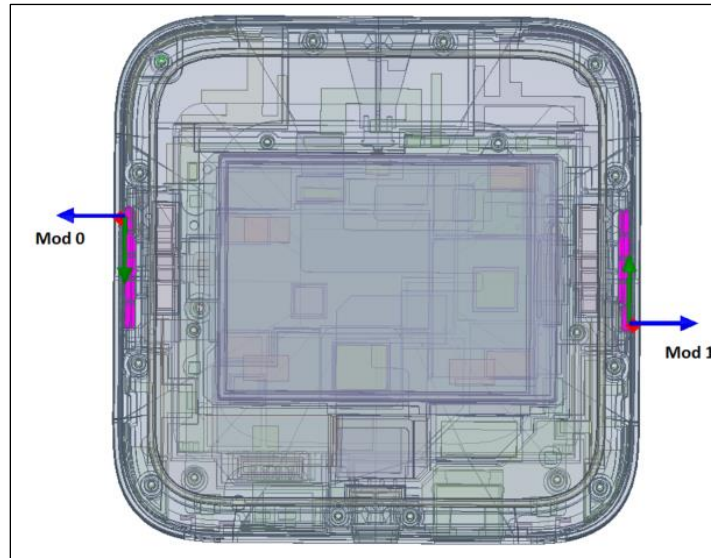


Figure 4 - 3: Netgear 5G travel router simulation model

As shown in Figure 4-4, the EM simulation is conducted for Module 0 and 1 in single model simultaneously with the relevant PD evaluation planes Left, Top, Bottom, Right, Front and Back at $d=10\text{mm}$ where the PD is dominant.

This device level simulation model for PD assessment is constructed according to best engineering practices. However, to characterize the mm-wave PD behavior accurately all the important details within at least two wavelengths around each QTM module is considered.

4.4.2 Simulation Setup

FEM simulations were performed to assess the power density of the EUT with QTM545 modules using ANSYS Electromagnetics Suite 2021.R2. The auto initial mesh defined “lambda refinement” (i.e., ANSYS refines the initial mesh based on the material-dependent wavelength) and 30% maximum refinement per pass are selected as adaptive options in the simulation setup.

The system (ANSYS Electromagnetics suite 2021R2) computes the error, and the iterative process (solve \rightarrow error analysis \rightarrow adaptive refinement) repeats until the convergence criteria is met with maximum magnitude of ΔS less than 2% which is defined by the user. If convergence is reached, the converged results are accurate. Figure 4-4 shows the adaptive mesh setup over a cross section.

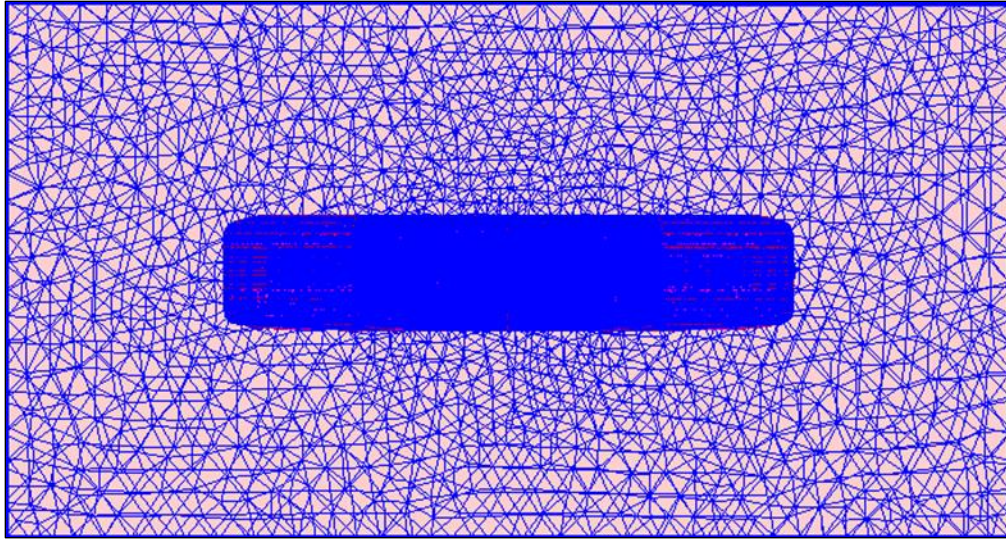


Figure 4 - 4: Simulation mesh setup

For radiation boundary, the 2nd order absorbing boundary condition (ABC) is used for all simulations in this report. This radiation boundary simulates an electrically open surface that allows waves to radiate infinitely far into space. The system absorbs the wave via the 2nd order radiation boundary condition, essentially ballooning the boundary infinitely far away from the structure and into space. The radiation boundaries may also be placed relatively close to a structure and can be of arbitrary shape.

Per ANSYS recommendations for their simulation tool, the radiation boundary plane must be located at least a quarter wavelength from strongly radiating structure, or at least a tenth of a wavelength from a weakly radiating structure. In this report, more than five wavelengths spacing (40mm) from the EUT in all directions are applied to ensure convergence (see Figure 4-5). This is enough to capture the PD hotspots at $d=10\text{mm}$ which fall well within the simulation domain and have been verified later in Table 4-3.

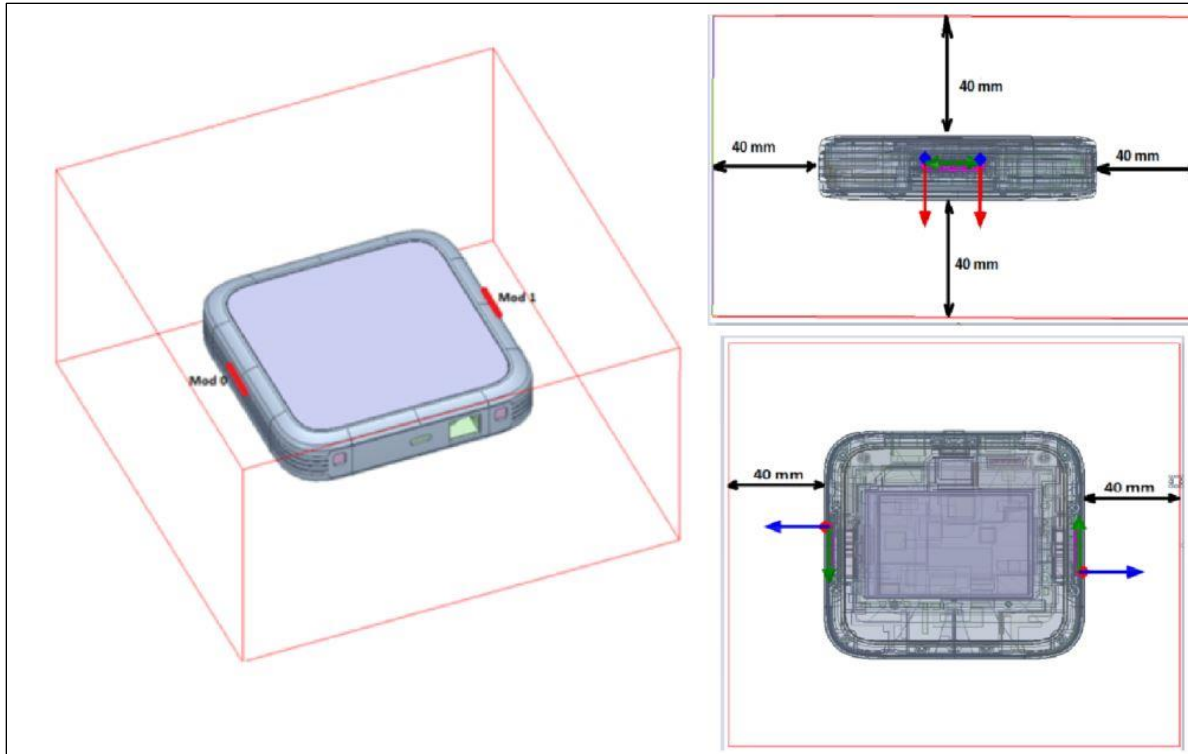
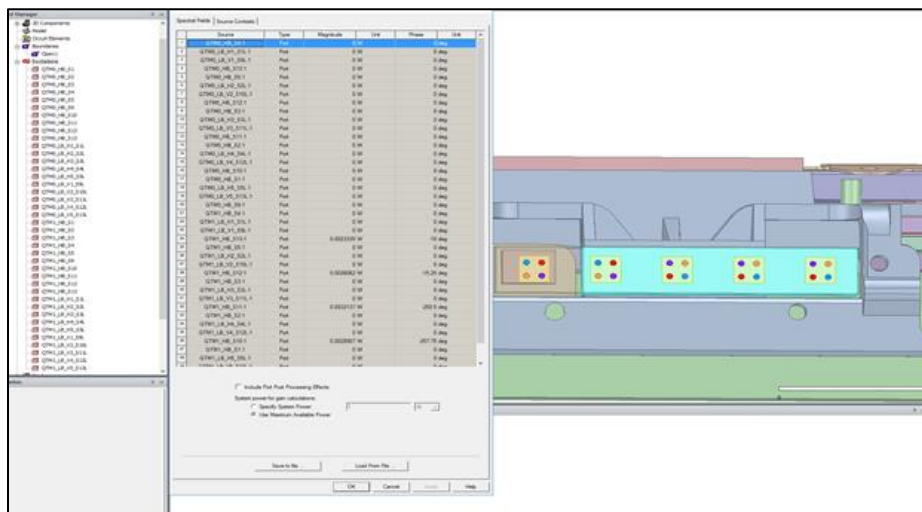


Figure 4 - 5: Radiation Boundary of Netgear 5G MHS Travel Router

Each antenna modules 0 & 1 are identical and has 20 ports. Out of these, 10 ports are for 1x5 patch array antennas for low band n258 (24.25-27.5 GHz) & n257/n261 (26.5-29.50 GHz) and 10 ports are for 1x5 patch array antennas for high band n260 (37-40 GHz) respectively. The device currently supports n260 and n261 band. Out of 10 ports of the patch array, 5 are for horizontal (Pol 1) and 5 are for vertical (Pol 2) polarization feeding respectively. With the encrypted QTM simulation model, the magnitude and phase information can be loaded for each port by using “Edit Sources” in ANSYS Electromagnetics suite 2021R2. Fig.4-6 shows the antenna port excitations.



After simulating the electric and magnetic (E & H) fields for a single beam formed by an array, the Poynting vector is calculated based on “peak” (i.e., non-RMS) field values in a grid with 0.95 mm step size, on the appropriate evaluation planes defined in Table 4-2. The Poynting vector at each spatial point is readily available in ANSYS Electromagnetics Suite 2021.R2 through the “Field Calculator” navigation option. The magnitude of the real part of the Poynting vector (all X, Y, Z components) at each spatial point i.e., the point power density is exported to do the averaging. The spatially averaged power density at each point on a given surface is then calculated by taking the average of the point power density over a 4 square cm area. Thus, the total power density (all X, Y, Z components) through any given surface is used to calculate the averaged power density

$$P_{avg} = \frac{1}{2A} \int_A |Re(\vec{E} * \vec{H}^*)|. dS$$

The PD calculation from the simulated E & H fields for a dual or beam pair is given in Appendix A.

4.4.3 Modeling validation with PD measurements

To validate modeling and simulation the process below is followed:

1. Select at-least one beam (i.e., antenna array configuration) per antenna type (dipole and/or patch), per antenna polarization (if applicable) and per antenna module and per band.

This EUT contains two QTM545 mmW antenna modules (Mod 0 and Mod 1). Each module has only patch type antenna arrays. Therefore, the beam selection criteria for each mmW antenna are:

- a) Two beams (Pol 1 & Pol 2) from Module 0
- b) Two beams (Pol 1 & Pol 2) from Module 1

Note: Since the relative phase between two single beams in a beam pair is uncontrolled and could vary from run to run, for the validation purpose, the selection is limited to the single beam antenna array configuration. Additionally, single beam containing a higher number of active antenna elements is selected. For example, a single beam with five active patches should be selected over beam with a single active patch antenna beam.

The single beams for modeling validation are already highlighted in yellow in Table 4-1.

2. For a given reference power level(6dBm), perform both PD simulation and PD measurement to obtain the simulated PD distributions and measured PD distributions on the surface in front of the antenna array as well as the surfaces that are adjacent to the antenna array as they could potentially have strong radiating energy when considering the orientation of antenna array and type of antenna array (i.e., patch array).
3. Validate modeling and simulation by correlating the simulated PD distribution and measured PD distribution for all antenna array configurations selected in Step 1 and for all surfaces selected in Step 2. Additional validation for Gen2 is demonstrated in Appendix D.

The modeling validation is performed through correlating the simulated point PD distribution to measured point PD distribution.

The difference in 4cm²-avg PD is not used for the purpose of validity of the modeling because the housing material property (for non-metal material) used in the simulation is an approximation (note that accurate material properties are not available at mmW frequencies). This discrepancy in PD magnitude

will be used to determine the worst-case housing influence (due to non-metal material property uncertainty) later in Section 4.7. The worst-case housing influence will be accounted for in PD Char generation for conservative RF exposure assessment, see Section 4.8 for details.

Based on the selection criteria described in Step 1 and Step 2, the beams and surfaces selected for modeling validation of the EUT are listed in Table 4-2.

Table 4 - 2: Beams and surfaces selection for PD correlation

Band	mmW Module	Polarization	Beam ID	Surface (see Fig.3-3)
n260	0	Pol 1(H)	31	Left, Top, Bottom
		Pol 2(V)	159	Left, Top, Bottom
	1	Pol 1(H)	36	Right, Top, Bottom
		Pol 2(V)	164	Right, Top, Bottom
n261	0	Pol 1(H)	39	Left, Top, Bottom
		Pol 2(V)	167	Left, Top, Bottom
	1	Pol 1(H)	36	Right, Top, Bottom
		Pol 2(V)	164	Right, Top, Bottom

With an input power of 6 dBm for n260 band and n261 band, PD measurement and PD simulation are conducted for all beams and surfaces listed in Table 4-2:

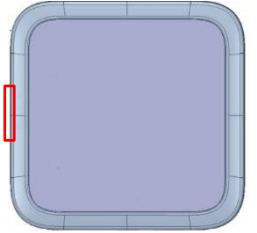
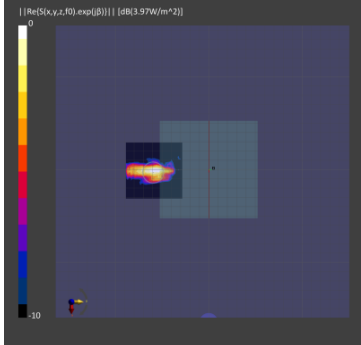
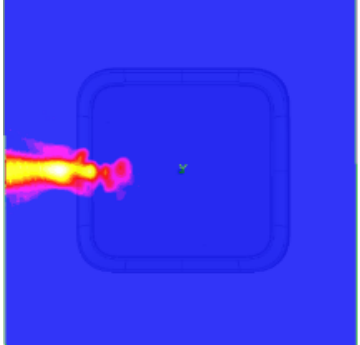
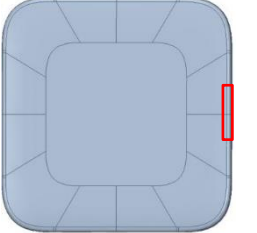
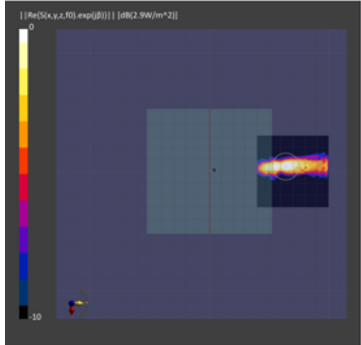
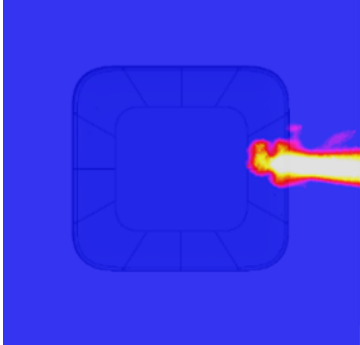

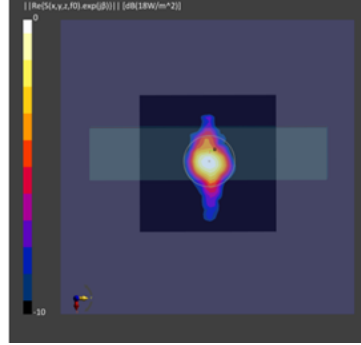
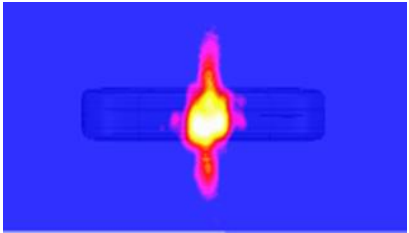
- PD distribution

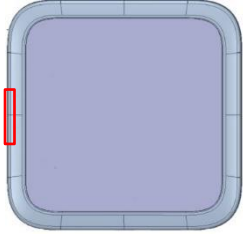
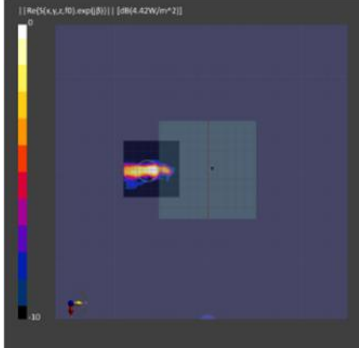
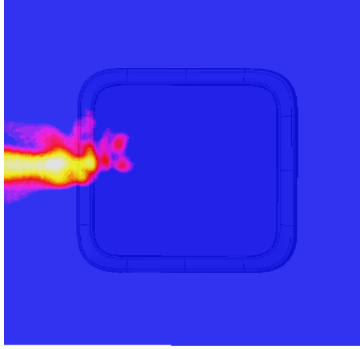
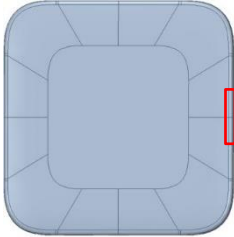
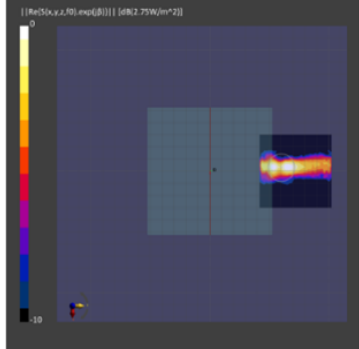
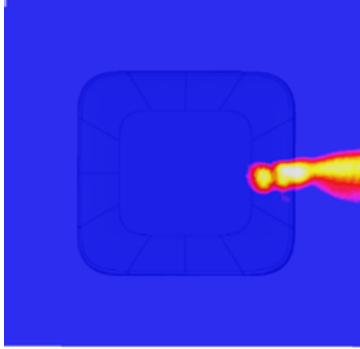

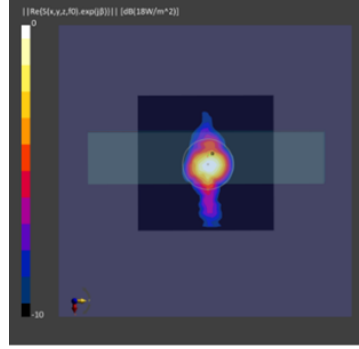
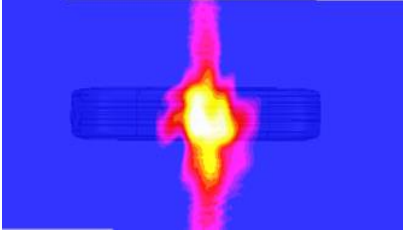
Table 4-3 shows the measured and simulated point PD distributions for all selected beams and surfaces for n260 and n261 bands. The “View” column depicts the orientation of the device, and the antenna module location is outlined in red. As can be seen, the simulated PD distributions correlate well with the measured PD distributions for all selected beams on all identified surfaces of the EUT. This confirms that the modeling is a good representation of the actual mmW QTM modules installed in the EUT. The location of the peak PD hotspots on various planes in Sporton Report No.: FA190614-06: Power Density Measurement Report also match well with simulation. Therefore, the simulation model to be used for performing mmW NR RF exposure assessment is valid for this EUT.

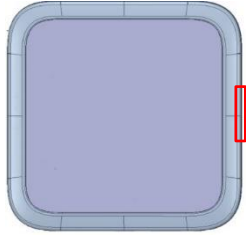
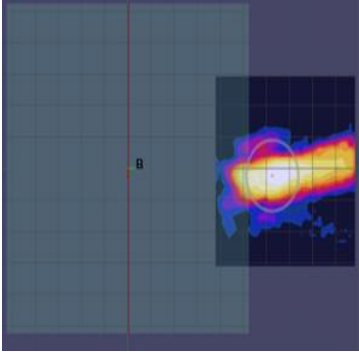
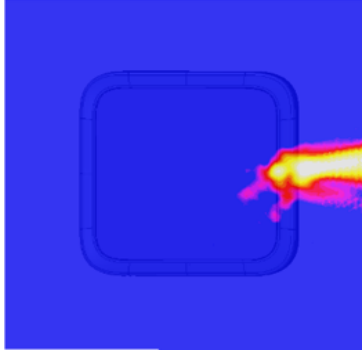
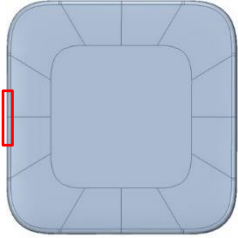
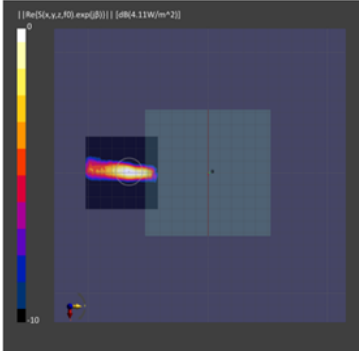
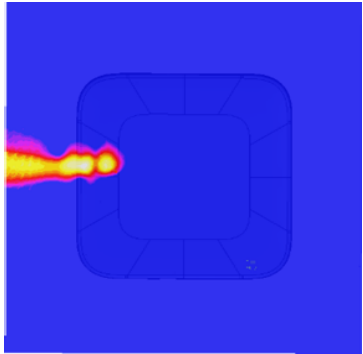

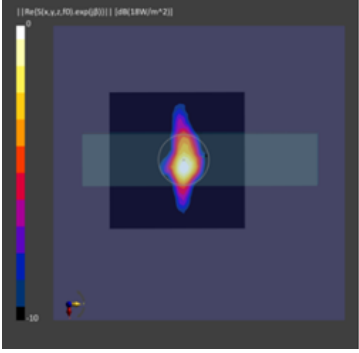
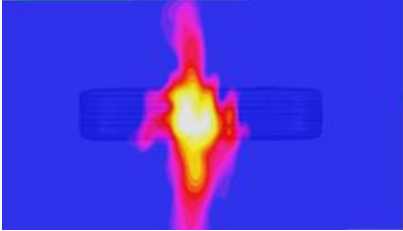
- 4cm2-averaged PD value

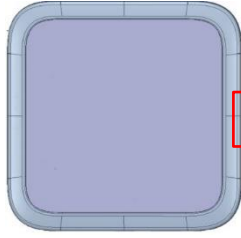
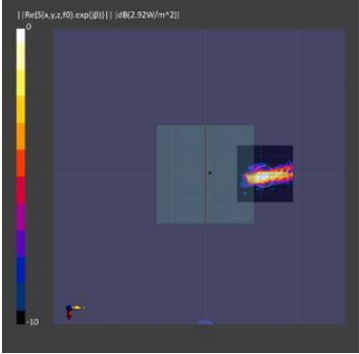
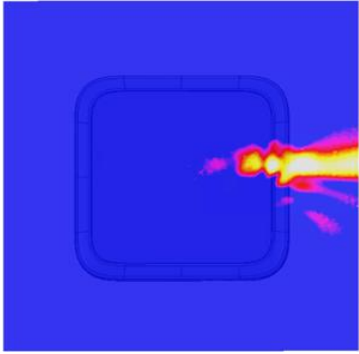
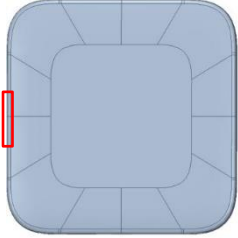
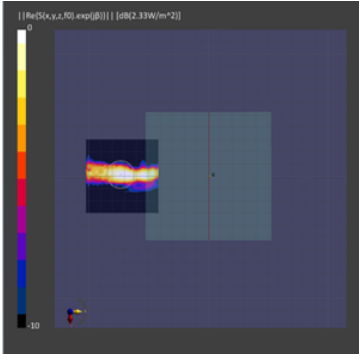
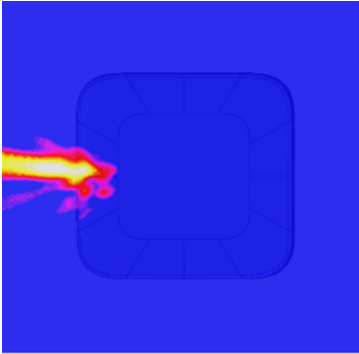

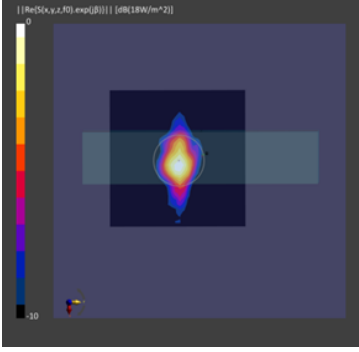
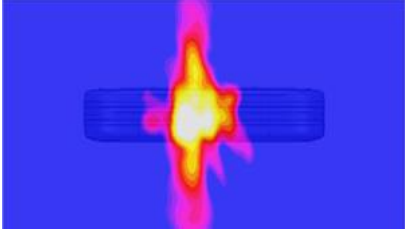
Table 4-4 lists the measured 4cm2-averaged PD and simulated 4cm2-averaged PD for all selected beams and surfaces for n260 and n261 bands. Refer to Sporton Report No.: FA190614-06: Power Density Measurement Report (Sec 10) for measurement details. The discrepancy between simulated and measured PD value will be used to determine worst-case housing influence for conservative assessment (see Section 4.7).

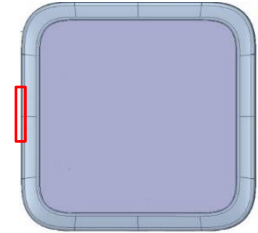
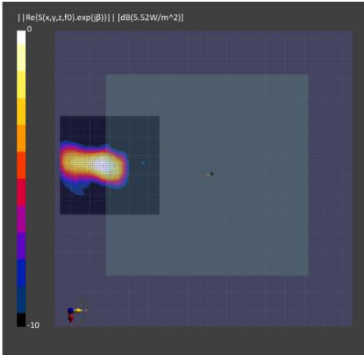
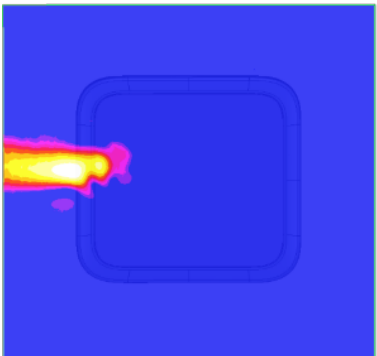
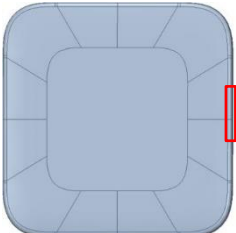
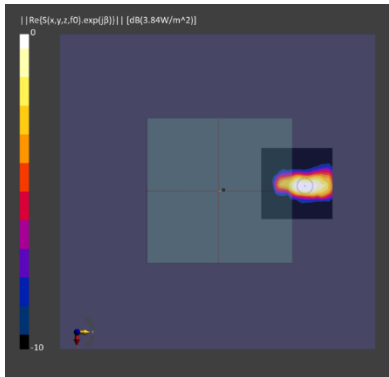
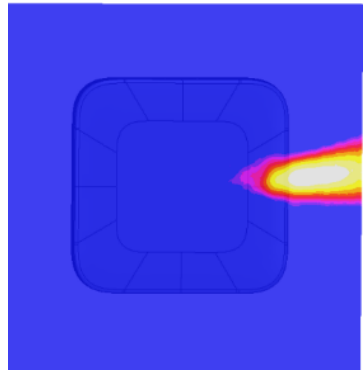

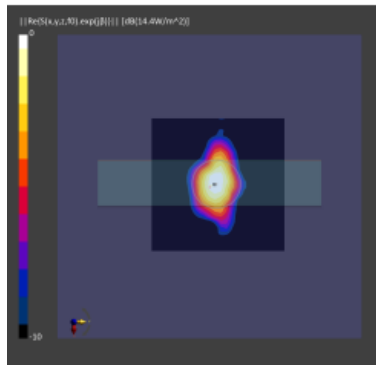
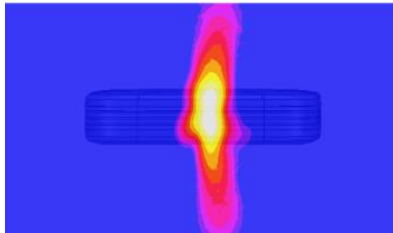
Table 4 - 3: Measured and Simulated PD distributions for selected beams at n260 and n261 bands

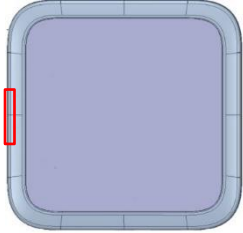
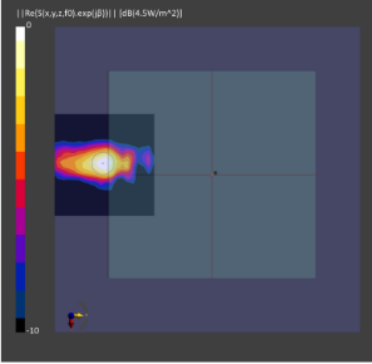
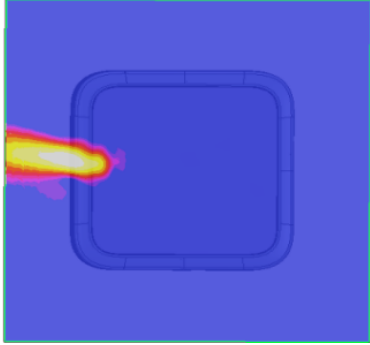
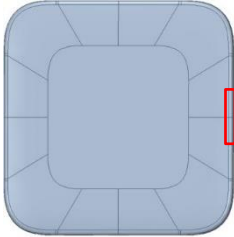
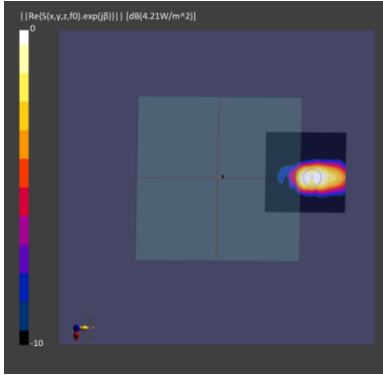
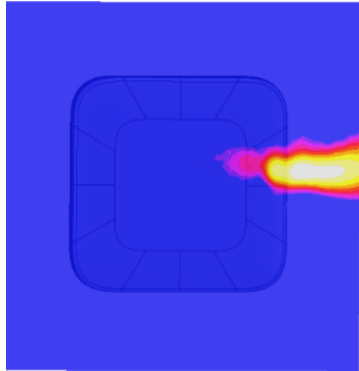

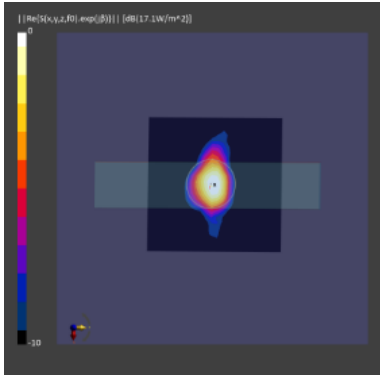
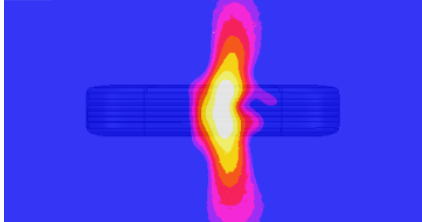
Band	Beam ID	Surface	View	Measured PD	Simulated PD
N260	31	Top			
		Bottom			
		Left			

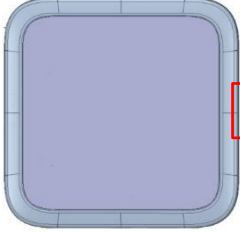
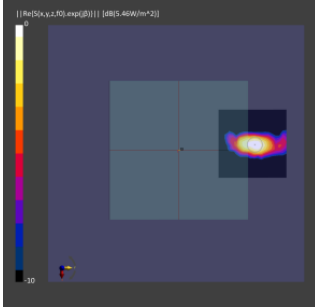

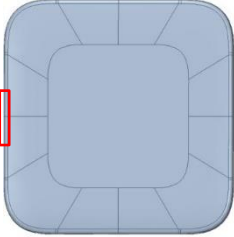
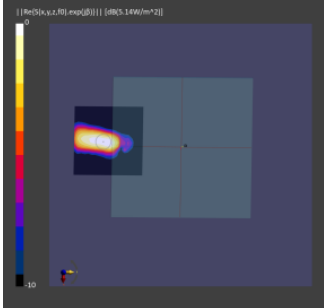


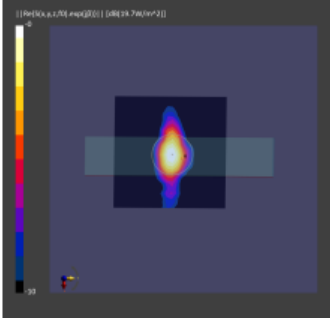
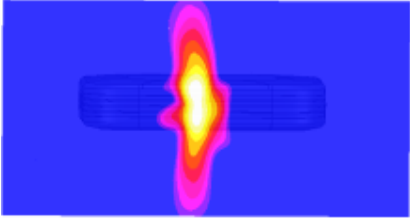
Band	Beam ID	Surface	View	Measured PD	Simulated PD
N260	159	Top			
		Bottom			
		Left			

Band	Beam ID	Surface	View	Measured PD	Simulated PD
N260	164	Top			
		Bottom			
		Right			

Band	Beam ID	Surface	View	Measured PD	Simulated PD
N260	36	Top			
		Bottom			
		Right			

Band	Beam ID	Surface	View	Measured PD	Simulated PD
N261	39	Top			
		Bottom			
		Left			

Band	Beam ID	Surface	View	Measured PD	Simulated PD
N261	167	Top			
		Bottom			
		Left			

Band	Beam ID	Surface	View	Measured PD	Simulated PD
N261	36	Top			
		Bottom			
		Right			

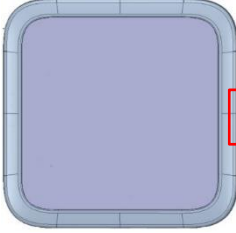
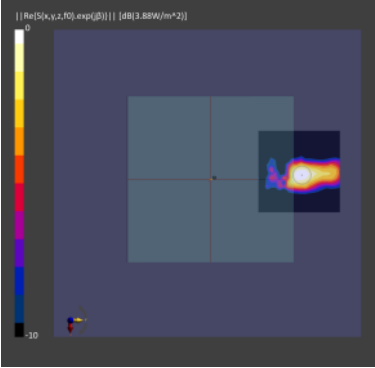
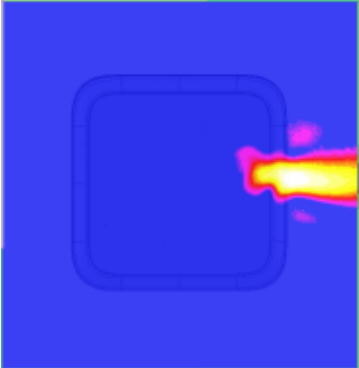
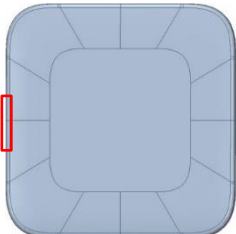
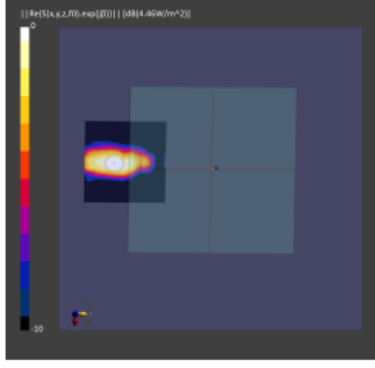
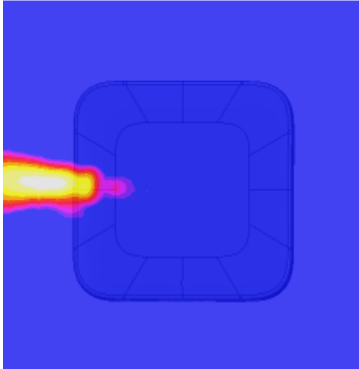

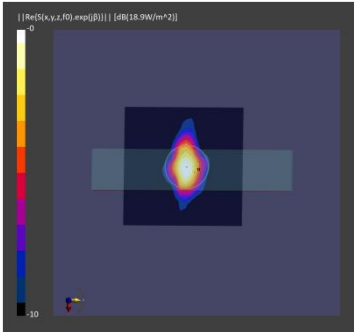
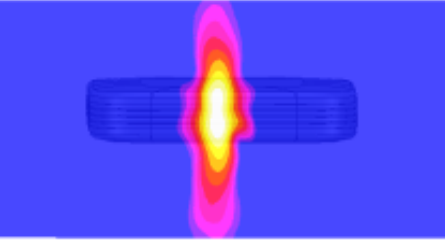
Band	Beam ID	Surface	View	Measured PD	Simulated PD
N261	164	Top		 <p> Re{S_{kx,z}(f₀) exp(jβ)} [dB] [3.88W/m²]</p>	
		Bottom		 <p> Re{S_{kx,z}(f₀) exp(jβ)} [dB] [4.40W/m²]</p>	
		Right		 <p> Re{S_{kx,z}(f₀) exp(jβ)} [dB] [18.9W/m²]</p>	

Table 4 - 4: Measured and simulated 4cm² averaged PD for selected beams with 6dBm input power

4cm ² avg. PD (W/m ²)						
Band	Ant Pol	Beam ID	Surface	Meas.	Sim	Delta = Sim. - Meas. (dB)
n260	Pol 1(H)	31	Top	2.08	2.63	1.02
			Bottom	1.59	2.48	1.93
			Left	7.27	9.65	1.23
	Pol 2(V)	159	Top	1.96	3.4	2.39
			Bottom	1.4	1.91	1.34
			Left	7.16	10.16	1.52
	Pol 1(H)	36	Top	1.42	2.47	2.4
			Bottom	1.25	2.33	2.7
			Right	6.58	9	1.36
	Pol 2(V)	164	Top	1.59	3.22	3.06
			Bottom	1.84	1.93	0.21
			Right	7.09	10.09	1.53
n261	Pol 1(H)	39	Top	4.28	3.84	-0.47
			Bottom	3.21	4.8	1.75
			Left	7.92	10.8	1.35
	Pol 2(V)	167	Top	3.48	4.6	1.21
			Bottom	3.42	4.33	1.02
			Left	8.01	10.96	1.36
	Pol 1(H)	36	Top	4.38	3.82	-0.59
			Bottom	4.18	4.78	0.58
			Right	8.75	10.8	0.91
	Pol 2(V)	164	Top	3.14	4.23	1.29
			Bottom	3.67	4.65	1.03
			Right	8.28	11.16	1.30

4.5 PD_design_target for Netgear 5G MHS Travel Router (FCC: PY322300575)

The 2dB of total uncertainty (k=2) provided by Qualcomm (please refer to document 80-W5693- 7: SDX65/QTM545 Uncertainty Budget for details) includes TxAGC (RF calibration) and IC/element level part to part variation.

To account for the total design related uncertainty, PD_design_target need to be:

$$PD_design_target < PD_{regulatory\ limit} * 10^{\frac{-total\ uncertainty}{10}}$$

For FCC 4cm²-averaged PD requirement of 10 W/m², the PD_design_target for Netgear 5G MHS Travel Router (FCC ID: PY322300575) is determined as

$$PD_design_target = 4.75\ W/m^2$$

4.6 Power Density Simulation of NETGEAR 5G TRVEL ROUTER (FCC ID: PY322300575)

Using the simulation approach validated in Section 4.4, this section describes the procedure used to obtain simulated input power limit, $sim.power_{limit}$ that corresponds to PD_design_target.

4.6.1 Simulated input power limit for single beams

To determine $sim.input\ power_{limit}$, perform simulation at low, mid, and high channel for each mmW band supported, with a given $sim.input.power.per.active.port$ (i.e., 6 dBm):

1. Obtain $PD_{surface}$ value (the worst PD among all identified surfaces of the EUT) at all three channels for all single beams specified in the codebook of Table 4-1.
2. Derive a scaling factor at low, mid, and high channel, $s(i)_{low_or_mid_or_high}$, by using:

$$s(i)_{low_or_mid_or_high} = \frac{PD\ design\ target}{sim.PD_{surface}(i)}, i \in single\ beams$$

3. Determine the worst-case scaling factor, $s(i)$, among low, mid, and high channels:

$$s(i) = \min\{s_{low}(i), s_{mid}(i), s_{high}(i)\}, i \in single\ beams$$

4. Determine the simulated input power limit, $sim.power_{limit}(i)$, among low, mid and high channels:
 $sim.power_{limit}(i)dBm = 10 * \log(s(i)) + sim.input.power.at.active.port, i \in single\ beams$

For 2nd generation of Smart Transmit, the $sim.power_{limit}$ is printed by “Qualcomm MG Script” for all three channels and is tabulated in Table B-1 and 4cm2-averaged PD values at a fixed reference level of 6dBm is tabulated in Table B-2.

4.6.2 Simulated input power limit For dual beams

The relative phase between beam pair is not controlled in QTM545 design and could vary from run to run. Therefore, for beam pair, based on the simulation results, the worst-case scaling factor needs to be determined mathematically to ensure the compliance.

For a beam pair, extract the E-fields and H-fields from the corresponding single beams at low, mid and high channel for each supported band and for all identified surfaces of the EUT.

For a given beam pair containing beam_a and beam_b, and for a given channel, let relative phase between beam_a and beam_b = ϕ ,

the total PD of the beam pair can be expressed as

$$\begin{aligned} total\ PD(\phi) &= \frac{1}{2} \sqrt{Re\{PD_x(\phi)\}^2 + Re\{PD_y(\phi)\}^2 + Re\{PD_z(\phi)\}^2} \\ &= \frac{1}{2} Re\left\{\left(\vec{E}_a + \vec{E}_b e^{j\omega\phi}\right) \times \left(\vec{H}_a + \vec{H}_b e^{j\omega\phi}\right)^*\right\} \end{aligned}$$

where, $PD_x(\phi)$, $PD_y(\phi)$ and $PD_z(\phi)$ are the three components of the $total\ PD(\phi)$; E_a and H_a are the extracted E-fields and H-fields of beam_a, while E_b and H_b are the extracted E-fields and H-fields of beam_b.

Sweep ϕ with a 5° step from 0° to 360° to determine the worst-case $\phi_{worstcase}$ which results in the highest $total\ PD(\phi)$ among all identified surfaces for this beam pair at this channel. For details on worst case $total\ PD(\phi)$ derivation, see Appendix A.

Follow the above procedure to determine $\phi_{worstcase}$ for all three channels, and obtain the scaling factor given by the below equation for low, mid and high channels

$$s(i)_{low_or_mid_or_high} = \frac{PD \text{ design target}}{total PD(\phi(i)_{worstcase})}, i \in \text{beam pairs}$$

The $\phi_{worstcase}$ varies with channel and beam pair, the lowest scaling factor among all three channels, $s(i)$, is determined for the beam pair i :

$$s(i) = \min\{s_{low}(i), s_{mid}(i), s_{high}(i)\}, i \in \text{beam pairs}$$

The simulated input power limit, $sim.power_{limit}$, for beam pair I can be determined by

$$sim.power_{limit}(i)dBm = 10 * \log(s(i)) + sim.input.power.at.active.port, i \in \text{beam pairs}$$

For 2nd generation of Smart Transmit, the $sim.power_{limit}$ is printed by “Qualcomm MG Script” for all three channels and is tabulated in Table B-1 and 4cm2-averaged PD values at a fixed reference level of 6dBm is tabulated in Table B-2.

4.7 Worst-case housing influence determination

For non-metal material, the material property cannot be accurately characterized at mmW frequencies to date. The estimated material property for the device housing used in the simulation model could influence the accuracy in simulation for PD amplitude quantification. Since the housing influence on PD could vary from surface to surface where the EM field propagates through, the most underestimated surface is used to quantify the worst-case housing influence for conservative assessment.

For this EUT, simulated 4cm2-averaged PD and measured 4 cm2-averaged PD are compared in Table 4-4. Surfaces Left and Right are selected which always have the highest 4cm2 averaged PD for the selected beams/all beams from the patch elements of the respective modules. Also, the worst value out of both polarizations on these selected surfaces are considered. The worst error introduced when using the estimated material property in the simulation for n260 band is 1.23dB for Mod 0 and 1.36dB for Mod 1 and for n261 band, it is 1.35dB and 0.91dB for Mod 0 and Mod 1 respectively which are highlighted in Table 4-4.

It is also proved that all the other surface(s) near-by the mmW module, i.e., surface(s) not selected in previous paragraph (Front, Back, Top, Right and Bottom for module 0 and Front, Back, Top, Left and Bottom for module 1) are not required for housing material loss quantification by:

- i. Scaling the simulated 4cm²-averaged PD values for all single beams to correspond to their $sim.power_{limit}$, and identifying the worst-PD beam per each non-selected surface.(Refer to Table 4-5).
- ii. 4cm²-averaged PD at input. power.limit(determined in Section 4.8) is measured for the identified worst-PD beam at each non-selected surface in FTM mode at mid channel.
- iii. It is demonstrated that 4cm²-averaged PD values are below PD_design_target(4.75 W/m²)

The measurements for non-selected surface(s) are tabulated in the Table 4-6

This worst-case housing influence, denoted as $\Delta min = Sim. PD - Meas. PD$, represents the worst case where RF exposure is underestimated the most in simulation for each module when using the estimated material property for glass/plastics of the housing in the vicinity of the relevant module. For conservative assessment, Δmin is used as the worst-case factor and applied to all the beams of a given QTM module to determine input power limits in PD char for compliance (see Section 4.8 for details)

Table 4 - 5: mid channel, 4 cm²-averaged PD at sim.power_{limit}

Band	Module	Beam Id	Front	Back	Left	Right	Top	Bottom
N260	0	1	0.10	0.24	4.62	0.03	0.93	0.76
	0	3	0.13	0.20	4.64	0.03	1.05	0.82
	0	5	0.12	0.18	4.62	0.03	1.04	1.16
	0	7	0.16	0.12	4.66	0.03	1.06	0.99
	0	9	0.20	0.13	4.65	0.03	1.19	0.96
	0	14	0.22	0.26	4.64	0.02	1.22	0.89
	0	15	0.11	0.11	4.64	0.01	1.10	0.92
	0	16	0.06	0.19	4.65	0.03	1.33	0.98
	0	17	0.36	0.31	4.64	0.05	1.67	1.36
	0	21	0.27	0.06	4.64	0.01	1.37	1.36
	0	22	0.08	0.07	4.64	0.02	1.19	1.26
	0	23	0.15	0.27	4.64	0.03	1.30	0.85
	0	29	0.54	0.43	4.63	0.04	2.49	1.46
	0	30	0.27	0.05	4.64	0.02	1.19	1.25
	0	31	0.03	0.03	4.64	0.02	1.26	1.19
	0	32	0.04	0.30	4.64	0.04	1.25	1.00
	0	33	0.24	0.38	4.64	0.04	1.33	1.08
	0	38	0.40	0.10	4.64	0.03	1.72	1.40
	0	39	0.10	0.03	4.64	0.01	1.13	1.22
	0	40	0.03	0.11	4.64	0.03	1.35	1.17
	0	41	0.11	0.42	4.64	0.05	1.19	1.03
	0	129	0.07	0.22	4.64	0.04	1.09	0.47
	0	131	0.13	0.23	4.66	0.03	1.20	0.74
	0	133	0.16	0.13	4.64	0.03	1.17	0.80
	0	135	0.20	0.14	4.63	0.03	1.15	0.92
	0	137	0.23	0.09	4.65	0.00	1.21	0.80
	0	142	0.51	0.29	4.65	0.02	1.60	0.91
	0	143	0.12	0.05	4.64	0.03	1.26	0.59
	0	144	0.08	0.17	4.64	0.01	0.94	1.02
	0	145	0.15	0.50	4.64	0.07	1.42	0.96
	0	149	0.17	0.16	4.64	0.02	1.29	0.75
	0	150	0.07	0.05	4.64	0.01	1.37	0.95
	0	151	0.20	0.25	4.64	0.01	0.99	1.00
	0	157	0.49	0.30	4.64	0.02	1.05	1.19
	0	158	0.25	0.07	4.64	0.03	1.68	0.98
	0	159	0.04	0.03	4.64	0.01	1.55	0.87
0	160	0.02	0.31	4.64	0.03	1.25	1.00	
0	161	0.49	0.79	4.64	0.04	2.24	1.21	
0	166	0.49	0.14	4.64	0.02	1.30	1.19	
0	167	0.09	0.04	4.63	0.02	1.64	0.81	
0	168	0.04	0.09	4.64	0.02	1.27	0.92	
0	169	0.15	0.50	4.65	0.03	1.77	1.26	
1	0	0	0.10	0.24	0.03	4.65	1.19	1.05

1	2	0.13	0.22	0.03	4.65	1.08	1.04
1	4	0.12	0.21	0.03	4.64	1.02	1.11
1	6	0.20	0.13	0.00	4.63	1.05	0.89
1	8	0.24	0.14	0.00	4.63	0.94	0.84
1	10	0.17	0.24	0.02	4.65	1.42	0.94
1	11	0.02	0.16	0.02	4.63	1.29	1.20
1	12	0.11	0.05	0.04	4.63	1.27	1.03
1	13	0.34	0.60	0.05	4.64	1.74	1.45
1	18	0.14	0.49	0.04	4.65	1.62	1.68
1	19	0.13	0.12	0.03	4.64	1.05	1.08
1	20	0.18	0.15	0.03	4.64	1.38	0.74
1	24	0.61	0.88	0.02	4.64	2.79	1.45
1	25	0.09	0.56	0.04	4.64	1.63	1.40
1	26	0.04	0.09	0.02	4.65	1.23	1.37
1	27	0.23	0.05	0.04	4.64	1.28	1.05
1	28	0.42	0.35	0.02	4.64	1.43	1.09
1	34	0.28	0.58	0.03	4.64	2.28	1.42
1	35	0.07	0.29	0.03	4.64	1.25	1.33
1	36	0.04	0.06	0.03	4.64	1.27	1.20
1	37	0.31	0.14	0.02	4.64	1.41	1.07
1	128	0.09	0.26	0.03	4.64	1.20	0.77
1	130	0.09	0.21	0.03	4.64	1.20	0.88
1	132	0.13	0.16	0.03	4.65	1.18	0.83
1	134	0.16	0.13	0.03	4.63	1.13	0.72
1	136	0.18	0.11	0.04	4.64	1.04	0.50
1	138	0.37	0.27	0.02	4.65	1.23	1.08
1	139	0.02	0.15	0.02	4.64	1.47	0.84
1	140	0.09	0.03	0.01	4.64	1.18	0.98
1	141	0.23	0.59	0.04	4.64	1.63	0.96
1	146	0.15	0.24	0.02	4.64	1.19	0.77
1	147	0.03	0.13	0.01	4.65	1.46	0.98
1	148	0.28	0.09	0.02	4.65	1.32	0.83
1	152	0.43	0.68	0.05	4.65	1.92	1.44
1	153	0.05	0.40	0.05	4.65	1.27	1.11
1	154	0.03	0.06	0.01	4.64	1.67	0.83
1	155	0.12	0.03	0.01	4.64	1.26	0.97
1	156	0.64	0.47	0.03	4.64	2.26	1.13
1	162	0.12	0.36	0.04	4.64	1.10	1.25
1	163	0.05	0.25	0.03	4.65	1.64	0.88
1	164	0.04	0.05	0.01	4.64	1.48	0.89
1	165	0.29	0.07	0.02	4.64	1.59	1.13
0	1	0.19	0.33	4.63	0.04	1.52	1.22
0	3	0.26	0.23	4.64	0.03	1.62	1.04
0	5	0.16	0.28	4.65	0.03	1.12	1.50
0	7	0.16	0.25	4.64	0.03	1.15	1.49
0	9	0.19	0.19	4.63	0.03	1.12	1.25

N261	0	14	0.37	0.71	4.64	0.09	1.86	1.33
	0	15	0.01	0.12	4.64	0.02	1.34	1.61
	0	16	0.23	0.12	4.64	0.03	1.38	1.34
	0	17	0.34	0.30	4.65	0.02	1.09	1.28
	0	21	0.12	0.41	4.63	0.03	1.97	1.81
	0	22	0.03	0.03	4.65	0.01	1.16	1.73
	0	23	0.29	0.14	4.64	0.03	1.41	1.11
	0	29	0.11	0.84	4.64	0.07	2.89	1.54
	0	30	0.01	0.06	4.64	0.02	1.81	1.97
	0	31	0.03	0.03	4.65	0.02	1.61	2.10
	0	32	0.10	0.03	4.64	0.03	1.55	1.67
	0	33	0.75	0.11	4.64	0.03	1.08	1.04
	0	38	0.05	0.28	4.65	0.02	2.56	1.91
	0	39	0.01	0.04	4.64	0.01	1.65	2.06
	0	40	0.03	0.05	4.64	0.03	1.72	2.02
	0	41	0.43	0.04	4.65	0.03	1.17	1.13
	0	129	0.18	0.18	4.63	0.04	1.77	1.84
	0	131	0.26	0.20	4.63	0.03	1.32	1.65
	0	133	0.18	0.24	4.65	0.03	1.38	0.96
	0	135	0.23	0.17	4.64	0.03	1.17	1.02
	0	137	0.21	0.15	4.63	0.03	1.23	0.95
	0	142	0.19	0.28	4.64	0.03	1.60	1.24
	0	143	0.02	0.12	4.65	0.02	1.47	1.06
	0	144	0.08	0.02	4.65	0.01	1.41	1.27
	0	145	0.33	0.21	4.64	0.02	2.22	2.01
	0	149	0.13	0.16	4.64	0.03	1.72	1.88
	0	150	0.04	0.03	4.64	0.01	1.28	1.49
	0	151	0.28	0.13	4.65	0.03	1.42	1.21
	0	157	0.09	0.49	4.64	0.03	1.56	0.92
	0	158	0.02	0.04	4.64	0.03	1.91	1.77
	0	159	0.03	0.02	4.64	0.01	1.71	1.90
	0	160	0.04	0.02	4.64	0.01	1.90	1.81
	0	161	0.36	0.09	4.64	0.02	2.51	1.48
	0	166	0.05	0.20	4.64	0.03	1.79	1.33
	0	167	0.01	0.03	4.64	0.02	1.95	1.83
	0	168	0.02	0.03	4.64	0.01	1.81	1.84
	0	169	0.18	0.05	4.65	0.02	2.24	1.60
	1	0	0.09	0.19	0.031	4.66	1.04	1.23
	1	2	0.16	0.16	0.031	4.64	1.12	1.59
	1	4	0.16	0.13	0.032	4.65	1.08	1.55
1	6	0.19	0.19	0.032	4.64	1.58	0.87	
1	8	0.34	0.17	0.000	4.63	1.30	1.13	
1	10	0.34	0.18	0.016	4.64	1.57	1.23	
1	11	0.16	0.07	0.013	4.64	1.57	1.60	
1	12	0.02	0.07	0.011	4.64	1.74	1.04	
1	13	0.23	0.28	0.035	4.64	1.42	1.20	

1	18	0.30	0.17	0.017	4.65	1.89	1.81
1	19	0.05	0.02	0.011	4.64	1.25	1.32
1	20	0.08	0.18	0.026	4.64	1.40	0.98
1	24	0.80	0.15	0.025	4.64	2.54	1.39
1	25	0.17	0.06	0.010	4.64	2.40	1.67
1	26	0.03	0.01	0.013	4.64	1.62	1.96
1	27	0.02	0.03	0.022	4.64	1.67	1.93
1	28	0.02	0.28	0.039	4.64	1.19	1.14
1	34	0.42	0.08	0.020	4.64	2.49	1.45
1	35	0.06	0.02	0.009	4.65	1.87	1.85
1	36	0.03	0.03	0.017	4.64	1.64	2.05
1	37	0.02	0.09	0.044	4.64	1.51	1.62
1	128	0.15	0.24	0.030	4.63	1.25	0.91
1	130	0.17	0.17	0.029	4.65	1.19	1.22
1	132	0.15	0.15	0.030	4.65	1.34	0.92
1	134	0.13	0.32	0.032	4.65	1.32	1.39
1	136	0.14	0.17	0.035	4.64	1.92	1.57
1	138	0.24	0.33	0.034	4.65	1.70	1.15
1	139	0.10	0.04	0.011	4.64	1.33	1.22
1	140	0.02	0.14	0.011	4.64	1.43	1.32
1	141	0.12	0.33	0.029	4.64	1.62	1.23
1	146	0.29	0.19	0.029	4.65	1.58	1.05
1	147	0.05	0.02	0.010	4.64	1.38	1.14
1	148	0.05	0.21	0.014	4.64	1.85	1.81
1	152	0.46	0.07	0.011	4.64	1.56	0.96
1	153	0.20	0.05	0.022	4.65	1.76	1.22
1	154	0.03	0.01	0.021	4.64	1.96	1.69
1	155	0.02	0.03	0.013	4.64	1.83	1.87
1	156	0.03	0.44	0.033	4.64	2.70	1.63
1	162	0.38	0.05	0.014	4.64	1.62	1.01
1	163	0.04	0.03	0.021	4.65	1.91	1.50
1	164	0.01	0.03	0.012	4.64	1.76	1.93
1	165	0.01	0.10	0.013	4.64	1.96	1.77

Table 4 - 6: 4cm²-averaged PD of the selected beams measured on the non-selected surfaces for Δ_{min} determination

Band	Beam Id	Module ID	Surface	input. power.limit (dBm)	Meas. 4cm ² PD(W/m ²)
n260	29	0	Front	5.89	0.21
	161	0	Back	5.80	0.076
	145	0	Right	9.58	0.036
	29	0	Top	5.89	0.766
	29	0	Bottom	5.89	0.928
	156	1	Front	5.58	0.039
	24	1	Back	6.64	0.335
	152	1	Left	5.95	0.029
	24	1	Top	6.64	0.834
	18	1	Bottom	9.68	0.985
n261	33	0	Front	4.49	0.066
	29	0	Back	5.47	0.048
	14	0	Right	10.24	0.041
	29	0	Top	5.47	1.54
	31	0	Bottom	2.82	1.11
	24	1	Front	5.44	0.072
	156	1	Back	4.15	0.031
	37	1	Left	2.57	0.03
	156	1	Top	4.15	0.899
	36	1	Bottom	2.44	1.4

4.8 PD Char

The PD Char specifies the limit of input power at any given antenna port that corresponds to PD_{design_target} for all the beams.

Ideally, if there is no uncertainty associated with hardware design, the input power limit, denoted as *input. power. limit(i)*, for beam i can be obtained after accounting for the housing influence (Δ_{min}) determined in Section 4.7, given by:

$$input. power. limit(i) = sim. power_{limit}(i) + \Delta_{min}, i \in all\ beams$$

Equation 1

If simulation overestimates the housing influence, then Δ_{min} = (simulated PD – measured PD) is negative, which means that the measured PD would be higher than the simulated PD. The input power to antenna elements determined via simulation must be decreased for compliance.

Similarly, if simulation underestimates the loss, then Δ_{min} is positive (measured PD would be lower than the simulated value). Input power to antenna elements determined via simulation can be increased and still be PD compliant.

The hardware design has uncertainty which must be properly considered. In Section 4.7, the TxAGC uncertainty is embedded in the process of Δ_{min} determination. Since TxAGC uncertainty is already

accounted for in PD_design_target (see Section 4.5), it needs to be removed to avoid double counting this uncertainty.

Thus equation 1 is modified to:

If $-TxAGC \text{ uncertainty} < \Delta_{min} < TxAGC \text{ uncertainty}$,

$$input.power.limit(i) = sim.power_{limit}(i), i \in \text{all beams}$$

Equation 2

else If $\Delta_{min} < -TxAGC \text{ uncertainty}$,

$$input.power.limit(i) = sim.power_{limit}(i) + (\Delta_{min} + TxAGC \text{ uncertainty}), i \in \text{all beams}$$

Equation 3

else if $\Delta_{min} > TxAGC \text{ uncertainty}$,

$$input.power.limit(i) = sim.power_{limit}(i) + (\Delta_{min} - TxAGC \text{ uncertainty}), i \in \text{all beams}$$

Equation 4

Following above logic, the input.power.limit for this EUT can be calculated using Equations (2), (3) and (4), i.e.,

Table 4 - 7: input.power.limit calculation

Band	Module ID	Input. Power. limit calculation (dB)
n260	0	$sim.power_{limit} + 0.6$
	1	$Sim.power_{limit} + 0.73$
n261	0	$sim.power_{limit} + 0.72$
	1	$Sim.power_{limit} + 0.28$

Following the above procedures, Table 4-8 also called PD char is generated.

Table 4 - 8: Netgear 5G MHS travel Router PD Char

Band	Beam Id1	Paired with Beam Id	input. power. Limit (dBm)
N260	0		12
	1		11.83
	2		11.73
	3		11.34
	4		11.01
	5		10.92
	6		11.51
	7		11.52
	8		12.01
	9		11.71
	10		8.56
	11		7.64
	12		7.5
	13		10.4
	14		8.94
	15		7.51
	16		7.7
	17		10.17
	18		9.68
	19		7.86
	20		8.35
	21		8.2
	22		7.19
	23		8.39
	24		6.64
	25		5.17
	26		3.76
	27		4.46
	28		5.77
	29		5.89
	30		4.41
	31		3.31
	32		4.32
	33		5.24
	34		5.86
	35		4.85
	36		3.5
	37		5.43
	38		5.17
	39		3.5
	40		3.86
	41		5.04
128		11.3	

	129		11.99
	130		11.41
	131		11.32
	132		10.7
	133		10.59
	134		11.53
	135		11.19
	136		12.07
	137		11.18
	138		10.29
	139		7.42
	140		7.11
	141		9.58
	142		9.63
	143		7.67
	144		6.92
	145		9.58
	146		8.8
	147		7.1
	148		9.26
	149		8.52
	150		6.87
	151		7.74
	152		5.95
	153		4.59
	154		3.46
	155		3.71
	156		5.58
	157		5.06
	158		4.68
	159		3.18
	160		4.21
	161		5.8
	162		5.17
	163		4.82
	164		3.33
	165		4.61
	166		4.76
	167		3.54
	168		3.33
	169		4.91
	0	128	8.09
	1	129	8.43
	2	130	7.96
	3	131	7.78
	4	132	7.43

	5	133	7.33
	6	134	7.89
	7	135	7.76
	8	136	8.56
	9	137	8.03
	10	138	5.38
	11	139	3.86
	12	140	3.34
	13	141	4.73
	14	142	6.26
	15	143	3.93
	16	144	2.82
	17	145	7.23
	18	146	6.25
	19	147	3.85
	20	148	6.14
	21	149	5.95
	22	150	3.41
	23	151	3.16
	24	152	2
	25	153	0.98
	26	154	0.24
	27	155	0.15
	28	156	1.48
	29	157	1.19
	30	158	0.91
	31	159	-0.15
	32	160	0.41
	33	161	1.34
	34	162	1.26
	35	163	1.06
	36	164	0.11
	37	165	0.76
	38	166	1
	39	167	0.12
	40	168	0.24
	41	169	0.87
N261		0	11.11
		1	12.16
		2	11.11
		3	11.59
		4	11.03
		5	11.53
		6	11.19
		7	11.46
		8	11.37

	9	11.43
	10	8.17
	11	7.38
	12	6.62
	13	8.54
	14	10.24
	15	7.12
	16	7.75
	17	8.36
	18	8.4
	19	6.41
	20	7.11
	21	8.37
	22	6.82
	23	7.85
	24	5.44
	25	3.19
	26	2.38
	27	2.54
	28	3.03
	29	5.47
	30	2.88
	31	2.82
	32	2.88
	33	4.49
	34	4.46
	35	2.56
	36	2.44
	37	2.57
	38	3.68
	39	2.89
	40	3.04
	41	3.47
	128	11.05
	129	12.13
	130	10.73
	131	11.56
	132	10.82
	133	11.42
	134	11.12
	135	11.11
	136	11.4
	137	11.29
	138	8.24
	139	6.5
	140	6.64

	141	7.76
	142	8.12
	143	6.82
	144	6.76
	145	8.69
	146	7.76
	147	6.07
	148	7.46
	149	8.04
	150	6.71
	151	7.85
	152	3.43
	153	2.55
	154	2.46
	155	2.43
	156	4.15
	157	3.76
	158	2.89
	159	2.7
	160	2.89
	161	4.51
	162	2.92
	163	2.44
	164	2.32
	165	2.61
	166	2.99
	167	2.82
	168	2.81
	169	3.51
128	0	7.79
129	1	8.17
130	2	7.61
131	3	8.17
132	4	7.58
133	5	8.02
134	6	7.86
135	7	8.08
136	8	7.66
137	9	8.11
138	10	5
139	11	3.88
140	12	3.63
141	13	5.15
142	14	5.55
143	15	3.73
144	16	4.3

	145	17	6.39
	146	18	4.58
	147	19	3.22
	148	20	3.88
	149	21	5.31
	150	22	3.52
	151	23	4.91
	152	24	0.63
	153	25	-0.62
	154	26	-1.07
	155	27	-0.75
	156	28	0.24
	157	29	0.86
	158	30	-0.59
	159	31	-0.57
	160	32	-0.36
	161	33	1.39
	162	34	0.03
	163	35	-0.96
	164	36	-1.01
	165	37	-0.69
	166	38	-0.18
	167	39	-0.59
	168	40	-0.38
	169	41	0.35

A Worst Phase Derivation for beam Pair

For beam pairs, beam ID $M+1 \sim N$, since the relative phase between two beams is unknown – finding the worst-case PD by sweeping the relative phase for all possible angles is required for conservative assessment.

Assuming E-field and H-field of beam_a are $\{Ex_a, Ey_a, Ez_a\}$ and $\{Hx_a, Hy_a, Hz_a\}$, respectively; E-field and H-field of beam_b are $\{Ex_b, Ey_b, Ez_b\}$ and $\{Hx_b, Hy_b, Hz_b\}$, respectively; and the relative phase is Φ , for beam pair consisting of beam_a and beam_b, the combined E and H, $\{Ex_{pair_i}, Ey_{pair_i}, Ez_{pair_i}\}$ and $\{Hx_{pair_i}, Hy_{pair_i}, Hz_{pair_i}\}$, can be expressed as:

$$Ex(\Phi)_{pair_i} = Ex_a + Ex_b \times e^{-j\omega\Phi}$$

$$Ey(\Phi)_{pair_i} = Ey_a + Ey_b \times e^{-j\omega\Phi}$$

$$Ez(\Phi)_{pair_i} = Ez_a + Ez_b \times e^{-j\omega\Phi}$$

$$Hx(\Phi)_{pair_i} = Hx_a + Hx_b \times e^{-j\omega\Phi}$$

$$Hy(\Phi)_{pair_i} = Hy_a + Hy_b \times e^{-j\omega\Phi}$$

$$Hz(\Phi)_{pair_i} = Hz_a + Hz_b \times e^{-j\omega\Phi}$$

The combined PD can then be calculated:

$$\begin{aligned} PDx(\Phi)_{pair_i} &= Ey(\Phi)_{pair_i} \times Hz(\Phi)_{pair_i} - Ez(\Phi)_{pair_i} \times Hy(\Phi)_{pair_i} \\ PDy(\Phi)_{pair_i} &= Ez(\Phi)_{pair_i} \times Hx(\Phi)_{pair_i} - Ex(\Phi)_{pair_i} \times Hz(\Phi)_{pair_i} \\ PDz(\Phi)_{pair_i} &= Ex(\Phi)_{pair_i} \times Hy(\Phi)_{pair_i} - Ey(\Phi)_{pair_i} \times Hx(\Phi)_{pair_i} \end{aligned}$$

$$PD(\Phi) = 12\sqrt{R} \{PDx(\Phi)\}_{pair_i} + Re\{PDy(\Phi)\}_{pair_i} + Re\{PDz(\Phi)\}_{pair_i}$$

Sweep Φ from 0 degree to 360 degree to find the highest PD (out of low, mid, and high channel) and its corresponding Φ , $\Phi_{worstcase}$, for all the beam pairs specified in the codebook_sim. The worst-case scaling factor $s(i)$ for beam pair should be determined with $\Phi(i)_{worstcase}$

B Scaling Factor S and 4cm²-avg PD for Netgear M6

Table B-1 lists *sim.power.limit* for all the beams that Netgear 5G MHS Travel Router (FCC ID: PY321100529) supports.

NOTE: $sim.power_{limit} = \min \{ sim.power_{limit_L}, sim.power_{limit_M}, sim.power_{limit_H} \}$,
where $sim.power_{limit_L}$, $sim.power_{limit_M}$, $sim.power_{limit_H}$ are the simulated power limits for low,
mid, and high channels, respectively.

Table B - 1 Netgear MHS Travel Router Sim.power.limit

Band	Pair with Beam Id	Beam_Id	Sim.power.limit_L	Sim.power.limit_M	Sim.power.limit_H	Sim.power.limit
N260		0	11.27	11.31	11.62	11.27
		1	11.23	11.38	11.76	11.23
		2	11.05	11	11.39	11
		3	11.51	11.17	10.74	10.74
		4	11.02	10.79	10.28	10.28
		5	10.97	10.86	10.32	10.32
		6	11.51	11.16	10.78	10.78
		7	11.13	10.92	11.56	10.92
		8	11.28	11.42	11.69	11.28
		9	11.11	11.18	11.51	11.11
		10	8.92	8.39	7.83	7.83
		11	6.91	6.94	7.65	6.91
		12	6.77	6.77	6.91	6.77
		13	10.31	10.14	9.67	9.67
		14	8.79	8.34	8.49	8.34
		15	6.91	7.02	7	6.91
		16	7.15	7.1	7.12	7.1
		17	10.07	10.09	9.57	9.57
		18	9.26	8.96	8.95	8.95
		19	7.13	7.24	7.2	7.13
		20	7.62	7.7	7.91	7.62
		21	7.87	7.6	8.28	7.6
		22	6.59	6.72	6.85	6.59
		23	7.99	7.79	7.86	7.79
		24	7.26	6.69	5.91	5.91
		25	5.39	4.83	4.44	4.44
		26	3.03	3.26	3.93	3.03
		27	4.26	3.99	3.73	3.73
		28	5.04	5.16	5.24	5.04
		29	6.5	5.83	5.29	5.29
		30	3.81	3.87	4.12	3.81
		31	2.71	2.82	3.64	2.71
		32	4.17	3.93	3.72	3.72
		33	4.64	5.12	5.04	4.64
		34	6.49	5.67	5.13	5.13
		35	4.12	4.23	4.4	4.12
		36	2.77	3.12	3.82	2.77
		37	4.7	4.8	4.75	4.7
		38	5.5	4.83	4.57	4.57
		39	2.9	3.09	3.79	2.9
		40	3.26	3.57	3.7	3.26
		41	4.48	4.44	4.46	4.44
	128	10.84	10.57	10.95	10.57	

		129	11.39	11.59	11.73	11.39
		130	10.98	10.68	10.81	10.68
		131	11.38	11.1	10.72	10.72
		132	10.36	10.27	9.97	9.97
		133	10.4	10.26	9.99	9.99
		134	11.46	10.98	10.8	10.8
		135	10.99	10.59	10.78	10.59
		136	11.34	11.56	11.7	11.34
		137	10.65	10.58	10.84	10.58
		138	9.9	9.91	9.56	9.56
		139	6.95	6.69	7.26	6.69
		140	6.55	6.38	6.92	6.38
		141	9.5	9.2	8.85	8.85
		142	10.42	9.47	9.03	9.03
		143	7.07	7.26	7.3	7.07
		144	6.59	6.32	6.41	6.32
		145	9.98	9.38	8.98	8.98
		146	8.29	8.26	8.07	8.07
		147	6.37	6.47	6.53	6.37
		148	9.08	8.68	8.53	8.53
		149	7.93	8.01	7.92	7.92
		150	6.27	6.29	6.36	6.27
		151	7.59	7.14	7.17	7.14
		152	5.22	5.38	5.4	5.22
		153	4.89	4.34	3.86	3.86
		154	2.73	2.9	3.66	2.73
		155	3.09	2.98	3.23	2.98
		156	5.68	5.31	4.85	4.85
		157	5.03	4.71	4.46	4.46
		158	4.23	4.35	4.08	4.08
		159	2.58	2.6	3.33	2.58
		160	3.92	3.61	3.65	3.61
		161	6.2	5.82	5.2	5.2
		162	4.98	4.57	4.44	4.44
		163	4.1	4.22	4.09	4.09
		164	2.6	2.63	3.2	2.6
		165	4.6	4.2	3.88	3.88
		166	5.14	4.52	4.16	4.16
		167	2.94	3.26	3.68	2.94
		168	2.73	2.85	3.22	2.73
		169	5.09	4.76	4.31	4.31
128	0	7.65	7.36	7.59	7.36	
129	1	8.05	8.07	7.83	7.83	
130	2	7.3	7.23	7.56	7.23	
131	3	7.86	7.43	7.18	7.18	
132	4	6.91	6.79	6.7	6.7	
133	5	6.89	6.91	6.73	6.73	
134	6	7.95	7.31	7.16	7.16	
135	7	7.39	7.16	7.49	7.16	
136	8	8.02	8.09	7.83	7.83	

	137	9	7.46	7.43	7.54	7.43
	138	10	5.98	5.13	4.65	4.65
	139	11	3.6	3.13	3.22	3.13
	140	12	3.07	2.61	2.74	2.61
	141	13	4.94	4.36	4	4
	142	14	6.21	5.66	5.7	5.66
	143	15	3.72	3.52	3.33	3.33
	144	16	2.67	2.22	2.26	2.22
	145	17	7.7	6.97	6.63	6.63
	146	18	6.57	6.03	5.52	5.52
	147	19	3.13	3.22	3.12	3.12
	148	20	5.99	5.68	5.41	5.41
	149	21	5.93	5.55	5.35	5.35
	150	22	2.81	3.1	3.34	2.81
	151	23	3.27	2.56	2.57	2.56
	152	24	2.44	1.92	1.27	1.27
	153	25	1.55	1.1	0.25	0.25
	154	26	-0.44	-0.36	-0.49	-0.49
	155	27	0.13	-0.29	-0.58	-0.58
	156	28	0.88	0.75	0.78	0.75
	157	29	2.7	1.3	0.59	0.59
	158	30	0.49	0.33	0.31	0.31
	159	31	-0.61	-0.67	-0.75	-0.75
	160	32	0.47	-0.14	-0.19	-0.19
	161	33	0.79	0.9	0.74	0.74
	162	34	2.25	1.14	0.53	0.53
	163	35	0.63	0.37	0.33	0.33
	164	36	-0.62	-0.39	-0.14	-0.62
	165	37	0.49	0.06	0.03	0.03
	166	38	1.79	1.19	0.4	0.4
	167	39	-0.22	-0.48	-0.33	-0.48
	168	40	-0.36	-0.06	-0.04	-0.36
	169	41	0.6	0.32	0.27	0.27
N261		0	11.19	10.98	10.83	10.83
		1	11.97	11.69	11.44	11.44
		2	11.02	10.93	10.83	10.83
		3	11.32	11.11	10.87	10.87
		4	11.12	11	10.75	10.75
		5	11.12	10.94	10.81	10.81
		6	11.1	11.08	10.91	10.91
		7	11.02	10.93	10.74	10.74
		8	11.69	11.35	11.09	11.09
		9	11.21	11.07	10.71	10.71
		10	8.28	8.15	7.89	7.89
		11	7.51	7.24	7.1	7.1
		12	6.72	6.53	6.34	6.34
		13	8.5	8.48	8.26	8.26
		14	9.68	9.61	9.52	9.52
		15	6.85	6.66	6.4	6.4

	16	7.39	7.24	7.03	7.03
	17	8.04	7.92	7.64	7.64
	18	8.59	8.28	8.12	8.12
	19	6.35	6.26	6.13	6.13
	20	7.32	7.1	6.83	6.83
	21	8.09	7.83	7.65	7.65
	22	6.43	6.26	6.1	6.1
	23	7.7	7.36	7.13	7.13
	24	5.73	5.28	5.16	5.16
	25	3.33	3.08	2.91	2.91
	26	2.38	2.24	2.1	2.1
	27	2.61	2.43	2.26	2.26
	28	2.91	2.84	2.75	2.75
	29	5.6	5.11	4.75	4.75
	30	2.54	2.33	2.16	2.16
	31	2.57	2.34	2.1	2.1
	32	2.53	2.39	2.16	2.16
	33	4.3	4.05	3.77	3.77
	34	4.72	4.32	4.18	4.18
	35	2.58	2.43	2.28	2.28
	36	2.48	2.33	2.16	2.16
	37	2.55	2.4	2.29	2.29
	38	3.6	3.28	2.96	2.96
	39	2.55	2.33	2.17	2.17
	40	2.77	2.56	2.32	2.32
	41	3.15	3.01	2.75	2.75
	128	11.08	10.84	10.77	10.77
	129	11.79	11.58	11.41	11.41
	130	10.82	10.63	10.45	10.45
	131	11.53	11.19	10.84	10.84
	132	10.85	10.74	10.54	10.54
	133	10.78	10.77	10.7	10.7
	134	11.31	11.09	10.84	10.84
	135	10.64	10.54	10.39	10.39
	136	11.7	11.43	11.12	11.12
	137	11.12	10.87	10.57	10.57
	138	8.79	8.36	7.96	7.96
	139	6.53	6.37	6.22	6.22
	140	6.69	6.54	6.36	6.36
	141	7.63	7.6	7.48	7.48
	142	7.8	7.63	7.4	7.4
	143	6.27	6.23	6.1	6.1
	144	6.46	6.26	6.04	6.04
	145	8.73	8.35	7.97	7.97
	146	7.84	7.62	7.48	7.48
	147	6.06	5.95	5.79	5.79

		148	7.7	7.38	7.18	7.18
		149	7.76	7.57	7.32	7.32
		150	6.34	6.18	5.99	5.99
		151	7.37	7.27	7.13	7.13
		152	4	3.4	3.15	3.15
		153	2.52	2.36	2.27	2.27
		154	2.45	2.29	2.18	2.18
		155	2.46	2.31	2.15	2.15
		156	4.29	4.13	3.87	3.87
		157	3.67	3.29	3.04	3.04
		158	2.42	2.3	2.17	2.17
		159	2.41	2.17	1.98	1.98
		160	2.65	2.46	2.17	2.17
		161	4.34	4.11	3.79	3.79
		162	3.21	2.8	2.64	2.64
		163	2.33	2.24	2.16	2.16
		164	2.42	2.19	2.04	2.04
		165	2.66	2.44	2.33	2.33
		166	2.61	2.37	2.27	2.27
		167	2.42	2.27	2.1	2.1
		168	2.49	2.33	2.09	2.09
		169	3.27	3.08	2.79	2.79
128	0		7.6	7.59	7.51	7.51
129	1		7.96	7.72	7.45	7.45
130	2		7.58	7.41	7.33	7.33
131	3		8.04	7.79	7.45	7.45
132	4		7.51	7.43	7.3	7.3
133	5		7.49	7.36	7.3	7.3
134	6		7.89	7.75	7.58	7.58
135	7		7.53	7.48	7.36	7.36
136	8		7.77	7.58	7.38	7.38
137	9		7.67	7.63	7.39	7.39
138	10		5.38	5.01	4.72	4.72
139	11		3.86	3.68	3.6	3.6
140	12		3.63	3.55	3.35	3.35
141	13		4.87	5.04	4.88	4.87
142	14		4.83	4.88	4.93	4.83
143	15		3.26	3.18	3.01	3.01
144	16		3.98	3.89	3.58	3.58
145	17		6.34	6.03	5.67	5.67
146	18		4.56	4.3	4.33	4.3
147	19		3.21	3.13	2.94	2.94
148	20		4.01	3.74	3.6	3.6
149	21		5.05	4.78	4.59	4.59
150	22		3.12	2.95	2.8	2.8
151	23		4.68	4.4	4.19	4.19

152	24	1.04	0.56	0.35	0.35
153	25	-0.69	-0.86	-0.9	-0.9
154	26	-1.03	-1.22	-1.35	-1.35
155	27	-0.68	-0.87	-1.03	-1.03
156	28	0.12	0.06	-0.04	-0.04
157	29	0.86	0.45	0.14	0.14
158	30	-1.01	-1.16	-1.31	-1.31
159	31	-0.81	-1.1	-1.29	-1.29
160	32	-0.59	-0.79	-1.08	-1.08
161	33	0.83	0.87	0.67	0.67
162	34	0.22	-0.11	-0.25	-0.25
163	35	-1.08	-1.18	-1.24	-1.24
164	36	-0.88	-1.1	-1.29	-1.29
165	37	-0.74	-0.92	-0.97	-0.97
166	38	-0.5	-0.72	-0.9	-0.9
167	39	-0.93	-1.15	-1.31	-1.31
168	40	-0.6	-0.86	-1.1	-1.1
169	41	-0.06	-0.12	-0.37	-0.37

Table B - 2:PD at input power of 6dBm

Band	Mod Id	Beam 1	Beam 2	4cm²PD(W/m²) at 6dBm																	
				Low Channel						Mid Channel						High Channel					
				Front	Back	Left	Right	Top	Bottom	Front	Back	Left	Right	Top	Bottom	Front	Back	Left	Right	Top	Bottom
N260	1	0		0.03	0.09	0.01	1.38	0.3	0.36	0.04	0.07	0.01	1.37	0.36	0.31	0.03	0.01	0.01	0.81	0.32	0.27
	0	1		0.04	0.06	1.39	0.01	0.31	0.21	0.03	0.07	1.34	0.01	0.27	0.22	0.02	0.06	1.23	0.01	0.28	0.24
	1	2		0.03	0.08	0.01	1.45	0.33	0.35	0.04	0.06	0.01	1.47	0.34	0.33	0.04	0.01	0.01	1.01	0.29	0.33
	0	3		0.04	0.07	1.3	0.01	0.34	0.2	0.04	0.06	1.41	0.01	0.32	0.25	0.03	0.05	1.56	0.01	0.31	0.26
	1	4		0.04	0.08	0.01	1.46	0.36	0.39	0.04	0.07	0.01	1.52	0.35	0.36	0.04	0.01	0.01	1.58	0.35	0.4
	0	5		0.05	0.05	1.48	0.01	0.37	0.38	0.05	0.07	1.52	0.01	0.35	0.38	0.05	0.05	1.72	0.01	0.36	0.37
	1	6		0.06	0.05	0	1.3	0.34	0.19	0.06	0.04	0	1.43	0.32	0.27	0.04	0.01	0	1.54	0.3	0.26
	0	7		0.05	0.04	1.43	0.01	0.33	0.34	0.05	0.04	1.51	0.01	0.34	0.32	0.06	0.05	1.29	0.01	0.31	0.35
	1	8		0.05	0.04	0	1.38	0.3	0.21	0.07	0.04	0	1.33	0.27	0.23	0.06	0	0	1.25	0.28	0.24
	0	9		0.06	0.04	1.43	0.01	0.33	0.34	0.06	0.04	1.4	0.01	0.35	0.28	0.06	0.05	1.3	0.01	0.34	0.31
	1	10		0.14	0.23	0.01	2.37	0.74	0.49	0.1	0.15	0.01	2.68	0.82	0.54	0.07	0.02	0.01	3.05	0.85	0.49
	1	11		0.01	0.13	0.02	3.77	1.05	1.05	0.02	0.13	0.02	3.73	1.05	0.99	0.02	0.02	0.03	2.49	1.03	0.84
	1	12		0.08	0.07	0.02	3.89	1.03	1.07	0.09	0.04	0.02	3.87	1.07	0.86	0.07	0.01	0.03	2.95	0.97	0.7
	1	13		0.1	0.24	0.02	1.72	0.54	0.51	0.13	0.23	0.02	1.8	0.66	0.55	0.11	0.02	0.02	1.4	0.6	0.56
	0	14		0.13	0.17	2.44	0.01	0.71	0.44	0.13	0.15	2.71	0.01	0.72	0.53	0.08	0.15	2.62	0.01	0.73	0.55
	0	15		0.08	0.06	3.77	0.01	1.01	0.83	0.1	0.09	3.67	0.01	0.89	0.73	0.1	0.1	3.69	0.01	0.8	0.57
	0	16		0.09	0.13	3.56	0.02	0.9	0.9	0.05	0.15	3.66	0.02	1.05	0.77	0.03	0.14	3.59	0.02	0.99	0.77
	0	17		0.16	0.12	1.82	0.01	0.58	0.51	0.14	0.11	1.83	0.02	0.65	0.51	0.18	0.14	2.04	0.02	0.6	0.56
	1	18		0.05	0.29	0.03	2.19	0.78	0.81	0.08	0.25	0.02	2.33	0.83	0.85	0.07	0.03	0.03	2.29	0.75	0.86
	1	19		0.08	0.04	0.01	3.57	1.04	0.9	0.1	0.09	0.02	3.5	0.79	0.81	0.11	0.02	0.02	3.38	0.61	0.8
	1	20		0.1	0.09	0.01	3.2	0.79	0.83	0.12	0.1	0.02	3.15	0.93	0.53	0.12	0.01	0.02	1.07	0.44	0.29
	0	21		0.18	0.03	3.02	0.02	1	0.95	0.19	0.04	3.23	0.01	0.94	0.91	0.2	0.05	2.75	0.02	0.86	1.02
	0	22		0.06	0.05	4.05	0.01	1.1	1.16	0.07	0.06	3.97	0.02	1.03	1.07	0.08	0.05	3.82	0.02	1.06	1.05
	0	23		0.13	0.17	2.93	0.01	0.72	0.69	0.1	0.19	3.12	0.02	0.87	0.57	0.09	0.17	3.02	0.02	0.83	0.62
	1	24		0.68	0.75	0.03	3.47	2.47	1.2	0.51	0.74	0.02	3.97	2.4	1.26	0.41	0.04	0.03	4.74	2.1	1.24
	1	25		0.16	0.84	0.07	5.34	2.07	1.79	0.12	0.73	0.05	6.08	2.13	1.84	0.14	0.09	0.05	6.61	1.97	1.88
	1	26		0.05	0.09	0.03	9.2	2.97	2.7	0.07	0.16	0.04	8.76	2.32	2.58	0.07	0.05	0.04	7.24	2.19	2.24
	1	27		0.29	0.07	0.05	6.92	2	2.07	0.36	0.08	0.07	7.36	2.05	1.69	0.28	0.04	0.05	6.27	1.6	1.49
	1	28		0.42	0.72	0.03	5.79	1.43	1.56	0.51	0.43	0.02	5.58	1.77	1.34	0.45	0.05	0.02	3.41	1.9	0.81
	0	29		0.44	0.61	4.14	0.04	2.69	1.56	0.55	0.45	4.85	0.04	2.62	1.52	0.55	0.28	5.46	0.03	2.16	1.57
	0	30		0.3	0.07	7.69	0.04	2.34	2	0.45	0.08	7.59	0.03	1.94	2.01	0.44	0.08	7.16	0.02	1.88	1.88
	0	31		0.11	0.04	9.91	0.03	3.07	2.75	0.06	0.06	9.6	0.04	2.64	2.48	0.12	0.13	7.99	0.04	2.36	2.28
	0	32		0.07	0.42	7.07	0.05	2.24	1.81	0.07	0.48	7.55	0.06	2.04	1.6	0.07	0.43	7.85	0.06	2.41	1.59
	0	33		0.51	0.59	6.35	0.04	1.35	1.75	0.29	0.47	5.77	0.05	1.61	1.35	0.2	0.54	5.79	0.04	1.81	1.4
	1	34		0.54	0.84	0.06	4.15	2.58	1.58	0.29	0.62	0.03	5.02	2.46	1.53	0.22	0.05	0.04	5.68	2.17	1.51
	1	35		0.1	0.3	0.04	7.16	2.26	1.97	0.11	0.43	0.05	6.97	1.88	2.03	0.14	0.08	0.05	6.72	1.74	1.88
	1	36		0.03	0.11	0.04	9.76	2.82	2.72	0.07	0.11	0.06	9.09	2.47	2.33	0.1	0.02	0.06	6.77	2.24	2.09
	1	37		0.49	0.37	0.03	6.26	1.56	1.83	0.42	0.2	0.03	6.05	1.87	1.43	0.39	0.05	0.02	3.38	1.25	0.63
	0	38		0.72	0.14	5.2	0.04	2.07	1.81	0.53	0.13	6.06	0.04	2.28	1.8	0.43	0.15	6.46	0.03	2.1	1.99
	0	39		0.08	0.04	9.49	0.03	2.93	2.42	0.18	0.05	9.05	0.02	2.21	2.37	0.25	0.08	7.72	0.03	1.99	2.07
	0	40		0.05	0.12	8.73	0.05	2.54	2.38	0.05	0.2	8.2	0.06	2.38	2.04	0.06	0.25	7.88	0.05	2.49	2.13
	0	41		0.19	0.72	6.58	0.06	1.86	1.82	0.16	0.6	6.72	0.07	1.7	1.51	0.14	0.53	6.62	0.04	1.79	1.5

N260	1	128		0.04	0.08	0.01	1.52	0.5	0.24	0.03	0.09	0.01	1.6	0.42	0.26	0.03	0.01	0.01	0.9	0.32	0.23
	0	129		0.03	0.06	1.34	0.01	0.25	0.18	0.02	0.06	1.29	0.01	0.3	0.13	0.02	0.08	1.24	0.01	0.28	0.21
	1	130		0.04	0.07	0.01	1.47	0.41	0.3	0.04	0.07	0.01	1.59	0.41	0.31	0.04	0.01	0.01	1.04	0.35	0.24
	0	131		0.03	0.09	1.34	0.01	0.31	0.32	0.04	0.07	1.43	0.01	0.37	0.23	0.03	0.06	1.57	0	0.36	0.25
	1	132		0.05	0.06	0.01	1.7	0.48	0.28	0.05	0.05	0.01	1.74	0.43	0.31	0.04	0.01	0	1.66	0.48	0.27
	0	133		0.06	0.07	1.69	0.01	0.47	0.28	0.06	0.05	1.75	0.01	0.44	0.31	0.05	0.05	1.85	0	0.49	0.32
	1	134		0.07	0.04	0.01	1.32	0.3	0.35	0.05	0.04	0.01	1.47	0.36	0.23	0.05	0.01	0.01	1.54	0.38	0.24
	0	135		0.07	0.05	1.47	0.01	0.42	0.31	0.07	0.06	1.62	0.01	0.4	0.32	0.07	0.04	1.55	0	0.35	0.31
	1	136		0.04	0.03	0	1.36	0.25	0.18	0.05	0.03	0.01	1.29	0.29	0.14	0.06	0.01	0	1.25	0.28	0.23
	0	137		0.08	0.04	1.59	0	0.49	0.26	0.08	0.03	1.62	0	0.42	0.27	0.07	0.03	1.52	0	0.43	0.28
	1	138		0.19	0.11	0.01	1.89	0.4	0.55	0.15	0.11	0.01	1.89	0.49	0.44	0.15	0.03	0.01	2.05	0.52	0.36
	1	139		0.02	0.14	0.02	3.73	1.15	0.74	0.01	0.13	0.02	3.93	1.24	0.71	0.02	0.03	0.03	2.65	1.07	0.74
	1	140		0.09	0.04	0.01	4.09	1.34	0.83	0.08	0.03	0.01	4.24	1.07	0.89	0.08	0.01	0.01	1.36	0.71	0.72
	1	141		0.13	0.29	0.02	2.07	0.89	0.44	0.1	0.28	0.02	2.22	0.76	0.46	0.08	0.02	0.02	1.79	0.56	0.39
	0	142		0.23	0.17	1.68	0.01	0.67	0.47	0.23	0.14	2.11	0.01	0.72	0.42	0.24	0.15	2.31	0.01	0.77	0.4
	0	143		0.08	0.04	3.63	0.01	0.79	0.67	0.09	0.04	3.49	0.02	0.95	0.44	0.07	0.04	3.44	0.01	0.98	0.52
	0	144		0.12	0.17	4.06	0.01	1.11	0.77	0.07	0.16	4.35	0.01	0.89	0.98	0.07	0.13	4.22	0.01	0.76	1.03
	0	145		0.05	0.26	1.85	0.03	0.58	0.45	0.07	0.23	2.13	0.03	0.65	0.45	0.07	0.25	2.34	0.02	0.71	0.43
	1	146		0.12	0.13	0.01	2.74	0.54	0.63	0.08	0.14	0.01	2.75	0.7	0.45	0.1	0.03	0.01	2.88	0.75	0.43
	1	147		0.02	0.09	0.01	4.26	1.42	0.89	0.03	0.12	0.01	4.19	1.31	0.88	0.03	0.02	0.01	3.53	1.25	0.84
	1	148		0.17	0.04	0.01	2.28	0.7	0.53	0.16	0.05	0.01	2.5	0.71	0.46	0.15	0.02	0.01	2.5	0.71	0.44
	0	149		0.1	0.12	2.98	0.01	0.62	0.62	0.11	0.1	2.93	0.01	0.81	0.47	0.09	0.1	2.98	0.01	0.75	0.46
	0	150		0.05	0.04	4.37	0.01	1.41	0.92	0.07	0.05	4.35	0.01	1.3	0.9	0.07	0.05	4.28	0.01	1.22	0.94
	0	151		0.19	0.22	3.22	0.01	0.97	0.6	0.16	0.19	3.62	0.01	0.78	0.8	0.16	0.14	3.54	0.01	0.7	0.81
	1	152		0.8	0.72	0.08	5.56	1.86	1.48	0.53	0.76	0.05	5.4	2.14	1.64	0.39	0.06	0.03	5.33	1.66	1.18
	1	153		0.08	0.75	0.06	5.99	1.64	1.94	0.07	0.59	0.06	6.77	1.87	1.62	0.08	0.09	0.06	7.58	2.22	1.62
	1	154		0.06	0.06	0.03	9.86	3.27	2.36	0.07	0.12	0.03	9.46	3.39	1.7	0.12	0.03	0.03	7.59	2.81	1.68
	1	155		0.2	0.05	0.03	9.07	2.96	1.93	0.24	0.06	0.02	9.27	2.49	1.93	0.23	0.02	0.02	6.3	2.22	1.91
	1	156		0.71	0.59	0.06	5	2.7	1.29	0.76	0.54	0.03	5.4	2.57	1.35	0.64	0.06	0.02	3.23	1.39	0.82
	0	157		0.62	0.55	5.81	0.04	1.17	1.93	0.65	0.42	6.28	0.04	1.42	1.61	0.7	0.25	6.61	0.02	1.93	1.34
	0	158		0.25	0.11	6.97	0.04	2.21	1.86	0.37	0.1	6.79	0.04	2.47	1.44	0.35	0.09	7.23	0.02	2.22	1.73
	0	159		0.06	0.07	10.1 9	0.02	3.53	2.36	0.09	0.07	10.2	0.02	3.41	1.92	0.14	0.11	8.58	0.01	2.95	1.87
0	160		0.07	0.48	7.49	0.05	2.53	1.71	0.04	0.55	8.09	0.05	2.18	1.78	0.05	0.45	7.97	0.03	2.09	1.86	
0	161		0.64	0.86	4.43	0.04	2.68	1.21	0.52	0.83	4.88	0.04	2.35	1.33	0.37	0.74	5.58	0.02	2.48	1.1	
1	162		0.23	0.63	0.05	5.87	1.28	2.05	0.17	0.5	0.04	6.43	1.51	1.72	0.22	0.08	0.04	6.65	1.61	1.45	
1	163		0.08	0.28	0.03	7.2	2.2	1.87	0.08	0.36	0.03	6.98	2.47	1.29	0.12	0.05	0.05	7.19	2.21	1.52	
1	164		0.07	0.07	0.02	10.16	3.63	2.16	0.08	0.11	0.02	10.08	3.21	1.94	0.12	0.02	0.02	7.45	2.81	2.1	
1	165		0.62	0.15	0.03	6.4	2.65	1.56	0.44	0.11	0.02	6.96	2.35	1.71	0.42	0.06	0.02	4.01	1.44	1.09	
0	166		0.63	0.14	5.66	0.04	1.61	1.91	0.69	0.2	6.58	0.03	1.84	1.69	0.59	0.1	7.08	0.02	2.03	1.57	
0	167		0.1	0.09	9.39	0.03	2.98	2.33	0.18	0.08	8.76	0.04	3.11	1.5	0.24	0.09	7.92	0.02	2.55	1.65	
0	168		0.06	0.1	9.85	0.02	3.24	1.9	0.09	0.19	9.6	0.04	2.63	1.91	0.05	0.2	8.8	0.02	2.48	2.04	
0	169		0.35	0.92	5.73	0.06	2.74	1.47	0.2	0.67	6.21	0.04	2.39	1.74	0.14	0.54	6.85	0.03	2.18	1.52	
1	0	128		0.1	0.23	0.03	3.17	0.98	0.94	0.1	0.31	0.03	3.36	1.16	0.95	0.1	0.03	0.04	2.51	1.04	0.82
0	1	129		0.08	0.17	2.89	0.03	0.75	0.56	0.09	0.23	2.9	0.03	0.83	0.54	0.06	0.25	3.04	0.02	0.83	0.56
1	2	130		0.12	0.21	0.02	3.44	0.99	1.03	0.12	0.21	0.02	3.49	1.08	1.01	0.11	0.04	0.03	2.87	0.89	0.83
0	3	131		0.12	0.23	3.02	0.03	0.89	0.71	0.13	0.22	3.34	0.03	0.99	0.75	0.09	0.19	3.54	0.01	0.92	0.68

N260	1	4	132	0.12	0.22	0.02	3.76	1.1	1.06	0.13	0.21	0.02	3.82	1.2	1	0.1	0.03	0.02	3.69	1.15	0.91
	0	5	133	0.15	0.21	3.79	0.02	1.11	1.06	0.16	0.21	3.82	0.02	1.23	1.05	0.19	0.15	3.92	0.01	1.18	0.81
	1	6	134	0.19	0.15	0.01	2.96	0.91	0.75	0.18	0.15	0.02	3.44	0.98	0.74	0.14	0.02	0.01	3.56	0.9	0.65
	0	7	135	0.18	0.15	3.37	0.02	1.01	1.04	0.2	0.16	3.59	0.02	1.08	0.98	0.2	0.14	3.29	0.01	0.91	0.83
	1	8	136	0.17	0.1	0.01	2.92	0.7	0.53	0.2	0.09	0.01	2.86	0.83	0.55	0.21	0.02	0.01	3.04	0.79	0.6
	0	9	137	0.25	0.11	3.31	0.02	1.03	0.92	0.22	0.11	3.35	0.01	1.1	0.91	0.25	0.13	3.26	0.02	1.05	0.84
	1	10	138	0.43	0.51	0.03	4.66	1.73	1.16	0.4	0.41	0.02	5.67	2.03	1.07	0.34	0.05	0.02	6.33	1.78	1.06
	1	11	139	0.04	0.47	0.06	8.06	2.99	2.91	0.04	0.46	0.07	9	3.41	2.97	0.07	0.08	0.11	7.45	2.86	2.4
	1	12	140	0.29	0.12	0.03	9.12	2.62	2.63	0.3	0.1	0.05	10.7	2.55	2.41	0.24	0.03	0.05	5.44	2.15	1.46
	1	13	141	0.35	0.79	0.08	5.92	2.25	1.51	0.35	0.95	0.06	6.78	2.3	1.61	0.32	0.07	0.05	5.11	2.08	1.54
	0	14	142	0.46	0.39	4.42	0.03	1.45	0.97	0.45	0.41	5.04	0.03	1.64	1.05	0.35	0.32	4.97	0.02	1.82	0.98
	0	15	143	0.23	0.14	7.85	0.03	2.11	2	0.3	0.16	8.24	0.03	2.18	1.55	0.28	0.15	8.58	0.02	1.77	1.5
	0	16	144	0.24	0.52	9.99	0.03	2.34	2.22	0.23	0.58	11.25	0.05	2.35	2.07	0.17	0.46	10.99	0.03	2.44	2.17
	0	17	145	0.27	0.45	3.14	0.04	1.12	1	0.26	0.42	3.73	0.05	1.33	0.86	0.27	0.42	4.02	0.04	1.24	0.86
	1	18	146	0.22	0.49	0.05	4.07	1.4	1.36	0.15	0.49	0.04	4.57	1.65	1.18	0.16	0.07	0.04	5.18	1.49	1.26
	1	19	147	0.12	0.24	0.04	8.98	3.29	2.65	0.16	0.38	0.04	8.81	3.03	2.49	0.17	0.05	0.04	8.1	2.82	1.87
	1	20	148	0.29	0.14	0.03	4.65	1.51	1.24	0.28	0.16	0.03	5.02	1.64	1.03	0.36	0.04	0.03	4.07	1.27	0.75
	0	21	149	0.32	0.19	4.71	0.03	1.37	1.44	0.33	0.15	5.19	0.03	1.6	1.21	0.32	0.17	5.39	0.03	1.37	1.39
	0	22	150	0.18	0.15	9.67	0.03	3.42	3.19	0.25	0.2	9.14	0.03	3.47	3.04	0.28	0.16	8.56	0.04	2.94	2.29
	0	23	151	0.39	0.66	8.7	0.03	2.3	1.52	0.48	0.7	10.42	0.05	2.32	1.6	0.44	0.55	10.24	0.03	2.37	1.86
	1	24	152	1.3	2.04	0.12	10.53	5.42	3.81	1	2.1	0.11	11.78	6.15	4.11	0.79	0.12	0.08	13.78	6.26	3.47
	1	25	153	0.25	2.18	0.2	12.94	4.48	5.51	0.23	1.7	0.18	14.42	5.31	5.09	0.31	0.23	0.17	17.29	6.22	5.31
	1	26	154	0.15	0.19	0.09	20.45	8.38	8.09	0.24	0.33	0.12	20.1	8.5	6.95	0.24	0.1	0.12	19.73	7.26	5.91
	1	27	155	0.63	0.19	0.08	17.95	5.33	5.27	0.69	0.18	0.1	19.6	4.85	4.23	0.59	0.06	0.11	14.79	5.18	4.23
	1	28	156	1.46	1.5	0.08	15.09	5.39	2.78	1.5	1.33	0.06	15.41	5.26	3.1	1.11	0.15	0.05	9.17	5.5	2.21
	0	29	157	1.51	1.03	9.92	0.09	4.48	4.95	1.65	0.95	13.74	0.09	5.24	4.4	2.08	0.88	16.13	0.06	5.71	4.08
	0	30	158	0.89	0.21	16.5	0.08	6.07	6.12	1.22	0.23	17.17	0.09	6.36	5.71	1.1	0.24	17.21	0.08	6.41	5.21
	0	31	159	0.24	0.11	21.25	0.1	8.64	8.1	0.16	0.19	21.48	0.1	8.97	6.91	0.37	0.4	21.95	0.06	7.4	5.94
	0	32	160	0.21	1.07	16.59	0.13	4.94	4.09	0.16	1.29	19.23	0.15	5	3.28	0.16	1.12	19.3	0.11	5.34	4.33
	0	33	161	1.38	1.84	15.42	0.11	4.64	3.21	1.33	1.83	15.24	0.14	5.1	3.37	0.91	1.6	15.6	0.07	5.6	3.56
	1	34	162	1.08	1.65	0.14	11.01	4.25	5.14	0.64	2.04	0.11	14.19	4.96	4.67	0.54	0.18	0.11	16.37	5.7	4.26
	1	35	163	0.27	0.89	0.1	15.98	6.1	6.12	0.27	1.24	0.14	16.94	6.35	5.44	0.3	0.18	0.19	16.39	6.37	5.21
	1	36	164	0.15	0.27	0.09	21.32	8.29	7.42	0.24	0.25	0.11	20.37	8.22	6.58	0.35	0.05	0.11	17.67	6.61	5.64
	1	37	165	1.6	0.68	0.07	16.52	5.11	3.42	1.31	0.44	0.06	18.02	5.88	3.2	1.22	0.12	0.06	10.08	4.62	2.21
	0	38	166	1.6	0.37	12.23	0.11	4.43	5.29	1.47	0.39	14.13	0.11	5.33	5.33	1.54	0.4	16.85	0.06	6.16	5.35
	0	39	167	0.23	0.15	19.46	0.08	7.84	7.65	0.6	0.18	20.61	0.09	7.94	6.44	0.86	0.27	19.94	0.07	7.03	5.54
	0	40	168	0.17	0.32	20.08	0.09	7.2	6.25	0.15	0.55	18.85	0.1	6.49	5.35	0.19	0.6	18.64	0.09	5.9	4.51
	0	41	169	0.68	2.21	16.08	0.12	5.5	3.09	0.45	1.91	17.38	0.11	5.43	3.52	0.26	1.54	17.36	0.08	5.69	3.97
	N261	1	0	0.03	0.07	0.01	1.41	0.34	0.35	0.03	0.06	0.01	1.48	0.33	0.39	0.03	0.05	0.01	1.53	0.32	0.4
		0	1	0.04	0.09	1.17	0.01	0.41	0.31	0.05	0.09	1.25	0.01	0.41	0.33	0.06	0.08	1.33	0.01	0.39	0.35
		1	2	0.05	0.05	0.01	1.46	0.36	0.48	0.05	0.05	0.01	1.49	0.36	0.51	0.05	0.05	0.01	1.53	0.35	0.52
0		3	0.07	0.07	1.36	0.01	0.5	0.33	0.08	0.07	1.43	0.01	0.5	0.32	0.08	0.07	1.51	0.01	0.48	0.31	
1		4	0.06	0.03	0.01	1.43	0.38	0.47	0.05	0.04	0.01	1.47	0.34	0.49	0.05	0.04	0.01	1.55	0.33	0.5	
0		5	0.04	0.09	1.43	0.01	0.4	0.48	0.05	0.09	1.49	0.01	0.36	0.48	0.05	0.09	1.53	0.01	0.37	0.5	
1		6	0.06	0.05	0.01	1.43	0.48	0.28	0.06	0.06	0.01	1.44	0.49	0.27	0.06	0.06	0.01	1.5	0.5	0.27	
0		7	0.05	0.08	1.46	0.01	0.39	0.45	0.05	0.08	1.49	0.01	0.37	0.48	0.06	0.07	1.56	0.01	0.38	0.49	
1		8	0.08	0.04	0	1.25	0.39	0.36	0.1	0.05	0	1.35	0.38	0.33	0.1	0.05	0.01	1.44	0.42	0.32	
0		9	0.07	0.06	1.4	0.01	0.38	0.34	0.06	0.06	1.44	0.01	0.35	0.39	0.05	0.05	1.57	0.01	0.34	0.4	
1		10	0.21	0.1	0.01	2.74	0.97	0.74	0.21	0.11	0.01	2.83	0.96	0.75	0.2	0.11	0.01	3	0.97	0.81	
1		11	0.1	0.07	0.01	3.28	1.17	1.1	0.12	0.05	0.01	3.49	1.18	1.2	0.12	0.05	0.01	3.6	1.09	1.24	
1		12	0.02	0.05	0.01	3.93	1.47	0.92	0.02	0.06	0.01	4.11	1.54	0.92	0.02	0.06	0.01	4.3	1.59	0.96	
1		13	0.15	0.14	0.02	2.61	0.86	0.65	0.13	0.16	0.02	2.62	0.8	0.68	0.12	0.18	0.02	2.76	0.79	0.74	
0	14	0.14	0.3	1.99	0.04	0.83	0.53	0.16	0.31	2.02	0.04	0.81	0.58	0.18	0.28	2.06	0.03	0.79	0.59		

0	15		0.02	0.09	3.82	0.02	1.23	1.26	0.01	0.1	3.99	0.02	1.15	1.38	0.02	0.1	4.24	0.01	1.14	1.45
0	16		0.15	0.11	3.37	0.02	1.05	0.98	0.17	0.09	3.49	0.02	1.04	1.01	0.19	0.07	3.66	0.02	1	1.09
0	17		0.23	0.18	2.9	0.01	0.76	0.82	0.22	0.19	2.99	0.01	0.7	0.82	0.21	0.18	3.18	0.02	0.65	0.81
1	18		0.2	0.09	0.01	2.56	1.11	0.97	0.18	0.1	0.01	2.75	1.12	1.07	0.2	0.12	0.02	2.85	1.14	1.14
1	19		0.05	0.02	0.01	4.28	1.26	1.24	0.05	0.02	0.01	4.37	1.18	1.24	0.05	0.03	0.01	4.5	1.15	1.25
1	20		0.05	0.13	0.02	3.42	1.05	0.75	0.06	0.14	0.02	3.6	1.09	0.76	0.07	0.16	0.02	3.83	1.17	0.79
0	21		0.07	0.28	2.87	0.02	1.31	1.06	0.08	0.27	3.04	0.02	1.29	1.19	0.09	0.25	3.17	0.02	1.33	1.2
0	22		0.03	0.03	4.21	0.01	1.21	1.54	0.03	0.03	4.38	0.01	1.09	1.63	0.03	0.03	4.54	0.02	1.03	1.74
0	23		0.18	0.1	3.14	0.02	1	0.78	0.21	0.1	3.39	0.02	1.03	0.81	0.21	0.09	3.58	0.02	1.02	0.8
1	24		0.9	0.14	0.03	4.93	3.1	1.4	0.95	0.18	0.03	5.48	3	1.64	0.93	0.19	0.04	5.63	3.09	1.76
1	25		0.34	0.13	0.02	8.59	4.61	3.25	0.34	0.11	0.02	9.09	4.7	3.28	0.3	0.13	0.02	9.45	4.62	3.37
1	26		0.07	0.04	0.02	10.68	3.96	4.48	0.07	0.03	0.03	11.04	3.85	4.65	0.07	0.03	0.03	11.39	3.69	4.74
1	27		0.05	0.06	0.04	10.13	3.86	4.21	0.05	0.06	0.05	10.56	3.81	4.4	0.05	0.07	0.06	10.99	3.63	4.52
1	28		0.06	0.55	0.08	9.45	2.26	2.22	0.05	0.57	0.08	9.6	2.46	2.36	0.05	0.62	0.08	9.81	2.64	2.6
0	29		0.16	0.96	5.09	0.08	3.44	1.54	0.14	1.03	5.7	0.09	3.55	1.89	0.16	0.98	6.2	0.09	3.66	2.02
0	30		0.03	0.15	10.29	0.04	4.32	4.35	0.03	0.14	10.8	0.04	4.21	4.58	0.02	0.12	11.25	0.04	4.09	4.73
0	31		0.08	0.09	10.22	0.04	3.94	4.62	0.06	0.07	10.79	0.04	3.75	4.88	0.05	0.06	11.38	0.05	3.59	5.18
0	32		0.21	0.06	10.32	0.07	3.51	3.59	0.22	0.06	10.66	0.07	3.57	3.83	0.24	0.06	11.23	0.07	3.49	3.98
0	33		1.05	0.23	6.87	0.03	1.69	1.52	1.18	0.18	7.27	0.04	1.69	1.63	1.22	0.18	7.76	0.04	1.76	1.75
1	34		0.6	0.09	0.02	6.23	3.65	1.89	0.62	0.12	0.03	6.83	3.66	2.14	0.64	0.12	0.03	7.06	3.73	2.28
1	35		0.12	0.04	0.02	10.19	4.23	4.19	0.13	0.04	0.02	10.57	4.25	4.21	0.12	0.05	0.03	10.92	4.15	4.35
1	36		0.06	0.07	0.04	10.45	3.83	4.52	0.06	0.06	0.04	10.8	3.82	4.78	0.06	0.06	0.05	11.24	3.71	4.91
1	37		0.04	0.2	0.09	10.28	3.44	3.58	0.05	0.2	0.1	10.64	3.46	3.7	0.06	0.2	0.1	10.91	3.4	3.91
0	38		0.09	0.52	8.06	0.04	4.89	3.19	0.09	0.52	8.69	0.04	4.78	3.57	0.11	0.5	9.36	0.05	4.77	3.79
0	39		0.03	0.11	10.28	0.03	4.13	4.54	0.03	0.1	10.8	0.03	3.84	4.8	0.04	0.08	11.22	0.03	3.65	4.93
0	40		0.07	0.12	9.78	0.05	3.91	4.16	0.06	0.11	10.24	0.06	3.8	4.47	0.05	0.09	10.83	0.06	3.62	4.8
0	41		0.8	0.09	8.94	0.05	2.19	2.08	0.86	0.08	9.25	0.06	2.32	2.24	0.94	0.08	9.81	0.05	2.39	2.46
1	128		0.05	0.1	0.01	1.44	0.38	0.29	0.05	0.08	0.01	1.52	0.41	0.3	0.05	0.07	0.01	1.55	0.41	0.31
0	129		0.06	0.05	1.22	0.01	0.53	0.47	0.05	0.05	1.28	0.01	0.49	0.51	0.06	0.04	1.33	0.01	0.48	0.53
1	130		0.06	0.06	0.01	1.53	0.44	0.4	0.06	0.06	0.01	1.6	0.41	0.42	0.06	0.06	0.01	1.67	0.4	0.42
0	131		0.08	0.05	1.3	0.01	0.42	0.48	0.08	0.06	1.4	0.01	0.4	0.5	0.08	0.05	1.52	0.01	0.38	0.5
1	132		0.05	0.05	0.01	1.52	0.47	0.31	0.05	0.05	0.01	1.56	0.45	0.31	0.05	0.05	0.01	1.63	0.42	0.33
0	133		0.07	0.07	1.54	0.01	0.48	0.31	0.06	0.08	1.55	0.01	0.46	0.32	0.05	0.06	1.57	0.01	0.45	0.35
1	134		0.05	0.1	0.01	1.37	0.42	0.41	0.04	0.1	0.01	1.44	0.41	0.43	0.04	0.09	0.01	1.52	0.38	0.47
0	135		0.09	0.06	1.59	0.01	0.43	0.36	0.08	0.06	1.63	0.01	0.41	0.36	0.07	0.06	1.69	0.01	0.41	0.35
1	136		0.05	0.05	0.01	1.25	0.55	0.41	0.04	0.05	0.01	1.33	0.55	0.45	0.05	0.05	0.01	1.43	0.53	0.46
0	137		0.07	0.04	1.43	0.01	0.38	0.27	0.07	0.05	1.51	0.01	0.4	0.31	0.07	0.05	1.62	0.01	0.43	0.36
1	138		0.15	0.2	0.02	2.44	1	0.63	0.14	0.19	0.02	2.7	0.99	0.67	0.16	0.18	0.02	2.96	0.97	0.7
1	139		0.08	0.05	0.01	4.11	1.3	1.06	0.09	0.04	0.01	4.26	1.22	1.12	0.1	0.03	0.02	4.41	1.13	1.21
1	140		0.03	0.11	0.01	3.96	1.24	1.16	0.02	0.12	0.01	4.1	1.26	1.17	0.02	0.12	0.01	4.27	1.21	1.23
1	141		0.05	0.24	0.03	3.19	1.13	0.83	0.08	0.23	0.02	3.21	1.12	0.85	0.08	0.21	0.02	3.3	1.11	0.91
0	142		0.15	0.18	3.07	0.02	1.16	0.81	0.13	0.19	3.19	0.02	1.1	0.85	0.12	0.17	3.36	0.02	1.01	0.9
0	143		0.02	0.12	4.36	0.02	1.46	0.94	0.02	0.11	4.41	0.02	1.39	1.01	0.03	0.11	4.54	0.02	1.3	1.09
0	144		0.09	0.02	4.18	0.01	1.32	1.11	0.08	0.02	4.38	0.01	1.33	1.2	0.07	0.02	4.6	0.01	1.32	1.27
0	145		0.21	0.1	2.48	0.01	1.36	1.08	0.19	0.12	2.7	0.01	1.29	1.17	0.21	0.1	2.95	0.02	1.28	1.24
1	146		0.2	0.12	0.02	3.04	1.04	0.69	0.2	0.13	0.02	3.2	1.09	0.72	0.2	0.13	0.02	3.3	1.07	0.76
1	147		0.05	0.02	0.01	4.58	1.48	1.1	0.05	0.02	0.01	4.69	1.4	1.15	0.05	0.02	0.01	4.88	1.35	1.19
1	148		0.05	0.15	0.01	3.14	1.41	1.2	0.04	0.15	0.01	3.38	1.35	1.32	0.04	0.15	0.02	3.54	1.3	1.38
0	149		0.09	0.11	3.09	0.02	1.24	1.23	0.09	0.11	3.23	0.02	1.2	1.31	0.09	0.1	3.43	0.02	1.19	1.32
0	150		0.04	0.03	4.29	0.01	1.25	1.36	0.04	0.03	4.45	0.01	1.23	1.43	0.05	0.03	4.66	0.01	1.19	1.44
0	151		0.23	0.09	3.39	0.01	1.07	0.95	0.21	0.1	3.47	0.02	1.06	0.9	0.18	0.08	3.58	0.02	1.15	0.91
1	152		0.72	0.15	0.02	7.35	2.42	1.61	0.83	0.13	0.02	8.45	2.84	1.75	0.85	0.11	0.03	8.94	3.03	1.88
1	153		0.47	0.15	0.05	10.33	3.8	2.64	0.47	0.12	0.05	10.74	4.06	2.81	0.42	0.11	0.05	10.96	4.15	2.94

1	154		0.07	0.03	0.05	10.52	4.67	3.67	0.07	0.03	0.05	10.9	4.61	3.96	0.06	0.04	0.06	11.2	4.31	4.24
1	155		0.04	0.07	0.03	10.49	4.31	4.24	0.05	0.08	0.03	10.86	4.28	4.37	0.05	0.07	0.02	11.25	4.12	4.66
1	156		0.05	0.59	0.05	6.88	4	2.33	0.05	0.68	0.05	7.14	4.15	2.5	0.05	0.81	0.06	7.59	4.19	2.63
0	157		0.2	0.89	7.93	0.04	2.64	1.51	0.16	0.92	8.66	0.05	2.91	1.71	0.13	1	9.18	0.06	3.26	1.94
0	158		0.06	0.1	10.6	0.08	4.49	3.81	0.05	0.1	10.88	0.08	4.48	4.14	0.07	0.1	11.22	0.09	4.43	4.15
0	159		0.07	0.06	10.6	0.03	4.29	4.4	0.07	0.06	11.2	0.03	4.14	4.58	0.06	0.06	11.71	0.03	3.95	4.74
0	160		0.11	0.04	10.03	0.03	4.32	3.82	0.1	0.04	10.48	0.02	4.3	4.1	0.1	0.04	11.22	0.02	4.28	4.54
0	161		0.56	0.16	6.81	0.02	3.9	2.23	0.56	0.14	7.17	0.03	3.88	2.28	0.6	0.11	7.71	0.04	4.12	2.47
1	162		0.69	0.13	0.03	8.82	2.97	1.94	0.79	0.1	0.03	9.69	3.39	2.12	0.78	0.09	0.03	10.06	3.57	2.22
1	163		0.12	0.12	0.05	10.8	4.49	3.47	0.1	0.08	0.05	11.05	4.53	3.57	0.09	0.08	0.06	11.24	4.35	3.76
1	164		0.03	0.09	0.03	10.59	4.32	4.41	0.03	0.08	0.03	11.16	4.23	4.65	0.03	0.06	0.03	11.55	3.97	4.85
1	165		0.03	0.23	0.03	10.01	4.37	3.8	0.03	0.23	0.03	10.54	4.45	4.02	0.02	0.24	0.03	10.81	4.39	4.13
0	166		0.15	0.44	10.13	0.06	3.95	2.72	0.11	0.45	10.71	0.07	4.13	3.06	0.14	0.45	10.96	0.08	4.2	3.21
0	167		0.03	0.07	10.59	0.04	4.63	4.04	0.03	0.06	10.96	0.04	4.6	4.33	0.03	0.06	11.4	0.04	4.36	4.45
0	168		0.06	0.05	10.4	0.03	4.31	4.01	0.05	0.06	10.8	0.02	4.21	4.29	0.05	0.08	11.42	0.03	4.13	4.61
0	169		0.35	0.11	8.7	0.03	4.42	3.09	0.35	0.1	9.1	0.03	4.39	3.14	0.35	0.07	9.72	0.03	4.51	3.49
1	0	128	0.1	0.2	0.02	3.21	0.86	0.75	0.11	0.16	0.02	3.22	0.95	0.79	0.1	0.14	0.02	3.28	0.87	0.82
0	1	129	0.13	0.19	2.96	0.02	1.33	0.99	0.14	0.18	3.12	0.02	1.24	1.05	0.13	0.16	3.32	0.02	1.21	1.1
1	2	130	0.15	0.13	0.02	3.23	1.16	1.25	0.16	0.13	0.02	3.36	1.09	1.29	0.16	0.14	0.02	3.42	1.02	1.28
0	3	131	0.18	0.14	2.9	0.02	1.15	1.07	0.2	0.15	3.08	0.02	1.08	1.07	0.21	0.15	3.32	0.02	0.98	1.05
1	4	132	0.14	0.1	0.02	3.28	1.26	0.99	0.14	0.1	0.02	3.34	1.14	1.01	0.16	0.1	0.02	3.44	1.09	1.07
0	5	133	0.15	0.26	3.29	0.02	1.29	0.99	0.15	0.24	3.39	0.02	1.16	1.04	0.15	0.19	3.44	0.02	1.11	1.13
1	6	134	0.13	0.23	0.01	3	1.16	0.83	0.12	0.25	0.02	3.1	1.03	0.88	0.12	0.26	0.02	3.23	0.97	0.95
0	7	135	0.22	0.19	3.27	0.02	1.2	1.12	0.22	0.18	3.3	0.02	1.09	1.16	0.22	0.17	3.4	0.02	1.03	1.13
1	8	136	0.14	0.15	0.01	3.09	1.27	1	0.14	0.16	0.01	3.23	1.33	0.99	0.14	0.16	0.02	3.38	1.39	0.97
0	9	137	0.23	0.12	3.16	0.01	0.93	0.78	0.2	0.14	3.19	0.02	1	0.91	0.17	0.13	3.37	0.01	1	0.97
1	10	138	0.42	0.43	0.04	5.35	2.39	1.6	0.36	0.44	0.04	5.83	2.3	1.67	0.42	0.42	0.04	6.24	2.39	1.89
1	11	139	0.26	0.16	0.02	7.59	3.21	2.66	0.3	0.12	0.03	7.93	3.13	2.8	0.3	0.12	0.03	8.08	2.89	2.93
1	12	140	0.09	0.19	0.02	8.01	3	2.31	0.08	0.21	0.03	8.15	2.94	2.26	0.07	0.25	0.03	8.54	2.81	2.31
1	13	141	0.28	0.52	0.06	6.03	2.25	1.76	0.27	0.53	0.05	5.79	2.31	1.83	0.26	0.55	0.05	6.01	2.34	1.94
0	14	142	0.37	0.6	6.07	0.05	2.34	1.53	0.41	0.64	6	0.06	2.27	1.6	0.4	0.53	5.94	0.07	2.29	1.59
0	15	143	0.05	0.34	8.72	0.03	3.87	2.89	0.05	0.32	8.88	0.04	3.71	3.18	0.05	0.3	9.25	0.04	3.45	3.34
0	16	144	0.28	0.16	7.39	0.03	2.8	2.26	0.28	0.14	7.54	0.03	2.81	2.37	0.3	0.11	8.11	0.03	2.61	2.4
0	17	145	0.55	0.39	4.3	0.04	2.39	1.89	0.5	0.38	4.61	0.04	2.24	2.07	0.5	0.34	5.01	0.04	2.16	2.1
1	18	146	0.56	0.25	0.04	6.46	3.48	2.32	0.59	0.27	0.04	6.86	3.58	2.45	0.61	0.29	0.05	6.82	3.56	2.57
1	19	147	0.14	0.06	0.02	8.82	3.19	2.71	0.15	0.06	0.02	8.98	2.91	2.78	0.15	0.05	0.03	9.39	2.71	2.79
1	20	148	0.14	0.44	0.04	7.34	3.83	2.64	0.11	0.5	0.05	7.8	3.7	2.76	0.12	0.51	0.06	8.06	3.65	2.83
0	21	149	0.21	0.45	5.77	0.05	2.98	3.02	0.22	0.42	6.14	0.05	2.86	3.35	0.23	0.38	6.43	0.06	2.86	3.38
0	22	150	0.1	0.12	9	0.03	3.37	4.03	0.09	0.11	9.38	0.03	3.07	4.31	0.08	0.11	9.69	0.04	2.83	4.46
0	23	151	0.49	0.26	6.29	0.03	2.24	1.68	0.5	0.27	6.7	0.03	2.18	1.65	0.53	0.22	7.04	0.03	2.16	1.69
1	24	152	1.95	0.52	0.06	14.54	7.18	3.53	2.15	0.45	0.06	16.23	7.7	3.72	2.23	0.43	0.07	17.05	8.33	4.02
1	25	153	1.05	0.42	0.09	21.68	12.53	6.78	1.12	0.38	0.08	22.51	13.18	7.14	1.02	0.38	0.09	22.75	13	7.57
1	26	154	0.19	0.09	0.1	23.4	10.77	10.04	0.18	0.07	0.1	24.49	9.99	10.68	0.16	0.07	0.12	25.24	9	10.91
1	27	155	0.14	0.21	0.07	21.61	10.94	10.98	0.15	0.2	0.09	22.56	10.37	11.28	0.14	0.16	0.12	23.42	9.56	11.6
1	28	156	0.12	1.58	0.14	17.96	9.2	5.77	0.12	1.52	0.16	18.22	9.62	6.47	0.12	1.54	0.18	18.63	9.98	7.14
0	29	157	0.4	2.35	15.17	0.15	8.37	3.31	0.38	2.34	16.68	0.17	9.1	4.03	0.36	2.42	17.88	0.17	9.85	4.75
0	30	158	0.1	0.36	23.29	0.19	11.8	9.97	0.11	0.3	24.12	0.19	11.33	10.67	0.13	0.22	24.96	0.21	10.76	10.87
0	31	159	0.26	0.25	22.27	0.08	10.29	11.99	0.24	0.24	23.81	0.09	9.31	12.48	0.21	0.21	24.88	0.11	8.55	12.9
0	32	160	0.32	0.14	21.16	0.11	10.73	9.36	0.38	0.13	22.17	0.11	10.59	9.95	0.41	0.12	23.68	0.12	10.25	10.48
0	33	161	1.87	0.68	15.25	0.07	7.14	4.13	1.91	0.52	15.13	0.09	7.39	4.49	2.21	0.42	15.82	0.1	8.24	5.62
1	34	162	1.74	0.39	0.06	17.56	9.37	4.51	1.82	0.27	0.06	18.96	10.19	4.69	1.85	0.2	0.06	19.58	10.69	5.14
1	35	163	0.26	0.22	0.09	23.69	12.2	9.31	0.28	0.18	0.11	24.24	12.04	9.47	0.26	0.19	0.12	24.58	11.14	9.79

	1	36	164	0.13	0.28	0.09	22.64	9.56	11.4	0.15	0.27	0.11	23.81	9.02	11.96	0.14	0.21	0.13	24.86	8.45	12.06
	1	37	165	0.11	0.53	0.17	21.92	11.4	9.84	0.09	0.5	0.19	22.86	11.25	10.2	0.09	0.5	0.19	23.08	10.78	10.48
	0	38	166	0.29	1.38	20.72	0.14	12.86	7.18	0.22	1.43	21.83	0.14	12.89	8.31	0.27	1.41	22.73	0.19	12.91	8.74
	0	39	167	0.06	0.25	22.91	0.12	11.22	10.95	0.07	0.19	24.1	0.11	10.36	11.63	0.07	0.17	24.98	0.12	9.44	11.95
	0	40	168	0.2	0.23	21.23	0.11	11.31	10.88	0.16	0.2	22.55	0.1	10.38	11.65	0.13	0.17	23.81	0.13	9.74	12.45
	0	41	169	1.24	0.3	18.75	0.08	9.33	6.48	1.4	0.25	18.99	0.09	9.61	6.64	1.63	0.22	20.13	0.09	10.1	7.68

C. Simulated PD Distribution Plots

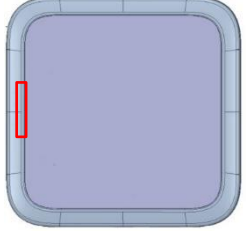
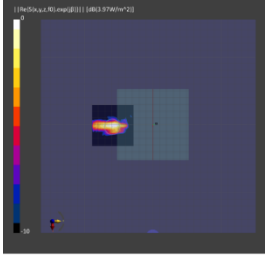
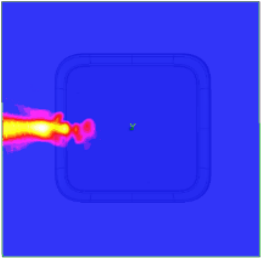
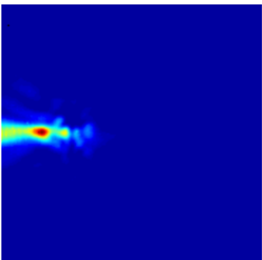
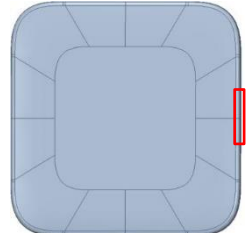
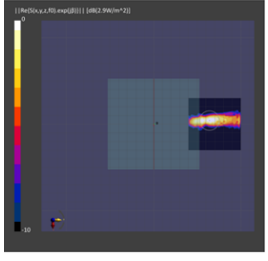
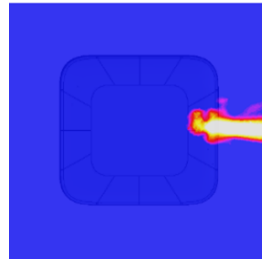
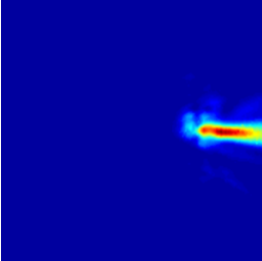

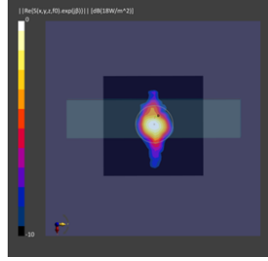
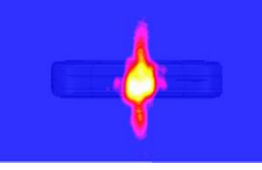
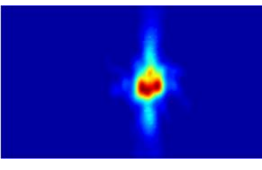
To comply with 2nd generation of Smart Transmit, entire EUT is simulated, therefore as suggested in Qualcomm document number 80-W2112-2 there is no need to print the PD distributions as the hotspot for all the beams is captured in simulation domain.

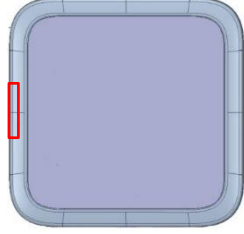
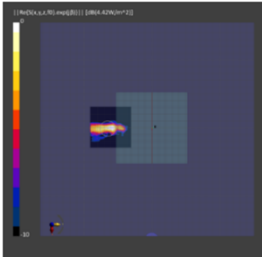
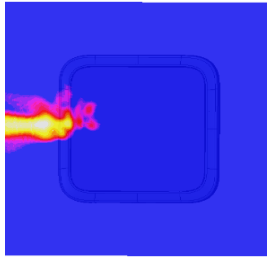
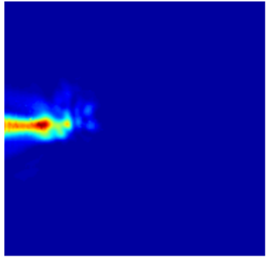
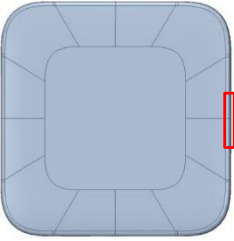
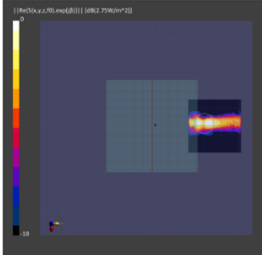
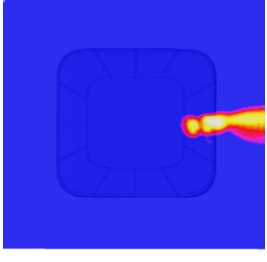
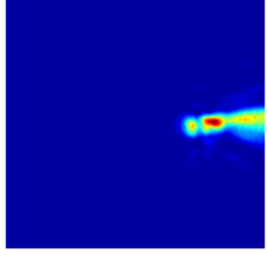

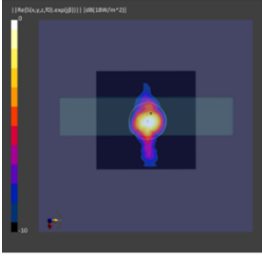
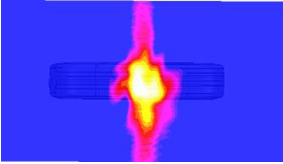
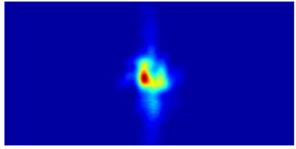
D PD Char Requirements for 2nd Generation of Smart transmit (GEN 2)

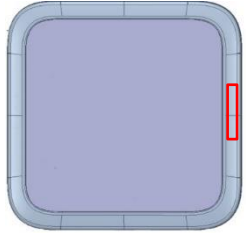
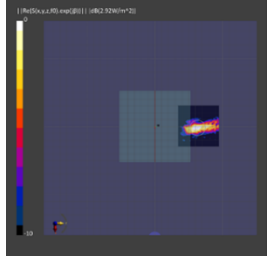
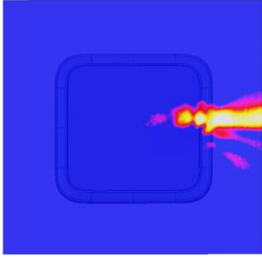
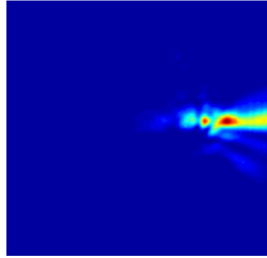
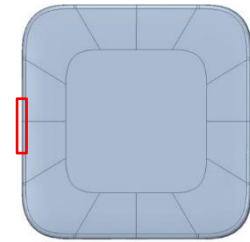
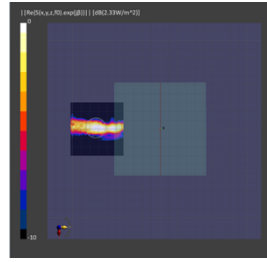
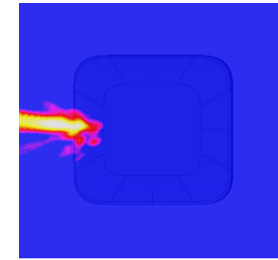
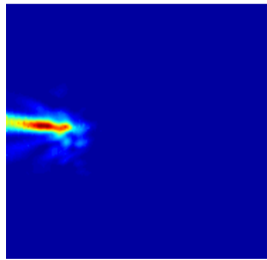

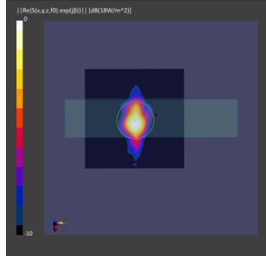
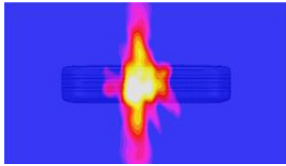
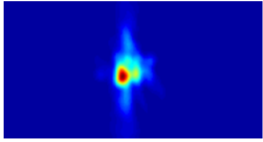
D.1 Verification 1

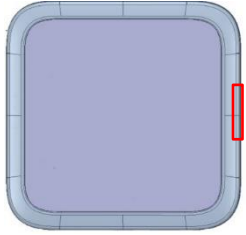
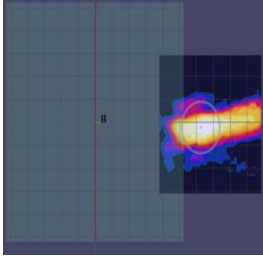
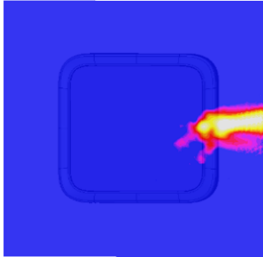
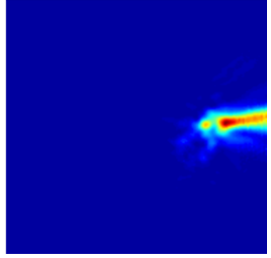
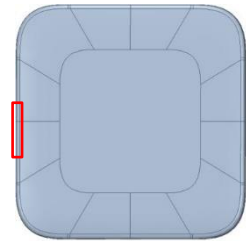
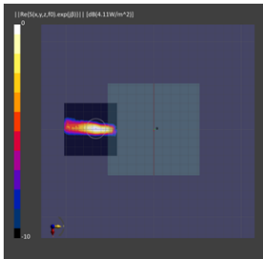
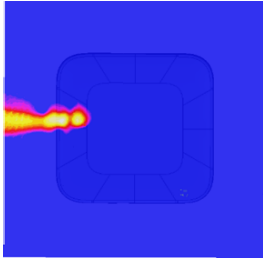
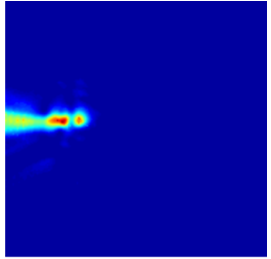

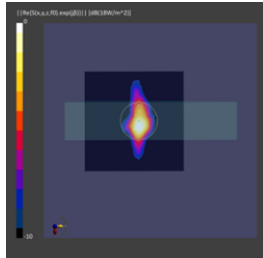
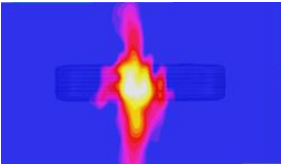
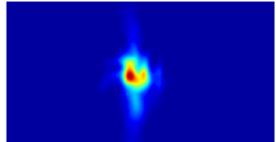
“Qualcomm MG script” is used to print the PD plots for all the beams selected and evaluated in Section 4-4 for model validation. PD distribution plots illustrated in Table 4-3 are compared to plots printed by MG script and are compared in Table D -1. It is noted that the values match well, hence validating the MG script.

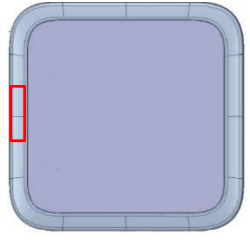
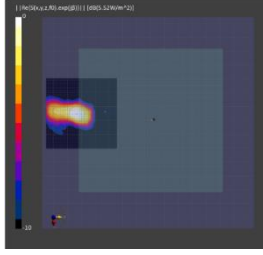

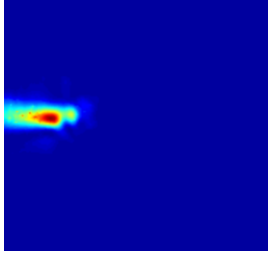
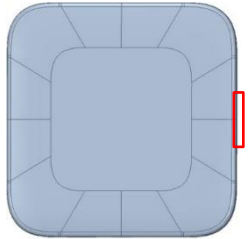
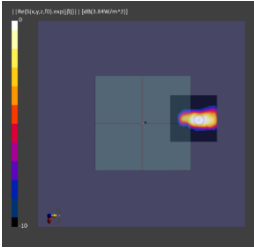
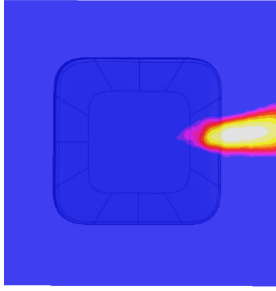
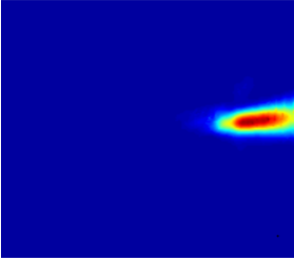

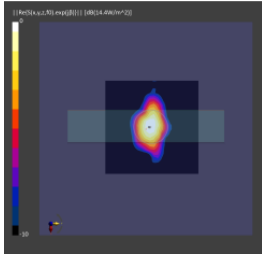
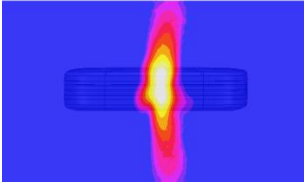
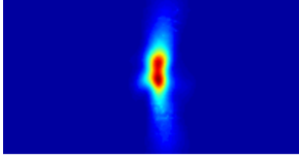
Table D - 1: Measured and simulated PD distribution for selected beams

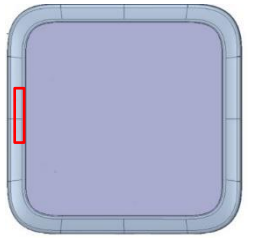
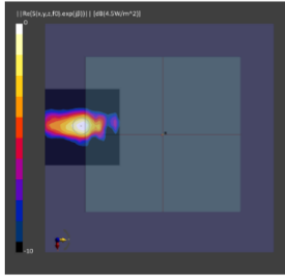
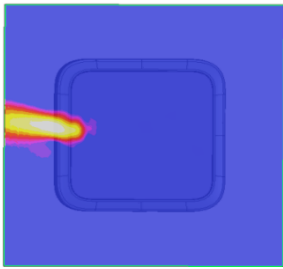
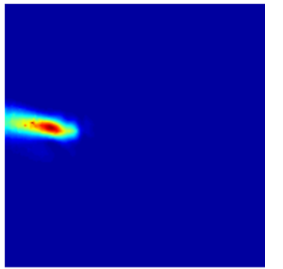
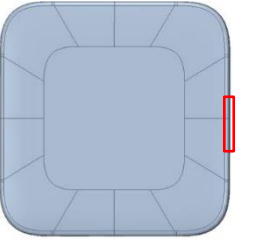
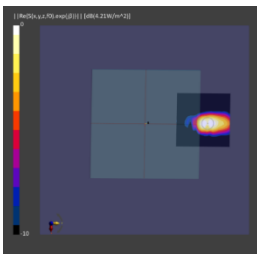
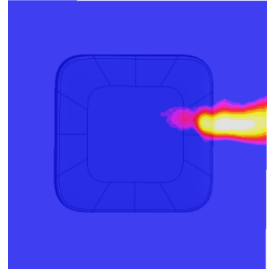
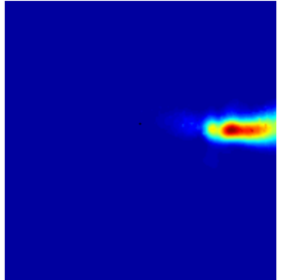

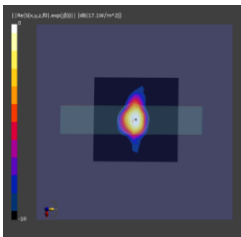
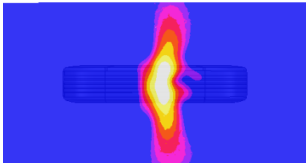
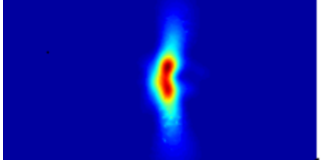
Band	Beam ID	Surface	View	Measured PD	Simulated PD	MG Script
N260	31	Top				
		Bottom				
		Left				

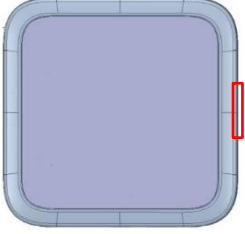
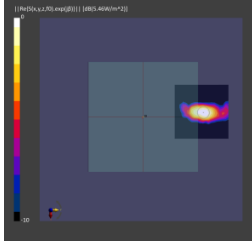
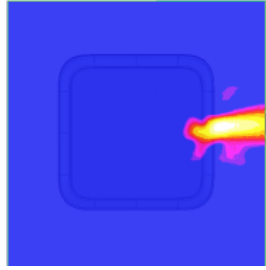
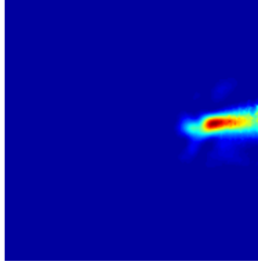
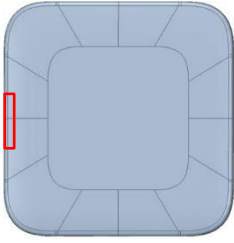
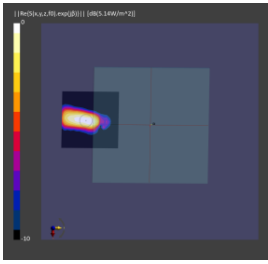
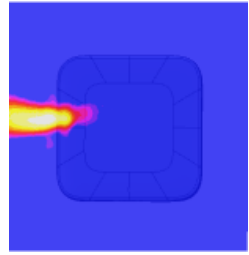
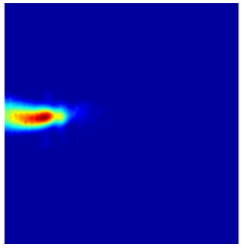

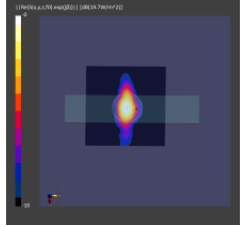
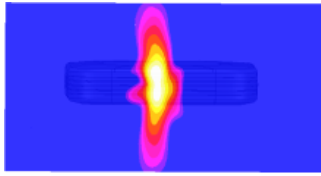
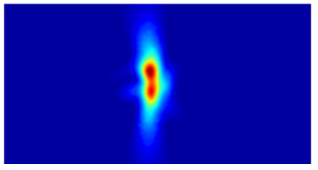
Band	Beam ID	Surface	View	Measured PD	Simulated PD	MG Script
N260	159	Top				
		Bottom				
		Left				

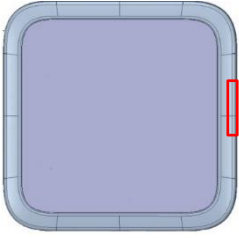
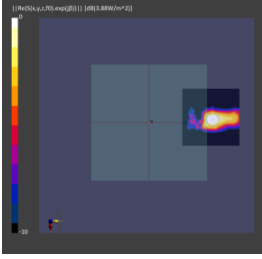
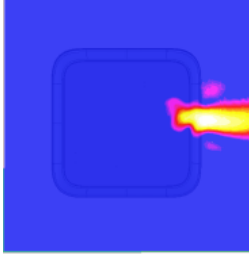
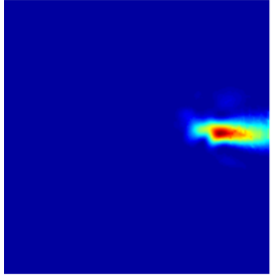
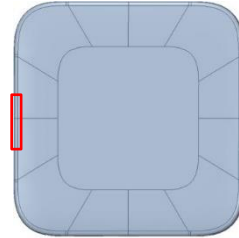
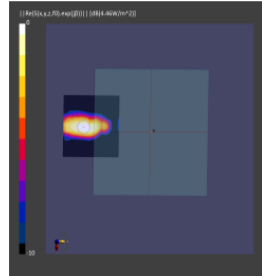
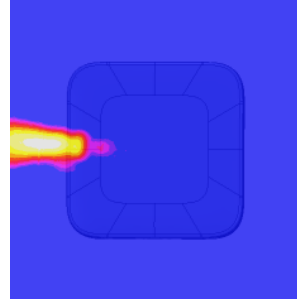
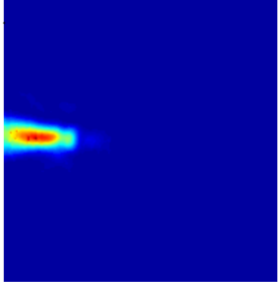
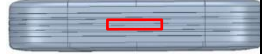
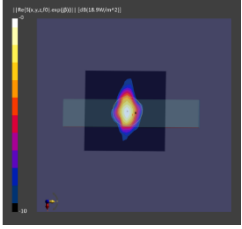
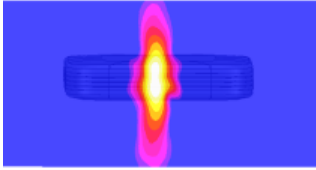
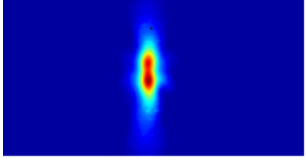
Band	Beam ID	Surface	View	Measured PD	Simulated PD	MG Script
N260	36	Top				
		Bottom				
		Right				

Band	Beam ID	Surface	View	Measured PD	Simulated PD	MG Script
N260	164	Top				
		Bottom				
		Right				

Band	Beam ID	Surface	View	Measured PD	Simulated PD	MG Script
N261	39	Top				
		Bottom				
		Left				

Band	Beam ID	Surface	View	Measured PD	Simulated PD	MG Script
N261	167	Top				
		Bottom				
		Left				

Band	Beam ID	Surface	View	Measured PD	Simulated PD	MG Script
N261	36	Top				
		Bottom				
		Right				

Band	Beam ID	Surface	View	Measured PD	Simulated PD	MG Script
N261	164	Top				
		Bottom				
		Right				

D-2 Verification 2:

“Qualcomm MG script” identifies the worst-case 4cm²PD and its location (x,y,z). This worst-case 4cm²PD is maximum 4cm²PD value out of all exposure surfaces when assuming the worst beam from each of the QTM’s are active. The script then identifies the worst beam from each module that contributes the most to the worst 4cm²PD and it prints their contribution factor, as well as the worst surface corresponding to the worst-case 4cm²PD, backoff value for each QTM and *verification.sim.powerlimit* (before backoff) value for each identified beams.

HFSS is used to calculate the simulated contribution factor for the identified beams. The simulated contribution factor, $C_{simulated}(i,j)$, for beam i from QTM j can be computed by

$$C_{simulated}(i,j) = \frac{4 \text{ cm}^2 \text{ PD at } (x, y, z) \text{ at } verification.sim.powerlimit}{PD_design_target}$$

Following two conditions must be verified:

1. the printed contribution factor, $c(i,j)$, matches the simulated contribution factor, $C_{simulated}(i,j)$, obtained from within 2% of numerical tolerance.
2. the normalized combined PD at worst-case location of (x,y,z) does not exceed 1.0, i.e.,

$$normalized \ combined \ PD = \sum (b_j * c(i, j)) \leq 1.0$$

where *combined PD* = PD from current QTM + PD contributions from other QTM’s; b_j = backoff value for QTM j , j = QTM #; $c(i,j)$ = contribution factor of beam i from QTM j to the worst 4cm²PD. Both b_j and $c(i,j)$ are printed from “Qualcomm MG script”.

The above two verification are tabulated below in Table D-2.

Table D -2 a: Contribution factors from Qualcomm MG script and from HFSS for selected beams, and normalized combined PD verification, for EUT with 2 QTM's at n260 band

Worst-Case Surface:					Right	
Worst-Case Location(x,y,z):					(0.06250m, 0.01190m, -0.02150m)	
PD_Design_Target					4.75 W/m ²	
Values printed from Qualcomm MG script					Values obtained from HFSS	
QTM #	Beam ID	C _{MGScript}	Backoff Factor b _j	verification.sim.power _{limit} (before backoff) [dBm]	Simulated 4cm ² at worst location at verification.sim.power _{limit} on Right	C _{Simulated} (I,j) = 4cm ² PD(I,j)/ PD_design_target
0	145	0.0092	0.9772	9.48	.020*10 [^] ((9.48-6)/10)	0.044/4.75 = 0.0093
1	13	1.0000	0.9772	10.24	1.78*10 [^] ((10.24-6)/10)	4.72/4.75 = 0.994
Verify 1:	$c(i,j) = C_{simulated}(i,j), i = 145, 13; j = 0, 1$ i. $c(0,145) [0.0092] = C_{simulated}(0,145) [0.0093]$ ii. $c(1,13) [1.0] = C_{simulated}(0,13) [0.994]$					
Verify 2:	$b_0 * c(0,145) + b_1 * c(1,13) = 0.9772 * (0.0092) + 0.9772 * (1) = 0.986 < 1$					

Table D -2 b: Contribution factors from Qualcomm MG script and from HFSS for selected beams, and normalized combined PD verification, for EUT with 2 QTM's at n261 band

Worst-Case Surface					Right	
Worst-Case Location					(0.06250m, 0.00905m, -0.0177m)	
PD_Design_Target					4.75 W/m ²	
Derived From MG Script					Obtained From HFSS	
QTM #	Beam ID	C _{MGScript}	Backoff(b _j)	Verification.sim.power _{limit} (before backoff) dBm	Simulated 4cm ² at worst location	C _{Simulated} (derived from HFSS)
0	29	0.0108	0.9772	5.21	0.060249*10 [^] ((5.21-6)/10)	0.050228457/4.75 = 0.0106
1	28	1.00	0.9772	2.94	9.585795*10 [^] ((2.94-6)/10)	4.7383619/4.75 = 0.998
Verify 1:	$c(i,j) = C_{simulated}(i,j), i = 29, 28; j = 0, 1$ i. $c(0,29) [0.0108] = C_{simulated}(0,29) [0.0106]$ ii. $c(1,28) [1.0] = C_{simulated}(0,28) [0.998]$					
Verify 2:	$b_0 * c(0,29) + b_1 * c(1,28) = 0.9772 * (0.0101) + 0.9772 * (1) = 0.987 < 1$					

D-3 verification 3:

Measure power density for the beams identified by “Qualcomm MG script” on their corresponding worst surfaces printed from the script. Set the device in FTM mode, the PD measurement should be performed at the reference power level with CW modulation. Scale the measured PD to obtain $4cm^2PD(i,j)$ for beam i from QTM j at their *input.power.limit*. Demonstrate that the *combined PD* (i.e., $\sum [c(i,j)*PD(i,j)]$) at the printed worst surface of QTM j is less than or equal to PD_design_target within the uncertainty at reference power level, i.e.,

$$combined\ PD = \sum [c(i,j) * measured\ 4cm^2PD(i,j)] \leq PD_{design_target} + uncertainty\ at\ reference\ power\ level(6\ dBm)$$

The verification is tabulated in Table D-3 below.

Table D - 3 a: Measured 4cm² PD on worst surface and combined PD at worst-case location for EUT with 2 QTM's at n260 band

QTM #	Beam ID	Dominant Surface	Measure 4cm ² PD at <i>input power.limit</i> on dominant Surface
0	145	Left	2.40
1	13	Right	3.20
<i>Combined PD at Worst-case location (x, y, z)</i>	$0.0092 * meas.4cm^2PD (145,0) + 1 * meas.4cm^2PD (13,1) = 3.22\ W/m^2$		
<i>PD_design_target + Uncertainty at ref power(6dBm)</i>	$= 4.75 * 10^{0.2} = 7.528\ W/m^2$		
Verify	Combined PD [3.22 W/m ²] < PD_design_target + Uncertainty [7.53 W/m ²]		

Table D - 3 b: Measured 4cm² PD on worst surface and combined PD at worst-case location for EUT with 2 QTM's at n261 band

QTM #	Beam ID	Dominant Surface	Measure 4cm ² PD at <i>input power.limit</i> on dominant Surface
0	29	Left	3.18
1	28	Right	2.34
<i>Combined PD at Worst-case location (x, y, z)</i>	$0.0108 * meas.4cm^2PD (29,0) + 1 * meas.4cm^2PD (28,1) = ?$		
<i>PD_design_target + Uncertainty at ref power(6dBm)</i>	$= 4.75 * 10^{0.2} = 7.528\ W/m^2$		
Verify	Combined PD [2.37 W/m ²] < PD_design_target + Uncertainty [7.53 W/m ²]		