



FCC RADIO TEST REPORT

FCC ID : PY322100558
Equipment : Netgear 5G MHS Travel Router
Brand Name : Netgear
Model Name : MR6400
Applicant : Netgear Inc
350 E. Plumeria Drive, San Jose, CA 95134, United States
Manufacturer : Netgear Inc
350 E. Plumeria Drive, San Jose, CA 95134, United States
Standard : FCC 47 CFR Part 2, 22(H), 24(E), 27

The product was received on Apr. 08, 2022 and testing was performed from Apr. 26, 2022 to May 11, 2022. We, Sporton International Inc. EMC & Wireless Communications Laboratory, would like to declare that the tested sample has been evaluated in accordance with the test procedures given in ANSI / TIA-603-E and has been in compliance with the applicable technical standards.

The test results in this variant report apply exclusively to the tested model / sample. Without written approval of Sporton International Inc. EMC & Wireless Communications Laboratory, the test report shall not be reproduced except in full.

Approved by: Louis Wu

Sporton International Inc. EMC & Wireless Communications Laboratory

No. 52, Huaya 1st Rd., Guishan Dist., Taoyuan City 333, Taiwan (R.O.C.)



Table of Contents

History of this test report	3
Summary of Test Result	4
1 General Description	6
1.1 Product Feature of Equipment Under Test.....	6
1.2 Testing Location	7
1.3 Applicable Standards.....	7
2 Test Configuration of Equipment Under Test	8
2.1 Test Mode.....	8
2.2 Connection Diagram of Test System.....	10
2.3 Support Unit used in test configuration and system	10
2.4 Measurement Results Explanation Example.....	10
2.5 Frequency List of Low/Middle/High Channels	11
3 Conducted Test Items	14
3.1 Measuring Instruments	14
3.2 Conducted Output Power and ERP/EIRP	15
3.3 Peak-to-Average Ratio	16
3.4 Occupied Bandwidth.....	17
3.5 Conducted Band Edge	18
3.6 Conducted Spurious Emission	20
3.7 Frequency Stability	21
4 Radiated Test Items	22
4.1 Measuring Instruments	22
4.2 Radiated Spurious Emission Measurement	24
5 List of Measuring Equipment	25
6 Uncertainty of Evaluation	27
Appendix A. Test Results of Conducted Test	
Appendix B. Test Results of Radiated Test	
Appendix C. Test Setup Photographs	



History of this test report

Report No.	Version	Description	Issued Date
FG190614-03B	01	Initial issue of report	May 11, 2022



Summary of Test Result

Report Clause	Ref Std. Clause	Test Items	Result (PASS/FAIL)	Remark
3.2	§2.1046	Conducted Output Power	Reporting only	-
	§22.913 (a)(2)	Effective Radiated Power (n5)	Pass	
	§27.50 (c)(10)	Effective Radiated Power (n12) (n71)		
	§24.232 (c) §27.50 (h)(2)	Equivalent Isotropic Radiated Power (n2) (n25) (n41)		
	§27.50 (d)(4)	Equivalent Isotropic Radiated Power (n66)		
3.3	§24.232 (d) §27.50 (d)(5)	Peak-to-Average Ratio	Pass	-
3.4	§2.1049	Occupied Bandwidth	Reporting only	-
3.5	§2.1051 §22.917 (a) §24.238 (a) §27.53 (g) §27.53 (h)	Conducted Band Edge Measurement (n2) (n5) (n12) (n25) (n66) (n71)	Pass	-
	§2.1051 §27.53 (m)(4)	Conducted Band Edge Measurement (n41)		
3.6	§2.1051 §22.917 (a) §24.238 (a) §27.53 (g) §27.53 (h)	Conducted Spurious Emission (n2) (n5) (n12) (n25) (n66) (n71)	Pass	-
	§2.1051 §27.53 (m)(4)	Conducted Spurious Emission (n41)		
3.7	§2.1055 §22.355 §24.235 §27.54	Frequency Stability Temperature & Voltage	Pass	-



Report Clause	Ref Std. Clause	Test Items	Result (PASS/FAIL)	Remark
4.2	§2.1053 §22.917 (a) §24.238 (a) §27.53 (g) §27.53 (h)	Radiated Spurious Emission (n2) (n5) (n12) (n25) (n66) (n71)	Pass	Under limit 9.38 dB at 10684.900 MHz
	§2.1051 §27.53 (m)(4)	Radiated Spurious Emission (n41)		

Remark: This is a variant report by adding support band via software. All the test cases were performed on original report which can be referred to Sporton Report Number FG190614B. Based on the original report, the test cases were verified.

Declaration of Conformity:
1. The test results (PASS/FAIL) with all measurement uncertainty excluded are presented in accordance with the regulation limits or requirements declared by manufacturers. It's means measurement values may risk exceeding the limit of regulation standards, if measurement uncertainty is include in test results.
2. The measurement uncertainty please refer to this report "Uncertainty of Evaluation".
Comments and Explanations:
The product specifications of the EUT presented in the report are declared by the manufacturer who shall take full responsibility for the authenticity.

Reviewed by: Avis Chuang
Report Producer: Vivian Hsu



1 General Description

1.1 Product Feature of Equipment Under Test

LTE/5G NR, Wi-Fi 2.4GHz 802.11b/g/n/ac/ax, Wi-Fi 5GHz 802.11a/n/ac/ax, Wi-Fi 6GHz 802.11a/n/ac/ax, and GNSS

Product Feature	
Antenna Type	WWAN: <Ant. 1> : Monopole Antenna <Ant. 2> : Monopole Antenna WLAN: <Ant. 3> : Monopole Antenna <Ant. 4> : Monopole Antenna GPS: PIFA Antenna

Remark: The EUT's information above was declared by manufacturer. Please refer to Comments and Explanations in report summary.

Antenna Information	
Internal Antenna Gain	<Ant. 1> : 5G NR n2: 0.67 dBi 5G NR n5: -0.88 dBi 5G NR n12: -0.83 dBi 5G NR n25: 0.67 dBi 5G NR n41: 0.39 dBi 5G NR n71: -0.83 dBi <Ant. 2> : 5G NR n2: 0.45 dBi 5G NR n25: 0.45 dBi 5G NR n41: -0.53 dBi 5G NR n66: 0.54 dBi
External Antenna Gain	<Ant. 1> : 5G NR n2: 4.00 dBi 5G NR n5: 4.00 dBi 5G NR n12: 4.00 dBi 5G NR n25: 4.00 dBi 5G NR n41: 4.00 dBi 5G NR n71: 4.00 dBi <Ant. 2> : 5G NR n2: 4.00 dBi 5G NR n5: 4.00 dBi 5G NR n41: 4.00 dBi 5G NR n66: 4.00 dBi
External Connector	TS9

Remark:

1. TS9 connector is for the external antennas, while the external antennas are connected, RF outputs are switched from internal antenna 1/2 to the external one.
2. The maximum antenna gain allowed for the external antenna is limited by the numbers in the table, and also illustrated in the user manual.



1.2 Testing Location

Test Site	Sporton International Inc. EMC & Wireless Communications Laboratory
Test Site Location	No.52, Huaya 1st Rd., Guishan Dist., Taoyuan City 333, Taiwan (R.O.C.) TEL: +886-3-327-3456 FAX: +886-3-328-4978
Test Site No.	Sporton Site No. TH03-HY
Test Engineer	Luffy Lin and Ivy Yeh
Temperature (°C)	20~24
Relative Humidity (%)	50~58

Test Site	Sporton International Inc. Wensan Laboratory
Test Site Location	No.58, Aly. 75, Ln. 564, Wenhua 3rd, Rd., Guishan Dist., Taoyuan City 333010, Taiwan (R.O.C.) TEL: +886-3-327-0868 FAX: +886-3-327-0855
Test Site No.	Sporton Site No. 03CH16-HY (TAF Code: 3786)
Test Engineer	Andy Yang and Karl Hou
Temperature (°C)	21~25
Relative Humidity (%)	48~58
Remark	The Radiated Spurious Emission test item subcontracted to Sporton International Inc. Wensan Laboratory

Note: The test site complies with ANSI C63.4 2014 requirement.

FCC Designation No.: TW1190 and TW3786

1.3 Applicable Standards

According to the specifications of the manufacturer, the EUT must comply with the requirements of the following standards:

- ♦ ANSI C63.26-2015
- ♦ ANSI / TIA-603-E
- ♦ FCC 47 CFR Part 2, 22(H), 24(E), 27
- ♦ FCC KDB 971168 D01 Power Meas. License Digital Systems v03r01
- ♦ FCC KDB 412172 D01 Determining ERP and EIRP v01r01
- ♦ FCC KDB 414788 D01 Radiated Test Site v01r01.

Remark:

1. All test items were verified and recorded according to the standards and without any deviation during the test.
2. The TAF code is not including all the FCC KDB listed without accreditation.



2 Test Configuration of Equipment Under Test

2.1 Test Mode

Antenna port conducted and radiated test items listed below are performed according to KDB 971168 D01 Power Meas. License Digital Systems v03r01 with maximum output power.

For radiated measurement, the measured emission level of the EUT was maximized by rotating the EUT on a turntable, adjusting the orientation of the EUT and EUT antenna in three orthogonal axis (X: flat, Y: portrait, Z: landscape), and adjusting the measurement antenna orientation, following C63.26 exploratory test procedures and find (X Plane with Adapter : <Ant. 2>: 5G NR n41; <Ant. 2+1>: EN-DC 2A-n41A, EN-DC 66A-n25A; Y Plane with Adapter : <Ant. 1>: 5G NR n71; <Ant. 2>: 5G NR n25; <Ant. 1+2>: EN-DC 12A-n25A; <Ant. 2+1>: EN-DC 2A-n71A, EN-DC 66A-n71A as worst plane.

Test Items	NR Band	Bandwidth (MHz)							Modulation					RB #			Test Channel		
		5	10	15	20	30	40	50	PI/2 BPSK	QPSK	16QAM	64QAM	256QAM	1	Half	Full	L	M	H
Max. Output Power	n25	v	v	v	v	-	-	-	v	v	v	v	v	v	v	v	v	v	v
	n71	v	v	v	v	-	-	-	v	v	v	v	v	v	v	v	v	v	v
Peak-to-Average Ratio	n25				v	-	-	-	v	v	v	v	v			v		v	
	n71				v	-	-	-	v	v	v	v	v			v		v	
26dB and 99% Bandwidth	n25	v	v	v	v	-	-	-	v	v	v	v	v			v		v	
	n71	v	v	v	v	-	-	-	v	v	v	v	v			v		v	
Conducted Band Edge	n25	v	v	v	v	-	-	-	v	v	v	v	v	v		v	v		v
	n71	v	v	v	v	-	-	-	v	v	v	v	v	v		v	v		v
Conducted Spurious Emission	n25	v				-	-	-		v				v			v	v	v
	n71	v				-	-	-		v				v			v	v	v
Frequency Stability	n25				v	-	-	-	v							v		v	
	n71				v	-	-	-	v							v		v	
E.R.P / E.I.R.P	n25	v	v	v	v	-	-	-	v	v	v	v	v	Max. Power					
	n71	v	v	v	v	-	-	-	v	v	v	v	v						
Radiated Spurious Emission	n25	Worst Case														v	v	v	
	n71	Worst Case														v	v	v	
Remark	<ol style="list-style-type: none"> The mark "v" means that this configuration is chosen for testing The mark "-" means that this bandwidth is not supported. The device is investigated from 30MHz to 10 times of fundamental signal for radiated spurious emission test under different RB size/offset and modulations in exploratory test. Subsequently, only the worst case emissions are reported. Test combination is EN-DC 12A-n25A, EN-DC 66A-n25A, EN-DC 2A-n71A, EN-DC 66A-n71A. For radiated measurement, pre-scanned in two modes, DFT-s OFDM and CP OFDM. The worst cases (DFT-s OFDM) were recorded in this report, the worst modes of FR1 and LTE for simultaneous transmission were verified and compliant. 																		



Test Items	NR Band	Bandwidth (MHz)											Modulation					RB #			Test Channel				
		10	15	20	30	40	50	60	70	80	90	100	PI/2 BPSK	QPSK	16QAM	64QAM	256QAM	1	Half	Full	L	M	H		
Max. Output Power	n41	-	-	v	v	v	v	v	v	v	v	v	v	v	v	v	v	v	v	v	v	v	v	v	v
Peak-to-Average Ratio	n41	-	-	v									v	v	v	v	v			v		v			
26dB and 99% Bandwidth	n41	-	-	v	v	v	v	v	v	v	v	v	v	v	v	v	v			v		v			
Conducted Band Edge	n41	-	-	v	v	v	v	v	v	v	v	v	v	v	v	v	v	v		v	v		v		
Conducted Spurious Emission	n41	-	-	v										v					v			v	v	v	
Frequency Stability	n41	-	-	v									v							v		v			
E.R.P / E.I.R.P	n41	-	-	v	v	v	v	v	v	v	v	v	v	v	v	v	v	Max Power							
Radiated Spurious Emission	n41	Worst Case																			v	v	v		
Remark	<ol style="list-style-type: none"> The mark "v " means that this configuration is chosen for testing The mark "- " means that this bandwidth is not supported. The device is investigated from 30MHz to 10 times of fundamental signal for radiated spurious emission test under different RB size/offset and modulations in exploratory test. Subsequently, only the worst case emissions are reported. Test combination is EN-DC 2A-n41A. For radiated measurement, pre-scanned in two modes, DFT-s OFDM and CP OFDM. The worst cases (DFT-s OFDM) were recorded in this report, the worst modes of FR1 and LTE for simultaneous transmission were verified and compliant. 																								

2.2 Connection Diagram of Test System

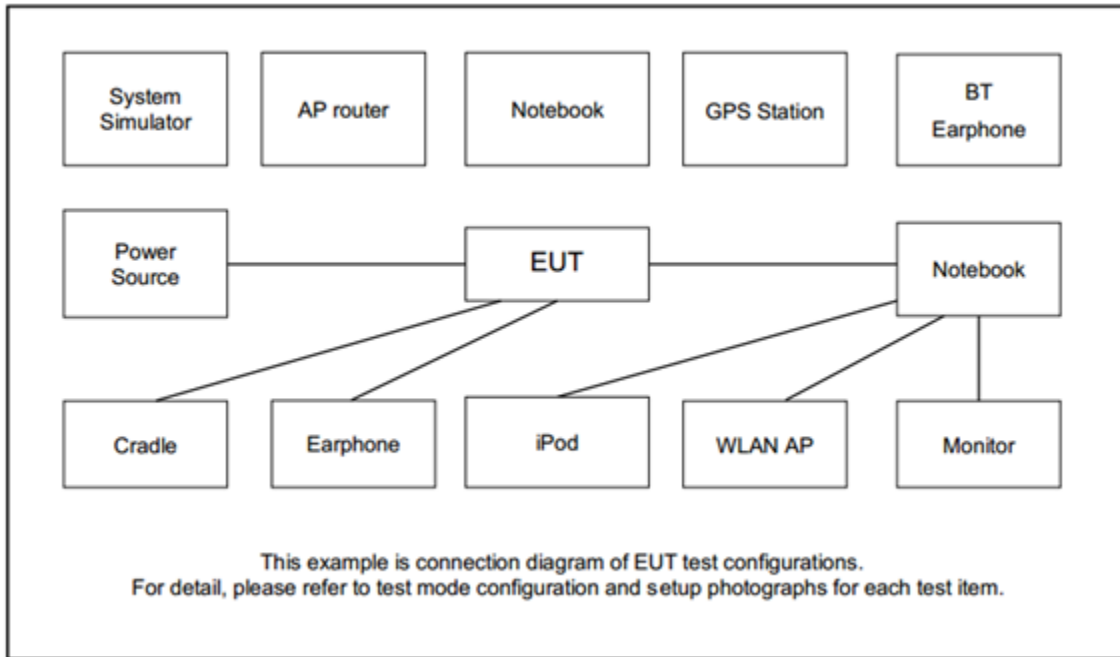

2.3 Support Unit used in test configuration and system

Item	Equipment	Brand Name	Model No.	FCC ID	Data Cable	Power Cord
1.	5G Wireless Test Platform	Keysight	MT8000A	N/A	N/A	Unshielded, 1.8m

2.4 Measurement Results Explanation Example

For all conducted test items:

The offset level is set in the spectrum analyzer to compensate the RF cable loss and attenuator factor between EUT conducted output port and spectrum analyzer. With the offset compensation, the spectrum analyzer reading level is exactly the EUT RF output level.

The spectrum analyzer offset is derived from RF cable loss and attenuator factor.

Offset = RF cable loss + attenuator factor.

Following shows an offset computation example with cable loss 4.2 dB and 10dB attenuator.

Example :

Offset(dB) = RF cable loss(dB) + attenuator factor(dB).

$$= 4.2 + 10 = 14.2 \text{ (dB)}$$



2.5 Frequency List of Low/Middle/High Channels

5G NR Band n2 Channel and Frequency List				
BW [MHz]	Channel/Frequency(MHz)	Lowest	Middle	Highest
20	Channel	372000	376000	380000
	Frequency	1860	1880	1900
15	Channel	371500	376000	380500
	Frequency	1857.5	1880	1902.5
10	Channel	371000	376000	381000
	Frequency	1855	1880	1905
5	Channel	370500	376000	381500
	Frequency	1852.5	1880	1907.5

5G NR Band n5 Channel and Frequency List				
BW [MHz]	Channel/Frequency(MHz)	Lowest	Middle	Highest
20	Channel	166800	167300	167800
	Frequency	834	836.5	839
15	Channel	166300	167300	168300
	Frequency	831.5	836.5	841.5
10	Channel	165800	167300	168800
	Frequency	829	836.5	844
5	Channel	165300	167300	169300
	Frequency	826.5	836.5	846.5

5G NR Band n12 Channel and Frequency List				
BW [MHz]	Channel/Frequency(MHz)	Lowest	Middle	Highest
15	Channel	141300	141500	141700
	Frequency	706.5	707.5	708.5
10	Channel	140800	141500	142200
	Frequency	704	707.5	711
5	Channel	140300	141500	142700
	Frequency	701.5	707.5	713.5



5G NR Band n25 Channel and Frequency List				
BW [MHz]	Channel/Frequency(MHz)	Lowest	Middle	Highest
20	Channel	372000	376500	381000
	Frequency	1860	1882.5	1905
15	Channel	371500	376500	381500
	Frequency	1857.5	1882.5	1907.5
10	Channel	371000	376500	382000
	Frequency	1855	1882.5	1910
5	Channel	370500	376500	382500
	Frequency	1852.5	1882.5	1912.5

5G NR Band n41 Channel and Frequency List				
BW [MHz]	Channel/Frequency(MHz)	Lowest	Middle	Highest
100	Channel	509202	518598	528000
	Frequency	2546.01	2592.99	2640
90	Channel	508200	518598	528996
	Frequency	2541	2592.99	2644.98
80	Channel	507204	518598	529998
	Frequency	2536.02	2592.99	2649.99
60	Channel	505200	518598	531996
	Frequency	2526	2592.99	2659.98
50	Channel	504204	518598	532998
	Frequency	2521.02	2592.99	2664.99
40	Channel	503202	518598	534000
	Frequency	2516.01	2592.99	2670
30	Channel	502200	518598	534996
	Frequency	2511	2592.99	2674.98
20	Channel	501204	518598	535998
	Frequency	2506.02	2592.99	2679.99
15	Channel	500700	518598	536496
	Frequency	2503.5	2592.99	2682.48
10	Channel	500202	518598	537000
	Frequency	2501.01	2592.99	2685



5G NR Band n66 Channel and Frequency List				
BW [MHz]	Channel/Frequency(MHz)	Lowest	Middle	Highest
40	Channel	346000	349000	352000
	Frequency	1730	1745	1760
30	Channel	345000	349000	353000
	Frequency	1725	1745	1765
20	Channel	344000	349000	354000
	Frequency	1720	1745	1770
15	Channel	343500	349000	354500
	Frequency	1717.5	1745	1772.5
10	Channel	343000	349000	355000
	Frequency	1715	1745	1775
5	Channel	342500	349000	355500
	Frequency	1712.5	1745	1777.5

5G NR Band n71 Channel and Frequency List				
BW [MHz]	Channel/Frequency(MHz)	Lowest	Middle	Highest
20	Channel	134600	136100	137600
	Frequency	673	680.5	688
15	Channel	134100	136100	138100
	Frequency	670.5	680.5	690.5
10	Channel	133600	136100	138600
	Frequency	668	680.5	693
5	Channel	133100	136100	139100
	Frequency	665.5	680.5	695.5

3 Conducted Test Items

3.1 Measuring Instruments

See list of measuring instruments of this test report.

3.1.1 Test Setup

3.1.2 Conducted Output Power

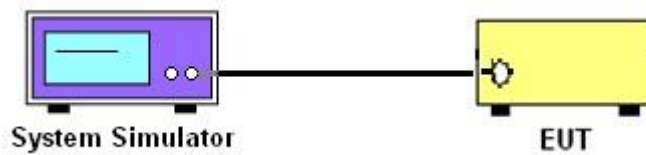

3.1.3 Peak-to-Average Ratio, Occupied Bandwidth ,Conducted Band-Edge and Conducted Spurious Emission

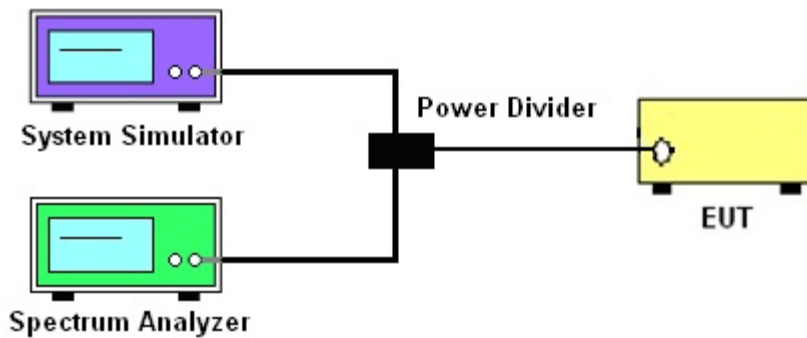

3.1.4 Frequency Stability

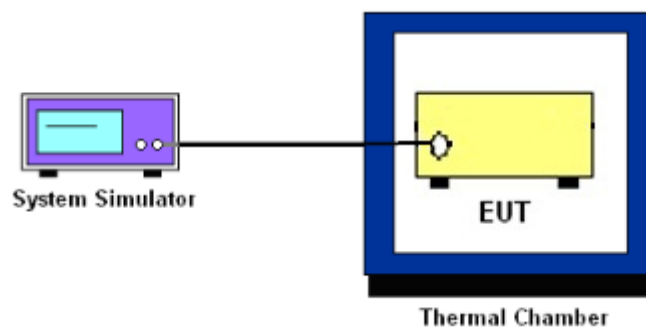

3.1.5 Test Result of Conducted Test

Please refer to Appendix A.



3.2 Conducted Output Power and ERP/EIRP

3.2.1 Description of the Conducted Output Power Measurement and ERP/EIRP Measurement

A system simulator was used to establish communication with the EUT. Its parameters were set to force the EUT transmitting at maximum output power. The measured power in the radio frequency on the transmitter output terminals shall be reported.

The ERP of mobile transmitters must not exceed 7 Watts for 5G NR n5

The ERP of mobile transmitters must not exceed 3 Watts for 5G NR n12 and n71

The EIRP of mobile transmitters must not exceed 2 Watts for 5G NR n2 and n25 and n41

The EIRP of mobile transmitters must not exceed 1 Watts for 5G NR n66

According to KDB 412172 D01 Power Approach,

$EIRP = P_T + G_T - L_C$, $ERP = EIRP - 2.15$, where

P_T = transmitter output power in dBm

G_T = gain of the transmitting antenna in dBi

L_C = signal attenuation in the connecting cable between the transmitter and antenna in dB

3.2.2 Test Procedures

1. The transmitter output port was connected to the system simulator.
2. Set EUT at maximum power through the system simulator.
3. Select lowest, middle, and highest channels for each band and different modulation.
4. Measure and record the power level from the system simulator.



3.3 Peak-to-Average Ratio

3.3.1 Description of the PAR Measurement

Power Complementary Cumulative Distribution Function (CCDF) curves provide a means for characterizing the power peaks of a digitally modulated signal on a statistical basis. A CCDF curve depicts the probability of the peak signal amplitude exceeding the average power level. Most contemporary measurement instrumentation include the capability to produce CCDF curves for an input signal provided that the instrument's resolution bandwidth can be set wide enough to accommodate the entire input signal bandwidth. In measuring transmissions in this band using an average power technique, the peak-to-average ratio (PAR) of the transmission may not exceed 13 dB.

3.3.2 Test Procedures

The testing follows ANSI C63.26-2015 Section 5.2.6

1. The EUT was connected to spectrum and system simulator via a power divider.
2. Set the CCDF (Complementary Cumulative Distribution Function) option in spectrum analyzer.
3. The highest RF powers were measured and recorded the maximum PAPR level associated with a probability of 0.1 %.
4. Record the deviation as Peak to Average Ratio.



3.4 Occupied Bandwidth

3.4.1 Description of Occupied Bandwidth Measurement

The occupied bandwidth is the width of a frequency band such that, below the lower and above the upper frequency limits, the mean powers emitted are each equal to a specified percentage 0.5% of the total mean transmitted power.

The 26 dB emission bandwidth is defined as the frequency range between two points, one above and one below the carrier frequency, at which the spectral density of the emission is attenuated 26 dB below the maximum in-band spectral density of the modulated signal. Spectral density (power per unit bandwidth) is to be measured with a detector of resolution bandwidth equal to approximately 1.0% of the emission bandwidth.

3.4.2 Test Procedures

The testing follows ANSI C63.26-2015 Section 5.4.3 (26dB) and Section 5.4.4 (99OB)

1. The EUT was connected to spectrum analyzer and system simulator via a power divider.
2. The spectrum analyzer center frequency is set to the nominal EUT channel center frequency. The span range for the spectrum analyzer shall be between two and five times the anticipated OBW.
3. The nominal resolution bandwidth (RBW) shall be in the range of 1 to 5 % of the anticipated OBW, and the VBW shall be at least 3 times the RBW.
4. Set the detection mode to peak, and the trace mode to max hold.
5. Determine the reference value: Set the EUT to transmit a modulated signal. Allow the trace to stabilize. Set the spectrum analyzer marker to the highest level of the displayed trace.
(this is the reference value)
6. Determine the “-26 dB down amplitude” as equal to (Reference Value – X).
7. Place two markers, one at the lowest and the other at the highest frequency of the envelope of the spectral display such that each marker is at or slightly below the “-X dB down amplitude” determined in step 6. If a marker is below this “-X dB down amplitude” value it shall be placed as close as possible to this value. The OBW is the positive frequency difference between the two markers.
8. Use the 99 % power bandwidth function of the spectrum analyzer and report the measured bandwidth.



3.5 Conducted Band Edge

3.5.1 Description of Conducted Band Edge Measurement

22.917(a)

For operations in the 824 – 849 MHz band, the FCC limit is $43 + 10\log_{10}(P[\text{Watts}])$ dB below the transmitter power $P(\text{Watts})$ in a 100kHz bandwidth. However, in the 1MHz bands immediately outside and adjacent to the licensee's frequency block, a resolution bandwidth of at least one percent of the emission bandwidth of the fundamental emission of the transmitter may be employed.

24.238 (a)

For operations in the 1850-1910 and 1930-1990 MHz band, the FCC limit is $43 + 10\log_{10}(P[\text{Watts}])$ dB below the transmitter power $P(\text{Watts})$ in a 1MHz bandwidth. However, in the 1 MHz bands immediately outside and adjacent to the frequency block a resolution bandwidth of at least one percent of the emission bandwidth of the fundamental emission of the transmitter may be employed.

27.53 (g)

For operations in the 600MHz band and 698-746 MHz band, the FCC limit is $43 + 10\log_{10}(P[\text{Watts}])$ dB below the transmitter power $P(\text{Watts})$ in a 100 kHz bandwidth. However, in the 100 kilohertz bands immediately outside and adjacent to a licensee's frequency block, a resolution bandwidth of at least 30 kHz may be employed.

27.53 (h)

For operations in the 1710 – 1755 MHz band, 1755-1780 MHz, the FCC limit is $43 + 10\log_{10}(P[\text{Watts}])$ dB below the transmitter power $P(\text{Watts})$ in a 1 MHz bandwidth. However, in the 1MHz bands immediately outside and adjacent to the licensee's frequency block, a resolution bandwidth of at least one percent of the emission bandwidth of the fundamental emission of the transmitter may be employed.

**27.53(m)(4)**

For mobile digital stations, the attenuation factor shall be not less than $40 + 10 \log (P)$ dB on all frequencies between the channel edge and 5 megahertz from the channel edge, $43 + 10 \log (P)$ dB on all frequencies between 5 megahertz and X megahertz from the channel edge, and $55 + 10 \log (P)$ dB on all frequencies more than X megahertz from the channel edge, where X is the greater of 6 megahertz or the actual emission bandwidth as defined in paragraph (m)(6) of this section. In addition, the attenuation factor shall not be less that $43 + 10 \log (P)$ dB on all frequencies between 2490.5 MHz and 2496 MHz and $55 + 10 \log (P)$ dB at or below 2490.5 MHz. Mobile Satellite Service licensees operating on frequencies below 2495 MHz may also submit a documented interference complaint against BRS licensees operating on channel BRS Channel 1 on the same terms and conditions as adjacent channel BRS or EBS licensees.

3.5.2 Test Procedures

The testing follows FCC KDB 971168 D01 v03r01 Section 6.1.

1. The EUT was connected to spectrum analyzer and system simulator via a power divider.
2. The band edges of low and high channels for the highest RF powers were measured.
3. Set RBW \geq 1% EBW in the 1MHz band immediately outside and adjacent to the band edge.
4. Beyond the 1 MHz band from the band edge, RBW=1MHz was used.
5. Set spectrum analyzer with RMS detector.
6. The RF fundamental frequency should be excluded against the limit line in the operating frequency band.
7. Checked that all the results comply with the emission limit line.

The limit line is derived from $43 + 10\log(P)$ dB below the transmitter power P(Watts)

For 5G NR n7, n38, n41

The other 40 dB, and 55 dB have additionally applied same calculation above.



3.6 Conducted Spurious Emission

3.6.1 Description of Conducted Spurious Emission Measurement

The power of any emission outside of the authorized operating frequency ranges must be lower than the transmitter power (P) by a factor of at least $43 + 10 \log (P)$ dB.

For 5G NR n41

The power of any emission outside of the authorized operating frequency ranges must be lower than the transmitter power (P) by a factor of at least $55 + 10 \log (P)$ dB.

It is measured by means of a calibrated spectrum analyzer and scanned from 30 MHz up to a frequency including its 10th harmonic.

3.6.2 Test Procedures

The testing follows FCC KDB 971168 D01 v03r01 Section 6.1.

1. The EUT was connected to spectrum analyzer and system simulator via a power divider.
2. The RF output of EUT was connected to the spectrum analyzer by RF cable and attenuator.
The path loss was compensated to the results for each measurement.
3. The middle channel for the highest RF power within the transmitting frequency was measured.
4. The conducted spurious emission for the whole frequency range was taken.
5. Make the measurement with the spectrum analyzer's RBW = 1MHz, VBW = 3MHz.
6. Set spectrum analyzer with RMS detector.
7. Taking the record of maximum spurious emission.
8. The RF fundamental frequency should be excluded against the limit line in the operating frequency band.
9. The limit line is derived from $43 + 10\log(P)$ dB below the transmitter power P(Watts)

For 5G NR n41

The limit line is derived from $55 + 10\log(P)$ dB below the transmitter power P(Watts)



3.7 Frequency Stability

3.7.1 Description of Frequency Stability Measurement

22.355

The frequency stability shall be measured by variation of ambient temperature and variation of primary supply voltage to ensure that the fundamental emission stays within the authorized frequency block. The frequency stability of the transmitter shall be maintained within $\pm 0.00025\%$ ($\pm 2.5\text{ppm}$) of the center frequency.

24.235 & 27.54

The frequency stability shall be sufficient to ensure that the fundamental emission stays within the authorized frequency block.

3.7.2 Test Procedures for Temperature Variation

The testing follows FCC KDB 971168 D01 v03r01 Section 9.0.

1. The EUT was set up in the thermal chamber and connected with the system simulator.
2. With power OFF, the temperature was decreased to -30°C and the EUT was stabilized before testing. Power was applied and the maximum change in frequency was recorded within one minute.
3. With power OFF, the temperature was raised in 10°C step up to 50°C . The EUT was stabilized at each step for at least half an hour. Power was applied and the maximum frequency change was recorded within one minute.

3.7.3 Test Procedures for Voltage Variation

The testing follows FCC KDB 971168 D01 v03r01 Section 9.0.

1. The EUT was placed in a temperature chamber at $20\pm 5^{\circ}\text{C}$ and connected with the system simulator.
2. The power supply voltage to the EUT was varied from 85% to 115% of the nominal value measured at the input to the EUT.
3. The variation in frequency was measured for the worst case.

4 Radiated Test Items

4.1 Measuring Instruments

See list of measuring instruments of this test report.

4.1.1 Test Setup

For radiated emissions below 30MHz

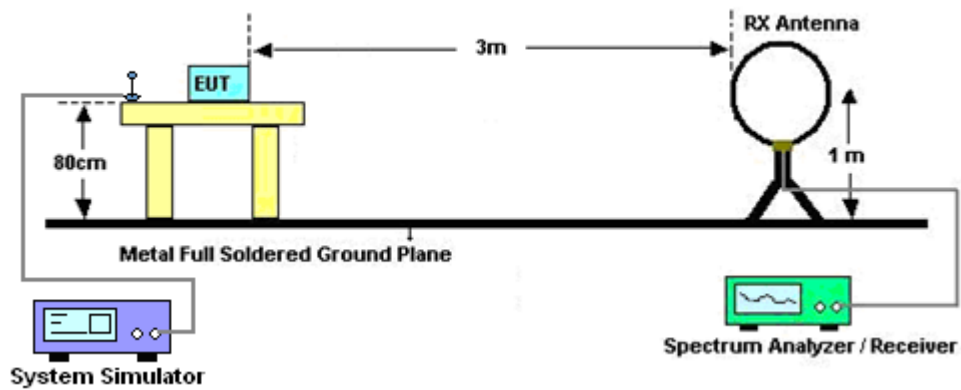

For radiated test from 30MHz to 1GHz

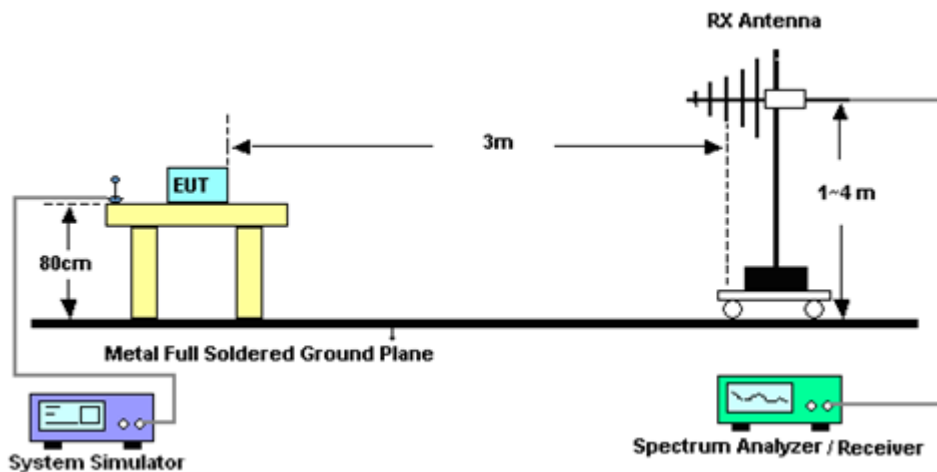

For radiated test from 1GHz to 18GHz

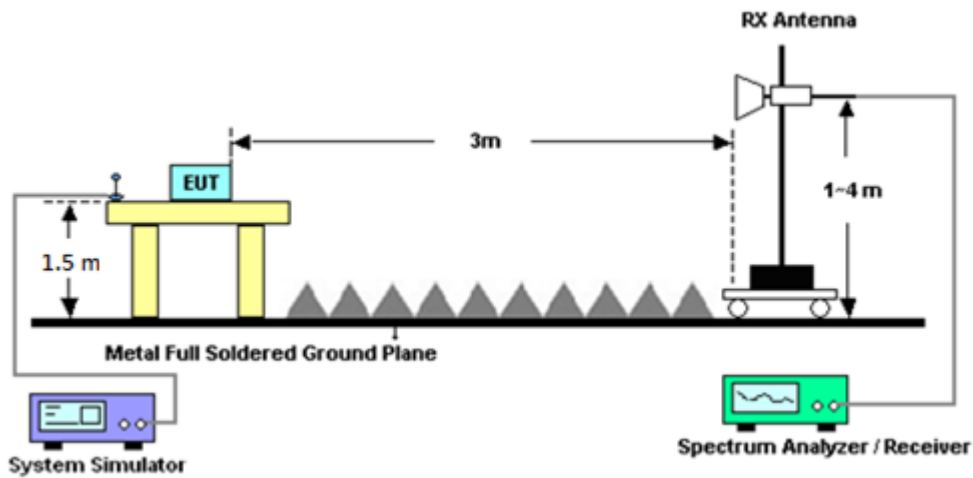

For radiated test above 18GHz

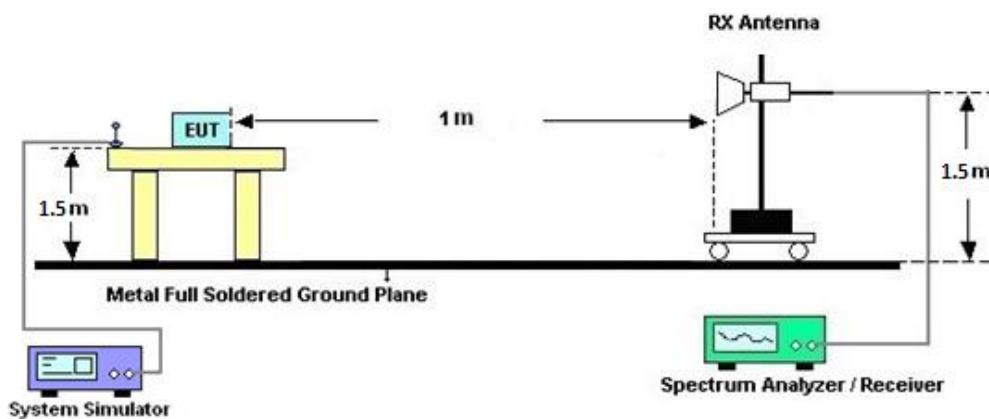

4.1.2 Test Result of Radiated Test

Please refer to Appendix B.

Note:

The low frequency, which started from 9 kHz to 30MHz, was pre-scanned and the result which was 20dB lower than the limit line was not reported.

There is adequate comparison measurement of both open-field test site and alternative test site - semi-Anechoic chamber according to 414788 D01 Radiated Test Site v01r01, and the result came out very similar.



4.2 Radiated Spurious Emission Measurement

4.2.1 Description of Radiated Spurious Emission Measurement

The radiated spurious emission was measured by substitution method according to ANSI / TIA-603-E. The power of any emission outside of the authorized operating frequency ranges must be attenuated below the transmitter power (P) by a factor of at least $43 + 10 \log (P)$ dB.

For 5G NR n41

The power of any emission outside of the authorized operating frequency ranges must be attenuated below the transmitter power (P) by a factor of at least $55 + 10 \log (P)$ dB.

The spectrum is scanned from 30 MHz up to a frequency including its 10th harmonic.

4.2.2 Test Procedures

The testing follows FCC KDB 971168 D01 v03r01 Section 7 and ANSI / TIA-603-E Section 2.2.12.

1. The EUT was placed on a turntable with 0.8 meter for frequency below 1GHz and 1.5 meter for frequency above 1GHz respectively above ground.
2. The EUT was set 3 meters from the receiving antenna, which was mounted on the antenna tower.
3. The table was rotated 360 degrees to determine the position of the highest spurious emission.
4. The height of the receiving antenna is varied between one meter and four meters to search the maximum spurious emission for both horizontal and vertical polarizations.
5. Make the measurement with the spectrum analyzer's RBW = 1MHz, VBW = 3MHz, taking the record of maximum spurious emission.
6. A horn antenna was substituted in place of the EUT and was driven by a signal generator.
7. Tune the output power of signal generator to the same emission level with EUT maximum spurious emission.
8. Taking the record of output power at antenna port.
9. Repeat step 7 to step 8 for another polarization.
10. The RF fundamental frequency should be excluded against the limit line in the operating frequency band.

The limit line is derived from $43 + 10\log(P)$ dB below the transmitter power P(Watts)

For 5G NR n7, n38, n41

The limit line is derived from $55 + 10\log(P)$ dB below the transmitter power P(Watts)

EIRP (dBm) = S.G. Power – Tx Cable Loss + Tx Antenna Gain

ERP (dBm) = EIRP - 2.15



5 List of Measuring Equipment

Instrument	Brand Name	Model No.	Serial No.	Characteristics	Calibration Date	Test Date	Due Date	Remark
Loop Antenna	Rohde & Schwarz	HFH2-Z2	100488	9 kHz~30 MHz	Sep. 07, 2021	Apr. 26, 2022~ May 11, 2022	Sep. 06, 2022	Radiation (03CH16-HY)
SHF-EHF Horn Antenna	SCHWARZBECK	BBHA9170	00993	18GHz~40GHz	Nov. 30, 2021	Apr. 26, 2022~ May 11, 2022	Nov. 29, 2022	Radiation (03CH16-HY)
SHF-EHF Horn Antenna	SCHWARZBECK	BBHA9170	BBHA917057 6	18GHz~40GHz	May 21, 2021	Apr. 26, 2022~ May 11, 2022	May 20, 2022	Radiation (03CH16-HY)
Spectrum Analyzer	Keysight	N9010A	MY54200486	10Hz~44GHz	Oct. 15, 2021	Apr. 26, 2022~ May 11, 2022	Oct. 14, 2022	Radiation (03CH16-HY)
Preamplifier	EMEC	EM18G40G	060801	18GHz~40GHz	Jun. 22, 2021	Apr. 26, 2022~ May 11, 2022	Jun. 21, 2022	Radiation (03CH16-HY)
RF Cable	HUBER + SUHNER	SUCOFLEX 102	804011/2,804 012/2	18-40G	Jan. 04, 2022	Apr. 26, 2022~ May 11, 2022	Jan. 03, 2023	Radiation (03CH16-HY)
Signal Generator	Agilent	MG3694C	163401	0.1Hz~40GHz	Feb. 13, 2022	Apr. 26, 2022~ May 11, 2022	Feb. 12, 2023	Radiation (03CH16-HY)
Bilog Antenna	TESEQ	CBL 6111D & 00800N1D01N -06	41912 & 05	30MHz to 1GHz	Feb. 06, 2022	Apr. 26, 2022~ May 11, 2022	Feb. 05, 2023	Radiation (03CH16-HY)
Bilog Antenna	TESEQ	CBL 6111D & 00802N1D01N -06	47020 & 06	30MHz to 1GHz	Oct. 09, 2021	Apr. 26, 2022~ May 11, 2022	Oct. 08, 2022	Radiation (03CH16-HY)
Horn Antenna	SCHWARZBECK	BBHA 9120 D	9120D-02114	1G~18GHz	Aug. 04, 2021	Apr. 26, 2022~ May 11, 2022	Aug. 03, 2022	Radiation (03CH16-HY)
Horn Antenna	SCHWARZBECK	BBHA 9120 D	9120D-1212	1G~18GHz	May 18, 2021	Apr. 26, 2022~ May 11, 2022	May 17, 2022	Radiation (03CH16-HY)
Amplifier	SONOMA	310N	371607	9kHz~1G	Jul. 05, 2021	Apr. 26, 2022~ May 11, 2022	Jul. 04, 2022	Radiation (03CH16-HY)
Amplifier	Jet-Power	JPA0118-55-3 03	1710001800 054001	1-18GHz	Jun. 16, 2021	Apr. 26, 2022~ May 11, 2022	Jun. 15, 2022	Radiation (03CH16-HY)
Preamplifier	Keysight	83017A	MY53270264	1GHz~26.5GHz	Dec. 09, 2021	Apr. 26, 2022~ May 11, 2022	Dec. 08, 2022	Radiation (03CH16-HY)
EMI Test Receiver	Keysight	N9038A	MY57290111	3Hz~26.5GHz	Dec. 15, 2021	Apr. 26, 2022~ May 11, 2022	Dec. 14, 2022	Radiation (03CH16-HY)
RF Cable	HUBER + SUHNER	SUCOFLEX 104	MY11680/4P E	NA	Aug. 28, 2021	Apr. 26, 2022~ May 11, 2022	Aug. 27, 2022	Radiation (03CH16-HY)
RF Cable	HUBER + SUHNER	SUCOFLEX 104	MY11688/4P E	NA	Aug. 28, 2021	Apr. 26, 2022~ May 11, 2022	Aug. 27, 2022	Radiation (03CH16-HY)
RF Cable	HUBER + SUHNER	SUCOFLEX 102	EC-A5-300-5 757	NA	Aug. 28, 2021	Apr. 26, 2022~ May 11, 2022	Aug. 27, 2022	Radiation (03CH16-HY)
Software	Audix	E3 6.2009-8-24	RK-001136	N/A	N/A	Apr. 26, 2022~ May 11, 2022	N/A	Radiation (03CH16-HY)
Controller	ChainTek	3000-1	N/A	Control Turn table & Ant Mast	N/A	Apr. 26, 2022~ May 11, 2022	N/A	Radiation (03CH16-HY)
Antenna Mast	ChainTek	MBS-520-1	N/A	1m~4m	N/A	Apr. 26, 2022~ May 11, 2022	N/A	Radiation (03CH16-HY)
Turn Table	ChainTek	T-200-S-1	N/A	0~360 Degree	N/A	Apr. 26, 2022~ May 11, 2022	N/A	Radiation (03CH16-HY)



Instrument	Brand Name	Model No.	Serial No.	Characteristics	Calibration Date	Test Date	Due Date	Remark
Programmable Power Supply	GW Instek	PSS-2005	EL890001	50Hz~60Hz	Oct. 06, 2021	Apr. 29, 2022~ May 11, 2022	Oct. 05, 2022	Conducted (TH03-HY)
Signal Analyzer	Rohde & Schwarz	FSV3044	101049	10Hz~44GHz	Aug. 31, 2021	Apr. 29, 2022~ May 11, 2022	Aug. 30, 2022	Conducted (TH03-HY)
Temperature Chamber	ESPEC	SU-241	92003713	-30℃ ~95℃	May 21, 2021	Apr. 29, 2022~ May 11, 2022	May 20, 2022	Conducted (TH03-HY)
Hygrometer	Testo	608-H11	34893240	NA	Nov. 17, 2021	Apr. 29, 2022~ May 11, 2022	Nov. 16, 2022	Conducted (TH03-HY)
Base Station (Measure)	Anritsu	MT8821C	6261849015	LTE	Ocr. 06, 2021	Apr. 29, 2022~ May 11, 2022	Oct. 05, 2022	Conducted (TH03-HY)
Base Station (Measure)	Anritsu	MT8000A	6261940327	FR1	Oct. 29, 2021	Apr. 29, 2022~ May 11, 2022	Oct. 28, 2022	Conducted (TH03-HY)



6 Uncertainty of Evaluation

Uncertainty of Radiated Emission Measurement (30 MHz ~ 1000 MHz)

Measuring Uncertainty for a Level of Confidence of 95% ($U = 2Uc(y)$)	2.86 dB
---	---------

Uncertainty of Radiated Emission Measurement (1 GHz ~ 18 GHz)

Measuring Uncertainty for a Level of Confidence of 95% ($U = 2Uc(y)$)	3.68 dB
---	---------

Uncertainty of Radiated Emission Measurement (18 GHz ~ 40 GHz)

Measuring Uncertainty for a Level of Confidence of 95% ($U = 2Uc(y)$)	4.00 dB
---	---------



Appendix A. Test Results of Conducted Test

Conducted Output Power (Average power) and ERP/EIRP

<Ant. 1>

NR n25 Maximum Average Power [dBm] (GT - LC = 0.67 dB)								
BW [MHz]	RB Size	RB Offset	Mod	Lowest	Middle	Highest	EIRP (dBm)	EIRP(W)
5	1	1	PI/2 BPSK	23.24	23.04	22.54	23.92	0.2466
5	1	23		23.22	23.20	22.46		
5	12	6		22.99	22.92	22.67		
5	1	0		22.45	22.59	22.06		
5	1	24		22.67	22.46	21.99		
5	25	0		22.49	22.68	22.00		
5	1	1	QPSK	23.25	23.03	22.66	23.92	0.2466
5	1	23		23.00	22.90	22.64		
5	12	6		22.93	23.14	22.42		
5	1	0		22.30	22.14	21.44		
5	1	24		21.99	21.87	21.42		
5	25	0		22.13	22.21	21.70		
5	1	1	16-QAM	22.70	21.98	21.68	23.37	0.2173
5	1	1	64-QAM	20.33	20.64	20.16		
5	1	1	256-QAM	17.96	18.21	17.84		
Limit	EIRP < 2W			Result			Pass	

NR n25 Maximum Average Power [dBm] (GT - LC = 0.67 dB)								
BW [MHz]	RB Size	RB Offset	Mod	Lowest	Middle	Highest	EIRP (dBm)	EIRP(W)
10	1	1	PI/2 BPSK	23.26	23.01	22.83	23.93	0.2472
10	1	50		23.22	22.79	22.69		
10	25	12		23.15	22.98	22.65		
10	1	0		22.63	22.36	22.37		
10	1	51		22.61	22.34	21.96		
10	50	0		22.70	22.64	22.12		
10	1	1	QPSK	23.14	22.92	22.61	23.93	0.2472
10	1	50		23.02	23.01	22.72		
10	25	12		23.09	23.10	22.73		
10	1	0		22.16	21.90	21.58		
10	1	51		22.02	22.05	21.70		
10	50	0		22.22	21.95	21.66		
10	1	1	16-QAM	22.62	22.06	21.66	23.29	0.2133
10	1	1	64-QAM	20.45	20.75	20.45		
10	1	1	256-QAM	17.96	17.97	17.56		
Limit	EIRP < 2W			Result			Pass	



NR n25 Maximum Average Power [dBm] (GT - LC = 0.67 dB)										
BW [MHz]	RB Size	RB Offset	Mod	Lowest	Middle	Highest	EIRP (dBm)	EIRP(W)		
15	1	1	PI/2 BPSK	23.23	23.27	22.98	24.12	0.2582		
15	1	77		23.16	22.94	22.77				
15	36	18		23.28	23.43	22.87				
15	1	0		22.73	22.84	22.55				
15	1	78		22.70	22.69	22.11				
15	75	0		22.74	22.79	22.26				
15	1	1	QPSK	23.26	23.21	22.93			22.8	0.1905
15	1	77		23.39	23.25	22.74				
15	36	18		23.45	23.23	23.00				
15	1	0		22.42	22.35	22.11				
15	1	78		22.29	22.19	21.63				
15	75	0		22.39	22.24	21.88				
15	1	1	16-QAM	22.13	22.12	21.76	22.8	0.1905		
15	1	1	64-QAM	21.18	20.94	20.60				
15	1	1	256-QAM	18.37	18.36	17.91				
Limit	EIRP < 2W			Result			Pass			

NR n25 Maximum Average Power [dBm] (GT - LC = 0.67 dB)										
BW [MHz]	RB Size	RB Offset	Mod	Lowest	Middle	Highest	EIRP (dBm)	EIRP(W)		
20	1	1	PI/2 BPSK	23.16	23.23	23.03	24.02	0.2523		
20	1	104		23.14	22.91	22.82				
20	50	25		23.27	23.35	23.00				
20	1	0		22.69	22.60	22.44				
20	1	105		22.54	22.64	22.31				
20	100	0		22.74	22.69	22.36				
20	1	1	QPSK	23.15	23.26	23.15			22.82	0.1914
20	1	104		23.04	23.05	22.80				
20	50	25		23.19	23.22	22.96				
20	1	0		22.44	22.36	22.19				
20	1	105		22.13	22.07	21.70				
20	100	0		22.16	22.23	21.83				
20	1	1	16-QAM	22.11	22.15	22.01	22.82	0.1914		
20	1	1	64-QAM	20.92	21.00	20.70				
20	1	1	256-QAM	18.44	18.31	18.07				
Limit	EIRP < 2W			Result			Pass			



NR n41 Maximum Average Power [dBm] (GT - LC = 0.39 dB)										
BW [MHz]	RB Size	RB Offset	Mod	Lowest	Middle	Highest	EIRP (dBm)	EIRP(W)		
20	1	1	PI/2 BPSK	22.27	22.69	22.69	23.21	0.2094		
20	1	49		22.45	22.62	22.41				
20	25	12		22.49	22.57	22.54				
20	1	0		21.82	22.28	21.86				
20	1	50		21.99	22.24	21.83				
20	50	0		22.05	22.15	22.04				
20	1	1	QPSK	22.30	22.74	22.47			23.21	0.2094
20	1	49		22.45	22.64	22.57				
20	25	12		22.42	22.82	22.41				
20	1	0		21.12	21.63	21.37				
20	1	50		21.31	21.53	21.46				
20	50	0		21.54	21.62	21.67				
20	1	1	16-QAM	21.10	21.63	21.23	22.02	0.1592		
20	1	1	64-QAM	19.85	20.12	20.09				
20	1	1	256-QAM	17.75	18.19	17.79				
Limit	EIRP < 2W			Result			Pass			

NR n41 Maximum Average Power [dBm] (GT - LC = 0.39 dB)										
BW [MHz]	RB Size	RB Offset	Mod	Lowest	Middle	Highest	EIRP (dBm)	EIRP(W)		
30	1	1	PI/2 BPSK	22.43	22.51	22.46	23.23	0.2104		
30	1	76		22.55	22.84	22.51				
30	36	18		22.42	22.74	22.60				
30	1	0		21.72	22.02	21.62				
30	1	77		22.02	22.46	22.04				
30	75	0		21.91	22.04	21.71				
30	1	1	QPSK	22.48	22.47	22.60			23.23	0.2104
30	1	76		22.51	22.60	22.50				
30	36	18		22.55	22.76	22.56				
30	1	0		21.35	21.39	21.55				
30	1	77		21.48	21.71	21.50				
30	75	0		21.45	21.63	21.62				
30	1	1	16-QAM	21.20	21.30	21.34	21.73	0.1489		
30	1	1	64-QAM	20.00	19.73	19.83				
30	1	1	256-QAM	17.69	18.26	18.43				
Limit	EIRP < 2W			Result			Pass			



NR n41 Maximum Average Power [dBm] (GT - LC = 0.39 dB)										
BW [MHz]	RB Size	RB Offset	Mod	Lowest	Middle	Highest	EIRP (dBm)	EIRP(W)		
40	1	1	PI/2 BPSK	22.31	22.73	22.80	23.28	0.2128		
40	1	104		22.45	22.72	22.54				
40	50	25		22.63	22.54	22.55				
40	1	0		22.01	22.26	22.33				
40	1	105		22.05	22.20	22.21				
40	100	0		21.87	22.17	22.10				
40	1	1	QPSK	22.28	22.54	22.60			22.20	0.1660
40	1	104		22.49	22.89	22.35				
40	50	25		22.47	22.69	22.63				
40	1	0		21.45	21.76	21.53				
40	1	105		21.46	21.95	21.48				
40	100	0		21.49	21.58	21.77				
40	1	1	16-QAM	21.27	21.81	21.47	22.20	0.1660		
40	1	1	64-QAM	19.86	20.22	20.22				
40	1	1	256-QAM	18.09	18.08	18.18				
Limit	EIRP < 2W			Result			Pass			

NR n41 Maximum Average Power [dBm] (GT - LC = 0.39 dB)										
BW [MHz]	RB Size	RB Offset	Mod	Lowest	Middle	Highest	EIRP (dBm)	EIRP(W)		
50	1	1	PI/2 BPSK	22.42	22.52	22.71	23.15	0.2065		
50	1	131		22.63	22.61	22.42				
50	64	32		22.48	22.73	22.71				
50	1	0		21.81	22.07	22.04				
50	1	132		21.95	22.05	21.94				
50	128	0		22.07	22.17	22.09				
50	1	1	QPSK	22.23	22.31	22.59			21.91	0.1552
50	1	131		22.71	22.67	22.34				
50	64	32		22.43	22.76	22.46				
50	1	0		21.39	21.34	21.41				
50	1	132		21.69	21.67	21.44				
50	128	0		21.31	21.77	21.61				
50	1	1	16-QAM	21.18	21.52	21.44	21.91	0.1552		
50	1	1	64-QAM	20.14	19.88	20.06				
50	1	1	256-QAM	17.99	18.03	18.08				
Limit	EIRP < 2W			Result			Pass			



NR n41 Maximum Average Power [dBm] (GT - LC = 0.39 dB)										
BW [MHz]	RB Size	RB Offset	Mod	Lowest	Middle	Highest	EIRP (dBm)	EIRP(W)		
60	1	1	PI/2 BPSK	22.49	22.46	22.50	23.16	0.2070		
60	1	160		22.44	22.65	22.17				
60	81	40		22.57	22.66	22.59				
60	1	0		21.82	21.94	21.91				
60	1	161		22.04	22.20	21.70				
60	162	0		22.12	22.12	22.00				
60	1	1	QPSK	22.24	22.31	22.55			23.16	0.2070
60	1	160		22.50	22.77	22.24				
60	81	40		22.55	22.73	22.55				
60	1	0		21.29	21.51	21.48				
60	1	161		21.31	21.54	21.41				
60	162	0		21.50	21.76	21.63				
60	1	1	16-QAM	21.32	21.26	21.12	21.71	0.1483		
60	1	1	64-QAM	20.07	19.81	19.99				
60	1	1	256-QAM	18.14	18.03	17.91				
Limit	EIRP < 2W			Result			Pass			

NR n41 Maximum Average Power [dBm] (GT - LC = 0.39 dB)										
BW [MHz]	RB Size	RB Offset	Mod	Lowest	Middle	Highest	EIRP (dBm)	EIRP(W)		
70	1	1	PI/2 BPSK	22.20	22.46	22.67	23.06	0.2023		
70	1	187		22.58	22.59	21.96				
70	90	45		22.22	22.55	22.26				
70	1	0		21.83	21.85	21.99				
70	1	188		22.06	21.98	21.42				
70	180	0		21.95	21.95	21.82				
70	1	1	QPSK	22.16	22.25	22.56			23.06	0.2023
70	1	187		22.50	22.44	21.93				
70	90	45		22.26	22.64	22.38				
70	1	0		21.10	21.17	21.41				
70	1	188		21.33	21.54	21.12				
70	180	0		21.30	21.39	21.24				
70	1	1	16-QAM	21.00	21.32	21.43	21.82	0.1521		
70	1	1	64-QAM	19.59	19.47	19.51				
70	1	1	256-QAM	17.56	17.83	17.95				
Limit	EIRP < 2W			Result			Pass			



NR n41 Maximum Average Power [dBm] (GT - LC = 0.39 dB)										
BW [MHz]	RB Size	RB Offset	Mod	Lowest	Middle	Highest	EIRP (dBm)	EIRP(W)		
80	1	1	PI/2 BPSK	22.09	22.50	22.33	23.05	0.2018		
80	1	215		22.23	22.66	22.31				
80	108	54		22.38	22.59	22.57				
80	1	0		21.79	21.93	22.02				
80	1	216		21.78	22.09	21.53				
80	216	0		21.90	22.14	21.89				
80	1	1	QPSK	22.09	22.42	22.24			21.75	0.1496
80	1	215		22.17	22.62	22.07				
80	108	54		22.50	22.60	22.25				
80	1	0		21.04	21.23	21.38				
80	1	216		21.40	21.50	21.21				
80	216	0		21.46	21.44	21.40				
80	1	1	16-QAM	21.04	21.14	21.36	21.75	0.1496		
80	1	1	64-QAM	19.88	19.93	19.75				
80	1	1	256-QAM	17.55	17.79	17.91				
Limit	EIRP < 2W			Result			Pass			

NR n41 Maximum Average Power [dBm] (GT - LC = 0.39 dB)										
BW [MHz]	RB Size	RB Offset	Mod	Lowest	Middle	Highest	EIRP (dBm)	EIRP(W)		
90	1	1	PI/2 BPSK	22.04	22.33	22.37	23.02	0.2004		
90	1	243		22.63	22.54	22.27				
90	120	60		22.58	22.59	22.48				
90	1	0		21.75	21.70	21.97				
90	1	244		22.03	22.21	21.78				
90	240	0		21.83	21.96	21.93				
90	1	1	QPSK	22.14	22.24	22.20			21.72	0.1486
90	1	243		22.44	22.51	22.41				
90	120	60		22.32	22.35	22.63				
90	1	0		21.01	21.05	21.24				
90	1	244		21.51	21.64	21.33				
90	240	0		21.45	21.43	21.36				
90	1	1	16-QAM	21.07	20.99	21.33	21.72	0.1486		
90	1	1	64-QAM	19.57	20.02	19.75				
90	1	1	256-QAM	17.82	17.73	17.85				
Limit	EIRP < 2W			Result			Pass			



NR n41 Maximum Average Power [dBm] (GT - LC = 0.39 dB)								
BW [MHz]	RB Size	RB Offset	Mod	Lowest	Middle	Highest	EIRP (dBm)	EIRP(W)
100	1	1	PI/2 BPSK	22.12	22.38	22.26	22.99	0.1991
100	1	271		22.59	22.60	22.31		
100	135	67		22.25	22.51	22.40		
100	1	0		21.65	21.90	21.84		
100	1	272		22.00	21.98	21.73		
100	270	0		21.95	22.08	21.87		
100	1	1	QPSK	22.19	22.42	22.16	21.54	0.1426
100	1	271		22.53	22.56	22.25		
100	135	67		22.19	22.47	22.39		
100	1	0		21.23	21.20	21.11		
100	1	272		21.42	21.43	21.29		
100	270	0		21.37	21.58	21.40		
100	1	1	16-QAM	21.04	21.14	21.15	21.54	0.1426
100	1	1	64-QAM	19.83	19.55	19.73		
100	1	1	256-QAM	17.72	17.86	17.99		
Limit	EIRP < 2W			Result			Pass	



NR n71 Maximum Average Power [dBm] (GT - LC = -0.83 dB)								
BW [MHz]	RB Size	RB Offset	Mod	Lowest	Middle	Highest	ERP (dBm)	ERP(W)
5	1	1	PI/2 BPSK	23.02	22.93	23.19	20.34	0.1081
5	1	23		22.96	23.04	23.32		
5	12	6		23.03	23.07	23.31		
5	1	0		22.45	22.36	22.70		
5	1	24		22.54	22.54	22.81		
5	25	0		22.51	22.54	22.44		
5	1	1	QPSK	22.95	22.88	23.21		
5	1	23		22.97	23.06	23.24		
5	12	6		22.98	23.03	23.25		
5	1	0		21.92	21.95	22.16		
5	1	24		21.95	22.05	22.35		
5	25	0		21.99	22.01	22.27		
5	1	1	16-QAM	21.96	21.83	22.16	19.18	0.0828
5	1	1	64-QAM	20.69	20.76	20.87		
5	1	1	256-QAM	17.90	17.92	18.16		
Limit	ERP < 3W			Result			Pass	

NR n71 Maximum Average Power [dBm] (GT - LC = -0.83 dB)								
BW [MHz]	RB Size	RB Offset	Mod	Lowest	Middle	Highest	ERP (dBm)	ERP(W)
10	1	1	PI/2 BPSK	22.98	23.05	23.16	20.23	0.1054
10	1	50		23.07	23.15	23.20		
10	25	12		23.01	23.05	23.21		
10	1	0		22.48	22.51	22.62		
10	1	51		22.53	22.65	22.69		
10	50	0		21.04	22.51	22.68		
10	1	1	QPSK	22.93	23.05	23.09		
10	1	50		23.08	23.14	23.20		
10	25	12		23.01	22.97	23.16		
10	1	0		21.94	22.03	22.10		
10	1	51		22.03	22.12	22.25		
10	50	0		22.04	21.98	22.19		
10	1	1	16-QAM	21.93	22.04	22.40	19.42	0.0875
10	1	1	64-QAM	20.55	20.67	20.21		
10	1	1	256-QAM	17.88	17.97	18.02		
Limit	ERP < 3W			Result			Pass	



NR n71 Maximum Average Power [dBm] (GT - LC = -0.83 dB)										
BW [MHz]	RB Size	RB Offset	Mod	Lowest	Middle	Highest	ERP (dBm)	ERP(W)		
15	1	1	PI/2 BPSK	22.95	23.08	23.11	20.33	0.1079		
15	1	77		23.08	23.16	23.31				
15	36	18		22.98	23.24	23.18				
15	1	0		22.36	22.65	22.61				
15	1	78		22.57	22.67	22.76				
15	75	0		22.54	22.72	22.67				
15	1	1	QPSK	22.91	23.10	23.09			20.33	0.1079
15	1	77		23.15	23.18	23.31				
15	36	18		23.04	23.19	23.28				
15	1	0		21.95	22.04	22.08				
15	1	78		22.13	22.18	22.31				
15	75	0		21.98	22.19	22.18				
15	1	1	16-QAM	21.83	22.04	22.03	19.06	0.0805		
15	1	1	64-QAM	20.56	20.74	20.66				
15	1	1	256-QAM	17.99	18.05	18.10				
Limit	ERP < 3W			Result			Pass			

NR n71 Maximum Average Power [dBm] (GT - LC = -0.83 dB)										
BW [MHz]	RB Size	RB Offset	Mod	Lowest	Middle	Highest	ERP (dBm)	ERP(W)		
20	1	1	PI/2 BPSK	22.86	23.09	23.32	20.37	0.1089		
20	1	104		23.06	23.25	23.30				
20	50	25		22.98	23.35	23.11				
20	1	0		22.36	22.56	22.65				
20	1	105		22.56	22.64	22.82				
20	100	0		22.48	22.75	22.66				
20	1	1	QPSK	22.87	22.96	23.24			20.37	0.1089
20	1	104		23.09	23.03	23.25				
20	50	25		23.02	23.24	23.16				
20	1	0		21.95	22.02	22.16				
20	1	105		22.01	22.04	22.35				
20	100	0		22.03	22.25	22.18				
20	1	1	16-QAM	21.79	21.81	22.12	19.14	0.0820		
20	1	1	64-QAM	20.52	20.73	20.81				
20	1	1	256-QAM	17.82	17.99	18.17				
Limit	ERP < 3W			Result			Pass			



<Ant. 2>

NR n25 Maximum Average Power [dBm] (GT - LC = 0.45 dB)								
BW [MHz]	RB Size	RB Offset	Mod	Lowest	Middle	Highest	EIRP (dBm)	EIRP(W)
5	1	1	PI/2 BPSK	23.27	23.14	22.81	23.72	0.2355
5	1	23		23.22	23.21	22.69		
5	12	6		23.20	23.19	22.74		
5	1	0		22.75	22.74	22.28		
5	1	24		22.72	22.61	22.19		
5	25	0		22.73	22.73	22.26		
5	1	1	QPSK	23.25	23.15	22.75		
5	1	23		23.20	23.13	22.66		
5	12	6		23.14	23.17	22.65		
5	1	0		22.31	22.18	21.73		
5	1	24		22.23	22.15	21.64		
5	25	0		22.24	22.23	21.73		
5	1	1	16-QAM	22.71	22.05	21.69	23.16	0.2070
5	1	1	64-QAM	20.54	20.88	20.45		
5	1	1	256-QAM	18.25	18.26	17.98		
Limit	EIRP < 2W			Result			Pass	

NR n25 Maximum Average Power [dBm] (GT - LC = 0.45 dB)								
BW [MHz]	RB Size	RB Offset	Mod	Lowest	Middle	Highest	EIRP (dBm)	EIRP(W)
10	1	1	PI/2 BPSK	23.28	23.11	22.84	23.74	0.2366
10	1	50		23.25	23.07	22.74		
10	25	12		23.21	23.28	22.92		
10	1	0		22.78	22.61	22.39		
10	1	51		22.77	22.54	22.21		
10	50	0		22.81	22.68	22.41		
10	1	1	QPSK	23.25	23.13	22.85		
10	1	50		23.29	23.07	22.74		
10	25	12		23.24	23.27	22.89		
10	1	0		22.29	22.13	21.87		
10	1	51		22.26	22.06	21.78		
10	50	0		22.29	22.13	21.88		
10	1	1	16-QAM	22.76	22.26	21.86	23.21	0.2094
10	1	1	64-QAM	20.69	20.85	20.56		
10	1	1	256-QAM	18.26	18.13	17.85		
Limit	EIRP < 2W			Result			Pass	



NR n25 Maximum Average Power [dBm] (GT - LC = 0.45 dB)										
BW [MHz]	RB Size	RB Offset	Mod	Lowest	Middle	Highest	EIRP (dBm)	EIRP(W)		
15	1	1	PI/2 BPSK	23.46	23.35	23.11	23.97	0.2495		
15	1	77		23.43	23.24	22.87				
15	36	18		23.42	23.45	23.05				
15	1	0		23.02	22.85	22.62				
15	1	78		22.95	22.72	22.34				
15	75	0		22.96	22.86	22.52				
15	1	1	QPSK	23.52	23.35	23.12			22.71	0.1866
15	1	77		23.49	23.25	22.88				
15	36	18		23.45	23.42	23.04				
15	1	0		22.58	22.43	22.14				
15	1	78		22.49	22.25	21.92				
15	75	0		22.49	22.40	22.04				
15	1	1	16-QAM	22.26	22.24	21.99	22.71	0.1866		
15	1	1	64-QAM	21.21	21.15	20.82				
15	1	1	256-QAM	18.52	18.41	18.12				
Limit	EIRP < 2W			Result			Pass			

NR n25 Maximum Average Power [dBm] (GT - LC = 0.45 dB)										
BW [MHz]	RB Size	RB Offset	Mod	Lowest	Middle	Highest	EIRP (dBm)	EIRP(W)		
20	1	1	PI/2 BPSK	23.38	23.28	23.21	23.87	0.2438		
20	1	104		23.33	23.02	22.83				
20	50	25		23.36	23.35	23.06				
20	1	0		22.90	22.74	22.66				
20	1	105		22.81	22.72	22.36				
20	100	0		22.89	22.85	22.56				
20	1	1	QPSK	23.42	23.37	23.18			22.72	0.1871
20	1	104		23.34	23.20	22.89				
20	50	25		23.41	23.33	23.01				
20	1	0		22.46	22.38	22.24				
20	1	105		22.40	22.20	21.87				
20	100	0		22.41	22.38	22.07				
20	1	1	16-QAM	22.27	22.16	22.09	22.72	0.1871		
20	1	1	64-QAM	21.16	21.14	20.85				
20	1	1	256-QAM	18.44	18.41	18.29				
Limit	EIRP < 2W			Result			Pass			



NR n41 Maximum Average Power [dBm] (GT - LC = -0.53 dB)										
BW [MHz]	RB Size	RB Offset	Mod	Lowest	Middle	Highest	EIRP (dBm)	EIRP(W)		
20	1	1	PI/2 BPSK	22.91	23.26	23.09	22.73	0.1875		
20	1	49		23.07	23.18	23.07				
20	25	12		22.98	23.21	23.11				
20	1	0		22.39	22.72	22.47				
20	1	50		22.53	22.71	22.53				
20	50	0		22.48	22.79	22.61				
20	1	1	QPSK	22.81	23.21	23.09			21.66	0.1466
20	1	49		22.99	23.19	23.01				
20	25	12		23.01	23.24	23.09				
20	1	0		21.80	22.16	21.99				
20	1	50		21.95	22.11	21.95				
20	50	0		21.96	22.22	22.10				
20	1	1	16-QAM	21.62	22.19	21.75	21.66	0.1466		
20	1	1	64-QAM	20.32	20.65	20.52				
20	1	1	256-QAM	18.42	18.78	18.42				
Limit	EIRP < 2W			Result			Pass			

NR n41 Maximum Average Power [dBm] (GT - LC = -0.53 dB)										
BW [MHz]	RB Size	RB Offset	Mod	Lowest	Middle	Highest	EIRP (dBm)	EIRP(W)		
30	1	1	PI/2 BPSK	22.95	23.21	23.16	22.84	0.1923		
30	1	76		23.14	23.37	23.14				
30	36	18		23.03	23.20	23.18				
30	1	0		22.42	22.47	22.11				
30	1	77		22.68	22.88	22.67				
30	75	0		22.53	22.69	22.24				
30	1	1	QPSK	22.90	23.09	23.13			21.44	0.1393
30	1	76		23.15	23.28	23.14				
30	36	18		22.99	23.23	23.21				
30	1	0		21.82	22.06	22.17				
30	1	77		22.06	22.21	22.13				
30	75	0		22.01	22.30	22.22				
30	1	1	16-QAM	21.74	21.94	21.97	21.44	0.1393		
30	1	1	64-QAM	20.40	20.34	20.48				
30	1	1	256-QAM	18.26	18.73	18.84				
Limit	EIRP < 2W			Result			Pass			



NR n41 Maximum Average Power [dBm] (GT - LC = -0.53 dB)										
BW [MHz]	RB Size	RB Offset	Mod	Lowest	Middle	Highest	EIRP (dBm)	EIRP(W)		
40	1	1	PI/2 BPSK	22.97	23.19	23.33	22.85	0.1928		
40	1	104		23.13	23.38	23.11				
40	50	25		23.06	23.23	23.18				
40	1	0		22.45	22.71	22.81				
40	1	105		22.62	22.88	22.62				
40	100	0		22.56	22.76	22.70				
40	1	1	QPSK	22.91	23.11	23.19			21.72	0.1486
40	1	104		23.10	23.30	23.04				
40	50	25		23.02	23.17	23.13				
40	1	0		21.92	22.19	22.22				
40	1	105		22.11	22.36	22.06				
40	100	0		22.06	22.25	22.24				
40	1	1	16-QAM	21.93	22.25	22.12	21.72	0.1486		
40	1	1	64-QAM	20.36	20.81	20.65				
40	1	1	256-QAM	18.69	18.73	18.74				
Limit	EIRP < 2W			Result			Pass			

NR n41 Maximum Average Power [dBm] (GT - LC = -0.53 dB)										
BW [MHz]	RB Size	RB Offset	Mod	Lowest	Middle	Highest	EIRP (dBm)	EIRP(W)		
50	1	1	PI/2 BPSK	22.95	23.11	23.17	22.77	0.1892		
50	1	131		23.15	23.26	23.05				
50	64	32		23.04	23.30	23.14				
50	1	0		22.46	22.56	22.66				
50	1	132		22.64	22.68	22.54				
50	128	0		22.54	22.71	22.64				
50	1	1	QPSK	22.91	23.01	23.13			21.50	0.1413
50	1	131		23.13	23.22	23.03				
50	64	32		23.06	23.29	23.14				
50	1	0		21.91	22.02	22.10				
50	1	132		22.11	22.15	22.01				
50	128	0		21.99	22.25	22.14				
50	1	1	16-QAM	21.85	21.97	22.03	21.50	0.1413		
50	1	1	64-QAM	20.56	20.51	20.58				
50	1	1	256-QAM	18.44	18.64	18.76				
Limit	EIRP < 2W			Result			Pass			



NR n41 Maximum Average Power [dBm] (GT - LC = -0.53 dB)										
BW [MHz]	RB Size	RB Offset	Mod	Lowest	Middle	Highest	EIRP (dBm)	EIRP(W)		
60	1	1	PI/2 BPSK	22.89	23.08	23.01	22.76	0.1888		
60	1	160		23.10	23.18	22.86				
60	81	40		23.10	23.29	23.07				
60	1	0		22.40	22.54	22.56				
60	1	161		22.57	22.70	22.38				
60	162	0		22.57	22.71	22.54				
60	1	1	QPSK	22.83	23.01	22.98			21.43	0.1390
60	1	160		23.02	23.17	22.91				
60	81	40		23.07	23.25	23.03				
60	1	0		21.85	22.01	22.00				
60	1	161		21.98	22.12	21.86				
60	162	0		22.06	22.26	22.07				
60	1	1	16-QAM	21.78	21.96	21.81	21.43	0.1390		
60	1	1	64-QAM	20.47	20.45	20.49				
60	1	1	256-QAM	18.57	18.46	18.53				
Limit	EIRP < 2W			Result			Pass			

NR n41 Maximum Average Power [dBm] (GT - LC = -0.53 dB)										
BW [MHz]	RB Size	RB Offset	Mod	Lowest	Middle	Highest	EIRP (dBm)	EIRP(W)		
70	1	1	PI/2 BPSK	22.79	22.92	23.12	22.59	0.1816		
70	1	187		23.06	23.11	22.63				
70	90	45		22.92	23.03	22.83				
70	1	0		22.26	22.42	22.60				
70	1	188		22.54	22.61	22.12				
70	180	0		22.47	22.54	22.38				
70	1	1	QPSK	22.67	22.91	23.04			21.42	0.1387
70	1	187		23.02	23.09	22.56				
70	90	45		22.89	23.05	22.83				
70	1	0		21.71	21.86	22.01				
70	1	188		21.94	22.08	21.59				
70	180	0		21.93	22.09	21.86				
70	1	1	16-QAM	21.62	21.78	21.95	21.42	0.1387		
70	1	1	64-QAM	20.19	20.15	20.19				
70	1	1	256-QAM	18.21	18.46	18.64				
Limit	EIRP < 2W			Result			Pass			



NR n41 Maximum Average Power [dBm] (GT - LC = -0.53 dB)										
BW [MHz]	RB Size	RB Offset	Mod	Lowest	Middle	Highest	EIRP (dBm)	EIRP(W)		
80	1	1	PI/2 BPSK	22.74	22.92	22.94	22.55	0.1799		
80	1	215		22.90	23.07	22.71				
80	108	54		22.96	23.07	22.98				
80	1	0		22.23	22.43	22.42				
80	1	216		22.42	22.59	22.23				
80	216	0		22.47	22.54	22.45				
80	1	1	QPSK	22.69	22.86	22.92			21.28	0.1343
80	1	215		22.84	23.06	22.72				
80	108	54		22.96	23.08	22.94				
80	1	0		21.69	21.84	21.86				
80	1	216		21.86	22.02	21.69				
80	216	0		21.89	22.05	21.95				
80	1	1	16-QAM	21.45	21.76	21.81	21.28	0.1343		
80	1	1	64-QAM	20.28	20.38	20.33				
80	1	1	256-QAM	18.20	18.30	18.44				
Limit	EIRP < 2W			Result			Pass			

NR n41 Maximum Average Power [dBm] (GT - LC = -0.53 dB)										
BW [MHz]	RB Size	RB Offset	Mod	Lowest	Middle	Highest	EIRP (dBm)	EIRP(W)		
90	1	1	PI/2 BPSK	22.73	22.85	22.87	22.63	0.1832		
90	1	243		23.15	23.16	22.88				
90	120	60		22.99	23.08	23.03				
90	1	0		22.22	22.31	22.38				
90	1	244		22.62	22.63	22.32				
90	240	0		22.48	22.54	22.50				
90	1	1	QPSK	22.71	22.82	22.86			21.24	0.1330
90	1	243		23.11	23.04	22.85				
90	120	60		23.01	23.05	23.04				
90	1	0		21.68	21.75	21.84				
90	1	244		22.06	22.10	21.82				
90	240	0		21.95	22.01	22.01				
90	1	1	16-QAM	21.59	21.68	21.77	21.24	0.1330		
90	1	1	64-QAM	20.18	20.48	20.36				
90	1	1	256-QAM	18.31	18.39	18.45				
Limit	EIRP < 2W			Result			Pass			



NR n41 Maximum Average Power [dBm] (GT - LC = -0.53 dB)								
BW [MHz]	RB Size	RB Offset	Mod	Lowest	Middle	Highest	EIRP (dBm)	EIRP(W)
100	1	1	PI/2 BPSK	22.77	22.85	22.92	22.54	0.1795
100	1	271		23.02	23.05	22.77		
100	135	67		22.92	23.06	23.06		
100	1	0		22.29	22.38	22.38		
100	1	272		22.47	22.56	22.30		
100	270	0		22.37	22.52	22.51		
100	1	1	QPSK	22.78	22.87	22.82	22.54	0.1795
100	1	271		22.99	23.07	22.75		
100	135	67		22.87	23.04	23.05		
100	1	0		21.69	21.80	21.81		
100	1	272		21.92	21.98	21.75		
100	270	0		21.90	22.03	22.01		
100	1	1	16-QAM	21.73	21.69	21.68	21.20	0.1318
100	1	1	64-QAM	20.32	20.18	20.35		
100	1	1	256-QAM	18.35	18.31	18.42		
Limit	EIRP < 2W			Result			Pass	



FR1 n25

Peak-to-Average Ratio

Mode	FR1 n25 / 20MHz / DFT-S OFDM				
Mod.	PI/2 BPSK	QPSK	16QAM	64QAM	Limit: 13dB
RB Size	Full RB	Full RB	Full RB	Full RB	Result
Middle CH	3.96	4.60	5.54	5.90	PASS
Mode	FR1 n25 / 20MHz / DFT-S OFDM				
Mod.	256QAM				Limit: 13dB
RB Size	Full RB				Result
Middle CH	6.44				PASS



FR1 n25 / 20MHz / DFT-S OFDM / Middle Channel / Full RB

PI/2 BPSK

QPSK

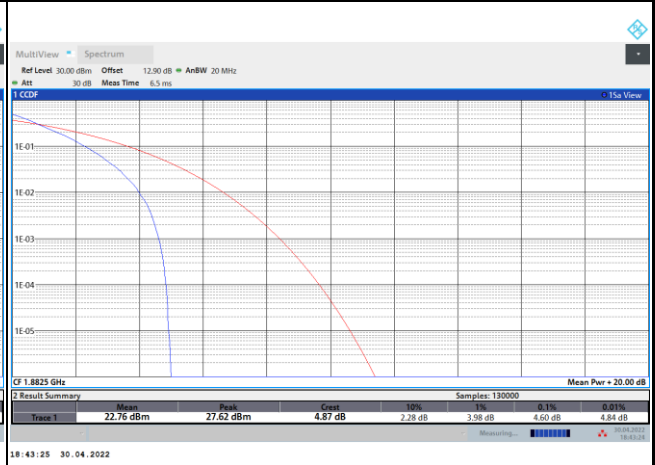
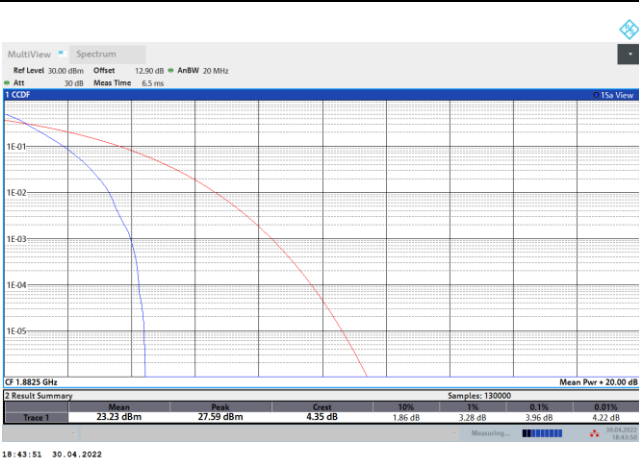

16QAM

64QAM

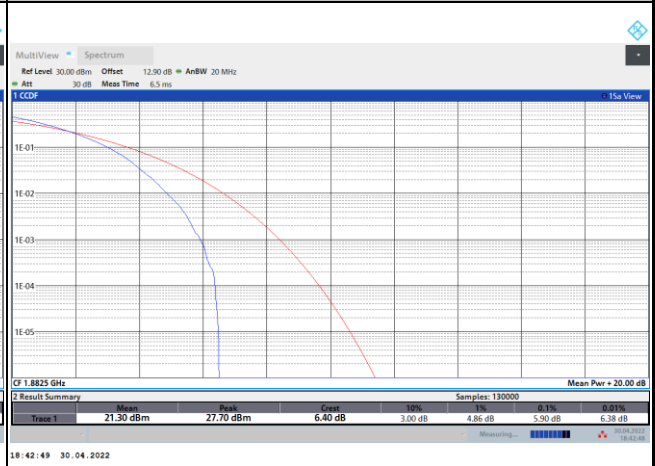
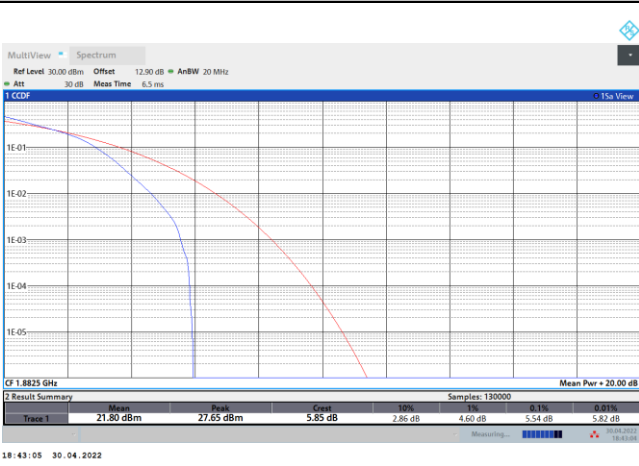

256QAM

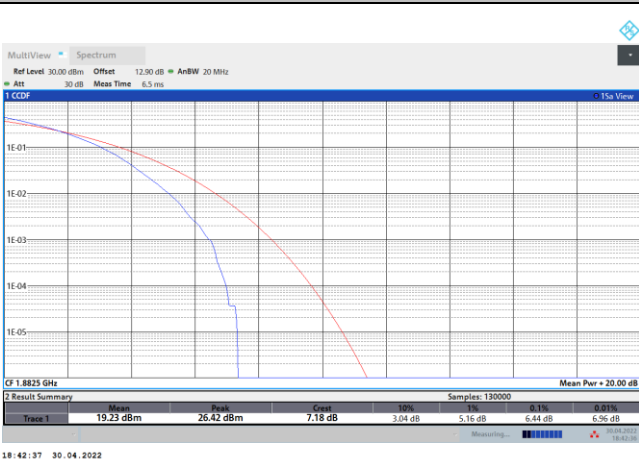



26dB Bandwidth

Mode	FR1 n25 : 26dB BW(MHz) / DFT-S OFDM							
BW	5MHz		10MHz		15MHz		20MHz	
Mod.	PI/2 BPSK		PI/2 BPSK		PI/2 BPSK		PI/2 BPSK	
Middle CH	5.07		9.51		14.39		19.02	

Mode	FR1 n25 : 26dB BW(MHz) / CP OFDM							
BW	5MHz		10MHz		15MHz		20MHz	
Mod.	QPSK	16QAM	QPSK	16QAM	QPSK	16QAM	QPSK	16QAM
Middle CH	5.20	5.04	9.99	9.73	15.13	15.13	19.98	19.98
Mod.	64QAM	256QAM	64QAM	256QAM	64QAM	256QAM	64QAM	256QAM
Middle CH	5.16	5.28	9.93	9.95	14.96	15.13	20.02	19.86



FR1 n25 / 5MHz / DFT-S OFDM / Middle Channel / Full RB

PI/2 BPSK

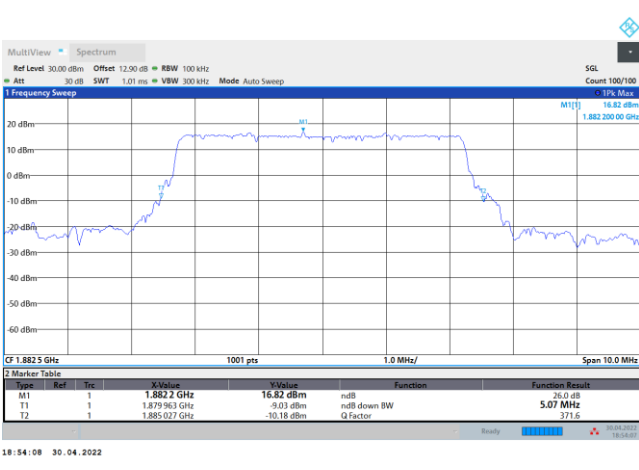

FR1 n25 / 5MHz / CP OFDM / Middle Channel / Full RB

QPSK

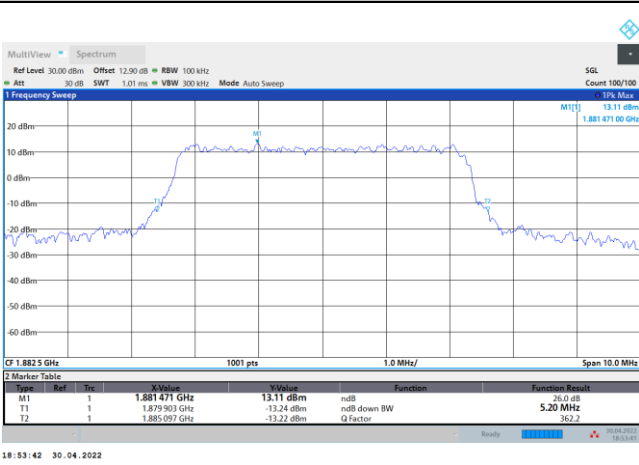

16QAM

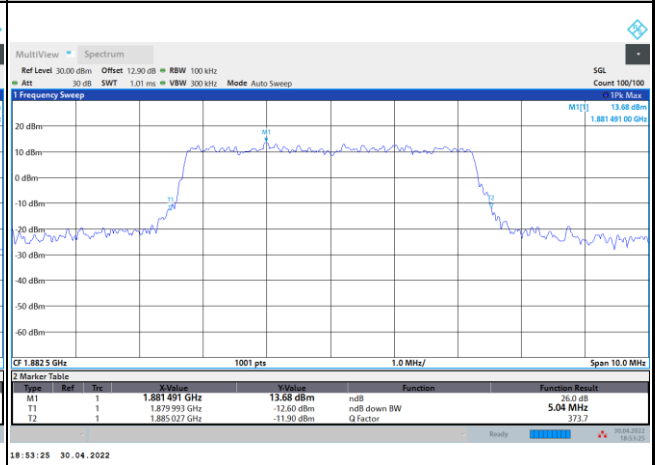

64QAM

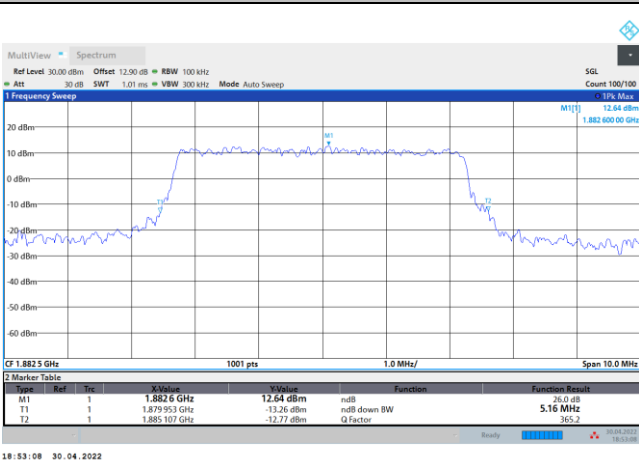

256QAM

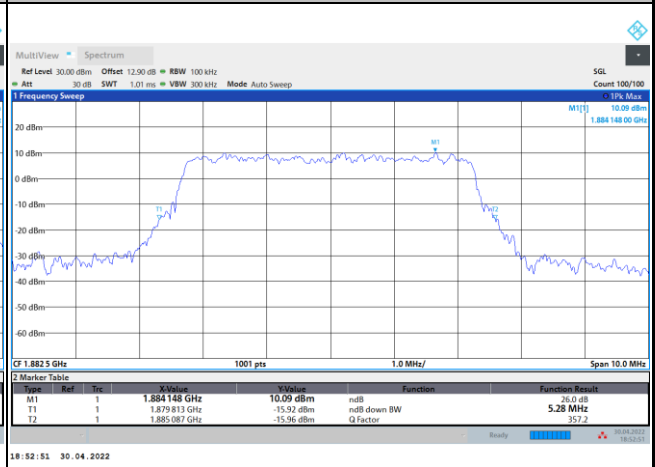



FR1 n25 / 10MHz / DFT-S OFDM / Middle Channel / Full RB

PI/2 BPSK

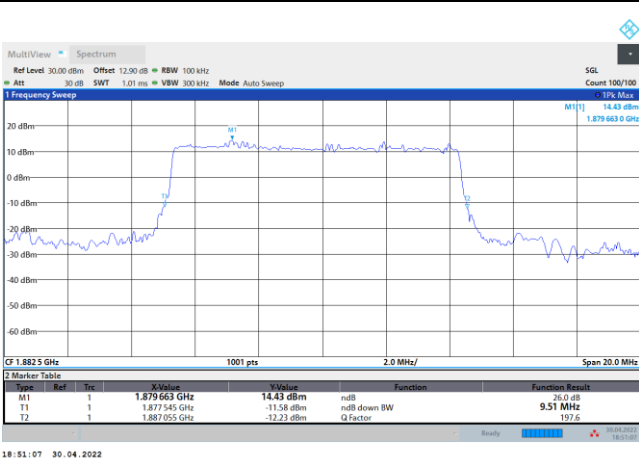

FR1 n25 / 10MHz / CP OFDM / Middle Channel / Full RB

QPSK

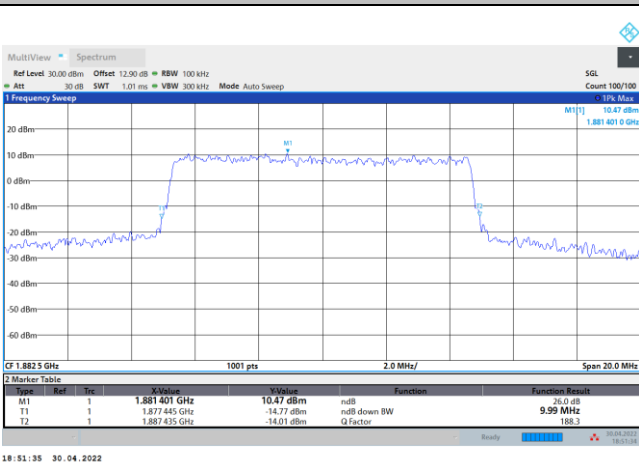

16QAM

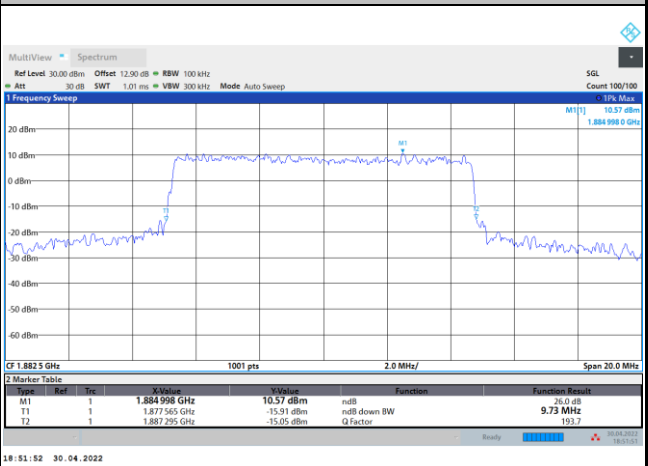

64QAM

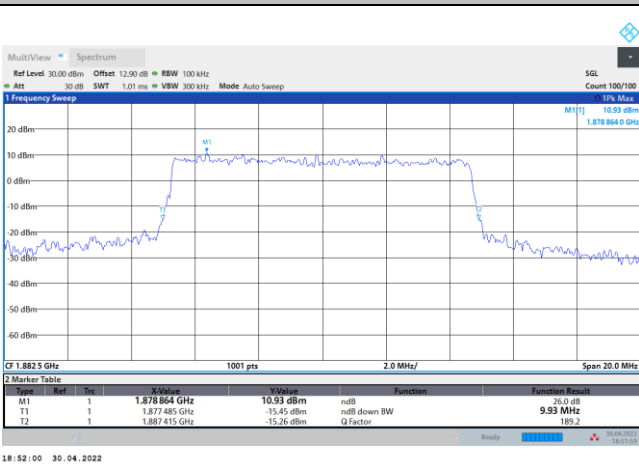

256QAM

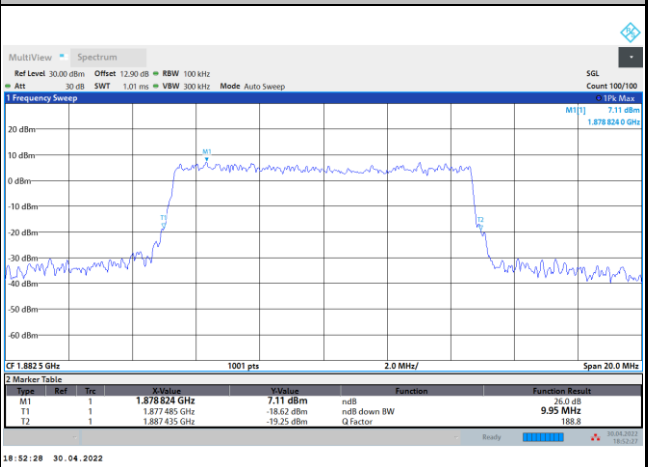



FR1 n25 / 15MHz / DFT-S OFDM / Middle Channel / Full RB

PI/2 BPSK

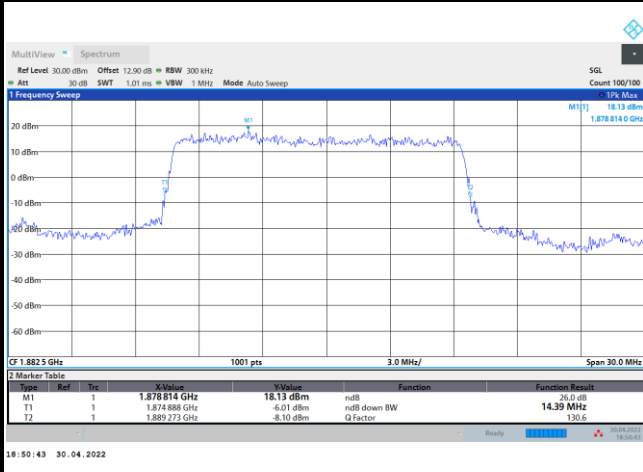

FR1 n25 / 15MHz / CP OFDM / Middle Channel / Full RB

QPSK

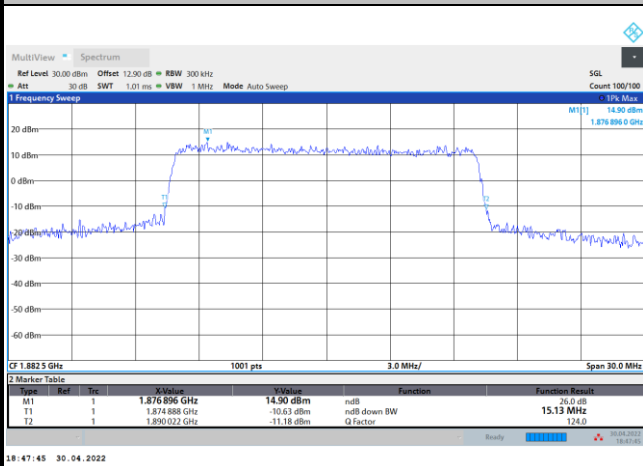

16QAM

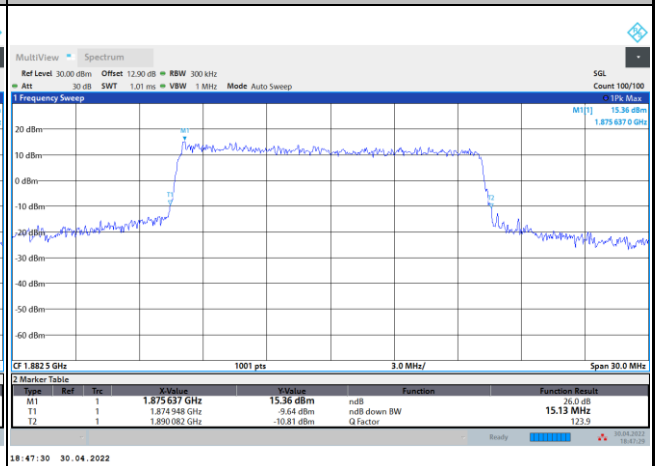

64QAM

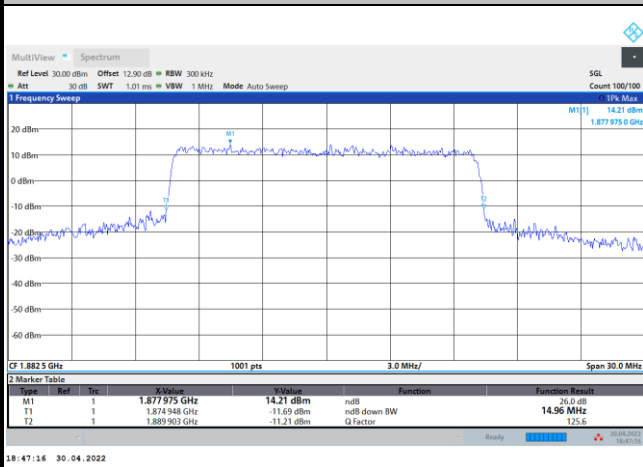

256QAM

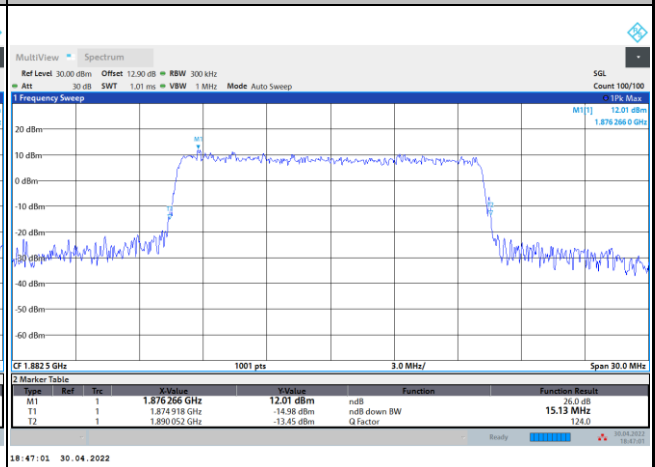



FR1 n25 / 20MHz / DFT-S OFDM / Middle Channel / Full RB

PI/2 BPSK

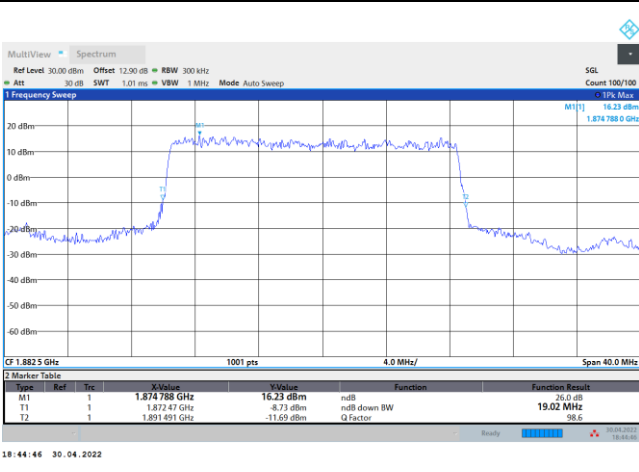

FR1 n25 / 20MHz / CP OFDM / Middle Channel / Full RB

QPSK

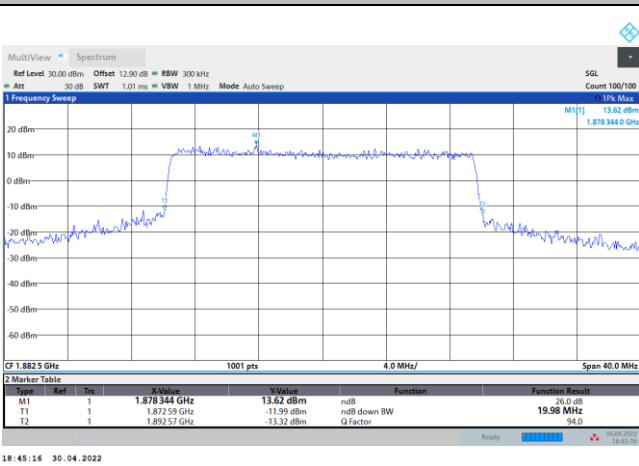

16QAM

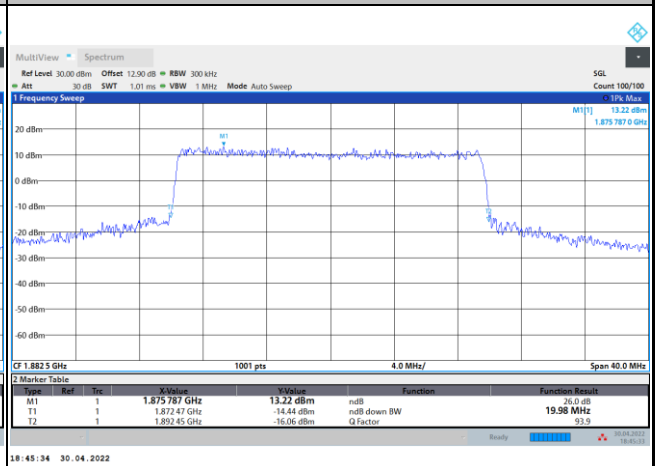

64QAM

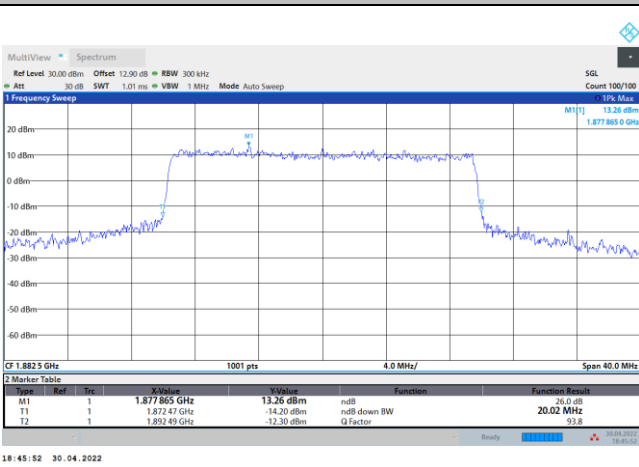

256QAM

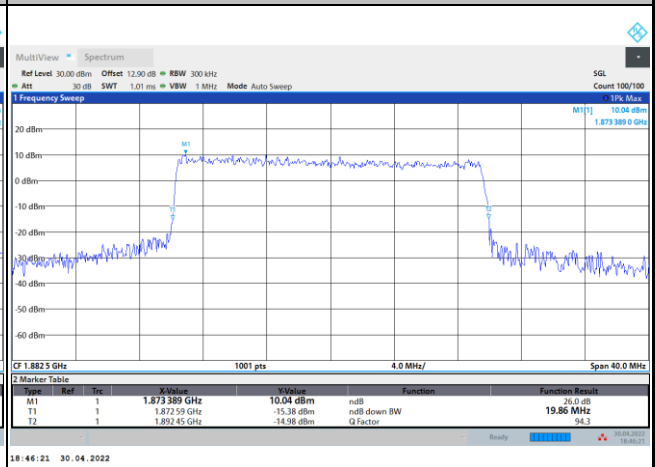



Occupied Bandwidth

Mode	FR1 n25 : 99%OBW(MHz) / DFT-S OFDM							
BW	5MHz		10MHz		15MHz		20MHz	
Mod.	PI/2 BPSK		PI/2 BPSK		PI/2 BPSK		PI/2 BPSK	
Middle CH	4.49		8.90		13.48		17.90	

Mode	FR1 n25 : 99%OBW (MHz) / CP OFDM							
BW	5MHz		10MHz		15MHz		20MHz	
Mod.	QPSK	16QAM	QPSK	16QAM	QPSK	16QAM	QPSK	16QAM
Middle CH	4.52	4.49	9.30	9.31	14.19	14.16	18.94	18.97
Mod.	64QAM	256QAM	64QAM	256QAM	64QAM	256QAM	64QAM	256QAM
Middle CH	4.49	4.52	9.28	9.29	14.22	14.16	18.95	19.05



FR1 n25 / 5MHz / DFT-S OFDM / Middle Channel / Full RB

PI/2 BPSK

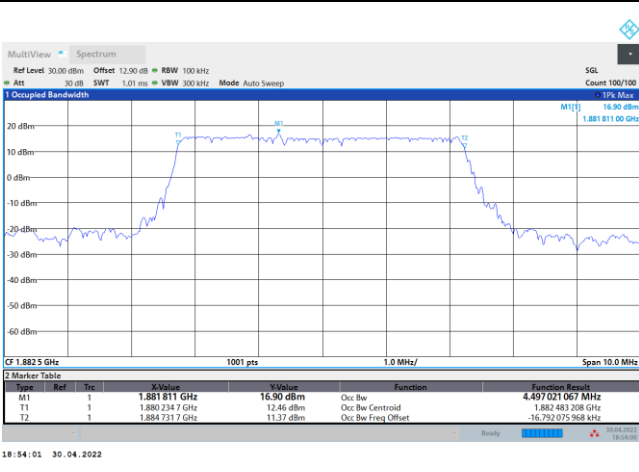

FR1 n25 / 5MHz / CP OFDM / Middle Channel / Full RB

QPSK

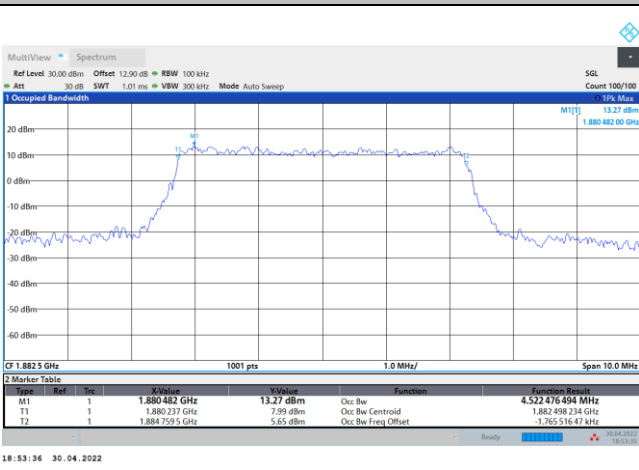

16QAM

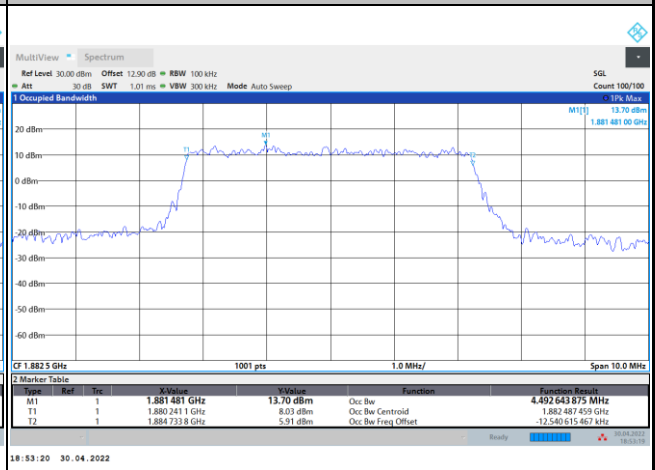

64QAM

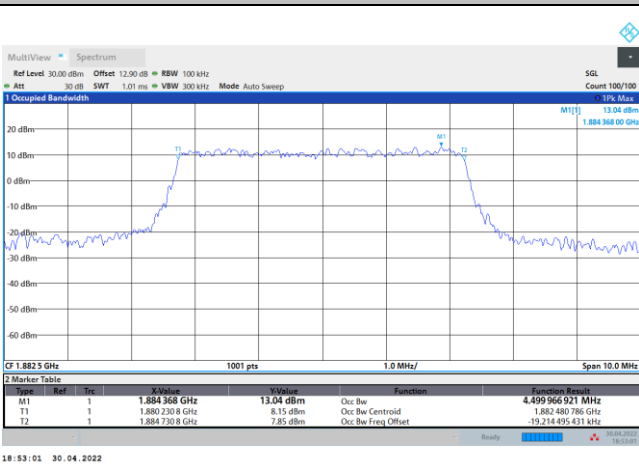

256QAM

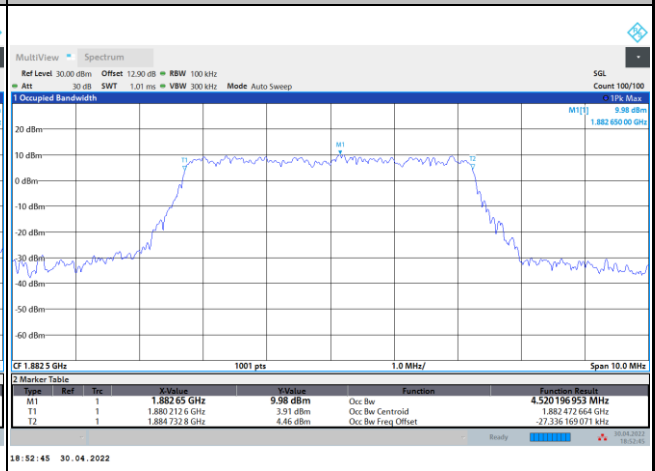



FR1 n25 / 10MHz / DFT-S OFDM / Middle Channel / Full RB

PI/2 BPSK

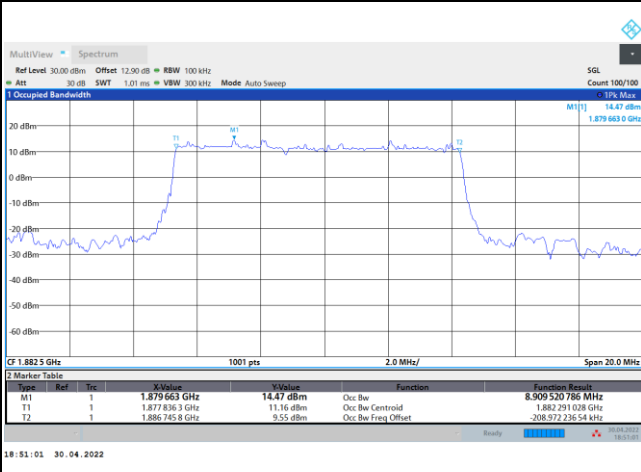

FR1 n25 / 10MHz / CP OFDM / Middle Channel / Full RB

QPSK

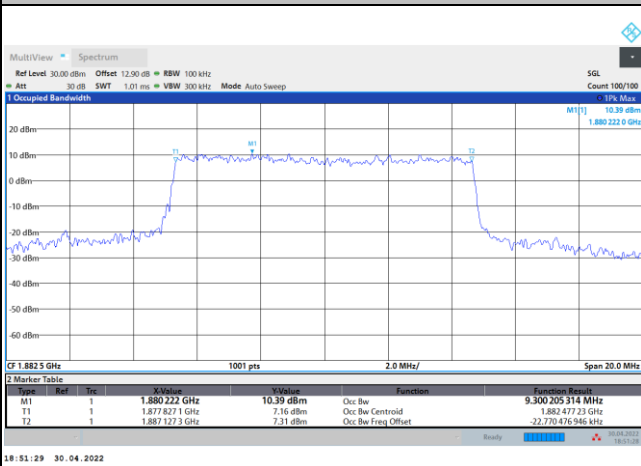

16QAM

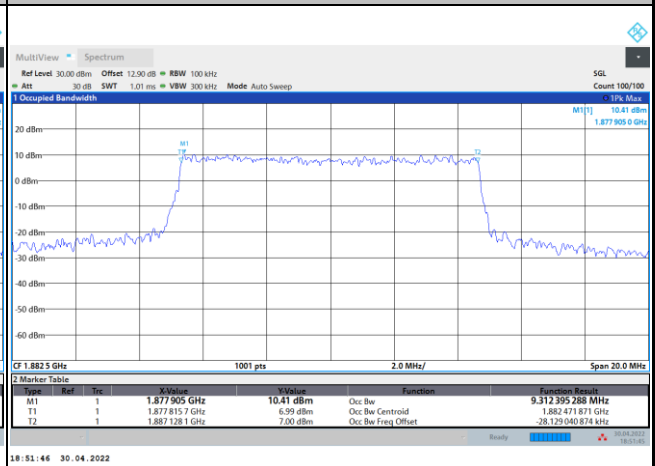

64QAM

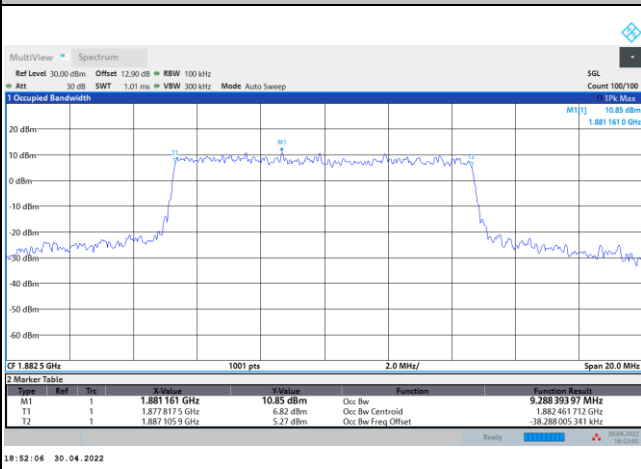

256QAM

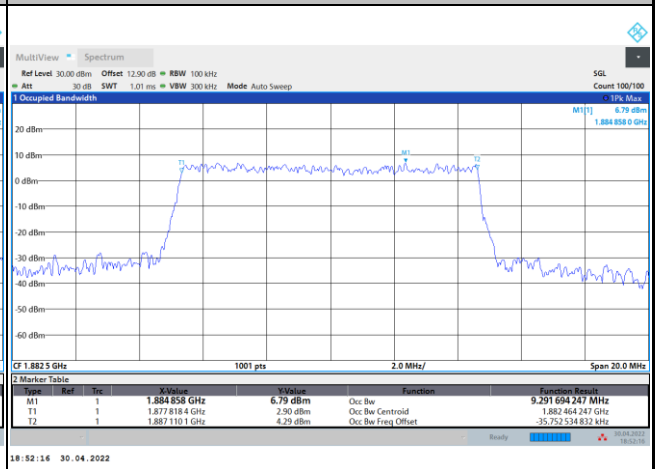



FR1 n25 / 15MHz / DFT-S OFDM / Middle Channel / Full RB

PI/2 BPSK

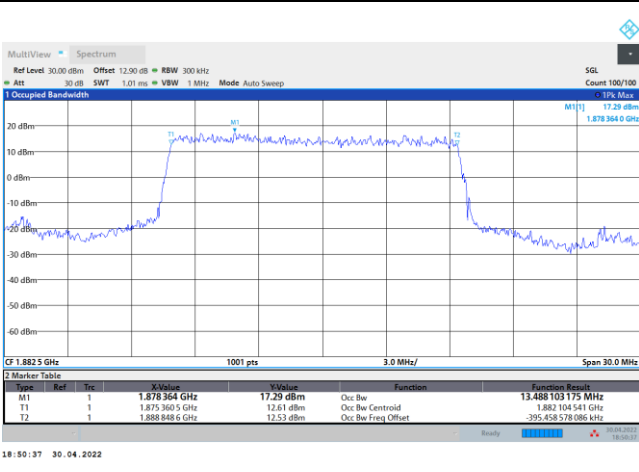

FR1 n25 / 15MHz / CP OFDM / Middle Channel / Full RB

QPSK

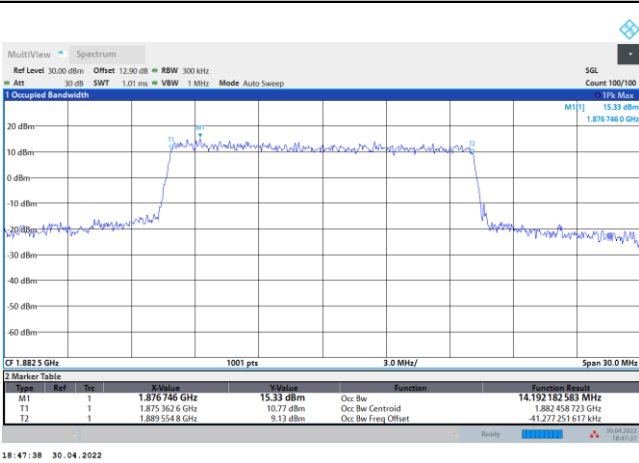

16QAM

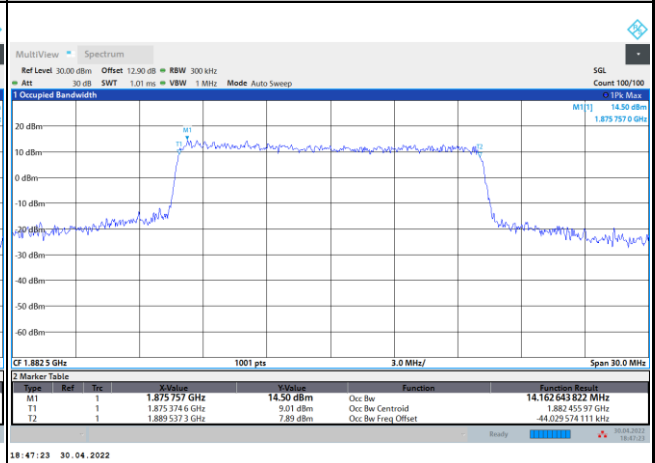

64QAM

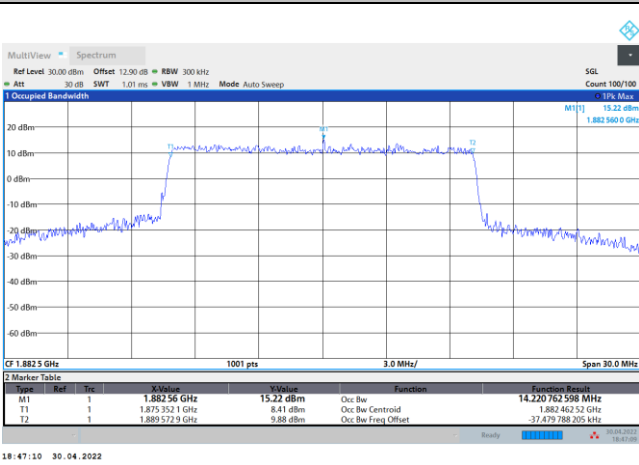

256QAM

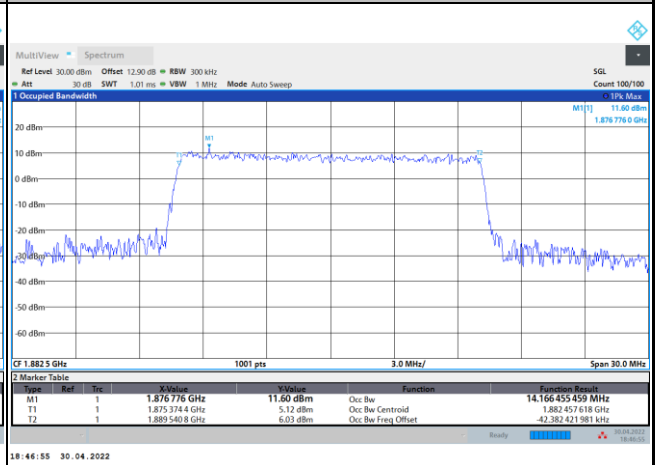



FR1 n25 / 20MHz / DFT-S OFDM / Middle Channel / Full RB

PI/2 BPSK

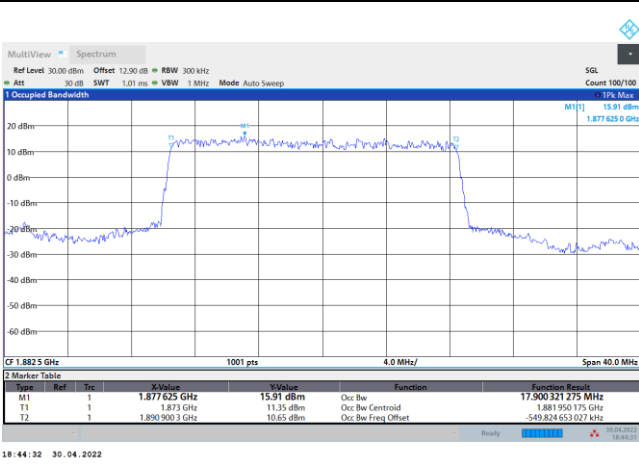

FR1 n25 / 20MHz / CP OFDM / Middle Channel / Full RB

QPSK

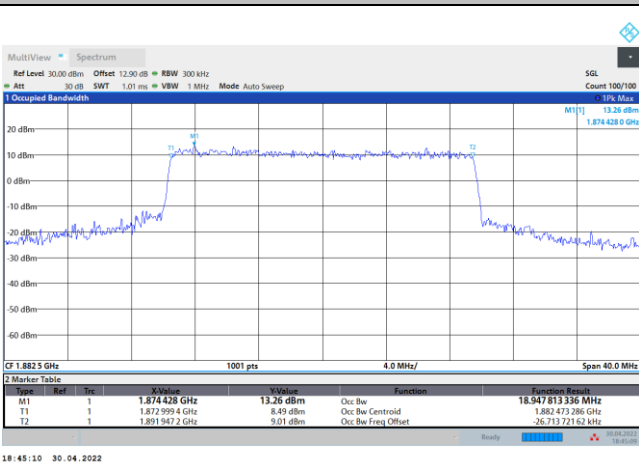

16QAM

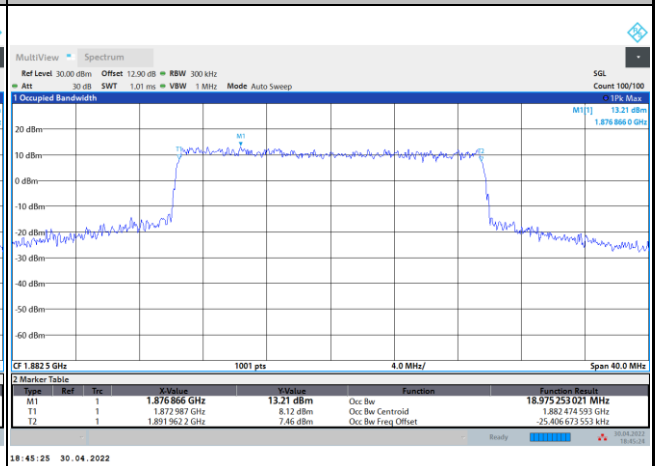

64QAM

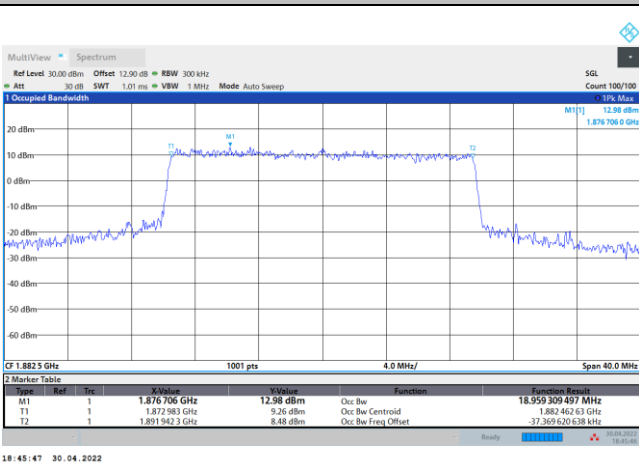

256QAM

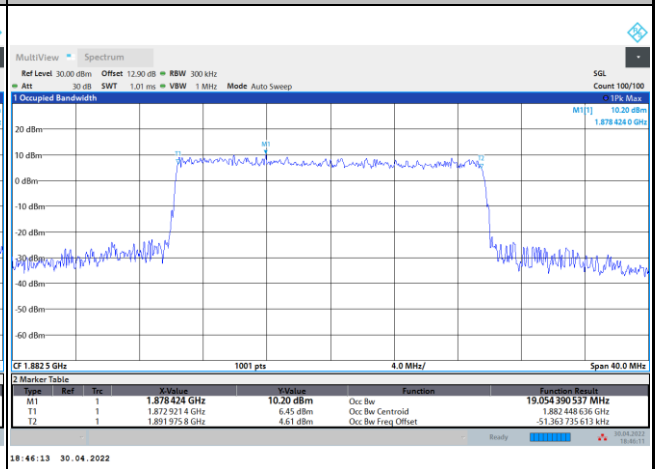



Conducted Band Edge

FR1 n25 / 5MHz / DFT-S OFDM / PI/2 BPSK

Lowest Band Edge / 1RB0

Highest Band Edge / 1RBmax

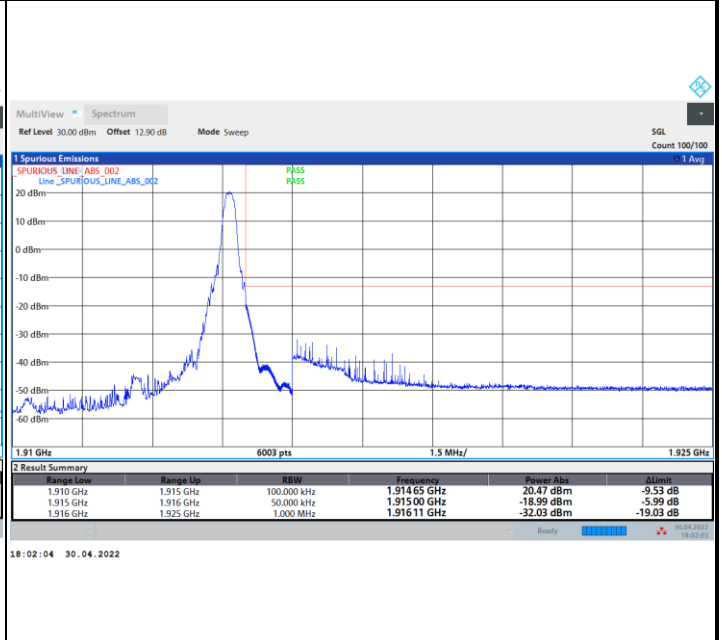
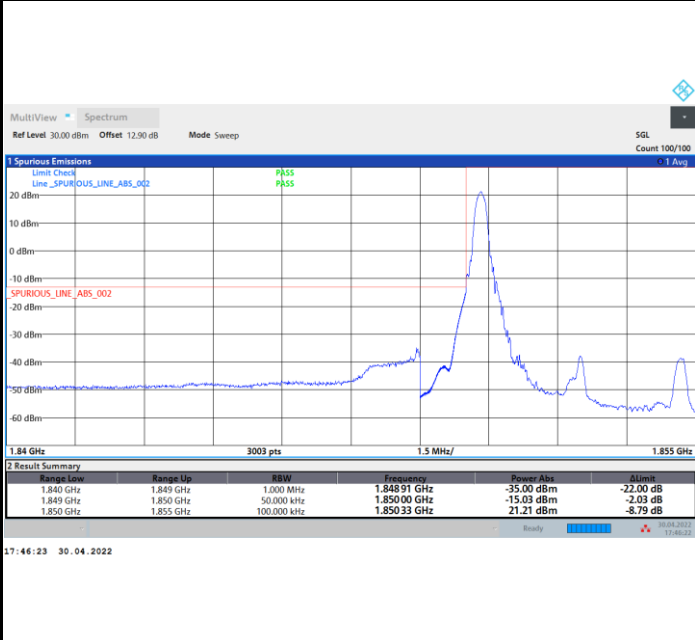

Lowest Band Edge / Full RB

Highest Band Edge / Full RB

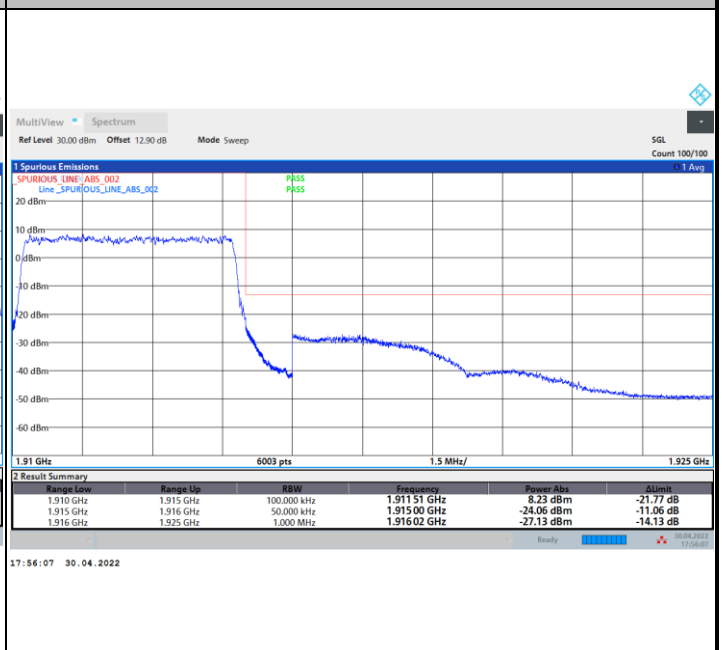



FR1 n25 / 5MHz / DFT-S OFDM / QPSK

Lowest Band Edge / 1RB0

Highest Band Edge / 1RBmax

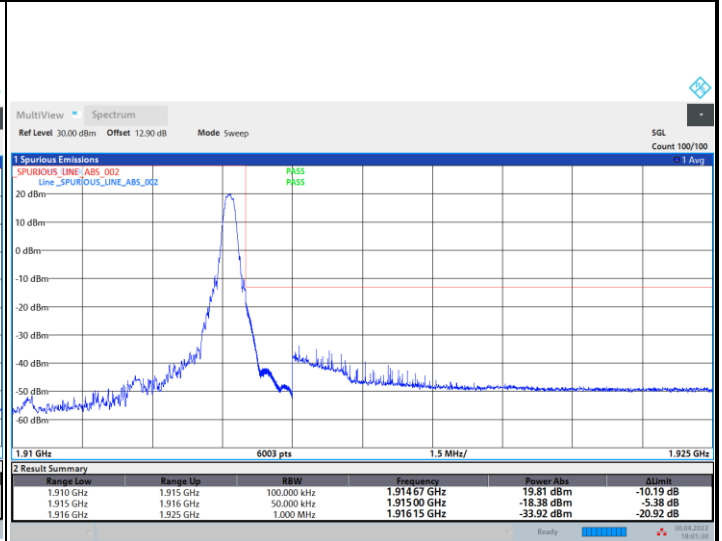
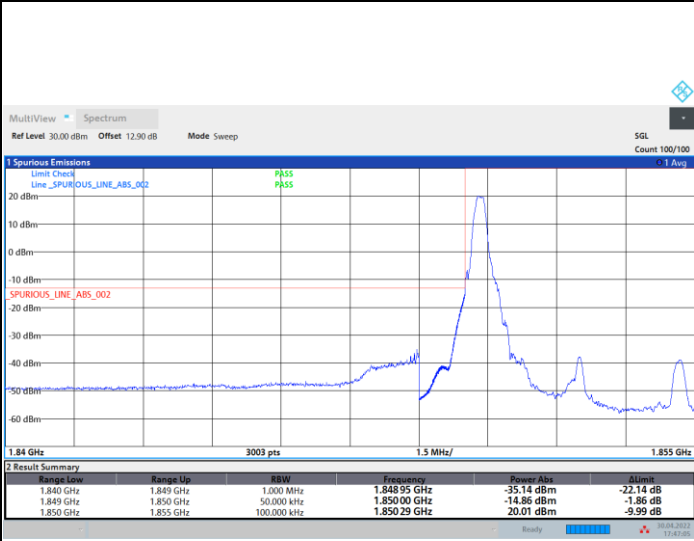

17:47:06 30.04.2022

18:01:31 30.04.2022

Lowest Band Edge / Full RB

Highest Band Edge / Full RB

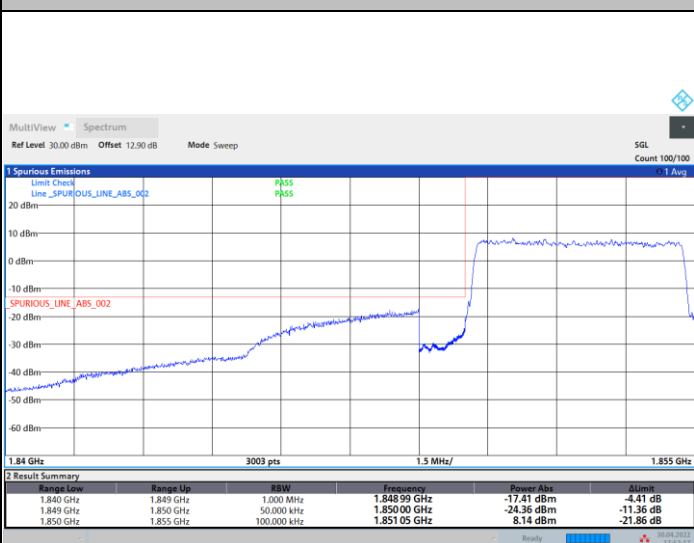

17:52:18 30.04.2022

17:57:17 30.04.2022



FR1 n25 / 5MHz / DFT-S OFDM / 16QAM

Lowest Band Edge / 1RB0

Highest Band Edge / 1RBmax

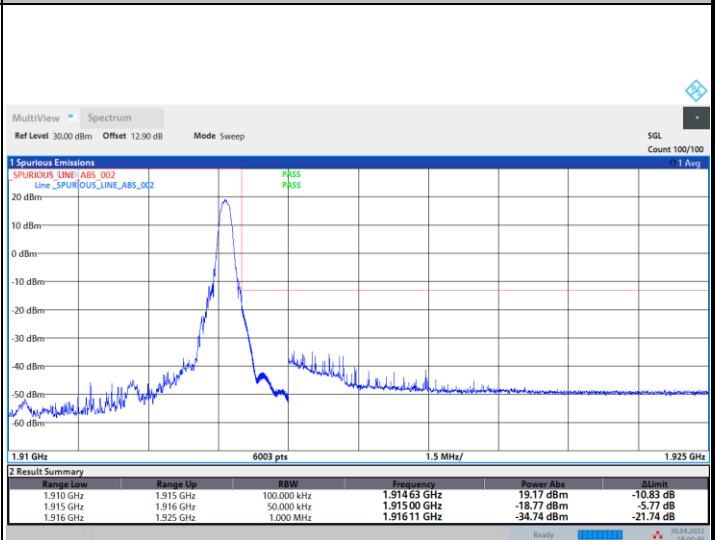
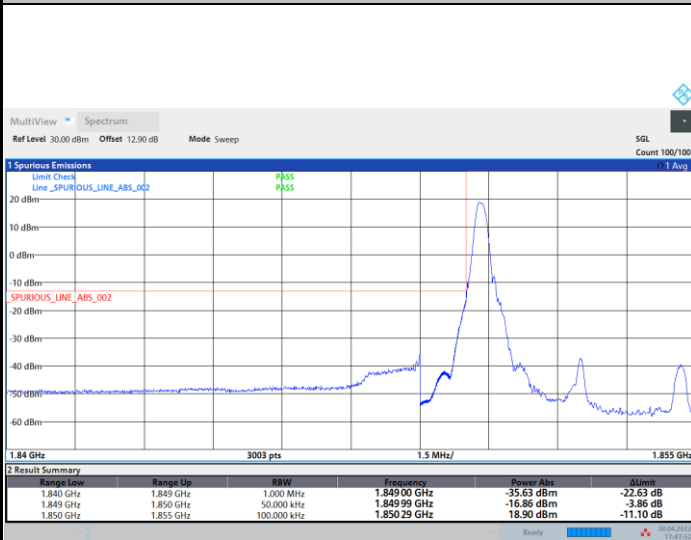

17:47:53 30.04.2022

18:00:46 30.04.2022

Lowest Band Edge / Full RB

Highest Band Edge / Full RB

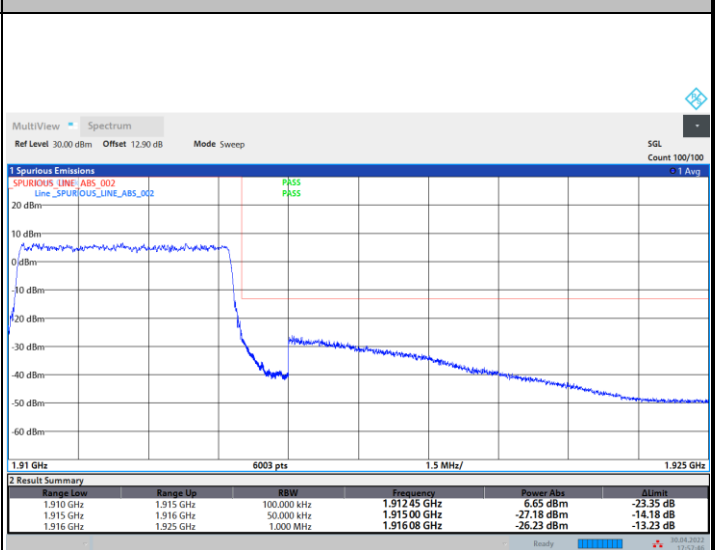
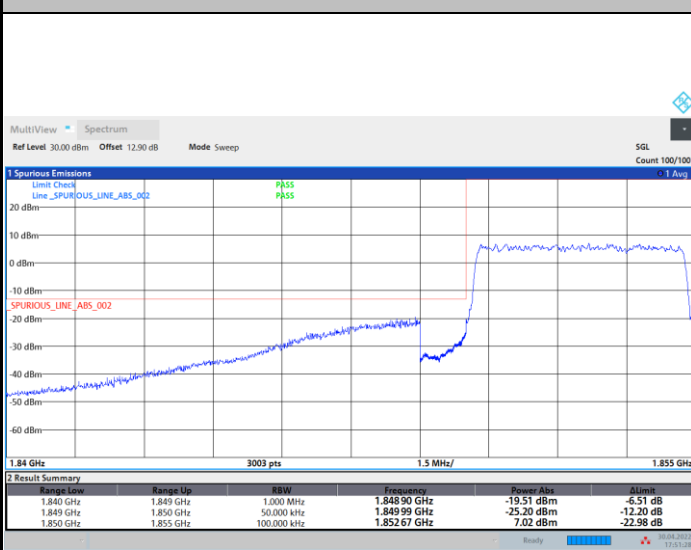

17:51:28 30.04.2022

17:57:46 30.04.2022



FR1 n25 / 5MHz / DFT-S OFDM / 64QAM

Lowest Band Edge / 1RB0

Highest Band Edge / 1RBmax

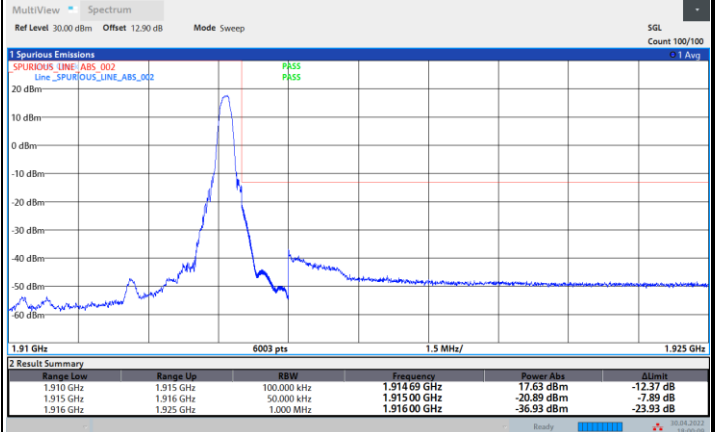
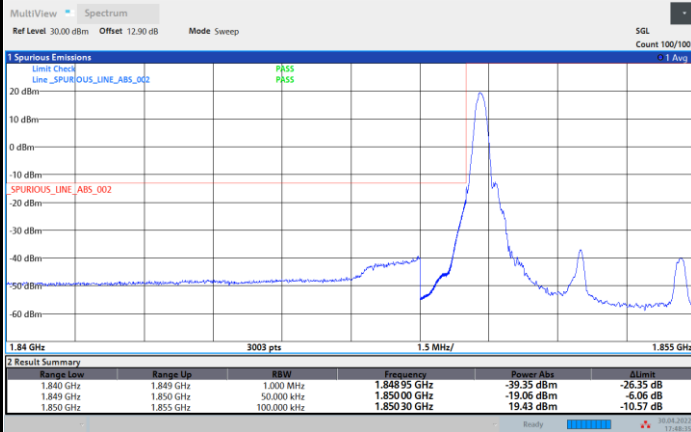

17:48:36 30.04.2022

18:00:10 30.04.2022

Lowest Band Edge / Full RB

Highest Band Edge / Full RB

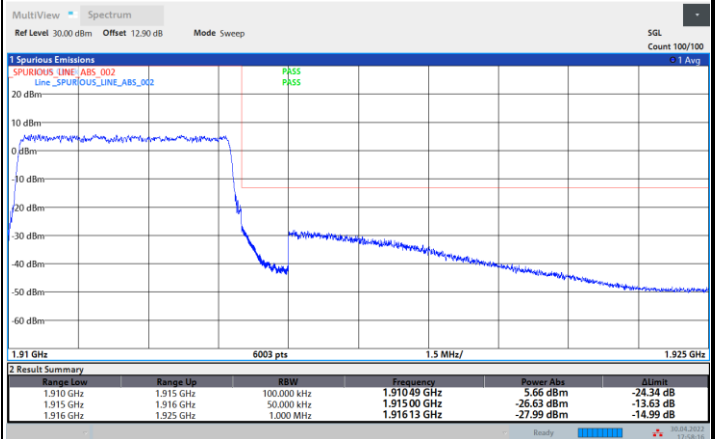
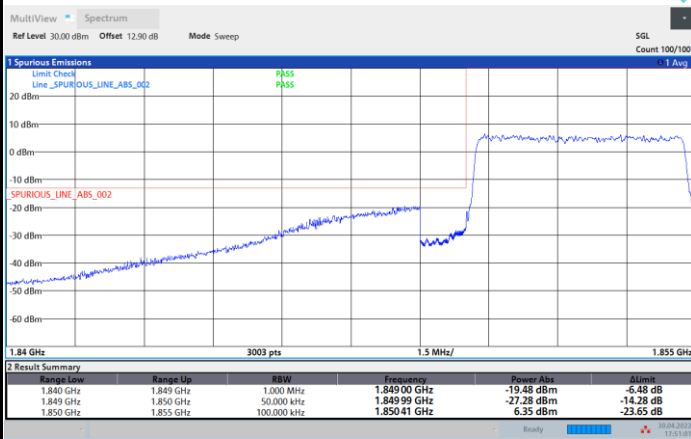

17:51:01 30.04.2022

17:58:17 30.04.2022



FR1 n25 / 5MHz / DFT-S OFDM / 256QAM

Lowest Band Edge / 1RB0

Highest Band Edge / 1RBmax

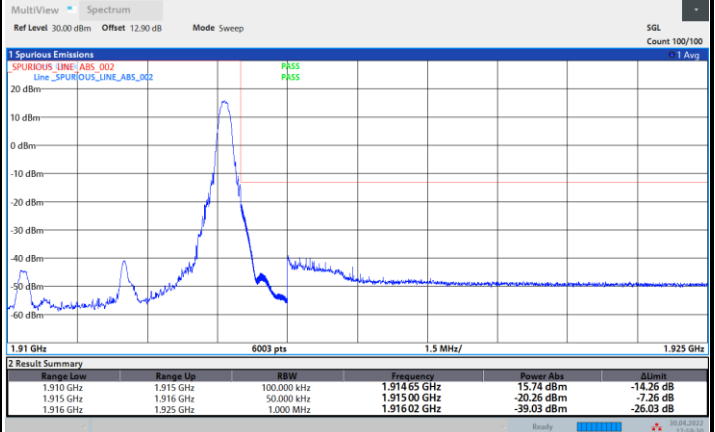
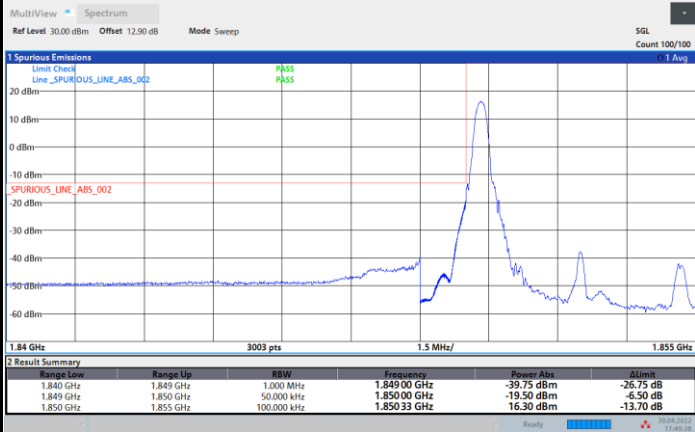

Lowest Band Edge / Full RB

Highest Band Edge / Full RB

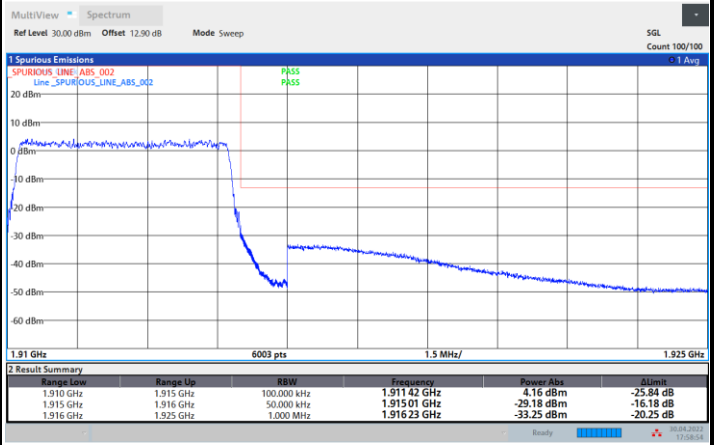
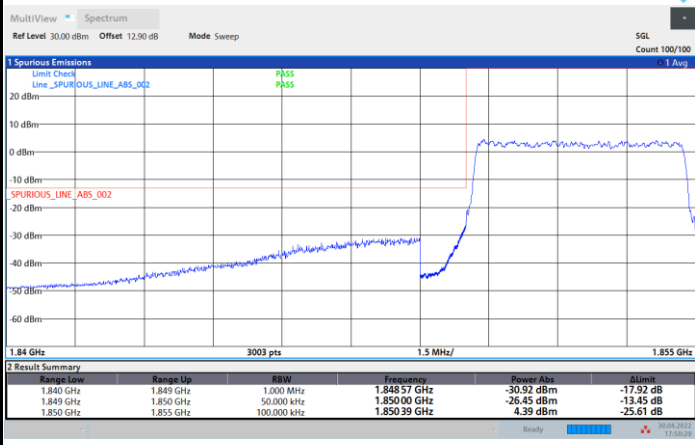



FR1 n25 / 5MHz / CP OFDM / QPSK / Full RB

Lowest Band Edge

Highest Band Edge

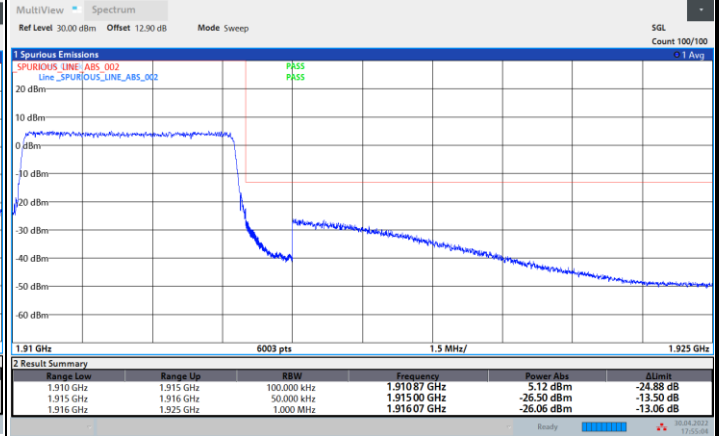
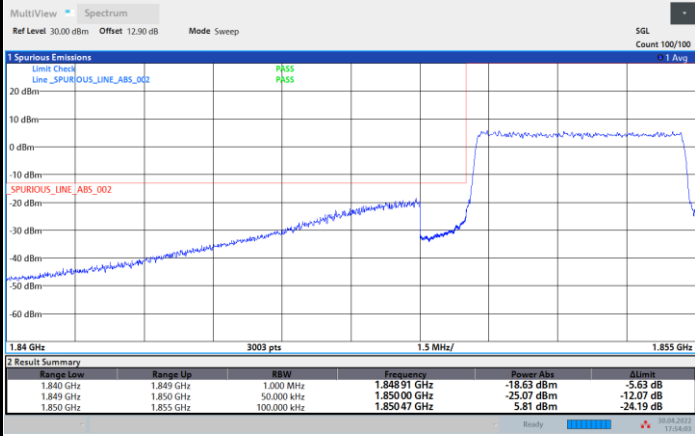

17:54:03 30.04.2022

17:55:05 30.04.2022



FR1 n25 / 10MHz / DFT-s-OFDM / PI/2 BPSK / Full RB

Lowest Band Edge

Highest Band Edge

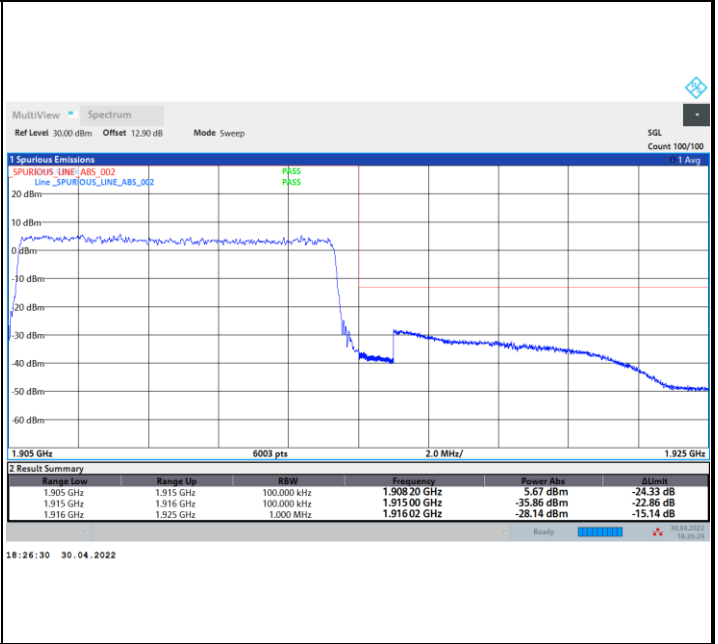
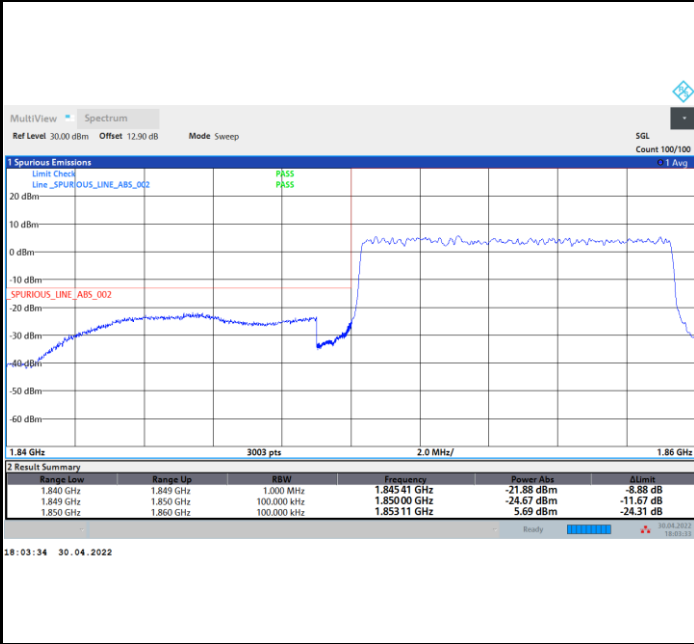

FR1 n25 / 10MHz / DFT-s-OFDM / QPSK / Full RB

Lowest Band Edge

Highest Band Edge

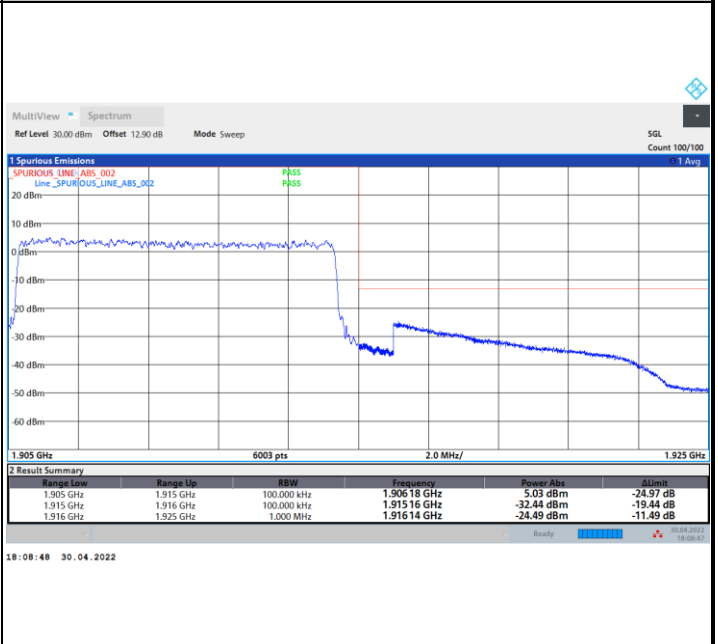
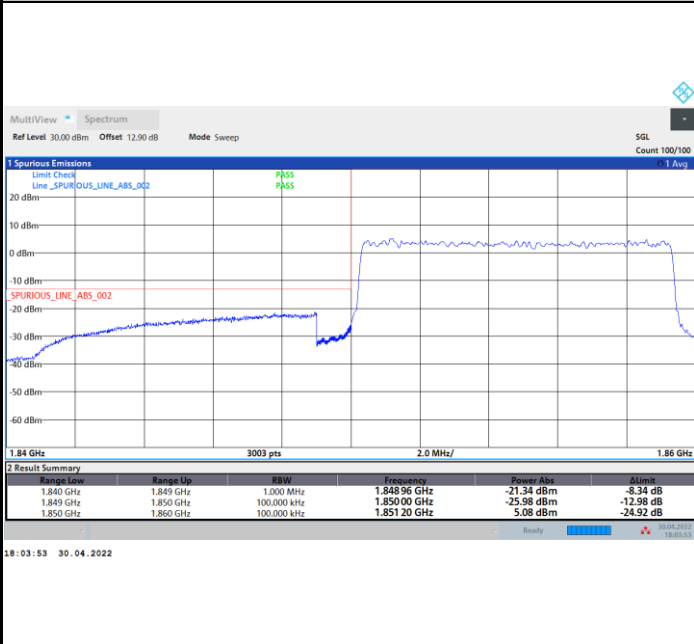

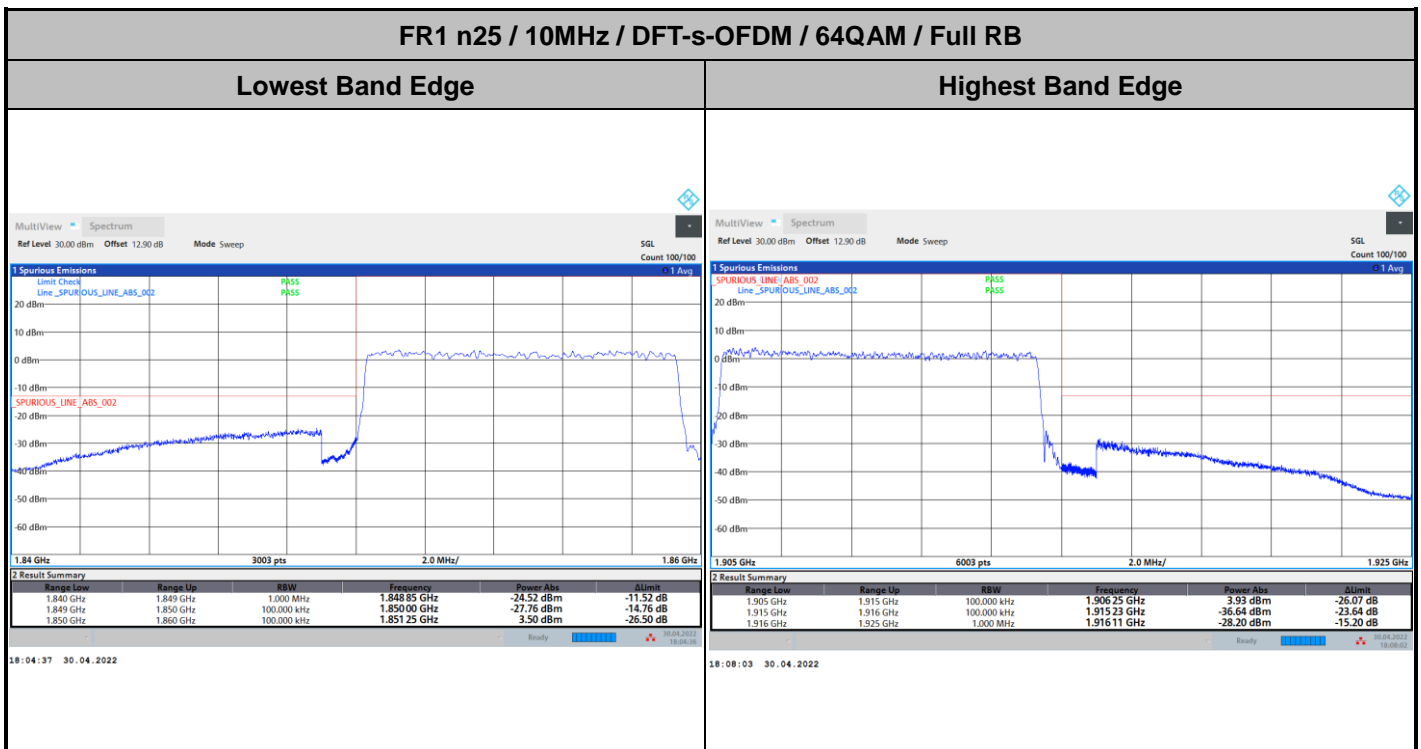
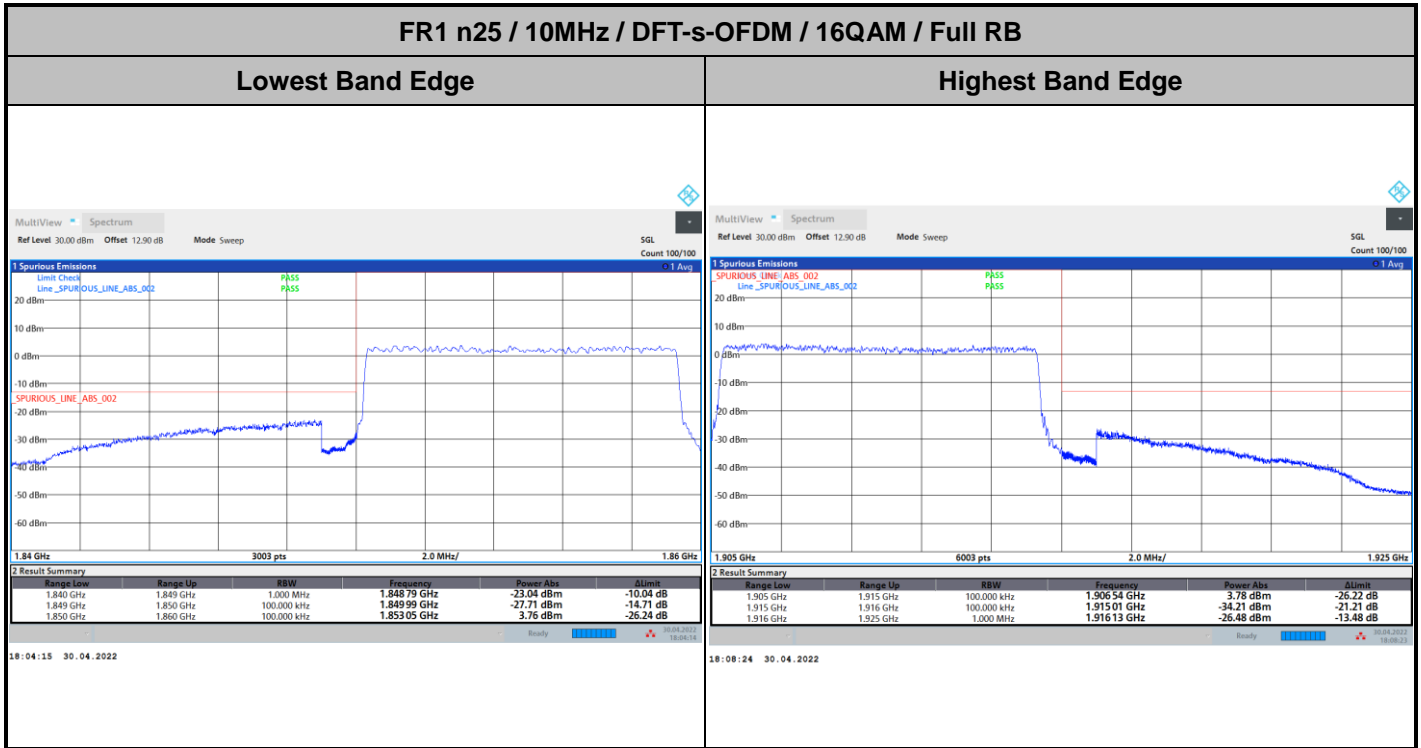



FR1 n25 / 10MHz / DFT-s-OFDM / 256QAM / Full RB

Lowest Band Edge

Highest Band Edge

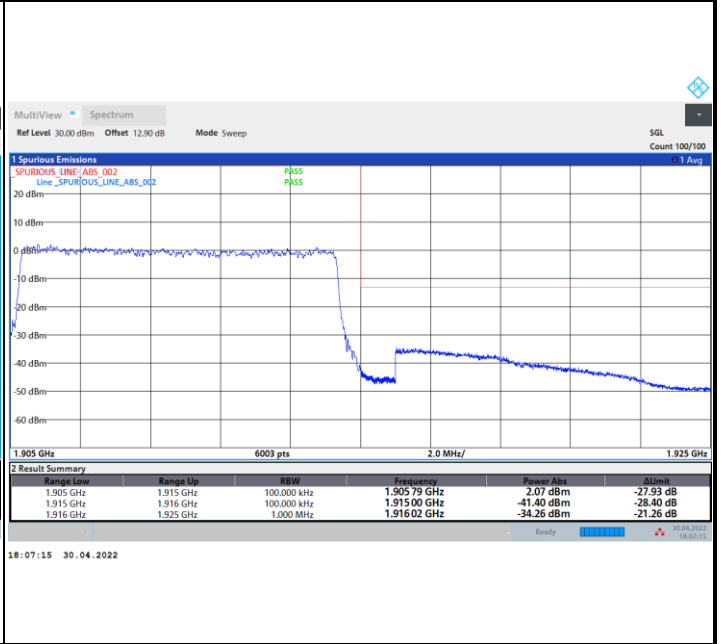
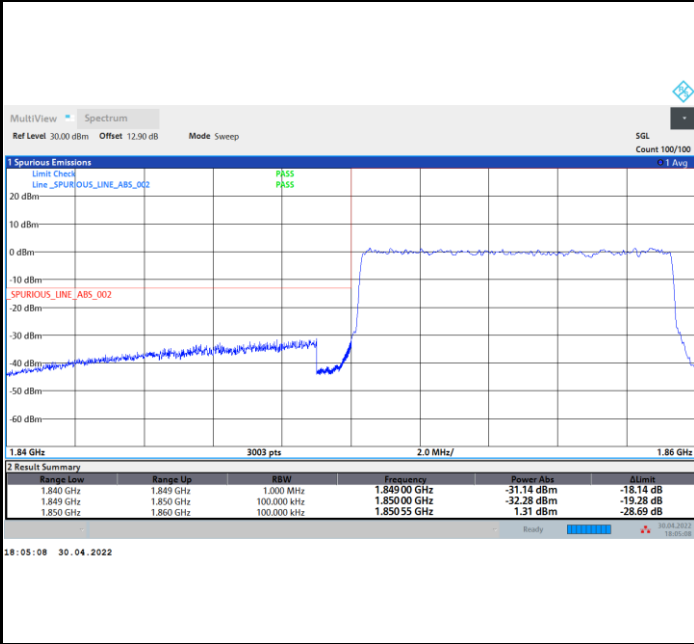

FR1 n25 / 10MHz / CP OFDM / QPSK / Full RB

Lowest Band Edge

Highest Band Edge

