



Wistron NeWeb Corp.

81VRAP15.G01 Data Sheet

Customer Name: **Netgear**

Date: **2022/06/29**

OEM P/N	403-10396-01
WNC P/N	81VRAP15.G01
Description	A8000 DONGLE ANTENNA, 1.13 LOW LOSS, 21MM BLACK\WHITE, IPEX 1L, VEAP-NO1
Version	A02

Provided By Wistron NeWeb Corp	Reviewed By Wistron NeWeb Corp	Approved By Customer
Dennis Huang	Gary Huang	

Wistron NeWeb Corporation
20 Park Avenue II,
Hsinchu Science Park,
Hsinchu 308, Taiwan, R.O.C.
TEL: +886-3-666-7799
FAX: +886-3-666-7321
<http://www.wnweb.com>



Wistron NeWeb Corp.

Index

1. Introduction fication

2. Antenna Performance

2.1 VSWR

2.2 Efficiency

2.3 Peak Gain

2.4 Radiation Pattern

Revision History

Date	Version	Change Description
2022/02/22	A01	NEW RELEASE
2022/06/29	A02	MODIFY ANTENNA PLACEMENT

1. Introduction

Antenna Material List

1. FPC
2. Plastic
3. Coaxial cable
4. Micro RF connector

Antenna Type	Dipole type
Photo	

2. Antenna Performance

2.1 VSWR

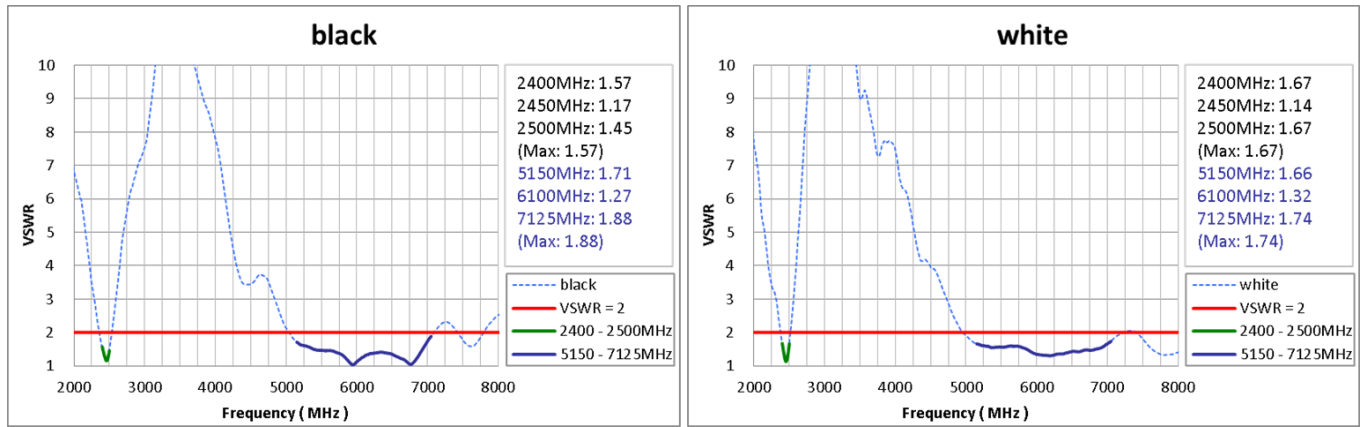

2.2 Efficiency & Peak Gain

2G Radio		2400	2450	2500	Avg.
Black	Eff.	73%	75%	67%	70%
Cable	Peak Gain	2.0	2.2	1.3	
White	Eff.	65%	74%	70%	70%
cable	Peak Gain	1.3	1.7	1.9	

5G Radio		5150	5350	5550	5750	5850	Avg.
Black	Eff.	70%	72%	76%	78%	77%	75%
Cable	Peak Gain	2.3	2.6	2.7	2.6	2.5	
White	Eff.	69%	74%	76%	79%	77%	75%
Cable	Peak Gain	2.1	2.8	1.9	2.5	2.0	

6G Radio		6000	6250	6450	6650	6850	7125	Avg.
Black	Eff.	74%	77%	71%	71%	66%	63%	70%
Cable	Peak Gain	2.2	2.4	2.7	2.6	2.0	1.7	
White	Eff.	75%	76%	77%	75%	68%	65%	73%
Cable	Peak Gain	2.3	2.5	2.0	2.7	2.5	1.9	

2.3 Radiation Pattern

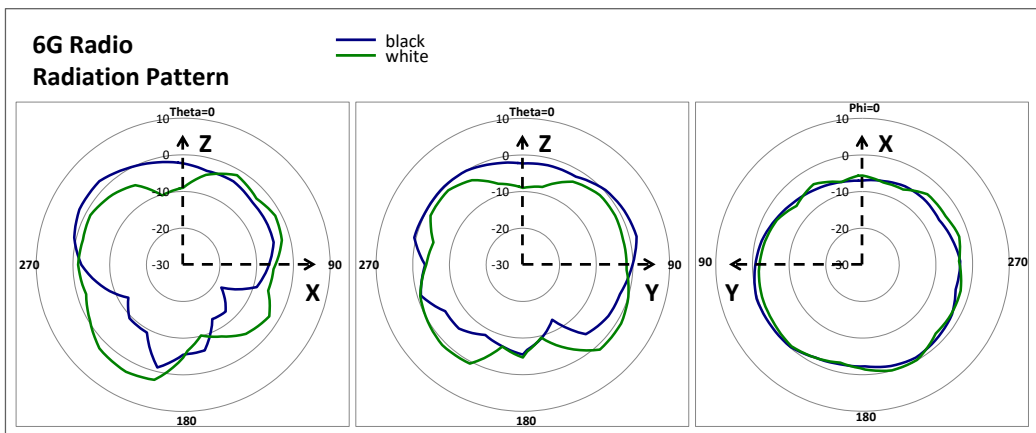
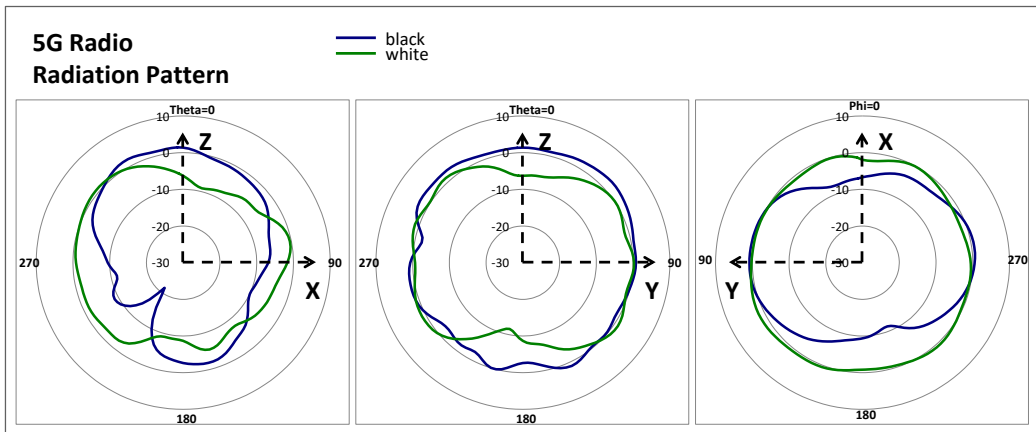
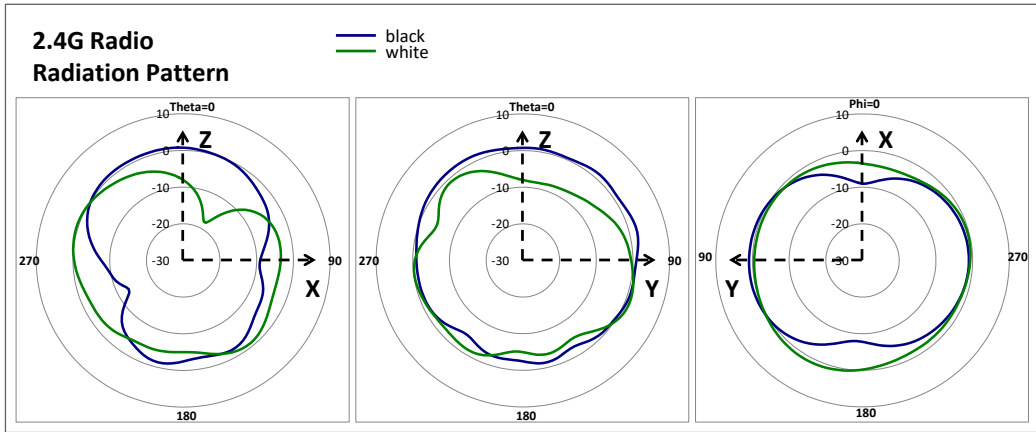
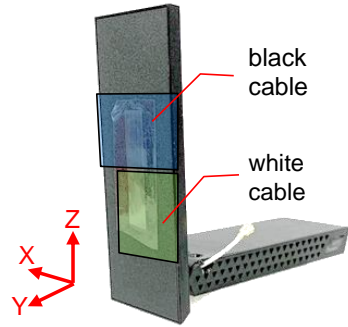

1

2

WNC PROPRIETARY

PART NUMBER BLOCK		CUSTOMER P/N BLOCK	
PART NUMBER	REV	PART NUMBER	REV
57VEAP15.001	F	403-10396-01	X06

REVISIONS				
ZONE	REV	DESCRIPTION	DATE	APPROVED
	F	REMOVE TAPE	06/29/22	VINCENT CC LIN

A

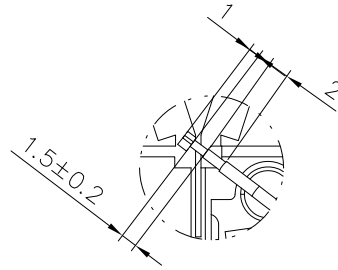
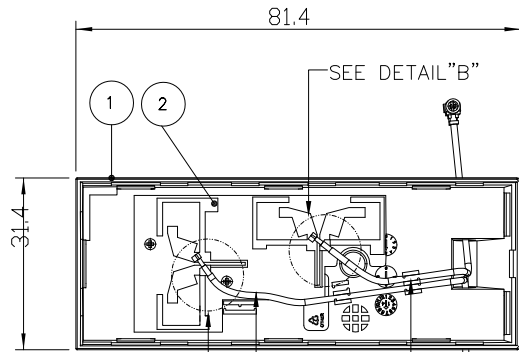

DETAIL B
SCALE: 4/1

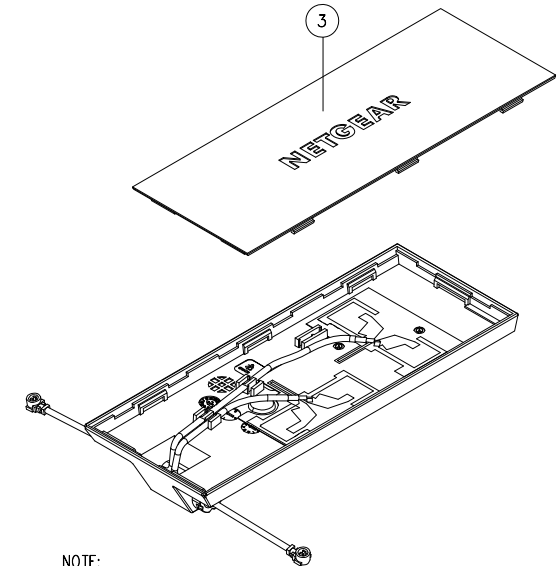
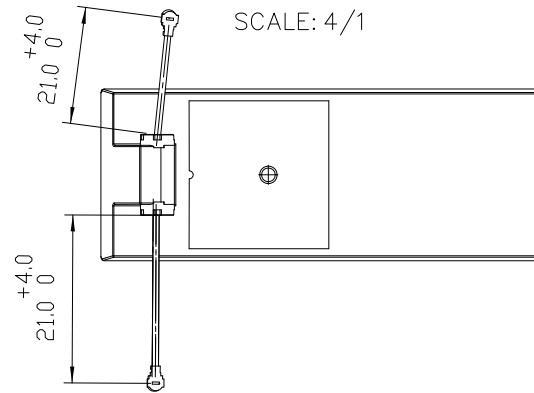

NOTE:
1. PULL CABLE TO FIND THE MAXIMUM STRENGTH OF CONNECTOR, MAXIMUM STRENGTH > 1.5Kg-w (CABLE>1.13mm)
2. PULL CABLE TO FIND THE MAXIMUM STRENGTH OF SOLDERING POINT (GROUND), MAXIMUM STRENGTH > 2.0Kg-w (CABLE>1.13mm)

SEE DETAIL "A"

LENGTH: 84.5±1
DIAMETER: ø1.13
COLOR: BLACK
LOW LOSS

LENGTH: 63±1
DIAMETER: ø1.13
COLOR: WHITE
LOW LOSS

CONNECTOR TYPE : 1.13-H2.5
端子頭朝上(REFERENCE)

B

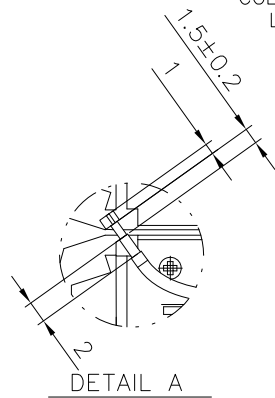

DETAIL A
SCALE: 4/1

ITEM	PART NO.	DESCRIPTION	ITEM	QTY
3	34.HVEAP.001	282-10933-01 , TOP,COVER ,A8000 ,VEAP-N01	EA	1
2	48VEAP01.SGCFYFD	VEAP-N01,FPC,1L,0.1MM(T),PI,OSP,WIFI6E,SAMPLE	EA	1
1	34.EAAT1.111	BOTTOM COVER, A6210, EAAT-NE1,34.EAAT1.111	EA	1

ONLY ME PARTS REFERENCE

		UNLESS OTHERWISE SPECIFIED ALL DIMENSIONS ARE IN mm AND TOLERANCES ARE: INTEGER DIMENSIONS ± 0.2 1 PLACE DECIMAL ± 0.1 2 PLACE DECIMALS ± 0.05				ANGULAR DIMENSIONS ± 1° HOLES UNDER ø5.00 ± 0.05		WNC 啓基科技股份有限公司 Wistron NeWeb Corp. 20 Park Avenue II, Hsinchu Science Park, Hsinchu 308, Taiwan, R.O.C. Tel: 886-3-6667799 Fax: 886-3-5788726	
MATERIAL: NA		FINISH: NA				DWG TITLE A8000 DONGLE ANTENNA, 1.13 LOW LOSS, 21MM BLACK\WHITE, IPEX 1L, VEAP-N01			
81VEAP15.G01	VEAP-N01	THIRD ANGLE PROJECTION	DRAWN	TERESA SF LIU	06/29/22	SIZE	DWG NO.	REV	
NEXT ASSY	USED ON		ENGR	DENNIS HUANG	06/29/22	A3	57VEAP15.001	F	
APPLICATION			APVD	VINCENT CC LIN	06/29/22	SCALE	1/1	SHEET	1 OF 2

1

2

A

B

PART NUMBER BLOCK	
PART NUMBER	REV
DP.EL.B15.514	1

WNC CONFIDENTIAL		REVISIONS		
ZONE	REV	DESCRIPTION	DATE	APPROVED
1		RELEASE TO FILE	01/25/21	TC GUO

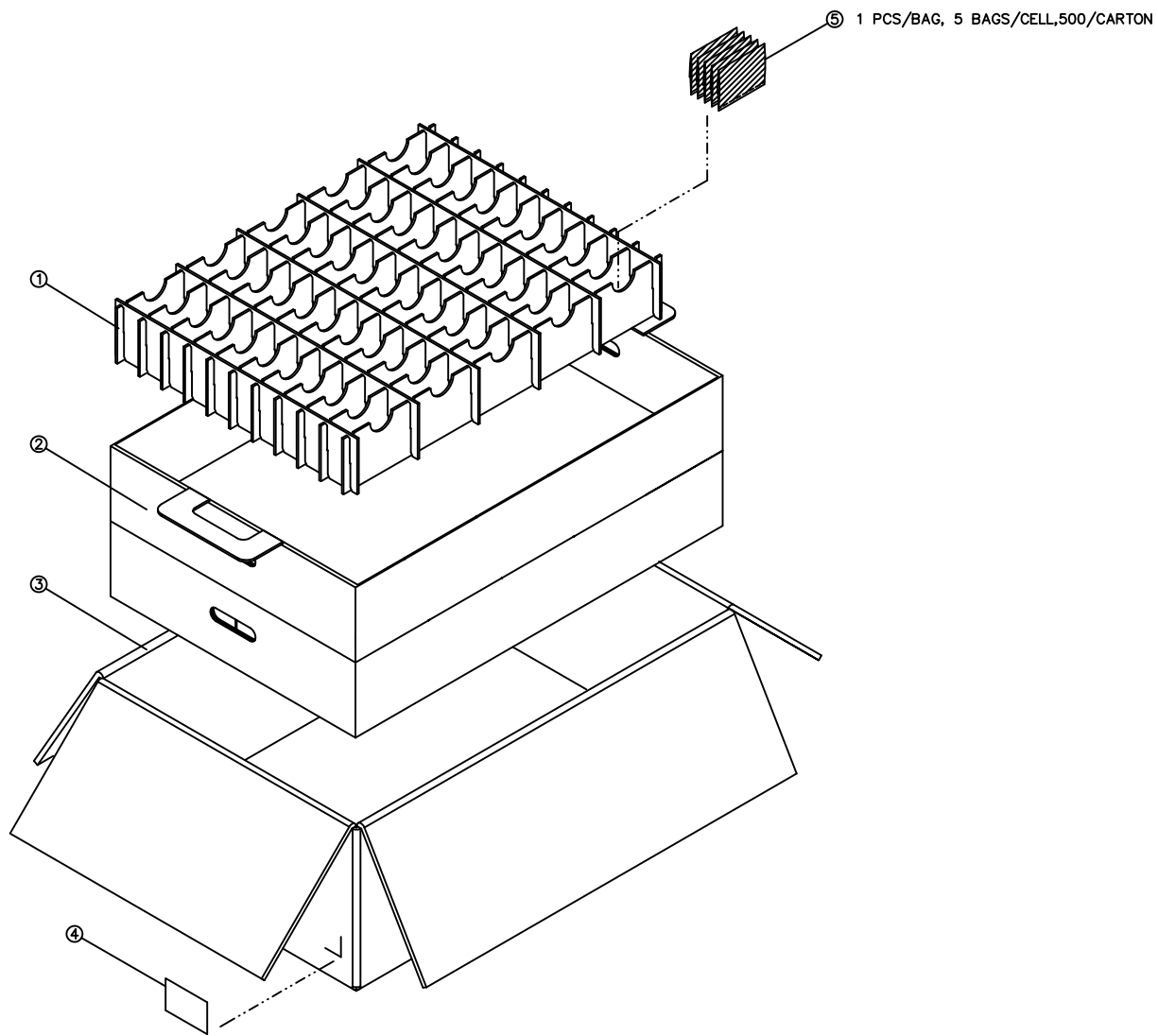

5	48-5082110-001	BAG, LDPE, 11.50X10.00MM, 500-C	EA	1
4	44-5082110-00212	LABEL, WHITE, 70X50, PAPER, 480G-581	EA	10,000
3	44-CAS13.000102	CARTON, OUTER CARTON B SEP4482207MM, CAS-Q	EA	10,000
2	44-CAS13.000102	CARTON, INNER CARTON B SEP4482207MM, CAS-Q	EA	10,000
1	08-ELB15.001	PARTITION ASSY, 0822457275MM, EB-1C1	EA	10,000

UNLESS OTHERWISE SPECIFIED ALL DIMENSIONS ARE IN MM AND TOLERANCES ARE: FRACTIONAL DECIMAL: ±0.5 ANGULAR DIMENSIONS: ±0.5 HOLE DIA: ±0.1 HOLE TAPER: ±0.5			
MATERIAL: NA		DWG TITLE: MISTRON PACKING, 3-IN-1 LABEL, 1PCS/BAG, 500/CARTON	
FINISH: NA		DRAWN: JUAN LJ 01/25/21	
ELB-U1		ENGR: KEN ZHOU 01/25/21	
USED ON		APVD: TC GUO 01/25/21	
APPLICATION		SCALE: 1/1	
NEXT ASSY		SIZE: DWG NO. DP.EL.B15.514	
REV 1		SHEET 1 OF 1	

測試報告

Test Report

號碼(No.): EKR22200427

日期(Date): 18-Feb-2022

頁數(Page): 1 of 43

台虹科技股份有限公司 (TAIFLEX SCIENTIFIC CO., LTD.)

高雄市前鎮區環區三路1號 (NO. 1, HUANQU 3RD RD., QIANZHEN DIST., KAOHSIUNG CITY, TAIWAN)

以下測試樣品係由申請廠商所提供及確認 (The following sample(s) was/were submitted and identified by the applicant as) :

送樣廠商(Sample Submitted By) : 台虹科技股份有限公司 (TAIFLEX SCIENTIFIC CO., LTD.)
樣品名稱(Sample Name) : FCCL HALOGEN FREE TYPE
樣品型號(Style/Item No.) : TH@(PI=1/3~2mil COPPER=1/3~2OZ AD=8~20um)

=====
收件日(Sample Receiving Date) : 10-Feb-2022
測試期間(Testing Period) : 10-Feb-2022 to 18-Feb-2022

測試需求(Test Requested) : (1) 依據客戶指定，參考RoHS 2011/65/EU Annex II及其修訂指令(EU) 2015/863測試鎘、鉛、汞、六價鉻、多溴聯苯、多溴聯苯醚, DBP, BBP, DEHP, DIBP。 (As specified by client, with reference to RoHS 2011/65/EU Annex II and amending Directive (EU) 2015/863 to determine Cadmium, Lead, Mercury, Cr(VI), PBBs, PBDEs, DBP, BBP, DEHP, DIBP contents in the submitted sample(s).)
(2) 依據客戶指定，測試 PAHs 及其他測項。 (As specified by client, to test PAHs and other item(s).)

測試結果(Test Results) : 請參閱下一頁 (Please refer to following pages.)

結論(Conclusion) : (1) 根據客戶所提供的樣品，其鎘、鉛、汞、六價鉻、多溴聯苯、多溴聯苯醚, DBP, BBP, DEHP, DIBP的測試結果符合RoHS 2011/65/EU Annex II暨其修訂指令(EU) 2015/863之限值要求。 (Based on the performed tests on submitted sample(s), the test results of Cadmium, Lead, Mercury, Cr(VI), PBBs, PBDEs, DBP, BBP, DEHP, DIBP comply with the limits as set by RoHS Directive (EU) 2015/863 amending Annex II to Directive 2011/65/EU.)

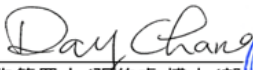
報告簽署人/張伯睿 博士/部經理
Ray Chang, Ph.D./ Department Manager
Signed for and on behalf of
SGS TAIWAN LTD.
化學實驗室-高雄/Chemical Laboratory-Kaohsiung



PIN CODE: 1FFF56BD

This document is issued by the Company subject to its General Conditions of Service printed overleaf, available on request or accessible at <https://www.sgs.com.tw/terms-of-service> and, for electronic format documents, subject to Terms and Conditions for Electronic Documents at <https://www.sgs.com.tw/terms-of-service>. Attention is drawn to the limitation of liability, indemnification and jurisdiction issues defined therein. Any holder of this document is advised that information contained hereon reflects the Company's findings at the time of its intervention only and within the limits of client's instruction, if any. The Company's sole responsibility is to its Client and this document does not exonerate parties to a transaction from exercising all their rights and obligations under the transaction documents. This document cannot be reproduced, except in full, without prior written approval of the Company. Any unauthorized alteration, forgery or falsification of the content or appearance of this document is unlawful and offenders may be prosecuted to the fullest extent of the law. Unless otherwise stated the results shown in this test report refer only to the sample(s) tested.

測試報告

Test Report

號碼(No.): EKR22200427

日期(Date): 18-Feb-2022

頁數(Page): 2 of 43

台虹科技股份有限公司 (TAIFLEX SCIENTIFIC CO., LTD.)

高雄市前鎮區環區三路1號 (NO. 1, HUANQU 3RD RD., QIANZHEN DIST., KAOHSIUNG CITY, TAIWAN)

測試部位敘述 (Test Part Description)

No.1 : 銅色 FCCL HALOGEN FREE TYPE (COPPER COLORED FCCL HALOGEN FREE TYPE)

測試結果 (Test Results)

測試項目 (Test Items)	測試方法 (Method)	單位 (Unit)	MDL	結果 (Result)	限值 (Limit)
				No.1	
鎘 (Cd) (Cadmium (Cd)) (CAS No.: 7440-43-9)	參考IEC 62321-5: 2013 · 以感應耦合電漿發射光譜儀分析。(With reference to IEC 62321-5: 2013, analysis was performed by ICP-OES.)	mg/kg	2	n.d.	100
鉛 (Pb) (Lead (Pb)) (CAS No.: 7439-92-1)	參考IEC 62321-5: 2013 · 以感應耦合電漿發射光譜儀分析。(With reference to IEC 62321-5: 2013, analysis was performed by ICP-OES.)	mg/kg	2	n.d.	1000
汞 (Hg) (Mercury (Hg)) (CAS No.: 7439-97-6)	參考IEC 62321-4: 2013+ AMD1: 2017 · 以感應耦合電漿發射光譜儀分析。(With reference to IEC 62321-4: 2013+ AMD1: 2017, analysis was performed by ICP-OES.)	mg/kg	2	n.d.	1000
六價鉻 (CrVI) (Hexavalent Chromium Cr(VI)) (CAS No.: 18540-29-9)	參考IEC 62321-7-2: 2017 · 以紫外光-可見光分光光度計分析。(With reference to IEC 62321-7-2: 2017, analysis was performed by UV-VIS.)	mg/kg	8	n.d.	1000
一溴聯苯 (Monobromobiphenyl)	參考IEC 62321-6: 2015 · 以氣相層析儀/質譜儀分析。(With reference to IEC 62321-6: 2015, analysis was performed by GC/MS.)	mg/kg	5	n.d.	-
二溴聯苯 (Dibromobiphenyl)		mg/kg	5	n.d.	-
三溴聯苯 (Tribromobiphenyl)		mg/kg	5	n.d.	-
四溴聯苯 (Tetrabromobiphenyl)		mg/kg	5	n.d.	-
五溴聯苯 (Pentabromobiphenyl)		mg/kg	5	n.d.	-
六溴聯苯 (Hexabromobiphenyl)		mg/kg	5	n.d.	-
七溴聯苯 (Heptabromobiphenyl)		mg/kg	5	n.d.	-
八溴聯苯 (Octabromobiphenyl)		mg/kg	5	n.d.	-
九溴聯苯 (Nonabromobiphenyl)		mg/kg	5	n.d.	-
十溴聯苯 (Decabromobiphenyl)		mg/kg	5	n.d.	-
多溴聯苯總和 (Sum of PBBs)		mg/kg	-	n.d.	1000

This document is issued by the Company subject to its General Conditions of Service printed overleaf, available on request or accessible at <https://www.sgs.com.tw/terms-of-service> and, for electronic format documents, subject to Terms and Conditions for Electronic Documents at <https://www.sgs.com.tw/terms-of-service>. Attention is drawn to the limitation of liability, indemnification and jurisdiction issues defined therein. Any holder of this document is advised that information contained hereon reflects the Company's findings at the time of its intervention only and within the limits of client's instruction, if any. The Company's sole responsibility is to its Client and this document does not exonerate parties to a transaction from exercising all their rights and obligations under the transaction documents. This document cannot be reproduced, except in full, without prior written approval of the Company. Any unauthorized alteration, forgery or falsification of the content or appearance of this document is unlawful and offenders may be prosecuted to the fullest extent of the law. Unless otherwise stated the results shown in this test report refer only to the sample(s) tested.

測試報告

Test Report

號碼(No.): EKR22200427

日期(Date): 18-Feb-2022

頁數(Page): 3 of 43

台虹科技股份有限公司 (TAIFLEX SCIENTIFIC CO., LTD.)

高雄市前鎮區環區三路1號 (NO. 1, HUANQU 3RD RD., QIANZHEN DIST., KAOHSIUNG CITY, TAIWAN)

測試項目 (Test Items)	測試方法 (Method)	單位 (Unit)	MDL	結果 (Result)	限值 (Limit)
				No.1	
一溴聯苯醚 (Monobromodiphenyl ether)	參考IEC 62321-6: 2015 · 以氣相層析儀/質譜儀分析。(With reference to IEC 62321-6: 2015, analysis was performed by GC/MS.)	mg/kg	5	n.d.	-
二溴聯苯醚 (Dibromodiphenyl ether)		mg/kg	5	n.d.	-
三溴聯苯醚 (Tribromodiphenyl ether)		mg/kg	5	n.d.	-
四溴聯苯醚 (Tetrabromodiphenyl ether)		mg/kg	5	n.d.	-
五溴聯苯醚 (Pentabromodiphenyl ether)		mg/kg	5	n.d.	-
六溴聯苯醚 (Hexabromodiphenyl ether)		mg/kg	5	n.d.	-
七溴聯苯醚 (Heptabromodiphenyl ether)		mg/kg	5	n.d.	-
八溴聯苯醚 (Octabromodiphenyl ether)		mg/kg	5	n.d.	-
九溴聯苯醚 (Nonabromodiphenyl ether)		mg/kg	5	n.d.	-
十溴聯苯醚 (Decabromodiphenyl ether)		mg/kg	5	n.d.	-
多溴聯苯醚總和 (Sum of PBDEs)		mg/kg	-	n.d.	1000
砷 (As) (Arsenic (As)) (CAS No.: 7440-38-2)	參考US EPA 3052: 1996 · 以感應耦合電漿發射光譜儀分析。(With reference to US EPA 3052: 1996, analysis was performed by ICP-OES.)	mg/kg	2	n.d.	-
鈹 (Be) (Beryllium (Be)) (CAS No.: 7440-41-7)	參考US EPA 3052: 1996 · 以感應耦合電漿發射光譜儀分析。(With reference to US EPA 3052: 1996, analysis was performed by ICP-OES.)	mg/kg	2	n.d.	-
氧化鈹 (BeO) (Beryllium oxide (BeO)) (CAS No.: 1304-56-9)	由鈹結果計算得之。(Calculated from the result of Beryllium.)	mg/kg	2▲	n.d.	-
銻 (Sb) (Antimony (Sb)) (CAS No.: 7440-36-0)	參考US EPA 3052: 1996 · 以感應耦合電漿發射光譜儀分析。(With reference to US EPA 3052: 1996, analysis was performed by ICP-OES.)	mg/kg	2	n.d.	-
三氧化二銻(Sb ₂ O ₃) (Antimony trioxide (Sb ₂ O ₃)) (CAS No.: 1309-64-4)	由銻結果計算得之。(Calculated from the result of Antimony.)	mg/kg	2▲	n.d.	-
四溴雙酚 A (TBBP-A) (Tetrabromobisphenol A (TBBP-A)) (CAS No.: 79-94-7)	參考RSTS-E&E-121 · 以液相層析儀/質譜儀分析。(With reference to RSTS-E&E-121, analysis was performed by LC/MS.)	mg/kg	10	n.d.	-

This document is issued by the Company subject to its General Conditions of Service printed overleaf, available on request or accessible at <https://www.sgs.com.tw/terms-of-service> and, for electronic format documents, subject to Terms and Conditions for Electronic Documents at <https://www.sgs.com.tw/terms-of-service>. Attention is drawn to the limitation of liability, indemnification and jurisdiction issues defined therein. Any holder of this document is advised that information contained hereon reflects the Company's findings at the time of its intervention only and within the limits of client's instruction, if any. The Company's sole responsibility is to its Client and this document does not exonerate parties to a transaction from exercising all their rights and obligations under the transaction documents. This document cannot be reproduced, except in full, without prior written approval of the Company. Any unauthorized alteration, forgery or falsification of the content or appearance of this document is unlawful and offenders may be prosecuted to the fullest extent of the law. Unless otherwise stated the results shown in this test report refer only to the sample(s) tested.

測試報告

Test Report

號碼(No.): EKR22200427

日期(Date): 18-Feb-2022

頁數(Page): 4 of 43

台虹科技股份有限公司 (TAIFLEX SCIENTIFIC CO., LTD.)

高雄市前鎮區環區三路1號 (NO. 1, HUANQU 3RD RD., QIANZHEN DIST., KAOHSIUNG CITY, TAIWAN)

測試項目 (Test Items)	測試方法 (Method)	單位 (Unit)	MDL	結果 (Result)	限值 (Limit)
				No.1	
六溴環十二烷及所有主要被辨別出的異構物(HBCDD) (α- HBCDD, β- HBCDD, γ- HBCDD) (Hexabromocyclododecane (HBCDD) and all major diastereoisomers identified (α- HBCDD, β- HBCDD, γ- HBCDD)) (CAS No.: 25637-99-4, 3194-55-6 (134237-51-7, 134237-50-6, 134237-52-8))	參考IEC 62321-9: 2021 · 以氣相層析儀/質譜儀分析。(With reference to IEC 62321-9: 2021, analysis was performed by GC/MS.)	mg/kg	20	n.d.	-
雙酚A (Bisphenol A) (CAS No.: 80-05-7)	參考RSTS-CHEM-239-1 · 以液相層析串聯質譜儀分析。(With reference to RSTS-CHEM-239-1, analysis was performed by LC/MS/MS.)	mg/kg	1	n.d.	-
滅蟻靈 (Mirex) (CAS No.: 2385-85-5)	參考US EPA 3550C: 2007 · 以氣相層析儀/質譜儀分析。(With reference to US EPA 3550C: 2007, analysis was performed by GC/MS.)	mg/kg	4	n.d.	-
富馬酸二甲酯 (DMFu) (Dimethyl fumarate (DMFu)) (CAS No.: 624-49-7)	參考US EPA 3550C: 2007 · 以氣相層析儀/質譜儀分析。(With reference to US EPA 3550C: 2007, analysis was performed by GC/MS.)	mg/kg	0.1	n.d.	-
聚氯乙烯 (Polyvinyl chloride) (PVC)	參考ASTM E1252: 2013 · 以傅立葉轉換紅外線光譜儀及焰色法分析。(With reference to ASTM E1252: 2013, analysis was performed by FT-IR and Flame Test.)	**	-	Negative	-
紅磷 (Red Phosphorus)	以熱裂解-氣相層析儀/質譜儀分析。(Analysis was performed by Pyrolyzer-GC/MS.)	**	-	Negative	-

This document is issued by the Company subject to its General Conditions of Service printed overleaf, available on request or accessible at <https://www.sgs.com.tw/terms-of-service> and, for electronic format documents, subject to Terms and Conditions for Electronic Documents at <https://www.sgs.com.tw/terms-of-service>. Attention is drawn to the limitation of liability, indemnification and jurisdiction issues defined therein. Any holder of this document is advised that information contained hereon reflects the Company's findings at the time of its intervention only and within the limits of client's instruction, if any. The Company's sole responsibility is to its Client and this document does not exonerate parties to a transaction from exercising all their rights and obligations under the transaction documents. This document cannot be reproduced, except in full, without prior written approval of the Company. Any unauthorized alteration, forgery or falsification of the content or appearance of this document is unlawful and offenders may be prosecuted to the fullest extent of the law. Unless otherwise stated the results shown in this test report refer only to the sample(s) tested.

測試報告

Test Report

號碼(No.): EKR22200427

日期(Date): 18-Feb-2022

頁數(Page): 5 of 43

台虹科技股份有限公司 (TAIFLEX SCIENTIFIC CO., LTD.)

高雄市前鎮區環區三路1號 (NO. 1, HUANQU 3RD RD., QIANZHEN DIST., KAOHSIUNG CITY, TAIWAN)

測試項目 (Test Items)	測試方法 (Method)	單位 (Unit)	MDL	結果 (Result)	限值 (Limit)
				No.1	
全氟辛酸 (PFOA)及其鹽類 (Perfluorooctanoic acid (PFOA) and its salt) (CAS No.: 335-67-1 and its salts)	參考CEN/TS 15968: 2010 · 以液相層析串聯質譜儀分析。(With reference to CEN/TS 15968: 2010, analysis was performed by LC/MS/MS.)	mg/kg	0.01	n.d.	-
全氟辛烷磺酸及其鹽類 (PFOS and its salts) (CAS No.: 1763-23-1 and its salts)	參考CEN/TS 15968: 2010 · 以液相層析串聯質譜儀分析。(With reference to CEN/TS 15968: 2010, analysis was performed by LC/MS/MS.)	mg/kg	0.01	n.d.	-
氟 (F) (Fluorine (F)) (CAS No.: 14762-94-8)	參考BS EN 14582: 2016 · 以離子層析儀分析。(With reference to BS EN 14582: 2016, analysis was performed by IC.)	mg/kg	50	n.d.	-
氯 (Cl) (Chlorine (Cl)) (CAS No.: 22537-15-1)		mg/kg	50	n.d.	-
溴 (Br) (Bromine (Br)) (CAS No.: 10097-32-2)		mg/kg	50	n.d.	-
碘 (I) (Iodine (I)) (CAS No.: 14362-44-8)		mg/kg	50	n.d.	-
鄰苯二甲酸丁苯甲酯 (BBP) (Butyl benzyl phthalate (BBP)) (CAS No.: 85-68-7)	參考IEC 62321-8: 2017 · 以氣相層析儀/質譜儀分析。(With reference to IEC 62321-8: 2017, analysis was performed by GC/MS.)	mg/kg	50	n.d.	1000
鄰苯二甲酸二丁酯 (DBP) (Dibutyl phthalate (DBP)) (CAS No.: 84-74-2)		mg/kg	50	n.d.	1000
鄰苯二甲酸二異丁酯 (DIBP) (Diisobutyl phthalate (DIBP)) (CAS No.: 84-69-5)		mg/kg	50	n.d.	1000
鄰苯二甲酸二(2-乙基己基)酯 (DEHP) (Di-(2-ethylhexyl) phthalate (DEHP)) (CAS No.: 117-81-7)		mg/kg	50	n.d.	1000
鄰苯二甲酸二異壬酯 (DINP) (Diisononyl phthalate (DINP)) (CAS No.: 28553-12-0, 68515-48-0)		mg/kg	50	n.d.	-
鄰苯二甲酸二異癸酯 (DIDP) (Diisodecyl phthalate (DIDP)) (CAS No.: 26761-40-0, 68515-49-1)		mg/kg	50	n.d.	-

This document is issued by the Company subject to its General Conditions of Service printed overleaf, available on request or accessible at <https://www.sgs.com.tw/terms-of-service> and, for electronic format documents, subject to Terms and Conditions for Electronic Documents at <https://www.sgs.com.tw/terms-of-service>. Attention is drawn to the limitation of liability, indemnification and jurisdiction issues defined therein. Any holder of this document is advised that information contained hereon reflects the Company's findings at the time of its intervention only and within the limits of client's instruction, if any. The Company's sole responsibility is to its Client and this document does not exonerate parties to a transaction from exercising all their rights and obligations under the transaction documents. This document cannot be reproduced, except in full, without prior written approval of the Company. Any unauthorized alteration, forgery or falsification of the content or appearance of this document is unlawful and offenders may be prosecuted to the fullest extent of the law. Unless otherwise stated the results shown in this test report refer only to the sample(s) tested.

測試報告

Test Report

號碼(No.): EKR22200427

日期(Date): 18-Feb-2022

頁數(Page): 6 of 43

台虹科技股份有限公司 (TAIFLEX SCIENTIFIC CO., LTD.)

高雄市前鎮區環區三路1號 (NO. 1, HUANQU 3RD RD., QIANZHEN DIST., KAOHSIUNG CITY, TAIWAN)

測試項目 (Test Items)	測試方法 (Method)	單位 (Unit)	MDL	結果 (Result)	限值 (Limit)
				No.1	
鄰苯二甲酸二正辛酯 (DNOP) (Di-n-octyl phthalate (DNOP)) (CAS No.: 117-84-0)	參考IEC 62321-8: 2017 · 以氣相層析儀/質譜儀分析。(With reference to IEC 62321-8: 2017, analysis was performed by GC/MS.)	mg/kg	50	n.d.	-
鄰苯二甲酸二乙酯 (DEP) (Di-ethyl phthalate (DEP)) (CAS No.: 84-66-2)		mg/kg	50	n.d.	-
鄰苯二甲酸二(C7-11支鏈與直鏈)烷基酯 (DHNUP) (1,2-Benzenedicarboxylic acid, di-C7-11-branched and linear alkyl esters (DHNUP)) (CAS No.: 68515-42-4)		mg/kg	50	n.d.	-
1,2-苯二酸-二(C6-8支鏈)烷基酯(富C7) (DIHP) (1,2-Benzenedicarboxylic acid, di-C6-8-branched alkyl esters, C7-rich (DIHP)) (CAS No.: 71888-89-6)		mg/kg	50	n.d.	-
鄰苯二甲酸二異戊酯 (DIPP) (Diisopentyl phthalate (DIPP)) (CAS No.: 605-50-5)		mg/kg	50	n.d.	-
鄰苯二甲酸二(2-甲氧基乙基)酯 (DMEP) (Bis-(2-methoxyethyl) phthalate (DMEP)) (CAS No.: 117-82-8)		mg/kg	50	n.d.	-
鄰苯二甲酸二甲酯 (DMP) (Dimethyl phthalate (DMP)) (CAS No.: 131-11-3)		mg/kg	50	n.d.	-
鄰苯二甲酸二正己酯 (DNHP) (Di-n-hexyl phthalate (DNHP)) (CAS No.: 84-75-3)		mg/kg	50	n.d.	-
鄰苯二甲酸二戊酯 (DPP) (Di-pentyl phthalate (DPP)) (CAS No.: 131-18-0)		mg/kg	50	n.d.	-

This document is issued by the Company subject to its General Conditions of Service printed overleaf, available on request or accessible at <https://www.sgs.com.tw/terms-of-service> and, for electronic format documents, subject to Terms and Conditions for Electronic Documents at <https://www.sgs.com.tw/terms-of-service>. Attention is drawn to the limitation of liability, indemnification and jurisdiction issues defined therein. Any holder of this document is advised that information contained hereon reflects the Company's findings at the time of its intervention only and within the limits of client's instruction, if any. The Company's sole responsibility is to its Client and this document does not exonerate parties to a transaction from exercising all their rights and obligations under the transaction documents. This document cannot be reproduced, except in full, without prior written approval of the Company. Any unauthorized alteration, forgery or falsification of the content or appearance of this document is unlawful and offenders may be prosecuted to the fullest extent of the law. Unless otherwise stated the results shown in this test report refer only to the sample(s) tested.

測試報告

Test Report

號碼(No.): EKR22200427

日期(Date): 18-Feb-2022

頁數(Page): 7 of 43

台虹科技股份有限公司 (TAIFLEX SCIENTIFIC CO., LTD.)

高雄市前鎮區環區三路1號 (NO. 1, HUANQU 3RD RD., QIANZHEN DIST., KAOHSIUNG CITY, TAIWAN)

測試項目 (Test Items)	測試方法 (Method)	單位 (Unit)	MDL	結果 (Result)	限值 (Limit)
				No.1	
多環芳香烴 (Polycyclic Aromatic Hydrocarbons) (PAHs)					
苯駢(a)芘 (Benzo[a]pyrene) (CAS No.: 50-32-8)	參考AfPS GS 2019:01 PAK · 以氣相層析儀/質譜儀分析。(With reference to AfPS GS 2019:01 PAK, analysis was performed by GC/MS.)	mg/kg	0.2	n.d.	-
苯駢(e)芘 (Benzo[e]pyrene) (CAS No.: 192-97-2)		mg/kg	0.2	n.d.	-
苯駢蒽 (Benzo[a]anthracene) (CAS No.: 56-55-3)		mg/kg	0.2	n.d.	-
苯(b)苯駢芴 (Benzo[b]fluoranthene) (CAS No.: 205-99-2)		mg/kg	0.2	n.d.	-
苯(j)苯駢芴 (Benzo[j]fluoranthene) (CAS No.: 205-82-3)		mg/kg	0.2	n.d.	-
苯(k)苯駢芴 (Benzo[k]fluoranthene) (CAS No.: 207-08-9)		mg/kg	0.2	n.d.	-
蒽 (Chrysene) (CAS No.: 218-01-9)		mg/kg	0.2	n.d.	-
二苯駢蒽 (Dibenzo[a,h]anthracene) (CAS No.: 53-70-3)		mg/kg	0.2	n.d.	-
苯駢芘 (Benzo[g,h,i]perylene) (CAS No.: 191-24-2)		mg/kg	0.2	n.d.	-
茚酮芘 (Indeno[1,2,3-c,d]pyrene) (CAS No.: 193-39-5)		mg/kg	0.2	n.d.	-
蒽 (Anthracene) (CAS No.: 120-12-7)		mg/kg	0.2	n.d.	-
苯駢芴 (Fluoranthene) (CAS No.: 206-44-0)		mg/kg	0.2	n.d.	-
菲 (Phenanthrene) (CAS No.: 85-01-8)		mg/kg	0.2	n.d.	-
芘 (Pyrene) (CAS No.: 129-00-0)		mg/kg	0.2	n.d.	-
萘 (Naphthalene) (CAS No.: 91-20-3)		mg/kg	0.2	n.d.	-
多環芳香烴15項總和 (Sum of 15 PAHs)		mg/kg	-	n.d.	-
芴烯 (Acenaphthylene) (CAS No.: 208-96-8)	參考AfPS GS 2019:01 PAK · 以氣相層析儀/質譜儀分析。(With reference to AfPS GS 2019:01 PAK, analysis was performed by GC/MS.)	mg/kg	0.2	n.d.	-
芴 (Acenaphthene) (CAS No.: 83-32-9)		mg/kg	0.2	n.d.	-
芴 (Fluorene) (CAS No.: 86-73-7)		mg/kg	0.2	n.d.	-

This document is issued by the Company subject to its General Conditions of Service printed overleaf, available on request or accessible at <https://www.sgs.com.tw/terms-of-service> and, for electronic format documents, subject to Terms and Conditions for Electronic Documents at <https://www.sgs.com.tw/terms-of-service>. Attention is drawn to the limitation of liability, indemnification and jurisdiction issues defined therein. Any holder of this document is advised that information contained hereon reflects the Company's findings at the time of its intervention only and within the limits of client's instruction, if any. The Company's sole responsibility is to its Client and this document does not exonerate parties to a transaction from exercising all their rights and obligations under the transaction documents. This document cannot be reproduced, except in full, without prior written approval of the Company. Any unauthorized alteration, forgery or falsification of the content or appearance of this document is unlawful and offenders may be prosecuted to the fullest extent of the law. Unless otherwise stated the results shown in this test report refer only to the sample(s) tested.

測試報告

Test Report

號碼(No.): EKR22200427

日期(Date): 18-Feb-2022

頁數(Page): 8 of 43

台虹科技股份有限公司 (TAIFLEX SCIENTIFIC CO., LTD.)

高雄市前鎮區環區三路1號 (NO. 1, HUANQU 3RD RD., QIANZHEN DIST., KAOHSIUNG CITY, TAIWAN)

測試項目 (Test Items)	測試方法 (Method)	單位 (Unit)	MDL	結果 (Result)	限值 (Limit)
				No.1	
氟氯碳化物 (Chlorofluorocarbons) (CFCs)					
CFC-11 (CAS No.: 75-69-4)	參考US EPA 5021A: 2014 · 以氣相層析儀/ 質譜儀分析。(With reference to US EPA 5021A: 2014, analysis was performed by GC/MS.)	mg/kg	1	n.d.	-
CFC-12 (CAS No.: 75-71-8)	參考US EPA 5021A: 2014 · 以氣相層析儀/ 質譜儀分析。(With reference to US EPA 5021A: 2014, analysis was performed by GC/MS.)	mg/kg	1	n.d.	-
CFC-13 (CAS No.: 75-72-9)	參考US EPA 5021A: 2014 · 以氣相層析儀/ 質譜儀分析。(With reference to US EPA 5021A: 2014, analysis was performed by GC/MS.)	mg/kg	1	n.d.	-
CFC-111 (CAS No.: 354-56-3)	參考US EPA 5021A: 2014 · 以氣相層析儀/ 質譜儀分析。(With reference to US EPA 5021A: 2014, analysis was performed by GC/MS.)	mg/kg	1	n.d.	-
CFC-112 (CAS No.: 76-12-0)	參考US EPA 5021A: 2014 · 以氣相層析儀/ 質譜儀分析。(With reference to US EPA 5021A: 2014, analysis was performed by GC/MS.)	mg/kg	1	n.d.	-
CFC-113 (CAS No.: 76-13-1)	參考US EPA 5021A: 2014 · 以氣相層析儀/ 質譜儀分析。(With reference to US EPA 5021A: 2014, analysis was performed by GC/MS.)	mg/kg	1	n.d.	-
CFC-114 (CAS No.: 76-14-2)	參考US EPA 5021A: 2014 · 以氣相層析儀/ 質譜儀分析。(With reference to US EPA 5021A: 2014, analysis was performed by GC/MS.)	mg/kg	1	n.d.	-

This document is issued by the Company subject to its General Conditions of Service printed overleaf, available on request or accessible at <https://www.sgs.com.tw/terms-of-service> and, for electronic format documents, subject to Terms and Conditions for Electronic Documents at <https://www.sgs.com.tw/terms-of-service>. Attention is drawn to the limitation of liability, indemnification and jurisdiction issues defined therein. Any holder of this document is advised that information contained hereon reflects the Company's findings at the time of its intervention only and within the limits of client's instruction, if any. The Company's sole responsibility is to its Client and this document does not exonerate parties to a transaction from exercising all their rights and obligations under the transaction documents. This document cannot be reproduced, except in full, without prior written approval of the Company. Any unauthorized alteration, forgery or falsification of the content or appearance of this document is unlawful and offenders may be prosecuted to the fullest extent of the law. Unless otherwise stated the results shown in this test report refer only to the sample(s) tested.

測試報告

Test Report

號碼(No.): EKR22200427

日期(Date): 18-Feb-2022

頁數(Page): 9 of 43

台虹科技股份有限公司 (TAIFLEX SCIENTIFIC CO., LTD.)

高雄市前鎮區環區三路1號 (NO. 1, HUANQU 3RD RD., QIANZHEN DIST., KAOHSIUNG CITY, TAIWAN)

測試項目 (Test Items)	測試方法 (Method)	單位 (Unit)	MDL	結果 (Result)	限值 (Limit)
				No.1	
CFC-115 (CAS No.: 76-15-3)	參考US EPA 5021A: 2014 · 以氣相層析儀/質譜儀分析。(With reference to US EPA 5021A: 2014, analysis was performed by GC/MS.)	mg/kg	1	n.d.	-
CFC-211 (CAS No.: 422-78-6)	參考US EPA 5021A: 2014 · 以氣相層析儀/質譜儀分析。(With reference to US EPA 5021A: 2014, analysis was performed by GC/MS.)	mg/kg	1	n.d.	-
CFC-212 (CAS No.: 3182-26-1)	參考US EPA 5021A: 2014 · 以氣相層析儀/質譜儀分析。(With reference to US EPA 5021A: 2014, analysis was performed by GC/MS.)	mg/kg	1	n.d.	-
CFC-213 (CAS No.: 2354-06-5)	參考US EPA 5021A: 2014 · 以氣相層析儀/質譜儀分析。(With reference to US EPA 5021A: 2014, analysis was performed by GC/MS.)	mg/kg	1	n.d.	-
CFC-214 (CAS No.: 29255-31-0)	參考US EPA 5021A: 2014 · 以氣相層析儀/質譜儀分析。(With reference to US EPA 5021A: 2014, analysis was performed by GC/MS.)	mg/kg	1	n.d.	-
CFC-215 (CAS No.: 4259-43-2)	參考US EPA 5021A: 2014 · 以氣相層析儀/質譜儀分析。(With reference to US EPA 5021A: 2014, analysis was performed by GC/MS.)	mg/kg	1	n.d.	-
CFC-216 (CAS No.: 661-97-2)	參考US EPA 5021A: 2014 · 以氣相層析儀/質譜儀分析。(With reference to US EPA 5021A: 2014, analysis was performed by GC/MS.)	mg/kg	1	n.d.	-
CFC-217 (CAS No.: 422-86-6)	參考US EPA 5021A: 2014 · 以氣相層析儀/質譜儀分析。(With reference to US EPA 5021A: 2014, analysis was performed by GC/MS.)	mg/kg	1	n.d.	-

This document is issued by the Company subject to its General Conditions of Service printed overleaf, available on request or accessible at <https://www.sgs.com.tw/terms-of-service> and, for electronic format documents, subject to Terms and Conditions for Electronic Documents at <https://www.sgs.com.tw/terms-of-service>. Attention is drawn to the limitation of liability, indemnification and jurisdiction issues defined therein. Any holder of this document is advised that information contained hereon reflects the Company's findings at the time of its intervention only and within the limits of client's instruction, if any. The Company's sole responsibility is to its Client and this document does not exonerate parties to a transaction from exercising all their rights and obligations under the transaction documents. This document cannot be reproduced, except in full, without prior written approval of the Company. Any unauthorized alteration, forgery or falsification of the content or appearance of this document is unlawful and offenders may be prosecuted to the fullest extent of the law. Unless otherwise stated the results shown in this test report refer only to the sample(s) tested.

測試報告

Test Report

號碼(No.): EKR22200427

日期(Date): 18-Feb-2022

頁數(Page): 10 of 43

台虹科技股份有限公司 (TAIFLEX SCIENTIFIC CO., LTD.)

高雄市前鎮區環區三路1號 (NO. 1, HUANQU 3RD RD., QIANZHEN DIST., KAOHSIUNG CITY, TAIWAN)

測試項目 (Test Items)	測試方法 (Method)	單位 (Unit)	MDL	結果 (Result)	限值 (Limit)
				No.1	
氟氯氫烷碳化物 (Hydrochlorofluorocarbons) (HCFCs)					
HCFC-21 (CAS No.: 75-43-4)	參考US EPA 5021A: 2014 · 以氣相層析儀/ 質譜儀分析。(With reference to US EPA 5021A: 2014, analysis was performed by GC/MS.)	mg/kg	1	n.d.	-
HCFC-22 (CAS No.: 75-45-6)	參考US EPA 5021A: 2014 · 以氣相層析儀/ 質譜儀分析。(With reference to US EPA 5021A: 2014, analysis was performed by GC/MS.)	mg/kg	1	n.d.	-
HCFC-31 (CAS No.: 593-70-4)	參考US EPA 5021A: 2014 · 以氣相層析儀/ 質譜儀分析。(With reference to US EPA 5021A: 2014, analysis was performed by GC/MS.)	mg/kg	1	n.d.	-
HCFC-121 (CAS No.: 354-14-3)	參考US EPA 5021A: 2014 · 以氣相層析儀/ 質譜儀分析。(With reference to US EPA 5021A: 2014, analysis was performed by GC/MS.)	mg/kg	1	n.d.	-
HCFC-122 (CAS No.: 354-21-2)	參考US EPA 5021A: 2014 · 以氣相層析儀/ 質譜儀分析。(With reference to US EPA 5021A: 2014, analysis was performed by GC/MS.)	mg/kg	1	n.d.	-
HCFC-123 (CAS No.: 306-83-2)	參考US EPA 5021A: 2014 · 以氣相層析儀/ 質譜儀分析。(With reference to US EPA 5021A: 2014, analysis was performed by GC/MS.)	mg/kg	1	n.d.	-
HCFC-124 (CAS No.: 2837-89-0)	參考US EPA 5021A: 2014 · 以氣相層析儀/ 質譜儀分析。(With reference to US EPA 5021A: 2014, analysis was performed by GC/MS.)	mg/kg	1	n.d.	-
HCFC-131 (CAS No.: 359-28-4)	參考US EPA 5021A: 2014 · 以氣相層析儀/ 質譜儀分析。(With reference to US EPA 5021A: 2014, analysis was performed by GC/MS.)	mg/kg	1	n.d.	-

This document is issued by the Company subject to its General Conditions of Service printed overleaf, available on request or accessible at <https://www.sgs.com.tw/terms-of-service> and, for electronic format documents, subject to Terms and Conditions for Electronic Documents at <https://www.sgs.com.tw/terms-of-service>. Attention is drawn to the limitation of liability, indemnification and jurisdiction issues defined therein. Any holder of this document is advised that information contained hereon reflects the Company's findings at the time of its intervention only and within the limits of client's instruction, if any. The Company's sole responsibility is to its Client and this document does not exonerate parties to a transaction from exercising all their rights and obligations under the transaction documents. This document cannot be reproduced, except in full, without prior written approval of the Company. Any unauthorized alteration, forgery or falsification of the content or appearance of this document is unlawful and offenders may be prosecuted to the fullest extent of the law. Unless otherwise stated the results shown in this test report refer only to the sample(s) tested.

測試報告

Test Report

號碼(No.): EKR22200427

日期(Date): 18-Feb-2022

頁數(Page): 11 of 43

台虹科技股份有限公司 (TAIFLEX SCIENTIFIC CO., LTD.)

高雄市前鎮區環區三路1號 (NO. 1, HUANQU 3RD RD., QIANZHEN DIST., KAOHSIUNG CITY, TAIWAN)

測試項目 (Test Items)	測試方法 (Method)	單位 (Unit)	MDL	結果 (Result)	限值 (Limit)
				No.1	
HCFC-141b (CAS No.: 1717-00-6)	參考US EPA 5021A: 2014 · 以氣相層析儀/質譜儀分析。(With reference to US EPA 5021A: 2014, analysis was performed by GC/MS.)	mg/kg	1	n.d.	-
HCFC-221 (CAS No.: 422-26-4)	參考US EPA 5021A: 2014 · 以氣相層析儀/質譜儀分析。(With reference to US EPA 5021A: 2014, analysis was performed by GC/MS.)	mg/kg	1	n.d.	-
HCFC-222 (CAS No.: 422-49-1)	參考US EPA 5021A: 2014 · 以氣相層析儀/質譜儀分析。(With reference to US EPA 5021A: 2014, analysis was performed by GC/MS.)	mg/kg	1	n.d.	-
HCFC-223 (CAS No.: 422-52-6)	參考US EPA 5021A: 2014 · 以氣相層析儀/質譜儀分析。(With reference to US EPA 5021A: 2014, analysis was performed by GC/MS.)	mg/kg	1	n.d.	-
HCFC-224 (CAS No.: 422-54-8)	參考US EPA 5021A: 2014 · 以氣相層析儀/質譜儀分析。(With reference to US EPA 5021A: 2014, analysis was performed by GC/MS.)	mg/kg	1	n.d.	-
HCFC-225ca (CAS No.: 422-56-0)	參考US EPA 5021A: 2014 · 以氣相層析儀/質譜儀分析。(With reference to US EPA 5021A: 2014, analysis was performed by GC/MS.)	mg/kg	1	n.d.	-
HCFC-225cb (CAS No.: 507-55-1)	參考US EPA 5021A: 2014 · 以氣相層析儀/質譜儀分析。(With reference to US EPA 5021A: 2014, analysis was performed by GC/MS.)	mg/kg	1	n.d.	-
HCFC-226 (CAS No.: 431-87-8)	參考US EPA 5021A: 2014 · 以氣相層析儀/質譜儀分析。(With reference to US EPA 5021A: 2014, analysis was performed by GC/MS.)	mg/kg	1	n.d.	-

This document is issued by the Company subject to its General Conditions of Service printed overleaf, available on request or accessible at <https://www.sgs.com.tw/terms-of-service> and, for electronic format documents, subject to Terms and Conditions for Electronic Documents at <https://www.sgs.com.tw/terms-of-service>. Attention is drawn to the limitation of liability, indemnification and jurisdiction issues defined therein. Any holder of this document is advised that information contained hereon reflects the Company's findings at the time of its intervention only and within the limits of client's instruction, if any. The Company's sole responsibility is to its Client and this document does not exonerate parties to a transaction from exercising all their rights and obligations under the transaction documents. This document cannot be reproduced, except in full, without prior written approval of the Company. Any unauthorized alteration, forgery or falsification of the content or appearance of this document is unlawful and offenders may be prosecuted to the fullest extent of the law. Unless otherwise stated the results shown in this test report refer only to the sample(s) tested.

測試報告

Test Report

號碼(No.): EKR22200427

日期(Date): 18-Feb-2022

頁數(Page): 12 of 43

台虹科技股份有限公司 (TAIFLEX SCIENTIFIC CO., LTD.)

高雄市前鎮區環區三路1號 (NO. 1, HUANQU 3RD RD., QIANZHEN DIST., KAOHSIUNG CITY, TAIWAN)

測試項目 (Test Items)	測試方法 (Method)	單位 (Unit)	MDL	結果 (Result)	限值 (Limit)
				No.1	
HCFC-231 (CAS No.: 421-94-3)	參考US EPA 5021A: 2014 · 以氣相層析儀/質譜儀分析。(With reference to US EPA 5021A: 2014, analysis was performed by GC/MS.)	mg/kg	1	n.d.	-
HCFC-232 (CAS No.: 460-89-9)	參考US EPA 5021A: 2014 · 以氣相層析儀/質譜儀分析。(With reference to US EPA 5021A: 2014, analysis was performed by GC/MS.)	mg/kg	1	n.d.	-
HCFC-233 (CAS No.: 7125-84-0)	參考US EPA 5021A: 2014 · 以氣相層析儀/質譜儀分析。(With reference to US EPA 5021A: 2014, analysis was performed by GC/MS.)	mg/kg	1	n.d.	-
HCFC-234 (CAS No.: 425-94-5)	參考US EPA 5021A: 2014 · 以氣相層析儀/質譜儀分析。(With reference to US EPA 5021A: 2014, analysis was performed by GC/MS.)	mg/kg	1	n.d.	-
HCFC-235 (CAS No.: 460-92-4)	參考US EPA 5021A: 2014 · 以氣相層析儀/質譜儀分析。(With reference to US EPA 5021A: 2014, analysis was performed by GC/MS.)	mg/kg	1	n.d.	-
HCFC-241 (CAS No.: 666-27-3)	參考US EPA 5021A: 2014 · 以氣相層析儀/質譜儀分析。(With reference to US EPA 5021A: 2014, analysis was performed by GC/MS.)	mg/kg	1	n.d.	-
HCFC-242 (CAS No.: 460-63-9)	參考US EPA 5021A: 2014 · 以氣相層析儀/質譜儀分析。(With reference to US EPA 5021A: 2014, analysis was performed by GC/MS.)	mg/kg	1	n.d.	-
HCFC-243 (CAS No.: 460-69-5)	參考US EPA 5021A: 2014 · 以氣相層析儀/質譜儀分析。(With reference to US EPA 5021A: 2014, analysis was performed by GC/MS.)	mg/kg	1	n.d.	-

This document is issued by the Company subject to its General Conditions of Service printed overleaf, available on request or accessible at <https://www.sgs.com.tw/terms-of-service> and, for electronic format documents, subject to Terms and Conditions for Electronic Documents at <https://www.sgs.com.tw/terms-of-service>. Attention is drawn to the limitation of liability, indemnification and jurisdiction issues defined therein. Any holder of this document is advised that information contained hereon reflects the Company's findings at the time of its intervention only and within the limits of client's instruction, if any. The Company's sole responsibility is to its Client and this document does not exonerate parties to a transaction from exercising all their rights and obligations under the transaction documents. This document cannot be reproduced, except in full, without prior written approval of the Company. Any unauthorized alteration, forgery or falsification of the content or appearance of this document is unlawful and offenders may be prosecuted to the fullest extent of the law. Unless otherwise stated the results shown in this test report refer only to the sample(s) tested.

測試報告

Test Report

號碼(No.): EKR22200427

日期(Date): 18-Feb-2022

頁數(Page): 13 of 43

台虹科技股份有限公司 (TAIFLEX SCIENTIFIC CO., LTD.)

高雄市前鎮區環區三路1號 (NO. 1, HUANQU 3RD RD., QIANZHEN DIST., KAOHSIUNG CITY, TAIWAN)

測試項目 (Test Items)	測試方法 (Method)	單位 (Unit)	MDL	結果 (Result)	限值 (Limit)
				No.1	
HCFC-244	參考US EPA 5021A: 2014 · 以氣相層析儀/質譜儀分析。(With reference to US EPA 5021A: 2014, analysis was performed by GC/MS.)	mg/kg	1	n.d.	-
HCFC-251 (CAS No.: 421-41-0)	參考US EPA 5021A: 2014 · 以氣相層析儀/質譜儀分析。(With reference to US EPA 5021A: 2014, analysis was performed by GC/MS.)	mg/kg	1	n.d.	-
HCFC-252 (CAS No.: 819-00-1)	參考US EPA 5021A: 2014 · 以氣相層析儀/質譜儀分析。(With reference to US EPA 5021A: 2014, analysis was performed by GC/MS.)	mg/kg	1	n.d.	-
HCFC-253 (CAS No.: 460-35-5)	參考US EPA 5021A: 2014 · 以氣相層析儀/質譜儀分析。(With reference to US EPA 5021A: 2014, analysis was performed by GC/MS.)	mg/kg	1	n.d.	-
HCFC-261 (CAS No.: 420-97-3)	參考US EPA 5021A: 2014 · 以氣相層析儀/質譜儀分析。(With reference to US EPA 5021A: 2014, analysis was performed by GC/MS.)	mg/kg	1	n.d.	-
HCFC-262 (CAS No.: 421-02-03)	參考US EPA 5021A: 2014 · 以氣相層析儀/質譜儀分析。(With reference to US EPA 5021A: 2014, analysis was performed by GC/MS.)	mg/kg	1	n.d.	-
HCFC-271 (CAS No.: 430-55-7)	參考US EPA 5021A: 2014 · 以氣相層析儀/質譜儀分析。(With reference to US EPA 5021A: 2014, analysis was performed by GC/MS.)	mg/kg	1	n.d.	-
HCFC-133a (CAS No.: 75-88-7)	參考US EPA 5021A: 2014 · 以氣相層析儀/質譜儀分析。(With reference to US EPA 5021A: 2014, analysis was performed by GC/MS.)	mg/kg	1	n.d.	-

This document is issued by the Company subject to its General Conditions of Service printed overleaf, available on request or accessible at <https://www.sgs.com.tw/terms-of-service> and, for electronic format documents, subject to Terms and Conditions for Electronic Documents at <https://www.sgs.com.tw/terms-of-service>. Attention is drawn to the limitation of liability, indemnification and jurisdiction issues defined therein. Any holder of this document is advised that information contained hereon reflects the Company's findings at the time of its intervention only and within the limits of client's instruction, if any. The Company's sole responsibility is to its Client and this document does not exonerate parties to a transaction from exercising all their rights and obligations under the transaction documents. This document cannot be reproduced, except in full, without prior written approval of the Company. Any unauthorized alteration, forgery or falsification of the content or appearance of this document is unlawful and offenders may be prosecuted to the fullest extent of the law. Unless otherwise stated the results shown in this test report refer only to the sample(s) tested.

測試報告

Test Report

號碼(No.): EKR22200427

日期(Date): 18-Feb-2022

頁數(Page): 14 of 43

台虹科技股份有限公司 (TAIFLEX SCIENTIFIC CO., LTD.)

高雄市前鎮區環區三路1號 (NO. 1, HUANQU 3RD RD., QIANZHEN DIST., KAOHSIUNG CITY, TAIWAN)

測試項目 (Test Items)	測試方法 (Method)	單位 (Unit)	MDL	結果 (Result)	限值 (Limit)
				No.1	
HCFC-142b (CAS No.: 75-68-3)	參考US EPA 5021A: 2014 · 以氣相層析儀/質譜儀分析。(With reference to US EPA 5021A: 2014, analysis was performed by GC/MS.)	mg/kg	1	n.d.	-
HCFC-132b (CAS No.: 1649-08-7)	參考US EPA 5021A: 2014 · 以氣相層析儀/質譜儀分析。(With reference to US EPA 5021A: 2014, analysis was performed by GC/MS.)	mg/kg	1	n.d.	-
HCFC-141	參考US EPA 5021A: 2014 · 以氣相層析儀/質譜儀分析。(With reference to US EPA 5021A: 2014, analysis was performed by GC/MS.)	mg/kg	1	n.d.	-
HCFC-142	參考US EPA 5021A: 2014 · 以氣相層析儀/質譜儀分析。(With reference to US EPA 5021A: 2014, analysis was performed by GC/MS.)	mg/kg	1	n.d.	-
HCFC-151	參考US EPA 5021A: 2014 · 以氣相層析儀/質譜儀分析。(With reference to US EPA 5021A: 2014, analysis was performed by GC/MS.)	mg/kg	1	n.d.	-
HCFC-225	參考US EPA 5021A: 2014 · 以氣相層析儀/質譜儀分析。(With reference to US EPA 5021A: 2014, analysis was performed by GC/MS.)	mg/kg	1	n.d.	-
海龍 (Halons)					
Halon-1211 (CAS No.: 353-59-3)	參考US EPA 5021A: 2014 · 以氣相層析儀/質譜儀分析。(With reference to US EPA 5021A: 2014, analysis was performed by GC/MS.)	mg/kg	1	n.d.	-
Halon-1301 (CAS No.: 75-63-8)		mg/kg	1	n.d.	-
海龍-2402 (Halon-2402) (CAS No.: 124-73-2)		mg/kg	1	n.d.	-

This document is issued by the Company subject to its General Conditions of Service printed overleaf, available on request or accessible at <https://www.sgs.com.tw/terms-of-service> and, for electronic format documents, subject to Terms and Conditions for Electronic Documents at <https://www.sgs.com.tw/terms-of-service>. Attention is drawn to the limitation of liability, indemnification and jurisdiction issues defined therein. Any holder of this document is advised that information contained hereon reflects the Company's findings at the time of its intervention only and within the limits of client's instruction, if any. The Company's sole responsibility is to its Client and this document does not exonerate parties to a transaction from exercising all their rights and obligations under the transaction documents. This document cannot be reproduced, except in full, without prior written approval of the Company. Any unauthorized alteration, forgery or falsification of the content or appearance of this document is unlawful and offenders may be prosecuted to the fullest extent of the law. Unless otherwise stated the results shown in this test report refer only to the sample(s) tested.

測試報告

Test Report

號碼(No.): EKR22200427

日期(Date): 18-Feb-2022

頁數(Page): 15 of 43

台虹科技股份有限公司 (TAIFLEX SCIENTIFIC CO., LTD.)

高雄市前鎮區環區三路1號 (NO. 1, HUANQU 3RD RD., QIANZHEN DIST., KAOHSIUNG CITY, TAIWAN)

測試項目 (Test Items)	測試方法 (Method)	單位 (Unit)	MDL	結果 (Result)	限值 (Limit)
				No.1	
溴甲烷 (Bromomethane) (CAS No.: 74-83-9)	參考US EPA 5021A: 2014 · 以氣相層析儀/質譜儀分析。(With reference to US EPA 5021A: 2014, analysis was performed by GC/MS.)	mg/kg	1	n.d.	-
不完全鹵化氟溴化物 (Hydrobromofluorocarbons) (HBFCs)					
HBFC-121B4 (C2HFBr4)	參考US EPA 5021A: 2014 · 以氣相層析儀/質譜儀分析。(With reference to US EPA 5021A: 2014, analysis was performed by GC/MS.)	mg/kg	1	n.d.	-
HBFC-122B3 (C2HF2Br3)	參考US EPA 5021A: 2014 · 以氣相層析儀/質譜儀分析。(With reference to US EPA 5021A: 2014, analysis was performed by GC/MS.)	mg/kg	1	n.d.	-
HBFC-123B2 (C2HF3Br2)	參考US EPA 5021A: 2014 · 以氣相層析儀/質譜儀分析。(With reference to US EPA 5021A: 2014, analysis was performed by GC/MS.)	mg/kg	1	n.d.	-
HBFC-124B1 (C2HF4Br)	參考US EPA 5021A: 2014 · 以氣相層析儀/質譜儀分析。(With reference to US EPA 5021A: 2014, analysis was performed by GC/MS.)	mg/kg	1	n.d.	-
HBFC-131B3 (C2H2FBr3)	參考US EPA 5021A: 2014 · 以氣相層析儀/質譜儀分析。(With reference to US EPA 5021A: 2014, analysis was performed by GC/MS.)	mg/kg	1	n.d.	-
HBFC-132B2 (C2H2F2Br2)	參考US EPA 5021A: 2014 · 以氣相層析儀/質譜儀分析。(With reference to US EPA 5021A: 2014, analysis was performed by GC/MS.)	mg/kg	1	n.d.	-
HBFC-133B1 (C2H2F3Br)	參考US EPA 5021A: 2014 · 以氣相層析儀/質譜儀分析。(With reference to US EPA 5021A: 2014, analysis was performed by GC/MS.)	mg/kg	1	n.d.	-

This document is issued by the Company subject to its General Conditions of Service printed overleaf, available on request or accessible at <https://www.sgs.com.tw/terms-of-service> and, for electronic format documents, subject to Terms and Conditions for Electronic Documents at <https://www.sgs.com.tw/terms-of-service>. Attention is drawn to the limitation of liability, indemnification and jurisdiction issues defined therein. Any holder of this document is advised that information contained hereon reflects the Company's findings at the time of its intervention only and within the limits of client's instruction, if any. The Company's sole responsibility is to its Client and this document does not exonerate parties to a transaction from exercising all their rights and obligations under the transaction documents. This document cannot be reproduced, except in full, without prior written approval of the Company. Any unauthorized alteration, forgery or falsification of the content or appearance of this document is unlawful and offenders may be prosecuted to the fullest extent of the law. Unless otherwise stated the results shown in this test report refer only to the sample(s) tested.

測試報告

Test Report

號碼(No.): EKR22200427

日期(Date): 18-Feb-2022

頁數(Page): 16 of 43

台虹科技股份有限公司 (TAIFLEX SCIENTIFIC CO., LTD.)

高雄市前鎮區環區三路1號 (NO. 1, HUANQU 3RD RD., QIANZHEN DIST., KAOHSIUNG CITY, TAIWAN)

測試項目 (Test Items)	測試方法 (Method)	單位 (Unit)	MDL	結果 (Result)	限值 (Limit)
				No.1	
HBFC-141B2 (C2H3FBr2)	參考US EPA 5021A: 2014 · 以氣相層析儀/質譜儀分析。(With reference to US EPA 5021A: 2014, analysis was performed by GC/MS.)	mg/kg	1	n.d.	-
HBFC-142B1 (C2H3F2Br)	參考US EPA 5021A: 2014 · 以氣相層析儀/質譜儀分析。(With reference to US EPA 5021A: 2014, analysis was performed by GC/MS.)	mg/kg	1	n.d.	-
HBFC-151B1 (C2H4FBr)	參考US EPA 5021A: 2014 · 以氣相層析儀/質譜儀分析。(With reference to US EPA 5021A: 2014, analysis was performed by GC/MS.)	mg/kg	1	n.d.	-
HBFC-21B2 (CHFBr2) (CAS No.: 1868-53-7)	參考US EPA 5021A: 2014 · 以氣相層析儀/質譜儀分析。(With reference to US EPA 5021A: 2014, analysis was performed by GC/MS.)	mg/kg	1	n.d.	-
HBFC-221B6 (C3HFBr6)	參考US EPA 5021A: 2014 · 以氣相層析儀/質譜儀分析。(With reference to US EPA 5021A: 2014, analysis was performed by GC/MS.)	mg/kg	1	n.d.	-
HBFC-222B5 (C3HF2Br5)	參考US EPA 5021A: 2014 · 以氣相層析儀/質譜儀分析。(With reference to US EPA 5021A: 2014, analysis was performed by GC/MS.)	mg/kg	1	n.d.	-
HBFC-223B4 (C3HF3Br4)	參考US EPA 5021A: 2014 · 以氣相層析儀/質譜儀分析。(With reference to US EPA 5021A: 2014, analysis was performed by GC/MS.)	mg/kg	1	n.d.	-
HBFC-224B3 (C3HF4Br3)	參考US EPA 5021A: 2014 · 以氣相層析儀/質譜儀分析。(With reference to US EPA 5021A: 2014, analysis was performed by GC/MS.)	mg/kg	1	n.d.	-

This document is issued by the Company subject to its General Conditions of Service printed overleaf, available on request or accessible at <https://www.sgs.com.tw/terms-of-service> and, for electronic format documents, subject to Terms and Conditions for Electronic Documents at <https://www.sgs.com.tw/terms-of-service>. Attention is drawn to the limitation of liability, indemnification and jurisdiction issues defined therein. Any holder of this document is advised that information contained hereon reflects the Company's findings at the time of its intervention only and within the limits of client's instruction, if any. The Company's sole responsibility is to its Client and this document does not exonerate parties to a transaction from exercising all their rights and obligations under the transaction documents. This document cannot be reproduced, except in full, without prior written approval of the Company. Any unauthorized alteration, forgery or falsification of the content or appearance of this document is unlawful and offenders may be prosecuted to the fullest extent of the law. Unless otherwise stated the results shown in this test report refer only to the sample(s) tested.

測試報告

Test Report

號碼(No.): EKR22200427

日期(Date): 18-Feb-2022

頁數(Page): 17 of 43

台虹科技股份有限公司 (TAIFLEX SCIENTIFIC CO., LTD.)

高雄市前鎮區環區三路1號 (NO. 1, HUANQU 3RD RD., QIANZHEN DIST., KAOHSIUNG CITY, TAIWAN)

測試項目 (Test Items)	測試方法 (Method)	單位 (Unit)	MDL	結果 (Result)	限值 (Limit)
				No.1	
HBFC-225B2 (C3HF5Br2)	參考US EPA 5021A: 2014 · 以氣相層析儀/質譜儀分析。(With reference to US EPA 5021A: 2014, analysis was performed by GC/MS.)	mg/kg	1	n.d.	-
HBFC-226B1 (C3HF6Br)	參考US EPA 5021A: 2014 · 以氣相層析儀/質譜儀分析。(With reference to US EPA 5021A: 2014, analysis was performed by GC/MS.)	mg/kg	1	n.d.	-
HBFC-22B1 (CHF2Br) (CAS No.: 1511-62-2)	參考US EPA 5021A: 2014 · 以氣相層析儀/質譜儀分析。(With reference to US EPA 5021A: 2014, analysis was performed by GC/MS.)	mg/kg	1	n.d.	-
HBFC-231B5 (C3H2FBr5)	參考US EPA 5021A: 2014 · 以氣相層析儀/質譜儀分析。(With reference to US EPA 5021A: 2014, analysis was performed by GC/MS.)	mg/kg	1	n.d.	-
HBFC-232B4 (C3H2F2Br4)	參考US EPA 5021A: 2014 · 以氣相層析儀/質譜儀分析。(With reference to US EPA 5021A: 2014, analysis was performed by GC/MS.)	mg/kg	1	n.d.	-
HBFC-233B3 (C3H2F3Br3)	參考US EPA 5021A: 2014 · 以氣相層析儀/質譜儀分析。(With reference to US EPA 5021A: 2014, analysis was performed by GC/MS.)	mg/kg	1	n.d.	-
HBFC-234B2 (C3H2F4Br2)	參考US EPA 5021A: 2014 · 以氣相層析儀/質譜儀分析。(With reference to US EPA 5021A: 2014, analysis was performed by GC/MS.)	mg/kg	1	n.d.	-
HBFC-235B1 (C3H2F5Br)	參考US EPA 5021A: 2014 · 以氣相層析儀/質譜儀分析。(With reference to US EPA 5021A: 2014, analysis was performed by GC/MS.)	mg/kg	1	n.d.	-

This document is issued by the Company subject to its General Conditions of Service printed overleaf, available on request or accessible at <https://www.sgs.com.tw/terms-of-service> and, for electronic format documents, subject to Terms and Conditions for Electronic Documents at <https://www.sgs.com.tw/terms-of-service>. Attention is drawn to the limitation of liability, indemnification and jurisdiction issues defined therein. Any holder of this document is advised that information contained hereon reflects the Company's findings at the time of its intervention only and within the limits of client's instruction, if any. The Company's sole responsibility is to its Client and this document does not exonerate parties to a transaction from exercising all their rights and obligations under the transaction documents. This document cannot be reproduced, except in full, without prior written approval of the Company. Any unauthorized alteration, forgery or falsification of the content or appearance of this document is unlawful and offenders may be prosecuted to the fullest extent of the law. Unless otherwise stated the results shown in this test report refer only to the sample(s) tested.

測試報告

Test Report

號碼(No.): EKR22200427

日期(Date): 18-Feb-2022

頁數(Page): 18 of 43

台虹科技股份有限公司 (TAIFLEX SCIENTIFIC CO., LTD.)

高雄市前鎮區環區三路1號 (NO. 1, HUANQU 3RD RD., QIANZHEN DIST., KAOHSIUNG CITY, TAIWAN)

測試項目 (Test Items)	測試方法 (Method)	單位 (Unit)	MDL	結果 (Result)	限值 (Limit)
				No.1	
HBFC-241B4 (C3H3FBr4)	參考US EPA 5021A: 2014 · 以氣相層析儀/質譜儀分析。(With reference to US EPA 5021A: 2014, analysis was performed by GC/MS.)	mg/kg	1	n.d.	-
HBFC-242B3 (C3H3F2Br3)	參考US EPA 5021A: 2014 · 以氣相層析儀/質譜儀分析。(With reference to US EPA 5021A: 2014, analysis was performed by GC/MS.)	mg/kg	1	n.d.	-
HBFC-243B2 (C3H3F3Br2)	參考US EPA 5021A: 2014 · 以氣相層析儀/質譜儀分析。(With reference to US EPA 5021A: 2014, analysis was performed by GC/MS.)	mg/kg	1	n.d.	-
HBFC-244B1 (C3H3F4Br)	參考US EPA 5021A: 2014 · 以氣相層析儀/質譜儀分析。(With reference to US EPA 5021A: 2014, analysis was performed by GC/MS.)	mg/kg	1	n.d.	-
HBFC-251B3 (C3H4FBr3)	參考US EPA 5021A: 2014 · 以氣相層析儀/質譜儀分析。(With reference to US EPA 5021A: 2014, analysis was performed by GC/MS.)	mg/kg	1	n.d.	-
HBFC-252B2 (C3H4F2Br2)	參考US EPA 5021A: 2014 · 以氣相層析儀/質譜儀分析。(With reference to US EPA 5021A: 2014, analysis was performed by GC/MS.)	mg/kg	1	n.d.	-
HBFC-253B1 (C3H4F3Br)	參考US EPA 5021A: 2014 · 以氣相層析儀/質譜儀分析。(With reference to US EPA 5021A: 2014, analysis was performed by GC/MS.)	mg/kg	1	n.d.	-
HBFC-261B2 (C3H5FBr2)	參考US EPA 5021A: 2014 · 以氣相層析儀/質譜儀分析。(With reference to US EPA 5021A: 2014, analysis was performed by GC/MS.)	mg/kg	1	n.d.	-

This document is issued by the Company subject to its General Conditions of Service printed overleaf, available on request or accessible at <https://www.sgs.com.tw/terms-of-service> and, for electronic format documents, subject to Terms and Conditions for Electronic Documents at <https://www.sgs.com.tw/terms-of-service>. Attention is drawn to the limitation of liability, indemnification and jurisdiction issues defined therein. Any holder of this document is advised that information contained hereon reflects the Company's findings at the time of its intervention only and within the limits of client's instruction, if any. The Company's sole responsibility is to its Client and this document does not exonerate parties to a transaction from exercising all their rights and obligations under the transaction documents. This document cannot be reproduced, except in full, without prior written approval of the Company. Any unauthorized alteration, forgery or falsification of the content or appearance of this document is unlawful and offenders may be prosecuted to the fullest extent of the law. Unless otherwise stated the results shown in this test report refer only to the sample(s) tested.

測試報告

Test Report

號碼(No.): EKR22200427

日期(Date): 18-Feb-2022

頁數(Page): 19 of 43

台虹科技股份有限公司 (TAIFLEX SCIENTIFIC CO., LTD.)

高雄市前鎮區環區三路1號 (NO. 1, HUANQU 3RD RD., QIANZHEN DIST., KAOHSIUNG CITY, TAIWAN)

測試項目 (Test Items)	測試方法 (Method)	單位 (Unit)	MDL	結果 (Result)	限值 (Limit)
				No.1	
HBFC-262B1 (C3H5F2Br)	參考US EPA 5021A: 2014 · 以氣相層析儀/質譜儀分析。(With reference to US EPA 5021A: 2014, analysis was performed by GC/MS.)	mg/kg	1	n.d.	-
HBFC-271B1 (C3H6FBr)	參考US EPA 5021A: 2014 · 以氣相層析儀/質譜儀分析。(With reference to US EPA 5021A: 2014, analysis was performed by GC/MS.)	mg/kg	1	n.d.	-
HBFC-31B1 (CH2FBr) (CAS No.: 373-52-4)	參考US EPA 5021A: 2014 · 以氣相層析儀/質譜儀分析。(With reference to US EPA 5021A: 2014, analysis was performed by GC/MS.)	mg/kg	1	n.d.	-
氫氟碳化合物 (Hydrofluorocarbon) (HFCs)					
HFC-125 (C2HF5)	參考US EPA 5021A: 2014 · 以氣相層析儀/質譜儀分析。(With reference to US EPA 5021A: 2014, analysis was performed by GC/MS.)	mg/kg	1	n.d.	-
HFC-134 (C2H2F4)	參考US EPA 5021A: 2014 · 以氣相層析儀/質譜儀分析。(With reference to US EPA 5021A: 2014, analysis was performed by GC/MS.)	mg/kg	1	n.d.	-
HFC-134a (CH2FCF3) (CAS No.: 811-97-2)	參考US EPA 5021A: 2014 · 以氣相層析儀/質譜儀分析。(With reference to US EPA 5021A: 2014, analysis was performed by GC/MS.)	mg/kg	1	n.d.	-
HFC-143 (CH3F3)	參考US EPA 5021A: 2014 · 以氣相層析儀/質譜儀分析。(With reference to US EPA 5021A: 2014, analysis was performed by GC/MS.)	mg/kg	1	n.d.	-
HFC-143a (CH3F3)	參考US EPA 5021A: 2014 · 以氣相層析儀/質譜儀分析。(With reference to US EPA 5021A: 2014, analysis was performed by GC/MS.)	mg/kg	1	n.d.	-

This document is issued by the Company subject to its General Conditions of Service printed overleaf, available on request or accessible at <https://www.sgs.com.tw/terms-of-service> and, for electronic format documents, subject to Terms and Conditions for Electronic Documents at <https://www.sgs.com.tw/terms-of-service>. Attention is drawn to the limitation of liability, indemnification and jurisdiction issues defined therein. Any holder of this document is advised that information contained hereon reflects the Company's findings at the time of its intervention only and within the limits of client's instruction, if any. The Company's sole responsibility is to its Client and this document does not exonerate parties to a transaction from exercising all their rights and obligations under the transaction documents. This document cannot be reproduced, except in full, without prior written approval of the Company. Any unauthorized alteration, forgery or falsification of the content or appearance of this document is unlawful and offenders may be prosecuted to the fullest extent of the law. Unless otherwise stated the results shown in this test report refer only to the sample(s) tested.

測試報告

Test Report

號碼(No.): EKR22200427

日期(Date): 18-Feb-2022

頁數(Page): 20 of 43

台虹科技股份有限公司 (TAIFLEX SCIENTIFIC CO., LTD.)

高雄市前鎮區環區三路1號 (NO. 1, HUANQU 3RD RD., QIANZHEN DIST., KAOHSIUNG CITY, TAIWAN)

測試項目 (Test Items)	測試方法 (Method)	單位 (Unit)	MDL	結果 (Result)	限值 (Limit)
				No.1	
HFC-152a (C2H4F2) (CAS No.: 75-37-6)	參考US EPA 5021A: 2014 · 以氣相層析儀/質譜儀分析。(With reference to US EPA 5021A: 2014, analysis was performed by GC/MS.)	mg/kg	1	n.d.	-
HFC-227ea (C3HF7) (CAS No.: 431-89-0)	參考US EPA 5021A: 2014 · 以氣相層析儀/質譜儀分析。(With reference to US EPA 5021A: 2014, analysis was performed by GC/MS.)	mg/kg	1	n.d.	-
HFC-23 (CHF3) (CAS No.: 75-46-7)	參考US EPA 5021A: 2014 · 以氣相層析儀/質譜儀分析。(With reference to US EPA 5021A: 2014, analysis was performed by GC/MS.)	mg/kg	1	n.d.	-
HFC-236ea (C3H2F6) (CAS No.: 431-63-0)	參考US EPA 5021A: 2014 · 以氣相層析儀/質譜儀分析。(With reference to US EPA 5021A: 2014, analysis was performed by GC/MS.)	mg/kg	1	n.d.	-
HFC-236fa (CAS No.: 431-63-0)	參考US EPA 5021A: 2014 · 以氣相層析儀/質譜儀分析。(With reference to US EPA 5021A: 2014, analysis was performed by GC/MS.)	mg/kg	1	n.d.	-
HFC-245ca (C3H3F5)	參考US EPA 5021A: 2014 · 以氣相層析儀/質譜儀分析。(With reference to US EPA 5021A: 2014, analysis was performed by GC/MS.)	mg/kg	1	n.d.	-
HFC-245fa (C3H3F5)	參考US EPA 5021A: 2014 · 以氣相層析儀/質譜儀分析。(With reference to US EPA 5021A: 2014, analysis was performed by GC/MS.)	mg/kg	1	n.d.	-
HFC-32 (CH2F2) (CAS No.: 75-10-5)	參考US EPA 5021A: 2014 · 以氣相層析儀/質譜儀分析。(With reference to US EPA 5021A: 2014, analysis was performed by GC/MS.)	mg/kg	1	n.d.	-

This document is issued by the Company subject to its General Conditions of Service printed overleaf, available on request or accessible at <https://www.sgs.com.tw/terms-of-service> and, for electronic format documents, subject to Terms and Conditions for Electronic Documents at <https://www.sgs.com.tw/terms-of-service>. Attention is drawn to the limitation of liability, indemnification and jurisdiction issues defined therein. Any holder of this document is advised that information contained hereon reflects the Company's findings at the time of its intervention only and within the limits of client's instruction, if any. The Company's sole responsibility is to its Client and this document does not exonerate parties to a transaction from exercising all their rights and obligations under the transaction documents. This document cannot be reproduced, except in full, without prior written approval of the Company. Any unauthorized alteration, forgery or falsification of the content or appearance of this document is unlawful and offenders may be prosecuted to the fullest extent of the law. Unless otherwise stated the results shown in this test report refer only to the sample(s) tested.



測試報告

Test Report

號碼(No.): EKR22200427

日期(Date): 18-Feb-2022

頁數(Page): 21 of 43

台虹科技股份有限公司 (TAIFLEX SCIENTIFIC CO., LTD.)

高雄市前鎮區環區三路1號 (NO. 1, HUANQU 3RD RD., QIANZHEN DIST., KAOHSIUNG CITY, TAIWAN)

測試項目 (Test Items)	測試方法 (Method)	單位 (Unit)	MDL	結果 (Result)	限值 (Limit)
				No.1	
HFC-365mfc (C4H5F5)	參考US EPA 5021A: 2014 · 以氣相層析儀/ 質譜儀分析。(With reference to US EPA 5021A: 2014, analysis was performed by GC/MS.)	mg/kg	1	n.d.	-
HFC-43-10mee (C5H2F10)	參考US EPA 5021A: 2014 · 以氣相層析儀/ 質譜儀分析。(With reference to US EPA 5021A: 2014, analysis was performed by GC/MS.)	mg/kg	1	n.d.	-
HFC-41 (CH3F) (CAS No.: 593-53-3)	參考US EPA 5021A: 2014 · 以氣相層析儀/ 質譜儀分析。(With reference to US EPA 5021A: 2014, analysis was performed by GC/MS.)	mg/kg	1	n.d.	-
全氟化碳 (Perfluorocarbon) (PFCs)					
六氟乙烷 (Fluorocarbon 116) (CAS No.: 76-16-4)	參考US EPA 5021A: 2014 · 以氣相層析儀/ 質譜儀分析。(With reference to US EPA 5021A: 2014, analysis was performed by GC/MS.)	mg/kg	1	n.d.	-
1,4-二氫八氟丁烷 (1,4- dihydrooctafluorobutane) (CAS No.: 377-36-6)	參考US EPA 5021A: 2014 · 以氣相層析儀/ 質譜儀分析。(With reference to US EPA 5021A: 2014, analysis was performed by GC/MS.)	mg/kg	1	n.d.	-
2-全氟甲基戊烷 (2- Perfluoromethylpentane) (CAS No.: 355-04-4)	參考US EPA 5021A: 2014 · 以氣相層析儀/ 質譜儀分析。(With reference to US EPA 5021A: 2014, analysis was performed by GC/MS.)	mg/kg	1	n.d.	-
十氟丁烷 (Decafluorobutane) (CAS No.: 355-25-9)	參考US EPA 5021A: 2014 · 以氣相層析儀/ 質譜儀分析。(With reference to US EPA 5021A: 2014, analysis was performed by GC/MS.)	mg/kg	1	n.d.	-
四氟甲烷 (Freon 14) (CAS No.: 75-73-0)	參考US EPA 5021A: 2014 · 以氣相層析儀/ 質譜儀分析。(With reference to US EPA 5021A: 2014, analysis was performed by GC/MS.)	mg/kg	1	n.d.	-

This document is issued by the Company subject to its General Conditions of Service printed overleaf, available on request or accessible at <https://www.sgs.com.tw/terms-of-service> and, for electronic format documents, subject to Terms and Conditions for Electronic Documents at <https://www.sgs.com.tw/terms-of-service>. Attention is drawn to the limitation of liability, indemnification and jurisdiction issues defined therein. Any holder of this document is advised that information contained hereon reflects the Company's findings at the time of its intervention only and within the limits of client's instruction, if any. The Company's sole responsibility is to its Client and this document does not exonerate parties to a transaction from exercising all their rights and obligations under the transaction documents. This document cannot be reproduced, except in full, without prior written approval of the Company. Any unauthorized alteration, forgery or falsification of the content or appearance of this document is unlawful and offenders may be prosecuted to the fullest extent of the law. Unless otherwise stated the results shown in this test report refer only to the sample(s) tested.

測試報告

Test Report

號碼(No.): EKR22200427

日期(Date): 18-Feb-2022

頁數(Page): 22 of 43

台虹科技股份有限公司 (TAIFLEX SCIENTIFIC CO., LTD.)

高雄市前鎮區環區三路1號 (NO. 1, HUANQU 3RD RD., QIANZHEN DIST., KAOHSIUNG CITY, TAIWAN)

測試項目 (Test Items)	測試方法 (Method)	單位 (Unit)	MDL	結果 (Result)	限值 (Limit)
				No.1	
八氟丙烷 (Freon 218) (CAS No.: 76-19-7)	參考US EPA 5021A: 2014 · 以氣相層析儀/質譜儀分析。(With reference to US EPA 5021A: 2014, analysis was performed by GC/MS.)	mg/kg	1	n.d.	-
2-全氟甲基丁烷 (Nonafluor-2-(trifluoromethyl)butane) (CAS No.: 594-91-2)	參考US EPA 5021A: 2014 · 以氣相層析儀/質譜儀分析。(With reference to US EPA 5021A: 2014, analysis was performed by GC/MS.)	mg/kg	1	n.d.	-
全氟-1-丁烯 (Perfluor-1-butene) (CAS No.: 357-26-6)	參考US EPA 5021A: 2014 · 以氣相層析儀/質譜儀分析。(With reference to US EPA 5021A: 2014, analysis was performed by GC/MS.)	mg/kg	1	n.d.	-
全氟異丁烯 (Perfluorisobutene) (CAS No.: 382-21-8)	參考US EPA 5021A: 2014 · 以氣相層析儀/質譜儀分析。(With reference to US EPA 5021A: 2014, analysis was performed by GC/MS.)	mg/kg	1	n.d.	-
全氟己烷 (Perfluorohexane) (CAS No.: 355-42-0)	參考US EPA 5021A: 2014 · 以氣相層析儀/質譜儀分析。(With reference to US EPA 5021A: 2014, analysis was performed by GC/MS.)	mg/kg	1	n.d.	-
全氟戊烷 (Perfluoro-n-pentane) (CAS No.: 678-26-2)	參考US EPA 5021A: 2014 · 以氣相層析儀/質譜儀分析。(With reference to US EPA 5021A: 2014, analysis was performed by GC/MS.)	mg/kg	1	n.d.	-
八氟環丁烷 (Freon C318) (CAS No.: 115-25-3)	參考US EPA 5021A: 2014 · 以氣相層析儀/質譜儀分析。(With reference to US EPA 5021A: 2014, analysis was performed by GC/MS.)	mg/kg	1	n.d.	-

This document is issued by the Company subject to its General Conditions of Service printed overleaf, available on request or accessible at <https://www.sgs.com.tw/terms-of-service> and, for electronic format documents, subject to Terms and Conditions for Electronic Documents at <https://www.sgs.com.tw/terms-of-service>. Attention is drawn to the limitation of liability, indemnification and jurisdiction issues defined therein. Any holder of this document is advised that information contained hereon reflects the Company's findings at the time of its intervention only and within the limits of client's instruction, if any. The Company's sole responsibility is to its Client and this document does not exonerate parties to a transaction from exercising all their rights and obligations under the transaction documents. This document cannot be reproduced, except in full, without prior written approval of the Company. Any unauthorized alteration, forgery or falsification of the content or appearance of this document is unlawful and offenders may be prosecuted to the fullest extent of the law. Unless otherwise stated the results shown in this test report refer only to the sample(s) tested.

測試報告

Test Report

號碼(No.): EKR22200427

日期(Date): 18-Feb-2022

頁數(Page): 23 of 43

台虹科技股份有限公司 (TAIFLEX SCIENTIFIC CO., LTD.)

高雄市前鎮區環區三路1號 (NO. 1, HUANQU 3RD RD., QIANZHEN DIST., KAOHSIUNG CITY, TAIWAN)

測試項目 (Test Items)	測試方法 (Method)	單位 (Unit)	MDL	結果 (Result)	限值 (Limit)
				No.1	
氯碳氫化物 (Chlorinate hydrocarbon) (CHCs)					
四氯甲烷 (四氯化碳) (Carbon tetrachloride) (CAS No.: 56-23-5)	參考US EPA 5021A: 2014 · 以氣相層析儀/質譜儀分析。(With reference to US EPA 5021A: 2014, analysis was performed by GC/MS.)	mg/kg	1	n.d.	-
1,1,1-三氯乙烷 (1,1,1-Trichloroethane) (CAS No.: 71-55-6)	參考US EPA 5021A: 2014 · 以氣相層析儀/質譜儀分析。(With reference to US EPA 5021A: 2014, analysis was performed by GC/MS.)	mg/kg	1	n.d.	-
1,1,1,2-四氯乙烷 (1,1,1,2-Tetrachloroethane) (CAS No.: 630-20-6)	參考US EPA 5021A: 2014 · 以氣相層析儀/質譜儀分析。(With reference to US EPA 5021A: 2014, analysis was performed by GC/MS.)	mg/kg	1	n.d.	-
1,1,2,2-四氯乙烷 (1,1,2,2-Tetrachloroethane) (CAS No.: 79-34-5)	參考US EPA 5021A: 2014 · 以氣相層析儀/質譜儀分析。(With reference to US EPA 5021A: 2014, analysis was performed by GC/MS.)	mg/kg	1	n.d.	-
1,1,2-三氯乙烷 (1,1,2-Trichloroethane) (CAS No.: 79-00-5)	參考US EPA 5021A: 2014 · 以氣相層析儀/質譜儀分析。(With reference to US EPA 5021A: 2014, analysis was performed by GC/MS.)	mg/kg	1	n.d.	-
1,1-二氯乙烷 (1,1-Dichloroethane) (CAS No.: 75-34-3)	參考US EPA 5021A: 2014 · 以氣相層析儀/質譜儀分析。(With reference to US EPA 5021A: 2014, analysis was performed by GC/MS.)	mg/kg	1	n.d.	-
1,1-二氯乙烯 (1,1-Dichloroethylene) (CAS No.: 75-35-4)	參考US EPA 5021A: 2014 · 以氣相層析儀/質譜儀分析。(With reference to US EPA 5021A: 2014, analysis was performed by GC/MS.)	mg/kg	1	n.d.	-
1,1-二氯丙烯 (1,1-Dichloropropene) (CAS No.: 563-58-6)	參考US EPA 5021A: 2014 · 以氣相層析儀/質譜儀分析。(With reference to US EPA 5021A: 2014, analysis was performed by GC/MS.)	mg/kg	1	n.d.	-

This document is issued by the Company subject to its General Conditions of Service printed overleaf, available on request or accessible at <https://www.sgs.com.tw/terms-of-service> and, for electronic format documents, subject to Terms and Conditions for Electronic Documents at <https://www.sgs.com.tw/terms-of-service>. Attention is drawn to the limitation of liability, indemnification and jurisdiction issues defined therein. Any holder of this document is advised that information contained hereon reflects the Company's findings at the time of its intervention only and within the limits of client's instruction, if any. The Company's sole responsibility is to its Client and this document does not exonerate parties to a transaction from exercising all their rights and obligations under the transaction documents. This document cannot be reproduced, except in full, without prior written approval of the Company. Any unauthorized alteration, forgery or falsification of the content or appearance of this document is unlawful and offenders may be prosecuted to the fullest extent of the law. Unless otherwise stated the results shown in this test report refer only to the sample(s) tested.

測試報告

Test Report

號碼(No.): EKR22200427

日期(Date): 18-Feb-2022

頁數(Page): 24 of 43

台虹科技股份有限公司 (TAIFLEX SCIENTIFIC CO., LTD.)

高雄市前鎮區環區三路1號 (NO. 1, HUANQU 3RD RD., QIANZHEN DIST., KAOHSIUNG CITY, TAIWAN)

測試項目 (Test Items)	測試方法 (Method)	單位 (Unit)	MDL	結果 (Result)	限值 (Limit)
				No.1	
1,2,3-三氯丙烷 (1,2,3-Trichloropropane) (CAS No.: 96-18-4)	參考US EPA 5021A: 2014 · 以氣相層析儀/ 質譜儀分析。(With reference to US EPA 5021A: 2014, analysis was performed by GC/MS.)	mg/kg	1	n.d.	-
1,2-二氯乙烷 (1,2-Dichloroethane) (CAS No.: 107-06-2)	參考US EPA 5021A: 2014 · 以氣相層析儀/ 質譜儀分析。(With reference to US EPA 5021A: 2014, analysis was performed by GC/MS.)	mg/kg	1	n.d.	-
1,2-二氯丙烷 (1,2-Dichloropropane) (CAS No.: 78-87-5)	參考US EPA 5021A: 2014 · 以氣相層析儀/ 質譜儀分析。(With reference to US EPA 5021A: 2014, analysis was performed by GC/MS.)	mg/kg	1	n.d.	-
1,3-二氯丙烷 (1,3-Dichloropropane) (CAS No.: 142-28-9)	參考US EPA 5021A: 2014 · 以氣相層析儀/ 質譜儀分析。(With reference to US EPA 5021A: 2014, analysis was performed by GC/MS.)	mg/kg	1	n.d.	-
2,2-二氯丙烷 (2,2-Dichloropropane) (CAS No.: 594-20-7)	參考US EPA 5021A: 2014 · 以氣相層析儀/ 質譜儀分析。(With reference to US EPA 5021A: 2014, analysis was performed by GC/MS.)	mg/kg	1	n.d.	-
氯仿 (Chloroform) (CAS No.: 67-66-3)	參考US EPA 5021A: 2014 · 以氣相層析儀/ 質譜儀分析。(With reference to US EPA 5021A: 2014, analysis was performed by GC/MS.)	mg/kg	1	n.d.	-
氯甲烷 (Chloromethane) (CAS No.: 74- 87-3)	參考US EPA 5021A: 2014 · 以氣相層析儀/ 質譜儀分析。(With reference to US EPA 5021A: 2014, analysis was performed by GC/MS.)	mg/kg	1	n.d.	-
順-1,2-二氯乙烯 (cis-1,2- Dichloroethene) (CAS No.: 156-59-2)	參考US EPA 5021A: 2014 · 以氣相層析儀/ 質譜儀分析。(With reference to US EPA 5021A: 2014, analysis was performed by GC/MS.)	mg/kg	1	n.d.	-

This document is issued by the Company subject to its General Conditions of Service printed overleaf, available on request or accessible at <https://www.sgs.com.tw/terms-of-service> and, for electronic format documents, subject to Terms and Conditions for Electronic Documents at <https://www.sgs.com.tw/terms-of-service>. Attention is drawn to the limitation of liability, indemnification and jurisdiction issues defined therein. Any holder of this document is advised that information contained hereon reflects the Company's findings at the time of its intervention only and within the limits of client's instruction, if any. The Company's sole responsibility is to its Client and this document does not exonerate parties to a transaction from exercising all their rights and obligations under the transaction documents. This document cannot be reproduced, except in full, without prior written approval of the Company. Any unauthorized alteration, forgery or falsification of the content or appearance of this document is unlawful and offenders may be prosecuted to the fullest extent of the law. Unless otherwise stated the results shown in this test report refer only to the sample(s) tested.

測試報告

Test Report

號碼(No.): EKR22200427

日期(Date): 18-Feb-2022

頁數(Page): 25 of 43

台虹科技股份有限公司 (TAIFLEX SCIENTIFIC CO., LTD.)

高雄市前鎮區環區三路1號 (NO. 1, HUANQU 3RD RD., QIANZHEN DIST., KAOHSIUNG CITY, TAIWAN)

測試項目 (Test Items)	測試方法 (Method)	單位 (Unit)	MDL	結果 (Result)	限值 (Limit)
				No.1	
順-1,3-二氯丙烯 (cis-1,3-Dichloropropene) (CAS No.: 10061-01-5)	參考US EPA 5021A: 2014 · 以氣相層析儀/質譜儀分析。(With reference to US EPA 5021A: 2014, analysis was performed by GC/MS.)	mg/kg	1	n.d.	-
二氯甲烷 (Dichloromethane) (CAS No.: 75-09-2)	參考US EPA 5021A: 2014 · 以氣相層析儀/質譜儀分析。(With reference to US EPA 5021A: 2014, analysis was performed by GC/MS.)	mg/kg	1	n.d.	-
四氯乙烯 (Tetrachloroethene) (CAS No.: 127-18-4)	參考US EPA 5021A: 2014 · 以氣相層析儀/質譜儀分析。(With reference to US EPA 5021A: 2014, analysis was performed by GC/MS.)	mg/kg	1	n.d.	-
反-1,2-二氯乙烯 (trans-1,2-Dichloroethene) (CAS No.: 156-60-5)	參考US EPA 5021A: 2014 · 以氣相層析儀/質譜儀分析。(With reference to US EPA 5021A: 2014, analysis was performed by GC/MS.)	mg/kg	1	n.d.	-
反-1,3-二氯丙烯 (trans-1,3-Dichloropropene) (CAS No.: 10061-02-6)	參考US EPA 5021A: 2014 · 以氣相層析儀/質譜儀分析。(With reference to US EPA 5021A: 2014, analysis was performed by GC/MS.)	mg/kg	1	n.d.	-
三氯乙烯 (Trichloroethylene) (CAS No.: 79-01-6)	參考US EPA 5021A: 2014 · 以氣相層析儀/質譜儀分析。(With reference to US EPA 5021A: 2014, analysis was performed by GC/MS.)	mg/kg	1	n.d.	-
氯乙烷 (Chloroethane) (CAS No.: 75-00-3)	參考US EPA 5021A: 2014 · 以氣相層析儀/質譜儀分析。(With reference to US EPA 5021A: 2014, analysis was performed by GC/MS.)	mg/kg	1	n.d.	-
六氯-1,3-丁二烯 (Hexachlorobutadiene) (CAS No.: 87-68-3)	參考US EPA 5021A: 2014 · 以氣相層析儀/質譜儀分析。(With reference to US EPA 5021A: 2014, analysis was performed by GC/MS.)	mg/kg	1	n.d.	-

This document is issued by the Company subject to its General Conditions of Service printed overleaf, available on request or accessible at <https://www.sgs.com.tw/terms-of-service> and, for electronic format documents, subject to Terms and Conditions for Electronic Documents at <https://www.sgs.com.tw/terms-of-service>. Attention is drawn to the limitation of liability, indemnification and jurisdiction issues defined therein. Any holder of this document is advised that information contained hereon reflects the Company's findings at the time of its intervention only and within the limits of client's instruction, if any. The Company's sole responsibility is to its Client and this document does not exonerate parties to a transaction from exercising all their rights and obligations under the transaction documents. This document cannot be reproduced, except in full, without prior written approval of the Company. Any unauthorized alteration, forgery or falsification of the content or appearance of this document is unlawful and offenders may be prosecuted to the fullest extent of the law. Unless otherwise stated the results shown in this test report refer only to the sample(s) tested.

測試報告

Test Report

號碼(No.): EKR22200427

日期(Date): 18-Feb-2022

頁數(Page): 26 of 43

台虹科技股份有限公司 (TAIFLEX SCIENTIFIC CO., LTD.)

高雄市前鎮區環區三路1號 (NO. 1, HUANQU 3RD RD., QIANZHEN DIST., KAOHSIUNG CITY, TAIWAN)

測試項目 (Test Items)	測試方法 (Method)	單位 (Unit)	MDL	結果 (Result)	限值 (Limit)
				No.1	
溴氯甲烷 (Bromochloromethane) (CAS No.: 74-97-5)	參考US EPA 5021A: 2014 · 以氣相層析儀/質譜儀分析。(With reference to US EPA 5021A: 2014, analysis was performed by GC/MS.)	mg/kg	1	n.d.	-
六氟化硫 (SF6) (Sulphur hexafluoride (SF6)) (CAS No.: 2551-62-4)	參考US EPA 5021A: 2014 · 以氣相層析儀/質譜儀分析。(With reference to US EPA 5021A: 2014, analysis was performed by GC/MS.)	mg/kg	1	n.d.	-

備註(Note) :

1. mg/kg = ppm ; 0.1wt% = 0.1% = 1000ppm
2. MDL = Method Detection Limit (方法偵測極限值)
3. n.d. = Not Detected (未檢出) ; 小於MDL / Less than MDL
4. "-" = Not Regulated (無規格值)
5. ** = Qualitative analysis (No Unit) 定性分析(無單位)
6. Negative = Undetectable 陰性(未偵測到); Positive = Detectable 陽性(已偵測到)
7. 全氟辛烷磺酸及其鹽類包含 (PFOS and its salts including) :
CAS No.: 29081-56-9, 2795-39-3, 29457-72-5, 70225-14-8, 56773-42-3, 251099-16-8, 307-35-7.
8. 全氟辛酸及其鹽類包含 (PFOA and its salts including) :
CAS No.: 3825-26-1, 335-95-5, 2395-00-8, 335-93-3, 335-66-0.
9. ▲ : MDL是針對元素/測試化合物之評估。(The MDL was evaluated for element / tested substance.)

換算公式 (Conversion Formula) : $AX = A \times F$

AX	A	F
氧化鈹 (Beryllium oxide) (BeO)	鈹 (Beryllium)	2.7753
三氧化二銻 (Antimony trioxide) (Sb ₂ O ₃)	銻 (Antimony)	1.1971

參數換算表 (Parameter Conversion Table) :

https://eecloud.sgs.com/Region_TW/DocDownload.aspx#otherDoc

10. 符合性結果之判定係以測試結果與限值做比較。(The statement of compliance conformity is based on comparison of testing results and limits.)

測試報告

Test Report

號碼(No.): EKR22200427

日期(Date): 18-Feb-2022

頁數(Page): 27 of 43

台虹科技股份有限公司 (TAIFLEX SCIENTIFIC CO., LTD.)

高雄市前鎮區環區三路1號 (NO. 1, HUANQU 3RD RD., QIANZHEN DIST., KAOHSIUNG CITY, TAIWAN)

Remark :

△ 德國產品安全委員會(AfPS): GS PAHs 要求

AfPS (German commission for Product Safety): GS PAHs requirements

項目 (Parameter)	第 1 類(Category 1)	第 2 類(Category 2)		第 3 類(Category 3)	
	意圖放入口中的材料或者長時間接觸皮膚(超過 30 秒)的 2009/48/EC 定義的玩具材料和 3 歲以下兒童使用的產品(Materials intended to be placed in the mouth, or materials in toys (Directive 2009/48/EC) or articles for children up to 3 years of age with intended long-term skin contact (> 30 seconds))	不屬於第 1 類的材料，並意圖或可預見與皮膚接觸逾 30 秒(長期皮膚接觸)或重複的短時間接觸(Materials that are not in Category 1, with intended or foreseeable long-term skin contact (> 30 seconds) or short-term repetitive contact with the skin)		不屬於第 1 類或第 2 類的材料，並意圖或可預見與皮膚接觸不超過 30 秒(短期皮膚接觸)(Materials not covered by Category 1 or 2, with intended or foreseeable short-term skin contact (≤ 30 seconds))	
		a. 供 14 歲以下兒童使用的產品(Use by children under 14)	b. 其它產品(Other consumer products)	a. 供 14 歲以下兒童使用的產品(Use by children under 14)	b. 其它產品(Other consumer products)
Naphthalene	< 1	< 2		< 10	
Phenanthrene	< 1 Sum	< 5 Sum	< 10 Sum	< 20 Sum	< 50 Sum
Anthracene					
Fluoranthene					
Pyrene					
Benzo[a]anthracene	< 0.2	< 0.2	< 0.5	< 0.5	< 1
Chrysene	< 0.2	< 0.2	< 0.5	< 0.5	< 1
Benzo[b]fluoranthene	< 0.2	< 0.2	< 0.5	< 0.5	< 1
Benzo[j]fluoranthene	< 0.2	< 0.2	< 0.5	< 0.5	< 1
Benzo[k]fluoranthene	< 0.2	< 0.2	< 0.5	< 0.5	< 1
Benzo[a]pyrene	< 0.2	< 0.2	< 0.5	< 0.5	< 1
Benzo[e]pyrene	< 0.2	< 0.2	< 0.5	< 0.5	< 1
Indeno[1,2,3-c,d] pyrene	< 0.2	< 0.2	< 0.5	< 0.5	< 1
Dibenzo[a,h]anthracene	< 0.2	< 0.2	< 0.5	< 0.5	< 1
Benzo[g,h,i]perylene	< 0.2	< 0.2	< 0.5	< 0.5	< 1
15 項 PAH 總濃度 (Sum of 15 PAH)	< 1	< 5	< 10	< 20	< 50

單位(Unit) : mg/kg

This document is issued by the Company subject to its General Conditions of Service printed overleaf, available on request or accessible at <https://www.sgs.com.tw/terms-of-service> and, for electronic format documents, subject to Terms and Conditions for Electronic Documents at <https://www.sgs.com.tw/terms-of-service>. Attention is drawn to the limitation of liability, indemnification and jurisdiction issues defined therein. Any holder of this document is advised that information contained hereon reflects the Company's findings at the time of its intervention only and within the limits of client's instruction, if any. The Company's sole responsibility is to its Client and this document does not exonerate parties to a transaction from exercising all their rights and obligations under the transaction documents. This document cannot be reproduced, except in full, without prior written approval of the Company. Any unauthorized alteration, forgery or falsification of the content or appearance of this document is unlawful and offenders may be prosecuted to the fullest extent of the law. Unless otherwise stated the results shown in this test report refer only to the sample(s) tested.

測試報告

Test Report

號碼(No.): EKR22200427

日期(Date): 18-Feb-2022

頁數(Page): 28 of 43

台虹科技股份有限公司 (TAIFLEX SCIENTIFIC CO., LTD.)

高雄市前鎮區環區三路1號 (NO. 1, HUANQU 3RD RD., QIANZHEN DIST., KAOHSIUNG CITY, TAIWAN)

重金屬流程圖 / Analytical flow chart of Heavy Metal

根據以下的流程圖之條件，樣品已完全溶解。(六價鉻測試方法除外)

These samples were dissolved totally by pre-conditioning method according to below flow chart.

(Cr⁶⁺ test method excluded)

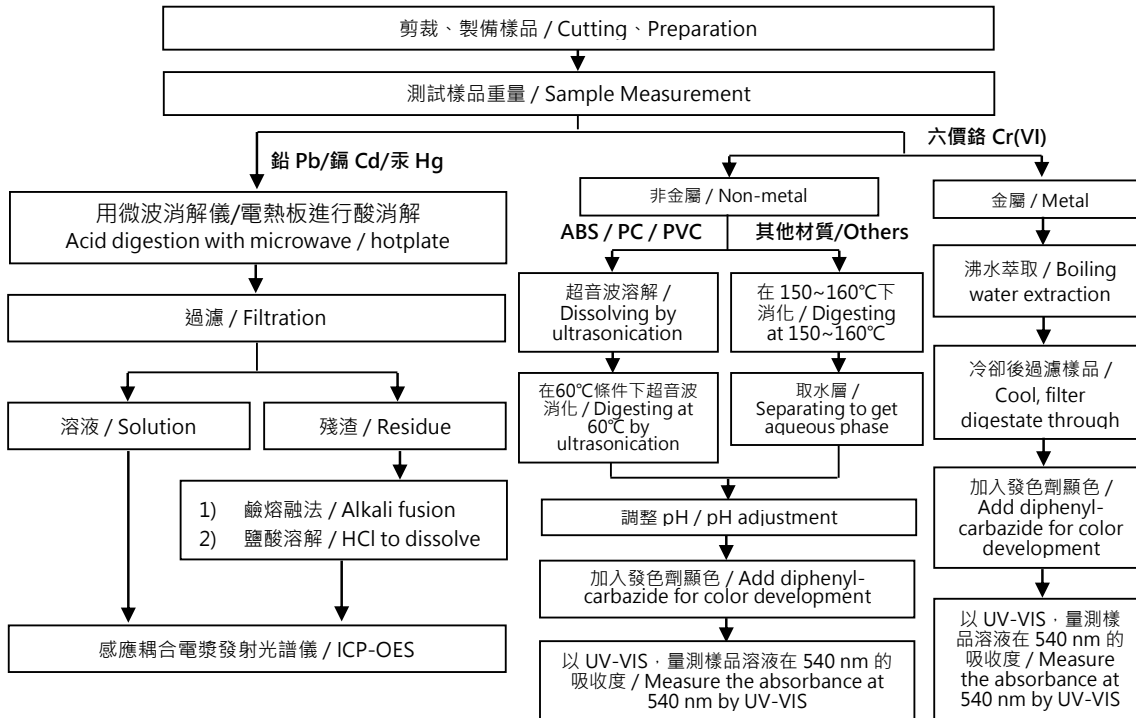

This document is issued by the Company subject to its General Conditions of Service printed overleaf, available on request or accessible at <https://www.sgs.com.tw/terms-of-service> and, for electronic format documents, subject to Terms and Conditions for Electronic Documents at <https://www.sgs.com.tw/terms-of-service>. Attention is drawn to the limitation of liability, indemnification and jurisdiction issues defined therein. Any holder of this document is advised that information contained hereon reflects the Company's findings at the time of its intervention only and within the limits of client's instruction, if any. The Company's sole responsibility is to its Client and this document does not exonerate parties to a transaction from exercising all their rights and obligations under the transaction documents. This document cannot be reproduced, except in full, without prior written approval of the Company. Any unauthorized alteration, forgery or falsification of the content or appearance of this document is unlawful and offenders may be prosecuted to the fullest extent of the law. Unless otherwise stated the results shown in this test report refer only to the sample(s) tested.

測試報告

Test Report

號碼(No.): EKR22200427

日期(Date): 18-Feb-2022

頁數(Page): 29 of 43

台虹科技股份有限公司 (TAIFLEX SCIENTIFIC CO., LTD.)

高雄市前鎮區環區三路1號 (NO. 1, HUANQU 3RD RD., QIANZHEN DIST., KAOHSIUNG CITY, TAIWAN)

多溴聯苯/多溴聯苯醚 分析流程圖 / PBB/PBDE analytical FLOW CHART

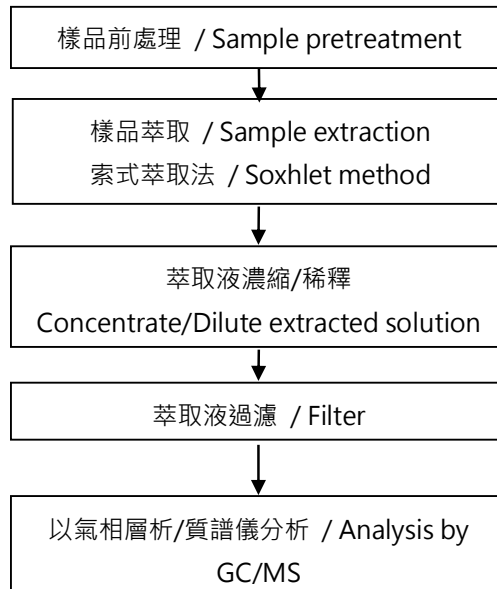

This document is issued by the Company subject to its General Conditions of Service printed overleaf, available on request or accessible at <https://www.sgs.com.tw/terms-of-service> and, for electronic format documents, subject to Terms and Conditions for Electronic Documents at <https://www.sgs.com.tw/terms-of-service>. Attention is drawn to the limitation of liability, indemnification and jurisdiction issues defined therein. Any holder of this document is advised that information contained hereon reflects the Company's findings at the time of its intervention only and within the limits of client's instruction, if any. The Company's sole responsibility is to its Client and this document does not exonerate parties to a transaction from exercising all their rights and obligations under the transaction documents. This document cannot be reproduced, except in full, without prior written approval of the Company. Any unauthorized alteration, forgery or falsification of the content or appearance of this document is unlawful and offenders may be prosecuted to the fullest extent of the law. Unless otherwise stated the results shown in this test report refer only to the sample(s) tested.

台虹科技股份有限公司 (TAIFLEX SCIENTIFIC CO., LTD.)

高雄市前鎮區環區三路1號 (NO. 1, HUANQU 3RD RD., QIANZHEN DIST., KAOHSIUNG CITY, TAIWAN)

元素(含重金屬)分析流程圖 / Analytical flow chart of Elements (Heavy metal included)

根據以下的流程圖之條件，樣品已完全溶解。

These samples were dissolved totally by pre-conditioning method according to below flow chart.

【參考方法/Reference method : US EPA 3051、US EPA 3052】

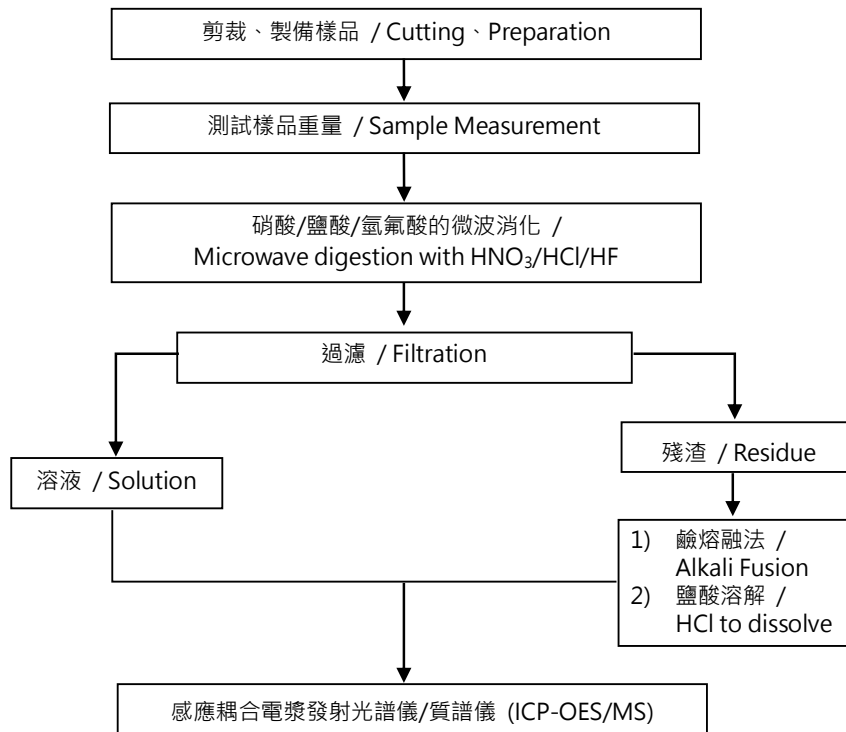

* US EPA 3051 方法未添加氫氟酸 / US EPA 3051 method does not add HF.

台虹科技股份有限公司 (TAIFLEX SCIENTIFIC CO., LTD.)

高雄市前鎮區環區三路1號 (NO. 1, HUANQU 3RD RD., QIANZHEN DIST., KAOHSIUNG CITY, TAIWAN)

四溴雙酚-A分析流程圖 / TBBP-A analytical flow chart

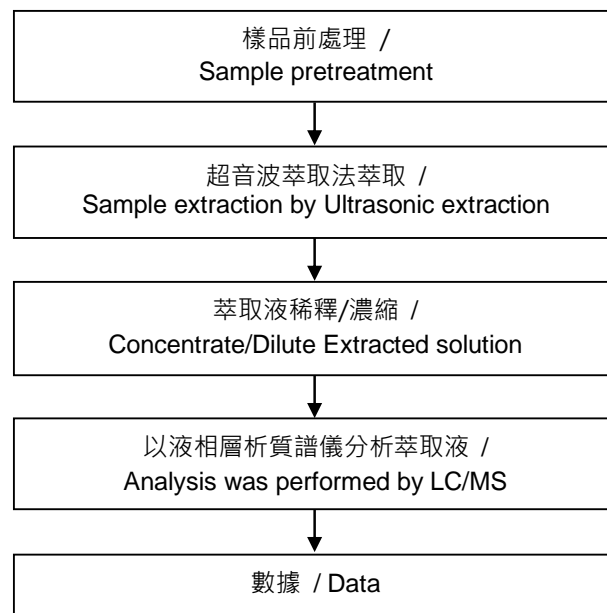

This document is issued by the Company subject to its General Conditions of Service printed overleaf, available on request or accessible at <https://www.sgs.com.tw/terms-of-service> and, for electronic format documents, subject to Terms and Conditions for Electronic Documents at <https://www.sgs.com.tw/terms-of-service>. Attention is drawn to the limitation of liability, indemnification and jurisdiction issues defined therein. Any holder of this document is advised that information contained hereon reflects the Company's findings at the time of its intervention only and within the limits of client's instruction, if any. The Company's sole responsibility is to its Client and this document does not exonerate parties to a transaction from exercising all their rights and obligations under the transaction documents. This document cannot be reproduced, except in full, without prior written approval of the Company. Any unauthorized alteration, forgery or falsification of the content or appearance of this document is unlawful and offenders may be prosecuted to the fullest extent of the law. Unless otherwise stated the results shown in this test report refer only to the sample(s) tested.

台虹科技股份有限公司 (TAIFLEX SCIENTIFIC CO., LTD.)

高雄市前鎮區環區三路1號 (NO. 1, HUANQU 3RD RD., QIANZHEN DIST., KAOHSIUNG CITY, TAIWAN)

六溴環十二烷分析流程圖 / Analytical flow chart - HBCDD

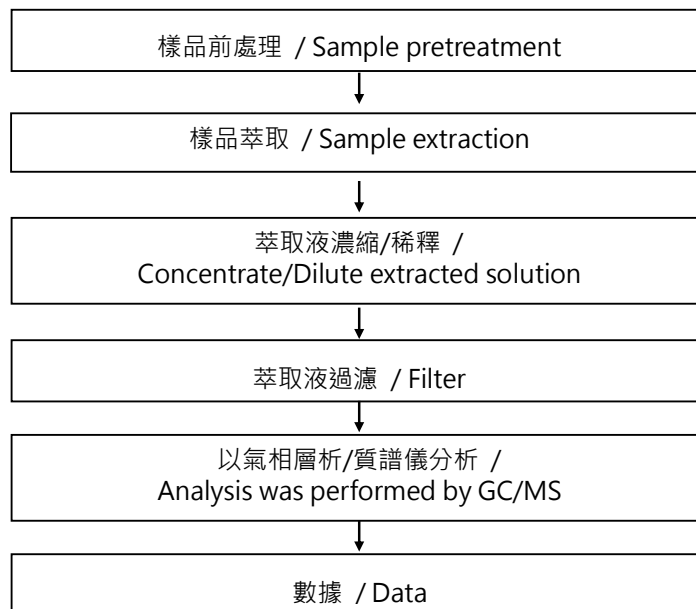

This document is issued by the Company subject to its General Conditions of Service printed overleaf, available on request or accessible at <https://www.sgs.com.tw/terms-of-service> and, for electronic format documents, subject to Terms and Conditions for Electronic Documents at <https://www.sgs.com.tw/terms-of-service>. Attention is drawn to the limitation of liability, indemnification and jurisdiction issues defined therein. Any holder of this document is advised that information contained hereon reflects the Company's findings at the time of its intervention only and within the limits of client's instruction, if any. The Company's sole responsibility is to its Client and this document does not exonerate parties to a transaction from exercising all their rights and obligations under the transaction documents. This document cannot be reproduced, except in full, without prior written approval of the Company. Any unauthorized alteration, forgery or falsification of the content or appearance of this document is unlawful and offenders may be prosecuted to the fullest extent of the law. Unless otherwise stated the results shown in this test report refer only to the sample(s) tested.

台虹科技股份有限公司 (TAIFLEX SCIENTIFIC CO., LTD.)

高雄市前鎮區環區三路1號 (NO. 1, HUANQU 3RD RD., QIANZHEN DIST., KAOHSIUNG CITY, TAIWAN)

雙酚A分析流程圖 / Bisphenol A analytical flow chart

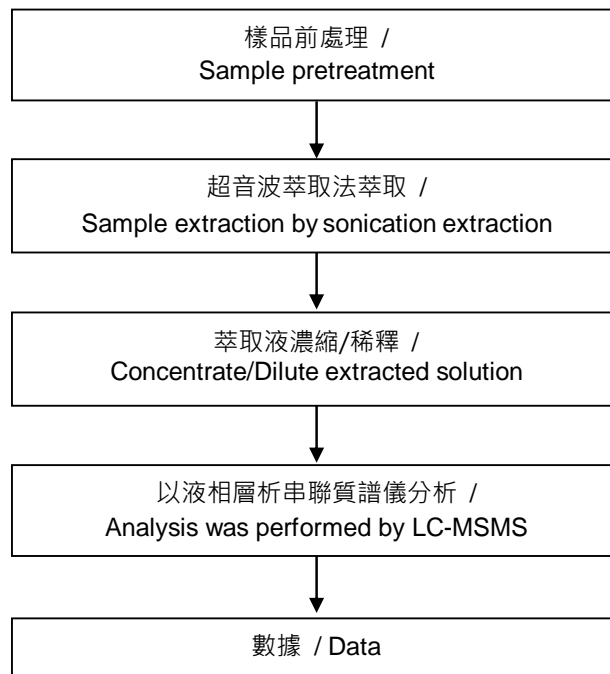

This document is issued by the Company subject to its General Conditions of Service printed overleaf, available on request or accessible at <https://www.sgs.com.tw/terms-of-service> and, for electronic format documents, subject to Terms and Conditions for Electronic Documents at <https://www.sgs.com.tw/terms-of-service>. Attention is drawn to the limitation of liability, indemnification and jurisdiction issues defined therein. Any holder of this document is advised that information contained hereon reflects the Company's findings at the time of its intervention only and within the limits of client's instruction, if any. The Company's sole responsibility is to its Client and this document does not exonerate parties to a transaction from exercising all their rights and obligations under the transaction documents. This document cannot be reproduced, except in full, without prior written approval of the Company. Any unauthorized alteration, forgery or falsification of the content or appearance of this document is unlawful and offenders may be prosecuted to the fullest extent of the law. Unless otherwise stated the results shown in this test report refer only to the sample(s) tested.

測試報告

Test Report

號碼(No.): EKR22200427

日期(Date): 18-Feb-2022

頁數(Page): 34 of 43

台虹科技股份有限公司 (TAIFLEX SCIENTIFIC CO., LTD.)

高雄市前鎮區環區三路1號 (NO. 1, HUANQU 3RD RD., QIANZHEN DIST., KAOHSIUNG CITY, TAIWAN)

分析流程圖 / Analytical flow chart

【適用於：多氯聯苯、多氯奈、多氯三聯苯、滅蟻靈、氯化石蠟、DBBT】

*Apply to: PCBs, PCNs, PCTs, Mirex, Chlorinated Paraffins, DBBT

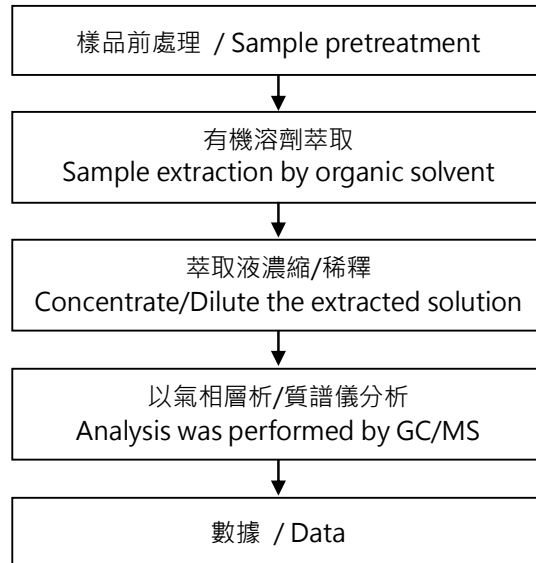

This document is issued by the Company subject to its General Conditions of Service printed overleaf, available on request or accessible at <https://www.sgs.com.tw/terms-of-service> and, for electronic format documents, subject to Terms and Conditions for Electronic Documents at <https://www.sgs.com.tw/terms-of-service>. Attention is drawn to the limitation of liability, indemnification and jurisdiction issues defined therein. Any holder of this document is advised that information contained hereon reflects the Company's findings at the time of its intervention only and within the limits of client's instruction, if any. The Company's sole responsibility is to its Client and this document does not exonerate parties to a transaction from exercising all their rights and obligations under the transaction documents. This document cannot be reproduced, except in full, without prior written approval of the Company. Any unauthorized alteration, forgery or falsification of the content or appearance of this document is unlawful and offenders may be prosecuted to the fullest extent of the law. Unless otherwise stated the results shown in this test report refer only to the sample(s) tested.

台虹科技股份有限公司 (TAIFLEX SCIENTIFIC CO., LTD.)

高雄市前鎮區環區三路1號 (NO. 1, HUANQU 3RD RD., QIANZHEN DIST., KAOHSIUNG CITY, TAIWAN)

富馬酸二甲酯分析流程圖 /
Analytical flow chart of Dimethyl Fumarate content

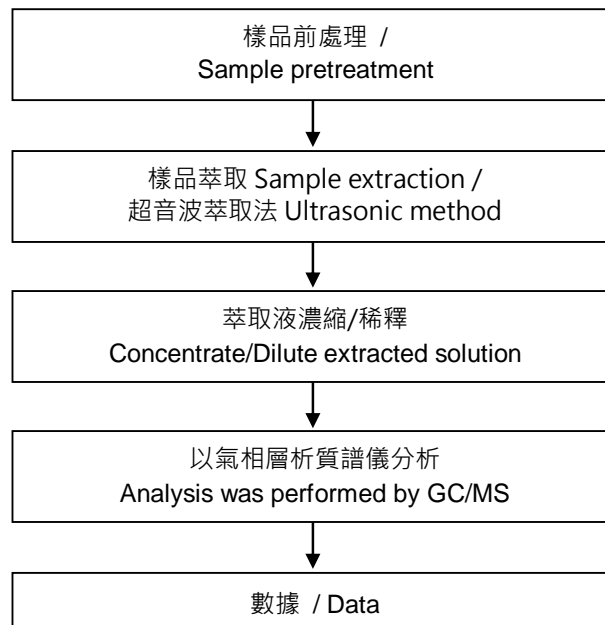

This document is issued by the Company subject to its General Conditions of Service printed overleaf, available on request or accessible at <https://www.sgs.com.tw/terms-of-service> and, for electronic format documents, subject to Terms and Conditions for Electronic Documents at <https://www.sgs.com.tw/terms-of-service>. Attention is drawn to the limitation of liability, indemnification and jurisdiction issues defined therein. Any holder of this document is advised that information contained hereon reflects the Company's findings at the time of its intervention only and within the limits of client's instruction, if any. The Company's sole responsibility is to its Client and this document does not exonerate parties to a transaction from exercising all their rights and obligations under the transaction documents. This document cannot be reproduced, except in full, without prior written approval of the Company. Any unauthorized alteration, forgery or falsification of the content or appearance of this document is unlawful and offenders may be prosecuted to the fullest extent of the law. Unless otherwise stated the results shown in this test report refer only to the sample(s) tested.

台虹科技股份有限公司 (TAIFLEX SCIENTIFIC CO., LTD.)

高雄市前鎮區環區三路1號 (NO. 1, HUANQU 3RD RD., QIANZHEN DIST., KAOHSIUNG CITY, TAIWAN)

紅磷分析流程 / Analytical flow chart - Red phosphorus

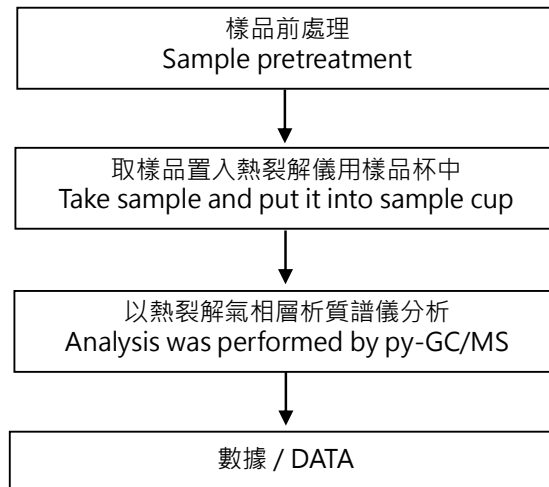

This document is issued by the Company subject to its General Conditions of Service printed overleaf, available on request or accessible at <https://www.sgs.com.tw/terms-of-service> and, for electronic format documents, subject to Terms and Conditions for Electronic Documents at <https://www.sgs.com.tw/terms-of-service>. Attention is drawn to the limitation of liability, indemnification and jurisdiction issues defined therein. Any holder of this document is advised that information contained hereon reflects the Company's findings at the time of its intervention only and within the limits of client's instruction, if any. The Company's sole responsibility is to its Client and this document does not exonerate parties to a transaction from exercising all their rights and obligations under the transaction documents. This document cannot be reproduced, except in full, without prior written approval of the Company. Any unauthorized alteration, forgery or falsification of the content or appearance of this document is unlawful and offenders may be prosecuted to the fullest extent of the law. Unless otherwise stated the results shown in this test report refer only to the sample(s) tested.

台虹科技股份有限公司 (TAIFLEX SCIENTIFIC CO., LTD.)

高雄市前鎮區環區三路1號 (NO. 1, HUANQU 3RD RD., QIANZHEN DIST., KAOHSIUNG CITY, TAIWAN)

全氟化合物(包含全氟辛酸/全氟辛烷磺酸/其相關化合物等等)分析流程圖 / Analytical flow chart – PFAS (including PFOA/PFOS/its related compound, etc.)

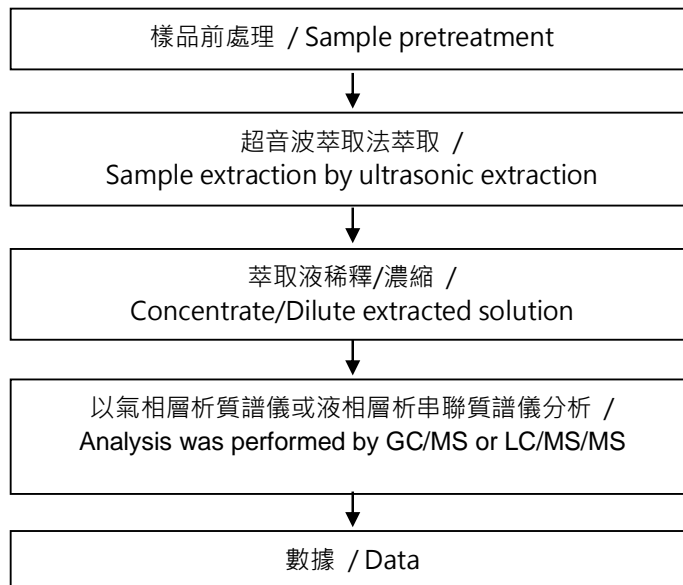

This document is issued by the Company subject to its General Conditions of Service printed overleaf, available on request or accessible at <https://www.sgs.com.tw/terms-of-service> and, for electronic format documents, subject to Terms and Conditions for Electronic Documents at <https://www.sgs.com.tw/terms-of-service>. Attention is drawn to the limitation of liability, indemnification and jurisdiction issues defined therein. Any holder of this document is advised that information contained hereon reflects the Company's findings at the time of its intervention only and within the limits of client's instruction, if any. The Company's sole responsibility is to its Client and this document does not exonerate parties to a transaction from exercising all their rights and obligations under the transaction documents. This document cannot be reproduced, except in full, without prior written approval of the Company. Any unauthorized alteration, forgery or falsification of the content or appearance of this document is unlawful and offenders may be prosecuted to the fullest extent of the law. Unless otherwise stated the results shown in this test report refer only to the sample(s) tested.

台虹科技股份有限公司 (TAIFLEX SCIENTIFIC CO., LTD.)

高雄市前鎮區環區三路1號 (NO. 1, HUANQU 3RD RD., QIANZHEN DIST., KAOHSIUNG CITY, TAIWAN)

鹵素分析流程圖 / Analytical flow chart of Halogen

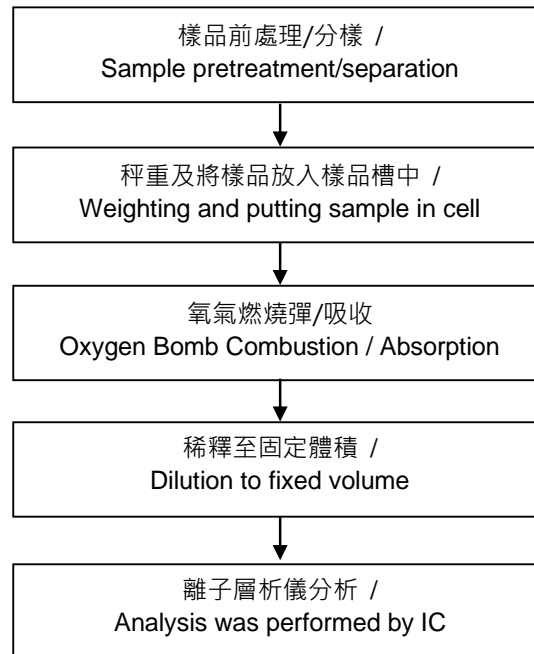

This document is issued by the Company subject to its General Conditions of Service printed overleaf, available on request or accessible at <https://www.sgs.com.tw/terms-of-service> and, for electronic format documents, subject to Terms and Conditions for Electronic Documents at <https://www.sgs.com.tw/terms-of-service>. Attention is drawn to the limitation of liability, indemnification and jurisdiction issues defined therein. Any holder of this document is advised that information contained hereon reflects the Company's findings at the time of its intervention only and within the limits of client's instruction, if any. The Company's sole responsibility is to its Client and this document does not exonerate parties to a transaction from exercising all their rights and obligations under the transaction documents. This document cannot be reproduced, except in full, without prior written approval of the Company. Any unauthorized alteration, forgery or falsification of the content or appearance of this document is unlawful and offenders may be prosecuted to the fullest extent of the law. Unless otherwise stated the results shown in this test report refer only to the sample(s) tested.

台虹科技股份有限公司 (TAIFLEX SCIENTIFIC CO., LTD.)

高雄市前鎮區環區三路1號 (NO. 1, HUANQU 3RD RD., QIANZHEN DIST., KAOHSIUNG CITY, TAIWAN)

可塑劑分析流程圖 / Analytical flow chart of phthalate content

【測試方法/Test method: IEC 62321-8】

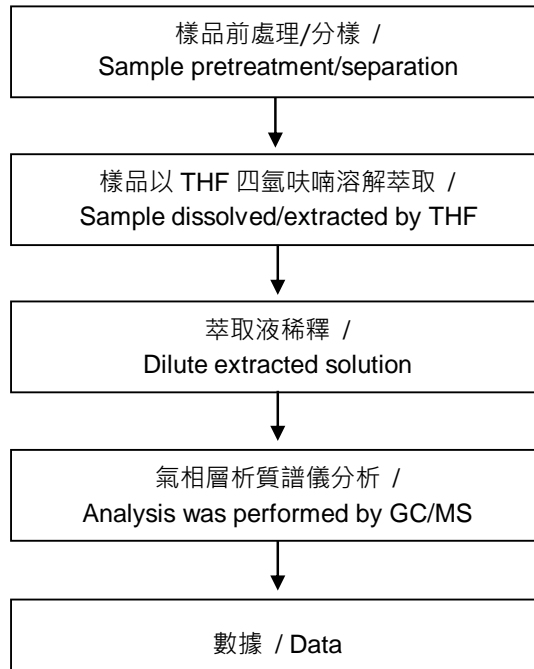

This document is issued by the Company subject to its General Conditions of Service printed overleaf, available on request or accessible at <https://www.sgs.com.tw/terms-of-service> and, for electronic format documents, subject to Terms and Conditions for Electronic Documents at <https://www.sgs.com.tw/terms-of-service>. Attention is drawn to the limitation of liability, indemnification and jurisdiction issues defined therein. Any holder of this document is advised that information contained hereon reflects the Company's findings at the time of its intervention only and within the limits of client's instruction, if any. The Company's sole responsibility is to its Client and this document does not exonerate parties to a transaction from exercising all their rights and obligations under the transaction documents. This document cannot be reproduced, except in full, without prior written approval of the Company. Any unauthorized alteration, forgery or falsification of the content or appearance of this document is unlawful and offenders may be prosecuted to the fullest extent of the law. Unless otherwise stated the results shown in this test report refer only to the sample(s) tested.

台虹科技股份有限公司 (TAIFLEX SCIENTIFIC CO., LTD.)

高雄市前鎮區環區三路1號 (NO. 1, HUANQU 3RD RD., QIANZHEN DIST., KAOHSIUNG CITY, TAIWAN)

多環芳香烴分析流程圖 /

PAHs (Poly Aromatic Hydrocarbons) analytical flow chart

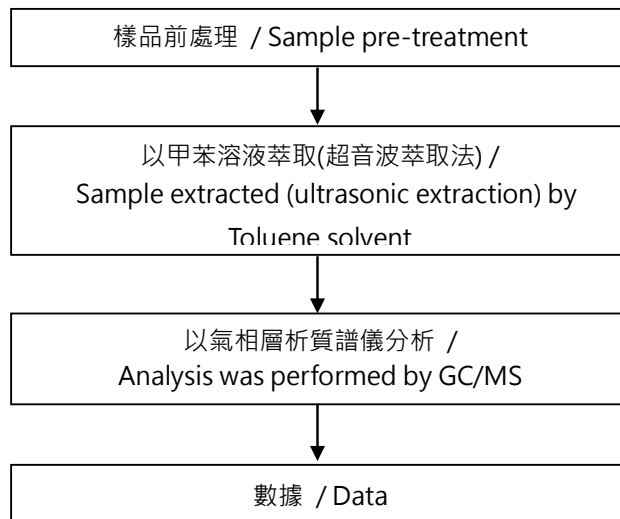

This document is issued by the Company subject to its General Conditions of Service printed overleaf, available on request or accessible at <https://www.sgs.com.tw/terms-of-service> and, for electronic format documents, subject to Terms and Conditions for Electronic Documents at <https://www.sgs.com.tw/terms-of-service>. Attention is drawn to the limitation of liability, indemnification and jurisdiction issues defined therein. Any holder of this document is advised that information contained hereon reflects the Company's findings at the time of its intervention only and within the limits of client's instruction, if any. The Company's sole responsibility is to its Client and this document does not exonerate parties to a transaction from exercising all their rights and obligations under the transaction documents. This document cannot be reproduced, except in full, without prior written approval of the Company. Any unauthorized alteration, forgery or falsification of the content or appearance of this document is unlawful and offenders may be prosecuted to the fullest extent of the law. Unless otherwise stated the results shown in this test report refer only to the sample(s) tested.

台虹科技股份有限公司 (TAIFLEX SCIENTIFIC CO., LTD.)

高雄市前鎮區環區三路1號 (NO. 1, HUANQU 3RD RD., QIANZHEN DIST., KAOHSIUNG CITY, TAIWAN)

揮發性有機化合物分析流程圖 /
Analytical flow chart of volatile organic compounds (VOCs)

【參考方法/Reference method : US EPA 5021A】

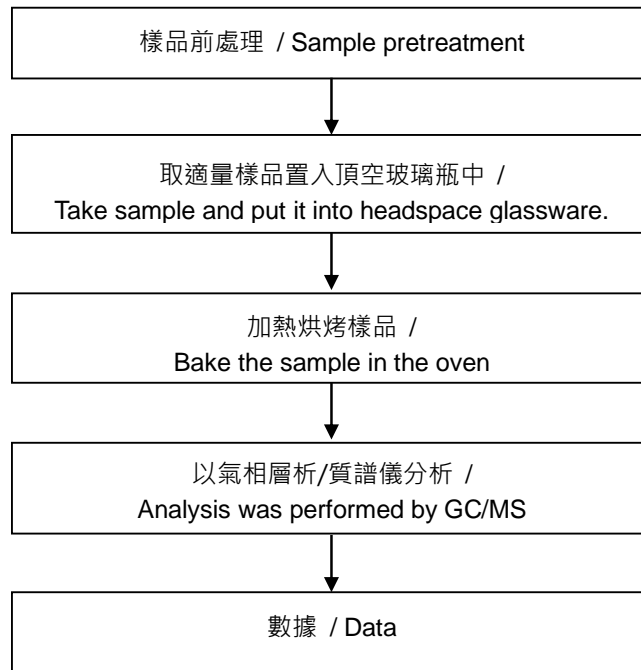

This document is issued by the Company subject to its General Conditions of Service printed overleaf, available on request or accessible at <https://www.sgs.com.tw/terms-of-service> and, for electronic format documents, subject to Terms and Conditions for Electronic Documents at <https://www.sgs.com.tw/terms-of-service>. Attention is drawn to the limitation of liability, indemnification and jurisdiction issues defined therein. Any holder of this document is advised that information contained hereon reflects the Company's findings at the time of its intervention only and within the limits of client's instruction, if any. The Company's sole responsibility is to its Client and this document does not exonerate parties to a transaction from exercising all their rights and obligations under the transaction documents. This document cannot be reproduced, except in full, without prior written approval of the Company. Any unauthorized alteration, forgery or falsification of the content or appearance of this document is unlawful and offenders may be prosecuted to the fullest extent of the law. Unless otherwise stated the results shown in this test report refer only to the sample(s) tested.

台虹科技股份有限公司 (TAIFLEX SCIENTIFIC CO., LTD.)

高雄市前鎮區環區三路1號 (NO. 1, HUANQU 3RD RD., QIANZHEN DIST., KAOHSIUNG CITY, TAIWAN)

聚氯乙烯物質判定分析流程圖 / Analysis flow chart - PVC

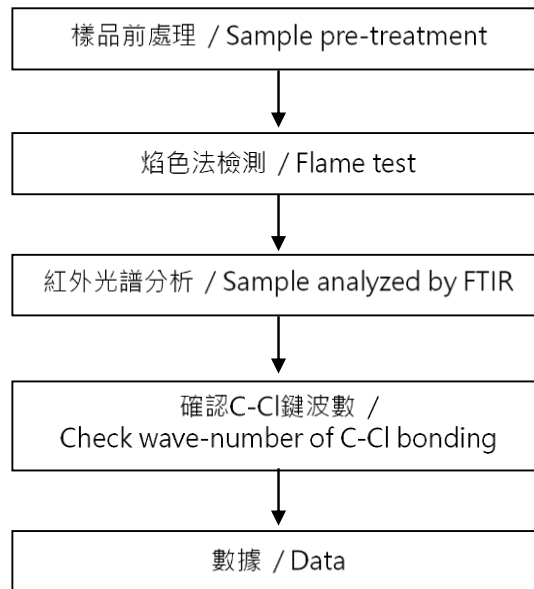

This document is issued by the Company subject to its General Conditions of Service printed overleaf, available on request or accessible at <https://www.sgs.com.tw/terms-of-service> and, for electronic format documents, subject to Terms and Conditions for Electronic Documents at <https://www.sgs.com.tw/terms-of-service>. Attention is drawn to the limitation of liability, indemnification and jurisdiction issues defined therein. Any holder of this document is advised that information contained hereon reflects the Company's findings at the time of its intervention only and within the limits of client's instruction, if any. The Company's sole responsibility is to its Client and this document does not exonerate parties to a transaction from exercising all their rights and obligations under the transaction documents. This document cannot be reproduced, except in full, without prior written approval of the Company. Any unauthorized alteration, forgery or falsification of the content or appearance of this document is unlawful and offenders may be prosecuted to the fullest extent of the law. Unless otherwise stated the results shown in this test report refer only to the sample(s) tested.

測試報告

Test Report

號碼(No.): EKR22200427

日期(Date): 18-Feb-2022

頁數(Page): 43 of 43

台虹科技股份有限公司 (TAIFLEX SCIENTIFIC CO., LTD.)

高雄市前鎮區環區三路1號 (NO. 1, HUANQU 3RD RD., QIANZHEN DIST., KAOHSIUNG CITY, TAIWAN)

* 照片中如有箭頭標示，則表示為實際檢測之樣品/部位。*

(The tested sample / part is marked by an arrow if it's shown on the photo.)

EKR22200427



** 報告結尾 (End of Report) **

This document is issued by the Company subject to its General Conditions of Service printed overleaf, available on request or accessible at <https://www.sgs.com.tw/terms-of-service> and, for electronic format documents, subject to Terms and Conditions for Electronic Documents at <https://www.sgs.com.tw/terms-of-service>. Attention is drawn to the limitation of liability, indemnification and jurisdiction issues defined therein. Any holder of this document is advised that information contained hereon reflects the Company's findings at the time of its intervention only and within the limits of client's instruction, if any. The Company's sole responsibility is to its Client and this document does not exonerate parties to a transaction from exercising all their rights and obligations under the transaction documents. This document cannot be reproduced, except in full, without prior written approval of the Company. Any unauthorized alteration, forgery or falsification of the content or appearance of this document is unlawful and offenders may be prosecuted to the fullest extent of the law. Unless otherwise stated the results shown in this test report refer only to the sample(s) tested.



Version: Jan 12, 2022

REGULATORY DATASHEET DECLARATION (RDS)
(For the SABIC SHPP Business Unit)

外來文件

QA-1312-03

Dear Most Valued Customer

Thank you for using SABIC products.

SABIC has manufacturing facilities in about 60 locations across 35 countries in the world. We manufacture and/or sell,

- (i) LEXAN™, CYCOLOY™, VALOX™, XENOY™, NORYL™, NORYL GTX™, NORYL PPX™, ULTEM™, SILTEM™, EXTEM™ resins or compounds, and
- (ii) COLORCOMP™, FARADDEX™, KONDUIT™, LUBRICOMP™, LUBRILOY™, STAT-KON™, STAT-LOY™, THERMOCOMP™, THERMOTUF™, VERTON™, ELCRES™, ELCRIN™ resins or compounds.

All existing grade-colour combinations of the above mentioned Resins/Compounds belonging to the SABIC SHPP Business Unit, except products which are designed to consume Post Consumer Recycle (PCR), are referred to in this document as 'SABIC Product(s)' here after.

This Regulatory Datasheet (RDS) covers the following content in this order:

- RoHS/ELV
- Packaging Directive
- Phthalate Directive
- ODS and Greenhouse Gas substances
- REACH-SVHC and REACH Annex XIV
- VOC
- Natural Rubber and Natural Rubber Latex
- TSE/BSE/GMO
- PFOA, its salts and related compounds; PFCAs, its salts and related compounds
- PAH/PAK
- POPs
- Conflict Minerals
- TSCA Section 6(h) PBT Chemicals, and Certain other Restricted Substances

Status of SABIC Product(s) with respect to RoHS/ELV

The SABIC Products do not contain restricted substances mentioned below as intentionally added components or as expected process impurities [above the threshold limit of 0.1% w/w (each) except Cadmium, which has a threshold limit of 0.01% w/w], which refers to Directive 2011/65/EU, 2015/863/EU, 2017/2102/EU and amendments for Restriction of Hazardous Substances (RoHS), and Directive 2000/53/EC, 2016/774/EC and their amendments for End-of-Life Vehicles (ELV),

DISCLAIMER: THE MATERIALS, PRODUCTS AND SERVICES OF SAUDI BASIC INDUSTRIES CORPORATION (SABIC) OR ITS SUBSIDIARIES OR AFFILIATES ("SELLER") ARE SOLD SUBJECT TO SELLER'S STANDARD CONDITIONS OF SALE, WHICH ARE AVAILABLE UPON REQUEST. INFORMATION AND RECOMMENDATIONS CONTAINED IN THIS DOCUMENT ARE GIVEN IN GOOD FAITH. HOWEVER, SELLER MAKES NO EXPRESS OR IMPLIED REPRESENTATION, WARRANTY OR GUARANTEE (i) THAT ANY RESULTS DESCRIBED IN THIS DOCUMENT WILL BE OBTAINED UNDER END-USE CONDITIONS, OR (ii) AS TO THE EFFECTIVENESS OR SAFETY OF ANY DESIGN OR APPLICATION INCORPORATING SELLER'S MATERIALS, PRODUCTS, SERVICES OR RECOMMENDATIONS. UNLESS OTHERWISE PROVIDED IN SELLER'S STANDARD CONDITIONS OF SALE, SELLER SHALL NOT BE RESPONSIBLE FOR ANY LOSS RESULTING FROM ANY USE OF ITS MATERIALS, PRODUCTS, SERVICES OR RECOMMENDATIONS DESCRIBED IN THIS DOCUMENT. Each user is responsible for making its own determination as to the suitability of Seller's materials, products, services or recommendations for the user's particular use through appropriate end-use and other testing and analysis. Nothing in any document or oral statement shall be deemed to alter or waive any provision of Seller's Standard Conditions of Sale or this Disclaimer, unless it is specifically agreed to in a writing signed by Seller. Statements by Seller concerning a possible use of any material, product, service or design do not, are not intended to, and should not be construed to grant any license under any patent or other intellectual property right of Seller or as a recommendation for the use of any material, product, service or design in a manner that infringes any patent or other intellectual property right.

SABIC and brands marked with ™ are trademarks of SABIC or its subsidiaries or affiliates, unless otherwise noted.

Version: Jan 12, 2022

- Lead and its compounds
- Mercury and its compounds
- Hexavalent Chromium compounds
- Cadmium and its compounds
- Polybrominated biphenyls (PBBs)
- Polybrominated diphenyl ethers (PBDEs)
- Bis(2-ethylhexyl) phthalate (DEHP)
- Butyl benzyl phthalate (BBP)
- Dibutyl phthalate (DBP)
- Diisobutyl phthalate (DIBP)

外來文件

QA-1312-03

Status of SABIC Product(s) with respect to Packaging Directive

The SABIC Product's packaging does not contain restricted substances mentioned below as intentionally added components [above 0.01% w/w (sum of concentration levels, if applicable)], which refers to Packaging Directive 94/62/EC as amended by 2004/12/EC:

- Lead and its compounds
- Mercury and its compounds
- Hexavalent Chromium compounds
- Cadmium and its compounds

Status of our product(s) with respect to Phthalate Directive

The SABIC Products do not contain restricted substances mentioned below as intentionally added components or as expected process impurities [above 0.1% w/w (each) threshold limits], which refers to Phthalates Regulation (Ref: EU Directive 2005/84/EC, US EPA-Phthalates Action Plan 2012).

- Butyl benzyl phthalate (BBP, CAS# 85-68-7)
- Di-n-butyl phthalate (DBP, CAS# 84-74-2)
- Di(2-ethylhexyl)phthalate (DEHP, CAS# 117-81- 7)
- Di-isononyl phthalate (DINP, CAS# 28553-12-0)
- Di-isodecyl phthalate (DIDP, CAS# 26761-40-0)
- Di-n-octyl phthalate (DNOP, CAS# 117-84-0)
- Diisobutyl phthalate (DIBP, CAS# 84-69-5)
- Di-n-pentyl phthalate (DNPP, CAS# 131-18-0)
- Di-n-hexyl phthalate (DNHP, CAS# 84-75-3)

DISCLAIMER: THE MATERIALS, PRODUCTS AND SERVICES OF SAUDI BASIC INDUSTRIES CORPORATION (SABIC) OR ITS SUBSIDIARIES OR AFFILIATES ("SELLER") ARE SOLD SUBJECT TO SELLER'S STANDARD CONDITIONS OF SALE, WHICH ARE AVAILABLE UPON REQUEST. INFORMATION AND RECOMMENDATIONS CONTAINED IN THIS DOCUMENT ARE GIVEN IN GOOD FAITH. HOWEVER, SELLER MAKES NO EXPRESS OR IMPLIED REPRESENTATION, WARRANTY OR GUARANTEE (i) THAT ANY RESULTS DESCRIBED IN THIS DOCUMENT WILL BE OBTAINED UNDER END-USE CONDITIONS, OR (ii) AS TO THE EFFECTIVENESS OR SAFETY OF ANY DESIGN OR APPLICATION INCORPORATING SELLER'S MATERIALS, PRODUCTS, SERVICES OR RECOMMENDATIONS. UNLESS OTHERWISE PROVIDED IN SELLER'S STANDARD CONDITIONS OF SALE, SELLER SHALL NOT BE RESPONSIBLE FOR ANY LOSS RESULTING FROM ANY USE OF ITS MATERIALS, PRODUCTS, SERVICES OR RECOMMENDATIONS DESCRIBED IN THIS DOCUMENT. Each user is responsible for making its own determination as to the suitability of Seller's materials, products, services or recommendations for the user's particular use through appropriate end-use and other testing and analysis. Nothing in any document or oral statement shall be deemed to alter or waive any provision of Seller's Standard Conditions of Sale or this Disclaimer, unless it is specifically agreed to in a writing signed by Seller. Statements by Seller concerning a possible use of any material, product, service or design do not, are not intended to, and should not be construed to grant any license under any patent or other intellectual property right of Seller or as a recommendation for the use of any material, product, service or design in a manner that infringes any patent or other intellectual property right. SABIC and brands marked with TM are trademarks of SABIC or its subsidiaries or affiliates, unless otherwise noted.

Status of SABIC Product(s) with respect to ODS and Greenhouse Gas substances

The SABIC Products do not contain restricted substances mentioned below as intentionally added components [above 0.1% w/w (each) threshold limits, if applicable], which refers to Ozone layer-Depleting Substances (ODS) on Annex A, B, C, E and F to the MONTREAL PROTOCOL and listed as class I & II of US Clean Air Act, and EC Regulation 1005/2009 Annex I and Annex II.

- As defined by Annex A, B, C, E and F to the MONTREAL PROTOCOL at <https://ozone.unep.org/treaties/montreal-protocol/montreal-protocol-substances-deplete-ozone-layer>
- As listed as class I & II substances by the US Clean Air Act at <https://www.epa.gov/ozone-layer-protection/ozone-depleting-substances>
- As defined by Annex I and Annex II to Regulation (EC) No 1005/2009 at <https://eur-lex.europa.eu/legal-content/EN/ALL/?uri=CELEX:32009R1005> (published 16 Sept. 2009)

The SABIC Products do not contain restricted substances mentioned below as intentionally added components [above 0.1% w/w (each) threshold limits, if applicable], which refers to Fluorinated greenhouse gases on REGULATION (EU) No 517/2014.

- As defined by REGULATION (EU) No 517/2014, subject to Emission Limits/ Reporting (Annexes I,II) at <https://eur-lex.europa.eu/legal-content/en/TXT/?uri=CELEX%3A32014R0517> (issued on 16 April 2014)

Status of SABIC Product(s) with respect to REACH SVHC and REACH Annex XIV

The SABIC Products do not contain restricted substances mentioned below as intentionally added components [above 0.1%^{[a][b]} w/w (each) threshold limits, if applicable], which refers to Registration, Evaluation, Authorization and Restriction of Chemical (**REACH**) Substances of Very High Concern (**SVHC**) on Regulation EC 1907/2006).

- Registration, Evaluation, Authorization and Restriction of Chemical (REACH) Substances of Very High Concern (SVHC) Ref : Regulation EC 1907/2006), as defined at: <https://echa.europa.eu/candidate-list-table> (Number of substances on the Candidate List: 219 as of July 8th 2021)

[a] Except the following product grades: A30009, A3000TXB, DFL36EU, DL003EU, FXW710SK, MV006SU, MV008SU, MV00ASU, TX02828 which contain **UV-328**, CAS RN 25973-55-1, respectively at over 0.1~5.0% w/w. Products manufactured from one of those materials should be assessed and follow EU REACH SVHC obligation guideline for article notification.

Version: Jan 12, 2022

[b] Except Grade 982156, 982456, ADDBL200, ADDBL228, ADDBL240, ADDBL271, ADDBL275, ADDBL278, ADDBL338, ADDBL339, ADDBL343, ADDBL345, ADDBL365, DMX9455, ER007619, ER007621, ER008802, ER009783, ER009843, ER009950, ER010038, ER010155, ER010259, ER010319, ER010351, ER010352, ER010644, ER011083, EX08302, EXL9012, EXUM0389, UR1000B, UR1000LC, which contain **Potassium Perfluorobutane Sulfonate (KPFBS) (C₄F₉O₃SK)**, CAS RN **29420-49-3**, at over 0.1~5% w/w. Products manufactured from these material should be assessed and follow EU REACH SVHC obligation guideline for article notification.

For the grade/products listed in [a][b], the customer may contact the respective SABIC business representative to obtain an updated version of the GHS/CLP SDS, which will disclose any REACH SVHC listed substances in section 3 or section 15 if it contains over 0.1% w/w within the product formulation.

SABIC Products do not contain substances mentioned below as intentionally added components or potential process impurities [above 0.1% w/w (each) threshold limit, if applicable], which refers to **Annex XIV** of EU **REACH**, amended through Regulation No 2020/171 of 06 February 2020.

- Substances listed in Annex XIV of REACH ("Authorization List"), as defined at <https://echa.europa.eu/authorisation-list> (54 substance/substance groups) on the date of this letter.

外來文件

QA-1312-03

Status of SABIC Product(s) with respect to REACH Registration

Please note carefully that this declaration ONLY applies to customers that have purchased a product from SHPP B.V. SABIC customers that ship SABIC products into the European Union (EU) as importer of record are themselves responsible for any obligations under REACH. SABIC will not act as or appoint an Only Representative.

REACH Regulation EC 1907/2006 is the European legislation aimed to regulate the **Registration, Evaluation, Authorization and Restriction of Chemical Substances**. Under REACH chemical substances produced in the EU or imported into the EU at a volume >1000 kg per year need to be registered with ECHA, the European Chemicals Agency. The purpose of this Regulation is to ensure a high level of protection of human health and the environment, including the promotion of alternative methods for assessment of hazards of substances, as well as the free circulation of substances on the internal market while enhancing competitiveness and innovation.

The SABIC REACH program is designed to support continued availability of finished goods (polymer preparations) for SABIC customers in Europe.

- (i) Main focus of our REACH program is on the registration of substances, such as intermediates and monomers, for the manufacture of resins and compounded polymer mixtures, of which SABIC is the producer or the importer of record.

DISCLAIMER: THE MATERIALS, PRODUCTS AND SERVICES OF SAUDI BASIC INDUSTRIES CORPORATION (SABIC) OR ITS SUBSIDIARIES OR AFFILIATES ("SELLER") ARE SOLD SUBJECT TO SELLER'S STANDARD CONDITIONS OF SALE, WHICH ARE AVAILABLE UPON REQUEST. INFORMATION AND RECOMMENDATIONS CONTAINED IN THIS DOCUMENT ARE GIVEN IN GOOD FAITH. HOWEVER, SELLER MAKES NO EXPRESS OR IMPLIED REPRESENTATION, WARRANTY OR GUARANTEE (i) THAT ANY RESULTS DESCRIBED IN THIS DOCUMENT WILL BE OBTAINED UNDER END-USE CONDITIONS, OR (ii) AS TO THE EFFECTIVENESS OR SAFETY OF ANY DESIGN OR APPLICATION INCORPORATING SELLER'S MATERIALS, PRODUCTS, SERVICES OR RECOMMENDATIONS. UNLESS OTHERWISE PROVIDED IN SELLER'S STANDARD CONDITIONS OF SALE, SELLER SHALL NOT BE RESPONSIBLE FOR ANY LOSS RESULTING FROM ANY USE OF ITS MATERIALS, PRODUCTS, SERVICES OR RECOMMENDATIONS DESCRIBED IN THIS DOCUMENT. Each user is responsible for making its own determination as to the suitability of Seller's materials, products, services or recommendations for the user's particular use through appropriate end-use and other testing and analysis. Nothing in any document or oral statement shall be deemed to alter or waive any provision of Seller's Standard Conditions of Sale or this Disclaimer, unless it is specifically agreed to in a writing signed by Seller. Statements by Seller concerning a possible use of any material, product, service or design do not, are not intended to, and should not be construed to grant any license under any patent or other intellectual property right of Seller or as a recommendation for the use of any material, product, service or design in a manner that infringes any patent or other intellectual property right. SABIC and brands marked with TM are trademarks of SABIC or its subsidiaries or affiliates, unless otherwise noted.

- (ii) SABIC is pleased to inform you that SABIC has successfully completed the registration of those substances for which SABIC had a registration deadline of November 30, 2010, May 31, 2013, and May 31, 2018. For selected substances SABIC took the initiative to act as Lead Registrant.
- (iii) SABIC will continue to work closely with external REACH experts to ensure registration dossier accuracy and completeness. These resources will not only facilitate timely dossier availability and submission but will also provide additional REACH legislative expertise.
- (iv) SABIC will extend its global vendor collaboration program to make certain that also for sourced substances timely REACH compliance is ensured so that SABIC as a downstream user in future will have continued access to compliant sourced raw materials.
- (v) SABIC committed to the CEFIC REACH Action Plan for Review/Improvement of Registration Dossiers. The Action plan will encourage and support companies in evaluating existing registration dossiers and implement follow up actions, while keeping close contact with ECHA and its strategy.
- (vi) Unfortunately SABIC is not in a position to communicate registration program details at a substance level since this potentially could imply revealing business confidential details of SABIC material technology.
- (vii) Should a SABIC customer ship a SABIC product into the EU as importer of record, the customer will have to fulfil its own REACH obligations. SABIC will not act as nor will it appoint an Only Representative.
- (viii) SABIC has meanwhile completed a CLP (Classification, Labelling and Packaging, Regulation EC 1272/2008) notification to ECHA for those substances from its raw material portfolio to date impacted by the CLP regulation.

外來文件

QA-1312-03

While SABIC will continue to update its customers regarding implementation of our REACH program throughout future registration phases, our customers remain responsible for complying with their own REACH obligations.

Additional information and guidance regarding your potential obligations under REACH is available at <http://echa.europa.eu/>.

In summary, SABIC considers itself in compliance with both the REACH Regulation EC 1907/2006 as well as the CLP Regulation EC 1272/2008. This will enable continued availability of compliant SABIC products for its customers.

Status of SABIC Product(s) with respect to VOC

The SABIC Products may contain volatile organic compounds (VOC) < 3% w/w and the SABIC Products may be called "VOC-duty free" with reference to the definition given in the Swiss VOC Verordnung (issued on November 12, 1997 and effective from January 1, 1998).



Version: Jan 12, 2022

Status of SABIC Product(s) with respect to Natural Rubber and Natural Rubber Latex

Neither the SABIC Products nor the process equipment coming in direct contact with them during manufacturing contain Natural Rubber Latex (NRL) or Natural rubber (ref: Latex-MEDDEV. 2.5/9 rev.1) as intentionally added components or as expected process impurities [above the threshold limits of 0.1% w/w].

外來文件

Status of SABIC Product(s) with respect to TSE/BSE/GMO

QA-1312-03

The SABIC Products are mainly of petrochemical origin. Some of our above products contain additives, or their raw material based on materials of animal (ovine or bovine tissue) origin. These additives or their raw materials extracted from ovine or bovine origin (fatty acids, fatty alcohols, metallic soaps, fatty amines, fatty amides, fatty acid esters, glycerin etc) are normally incorporated into plastics as lubricants, slip agents, anti-static agents, emulsifiers, anti-oxidants or corrosion inhibitors as an important component to achieve certain functional properties required for the end use.

As informed by our suppliers, during manufacturing process of these additives the ovine or bovine originated material is exposed to high temperatures and undergoes rigorous chemical reactions exceeding the stringent requirements mentioned in the "Opinion of the Scientific Steering Committee of Feb. 19-20, 1998" or "Note for Guidance on Minimizing the Risk of Transmitting Animal Spongiform Encephalopathy Agents via Medicinal Products" of March 25 1999 (CPMP/BWP/1230/98) respectively and in the document WHO/CDS/VPH/95.145. These conditions are considered to be sufficient to inactivate Genetically Modified Organisms (GMO) &/or Transmissible Spongiform Encephalopathies (TSE) &/or Bovine Spongiform Encephalopathy (BSE) transmitters.

Further, during the manufacturing process of these resins, compounds and sheets at SABIC, the ovine or bovine material is further exposed to high temperature/pressure, which is considered (the fact of being exposed) to be sufficient to inactivate any active prions present.

In view of the repeated chemical/heat/pressure treatments that the additives undergo in the various successive process steps of manufacturing of the SABIC Products, it is considered that the SABIC Products do not pose any threat in the context of GMO and/or TSE/BSE. Furthermore, we believe that SABIC Products do not pose any risk of transmitting animal spongiform encephalopathy agents via human and veterinary medicinal products (per the Note on Guidance EMA/410/01 rev.3) (2011/C 73/01).

Version: Jan 12, 2022

外來文件

QA-1312-03

Status of SABIC Product(s) with respect to Commission Regulation (EU) 2020/784 amending Annex I to Regulation (EU) 2019/1021 as regards the listing of perfluorooctanoic acid (PFOA), its salts and PFOA-related compounds, and COMMISSION REGULATION (EU) 2021/1297 of 4 August 2021 amending Annex XVII to Regulation (EC) No 1907/2006 of the European Parliament and of the Council as regards perfluorocarboxylic acids containing 9 to 14 carbon atoms in the chain (C₉-C₁₄ PFCAs), their salts and C₉-C₁₄ PFOA-related substances

On Commission Regulation (EU) 2020/784 amending Annex I to Regulation (EU) 2019/1021 regarding the listing of perfluorooctanoic acid (PFOA), its salts and PFOA-related compounds (EU POP Regulation for PFOA), effective July 4, 2020, SABIC provides the following information:

The SABIC Products do not contain perfluorooctanoic acid (PFOA), PFOA salts, or PFOA-related substances as intentionally added components.

To the extent the SABIC Products may contain any PFOA, PFOA salts, or PFOA-related compounds as impurities ^[a] ^[b], such substances are present at (i) less than 0,025 mg/kg (0,0000025 % w/w) of PFOA and PFOA salts, and (ii) less than 1 mg/kg (0,0001 % w/w) of any individual PFOA-related compound or a combination of PFOA-related compounds.

[a] Except following products, produced from SABIC America region or EU region: DCP32-NAT, DFL34-NC, DL003-BK8250, DL003-WH974306, DP003-BK8115, EX00548C-NC, LCL33E-BK8229, LCL33E-BKNAT, OFL36A-BRNAT, OFL36-BRNAT, RFL13-NAT, RL004S-NAT, YL003C-NA8D027, DFL16EH-8H9B1016, DFL16EH-GN4D149, DX94375H-BK8065, EFL34HL-NA6D007, ER009540-WH9D490, GFL36L-NC, IFL36XXJ-8H3D170, KP004AH-GY9D177, MFL36S-NA9E040, MFL36S-NC, WX12001J-2H5D322F, WX12001J-3H7D090F, WX12001J-4H8D034F, WX12001J-6H8D046F, WX12001J-7G1A1213F, WX12001J-7H5D518F, WX12001J-7H7D521, WX12001J-7H8D513F, WX12001J-NA9G018F, WX12001J-RD8G002, WX95752L-GYLTNAT, DFL34-BK8115, DL002-GY03602, DL003-BK8250, ER007917-NC, ER008847-BKNAT, NL001-GY1D448, NL001-WH970114, RFL36-BK8115, RFL36-NAT, RFL36S-BK1A842, RFL36S-NAT, UFL36AS-BK8115, UFL36AS-NAT, NL001-BK76701, NL001-YWLTNAT, 9X06030-NC, 9X06084-NC, FL1650_BKD-1000, KL201-BK1B528, KL201-BL7A213, KL201-GYLTNAT, LX97024-NA3E004, OFL36A-BK1B639. These specific Products do contain polytetrafluoroethylene (PTFE) micro-powders produced by ionising irradiation of up to 400 kilograys or by thermal degradation. Accordingly, these Products may be considered for use in production of articles or mixtures in accordance with EU POP Regulation for PFOA, amendment to Annex I, Part A, Specific Exemption 4, provided the other requirements of that exemption are met, which means, any PFOA, PFOA salts, or PFOA-related compounds as an impurity, such substances are present at (i) less than 1mg/kg(0,0001 %by weight) of PFOA and PFOA salts, and (ii) less than 1 mg/kg (0,0001 %by weight) of any individual PFOA-related compound or a combination of PFOA-related compounds. However considering Japanese POP Regulation for PFOA has no any exemption rules, SABIC does not suggest downstream customers to use those mentioned products for Japanese market.

[b] Except following products, produced from SABIC America region: MFL36S-BK1A588, DFL369XF-BK1A662, JX91198-BKNAT, LX91475-BKNAT, OFL36-BK1A937. Those products do contain polytetrafluoroethylene (PTFE) component, there are uncertainty on PFOA impurity level in these products. SABIC does not suggest any downstream customers to use those few products for EU and Japanese market.

On COMMISSION REGULATION (EU) 2021/1297 of 4 August 2021 amending Annex XVII to Regulation (EC) No 1907/2006 of the European Parliament and of the Council as regards perfluorocarboxylic acids containing 9 to 14 carbon atoms in the chain (C₉-C₁₄ PFCAs), their salts and C₉-C₁₄ PFOA-related substances, SABIC can provide the following information: :

DISCLAIMER: THE MATERIALS, PRODUCTS AND SERVICES OF SAUDI BASIC INDUSTRIES CORPORATION (SABIC) OR ITS SUBSIDIARIES OR AFFILIATES ("SELLER") ARE SOLD SUBJECT TO SELLER'S STANDARD CONDITIONS OF SALE, WHICH ARE AVAILABLE UPON REQUEST. INFORMATION AND RECOMMENDATIONS CONTAINED IN THIS DOCUMENT ARE GIVEN IN GOOD FAITH. HOWEVER, SELLER MAKES NO EXPRESS OR IMPLIED REPRESENTATION, WARRANTY OR GUARANTEE (i) THAT ANY RESULTS DESCRIBED IN THIS DOCUMENT WILL BE OBTAINED UNDER END-USE CONDITIONS, OR (ii) AS TO THE EFFECTIVENESS OR SAFETY OF ANY DESIGN OR APPLICATION INCORPORATING SELLER'S MATERIALS, PRODUCTS, SERVICES OR RECOMMENDATIONS. UNLESS OTHERWISE PROVIDED IN SELLER'S STANDARD CONDITIONS OF SALE, SELLER SHALL NOT BE RESPONSIBLE FOR ANY LOSS RESULTING FROM ANY USE OF ITS MATERIALS, PRODUCTS, SERVICES OR RECOMMENDATIONS DESCRIBED IN THIS DOCUMENT. Each user is responsible for making its own determination as to the suitability of Seller's materials, products, services or recommendations for the user's particular use through appropriate end-use and other testing and analysis. Nothing in any document or oral statement shall be deemed to alter or waive any provision of Seller's Standard Conditions of Sale or this Disclaimer, unless it is specifically agreed to in a writing signed by Seller. Statements by Seller concerning a possible use of any material, product, service or design do not, are not intended to, and should not be construed to grant any license under any patent or other intellectual property right of Seller or as a recommendation for the use of any material, product, service or design in a manner that infringes any patent or other intellectual property right.

SABIC and brands marked with TM are trademarks of SABIC or its subsidiaries or affiliates, unless otherwise noted.

Based on SABIC current product's formulation, the SABIC Products do not contain perfluorocarboxylic acids containing 9 to 14 carbon atoms in the chain (C₉-C₁₄ PFCAs) and their salts and C₉-C₁₄ PFCA -related substances as intentionally added components. Here PFCAs defined scope includes: (i) Linear and branched perfluorocarboxylic acids of the formula C_nF_{2n+1}-C(=O)OH where n = 8, 9, 10, 11, 12, or 13 (C₉-C₁₄ PFCAs), including their salts, and any combinations thereof, (ii) Any C₉-C₁₄ PFCA -related substance having a perfluoro group with the formula C_nF_{2n+1}- directly attached to another carbon atom, where n = 8, 9, 10, 11, 12, or 13, including their salts and any combinations thereof, (iii) Any C₉-C₁₄ PFCA -related substance having a perfluoro group with the formula C_nF_{2n+1}- that it is not directly attached to another carbon atom, where n = 9, 10, 11, 12, 13 or 14 as one of the structural elements, including their salts and any combinations thereof.

To the extent the SABIC Products may contain any chain (C₉-C₁₄ PFCAs) and their salts and C₉-C₁₄ PFCA-related substances as impurities, such substances are present at (i) less than 25ppb (0,000025 %by weight) for the sum of C₉-C₁₄ PFCAs and their salts, and (ii) less than 260 ppb (0,000026 %by weight) for the sum of C₉-C₁₄ PFCA-related substances.

外來文件

QA-1312-03

Status of SABIC Product(s) with respect to PAH/PAK

The SABIC Products do not contain restricted Polycyclic Aromatic Hydrocarbons (PAHs) mentioned below as intentionally added components [above 0.1% w/w (each) threshold limits, if applicable], which refers to Entry 50 of Annex XVII to Regulation EC 1907/2006 and AfPS GS 2019:01 PAK related Restriction of PAHs Hazardous Substances requirements.

- Anthracene (CAS# 120-12-7)
- Benzo(a)anthracene (CAS# 56-55-3)
- Benzo(a)pyrene (CAS# 50-32-8)
- Benzo(e)pyrene (CAS# 192-97-2)
- Benzo(b)fluoranthene (CAS# 205-99-2)
- Benzo(g,h,i)perylene (CAS# 191-24-2)
- Benzo(j)fluoranthene (CAS# 205-82-3)
- Benzo(k)fluoranthene (CAS# 207-08-9)
- Chrysene (CAS# 218-01-9)
- Dibenzo(a,h)anthracene (CAS# 53-70-3)
- Fluoranthene (CAS# 206-44-0)
- Indeno(1,2,3-c,d)pyrene (CAS# 193-39-5)
- Naphthalene (CAS# 91-20-3)
- Phenanthrene (CAS# 85-01-8)
- Pyrene (CAS# 129-00-0)

Status of SABIC Product(s) with respect to POPs

The SABIC Products do not contain restricted substances mentioned below as intentionally added components or as expected process impurities [above corresponding threshold limits mentioned below, if applicable], which refers to those substances listed on Annex A, B and C of the Stockholm Convention on Persistent Organic Pollutants (POPs) and Annex I, II and III to REGULATION (EU) 2019/1021 and its amendments,

- DDT (1,1,1-trichloro-2,2-bis(4-chlorophenyl)ethane) (CAS# 50-29-3, 8017-34-3, 50 mg/kg)
- Chlordane (CAS# 57-74-9, 50mg/kg)
- Dieldrin (CAS# 60-57-1, 50mg/kg)
- Endrin (CAS# 72-20-8, 50mg/kg)
- Heptachlor (CAS# 76-44-8, 50mg/kg)
- Hexachlorobutadiene (CAS# 87-68-3, 100mg/kg)
- Technical endosulfan, and its related isomers (CAS# 115-29-7, 959-98-8, 33213-65-9, 1031-07-8, 50mg/kg)
- Hexachlorobenzene (HCB) (CAS# 118-74-1, 50mg/kg)
- Chlordecone (CAS# 143-50-0, 50mg/kg)
- Polychlorinated biphenyls (PCB) (CAS# 1336-36-3, 50mg/kg)
- Perfluorooctane sulfonic acid (PFOS), its derivatives (C₈F₁₇SO₂X) (CAS# 1763-23-1, 2795-39-3, 29457-72-5, 29081-56-9, 70225-14-8, 56773-42-3, 251099-16-8, 4151-50-2, 31506-32-8, 1691-99-2, 24448-09-7, 307-35-7, total 10mg/kg)
- Aldrin (CAS# 309-00-2, 50mg/kg)
- Hexachlorocyclohexanes, including lindane (CAS# 58-89-9, 319-84-6, 319-85-7, 608-73-1, 50mg/kg)
- Pentachlorobenzene (PECB) (CAS# 608-93-5, 50mg/kg)
- Polychlorinated naphthalenes (1 or more chlorine atoms) (CAS# 28699-88-9, 1321-65-9, 1335-88-2, 1321-64-8, 32241-08-0, 1335-87-1, 2234-13-1, 70776-03-3, 90-13-1, 91-58-7, 10mg/kg)
- Mirex (Perchlordecone); Dodecachlorooctahydro-1,3,4-metheno-2H-cycrobuta(cd)pentalene (CAS# 2385-85-5, 50mg/kg)
- Polybromodiphenyl ethers (Br=4-7) (PBDEs) (CAS# 40088-47-9, 32534-81-9, 36483-60-0, 68928-80-3, Total 500mg/kg)
- Toxaphene (CAS# 8001-35-2, 50mg/kg)
- Hexabromobiphenyl (CAS# 36355-01-8, 50 mg/kg)
- Polychlorinated dibenzofurans (PCDF) (15 ug/kg)
- Polychlorinated dibenzo-p-dioxins (PCDD) (15 ug/kg)
- Hexabromocyclododecane (HBCDD) (CAS# 3194-55-6, 25637-99-4, 134237-50-6, 134237-51-7, 134237-52-8, 100mg/kg)
- Short-chained chlorinated paraffins-C10-13 (SCCP) (CAS# 85535-84-8, 0.1% w/w)
- Decabromodiphenyl ether (decaBDE) (CAS# 1163-19-5, 10mg/kg)
- Pentachlorophenol (CAS# 87-86-5, 5 mg/kg)
- Pentachloroanisole (CAS# 1825-21-4, 0.1% w/w)
- Sodium pentachlorophenate (CAS# 131-52-2, 0.1 % w/w)
- Pentachlorophenyl laurate (CAS# 3772-94-9, 0.1 % w/w)
- Sodium pentachlorophenate monohydrate (CAS# 27735-64-4, 0.1% w/w)

外來文件
QA-1312-03

DISCLAIMER: THE MATERIALS, PRODUCTS AND SERVICES OF SAUDI BASIC INDUSTRIES CORPORATION (SABIC) OR ITS SUBSIDIARIES OR AFFILIATES ("SELLER") ARE SOLD SUBJECT TO SELLER'S STANDARD CONDITIONS OF SALE, WHICH ARE AVAILABLE UPON REQUEST. INFORMATION AND RECOMMENDATIONS CONTAINED IN THIS DOCUMENT ARE GIVEN IN GOOD FAITH. HOWEVER, SELLER MAKES NO EXPRESS OR IMPLIED REPRESENTATION, WARRANTY OR GUARANTEE (i) THAT ANY RESULTS DESCRIBED IN THIS DOCUMENT WILL BE OBTAINED UNDER END-USE CONDITIONS, OR (ii) AS TO THE EFFECTIVENESS OR SAFETY OF ANY DESIGN OR APPLICATION INCORPORATING SELLER'S MATERIALS, PRODUCTS, SERVICES OR RECOMMENDATIONS. UNLESS OTHERWISE PROVIDED IN SELLER'S STANDARD CONDITIONS OF SALE, SELLER SHALL NOT BE RESPONSIBLE FOR ANY LOSS RESULTING FROM ANY USE OF ITS MATERIALS, PRODUCTS, SERVICES OR RECOMMENDATIONS DESCRIBED IN THIS DOCUMENT. Each user is responsible for making its own determination as to the suitability of Seller's materials, products, services or recommendations for the user's particular use through appropriate end-use and other testing and analysis. Nothing in any document or oral statement shall be deemed to alter or waive any provision of Seller's Standard Conditions of Sale or this Disclaimer, unless it is specifically agreed to in a writing signed by Seller. Statements by Seller concerning a possible use of any material, product, service or design do not, are not intended to, and should not be construed to grant any license under any patent or other intellectual property right of Seller or as a recommendation for the use of any material, product, service or design in a manner that infringes any patent or other intellectual property right.

SABIC and brands marked with TM are trademarks of SABIC or its subsidiaries or affiliates, unless otherwise noted.

Version: Jan 12, 2022

外來文件

QA-1312-03

- Dicofof (CAS# 115-32-2, 0.1% w/w)

Status of SABIC Product(s) with respect to Title XV, Section 1502 “Conflict Minerals” of the Dodd-Frank Wall Street Reform and Consumer Protection Act

Title XV section 1502 “Conflict Minerals” of the Dodd-Frank Wall Street Reform and Consumer Protection Act requires U.S. and foreign publicly-traded companies to report to the Securities and Exchange Commission whether their products may contain certain metals (tungsten, tin, tantalum and gold) which are considered “conflict minerals” because they are mined in the Democratic Republic of the Congo (DRC) or adjoining countries. Companies subject to the law are required to file their annual reports by May 31, 2022.

The vast majority of the “SABIC Products” do not contain tungsten, tin, tantalum or gold.

If you are buying a “SABIC Products” other than those listed below ^[1], this letter certifies that the product(s) you are buying do not contain tungsten, tin, tantalum, or gold necessary to the functionality or production of the product.

Note ^[1] Requiring Further Conflict Minerals Certification from SABIC for below products

- LEXAN™ resin:
ER007636-1001,
FXG121R-1G9B3466G, FXG121R-BK1622MG, FXG121R-BL2546MG,
FXG121R-BL4F027G, FXG121R-BL7192MG, FXG121R-GY3C064G,
FXG121R-NA1070MG, FXG121R-NA9G225G, FXG121R-RD9D002G,
FXG121R-WH4508MG, FXG121R-WH8G886G, FXG123R-GY274308,
FXG1414T-1G9A6521G, FXG1414T-BL1G109G, FXG1414T-BL5E044G,
FXG1414T-BL6G093G, FXG1414T-BL7G075G, FXG1414T-BR1G141G,
FXG1414T-NA8F001G, FXG1414T-RD8G037G, FXG1414T-VT7G014G
- NORYL™ resins:
PX5511-BL5B142M, PX5511-GN8A082M, PX5511-GY7E126M,
PX6120-GN8A082M, PX6120L-GN8A082M, PX7511-RD7A001P
- THERMOCOMP™ compound:
AO30F-NAT, ER008968-5G5A8940X, ER008968-5G6A8941X,
ER008968-NC, ER009541-701, ER009989-WHNAT,
F5000UZ-WHNAT, OFC08V-GYNAT, OFC08V-NC,
PF004S-GY02885, RF007H-GY3D672M, WH0420A-GY5A749

Status of SABIC Product(s) with respect to TSCA Section 6(h) PBT Chemicals and certain restricted substances

The SABIC Products do not contain substances mentioned below as intentionally added components, which are required under the Toxic Substances Control Act (TSCA), as amended by the Frank R. Lautenberg Chemical Safety for the 21st Century Act (five final rules issued by EPA on January 6, 2021) (Persistent, Bio-accumulative, and Toxic (PBT) Chemicals under TSCA Section 6(h)).

- Phenol, isopropylated, phosphate (3:1) (CAS# 68937-41-7)
- DecaBDE (decabromodiphenyl ether (CAS# 1163-19-5)

DISCLAIMER: THE MATERIALS, PRODUCTS AND SERVICES OF SAUDI BASIC INDUSTRIES CORPORATION (SABIC) OR ITS SUBSIDIARIES OR AFFILIATES (“SELLER”) ARE SOLD SUBJECT TO SELLER’S STANDARD CONDITIONS OF SALE, WHICH ARE AVAILABLE UPON REQUEST. INFORMATION AND RECOMMENDATIONS CONTAINED IN THIS DOCUMENT ARE GIVEN IN GOOD FAITH. HOWEVER, SELLER MAKES NO EXPRESS OR IMPLIED REPRESENTATION, WARRANTY OR GUARANTEE (i) THAT ANY RESULTS DESCRIBED IN THIS DOCUMENT WILL BE OBTAINED UNDER END-USE CONDITIONS, OR (ii) AS TO THE EFFECTIVENESS OR SAFETY OF ANY DESIGN OR APPLICATION INCORPORATING SELLER’S MATERIALS, PRODUCTS, SERVICES OR RECOMMENDATIONS. UNLESS OTHERWISE PROVIDED IN SELLER’S STANDARD CONDITIONS OF SALE, SELLER SHALL NOT BE RESPONSIBLE FOR ANY LOSS RESULTING FROM ANY USE OF ITS MATERIALS, PRODUCTS, SERVICES OR RECOMMENDATIONS DESCRIBED IN THIS DOCUMENT. Each user is responsible for making its own determination as to the suitability of Seller’s materials, products, services or recommendations for the user’s particular use through appropriate end-use and other testing and analysis. Nothing in any document or oral statement shall be deemed to alter or waive any provision of Seller’s Standard Conditions of Sale or this Disclaimer, unless it is specifically agreed to in a writing signed by Seller. Statements by Seller concerning a possible use of any material, product, service or design do not, are not intended to, and should not be construed to grant any license under any patent or other intellectual property right of Seller or as a recommendation for the use of any material, product, service or design in a manner that infringes any patent or other intellectual property right. SABIC and brands marked with ™ are trademarks of SABIC or its subsidiaries or affiliates, unless otherwise noted.



Version: Jan 12, 2022

We are disclosing above information, to the best of our knowledge, based upon data from our raw material suppliers or manufacturers. Please note that analysis of the raw materials and/or SABIC Product/s for presence of the above-mentioned substances on a routine basis neither is a part of our quality control plan, nor is a part of the SABIC Product specifications, and hence it shall not be construed as any warranty, expressed or implied.

We recommend that users take appropriate precaution during storage, transportation and use of SABIC Products to avoid contamination and deterioration. Please refer to the SABIC Product's Safety Data Sheet (SDS) before use and consult SABIC representative, if there are further needs.

This declaration applies to the material as it leaves its production facilities. It does not cover any substance(s) or preparation(s) subsequently added and/or improper material processing or article fabrication further down the supply chain.

Please be informed that certain products are designed to consume Post Consumer Recycle (PCR) for environmental waste reduction. The details about use of the PCR, if any, are stated in the respective SDS. Please contact our Customer Service or Product Stewardship team representative to request information regarding the chemical compliance attributes of these PCR-containing products, which may differ from those referred to in this letter.

Do note that the information above is current as of the date of this letter. This declaration replaces all previous ones relating to this subject matter and is, unless revoked in writing, valid for a period of one year as of the date of issuance, after which it will automatically expire.

Should you have further questions about SABIC products, please contact your SABIC commercial representative, or customer services, or send an email to webinquiries@sabic-hpp.com (Europe or Middle East regions), or productinquiries@sabic-hpp.com (Americas regions), or Contactus.ShppAsia@sabic-hpp.com (Asia-Pacific region).

In the name of the manufacturer, for SABIC

外來文件

QA-1312-03

Gregory M. Porta, Ph.D.
Director, Global Product Stewardship & Toxicology

Saudi Basic Industries Corporation (SABIC)

www.SABIC.com

DISCLAIMER: THE MATERIALS, PRODUCTS AND SERVICES OF SAUDI BASIC INDUSTRIES CORPORATION (SABIC) OR ITS SUBSIDIARIES OR AFFILIATES ("SELLER") ARE SOLD SUBJECT TO SELLER'S STANDARD CONDITIONS OF SALE, WHICH ARE AVAILABLE UPON REQUEST. INFORMATION AND RECOMMENDATIONS CONTAINED IN THIS DOCUMENT ARE GIVEN IN GOOD FAITH. HOWEVER, SELLER MAKES NO EXPRESS OR IMPLIED REPRESENTATION, WARRANTY OR GUARANTEE (i) THAT ANY RESULTS DESCRIBED IN THIS DOCUMENT WILL BE OBTAINED UNDER END-USE CONDITIONS, OR (ii) AS TO THE EFFECTIVENESS OR SAFETY OF ANY DESIGN OR APPLICATION INCORPORATING SELLER'S MATERIALS, PRODUCTS, SERVICES OR RECOMMENDATIONS. UNLESS OTHERWISE PROVIDED IN SELLER'S STANDARD CONDITIONS OF SALE, SELLER SHALL NOT BE RESPONSIBLE FOR ANY LOSS RESULTING FROM ANY USE OF ITS MATERIALS, PRODUCTS, SERVICES OR RECOMMENDATIONS DESCRIBED IN THIS DOCUMENT. Each user is responsible for making its own determination as to the suitability of Seller's materials, products, services or recommendations for the user's particular use through appropriate end-use and other testing and analysis. Nothing in any document or oral statement shall be deemed to alter or waive any provision of Seller's Standard Conditions of Sale or this Disclaimer, unless it is specifically agreed to in a writing signed by Seller. Statements by Seller concerning a possible use of any material, product, service or design do not, are not intended to, and should not be construed to grant any license under any patent or other intellectual property right of Seller or as a recommendation for the use of any material, product, service or design in a manner that infringes any patent or other intellectual property right.

SABIC and brands marked with TM are trademarks of SABIC or its subsidiaries or affiliates, unless otherwise noted.