

## FCC Test Report

**Report No.:** RFBBQZ-WTW-P22030481-3

**FCC ID:** PY322200565

**Test Model:** A8000

**Received Date:** Mar. 14, 2022

**Test Date:** Jul. 13 ~ Jul. 30, 2022

**Issued Date:** Aug. 05, 2022

**Applicant and Manufacturer:** NETGEAR, INC.

**Address:** 350 East Plumeria Drive, San Jose, CA 95134, USA

**Issued By:** Bureau Veritas Consumer Products Services (H.K.) Ltd., Taoyuan Branch  
Lin Kou Laboratories

**Lab Address:** No. 47-2, 14th Ling, Chia Pau Vil., Lin Kou Dist., New Taipei City, Taiwan

**Test Location:** No. 19, Hwa Ya 2nd Rd., Wen Hwa Vil., Kwei Shan Dist., Taoyuan City  
33383, Taiwan

**FCC Registration /  
Designation Number:** 788550 / TW0003



This report is governed by, and incorporates by reference, the Conditions of Testing as posted at the date of issuance of this report at <http://www.bureauveritas.com/home/about-us/our-business/cps/about-us/terms-conditions/> and is intended for your exclusive use. Any copying or replication of this report to or for any other person or entity, or use of our name or trademark, is permitted only with our prior written permission. This report sets forth our findings solely with respect to the test samples identified herein. The results set forth in this report are not indicative or representative of the quality or characteristics of the lot from which a test sample was taken or any similar or identical product unless specifically and expressly noted. Our report includes all of the tests requested by you and the results thereof based upon the information that you provided to us. Measurement uncertainty is only provided upon request for accredited tests. Statements of conformity are based on simple acceptance criteria without taking measurement uncertainty into account, unless otherwise requested in writing. You have 60 days from date of issuance of this report to notify us of any material error or omission caused by our negligence or if you require measurement uncertainty; provided, however, that such notice shall be in writing and shall specifically address the issue you wish to raise. A failure to raise such issue within the prescribed time shall constitute your unqualified acceptance of the completeness of this report, the tests conducted and the correctness of the report contents.

## Table of Contents

<b>Release Control Record</b> .....	<b>4</b>
<b>1 Certificate of Conformity</b> .....	<b>5</b>
<b>2 Summary of Test Results</b> .....	<b>6</b>
2.1 Measurement Uncertainty.....	6
2.2 Modification Record.....	6
<b>3 General Information</b> .....	<b>7</b>
3.1 General Description of EUT.....	7
3.2 Description of Test Modes.....	9
3.2.1 Test Mode Applicability and Tested Channel Detail.....	11
3.3 Duty Cycle of Test Signal.....	15
3.4 Description of Support Units.....	17
3.4.1 Configuration of System under Test.....	17
3.5 General Description of Applied Standards and References.....	17
<b>4 Test Types and Results</b> .....	<b>18</b>
4.1 Radiated Emission and Bandedge Measurement.....	18
4.1.1 Limits of Radiated Emission and Bandedge Measurement.....	18
4.1.2 Test Instruments.....	19
4.1.3 Test Procedures.....	20
4.1.4 Deviation from Test Standard.....	21
4.1.5 Test Setup.....	21
4.1.6 EUT Operating Conditions.....	22
4.1.7 Test Results.....	23
4.2 In-Band Emission (Mask) Measurement.....	112
4.2.1 Limits of In-Band Emission (Mask) Measurement.....	112
4.2.2 Test Setup.....	112
4.2.3 Test Instruments.....	112
4.2.4 Test Procedure.....	113
4.2.5 EUT Operating Condition.....	113
4.2.6 Test Results.....	114
4.3 Conducted Emission Measurement.....	148
4.3.1 Limits of Conducted Emission Measurement.....	148
4.3.2 Test Instruments.....	148
4.3.3 Test Procedures.....	149
4.3.4 Deviation from Test Standard.....	149
4.3.5 Test Setup.....	149
4.3.6 EUT Operating Conditions.....	149
4.3.7 Test Results.....	150
4.4 Transmit Power Measurement.....	154
4.4.1 Limits of Transmit Power Measurement.....	154
4.4.2 Test Setup.....	154
4.4.3 Test Instruments.....	154
4.4.4 Test Procedure.....	155
4.4.5 Deviation from Test Standard.....	155
4.4.6 EUT Operating Conditions.....	155
4.4.7 Test Result.....	156
4.5 Emission Bandwidth Measurement.....	162
4.5.1 Test Setup.....	162
4.5.2 Test Instruments.....	162
4.5.3 Test Procedure.....	162
4.5.4 Test Result.....	163
4.6 Peak Power Spectral Density Measurement.....	187
4.6.1 Limits of Peak Power Spectral Density Measurement.....	187
4.6.2 Test Setup.....	187

4.6.3	Test Instruments .....	187
4.6.4	Test Procedures.....	188
4.6.5	Deviation from Test Standard .....	188
4.6.6	EUT Operating Conditions.....	188
4.6.7	Test Results .....	189
4.7	Contention Based Protocol Measurement .....	196
4.7.1	Limits of Contention Based Protocol Measurement .....	196
4.7.2	Test Setup.....	196
4.7.3	Test Instruments .....	196
4.7.4	Test Procedure .....	197
4.7.5	EUT Operating Condition .....	197
4.7.6	Test Results .....	198
4.8	Frequency Stability.....	210
4.8.1	Limits of Frequency Stability Measurement .....	210
4.8.2	Test Setup.....	210
4.8.3	Test Instruments .....	210
4.8.4	Test Procedure .....	210
4.8.5	Deviation from Test Standard .....	211
4.8.6	EUT Operating Condition .....	211
4.8.7	Test Results .....	211
4.9	Operational Restrictions for 6 GHz U-NII Devices .....	212
4.9.1	Limits of Operational Restrictions for 6 GHz U-NII Devices.....	212
4.9.2	Test Setup.....	212
4.9.3	Test Instruments .....	212
4.9.4	Test Procedure .....	212
4.9.5	Test Results .....	212
<b>5</b>	<b>Pictures of Test Arrangements.....</b>	<b>213</b>
	<b>Annex A - Band Edge Measurement.....</b>	<b>214</b>
	<b>Appendix – Information of the Testing Laboratories .....</b>	<b>221</b>

### Release Control Record

Issue No.	Description	Date Issued
RFBBQZ-WTW-P22030481-3	Original release.	Aug. 05, 2022

## 1 Certificate of Conformity

**Product:** AXE3000 USB3.0 Wireless Adapter

**Brand:** Netgear

**Test Model:** A8000

**Sample Status:** Engineering sample

**Applicant and Manufacturer:** NETGEAR, INC.

**Test Date:** Jul. 13 ~ Jul. 30, 2022

**Standards:** 47 CFR FCC Part 15, Subpart E (Section 15.407)  
ANSI C63.10:2013

The above equipment has been tested by **Bureau Veritas Consumer Products Services (H.K.) Ltd., Taoyuan Branch**, and found compliance with the requirement of the above standards. The test record, data evaluation & Equipment Under Test (EUT) configurations represented herein are true and accurate accounts of the measurements of the sample's RF characteristics under the conditions specified in this report.

**Prepared by :**  , **Date:** Aug. 05, 2022  
Polly Chien / Specialist

**Approved by :**  , **Date:** Aug. 05, 2022  
Jeremy Lin / Project Engineer

## 2 Summary of Test Results

47 CFR FCC Part 15, Subpart E (Section 15.407)			
FCC Clause	Test Item	Result	Remarks
15.407(b)(9)	AC Power Conducted Emissions	Pass	Meet the requirement of limit. Minimum passing margin is -16.44dB at 4.63000MHz.
15.407(b)(6)(9)	Radiated Emissions	Pass	Meet the requirement of limit. Minimum passing margin is -0.2dB at 7125.00MHz.
15.407(b)(7)	In-Band Emission (Mask)	Pass	Meet the requirement of limit.
15.407(a)(7)	Max Average Transmit Power	Pass	Meet the requirement of limit.
15.407(a)(10)	Emission Bandwidth Measurement	Pass	Meet the requirement of limit.
15.407(a)(5)	Peak Power Spectral Density	Pass	Meet the requirement of limit.
15.407 (d)(6)	Contention-based Protocol.	Pass	Meet the requirement of limit.
15.407(g)	Frequency Stability	Pass	Meet the requirement of limit.
15.407(a)(7)(8)	Dual Client- Proper Power Adjustment	N/A	Device associates with low power indoor AP only.
15.407(d)(5)	Operational restrictions for 6 GHz U-NII devices	Pass	Declaration by applicant
15.203	Antenna Requirement	Pass	Antenna connector is IPEX not a standard connector.

Note: Determining compliance based on the results of the compliance measurement, not taking into account measurement instrumentation uncertainty.

### 2.1 Measurement Uncertainty

Where relevant, the following measurement uncertainty levels have been estimated for tests performed on the EUT as specified in CISPR 16-4-2:

Measurement	Frequency	Expanded Uncertainty (k=2) (±)
Conducted Emissions at mains ports	150kHz ~ 30MHz	2.79 dB
Radiated Emissions up to 1 GHz	9kHz ~ 30MHz	3.04 dB
	30MHz ~ 200MHz	3.63 dB
	200MHz ~1000MHz	3.64 dB
Radiated Emissions above 1 GHz	1GHz ~ 18GHz	2.29 dB
	18GHz ~ 40GHz	2.29 dB

### 2.2 Modification Record

There were no modifications required for compliance.

### 3 General Information

#### 3.1 General Description of EUT

Product	AXE3000 USB3.0 Wireless Adapter
Brand	Netgear
Test Model	A8000
Sample Status	Engineering sample
Power Supply Rating	5Vdc from host equipment
Modulation Type	256QAM, 64QAM, 16QAM, QPSK, BPSK for OFDM 1024QAM, 256QAM, 64QAM, 16QAM, QPSK, BPSK for OFDMA
Modulation Technology	OFDM, OFDMA
Transfer Rate	802.11a: 54/48/36/24/18/12/9/6Mbps 802.11ax: up to 1201.0Mbps
Operating Frequency	5955 ~ 6415MHz, 6435 ~ 6525MHz, 6525 ~ 6875MHz, 6875 ~ 7115MHz
Number of Channel	802.11a/ax (HE20): 59 802.11ax (HE40): 29 802.11ax (HE80): 14
Output EIRP Power	<b>Nss 1</b> 5955 ~ 6415MHz: 15.76dBm / 37.670mW 6435 ~ 6525MHz: 15.69dBm / 37.068mW 6525 ~ 6875MHz: 15.75dBm / 37.584mW 6875 ~ 7115MHz: 15.72dBm / 37.325mW <b>Nss 2</b> 5955 ~ 6415MHz: 16.29dBm / 42.560mW 6435 ~ 6525MHz: 16.68dBm / 46.559mW 6525 ~ 6875MHz: 16.62dBm / 45.920mW 6875 ~ 7115MHz: 16.06dBm / 40.365mW
Antenna Type	Refer to note
Antenna Connector	Refer to note
Accessory Device	Refer to note
Cable Supplied	NA

**Note:**

1. The EUT incorporates a MIMO function. Physically, the EUT provides 2 completed transmitters and 2 receivers.

Modulation Mode	TX Function
802.11a	2TX (Nss 1)
802.11ax (HE20)	2TX (Nss 1 / Nss 2)
802.11ax (HE40)	2TX (Nss 1 / Nss 2)
802.11ax (HE80)	2TX (Nss 1 / Nss 2)

2. The EUT uses following accessories.

Dock		
Brand	Model	Specification
Nienyi	107-1059401	Line length : 0.83 m

3. The antenna information is listed as below.

ANT. No.	Type	Connector	Frequency Range	Gain (dBi)	
				Max.	Min.
6G_0	Dipole	IPEX	5955~6415MHz	2.40	2.20
			6435~6525MHz	2.70	2.70
			6525~6875MHz	2.60	2.00
			6875~7115MHz	1.70	1.70
6G_1	Dipole	IPEX	5955~6415MHz	2.50	2.30
			6435~6525MHz	2.00	2.00
			6525~6875MHz	2.70	2.50
			6875~7115MHz	1.90	1.90

\*Detail antenna specification please refer to antenna datasheet.

4. WLAN 2.4GHz, WLAN 5GHz & WLAN 6GHz technology cannot transmit at the same time.



### 3.2 Description of Test Modes

For 5925 ~ 6425MHz (U-NII-5 band)

24 channels are provided for 802.11a, 802.11ax (HE20):

Channel	Frequency	Channel	Frequency	Channel	Frequency	Channel	Frequency
1	5955 MHz	5	5975 MHz	9	5995 MHz	13	6015 MHz
17	6035 MHz	21	6055 MHz	25	6075 MHz	29	6095 MHz
33	6115 MHz	37	6135 MHz	41	6155 MHz	45	6175 MHz
49	6195 MHz	53	6215 MHz	57	6235 MHz	61	6255 MHz
65	6275 MHz	69	6295 MHz	73	6315 MHz	77	6335 MHz
81	6355 MHz	85	6375 MHz	89	6395 MHz	93	6415 MHz

12 channels are provided for 802.11ax (HE40):

Channel	Frequency	Channel	Frequency	Channel	Frequency	Channel	Frequency
3	5965 MHz	11	6005 MHz	19	6045 MHz	27	6085 MHz
35	6125 MHz	43	6165 MHz	51	6205 MHz	59	6245 MHz
67	6285 MHz	75	6325 MHz	83	6365 MHz	91	6405 MHz

6 channel is provided for 802.11ax (HE80):

Channel	Frequency	Channel	Frequency	Channel	Frequency	Channel	Frequency
7	5985 MHz	23	6065 MHz	39	6145 MHz	55	6225 MHz
71	6305 MHz	87	6385 MHz				

For 6425 ~ 6525MHz (U-NII-6 band)

5 channels are provided for 802.11a, 802.11ax (HE20):

Channel	Frequency	Channel	Frequency	Channel	Frequency	Channel	Frequency
97	6435 MHz	101	6455 MHz	105	6475 MHz	109	6495 MHz
113	6515 MHz						

3 channels are provided for 802.11ax (HE40):

Channel	Frequency	Channel	Frequency	Channel	Frequency
99	6445 MHz	107	6485 MHz	*115	6525 MHz

2 channel are provided for 802.11ax (HE80):

Channel	Frequency	Channel	Frequency
103	6465 MHz	*119	6545 MHz

For 6525 ~ 6875MHz (U-NII-7 band)

18 channels are provided for 802.11a, 802.11ax (HE20):

Channel	Frequency	Channel	Frequency	Channel	Frequency	Channel	Frequency
117	6535 MHz	121	6555 MHz	125	6575 MHz	129	6595 MHz
133	6615 MHz	137	6635 MHz	141	6655 MHz	145	6675 MHz
149	6695 MHz	153	6715 MHz	157	6735 MHz	161	6755 MHz
165	6775 MHz	169	6795 MHz	173	6815 MHz	177	6835 MHz
181	6855 MHz	*185	6875 MHz				

9 channels are provided for 802.11ax (HE40):

Channel	Frequency	Channel	Frequency	Channel	Frequency	Channel	Frequency
123	6565 MHz	131	6605 MHz	139	6645 MHz	147	6685 MHz
155	6725 MHz	163	6765 MHz	171	6805 MHz	179	6845 MHz
*187	6885 MHz						

4 channels are provided for 802.11ax (HE80):

Channel	Frequency	Channel	Frequency	Channel	Frequency	Channel	Frequency
135	6625 MHz	151	6705 MHz	167	6785 MHz	*183	6865 MHz

For 6875 ~ 7125MHz (U-NII-8 band):

12 channels are provided for 802.11a, 802.11ax (HE20):

Channel	Frequency	Channel	Frequency	Channel	Frequency	Channel	Frequency
189	6895 MHz	193	6915 MHz	197	6935 MHz	201	6955 MHz
205	6975 MHz	209	6995 MHz	213	7015 MHz	217	7035 MHz
221	7055 MHz	225	7075 MHz	229	7095 MHz	233	7115 MHz

5 channels are provided for 802.11ax (HE40):

Channel	Frequency	Channel	Frequency	Channel	Frequency
195	6925 MHz	203	6965 MHz	211	7005 MHz
219	7045 MHz	227	7085 MHz		

2 channel is provided for 802.11ax (HE80):

Channel	Frequency	Channel	Frequency
199	6945 MHz	215	7025 MHz

Note: \* mean this's straddle channel.

### 3.2.1 Test Mode Applicability and Tested Channel Detail

EUT Configure Mode	Applicable to						Description
	RE≥1G	RE<1G	IBE	PLC	CBP	APCM	
A	√	√	√	√	√	√	EUT with Dock
B	-	√	-	√	-	-	EUT with Notebook

Where **RE≥1G**: Radiated Emission above 1GHz  
**RE<1G**: Radiated Emission below 1GHz  
**PLC**: Power Line Conducted Emission  
**APCM**: Antenna Port Conducted Measurement  
**IBE**: In-Band Emission (MASK)  
**CBP**:Contention Based Protocol

Note:

- The EUT had been pre-tested on mode A (EUT with Dock) of 2 antenna angles (0° & 90° ). The worst case was found when positioned on mode A(0° ). And mode B (EUT with NB) of 2 antenna angles (0° & 90° ). The worst case was found when positioned on mode A(90° )
- "-": Means no effect.
- Radiated emission (below 1GHz) and power line conducted emission test items chosen the worst maximum power.

#### Radiated Emission Measurement (Above 1GHz):

- Pre-Scan has been conducted to determine the worst-case mode from all possible combinations between available modulations, data rates and antenna ports (if EUT with antenna diversity architecture).
- Following channel(s) was (were) selected for the final test as listed below.

EUT Configure Mode	Mode	Frequency Band (MHz)	Available Channel	Tested Channel	Modulation Technology	Modulation Type	Data Rate Parameter
A	802.11a	5955-6415	1 to 93	1, 45, 93	OFDM	BPSK	6Mb/s
		6435-6525	97 to 113	97, 105, 113	OFDM	BPSK	6Mb/s
		6525-6855	117 to 185	117, 153, 181, 185	OFDM	BPSK	6Mb/s
		6875-7115	185 to 233	185, 213, 229, 233	OFDM	BPSK	6Mb/s
A	802.11ax (HE20)	5955-6415	1 to 93	1, 45, 93	OFDMA	BPSK	MCS0
		6435-6525	97 to 113	97, 105, 113	OFDMA	BPSK	MCS0
		6525-6855	117 to 185	117, 153, 181, 185	OFDMA	BPSK	MCS0
		6875-7115	185 to 233	185, 213, 229, 233	OFDMA	BPSK	MCS0
A	802.11ax (HE40)	5955-6415	3 to 91	3, 43, 91	OFDMA	BPSK	MCS0
		6435-6525	99 to 115	99, 107, 115	OFDMA	BPSK	MCS0
		6525-6855	115 to 187	115, 123, 155, 179, 187	OFDMA	BPSK	MCS0
		6875-7115	187 to 227	187, 211, 227	OFDMA	BPSK	MCS0
A	802.11ax (HE80)	5955-6415	7 to 87	7, 39, 87	OFDMA	BPSK	MCS0
		6435-6525	103 to 119	103, 119	OFDMA	BPSK	MCS0
		6525-6855	119 to 183	119, 135, 151, 167, 183	OFDMA	BPSK	MCS0
		6875-7115	183 to 215	183, 199, 215	OFDMA	BPSK	MCS0

**Radiated Emission Measurement (Below 1GHz):**

- Pre-Scan has been conducted to determine the worst-case mode from all possible combinations between available modulations, data rates and antenna ports (if EUT with antenna diversity architecture).
- Following channel(s) was (were) selected for the final test as listed below.

EUT Configure Mode	Mode	Frequency Band (MHz)	Available Channel	Tested Channel	Modulation Technology	Modulation Type	Data Rate Parameter
A, B	802.11ax (HE80)	5955-6415	7 to 87	215	OFDMA	BPSK	MCS0
		6435-6525	103 to 119		OFDMA	BPSK	MCS0
		6525-6855	119 to 183		OFDMA	BPSK	MCS0
		6875-7115	183 to 215		OFDMA	BPSK	MCS0

**In-Band Emission (MASK) Measurement:**

EUT Configure Mode	Mode	Frequency Band (MHz)	Available Channel	Tested Channel	Modulation Technology	Modulation Type	Data Rate Parameter
A	802.11a	5955-6415	1 to 93	1, 45, 93	OFDM	BPSK	6Mb/s
		6435-6525	97 to 113	97, 105, 113	OFDM	BPSK	6Mb/s
		6525-6855	117 to 185	117, 153, 181, 185	OFDM	BPSK	6Mb/s
		6875-7115	185 to 233	185, 213, 229, 233	OFDM	BPSK	6Mb/s
A	802.11ax (HE20)	5955-6415	1 to 93	1, 45, 93	OFDMA	BPSK	MCS0
		6435-6525	97 to 113	97, 105, 113	OFDMA	BPSK	MCS0
		6525-6855	117 to 185	117, 153, 181, 185	OFDMA	BPSK	MCS0
		6875-7115	185 to 233	185, 213, 229, 233	OFDMA	BPSK	MCS0
A	802.11ax (HE40)	5955-6415	3 to 91	3, 43, 91	OFDMA	BPSK	MCS0
		6435-6525	99 to 115	99, 107, 115	OFDMA	BPSK	MCS0
		6525-6855	115 to 187	115, 123, 155, 179, 187	OFDMA	BPSK	MCS0
		6875-7115	187 to 227	187, 211, 227	OFDMA	BPSK	MCS0
A	802.11ax (HE80)	5955-6415	7 to 87	7, 39, 87	OFDMA	BPSK	MCS0
		6435-6525	103 to 119	103, 119	OFDMA	BPSK	MCS0
		6525-6855	119 to 183	119, 135, 151, 167, 183	OFDMA	BPSK	MCS0
		6875-7115	183 to 215	183, 199, 215	OFDMA	BPSK	MCS0

**Power Line Conducted Emission Measurement:**

- Pre-Scan has been conducted to determine the worst-case mode from all possible combinations between available modulations, data rates and antenna ports (if EUT with antenna diversity architecture).
- Following channel(s) was (were) selected for the final test as listed below.

EUT Configure Mode	Mode	Frequency Band (MHz)	Available Channel	Tested Channel	Modulation Technology	Modulation Type	Data Rate Parameter
A, B	802.11ax (HE80)	5955-6415	7 to 87	215	OFDMA	BPSK	MCS0
		6435-6525	103 to 119		OFDMA	BPSK	MCS0
		6525-6855	119 to 183		OFDMA	BPSK	MCS0
		6875-7115	183 to 215		OFDMA	BPSK	MCS0

**Antenna Port Conducted Measurement:**

- This item includes all test value of each mode, but only includes spectrum plot of worst value of each mode.
- Pre-Scan has been conducted to determine the worst-case mode from all possible combinations between available modulations, data rates and antenna ports (if EUT with antenna diversity architecture).
- Following channel(s) was (were) selected for the final test as listed below.

EUT Configure Mode	Mode	Frequency Band (MHz)	Available Channel	Tested Channel	Modulation Technology	Modulation Type	Data Rate Parameter
A	802.11a	5955-6415	1 to 93	1, 45, 93	OFDM	BPSK	6Mb/s
		6435-6525	97 to 113	97, 105, 113	OFDM	BPSK	6Mb/s
		6525-6855	117 to 185	117, 153, 181, 185	OFDM	BPSK	6Mb/s
		6875-7115	185 to 233	185, 213, 229, 233	OFDM	BPSK	6Mb/s
A	802.11ax (HE20)	5955-6415	1 to 93	1, 45, 93	OFDMA	BPSK	MCS0
		6435-6525	97 to 113	97, 105, 113	OFDMA	BPSK	MCS0
		6525-6855	117 to 185	117, 153, 181, 185	OFDMA	BPSK	MCS0
		6875-7115	185 to 233	185, 213, 229, 233	OFDMA	BPSK	MCS0
A	802.11ax (HE40)	5955-6415	3 to 91	3, 43, 91	OFDMA	BPSK	MCS0
		6435-6525	99 to 115	99, 107, 115	OFDMA	BPSK	MCS0
		6525-6855	115 to 187	115, 123, 155, 179, 187	OFDMA	BPSK	MCS0
		6875-7115	187 to 227	187, 211, 227	OFDMA	BPSK	MCS0
A	802.11ax (HE80)	5955-6415	7 to 87	7, 39, 87	OFDMA	BPSK	MCS0
		6435-6525	103 to 119	103, 119	OFDMA	BPSK	MCS0
		6525-6855	119 to 183	119, 135, 151, 167, 183	OFDMA	BPSK	MCS0
		6875-7115	183 to 215	183, 199, 215	OFDMA	BPSK	MCS0

**Contention Based Protocol Measurement:**

- Pre-Scan has been conducted to determine the worst-case mode from all possible combinations between available modulations, data rates and antenna ports (if EUT with antenna diversity architecture).
- Following channel(s) was (were) selected for the final test as listed below.

EUT Configure Mode	Mode	Frequency Band (MHz)	Available Channel	Tested Channel	Modulation Technology	Modulation Type	Data Rate Parameter
A	802.11ax (HE20)	5955-6415	1 to 93	45	OFDMA	BPSK	MCS0
		6435-6525	97 to 113	97	OFDMA	BPSK	MCS0
		6525-6855	117 to 185	149	OFDMA	BPSK	MCS0
		6875-7115	185 to 233	209	OFDMA	BPSK	MCS0
A	802.11ax (HE80)	5955-6415	7 to 87	39	OFDMA	BPSK	MCS0
		6435-6525	103 to 119	103	OFDMA	BPSK	MCS0
		6525-6855	119 to 183	151	OFDMA	BPSK	MCS0
		6875-7115	183 to 215	215	OFDMA	BPSK	MCS0

**Test Condition:**

Applicable to	Environmental Conditions	Input Power (System)	Tested by
RE $\geq$ 1G	23 deg. C, 69% RH	120Vac, 60Hz,	Greg Lin
RE<1G	23 deg. C, 69% RH	120Vac, 60Hz,	Greg Lin
PLC	23 deg. C, 69% RH	120Vac, 60Hz,	Greg Lin
APCM	25 deg. C, 60% RH	120Vac, 60Hz	Ivan Tseng

### 3.3 Duty Cycle of Test Signal

#### Nss 1

Duty cycle of test signal is < 98%, duty factor is required.

802.11a: Duty cycle = 1.391ms/1.444ms = 0.963, Duty factor =  $10 * \log(1/0.963) = 0.16$

802.11ax (HE20): Duty cycle = 1.97ms/2.024ms = 0.973, Duty factor =  $10 * \log(1/0.973) = 0.12$

802.11ax (HE40): Duty cycle = 1.97ms/2.025ms = 0.973, Duty factor =  $10 * \log(1/0.973) = 0.12$

802.11ax (HE80): Duty cycle = 1.865ms/1.919ms = 0.972, Duty factor =  $10 * \log(1/0.972) = 0.12$

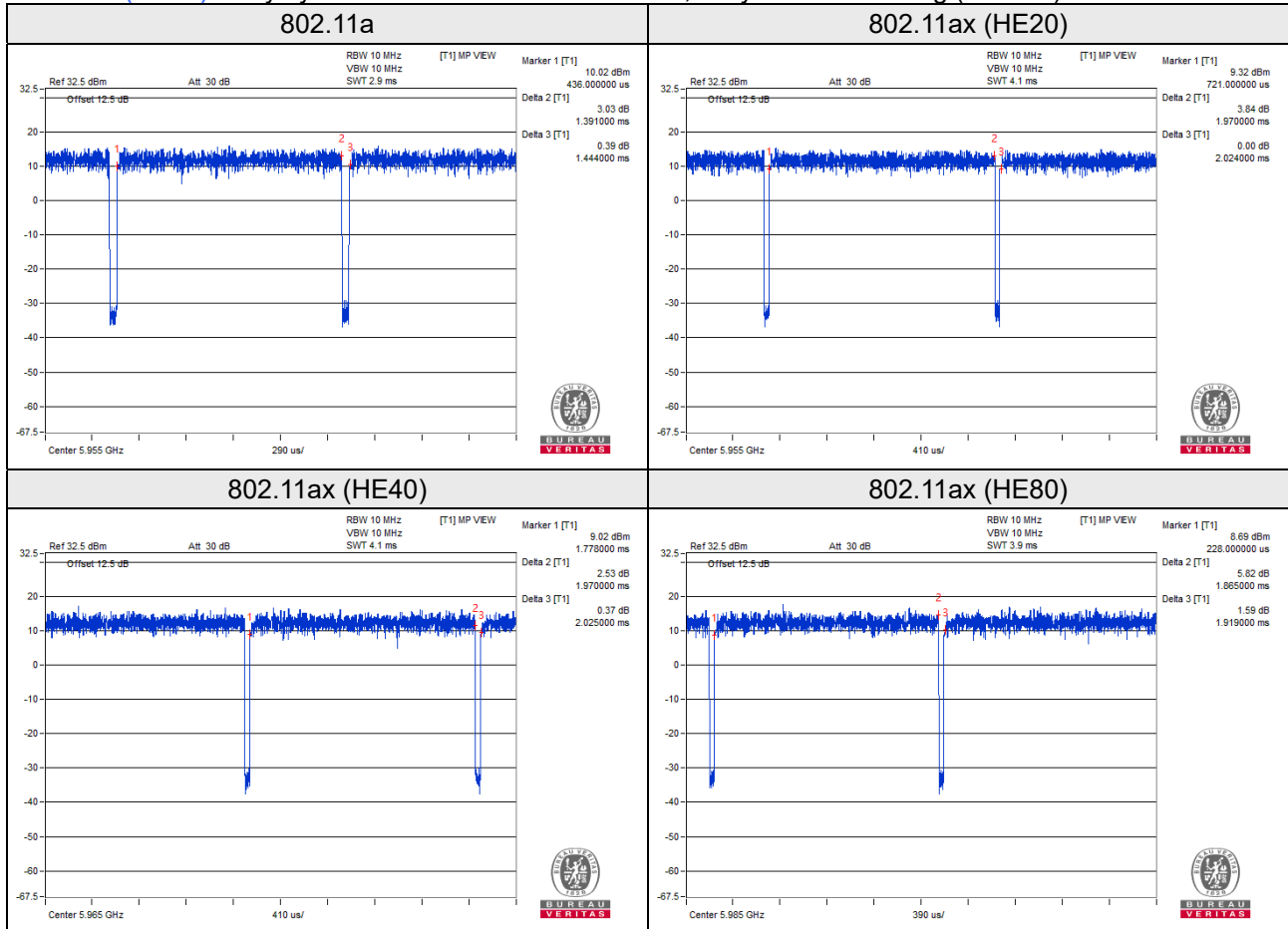

Nss 2

Duty cycle of test signal is < 98%, duty factor is required.

802.11ax (HE20): Duty cycle = 1.032ms/1.078ms = 0.957, Duty factor =  $10 \cdot \log(1/0.957) = 0.19$

802.11ax (HE40): Duty cycle = 1.032ms/1.085ms = 0.951, Duty factor =  $10 \cdot \log(1/0.951) = 0.22$

802.11ax (HE80): Duty cycle = 0.978ms/1.022ms = 0.957, Duty factor =  $10 \cdot \log(1/0.957) = 0.19$





### 3.4 Description of Support Units

The EUT has been tested as an independent unit together with other necessary accessories or support units. The following support units or accessories were used to form a representative test configuration during the tests.

ID	Product	Brand	Model No.	Serial No.	FCC ID	Remarks
A.	Notebook	DELL	E5420	33MJMQ1	FCC DoC Approved	-
B.	Dock	Nienyi	107-1059401	NA	NA	Accessory of EUT

Note:

1. All power cords of the above support units are non-shielded (1.8m).
2. Item A acted as a communication partner to transfer data.

#### 3.4.1 Configuration of System under Test

Mode A

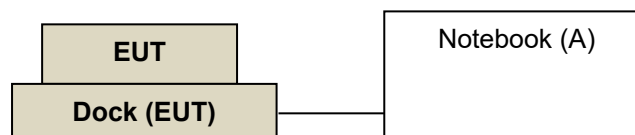

Mode B

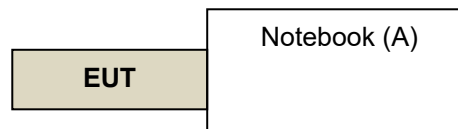

### 3.5 General Description of Applied Standards and References

The EUT is a RF Product. According to the specifications of the manufacturer, it must comply with the requirements of the following standards and references:

**Test standard:**

**FCC Part 15, Subpart E (15.407)**

ANSI C63.10:2013

All test items have been performed and recorded as per the above standards.

**References Test Guidance:**

**KDB 987594 D02 EMC Measurement v01r01**

**KDB 789033 D02 General UNII Test Procedure New Rules v02r01**

**KDB 662911 D01 Multiple Transmitter Output v02r01**

All test items have been performed as a reference to the above KDB test guidance.

## 4 Test Types and Results

### 4.1 Radiated Emission and Bandedge Measurement

#### 4.1.1 Limits of Radiated Emission and Bandedge Measurement

Radiated emissions which fall in the restricted bands must comply with the radiated emission limits specified as below table.

Frequencies (MHz)	Field Strength (microvolts/meter)	Measurement Distance (meters)
0.009 ~ 0.490	2400/F(kHz)	300
0.490 ~ 1.705	24000/F(kHz)	30
1.705 ~ 30.0	30	30
30 ~ 88	100	3
88 ~ 216	150	3
216 ~ 960	200	3
Above 960	500	3

Note:

1. The lower limit shall apply at the transition frequencies.
2. Emission level (dBuV/m) = 20 log Emission level (uV/m).
3. For frequencies above 1000MHz, the field strength limits are based on average detector, however, the peak field strength of any emission shall not exceed the maximum permitted average limits, specified above by more than 20dB under any condition of modulation.

Limits of unwanted emission out of the restricted bands

Frequencies (MHz)	EIRP Limit	Equivalent Field Strength at 3m
5925MHz > F > 7125MHz	Peak:-7 (dBm/MHz)	88.2(dBμV/m)
	Average: -27 (dBm/MHz)	68.2(dBμV/m)

Note: The following formula is used to convert the equipment isotropic radiated power (eirp) to field strength:

$$E = \frac{1000000\sqrt{30P}}{3} \mu\text{V/m, where P is the eirp (Watts).}$$

#### 4.1.2 Test Instruments

Description & Manufacturer	Model No.	Serial No.	Cal. Date	Cal. Due
Test Receiver ROHDE & SCHWARZ	ESCI	100424	Dec. 30, 2021	Dec. 29, 2022
Spectrum Analyzer ROHDE & SCHWARZ	FSP40	100040	Sep. 15, 2021	Sep. 14, 2022
BILOG Antenna SCHWARZBECK	VULB9168	9168-155	Nov. 01, 2021	Oct. 30, 2022
HORN Antenna SCHWARZBECK	BBHA 9120D	9120D-1170	Nov. 14, 2021	Nov. 13, 2022
HORN Antenna SCHWARZBECK	BBHA 9170	BBHA9170241	Oct. 26, 2021	Oct. 25, 2022
Loop Antenna TESEQ	HLA 6121	45745	Jul. 21, 2021	Jul. 20, 2022
			Jul. 27, 2022	Jul. 26, 2023
Preamplifier Agilent (Below 1GHz)	8447D	2944A10631	May 14, 2022	May 13, 2023
Preamplifier KEYSIGHT (Above 1GHz)	83017A	MY53270295	May 14, 2022	May 13, 2023
RF Coaxial Cable 57140938WOKEN With 5dB PAD	8D-FB	Cable-CH4-01	Jul. 24, 2021	Jul. 23, 2022
			Jul. 09, 2022	Jul. 08, 2023
RF Coaxial Cable EMCI	EMC102-KM-KM-3000	150929	Jul. 24, 2021	Jul. 23, 2022
			Jul. 09, 2022	Jul. 08, 2023
RF Coaxial Cable EMCI	EMC102-KM-KM-600	150928	Jul. 24, 2021	Jul. 23, 2022
			Jul. 09, 2022	Jul. 08, 2023
RF signal cable HUBER+SUHNER	SUCOFLEX 104	MY 13380+295012/04	May 14, 2022	May 13, 2023
RF signal cable HUBER+SUHNER	SUCOFLEX 104	Cable-CH4-03 (250724)	May 14, 2022	May 13, 2023
Software BV ADT	ADT_Radiated_V7.6.15.9.5	NA	NA	NA
Antenna Tower inn-co GmbH	MA 4000	010303	NA	NA
Antenna Tower Controller BV ADT	AT100	AT93021703	NA	NA
Turn Table BV ADT	TT100	TT93021703	NA	NA
Turn Table Controller BV ADT	SC100	SC93021703	NA	NA
Boresight Antenna Fixture	FBA-01	FBA-SIP01	NA	NA
Pre-amplifier (18GHz-40GHz) EMC	EMC184045B	980175	Sep. 04, 2021	Sep. 03, 2022
Peak Power Analyzer KEYSIGHT	8990B	MY51000485	Jan. 18, 2022	Jan. 17, 2023
Wideband Power Sensor KEYSIGHT	N1923A	MY58190002	May 06, 2022	May 05, 2023

Note: 1. The calibration interval of the above test instruments is 12 months and the calibrations are traceable to NML/ROC and NIST/USA.  
2. The test was performed in HwaYa Chamber 4.

### 4.1.3 Test Procedures

#### For Radiated emission below 30MHz

- a. The EUT was placed on the top of a rotating table 0.8 meters above the ground at a 3 meter chamber room. The table was rotated 360 degrees to determine the position of the highest radiation.
- b. The EUT was set 3 meters away from the interference-receiving antenna, which was mounted on the top of a variable-height antenna tower.
- c. Parallel, perpendicular, and ground-parallel orientations of the antenna are set to make the measurement.
- d. For each suspected emission, the EUT was arranged to its worst case and the rotatable table was turned from 0 degrees to 360 degrees to find the maximum reading.
- e. The test-receiver system was set to Quasi-Peak Detect Function and Specified Bandwidth with Maximum Hold Mode.

Note:

1. The resolution bandwidth and video bandwidth of test receiver/spectrum analyzer is 9kHz at frequency below 30MHz.

#### For Radiated emission above 30MHz

- a. The EUT was placed on the top of a rotating table 0.8 meters (for 30MHz ~ 1GHz) / 1.5 meters (for above 1GHz) above the ground at 3 meter chamber room for test. The table was rotated 360 degrees to determine the position of the highest radiation.
- b. The EUT was set 3 meters away from the interference-receiving antenna, which was mounted on the top of a variable-height antenna tower.
- c. The height of antenna is varied from one meter to four meters above the ground to determine the maximum value of the field strength. Both horizontal and vertical polarizations of the antenna are set to make the measurement.
- d. For each suspected emission, the EUT was arranged to its worst case and then the antenna was tuned to heights from 1 meter to 4 meters and the rotatable table was turned from 0 degrees to 360 degrees to find the maximum reading.
- e. The test-receiver system was set to quasi-peak detect function and specified bandwidth with maximum hold mode when the test frequency is below 1 GHz.
- f. The test-receiver system was set to peak and average detect function and specified bandwidth with maximum hold mode when the test frequency is above 1 GHz. If the peak reading value also meets average limit, measurement with the average detector is unnecessary.

Note:

1. The resolution bandwidth and video bandwidth of test receiver/spectrum analyzer is 120kHz for Quasi-peak detection (QP) at frequency below 1GHz.
2. The resolution bandwidth of test receiver/spectrum analyzer is 1 MHz and the video bandwidth is 3 MHz for Peak detection (PK) at frequency above 1GHz.

3. The resolution bandwidth of test receiver/spectrum analyzer is 1MHz and the video bandwidth is  $\geq 1/T$  (Duty cycle  $< 98\%$ ) or 10Hz (Duty cycle  $\geq 98\%$ ) for Average detection (AV) at frequency above 1GHz.

**Nss 1**

(802.11a: RBW = 1MHz, VBW = 1kHz; 802.11ax (HE20): RBW = 1MHz, VBW = 1kHz; 802.11ax (HE40): RBW = 1MHz, VBW = 1kHz; 802.11ax (HE80): RBW = 1MHz, VBW = 1kHz)

**Nss 2**

(802.11ax (HE20): RBW = 1MHz, VBW = 1kHz; 802.11ax (HE40): RBW = 1MHz, VBW = 1kHz; 802.11ax (HE80): RBW = 1MHz, VBW = 1kHz)

4. All modes of operation were investigated and the worst-case emissions are reported.

**4.1.4 Deviation from Test Standard**

No deviation.

**4.1.5 Test Setup**

**For Radiated emission below 30MHz**

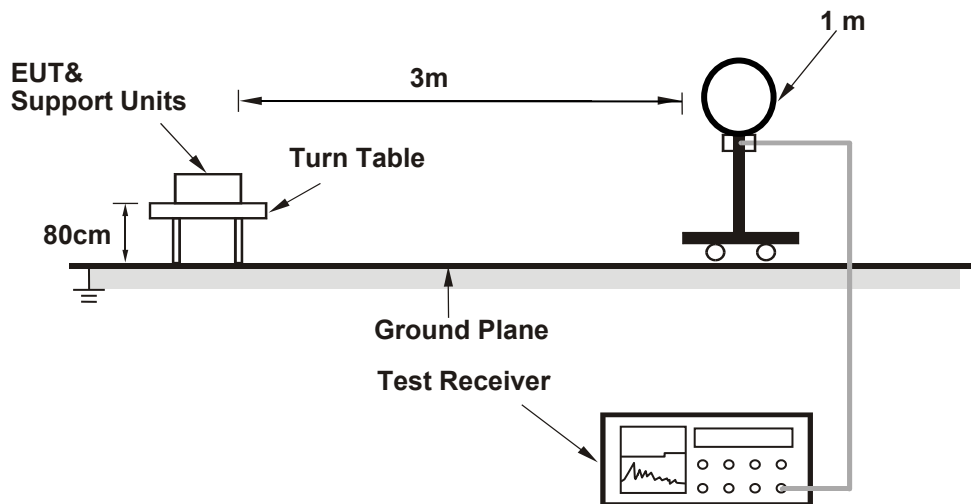

**For Radiated emission 30MHz to 1GHz**

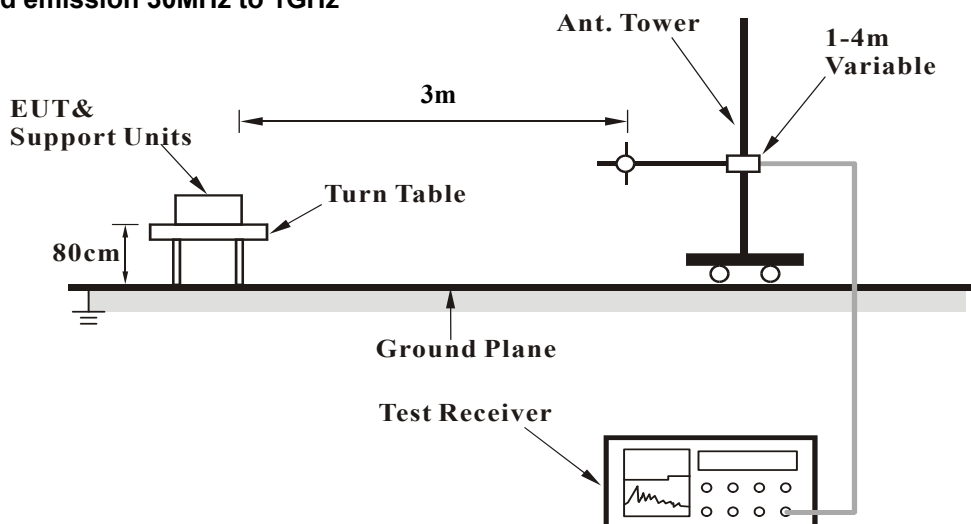

### For Radiated emission above 1GHz

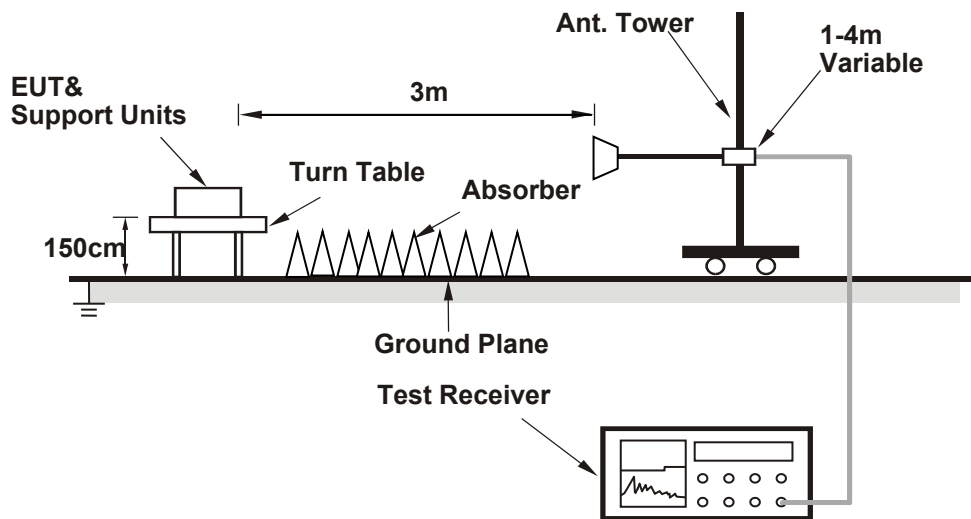

For the actual test configuration, please refer to the attached file (Test Setup Photo).

#### 4.1.6 EUT Operating Conditions

##### Mode A

- a. EUT connected to the Notebook through dock via USB cable.
- b. The EUT under transmission condition continuously at specific channel frequency.

##### Mode B

- a. EUT plugged into the Notebook.
- b. The EUT under transmission condition continuously at specific channel frequency.

#### 4.1.7 Test Results

Above 1GHz data:

Nss 1

RF Mode	TX 802.11a 6G	Channel	CH 1 : 5955 MHz
Frequency Range	1GHz ~ 40GHz	Detector Function	Peak (PK) Average (AV)

Antenna Polarity & Test Distance : Horizontal at 3 m								
No	Frequency (MHz)	Emission Level (dBuV/m)	Limit (dBuV/m)	Margin (dB)	Antenna Height (m)	Table Angle (Degree)	Raw Value (dBuV)	Correction Factor (dB/m)
1	#5925.00	62.1 PK	88.2	-26.1	1.20 H	179	47.7	14.4
2	#5925.00	49.0 AV	68.2	-19.2	1.20 H	179	34.6	14.4
3	*5955.00	95.1 PK			1.20 H	179	50.9	44.2
4	*5955.00	85.1 AV			1.20 H	179	40.9	44.2
5	11910.00	62.6 PK	74.0	-11.4	2.04 H	238	39.7	22.9
6	11910.00	49.6 AV	54.0	-4.4	2.04 H	238	26.7	22.9

Antenna Polarity & Test Distance : Vertical at 3 m								
No	Frequency (MHz)	Emission Level (dBuV/m)	Limit (dBuV/m)	Margin (dB)	Antenna Height (m)	Table Angle (Degree)	Raw Value (dBuV)	Correction Factor (dB/m)
1	#5925.00	62.6 PK	88.2	-25.6	2.32 V	203	48.2	14.4
2	#5925.00	49.1 AV	68.2	-19.1	2.32 V	203	34.7	14.4
3	*5955.00	99.8 PK			2.32 V	203	55.6	44.2
4	*5955.00	89.7 AV			2.32 V	203	45.5	44.2
5	11910.00	63.1 PK	74.0	-10.9	2.87 V	306	40.2	22.9
6	11910.00	49.7 AV	54.0	-4.3	2.87 V	306	26.8	22.9

Remarks:

1. Emission Level(dBuV/m) = Raw Value(dBuV) + Correction Factor(dB/m)
2. Correction Factor(dB/m) = Antenna Factor(dB/m) + Cable Factor(dB) – Pre-Amplifier Factor(dB)
3. Margin value = Emission Level – Limit value
4. The other emission levels were very low against the limit.
5. " \* ": Fundamental frequency.
6. " # ": The radiated frequency is out of the restricted band.

RF Mode	TX 802.11a 6G	Channel	CH 45 : 6175 MHz
Frequency Range	1GHz ~ 40GHz	Detector Function	Peak (PK) Average (AV)

**Antenna Polarity & Test Distance : Horizontal at 3 m**

No	Frequency (MHz)	Emission Level (dBuV/m)	Limit (dBuV/m)	Margin (dB)	Antenna Height (m)	Table Angle (Degree)	Raw Value (dBuV)	Correction Factor (dB/m)
1	*6175.00	95.3 PK			1.27 H	178	50.8	44.5
2	*6175.00	85.1 AV			1.27 H	178	40.6	44.5
3	12350.00	62.2 PK	74.0	-11.8	2.03 H	238	39.5	22.7
4	12350.00	49.1 AV	54.0	-4.9	2.03 H	238	26.4	22.7

**Antenna Polarity & Test Distance : Vertical at 3 m**

No	Frequency (MHz)	Emission Level (dBuV/m)	Limit (dBuV/m)	Margin (dB)	Antenna Height (m)	Table Angle (Degree)	Raw Value (dBuV)	Correction Factor (dB/m)
1	*6175.00	99.7 PK			2.56 V	196	55.2	44.5
2	*6175.00	89.6 AV			2.56 V	196	45.1	44.5
3	12350.00	62.6 PK	74.0	-11.4	2.83 V	307	39.9	22.7
4	12350.00	49.3 AV	54.0	-4.7	2.83 V	307	26.6	22.7

**Remarks:**

1. Emission Level(dBuV/m) = Raw Value(dBuV) + Correction Factor(dB/m)
2. Correction Factor(dB/m) = Antenna Factor(dB/m) + Cable Factor(dB) – Pre-Amplifier Factor(dB)
3. Margin value = Emission Level – Limit value
4. The other emission levels were very low against the limit.
5. " \* " : Fundamental frequency.



RF Mode	TX 802.11a 6G	Channel	CH 93 : 6415 MHz
Frequency Range	1GHz ~ 40GHz	Detector Function	Peak (PK) Average (AV)

**Antenna Polarity & Test Distance : Horizontal at 3 m**

No	Frequency (MHz)	Emission Level (dBuV/m)	Limit (dBuV/m)	Margin (dB)	Antenna Height (m)	Table Angle (Degree)	Raw Value (dBuV)	Correction Factor (dB/m)
1	*6415.00	95.3 PK			1.22 H	175	49.8	45.5
2	*6415.00	85.2 AV			1.22 H	175	39.7	45.5
3	#12830.00	63.1 PK	88.2	-25.1	1.94 H	235	39.8	23.3
4	#12830.00	50.0 AV	68.2	-18.2	1.94 H	235	26.7	23.3

**Antenna Polarity & Test Distance : Vertical at 3 m**

No	Frequency (MHz)	Emission Level (dBuV/m)	Limit (dBuV/m)	Margin (dB)	Antenna Height (m)	Table Angle (Degree)	Raw Value (dBuV)	Correction Factor (dB/m)
1	*6415.00	99.7 PK			2.36 V	208	54.2	45.5
2	*6415.00	89.7 AV			2.36 V	208	44.2	45.5
3	#12830.00	63.4 PK	88.2	-24.8	2.74 V	303	40.1	23.3
4	#12830.00	50.1 AV	68.2	-18.1	2.74 V	303	26.8	23.3

**Remarks:**

1. Emission Level(dBuV/m) = Raw Value(dBuV) + Correction Factor(dB/m)
2. Correction Factor(dB/m) = Antenna Factor(dB/m) + Cable Factor(dB) – Pre-Amplifier Factor(dB)
3. Margin value = Emission Level – Limit value
4. The other emission levels were very low against the limit.
5. " \* ": Fundamental frequency.
6. " # ": The radiated frequency is out of the restricted band.

RF Mode	TX 802.11a 6G	Channel	CH 97 : 6435 MHz
Frequency Range	1GHz ~ 40GHz	Detector Function	Peak (PK) Average (AV)

**Antenna Polarity & Test Distance : Horizontal at 3 m**

No	Frequency (MHz)	Emission Level (dBuV/m)	Limit (dBuV/m)	Margin (dB)	Antenna Height (m)	Table Angle (Degree)	Raw Value (dBuV)	Correction Factor (dB/m)
1	*6435.00	95.1 PK			1.39 H	184	49.5	45.6
2	*6435.00	85.1 AV			1.39 H	184	39.5	45.6
3	#12870.00	63.2 PK	88.2	-25.0	2.05 H	236	39.8	23.4
4	#12870.00	50.1 AV	68.2	-18.1	2.05 H	236	26.7	23.4

**Antenna Polarity & Test Distance : Vertical at 3 m**

No	Frequency (MHz)	Emission Level (dBuV/m)	Limit (dBuV/m)	Margin (dB)	Antenna Height (m)	Table Angle (Degree)	Raw Value (dBuV)	Correction Factor (dB/m)
1	*6435.00	99.9 PK			2.87 V	291	54.3	45.6
2	*6435.00	89.8 AV			2.87 V	291	44.2	45.6
3	#12870.00	63.5 PK	88.2	-24.7	2.74 V	315	40.1	23.4
4	#12870.00	50.4 AV	68.2	-17.8	2.74 V	315	27.0	23.4

**Remarks:**

1. Emission Level(dBuV/m) = Raw Value(dBuV) + Correction Factor(dB/m)
2. Correction Factor(dB/m) = Antenna Factor(dB/m) + Cable Factor(dB) – Pre-Amplifier Factor(dB)
3. Margin value = Emission Level – Limit value
4. The other emission levels were very low against the limit.
5. " \* ": Fundamental frequency.
6. " # ": The radiated frequency is out of the restricted band.

RF Mode	TX 802.11a 6G	Channel	CH 105 : 6475 MHz
Frequency Range	1GHz ~ 40GHz	Detector Function	Peak (PK) Average (AV)

**Antenna Polarity & Test Distance : Horizontal at 3 m**

No	Frequency (MHz)	Emission Level (dBuV/m)	Limit (dBuV/m)	Margin (dB)	Antenna Height (m)	Table Angle (Degree)	Raw Value (dBuV)	Correction Factor (dB/m)
1	*6475.00	95.3 PK			1.36 H	194	49.3	46.0
2	*6475.00	85.2 AV			1.36 H	194	39.2	46.0
3	#12950.00	63.1 PK	88.2	-25.1	2.14 H	253	39.6	23.5
4	#12950.00	50.2 AV	68.2	-18.0	2.14 H	253	26.7	23.5

**Antenna Polarity & Test Distance : Vertical at 3 m**

No	Frequency (MHz)	Emission Level (dBuV/m)	Limit (dBuV/m)	Margin (dB)	Antenna Height (m)	Table Angle (Degree)	Raw Value (dBuV)	Correction Factor (dB/m)
1	*6475.00	100.3 PK			2.87 V	299	54.3	46.0
2	*6475.00	90.2 AV			2.87 V	299	44.2	46.0
3	#12950.00	63.4 PK	88.2	-24.8	2.93 V	322	39.9	23.5
4	#12950.00	50.4 AV	68.2	-17.8	2.93 V	322	26.9	23.5

**Remarks:**

1. Emission Level(dBuV/m) = Raw Value(dBuV) + Correction Factor(dB/m)
2. Correction Factor(dB/m) = Antenna Factor(dB/m) + Cable Factor(dB) – Pre-Amplifier Factor(dB)
3. Margin value = Emission Level – Limit value
4. The other emission levels were very low against the limit.
5. " \* " : Fundamental frequency.
6. " # " : The radiated frequency is out of the restricted band.

RF Mode	TX 802.11a 6G	Channel	CH 113 : 6515 MHz
Frequency Range	1GHz ~ 40GHz	Detector Function	Peak (PK) Average (AV)

**Antenna Polarity & Test Distance : Horizontal at 3 m**

No	Frequency (MHz)	Emission Level (dBuV/m)	Limit (dBuV/m)	Margin (dB)	Antenna Height (m)	Table Angle (Degree)	Raw Value (dBuV)	Correction Factor (dB/m)
1	*6515.00	95.2 PK			2.37 H	179	48.9	46.3
2	*6515.00	85.2 AV			2.37 H	179	38.9	46.3
3	#13030.00	63.3 PK	88.2	-24.9	1.99 H	238	39.8	23.5
4	#13030.00	50.2 AV	68.2	-18.0	1.99 H	238	26.7	23.5

**Antenna Polarity & Test Distance : Vertical at 3 m**

No	Frequency (MHz)	Emission Level (dBuV/m)	Limit (dBuV/m)	Margin (dB)	Antenna Height (m)	Table Angle (Degree)	Raw Value (dBuV)	Correction Factor (dB/m)
1	*6515.00	99.7 PK			2.86 V	291	53.4	46.3
2	*6515.00	89.7 AV			2.86 V	291	43.4	46.3
3	#13030.00	63.7 PK	88.2	-24.5	2.92 V	318	40.2	23.5
4	#13030.00	50.5 AV	68.2	-17.7	2.92 V	318	27.0	23.5

**Remarks:**

1. Emission Level(dBuV/m) = Raw Value(dBuV) + Correction Factor(dB/m)
2. Correction Factor(dB/m) = Antenna Factor(dB/m) + Cable Factor(dB) – Pre-Amplifier Factor(dB)
3. Margin value = Emission Level – Limit value
4. The other emission levels were very low against the limit.
5. " \* ": Fundamental frequency.
6. " # ": The radiated frequency is out of the restricted band.

RF Mode	TX 802.11a 6G	Channel	CH 117 : 6535 MHz
Frequency Range	1GHz ~ 40GHz	Detector Function	Peak (PK) Average (AV)

**Antenna Polarity & Test Distance : Horizontal at 3 m**

No	Frequency (MHz)	Emission Level (dBuV/m)	Limit (dBuV/m)	Margin (dB)	Antenna Height (m)	Table Angle (Degree)	Raw Value (dBuV)	Correction Factor (dB/m)
1	*6535.00	94.9 PK			1.26 H	175	48.5	46.4
2	*6535.00	84.8 AV			1.26 H	175	38.4	46.4
3	#13070.00	63.1 PK	88.2	-25.1	2.08 H	254	39.7	23.4
4	#13070.00	50.2 AV	68.2	-18.0	2.08 H	254	26.8	23.4

**Antenna Polarity & Test Distance : Vertical at 3 m**

No	Frequency (MHz)	Emission Level (dBuV/m)	Limit (dBuV/m)	Margin (dB)	Antenna Height (m)	Table Angle (Degree)	Raw Value (dBuV)	Correction Factor (dB/m)
1	*6535.00	99.4 PK			2.95 V	290	53.0	46.4
2	*6535.00	89.3 AV			2.95 V	290	42.9	46.4
3	#13070.00	63.7 PK	88.2	-24.5	2.74 V	295	40.3	23.4
4	#13070.00	50.5 AV	68.2	-17.7	2.74 V	295	27.1	23.4

**Remarks:**

1. Emission Level(dBuV/m) = Raw Value(dBuV) + Correction Factor(dB/m)
2. Correction Factor(dB/m) = Antenna Factor(dB/m) + Cable Factor(dB) – Pre-Amplifier Factor(dB)
3. Margin value = Emission Level – Limit value
4. The other emission levels were very low against the limit.
5. " \* ": Fundamental frequency.
6. " # ": The radiated frequency is out of the restricted band.

RF Mode	TX 802.11a 6G	Channel	CH 153 : 6715 MHz
Frequency Range	1GHz ~ 40GHz	Detector Function	Peak (PK) Average (AV)

**Antenna Polarity & Test Distance : Horizontal at 3 m**

No	Frequency (MHz)	Emission Level (dBuV/m)	Limit (dBuV/m)	Margin (dB)	Antenna Height (m)	Table Angle (Degree)	Raw Value (dBuV)	Correction Factor (dB/m)
1	*6715.00	94.8 PK			1.25 H	180	48.7	46.1
2	*6715.00	84.9 AV			1.25 H	180	38.8	46.1
3	#13430.00	63.9 PK	88.2	-24.3	2.23 H	258	39.8	24.1
4	#13430.00	50.8 AV	68.2	-17.4	2.23 H	258	26.7	24.1

**Antenna Polarity & Test Distance : Vertical at 3 m**

No	Frequency (MHz)	Emission Level (dBuV/m)	Limit (dBuV/m)	Margin (dB)	Antenna Height (m)	Table Angle (Degree)	Raw Value (dBuV)	Correction Factor (dB/m)
1	*6715.00	99.2 PK			2.89 V	292	53.1	46.1
2	*6715.00	89.2 AV			2.89 V	292	43.1	46.1
3	#13430.00	64.2 PK	88.2	-24.0	2.73 V	312	40.1	24.1
4	#13430.00	51.0 AV	68.2	-17.2	2.73 V	312	26.9	24.1

**Remarks:**

1. Emission Level(dBuV/m) = Raw Value(dBuV) + Correction Factor(dB/m)
2. Correction Factor(dB/m) = Antenna Factor(dB/m) + Cable Factor(dB) – Pre-Amplifier Factor(dB)
3. Margin value = Emission Level – Limit value
4. The other emission levels were very low against the limit.
5. " \* ": Fundamental frequency.
6. " # ": The radiated frequency is out of the restricted band.

RF Mode	TX 802.11a 6G	Channel	CH 181 : 6855 MHz
Frequency Range	1GHz ~ 40GHz	Detector Function	Peak (PK) Average (AV)

**Antenna Polarity & Test Distance : Horizontal at 3 m**

No	Frequency (MHz)	Emission Level (dBuV/m)	Limit (dBuV/m)	Margin (dB)	Antenna Height (m)	Table Angle (Degree)	Raw Value (dBuV)	Correction Factor (dB/m)
1	*6855.00	94.7 PK			1.36 H	167	48.1	46.6
2	*6855.00	84.6 AV			1.36 H	167	38.0	46.6
3	#13710.00	64.3 PK	88.2	-23.9	2.24 H	253	39.7	24.6
4	#13710.00	51.2 AV	68.2	-17.0	2.24 H	253	26.6	24.6

**Antenna Polarity & Test Distance : Vertical at 3 m**

No	Frequency (MHz)	Emission Level (dBuV/m)	Limit (dBuV/m)	Margin (dB)	Antenna Height (m)	Table Angle (Degree)	Raw Value (dBuV)	Correction Factor (dB/m)
1	*6855.00	99.1 PK			2.87 V	266	52.5	46.6
2	*6855.00	89.0 AV			2.87 V	266	42.4	46.6
3	#13710.00	64.5 PK	88.2	-23.7	2.97 V	316	39.9	24.6
4	#13710.00	51.4 AV	68.2	-16.8	2.97 V	316	26.8	24.6

**Remarks:**

1. Emission Level(dBuV/m) = Raw Value(dBuV) + Correction Factor(dB/m)
2. Correction Factor(dB/m) = Antenna Factor(dB/m) + Cable Factor(dB) – Pre-Amplifier Factor(dB)
3. Margin value = Emission Level – Limit value
4. The other emission levels were very low against the limit.
5. " \* ": Fundamental frequency.
6. " # ": The radiated frequency is out of the restricted band.

RF Mode	TX 802.11a 6G	Channel	CH 185 : 6875 MHz
Frequency Range	1GHz ~ 40GHz	Detector Function	Peak (PK) Average (AV)

**Antenna Polarity & Test Distance : Horizontal at 3 m**

No	Frequency (MHz)	Emission Level (dBuV/m)	Limit (dBuV/m)	Margin (dB)	Antenna Height (m)	Table Angle (Degree)	Raw Value (dBuV)	Correction Factor (dB/m)
1	*6875.00	96.5 PK			1.45 H	157	49.9	46.6
2	*6875.00	86.3 AV			1.45 H	157	39.7	46.6
3	#13750.00	64.3 PK	88.2	-23.9	2.36 H	259	39.8	24.5
4	#13750.00	51.1 AV	68.2	-17.1	2.36 H	259	26.6	24.5

**Antenna Polarity & Test Distance : Vertical at 3 m**

No	Frequency (MHz)	Emission Level (dBuV/m)	Limit (dBuV/m)	Margin (dB)	Antenna Height (m)	Table Angle (Degree)	Raw Value (dBuV)	Correction Factor (dB/m)
1	*6875.00	101.1 PK			2.42 V	269	54.5	46.6
2	*6875.00	90.8 AV			2.42 V	269	44.2	46.6
3	#13750.00	64.8 PK	88.2	-23.4	2.76 V	323	40.3	24.5
4	#13750.00	51.5 AV	68.2	-16.7	2.76 V	323	27.0	24.5

**Remarks:**

1. Emission Level(dBuV/m) = Raw Value(dBuV) + Correction Factor(dB/m)
2. Correction Factor(dB/m) = Antenna Factor(dB/m) + Cable Factor(dB) – Pre-Amplifier Factor(dB)
3. Margin value = Emission Level – Limit value
4. The other emission levels were very low against the limit.
5. " \* ": Fundamental frequency.
6. " # ": The radiated frequency is out of the restricted band.



RF Mode	TX 802.11a 6G	Channel	CH 213 : 7015 MHz
Frequency Range	1GHz ~ 40GHz	Detector Function	Peak (PK) Average (AV)

**Antenna Polarity & Test Distance : Horizontal at 3 m**

No	Frequency (MHz)	Emission Level (dBuV/m)	Limit (dBuV/m)	Margin (dB)	Antenna Height (m)	Table Angle (Degree)	Raw Value (dBuV)	Correction Factor (dB/m)
1	*7015.00	96.3 PK			1.45 H	169	48.5	47.8
2	*7015.00	86.1 AV			1.45 H	169	38.3	47.8
3	#14030.00	65.0 PK	88.2	-23.2	2.35 H	264	39.8	25.2
4	#14030.00	51.9 AV	68.2	-16.3	2.35 H	264	26.7	25.2

**Antenna Polarity & Test Distance : Vertical at 3 m**

No	Frequency (MHz)	Emission Level (dBuV/m)	Limit (dBuV/m)	Margin (dB)	Antenna Height (m)	Table Angle (Degree)	Raw Value (dBuV)	Correction Factor (dB/m)
1	*7015.00	100.7 PK			2.53 V	273	52.9	47.8
2	*7015.00	90.5 AV			2.53 V	273	42.7	47.8
3	#14030.00	65.3 PK	88.2	-22.9	3.03 V	316	40.1	25.2
4	#14030.00	52.1 AV	68.2	-16.1	3.03 V	316	26.9	25.2

**Remarks:**

1. Emission Level(dBuV/m) = Raw Value(dBuV) + Correction Factor(dB/m)
2. Correction Factor(dB/m) = Antenna Factor(dB/m) + Cable Factor(dB) – Pre-Amplifier Factor(dB)
3. Margin value = Emission Level – Limit value
4. The other emission levels were very low against the limit.
5. " \* ": Fundamental frequency.
6. " # ": The radiated frequency is out of the restricted band.

RF Mode	TX 802.11a 6G	Channel	CH 229 : 7095 MHz
Frequency Range	1GHz ~ 40GHz	Detector Function	Peak (PK) Average (AV)

**Antenna Polarity & Test Distance : Horizontal at 3 m**

No	Frequency (MHz)	Emission Level (dBuV/m)	Limit (dBuV/m)	Margin (dB)	Antenna Height (m)	Table Angle (Degree)	Raw Value (dBuV)	Correction Factor (dB/m)
1	*7095.00	96.7 PK			1.34 H	183	49.0	47.7
2	*7095.00	86.6 AV			1.34 H	183	38.9	47.7
3	#14190.00	65.3 PK	88.2	-22.9	2.08 H	264	39.9	25.4
4	#14190.00	52.2 AV	68.2	-16.0	2.08 H	264	26.8	25.4

**Antenna Polarity & Test Distance : Vertical at 3 m**

No	Frequency (MHz)	Emission Level (dBuV/m)	Limit (dBuV/m)	Margin (dB)	Antenna Height (m)	Table Angle (Degree)	Raw Value (dBuV)	Correction Factor (dB/m)
1	*7095.00	101.2 PK			2.45 V	273	53.5	47.7
2	*7095.00	91.0 AV			2.45 V	273	43.3	47.7
3	#14190.00	40.3 PK	88.2	-47.9	2.79 V	303	14.9	25.4
4	#14190.00	27.2 AV	68.2	-41.0	2.79 V	303	1.8	25.4

**Remarks:**

1. Emission Level(dBuV/m) = Raw Value(dBuV) + Correction Factor(dB/m)
2. Correction Factor(dB/m) = Antenna Factor(dB/m) + Cable Factor(dB) – Pre-Amplifier Factor(dB)
3. Margin value = Emission Level – Limit value
4. The other emission levels were very low against the limit.
5. " \* ": Fundamental frequency.
6. " # ": The radiated frequency is out of the restricted band.

RF Mode	TX 802.11a 6G	Channel	CH 233 : 7115 MHz
Frequency Range	1GHz ~ 40GHz	Detector Function	Peak (PK) Average (AV)

**Antenna Polarity & Test Distance : Horizontal at 3 m**

No	Frequency (MHz)	Emission Level (dBuV/m)	Limit (dBuV/m)	Margin (dB)	Antenna Height (m)	Table Angle (Degree)	Raw Value (dBuV)	Correction Factor (dB/m)
1	*7115.00	96.6 PK			1.34 H	178	48.6	48.0
2	*7115.00	86.5 AV			1.34 H	178	38.5	48.0
3	#7125.00	79.6 PK	88.2	-8.6	1.34 H	178	62.1	17.5
4	#7125.00	56.6 AV	68.2	-11.6	1.34 H	178	39.1	17.5
5	#14230.00	65.3 PK	88.2	-22.9	2.31 H	257	39.8	25.5
6	#14230.00	52.3 AV	68.2	-15.9	2.31 H	257	26.8	25.5

**Antenna Polarity & Test Distance : Vertical at 3 m**

No	Frequency (MHz)	Emission Level (dBuV/m)	Limit (dBuV/m)	Margin (dB)	Antenna Height (m)	Table Angle (Degree)	Raw Value (dBuV)	Correction Factor (dB/m)
1	*7115.00	100.8 PK			2.66 V	264	52.8	48.0
2	*7115.00	90.8 AV			2.66 V	264	42.8	48.0
3	#7125.00	82.4 PK	88.2	-5.8	2.66 V	264	64.9	17.5
4	#7125.00	58.1 AV	68.2	-10.1	2.66 V	264	40.6	17.5
5	#14230.00	65.8 PK	88.2	-22.4	3.02 V	326	40.3	25.5
6	#14230.00	52.6 AV	68.2	-15.6	3.02 V	326	27.1	25.5

**Remarks:**

1. Emission Level(dBuV/m) = Raw Value(dBuV) + Correction Factor(dB/m)
2. Correction Factor(dB/m) = Antenna Factor(dB/m) + Cable Factor(dB) – Pre-Amplifier Factor(dB)
3. Margin value = Emission Level – Limit value
4. The other emission levels were very low against the limit.
5. " \* " : Fundamental frequency.
6. " # " : The radiated frequency is out of the restricted band.

RF Mode	TX 802.11ax (HE20)	Channel	CH 1 : 5955 MHz
Frequency Range	1GHz ~ 40GHz	Detector Function	Peak (PK) Average (AV)

**Antenna Polarity & Test Distance : Horizontal at 3 m**

No	Frequency (MHz)	Emission Level (dBuV/m)	Limit (dBuV/m)	Margin (dB)	Antenna Height (m)	Table Angle (Degree)	Raw Value (dBuV)	Correction Factor (dB/m)
1	#5925.00	62.2 PK	88.2	-26.0	1.24 H	178	47.8	14.4
2	#5925.00	49.3 AV	68.2	-18.9	1.24 H	178	34.9	14.4
3	*5955.00	98.3 PK			1.24 H	178	54.1	44.2
4	*5955.00	85.4 AV			1.24 H	178	41.2	44.2
5	11910.00	62.7 PK	74.0	-11.3	2.08 H	247	39.8	22.9
6	11910.00	49.7 AV	54.0	-4.3	2.08 H	247	26.8	22.9

**Antenna Polarity & Test Distance : Vertical at 3 m**

No	Frequency (MHz)	Emission Level (dBuV/m)	Limit (dBuV/m)	Margin (dB)	Antenna Height (m)	Table Angle (Degree)	Raw Value (dBuV)	Correction Factor (dB/m)
1	#5925.00	62.8 PK	88.2	-25.4	2.33 V	202	48.4	14.4
2	#5925.00	49.7 AV	68.2	-18.5	2.33 V	202	35.3	14.4
3	*5955.00	102.8 PK			2.33 V	202	58.6	44.2
4	*5955.00	90.1 AV			2.33 V	202	45.9	44.2
5	11910.00	63.3 PK	74.0	-10.7	2.73 V	314	40.4	22.9
6	11910.00	49.8 AV	54.0	-4.2	2.73 V	314	26.9	22.9

**Remarks:**

1. Emission Level(dBuV/m) = Raw Value(dBuV) + Correction Factor(dB/m)
2. Correction Factor(dB/m) = Antenna Factor(dB/m) + Cable Factor(dB) – Pre-Amplifier Factor(dB)
3. Margin value = Emission Level – Limit value
4. The other emission levels were very low against the limit.
5. " \* " : Fundamental frequency.
6. " # " : The radiated frequency is out of the restricted band.

RF Mode	TX 802.11ax (HE20)	Channel	CH 45 : 6175 MHz
Frequency Range	1GHz ~ 40GHz	Detector Function	Peak (PK) Average (AV)

**Antenna Polarity & Test Distance : Horizontal at 3 m**

No	Frequency (MHz)	Emission Level (dBuV/m)	Limit (dBuV/m)	Margin (dB)	Antenna Height (m)	Table Angle (Degree)	Raw Value (dBuV)	Correction Factor (dB/m)
1	*6175.00	98.1 PK			1.28 H	182	53.6	44.5
2	*6175.00	85.4 AV			1.28 H	182	40.9	44.5
3	12350.00	62.6 PK	74.0	-11.4	1.97 H	236	39.9	22.7
4	12350.00	49.5 AV	54.0	-4.5	1.97 H	236	26.8	22.7

**Antenna Polarity & Test Distance : Vertical at 3 m**

No	Frequency (MHz)	Emission Level (dBuV/m)	Limit (dBuV/m)	Margin (dB)	Antenna Height (m)	Table Angle (Degree)	Raw Value (dBuV)	Correction Factor (dB/m)
1	*6175.00	103.0 PK			2.38 V	226	58.5	44.5
2	*6175.00	90.2 AV			2.38 V	226	45.7	44.5
3	12350.00	63.0 PK	74.0	-11.0	2.82 V	311	40.3	22.7
4	12350.00	49.7 AV	54.0	-4.3	2.82 V	311	27.0	22.7

**Remarks:**

1. Emission Level(dBuV/m) = Raw Value(dBuV) + Correction Factor(dB/m)
2. Correction Factor(dB/m) = Antenna Factor(dB/m) + Cable Factor(dB) – Pre-Amplifier Factor(dB)
3. Margin value = Emission Level – Limit value
4. The other emission levels were very low against the limit.
5. " \* ": Fundamental frequency.

RF Mode	TX 802.11ax (HE20)	Channel	CH 93 : 6415 MHz
Frequency Range	1GHz ~ 40GHz	Detector Function	Peak (PK) Average (AV)

**Antenna Polarity & Test Distance : Horizontal at 3 m**

No	Frequency (MHz)	Emission Level (dBuV/m)	Limit (dBuV/m)	Margin (dB)	Antenna Height (m)	Table Angle (Degree)	Raw Value (dBuV)	Correction Factor (dB/m)
1	*6415.00	98.6 PK			1.18 H	174	53.1	45.5
2	*6415.00	85.8 AV			1.18 H	174	40.3	45.5
3	#12830.00	63.1 PK	88.2	-25.1	2.04 H	235	39.8	23.3
4	#12830.00	49.9 AV	68.2	-18.3	2.04 H	235	26.6	23.3

**Antenna Polarity & Test Distance : Vertical at 3 m**

No	Frequency (MHz)	Emission Level (dBuV/m)	Limit (dBuV/m)	Margin (dB)	Antenna Height (m)	Table Angle (Degree)	Raw Value (dBuV)	Correction Factor (dB/m)
1	*6415.00	103.1 PK			2.38 V	197	57.6	45.5
2	*6415.00	90.4 AV			2.38 V	197	44.9	45.5
3	#12830.00	63.5 PK	88.2	-24.7	2.88 V	310	40.2	23.3
4	#12830.00	50.2 AV	68.2	-18.0	2.88 V	310	26.9	23.3

**Remarks:**

1. Emission Level(dBuV/m) = Raw Value(dBuV) + Correction Factor(dB/m)
2. Correction Factor(dB/m) = Antenna Factor(dB/m) + Cable Factor(dB) – Pre-Amplifier Factor(dB)
3. Margin value = Emission Level – Limit value
4. The other emission levels were very low against the limit.
5. " \* ": Fundamental frequency.
6. " # ": The radiated frequency is out of the restricted band.

RF Mode	TX 802.11ax (HE20)	Channel	CH 97 : 6435 MHz
Frequency Range	1GHz ~ 40GHz	Detector Function	Peak (PK) Average (AV)

**Antenna Polarity & Test Distance : Horizontal at 3 m**

No	Frequency (MHz)	Emission Level (dBuV/m)	Limit (dBuV/m)	Margin (dB)	Antenna Height (m)	Table Angle (Degree)	Raw Value (dBuV)	Correction Factor (dB/m)
1	*6435.00	98.0 PK			1.39 H	188	52.4	45.6
2	*6435.00	85.1 AV			1.39 H	188	39.5	45.6
3	#12870.00	63.2 PK	88.2	-25.0	2.11 H	235	39.8	23.4
4	#12870.00	50.3 AV	68.2	-17.9	2.11 H	235	26.9	23.4

**Antenna Polarity & Test Distance : Vertical at 3 m**

No	Frequency (MHz)	Emission Level (dBuV/m)	Limit (dBuV/m)	Margin (dB)	Antenna Height (m)	Table Angle (Degree)	Raw Value (dBuV)	Correction Factor (dB/m)
1	*6435.00	102.7 PK			2.87 V	298	57.1	45.6
2	*6435.00	89.8 AV			2.87 V	298	44.2	45.6
3	#12870.00	63.7 PK	88.2	-24.5	2.97 V	316	40.3	23.4
4	#12870.00	50.5 AV	68.2	-17.7	2.97 V	316	27.1	23.4

**Remarks:**

1. Emission Level(dBuV/m) = Raw Value(dBuV) + Correction Factor(dB/m)
2. Correction Factor(dB/m) = Antenna Factor(dB/m) + Cable Factor(dB) – Pre-Amplifier Factor(dB)
3. Margin value = Emission Level – Limit value
4. The other emission levels were very low against the limit.
5. " \* ": Fundamental frequency.
6. " # ": The radiated frequency is out of the restricted band.

RF Mode	TX 802.11ax (HE20)	Channel	CH 105 : 6475 MHz
Frequency Range	1GHz ~ 40GHz	Detector Function	Peak (PK) Average (AV)

**Antenna Polarity & Test Distance : Horizontal at 3 m**

No	Frequency (MHz)	Emission Level (dBuV/m)	Limit (dBuV/m)	Margin (dB)	Antenna Height (m)	Table Angle (Degree)	Raw Value (dBuV)	Correction Factor (dB/m)
1	*6475.00	97.8 PK			1.27 H	178	51.8	46.0
2	*6475.00	84.9 AV			1.27 H	178	38.9	46.0
3	#12950.00	63.2 PK	88.2	-25.0	2.14 H	252	39.7	23.5
4	#12950.00	50.1 AV	68.2	-18.1	2.14 H	252	26.6	23.5

**Antenna Polarity & Test Distance : Vertical at 3 m**

No	Frequency (MHz)	Emission Level (dBuV/m)	Limit (dBuV/m)	Margin (dB)	Antenna Height (m)	Table Angle (Degree)	Raw Value (dBuV)	Correction Factor (dB/m)
1	*6475.00	102.6 PK			2.76 V	289	56.6	46.0
2	*6475.00	89.6 AV			2.76 V	289	43.6	46.0
3	#12950.00	63.7 PK	88.2	-24.5	2.77 V	308	40.2	23.5
4	#12950.00	50.4 AV	68.2	-17.8	2.77 V	308	26.9	23.5

**Remarks:**

1. Emission Level(dBuV/m) = Raw Value(dBuV) + Correction Factor(dB/m)
2. Correction Factor(dB/m) = Antenna Factor(dB/m) + Cable Factor(dB) – Pre-Amplifier Factor(dB)
3. Margin value = Emission Level – Limit value
4. The other emission levels were very low against the limit.
5. " \* ": Fundamental frequency.
6. " # ": The radiated frequency is out of the restricted band.



RF Mode	TX 802.11ax (HE20)	Channel	CH 113 : 6515 MHz
Frequency Range	1GHz ~ 40GHz	Detector Function	Peak (PK) Average (AV)

**Antenna Polarity & Test Distance : Horizontal at 3 m**

No	Frequency (MHz)	Emission Level (dBuV/m)	Limit (dBuV/m)	Margin (dB)	Antenna Height (m)	Table Angle (Degree)	Raw Value (dBuV)	Correction Factor (dB/m)
1	*6515.00	97.9 PK			1.37 H	192	51.6	46.3
2	*6515.00	85.1 AV			1.37 H	192	38.8	46.3
3	#13030.00	63.2 PK	88.2	-25.0	2.13 H	251	39.7	23.5
4	#13030.00	50.1 AV	68.2	-18.1	2.13 H	251	26.6	23.5

**Antenna Polarity & Test Distance : Vertical at 3 m**

No	Frequency (MHz)	Emission Level (dBuV/m)	Limit (dBuV/m)	Margin (dB)	Antenna Height (m)	Table Angle (Degree)	Raw Value (dBuV)	Correction Factor (dB/m)
1	*6515.00	102.8 PK			2.83 V	294	56.5	46.3
2	*6515.00	89.9 AV			2.83 V	294	43.6	46.3
3	#13030.00	63.6 PK	88.2	-24.6	2.73 V	296	40.1	23.5
4	#13030.00	50.4 AV	68.2	-17.8	2.73 V	296	26.9	23.5

**Remarks:**

1. Emission Level(dBuV/m) = Raw Value(dBuV) + Correction Factor(dB/m)
2. Correction Factor(dB/m) = Antenna Factor(dB/m) + Cable Factor(dB) – Pre-Amplifier Factor(dB)
3. Margin value = Emission Level – Limit value
4. The other emission levels were very low against the limit.
5. " \* ": Fundamental frequency.
6. " # ": The radiated frequency is out of the restricted band.

RF Mode	TX 802.11ax (HE20)	Channel	CH 117 : 6535 MHz
Frequency Range	1GHz ~ 40GHz	Detector Function	Peak (PK) Average (AV)

**Antenna Polarity & Test Distance : Horizontal at 3 m**

No	Frequency (MHz)	Emission Level (dBuV/m)	Limit (dBuV/m)	Margin (dB)	Antenna Height (m)	Table Angle (Degree)	Raw Value (dBuV)	Correction Factor (dB/m)
1	*6535.00	98.0 PK			1.37 H	165	51.6	46.4
2	*6535.00	85.0 AV			1.37 H	165	38.6	46.4
3	#13070.00	63.2 PK	88.2	-25.0	2.23 H	261	39.8	23.4
4	#13070.00	50.1 AV	68.2	-18.1	2.23 H	261	26.7	23.4

**Antenna Polarity & Test Distance : Vertical at 3 m**

No	Frequency (MHz)	Emission Level (dBuV/m)	Limit (dBuV/m)	Margin (dB)	Antenna Height (m)	Table Angle (Degree)	Raw Value (dBuV)	Correction Factor (dB/m)
1	*6535.00	102.5 PK			2.94 V	290	56.1	46.4
2	*6535.00	89.4 AV			2.94 V	290	43.0	46.4
3	#13070.00	63.8 PK	88.2	-24.4	2.97 V	308	40.4	23.4
4	#13070.00	50.5 AV	68.2	-17.7	2.97 V	308	27.1	23.4

**Remarks:**

1. Emission Level(dBuV/m) = Raw Value(dBuV) + Correction Factor(dB/m)
2. Correction Factor(dB/m) = Antenna Factor(dB/m) + Cable Factor(dB) – Pre-Amplifier Factor(dB)
3. Margin value = Emission Level – Limit value
4. The other emission levels were very low against the limit.
5. " \* ": Fundamental frequency.
6. " # ": The radiated frequency is out of the restricted band.

RF Mode	TX 802.11ax (HE20)	Channel	CH 153 : 6715 MHz
Frequency Range	1GHz ~ 40GHz	Detector Function	Peak (PK) Average (AV)

**Antenna Polarity & Test Distance : Horizontal at 3 m**

No	Frequency (MHz)	Emission Level (dBuV/m)	Limit (dBuV/m)	Margin (dB)	Antenna Height (m)	Table Angle (Degree)	Raw Value (dBuV)	Correction Factor (dB/m)
1	*6715.00	98.4 PK			1.38 H	170	52.3	46.1
2	*6715.00	85.2 AV			1.38 H	170	39.1	46.1
3	#13430.00	64.0 PK	88.2	-24.2	2.18 H	263	39.9	24.1
4	#13430.00	50.9 AV	68.2	-17.3	2.18 H	263	26.8	24.1

**Antenna Polarity & Test Distance : Vertical at 3 m**

No	Frequency (MHz)	Emission Level (dBuV/m)	Limit (dBuV/m)	Margin (dB)	Antenna Height (m)	Table Angle (Degree)	Raw Value (dBuV)	Correction Factor (dB/m)
1	*6715.00	102.7 PK			2.87 V	284	56.6	46.1
2	*6715.00	89.7 AV			2.87 V	284	43.6	46.1
3	#13430.00	64.3 PK	88.2	-23.9	2.84 V	325	40.2	24.1
4	#13430.00	51.0 AV	68.2	-17.2	2.84 V	325	26.9	24.1

**Remarks:**

1. Emission Level(dBuV/m) = Raw Value(dBuV) + Correction Factor(dB/m)
2. Correction Factor(dB/m) = Antenna Factor(dB/m) + Cable Factor(dB) – Pre-Amplifier Factor(dB)
3. Margin value = Emission Level – Limit value
4. The other emission levels were very low against the limit.
5. " \* ": Fundamental frequency.
6. " # ": The radiated frequency is out of the restricted band.

RF Mode	TX 802.11ax (HE20)	Channel	CH 181 : 6855 MHz
Frequency Range	1GHz ~ 40GHz	Detector Function	Peak (PK) Average (AV)

**Antenna Polarity & Test Distance : Horizontal at 3 m**

No	Frequency (MHz)	Emission Level (dBuV/m)	Limit (dBuV/m)	Margin (dB)	Antenna Height (m)	Table Angle (Degree)	Raw Value (dBuV)	Correction Factor (dB/m)
1	*6855.00	98.4 PK			1.34 H	165	51.8	46.6
2	*6855.00	85.2 AV			1.34 H	165	38.6	46.6
3	#13710.00	64.5 PK	88.2	-23.7	2.24 H	267	39.9	24.6
4	#13710.00	51.4 AV	68.2	-16.8	2.24 H	267	26.8	24.6

**Antenna Polarity & Test Distance : Vertical at 3 m**

No	Frequency (MHz)	Emission Level (dBuV/m)	Limit (dBuV/m)	Margin (dB)	Antenna Height (m)	Table Angle (Degree)	Raw Value (dBuV)	Correction Factor (dB/m)
1	*6855.00	102.6 PK			3.02 V	288	56.0	46.6
2	*6855.00	89.5 AV			3.02 V	288	42.9	46.6
3	#13710.00	64.8 PK	88.2	-23.4	2.93 V	311	40.2	24.6
4	#13710.00	51.7 AV	68.2	-16.5	2.93 V	311	27.1	24.6

**Remarks:**

1. Emission Level(dBuV/m) = Raw Value(dBuV) + Correction Factor(dB/m)
2. Correction Factor(dB/m) = Antenna Factor(dB/m) + Cable Factor(dB) – Pre-Amplifier Factor(dB)
3. Margin value = Emission Level – Limit value
4. The other emission levels were very low against the limit.
5. " \* ": Fundamental frequency.
6. " # ": The radiated frequency is out of the restricted band.

RF Mode	TX 802.11ax (HE20)	Channel	CH 185 : 6875 MHz
Frequency Range	1GHz ~ 40GHz	Detector Function	Peak (PK) Average (AV)

**Antenna Polarity & Test Distance : Horizontal at 3 m**

No	Frequency (MHz)	Emission Level (dBuV/m)	Limit (dBuV/m)	Margin (dB)	Antenna Height (m)	Table Angle (Degree)	Raw Value (dBuV)	Correction Factor (dB/m)
1	*6875.00	100.0 PK			1.45 H	172	53.4	46.6
2	*6875.00	86.8 AV			1.45 H	172	40.2	46.6
3	#13750.00	64.4 PK	88.2	-23.8	2.23 H	264	39.9	24.5
4	#13750.00	51.2 AV	68.2	-17.0	2.23 H	264	26.7	24.5

**Antenna Polarity & Test Distance : Vertical at 3 m**

No	Frequency (MHz)	Emission Level (dBuV/m)	Limit (dBuV/m)	Margin (dB)	Antenna Height (m)	Table Angle (Degree)	Raw Value (dBuV)	Correction Factor (dB/m)
1	*6875.00	104.4 PK			2.43 V	268	57.8	46.6
2	*6875.00	91.3 AV			2.43 V	268	44.7	46.6
3	#13750.00	64.9 PK	88.2	-23.3	2.85 V	314	40.4	24.5
4	#13750.00	51.7 AV	68.2	-16.5	2.85 V	314	27.2	24.5

**Remarks:**

1. Emission Level(dBuV/m) = Raw Value(dBuV) + Correction Factor(dB/m)
2. Correction Factor(dB/m) = Antenna Factor(dB/m) + Cable Factor(dB) – Pre-Amplifier Factor(dB)
3. Margin value = Emission Level – Limit value
4. The other emission levels were very low against the limit.
5. " \* " : Fundamental frequency.
6. " # " : The radiated frequency is out of the restricted band.

RF Mode	TX 802.11ax (HE20)	Channel	CH 213 : 7015 MHz
Frequency Range	1GHz ~ 40GHz	Detector Function	Peak (PK) Average (AV)

**Antenna Polarity & Test Distance : Horizontal at 3 m**

No	Frequency (MHz)	Emission Level (dBuV/m)	Limit (dBuV/m)	Margin (dB)	Antenna Height (m)	Table Angle (Degree)	Raw Value (dBuV)	Correction Factor (dB/m)
1	*7015.00	100.1 PK			1.41 H	158	52.3	47.8
2	*7015.00	86.9 AV			1.41 H	158	39.1	47.8
3	#14030.00	65.0 PK	88.2	-23.2	2.36 H	274	39.8	25.2
4	#14030.00	51.9 AV	68.2	-16.3	2.36 H	274	26.7	25.2

**Antenna Polarity & Test Distance : Vertical at 3 m**

No	Frequency (MHz)	Emission Level (dBuV/m)	Limit (dBuV/m)	Margin (dB)	Antenna Height (m)	Table Angle (Degree)	Raw Value (dBuV)	Correction Factor (dB/m)
1	*7015.00	104.7 PK			2.56 V	273	56.9	47.8
2	*7015.00	91.5 AV			2.56 V	273	43.7	47.8
3	#14030.00	65.4 PK	88.2	-22.8	3.03 V	326	40.2	25.2
4	#14030.00	52.3 AV	68.2	-15.9	3.03 V	326	27.1	25.2

**Remarks:**

1. Emission Level(dBuV/m) = Raw Value(dBuV) + Correction Factor(dB/m)
2. Correction Factor(dB/m) = Antenna Factor(dB/m) + Cable Factor(dB) – Pre-Amplifier Factor(dB)
3. Margin value = Emission Level – Limit value
4. The other emission levels were very low against the limit.
5. " \* ": Fundamental frequency.
6. " # ": The radiated frequency is out of the restricted band.

RF Mode	TX 802.11ax (HE20)	Channel	CH 229 : 7095 MHz
Frequency Range	1GHz ~ 40GHz	Detector Function	Peak (PK) Average (AV)

**Antenna Polarity & Test Distance : Horizontal at 3 m**

No	Frequency (MHz)	Emission Level (dBuV/m)	Limit (dBuV/m)	Margin (dB)	Antenna Height (m)	Table Angle (Degree)	Raw Value (dBuV)	Correction Factor (dB/m)
1	*7095.00	100.3 PK			1.35 H	179	52.6	47.7
2	*7095.00	87.0 AV			1.35 H	179	39.3	47.7
3	#14190.00	65.2 PK	88.2	-23.0	2.03 H	268	39.8	25.4
4	#14190.00	52.2 AV	68.2	-16.0	2.03 H	268	26.8	25.4

**Antenna Polarity & Test Distance : Vertical at 3 m**

No	Frequency (MHz)	Emission Level (dBuV/m)	Limit (dBuV/m)	Margin (dB)	Antenna Height (m)	Table Angle (Degree)	Raw Value (dBuV)	Correction Factor (dB/m)
1	*7095.00	104.8 PK			2.67 V	273	57.1	47.7
2	*7095.00	91.6 AV			2.67 V	273	43.9	47.7
3	#14190.00	65.5 PK	88.2	-22.7	2.87 V	316	40.1	25.4
4	#14190.00	52.4 AV	68.2	-15.8	2.87 V	316	27.0	25.4

**Remarks:**

1. Emission Level(dBuV/m) = Raw Value(dBuV) + Correction Factor(dB/m)
2. Correction Factor(dB/m) = Antenna Factor(dB/m) + Cable Factor(dB) – Pre-Amplifier Factor(dB)
3. Margin value = Emission Level – Limit value
4. The other emission levels were very low against the limit.
5. " \* ": Fundamental frequency.
6. " # ": The radiated frequency is out of the restricted band.

RF Mode	TX 802.11ax (HE20)	Channel	CH 233 : 7115 MHz
Frequency Range	1GHz ~ 40GHz	Detector Function	Peak (PK) Average (AV)

**Antenna Polarity & Test Distance : Horizontal at 3 m**

No	Frequency (MHz)	Emission Level (dBuV/m)	Limit (dBuV/m)	Margin (dB)	Antenna Height (m)	Table Angle (Degree)	Raw Value (dBuV)	Correction Factor (dB/m)
1	*7115.00	99.3 PK			1.31 H	168	51.3	48.0
2	*7115.00	86.0 AV			1.31 H	168	38.0	48.0
3	#7125.00	82.7 PK	88.2	-5.5	1.31 H	168	65.2	17.5
4	#7125.00	66.1 AV	68.2	-2.1	1.31 H	168	48.6	17.5
5	#14230.00	65.2 PK	88.2	-23.0	2.07 H	254	39.7	25.5
6	#14230.00	52.1 AV	68.2	-16.1	2.07 H	254	26.6	25.5

**Antenna Polarity & Test Distance : Vertical at 3 m**

No	Frequency (MHz)	Emission Level (dBuV/m)	Limit (dBuV/m)	Margin (dB)	Antenna Height (m)	Table Angle (Degree)	Raw Value (dBuV)	Correction Factor (dB/m)
1	*7115.00	103.7 PK			2.52 V	264	55.7	48.0
2	*7115.00	90.4 AV			2.52 V	264	42.4	48.0
3	#7125.00	86.9 PK	88.2	-1.3	2.52 V	264	69.4	17.5
4	#7125.00	67.5 AV	68.2	-0.7	2.52 V	264	50.0	17.5
5	#14230.00	65.4 PK	88.2	-22.8	2.99 V	318	39.9	25.5
6	#14230.00	52.2 AV	68.2	-16.0	2.99 V	318	26.7	25.5

**Remarks:**

1. Emission Level(dBuV/m) = Raw Value(dBuV) + Correction Factor(dB/m)
2. Correction Factor(dB/m) = Antenna Factor(dB/m) + Cable Factor(dB) – Pre-Amplifier Factor(dB)
3. Margin value = Emission Level – Limit value
4. The other emission levels were very low against the limit.
5. " \* " : Fundamental frequency.
6. " # " : The radiated frequency is out of the restricted band.



RF Mode	TX 802.11ax (HE40)	Channel	CH 3 : 5965 MHz
Frequency Range	1GHz ~ 40GHz	Detector Function	Peak (PK) Average (AV)

**Antenna Polarity & Test Distance : Horizontal at 3 m**

No	Frequency (MHz)	Emission Level (dBuV/m)	Limit (dBuV/m)	Margin (dB)	Antenna Height (m)	Table Angle (Degree)	Raw Value (dBuV)	Correction Factor (dB/m)
1	#5925.00	62.6 PK	88.2	-25.6	1.22 H	174	48.2	14.4
2	#5925.00	49.5 AV	68.2	-18.7	1.22 H	174	35.1	14.4
3	*5965.00	98.6 PK			1.22 H	174	54.4	44.2
4	*5965.00	85.8 AV			1.22 H	174	41.6	44.2
5	11930.00	62.3 PK	74.0	-11.7	2.14 H	233	39.4	22.9
6	11930.00	49.3 AV	54.0	-4.7	2.14 H	233	26.4	22.9

**Antenna Polarity & Test Distance : Vertical at 3 m**

No	Frequency (MHz)	Emission Level (dBuV/m)	Limit (dBuV/m)	Margin (dB)	Antenna Height (m)	Table Angle (Degree)	Raw Value (dBuV)	Correction Factor (dB/m)
1	#5925.00	63.0 PK	88.2	-25.2	2.76 V	212	48.6	14.4
2	#5925.00	49.8 AV	68.2	-18.4	2.76 V	212	35.4	14.4
3	*5965.00	103.5 PK			2.76 V	212	59.3	44.2
4	*5965.00	90.6 AV			2.76 V	212	46.4	44.2
5	11930.00	62.8 PK	74.0	-11.2	2.73 V	301	39.9	22.9
6	11930.00	49.7 AV	54.0	-4.3	2.73 V	301	26.8	22.9

**Remarks:**

1. Emission Level(dBuV/m) = Raw Value(dBuV) + Correction Factor(dB/m)
2. Correction Factor(dB/m) = Antenna Factor(dB/m) + Cable Factor(dB) – Pre-Amplifier Factor(dB)
3. Margin value = Emission Level – Limit value
4. The other emission levels were very low against the limit.
5. " \* " : Fundamental frequency.
6. " # " : The radiated frequency is out of the restricted band.

RF Mode	TX 802.11ax (HE40)	Channel	CH 43 : 6165 MHz
Frequency Range	1GHz ~ 40GHz	Detector Function	Peak (PK) Average (AV)

**Antenna Polarity & Test Distance : Horizontal at 3 m**

No	Frequency (MHz)	Emission Level (dBuV/m)	Limit (dBuV/m)	Margin (dB)	Antenna Height (m)	Table Angle (Degree)	Raw Value (dBuV)	Correction Factor (dB/m)
1	*6165.00	98.9 PK			1.21 H	176	54.4	44.5
2	*6165.00	86.0 AV			1.21 H	176	41.5	44.5
3	12330.00	62.3 PK	74.0	-11.7	2.03 H	244	39.6	22.7
4	12330.00	49.2 AV	54.0	-4.8	2.03 H	244	26.5	22.7

**Antenna Polarity & Test Distance : Vertical at 3 m**

No	Frequency (MHz)	Emission Level (dBuV/m)	Limit (dBuV/m)	Margin (dB)	Antenna Height (m)	Table Angle (Degree)	Raw Value (dBuV)	Correction Factor (dB/m)
1	*6165.00	103.8 PK			2.53 V	217	59.3	44.5
2	*6165.00	90.8 AV			2.53 V	217	46.3	44.5
3	12330.00	62.8 PK	74.0	-11.2	2.71 V	306	40.1	22.7
4	12330.00	49.5 AV	54.0	-4.5	2.71 V	306	26.8	22.7

**Remarks:**

1. Emission Level(dBuV/m) = Raw Value(dBuV) + Correction Factor(dB/m)
2. Correction Factor(dB/m) = Antenna Factor(dB/m) + Cable Factor(dB) – Pre-Amplifier Factor(dB)
3. Margin value = Emission Level – Limit value
4. The other emission levels were very low against the limit.
5. " \* " : Fundamental frequency.

RF Mode	TX 802.11ax (HE40)	Channel	CH 91 : 6405 MHz
Frequency Range	1GHz ~ 40GHz	Detector Function	Peak (PK) Average (AV)

**Antenna Polarity & Test Distance : Horizontal at 3 m**

No	Frequency (MHz)	Emission Level (dBuV/m)	Limit (dBuV/m)	Margin (dB)	Antenna Height (m)	Table Angle (Degree)	Raw Value (dBuV)	Correction Factor (dB/m)
1	*6405.00	98.5 PK			1.31 H	186	53.1	45.4
2	*6405.00	85.7 AV			1.31 H	186	40.3	45.4
3	#12810.00	62.8 PK	88.2	-25.4	1.98 H	236	39.5	23.3
4	#12810.00	49.7 AV	68.2	-18.5	1.98 H	236	26.4	23.3

**Antenna Polarity & Test Distance : Vertical at 3 m**

No	Frequency (MHz)	Emission Level (dBuV/m)	Limit (dBuV/m)	Margin (dB)	Antenna Height (m)	Table Angle (Degree)	Raw Value (dBuV)	Correction Factor (dB/m)
1	*6405.00	103.3 PK			2.58 V	211	57.9	45.4
2	*6405.00	90.4 AV			2.58 V	211	45.0	45.4
3	#12810.00	63.1 PK	88.2	-25.1	2.75 V	314	39.8	23.3
4	#12810.00	50.0 AV	68.2	-18.2	2.75 V	314	26.7	23.3

**Remarks:**

1. Emission Level(dBuV/m) = Raw Value(dBuV) + Correction Factor(dB/m)
2. Correction Factor(dB/m) = Antenna Factor(dB/m) + Cable Factor(dB) – Pre-Amplifier Factor(dB)
3. Margin value = Emission Level – Limit value
4. The other emission levels were very low against the limit.
5. " \* ": Fundamental frequency.
6. " # ": The radiated frequency is out of the restricted band.

RF Mode	TX 802.11ax (HE40)	Channel	CH 99 : 6445 MHz
Frequency Range	1GHz ~ 40GHz	Detector Function	Peak (PK) Average (AV)

**Antenna Polarity & Test Distance : Horizontal at 3 m**

No	Frequency (MHz)	Emission Level (dBuV/m)	Limit (dBuV/m)	Margin (dB)	Antenna Height (m)	Table Angle (Degree)	Raw Value (dBuV)	Correction Factor (dB/m)
1	*6445.00	98.8 PK			1.25 H	182	53.1	45.7
2	*6445.00	85.9 AV			1.25 H	182	40.2	45.7
3	#12890.00	63.0 PK	88.2	-25.2	2.12 H	235	39.6	23.4
4	#12890.00	49.9 AV	68.2	-18.3	2.12 H	235	26.5	23.4

**Antenna Polarity & Test Distance : Vertical at 3 m**

No	Frequency (MHz)	Emission Level (dBuV/m)	Limit (dBuV/m)	Margin (dB)	Antenna Height (m)	Table Angle (Degree)	Raw Value (dBuV)	Correction Factor (dB/m)
1	*6445.00	103.5 PK			2.85 V	299	57.8	45.7
2	*6445.00	90.6 AV			2.85 V	299	44.9	45.7
3	#12890.00	63.2 PK	88.2	-25.0	2.92 V	314	39.8	23.4
4	#12890.00	50.2 AV	68.2	-18.0	2.92 V	314	26.8	23.4

**Remarks:**

1. Emission Level(dBuV/m) = Raw Value(dBuV) + Correction Factor(dB/m)
2. Correction Factor(dB/m) = Antenna Factor(dB/m) + Cable Factor(dB) – Pre-Amplifier Factor(dB)
3. Margin value = Emission Level – Limit value
4. The other emission levels were very low against the limit.
5. " \* ": Fundamental frequency.
6. " # ": The radiated frequency is out of the restricted band.

RF Mode	TX 802.11ax (HE40)	Channel	CH 107 : 6485 MHz
Frequency Range	1GHz ~ 40GHz	Detector Function	Peak (PK) Average (AV)

**Antenna Polarity & Test Distance : Horizontal at 3 m**

No	Frequency (MHz)	Emission Level (dBuV/m)	Limit (dBuV/m)	Margin (dB)	Antenna Height (m)	Table Angle (Degree)	Raw Value (dBuV)	Correction Factor (dB/m)
1	*6485.00	99.0 PK			1.34 H	182	52.9	46.1
2	*6485.00	86.2 AV			1.34 H	182	40.1	46.1
3	#12970.00	63.1 PK	88.2	-25.1	2.11 H	236	39.6	23.5
4	#12970.00	50.0 AV	68.2	-18.2	2.11 H	236	26.5	23.5

**Antenna Polarity & Test Distance : Vertical at 3 m**

No	Frequency (MHz)	Emission Level (dBuV/m)	Limit (dBuV/m)	Margin (dB)	Antenna Height (m)	Table Angle (Degree)	Raw Value (dBuV)	Correction Factor (dB/m)
1	*6485.00	103.7 PK			2.84 V	292	57.6	46.1
2	*6485.00	90.8 AV			2.84 V	292	44.7	46.1
3	#12970.00	63.3 PK	88.2	-24.9	2.73 V	298	39.8	23.5
4	#12970.00	50.2 AV	68.2	-18.0	2.73 V	298	26.7	23.5

**Remarks:**

1. Emission Level(dBuV/m) = Raw Value(dBuV) + Correction Factor(dB/m)
2. Correction Factor(dB/m) = Antenna Factor(dB/m) + Cable Factor(dB) – Pre-Amplifier Factor(dB)
3. Margin value = Emission Level – Limit value
4. The other emission levels were very low against the limit.
5. " \* ": Fundamental frequency.
6. " # ": The radiated frequency is out of the restricted band.

RF Mode	TX 802.11ax (HE40)	Channel	CH 115 : 6525 MHz
Frequency Range	1GHz ~ 40GHz	Detector Function	Peak (PK) Average (AV)

**Antenna Polarity & Test Distance : Horizontal at 3 m**

No	Frequency (MHz)	Emission Level (dBuV/m)	Limit (dBuV/m)	Margin (dB)	Antenna Height (m)	Table Angle (Degree)	Raw Value (dBuV)	Correction Factor (dB/m)
1	*6525.00	98.6 PK			1.33 H	181	52.3	46.3
2	*6525.00	85.7 AV			1.33 H	181	39.4	46.3
3	#13050.00	62.9 PK	88.2	-25.3	2.12 H	253	39.4	23.5
4	#13050.00	49.9 AV	68.2	-18.3	2.12 H	253	26.4	23.5

**Antenna Polarity & Test Distance : Vertical at 3 m**

No	Frequency (MHz)	Emission Level (dBuV/m)	Limit (dBuV/m)	Margin (dB)	Antenna Height (m)	Table Angle (Degree)	Raw Value (dBuV)	Correction Factor (dB/m)
1	*6525.00	103.2 PK			2.84 V	296	56.9	46.3
2	*6525.00	90.4 AV			2.84 V	296	44.1	46.3
3	#13050.00	63.3 PK	88.2	-24.9	2.71 V	302	39.8	23.5
4	#13050.00	50.2 AV	68.2	-18.0	2.71 V	302	26.7	23.5

**Remarks:**

1. Emission Level(dBuV/m) = Raw Value(dBuV) + Correction Factor(dB/m)
2. Correction Factor(dB/m) = Antenna Factor(dB/m) + Cable Factor(dB) – Pre-Amplifier Factor(dB)
3. Margin value = Emission Level – Limit value
4. The other emission levels were very low against the limit.
5. " \* ": Fundamental frequency.
6. " # ": The radiated frequency is out of the restricted band.

RF Mode	TX 802.11ax (HE40)	Channel	CH 123 : 6565 MHz
Frequency Range	1GHz ~ 40GHz	Detector Function	Peak (PK) Average (AV)

**Antenna Polarity & Test Distance : Horizontal at 3 m**

No	Frequency (MHz)	Emission Level (dBuV/m)	Limit (dBuV/m)	Margin (dB)	Antenna Height (m)	Table Angle (Degree)	Raw Value (dBuV)	Correction Factor (dB/m)
1	*6565.00	99.2 PK			1.44 H	168	52.7	46.5
2	*6565.00	86.1 AV			1.44 H	168	39.6	46.5
3	#13130.00	62.9 PK	88.2	-25.3	2.23 H	261	39.5	23.4
4	#13130.00	49.8 AV	68.2	-18.4	2.23 H	261	26.4	23.4

**Antenna Polarity & Test Distance : Vertical at 3 m**

No	Frequency (MHz)	Emission Level (dBuV/m)	Limit (dBuV/m)	Margin (dB)	Antenna Height (m)	Table Angle (Degree)	Raw Value (dBuV)	Correction Factor (dB/m)
1	*6565.00	103.7 PK			2.92 V	289	57.2	46.5
2	*6565.00	90.5 AV			2.92 V	289	44.0	46.5
3	#13130.00	63.3 PK	88.2	-24.9	3.03 V	317	39.9	23.4
4	#13130.00	50.3 AV	68.2	-17.9	3.03 V	317	26.9	23.4

**Remarks:**

1. Emission Level(dBuV/m) = Raw Value(dBuV) + Correction Factor(dB/m)
2. Correction Factor(dB/m) = Antenna Factor(dB/m) + Cable Factor(dB) – Pre-Amplifier Factor(dB)
3. Margin value = Emission Level – Limit value
4. The other emission levels were very low against the limit.
5. " \* ": Fundamental frequency.
6. " # ": The radiated frequency is out of the restricted band.

RF Mode	TX 802.11ax (HE40)	Channel	CH 155 : 6725 MHz
Frequency Range	1GHz ~ 40GHz	Detector Function	Peak (PK) Average (AV)

**Antenna Polarity & Test Distance : Horizontal at 3 m**

No	Frequency (MHz)	Emission Level (dBuV/m)	Limit (dBuV/m)	Margin (dB)	Antenna Height (m)	Table Angle (Degree)	Raw Value (dBuV)	Correction Factor (dB/m)
1	*6725.00	99.0 PK			1.24 H	169	52.8	46.2
2	*6725.00	85.7 AV			1.24 H	169	39.5	46.2
3	#13450.00	63.9 PK	88.2	-24.3	2.17 H	259	39.6	24.3
4	#13450.00	50.8 AV	68.2	-17.4	2.17 H	259	26.5	24.3

**Antenna Polarity & Test Distance : Vertical at 3 m**

No	Frequency (MHz)	Emission Level (dBuV/m)	Limit (dBuV/m)	Margin (dB)	Antenna Height (m)	Table Angle (Degree)	Raw Value (dBuV)	Correction Factor (dB/m)
1	*6725.00	103.4 PK			2.94 V	288	57.2	46.2
2	*6725.00	90.3 AV			2.94 V	288	44.1	46.2
3	#13450.00	64.1 PK	88.2	-24.1	2.95 V	312	39.8	24.3
4	#13450.00	51.0 AV	68.2	-17.2	2.95 V	312	26.7	24.3

**Remarks:**

1. Emission Level(dBuV/m) = Raw Value(dBuV) + Correction Factor(dB/m)
2. Correction Factor(dB/m) = Antenna Factor(dB/m) + Cable Factor(dB) – Pre-Amplifier Factor(dB)
3. Margin value = Emission Level – Limit value
4. The other emission levels were very low against the limit.
5. " \* " : Fundamental frequency.
6. " # " : The radiated frequency is out of the restricted band.



RF Mode	TX 802.11ax (HE40)	Channel	CH 179 : 6845 MHz
Frequency Range	1GHz ~ 40GHz	Detector Function	Peak (PK) Average (AV)

**Antenna Polarity & Test Distance : Horizontal at 3 m**

No	Frequency (MHz)	Emission Level (dBuV/m)	Limit (dBuV/m)	Margin (dB)	Antenna Height (m)	Table Angle (Degree)	Raw Value (dBuV)	Correction Factor (dB/m)
1	*6845.00	98.7 PK			1.31 H	162	52.1	46.6
2	*6845.00	85.6 AV			1.31 H	162	39.0	46.6
3	#13690.00	64.1 PK	88.2	-24.1	2.09 H	248	39.6	24.5
4	#13690.00	50.9 AV	68.2	-17.3	2.09 H	248	26.4	24.5

**Antenna Polarity & Test Distance : Vertical at 3 m**

No	Frequency (MHz)	Emission Level (dBuV/m)	Limit (dBuV/m)	Margin (dB)	Antenna Height (m)	Table Angle (Degree)	Raw Value (dBuV)	Correction Factor (dB/m)
1	*6845.00	103.5 PK			2.85 V	291	56.9	46.6
2	*6845.00	90.2 AV			2.85 V	291	43.6	46.6
3	#13690.00	64.3 PK	88.2	-23.9	2.98 V	317	39.8	24.5
4	#13690.00	51.3 AV	68.2	-16.9	2.98 V	317	26.8	24.5

**Remarks:**

1. Emission Level(dBuV/m) = Raw Value(dBuV) + Correction Factor(dB/m)
2. Correction Factor(dB/m) = Antenna Factor(dB/m) + Cable Factor(dB) – Pre-Amplifier Factor(dB)
3. Margin value = Emission Level – Limit value
4. The other emission levels were very low against the limit.
5. " \* ": Fundamental frequency.
6. " # ": The radiated frequency is out of the restricted band.

RF Mode	TX 802.11ax (HE40)	Channel	CH 187 : 6885 MHz
Frequency Range	1GHz ~ 40GHz	Detector Function	Peak (PK) Average (AV)

**Antenna Polarity & Test Distance : Horizontal at 3 m**

No	Frequency (MHz)	Emission Level (dBuV/m)	Limit (dBuV/m)	Margin (dB)	Antenna Height (m)	Table Angle (Degree)	Raw Value (dBuV)	Correction Factor (dB/m)
1	*6885.00	99.4 PK			1.30 H	165	52.7	46.7
2	*6885.00	86.1 AV			1.30 H	165	39.4	46.7
3	#13770.00	64.0 PK	88.2	-24.2	2.26 H	259	39.5	24.5
4	#13770.00	50.9 AV	68.2	-17.3	2.26 H	259	26.4	24.5

**Antenna Polarity & Test Distance : Vertical at 3 m**

No	Frequency (MHz)	Emission Level (dBuV/m)	Limit (dBuV/m)	Margin (dB)	Antenna Height (m)	Table Angle (Degree)	Raw Value (dBuV)	Correction Factor (dB/m)
1	*6885.00	103.7 PK			2.58 V	257	57.0	46.7
2	*6885.00	90.5 AV			2.58 V	257	43.8	46.7
3	#13770.00	64.3 PK	88.2	-23.9	2.88 V	314	39.8	24.5
4	#13770.00	51.3 AV	68.2	-16.9	2.88 V	314	26.8	24.5

**Remarks:**

1. Emission Level(dBuV/m) = Raw Value(dBuV) + Correction Factor(dB/m)
2. Correction Factor(dB/m) = Antenna Factor(dB/m) + Cable Factor(dB) – Pre-Amplifier Factor(dB)
3. Margin value = Emission Level – Limit value
4. The other emission levels were very low against the limit.
5. " \* ": Fundamental frequency.
6. " # ": The radiated frequency is out of the restricted band.

RF Mode	TX 802.11ax (HE40)	Channel	CH 211 : 7005 MHz
Frequency Range	1GHz ~ 40GHz	Detector Function	Peak (PK) Average (AV)

**Antenna Polarity & Test Distance : Horizontal at 3 m**

No	Frequency (MHz)	Emission Level (dBuV/m)	Limit (dBuV/m)	Margin (dB)	Antenna Height (m)	Table Angle (Degree)	Raw Value (dBuV)	Correction Factor (dB/m)
1	*7005.00	99.1 PK			1.25 H	181	51.3	47.8
2	*7005.00	85.9 AV			1.25 H	181	38.1	47.8
3	#14010.00	64.8 PK	88.2	-23.4	2.06 H	263	39.6	25.2
4	#14010.00	51.6 AV	68.2	-16.6	2.06 H	263	26.4	25.2

**Antenna Polarity & Test Distance : Vertical at 3 m**

No	Frequency (MHz)	Emission Level (dBuV/m)	Limit (dBuV/m)	Margin (dB)	Antenna Height (m)	Table Angle (Degree)	Raw Value (dBuV)	Correction Factor (dB/m)
1	*7005.00	103.6 PK			2.74 V	269	55.8	47.8
2	*7005.00	90.3 AV			2.74 V	269	42.5	47.8
3	#14010.00	64.9 PK	88.2	-23.3	2.95 V	307	39.7	25.2
4	#14010.00	51.9 AV	68.2	-16.3	2.95 V	307	26.7	25.2

**Remarks:**

1. Emission Level(dBuV/m) = Raw Value(dBuV) + Correction Factor(dB/m)
2. Correction Factor(dB/m) = Antenna Factor(dB/m) + Cable Factor(dB) – Pre-Amplifier Factor(dB)
3. Margin value = Emission Level – Limit value
4. The other emission levels were very low against the limit.
5. " \* ": Fundamental frequency.
6. " # ": The radiated frequency is out of the restricted band.

RF Mode	TX 802.11ax (HE40)	Channel	CH 227 : 7085 MHz
Frequency Range	1GHz ~ 40GHz	Detector Function	Peak (PK) Average (AV)

**Antenna Polarity & Test Distance : Horizontal at 3 m**

No	Frequency (MHz)	Emission Level (dBuV/m)	Limit (dBuV/m)	Margin (dB)	Antenna Height (m)	Table Angle (Degree)	Raw Value (dBuV)	Correction Factor (dB/m)
1	*7085.00	98.9 PK			1.38 H	163	51.2	47.7
2	*7085.00	85.6 AV			1.38 H	163	37.9	47.7
3	#7125.00	66.9 PK	88.2	-21.3	1.38 H	163	49.4	17.5
4	#7125.00	54.0 AV	68.2	-14.2	1.38 H	163	36.5	17.5
5	#14170.00	64.9 PK	88.2	-23.3	2.31 H	266	39.6	25.3
6	#14170.00	51.7 AV	68.2	-16.5	2.31 H	266	26.4	25.3

**Antenna Polarity & Test Distance : Vertical at 3 m**

No	Frequency (MHz)	Emission Level (dBuV/m)	Limit (dBuV/m)	Margin (dB)	Antenna Height (m)	Table Angle (Degree)	Raw Value (dBuV)	Correction Factor (dB/m)
1	*7085.00	103.5 PK			2.50 V	251	55.8	47.7
2	*7085.00	90.2 AV			2.50 V	251	42.5	47.7
3	#7125.00	67.3 PK	88.2	-20.9	2.50 V	251	49.8	17.5
4	#7125.00	54.2 AV	68.2	-14.0	2.50 V	251	36.7	17.5
5	#14170.00	65.1 PK	88.2	-23.1	2.89 V	322	39.8	25.3
6	#14170.00	52.0 AV	68.2	-16.2	2.89 V	322	26.7	25.3

**Remarks:**

1. Emission Level(dBuV/m) = Raw Value(dBuV) + Correction Factor(dB/m)
2. Correction Factor(dB/m) = Antenna Factor(dB/m) + Cable Factor(dB) – Pre-Amplifier Factor(dB)
3. Margin value = Emission Level – Limit value
4. The other emission levels were very low against the limit.
5. " \* ": Fundamental frequency.
6. " # ": The radiated frequency is out of the restricted band.

RF Mode	TX 802.11ax (HE80)	Channel	CH 7 : 5985 MHz
Frequency Range	1GHz ~ 40GHz	Detector Function	Peak (PK) Average (AV)

**Antenna Polarity & Test Distance : Horizontal at 3 m**

No	Frequency (MHz)	Emission Level (dBuV/m)	Limit (dBuV/m)	Margin (dB)	Antenna Height (m)	Table Angle (Degree)	Raw Value (dBuV)	Correction Factor (dB/m)
1	#5925.00	62.7 PK	88.2	-25.5	1.28 H	184	48.3	14.4
2	#5925.00	49.6 AV	68.2	-18.6	1.28 H	184	35.2	14.4
3	*5985.00	98.5 PK			1.28 H	184	54.4	44.1
4	*5985.00	85.5 AV			1.28 H	184	41.4	44.1
5	11970.00	62.5 PK	74.0	-11.5	2.05 H	248	39.4	23.1
6	11970.00	49.4 AV	54.0	-4.6	2.05 H	248	26.3	23.1

**Antenna Polarity & Test Distance : Vertical at 3 m**

No	Frequency (MHz)	Emission Level (dBuV/m)	Limit (dBuV/m)	Margin (dB)	Antenna Height (m)	Table Angle (Degree)	Raw Value (dBuV)	Correction Factor (dB/m)
1	#5925.00	63.7 PK	88.2	-24.5	2.85 V	211	49.3	14.4
2	#5925.00	50.3 AV	68.2	-17.9	2.85 V	211	35.9	14.4
3	*5985.00	103.6 PK			2.85 V	211	59.5	44.1
4	*5985.00	90.3 AV			2.85 V	211	46.2	44.1
5	11970.00	62.8 PK	74.0	-11.2	2.79 V	304	39.7	23.1
6	11970.00	49.7 AV	54.0	-4.3	2.79 V	304	26.6	23.1

**Remarks:**

1. Emission Level(dBuV/m) = Raw Value(dBuV) + Correction Factor(dB/m)
2. Correction Factor(dB/m) = Antenna Factor(dB/m) + Cable Factor(dB) – Pre-Amplifier Factor(dB)
3. Margin value = Emission Level – Limit value
4. The other emission levels were very low against the limit.
5. " \* " : Fundamental frequency.
6. " # " : The radiated frequency is out of the restricted band.

RF Mode	TX 802.11ax (HE80)	Channel	CH 39 : 6145 MHz
Frequency Range	1GHz ~ 40GHz	Detector Function	Peak (PK) Average (AV)

**Antenna Polarity & Test Distance : Horizontal at 3 m**

No	Frequency (MHz)	Emission Level (dBuV/m)	Limit (dBuV/m)	Margin (dB)	Antenna Height (m)	Table Angle (Degree)	Raw Value (dBuV)	Correction Factor (dB/m)
1	*6145.00	98.1 PK			1.24 H	181	53.6	44.5
2	*6145.00	85.4 AV			1.24 H	181	40.9	44.5
3	12290.00	62.4 PK	74.0	-11.6	1.96 H	228	39.5	22.9
4	12290.00	49.3 AV	54.0	-4.7	1.96 H	228	26.4	22.9

**Antenna Polarity & Test Distance : Vertical at 3 m**

No	Frequency (MHz)	Emission Level (dBuV/m)	Limit (dBuV/m)	Margin (dB)	Antenna Height (m)	Table Angle (Degree)	Raw Value (dBuV)	Correction Factor (dB/m)
1	*6145.00	103.4 PK			2.56 V	214	58.9	44.5
2	*6145.00	90.2 AV			2.56 V	214	45.7	44.5
3	12290.00	62.7 PK	74.0	-11.3	2.77 V	301	39.8	22.9
4	12290.00	49.7 AV	54.0	-4.3	2.77 V	301	26.8	22.9

**Remarks:**

1. Emission Level(dBuV/m) = Raw Value(dBuV) + Correction Factor(dB/m)
2. Correction Factor(dB/m) = Antenna Factor(dB/m) + Cable Factor(dB) – Pre-Amplifier Factor(dB)
3. Margin value = Emission Level – Limit value
4. The other emission levels were very low against the limit.
5. " \* " : Fundamental frequency.

RF Mode	TX 802.11ax (HE80)	Channel	CH 87 : 6385 MHz
Frequency Range	1GHz ~ 40GHz	Detector Function	Peak (PK) Average (AV)

**Antenna Polarity & Test Distance : Horizontal at 3 m**

No	Frequency (MHz)	Emission Level (dBuV/m)	Limit (dBuV/m)	Margin (dB)	Antenna Height (m)	Table Angle (Degree)	Raw Value (dBuV)	Correction Factor (dB/m)
1	*6385.00	98.6 PK			1.18 H	168	53.2	45.4
2	*6385.00	85.7 AV			1.18 H	168	40.3	45.4
3	#12770.00	62.6 PK	88.2	-25.6	1.95 H	236	39.4	23.2
4	#12770.00	49.5 AV	68.2	-18.7	1.95 H	236	26.3	23.2

**Antenna Polarity & Test Distance : Vertical at 3 m**

No	Frequency (MHz)	Emission Level (dBuV/m)	Limit (dBuV/m)	Margin (dB)	Antenna Height (m)	Table Angle (Degree)	Raw Value (dBuV)	Correction Factor (dB/m)
1	*6385.00	103.5 PK			2.77 V	208	58.1	45.4
2	*6385.00	90.5 AV			2.77 V	208	45.1	45.4
3	#12770.00	62.8 PK	88.2	-25.4	2.74 V	298	39.6	23.2
4	#12770.00	49.8 AV	68.2	-18.4	2.74 V	298	26.6	23.2

**Remarks:**

1. Emission Level(dBuV/m) = Raw Value(dBuV) + Correction Factor(dB/m)
2. Correction Factor(dB/m) = Antenna Factor(dB/m) + Cable Factor(dB) – Pre-Amplifier Factor(dB)
3. Margin value = Emission Level – Limit value
4. The other emission levels were very low against the limit.
5. " \* ": Fundamental frequency.
6. " # ": The radiated frequency is out of the restricted band.

RF Mode	TX 802.11ax (HE80)	Channel	CH 103 : 6465 MHz
Frequency Range	1GHz ~ 40GHz	Detector Function	Peak (PK) Average (AV)

**Antenna Polarity & Test Distance : Horizontal at 3 m**

No	Frequency (MHz)	Emission Level (dBuV/m)	Limit (dBuV/m)	Margin (dB)	Antenna Height (m)	Table Angle (Degree)	Raw Value (dBuV)	Correction Factor (dB/m)
1	*6465.00	98.4 PK			1.24 H	178	52.5	45.9
2	*6465.00	85.5 AV			1.24 H	178	39.6	45.9
3	#12930.00	62.9 PK	88.2	-25.3	1.32 H	184	39.4	23.5
4	#12930.00	49.8 AV	68.2	-18.4	1.32 H	184	26.3	23.5

**Antenna Polarity & Test Distance : Vertical at 3 m**

No	Frequency (MHz)	Emission Level (dBuV/m)	Limit (dBuV/m)	Margin (dB)	Antenna Height (m)	Table Angle (Degree)	Raw Value (dBuV)	Correction Factor (dB/m)
1	*6465.00	103.2 PK			3.02 V	298	57.3	45.9
2	*6465.00	90.2 AV			3.02 V	298	44.3	45.9
3	#12930.00	63.2 PK	88.2	-25.0	2.83 V	311	39.7	23.5
4	#12930.00	50.1 AV	68.2	-18.1	2.83 V	311	26.6	23.5

**Remarks:**

1. Emission Level(dBuV/m) = Raw Value(dBuV) + Correction Factor(dB/m)
2. Correction Factor(dB/m) = Antenna Factor(dB/m) + Cable Factor(dB) – Pre-Amplifier Factor(dB)
3. Margin value = Emission Level – Limit value
4. The other emission levels were very low against the limit.
5. " \* ": Fundamental frequency.
6. " # ": The radiated frequency is out of the restricted band.



RF Mode	TX 802.11ax (HE80)	Channel	CH 119 : 6545 MHz
Frequency Range	1GHz ~ 40GHz	Detector Function	Peak (PK) Average (AV)

**Antenna Polarity & Test Distance : Horizontal at 3 m**

No	Frequency (MHz)	Emission Level (dBuV/m)	Limit (dBuV/m)	Margin (dB)	Antenna Height (m)	Table Angle (Degree)	Raw Value (dBuV)	Correction Factor (dB/m)
1	*6545.00	98.6 PK			1.22 H	183	52.2	46.4
2	*6545.00	85.7 AV			1.22 H	183	39.3	46.4
3	#13090.00	62.8 PK	88.2	-25.4	1.98 H	236	39.5	23.3
4	#13090.00	49.7 AV	68.2	-18.5	1.98 H	236	26.4	23.3

**Antenna Polarity & Test Distance : Vertical at 3 m**

No	Frequency (MHz)	Emission Level (dBuV/m)	Limit (dBuV/m)	Margin (dB)	Antenna Height (m)	Table Angle (Degree)	Raw Value (dBuV)	Correction Factor (dB/m)
1	*6545.00	103.4 PK			2.96 V	294	57.0	46.4
2	*6545.00	90.4 AV			2.96 V	294	44.0	46.4
3	#13090.00	63.1 PK	88.2	-25.1	2.91 V	307	39.8	23.3
4	#13090.00	50.0 AV	68.2	-18.2	2.91 V	307	26.7	23.3

**Remarks:**

1. Emission Level(dBuV/m) = Raw Value(dBuV) + Correction Factor(dB/m)
2. Correction Factor(dB/m) = Antenna Factor(dB/m) + Cable Factor(dB) – Pre-Amplifier Factor(dB)
3. Margin value = Emission Level – Limit value
4. The other emission levels were very low against the limit.
5. " \* ": Fundamental frequency.
6. " # ": The radiated frequency is out of the restricted band.

RF Mode	TX 802.11ax (HE80)	Channel	CH 135 : 6625 MHz
Frequency Range	1GHz ~ 40GHz	Detector Function	Peak (PK) Average (AV)

**Antenna Polarity & Test Distance : Horizontal at 3 m**

No	Frequency (MHz)	Emission Level (dBuV/m)	Limit (dBuV/m)	Margin (dB)	Antenna Height (m)	Table Angle (Degree)	Raw Value (dBuV)	Correction Factor (dB/m)
1	*6625.00	97.4 PK			1.33 H	167	51.2	46.2
2	*6625.00	84.1 AV			1.33 H	167	37.9	46.2
3	13250.00	63.2 PK	74.0	-10.8	2.06 H	251	39.5	23.7
4	13250.00	50.0 AV	54.0	-4.0	2.06 H	251	26.3	23.7

**Antenna Polarity & Test Distance : Vertical at 3 m**

No	Frequency (MHz)	Emission Level (dBuV/m)	Limit (dBuV/m)	Margin (dB)	Antenna Height (m)	Table Angle (Degree)	Raw Value (dBuV)	Correction Factor (dB/m)
1	*6625.00	101.7 PK			2.91 V	279	55.5	46.2
2	*6625.00	88.6 AV			2.91 V	279	42.4	46.2
3	13250.00	63.4 PK	74.0	-10.6	2.87 V	306	39.7	23.7
4	13250.00	50.3 AV	54.0	-3.7	2.87 V	306	26.6	23.7

**Remarks:**

1. Emission Level(dBuV/m) = Raw Value(dBuV) + Correction Factor(dB/m)
2. Correction Factor(dB/m) = Antenna Factor(dB/m) + Cable Factor(dB) – Pre-Amplifier Factor(dB)
3. Margin value = Emission Level – Limit value
4. The other emission levels were very low against the limit.
5. " \* " : Fundamental frequency.

RF Mode	TX 802.11ax (HE80)	Channel	CH 151 : 6705 MHz
Frequency Range	1GHz ~ 40GHz	Detector Function	Peak (PK) Average (AV)

**Antenna Polarity & Test Distance : Horizontal at 3 m**

No	Frequency (MHz)	Emission Level (dBuV/m)	Limit (dBuV/m)	Margin (dB)	Antenna Height (m)	Table Angle (Degree)	Raw Value (dBuV)	Correction Factor (dB/m)
1	*6705.00	97.5 PK			1.33 H	177	51.4	46.1
2	*6705.00	84.3 AV			1.33 H	177	38.2	46.1
3	#13410.00	63.5 PK	88.2	-24.7	2.13 H	250	39.4	24.1
4	#13410.00	50.4 AV	68.2	-17.8	2.13 H	250	26.3	24.1

**Antenna Polarity & Test Distance : Vertical at 3 m**

No	Frequency (MHz)	Emission Level (dBuV/m)	Limit (dBuV/m)	Margin (dB)	Antenna Height (m)	Table Angle (Degree)	Raw Value (dBuV)	Correction Factor (dB/m)
1	*6705.00	102.0 PK			2.93 V	287	55.9	46.1
2	*6705.00	88.7 AV			2.93 V	287	42.6	46.1
3	#13410.00	63.7 PK	88.2	-24.5	2.91 V	315	39.6	24.1
4	#13410.00	50.5 AV	68.2	-17.7	2.91 V	315	26.4	24.1

**Remarks:**

1. Emission Level(dBuV/m) = Raw Value(dBuV) + Correction Factor(dB/m)
2. Correction Factor(dB/m) = Antenna Factor(dB/m) + Cable Factor(dB) – Pre-Amplifier Factor(dB)
3. Margin value = Emission Level – Limit value
4. The other emission levels were very low against the limit.
5. " \* ": Fundamental frequency.
6. " # ": The radiated frequency is out of the restricted band.

RF Mode	TX 802.11ax (HE80)	Channel	CH 167 : 6785 MHz
Frequency Range	1GHz ~ 40GHz	Detector Function	Peak (PK) Average (AV)

**Antenna Polarity & Test Distance : Horizontal at 3 m**

No	Frequency (MHz)	Emission Level (dBuV/m)	Limit (dBuV/m)	Margin (dB)	Antenna Height (m)	Table Angle (Degree)	Raw Value (dBuV)	Correction Factor (dB/m)
1	*6785.00	97.3 PK			1.39 H	179	51.0	46.3
2	*6785.00	84.1 AV			1.39 H	179	37.8	46.3
3	#13570.00	63.7 PK	88.2	-24.5	2.21 H	256	39.3	24.4
4	#13570.00	50.6 AV	68.2	-17.6	2.21 H	256	26.2	24.4

**Antenna Polarity & Test Distance : Vertical at 3 m**

No	Frequency (MHz)	Emission Level (dBuV/m)	Limit (dBuV/m)	Margin (dB)	Antenna Height (m)	Table Angle (Degree)	Raw Value (dBuV)	Correction Factor (dB/m)
1	*6785.00	101.5 PK			2.87 V	281	55.2	46.3
2	*6785.00	88.5 AV			2.87 V	281	42.2	46.3
3	#13570.00	64.0 PK	88.2	-24.2	3.02 V	324	39.6	24.4
4	#13570.00	50.9 AV	68.2	-17.3	3.02 V	324	26.5	24.4

**Remarks:**

1. Emission Level(dBuV/m) = Raw Value(dBuV) + Correction Factor(dB/m)
2. Correction Factor(dB/m) = Antenna Factor(dB/m) + Cable Factor(dB) – Pre-Amplifier Factor(dB)
3. Margin value = Emission Level – Limit value
4. The other emission levels were very low against the limit.
5. " \* ": Fundamental frequency.
6. " # ": The radiated frequency is out of the restricted band.

RF Mode	TX 802.11ax (HE80)	Channel	CH 183 : 6865 MHz
Frequency Range	1GHz ~ 40GHz	Detector Function	Peak (PK) Average (AV)

**Antenna Polarity & Test Distance : Horizontal at 3 m**

No	Frequency (MHz)	Emission Level (dBuV/m)	Limit (dBuV/m)	Margin (dB)	Antenna Height (m)	Table Angle (Degree)	Raw Value (dBuV)	Correction Factor (dB/m)
1	*6865.00	97.7 PK			1.25 H	171	51.1	46.6
2	*6865.00	84.5 AV			1.25 H	171	37.9	46.6
3	#13730.00	64.1 PK	88.2	-24.1	2.14 H	263	39.6	24.5
4	#13730.00	51.1 AV	68.2	-17.1	2.14 H	263	26.6	24.5

**Antenna Polarity & Test Distance : Vertical at 3 m**

No	Frequency (MHz)	Emission Level (dBuV/m)	Limit (dBuV/m)	Margin (dB)	Antenna Height (m)	Table Angle (Degree)	Raw Value (dBuV)	Correction Factor (dB/m)
1	*6865.00	102.2 PK			2.89 V	284	55.6	46.6
2	*6865.00	88.9 AV			2.89 V	284	42.3	46.6
3	#13730.00	64.3 PK	88.2	-23.9	2.87 V	309	39.8	24.5
4	#13730.00	51.2 AV	68.2	-17.0	2.87 V	309	26.7	24.5

**Remarks:**

1. Emission Level(dBuV/m) = Raw Value(dBuV) + Correction Factor(dB/m)
2. Correction Factor(dB/m) = Antenna Factor(dB/m) + Cable Factor(dB) – Pre-Amplifier Factor(dB)
3. Margin value = Emission Level – Limit value
4. The other emission levels were very low against the limit.
5. " \* ": Fundamental frequency.
6. " # ": The radiated frequency is out of the restricted band.

RF Mode	TX 802.11ax (HE80)	Channel	CH 199 : 6945 MHz
Frequency Range	1GHz ~ 40GHz	Detector Function	Peak (PK) Average (AV)

**Antenna Polarity & Test Distance : Horizontal at 3 m**

No	Frequency (MHz)	Emission Level (dBuV/m)	Limit (dBuV/m)	Margin (dB)	Antenna Height (m)	Table Angle (Degree)	Raw Value (dBuV)	Correction Factor (dB/m)
1	*6945.00	99.4 PK			1.39 H	157	52.1	47.3
2	*6945.00	86.1 AV			1.39 H	157	38.8	47.3
3	#13890.00	64.4 PK	88.2	-23.8	2.12 H	263	39.4	25.0
4	#13890.00	51.4 AV	68.2	-16.8	2.12 H	263	26.4	25.0

**Antenna Polarity & Test Distance : Vertical at 3 m**

No	Frequency (MHz)	Emission Level (dBuV/m)	Limit (dBuV/m)	Margin (dB)	Antenna Height (m)	Table Angle (Degree)	Raw Value (dBuV)	Correction Factor (dB/m)
1	*6945.00	103.9 PK			2.53 V	250	56.6	47.3
2	*6945.00	90.7 AV			2.53 V	250	43.4	47.3
3	#13890.00	64.7 PK	88.2	-23.5	2.85 V	303	39.7	25.0
4	#13890.00	51.5 AV	68.2	-16.7	2.85 V	303	26.5	25.0

**Remarks:**

1. Emission Level(dBuV/m) = Raw Value(dBuV) + Correction Factor(dB/m)
2. Correction Factor(dB/m) = Antenna Factor(dB/m) + Cable Factor(dB) – Pre-Amplifier Factor(dB)
3. Margin value = Emission Level – Limit value
4. The other emission levels were very low against the limit.
5. " \* ": Fundamental frequency.
6. " # ": The radiated frequency is out of the restricted band.

RF Mode	TX 802.11ax (HE80)	Channel	CH 215 : 7025 MHz
Frequency Range	1GHz ~ 40GHz	Detector Function	Peak (PK) Average (AV)

**Antenna Polarity & Test Distance : Horizontal at 3 m**

No	Frequency (MHz)	Emission Level (dBuV/m)	Limit (dBuV/m)	Margin (dB)	Antenna Height (m)	Table Angle (Degree)	Raw Value (dBuV)	Correction Factor (dB/m)
1	*7025.00	99.1 PK			1.38 H	171	51.3	47.8
2	*7025.00	85.9 AV			1.38 H	171	38.1	47.8
3	#7125.00	66.7 PK	88.2	-21.5	1.38 H	171	49.2	17.5
4	#7125.00	53.8 AV	68.2	-14.4	1.38 H	171	36.3	17.5
5	#14050.00	64.7 PK	88.2	-23.5	2.35 H	264	39.4	25.3
6	#14050.00	51.6 AV	68.2	-16.6	2.35 H	264	26.3	25.3

**Antenna Polarity & Test Distance : Vertical at 3 m**

No	Frequency (MHz)	Emission Level (dBuV/m)	Limit (dBuV/m)	Margin (dB)	Antenna Height (m)	Table Angle (Degree)	Raw Value (dBuV)	Correction Factor (dB/m)
1	*7025.00	103.7 PK			2.48 V	257	55.9	47.8
2	*7025.00	90.4 AV			2.48 V	257	42.6	47.8
3	#7125.00	67.0 PK	88.2	-21.2	2.48 V	257	49.5	17.5
4	#7125.00	54.0 AV	68.2	-14.2	2.48 V	257	36.5	17.5
5	#14050.00	64.9 PK	88.2	-23.3	3.08 V	324	39.6	25.3
6	#14050.00	51.8 AV	68.2	-16.4	3.08 V	324	26.5	25.3

**Remarks:**

1. Emission Level(dBuV/m) = Raw Value(dBuV) + Correction Factor(dB/m)
2. Correction Factor(dB/m) = Antenna Factor(dB/m) + Cable Factor(dB) – Pre-Amplifier Factor(dB)
3. Margin value = Emission Level – Limit value
4. The other emission levels were very low against the limit.
5. " \* " : Fundamental frequency.
6. " # " : The radiated frequency is out of the restricted band.

Nss 2

RF Mode	TX 802.11ax (HE20)	Channel	CH 1 : 5955 MHz
Frequency Range	1GHz ~ 40GHz	Detector Function	Peak (PK) Average (AV)

Antenna Polarity & Test Distance : Horizontal at 3 m								
No	Frequency (MHz)	Emission Level (dBuV/m)	Limit (dBuV/m)	Margin (dB)	Antenna Height (m)	Table Angle (Degree)	Raw Value (dBuV)	Correction Factor (dB/m)
1	#5925.00	62.5 PK	88.2	-25.7	1.38 H	186	48.1	14.4
2	#5925.00	49.3 AV	68.2	-18.9	1.38 H	186	34.9	14.4
3	*5955.00	97.9 PK			1.38 H	186	53.7	44.2
4	*5955.00	84.8 AV			1.38 H	186	40.6	44.2
5	11910.00	62.6 PK	74.0	-11.4	2.26 H	267	39.7	22.9
6	11910.00	49.6 AV	54.0	-4.4	2.26 H	267	26.7	22.9

Antenna Polarity & Test Distance : Vertical at 3 m								
No	Frequency (MHz)	Emission Level (dBuV/m)	Limit (dBuV/m)	Margin (dB)	Antenna Height (m)	Table Angle (Degree)	Raw Value (dBuV)	Correction Factor (dB/m)
1	#5925.00	62.7 PK	88.2	-25.5	2.70 V	288	48.3	14.4
2	#5925.00	49.6 AV	68.2	-18.6	2.70 V	288	35.2	14.4
3	*5955.00	102.1 PK			2.70 V	288	57.9	44.2
4	*5955.00	89.2 AV			2.70 V	288	45.0	44.2
5	11910.00	63.2 PK	74.0	-10.8	2.83 V	324	40.3	22.9
6	11910.00	50.0 AV	54.0	-4.0	2.83 V	324	27.1	22.9

Remarks:

1. Emission Level(dBuV/m) = Raw Value(dBuV) + Correction Factor(dB/m)
2. Correction Factor(dB/m) = Antenna Factor(dB/m) + Cable Factor(dB) – Pre-Amplifier Factor(dB)
3. Margin value = Emission Level – Limit value
4. The other emission levels were very low against the limit.
5. " \* " : Fundamental frequency.
6. " # " : The radiated frequency is out of the restricted band.



RF Mode	TX 802.11ax (HE20)	Channel	CH 45 : 6175 MHz
Frequency Range	1GHz ~ 40GHz	Detector Function	Peak (PK) Average (AV)

**Antenna Polarity & Test Distance : Horizontal at 3 m**

No	Frequency (MHz)	Emission Level (dBuV/m)	Limit (dBuV/m)	Margin (dB)	Antenna Height (m)	Table Angle (Degree)	Raw Value (dBuV)	Correction Factor (dB/m)
1	*6175.00	97.6 PK			1.27 H	194	53.1	44.5
2	*6175.00	84.8 AV			1.27 H	194	40.3	44.5
3	12350.00	62.5 PK	74.0	-11.5	2.19 H	273	39.8	22.7
4	12350.00	49.4 AV	54.0	-4.6	2.19 H	273	26.7	22.7

**Antenna Polarity & Test Distance : Vertical at 3 m**

No	Frequency (MHz)	Emission Level (dBuV/m)	Limit (dBuV/m)	Margin (dB)	Antenna Height (m)	Table Angle (Degree)	Raw Value (dBuV)	Correction Factor (dB/m)
1	*6175.00	102.2 PK			2.74 V	287	57.7	44.5
2	*6175.00	89.4 AV			2.74 V	287	44.9	44.5
3	12350.00	62.9 PK	74.0	-11.1	2.74 V	322	40.2	22.7
4	12350.00	49.7 AV	54.0	-4.3	2.74 V	322	27.0	22.7

**Remarks:**

1. Emission Level(dBuV/m) = Raw Value(dBuV) + Correction Factor(dB/m)
2. Correction Factor(dB/m) = Antenna Factor(dB/m) + Cable Factor(dB) – Pre-Amplifier Factor(dB)
3. Margin value = Emission Level – Limit value
4. The other emission levels were very low against the limit.
5. " \* " : Fundamental frequency.

RF Mode	TX 802.11ax (HE20)	Channel	CH 93 : 6415 MHz
Frequency Range	1GHz ~ 40GHz	Detector Function	Peak (PK) Average (AV)

**Antenna Polarity & Test Distance : Horizontal at 3 m**

No	Frequency (MHz)	Emission Level (dBuV/m)	Limit (dBuV/m)	Margin (dB)	Antenna Height (m)	Table Angle (Degree)	Raw Value (dBuV)	Correction Factor (dB/m)
1	*6415.00	98.1 PK			1.34 H	187	52.6	45.5
2	*6415.00	85.0 AV			1.34 H	187	39.5	45.5
3	#12830.00	63.0 PK	88.2	-25.2	2.24 H	269	39.7	23.3
4	#12830.00	50.1 AV	68.2	-18.1	2.24 H	269	26.8	23.3

**Antenna Polarity & Test Distance : Vertical at 3 m**

No	Frequency (MHz)	Emission Level (dBuV/m)	Limit (dBuV/m)	Margin (dB)	Antenna Height (m)	Table Angle (Degree)	Raw Value (dBuV)	Correction Factor (dB/m)
1	*6415.00	102.3 PK			2.89 V	291	56.8	45.5
2	*6415.00	89.5 AV			2.89 V	291	44.0	45.5
3	#12830.00	63.4 PK	88.2	-24.8	2.74 V	332	40.1	23.3
4	#12830.00	50.3 AV	68.2	-17.9	2.74 V	332	27.0	23.3

**Remarks:**

1. Emission Level(dBuV/m) = Raw Value(dBuV) + Correction Factor(dB/m)
2. Correction Factor(dB/m) = Antenna Factor(dB/m) + Cable Factor(dB) – Pre-Amplifier Factor(dB)
3. Margin value = Emission Level – Limit value
4. The other emission levels were very low against the limit.
5. " \* ": Fundamental frequency.
6. " # ": The radiated frequency is out of the restricted band.

RF Mode	TX 802.11ax (HE20)	Channel	CH 97 : 6435 MHz
Frequency Range	1GHz ~ 40GHz	Detector Function	Peak (PK) Average (AV)

**Antenna Polarity & Test Distance : Horizontal at 3 m**

No	Frequency (MHz)	Emission Level (dBuV/m)	Limit (dBuV/m)	Margin (dB)	Antenna Height (m)	Table Angle (Degree)	Raw Value (dBuV)	Correction Factor (dB/m)
1	*6435.00	97.5 PK			1.42 H	187	51.9	45.6
2	*6435.00	84.4 AV			1.42 H	187	38.8	45.6
3	#12870.00	63.3 PK	88.2	-24.9	2.23 H	274	39.9	23.4
4	#12870.00	50.2 AV	68.2	-18.0	2.23 H	274	26.8	23.4

**Antenna Polarity & Test Distance : Vertical at 3 m**

No	Frequency (MHz)	Emission Level (dBuV/m)	Limit (dBuV/m)	Margin (dB)	Antenna Height (m)	Table Angle (Degree)	Raw Value (dBuV)	Correction Factor (dB/m)
1	*6435.00	101.9 PK			2.83 V	286	56.3	45.6
2	*6435.00	88.8 AV			2.83 V	286	43.2	45.6
3	#12870.00	63.7 PK	88.2	-24.5	2.79 V	330	40.3	23.4
4	#12870.00	50.6 AV	68.2	-17.6	2.79 V	330	27.2	23.4

**Remarks:**

1. Emission Level(dBuV/m) = Raw Value(dBuV) + Correction Factor(dB/m)
2. Correction Factor(dB/m) = Antenna Factor(dB/m) + Cable Factor(dB) – Pre-Amplifier Factor(dB)
3. Margin value = Emission Level – Limit value
4. The other emission levels were very low against the limit.
5. " \* ": Fundamental frequency.
6. " # ": The radiated frequency is out of the restricted band.

RF Mode	TX 802.11ax (HE20)	Channel	CH 105 : 6475 MHz
Frequency Range	1GHz ~ 40GHz	Detector Function	Peak (PK) Average (AV)

**Antenna Polarity & Test Distance : Horizontal at 3 m**

No	Frequency (MHz)	Emission Level (dBuV/m)	Limit (dBuV/m)	Margin (dB)	Antenna Height (m)	Table Angle (Degree)	Raw Value (dBuV)	Correction Factor (dB/m)
1	*6475.00	97.2 PK			1.37 H	181	51.2	46.0
2	*6475.00	84.2 AV			1.37 H	181	38.2	46.0
3	#12950.00	63.3 PK	88.2	-24.9	2.32 H	269	39.8	23.5
4	#12950.00	50.2 AV	68.2	-18.0	2.32 H	269	26.7	23.5

**Antenna Polarity & Test Distance : Vertical at 3 m**

No	Frequency (MHz)	Emission Level (dBuV/m)	Limit (dBuV/m)	Margin (dB)	Antenna Height (m)	Table Angle (Degree)	Raw Value (dBuV)	Correction Factor (dB/m)
1	*6475.00	101.8 PK			2.77 V	292	55.8	46.0
2	*6475.00	88.7 AV			2.77 V	292	42.7	46.0
3	#12950.00	63.7 PK	88.2	-24.5	2.93 V	334	40.2	23.5
4	#12950.00	50.6 AV	68.2	-17.6	2.93 V	334	27.1	23.5

**Remarks:**

1. Emission Level(dBuV/m) = Raw Value(dBuV) + Correction Factor(dB/m)
2. Correction Factor(dB/m) = Antenna Factor(dB/m) + Cable Factor(dB) – Pre-Amplifier Factor(dB)
3. Margin value = Emission Level – Limit value
4. The other emission levels were very low against the limit.
5. " \* ": Fundamental frequency.
6. " # ": The radiated frequency is out of the restricted band.

RF Mode	TX 802.11ax (HE20)	Channel	CH 113 : 6515 MHz
Frequency Range	1GHz ~ 40GHz	Detector Function	Peak (PK) Average (AV)

**Antenna Polarity & Test Distance : Horizontal at 3 m**

No	Frequency (MHz)	Emission Level (dBuV/m)	Limit (dBuV/m)	Margin (dB)	Antenna Height (m)	Table Angle (Degree)	Raw Value (dBuV)	Correction Factor (dB/m)
1	*6515.00	97.4 PK			1.43 H	187	51.1	46.3
2	*6515.00	84.5 AV			1.43 H	187	38.2	46.3
3	#13030.00	63.3 PK	88.2	-24.9	2.24 H	273	39.8	23.5
4	#13030.00	50.3 AV	68.2	-17.9	2.24 H	273	26.8	23.5

**Antenna Polarity & Test Distance : Vertical at 3 m**

No	Frequency (MHz)	Emission Level (dBuV/m)	Limit (dBuV/m)	Margin (dB)	Antenna Height (m)	Table Angle (Degree)	Raw Value (dBuV)	Correction Factor (dB/m)
1	*6515.00	102.0 PK			2.91 V	285	55.7	46.3
2	*6515.00	89.0 AV			2.91 V	285	42.7	46.3
3	#13030.00	63.6 PK	88.2	-24.6	2.81 V	316	40.1	23.5
4	#13030.00	50.5 AV	68.2	-17.7	2.81 V	316	27.0	23.5

**Remarks:**

1. Emission Level(dBuV/m) = Raw Value(dBuV) + Correction Factor(dB/m)
2. Correction Factor(dB/m) = Antenna Factor(dB/m) + Cable Factor(dB) – Pre-Amplifier Factor(dB)
3. Margin value = Emission Level – Limit value
4. The other emission levels were very low against the limit.
5. " \* ": Fundamental frequency.
6. " # ": The radiated frequency is out of the restricted band.

RF Mode	TX 802.11ax (HE20)	Channel	CH 117 : 6535 MHz
Frequency Range	1GHz ~ 40GHz	Detector Function	Peak (PK) Average (AV)

**Antenna Polarity & Test Distance : Horizontal at 3 m**

No	Frequency (MHz)	Emission Level (dBuV/m)	Limit (dBuV/m)	Margin (dB)	Antenna Height (m)	Table Angle (Degree)	Raw Value (dBuV)	Correction Factor (dB/m)
1	*6535.00	97.6 PK			1.24 H	186	51.2	46.4
2	*6535.00	84.3 AV			1.24 H	186	37.9	46.4
3	#13070.00	63.2 PK	88.2	-25.0	2.12 H	278	39.8	23.4
4	#13070.00	50.1 AV	68.2	-18.1	2.12 H	278	26.7	23.4

**Antenna Polarity & Test Distance : Vertical at 3 m**

No	Frequency (MHz)	Emission Level (dBuV/m)	Limit (dBuV/m)	Margin (dB)	Antenna Height (m)	Table Angle (Degree)	Raw Value (dBuV)	Correction Factor (dB/m)
1	*6535.00	102.0 PK			2.87 V	291	55.6	46.4
2	*6535.00	88.8 AV			2.87 V	291	42.4	46.4
3	#13070.00	63.6 PK	88.2	-24.6	2.78 V	323	40.2	23.4
4	#13070.00	50.5 AV	68.2	-17.7	2.78 V	323	27.1	23.4

**Remarks:**

1. Emission Level(dBuV/m) = Raw Value(dBuV) + Correction Factor(dB/m)
2. Correction Factor(dB/m) = Antenna Factor(dB/m) + Cable Factor(dB) – Pre-Amplifier Factor(dB)
3. Margin value = Emission Level – Limit value
4. The other emission levels were very low against the limit.
5. " \* ": Fundamental frequency.
6. " # ": The radiated frequency is out of the restricted band.

RF Mode	TX 802.11ax (HE20)	Channel	CH 153 : 6715 MHz
Frequency Range	1GHz ~ 40GHz	Detector Function	Peak (PK) Average (AV)

**Antenna Polarity & Test Distance : Horizontal at 3 m**

No	Frequency (MHz)	Emission Level (dBuV/m)	Limit (dBuV/m)	Margin (dB)	Antenna Height (m)	Table Angle (Degree)	Raw Value (dBuV)	Correction Factor (dB/m)
1	*6715.00	96.2 PK			1.25 H	184	50.1	46.1
2	*6715.00	82.9 AV			1.25 H	184	36.8	46.1
3	#13430.00	63.9 PK	88.2	-24.3	2.25 H	276	39.8	24.1
4	#13430.00	50.9 AV	68.2	-17.3	2.25 H	276	26.8	24.1

**Antenna Polarity & Test Distance : Vertical at 3 m**

No	Frequency (MHz)	Emission Level (dBuV/m)	Limit (dBuV/m)	Margin (dB)	Antenna Height (m)	Table Angle (Degree)	Raw Value (dBuV)	Correction Factor (dB/m)
1	*6715.00	100.6 PK			2.95 V	283	54.5	46.1
2	*6715.00	87.3 AV			2.95 V	283	41.2	46.1
3	#13430.00	64.4 PK	88.2	-23.8	2.76 V	319	40.3	24.1
4	#13430.00	51.3 AV	68.2	-16.9	2.76 V	319	27.2	24.1

**Remarks:**

1. Emission Level(dBuV/m) = Raw Value(dBuV) + Correction Factor(dB/m)
2. Correction Factor(dB/m) = Antenna Factor(dB/m) + Cable Factor(dB) – Pre-Amplifier Factor(dB)
3. Margin value = Emission Level – Limit value
4. The other emission levels were very low against the limit.
5. " \* ": Fundamental frequency.
6. " # ": The radiated frequency is out of the restricted band.

RF Mode	TX 802.11ax (HE20)	Channel	CH 181 : 6855 MHz
Frequency Range	1GHz ~ 40GHz	Detector Function	Peak (PK) Average (AV)

**Antenna Polarity & Test Distance : Horizontal at 3 m**

No	Frequency (MHz)	Emission Level (dBuV/m)	Limit (dBuV/m)	Margin (dB)	Antenna Height (m)	Table Angle (Degree)	Raw Value (dBuV)	Correction Factor (dB/m)
1	*6855.00	97.3 PK			1.36 H	178	50.7	46.6
2	*6855.00	84.1 AV			1.36 H	178	37.5	46.6
3	#13710.00	64.3 PK	88.2	-23.9	2.21 H	273	39.7	24.6
4	#13710.00	51.2 AV	68.2	-17.0	2.21 H	273	26.6	24.6

**Antenna Polarity & Test Distance : Vertical at 3 m**

No	Frequency (MHz)	Emission Level (dBuV/m)	Limit (dBuV/m)	Margin (dB)	Antenna Height (m)	Table Angle (Degree)	Raw Value (dBuV)	Correction Factor (dB/m)
1	*6855.00	101.8 PK			2.76 V	283	55.2	46.6
2	*6855.00	88.6 AV			2.76 V	283	42.0	46.6
3	#13710.00	64.8 PK	88.2	-23.4	2.71 V	316	40.2	24.6
4	#13710.00	51.6 AV	68.2	-16.6	2.71 V	316	27.0	24.6

**Remarks:**

1. Emission Level(dBuV/m) = Raw Value(dBuV) + Correction Factor(dB/m)
2. Correction Factor(dB/m) = Antenna Factor(dB/m) + Cable Factor(dB) – Pre-Amplifier Factor(dB)
3. Margin value = Emission Level – Limit value
4. The other emission levels were very low against the limit.
5. " \* ": Fundamental frequency.
6. " # ": The radiated frequency is out of the restricted band.



RF Mode	TX 802.11ax (HE20)	Channel	CH 185 : 6875 MHz
Frequency Range	1GHz ~ 40GHz	Detector Function	Peak (PK) Average (AV)

**Antenna Polarity & Test Distance : Horizontal at 3 m**

No	Frequency (MHz)	Emission Level (dBuV/m)	Limit (dBuV/m)	Margin (dB)	Antenna Height (m)	Table Angle (Degree)	Raw Value (dBuV)	Correction Factor (dB/m)
1	*6875.00	100.3 PK			1.27 H	182	53.7	46.6
2	*6875.00	87.0 AV			1.27 H	182	40.4	46.6
3	#13750.00	64.3 PK	88.2	-23.9	2.26 H	265	39.8	24.5
4	#13750.00	51.3 AV	68.2	-16.9	2.26 H	265	26.8	24.5

**Antenna Polarity & Test Distance : Vertical at 3 m**

No	Frequency (MHz)	Emission Level (dBuV/m)	Limit (dBuV/m)	Margin (dB)	Antenna Height (m)	Table Angle (Degree)	Raw Value (dBuV)	Correction Factor (dB/m)
1	*6875.00	104.8 PK			2.95 V	284	58.2	46.6
2	*6875.00	91.6 AV			2.95 V	284	45.0	46.6
3	#13750.00	64.8 PK	88.2	-23.4	2.69 V	331	40.3	24.5
4	#13750.00	51.7 AV	68.2	-16.5	2.69 V	331	27.2	24.5

**Remarks:**

1. Emission Level(dBuV/m) = Raw Value(dBuV) + Correction Factor(dB/m)
2. Correction Factor(dB/m) = Antenna Factor(dB/m) + Cable Factor(dB) – Pre-Amplifier Factor(dB)
3. Margin value = Emission Level – Limit value
4. The other emission levels were very low against the limit.
5. " \* " : Fundamental frequency.
6. " # " : The radiated frequency is out of the restricted band.

RF Mode	TX 802.11ax (HE20)	Channel	CH 213 : 7015 MHz
Frequency Range	1GHz ~ 40GHz	Detector Function	Peak (PK) Average (AV)

**Antenna Polarity & Test Distance : Horizontal at 3 m**

No	Frequency (MHz)	Emission Level (dBuV/m)	Limit (dBuV/m)	Margin (dB)	Antenna Height (m)	Table Angle (Degree)	Raw Value (dBuV)	Correction Factor (dB/m)
1	*7015.00	100.6 PK			1.43 H	191	52.8	47.8
2	*7015.00	87.4 AV			1.43 H	191	39.6	47.8
3	#14030.00	65.1 PK	88.2	-23.1	2.28 H	263	39.9	25.2
4	#14030.00	51.9 AV	68.2	-16.3	2.28 H	263	26.7	25.2

**Antenna Polarity & Test Distance : Vertical at 3 m**

No	Frequency (MHz)	Emission Level (dBuV/m)	Limit (dBuV/m)	Margin (dB)	Antenna Height (m)	Table Angle (Degree)	Raw Value (dBuV)	Correction Factor (dB/m)
1	*7015.00	105.3 PK			2.87 V	290	57.5	47.8
2	*7015.00	92.1 AV			2.87 V	290	44.3	47.8
3	#14030.00	65.3 PK	88.2	-22.9	2.69 V	327	40.1	25.2
4	#14030.00	52.2 AV	68.2	-16.0	2.69 V	327	27.0	25.2

**Remarks:**

1. Emission Level(dBuV/m) = Raw Value(dBuV) + Correction Factor(dB/m)
2. Correction Factor(dB/m) = Antenna Factor(dB/m) + Cable Factor(dB) – Pre-Amplifier Factor(dB)
3. Margin value = Emission Level – Limit value
4. The other emission levels were very low against the limit.
5. " \* ": Fundamental frequency.
6. " # ": The radiated frequency is out of the restricted band.

RF Mode	TX 802.11ax (HE20)	Channel	CH 229 : 7095 MHz
Frequency Range	1GHz ~ 40GHz	Detector Function	Peak (PK) Average (AV)

**Antenna Polarity & Test Distance : Horizontal at 3 m**

No	Frequency (MHz)	Emission Level (dBuV/m)	Limit (dBuV/m)	Margin (dB)	Antenna Height (m)	Table Angle (Degree)	Raw Value (dBuV)	Correction Factor (dB/m)
1	*7095.00	101.8 PK			1.34 H	186	54.1	47.7
2	*7095.00	88.5 AV			1.34 H	186	40.8	47.7
3	#14190.00	65.2 PK	88.2	-23.0	2.23 H	258	39.8	25.4
4	#14190.00	52.1 AV	68.2	-16.1	2.23 H	258	26.7	25.4

**Antenna Polarity & Test Distance : Vertical at 3 m**

No	Frequency (MHz)	Emission Level (dBuV/m)	Limit (dBuV/m)	Margin (dB)	Antenna Height (m)	Table Angle (Degree)	Raw Value (dBuV)	Correction Factor (dB/m)
1	*7095.00	106.5 PK			2.73 V	284	58.8	47.7
2	*7095.00	93.2 AV			2.73 V	284	45.5	47.7
3	#14190.00	65.7 PK	88.2	-22.5	2.73 V	317	40.3	25.4
4	#14190.00	52.6 AV	68.2	-15.6	2.73 V	317	27.2	25.4

**Remarks:**

1. Emission Level(dBuV/m) = Raw Value(dBuV) + Correction Factor(dB/m)
2. Correction Factor(dB/m) = Antenna Factor(dB/m) + Cable Factor(dB) – Pre-Amplifier Factor(dB)
3. Margin value = Emission Level – Limit value
4. The other emission levels were very low against the limit.
5. " \* ": Fundamental frequency.
6. " # ": The radiated frequency is out of the restricted band.

RF Mode	TX 802.11ax (HE20)	Channel	CH 233 : 7115 MHz
Frequency Range	1GHz ~ 40GHz	Detector Function	Peak (PK) Average (AV)

**Antenna Polarity & Test Distance : Horizontal at 3 m**

No	Frequency (MHz)	Emission Level (dBuV/m)	Limit (dBuV/m)	Margin (dB)	Antenna Height (m)	Table Angle (Degree)	Raw Value (dBuV)	Correction Factor (dB/m)
1	*7115.00	95.6 PK			1.38 H	183	47.6	48.0
2	*7115.00	82.4 AV			1.38 H	183	34.4	48.0
3	#7125.00	82.2 PK	88.2	-6.0	1.38 H	183	64.7	17.5
4	#7125.00	66.4 AV	68.2	-1.8	1.38 H	183	48.9	17.5
5	#14230.00	65.0 PK	88.2	-23.2	2.27 H	271	39.5	25.5
6	#14230.00	51.9 AV	68.2	-16.3	2.27 H	271	26.4	25.5

**Antenna Polarity & Test Distance : Vertical at 3 m**

No	Frequency (MHz)	Emission Level (dBuV/m)	Limit (dBuV/m)	Margin (dB)	Antenna Height (m)	Table Angle (Degree)	Raw Value (dBuV)	Correction Factor (dB/m)
1	*7115.00	100.2 PK			2.94 V	271	52.2	48.0
2	*7115.00	86.8 AV			2.94 V	271	38.8	48.0
3	#7125.00	86.8 PK	88.2	-1.4	2.94 V	271	69.3	17.5
<b>4</b>	<b>#7125.00</b>	<b>68.0 AV</b>	<b>68.2</b>	<b>-0.2</b>	<b>2.94 V</b>	<b>271</b>	<b>50.5</b>	<b>17.5</b>
5	#14230.00	65.2 PK	88.2	-23.0	2.79 V	317	39.7	25.5
6	#14230.00	52.1 AV	68.2	-16.1	2.79 V	317	26.6	25.5

**Remarks:**

1. Emission Level(dBuV/m) = Raw Value(dBuV) + Correction Factor(dB/m)
2. Correction Factor(dB/m) = Antenna Factor(dB/m) + Cable Factor(dB) – Pre-Amplifier Factor(dB)
3. Margin value = Emission Level – Limit value
4. The other emission levels were very low against the limit.
5. " \* " : Fundamental frequency.
6. " # " : The radiated frequency is out of the restricted band.

RF Mode	TX 802.11ax (HE40)	Channel	CH 3 : 5965 MHz
Frequency Range	1GHz ~ 40GHz	Detector Function	Peak (PK) Average (AV)

**Antenna Polarity & Test Distance : Horizontal at 3 m**

No	Frequency (MHz)	Emission Level (dBuV/m)	Limit (dBuV/m)	Margin (dB)	Antenna Height (m)	Table Angle (Degree)	Raw Value (dBuV)	Correction Factor (dB/m)
1	#5925.00	62.5 PK	88.2	-25.7	1.33 H	174	48.1	14.4
2	#5925.00	49.4 AV	68.2	-18.8	1.33 H	174	35.0	14.4
3	*5965.00	97.7 PK			1.33 H	174	53.5	44.2
4	*5965.00	84.7 AV			1.33 H	174	40.5	44.2
5	11930.00	62.4 PK	74.0	-11.6	2.27 H	261	39.5	22.9
6	11930.00	49.5 AV	54.0	-4.5	2.27 H	261	26.6	22.9

**Antenna Polarity & Test Distance : Vertical at 3 m**

No	Frequency (MHz)	Emission Level (dBuV/m)	Limit (dBuV/m)	Margin (dB)	Antenna Height (m)	Table Angle (Degree)	Raw Value (dBuV)	Correction Factor (dB/m)
1	#5925.00	62.7 PK	88.2	-25.5	2.82 V	292	48.3	14.4
2	#5925.00	49.5 AV	68.2	-18.7	2.82 V	292	35.1	14.4
3	*5965.00	102.7 PK			2.82 V	292	58.5	44.2
4	*5965.00	89.6 AV			2.82 V	292	45.4	44.2
5	11930.00	63.1 PK	74.0	-10.9	2.72 V	336	40.2	22.9
6	11930.00	49.9 AV	54.0	-4.1	2.72 V	336	27.0	22.9

**Remarks:**

1. Emission Level(dBuV/m) = Raw Value(dBuV) + Correction Factor(dB/m)
2. Correction Factor(dB/m) = Antenna Factor(dB/m) + Cable Factor(dB) – Pre-Amplifier Factor(dB)
3. Margin value = Emission Level – Limit value
4. The other emission levels were very low against the limit.
5. " \* " : Fundamental frequency.
6. " # " : The radiated frequency is out of the restricted band.

RF Mode	TX 802.11ax (HE40)	Channel	CH 43 : 6165 MHz
Frequency Range	1GHz ~ 40GHz	Detector Function	Peak (PK) Average (AV)

**Antenna Polarity & Test Distance : Horizontal at 3 m**

No	Frequency (MHz)	Emission Level (dBuV/m)	Limit (dBuV/m)	Margin (dB)	Antenna Height (m)	Table Angle (Degree)	Raw Value (dBuV)	Correction Factor (dB/m)
1	*6165.00	97.8 PK			1.26 H	191	53.3	44.5
2	*6165.00	84.7 AV			1.26 H	191	40.2	44.5
3	12330.00	62.2 PK	74.0	-11.8	2.14 H	273	39.5	22.7
4	12330.00	49.2 AV	54.0	-4.8	2.14 H	273	26.5	22.7

**Antenna Polarity & Test Distance : Vertical at 3 m**

No	Frequency (MHz)	Emission Level (dBuV/m)	Limit (dBuV/m)	Margin (dB)	Antenna Height (m)	Table Angle (Degree)	Raw Value (dBuV)	Correction Factor (dB/m)
1	*6165.00	102.1 PK			2.76 V	284	57.6	44.5
2	*6165.00	89.2 AV			2.76 V	284	44.7	44.5
3	12330.00	62.6 PK	74.0	-11.4	2.81 V	321	39.9	22.7
4	12330.00	49.6 AV	54.0	-4.4	2.81 V	321	26.9	22.7

**Remarks:**

1. Emission Level(dBuV/m) = Raw Value(dBuV) + Correction Factor(dB/m)
2. Correction Factor(dB/m) = Antenna Factor(dB/m) + Cable Factor(dB) – Pre-Amplifier Factor(dB)
3. Margin value = Emission Level – Limit value
4. The other emission levels were very low against the limit.
5. " \* " : Fundamental frequency.

RF Mode	TX 802.11ax (HE40)	Channel	CH 91 : 6405 MHz
Frequency Range	1GHz ~ 40GHz	Detector Function	Peak (PK) Average (AV)

**Antenna Polarity & Test Distance : Horizontal at 3 m**

No	Frequency (MHz)	Emission Level (dBuV/m)	Limit (dBuV/m)	Margin (dB)	Antenna Height (m)	Table Angle (Degree)	Raw Value (dBuV)	Correction Factor (dB/m)
1	*6405.00	97.6 PK			1.43 H	191	52.2	45.4
2	*6405.00	84.6 AV			1.43 H	191	39.2	45.4
3	#12810.00	62.9 PK	88.2	-25.3	2.18 H	259	39.6	23.3
4	#12810.00	49.8 AV	68.2	-18.4	2.18 H	259	26.5	23.3

**Antenna Polarity & Test Distance : Vertical at 3 m**

No	Frequency (MHz)	Emission Level (dBuV/m)	Limit (dBuV/m)	Margin (dB)	Antenna Height (m)	Table Angle (Degree)	Raw Value (dBuV)	Correction Factor (dB/m)
1	*6405.00	102.2 PK			2.88 V	283	56.8	45.4
2	*6405.00	89.0 AV			2.88 V	283	43.6	45.4
3	#12810.00	63.0 PK	88.2	-25.2	2.69 V	315	39.7	23.3
4	#12810.00	50.0 AV	68.2	-18.2	2.69 V	315	26.7	23.3

**Remarks:**

1. Emission Level(dBuV/m) = Raw Value(dBuV) + Correction Factor(dB/m)
2. Correction Factor(dB/m) = Antenna Factor(dB/m) + Cable Factor(dB) – Pre-Amplifier Factor(dB)
3. Margin value = Emission Level – Limit value
4. The other emission levels were very low against the limit.
5. " \* ": Fundamental frequency.
6. " # ": The radiated frequency is out of the restricted band.

RF Mode	TX 802.11ax (HE40)	Channel	CH 99 : 6445 MHz
Frequency Range	1GHz ~ 40GHz	Detector Function	Peak (PK) Average (AV)

**Antenna Polarity & Test Distance : Horizontal at 3 m**

No	Frequency (MHz)	Emission Level (dBuV/m)	Limit (dBuV/m)	Margin (dB)	Antenna Height (m)	Table Angle (Degree)	Raw Value (dBuV)	Correction Factor (dB/m)
1	*6445.00	97.1 PK			1.37 H	192	51.4	45.7
2	*6445.00	84.1 AV			1.37 H	192	38.4	45.7
3	#12890.00	63.0 PK	88.2	-25.2	2.32 H	271	39.6	23.4
4	#12890.00	50.0 AV	68.2	-18.2	2.32 H	271	26.6	23.4

**Antenna Polarity & Test Distance : Vertical at 3 m**

No	Frequency (MHz)	Emission Level (dBuV/m)	Limit (dBuV/m)	Margin (dB)	Antenna Height (m)	Table Angle (Degree)	Raw Value (dBuV)	Correction Factor (dB/m)
1	*6445.00	101.8 PK			2.79 V	287	56.1	45.7
2	*6445.00	88.7 AV			2.79 V	287	43.0	45.7
3	#12890.00	63.1 PK	88.2	-25.1	2.72 V	311	39.7	23.4
4	#12890.00	50.2 AV	68.2	-18.0	2.72 V	311	26.8	23.4

**Remarks:**

1. Emission Level(dBuV/m) = Raw Value(dBuV) + Correction Factor(dB/m)
2. Correction Factor(dB/m) = Antenna Factor(dB/m) + Cable Factor(dB) – Pre-Amplifier Factor(dB)
3. Margin value = Emission Level – Limit value
4. The other emission levels were very low against the limit.
5. " \* ": Fundamental frequency.
6. " # ": The radiated frequency is out of the restricted band.



RF Mode	TX 802.11ax (HE40)	Channel	CH 107 : 6485 MHz
Frequency Range	1GHz ~ 40GHz	Detector Function	Peak (PK) Average (AV)

**Antenna Polarity & Test Distance : Horizontal at 3 m**

No	Frequency (MHz)	Emission Level (dBuV/m)	Limit (dBuV/m)	Margin (dB)	Antenna Height (m)	Table Angle (Degree)	Raw Value (dBuV)	Correction Factor (dB/m)
1	*6485.00	97.8 PK			1.19 H	174	51.7	46.1
2	*6485.00	84.6 AV			1.19 H	174	38.5	46.1
3	#12970.00	63.1 PK	88.2	-25.1	2.16 H	256	39.6	23.5
4	#12970.00	49.9 AV	68.2	-18.3	2.16 H	256	26.4	23.5

**Antenna Polarity & Test Distance : Vertical at 3 m**

No	Frequency (MHz)	Emission Level (dBuV/m)	Limit (dBuV/m)	Margin (dB)	Antenna Height (m)	Table Angle (Degree)	Raw Value (dBuV)	Correction Factor (dB/m)
1	*6485.00	102.3 PK			2.96 V	291	56.2	46.1
2	*6485.00	89.2 AV			2.96 V	291	43.1	46.1
3	#12970.00	63.2 PK	88.2	-25.0	2.73 V	304	39.7	23.5
4	#12970.00	50.2 AV	68.2	-18.0	2.73 V	304	26.7	23.5

**Remarks:**

1. Emission Level(dBuV/m) = Raw Value(dBuV) + Correction Factor(dB/m)
2. Correction Factor(dB/m) = Antenna Factor(dB/m) + Cable Factor(dB) – Pre-Amplifier Factor(dB)
3. Margin value = Emission Level – Limit value
4. The other emission levels were very low against the limit.
5. " \* ": Fundamental frequency.
6. " # ": The radiated frequency is out of the restricted band.

RF Mode	TX 802.11ax (HE40)	Channel	CH 115 : 6525 MHz
Frequency Range	1GHz ~ 40GHz	Detector Function	Peak (PK) Average (AV)

**Antenna Polarity & Test Distance : Horizontal at 3 m**

No	Frequency (MHz)	Emission Level (dBuV/m)	Limit (dBuV/m)	Margin (dB)	Antenna Height (m)	Table Angle (Degree)	Raw Value (dBuV)	Correction Factor (dB/m)
1	*6525.00	97.0 PK			1.22 H	185	50.7	46.3
2	*6525.00	83.9 AV			1.22 H	185	37.6	46.3
3	#13050.00	63.0 PK	88.2	-25.2	2.09 H	277	39.5	23.5
4	#13050.00	49.8 AV	68.2	-18.4	2.09 H	277	26.3	23.5

**Antenna Polarity & Test Distance : Vertical at 3 m**

No	Frequency (MHz)	Emission Level (dBuV/m)	Limit (dBuV/m)	Margin (dB)	Antenna Height (m)	Table Angle (Degree)	Raw Value (dBuV)	Correction Factor (dB/m)
1	*6525.00	101.6 PK			2.86 V	293	55.3	46.3
2	*6525.00	88.4 AV			2.86 V	293	42.1	46.3
3	#13050.00	63.2 PK	88.2	-25.0	2.76 V	310	39.7	23.5
4	#13050.00	50.2 AV	68.2	-18.0	2.76 V	310	26.7	23.5

**Remarks:**

1. Emission Level(dBuV/m) = Raw Value(dBuV) + Correction Factor(dB/m)
2. Correction Factor(dB/m) = Antenna Factor(dB/m) + Cable Factor(dB) – Pre-Amplifier Factor(dB)
3. Margin value = Emission Level – Limit value
4. The other emission levels were very low against the limit.
5. " \* ": Fundamental frequency.
6. " # ": The radiated frequency is out of the restricted band.

RF Mode	TX 802.11ax (HE40)	Channel	CH 123 : 6565 MHz
Frequency Range	1GHz ~ 40GHz	Detector Function	Peak (PK) Average (AV)

**Antenna Polarity & Test Distance : Horizontal at 3 m**

No	Frequency (MHz)	Emission Level (dBuV/m)	Limit (dBuV/m)	Margin (dB)	Antenna Height (m)	Table Angle (Degree)	Raw Value (dBuV)	Correction Factor (dB/m)
1	*6565.00	96.3 PK			1.31 H	188	49.8	46.5
2	*6565.00	83.1 AV			1.31 H	188	36.6	46.5
3	#13130.00	63.1 PK	88.2	-25.1	2.35 H	276	39.7	23.4
4	#13130.00	50.0 AV	68.2	-18.2	2.35 H	276	26.6	23.4

**Antenna Polarity & Test Distance : Vertical at 3 m**

No	Frequency (MHz)	Emission Level (dBuV/m)	Limit (dBuV/m)	Margin (dB)	Antenna Height (m)	Table Angle (Degree)	Raw Value (dBuV)	Correction Factor (dB/m)
1	*6565.00	100.8 PK			2.78 V	293	54.3	46.5
2	*6565.00	87.6 AV			2.78 V	293	41.1	46.5
3	#13130.00	63.4 PK	88.2	-24.8	2.81 V	324	40.0	23.4
4	#13130.00	50.3 AV	68.2	-17.9	2.81 V	324	26.9	23.4

**Remarks:**

1. Emission Level(dBuV/m) = Raw Value(dBuV) + Correction Factor(dB/m)
2. Correction Factor(dB/m) = Antenna Factor(dB/m) + Cable Factor(dB) – Pre-Amplifier Factor(dB)
3. Margin value = Emission Level – Limit value
4. The other emission levels were very low against the limit.
5. " \* ": Fundamental frequency.
6. " # ": The radiated frequency is out of the restricted band.

RF Mode	TX 802.11ax (HE40)	Channel	CH 155 : 6725 MHz
Frequency Range	1GHz ~ 40GHz	Detector Function	Peak (PK) Average (AV)

**Antenna Polarity & Test Distance : Horizontal at 3 m**

No	Frequency (MHz)	Emission Level (dBuV/m)	Limit (dBuV/m)	Margin (dB)	Antenna Height (m)	Table Angle (Degree)	Raw Value (dBuV)	Correction Factor (dB/m)
1	*6725.00	96.7 PK			2.22 H	267	50.5	46.2
2	*6725.00	83.6 AV			2.22 H	267	37.4	46.2
3	#13450.00	63.9 PK	88.2	-24.3	2.17 H	256	39.6	24.3
4	#13450.00	50.8 AV	68.2	-17.4	2.17 H	256	26.5	24.3

**Antenna Polarity & Test Distance : Vertical at 3 m**

No	Frequency (MHz)	Emission Level (dBuV/m)	Limit (dBuV/m)	Margin (dB)	Antenna Height (m)	Table Angle (Degree)	Raw Value (dBuV)	Correction Factor (dB/m)
1	*6725.00	101.4 PK			2.80 V	293	55.2	46.2
2	*6725.00	88.2 AV			2.80 V	293	42.0	46.2
3	#13450.00	64.1 PK	88.2	-24.1	2.82 V	332	39.8	24.3
4	#13450.00	50.9 AV	68.2	-17.3	2.82 V	332	26.6	24.3

**Remarks:**

1. Emission Level(dBuV/m) = Raw Value(dBuV) + Correction Factor(dB/m)
2. Correction Factor(dB/m) = Antenna Factor(dB/m) + Cable Factor(dB) – Pre-Amplifier Factor(dB)
3. Margin value = Emission Level – Limit value
4. The other emission levels were very low against the limit.
5. " \* " : Fundamental frequency.
6. " # " : The radiated frequency is out of the restricted band.

RF Mode	TX 802.11ax (HE40)	Channel	CH 179 : 6845 MHz
Frequency Range	1GHz ~ 40GHz	Detector Function	Peak (PK) Average (AV)

**Antenna Polarity & Test Distance : Horizontal at 3 m**

No	Frequency (MHz)	Emission Level (dBuV/m)	Limit (dBuV/m)	Margin (dB)	Antenna Height (m)	Table Angle (Degree)	Raw Value (dBuV)	Correction Factor (dB/m)
1	*6845.00	97.1 PK			1.18 H	176	50.5	46.6
2	*6845.00	83.9 AV			1.18 H	176	37.3	46.6
3	#13690.00	64.1 PK	88.2	-24.1	2.37 H	279	39.6	24.5
4	#13690.00	50.9 AV	68.2	-17.3	2.37 H	279	26.4	24.5

**Antenna Polarity & Test Distance : Vertical at 3 m**

No	Frequency (MHz)	Emission Level (dBuV/m)	Limit (dBuV/m)	Margin (dB)	Antenna Height (m)	Table Angle (Degree)	Raw Value (dBuV)	Correction Factor (dB/m)
1	*6845.00	101.5 PK			2.89 V	294	54.9	46.6
2	*6845.00	88.3 AV			2.89 V	294	41.7	46.6
3	#13690.00	64.2 PK	88.2	-24.0	2.68 V	337	39.7	24.5
4	#13690.00	51.1 AV	68.2	-17.1	2.68 V	337	26.6	24.5

**Remarks:**

1. Emission Level(dBuV/m) = Raw Value(dBuV) + Correction Factor(dB/m)
2. Correction Factor(dB/m) = Antenna Factor(dB/m) + Cable Factor(dB) – Pre-Amplifier Factor(dB)
3. Margin value = Emission Level – Limit value
4. The other emission levels were very low against the limit.
5. " \* ": Fundamental frequency.
6. " # ": The radiated frequency is out of the restricted band.

RF Mode	TX 802.11ax (HE40)	Channel	CH 187 : 6885 MHz
Frequency Range	1GHz ~ 40GHz	Detector Function	Peak (PK) Average (AV)

**Antenna Polarity & Test Distance : Horizontal at 3 m**

No	Frequency (MHz)	Emission Level (dBuV/m)	Limit (dBuV/m)	Margin (dB)	Antenna Height (m)	Table Angle (Degree)	Raw Value (dBuV)	Correction Factor (dB/m)
1	*6885.00	97.6 PK			1.34 H	176	50.9	46.7
2	*6885.00	84.3 AV			1.34 H	176	37.6	46.7
3	#13770.00	64.1 PK	88.2	-24.1	2.26 H	253	39.6	24.5
4	#13770.00	51.0 AV	68.2	-17.2	2.26 H	253	26.5	24.5

**Antenna Polarity & Test Distance : Vertical at 3 m**

No	Frequency (MHz)	Emission Level (dBuV/m)	Limit (dBuV/m)	Margin (dB)	Antenna Height (m)	Table Angle (Degree)	Raw Value (dBuV)	Correction Factor (dB/m)
1	*6885.00	102.0 PK			2.83 V	294	55.3	46.7
2	*6885.00	88.8 AV			2.83 V	294	42.1	46.7
3	#13770.00	64.4 PK	88.2	-23.8	2.67 V	314	39.9	24.5
4	#13770.00	51.3 AV	68.2	-16.9	2.67 V	314	26.8	24.5

**Remarks:**

1. Emission Level(dBuV/m) = Raw Value(dBuV) + Correction Factor(dB/m)
2. Correction Factor(dB/m) = Antenna Factor(dB/m) + Cable Factor(dB) – Pre-Amplifier Factor(dB)
3. Margin value = Emission Level – Limit value
4. The other emission levels were very low against the limit.
5. " \* ": Fundamental frequency.
6. " # ": The radiated frequency is out of the restricted band.

RF Mode	TX 802.11ax (HE40)	Channel	CH 211 : 7005 MHz
Frequency Range	1GHz ~ 40GHz	Detector Function	Peak (PK) Average (AV)

**Antenna Polarity & Test Distance : Horizontal at 3 m**

No	Frequency (MHz)	Emission Level (dBuV/m)	Limit (dBuV/m)	Margin (dB)	Antenna Height (m)	Table Angle (Degree)	Raw Value (dBuV)	Correction Factor (dB/m)
1	*7005.00	98.9 PK			1.28 H	179	51.1	47.8
2	*7005.00	85.6 AV			1.28 H	179	37.8	47.8
3	#14010.00	64.9 PK	88.2	-23.3	2.23 H	270	39.7	25.2
4	#14010.00	51.8 AV	68.2	-16.4	2.23 H	270	26.6	25.2

**Antenna Polarity & Test Distance : Vertical at 3 m**

No	Frequency (MHz)	Emission Level (dBuV/m)	Limit (dBuV/m)	Margin (dB)	Antenna Height (m)	Table Angle (Degree)	Raw Value (dBuV)	Correction Factor (dB/m)
1	*7005.00	103.4 PK			2.87 V	289	55.6	47.8
2	*7005.00	90.1 AV			2.87 V	289	42.3	47.8
3	#14010.00	65.0 PK	88.2	-23.2	2.58 V	315	39.8	25.2
4	#14010.00	52.0 AV	68.2	-16.2	2.58 V	315	26.8	25.2

**Remarks:**

1. Emission Level(dBuV/m) = Raw Value(dBuV) + Correction Factor(dB/m)
2. Correction Factor(dB/m) = Antenna Factor(dB/m) + Cable Factor(dB) – Pre-Amplifier Factor(dB)
3. Margin value = Emission Level – Limit value
4. The other emission levels were very low against the limit.
5. " \* ": Fundamental frequency.
6. " # ": The radiated frequency is out of the restricted band.

RF Mode	TX 802.11ax (HE40)	Channel	CH 227 : 7085 MHz
Frequency Range	1GHz ~ 40GHz	Detector Function	Peak (PK) Average (AV)

**Antenna Polarity & Test Distance : Horizontal at 3 m**

No	Frequency (MHz)	Emission Level (dBuV/m)	Limit (dBuV/m)	Margin (dB)	Antenna Height (m)	Table Angle (Degree)	Raw Value (dBuV)	Correction Factor (dB/m)
1	*7085.00	101.5 PK			1.31 H	187	53.8	47.7
2	*7085.00	88.3 AV			1.31 H	187	40.6	47.7
3	#7125.00	66.3 PK	88.2	-21.9	1.31 H	187	48.8	17.5
4	#7125.00	53.5 AV	68.2	-14.7	1.31 H	187	36.0	17.5
5	#14170.00	64.9 PK	88.2	-23.3	2.24 H	256	39.6	25.3
6	#14170.00	51.8 AV	68.2	-16.4	2.24 H	256	26.5	25.3

**Antenna Polarity & Test Distance : Vertical at 3 m**

No	Frequency (MHz)	Emission Level (dBuV/m)	Limit (dBuV/m)	Margin (dB)	Antenna Height (m)	Table Angle (Degree)	Raw Value (dBuV)	Correction Factor (dB/m)
1	*7085.00	106.2 PK			2.98 V	271	58.5	47.7
2	*7085.00	92.8 AV			2.98 V	271	45.1	47.7
3	#7125.00	66.9 PK	88.2	-21.3	2.98 V	271	49.4	17.5
4	#7125.00	53.8 AV	68.2	-14.4	2.98 V	271	36.3	17.5
5	#14170.00	65.2 PK	88.2	-23.0	2.76 V	318	39.9	25.3
6	#14170.00	52.1 AV	68.2	-16.1	2.76 V	318	26.8	25.3

**Remarks:**

1. Emission Level(dBuV/m) = Raw Value(dBuV) + Correction Factor(dB/m)
2. Correction Factor(dB/m) = Antenna Factor(dB/m) + Cable Factor(dB) – Pre-Amplifier Factor(dB)
3. Margin value = Emission Level – Limit value
4. The other emission levels were very low against the limit.
5. " \* ": Fundamental frequency.
6. " # ": The radiated frequency is out of the restricted band.



RF Mode	TX 802.11ax (HE80)	Channel	CH 7 : 5985 MHz
Frequency Range	1GHz ~ 40GHz	Detector Function	Peak (PK) Average (AV)

**Antenna Polarity & Test Distance : Horizontal at 3 m**

No	Frequency (MHz)	Emission Level (dBuV/m)	Limit (dBuV/m)	Margin (dB)	Antenna Height (m)	Table Angle (Degree)	Raw Value (dBuV)	Correction Factor (dB/m)
1	#5925.00	62.8 PK	88.2	-25.4	1.32 H	187	48.4	14.4
2	#5925.00	49.8 AV	68.2	-18.4	1.32 H	187	35.4	14.4
3	*5985.00	98.2 PK			1.32 H	187	54.1	44.1
4	*5985.00	85.0 AV			1.32 H	187	40.9	44.1
5	11970.00	62.4 PK	74.0	-11.6	2.27 H	258	39.3	23.1
6	11970.00	49.4 AV	54.0	-4.6	2.27 H	258	26.3	23.1

**Antenna Polarity & Test Distance : Vertical at 3 m**

No	Frequency (MHz)	Emission Level (dBuV/m)	Limit (dBuV/m)	Margin (dB)	Antenna Height (m)	Table Angle (Degree)	Raw Value (dBuV)	Correction Factor (dB/m)
1	#5925.00	63.8 PK	88.2	-24.4	2.84 V	288	49.4	14.4
2	#5925.00	50.6 AV	68.2	-17.6	2.84 V	288	36.2	14.4
3	*5985.00	102.6 PK			2.84 V	288	58.5	44.1
4	*5985.00	89.4 AV			2.84 V	288	45.3	44.1
5	11970.00	62.7 PK	74.0	-11.3	2.73 V	297	39.6	23.1
6	11970.00	49.6 AV	54.0	-4.4	2.73 V	297	26.5	23.1

**Remarks:**

1. Emission Level(dBuV/m) = Raw Value(dBuV) + Correction Factor(dB/m)
2. Correction Factor(dB/m) = Antenna Factor(dB/m) + Cable Factor(dB) – Pre-Amplifier Factor(dB)
3. Margin value = Emission Level – Limit value
4. The other emission levels were very low against the limit.
5. " \* " : Fundamental frequency.
6. " # " : The radiated frequency is out of the restricted band.

RF Mode	TX 802.11ax (HE80)	Channel	CH 39 : 6145 MHz
Frequency Range	1GHz ~ 40GHz	Detector Function	Peak (PK) Average (AV)

**Antenna Polarity & Test Distance : Horizontal at 3 m**

No	Frequency (MHz)	Emission Level (dBuV/m)	Limit (dBuV/m)	Margin (dB)	Antenna Height (m)	Table Angle (Degree)	Raw Value (dBuV)	Correction Factor (dB/m)
1	*6145.00	97.5 PK			1.32 H	177	53.0	44.5
2	*6145.00	84.4 AV			1.32 H	177	39.9	44.5
3	12290.00	62.5 PK	74.0	-11.5	2.34 H	257	39.6	22.9
4	12290.00	49.4 AV	54.0	-4.6	2.34 H	257	26.5	22.9

**Antenna Polarity & Test Distance : Vertical at 3 m**

No	Frequency (MHz)	Emission Level (dBuV/m)	Limit (dBuV/m)	Margin (dB)	Antenna Height (m)	Table Angle (Degree)	Raw Value (dBuV)	Correction Factor (dB/m)
1	*6145.00	102.1 PK			2.87 V	293	57.6	44.5
2	*6145.00	88.9 AV			2.87 V	293	44.4	44.5
3	12290.00	62.6 PK	74.0	-11.4	2.79 V	36	39.7	22.9
4	12290.00	49.6 AV	54.0	-4.4	2.79 V	36	26.7	22.9

**Remarks:**

1. Emission Level(dBuV/m) = Raw Value(dBuV) + Correction Factor(dB/m)
2. Correction Factor(dB/m) = Antenna Factor(dB/m) + Cable Factor(dB) – Pre-Amplifier Factor(dB)
3. Margin value = Emission Level – Limit value
4. The other emission levels were very low against the limit.
5. " \* " : Fundamental frequency.

RF Mode	TX 802.11ax (HE80)	Channel	CH 87 : 6385 MHz
Frequency Range	1GHz ~ 40GHz	Detector Function	Peak (PK) Average (AV)

**Antenna Polarity & Test Distance : Horizontal at 3 m**

No	Frequency (MHz)	Emission Level (dBuV/m)	Limit (dBuV/m)	Margin (dB)	Antenna Height (m)	Table Angle (Degree)	Raw Value (dBuV)	Correction Factor (dB/m)
1	*6385.00	98.0 PK			1.23 H	176	52.6	45.4
2	*6385.00	84.7 AV			1.23 H	176	39.3	45.4
3	#12770.00	62.6 PK	88.2	-25.6	2.35 H	273	39.4	23.2
4	#12770.00	49.6 AV	68.2	-18.6	2.35 H	273	26.4	23.2

**Antenna Polarity & Test Distance : Vertical at 3 m**

No	Frequency (MHz)	Emission Level (dBuV/m)	Limit (dBuV/m)	Margin (dB)	Antenna Height (m)	Table Angle (Degree)	Raw Value (dBuV)	Correction Factor (dB/m)
1	*6385.00	102.3 PK			2.76 V	283	56.9	45.4
2	*6385.00	89.1 AV			2.76 V	283	43.7	45.4
3	#12770.00	62.9 PK	88.2	-25.3	2.94 V	331	39.7	23.2
4	#12770.00	49.8 AV	68.2	-18.4	2.94 V	331	26.6	23.2

**Remarks:**

1. Emission Level(dBuV/m) = Raw Value(dBuV) + Correction Factor(dB/m)
2. Correction Factor(dB/m) = Antenna Factor(dB/m) + Cable Factor(dB) – Pre-Amplifier Factor(dB)
3. Margin value = Emission Level – Limit value
4. The other emission levels were very low against the limit.
5. " \* ": Fundamental frequency.
6. " # ": The radiated frequency is out of the restricted band.

RF Mode	TX 802.11ax (HE80)	Channel	CH 103 : 6465 MHz
Frequency Range	1GHz ~ 40GHz	Detector Function	Peak (PK) Average (AV)

**Antenna Polarity & Test Distance : Horizontal at 3 m**

No	Frequency (MHz)	Emission Level (dBuV/m)	Limit (dBuV/m)	Margin (dB)	Antenna Height (m)	Table Angle (Degree)	Raw Value (dBuV)	Correction Factor (dB/m)
1	*6465.00	97.3 PK			1.33 H	189	51.4	45.9
2	*6465.00	84.1 AV			1.33 H	189	38.2	45.9
3	#12930.00	62.9 PK	88.2	-25.3	2.27 H	254	39.4	23.5
4	#12930.00	49.8 AV	68.2	-18.4	2.27 H	254	26.3	23.5

**Antenna Polarity & Test Distance : Vertical at 3 m**

No	Frequency (MHz)	Emission Level (dBuV/m)	Limit (dBuV/m)	Margin (dB)	Antenna Height (m)	Table Angle (Degree)	Raw Value (dBuV)	Correction Factor (dB/m)
1	*6465.00	102.0 PK			2.82 V	296	56.1	45.9
2	*6465.00	88.7 AV			2.82 V	296	42.8	45.9
3	#12930.00	63.3 PK	88.2	-24.9	2.68 V	333	39.8	23.5
4	#12930.00	50.2 AV	68.2	-18.0	2.68 V	333	26.7	23.5

**Remarks:**

1. Emission Level(dBuV/m) = Raw Value(dBuV) + Correction Factor(dB/m)
2. Correction Factor(dB/m) = Antenna Factor(dB/m) + Cable Factor(dB) – Pre-Amplifier Factor(dB)
3. Margin value = Emission Level – Limit value
4. The other emission levels were very low against the limit.
5. " \* ": Fundamental frequency.
6. " # ": The radiated frequency is out of the restricted band.

RF Mode	TX 802.11ax (HE80)	Channel	CH 119 : 6545 MHz
Frequency Range	1GHz ~ 40GHz	Detector Function	Peak (PK) Average (AV)

**Antenna Polarity & Test Distance : Horizontal at 3 m**

No	Frequency (MHz)	Emission Level (dBuV/m)	Limit (dBuV/m)	Margin (dB)	Antenna Height (m)	Table Angle (Degree)	Raw Value (dBuV)	Correction Factor (dB/m)
1	*6545.00	97.4 PK			1.39 H	197	51.0	46.4
2	*6545.00	84.1 AV			1.39 H	197	37.7	46.4
3	#13090.00	62.8 PK	88.2	-25.4	2.28 H	271	39.5	23.3
4	#13090.00	49.7 AV	68.2	-18.5	2.28 H	271	26.4	23.3

**Antenna Polarity & Test Distance : Vertical at 3 m**

No	Frequency (MHz)	Emission Level (dBuV/m)	Limit (dBuV/m)	Margin (dB)	Antenna Height (m)	Table Angle (Degree)	Raw Value (dBuV)	Correction Factor (dB/m)
1	*6545.00	102.0 PK			2.77 V	289	55.6	46.4
2	*6545.00	88.7 AV			2.77 V	289	42.3	46.4
3	#13090.00	63.2 PK	88.2	-25.0	2.67 V	305	39.9	23.3
4	#13090.00	50.1 AV	68.2	-18.1	2.67 V	305	26.8	23.3

**Remarks:**

1. Emission Level(dBuV/m) = Raw Value(dBuV) + Correction Factor(dB/m)
2. Correction Factor(dB/m) = Antenna Factor(dB/m) + Cable Factor(dB) – Pre-Amplifier Factor(dB)
3. Margin value = Emission Level – Limit value
4. The other emission levels were very low against the limit.
5. " \* ": Fundamental frequency.
6. " # ": The radiated frequency is out of the restricted band.

RF Mode	TX 802.11ax (HE80)	Channel	CH 135 : 6625 MHz
Frequency Range	1GHz ~ 40GHz	Detector Function	Peak (PK) Average (AV)

**Antenna Polarity & Test Distance : Horizontal at 3 m**

No	Frequency (MHz)	Emission Level (dBuV/m)	Limit (dBuV/m)	Margin (dB)	Antenna Height (m)	Table Angle (Degree)	Raw Value (dBuV)	Correction Factor (dB/m)
1	*6625.00	96.4 PK			1.38 H	172	50.2	46.2
2	*6625.00	83.2 AV			1.38 H	172	37.0	46.2
3	13250.00	63.1 PK	74.0	-10.9	2.19 H	276	39.4	23.7
4	13250.00	50.0 AV	54.0	-4.0	2.19 H	276	26.3	23.7

**Antenna Polarity & Test Distance : Vertical at 3 m**

No	Frequency (MHz)	Emission Level (dBuV/m)	Limit (dBuV/m)	Margin (dB)	Antenna Height (m)	Table Angle (Degree)	Raw Value (dBuV)	Correction Factor (dB/m)
1	*6625.00	100.6 PK			2.92 V	275	54.4	46.2
2	*6625.00	87.3 AV			2.92 V	275	41.1	46.2
3	13250.00	63.3 PK	74.0	-10.7	2.87 V	336	39.6	23.7
4	13250.00	50.3 AV	54.0	-3.7	2.87 V	336	26.6	23.7

**Remarks:**

1. Emission Level(dBuV/m) = Raw Value(dBuV) + Correction Factor(dB/m)
2. Correction Factor(dB/m) = Antenna Factor(dB/m) + Cable Factor(dB) – Pre-Amplifier Factor(dB)
3. Margin value = Emission Level – Limit value
4. The other emission levels were very low against the limit.
5. " \* " : Fundamental frequency.

RF Mode	TX 802.11ax (HE80)	Channel	CH 151 : 6705 MHz
Frequency Range	1GHz ~ 40GHz	Detector Function	Peak (PK) Average (AV)

**Antenna Polarity & Test Distance : Horizontal at 3 m**

No	Frequency (MHz)	Emission Level (dBuV/m)	Limit (dBuV/m)	Margin (dB)	Antenna Height (m)	Table Angle (Degree)	Raw Value (dBuV)	Correction Factor (dB/m)
1	*6705.00	96.3 PK			1.42 H	182	50.2	46.1
2	*6705.00	82.9 AV			1.42 H	182	36.8	46.1
3	#13410.00	63.6 PK	88.2	-24.6	2.26 H	283	39.5	24.1
4	#13410.00	50.4 AV	68.2	-17.8	2.26 H	283	26.3	24.1

**Antenna Polarity & Test Distance : Vertical at 3 m**

No	Frequency (MHz)	Emission Level (dBuV/m)	Limit (dBuV/m)	Margin (dB)	Antenna Height (m)	Table Angle (Degree)	Raw Value (dBuV)	Correction Factor (dB/m)
1	*6705.00	100.8 PK			2.86 V	294	54.7	46.1
2	*6705.00	87.4 AV			2.86 V	294	41.3	46.1
3	#13410.00	63.8 PK	88.2	-24.4	2.69 V	323	39.7	24.1
4	#13410.00	50.7 AV	68.2	-17.5	2.69 V	323	26.6	24.1

**Remarks:**

1. Emission Level(dBuV/m) = Raw Value(dBuV) + Correction Factor(dB/m)
2. Correction Factor(dB/m) = Antenna Factor(dB/m) + Cable Factor(dB) – Pre-Amplifier Factor(dB)
3. Margin value = Emission Level – Limit value
4. The other emission levels were very low against the limit.
5. " \* ": Fundamental frequency.
6. " # ": The radiated frequency is out of the restricted band.

RF Mode	TX 802.11ax (HE80)	Channel	CH 167 : 6785 MHz
Frequency Range	1GHz ~ 40GHz	Detector Function	Peak (PK) Average (AV)

**Antenna Polarity & Test Distance : Horizontal at 3 m**

No	Frequency (MHz)	Emission Level (dBuV/m)	Limit (dBuV/m)	Margin (dB)	Antenna Height (m)	Table Angle (Degree)	Raw Value (dBuV)	Correction Factor (dB/m)
1	*6785.00	96.4 PK			1.45 H	171	50.1	46.3
2	*6785.00	83.1 AV			1.45 H	171	36.8	46.3
3	#13570.00	63.6 PK	88.2	-24.6	2.21 H	275	39.2	24.4
4	#13570.00	50.5 AV	68.2	-17.7	2.21 H	275	26.1	24.4

**Antenna Polarity & Test Distance : Vertical at 3 m**

No	Frequency (MHz)	Emission Level (dBuV/m)	Limit (dBuV/m)	Margin (dB)	Antenna Height (m)	Table Angle (Degree)	Raw Value (dBuV)	Correction Factor (dB/m)
1	*6785.00	100.7 PK			2.91 V	285	54.4	46.3
2	*6785.00	87.4 AV			2.91 V	285	41.1	46.3
3	#13570.00	64.0 PK	88.2	-24.2	2.57 V	332	39.6	24.4
4	#13570.00	51.0 AV	68.2	-17.2	2.57 V	332	26.6	24.4

**Remarks:**

1. Emission Level(dBuV/m) = Raw Value(dBuV) + Correction Factor(dB/m)
2. Correction Factor(dB/m) = Antenna Factor(dB/m) + Cable Factor(dB) – Pre-Amplifier Factor(dB)
3. Margin value = Emission Level – Limit value
4. The other emission levels were very low against the limit.
5. " \* ": Fundamental frequency.
6. " # ": The radiated frequency is out of the restricted band.



RF Mode	TX 802.11ax (HE80)	Channel	CH 183 : 6865 MHz
Frequency Range	1GHz ~ 40GHz	Detector Function	Peak (PK) Average (AV)

**Antenna Polarity & Test Distance : Horizontal at 3 m**

No	Frequency (MHz)	Emission Level (dBuV/m)	Limit (dBuV/m)	Margin (dB)	Antenna Height (m)	Table Angle (Degree)	Raw Value (dBuV)	Correction Factor (dB/m)
1	*6865.00	97.2 PK			1.33 H	191	50.6	46.6
2	*6865.00	83.9 AV			1.33 H	191	37.3	46.6
3	#13730.00	64.0 PK	88.2	-24.2	2.26 H	271	39.5	24.5
4	#13730.00	50.9 AV	68.2	-17.3	2.26 H	271	26.4	24.5

**Antenna Polarity & Test Distance : Vertical at 3 m**

No	Frequency (MHz)	Emission Level (dBuV/m)	Limit (dBuV/m)	Margin (dB)	Antenna Height (m)	Table Angle (Degree)	Raw Value (dBuV)	Correction Factor (dB/m)
1	*6865.00	101.5 PK			2.89 V	286	54.9	46.6
2	*6865.00	88.3 AV			2.89 V	286	41.7	46.6
3	#13730.00	64.2 PK	88.2	-24.0	2.69 V	310	39.7	24.5
4	#13730.00	51.2 AV	68.2	-17.0	2.69 V	310	26.7	24.5

**Remarks:**

1. Emission Level(dBuV/m) = Raw Value(dBuV) + Correction Factor(dB/m)
2. Correction Factor(dB/m) = Antenna Factor(dB/m) + Cable Factor(dB) – Pre-Amplifier Factor(dB)
3. Margin value = Emission Level – Limit value
4. The other emission levels were very low against the limit.
5. " \* ": Fundamental frequency.
6. " # ": The radiated frequency is out of the restricted band.

RF Mode	TX 802.11ax (HE80)	Channel	CH 199 : 6945 MHz
Frequency Range	1GHz ~ 40GHz	Detector Function	Peak (PK) Average (AV)

**Antenna Polarity & Test Distance : Horizontal at 3 m**

No	Frequency (MHz)	Emission Level (dBuV/m)	Limit (dBuV/m)	Margin (dB)	Antenna Height (m)	Table Angle (Degree)	Raw Value (dBuV)	Correction Factor (dB/m)
1	*6945.00	98.4 PK			1.28 H	175	51.1	47.3
2	*6945.00	85.1 AV			1.28 H	175	37.8	47.3
3	#13890.00	64.4 PK	88.2	-23.8	2.27 H	282	39.4	25.0
4	#13890.00	51.3 AV	68.2	-16.9	2.27 H	282	26.3	25.0

**Antenna Polarity & Test Distance : Vertical at 3 m**

No	Frequency (MHz)	Emission Level (dBuV/m)	Limit (dBuV/m)	Margin (dB)	Antenna Height (m)	Table Angle (Degree)	Raw Value (dBuV)	Correction Factor (dB/m)
1	*6945.00	102.9 PK			2.81 V	297	55.6	47.3
2	*6945.00	89.6 AV			2.81 V	297	42.3	47.3
3	#13980.00	64.8 PK	88.2	-23.4	2.81 V	316	39.7	25.1
4	#13980.00	51.7 AV	68.2	-16.5	2.81 V	316	26.6	25.1

**Remarks:**

1. Emission Level(dBuV/m) = Raw Value(dBuV) + Correction Factor(dB/m)
2. Correction Factor(dB/m) = Antenna Factor(dB/m) + Cable Factor(dB) – Pre-Amplifier Factor(dB)
3. Margin value = Emission Level – Limit value
4. The other emission levels were very low against the limit.
5. " \* ": Fundamental frequency.
6. " # ": The radiated frequency is out of the restricted band.

RF Mode	TX 802.11ax (HE80)	Channel	CH 215 : 7025 MHz
Frequency Range	1GHz ~ 40GHz	Detector Function	Peak (PK) Average (AV)

**Antenna Polarity & Test Distance : Horizontal at 3 m**

No	Frequency (MHz)	Emission Level (dBuV/m)	Limit (dBuV/m)	Margin (dB)	Antenna Height (m)	Table Angle (Degree)	Raw Value (dBuV)	Correction Factor (dB/m)
1	*7025.00	100.2 PK			1.33 H	185	52.4	47.8
2	*7025.00	87.0 AV			1.33 H	185	39.2	47.8
3	#7125.00	66.2 PK	88.2	-22.0	1.33 H	185	48.7	17.5
4	#7125.00	53.4 AV	68.2	-14.8	1.33 H	185	35.9	17.5
5	#14050.00	64.7 PK	88.2	-23.5	4.00 H	269	39.4	25.3
6	#14050.00	51.7 AV	68.2	-16.5	4.00 H	269	26.4	25.3

**Antenna Polarity & Test Distance : Vertical at 3 m**

No	Frequency (MHz)	Emission Level (dBuV/m)	Limit (dBuV/m)	Margin (dB)	Antenna Height (m)	Table Angle (Degree)	Raw Value (dBuV)	Correction Factor (dB/m)
1	*7025.00	104.4 PK			2.91 V	273	56.6	47.8
2	*7025.00	91.4 AV			2.91 V	273	43.6	47.8
3	#7125.00	66.9 PK	88.2	-21.3	2.91 V	273	49.4	17.5
4	#7125.00	53.8 AV	68.2	-14.4	2.91 V	273	36.3	17.5
5	#14050.00	65.0 PK	88.2	-23.2	2.83 V	324	39.7	25.3
6	#14050.00	51.9 AV	68.2	-16.3	2.83 V	324	26.6	25.3

**Remarks:**

1. Emission Level(dBuV/m) = Raw Value(dBuV) + Correction Factor(dB/m)
2. Correction Factor(dB/m) = Antenna Factor(dB/m) + Cable Factor(dB) – Pre-Amplifier Factor(dB)
3. Margin value = Emission Level – Limit value
4. The other emission levels were very low against the limit.
5. " \* ": Fundamental frequency.
6. " # ": The radiated frequency is out of the restricted band.

Below 1GHz Worst-Case Data:

Nss 1

RF Mode	TX 802.11ax (HE80)	Channel	CH 215 : 7025 MHz
Frequency Range	30MHz ~ 1GHz	Detector Function	Quasi-Peak (QP)
Test Mode	A		

Antenna Polarity & Test Distance : Horizontal at 3 m								
No	Frequency (MHz)	Emission Level (dBuV/m)	Limit (dBuV/m)	Margin (dB)	Antenna Height (m)	Table Angle (Degree)	Raw Value (dBuV)	Correction Factor (dB/m)
1	35.82	29.3 QP	40.0	-10.7	1.00 H	91	39.3	-10.0
2	109.54	29.0 QP	43.5	-14.5	1.25 H	334	41.1	-12.1
3	216.24	29.7 QP	46.0	-16.3	1.00 H	157	41.2	-11.5
4	317.12	32.1 QP	46.0	-13.9	1.50 H	91	39.3	-7.2
5	660.50	34.8 QP	46.0	-11.2	1.50 H	212	35.6	-0.8
6	870.02	36.4 QP	46.0	-9.6	1.00 H	159	32.4	4.0

Remarks:

1. Emission Level(dBuV/m) = Raw Value(dBuV) + Correction Factor(dB/m).
2. Correction Factor(dB/m) = Antenna Factor(dB/m) + Cable Factor(dB) – Pre-Amplifier Factor(dB).
3. The other emission levels were very low against the limit of frequency range 30MHz ~ 1000MHz.
4. Margin value = Emission Level – Limit value.
5. The emission levels were very low against the limit of frequency range 9kHz ~ 30MHz: the amplitude of spurious emissions attenuated more than 20 dB below the permissible value to be report.

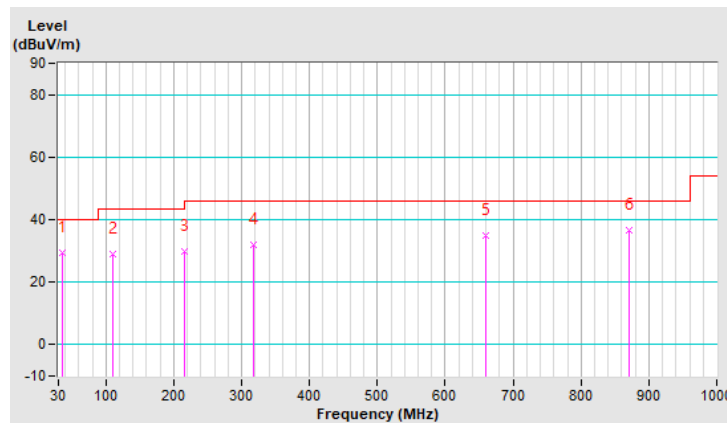

RF Mode	TX 802.11ax (HE80)	Channel	CH 215 : 7025 MHz
Frequency Range	30MHz ~ 1GHz	Detector Function	Quasi-Peak (QP)
Test Mode	A		

Antenna Polarity & Test Distance : Vertical at 3 m								
No	Frequency (MHz)	Emission Level (dBuV/m)	Limit (dBuV/m)	Margin (dB)	Antenna Height (m)	Table Angle (Degree)	Raw Value (dBuV)	Correction Factor (dB/m)
1	45.52	30.3 QP	40.0	-9.7	1.25 V	24	39.0	-8.7
2	97.90	30.6 QP	43.5	-12.9	1.25 V	191	44.2	-13.6
3	127.00	35.4 QP	43.5	-8.1	1.00 V	153	46.0	-10.6
4	278.32	36.5 QP	46.0	-9.5	1.50 V	155	44.6	-8.1
5	666.32	33.0 QP	46.0	-13.0	1.00 V	85	33.7	-0.7
6	771.08	34.4 QP	46.0	-11.6	1.50 V	53	32.3	2.1

Remarks:

1. Emission Level(dBuV/m) = Raw Value(dBuV) + Correction Factor(dB/m).
2. Correction Factor(dB/m) = Antenna Factor(dB/m) + Cable Factor(dB) – Pre-Amplifier Factor(dB).
3. The other emission levels were very low against the limit of frequency range 30MHz ~ 1000MHz.
4. Margin value = Emission Level – Limit value.
5. The emission levels were very low against the limit of frequency range 9kHz ~ 30MHz: the amplitude of spurious emissions attenuated more than 20 dB below the permissible value to be report.

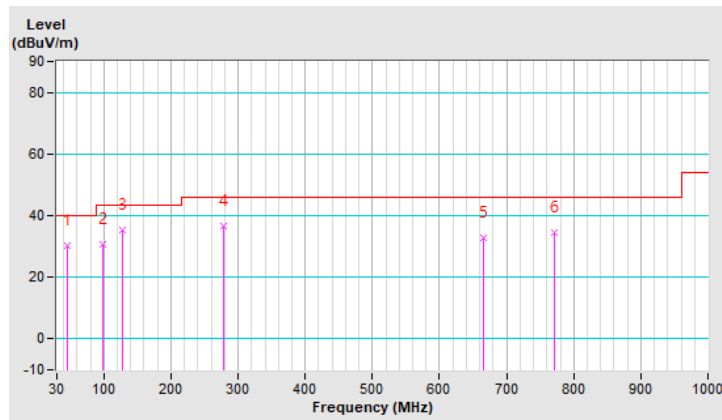

RF Mode	TX 802.11ax (HE80)	Channel	CH 215 : 7025 MHz
Frequency Range	30MHz ~ 1GHz	Detector Function	Quasi-Peak (QP)
Test Mode	B		

Antenna Polarity & Test Distance : Horizontal at 3 m								
No	Frequency (MHz)	Emission Level (dBuV/m)	Limit (dBuV/m)	Margin (dB)	Antenna Height (m)	Table Angle (Degree)	Raw Value (dBuV)	Correction Factor (dB/m)
1	31.94	34.8 QP	40.0	-5.2	1.00 H	313	45.1	-10.3
2	105.66	36.5 QP	43.5	-7.0	1.25 H	104	49.1	-12.6
3	293.84	41.7 QP	46.0	-4.3	1.50 H	85	49.5	-7.8
4	332.64	33.2 QP	46.0	-12.8	1.25 H	110	40.0	-6.8
5	774.96	31.9 QP	46.0	-14.1	1.00 H	337	29.7	2.2
6	934.04	34.7 QP	46.0	-11.3	1.00 H	113	29.4	5.3

Remarks:

1. Emission Level(dBuV/m) = Raw Value(dBuV) + Correction Factor(dB/m).
2. Correction Factor(dB/m) = Antenna Factor(dB/m) + Cable Factor(dB) – Pre-Amplifier Factor(dB).
3. The other emission levels were very low against the limit of frequency range 30MHz ~ 1000MHz.
4. Margin value = Emission Level – Limit value.
5. The emission levels were very low against the limit of frequency range 9kHz ~ 30MHz: the amplitude of spurious emissions attenuated more than 20 dB below the permissible value to be report.

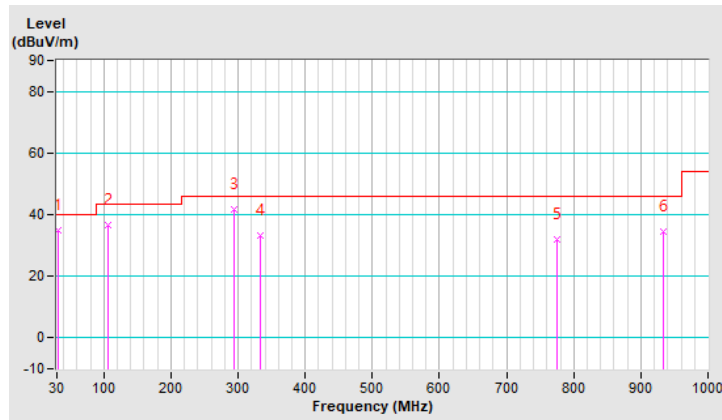

RF Mode	TX 802.11ax (HE80)	Channel	CH 215 : 7025 MHz
Frequency Range	30MHz ~ 1GHz	Detector Function	Quasi-Peak (QP)
Test Mode	B		

Antenna Polarity & Test Distance : Vertical at 3 m								
No	Frequency (MHz)	Emission Level (dBuV/m)	Limit (dBuV/m)	Margin (dB)	Antenna Height (m)	Table Angle (Degree)	Raw Value (dBuV)	Correction Factor (dB/m)
1	30.00	28.2 QP	40.0	-11.8	1.00 V	33	38.4	-10.2
2	62.98	29.0 QP	40.0	-11.0	1.25 V	106	38.6	-9.6
3	109.54	29.9 QP	43.5	-13.6	1.50 V	106	42.0	-12.1
4	394.72	34.8 QP	46.0	-11.2	1.50 V	106	40.9	-6.1
5	662.44	35.0 QP	46.0	-11.0	1.00 V	107	35.7	-0.7
6	932.10	36.0 QP	46.0	-10.0	1.25 V	348	30.8	5.2

Remarks:

1. Emission Level(dBuV/m) = Raw Value(dBuV) + Correction Factor(dB/m).
2. Correction Factor(dB/m) = Antenna Factor(dB/m) + Cable Factor(dB) – Pre-Amplifier Factor(dB).
3. The other emission levels were very low against the limit of frequency range 30MHz ~ 1000MHz.
4. Margin value = Emission Level – Limit value.
5. The emission levels were very low against the limit of frequency range 9kHz ~ 30MHz: the amplitude of spurious emissions attenuated more than 20 dB below the permissible value to be report.

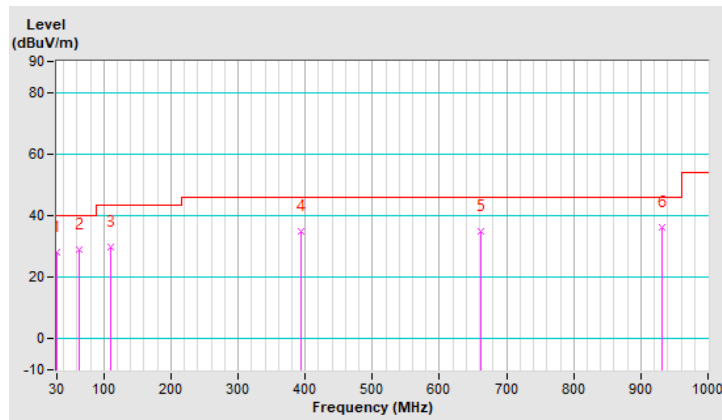

## 4.2 In-Band Emission (Mask) Measurement

### 4.2.1 Limits of In-Band Emission (Mask) Measurement

Test Item	Frequencies (MHz)	(X) dBc <sup>*1</sup>
Emission Mask	At 1 MHz outside of channel edge	20
	At one channel bandwidth from the channel center <sup>*2</sup>	28
	At one- and one-half times the channel bandwidth away from channel center <sup>*3</sup>	40
	More than one- and one-half times the channel bandwidth	40

\*1 : The power spectral density must be suppressed by "x" dB

\*2 : At frequencies between one megahertz outside an unlicensed device's channel edge and one channel bandwidth from the center of the channel, the limits must be linearly interpolated between 20 dB and 28 dB suppression,

\*3 : At frequencies between one and one- and one-half times an unlicensed device's channel bandwidth, the limits must be linearly interpolated between 28 dB and 40 dB suppression.

### 4.2.2 Test Setup

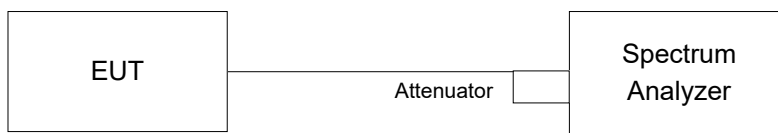

### 4.2.3 Test Instruments

Refer to section 4.1.2 to get information of above instrument.



#### 4.2.4 Test Procedure

- a. Connect output of the antenna port to a spectrum analyzer and adjust appropriate attenuation.
- b. Measure the 26 dB EBW using the test procedure 12.4.1 of ANSI C63.10-2013. (Determine the channel edge.)
- c. Measure the power spectral density ( for emissions mask reference) using the following procedure:
  - a) Set the span to encompass the entire 26 dB EBW of the signal.
  - b) Set RBW = same RBW used for 26 dB EBW measurement.
  - c) Set VBW  $\geq 3 \times$  RBW
  - d) Number of points in sweep  $\geq [2 \times \text{span} / \text{RBW}]$ .
  - e) Sweep time = auto.
  - f) Detector = RMS (i.e., power averaging)
  - g) Trace average at least 100 traces in power averaging (rms) mode.
  - h) Use the peak search function on the instrument to find the peak of the spectrum.
- d. Using the measuring equipment limit line function, develop the emissions mask based on the following requirements. The emissions power spectral density must be reduced below the peak power spectral density (in dB) as follows:
  - a) Suppressed by 20 dB at 1 MHz outside of the channel edge. (The channel edge is defined as the 26-dB point on either side of the carrier center frequency.)
  - b) Suppressed by 28 dB at one channel bandwidth from the channel center.
  - c) Suppressed by 40 dB at one- and one-half times the channel bandwidth from the channel center.
- e. Adjust the span to encompass the entire mask as necessary and clear trace.
- f. Trace average at least 100 traces in power averaging (rms) mode.
- g. Adjust the reference level as necessary so that the crest of the channel touches the top of the emission mask

#### 4.2.5 EUT Operating Condition

The software provided by client to enable the EUT under transmission condition continuously at lowest, middle and highest channel frequencies individually.

## 4.2.6 Test Results

Nss 1

802.11a\_Chain 0

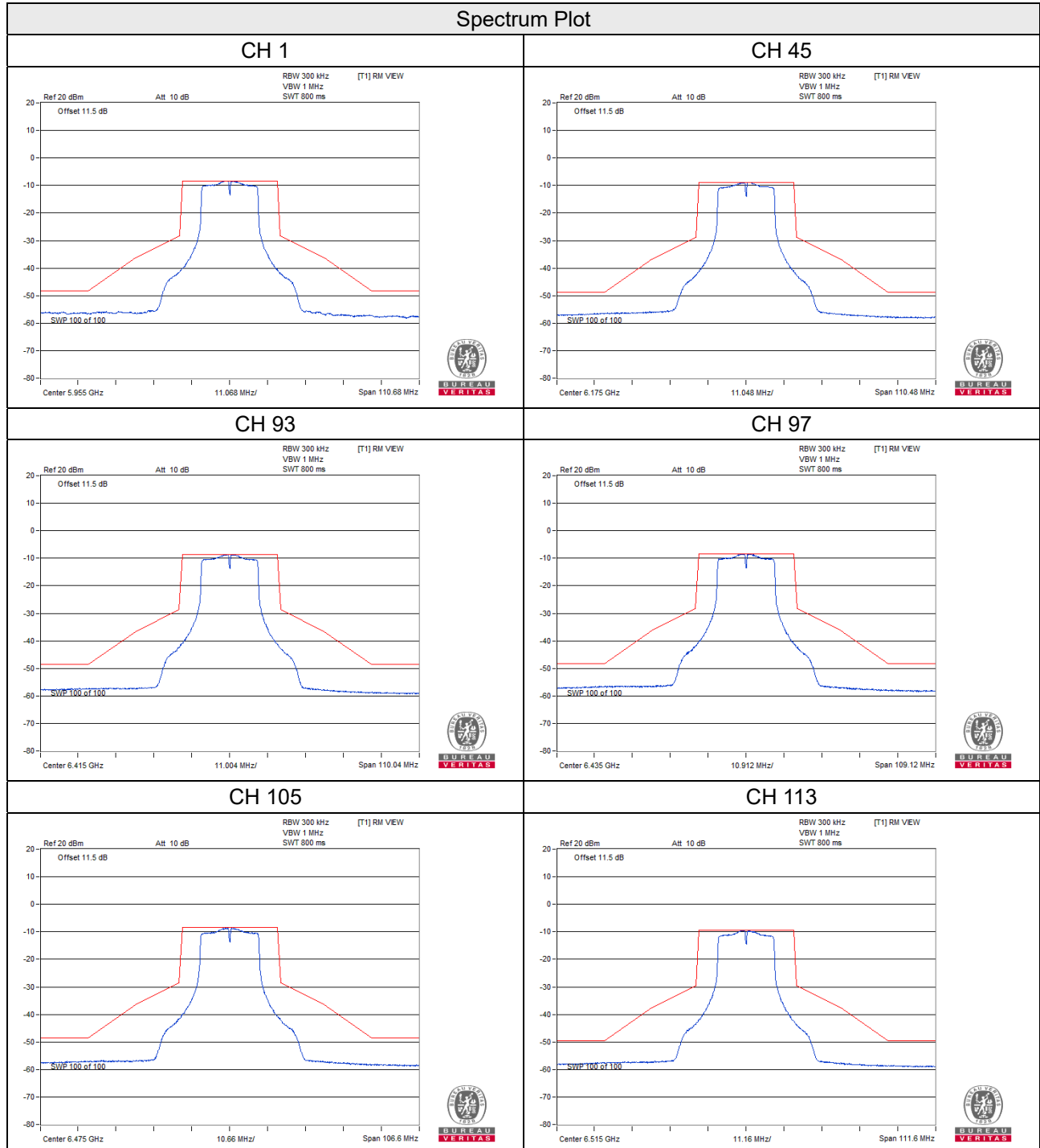

### Spectrum Plot

#### CH 117

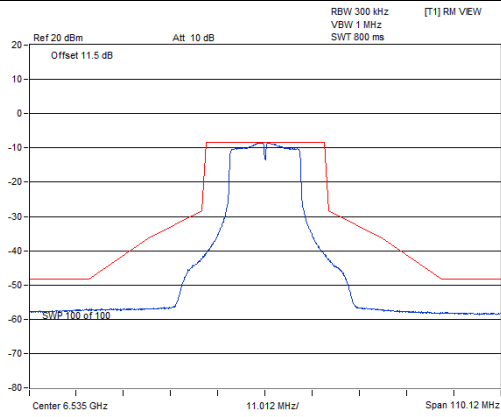

#### CH 153

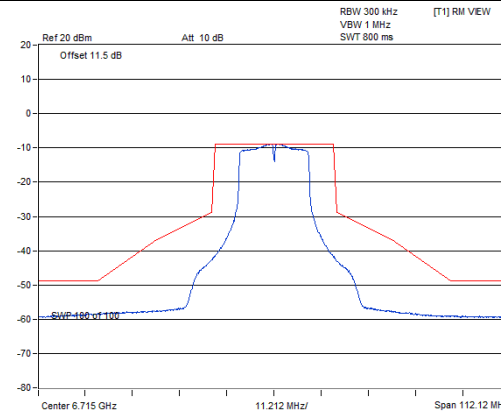

#### CH 181

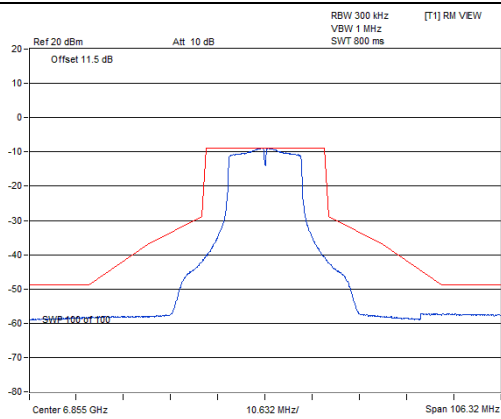

#### CH 185

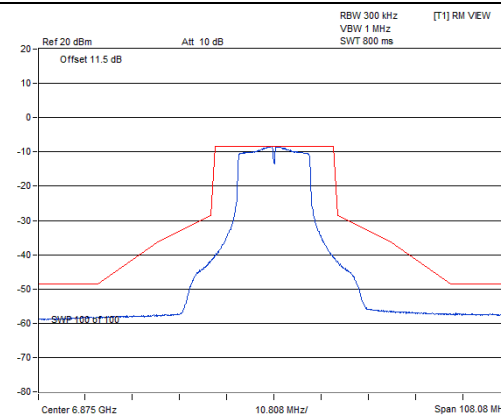

#### CH 213

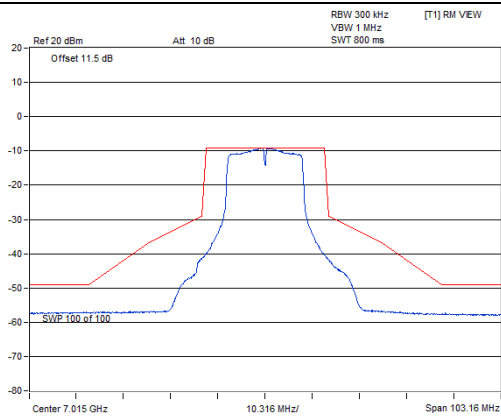

#### CH 229

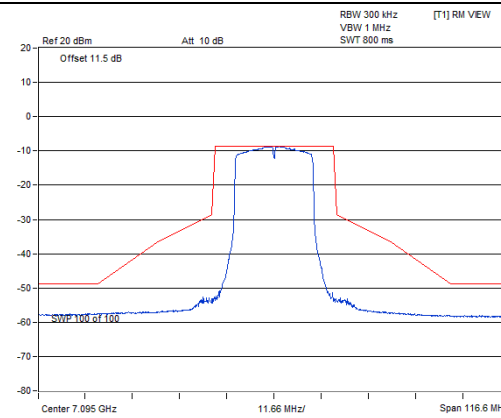

### Spectrum Plot

CH 233

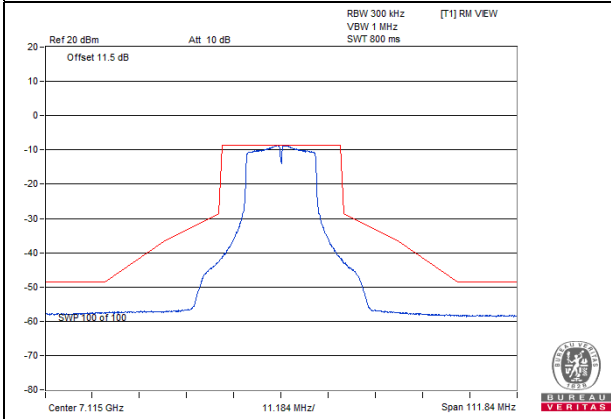

802.11a\_Chain 1

Spectrum Plot

CH 1

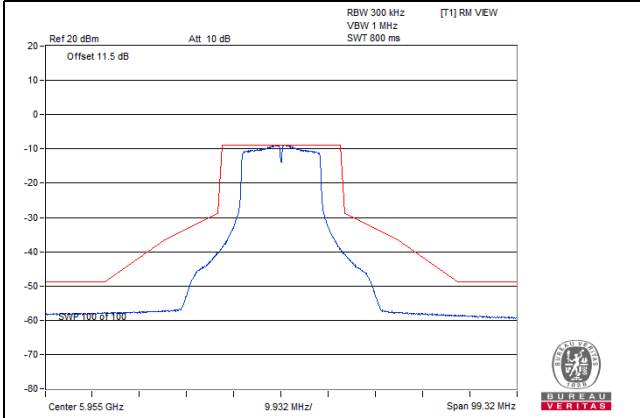

CH 45

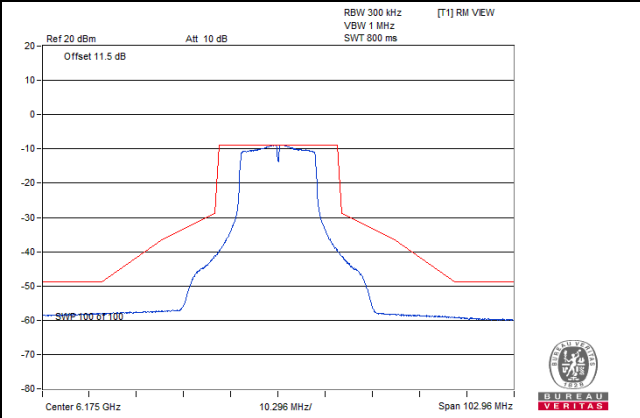

CH 93

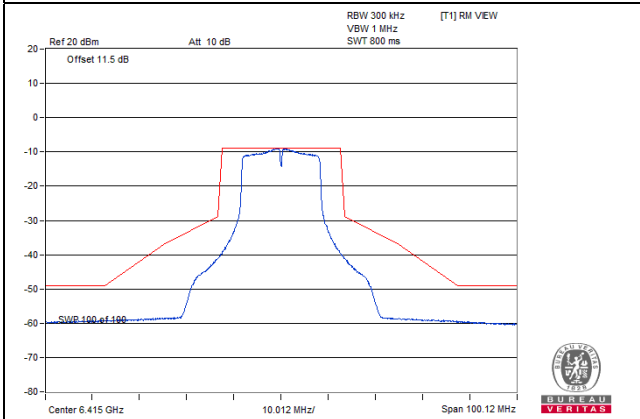

CH 97

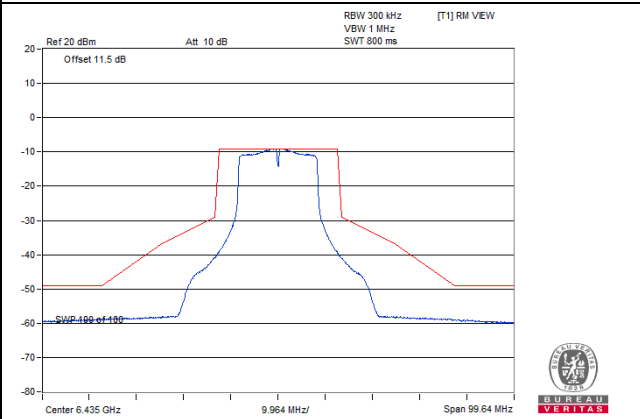

CH 105

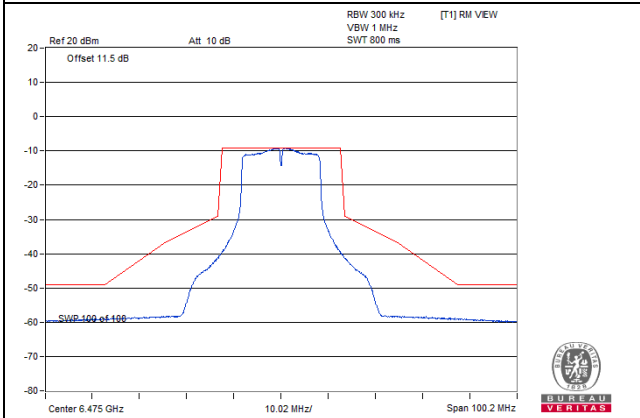

CH 113

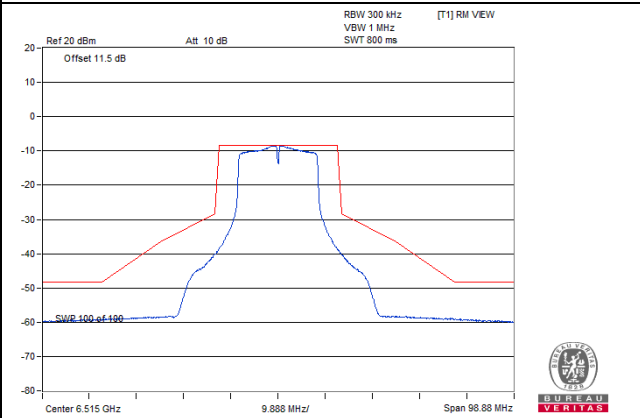

### Spectrum Plot

#### CH 117

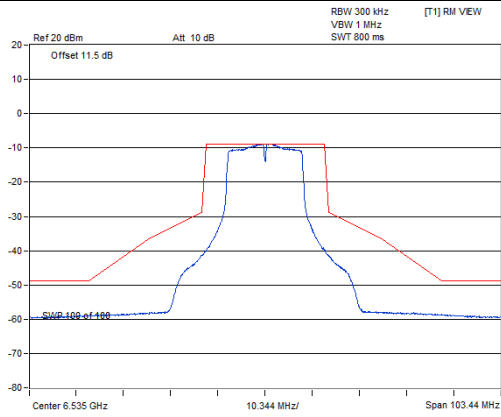

#### CH 153

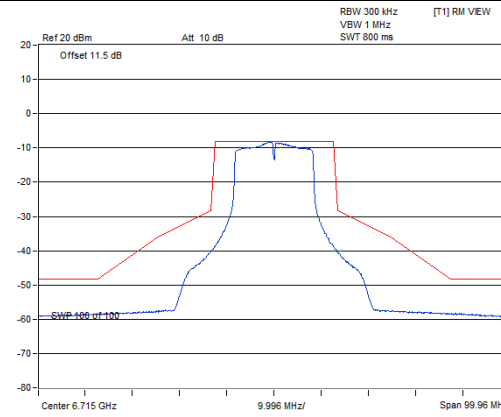

#### CH 181

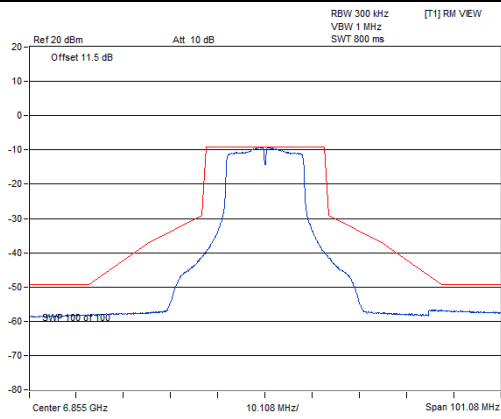

#### CH 185

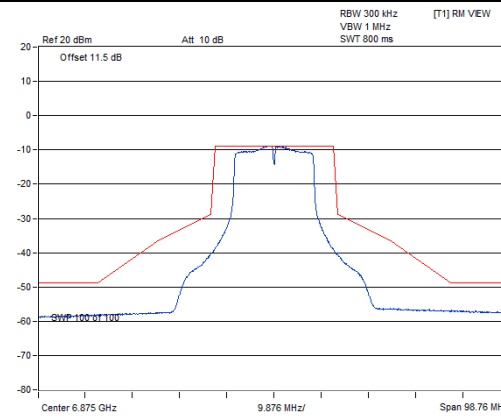

#### CH 213

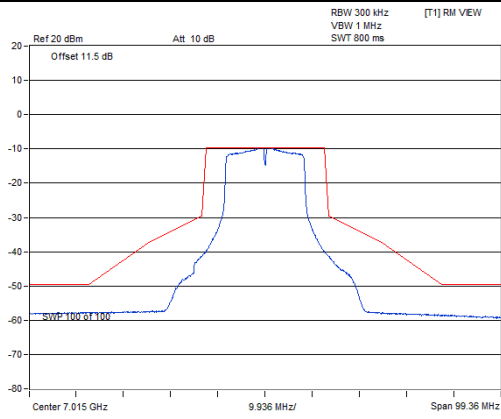

#### CH 229

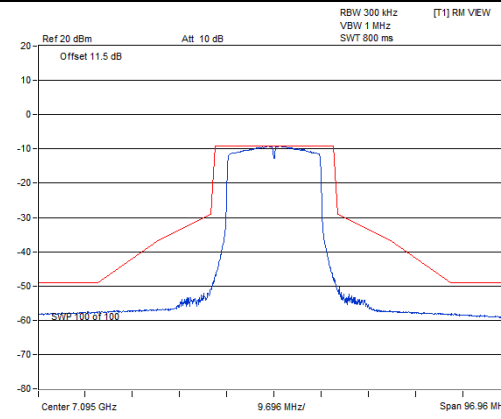

### Spectrum Plot

CH 233

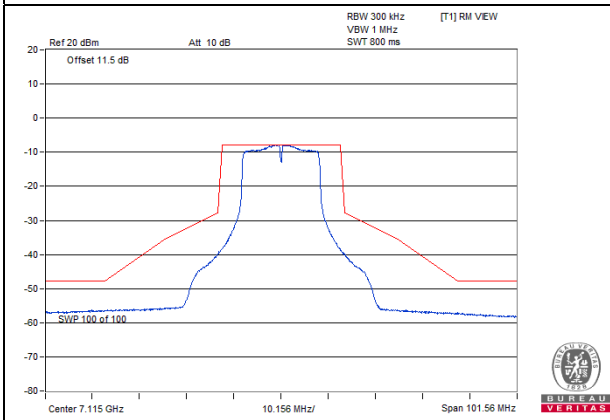

802.11ax (HE20)\_Chain 0

Spectrum Plot

CH 1

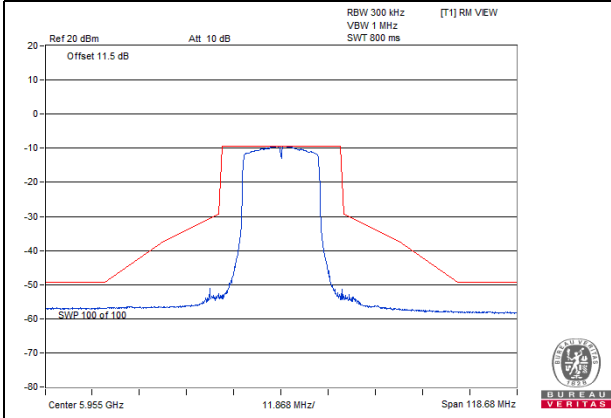

CH 45

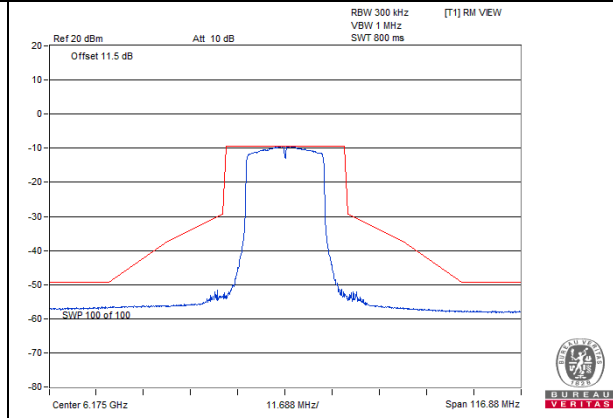

CH 93

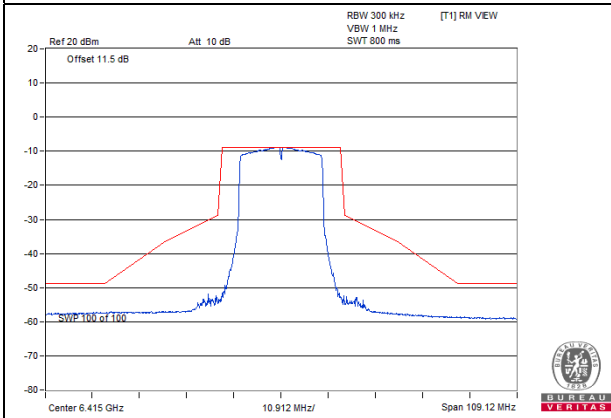

CH 97

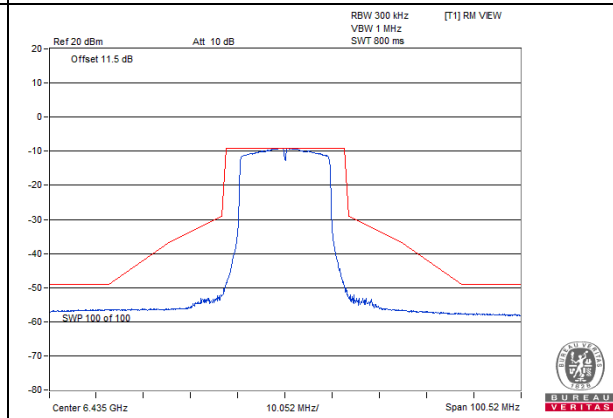

CH 105

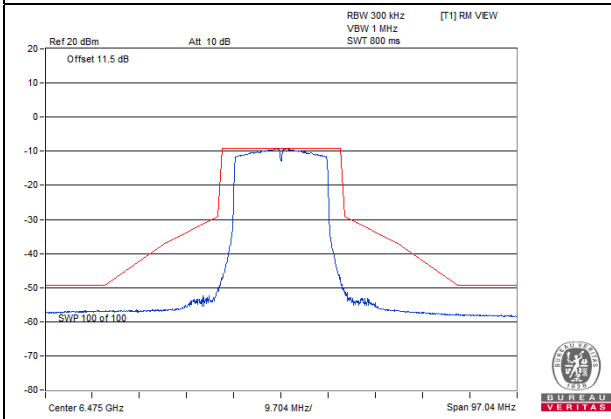

CH 113

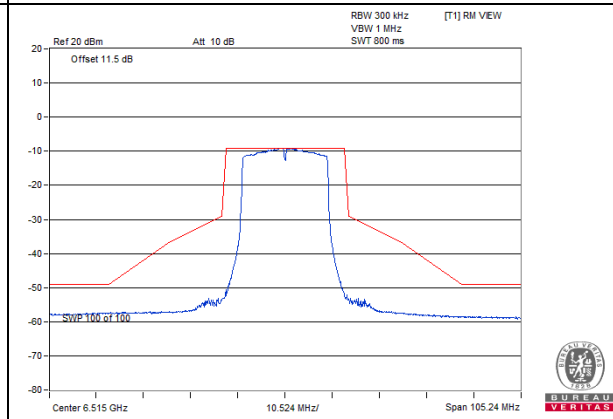



### Spectrum Plot

#### CH 117

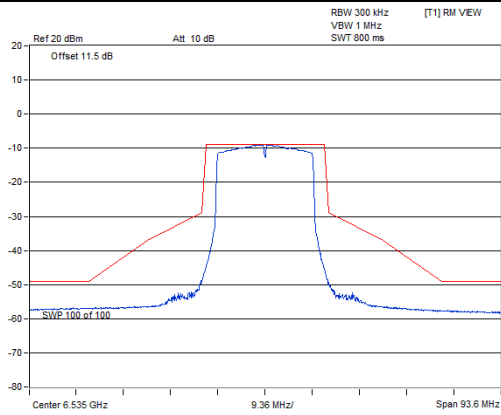

#### CH 153

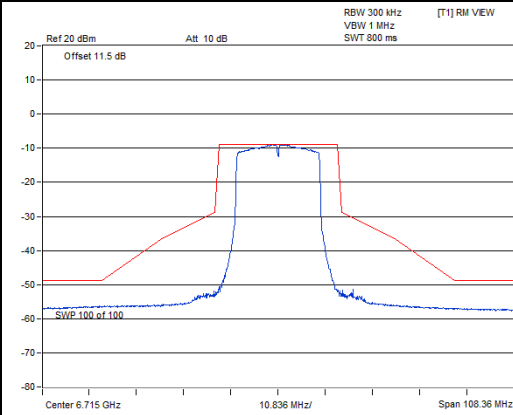

#### CH 181

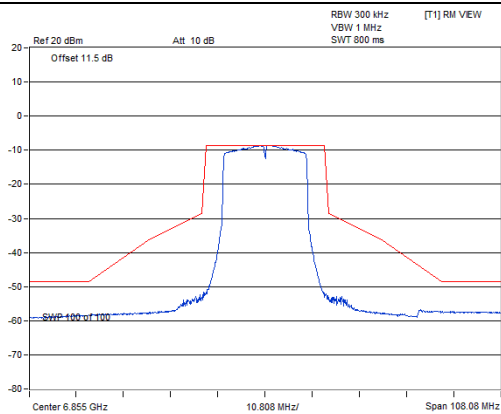

#### CH 185

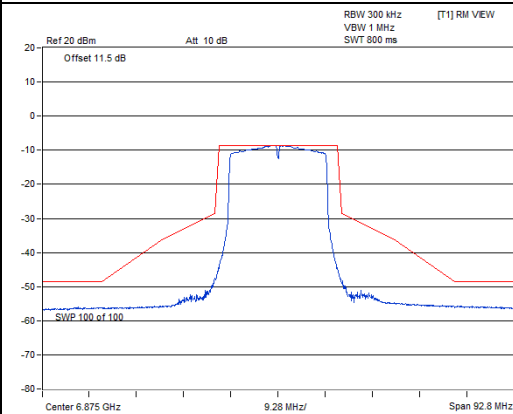

#### CH 213

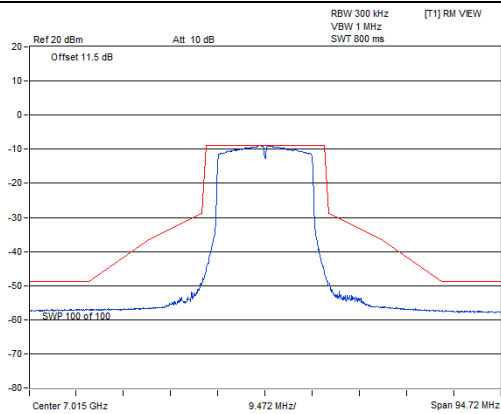

#### CH 229

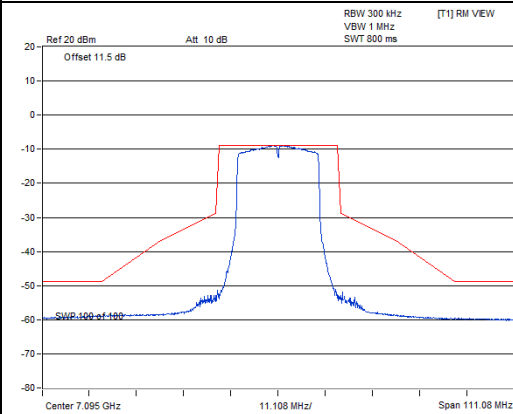

### Spectrum Plot

CH 233

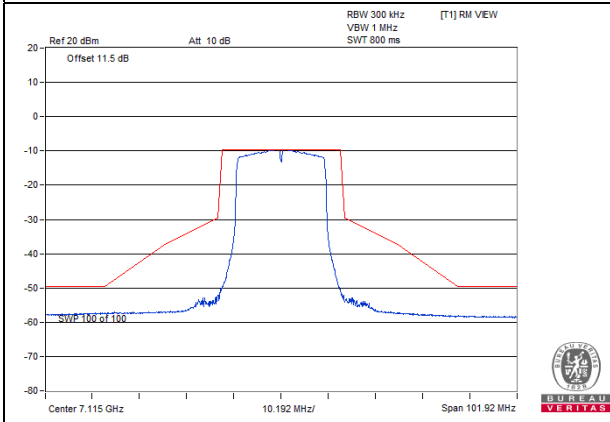

802.11ax (HE20)\_Chain 1

Spectrum Plot

CH 1

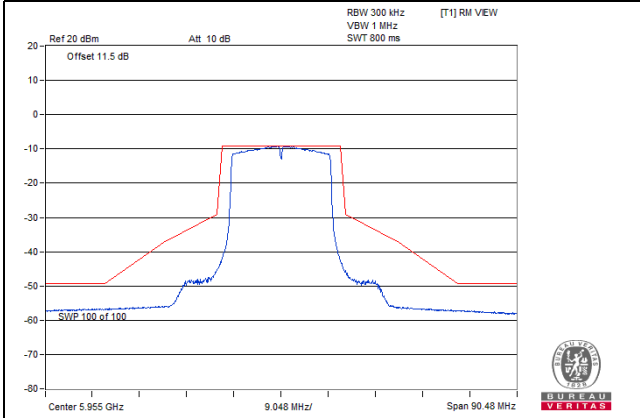

CH 45

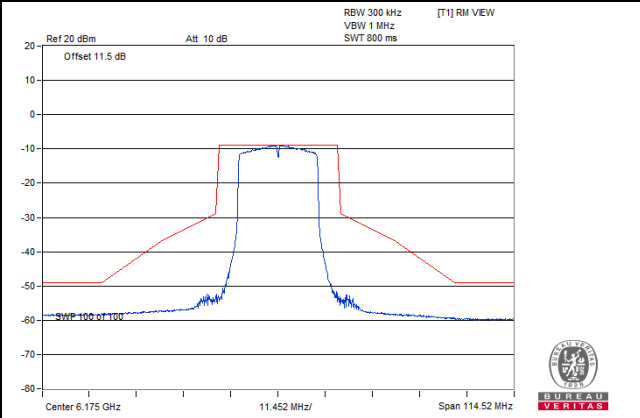

CH 93

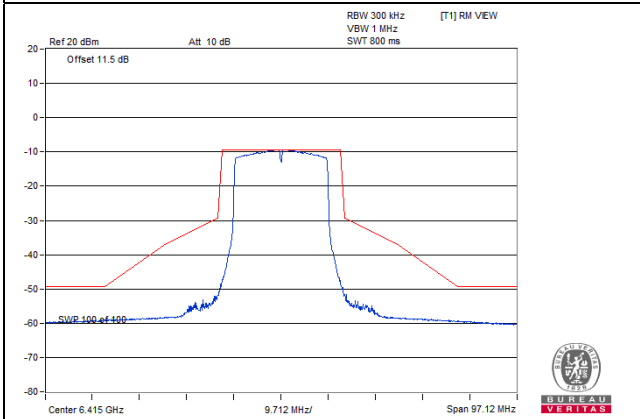

CH 97

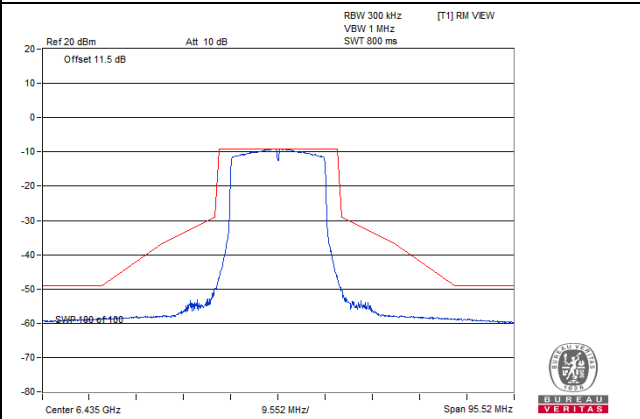

CH 105

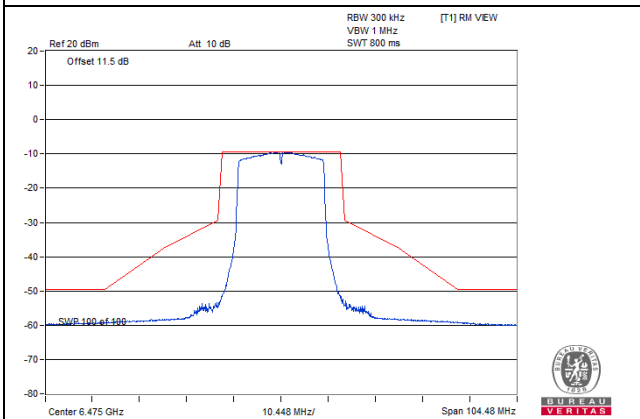

CH 113

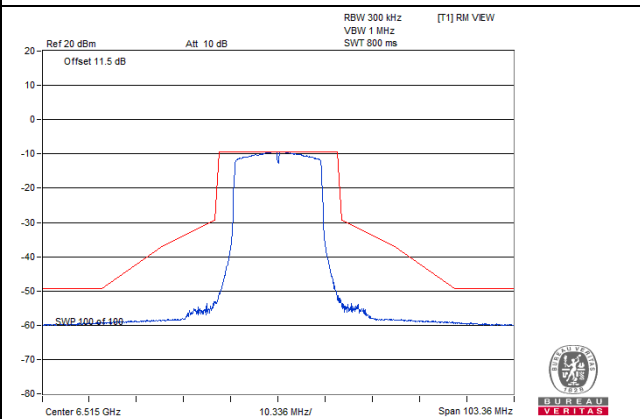

### Spectrum Plot

#### CH 117

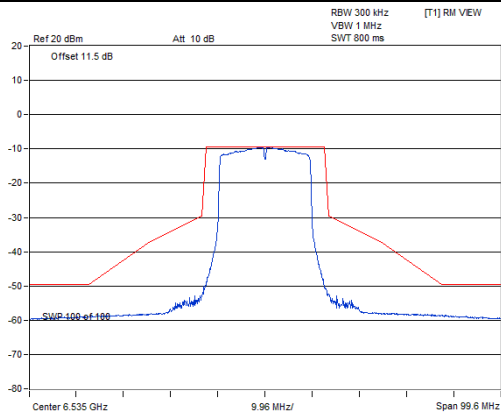

#### CH 153

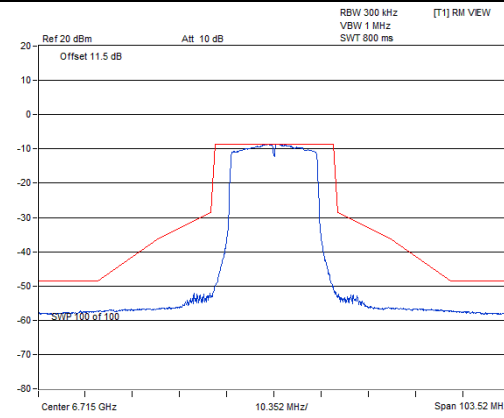

#### CH 181

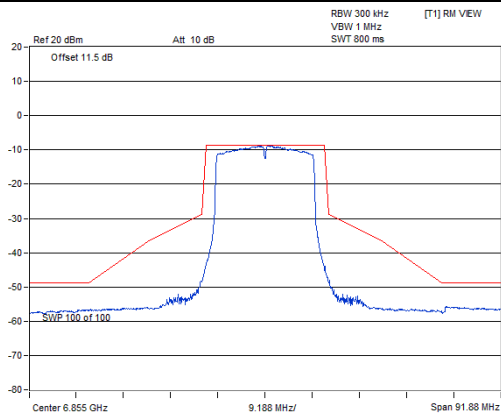

#### CH 185

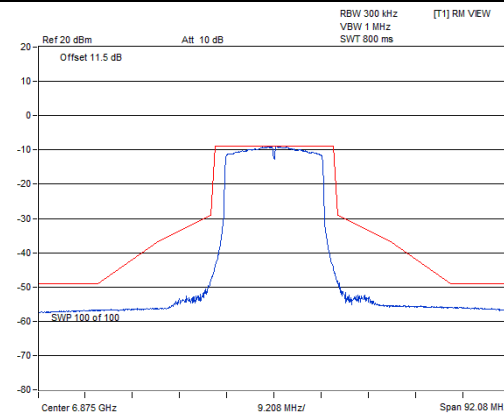

#### CH 213

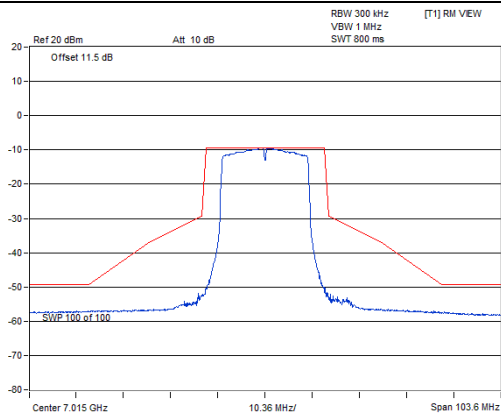

#### CH 229

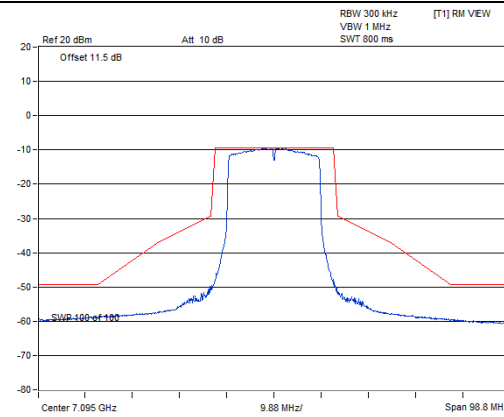

### Spectrum Plot

CH 233

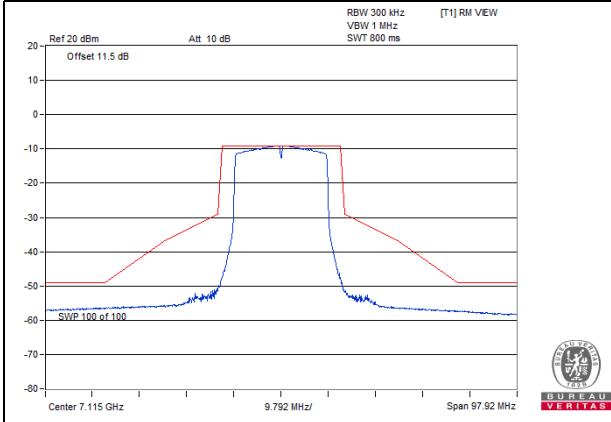

802.11ax (HE40)\_Chain 0

Spectrum Plot

CH 3

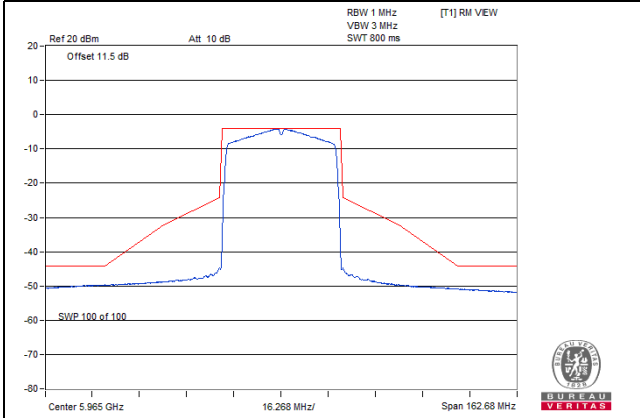

CH 43

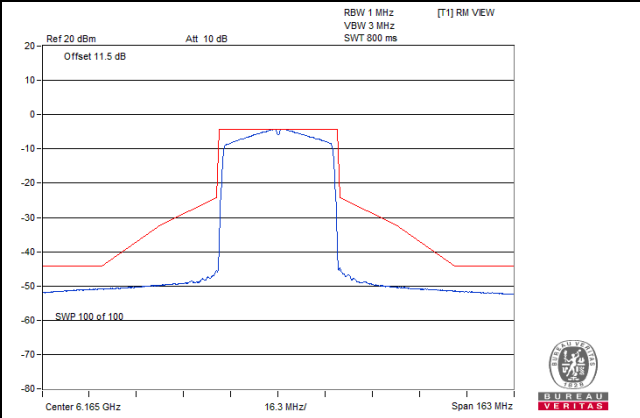

CH 91

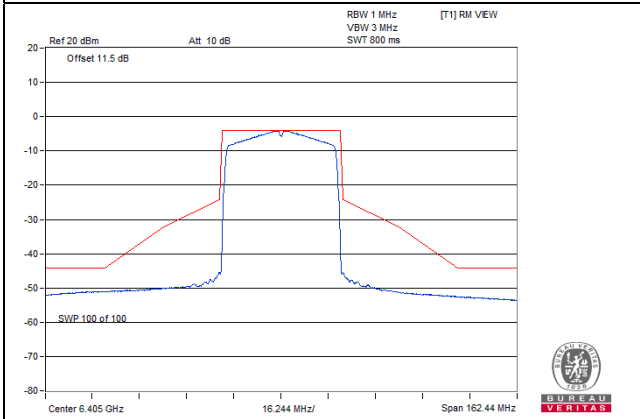

CH 99

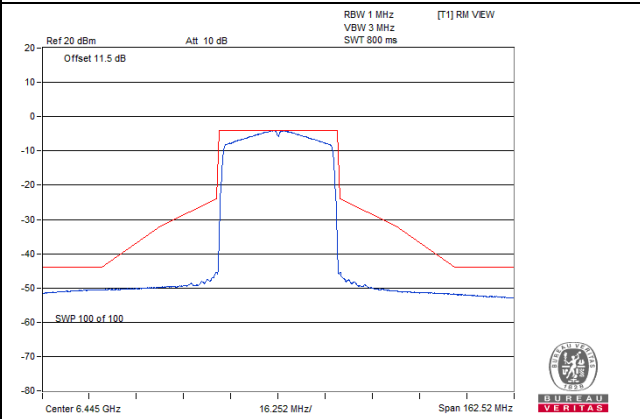

CH 107

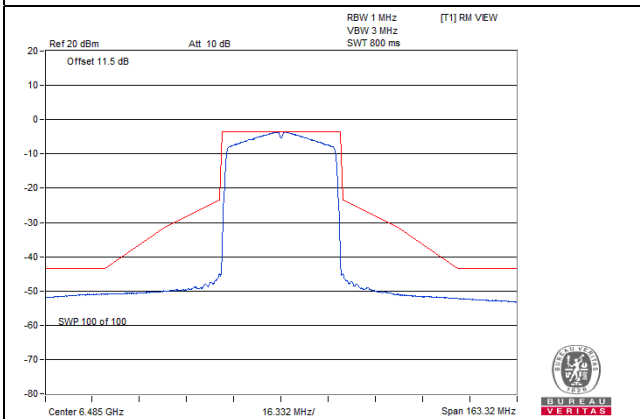

CH 115

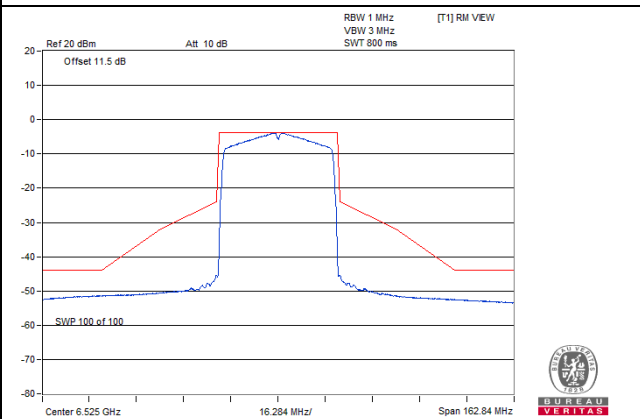

### Spectrum Plot

#### CH 123

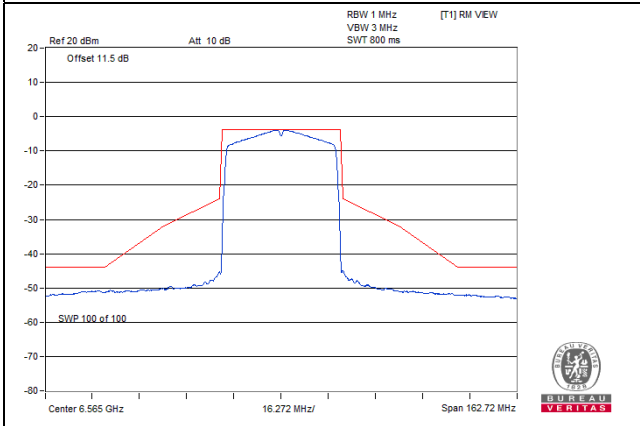

#### CH 155

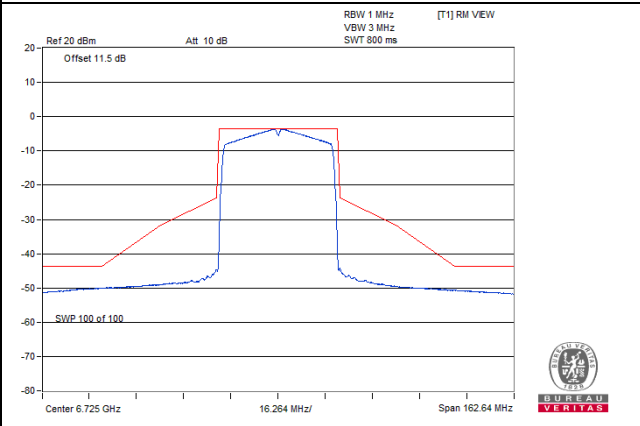

#### CH 179

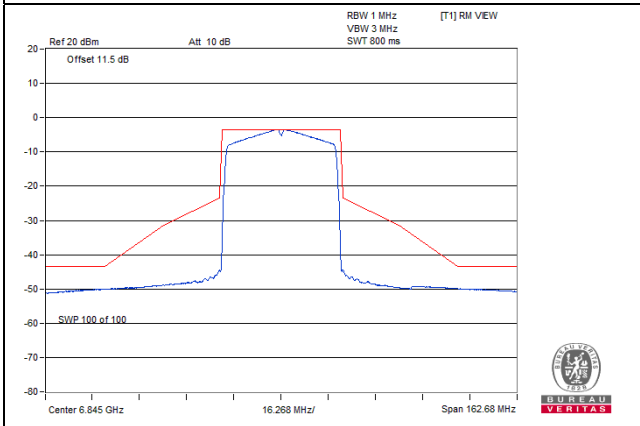

#### CH 187

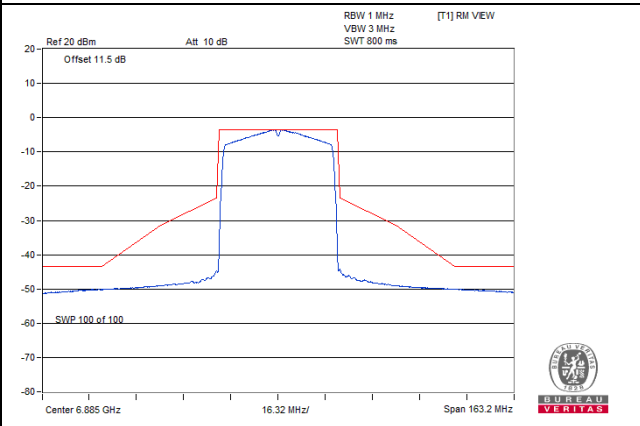

#### CH 211

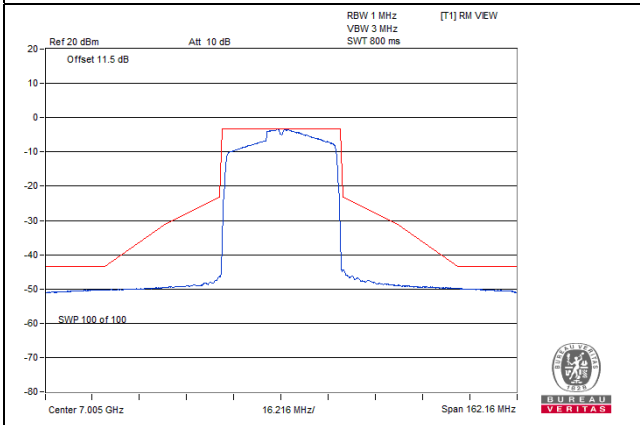

#### CH 227

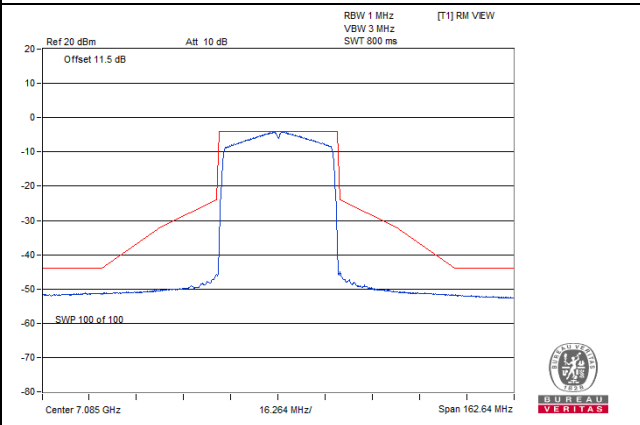

802.11ax (HE40)\_Chain 1

Spectrum Plot

CH 3

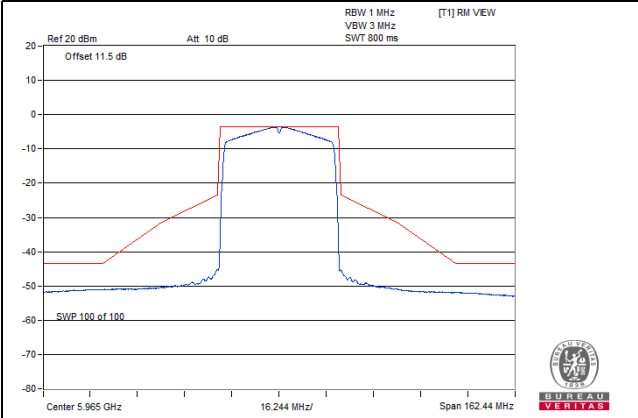

CH 43

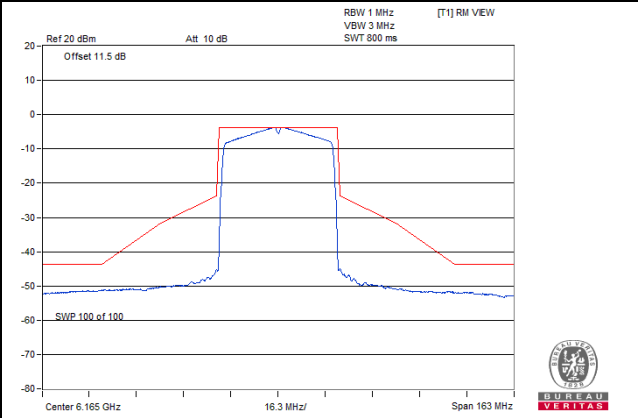

CH 91

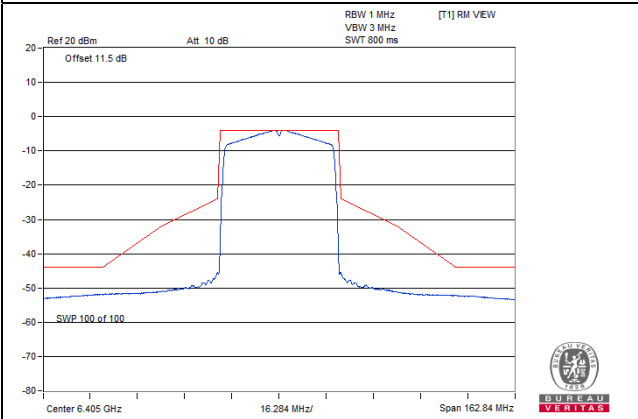

CH 99

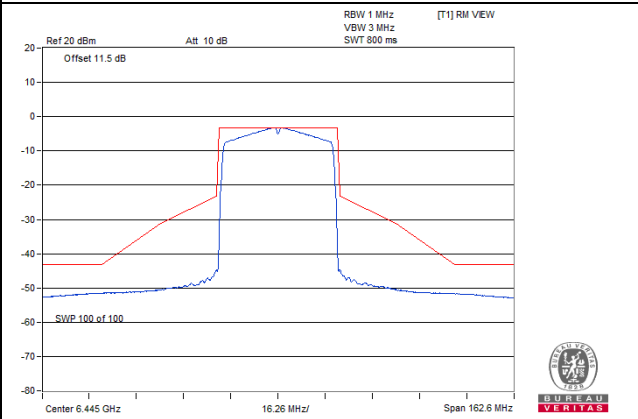

CH 107

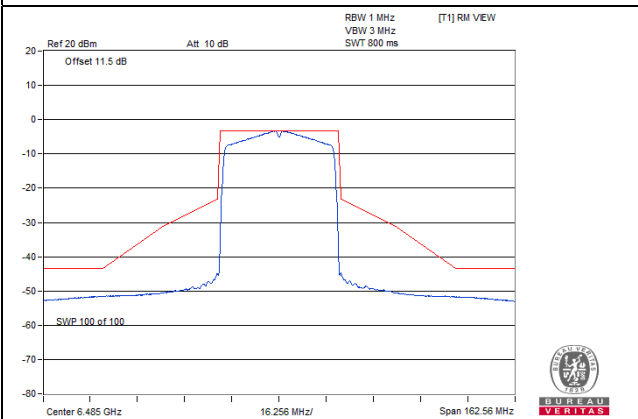

CH 115

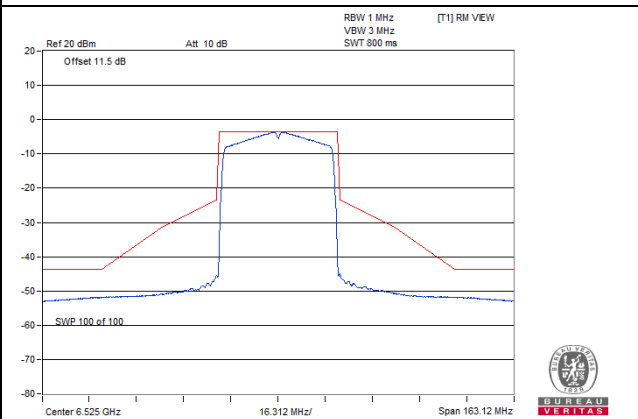



### Spectrum Plot

#### CH 123

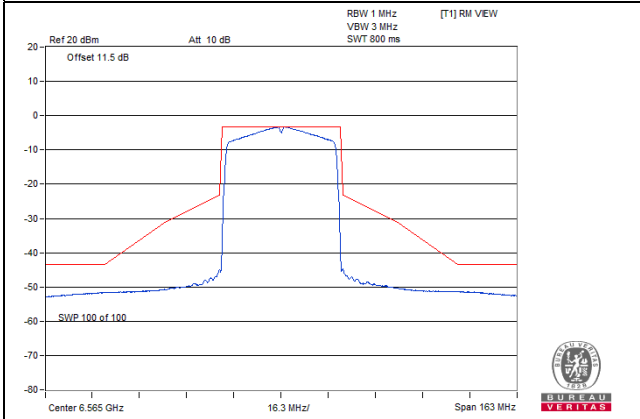

#### CH 155

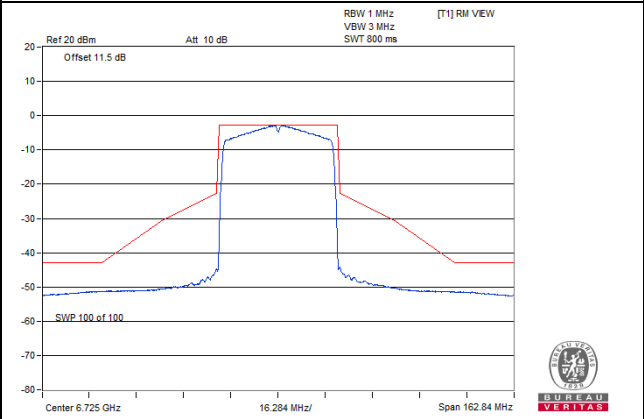

#### CH 179

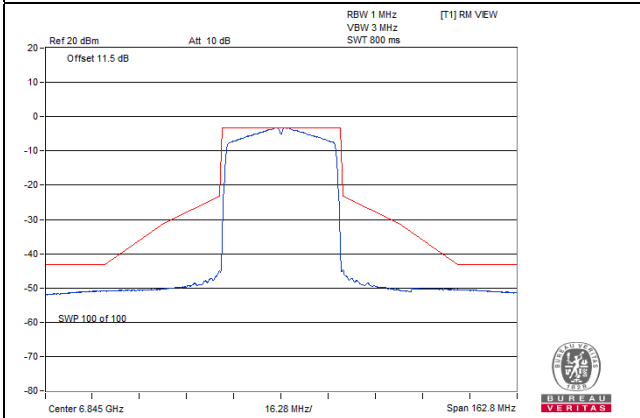

#### CH 187

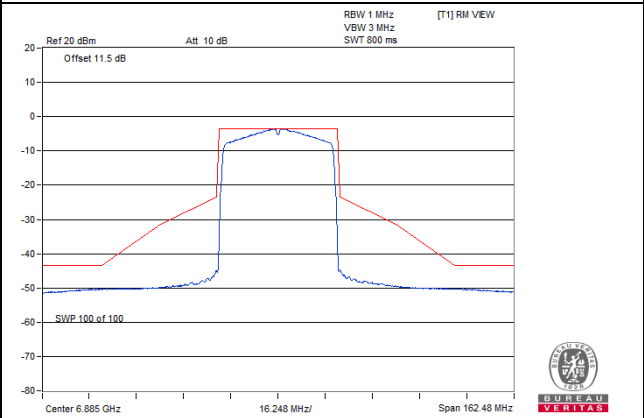

#### CH 211

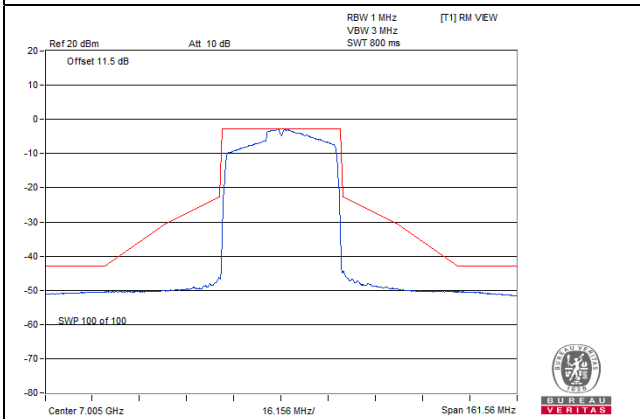

#### CH 227

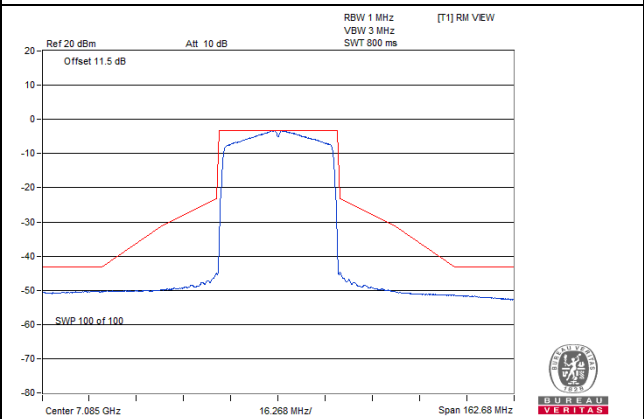

802.11ax (HE80)\_Chain 0

Spectrum Plot

CH 7

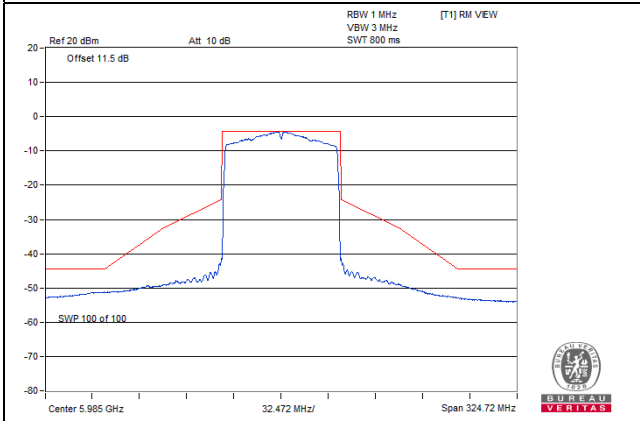

CH 39

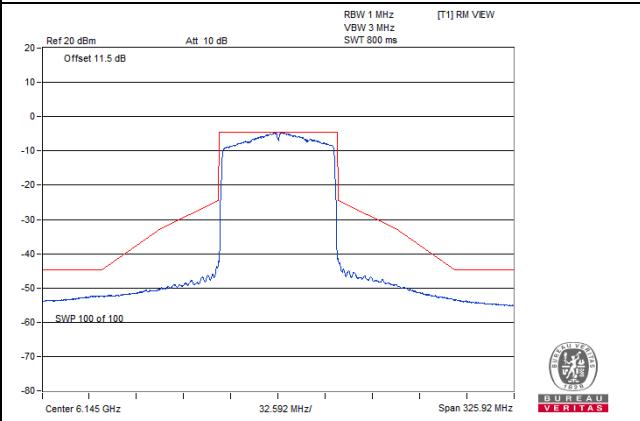

CH 87

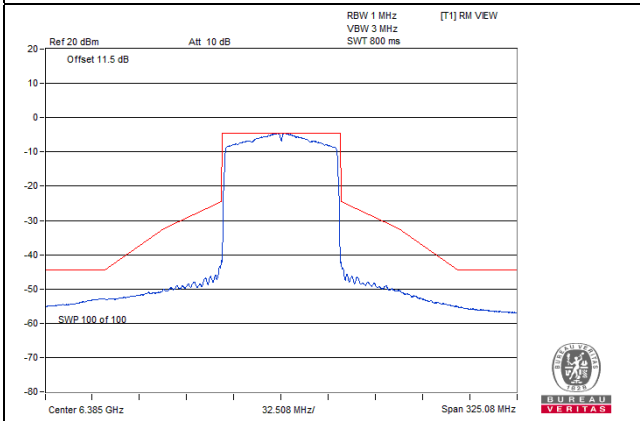

CH 103

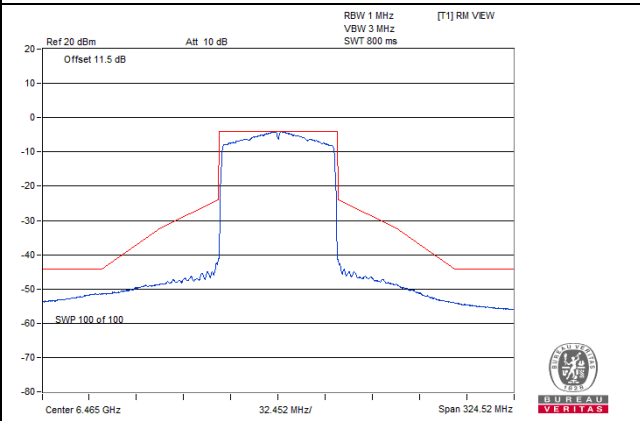

CH 119

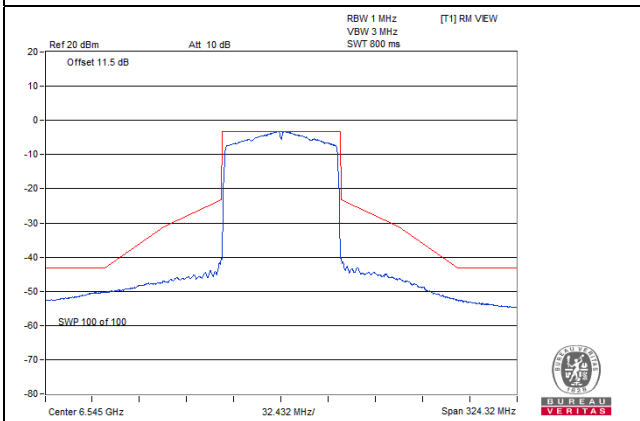

CH 183

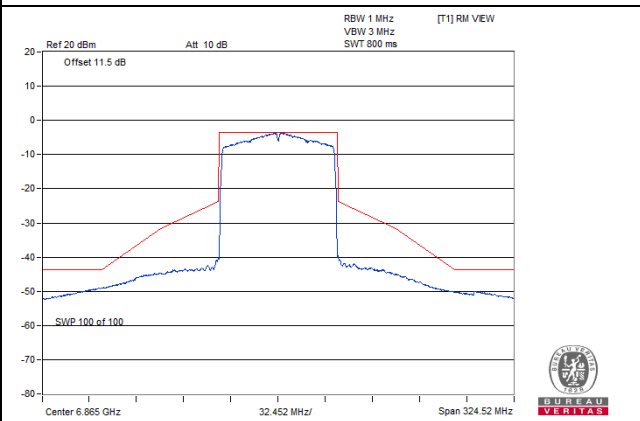

### Spectrum Plot

#### CH 199

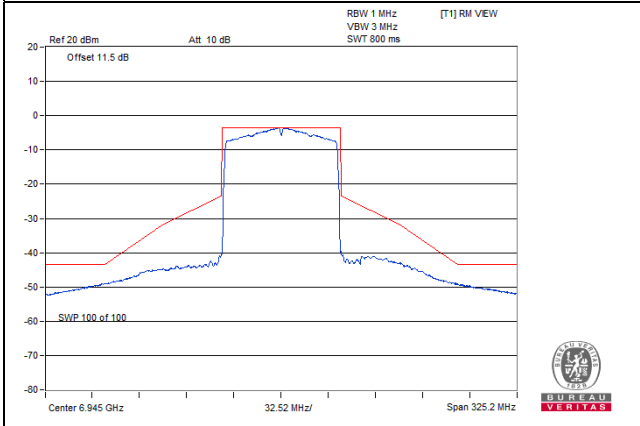

#### CH 215

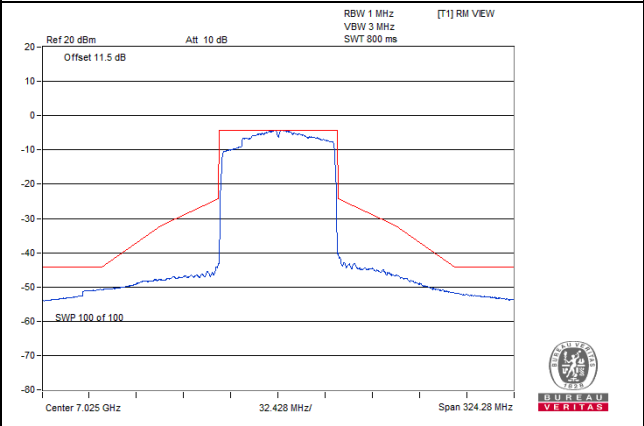

802.11ax (HE80)\_Chain 1

Spectrum Plot

CH 7

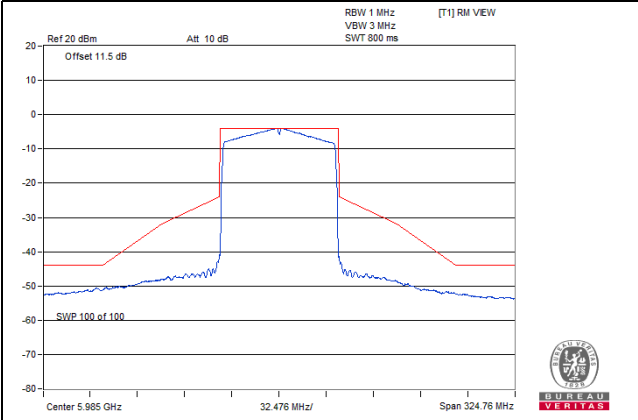

CH 39

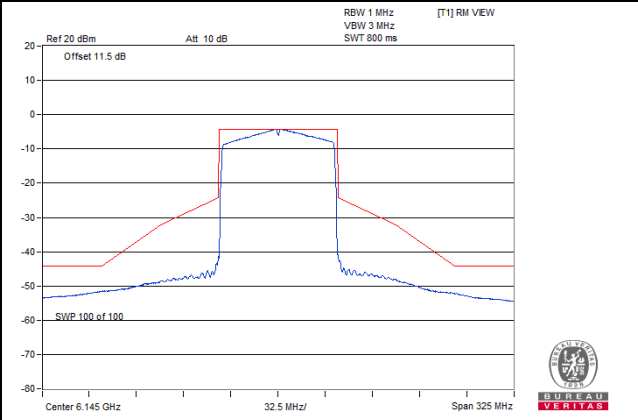

CH 87

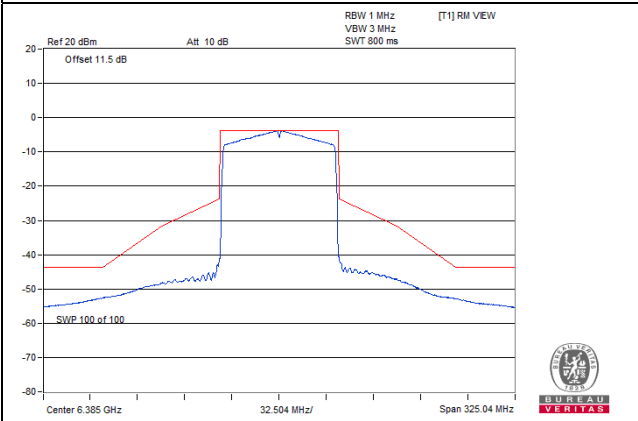

CH 103

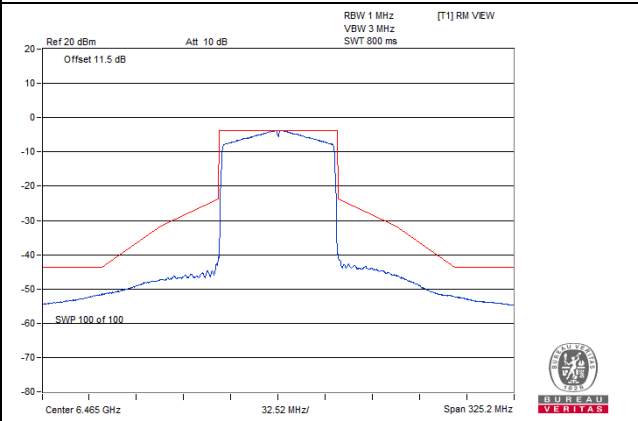

CH 119

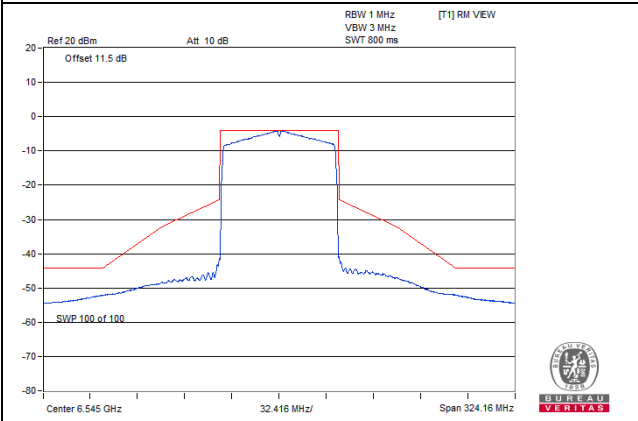

CH 183

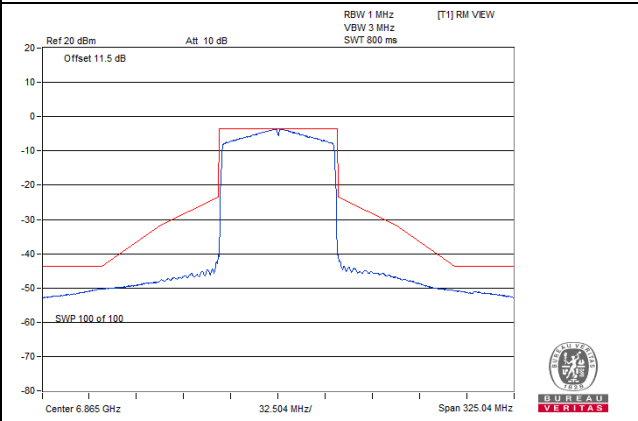

### Spectrum Plot

#### CH 199

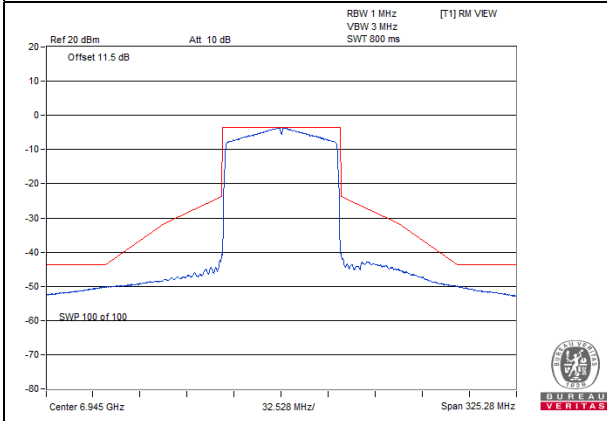

#### CH 215

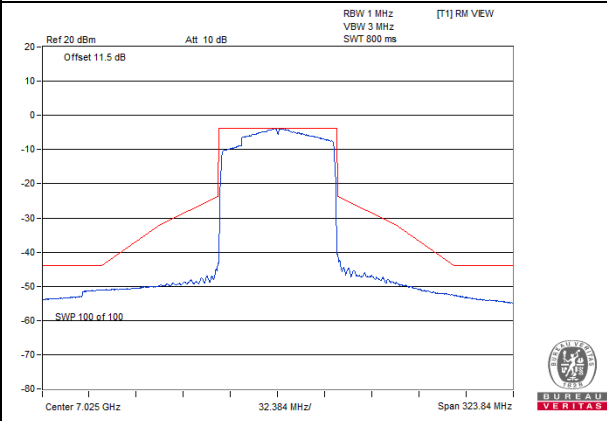

Nss 2

802.11ax (HE20)\_Chain 0

Spectrum Plot

CH 1

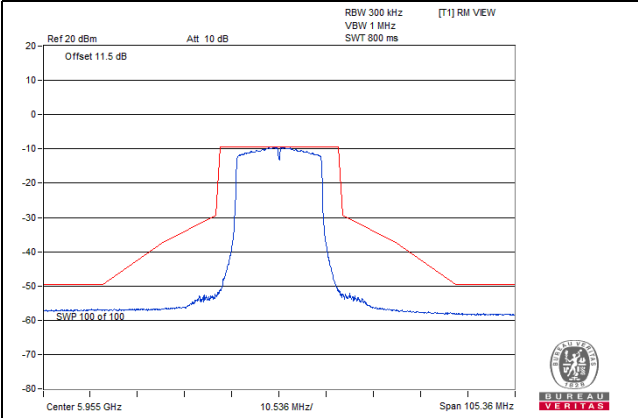

CH 45

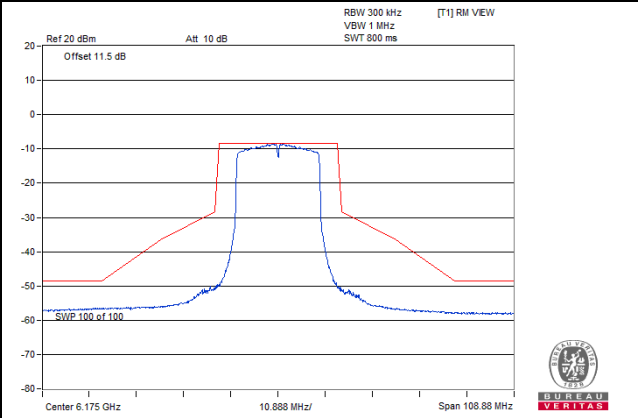

CH 93

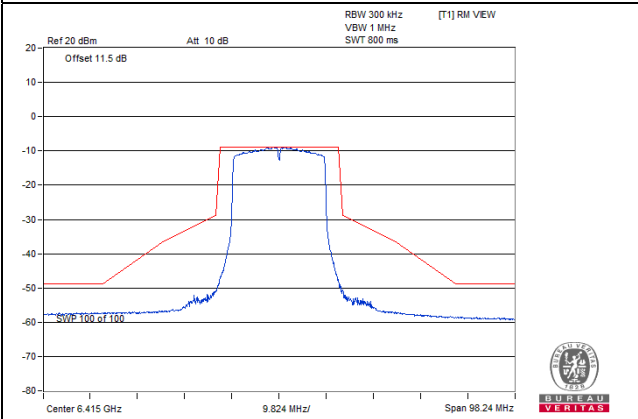

CH 97

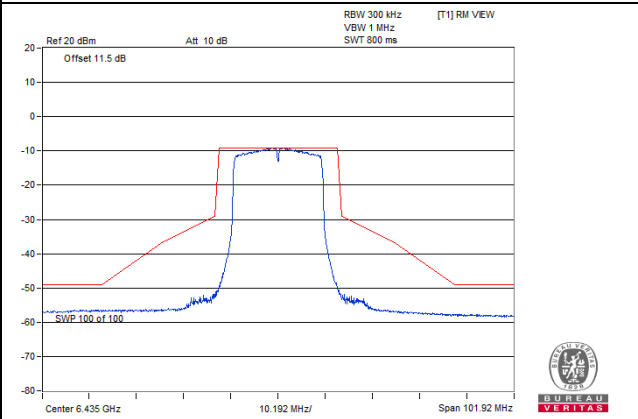

CH 105

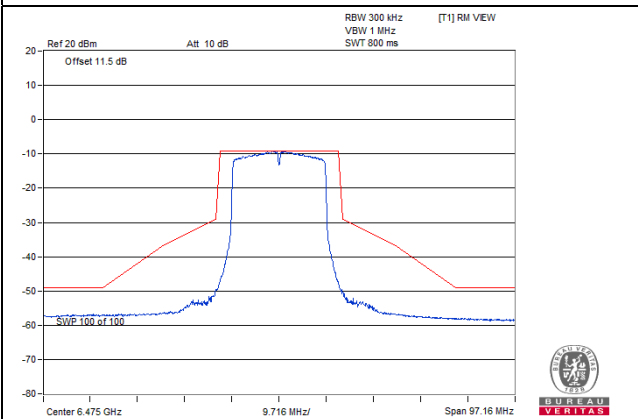

CH 113

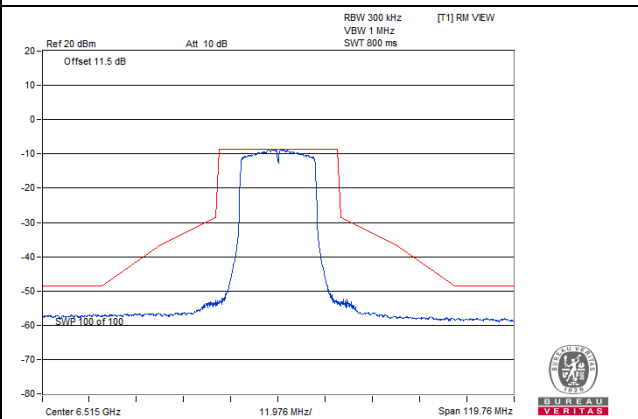

### Spectrum Plot

#### CH 117

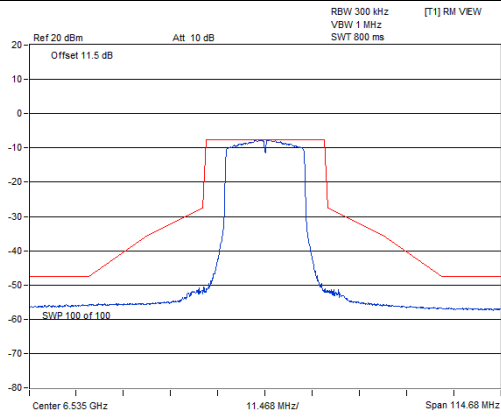

#### CH 153

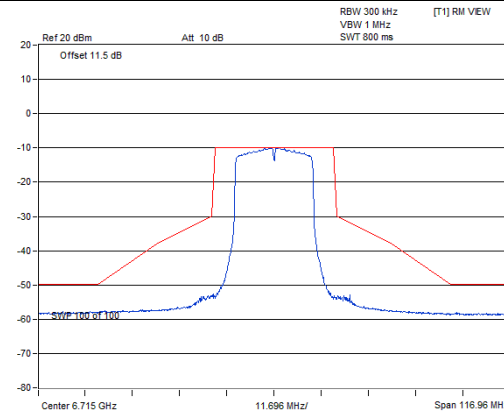

#### CH 181

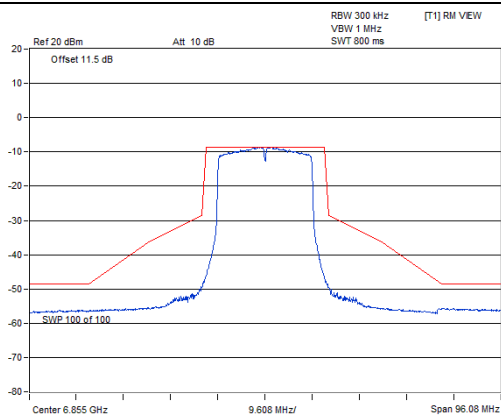

#### CH 185

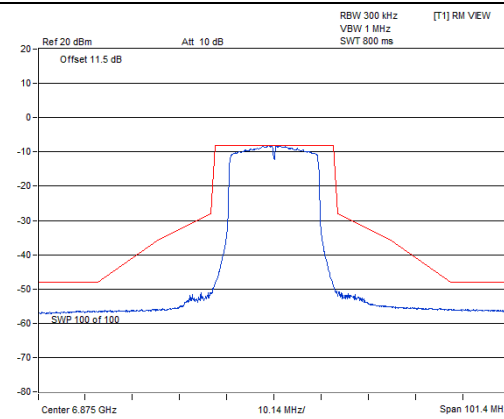

#### CH 213

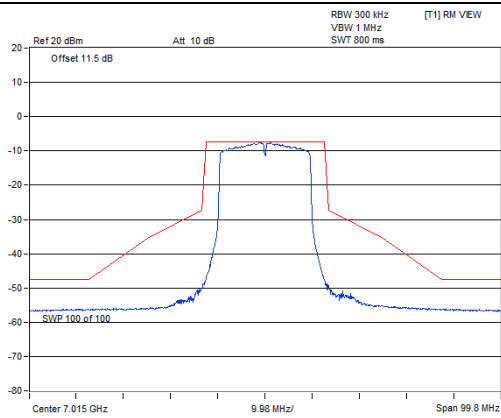

#### CH 229

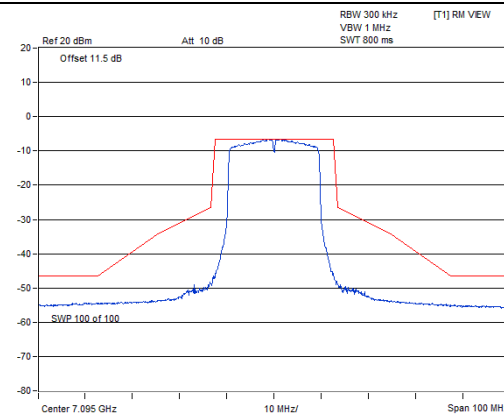

### Spectrum Plot

CH 233

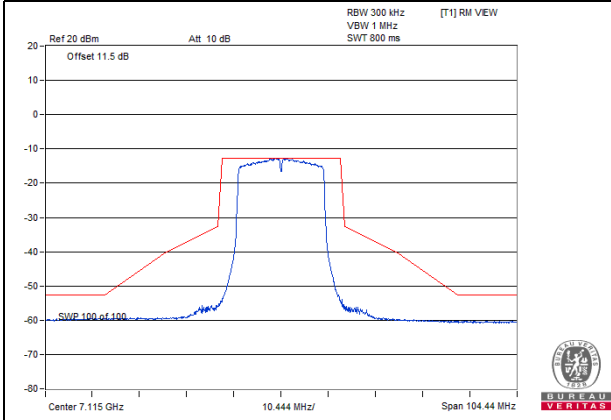



802.11ax (HE20)\_Chain 1

Spectrum Plot

CH 1

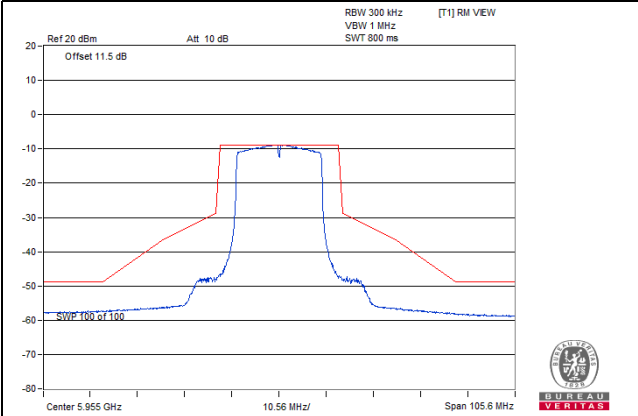

CH 45

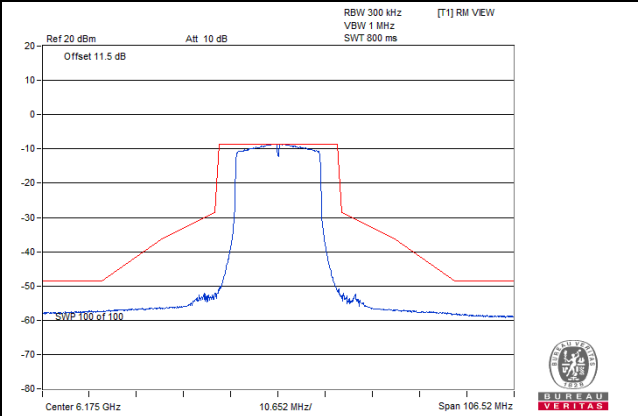

CH 93

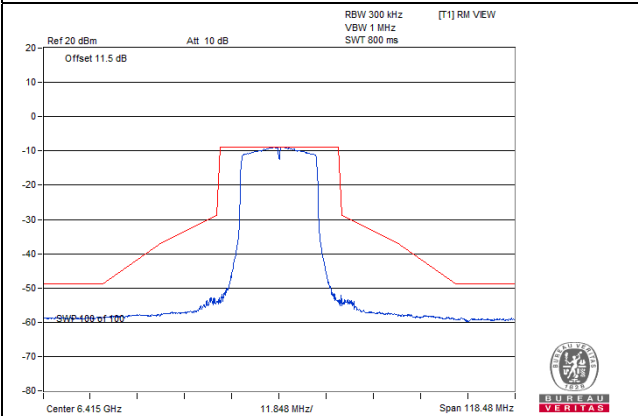

CH 97

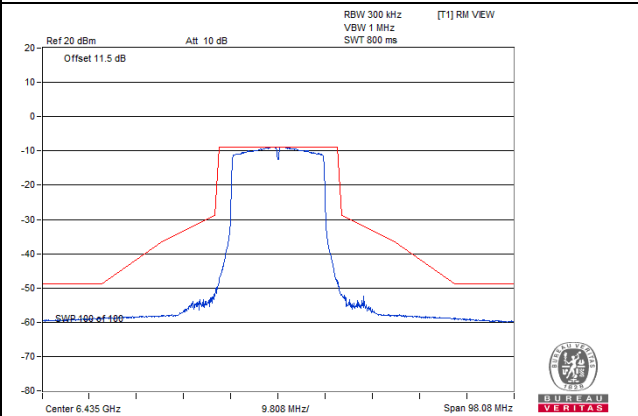

CH 105

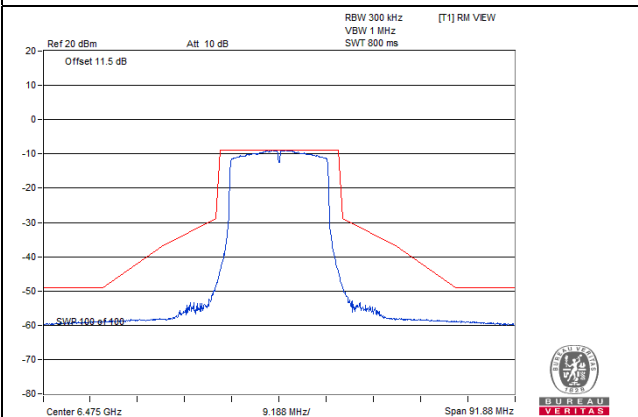

CH 113

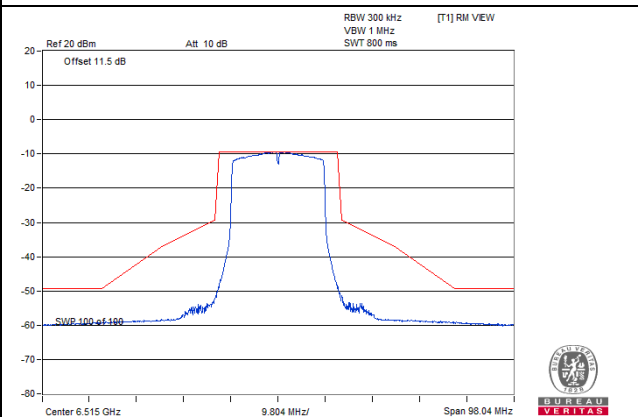

### Spectrum Plot

#### CH 117

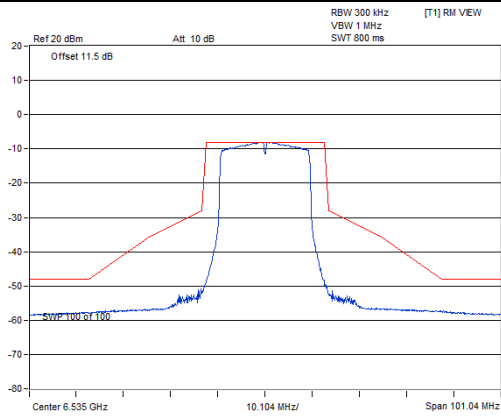

#### CH 153

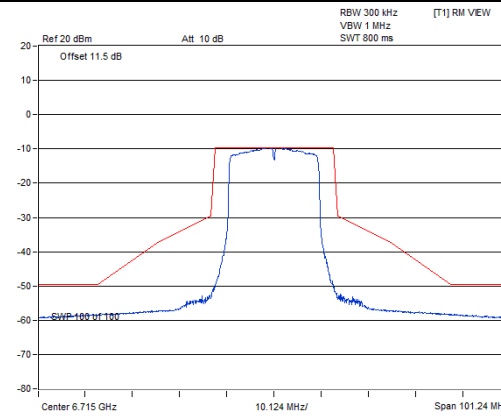

#### CH 181

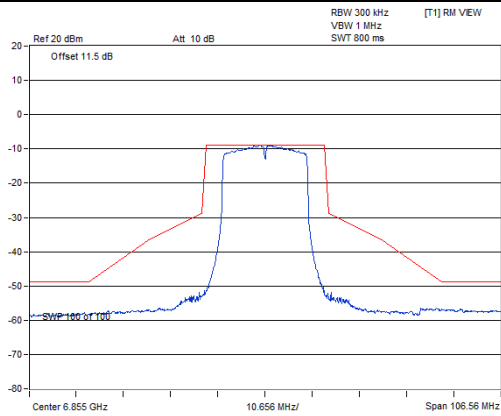

#### CH 185

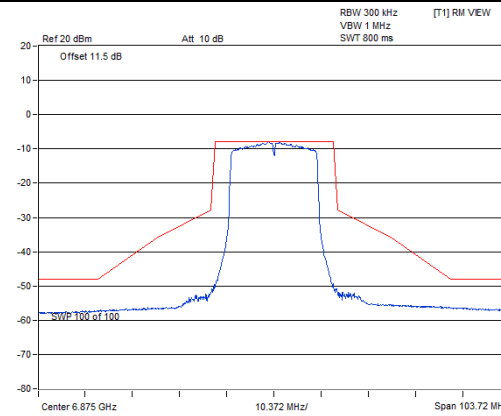

#### CH 213

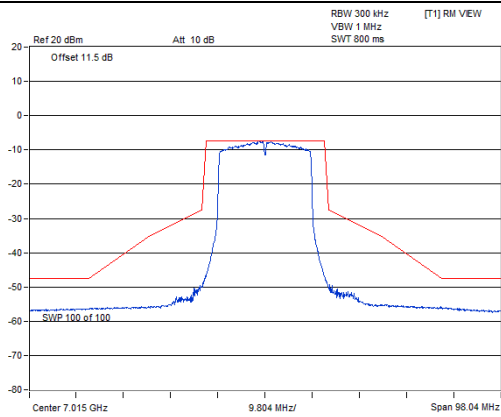

#### CH 229

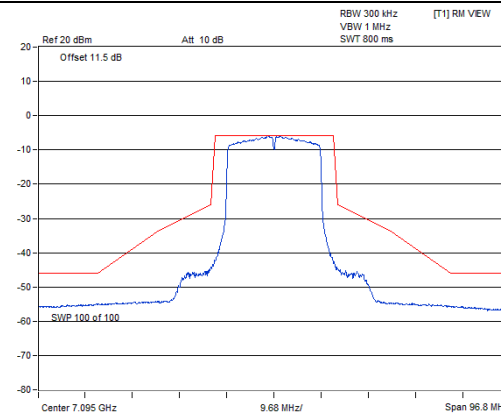

### Spectrum Plot

CH 233

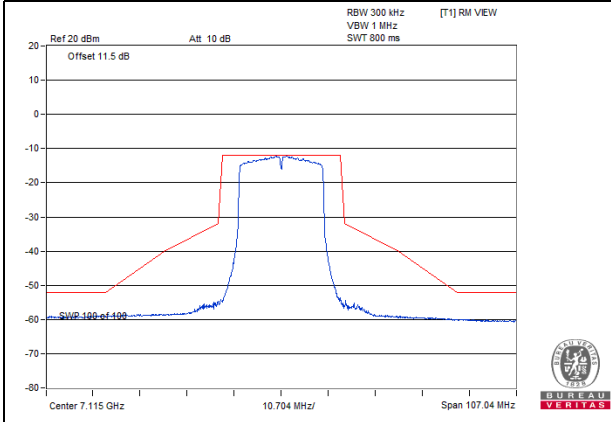

802.11ax (HE40)\_Chain 0

Spectrum Plot

CH 3

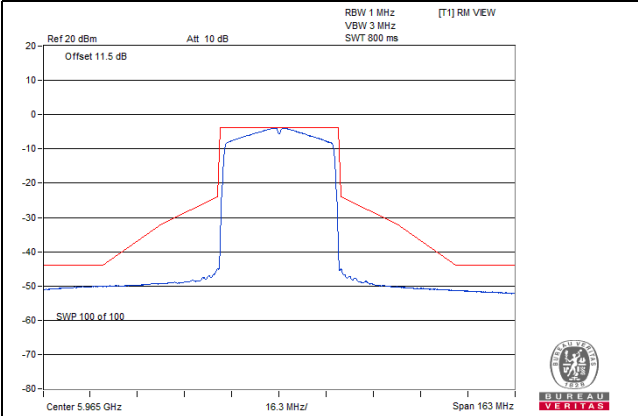

CH 43

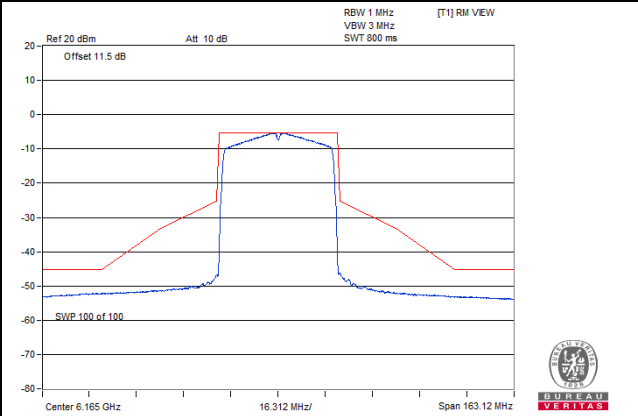

CH 91

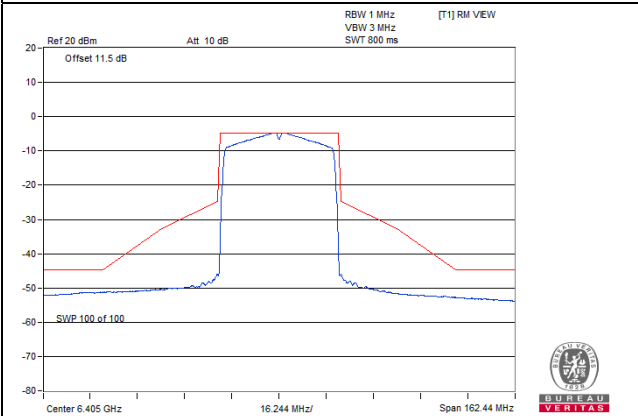

CH 99

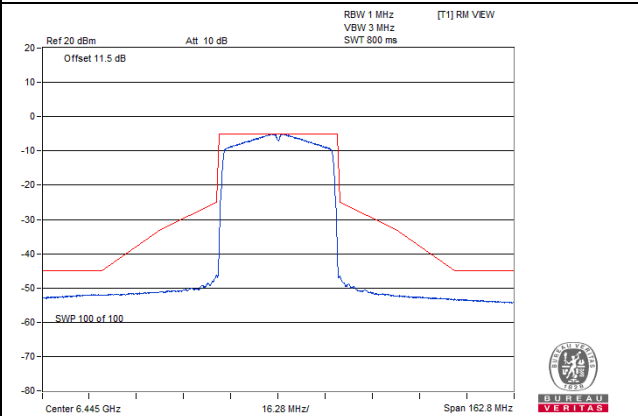

CH 107

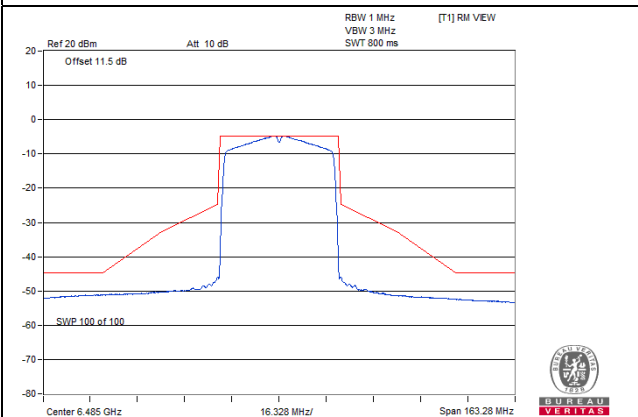

CH 115

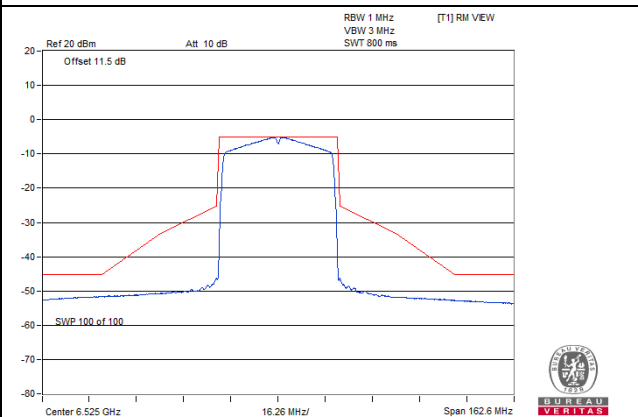

### Spectrum Plot

#### CH 123

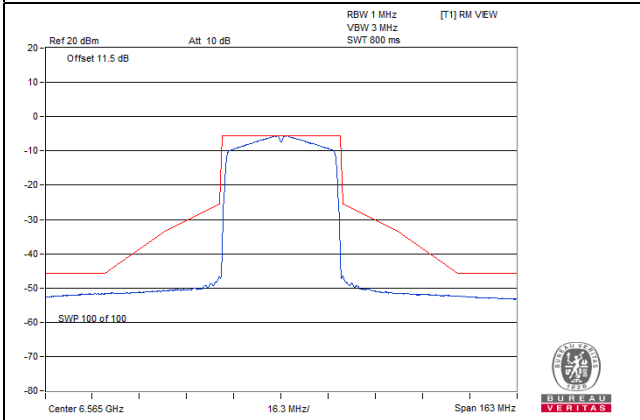

#### CH 155

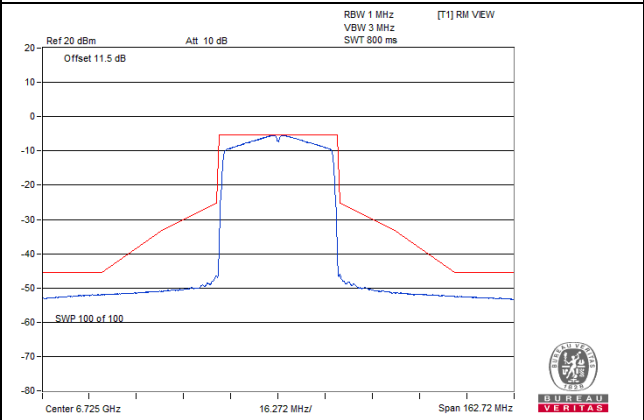

#### CH 179

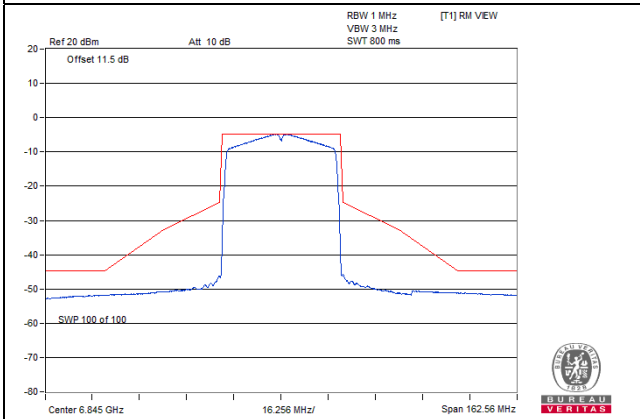

#### CH 187

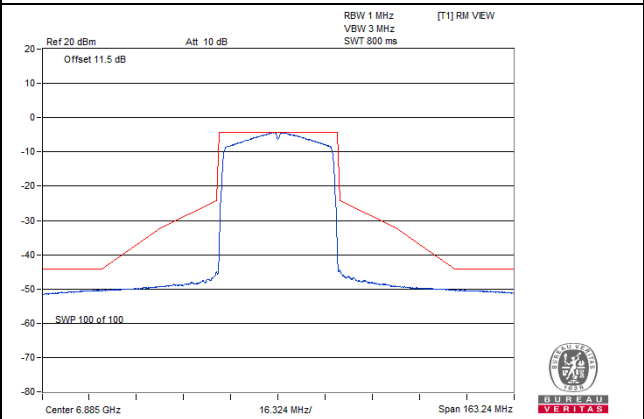

#### CH 211

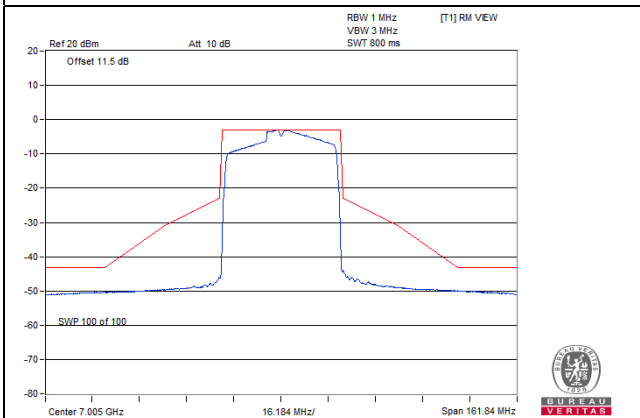

#### CH 227

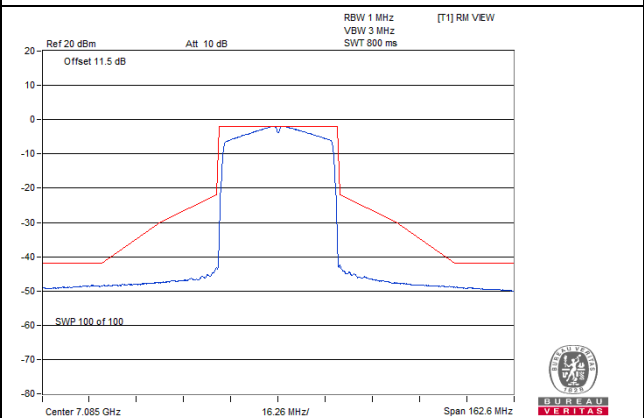

802.11ax (HE40)\_Chain 1

Spectrum Plot

CH 3

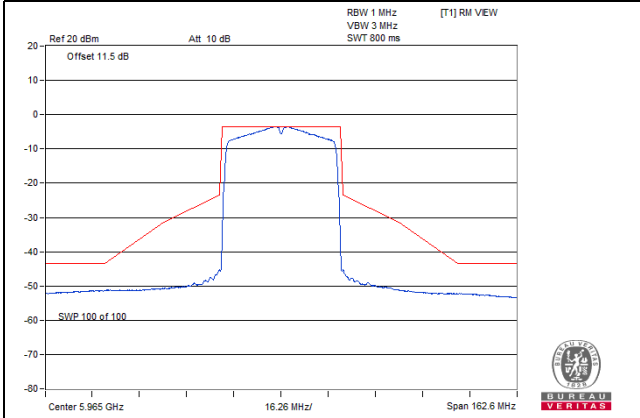

CH 43

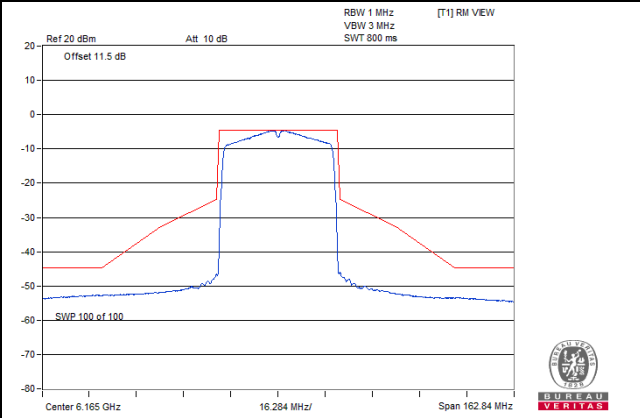

CH 91

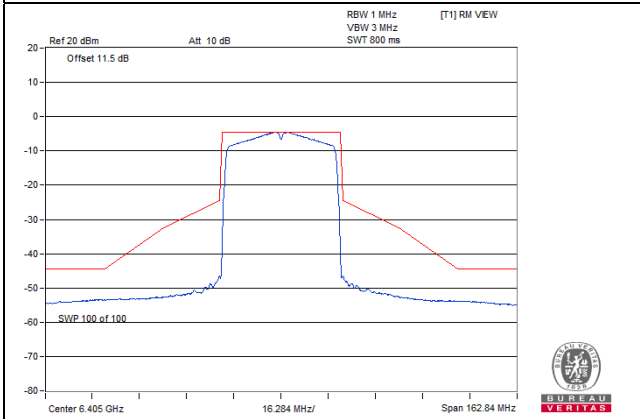

CH 99

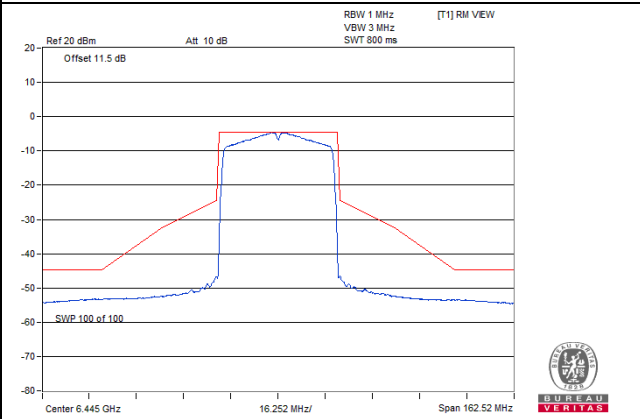

CH 107

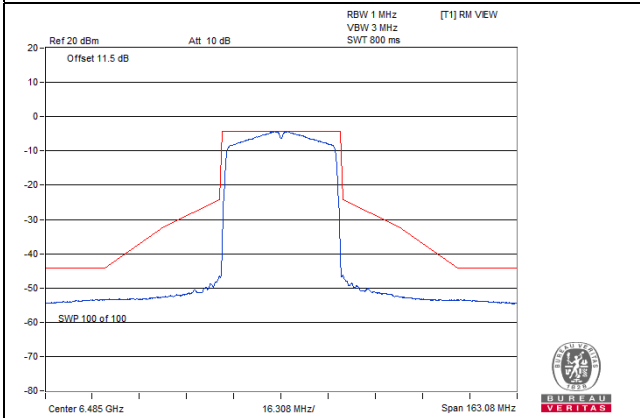

CH 115

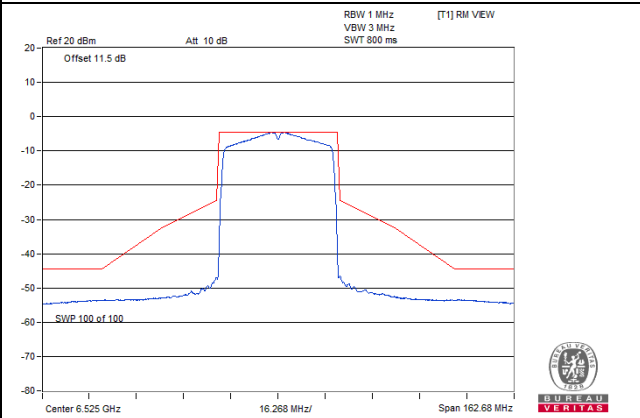

### Spectrum Plot

#### CH 123

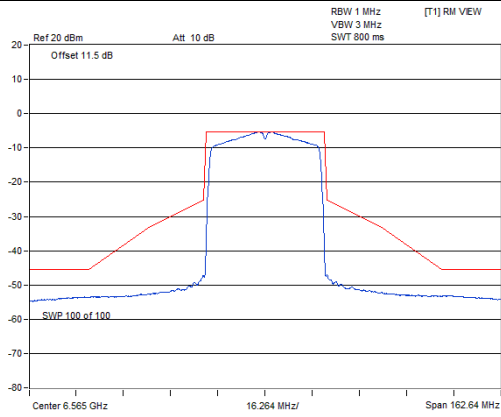

#### CH 155

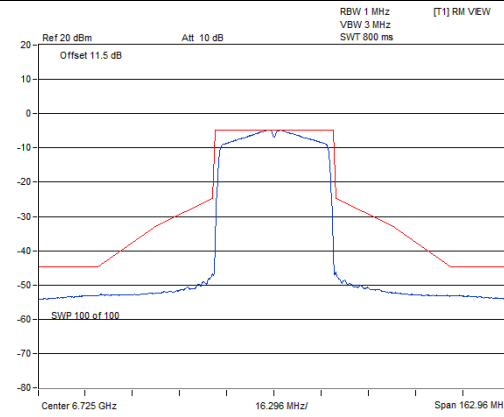

#### CH 179

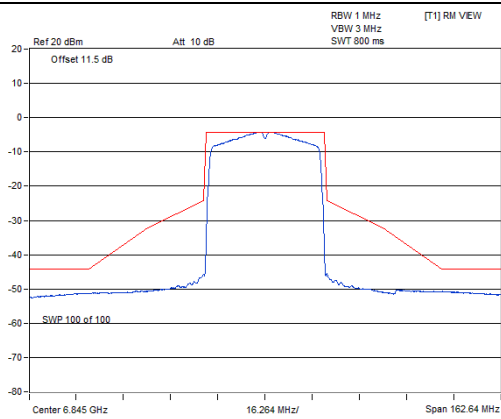

#### CH 187

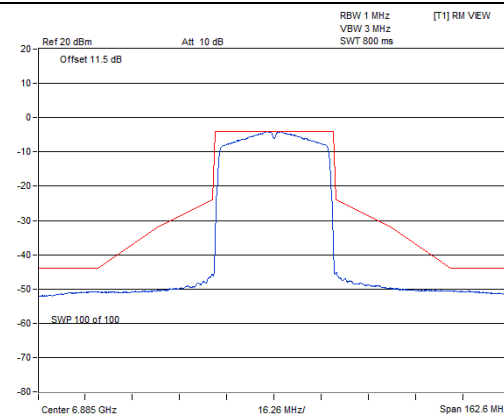

#### CH 211

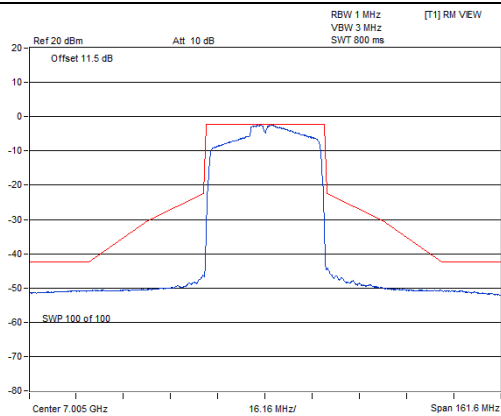

#### CH 227

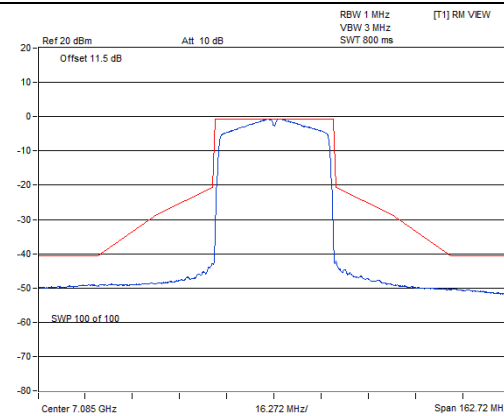

802.11ax (HE80)\_Chain 0

Spectrum Plot

CH 7

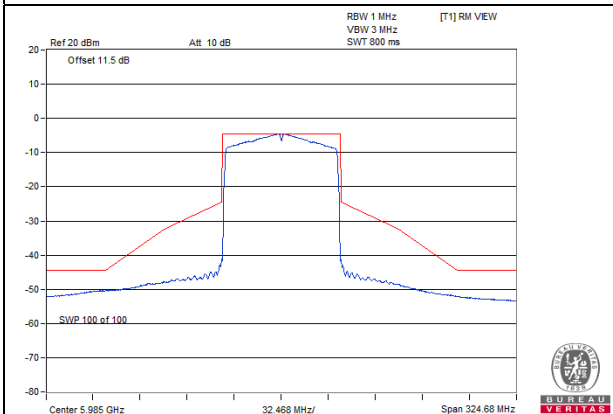

CH 39

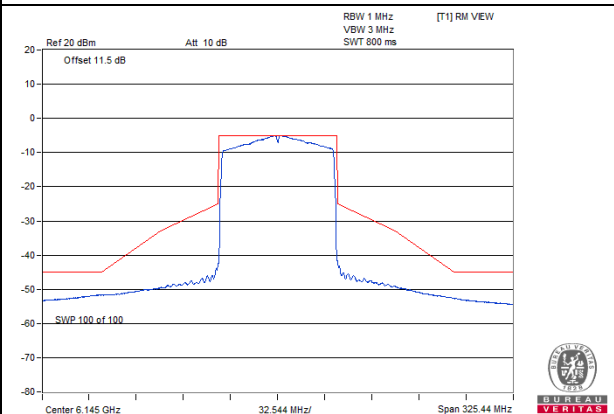

CH 87

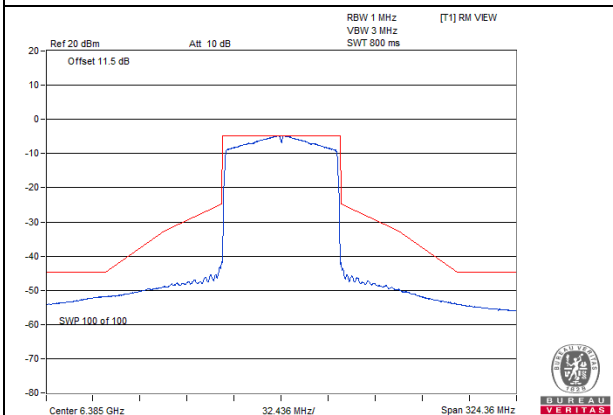

CH 103

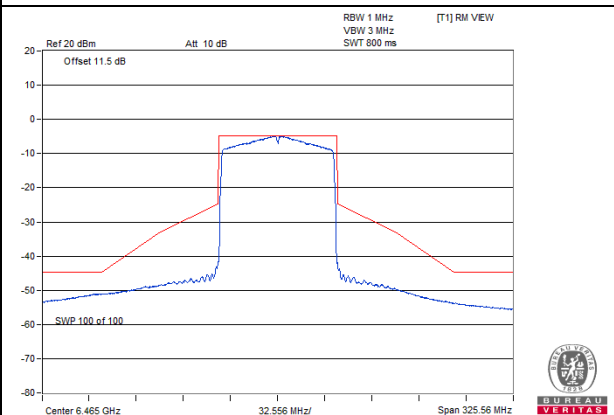

CH 119

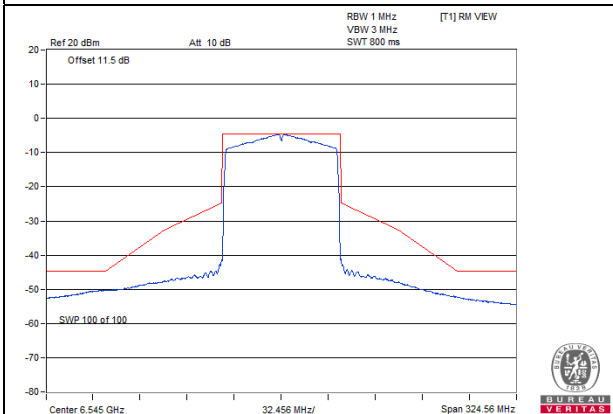

CH 183

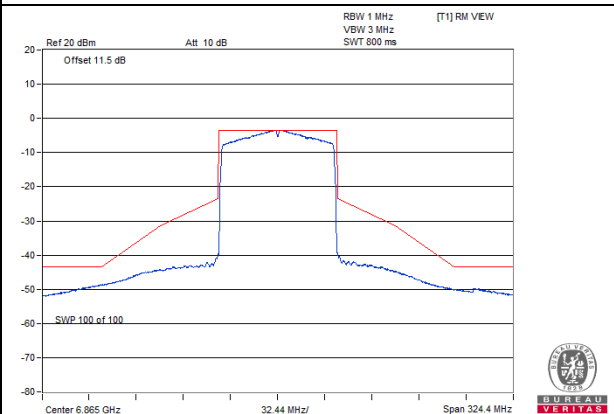



### Spectrum Plot

#### CH 199

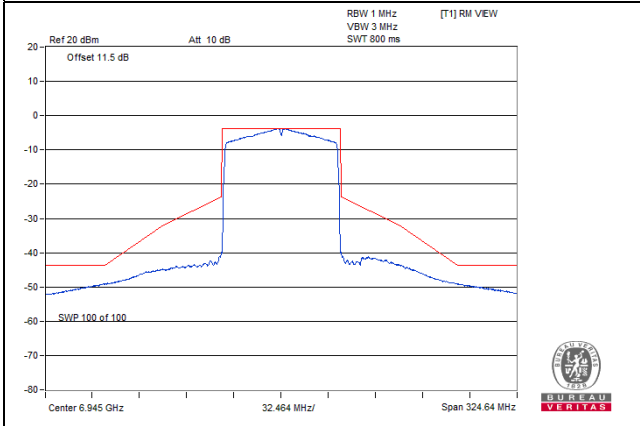

#### CH 215

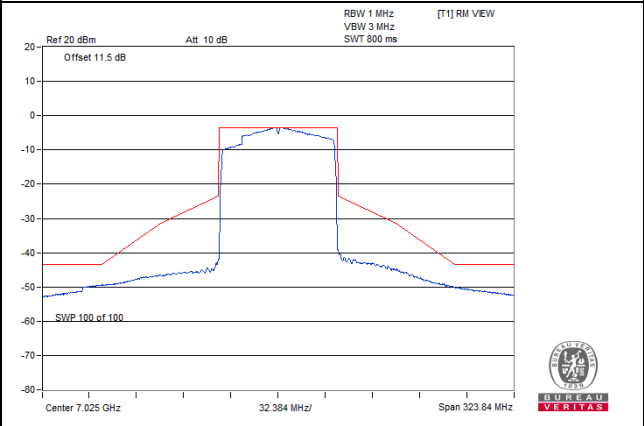

802.11ax (HE80)\_Chain 1

Spectrum Plot

CH 7

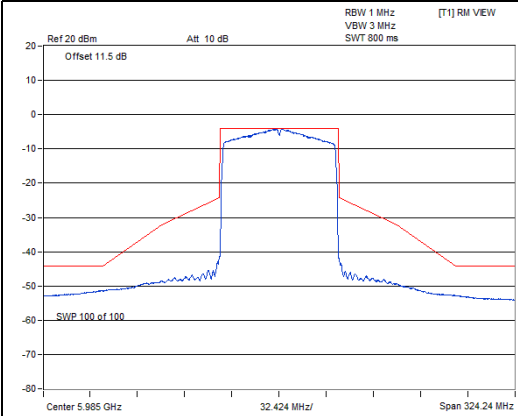

CH 39

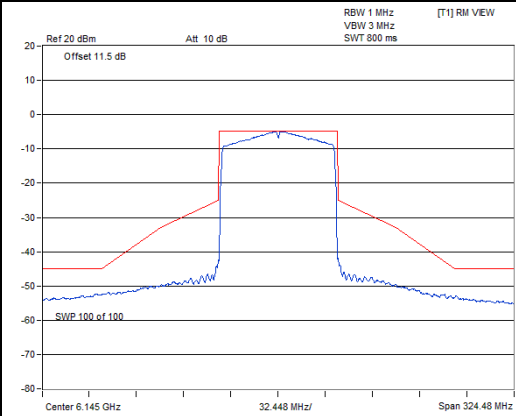

CH 87

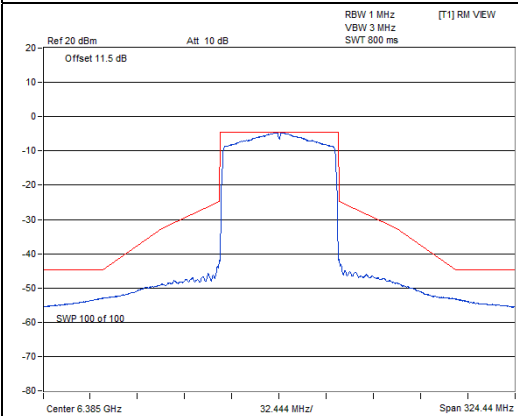

CH 103

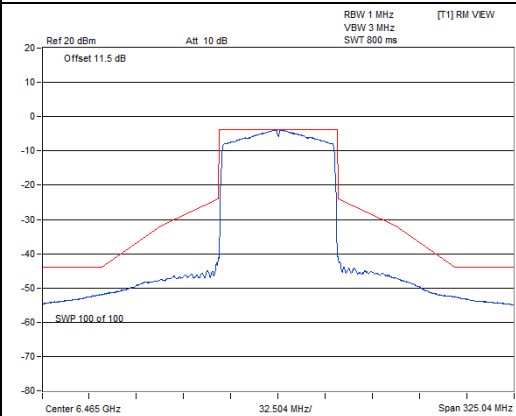

CH 119

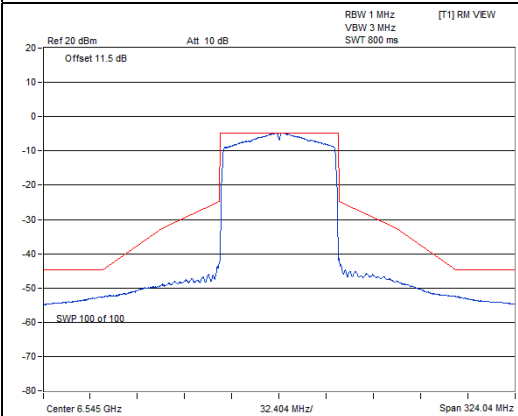

CH 183

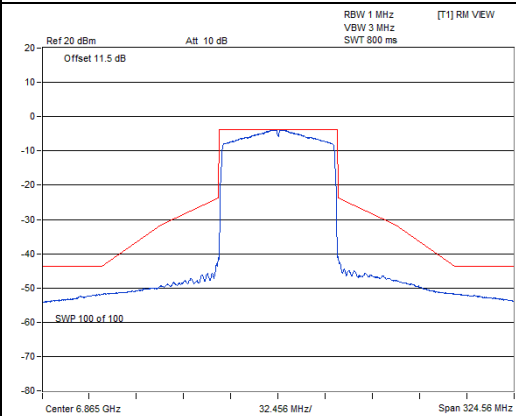

### Spectrum Plot

#### CH 199

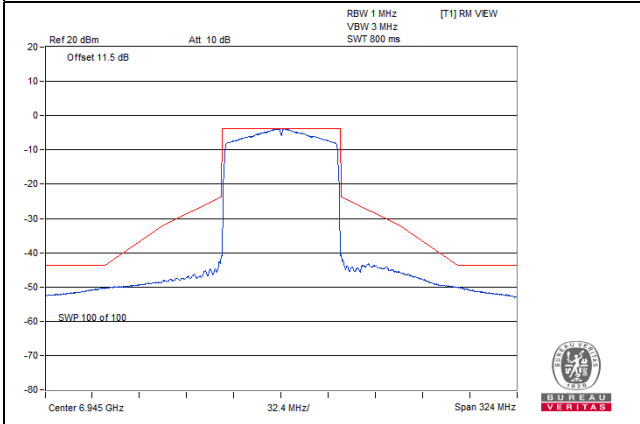

#### CH 215

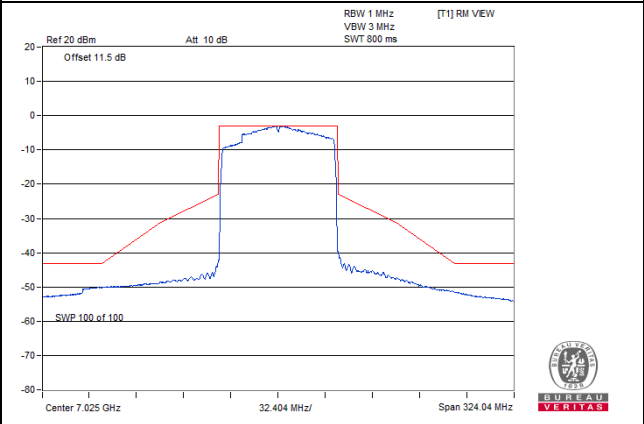

### 4.3 Conducted Emission Measurement

#### 4.3.1 Limits of Conducted Emission Measurement

Frequency (MHz)	Conducted Limit (dBuV)	
	Quasi-peak	Average
0.15 - 0.5	66 - 56	56 - 46
0.50 - 5.0	56	46
5.0 - 30.0	60	50

Note: 1. The lower limit shall apply at the transition frequencies.  
 2. The limit decreases in line with the logarithm of the frequency in the range of 0.15 to 0.50MHz.

#### 4.3.2 Test Instruments

Description & Manufacturer	Model No.	Serial No.	Cal. Date	Cal. Due
Test Receiver ROHDE & SCHWARZ	ESCI	100613	Dec. 03, 2021	Dec. 02, 2022
RF signal cable Woken	5D-FB	Cable-cond1-01	Jan. 15, 2022	Jan. 14, 2023
LISN ROHDE & SCHWARZ (EUT)	ENV216	101826	Mar. 14, 2022	Mar. 13, 2023
LISN ROHDE & SCHWARZ (Peripheral)	ESH3-Z5	100311	Sep. 07, 2021	Sep. 06, 2022
Software ADT	BV ADT_Cond_ V7.3.7.4	NA	NA	NA

Note: 1. The calibration interval of the above test instruments is 12 months and the calibrations are traceable to NML/ROC and NIST/USA.  
 2. The test was performed in HwaYa Shielded Room 1(Conduction 1).  
 3. The VCCI Site Registration No. is C-12040.  
 4. Tested date: Jul. 17, 2022

### 4.3.3 Test Procedures

- The EUT was placed 0.4 meters from the conducting wall of the shielded room with EUT being connected to the power mains through a line impedance stabilization network (LISN). Other support units were connected to the power mains through another LISN. The two LISNs provide 50 ohm/ 50uH of coupling impedance for the measuring instrument.
- Both lines of the power mains connected to the EUT were checked for maximum conducted interference.
- The frequency range from 150kHz to 30MHz was searched. Emission levels under (Limit - 20dB) was not recorded.

Note: The resolution bandwidth and video bandwidth of test receiver is 9kHz for quasi-peak detection (QP) and average detection (AV) at frequency 0.15MHz-30MHz.

### 4.3.4 Deviation from Test Standard

No deviation.

### 4.3.5 Test Setup

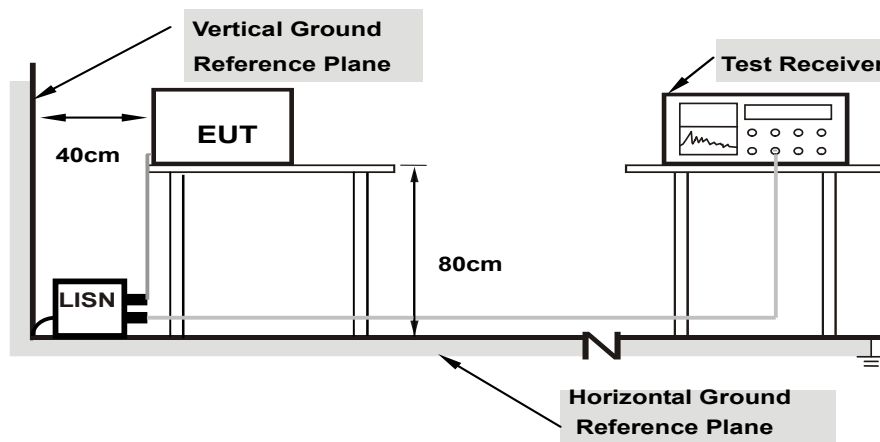

Note: 1.Support units were connected to second LISN.

For the actual test configuration, please refer to the attached file (Test Setup Photo).

### 4.3.6 EUT Operating Conditions

Same as 4.1.6.

### 4.3.7 Test Results

Worst-case data:

Nss 1

802.11ax (HE80)

Phase	Line (L)	Detector Function	Quasi-Peak (QP) / Average (AV)
Test Mode	A		

No	Freq. [MHz]	Corr. Factor (dB)	Reading Value [dB (uV)]		Emission Level [dB (uV)]		Limit [dB (uV)]		Margin (dB)	
			Q.P.	AV.	Q.P.	AV.	Q.P.	AV.	Q.P.	AV.
			1	0.17000	9.63	32.13	17.98	41.76	27.61	64.96
2	0.19800	9.64	28.76	15.47	38.40	25.11	63.69	53.69	-25.29	-28.58
3	0.24549	9.65	24.61	13.35	34.26	23.00	61.91	51.91	-27.65	-28.91
4	3.30200	9.74	24.79	16.48	34.53	26.22	56.00	46.00	-21.47	-19.78
5	4.75000	9.76	18.68	13.43	28.44	23.19	56.00	46.00	-27.56	-22.81
6	21.63000	9.87	16.63	6.78	26.50	16.65	60.00	50.00	-33.50	-33.35

Remarks:

1. Q.P. and AV. are abbreviations of quasi-peak and average individually.
2. The emission levels of other frequencies were very low against the limit.
3. Margin value = Emission level - Limit value
4. Correction factor = Insertion loss + Cable loss
5. Emission Level = Correction Factor + Reading Value.

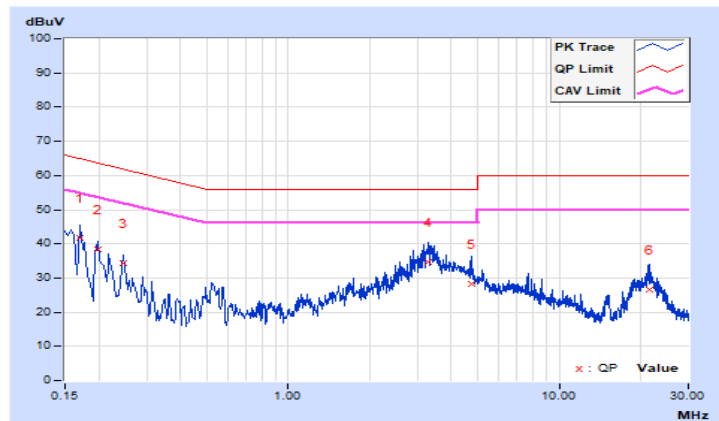

Phase	Neutral (N)	Detector Function	Quasi-Peak (QP) / Average (AV)
Test Mode	A		

No	Freq. [MHz]	Corr. Factor (dB)	Reading Value [dB (uV)]		Emission Level [dB (uV)]		Limit [dB (uV)]		Margin (dB)	
			Q.P.	AV.	Q.P.	AV.	Q.P.	AV.	Q.P.	AV.
			1	0.15000	9.62	32.87	18.26	42.49	27.88	66.00
2	0.17800	9.63	32.78	17.80	42.41	27.43	64.58	54.58	-22.17	-27.15
3	0.20200	9.64	28.89	14.29	38.53	23.93	63.53	53.53	-25.00	-29.60
4	3.51400	9.75	24.48	16.71	34.23	26.46	56.00	46.00	-21.77	-19.54
5	4.41400	9.75	20.81	15.33	30.56	25.08	56.00	46.00	-25.44	-20.92
6	21.80200	9.89	15.63	5.02	25.52	14.91	60.00	50.00	-34.48	-35.09

Remarks:

1. Q.P. and AV. are abbreviations of quasi-peak and average individually.
2. The emission levels of other frequencies were very low against the limit.
3. Margin value = Emission level - Limit value
4. Correction factor = Insertion loss + Cable loss
5. Emission Level = Correction Factor + Reading Value.

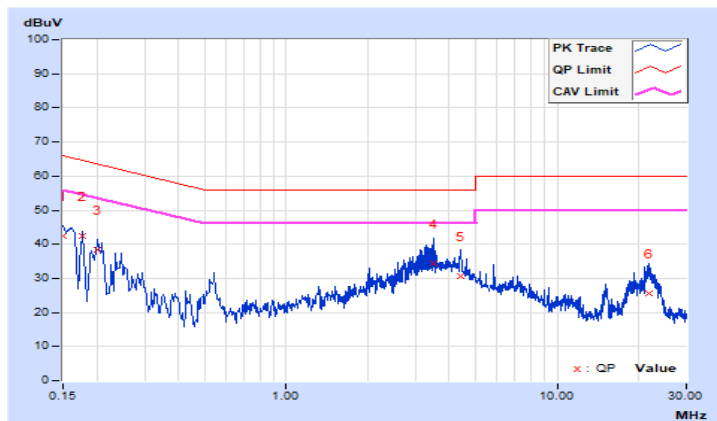

Phase	Line (L)	Detector Function	Quasi-Peak (QP) / Average (AV)
Test Mode	B		

No	Freq. [MHz]	Corr. Factor (dB)	Reading Value [dB (uV)]		Emission Level [dB (uV)]		Limit [dB (uV)]		Margin (dB)	
			Q.P.	AV.	Q.P.	AV.	Q.P.	AV.	Q.P.	AV.
			1	0.15800	9.62	38.88	25.55	48.50	35.17	65.57
2	0.20600	9.64	32.41	19.74	42.05	29.38	63.37	53.37	-21.32	-23.99
3	0.21800	9.64	27.51	10.01	37.15	19.65	62.89	52.89	-25.74	-33.24
4	3.35400	9.74	26.97	17.33	36.71	27.07	56.00	46.00	-19.29	-18.93
5	5.15000	9.76	27.64	14.87	37.40	24.63	60.00	50.00	-22.60	-25.37
6	20.97000	9.87	20.78	8.31	30.65	18.18	60.00	50.00	-29.35	-31.82

Remarks:

1. Q.P. and AV. are abbreviations of quasi-peak and average individually.
2. The emission levels of other frequencies were very low against the limit.
3. Margin value = Emission level - Limit value
4. Correction factor = Insertion loss + Cable loss
5. Emission Level = Correction Factor + Reading Value.

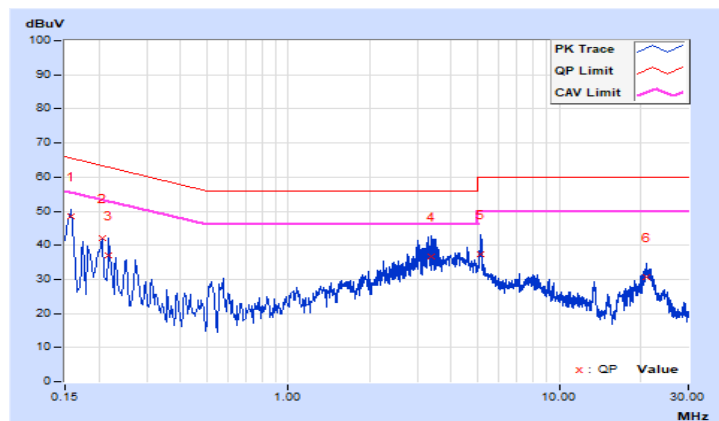



Phase	Neutral (N)	Detector Function	Quasi-Peak (QP) / Average (AV)
Test Mode	B		

No	Freq. [MHz]	Corr. Factor (dB)	Reading Value [dB (uV)]		Emission Level [dB (uV)]		Limit [dB (uV)]		Margin (dB)	
			Q.P.	AV.	Q.P.	AV.	Q.P.	AV.	Q.P.	AV.
			1	0.15800	9.62	37.45	26.21	47.07	35.83	65.57
2	0.17000	9.63	36.64	20.59	46.27	30.22	64.96	54.96	-18.69	-24.74
3	0.21800	9.64	30.84	15.53	40.48	25.17	62.89	52.89	-22.41	-27.72
4	3.26200	9.74	27.16	17.64	36.90	27.38	56.00	46.00	-19.10	-18.62
<b>5</b>	<b>4.63000</b>	<b>9.76</b>	<b>26.26</b>	<b>19.80</b>	<b>36.02</b>	<b>29.56</b>	<b>56.00</b>	<b>46.00</b>	<b>-19.98</b>	<b>-16.44</b>
6	21.36600	9.89	20.92	8.70	30.81	18.59	60.00	50.00	-29.19	-31.41

Remarks:

1. Q.P. and AV. are abbreviations of quasi-peak and average individually.
2. The emission levels of other frequencies were very low against the limit.
3. Margin value = Emission level - Limit value
4. Correction factor = Insertion loss + Cable loss
5. Emission Level = Correction Factor + Reading Value.

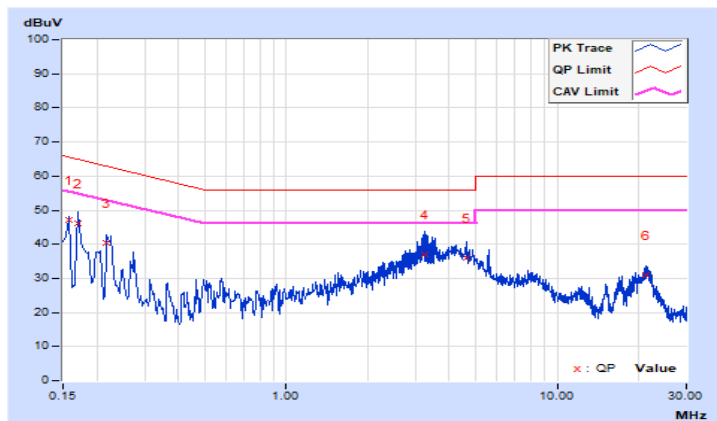

#### 4.4 Transmit Power Measurement

##### 4.4.1 Limits of Transmit Power Measurement

Operation Band	EUT Category	Limit
		Max Average Power
U-NII-5 U-NII-6 U-NII-7 U-NII-8	Client Devices ( controlled of an indoor AP )	EIRP 24 dBm

##### 4.4.2 Test Setup

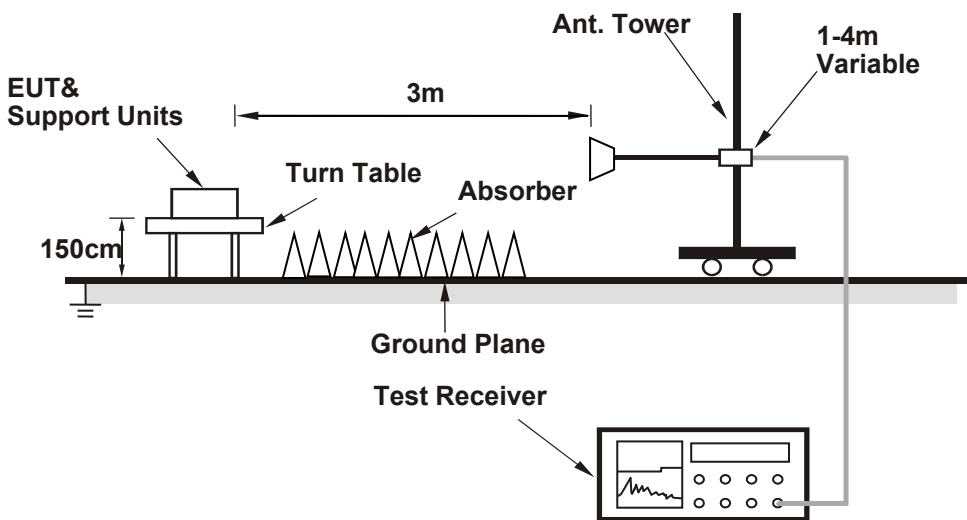

##### 4.4.3 Test Instruments

Refer to section 4.1.2 to get information of above instrument.

#### 4.4.4 Test Procedure

- a. The EUT was placed on the top of a rotating table 1.5 meters above the ground at 3 meter chamber room for test. The table was rotated 360 degrees to determine the position of the highest radiation.
- b. The EUT was set 3 meters away from the interference-receiving antenna, which was mounted on the top of a variable-height antenna tower.
- c. The height of antenna is varied from one meter to four meters above the ground to determine the maximum value of the field strength. Both horizontal and vertical polarizations of the antenna are set to make the measurement.
- d. Perform a field strength measurement and record the worse read value, is the field strength value via a spectrum reading obtained corrected for antenna factor, cable loss and pre-amplifier factor and then mathematically convert the measured field strength level to EIRP level.
- e. Follow ANSI 63.10 and KDB 412172 D01 v01r01, EIRP Value (dBm) = Field Strength Value (dB $\mu$ V/m) + Correction Factor @ 3m.
- f. Correction Factor (dB) @ 3m =  $20\log(D) - 104.7$ ; where D is the measurement distance @3m = -95.23dB

#### 4.4.5 Deviation from Test Standard

No deviation.

#### 4.4.6 EUT Operating Conditions

The software provided by client to enable the EUT under transmission condition continuously at lowest, middle and highest channel frequencies individually.

#### 4.4.7 Test Result

Nss 1

802.11a

Chan.	Chan. Freq. (MHz)	Field Strength (dBUV/m)	Correction Factor (dB)	EIRP (mW)	EIRP (dBm)	EIRP Limit (dBm)	Pass / Fail
1	5955	105.52	-95.23	10.691	10.29	24.00	Pass
45	6175	105.59	-95.23	10.864	10.36	24.00	Pass
93	6415	105.57	-95.23	10.814	10.34	24.00	Pass
97	6435	105.44	-95.23	10.495	10.21	24.00	Pass
105	6475	105.38	-95.23	10.351	10.15	24.00	Pass
113	6515	105.36	-95.23	10.304	10.13	24.00	Pass
117	6535	105.49	-95.23	10.617	10.26	24.00	Pass
153	6715	105.39	-95.23	10.375	10.16	24.00	Pass
181	6855	105.36	-95.23	10.304	10.13	24.00	Pass
185	6875	105.22	-95.23	9.977	9.99	24.00	Pass
213	7015	105.17	-95.23	9.863	9.94	24.00	Pass
229	7095	105.36	-95.23	10.304	10.13	24.00	Pass
233	7115	105.26	-95.23	10.069	10.03	24.00	Pass

802.11ax (HE20)

Chan.	Chan. Freq. (MHz)	Field Strength (dBuV/m)	Correction Factor (dB)	EIRP (mW)	EIRP (dBm)	EIRP Limit (dBm)	Pass / Fail
1	5955	105.91	-95.23	11.695	10.68	24.00	Pass
45	6175	105.87	-95.23	11.588	10.64	24.00	Pass
93	6415	105.96	-95.23	11.830	10.73	24.00	Pass
97	6435	105.98	-95.23	11.885	10.75	24.00	Pass
105	6475	105.82	-95.23	11.455	10.59	24.00	Pass
113	6515	105.86	-95.23	11.561	10.63	24.00	Pass
117	6535	105.82	-95.23	11.455	10.59	24.00	Pass
153	6715	105.74	-95.23	11.246	10.51	24.00	Pass
181	6855	105.91	-95.23	11.695	10.68	24.00	Pass
185	6875	105.71	-95.23	11.169	10.48	24.00	Pass
213	7015	105.74	-95.23	11.246	10.51	24.00	Pass
229	7095	105.83	-95.23	11.482	10.60	24.00	Pass
233	7115	105.64	-95.23	10.990	10.41	24.00	Pass

802.11ax (HE40)

Chan.	Chan. Freq. (MHz)	Field Strength (dBuV/m)	Correction Factor (dB)	EIRP (mW)	EIRP (dBm)	EIRP Limit (dBm)	Pass / Fail
3	5965	108.39	-95.23	20.701	13.16	24.00	Pass
43	6165	108.31	-95.23	20.324	13.08	24.00	Pass
91	6405	108.21	-95.23	19.861	12.98	24.00	Pass
99	6445	108.37	-95.23	20.606	13.14	24.00	Pass
107	6485	108.43	-95.23	20.893	13.20	24.00	Pass
115	6525	108.26	-95.23	20.091	13.03	24.00	Pass
123	6565	108.47	-95.23	21.086	13.24	24.00	Pass
155	6725	108.19	-95.23	19.770	12.96	24.00	Pass
179	6845	108.18	-95.23	19.724	12.95	24.00	Pass
187	6885	108.48	-95.23	21.135	13.25	24.00	Pass
211	7005	108.33	-95.23	20.417	13.10	24.00	Pass
227	7085	108.41	-95.23	20.797	13.18	24.00	Pass

802.11ax (HE80)

Chan.	Chan. Freq. (MHz)	Field Strength (dBuV/m)	Correction Factor (dB)	EIRP (mW)	EIRP (dBm)	EIRP Limit (dBm)	Pass / Fail
7	5985	110.99	-95.23	<b>37.670</b>	15.76	24.00	Pass
39	6145	110.78	-95.23	35.892	15.55	24.00	Pass
87	6385	110.63	-95.23	34.674	15.40	24.00	Pass
103	6465	110.92	-95.23	<b>37.068</b>	15.69	24.00	Pass
119	6545	110.85	-95.23	36.475	15.62	24.00	Pass
135	6625	110.94	-95.23	37.239	15.71	24.00	Pass
151	6705	110.91	-95.23	36.983	15.68	24.00	Pass
167	6785	110.86	-95.23	36.559	15.63	24.00	Pass
183	6865	110.98	-95.23	<b>37.584</b>	15.75	24.00	Pass
199	6945	110.95	-95.23	<b>37.325</b>	15.72	24.00	Pass
215	7025	110.87	-95.23	36.644	15.64	24.00	Pass

Spectrum Plot of Worst Value

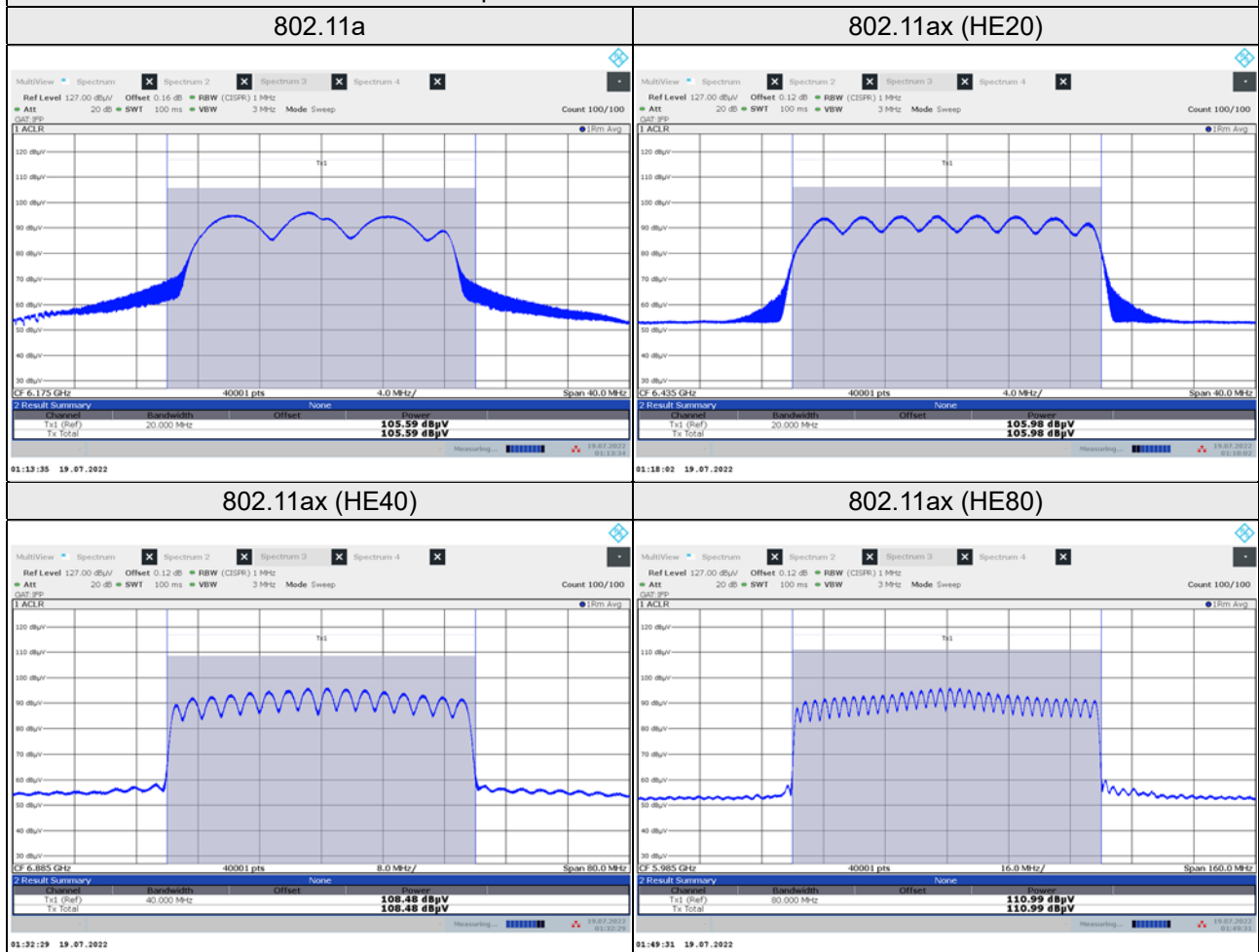

Nss 2

802.11ax (HE20)

Chan.	Chan. Freq. (MHz)	Field Strength (dBuV/m)	Correction Factor (dB)	EIRP (mW)	EIRP (dBm)	EIRP Limit (dBm)	Pass / Fail
1	5955	106.47	-95.23	13.305	11.24	24.00	Pass
45	6175	106.42	-95.23	13.152	11.19	24.00	Pass
93	6415	106.71	-95.23	14.060	11.48	24.00	Pass
97	6435	106.86	-95.23	14.555	11.63	24.00	Pass
105	6475	106.61	-95.23	13.740	11.38	24.00	Pass
113	6515	106.35	-95.23	12.942	11.12	24.00	Pass
117	6535	106.38	-95.23	13.032	11.15	24.00	Pass
153	6715	106.23	-95.23	12.589	11.00	24.00	Pass
181	6855	106.32	-95.23	12.853	11.09	24.00	Pass
185	6875	106.74	-95.23	14.158	11.51	24.00	Pass
213	7015	106.39	-95.23	13.062	11.16	24.00	Pass
229	7095	106.25	-95.23	12.647	11.02	24.00	Pass
233	7115	99.22	-95.23	2.506	3.99	24.00	Pass

802.11ax (HE40)

Chan.	Chan. Freq. (MHz)	Field Strength (dBuV/m)	Correction Factor (dB)	EIRP (mW)	EIRP (dBm)	EIRP Limit (dBm)	Pass / Fail
3	5965	108.68	-95.23	22.131	13.45	24.00	Pass
43	6165	108.43	-95.23	20.893	13.20	24.00	Pass
91	6405	108.03	-95.23	19.055	12.80	24.00	Pass
99	6445	108.45	-95.23	20.989	13.22	24.00	Pass
107	6485	108.59	-95.23	21.677	13.36	24.00	Pass
115	6525	108.61	-95.23	21.777	13.38	24.00	Pass
123	6565	108.69	-95.23	22.182	13.46	24.00	Pass
155	6725	108.54	-95.23	21.429	13.31	24.00	Pass
179	6845	108.08	-95.23	19.275	12.85	24.00	Pass
187	6885	108.43	-95.23	20.893	13.20	24.00	Pass
211	7005	108.47	-95.23	21.086	13.24	24.00	Pass
227	7085	108.26	-95.23	20.091	13.03	24.00	Pass

802.11ax (HE80)

Chan.	Chan. Freq. (MHz)	Field Strength (dBuV/m)	Correction Factor (dB)	EIRP (mW)	EIRP (dBm)	EIRP Limit (dBm)	Pass / Fail
7	5985	111.52	-95.23	<b>42.560</b>	16.29	24.00	Pass
39	6145	111.39	-95.23	41.305	16.16	24.00	Pass
87	6385	111.31	-95.23	40.551	16.08	24.00	Pass
103	6465	111.91	-95.23	<b>46.559</b>	16.68	24.00	Pass
119	6545	111.47	-95.23	42.073	16.24	24.00	Pass
135	6625	111.85	-95.23	<b>45.920</b>	16.62	24.00	Pass
151	6705	111.61	-95.23	43.451	16.38	24.00	Pass
167	6785	111.38	-95.23	41.210	16.15	24.00	Pass
183	6865	111.54	-95.23	42.756	16.31	24.00	Pass
199	6945	111.29	-95.23	<b>40.365</b>	16.06	24.00	Pass
215	7025	110.63	-95.23	34.674	15.40	24.00	Pass



### Spectrum Plot of Worst Value

#### 802.11ax (HE20)

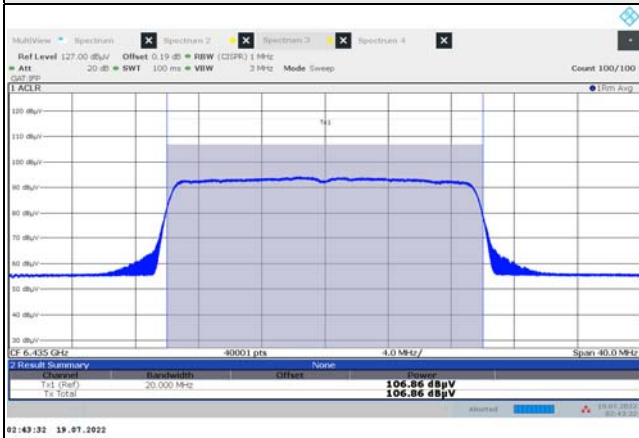

#### 802.11ax (HE40)



#### 802.11ax (HE80)

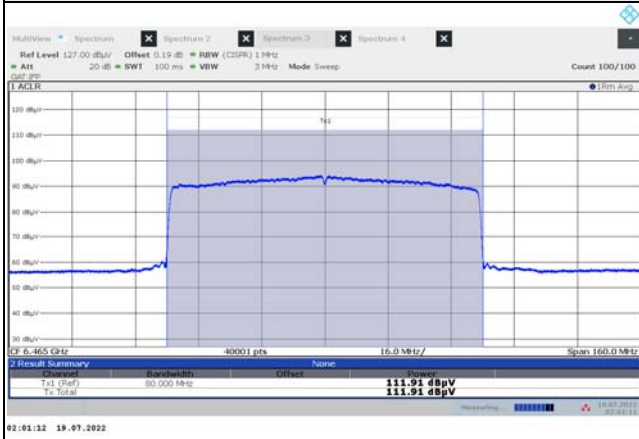

## 4.5 Emission Bandwidth Measurement

### 4.5.1 Test Setup

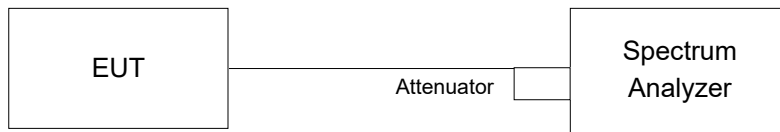

### 4.5.2 Test Instruments

Refer to section 4.1.2 to get information of above instrument.

### 4.5.3 Test Procedure

#### For 99% Occupied Bandwidth

The transmitter output was connected to the spectrum analyzer through an attenuator. The bandwidth of the fundamental frequency was measured by spectrum analyzer with resolution bandwidth in the range of 1% to 5% of the anticipated emission bandwidth, and a video bandwidth at least 3x the resolution bandwidth and set the detector to sampling. The width of a frequency band such that, below the lower and above the upper frequency limits, the mean powers emitted are each equal to a specified percentage 0.5 % of the total mean power of a given emission.

#### For 26dB Bandwidth

- Set RBW = approximately 1% of the emission bandwidth.
- Set the VBW > RBW.
- Detector = Peak.
- Trace mode = max hold.
- Measure the maximum width of the emission that is 26 dB down from the peak of the emission. Compare this with the RBW setting of the analyzer. Readjust RBW and repeat measurement as needed until the RBW/EBW ratio is approximately 1%.

#### 4.5.4 Test Result

99% Occupied Bandwidth

Nss 1

802.11a

Chan.	Freq. (MHz)	Occupied Bandwidth (MHz)		
		Chain 0	Chain 1	Limit (MHz)
1	5955	18.09	17.04	320
45	6175	17.16	17.16	320
93	6415	17.52	17.16	320
97	6435	17.40	17.04	320
105	6475	17.40	17.16	320
113	6515	17.52	17.16	320
117	6535	17.52	17.04	320
153	6715	17.40	17.16	320
181	6855	17.40	17.16	320
185	6875	17.28	16.92	320
213	7015	17.39	17.04	320
229	7095	19.08	19.08	320
233	7115	17.40	17.16	320

802.11ax (HE20)

Chan.	Freq. (MHz)	Occupied Bandwidth (MHz)		
		Chain 0	Chain 1	Limit (MHz)
1	5955	19.08	19.20	320
45	6175	19.08	19.08	320
93	6415	19.08	19.08	320
97	6435	19.08	19.08	320
105	6475	19.08	19.08	320
113	6515	19.08	19.08	320
117	6535	19.20	19.08	320
153	6715	19.08	19.08	320
181	6855	19.08	19.08	320
185	6875	19.08	19.08	320
213	7015	19.08	19.08	320
229	7095	19.13	19.04	320
233	7115	19.20	19.08	320

802.11ax (HE40)

Chan.	Freq. (MHz)	Occupied Bandwidth (MHz)		
		Chain 0	Chain 1	Limit (MHz)
3	5965	37.65	37.68	320
43	6165	37.68	37.80	320
91	6405	37.68	37.68	320
99	6445	37.68	37.80	320
107	6485	37.68	37.68	320
115	6525	37.68	37.56	320
123	6565	37.80	37.68	320
155	6725	37.68	37.56	320
179	6845	37.80	37.68	320
187	6885	37.68	37.80	320
211	7005	37.32	37.32	320
227	7085	37.68	37.56	320

802.11ax (HE80)

Chan.	Freq. (MHz)	Occupied Bandwidth (MHz)		
		Chain 0	Chain 1	Limit (MHz)
7	5985	76.80	76.80	320
39	6145	76.80	76.80	320
87	6385	77.04	76.80	320
103	6465	77.04	77.04	320
119	6545	76.80	76.80	320
135	6625	77.04	77.04	320
151	6705	76.80	76.56	320
167	6785	76.80	76.80	320
183	6865	76.80	76.80	320
199	6945	77.28	76.80	320
215	7025	76.56	76.56	320

### Spectrum Plot of Max. Value

**802.11a\_Chain 0 / CH 1 (U-NII-5 Band)**

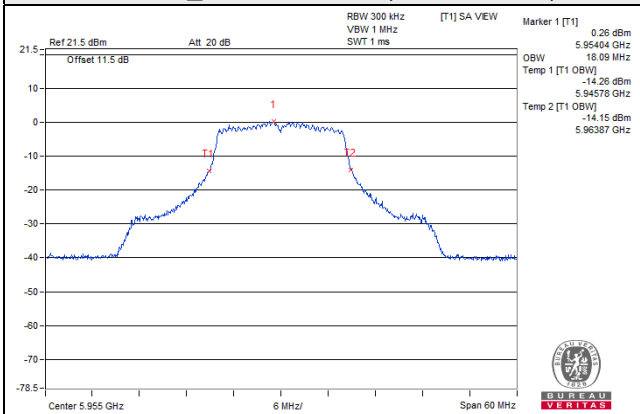

**802.11a\_Chain 0 / CH 113 (U-NII-6 Band)**

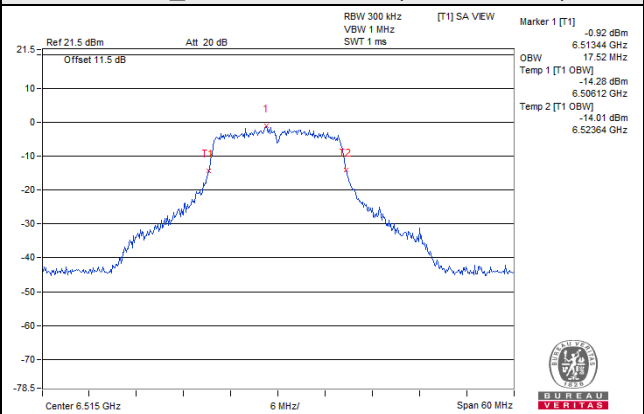

**802.11a\_Chain 0 / CH 117 (U-NII-7 Band)**

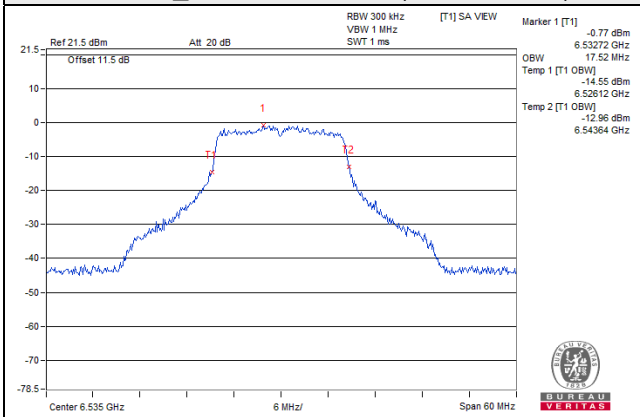

**802.11a\_Chain 0 / CH 229 (U-NII-8 Band)**

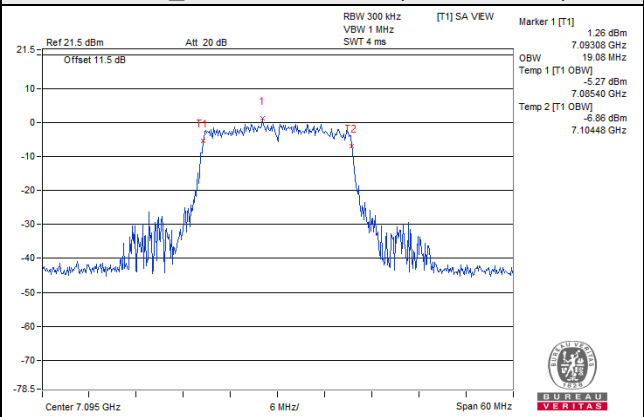

### Spectrum Plot of Max. Value

802.11ax (HE20)\_Chain 1 / CH 1 (U-NII-5 Band)

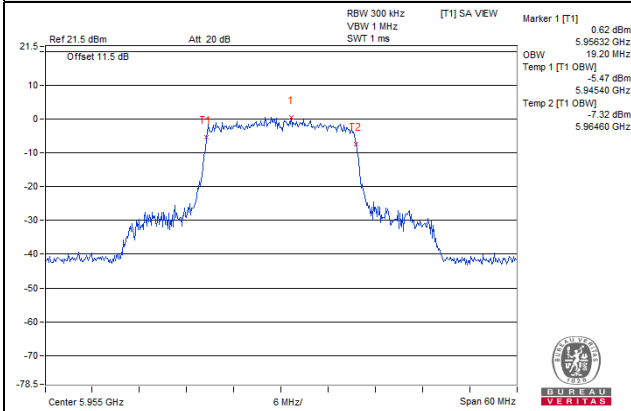

802.11ax (HE20)\_Chain 0 / CH 97 (U-NII-6 Band)

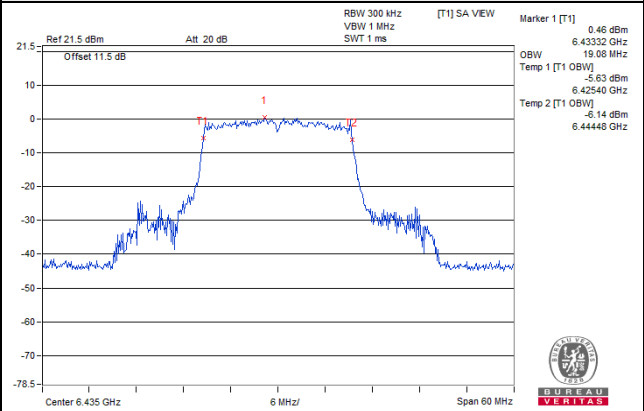

802.11ax (HE20)\_Chain 0 / CH 117 (U-NII-7 Band)

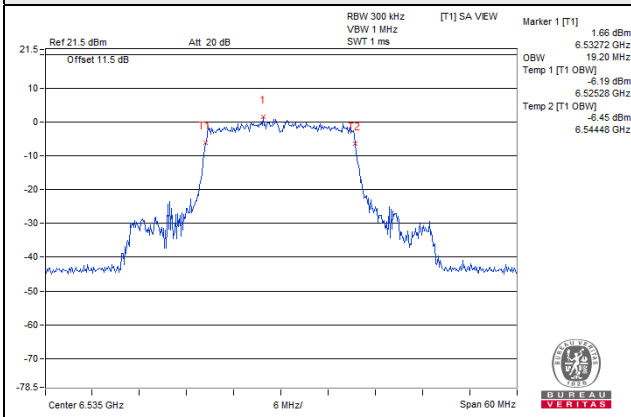

802.11ax (HE20)\_Chain 0 / CH 233 (U-NII-8 Band)

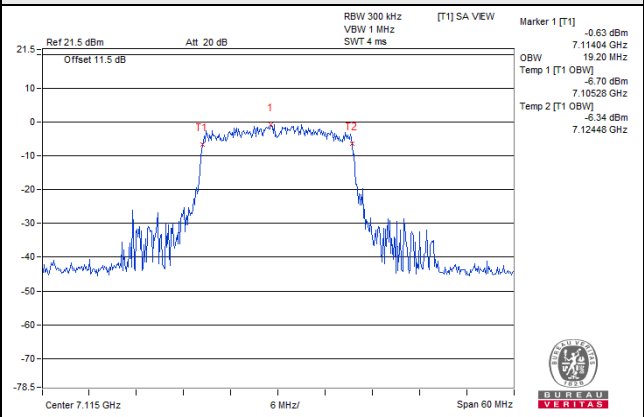

### Spectrum Plot of Max. Value

802.11ax (HE40)\_Chain 1 / CH 43 (U-NII-5 Band)

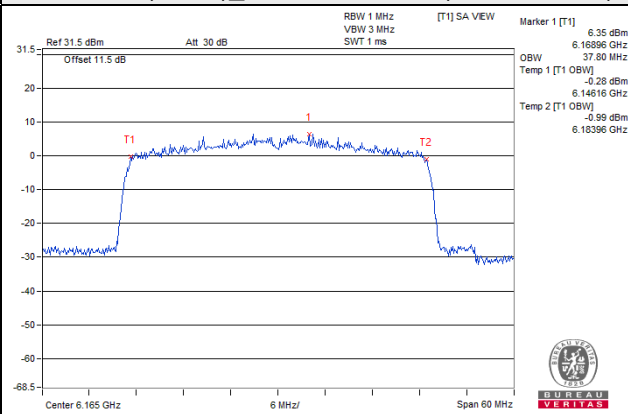

802.11ax (HE40)\_Chain 1 / CH 115 (U-NII-6 Band)

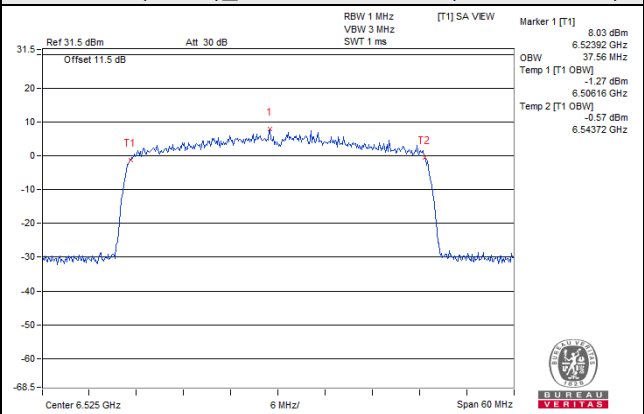

802.11ax (HE40)\_Chain 0 / CH 123 (U-NII-7 Band)

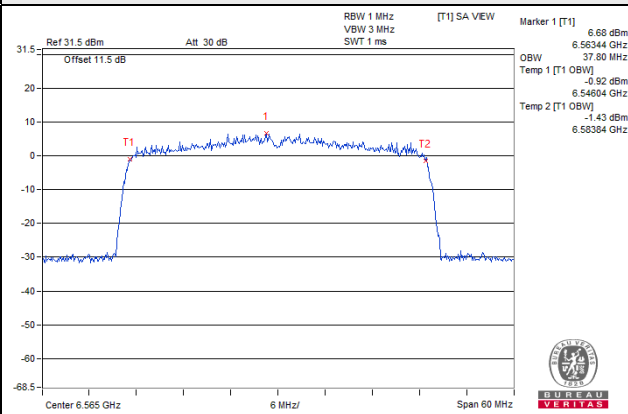

802.11ax (HE40)\_Chain 0 / CH 227 (U-NII-8 Band)

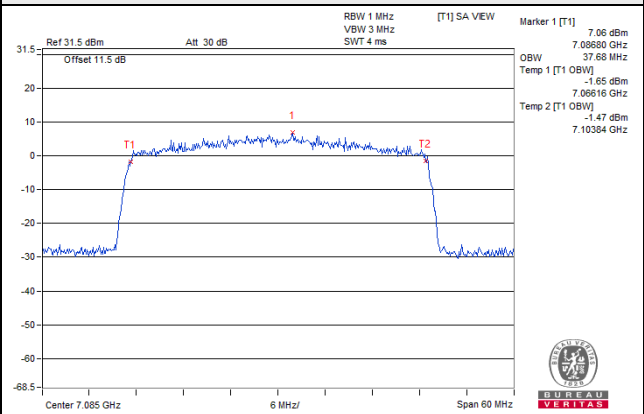



### Spectrum Plot of Max. Value

**802.11ax (HE80)\_Chain 0 / CH 87 (U-NII-5 Band)**

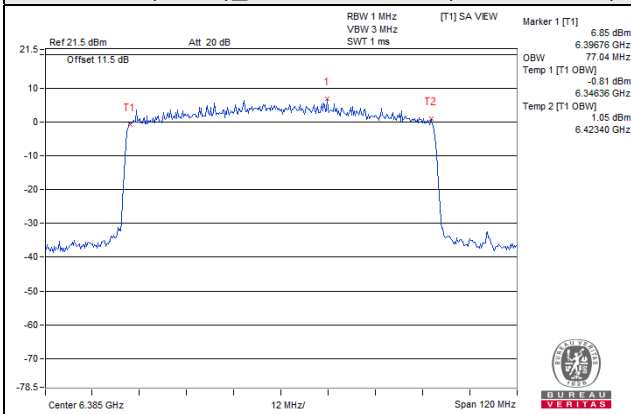

**802.11ax (HE80)\_Chain 0 / CH 103 (U-NII-6 Band)**

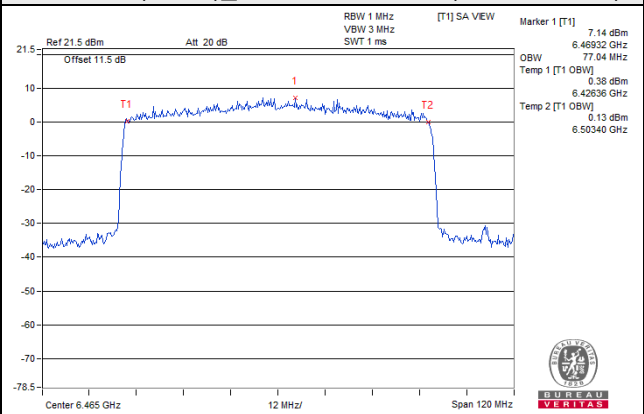

**802.11ax (HE80)\_Chain 0 / CH 135 (U-NII-7 Band)**

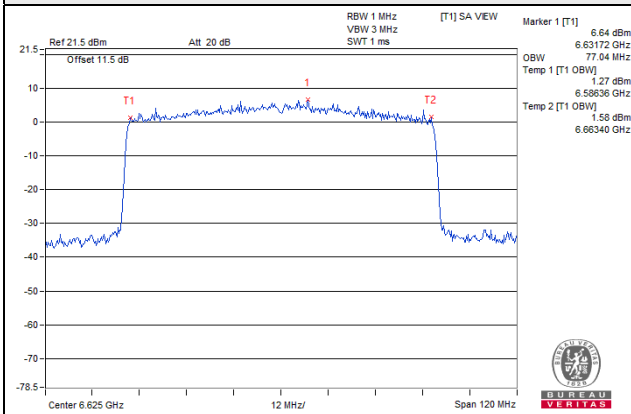

**802.11ax (HE80)\_Chain 0 / CH 199 (U-NII-8 Band)**

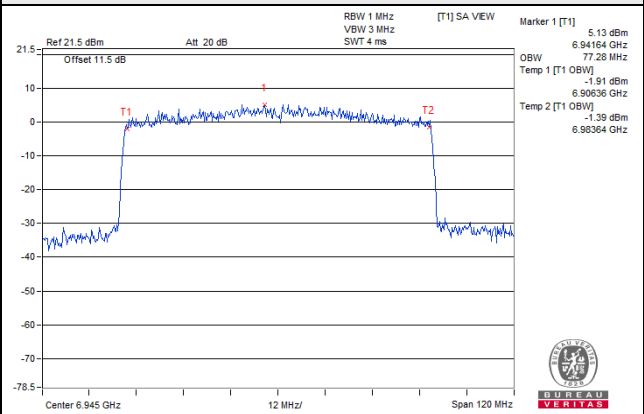

Nss 2

802.11ax (HE20)

Chan.	Freq. (MHz)	Occupied Bandwidth (MHz)		
		Chain 0	Chain 1	Limit (MHz)
1	5955	19.14	19.14	320
45	6175	19.08	19.08	320
93	6415	19.20	19.08	320
97	6435	19.20	19.08	320
105	6475	19.08	19.08	320
113	6515	19.08	19.08	320
117	6535	19.08	19.08	320
153	6715	19.08	19.08	320
181	6855	19.20	19.08	320
185	6875	19.08	19.08	320
213	7015	19.08	19.08	320
229	7095	19.08	19.08	320
233	7115	19.08	19.08	320

802.11ax (HE40)

Chan.	Freq. (MHz)	Occupied Bandwidth (MHz)		
		Chain 0	Chain 1	Limit (MHz)
3	5965	37.68	37.80	320
43	6165	37.56	37.56	320
91	6405	37.80	37.68	320
99	6445	37.68	37.68	320
107	6485	37.56	37.80	320
115	6525	37.68	37.56	320
123	6565	37.80	37.56	320
155	6725	37.68	37.56	320
179	6845	37.68	37.80	320
187	6885	37.80	37.80	320
211	7005	37.32	37.44	320
227	7085	37.68	37.56	320

802.11ax (HE80)

Chan.	Freq. (MHz)	Occupied Bandwidth (MHz)		
		Chain 0	Chain 1	Limit (MHz)
7	5985	76.80	76.56	320
39	6145	76.80	76.80	320
87	6385	77.04	77.04	320
103	6465	77.04	76.56	320
119	6545	77.04	77.04	320
135	6625	77.04	77.04	320
151	6705	76.80	76.80	320
167	6785	77.04	77.04	320
183	6865	77.04	76.80	320
199	6945	76.80	76.56	320
215	7025	76.32	76.80	320

### Spectrum Plot of Max. Value

**802.11ax (HE20)\_Chain 0 / CH 93 (U-NII-5 Band)**

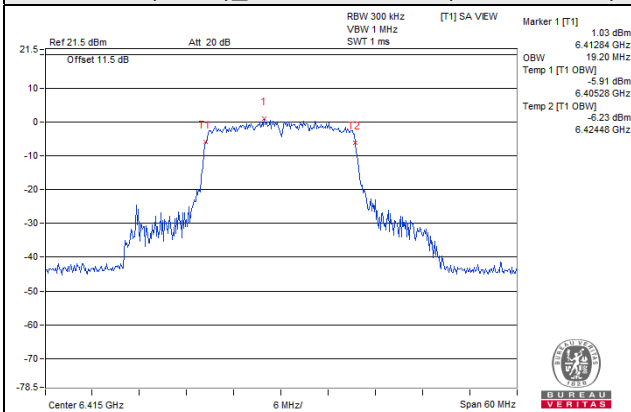

**802.11ax (HE20)\_Chain 0 / CH 97 (U-NII-6 Band)**

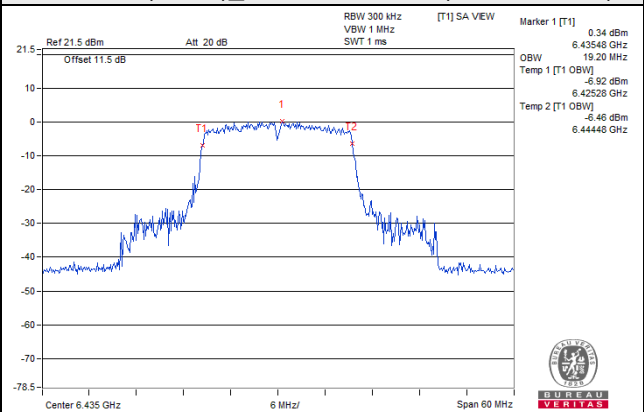

**802.11ax (HE20)\_Chain 0 / CH 181 (U-NII-7 Band)**

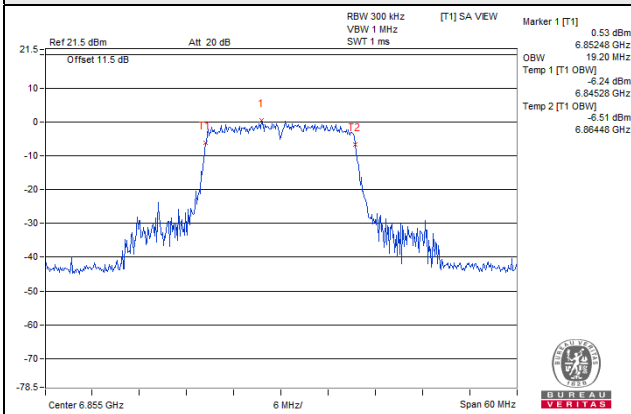

**802.11ax (HE20)\_Chain 0 / CH 213 (U-NII-8 Band)**

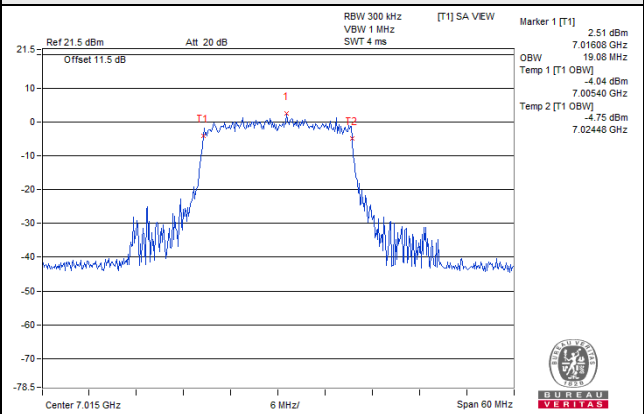

### Spectrum Plot of Max. Value

802.11ax (HE40)\_Chain 0 / CH 91 (U-NII-5 Band)

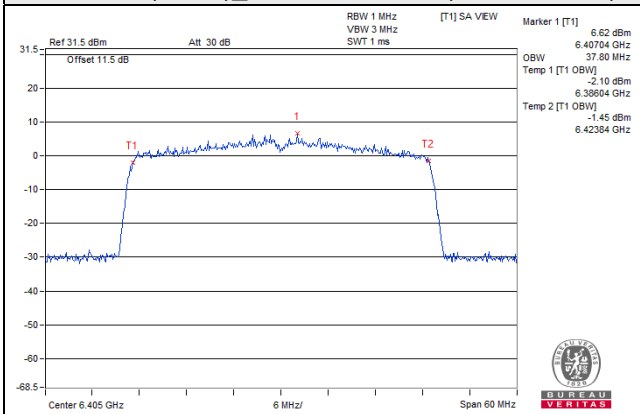

802.11ax (HE40)\_Chain 1 / CH 107 (U-NII-6 Band)

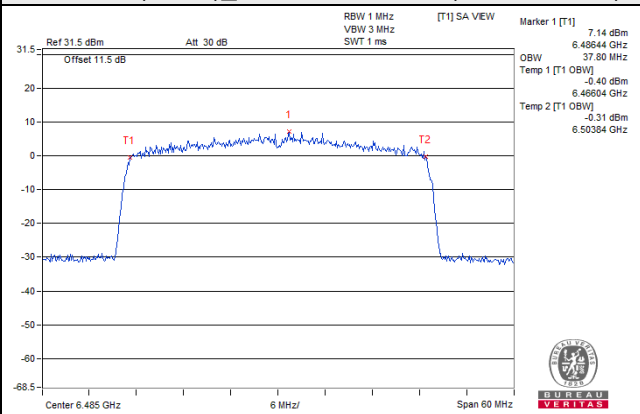

802.11ax (HE40)\_Chain 0 / CH 123 (U-NII-7 Band)

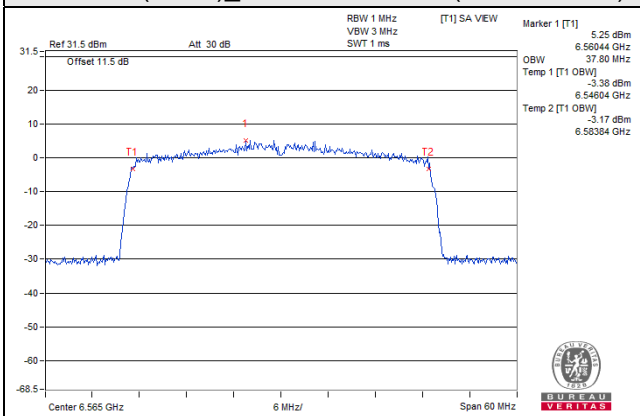

802.11ax (HE40)\_Chain 0 / CH 227 (U-NII-8 Band)

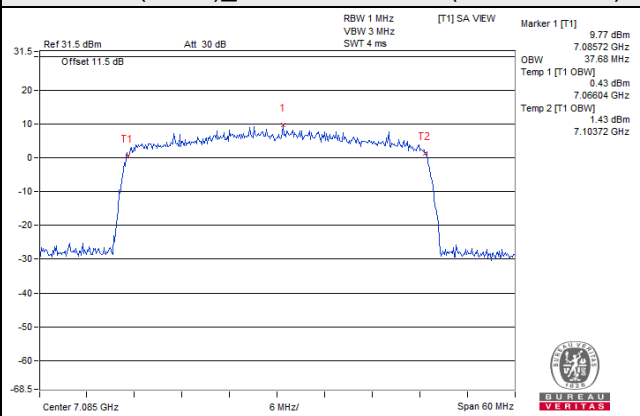

### Spectrum Plot of Max. Value

**802.11ax (HE80)\_Chain 0 / CH 87 (U-NII-5 Band)**

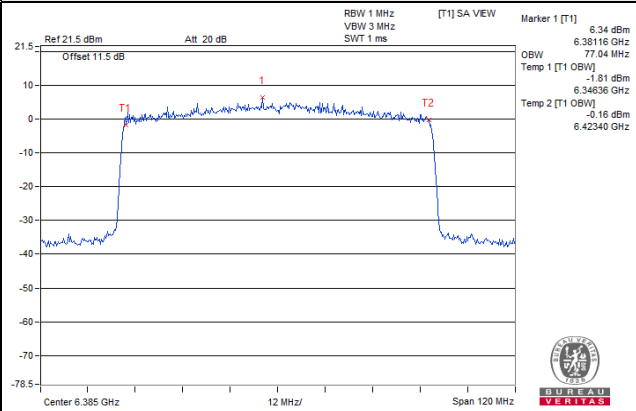

**802.11ax (HE80)\_Chain 0 / CH 119 (U-NII-6 Band)**

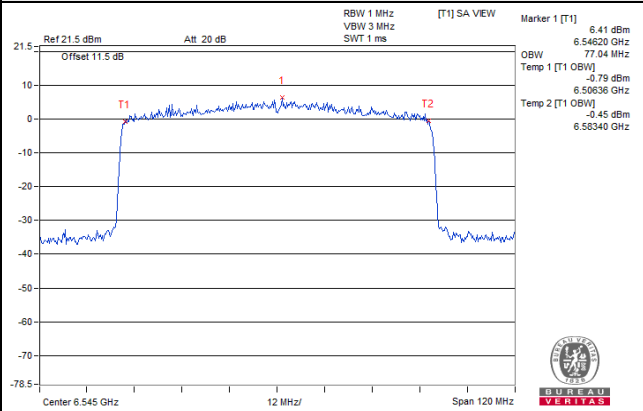

**802.11ax (HE80)\_Chain 0 / CH 167 (U-NII-7 Band)**

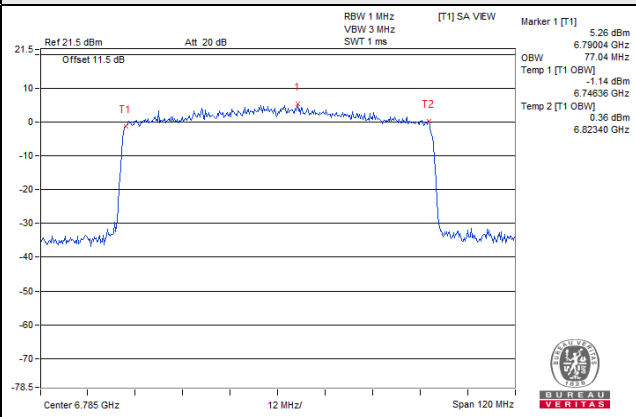

**802.11ax (HE80)\_Chain 0 / CH 199 (U-NII-8 Band)**

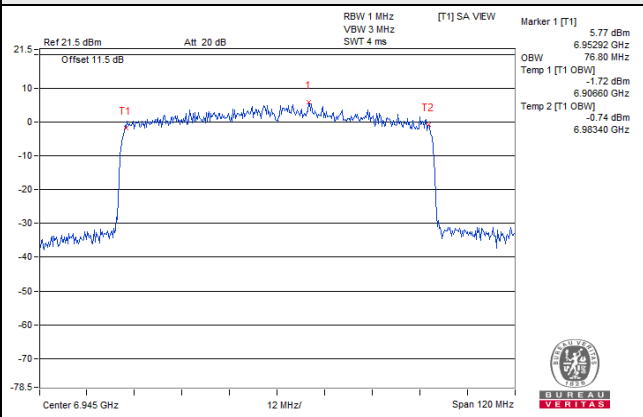

26dB Bandwidth

Nss 1

802.11a

Chan.	Freq. (MHz)	26dB Bandwidth (MHz)		
		Chain 0	Chain 1	Limit (MHz)
1	5955	27.67	24.83	320
45	6175	27.62	25.74	320
93	6415	27.51	25.03	320
97	6435	27.28	24.91	320
105	6475	26.65	25.05	320
113	6515	27.90	24.72	320
117	6535	27.53	25.86	320
153	6715	28.03	24.99	320
181	6855	26.58	25.27	320
185	6875	27.02	24.69	320
213	7015	25.79	24.84	320
229	7095	29.15	24.24	320
233	7115	27.96	25.39	320

802.11ax (HE20)

Chan.	Freq. (MHz)	26dB Bandwidth (MHz)		
		Chain 0	Chain 1	Limit (MHz)
1	5955	29.67	22.62	320
45	6175	29.22	28.63	320
93	6415	27.28	24.28	320
97	6435	25.13	23.88	320
105	6475	24.26	26.12	320
113	6515	26.31	25.84	320
117	6535	23.40	24.90	320
153	6715	27.09	25.88	320
181	6855	27.02	22.97	320
185	6875	23.20	23.02	320
213	7015	23.68	25.90	320
229	7095	27.77	24.70	320
233	7115	25.48	24.48	320

802.11ax (HE40)

Chan.	Freq. (MHz)	26dB Bandwidth (MHz)		
		Chain 0	Chain 1	Limit (MHz)
3	5965	40.67	40.61	320
43	6165	40.75	40.75	320
91	6405	40.61	40.71	320
99	6445	40.63	40.65	320
107	6485	40.83	40.64	320
115	6525	40.71	40.78	320
123	6565	40.68	40.75	320
155	6725	40.66	40.71	320
179	6845	40.67	40.70	320
187	6885	40.80	40.62	320
211	7005	40.54	40.39	320
227	7085	40.66	40.67	320



802.11ax (HE80)

Chan.	Freq. (MHz)	26dB Bandwidth (MHz)		
		Chain 0	Chain 1	Limit (MHz)
7	5985	81.18	81.19	320
39	6145	81.48	81.25	320
87	6385	81.27	81.26	320
103	6465	81.13	81.30	320
119	6545	81.08	81.04	320
135	6625	81.00	81.12	320
151	6705	81.26	81.15	320
167	6785	81.00	81.21	320
183	6865	81.13	81.26	320
199	6945	81.30	81.32	320
215	7025	81.07	80.96	320

### Spectrum Plot of Max. Value

802.11a\_Chain 0 / CH 1 (U-NII-5 Band)

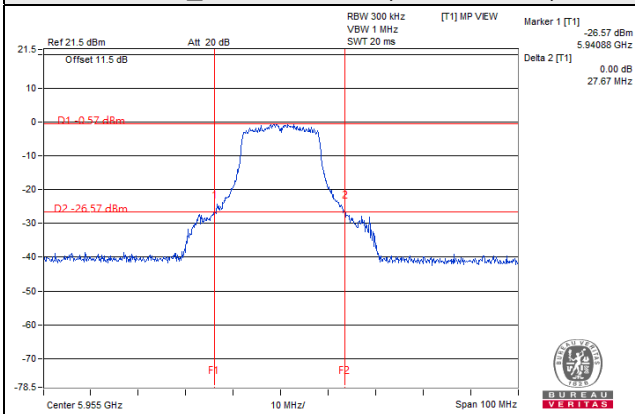

802.11a\_Chain 0 / CH 113 (U-NII-6 Band)

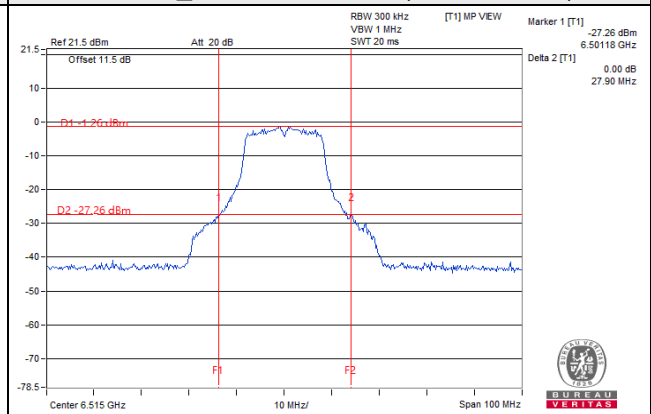

802.11a\_Chain 0 / CH 153 (U-NII-7 Band)

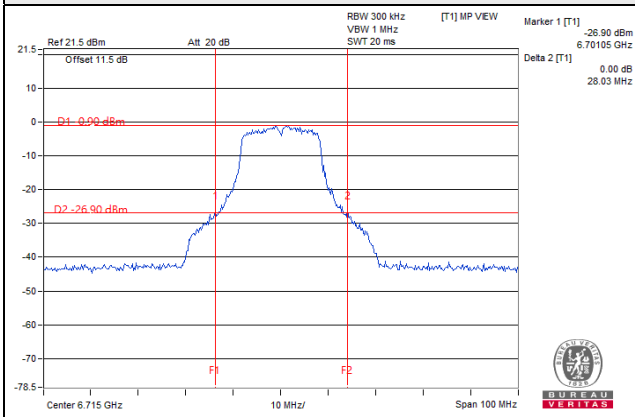

802.11a\_Chain 0 / CH 229 (U-NII-8 Band)

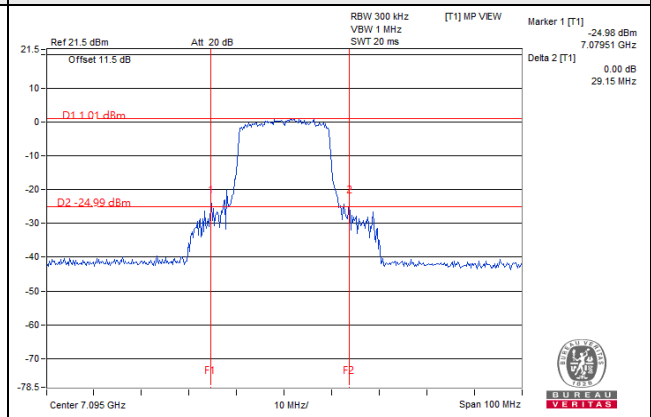

### Spectrum Plot of Max. Value

**802.11ax (HE20)\_Chain 0 / CH 1 (U-NII-5 Band)**

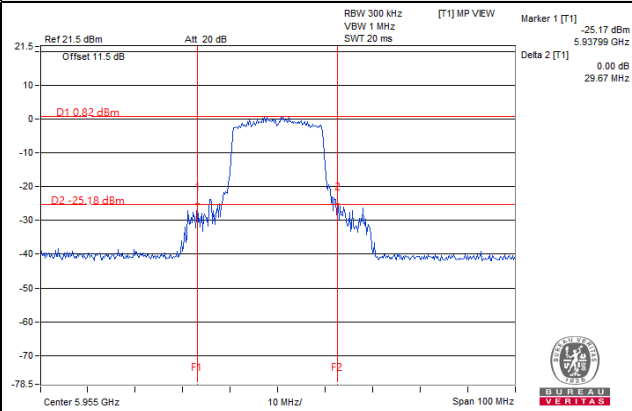

**802.11ax (HE20)\_Chain 0 / CH 113 (U-NII-6 Band)**

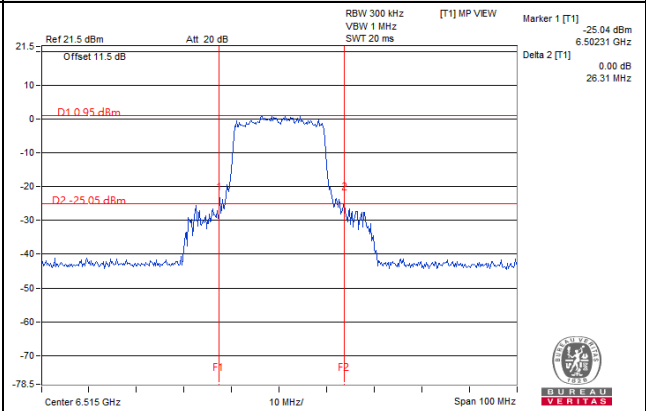

**802.11ax (HE20)\_Chain 0 / CH 153 (U-NII-7 Band)**

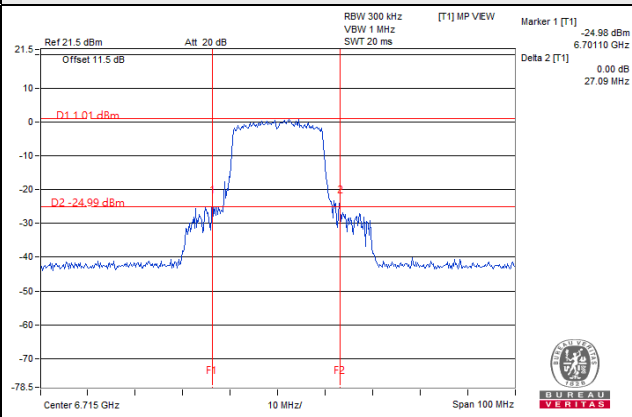

**802.11ax (HE20)\_Chain 0 / CH 229 (U-NII-8 Band)**

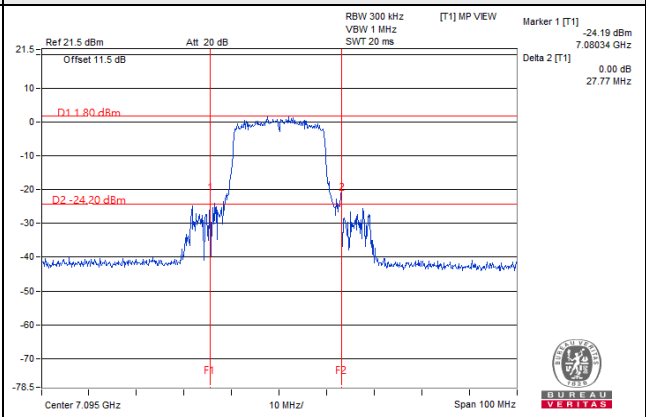

### Spectrum Plot of Max. Value

**802.11ax (HE40)\_Chain 0 / CH 43 (U-NII-5 Band)**

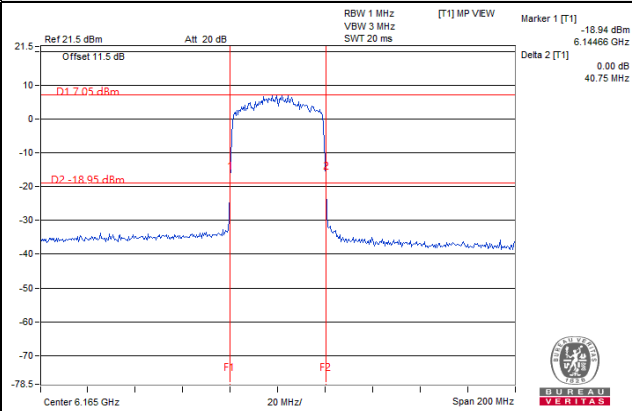

**802.11ax (HE40)\_Chain 0 / CH 107 (U-NII-6 Band)**

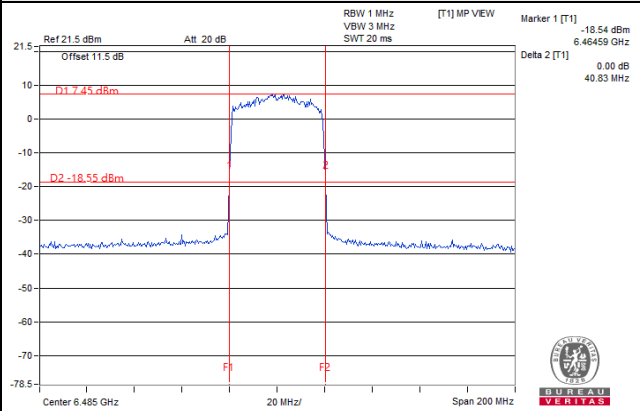

**802.11ax (HE40)\_Chain 0 / CH 187 (U-NII-7 Band)**

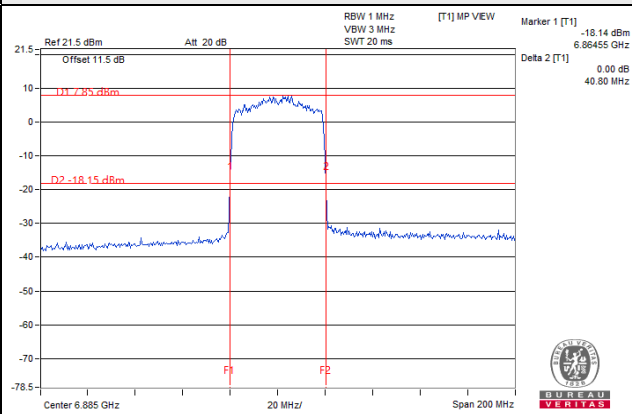

**802.11ax (HE40)\_Chain 1 / CH 227 (U-NII-8 Band)**

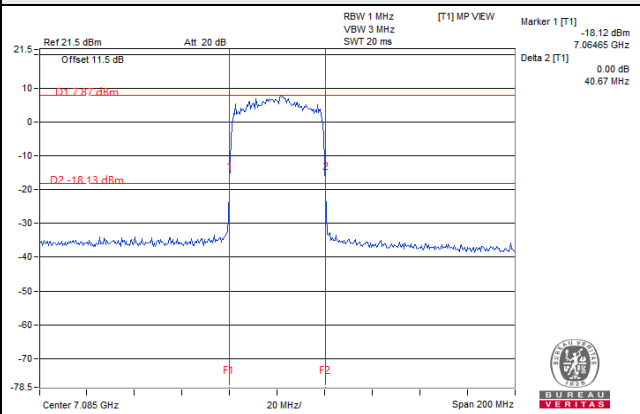

Spectrum Plot of Max. Value

802.11ax (HE80)\_Chain 0 / CH 39 (U-NII-5 Band)

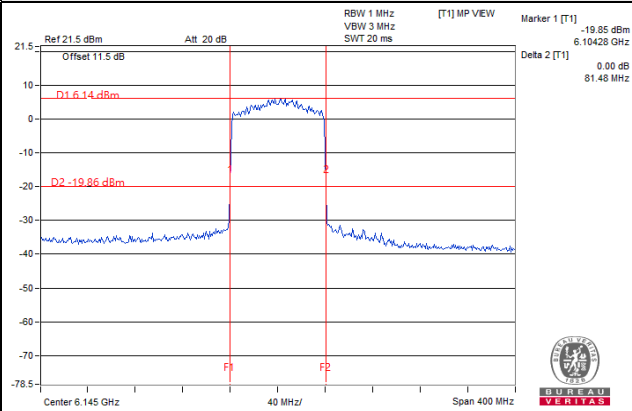

802.11ax (HE80)\_Chain 1 / CH 103 (U-NII-6 Band)

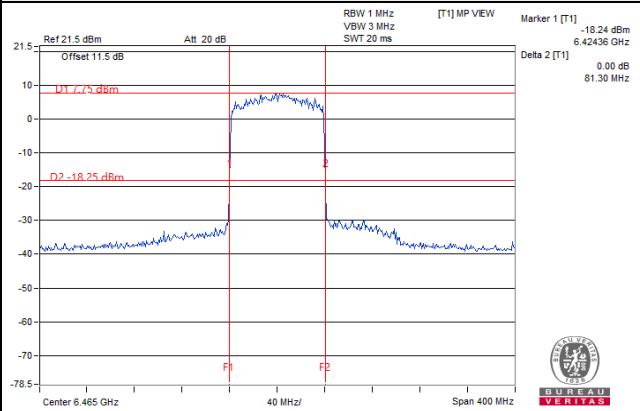

802.11ax (HE80)\_Chain 1 / CH 183 (U-NII-7 Band)

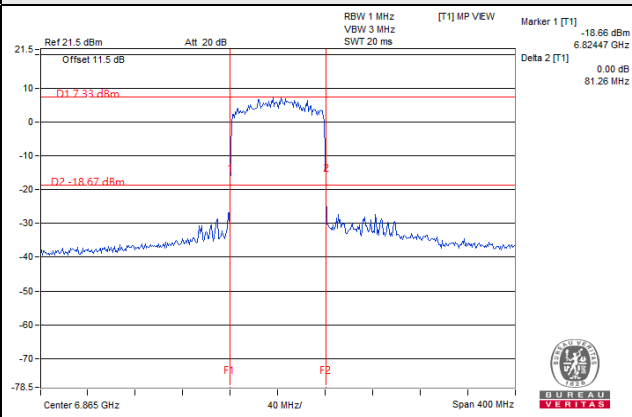

802.11ax (HE80)\_Chain 1 / CH 199 (U-NII-8 Band)

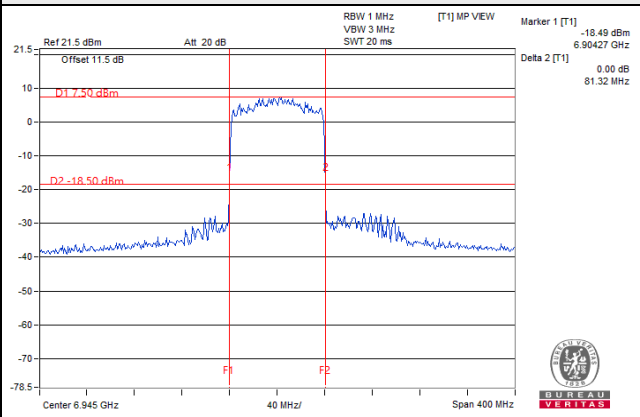

Nss 2

802.11ax (HE20)

Chan.	Freq. (MHz)	26dB Bandwidth (MHz)		
		Chain 0	Chain 1	Limit (MHz)
1	5955	26.34	26.40	320
45	6175	27.22	26.63	320
93	6415	24.56	29.62	320
97	6435	25.48	24.52	320
105	6475	24.29	22.97	320
113	6515	29.94	24.51	320
117	6535	28.67	25.26	320
153	6715	29.24	25.31	320
181	6855	24.02	26.64	320
185	6875	25.35	25.93	320
213	7015	24.95	24.51	320
229	7095	25.00	24.20	320
233	7115	26.11	26.76	320

802.11ax (HE40)

Chan.	Freq. (MHz)	26dB Bandwidth (MHz)		
		Chain 0	Chain 1	Limit (MHz)
3	5965	40.75	40.65	320
43	6165	40.78	40.71	320
91	6405	40.61	40.71	320
99	6445	40.70	40.63	320
107	6485	40.82	40.77	320
115	6525	40.65	40.67	320
123	6565	40.75	40.66	320
155	6725	40.68	40.74	320
179	6845	40.64	40.66	320
187	6885	40.81	40.65	320
211	7005	40.46	40.40	320
227	7085	40.65	40.68	320

802.11ax (HE80)

Chan.	Freq. (MHz)	26dB Bandwidth (MHz)		
		Chain 0	Chain 1	Limit (MHz)
7	5985	81.17	81.06	320
39	6145	81.36	81.12	320
87	6385	81.09	81.11	320
103	6465	81.39	81.26	320
119	6545	81.14	81.01	320
135	6625	81.07	81.08	320
151	6705	81.19	81.08	320
167	6785	81.12	81.21	320
183	6865	81.10	81.14	320
199	6945	81.16	81.00	320
215	7025	80.96	81.01	320

### Spectrum Plot of Max. Value

**802.11ax (HE20)\_Chain 1 / CH 93 (U-NII-5 Band)**

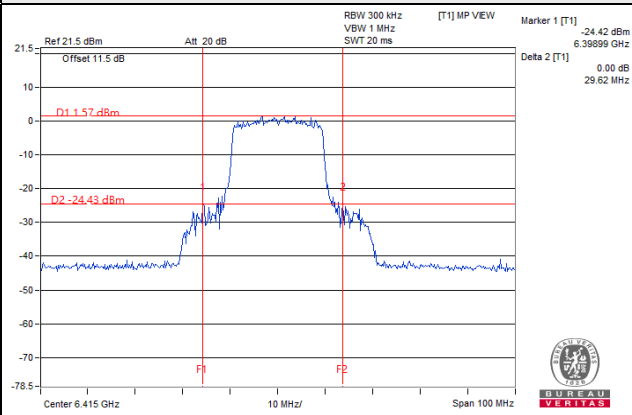

**802.11ax (HE20)\_Chain 0 / CH 113 (U-NII-6 Band)**

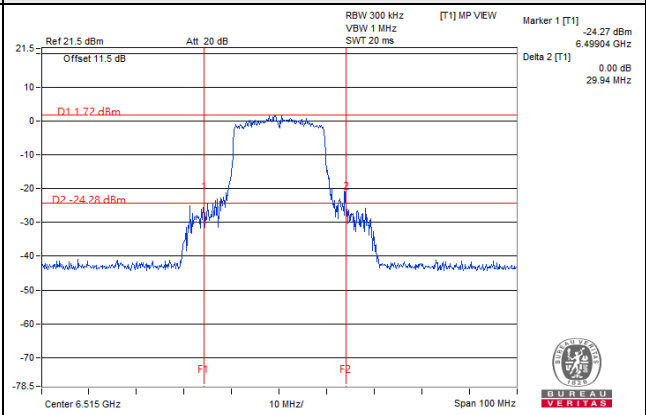

**802.11ax (HE20)\_Chain 0 / CH153 (U-NII-7 Band)**

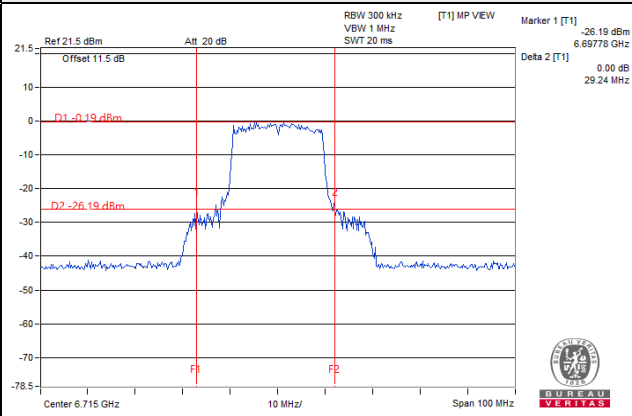

**802.11ax (HE20)\_Chain 1 / CH 233 (U-NII-8 Band)**

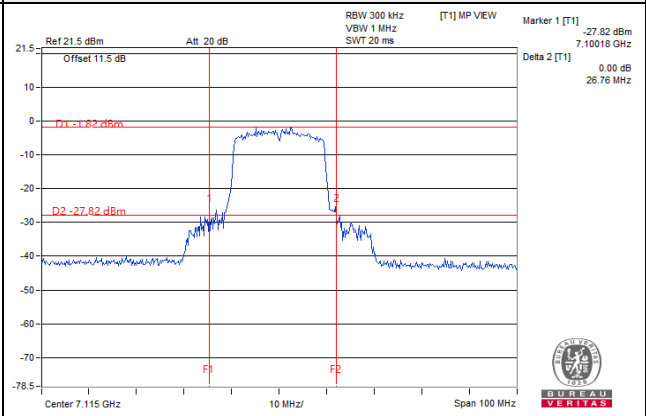



### Spectrum Plot of Max. Value

**802.11ax (HE40)\_Chain 0 / CH 43 (U-NII-5 Band)**

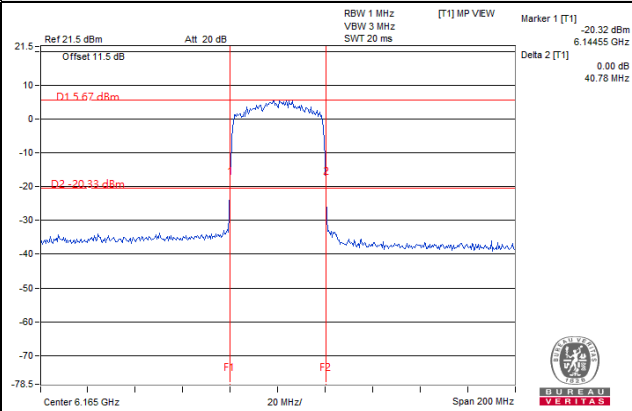

**802.11ax (HE40)\_Chain 0 / CH 107 (U-NII-6 Band)**

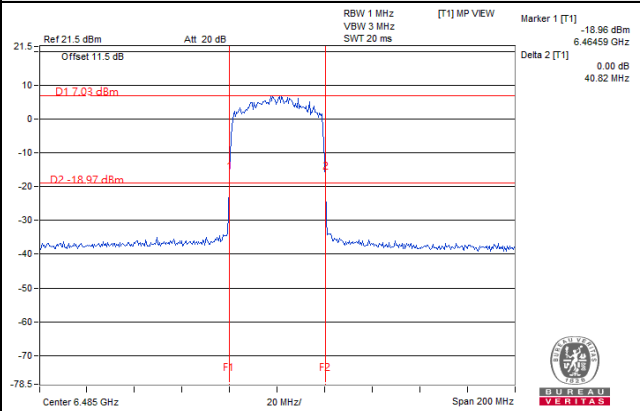

**802.11ax (HE40)\_Chain 0 / CH 187 (U-NII-7 Band)**

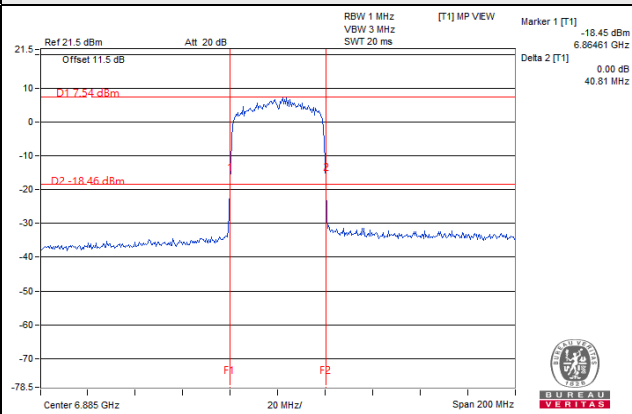

**802.11ax (HE40)\_Chain 1 / CH 227 (U-NII-8 Band)**

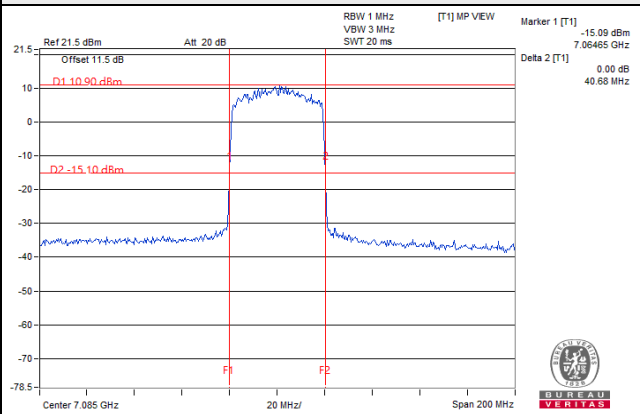

### Spectrum Plot of Max. Value

**802.11ax (HE80)\_Chain 0 / CH 39 (U-NII-5 Band)**

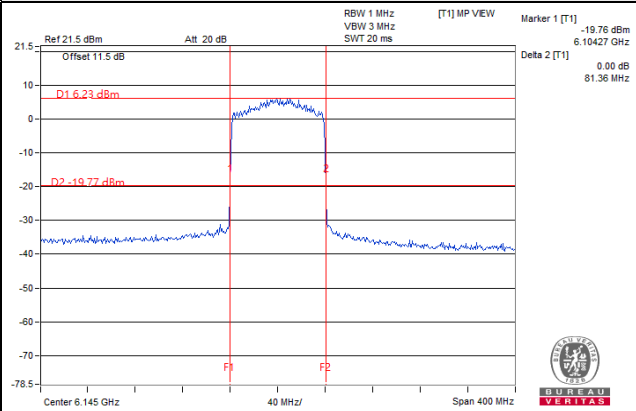

**802.11ax (HE80)\_Chain 0 / CH 103 (U-NII-6 Band)**

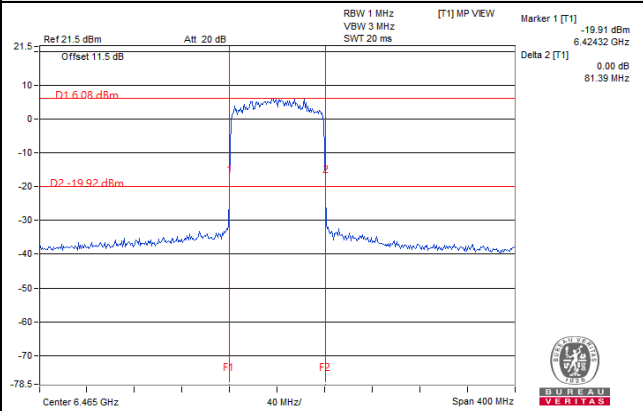

**802.11ax (HE80)\_Chain 1 / CH 167 (U-NII-7 Band)**

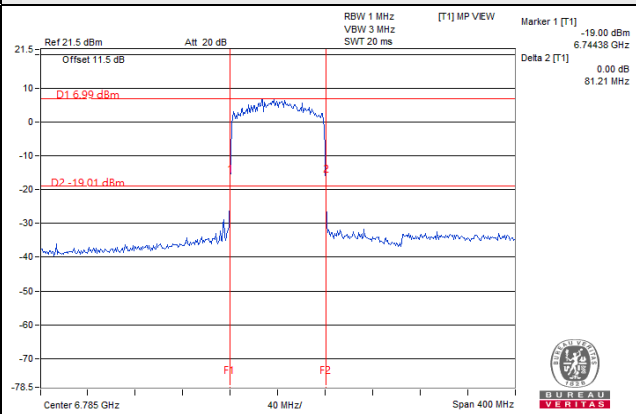

**802.11ax (HE80)\_Chain 0 / CH 199 (U-NII-8 Band)**

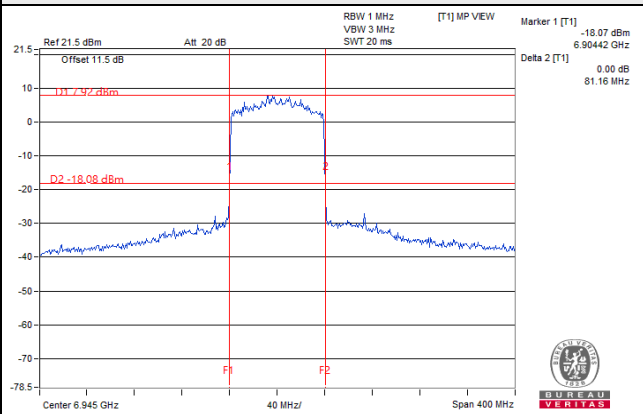

## 4.6 Peak Power Spectral Density Measurement

### 4.6.1 Limits of Peak Power Spectral Density Measurement

Operation Band	EUT Category	Limit
		Peak Power Density (EIRP)
U-NII-5 U-NII-6 U-NII-7 U-NII-8	Client Devices ( controlled of an indoor AP )	-1 dBm/MHz

### 4.6.2 Test Setup

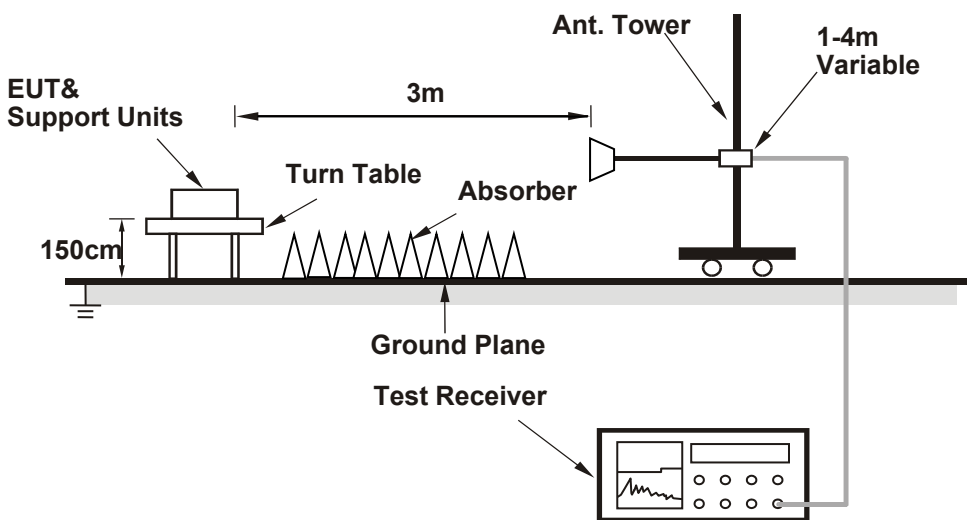

### 4.6.3 Test Instruments

Refer to section 4.1.2 to get information of above instrument.

#### 4.6.4 Test Procedures

- a. The EUT was placed on the top of a rotating table 1.5 meters above the ground at 3 meter chamber room for test. The table was rotated 360 degrees to determine the position of the highest radiation.
- b. The EUT was set 3 meters away from the interference-receiving antenna, which was mounted on the top of a variable-height antenna tower.
- c. The height of antenna is varied from one meter to four meters above the ground to determine the maximum value of the field strength. Both horizontal and vertical polarizations of the antenna are set to make the measurement.
- d. Perform a field strength measurement and record the worse read value, is the field strength value via a spectrum reading obtained corrected for antenna factor, cable loss and pre-amplifier factor and then mathematically convert the measured field strength level to EIRP level.
- e. Follow ANSI 63.10 and KDB 412172 D01 v01r01, EIRP Value (dBm) = Field Strength Value (dB $\mu$ V/m) + Correction Factor @ 3m.
- f. Correction Factor (dB) @ 3m =  $20\log(D) - 104.7$ ; where D is the measurement distance @3m=-95.23dB

Note: Spectrum analyzer setting as below:

#### Method SA-2

1. Set span to encompass the entire emission bandwidth (EBW) of the signal.
2. Set RBW = 1 MHz, Set VBW  $\geq$  3 MHz, Detector = RMS
3. Sweep time = auto, trigger set to "free run" .
4. Trace average at least 100 traces in power averaging mode.
5. Record the max value and add  $10 \log (1/\text{duty cycle})$

#### 4.6.5 Deviation from Test Standard

No deviation.

#### 4.6.6 EUT Operating Conditions

Same as 4.3.6.

#### 4.6.7 Test Results

Nss 1

802.11a

Chan.	Chan. Freq. (MHz)	Field Strength (dBuV/m)	Correction Factor (dB)	Duty Factor (dB)	EIRP PSD (dBm/MHz)	EIRP PSD Limit (dBm/MHz)	Pass / Fail
1	5955	94.09	-95.23	0.16	-1.14	-1.00	Pass
45	6175	94.16	-95.23	0.16	-1.07	-1.00	Pass
93	6415	94.13	-95.23	0.16	-1.10	-1.00	Pass
97	6435	94.19	-95.23	0.16	-1.04	-1.00	Pass
105	6475	94.16	-95.23	0.16	-1.07	-1.00	Pass
113	6515	94.12	-95.23	0.16	-1.11	-1.00	Pass
117	6535	94.16	-95.23	0.16	-1.07	-1.00	Pass
153	6715	94.11	-95.23	0.16	-1.12	-1.00	Pass
181	6855	94.06	-95.23	0.16	-1.17	-1.00	Pass
185	6875	94.05	-95.23	0.16	-1.18	-1.00	Pass
213	7015	94.05	-95.23	0.16	-1.18	-1.00	Pass
229	7095	94.18	-95.23	0.16	-1.05	-1.00	Pass
233	7115	94.09	-95.23	0.16	-1.14	-1.00	Pass

\*The duty factor is included in the field strength.

802.11ax (HE20)

Chan.	Chan. Freq. (MHz)	Field Strength (dBuV/m)	Correction Factor (dB)	Duty Factor (dB)	EIRP PSD (dBm/MHz)	EIRP PSD Limit (dBm/MHz)	Pass / Fail
1	5955	94.03	-95.23	0.12	-1.20	-1.00	Pass
45	6175	94.02	-95.23	0.12	-1.21	-1.00	Pass
93	6415	94.12	-95.23	0.12	-1.11	-1.00	Pass
97	6435	94.15	-95.23	0.12	-1.08	-1.00	Pass
105	6475	94.02	-95.23	0.12	-1.21	-1.00	Pass
113	6515	94.06	-95.23	0.12	-1.17	-1.00	Pass
117	6535	94.09	-95.23	0.12	-1.14	-1.00	Pass
153	6715	94.12	-95.23	0.12	-1.11	-1.00	Pass
181	6855	94.18	-95.23	0.12	-1.05	-1.00	Pass
185	6875	94.11	-95.23	0.12	-1.12	-1.00	Pass
213	7015	94.13	-95.23	0.12	-1.10	-1.00	Pass
229	7095	94.19	-95.23	0.12	-1.04	-1.00	Pass
233	7115	94.08	-95.23	0.12	-1.15	-1.00	Pass

\*The duty factor is included in the field strength.

802.11ax (HE40)

Chan.	Chan. Freq. (MHz)	Field Strength (dBuV/m)	Correction Factor (dB)	Duty Factor (dB)	EIRP PSD (dBm/MHz)	EIRP PSD Limit (dBm/MHz)	Pass / Fail
3	5965	94.13	-95.23	0.12	-1.10	-1.00	Pass
43	6165	94.09	-95.23	0.12	-1.14	-1.00	Pass
91	6405	94.05	-95.23	0.12	-1.18	-1.00	Pass
99	6445	94.18	-95.23	0.12	-1.05	-1.00	Pass
107	6485	94.19	-95.23	0.12	-1.04	-1.00	Pass
115	6525	94.12	-95.23	0.12	-1.11	-1.00	Pass
123	6565	94.21	-95.23	0.12	-1.02	-1.00	Pass
155	6725	94.06	-95.23	0.12	-1.17	-1.00	Pass
179	6845	94.02	-95.23	0.12	-1.21	-1.00	Pass
187	6885	94.09	-95.23	0.12	-1.14	-1.00	Pass
211	7005	93.98	-95.23	0.12	-1.25	-1.00	Pass
227	7085	93.95	-95.23	0.12	-1.28	-1.00	Pass

\*The duty factor is included in the field strength.

802.11ax (HE80)

Chan.	Chan. Freq. (MHz)	Field Strength (dBuV/m)	Correction Factor (dB)	Duty Factor (dB)	EIRP PSD (dBm/MHz)	EIRP PSD Limit (dBm/MHz)	Pass / Fail
7	5985	94.18	-95.23	0.12	-1.05	-1.00	Pass
39	6145	94.15	-95.23	0.12	-1.08	-1.00	Pass
87	6385	94.09	-95.23	0.12	-1.14	-1.00	Pass
103	6465	92.98	-95.23	0.12	-2.25	-1.00	Pass
119	6545	92.92	-95.23	0.12	-2.31	-1.00	Pass
135	6625	93.86	-95.23	0.12	-1.37	-1.00	Pass
151	6705	93.78	-95.23	0.12	-1.45	-1.00	Pass
167	6785	93.76	-95.23	0.12	-1.47	-1.00	Pass
183	6865	93.95	-95.23	0.12	-1.28	-1.00	Pass
199	6945	94.02	-95.23	0.12	-1.21	-1.00	Pass
215	7025	94.18	-95.23	0.12	-1.05	-1.00	Pass

\*The duty factor is included in the field strength.

### Spectrum Plot of Worst Value

802.11a

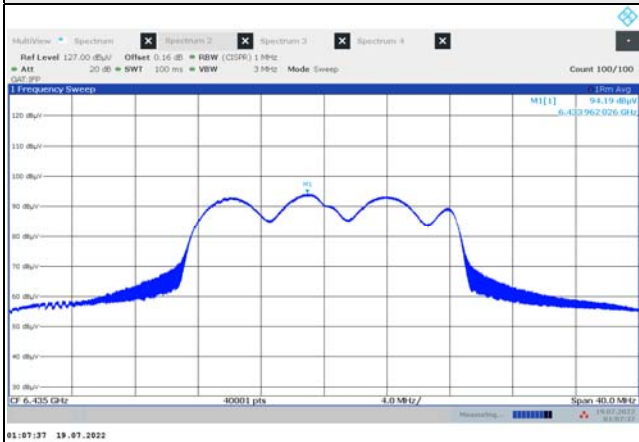

802.11ax (HE20)

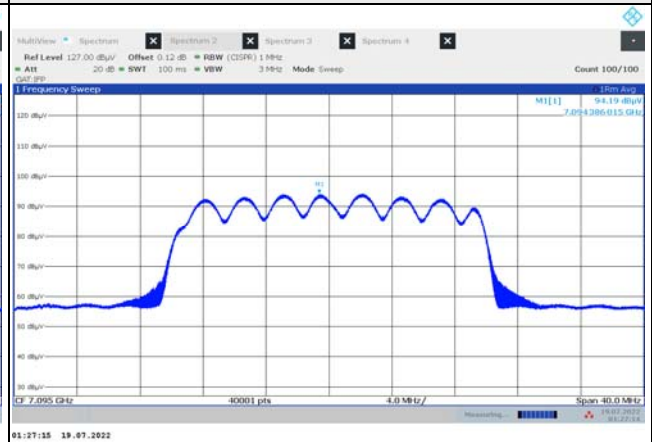

802.11ax (HE40)

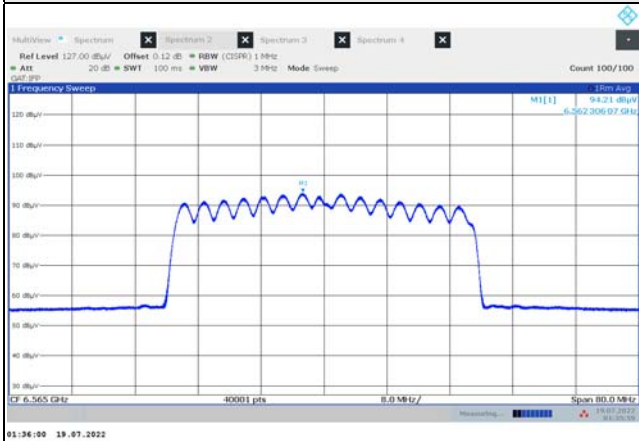

802.11ax (HE80)

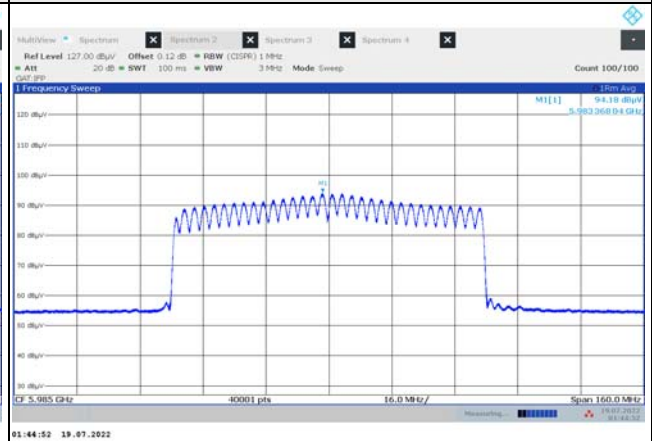



Nss 2

802.11ax (HE20)

Chan.	Chan. Freq. (MHz)	Field Strength (dBuV/m)	Correction Factor (dB)	Duty Factor (dB)	EIRP PSD (dBm/MHz)	EIRP PSD Limit (dBm/MHz)	Pass / Fail
1	5955	94.21	-95.23	0.19	-1.02	-1.00	Pass
45	6175	94.08	-95.23	0.19	-1.15	-1.00	Pass
93	6415	94.09	-95.23	0.19	-1.14	-1.00	Pass
97	6435	94.22	-95.23	0.19	-1.01	-1.00	Pass
105	6475	94.21	-95.23	0.19	-1.02	-1.00	Pass
113	6515	94.15	-95.23	0.19	-1.08	-1.00	Pass
117	6535	94.14	-95.23	0.19	-1.09	-1.00	Pass
153	6715	94.21	-95.23	0.19	-1.02	-1.00	Pass
181	6855	94.18	-95.23	0.19	-1.05	-1.00	Pass
185	6875	94.21	-95.23	0.19	-1.02	-1.00	Pass
213	7015	94.19	-95.23	0.19	-1.04	-1.00	Pass
229	7095	94.21	-95.23	0.19	-1.02	-1.00	Pass
233	7115	86.95	-95.23	0.19	-8.28	-1.00	Pass

\*The duty factor is included in the field strength.

802.11ax (HE40)

Chan.	Chan. Freq. (MHz)	Field Strength (dBuV/m)	Correction Factor (dB)	Duty Factor (dB)	EIRP PSD (dBm/MHz)	EIRP PSD Limit (dBm/MHz)	Pass / Fail
3	5965	94.21	-95.23	0.22	-1.02	-1.00	Pass
43	6165	94.22	-95.23	0.22	-1.01	-1.00	Pass
91	6405	94.05	-95.23	0.22	-1.18	-1.00	Pass
99	6445	94.22	-95.23	0.22	-1.01	-1.00	Pass
107	6485	94.18	-95.23	0.22	-1.05	-1.00	Pass
115	6525	94.21	-95.23	0.22	-1.02	-1.00	Pass
123	6565	94.21	-95.23	0.22	-1.02	-1.00	Pass
155	6725	94.22	-95.23	0.22	-1.01	-1.00	Pass
179	6845	94.09	-95.23	0.22	-1.14	-1.00	Pass
187	6885	94.21	-95.23	0.22	-1.02	-1.00	Pass
211	7005	94.22	-95.23	0.22	-1.01	-1.00	Pass
227	7085	94.11	-95.23	0.22	-1.12	-1.00	Pass

\*The duty factor is included in the field strength.

802.11ax (HE80)

Chan.	Chan. Freq. (MHz)	Field Strength (dBuV/m)	Correction Factor (dB)	Duty Factor (dB)	EIRP PSD (dBm/MHz)	EIRP PSD Limit (dBm/MHz)	Pass / Fail
7	5985	94.05	-95.23	0.19	-1.18	-1.00	Pass
39	6145	94.19	-95.23	0.19	-1.04	-1.00	Pass
87	6385	94.09	-95.23	0.19	-1.14	-1.00	Pass
103	6465	94.22	-95.23	0.19	-1.01	-1.00	Pass
119	6545	94.18	-95.23	0.19	-1.05	-1.00	Pass
135	6625	94.05	-95.23	0.19	-1.18	-1.00	Pass
151	6705	94.15	-95.23	0.19	-1.08	-1.00	Pass
167	6785	94.12	-95.23	0.19	-1.11	-1.00	Pass
183	6865	94.19	-95.23	0.19	-1.04	-1.00	Pass
199	6945	94.10	-95.23	0.19	-1.13	-1.00	Pass
215	7025	93.53	-95.23	0.19	-1.70	-1.00	Pass

\*The duty factor is included in the field strength.

### Spectrum Plot of Worst Value

#### 802.11ax (HE20)

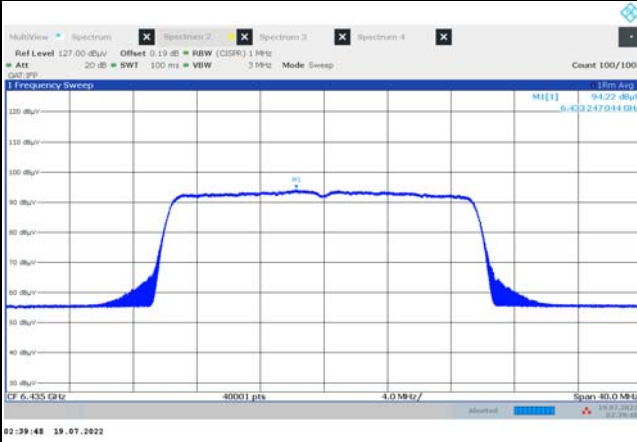

#### 802.11ax (HE40)

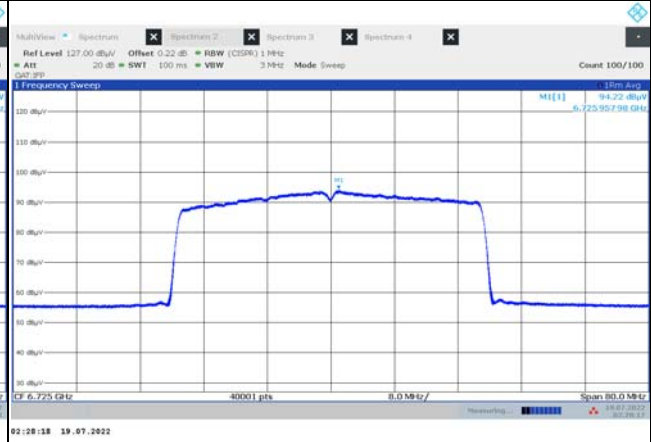

#### 802.11ax (HE80)

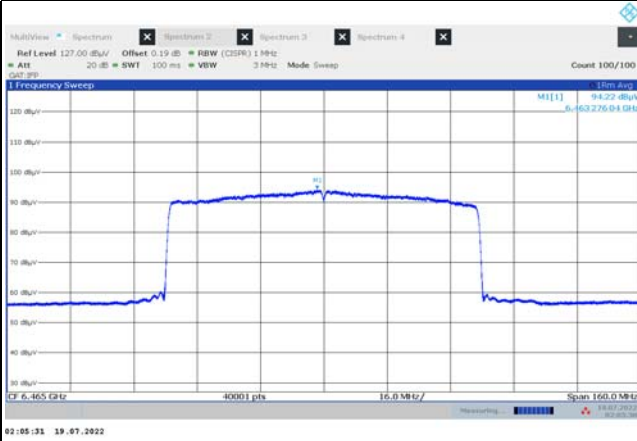

## 4.7 Contention Based Protocol Measurement

### 4.7.1 Limits of Contention Based Protocol Measurement

Unlicensed indoor low-power devices must detect co-channel radio frequency power that is at least -62 dBm (The threshold is referenced to a 0 dBi antenna gain.) or lower. Additionally, indoor low-power devices must detect co-channel energy with 90% or greater certainty.

### 4.7.2 Test Setup

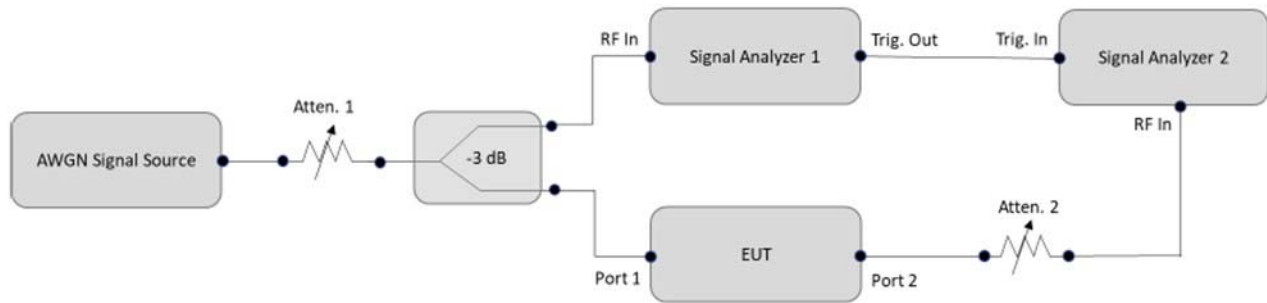

### 4.7.3 Test Instruments

Description & Manufacturer	Model No.	Serial No.	Cal. Date	Cal. Due
Spectrum Analyzer R&S	FSW	102023	Nov. 10, 2021	Nov. 09, 2022
Spectrum Analyzer R&S	FSV40	101516	Mar. 07, 2022	Mar. 06, 2023
MXG X-Series RF Vector Signal Generator Agilent	N5182B	MY59100182	Apr. 26, 2022	Apr. 25, 2023
N5182BU KEYSIGHT	N5182BX07	MY59360203	Apr. 26, 2022	Apr. 25, 2023
Power Splitter/combiner Mini-Circuits	ZFRSC-123-S+	F698501347_01	Jan. 26, 2022	Jan. 25, 2023

Note: 1. The test was performed in Femtocell room.

2. The calibration interval of the above test instruments is 12 months and the calibrations are traceable to NML/ROC and NIST/USA.

#### 4.7.4 Test Procedure

- a. Set the signal analyzer center frequency to the nominal EUT channel center frequency. The span range of the signal analyzer shall be between two times and five times the OBW of the EUT. Connect the output port of the EUT to the signal analyzer 2. Ensure that the attenuator 2 provides enough attenuation to not overload the signal analyzer 2 receiver.
- b. Monitoring the signal analyzer 2, verify the EUT is operating and transmitting with the parameters (set as following section 4.7.5 EUT operating condition).
- c. Determine number of times detection threshold test as following table,

If	Number of Tests	Placement of Incumbent Transmission
$BW_{EUT} \leq BW_{Inc}$	Once	Same as EUT transmission
$BW_{Inc} < BW_{EUT} \leq 2x BW_{Inc}$	Once	Contained within $BW_{EUT}$
$2x BW_{Inc} < BW_{EUT} \leq 4x BW_{Inc}$	Twice. (Incumbent transmission is contained within $BW_{EUT}$ )	Closely to the lower edge and upper edge of the EUT Channel
$BW_{EUT} > 4x BW_{Inc}$	Three times	Closely to the lower edge ,in the middle and upper edge of the EUT Channel

- d. Using an AWGN signal source, generate (but do not transmit, i.e., RF OFF) a 10 MHz-wide AWGN signal. Use step c table to determine the center frequency of the 10 MHz AWGN signal relative to the EUT's channel bandwidth and center frequency.
- e. Set the AWGN signal power to an extremely low level (more than 20 dB below the -62 dBm threshold). Connect the AWGN signal source, via a 3-dB splitter, to the signal analyzer 1 and the EUT.
- f. Transmit the AWGN signal (RF ON) and verify its characteristics on the signal analyzer 1.
- g. Monitor the signal analyzer 2 to verify if the AWGN signal has been detected and the EUT has ceased transmission. If the EUT continues to transmit, then incrementally increase the AWGN signal power level until the EUT stops transmitting.
- h. (Including all losses in the RF paths) Determine and record the AWGN signal power level (at the EUT's antenna port) at which the EUT ceased transmission. Repeat the procedure at least 10 times to verify the EUT can detect an AWGN signal with 90% (or better) level of certainty.
- i. Refer to step c table to determine number of times the detection threshold testing needs to be repeated. If testing is required more than once, then go back to step d, choose a different center frequency for the AWGN signal and repeat the process.

#### 4.7.5 EUT Operating Condition

Set the EUT to transmit with a constant duty cycle and relative operating parameters which including power level, operating frequency, modulation and bandwidth.

#### 4.7.6 Test Results

UNII Band 5:

Contention Based Protocol Measurement												
Operation Mode	Channel Bandwidth (MHz)	Channel Number	Channel Freq. (MHz)	Injected Signal (AWGN)		Antenna Gain (dBi)	Path Loss (dB)	Adjusted Power (dBi)	Detection Limit	EUT TX Status		
				Freq. (MHz)	Power (dBm)							
802.11ax	20	45	6175	6175	-59.8	2.2	0	-62	-62	OFF		
					-61.8	2.2	0	-64	-62	Minimal		
					-79.8	2.2	0	-82	-62	ON		
			80	39	6145	6110	-59.8	2.2	0	-62	-62	OFF
							-63.8	2.2	0	-66	-62	Minimal
							-79.8	2.2	0	-82	-62	ON
	80	39	6145	6145	-59.8	2.2	0	-62	-62	OFF		
					-61.8	2.2	0	-64	-62	Minimal		
					-79.8	2.2	0	-82	-62	ON		
			6180	-59.8	2.2	0	-62	-62	OFF			
				-63.8	2.2	0	-66	-62	Minimal			
				-79.8	2.2	0	-82	-62	ON			

Note: Adjusted Power = Injected Signal (AWGN) Power - Antenna Gain + Path Loss

\*Antenna gain values include all the applicable path losses.

Contention Based Protocol Detection Probability															
Operation Mode	Channel Bandwidth (MHz)	AWGN Signal Freq. (MHz)	#01	#02	#03	#04	#05	#06	#07	#08	#09	#10	Detection Probability	Detection Limit	Test Result
802.11ax	20	6175	v	v	v	v	v	v	v	v	v	v	100%	90%	Pass
	80	6110	v	v	v	v	v	v	v	v	v	v	100%	90%	Pass
		6145	v	v	v	v	v	v	v	v	v	v	100%	90%	Pass
		6180	v	v	v	v	v	v	v	v	v	v	100%	90%	Pass

UNII Band 6:

Contention Based Protocol Measurement										
Operation Mode	Channel Bandwidth (MHz)	Channel Number	Channel Freq. (MHz)	Injected Signal (AWGN)		Antenna Gain (dBi)	Path Loss (dB)	Adjusted Power (dBi)	Detection Limit	EUT TX Status
				Freq. (MHz)	Power (dBm)					
802.11ax	20	105	6475	6475	-60	2	0	-62	-62	OFF
					-64	2	0	-66	-62	Minimal
					-80	2	0	-82	-62	ON
	80	103	6465	6430	-60	2	0	-62	-62	OFF
					-64	2	0	-66	-62	Minimal
					-80	2	0	-82	-62	ON
				6465	-60	2	0	-62	-62	OFF
					-62	2	0	-64	-62	Minimal
					-80	2	0	-82	-62	ON
		6500	-60	2	0	-62	-62	OFF		
			-62	2	0	-64	-62	Minimal		
			-80	2	0	-82	-62	ON		

Note: Adjusted Power = Injected Signal (AWGN) Power - Antenna Gain + Path Loss  
 \*Antenna gain values include all the applicable path losses.

Contention Based Protocol Detection Probability															
Operation Mode	Channel Bandwidth (MHz)	AWGN Signal Freq. (MHz)	#01	#02	#03	#04	#05	#06	#07	#08	#09	#10	Detection Probability	Detection Limit	Test Result
802.11ax	20	6475	v	v	v	v	v	v	v	v	v	v	100%	90%	Pass
	80	6430	v	v	v	v	v	v	v	v	v	v	100%	90%	Pass
		6465	v	v	v	v	v	v	v	v	v	v	100%	90%	Pass
		6500	v	v	v	v	v	v	v	v	v	v	100%	90%	Pass

UNII Band 7:

Contention Based Protocol Measurement										
Operation Mode	Channel Bandwidth (MHz)	Channel Number	Channel Freq. (MHz)	Injected Signal (AWGN)		Antenna Gain (dBi)	Path Loss (dB)	Adjusted Power (dBi)	Detection Limit	EUT TX Status
				Freq. (MHz)	Power (dBm)					
802.11ax	20	149	6695	6695	-60	2	0	-62	-62	OFF
					-64	2	0	-66	-62	Minimal
					-80	2	0	-82	-62	ON
	80	151	6705	6670	-60	2	0	-62	-62	OFF
					-64	2	0	-66	-62	Minimal
					-80	2	0	-82	-62	ON
				6705	-60	2	0	-62	-62	OFF
					-62	2	0	-64	-62	Minimal
					-80	2	0	-82	-62	ON
		6740	-60	2	0	-62	-62	OFF		
			-62	2	0	-64	-62	Minimal		
			-80	2	0	-82	-62	ON		

Note: Adjusted Power = Injected Signal (AWGN) Power - Antenna Gain + Path Loss  
 \*Antenna gain values include all the applicable path losses.

Contention Based Protocol Detection Probability															
Operation Mode	Channel Bandwidth (MHz)	AWGN Signal Freq. (MHz)	#01	#02	#03	#04	#05	#06	#07	#08	#09	#10	Detection Probability	Detection Limit	Test Result
802.11ax	20	6695	v	v	v	v	v	v	v	v	v	v	100%	90%	Pass
	80	6670	v	v	v	v	v	v	v	v	v	v	100%	90%	Pass
		6705	v	v	v	v	v	v	v	v	v	v	100%	90%	Pass
		6740	v	v	v	v	v	v	v	v	v	v	100%	90%	Pass



UNII Band 8:

Contention Based Protocol Measurement										
Operation Mode	Channel Bandwidth (MHz)	Channel Number	Channel Freq. (MHz)	Injected Signal (AWGN)		Antenna Gain (dBi)	Path Loss (dB)	Adjusted Power (dBi)	Detection Limit	EUT TX Status
				Freq. (MHz)	Power (dBm)					
802.11ax	20	209	6995	6995	-60.3	1.7	0	-62	-62	OFF
					-64.3	1.7	0	-66	-62	Minimal
					-80.3	1.7	0	-82	-62	ON
	80	215	7025	6990	-60.3	1.7	0	-62	-62	OFF
					-64.3	1.7	0	-66	-62	Minimal
					-80.3	1.7	0	-82	-62	ON
				7025	-60.3	1.7	0	-62	-62	OFF
					-62.3	1.7	0	-64	-62	Minimal
					-80.3	1.7	0	-82	-62	ON
				7060	-60.3	1.7	0	-62	-62	OFF
					-62.3	1.7	0	-64	-62	Minimal
					-80.3	1.7	0	-82	-62	ON

Note: Adjusted Power = Injected Signal (AWGN) Power - Antenna Gain + Path Loss  
 \*Antenna gain values include all the applicable path losses.

Contention Based Protocol Detection Probability															
Operation Mode	Channel Bandwidth (MHz)	AWGN Signal Freq. (MHz)	#01	#02	#03	#04	#05	#06	#07	#08	#09	#10	Detection Probability	Detection Limit	Test Result
802.11ax	20	6995	v	v	v	v	v	v	v	v	v	v	100%	90%	Pass
	80	6990	v	v	v	v	v	v	v	v	v	v	100%	90%	Pass
		7025	v	v	v	v	v	v	v	v	v	v	100%	90%	Pass
		7060	v	v	v	v	v	v	v	v	v	v	100%	90%	Pass

For U-NII-5 band

Plots of EUT Tx waveform

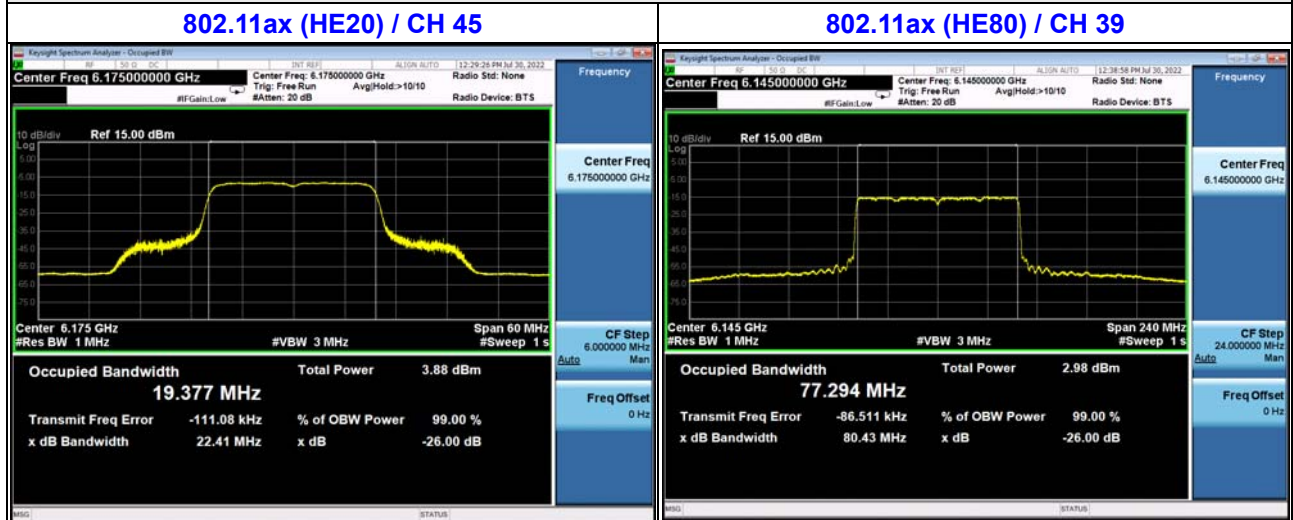

Plots of Incumbent signal (AWGN) Level

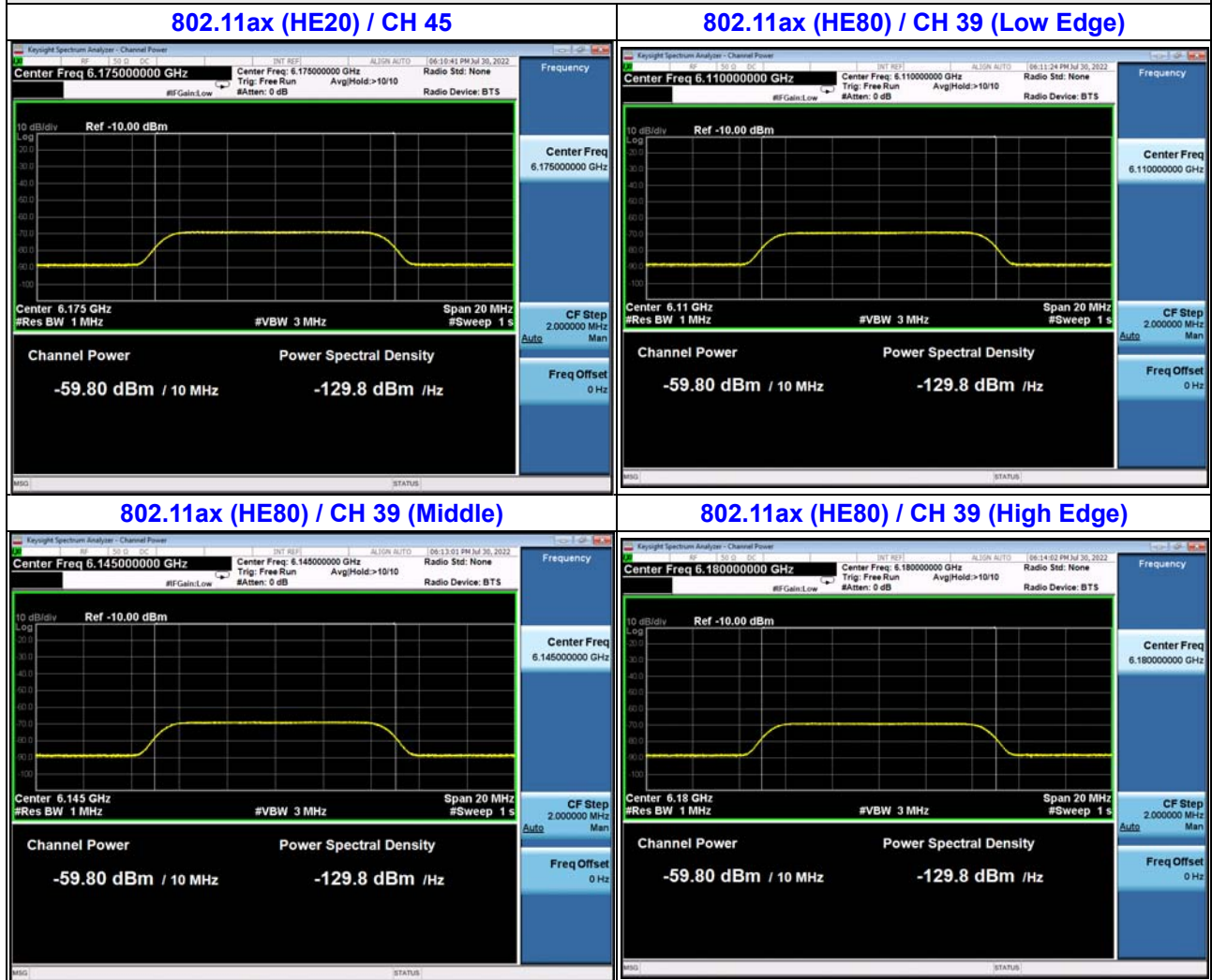

Plots of EUT ceased transmission in the time domain

802.11ax (HE20) / CH 45

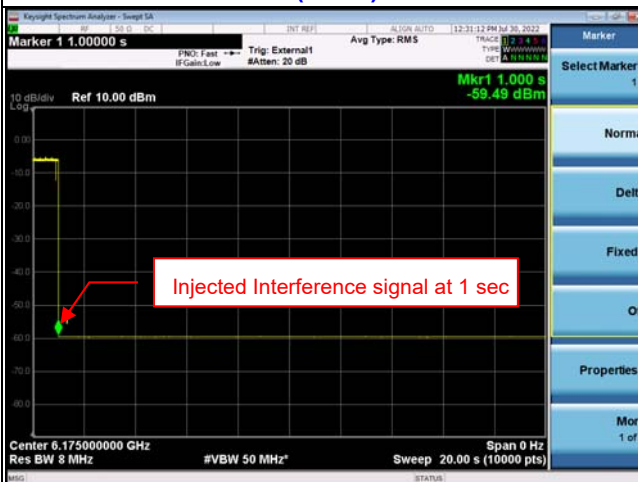

802.11ax (HE80) / CH 39 (Low Edge)



802.11ax (HE80) / CH 39 (Middle)

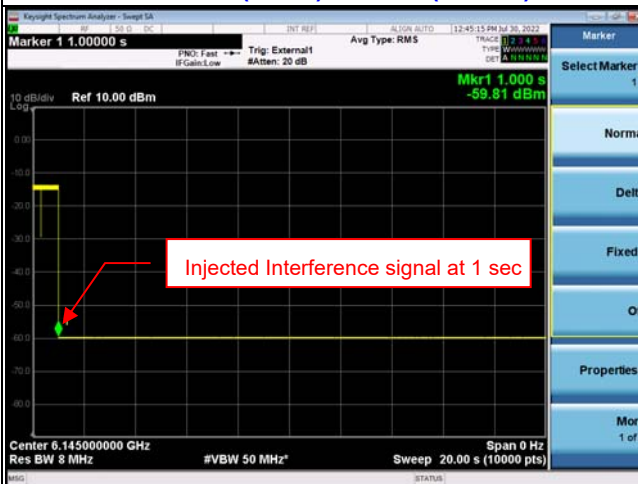

802.11ax (HE80) / CH 39 (High Edge)

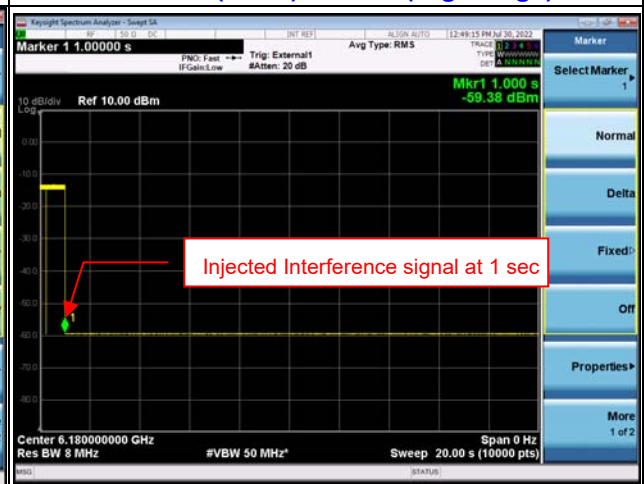

For U-NII-6 band

Plots of EUT Tx waveform

802.11ax (HE20) / CH 97



802.11ax (HE80) / CH 103



Plots of Incumbent signal (AWGN) Level

802.11ax (HE20) / CH 97

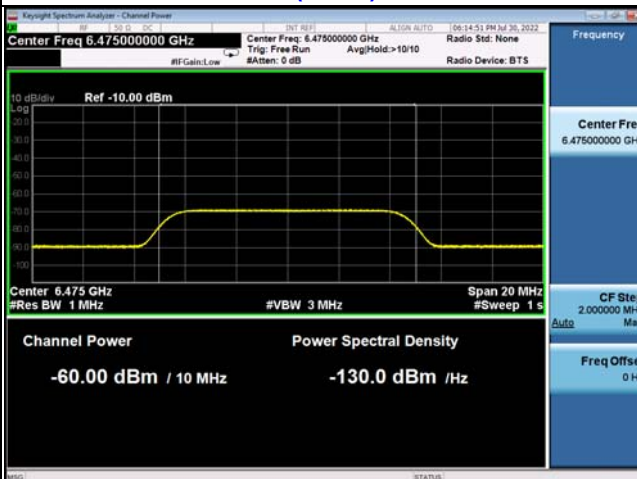

802.11ax (HE80) / CH 103 (Low Edge)



802.11ax (HE80) / CH 103 (Middle)



802.11ax (HE80) / CH 103 (High Edge)

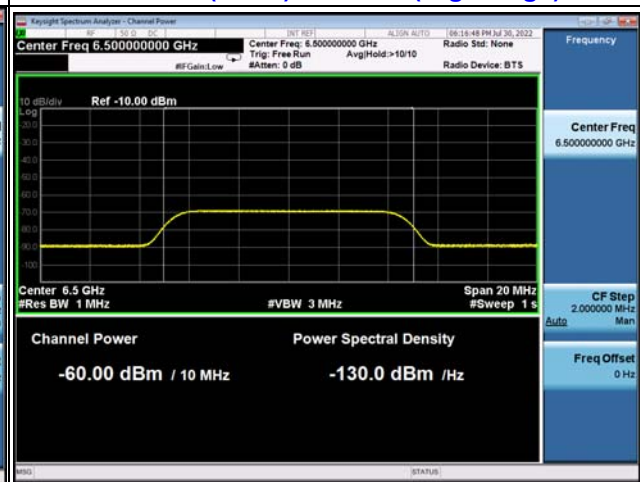

Plots of EUT ceased transmission in the time domain

802.11ax (HE20) / CH 97

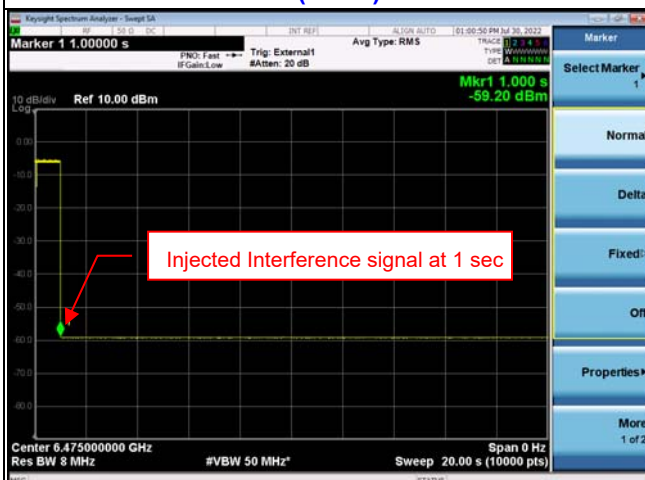

802.11ax (HE80) / CH 103 (Low Edge)

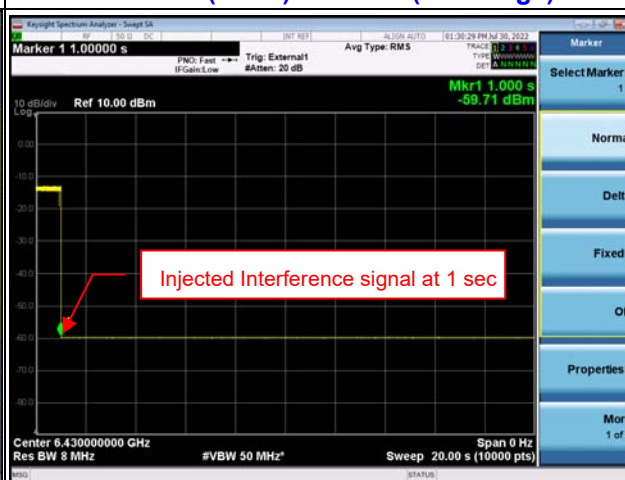

802.11ax (HE80) / CH 103 (Middle)



802.11ax (HE80) / CH 103 (High Edge)



For U-NII-7 band

Plots of EUT Tx waveform

802.11ax (HE20) / CH 149



802.11ax (HE80) / CH 151



Plots of Incumbent signal (AWGN) Level

802.11ax (HE20) / CH 149

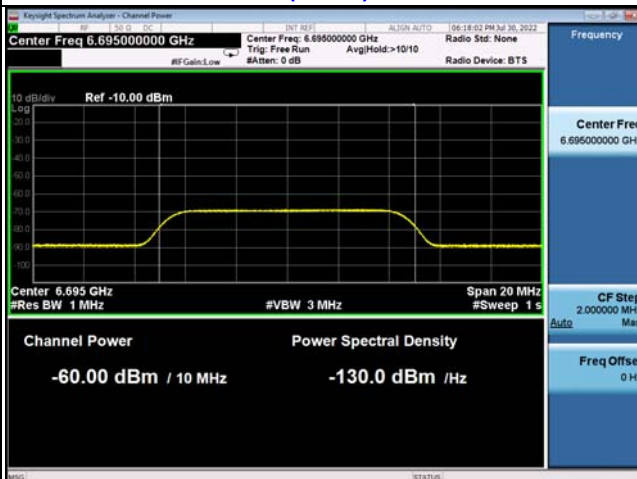

802.11ax (HE80) / CH 151 (Low Edge)



802.11ax (HE80) / CH 151 (Middle)



802.11ax (HE80) / CH 151 (High Edge)

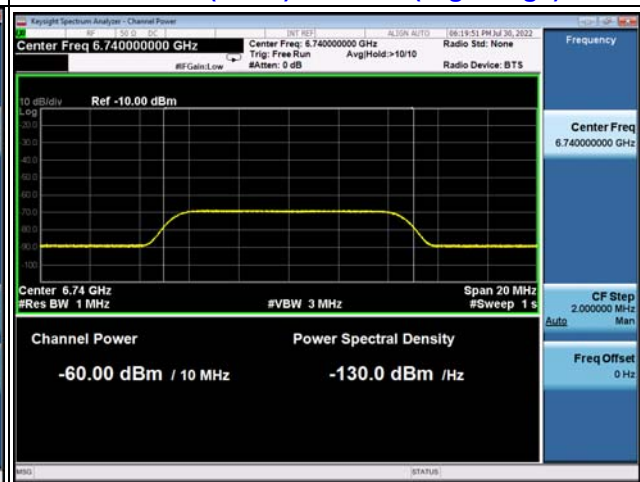

Plots of EUT ceased transmission in the time domain

802.11ax (HE20) / CH 149



802.11ax (HE80) / CH 151 (Low Edge)



802.11ax (HE80) / CH 151 (Middle)

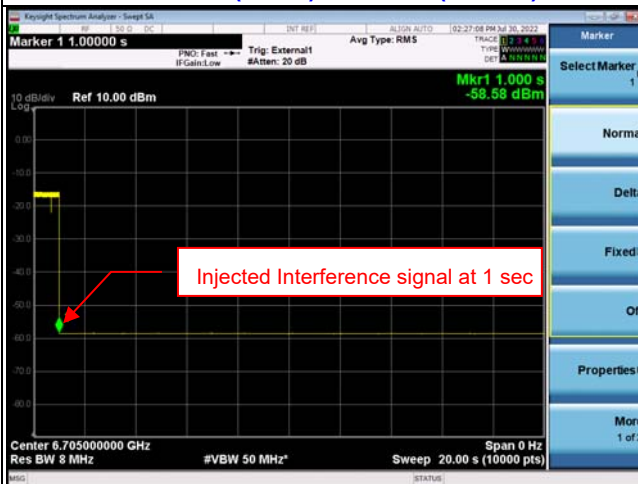

802.11ax (HE80) / CH 151 (High Edge)



For U-NII-8 band

Plots of EUT Tx waveform

802.11ax (HE20) / CH 209

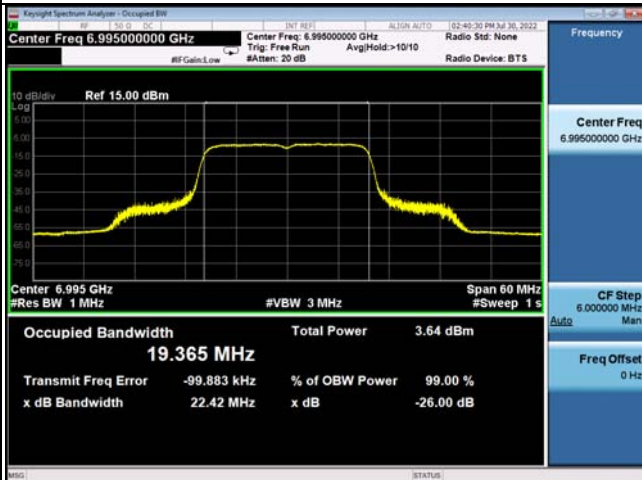

802.11ax (HE80) / CH 215



Plots of Incumbent signal (AWGN) Level

802.11ax (HE20) / CH 209

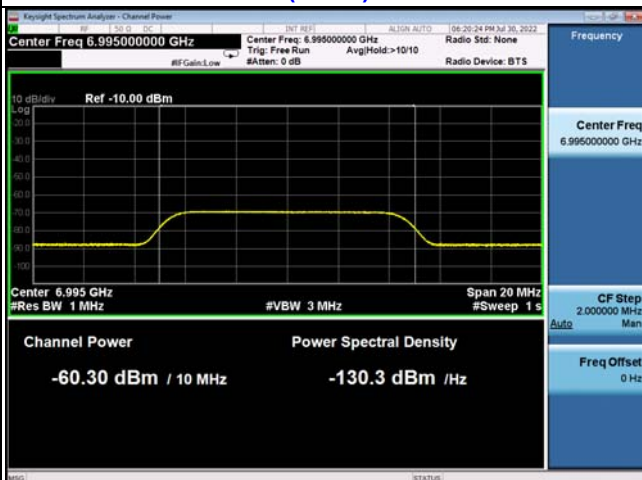

802.11ax (HE80) / CH 215 (Low Edge)

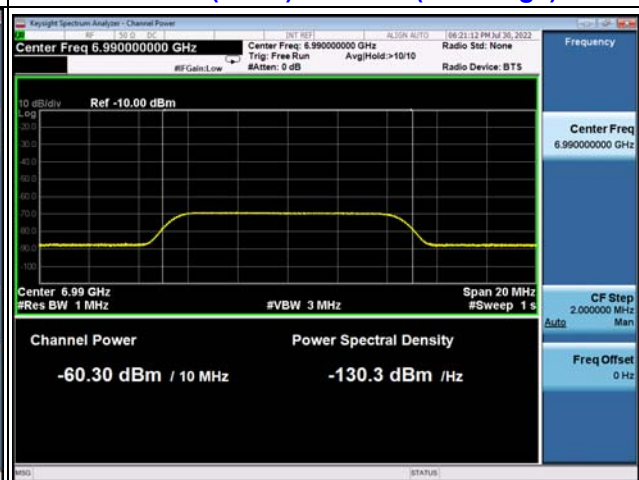

802.11ax (HE80) / CH 215 (Middle)

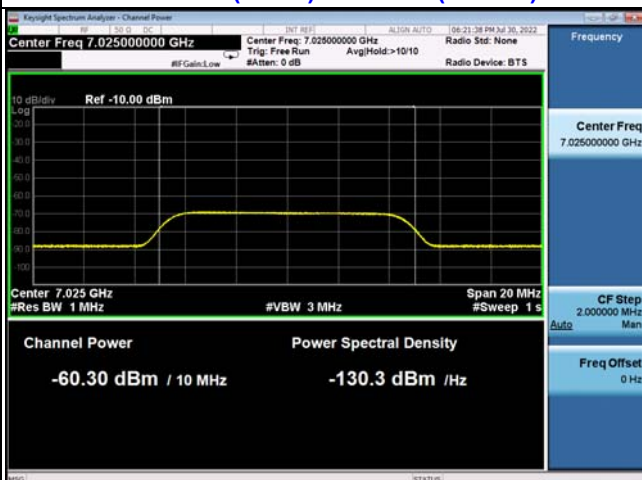

802.11ax (HE80) / CH 215 (High Edge)

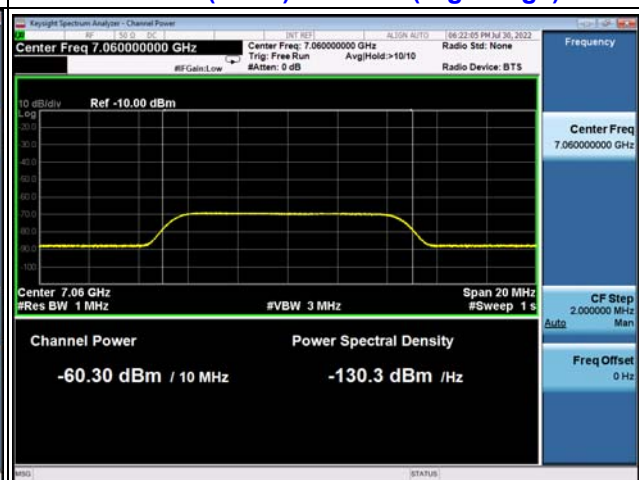



Plots of EUT ceased transmission in the time domain

802.11ax (HE80) / CH 215 (Low Edge)

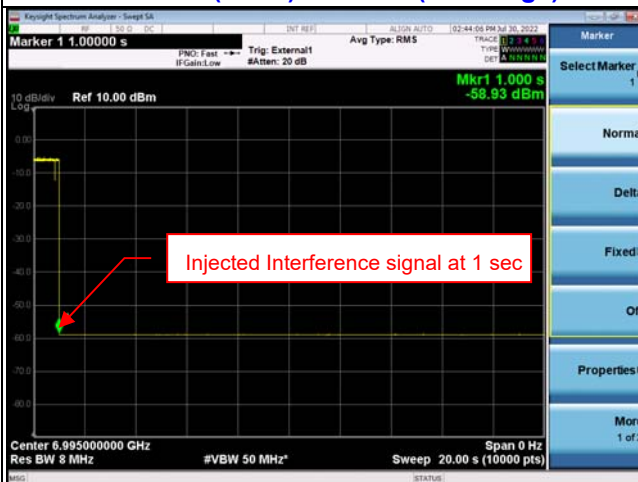

802.11ax (HE80) / CH 215 (Low Edge)

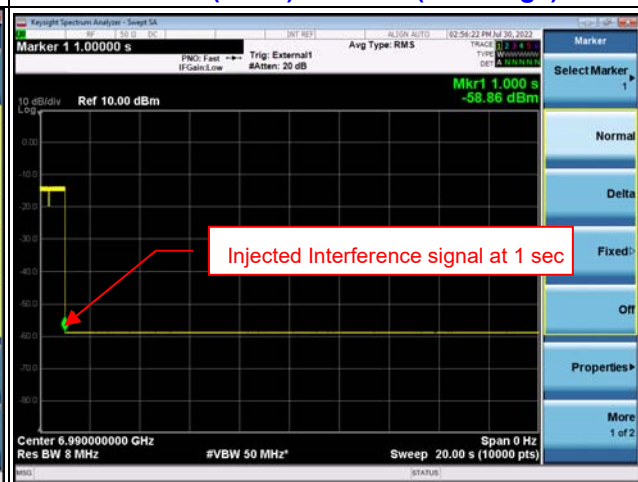

802.11ax (HE80) / CH 215 (Middle)

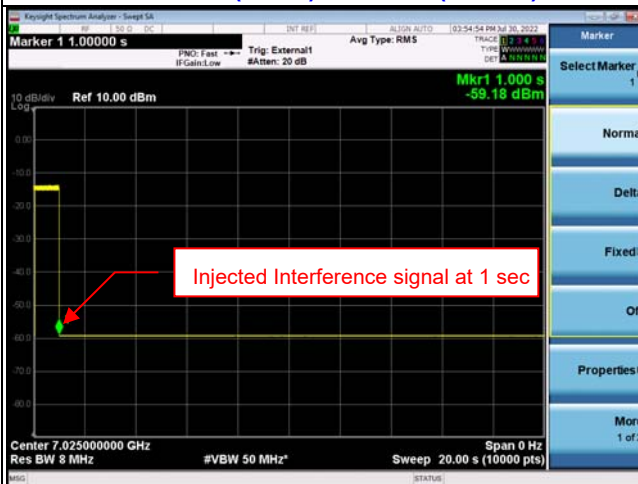

802.11ax (HE80) / CH 215 (High Edge)

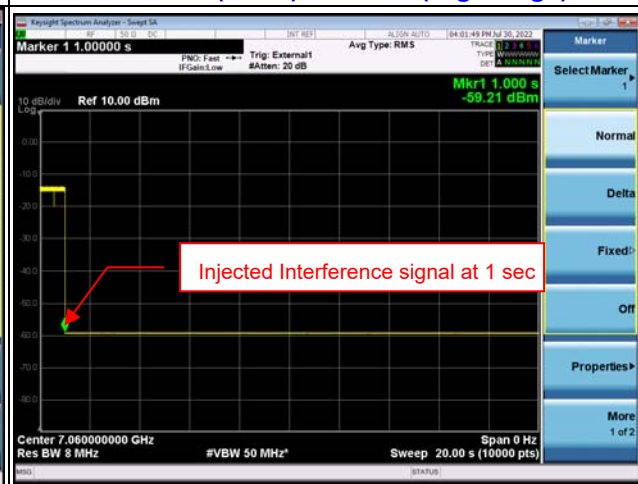

## 4.8 Frequency Stability

### 4.8.1 Limits of Frequency Stability Measurement

The frequency of the carrier signal shall be maintained within band of operation

### 4.8.2 Test Setup

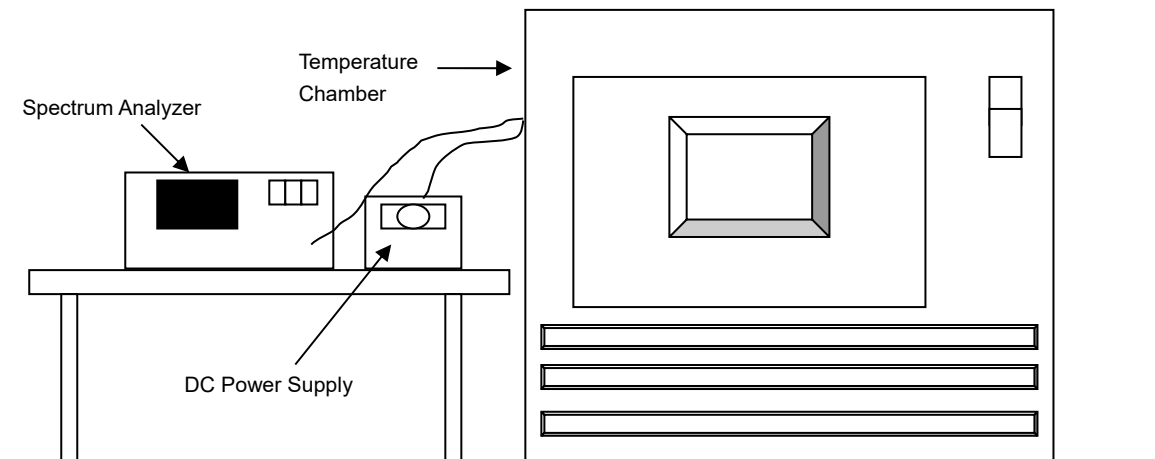

### 4.8.3 Test Instruments

Description & Manufacturer	Model No.	Serial No.	Cal. Date	Cal. Due
Spectrum Analyzer ROHDE & SCHWARZ	FSP40	100040	Sep. 15, 2021	Sep. 14, 2022
WIT Standard Temperature And Humidity Chamber	TH-4S-C	W981030	May 30, 2022	May 29, 2023
Three-phase coupling / decoupling network TESEQ	CDN 3063	4006	Mar. 08, 2022	Mar. 07, 2023
DC Power Supply Topward	6306A	727263	NA	NA

Note: 1. The calibration interval of the above test instruments is 12 months and the calibrations are traceable to NML/ROC and NIST/USA.

2. Tested date: Jul. 15, 2022

### 4.8.4 Test Procedure

- The EUT was placed inside the environmental test chamber and powered by nominal DC voltage.
- Turn the EUT on and couple its output to a spectrum analyzer.
- Turn the EUT off and set the chamber to the highest temperature specified.
- Allow sufficient time (approximately 30 min) for the temperature of the chamber to stabilize, turn the EUT on and measure the operating frequency after 2, 5, and 10 minutes.
- Repeat step d with every 10 degrees reduction until the lowest temperature achieved.
- The test chamber was allowed to stabilize at +20 degree C for a minimum of 30 minutes. The supply voltage was then adjusted on the EUT from 85% to 115% and the frequency record.

#### 4.8.5 Deviation from Test Standard

No deviation.

#### 4.8.6 EUT Operating Condition

Set the EUT transmit at un-modulation mode to test frequency stability.

#### 4.8.7 Test Results

Nss 1

Frequency Stability Versus Temp.									
Operating Frequency: 5955MHz									
Temp. (°C)	Power Supply (Vdc)	0 Minute		2 Minute		5 Minute		10 Minute	
		Measured Frequency (MHz)	Result	Measured Frequency (MHz)	Result	Measured Frequency (MHz)	Result	Measured Frequency (MHz)	Result
40	5	5955.0141	Pass	5955.0128	Pass	5955.0152	Pass	5955.0141	Pass
30	5	5954.9984	Pass	5954.9996	Pass	5954.9976	Pass	5954.9976	Pass
20	5	5954.9875	Pass	5954.9907	Pass	5954.9873	Pass	5954.9887	Pass
10	5	5955.0005	Pass	5955.0025	Pass	5955.0009	Pass	5955.0014	Pass
0	5	5955.0200	Pass	5955.0197	Pass	5955.0190	Pass	5955.0211	Pass

Frequency Stability Versus Voltage									
Operating Frequency: 5955MHz									
Temp. (°C)	Power Supply (Vdc)	0 Minute		2 Minute		5 Minute		10 Minute	
		Measured Frequency (MHz)	Result	Measured Frequency (MHz)	Result	Measured Frequency (MHz)	Result	Measured Frequency (MHz)	Result
20	5.75	5954.9909	Pass	5954.9934	Pass	5954.9903	Pass	5954.9909	Pass
	5.00	5954.9875	Pass	5954.9907	Pass	5954.9873	Pass	5954.9887	Pass
	4.25	5954.9768	Pass	5954.9772	Pass	5954.9789	Pass	5954.9754	Pass

## **4.9 Operational Restrictions for 6 GHz U-NII Devices**

### **4.9.1 Limits of Operational Restrictions for 6 GHz U-NII Devices**

- (1) Operation of indoor access points in the 5.925-7.125 GHz band is prohibited on oil platforms, cars, trains, boats, and aircraft, except that indoor access points are permitted to operate in the 5.925-6.425 GHz bands in large aircraft while flying above 10,000 feet.
- (2) Operation of transmitters in the 5.925-7.125 GHz band is prohibited for control of or communications with unmanned aircraft systems.
- (3) Transmitters operating under indoor access points are limited to indoor locations.
- (4) In the 5.925-7.125 GHz band, indoor access points must bear the following statement in a conspicuous location on the device and in the user's manual: FCC regulations restrict operation of this device to indoor use only. The operation of this device is prohibited on oil platforms, cars, trains, boats, and aircraft, except that operation of this device is permitted in large aircraft while flying above 10,000 feet.
- (5) In the 5.925-7.125 GHz band, Access points may connect to other access points or subordinate devices.
- (6) Indoor access points, operating in the 5.925-7.125 GHz band must employ a contention-based protocol.

### **4.9.2 Test Setup**

N/A

### **4.9.3 Test Instruments**

N/A

### **4.9.4 Test Procedure**

N/A.

### **4.9.5 Test Results**

Device is an client device under the control of a low power indoor access point. Please refer to the declaration letter exhibit supplied within this application.

## 5 Pictures of Test Arrangements

Please refer to the attached file (Test Setup Photo).

# Annex A - Band Edge Measurement

Nss 1

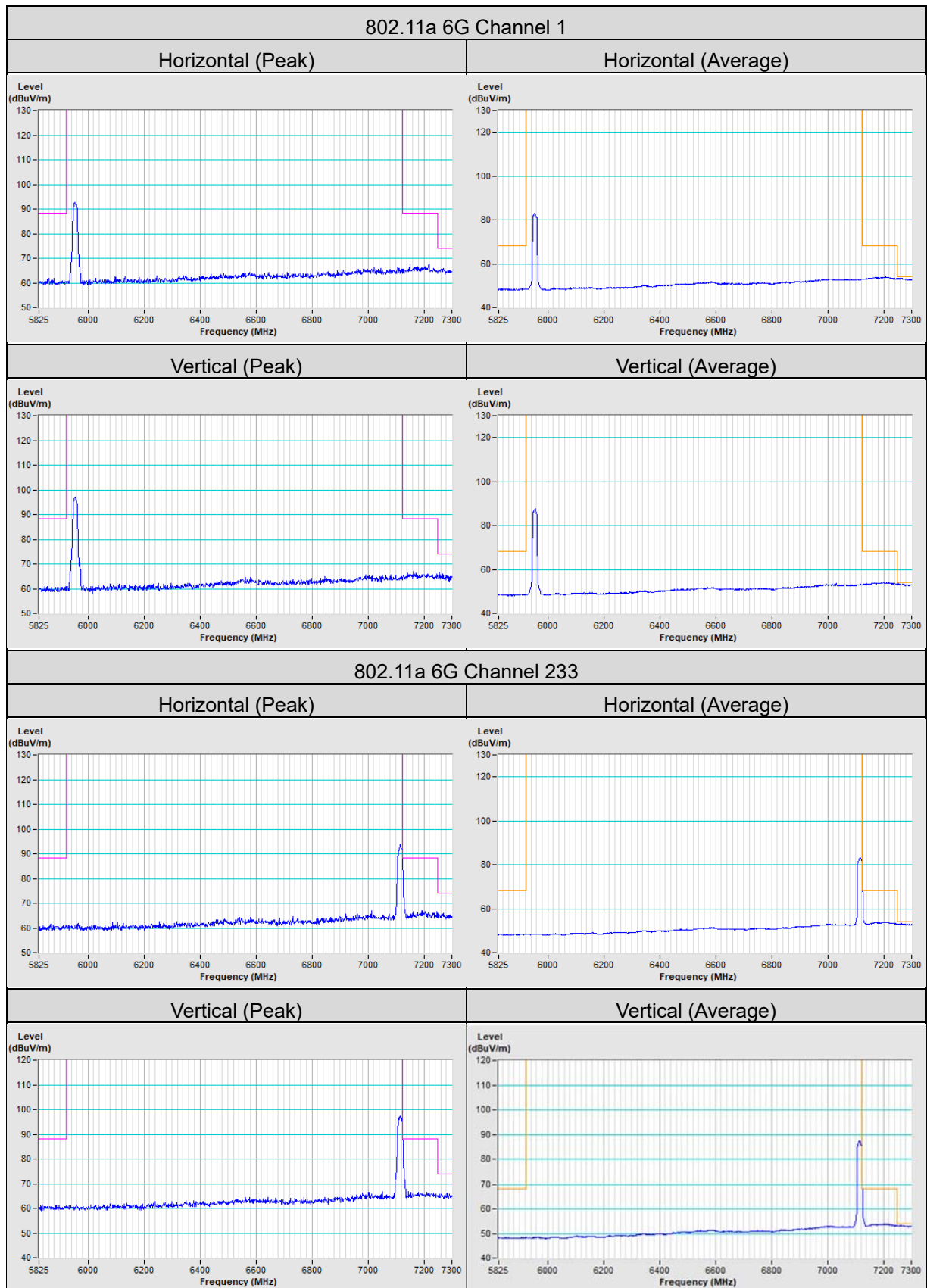

### 802.11ax (HE20) Channel 1

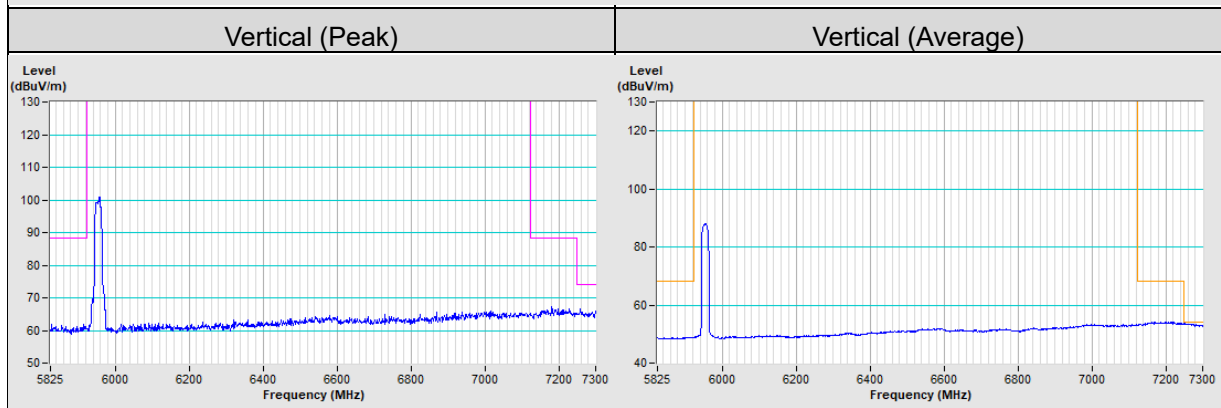
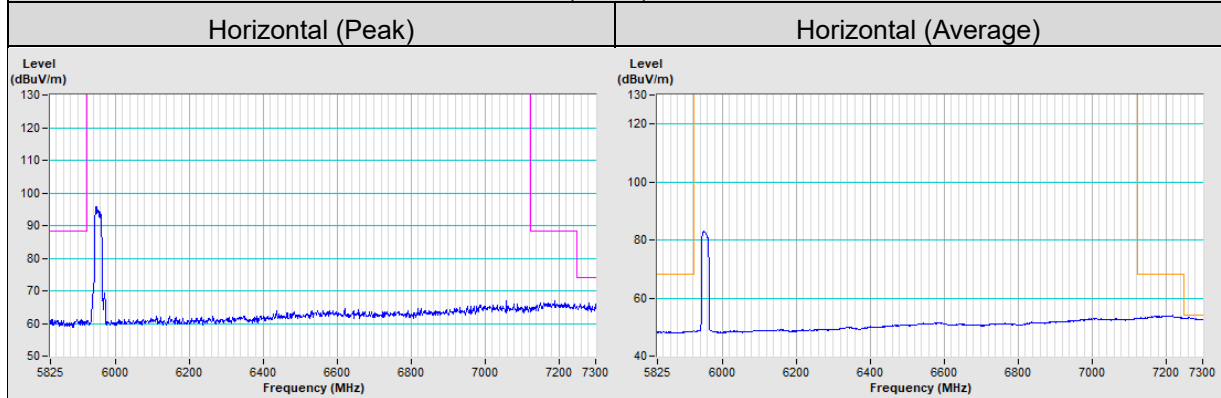

### 802.11ax (HE20) Channel 233

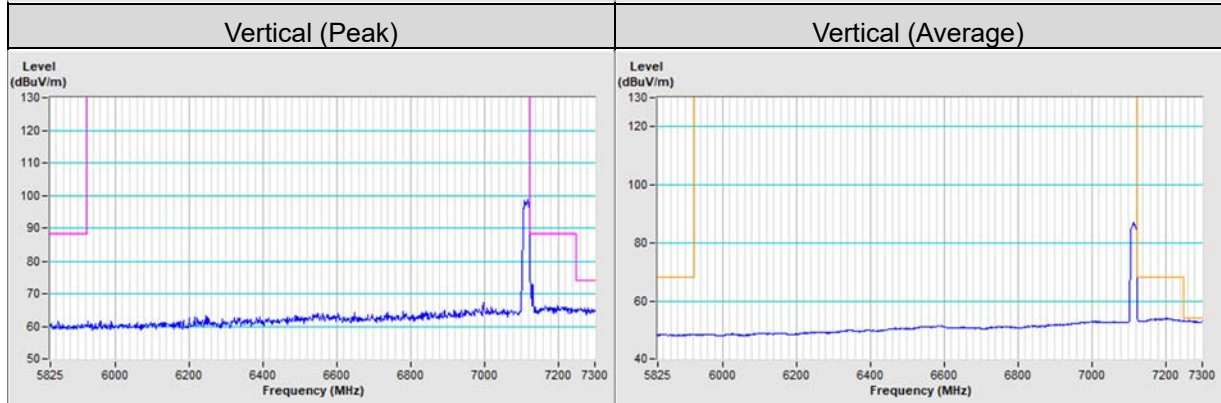
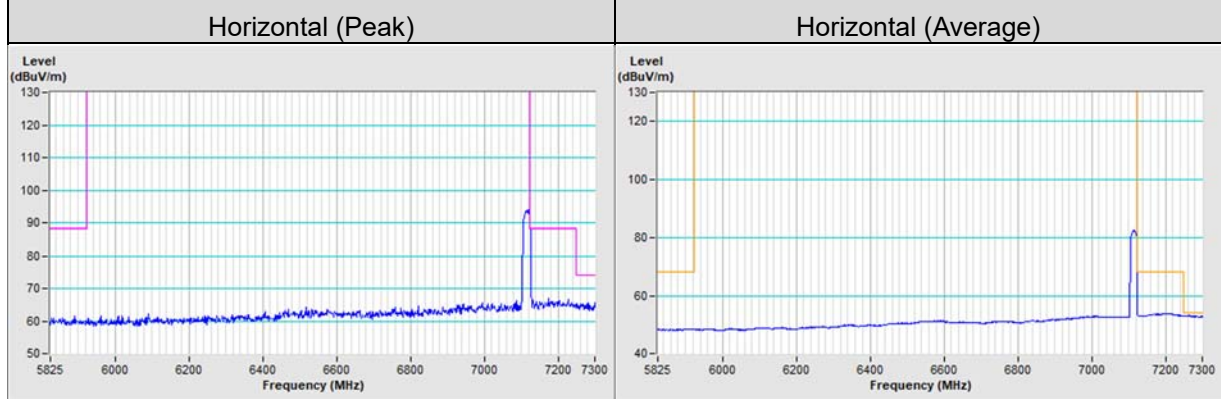

**802.11ax (HE40) Channel 3**

<b>Horizontal (Peak)</b>	<b>Horizontal (Average)</b>
--------------------------	-----------------------------

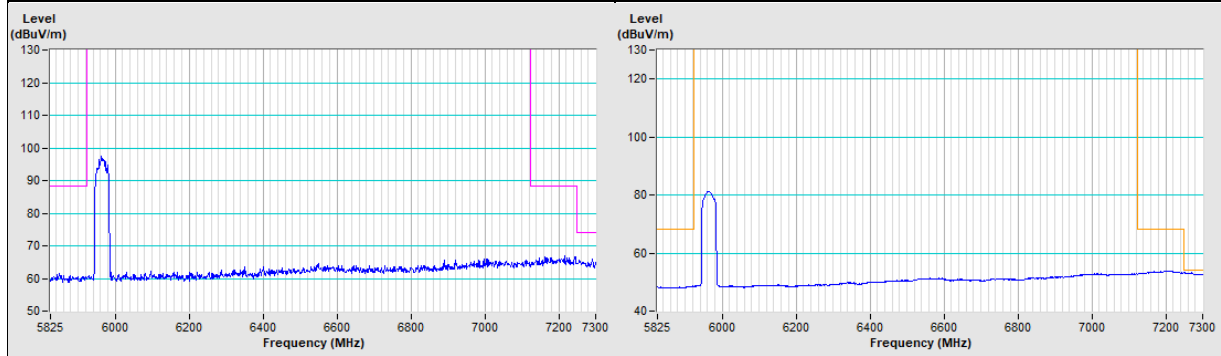

<b>Vertical (Peak)</b>	<b>Vertical (Average)</b>
------------------------	---------------------------

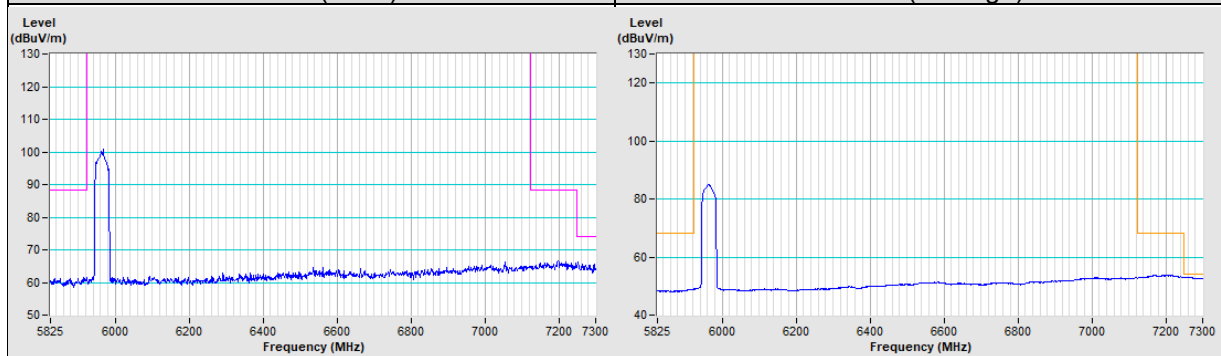

**802.11ax (HE40) Channel 227**

<b>Horizontal (Peak)</b>	<b>Horizontal (Average)</b>
--------------------------	-----------------------------

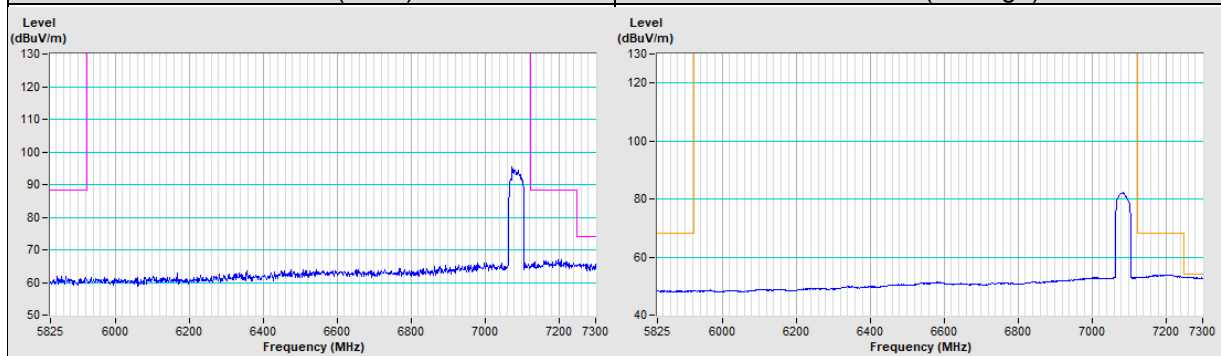

<b>Vertical (Peak)</b>	<b>Vertical (Average)</b>
------------------------	---------------------------

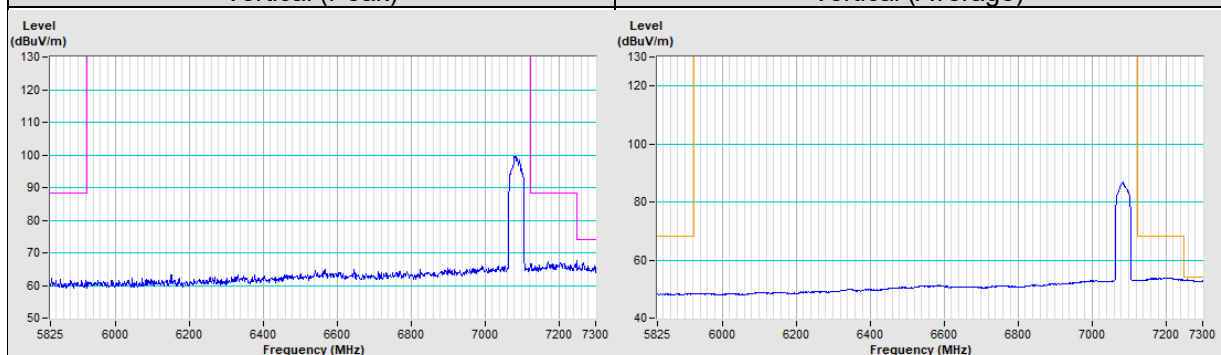



**802.11ax (HE80) Channel 7**

<b>Horizontal (Peak)</b>	<b>Horizontal (Average)</b>
--------------------------	-----------------------------

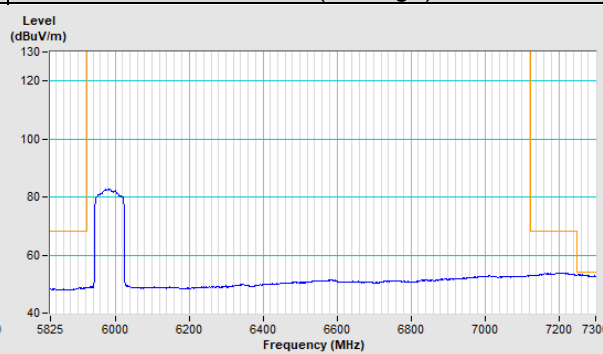
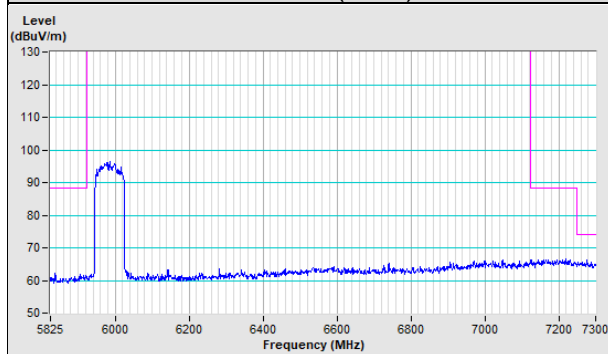

<b>Vertical (Peak)</b>	<b>Vertical (Average)</b>
------------------------	---------------------------

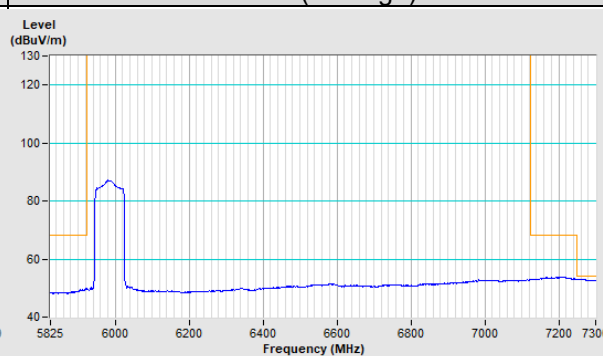
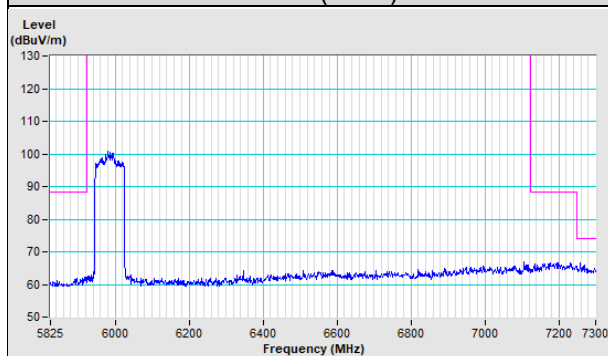

**802.11ax (HE80) Channel 215**

<b>Horizontal (Peak)</b>	<b>Horizontal (Average)</b>
--------------------------	-----------------------------

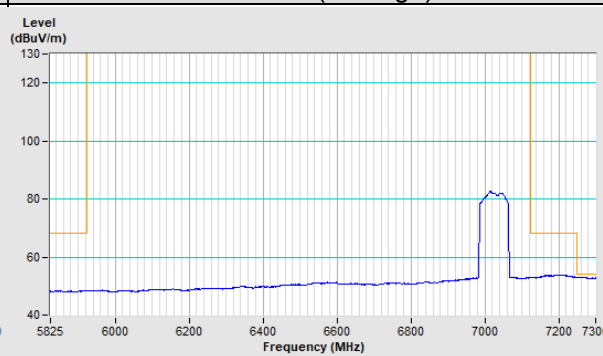
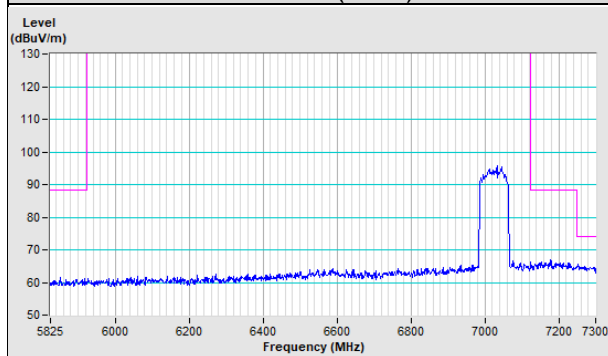

<b>Vertical (Peak)</b>	<b>Vertical (Average)</b>
------------------------	---------------------------

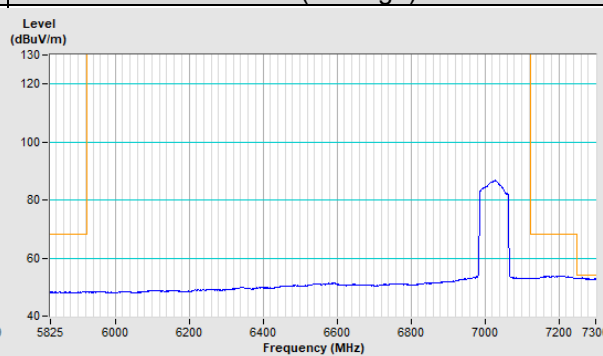
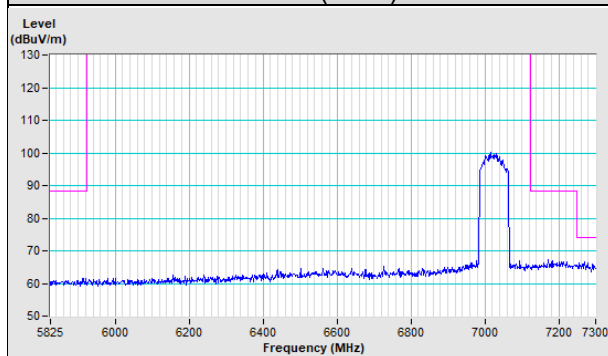

Nss 2

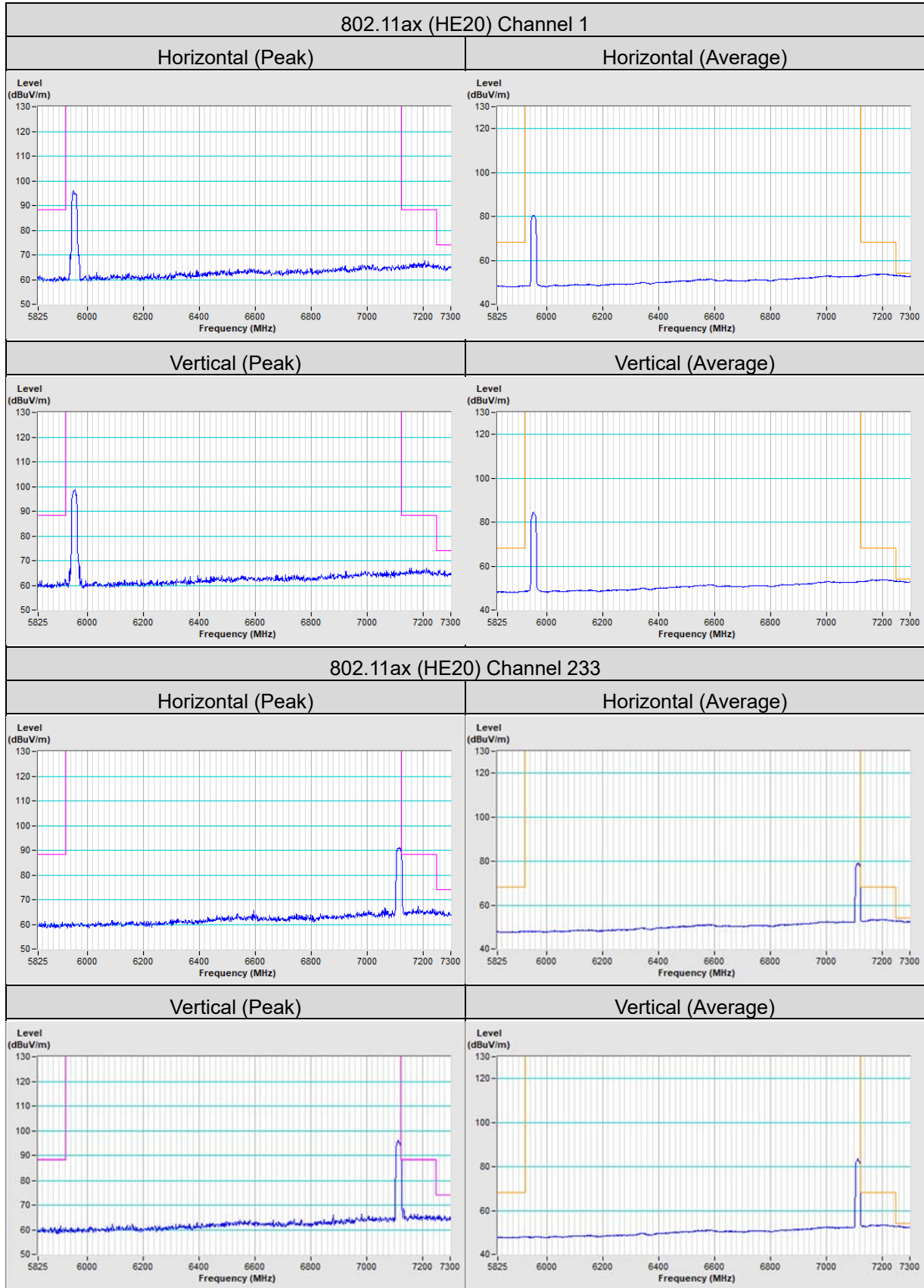

### 802.11ax (HE40) Channel 3

Horizontal (Peak)

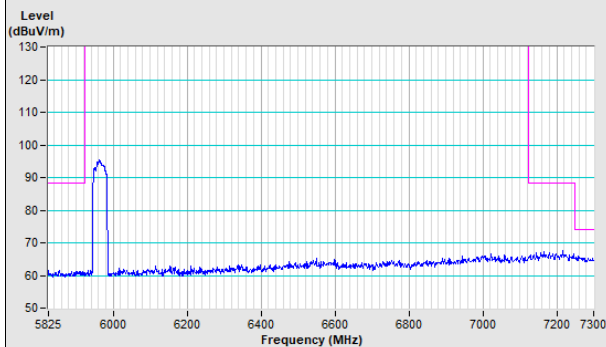

Horizontal (Average)

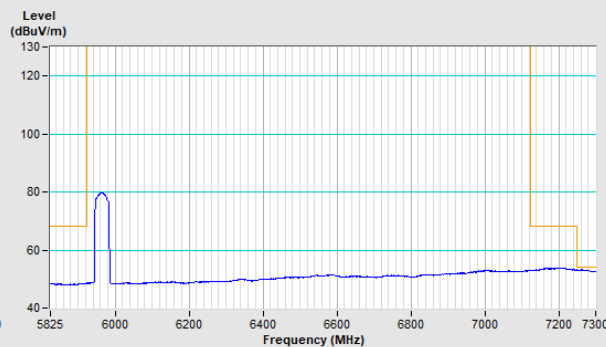

Vertical (Peak)

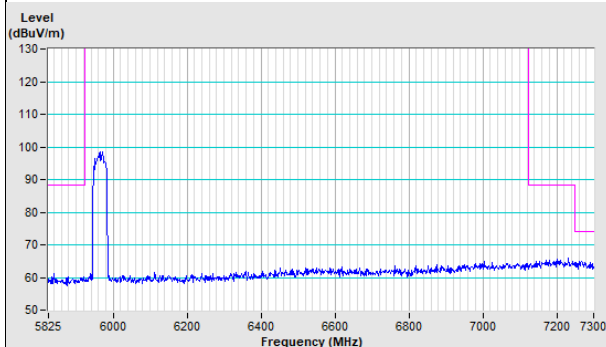

Vertical (Average)

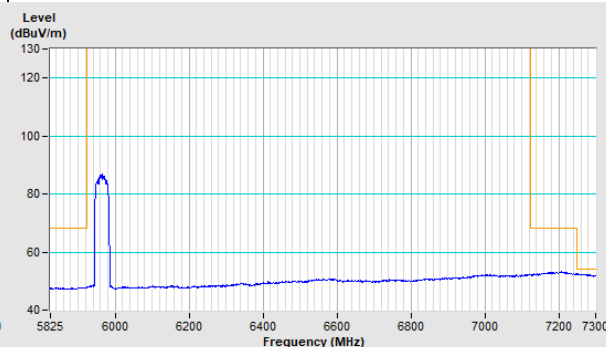

### 802.11ax (HE40) Channel 227

Horizontal (Peak)

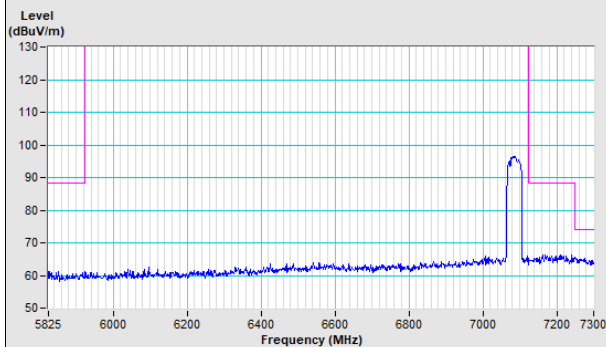

Horizontal (Average)

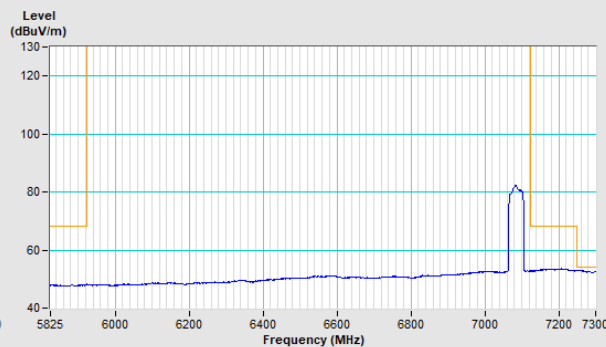

Vertical (Peak)

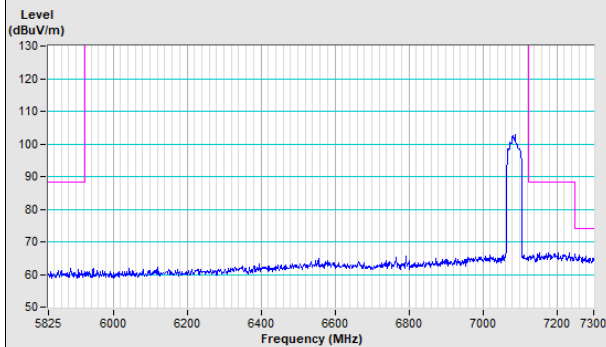

Vertical (Average)

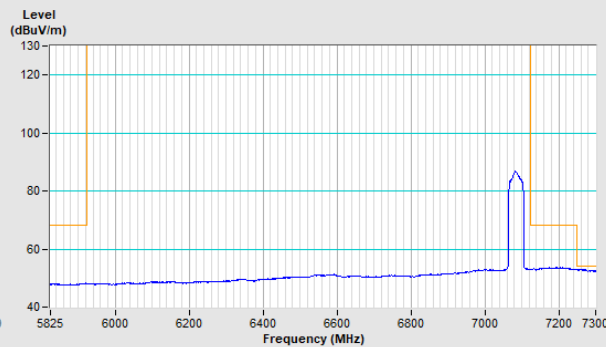

**802.11ax (HE80) Channel 7**

<b>Horizontal (Peak)</b>	<b>Horizontal (Average)</b>
--------------------------	-----------------------------

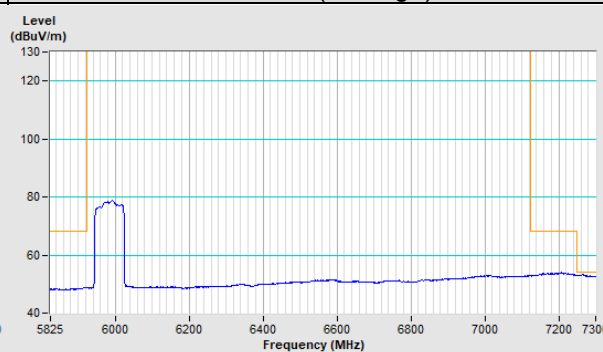
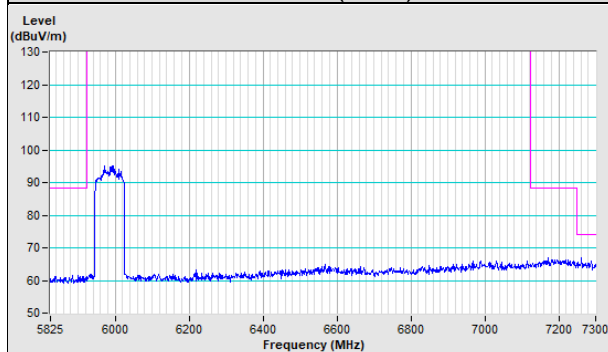

<b>Vertical (Peak)</b>	<b>Vertical (Average)</b>
------------------------	---------------------------

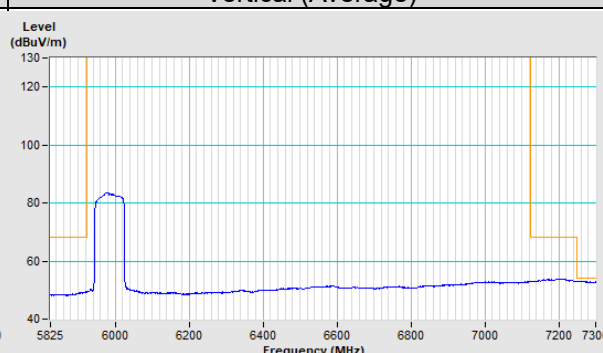
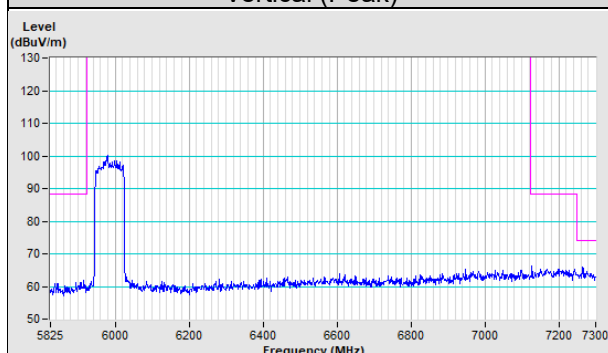

**802.11ax (HE80) Channel 215**

<b>Horizontal (Peak)</b>	<b>Horizontal (Average)</b>
--------------------------	-----------------------------

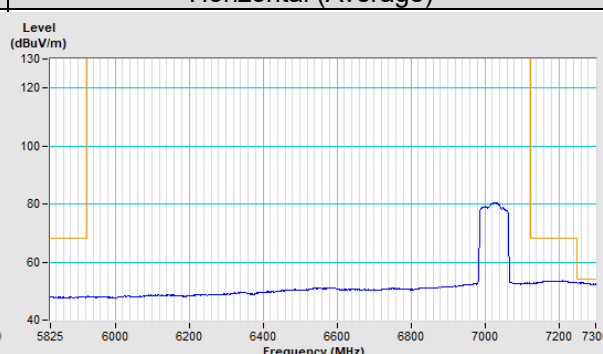
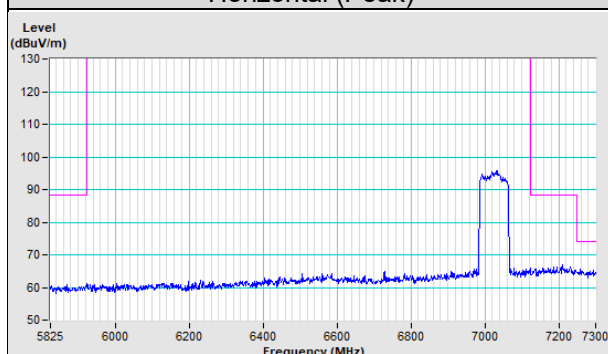

<b>Vertical (Peak)</b>	<b>Vertical (Average)</b>
------------------------	---------------------------

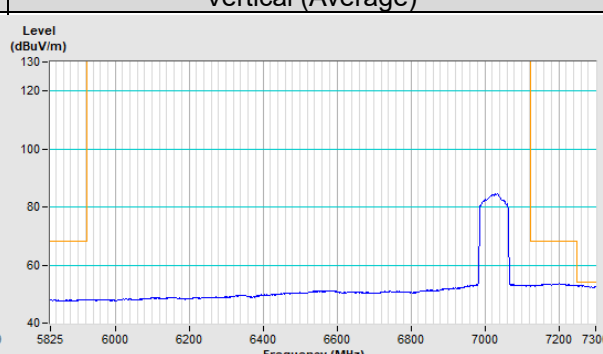
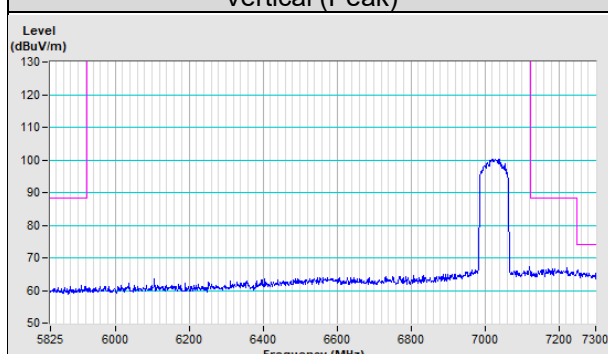

## Appendix – Information of the Testing Laboratories

We, Bureau Veritas Consumer Products Services (H.K.) Ltd., Taoyuan Branch, were founded in 1988 to provide our best service in EMC, Radio, Telecom and Safety consultation. Our laboratories are FCC recognized accredited test firms and accredited and approved according to ISO/IEC 17025.

If you have any comments, please feel free to contact us at the following:

### Lin Kou EMC/RF Lab

Tel: 886-2-26052180

Fax: 886-2-26051924

### Hsin Chu EMC/RF/Telecom Lab

Tel: 886-3-6668565

Fax: 886-3-6668323

### Hwa Ya EMC/RF/Safety

Tel: 886-3-3183232

Fax: 886-3-3270892

**Email:** [service.adt@tw.bureauveritas.com](mailto:service.adt@tw.bureauveritas.com)

**Web Site:** [www.bureauveritas-adt.com](http://www.bureauveritas-adt.com)

The address and road map of all our labs can be found in our web site also.

--- END ---