

FCC Test Report

Report No.: RFBBQZ-WTW-P22030481-1

FCC ID: PY322200565

Test Model: A8000

Received Date: Mar. 14, 2022

Test Date: Jul. 08 ~ Jul. 17, 2022

Issued Date: Aug. 02, 2022

Applicant and Manufacturer: NETGEAR, INC.

Address: 350 East Plumeria Drive, San Jose, CA 95134, USA

Issued By: Bureau Veritas Consumer Products Services (H.K.) Ltd., Taoyuan Branch
Lin Kou Laboratories

Lab Address: No. 47-2, 14th Ling, Chia Pau Vil., Lin Kou Dist., New Taipei City, Taiwan

Test Location: No. 19, Hwa Ya 2nd Rd., Wen Hwa Vil., Kwei Shan Dist., Taoyuan City
33383, TAIWAN

**FCC Registration /
Designation Number:** 788550 / TW0003



This report is governed by, and incorporates by reference, the Conditions of Testing as posted at the date of issuance of this report at <http://www.bureauveritas.com/home/about-us/our-business/cps/about-us/terms-conditions/> and is intended for your exclusive use. Any copying or replication of this report to or for any other person or entity, or use of our name or trademark, is permitted only with our prior written permission. This report sets forth our findings solely with respect to the test samples identified herein. The results set forth in this report are not indicative or representative of the quality or characteristics of the lot from which a test sample was taken or any similar or identical product unless specifically and expressly noted. Our report includes all of the tests requested by you and the results thereof based upon the information that you provided to us. Measurement uncertainty is only provided upon request for accredited tests. Statements of conformity are based on simple acceptance criteria without taking measurement uncertainty into account, unless otherwise requested in writing. You have 60 days from date of issuance of this report to notify us of any material error or omission caused by our negligence or if you require measurement uncertainty; provided, however, that such notice shall be in writing and shall specifically address the issue you wish to raise. A failure to raise such issue within the prescribed time shall constitute your unqualified acceptance of the completeness of this report, the tests conducted and the correctness of the report contents.

Table of Contents

Release Control Record	4
1 Certificate of Conformity	5
2 Summary of Test Results	6
2.1 Measurement Uncertainty.....	6
2.2 Modification Record.....	6
3 General Information	7
3.1 General Description of EUT.....	7
3.2 Description of Test Modes.....	9
3.2.1 Test Mode Applicability and Tested Channel Detail.....	11
3.3 Duty Cycle of Test Signal.....	14
3.4 Description of Support Units.....	15
3.4.1 Configuration of System under Test.....	15
3.5 General Description of Applied Standards and References.....	15
4 Test Types and Results	16
4.1 Radiated Emission and Bandedge Measurement.....	16
4.1.1 Limits of Radiated Emission and Bandedge Measurement.....	16
4.1.2 Test Instruments.....	17
4.1.3 Test Procedures.....	18
4.1.4 Deviation from Test Standard.....	19
4.1.5 Test Setup.....	19
4.1.6 EUT Operating Conditions.....	20
4.1.7 Test Results.....	21
4.2 Conducted Emission Measurement.....	67
4.2.1 Limits of Conducted Emission Measurement.....	67
4.2.2 Test Instruments.....	67
4.2.3 Test Procedures.....	68
4.2.4 Deviation from Test Standard.....	68
4.2.5 Test Setup.....	68
4.2.6 EUT Operating Conditions.....	68
4.2.7 Test Results.....	69
4.3 Transmit Power Measurement.....	73
4.3.1 Limits of Transmit Power Measurement.....	73
4.3.2 Test Setup.....	73
4.3.3 Test Instruments.....	74
4.3.4 Test Procedure.....	74
4.3.5 Deviation from Test Standard.....	74
4.3.6 EUT Operating Conditions.....	74
4.3.7 Test Result.....	75
4.4 Occupied Bandwidth Measurement.....	87
4.4.1 Test Setup.....	87
4.4.2 Test Instruments.....	87
4.4.3 Test Procedure.....	87
4.4.4 Test Result.....	88
4.5 Peak Power Spectral Density Measurement.....	94
4.5.1 Limits of Peak Power Spectral Density Measurement.....	94
4.5.2 Test Setup.....	94
4.5.3 Test Instruments.....	94
4.5.4 Test Procedures.....	95
4.5.5 Deviation from Test Standard.....	95
4.5.6 EUT Operating Conditions.....	95
4.5.7 Test Results.....	96
4.6 Frequency Stability.....	103
4.6.1 Limits of Frequency Stability Measurement.....	103

4.6.2	Test Setup.....	103
4.6.3	Test Instruments	103
4.6.4	Test Procedure	103
4.6.5	Deviation from Test Standard	104
4.6.6	EUT Operating Condition	104
4.6.7	Test Results	104
4.7	6dB Bandwidth Measurement.....	105
4.7.1	Limits of 6dB Bandwidth Measurement.....	105
4.7.2	Test Setup.....	105
4.7.3	Test Instruments	105
4.7.4	Test Procedure	105
4.7.5	Deviation from Test Standard	105
4.7.6	EUT Operating Condition	105
4.7.7	Test Results	106
5	Pictures of Test Arrangements.....	108
	Annex A - Radiated Out of Band Emission (OOBE) Measurement (For U-NII-3 band)	109
	Annex B - Band Edge Measurement.....	112
	Appendix – Information of the Testing Laboratories	123



Release Control Record

Issue No.	Description	Date Issued
RFBBQZ-WTW-P22030481-1	Original release.	Aug. 02, 2022

1 Certificate of Conformity

Product: AXE3000 USB3.0 Wireless Adapter

Brand: Netgear

Test Model: A8000

Sample Status: Engineering Sample

**Applicant and
Manufacturer:** NETGEAR, INC.

Test Date: Jul. 08 ~ Jul. 17, 2022

Standards: 47 CFR FCC Part 15, Subpart E (Section 15.407)
ANSI C63.10:2013

The above equipment has been tested by **Bureau Veritas Consumer Products Services (H.K.) Ltd., Taoyuan Branch**, and found compliance with the requirement of the above standards. The test record, data evaluation & Equipment Under Test (EUT) configurations represented herein are true and accurate accounts of the measurements of the sample's RF characteristics under the conditions specified in this report.

Prepared by :  , **Date:** Aug. 02, 2022
Rolly Chien / Specialist

Approved by :  , **Date:** Aug. 02, 2022
Jeremy Lin / Project Engineer

2 Summary of Test Results

47 CFR FCC Part 15, Subpart E (Section 15.407)			
FCC Clause	Test Item	Result	Remarks
15.407(b)(9)	AC Power Conducted Emissions	Pass	Meet the requirement of limit. Minimum passing margin is -15.80dB at 0.16600MHz.
15.407(b)(1/2/3/4(i/ii)/9)	Radiated Emissions & Band Edge Measurement	Pass	Meet the requirement of limit. Minimum passing margin is -1.4dB at 11490.00MHz.
15.407(a)(1/2/3)	Max Average Transmit Power	Pass	Meet the requirement of limit.
---	Occupied Bandwidth Measurement	-	Reference only.
15.407(a)(1/2/3)	Peak Power Spectral Density	Pass	Meet the requirement of limit.
15.407(e)	6dB bandwidth	Pass	Meet the requirement of limit. (U-NII-3 Band only)
15.407(g)	Frequency Stability	Pass	Meet the requirement of limit.
15.203	Antenna Requirement	Pass	Antenna connector is IPEX not a standard connector.

Note:

- For U-NII-3 band compliance with rule part 15.407(b)(4)(i), the OOB test plots were recorded in Annex A.
- For U-NII-1, U-NII-2A, U-NII-2C band compliance with rule 15.407(b) of the band-edge items, the test plots were recorded in Annex B. Test Procedures refer to report 4.1.3.
- Determining compliance based on the results of the compliance measurement, not taking into account measurement instrumentation uncertainty.

2.1 Measurement Uncertainty

Where relevant, the following measurement uncertainty levels have been estimated for tests performed on the EUT as specified in CISPR 16-4-2:

Measurement	Frequency	Expanded Uncertainty (k=2) (\pm)
Conducted Emissions at mains ports	150kHz ~ 30MHz	2.79 dB
Radiated Emissions up to 1 GHz	9kHz ~ 30MHz	3.04 dB
	30MHz ~ 200MHz	3.63 dB
	200MHz ~ 1000MHz	3.64 dB
Radiated Emissions above 1 GHz	1GHz ~ 18GHz	2.29 dB
	18GHz ~ 40GHz	2.29 dB

2.2 Modification Record

There were no modifications required for compliance.

3 General Information

3.1 General Description of EUT

Product	AXE3000 USB3.0 Wireless Adapter
Brand	Netgear
Test Model	A8000
Sample Status	Engineering Sample
Power Supply Rating	5Vdc from host equipment
Modulation Type	256QAM, 64QAM, 16QAM, QPSK, BPSK for OFDM 1024QAM, 256QAM, 64QAM, 16QAM, QPSK, BPSK for OFDMA
Modulation Technology	OFDM, OFDMA
Transfer Rate	802.11a: 54/48/36/24/18/12/9/6Mbps 802.11n: up to 300Mbps 802.11ac: up to 866.7Mbps 802.11ax: up to 1201.0Mbps
Operating Frequency	5180 ~ 5320MHz, 5500 ~ 5720MHz, 5745 ~ 5825MHz
Number of Channel	5180 ~ 5320MHz: 802.11a, 802.11n (HT20), 802.11ac (VHT20), 802.11ax (HE20): 8 802.11n (HT40), 802.11ac (VHT40), 802.11ax (HE40): 4 802.11ac (VHT80), 802.11ax (HE80): 2 5500 ~ 5720MHz: 802.11a, 802.11n (HT20), 802.11ac (VHT20), 802.11ax (HE20): 12 802.11n (HT40), 802.11ac (VHT40), 802.11ax (HE40): 6 802.11ac (VHT80), 802.11ax (HE80): 3 5745 ~ 5825MHz: 802.11a, 802.11n (HT20), 802.11ac (VHT20), 802.11ax (HE20): 5 802.11n (HT40), 802.11ac (VHT40), 802.11ax (HE40): 2 802.11ac (VHT80), 802.11ax (HE80): 1
Output Power	5180 ~ 5250MHz: 49.103mW 5250 ~ 5320MHz: 49.951mW 5500 ~ 5720MHz: 49.898mW 5745 ~ 5825MHz: 47.647mW
Antenna Type	Refer to note
Antenna Connector	Refer to note
Accessory Device	Refer to note
Cable Supplied	NA

Note:

1. The EUT incorporates a MIMO function. Physically, the EUT provides 2 completed transmitters and 2 receivers.

Modulation Mode	TX Function
802.11a	2TX
802.11n (HT20)	2TX
802.11n (HT40)	2TX
802.11ac (VHT20)	2TX
802.11ac (VHT40)	2TX
802.11ac (VHT80)	2TX
802.11ax (HE20)	2TX
802.11ax (HE40)	2TX
802.11ax (HE80)	2TX

* The bandwidth and modulation are similar for 802.11n mode for 20MHz (40MHz), 802.11ac mode for 20MHz (40MHz, 80MHz) and 802.11ax mode for 20MHz (40MHz, 80MHz). Therefore the investigated worst case is the representative mode in test report. (Final test mode refer section 3.2.1)

2. The EUT uses following accessories.

Dock		
Brand	Model	Specification
Nienyi	107-1059401	Line length : 0.83 m

3. The EUT with follow antennas gain is listed as table below.

ANT. No.	Type	Connector	Frequency Range	Gain (dBi)
2.4G_0	Dipole	IPEX	2400~2483.5MHz	2.20
2.4G_1	Dipole	IPEX	2400~2483.5MHz	1.90
5G_0	Dipole	IPEX	5150~5250MHz	2.30
			5250~5350MHz	2.60
			5470~5725MHz	2.70
			5725~5850MHz	2.60
5G_1	Dipole	IPEX	5150~5250MHz	2.10
			5250~5350MHz	2.80
			5470~5725MHz	1.90
			5725~5850MHz	2.50

*Detail antenna specification please refer to antenna datasheet.

4. WLAN 2.4GHz, WLAN 5GHz & WLAN 6GHz technology cannot transmit at the same time.

3.2 Description of Test Modes

For 5180 ~ 5320MHz:

8 channels are provided for 802.11a, 802.11n (HT20), 802.11ac (VHT20), 802.11ax (HE20):

Channel	Frequency	Channel	Frequency
36	5180 MHz	44	5220 MHz
40	5200 MHz	48	5240 MHz
52	5260 MHz	60	5300 MHz
56	5280 MHz	64	5320 MHz

4 channels are provided for 802.11n (HT40), 802.11ac (VHT40), 802.11ax (HE40):

Channel	Frequency	Channel	Frequency
38	5190 MHz	46	5230 MHz
54	5270 MHz	62	5310 MHz

2 channels are provided for 802.11ac (VHT80), 802.11ax (HE80):

Channel	Frequency	Channel	Frequency
42	5210MHz	58	5290MHz

For 5500 ~ 5720MHz:

12 channels are provided for 802.11a, 802.11n (HT20), 802.11ac (VHT20), 802.11ax (HE20):

Channel	Frequency	Channel	Frequency
100	5500 MHz	124	5620 MHz
104	5520 MHz	128	5640 MHz
108	5540 MHz	132	5660 MHz
112	5560 MHz	136	5680 MHz
116	5580 MHz	140	5700 MHz
120	5600 MHz	144	5720 MHz

6 channels are provided for 802.11n (HT40), 802.11ac (VHT40), 802.11ax (HE40):

Channel	Frequency	Channel	Frequency
102	5510 MHz	126	5630 MHz
110	5550 MHz	134	5670 MHz
118	5590 MHz	142	5710 MHz

3 channels are provided for 802.11ac (VHT80), 802.11ax (HE80):

Channel	Frequency	Channel	Frequency
106	5530 MHz	122	5610 MHz
138	5690 MHz		

For 5745 ~ 5825MHz:

5 channels are provided for 802.11a, 802.11n (HT20), 802.11ac (VHT20), 802.11ax (HE20):

Channel	Frequency	Channel	Frequency
149	5745MHz	161	5805MHz
153	5765MHz	165	5825MHz
157	5785MHz		

2 channels are provided for 802.11n (HT40), 802.11ac (VHT40), 802.11ax (HE40):

Channel	Frequency	Channel	Frequency
151	5755MHz	159	5795MHz

1 channel is provided for 802.11ac (VHT80), 802.11ax (HE80):

Channel	Frequency
155	5775MHz

3.2.1 Test Mode Applicability and Tested Channel Detail

EUT Configure Mode	Applicable to				Description
	RE \geq 1G	RE<1G	PLC	APCM	
A	√	√	√	√	EUT with Dock
B	-	√	√	-	EUT with Notebook

Where RE \geq 1G: Radiated Emission above 1GHz & Bandedge Measurement
 RE<1G: Radiated Emission below 1GHz
 PLC: Power Line Conducted Emission
 APCM: Antenna Port Conducted Measurement

Note:

- The EUT had been pre-tested on mode A (EUT with Dock) of 2 antenna angles (0° & 90°). The worst case was found when positioned on mode A(0°). And mode B (EUT with NB) of 2 antenna angles (0° & 90°). The worst case was found when positioned on mode A(90°)
- "-": Means no effect.
- Radiated emission (below 1GHz) and power line conducted emission test items chosen the worst maximum power.

Radiated Emission Test (Above 1GHz):

- Pre-Scan has been conducted to determine the worst-case mode from all possible combinations between available modulations, data rates and antenna ports (if EUT with antenna diversity architecture).
- Following channel(s) was (were) selected for the final test as listed below.

EUT Configure Mode	Mode	Frequency Band (MHz)	Available Channel	Tested Channel	Modulation Technology	Data Rate (Mbps)	Remark
A	802.11a	5180-5250	36 to 48	36, 40, 48	OFDM	6.0	-
	802.11ax (HE20)		36 to 48	36, 40, 48	OFDMA	MCS0	
	802.11ax (HE40)		38 to 46	38, 46	OFDMA	MCS0	
	802.11ax (HE80)		42	42	OFDMA	MCS0	
A	802.11a	5250-5320	52 to 64	52, 60, 64	OFDM	6.0	-
	802.11ax (HE20)		52 to 64	52, 60, 64	OFDMA	MCS0	
	802.11ax (HE40)		54 to 62	54, 62	OFDMA	MCS0	
	802.11ax (HE80)		58	58	OFDMA	MCS0	
A	802.11a	5500-5720	100 to 144	100, 116, 140, 144	OFDM	6.0	-
	802.11ax (HE20)		100 to 144	100, 116, 140, 144	OFDMA	MCS0	
	802.11ax (HE40)		102 to 142	102, 110, 134, 142	OFDMA	MCS0	
	802.11ax (HE80)		106 to 138	106, 122, 138	OFDMA	MCS0	
A	802.11a	5745-5825	149 to 165	149, 157, 165	OFDM	6.0	-
	802.11ax (HE20)		149 to 165	149, 157, 165	OFDMA	MCS0	
	802.11ax (HE40)		151 to 159	151, 159	OFDMA	MCS0	
	802.11ax (HE80)		155	155	OFDMA	MCS0	

Radiated Emission Test (Below 1GHz):

- Pre-Scan has been conducted to determine the worst-case mode from all possible combinations between available modulations, data rates and antenna ports (if EUT with antenna diversity architecture).
- Following channel(s) was (were) selected for the final test as listed below.

EUT Configure Mode	Mode	Frequency Band (MHz)	Available Channel	Tested Channel	Modulation Technology	Data Rate (Mbps)	Remark
A, B	802.11a	5180-5250	36 to 48	116	OFDM	6.0	-
	802.11a	5250-5320	52 to 64		OFDM	6.0	
	802.11a	5500-5720	100 to 144		OFDM	6.0	
	802.11a	5745-5825	149 to 165		OFDM	6.0	

Power Line Conducted Emission Test:

- Pre-Scan has been conducted to determine the worst-case mode from all possible combinations between available modulations, data rates and antenna ports (if EUT with antenna diversity architecture).
- Following channel(s) was (were) selected for the final test as listed below.

EUT Configure Mode	Mode	Frequency Band (MHz)	Available Channel	Tested Channel	Modulation Technology	Data Rate (Mbps)	Remark
A, B	802.11a	5180-5250	36 to 48	116	OFDM	6.0	-
	802.11a	5250-5320	52 to 64		OFDM	6.0	
	802.11a	5500-5720	100 to 144		OFDM	6.0	
	802.11a	5745-5825	149 to 165		OFDM	6.0	

Antenna Port Conducted Measurement:

- This item includes all test value of each mode, but only includes spectrum plot of worst value of each mode.
- Pre-Scan has been conducted to determine the worst-case mode from all possible combinations between available modulations, data rates and antenna ports (if EUT with antenna diversity architecture).
- Following channel(s) was (were) selected for the final test as listed below.

EUT Configure Mode	Mode	Frequency Band (MHz)	Available Channel	Tested Channel	Modulation Technology	Data Rate (Mbps)	Remark
A	802.11a	5180-5250	36 to 48	36, 40, 48	OFDM	6.0	-
	802.11ax (HE20)		36 to 48	36, 40, 48	OFDMA	MCS0	
	802.11ax (HE40)		38 to 46	38, 46	OFDMA	MCS0	
	802.11ax (HE80)		42	42	OFDMA	MCS0	
A	802.11a	5250-5320	52 to 64	52, 60, 64	OFDM	6.0	-
	802.11ax (HE20)		52 to 64	52, 60, 64	OFDMA	MCS0	
	802.11ax (HE40)		54 to 62	54, 62	OFDMA	MCS0	
	802.11ax (HE80)		58	58	OFDMA	MCS0	
A	802.11a	5500-5720	100 to 144	100, 116, 140, 144	OFDM	6.0	-
	802.11ax (HE20)		100 to 144	100, 116, 140, 144	OFDMA	MCS0	
	802.11ax (HE40)		102 to 142	102, 110, 134, 142	OFDMA	MCS0	
	802.11ax (HE80)		106 to 138	106, 122, 138	OFDMA	MCS0	
A	802.11a	5745-5825	149 to 165	149, 157, 165	OFDM	6.0	-
	802.11ax (HE20)		149 to 165	149, 157, 165	OFDMA	MCS0	
	802.11ax (HE40)		151 to 159	151, 159	OFDMA	MCS0	
	802.11ax (HE80)		155	155	OFDMA	MCS0	

Test Condition:

Applicable to	Environmental Conditions	Input Power (System)	Tested by
RE \geq 1G	23 deg. C, 69% RH	120Vac, 60Hz,	Greg Lin
RE<1G	23 deg. C, 69% RH	120Vac, 60Hz,	Greg Lin
PLC	23 deg. C, 69% RH	120Vac, 60Hz,	Greg Lin
APCM	25 deg. C, 60% RH	120Vac, 60Hz	Ivan Tseng

3.3 Duty Cycle of Test Signal

Duty cycle of test signal is < 98%, duty factor is required.

802.11a: Duty cycle = 1.391ms/1.437ms = 0.968, Duty factor = $10 * \log(1/0.968) = 0.14$

802.11ax (HE20): Duty cycle = 1.022ms/1.067ms = 0.958, Duty factor = $10 * \log(1/0.958) = 0.19$

802.11ax (HE40): Duty cycle = 1.969ms/2.024ms = 0.973, Duty factor = $10 * \log(1/0.973) = 0.12$

802.11ax (HE80): Duty cycle = 1.865ms/1.911ms = 0.976, Duty factor = $10 * \log(1/0.976) = 0.11$

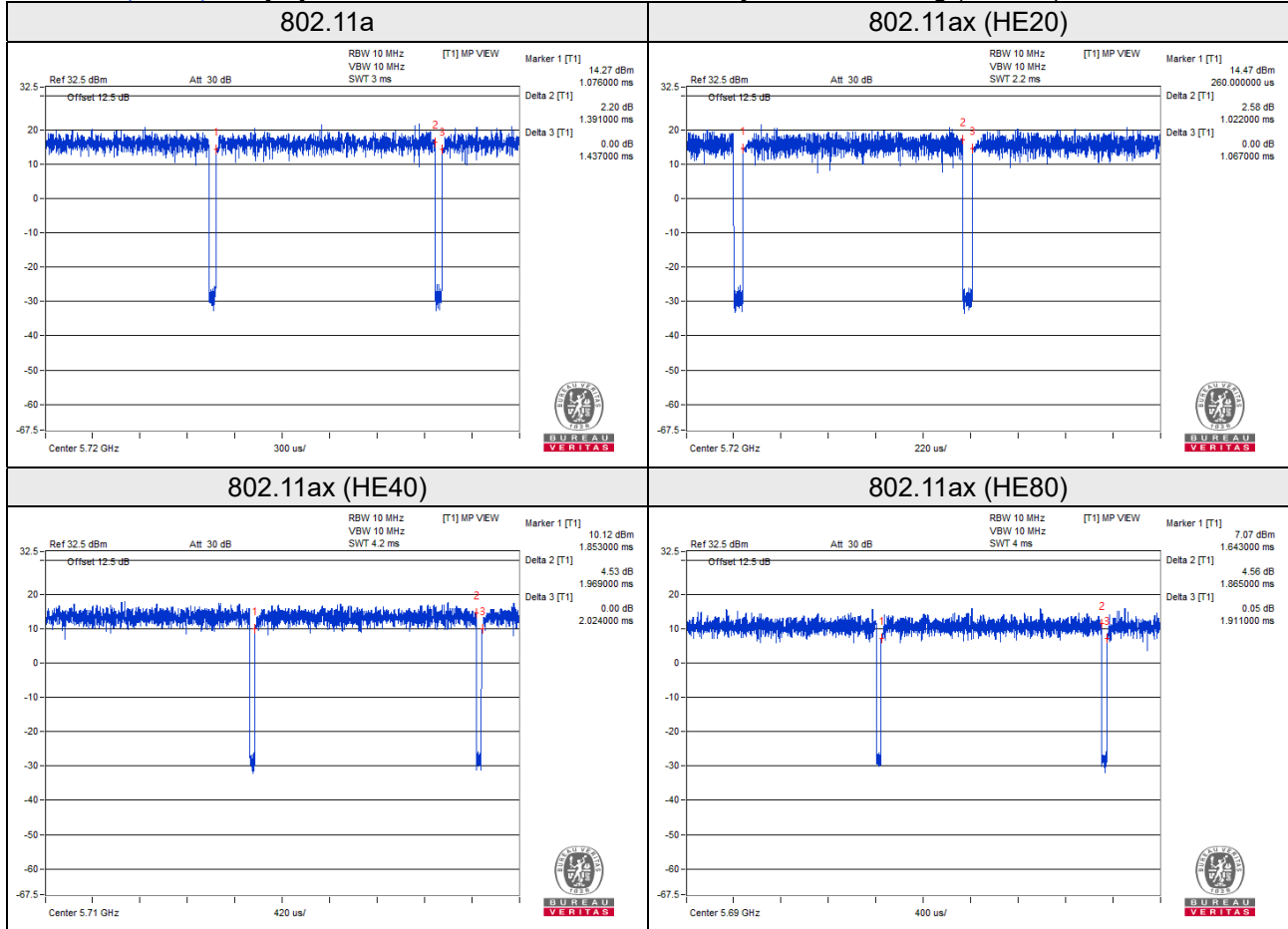

3.4 Description of Support Units

The EUT has been tested as an independent unit together with other necessary accessories or support units. The following support units or accessories were used to form a representative test configuration during the tests.

ID	Product	Brand	Model No.	Serial No.	FCC ID	Remarks
A.	Notebook	DELL	E5420	33MJMQ1	FCC DoC Approved	-
B.	Dock	Nienyi	107-1059401	NA	NA	Accessory of EUT

Note:

1. All power cords of the above support units are non-shielded (1.8m).
2. Item A acted as a communication partner to transfer data.

3.4.1 Configuration of System under Test

Mode A

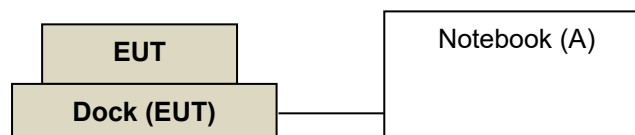

Mode B

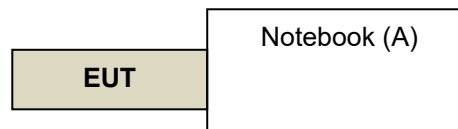

3.5 General Description of Applied Standards and References

The EUT is a RF Product. According to the specifications of the manufacturer, it must comply with the requirements of the following standards and references:

Test standard:

FCC Part 15, Subpart E (15.407)

ANSI C63.10:2013

All test items have been performed and recorded as per the above standards.

References Test Guidance:

KDB 789033 D02 General UNII Test Procedure New Rules v02r01

KDB 662911 D01 Multiple Transmitter Output v02r01

All test items have been performed as a reference to the above KDB test guidance.

4 Test Types and Results

4.1 Radiated Emission and Bandedge Measurement

4.1.1 Limits of Radiated Emission and Bandedge Measurement

Radiated emissions which fall in the restricted bands must comply with the radiated emission limits specified as below table.

Frequencies (MHz)	Field Strength (microvolts/meter)	Measurement Distance (meters)
0.009 ~ 0.490	2400/F(kHz)	300
0.490 ~ 1.705	24000/F(kHz)	30
1.705 ~ 30.0	30	30
30 ~ 88	100	3
88 ~ 216	150	3
216 ~ 960	200	3
Above 960	500	3

Note:

1. The lower limit shall apply at the transition frequencies.
2. Emission level (dBuV/m) = 20 log Emission level (uV/m).
3. For frequencies above 1000MHz, the field strength limits are based on average detector, however, the peak field strength of any emission shall not exceed the maximum permitted average limits, specified above by more than 20dB under any condition of modulation.

Limits of unwanted emission out of the restricted bands

Applicable To		Limit	
789033 D02 General UNII Test Procedure New Rules v02r01		Field Strength at 3m	
		PK: 74 (dBuV/m)	AV: 54 (dBuV/m)
Frequency Band	Applicable To	EIRP Limit	Equivalent Field Strength at 3m
5150~5250 MHz	15.407(b)(1)	PK: -27 (dBm/MHz)	PK: 68.2(dBuV/m)
5250~5350 MHz	15.407(b)(2)		
5470~5725 MHz	15.407(b)(3)		
5725~5850 MHz	15.407(b)(4)(i)	PK: -27 (dBm/MHz) ^{*1} PK: 10 (dBm/MHz) ^{*2} PK: 15.6 (dBm/MHz) ^{*3} PK: 27 (dBm/MHz) ^{*4}	PK: 68.2(dBuV/m) ^{*1} PK: 105.2 (dBuV/m) ^{*2} PK: 110.8(dBuV/m) ^{*3} PK: 122.2 (dBuV/m) ^{*4}
^{*1} beyond 75 MHz or more above of the band edge.		^{*2} below the band edge increasing linearly to 10 dBm/MHz at 25 MHz above.	
^{*3} below the band edge increasing linearly to a level of 15.6 dBm/MHz at 5 MHz above.		^{*4} from 5 MHz above or below the band edge increasing linearly to a level of 27 dBm/MHz at the band edge.	

Note: The following formula is used to convert the equipment isotropic radiated power (eirp) to field strength:

$$E = \frac{1000000\sqrt{30P}}{3} \mu\text{V/m, where P is the eirp (Watts).}$$

4.1.2 Test Instruments

Description & Manufacturer	Model No.	Serial No.	Cal. Date	Cal. Due
Test Receiver ROHDE & SCHWARZ	ESCI	100424	Dec. 30, 2021	Dec. 29, 2022
Spectrum Analyzer ROHDE & SCHWARZ	FSP40	100040	Sep. 15, 2021	Sep. 14, 2022
BILOG Antenna SCHWARZBECK	VULB9168	9168-155	Nov. 01, 2021	Oct. 30, 2022
HORN Antenna SCHWARZBECK	BBHA 9120D	9120D-1170	Nov. 14, 2021	Nov. 13, 2022
HORN Antenna SCHWARZBECK	BBHA 9170	BBHA9170241	Oct. 26, 2021	Oct. 25, 2022
Loop Antenna TESEQ	HLA 6121	45745	Jul. 21, 2021	Jul. 20, 2022
Preamplifier Agilent (Below 1GHz)	8447D	2944A10631	May 14, 2022	May 13, 2023
Preamplifier KEYSIGHT (Above 1GHz)	83017A	MY53270295	May 14, 2022	May 13, 2023
RF Coaxial Cable 57140938WOKEN With 5dB PAD	8D-FB	Cable-CH4-01	Jul. 24, 2021	Jul. 23, 2022
RF Coaxial Cable EMCI	EMC102-KM-KM-3000	150929	Jul. 24, 2021	Jul. 23, 2022
RF Coaxial Cable EMCI	EMC102-KM-KM-600	150928	Jul. 24, 2021	Jul. 23, 2022
RF signal cable HUBER+SUHNER	SUCOFLEX 104	MY 13380+295012/04	May 14, 2022	May 13, 2023
RF signal cable HUBER+SUHNER	SUCOFLEX 104	Cable-CH4-03 (250724)	May 14, 2022	May 13, 2023
Software BV ADT	ADT_Radiated_V7.6.15.9.5	NA	NA	NA
Antenna Tower inn-co GmbH	MA 4000	010303	NA	NA
Antenna Tower Controller BV ADT	AT100	AT93021703	NA	NA
Turn Table BV ADT	TT100	TT93021703	NA	NA
Turn Table Controller BV ADT	SC100	SC93021703	NA	NA
Boresight Antenna Fixture	FBA-01	FBA-SIP01	NA	NA
Pre-amplifier (18GHz-40GHz) EMC	EMC184045B	980175	Sep. 04, 2021	Sep. 03, 2022
Peak Power Analyzer KEYSIGHT	8990B	MY51000485	Jan. 18, 2022	Jan. 17, 2023
Wideband Power Sensor KEYSIGHT	N1923A	MY58190002	May 06, 2022	May 05, 2023

Note: 1. The calibration interval of the above test instruments is 12 months and the calibrations are traceable to NML/ROC and NIST/USA.
2. The test was performed in HwaYa Chamber 4.

4.1.3 Test Procedures

For Radiated emission below 30MHz

- a. The EUT was placed on the top of a rotating table 0.8 meters above the ground at a 3 meter chamber room. The table was rotated 360 degrees to determine the position of the highest radiation.
- b. The EUT was set 3 meters away from the interference-receiving antenna, which was mounted on the top of a variable-height antenna tower.
- c. Parallel, perpendicular, and ground-parallel orientations of the antenna are set to make the measurement.
- d. For each suspected emission, the EUT was arranged to its worst case and the rotatable table was turned from 0 degrees to 360 degrees to find the maximum reading.
- e. The test-receiver system was set to Quasi-Peak Detect Function and Specified Bandwidth with Maximum Hold Mode.

Note:

1. The resolution bandwidth and video bandwidth of test receiver/spectrum analyzer is 9kHz at frequency below 30MHz.

For Radiated emission above 30MHz

- a. The EUT was placed on the top of a rotating table 0.8 meters (for 30MHz ~ 1GHz) / 1.5 meters (for above 1GHz) above the ground at 3 meter chamber room for test. The table was rotated 360 degrees to determine the position of the highest radiation.
- b. The EUT was set 3 meters away from the interference-receiving antenna, which was mounted on the top of a variable-height antenna tower.
- c. The height of antenna is varied from one meter to four meters above the ground to determine the maximum value of the field strength. Both horizontal and vertical polarizations of the antenna are set to make the measurement.
- d. For each suspected emission, the EUT was arranged to its worst case and then the antenna was tuned to heights from 1 meter to 4 meters and the rotatable table was turned from 0 degrees to 360 degrees to find the maximum reading.
- e. The test-receiver system was set to quasi-peak detect function and specified bandwidth with maximum hold mode when the test frequency is below 1 GHz.
- f. The test-receiver system was set to peak and average detect function and specified bandwidth with maximum hold mode when the test frequency is above 1 GHz. If the peak reading value also meets average limit, measurement with the average detector is unnecessary.

Note:

1. The resolution bandwidth and video bandwidth of test receiver/spectrum analyzer is 120kHz for Quasi-peak detection (QP) at frequency below 1GHz.
2. The resolution bandwidth of test receiver/spectrum analyzer is 1 MHz and the video bandwidth is 3 MHz for Peak detection (PK) at frequency above 1GHz.
3. The resolution bandwidth of test receiver/spectrum analyzer is 1MHz and the video bandwidth is $\geq 1/T$ (Duty cycle < 98%) or 10Hz (Duty cycle $\geq 98\%$) for Average detection (AV) at frequency above 1GHz. (802.11a: RBW = 1MHz, VBW = 1kHz; 802.11ax (HE20): RBW = 1MHz, VBW = 1kHz; 802.11ax (HE40): RBW = 1MHz, VBW = 1kHz; 802.11ax (HE80): RBW = 1MHz, VBW = 1kHz)
4. All modes of operation were investigated and the worst-case emissions are reported.

4.1.4 Deviation from Test Standard

No deviation.

4.1.5 Test Setup

For Radiated emission below 30MHz

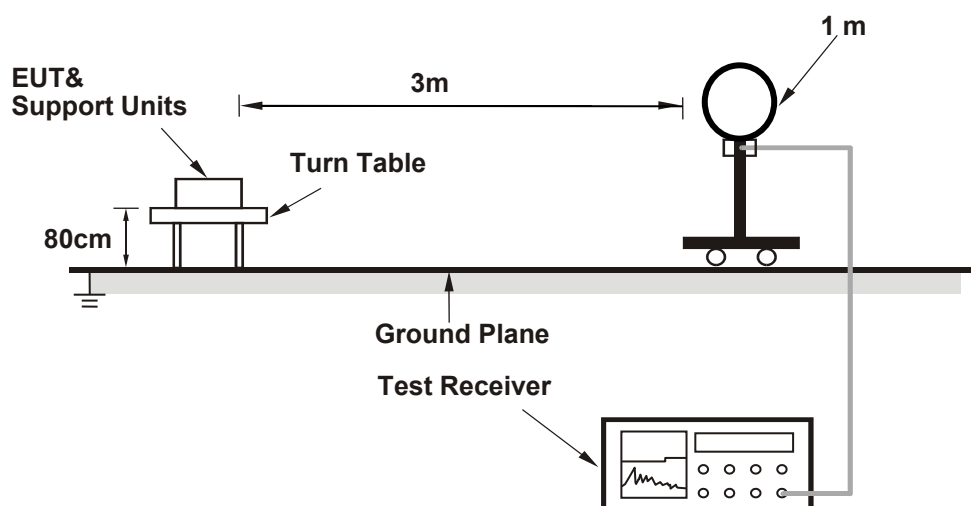

For Radiated emission 30MHz to 1GHz

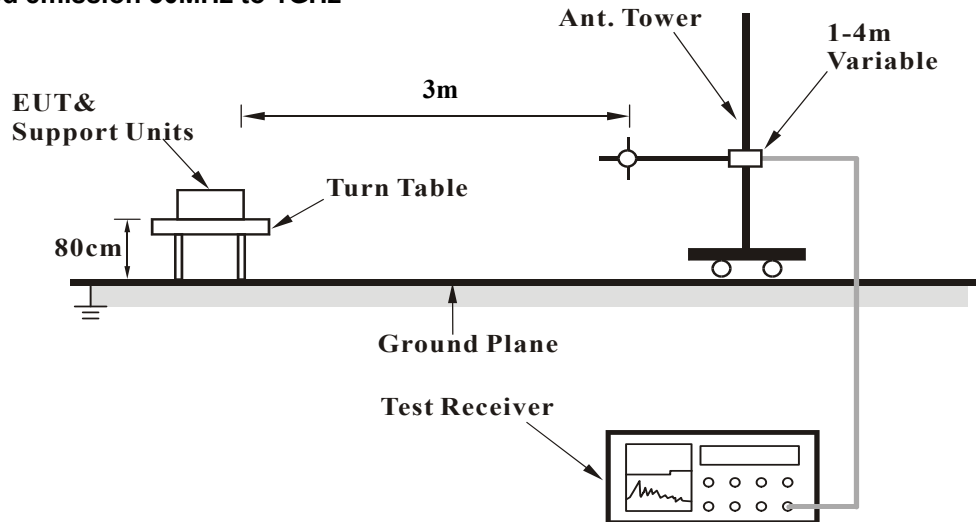

For Radiated emission above 1GHz

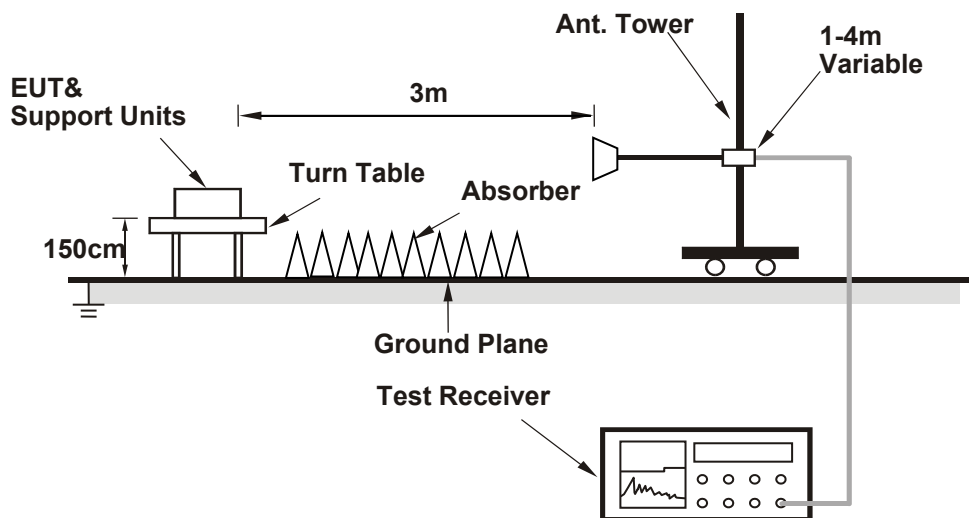

For the actual test configuration, please refer to the attached file (Test Setup Photo).

4.1.6 EUT Operating Conditions

Mode A

- a. EUT connected to the Notebook through dock via USB cable.
- b. The EUT under transmission condition continuously at specific channel frequency.

Mode B

- a. EUT plugged into the Notebook.
- b. The EUT under transmission condition continuously at specific channel frequency.

4.1.7 Test Results

Above 1GHz worst-Case data:

RF Mode	TX 802.11a	Channel	CH 36 : 5180 MHz
Frequency Range	1GHz ~ 40GHz	Detector Function	Peak (PK) Average (AV)

Antenna Polarity & Test Distance : Horizontal at 3 m								
No	Frequency (MHz)	Emission Level (dBuV/m)	Limit (dBuV/m)	Margin (dB)	Antenna Height (m)	Table Angle (Degree)	Raw Value (dBuV)	Correction Factor (dB/m)
1	5150.00	60.6 PK	74.0	-13.4	1.12 H	177	47.7	12.9
2	5150.00	47.8 AV	54.0	-6.2	1.12 H	177	34.9	12.9
3	*5180.00	103.6 PK			1.12 H	177	61.2	42.4
4	*5180.00	93.5 AV			1.12 H	177	51.1	42.4
5	#10360.00	63.0 PK	68.2	-5.2	1.94 H	217	40.4	22.6

Antenna Polarity & Test Distance : Vertical at 3 m								
No	Frequency (MHz)	Emission Level (dBuV/m)	Limit (dBuV/m)	Margin (dB)	Antenna Height (m)	Table Angle (Degree)	Raw Value (dBuV)	Correction Factor (dB/m)
1	5150.00	61.4 PK	74.0	-12.6	1.64 V	163	48.5	12.9
2	5150.00	48.2 AV	54.0	-5.8	1.64 V	163	35.3	12.9
3	*5180.00	107.3 PK			1.64 V	163	64.9	42.4
4	*5180.00	97.2 AV			1.64 V	163	54.8	42.4
5	#10360.00	63.8 PK	68.2	-4.4	2.51 V	334	41.2	22.6

Remarks:

1. Emission Level(dBuV/m) = Raw Value(dBuV) + Correction Factor(dB/m)
2. Correction Factor(dB/m) = Antenna Factor(dB/m) + Cable Factor(dB) – Pre-Amplifier Factor(dB)
3. Margin value = Emission Level – Limit value
4. The other emission levels were very low against the limit.
5. " * ": Fundamental frequency.
6. " # ": The radiated frequency is out of the restricted band.

RF Mode	TX 802.11a	Channel	CH 40 : 5200 MHz
Frequency Range	1GHz ~ 40GHz	Detector Function	Peak (PK) Average (AV)

Antenna Polarity & Test Distance : Horizontal at 3 m

No	Frequency (MHz)	Emission Level (dBuV/m)	Limit (dBuV/m)	Margin (dB)	Antenna Height (m)	Table Angle (Degree)	Raw Value (dBuV)	Correction Factor (dB/m)
1	*5200.00	103.7 PK			1.18 H	176	61.5	42.2
2	*5200.00	93.7 AV			1.18 H	176	51.5	42.2
3	#10400.00	63.4 PK	68.2	-4.8	2.01 H	239	40.6	22.8

Antenna Polarity & Test Distance : Vertical at 3 m

No	Frequency (MHz)	Emission Level (dBuV/m)	Limit (dBuV/m)	Margin (dB)	Antenna Height (m)	Table Angle (Degree)	Raw Value (dBuV)	Correction Factor (dB/m)
1	*5200.00	107.3 PK			1.78 V	162	65.1	42.2
2	*5200.00	97.4 AV			1.78 V	162	55.2	42.2
3	#10400.00	64.2 PK	68.2	-4.0	2.43 V	331	41.4	22.8

Remarks:

1. Emission Level(dBuV/m) = Raw Value(dBuV) + Correction Factor(dB/m)
2. Correction Factor(dB/m) = Antenna Factor(dB/m) + Cable Factor(dB) – Pre-Amplifier Factor(dB)
3. Margin value = Emission Level – Limit value
4. The other emission levels were very low against the limit.
5. " * " : Fundamental frequency.
6. " # " : The radiated frequency is out of the restricted band.

RF Mode	TX 802.11a	Channel	CH 48 : 5240 MHz
Frequency Range	1GHz ~ 40GHz	Detector Function	Peak (PK) Average (AV)

Antenna Polarity & Test Distance : Horizontal at 3 m

No	Frequency (MHz)	Emission Level (dBuV/m)	Limit (dBuV/m)	Margin (dB)	Antenna Height (m)	Table Angle (Degree)	Raw Value (dBuV)	Correction Factor (dB/m)
1	*5240.00	103.0 PK			1.15 H	170	60.8	42.2
2	*5240.00	93.0 AV			1.15 H	170	50.8	42.2
3	5350.00	61.3 PK	74.0	-12.7	1.15 H	170	48.3	13.0
4	5350.00	47.4 AV	54.0	-6.6	1.15 H	170	34.4	13.0
5	#10480.00	63.5 PK	68.2	-4.7	1.94 H	235	40.7	22.8

Antenna Polarity & Test Distance : Vertical at 3 m

No	Frequency (MHz)	Emission Level (dBuV/m)	Limit (dBuV/m)	Margin (dB)	Antenna Height (m)	Table Angle (Degree)	Raw Value (dBuV)	Correction Factor (dB/m)
1	*5240.00	106.8 PK			1.95 V	160	64.6	42.2
2	*5240.00	96.8 AV			1.95 V	160	54.6	42.2
3	5350.00	61.5 PK	74.0	-12.5	1.95 V	160	48.5	13.0
4	5350.00	47.7 AV	54.0	-6.3	1.95 V	160	34.7	13.0
5	#10480.00	64.1 PK	68.2	-4.1	2.43 V	331	41.3	22.8

Remarks:

1. Emission Level(dBuV/m) = Raw Value(dBuV) + Correction Factor(dB/m)
2. Correction Factor(dB/m) = Antenna Factor(dB/m) + Cable Factor(dB) – Pre-Amplifier Factor(dB)
3. Margin value = Emission Level – Limit value
4. The other emission levels were very low against the limit.
5. " * " : Fundamental frequency.
6. " # " : The radiated frequency is out of the restricted band.

RF Mode	TX 802.11a	Channel	CH 52 : 5260 MHz
Frequency Range	1GHz ~ 40GHz	Detector Function	Peak (PK) Average (AV)

Antenna Polarity & Test Distance : Horizontal at 3 m

No	Frequency (MHz)	Emission Level (dBuV/m)	Limit (dBuV/m)	Margin (dB)	Antenna Height (m)	Table Angle (Degree)	Raw Value (dBuV)	Correction Factor (dB/m)
1	5150.00	60.3 PK	74.0	-13.7	1.19 H	168	47.4	12.9
2	5150.00	48.1 AV	54.0	-5.9	1.19 H	168	35.2	12.9
3	*5260.00	102.8 PK			1.19 H	168	60.5	42.3
4	*5260.00	93.0 AV			1.19 H	168	50.7	42.3
5	#10520.00	62.9 PK	68.2	-5.3	1.97 H	228	39.9	23.0

Antenna Polarity & Test Distance : Vertical at 3 m

No	Frequency (MHz)	Emission Level (dBuV/m)	Limit (dBuV/m)	Margin (dB)	Antenna Height (m)	Table Angle (Degree)	Raw Value (dBuV)	Correction Factor (dB/m)
1	5150.00	60.4 PK	74.0	-13.6	1.63 V	160	47.5	12.9
2	5150.00	48.3 AV	54.0	-5.7	1.63 V	160	35.4	12.9
3	*5260.00	106.6 PK			1.63 V	160	64.3	42.3
4	*5260.00	97.1 AV			1.63 V	160	54.8	42.3
5	#10520.00	64.3 PK	68.2	-3.9	2.48 V	338	41.3	23.0

Remarks:

1. Emission Level(dBuV/m) = Raw Value(dBuV) + Correction Factor(dB/m)
2. Correction Factor(dB/m) = Antenna Factor(dB/m) + Cable Factor(dB) – Pre-Amplifier Factor(dB)
3. Margin value = Emission Level – Limit value
4. The other emission levels were very low against the limit.
5. " * " : Fundamental frequency.
6. " # " : The radiated frequency is out of the restricted band.

RF Mode	TX 802.11a	Channel	CH 60 : 5300 MHz
Frequency Range	1GHz ~ 40GHz	Detector Function	Peak (PK) Average (AV)

Antenna Polarity & Test Distance : Horizontal at 3 m

No	Frequency (MHz)	Emission Level (dBuV/m)	Limit (dBuV/m)	Margin (dB)	Antenna Height (m)	Table Angle (Degree)	Raw Value (dBuV)	Correction Factor (dB/m)
1	*5300.00	102.6 PK			1.23 H	169	60.3	42.3
2	*5300.00	92.5 AV			1.23 H	169	50.2	42.3
3	10600.00	64.3 PK	74.0	-9.7	1.95 H	224	40.8	23.5
4	10600.00	49.7 AV	54.0	-4.3	1.95 H	224	26.2	23.5

Antenna Polarity & Test Distance : Vertical at 3 m

No	Frequency (MHz)	Emission Level (dBuV/m)	Limit (dBuV/m)	Margin (dB)	Antenna Height (m)	Table Angle (Degree)	Raw Value (dBuV)	Correction Factor (dB/m)
1	*5300.00	107.0 PK			1.63 V	159	64.7	42.3
2	*5300.00	97.0 AV			1.63 V	159	54.7	42.3
3	10600.00	64.9 PK	74.0	-9.1	2.49 V	334	41.4	23.5
4	10600.00	50.3 AV	54.0	-3.7	2.49 V	334	26.8	23.5

Remarks:

1. Emission Level(dBuV/m) = Raw Value(dBuV) + Correction Factor(dB/m)
2. Correction Factor(dB/m) = Antenna Factor(dB/m) + Cable Factor(dB) – Pre-Amplifier Factor(dB)
3. Margin value = Emission Level – Limit value
4. The other emission levels were very low against the limit.
5. " * " : Fundamental frequency.

RF Mode	TX 802.11a	Channel	CH 64 : 5320 MHz
Frequency Range	1GHz ~ 40GHz	Detector Function	Peak (PK) Average (AV)

Antenna Polarity & Test Distance : Horizontal at 3 m

No	Frequency (MHz)	Emission Level (dBuV/m)	Limit (dBuV/m)	Margin (dB)	Antenna Height (m)	Table Angle (Degree)	Raw Value (dBuV)	Correction Factor (dB/m)
1	*5320.00	104.7 PK			1.17 H	165	62.3	42.4
2	*5320.00	93.9 AV			1.17 H	165	51.5	42.4
3	5350.00	62.2 PK	74.0	-11.8	1.17 H	165	49.2	13.0
4	5350.00	48.4 AV	54.0	-5.6	1.17 H	165	35.4	13.0
5	10640.00	64.5 PK	74.0	-9.5	1.99 H	226	41.0	23.5
6	10640.00	49.8 AV	54.0	-4.2	1.99 H	226	26.3	23.5

Antenna Polarity & Test Distance : Vertical at 3 m

No	Frequency (MHz)	Emission Level (dBuV/m)	Limit (dBuV/m)	Margin (dB)	Antenna Height (m)	Table Angle (Degree)	Raw Value (dBuV)	Correction Factor (dB/m)
1	*5320.00	108.5 PK			1.64 V	160	66.1	42.4
2	*5320.00	97.6 AV			1.64 V	160	55.2	42.4
3	5350.00	62.5 PK	74.0	-11.5	1.64 V	160	49.5	13.0
4	5350.00	48.8 AV	54.0	-5.2	1.64 V	160	35.8	13.0
5	10640.00	65.0 PK	74.0	-9.0	2.41 V	329	41.5	23.5
6	10640.00	50.3 AV	54.0	-3.7	2.41 V	329	26.8	23.5

Remarks:

1. Emission Level(dBuV/m) = Raw Value(dBuV) + Correction Factor(dB/m)
2. Correction Factor(dB/m) = Antenna Factor(dB/m) + Cable Factor(dB) – Pre-Amplifier Factor(dB)
3. Margin value = Emission Level – Limit value
4. The other emission levels were very low against the limit.
5. " * ": Fundamental frequency.

RF Mode	TX 802.11a	Channel	CH 100 : 5500 MHz
Frequency Range	1GHz ~ 40GHz	Detector Function	Peak (PK) Average (AV)

Antenna Polarity & Test Distance : Horizontal at 3 m

No	Frequency (MHz)	Emission Level (dBuV/m)	Limit (dBuV/m)	Margin (dB)	Antenna Height (m)	Table Angle (Degree)	Raw Value (dBuV)	Correction Factor (dB/m)
1	5460.00	61.5 PK	74.0	-12.5	1.17 H	182	48.1	13.4
2	5460.00	49.3 AV	54.0	-4.7	1.17 H	182	35.9	13.4
3	#5470.00	62.3 PK	68.2	-5.9	1.17 H	182	48.7	13.6
4	*5500.00	104.4 PK			1.17 H	182	61.2	43.2
5	*5500.00	94.2 AV			1.17 H	182	51.0	43.2
6	11000.00	65.2 PK	74.0	-8.8	2.09 H	245	40.8	24.4
7	11000.00	51.3 AV	54.0	-2.7	2.09 H	245	26.9	24.4

Antenna Polarity & Test Distance : Vertical at 3 m

No	Frequency (MHz)	Emission Level (dBuV/m)	Limit (dBuV/m)	Margin (dB)	Antenna Height (m)	Table Angle (Degree)	Raw Value (dBuV)	Correction Factor (dB/m)
1	5460.00	61.7 PK	74.0	-12.3	2.46 V	145	48.3	13.4
2	5460.00	49.7 AV	54.0	-4.3	2.46 V	145	36.3	13.4
3	#5470.00	62.9 PK	68.2	-5.3	2.46 V	145	49.3	13.6
4	*5500.00	108.0 PK			2.46 V	145	64.8	43.2
5	*5500.00	97.9 AV			2.46 V	145	54.7	43.2
6	11000.00	65.7 PK	74.0	-8.3	2.73 V	324	41.3	24.4
7	11000.00	51.8 AV	54.0	-2.2	2.73 V	324	27.4	24.4

Remarks:

1. Emission Level(dBuV/m) = Raw Value(dBuV) + Correction Factor(dB/m)
2. Correction Factor(dB/m) = Antenna Factor(dB/m) + Cable Factor(dB) – Pre-Amplifier Factor(dB)
3. Margin value = Emission Level – Limit value
4. The other emission levels were very low against the limit.
5. " * ": Fundamental frequency.
6. " # ": The radiated frequency is out of the restricted band.

RF Mode	TX 802.11a	Channel	CH 116 : 5580 MHz
Frequency Range	1GHz ~ 40GHz	Detector Function	Peak (PK) Average (AV)

Antenna Polarity & Test Distance : Horizontal at 3 m

No	Frequency (MHz)	Emission Level (dBuV/m)	Limit (dBuV/m)	Margin (dB)	Antenna Height (m)	Table Angle (Degree)	Raw Value (dBuV)	Correction Factor (dB/m)
1	*5580.00	104.3 PK			1.12 H	177	61.2	43.1
2	*5580.00	94.2 AV			1.12 H	177	51.1	43.1
3	11160.00	65.1 PK	74.0	-8.9	1.96 H	224	40.7	24.4
4	11160.00	51.5 AV	54.0	-2.5	1.96 H	224	27.1	24.4

Antenna Polarity & Test Distance : Vertical at 3 m

No	Frequency (MHz)	Emission Level (dBuV/m)	Limit (dBuV/m)	Margin (dB)	Antenna Height (m)	Table Angle (Degree)	Raw Value (dBuV)	Correction Factor (dB/m)
1	*5580.00	108.2 PK			2.43 V	142	65.1	43.1
2	*5580.00	98.0 AV			2.43 V	142	54.9	43.1
3	11160.00	65.8 PK	74.0	-8.2	2.62 V	337	41.4	24.4
4	11160.00	51.9 AV	54.0	-2.1	2.62 V	337	27.5	24.4

Remarks:

1. Emission Level(dBuV/m) = Raw Value(dBuV) + Correction Factor(dB/m)
2. Correction Factor(dB/m) = Antenna Factor(dB/m) + Cable Factor(dB) – Pre-Amplifier Factor(dB)
3. Margin value = Emission Level – Limit value
4. The other emission levels were very low against the limit.
5. " * " : Fundamental frequency.

RF Mode	TX 802.11a	Channel	CH 140 : 5700 MHz
Frequency Range	1GHz ~ 40GHz	Detector Function	Peak (PK) Average (AV)

Antenna Polarity & Test Distance : Horizontal at 3 m

No	Frequency (MHz)	Emission Level (dBuV/m)	Limit (dBuV/m)	Margin (dB)	Antenna Height (m)	Table Angle (Degree)	Raw Value (dBuV)	Correction Factor (dB/m)
1	*5700.00	104.0 PK			1.18 H	172	60.9	43.1
2	*5700.00	93.9 AV			1.18 H	172	50.8	43.1
3	#5725.00	62.0 PK	68.2	-6.2	1.18 H	172	48.3	13.7
4	11400.00	65.8 PK	74.0	-8.2	2.01 H	229	40.6	25.2
5	11400.00	52.2 AV	54.0	-1.8	2.01 H	229	27.0	25.2

Antenna Polarity & Test Distance : Vertical at 3 m

No	Frequency (MHz)	Emission Level (dBuV/m)	Limit (dBuV/m)	Margin (dB)	Antenna Height (m)	Table Angle (Degree)	Raw Value (dBuV)	Correction Factor (dB/m)
1	*5700.00	107.8 PK			2.48 V	138	64.7	43.1
2	*5700.00	97.7 AV			2.48 V	138	54.6	43.1
3	#5725.00	62.8 PK	68.2	-5.4	2.48 V	138	49.1	13.7
4	11400.00	66.5 PK	74.0	-7.5	2.47 V	331	41.3	25.2
5	11400.00	52.5 AV	54.0	-1.5	2.47 V	331	27.3	25.2

Remarks:

1. Emission Level(dBuV/m) = Raw Value(dBuV) + Correction Factor(dB/m)
2. Correction Factor(dB/m) = Antenna Factor(dB/m) + Cable Factor(dB) – Pre-Amplifier Factor(dB)
3. Margin value = Emission Level – Limit value
4. The other emission levels were very low against the limit.
5. " * " : Fundamental frequency.
6. " # " : The radiated frequency is out of the restricted band.

RF Mode	TX 802.11a	Channel	CH 144 : 5720 MHz
Frequency Range	1GHz ~ 40GHz	Detector Function	Peak (PK) Average (AV)

Antenna Polarity & Test Distance : Horizontal at 3 m

No	Frequency (MHz)	Emission Level (dBuV/m)	Limit (dBuV/m)	Margin (dB)	Antenna Height (m)	Table Angle (Degree)	Raw Value (dBuV)	Correction Factor (dB/m)
1	#5470.00	61.7 PK	68.2	-6.5	1.18 H	177	48.1	13.6
2	*5720.00	104.3 PK			1.18 H	177	60.9	43.4
3	*5720.00	94.1 AV			1.18 H	177	50.7	43.4
4	#5850.00	62.4 PK	68.2	-5.8	1.18 H	177	48.1	14.3
5	11440.00	65.7 PK	74.0	-8.3	2.07 H	221	40.5	25.2
6	11440.00	52.0 AV	54.0	-2.0	2.07 H	221	26.8	25.2

Antenna Polarity & Test Distance : Vertical at 3 m

No	Frequency (MHz)	Emission Level (dBuV/m)	Limit (dBuV/m)	Margin (dB)	Antenna Height (m)	Table Angle (Degree)	Raw Value (dBuV)	Correction Factor (dB/m)
1	#5470.00	62.2 PK	68.2	-6.0	2.81 V	146	48.6	13.6
2	*5720.00	108.2 PK			2.81 V	146	64.8	43.4
3	*5720.00	98.0 AV			2.81 V	146	54.6	43.4
4	#5850.00	63.1 PK	68.2	-5.1	2.81 V	146	48.8	14.3
5	11440.00	66.5 PK	74.0	-7.5	2.47 V	336	41.3	25.2
6	11440.00	52.4 AV	54.0	-1.6	2.47 V	336	27.2	25.2

Remarks:

1. Emission Level(dBuV/m) = Raw Value(dBuV) + Correction Factor(dB/m)
2. Correction Factor(dB/m) = Antenna Factor(dB/m) + Cable Factor(dB) – Pre-Amplifier Factor(dB)
3. Margin value = Emission Level – Limit value
4. The other emission levels were very low against the limit.
5. " * ": Fundamental frequency.
6. " # ": The radiated frequency is out of the restricted band.

RF Mode	TX 802.11a	Channel	CH 149 : 5745 MHz
Frequency Range	1GHz ~ 40GHz	Detector Function	Peak (PK) Average (AV)

Antenna Polarity & Test Distance : Horizontal at 3 m

No	Frequency (MHz)	Emission Level (dBuV/m)	Limit (dBuV/m)	Margin (dB)	Antenna Height (m)	Table Angle (Degree)	Raw Value (dBuV)	Correction Factor (dB/m)
1	#5620.80	62.0 PK	68.2	-6.2	1.12 H	175	48.5	13.5
2	*5745.00	104.0 PK			1.12 H	175	60.4	43.6
3	*5745.00	93.9 AV			1.12 H	175	50.3	43.6
4	#5944.40	63.7 PK	68.2	-4.5	1.12 H	175	49.3	14.4
5	11490.00	65.8 PK	74.0	-8.2	2.08 H	223	40.5	25.3
6	11490.00	52.1 AV	54.0	-1.9	2.08 H	223	26.8	25.3

Antenna Polarity & Test Distance : Vertical at 3 m

No	Frequency (MHz)	Emission Level (dBuV/m)	Limit (dBuV/m)	Margin (dB)	Antenna Height (m)	Table Angle (Degree)	Raw Value (dBuV)	Correction Factor (dB/m)
1	#5622.00	62.4 PK	68.2	-5.8	2.50 V	141	48.9	13.5
2	*5745.00	107.9 PK			2.50 V	141	64.3	43.6
3	*5745.00	97.8 AV			2.50 V	141	54.2	43.6
4	#5958.00	63.0 PK	68.2	-5.2	2.50 V	141	48.6	14.4
5	11490.00	66.6 PK	74.0	-7.4	2.47 V	331	41.3	25.3
6	11490.00	52.6 AV	54.0	-1.4	2.47 V	331	27.3	25.3

Remarks:

1. Emission Level(dBuV/m) = Raw Value(dBuV) + Correction Factor(dB/m)
2. Correction Factor(dB/m) = Antenna Factor(dB/m) + Cable Factor(dB) – Pre-Amplifier Factor(dB)
3. Margin value = Emission Level – Limit value
4. The other emission levels were very low against the limit.
5. " * " : Fundamental frequency.
6. " # " : The radiated frequency is out of the restricted band.

RF Mode	TX 802.11a	Channel	CH 157 : 5785 MHz
Frequency Range	1GHz ~ 40GHz	Detector Function	Peak (PK) Average (AV)

Antenna Polarity & Test Distance : Horizontal at 3 m

No	Frequency (MHz)	Emission Level (dBuV/m)	Limit (dBuV/m)	Margin (dB)	Antenna Height (m)	Table Angle (Degree)	Raw Value (dBuV)	Correction Factor (dB/m)
1	#5614.40	61.8 PK	68.2	-6.4	1.15 H	183	48.3	13.5
2	*5785.00	104.6 PK			1.15 H	183	60.8	43.8
3	*5785.00	94.5 AV			1.15 H	183	50.7	43.8
4	#5982.40	63.0 PK	68.2	-5.2	1.15 H	183	48.7	14.3
5	11570.00	65.7 PK	74.0	-8.3	2.14 H	243	40.7	25.0
6	11570.00	51.9 AV	54.0	-2.1	2.14 H	243	26.9	25.0

Antenna Polarity & Test Distance : Vertical at 3 m

No	Frequency (MHz)	Emission Level (dBuV/m)	Limit (dBuV/m)	Margin (dB)	Antenna Height (m)	Table Angle (Degree)	Raw Value (dBuV)	Correction Factor (dB/m)
1	#5643.20	61.8 PK	68.2	-6.4	2.53 V	147	48.3	13.5
2	*5785.00	108.3 PK			2.53 V	147	64.5	43.8
3	*5785.00	98.2 AV			2.53 V	147	54.4	43.8
4	#5955.20	62.8 PK	68.2	-5.4	2.53 V	147	48.4	14.4
5	11570.00	66.3 PK	74.0	-7.7	2.57 V	332	41.3	25.0
6	11570.00	52.4 AV	54.0	-1.6	2.57 V	332	27.4	25.0

Remarks:

1. Emission Level(dBuV/m) = Raw Value(dBuV) + Correction Factor(dB/m)
2. Correction Factor(dB/m) = Antenna Factor(dB/m) + Cable Factor(dB) – Pre-Amplifier Factor(dB)
3. Margin value = Emission Level – Limit value
4. The other emission levels were very low against the limit.
5. " * ": Fundamental frequency.
6. " # ": The radiated frequency is out of the restricted band.

RF Mode	TX 802.11a	Channel	CH 165 : 5825 MHz
Frequency Range	1GHz ~ 40GHz	Detector Function	Peak (PK) Average (AV)

Antenna Polarity & Test Distance : Horizontal at 3 m

No	Frequency (MHz)	Emission Level (dBuV/m)	Limit (dBuV/m)	Margin (dB)	Antenna Height (m)	Table Angle (Degree)	Raw Value (dBuV)	Correction Factor (dB/m)
1	#5604.40	60.4 PK	68.2	-7.8	1.11 H	173	47.0	13.4
2	*5825.00	103.8 PK			1.11 H	173	59.8	44.0
3	*5825.00	93.7 AV			1.11 H	173	49.7	44.0
4	#5952.80	61.3 PK	68.2	-6.9	1.11 H	173	46.9	14.4
5	11650.00	65.2 PK	74.0	-8.8	1.94 H	226	40.6	24.6
6	11650.00	51.5 AV	54.0	-2.5	1.94 H	226	26.9	24.6

Antenna Polarity & Test Distance : Vertical at 3 m

No	Frequency (MHz)	Emission Level (dBuV/m)	Limit (dBuV/m)	Margin (dB)	Antenna Height (m)	Table Angle (Degree)	Raw Value (dBuV)	Correction Factor (dB/m)
1	#5621.60	61.1 PK	68.2	-7.1	2.53 V	143	47.6	13.5
2	*5825.00	107.5 PK			2.53 V	143	63.5	44.0
3	*5825.00	97.5 AV			2.53 V	143	53.5	44.0
4	#5957.60	62.8 PK	68.2	-5.4	2.53 V	143	48.4	14.4
5	11650.00	65.8 PK	74.0	-8.2	2.56 V	324	41.2	24.6
6	11650.00	51.8 AV	54.0	-2.2	2.56 V	324	27.2	24.6

Remarks:

1. Emission Level(dBuV/m) = Raw Value(dBuV) + Correction Factor(dB/m)
2. Correction Factor(dB/m) = Antenna Factor(dB/m) + Cable Factor(dB) – Pre-Amplifier Factor(dB)
3. Margin value = Emission Level – Limit value
4. The other emission levels were very low against the limit.
5. " * ": Fundamental frequency.
6. " # ": The radiated frequency is out of the restricted band.

RF Mode	TX 802.11ax (HE20)	Channel	CH 36 : 5180 MHz
Frequency Range	1GHz ~ 40GHz	Detector Function	Peak (PK) Average (AV)

Antenna Polarity & Test Distance : Horizontal at 3 m

No	Frequency (MHz)	Emission Level (dBuV/m)	Limit (dBuV/m)	Margin (dB)	Antenna Height (m)	Table Angle (Degree)	Raw Value (dBuV)	Correction Factor (dB/m)
1	5150.00	60.6 PK	74.0	-13.4	1.15 H	176	47.7	12.9
2	5150.00	48.1 AV	54.0	-5.9	1.15 H	176	35.2	12.9
3	*5180.00	102.9 PK			1.15 H	176	60.5	42.4
4	*5180.00	92.8 AV			1.15 H	176	50.4	42.4
5	#10360.00	63.3 PK	68.2	-4.9	1.97 H	235	40.7	22.6

Antenna Polarity & Test Distance : Vertical at 3 m

No	Frequency (MHz)	Emission Level (dBuV/m)	Limit (dBuV/m)	Margin (dB)	Antenna Height (m)	Table Angle (Degree)	Raw Value (dBuV)	Correction Factor (dB/m)
1	5150.00	61.4 PK	74.0	-12.6	1.62 V	160	48.5	12.9
2	5150.00	48.6 AV	54.0	-5.4	1.62 V	160	35.7	12.9
3	*5180.00	109.8 PK			1.62 V	160	67.4	42.4
4	*5180.00	96.5 AV			1.62 V	160	54.1	42.4
5	#10360.00	63.8 PK	68.2	-4.4	2.51 V	324	41.2	22.6

Remarks:

1. Emission Level(dBuV/m) = Raw Value(dBuV) + Correction Factor(dB/m)
2. Correction Factor(dB/m) = Antenna Factor(dB/m) + Cable Factor(dB) – Pre-Amplifier Factor(dB)
3. Margin value = Emission Level – Limit value
4. The other emission levels were very low against the limit.
5. " * " : Fundamental frequency.
6. " # " : The radiated frequency is out of the restricted band.

RF Mode	TX 802.11ax (HE20)	Channel	CH 40 : 5200 MHz
Frequency Range	1GHz ~ 40GHz	Detector Function	Peak (PK) Average (AV)

Antenna Polarity & Test Distance : Horizontal at 3 m

No	Frequency (MHz)	Emission Level (dBuV/m)	Limit (dBuV/m)	Margin (dB)	Antenna Height (m)	Table Angle (Degree)	Raw Value (dBuV)	Correction Factor (dB/m)
1	*5200.00	106.5 PK			1.16 H	171	64.3	42.2
2	*5200.00	93.3 AV			1.16 H	171	51.1	42.2
3	#10400.00	63.5 PK	68.2	-4.7	2.06 H	237	40.7	22.8

Antenna Polarity & Test Distance : Vertical at 3 m

No	Frequency (MHz)	Emission Level (dBuV/m)	Limit (dBuV/m)	Margin (dB)	Antenna Height (m)	Table Angle (Degree)	Raw Value (dBuV)	Correction Factor (dB/m)
1	*5200.00	110.1 PK			1.67 V	161	67.9	42.2
2	*5200.00	97.0 AV			1.67 V	161	54.8	42.2
3	#10400.00	64.1 PK	68.2	-4.1	2.53 V	327	41.3	22.8

Remarks:

1. Emission Level(dBuV/m) = Raw Value(dBuV) + Correction Factor(dB/m)
2. Correction Factor(dB/m) = Antenna Factor(dB/m) + Cable Factor(dB) – Pre-Amplifier Factor(dB)
3. Margin value = Emission Level – Limit value
4. The other emission levels were very low against the limit.
5. " * " : Fundamental frequency.
6. " # " : The radiated frequency is out of the restricted band.

RF Mode	TX 802.11ax (HE20)	Channel	CH 48 : 5240 MHz
Frequency Range	1GHz ~ 40GHz	Detector Function	Peak (PK) Average (AV)

Antenna Polarity & Test Distance : Horizontal at 3 m

No	Frequency (MHz)	Emission Level (dBuV/m)	Limit (dBuV/m)	Margin (dB)	Antenna Height (m)	Table Angle (Degree)	Raw Value (dBuV)	Correction Factor (dB/m)
1	*5240.00	106.1 PK			1.16 H	172	63.9	42.2
2	*5240.00	93.0 AV			1.16 H	172	50.8	42.2
3	5350.00	60.8 PK	74.0	-13.2	1.16 H	172	47.8	13.0
4	5350.00	47.7 AV	54.0	-6.3	1.16 H	172	34.7	13.0
5	#10480.00	63.4 PK	68.2	-4.8	2.12 H	226	40.6	22.8

Antenna Polarity & Test Distance : Vertical at 3 m

No	Frequency (MHz)	Emission Level (dBuV/m)	Limit (dBuV/m)	Margin (dB)	Antenna Height (m)	Table Angle (Degree)	Raw Value (dBuV)	Correction Factor (dB/m)
1	*5240.00	109.9 PK			1.62 V	162	67.7	42.2
2	*5240.00	96.7 AV			1.62 V	162	54.5	42.2
3	5350.00	61.3 PK	74.0	-12.7	1.62 V	162	48.3	13.0
4	5350.00	48.4 AV	54.0	-5.6	1.62 V	162	35.4	13.0
5	#10480.00	63.9 PK	68.2	-4.3	2.54 V	338	41.1	22.8

Remarks:

1. Emission Level(dBuV/m) = Raw Value(dBuV) + Correction Factor(dB/m)
2. Correction Factor(dB/m) = Antenna Factor(dB/m) + Cable Factor(dB) – Pre-Amplifier Factor(dB)
3. Margin value = Emission Level – Limit value
4. The other emission levels were very low against the limit.
5. " * " : Fundamental frequency.
6. " # " : The radiated frequency is out of the restricted band.

RF Mode	TX 802.11ax (HE20)	Channel	CH 52 : 5260 MHz
Frequency Range	1GHz ~ 40GHz	Detector Function	Peak (PK) Average (AV)

Antenna Polarity & Test Distance : Horizontal at 3 m

No	Frequency (MHz)	Emission Level (dBuV/m)	Limit (dBuV/m)	Margin (dB)	Antenna Height (m)	Table Angle (Degree)	Raw Value (dBuV)	Correction Factor (dB/m)
1	5150.00	60.1 PK	74.0	-13.9	1.17 H	168	47.2	12.9
2	5150.00	48.2 AV	54.0	-5.8	1.17 H	168	35.3	12.9
3	*5260.00	104.7 PK			1.17 H	168	62.4	42.3
4	*5260.00	92.4 AV			1.17 H	168	50.1	42.3
5	#10520.00	63.8 PK	68.2	-4.4	1.99 H	214	40.8	23.0

Antenna Polarity & Test Distance : Vertical at 3 m

No	Frequency (MHz)	Emission Level (dBuV/m)	Limit (dBuV/m)	Margin (dB)	Antenna Height (m)	Table Angle (Degree)	Raw Value (dBuV)	Correction Factor (dB/m)
1	5150.00	60.5 PK	74.0	-13.5	1.64 V	160	47.6	12.9
2	5150.00	48.6 AV	54.0	-5.4	1.64 V	160	35.7	12.9
3	*5260.00	108.6 PK			1.64 V	160	66.3	42.3
4	*5260.00	95.7 AV			1.64 V	160	53.4	42.3
5	#10520.00	64.5 PK	68.2	-3.7	2.41 V	328	41.5	23.0

Remarks:

1. Emission Level(dBuV/m) = Raw Value(dBuV) + Correction Factor(dB/m)
2. Correction Factor(dB/m) = Antenna Factor(dB/m) + Cable Factor(dB) – Pre-Amplifier Factor(dB)
3. Margin value = Emission Level – Limit value
4. The other emission levels were very low against the limit.
5. " * " : Fundamental frequency.
6. " # " : The radiated frequency is out of the restricted band.

RF Mode	TX 802.11ax (HE20)	Channel	CH 60 : 5300 MHz
Frequency Range	1GHz ~ 40GHz	Detector Function	Peak (PK) Average (AV)

Antenna Polarity & Test Distance : Horizontal at 3 m

No	Frequency (MHz)	Emission Level (dBuV/m)	Limit (dBuV/m)	Margin (dB)	Antenna Height (m)	Table Angle (Degree)	Raw Value (dBuV)	Correction Factor (dB/m)
1	*5300.00	104.6 PK			1.23 H	169	62.3	42.3
2	*5300.00	92.5 AV			1.23 H	169	50.2	42.3
3	10600.00	64.2 PK	74.0	-9.8	1.96 H	225	40.7	23.5
4	10600.00	49.7 AV	54.0	-4.3	1.96 H	225	26.2	23.5

Antenna Polarity & Test Distance : Vertical at 3 m

No	Frequency (MHz)	Emission Level (dBuV/m)	Limit (dBuV/m)	Margin (dB)	Antenna Height (m)	Table Angle (Degree)	Raw Value (dBuV)	Correction Factor (dB/m)
1	*5300.00	108.3 PK			1.64 V	159	66.0	42.3
2	*5300.00	95.7 AV			1.64 V	159	53.4	42.3
3	10600.00	65.1 PK	74.0	-8.9	2.44 V	319	41.6	23.5
4	10600.00	50.4 AV	54.0	-3.6	2.44 V	319	26.9	23.5

Remarks:

1. Emission Level(dBuV/m) = Raw Value(dBuV) + Correction Factor(dB/m)
2. Correction Factor(dB/m) = Antenna Factor(dB/m) + Cable Factor(dB) – Pre-Amplifier Factor(dB)
3. Margin value = Emission Level – Limit value
4. The other emission levels were very low against the limit.
5. " * " : Fundamental frequency.

RF Mode	TX 802.11ax (HE20)	Channel	CH 64 : 5320 MHz
Frequency Range	1GHz ~ 40GHz	Detector Function	Peak (PK) Average (AV)

Antenna Polarity & Test Distance : Horizontal at 3 m

No	Frequency (MHz)	Emission Level (dBuV/m)	Limit (dBuV/m)	Margin (dB)	Antenna Height (m)	Table Angle (Degree)	Raw Value (dBuV)	Correction Factor (dB/m)
1	*5320.00	104.4 PK			1.18 H	163	62.0	42.4
2	*5320.00	92.5 AV			1.18 H	163	50.1	42.4
3	5350.00	61.8 PK	74.0	-12.2	1.18 H	163	48.8	13.0
4	5350.00	48.2 AV	54.0	-5.8	1.18 H	163	35.2	13.0
5	10640.00	64.2 PK	74.0	-9.8	1.93 H	228	40.7	23.5
6	10640.00	49.7 AV	54.0	-4.3	1.93 H	228	26.2	23.5

Antenna Polarity & Test Distance : Vertical at 3 m

No	Frequency (MHz)	Emission Level (dBuV/m)	Limit (dBuV/m)	Margin (dB)	Antenna Height (m)	Table Angle (Degree)	Raw Value (dBuV)	Correction Factor (dB/m)
1	*5320.00	108.1 PK			1.64 V	159	65.7	42.4
2	*5320.00	95.9 AV			1.64 V	159	53.5	42.4
3	5350.00	62.7 PK	74.0	-11.3	1.64 V	159	49.7	13.0
4	5350.00	48.9 AV	54.0	-5.1	1.64 V	159	35.9	13.0
5	10640.00	64.9 PK	74.0	-9.1	2.39 V	324	41.4	23.5
6	10640.00	50.2 AV	54.0	-3.8	2.39 V	324	26.7	23.5

Remarks:

1. Emission Level(dBuV/m) = Raw Value(dBuV) + Correction Factor(dB/m)
2. Correction Factor(dB/m) = Antenna Factor(dB/m) + Cable Factor(dB) – Pre-Amplifier Factor(dB)
3. Margin value = Emission Level – Limit value
4. The other emission levels were very low against the limit.
5. " * ": Fundamental frequency.

RF Mode	TX 802.11ax (HE20)	Channel	CH 100 : 5500 MHz
Frequency Range	1GHz ~ 40GHz	Detector Function	Peak (PK) Average (AV)

Antenna Polarity & Test Distance : Horizontal at 3 m

No	Frequency (MHz)	Emission Level (dBuV/m)	Limit (dBuV/m)	Margin (dB)	Antenna Height (m)	Table Angle (Degree)	Raw Value (dBuV)	Correction Factor (dB/m)
1	5460.00	61.6 PK	74.0	-12.4	1.14 H	180	48.2	13.4
2	5460.00	48.9 AV	54.0	-5.1	1.14 H	180	35.5	13.4
3	#5470.00	62.5 PK	68.2	-5.7	1.14 H	180	48.9	13.6
4	*5500.00	106.4 PK			1.14 H	180	63.2	43.2
5	*5500.00	93.6 AV			1.14 H	180	50.4	43.2
6	11000.00	65.0 PK	74.0	-9.0	2.03 H	228	40.6	24.4
7	11000.00	51.2 AV	54.0	-2.8	2.03 H	228	26.8	24.4

Antenna Polarity & Test Distance : Vertical at 3 m

No	Frequency (MHz)	Emission Level (dBuV/m)	Limit (dBuV/m)	Margin (dB)	Antenna Height (m)	Table Angle (Degree)	Raw Value (dBuV)	Correction Factor (dB/m)
1	5460.00	62.1 PK	74.0	-11.9	2.54 V	127	48.7	13.4
2	5460.00	49.9 AV	54.0	-4.1	2.54 V	127	36.5	13.4
3	#5470.00	63.2 PK	68.2	-5.0	2.54 V	127	49.6	13.6
4	*5500.00	110.4 PK			2.54 V	127	67.2	43.2
5	*5500.00	97.4 AV			2.54 V	127	54.2	43.2
6	11000.00	65.9 PK	74.0	-8.1	2.58 V	336	41.5	24.4
7	11000.00	51.8 AV	54.0	-2.2	2.58 V	336	27.4	24.4

Remarks:

1. Emission Level(dBuV/m) = Raw Value(dBuV) + Correction Factor(dB/m)
2. Correction Factor(dB/m) = Antenna Factor(dB/m) + Cable Factor(dB) – Pre-Amplifier Factor(dB)
3. Margin value = Emission Level – Limit value
4. The other emission levels were very low against the limit.
5. " * ": Fundamental frequency.
6. " # ": The radiated frequency is out of the restricted band.

RF Mode	TX 802.11ax (HE20)	Channel	CH 116 : 5580 MHz
Frequency Range	1GHz ~ 40GHz	Detector Function	Peak (PK) Average (AV)

Antenna Polarity & Test Distance : Horizontal at 3 m

No	Frequency (MHz)	Emission Level (dBuV/m)	Limit (dBuV/m)	Margin (dB)	Antenna Height (m)	Table Angle (Degree)	Raw Value (dBuV)	Correction Factor (dB/m)
1	*5580.00	106.8 PK			1.15 H	182	63.7	43.1
2	*5580.00	93.8 AV			1.15 H	182	50.7	43.1
3	11160.00	64.9 PK	74.0	-9.1	1.93 H	242	40.5	24.4
4	11160.00	51.2 AV	54.0	-2.8	1.93 H	242	26.8	24.4

Antenna Polarity & Test Distance : Vertical at 3 m

No	Frequency (MHz)	Emission Level (dBuV/m)	Limit (dBuV/m)	Margin (dB)	Antenna Height (m)	Table Angle (Degree)	Raw Value (dBuV)	Correction Factor (dB/m)
1	*5580.00	110.5 PK			2.51 V	137	67.4	43.1
2	*5580.00	97.6 AV			2.51 V	137	54.5	43.1
3	11160.00	65.6 PK	74.0	-8.4	2.56 V	334	41.2	24.4
4	11160.00	51.5 AV	54.0	-2.5	2.56 V	334	27.1	24.4

Remarks:

1. Emission Level(dBuV/m) = Raw Value(dBuV) + Correction Factor(dB/m)
2. Correction Factor(dB/m) = Antenna Factor(dB/m) + Cable Factor(dB) – Pre-Amplifier Factor(dB)
3. Margin value = Emission Level – Limit value
4. The other emission levels were very low against the limit.
5. " * " : Fundamental frequency.

RF Mode	TX 802.11ax (HE20)	Channel	CH 140 : 5700 MHz
Frequency Range	1GHz ~ 40GHz	Detector Function	Peak (PK) Average (AV)

Antenna Polarity & Test Distance : Horizontal at 3 m

No	Frequency (MHz)	Emission Level (dBuV/m)	Limit (dBuV/m)	Margin (dB)	Antenna Height (m)	Table Angle (Degree)	Raw Value (dBuV)	Correction Factor (dB/m)
1	*5700.00	106.0 PK			1.16 H	181	62.9	43.1
2	*5700.00	93.2 AV			1.16 H	181	50.1	43.1
3	#5725.00	62.0 PK	68.2	-6.2	1.16 H	181	48.3	13.7
4	11400.00	65.7 PK	74.0	-8.3	2.03 H	236	40.5	25.2
5	11400.00	51.9 AV	54.0	-2.1	2.03 H	236	26.7	25.2

Antenna Polarity & Test Distance : Vertical at 3 m

No	Frequency (MHz)	Emission Level (dBuV/m)	Limit (dBuV/m)	Margin (dB)	Antenna Height (m)	Table Angle (Degree)	Raw Value (dBuV)	Correction Factor (dB/m)
1	*5700.00	109.7 PK			2.55 V	147	66.6	43.1
2	*5700.00	96.9 AV			2.55 V	147	53.8	43.1
3	#5725.00	63.5 PK	68.2	-4.7	2.55 V	147	49.8	13.7
4	11400.00	66.5 PK	74.0	-7.5	2.42 V	327	41.3	25.2
5	11400.00	52.4 AV	54.0	-1.6	2.42 V	327	27.2	25.2

Remarks:

1. Emission Level(dBuV/m) = Raw Value(dBuV) + Correction Factor(dB/m)
2. Correction Factor(dB/m) = Antenna Factor(dB/m) + Cable Factor(dB) – Pre-Amplifier Factor(dB)
3. Margin value = Emission Level – Limit value
4. The other emission levels were very low against the limit.
5. " * " : Fundamental frequency.
6. " # " : The radiated frequency is out of the restricted band.

RF Mode	TX 802.11ax (HE20)	Channel	CH 144 : 5720 MHz
Frequency Range	1GHz ~ 40GHz	Detector Function	Peak (PK) Average (AV)

Antenna Polarity & Test Distance : Horizontal at 3 m

No	Frequency (MHz)	Emission Level (dBuV/m)	Limit (dBuV/m)	Margin (dB)	Antenna Height (m)	Table Angle (Degree)	Raw Value (dBuV)	Correction Factor (dB/m)
1	#5470.00	62.0 PK	68.2	-6.2	1.10 H	175	48.4	13.6
2	*5720.00	107.1 PK			1.10 H	175	63.7	43.4
3	*5720.00	93.3 AV			1.10 H	175	49.9	43.4
4	#5850.00	62.6 PK	68.2	-5.6	1.10 H	175	48.3	14.3
5	11440.00	65.6 PK	74.0	-8.4	1.93 H	246	40.4	25.2
6	11440.00	51.9 AV	54.0	-2.1	1.93 H	246	26.7	25.2

Antenna Polarity & Test Distance : Vertical at 3 m

No	Frequency (MHz)	Emission Level (dBuV/m)	Limit (dBuV/m)	Margin (dB)	Antenna Height (m)	Table Angle (Degree)	Raw Value (dBuV)	Correction Factor (dB/m)
1	#5470.00	62.3 PK	68.2	-5.9	2.63 V	143	48.7	13.6
2	*5720.00	109.9 PK			2.63 V	143	66.5	43.4
3	*5720.00	97.0 AV			2.63 V	143	53.6	43.4
4	#5850.00	63.6 PK	68.2	-4.6	2.63 V	143	49.3	14.3
5	11440.00	66.5 PK	74.0	-7.5	2.64 V	341	41.3	25.2
6	11440.00	52.5 AV	54.0	-1.5	2.64 V	341	27.3	25.2

Remarks:

1. Emission Level(dBuV/m) = Raw Value(dBuV) + Correction Factor(dB/m)
2. Correction Factor(dB/m) = Antenna Factor(dB/m) + Cable Factor(dB) – Pre-Amplifier Factor(dB)
3. Margin value = Emission Level – Limit value
4. The other emission levels were very low against the limit.
5. " * " : Fundamental frequency.
6. " # " : The radiated frequency is out of the restricted band.

RF Mode	TX 802.11ax (HE20)	Channel	CH 149 : 5745 MHz
Frequency Range	1GHz ~ 40GHz	Detector Function	Peak (PK) Average (AV)

Antenna Polarity & Test Distance : Horizontal at 3 m

No	Frequency (MHz)	Emission Level (dBuV/m)	Limit (dBuV/m)	Margin (dB)	Antenna Height (m)	Table Angle (Degree)	Raw Value (dBuV)	Correction Factor (dB/m)
1	#5607.60	61.7 PK	68.2	-6.5	1.12 H	179	48.2	13.5
2	*5745.00	105.8 PK			1.12 H	179	62.2	43.6
3	*5745.00	92.9 AV			1.12 H	179	49.3	43.6
4	#5940.80	63.5 PK	68.2	-4.7	1.12 H	179	49.1	14.4
5	11490.00	65.9 PK	74.0	-8.1	2.04 H	225	40.6	25.3
6	11490.00	52.1 AV	54.0	-1.9	2.04 H	225	26.8	25.3

Antenna Polarity & Test Distance : Vertical at 3 m

No	Frequency (MHz)	Emission Level (dBuV/m)	Limit (dBuV/m)	Margin (dB)	Antenna Height (m)	Table Angle (Degree)	Raw Value (dBuV)	Correction Factor (dB/m)
1	#5632.00	63.1 PK	68.2	-5.1	2.53 V	146	49.6	13.5
2	*5745.00	109.8 PK			2.53 V	146	66.2	43.6
3	*5745.00	96.9 AV			2.53 V	146	53.3	43.6
4	#5963.60	62.8 PK	68.2	-5.4	2.53 V	146	48.4	14.4
5	11490.00	66.6 PK	74.0	-7.4	2.47 V	339	41.3	25.3
6	11490.00	52.6 AV	54.0	-1.4	2.47 V	339	27.3	25.3

Remarks:

1. Emission Level(dBuV/m) = Raw Value(dBuV) + Correction Factor(dB/m)
2. Correction Factor(dB/m) = Antenna Factor(dB/m) + Cable Factor(dB) – Pre-Amplifier Factor(dB)
3. Margin value = Emission Level – Limit value
4. The other emission levels were very low against the limit.
5. " * " : Fundamental frequency.
6. " # " : The radiated frequency is out of the restricted band.

RF Mode	TX 802.11ax (HE20)	Channel	CH 157 : 5785 MHz
Frequency Range	1GHz ~ 40GHz	Detector Function	Peak (PK) Average (AV)

Antenna Polarity & Test Distance : Horizontal at 3 m

No	Frequency (MHz)	Emission Level (dBuV/m)	Limit (dBuV/m)	Margin (dB)	Antenna Height (m)	Table Angle (Degree)	Raw Value (dBuV)	Correction Factor (dB/m)
1	#5621.20	61.8 PK	68.2	-6.4	1.17 H	178	48.3	13.5
2	*5785.00	106.0 PK			1.17 H	178	62.2	43.8
3	*5785.00	93.1 AV			1.17 H	178	49.3	43.8
4	#5950.00	63.1 PK	68.2	-5.1	1.17 H	178	48.7	14.4
5	11570.00	65.5 PK	74.0	-8.5	1.97 H	226	40.5	25.0
6	11570.00	51.7 AV	54.0	-2.3	1.97 H	226	26.7	25.0

Antenna Polarity & Test Distance : Vertical at 3 m

No	Frequency (MHz)	Emission Level (dBuV/m)	Limit (dBuV/m)	Margin (dB)	Antenna Height (m)	Table Angle (Degree)	Raw Value (dBuV)	Correction Factor (dB/m)
1	#5626.00	61.6 PK	68.2	-6.6	2.54 V	147	48.1	13.5
2	*5785.00	109.8 PK			2.54 V	147	66.0	43.8
3	*5785.00	96.9 AV			2.54 V	147	53.1	43.8
4	#5999.20	63.0 PK	68.2	-5.2	2.54 V	147	48.7	14.3
5	11570.00	65.6 PK	74.0	-8.4	2.11 V	226	40.6	25.0
6	11570.00	51.9 AV	54.0	-2.1	2.11 V	226	26.9	25.0

Remarks:

1. Emission Level(dBuV/m) = Raw Value(dBuV) + Correction Factor(dB/m)
2. Correction Factor(dB/m) = Antenna Factor(dB/m) + Cable Factor(dB) – Pre-Amplifier Factor(dB)
3. Margin value = Emission Level – Limit value
4. The other emission levels were very low against the limit.
5. " * " : Fundamental frequency.
6. " # " : The radiated frequency is out of the restricted band.

RF Mode	TX 802.11ax (HE20)	Channel	CH 165 : 5825 MHz
Frequency Range	1GHz ~ 40GHz	Detector Function	Peak (PK) Average (AV)

Antenna Polarity & Test Distance : Horizontal at 3 m

No	Frequency (MHz)	Emission Level (dBuV/m)	Limit (dBuV/m)	Margin (dB)	Antenna Height (m)	Table Angle (Degree)	Raw Value (dBuV)	Correction Factor (dB/m)
1	#5644.80	61.8 PK	68.2	-6.4	1.10 H	175	48.3	13.5
2	*5825.00	105.2 PK			1.10 H	175	61.2	44.0
3	*5825.00	92.3 AV			1.10 H	175	48.3	44.0
4	#5938.40	62.7 PK	68.2	-5.5	1.10 H	175	48.3	14.4
5	11650.00	65.1 PK	74.0	-8.9	2.05 H	231	40.5	24.6
6	11650.00	51.2 AV	54.0	-2.8	2.05 H	231	26.6	24.6

Antenna Polarity & Test Distance : Vertical at 3 m

No	Frequency (MHz)	Emission Level (dBuV/m)	Limit (dBuV/m)	Margin (dB)	Antenna Height (m)	Table Angle (Degree)	Raw Value (dBuV)	Correction Factor (dB/m)
1	#5615.60	61.5 PK	68.2	-6.7	2.72 V	145	48.0	13.5
2	*5825.00	109.1 PK			2.72 V	145	65.1	44.0
3	*5825.00	96.2 AV			2.72 V	145	52.2	44.0
4	#5956.00	62.8 PK	68.2	-5.4	2.72 V	145	48.4	14.4
5	11650.00	65.7 PK	74.0	-8.3	2.62 V	337	41.1	24.6
6	11650.00	51.7 AV	54.0	-2.3	2.62 V	337	27.1	24.6

Remarks:

1. Emission Level(dBuV/m) = Raw Value(dBuV) + Correction Factor(dB/m)
2. Correction Factor(dB/m) = Antenna Factor(dB/m) + Cable Factor(dB) – Pre-Amplifier Factor(dB)
3. Margin value = Emission Level – Limit value
4. The other emission levels were very low against the limit.
5. " * " : Fundamental frequency.
6. " # " : The radiated frequency is out of the restricted band.

RF Mode	TX 802.11ax (HE40)	Channel	CH 38 : 5190 MHz
Frequency Range	1GHz ~ 40GHz	Detector Function	Peak (PK) Average (AV)

Antenna Polarity & Test Distance : Horizontal at 3 m

No	Frequency (MHz)	Emission Level (dBuV/m)	Limit (dBuV/m)	Margin (dB)	Antenna Height (m)	Table Angle (Degree)	Raw Value (dBuV)	Correction Factor (dB/m)
1	5150.00	61.3 PK	74.0	-12.7	1.11 H	172	48.4	12.9
2	5150.00	47.8 AV	54.0	-6.2	1.11 H	172	34.9	12.9
3	*5190.00	103.4 PK			1.11 H	172	61.1	42.3
4	*5190.00	90.5 AV			1.11 H	172	48.2	42.3
5	#10380.00	63.1 PK	68.2	-5.1	2.01 H	223	40.4	22.7

Antenna Polarity & Test Distance : Vertical at 3 m

No	Frequency (MHz)	Emission Level (dBuV/m)	Limit (dBuV/m)	Margin (dB)	Antenna Height (m)	Table Angle (Degree)	Raw Value (dBuV)	Correction Factor (dB/m)
1	5150.00	61.7 PK	74.0	-12.3	1.73 V	162	48.8	12.9
2	5150.00	48.5 AV	54.0	-5.5	1.73 V	162	35.6	12.9
3	*5190.00	107.0 PK			1.73 V	162	64.7	42.3
4	*5190.00	94.3 AV			1.73 V	162	52.0	42.3
5	#10380.00	63.6 PK	68.2	-4.6	2.57 V	326	40.9	22.7

Remarks:

1. Emission Level(dBuV/m) = Raw Value(dBuV) + Correction Factor(dB/m)
2. Correction Factor(dB/m) = Antenna Factor(dB/m) + Cable Factor(dB) – Pre-Amplifier Factor(dB)
3. Margin value = Emission Level – Limit value
4. The other emission levels were very low against the limit.
5. " * " : Fundamental frequency.
6. " # " : The radiated frequency is out of the restricted band.

RF Mode	TX 802.11ax (HE40)	Channel	CH 46 : 5230 MHz
Frequency Range	1GHz ~ 40GHz	Detector Function	Peak (PK) Average (AV)

Antenna Polarity & Test Distance : Horizontal at 3 m

No	Frequency (MHz)	Emission Level (dBuV/m)	Limit (dBuV/m)	Margin (dB)	Antenna Height (m)	Table Angle (Degree)	Raw Value (dBuV)	Correction Factor (dB/m)
1	*5230.00	103.9 PK			1.13 H	179	61.7	42.2
2	*5230.00	91.1 AV			1.13 H	179	48.9	42.2
3	5350.00	60.9 PK	74.0	-13.1	1.13 H	179	47.9	13.0
4	5350.00	47.5 AV	54.0	-6.5	1.13 H	179	34.5	13.0
5	#10460.00	63.2 PK	68.2	-5.0	2.11 H	229	40.3	22.9

Antenna Polarity & Test Distance : Vertical at 3 m

No	Frequency (MHz)	Emission Level (dBuV/m)	Limit (dBuV/m)	Margin (dB)	Antenna Height (m)	Table Angle (Degree)	Raw Value (dBuV)	Correction Factor (dB/m)
1	*5230.00	107.5 PK			1.53 V	162	65.3	42.2
2	*5230.00	94.7 AV			1.53 V	162	52.5	42.2
3	5350.00	61.6 PK	74.0	-12.4	1.53 V	162	48.6	13.0
4	5350.00	48.2 AV	54.0	-5.8	1.53 V	162	35.2	13.0
5	#10460.00	63.7 PK	68.2	-4.5	2.52 V	331	40.8	22.9

Remarks:

1. Emission Level(dBuV/m) = Raw Value(dBuV) + Correction Factor(dB/m)
2. Correction Factor(dB/m) = Antenna Factor(dB/m) + Cable Factor(dB) – Pre-Amplifier Factor(dB)
3. Margin value = Emission Level – Limit value
4. The other emission levels were very low against the limit.
5. " * " : Fundamental frequency.
6. " # " : The radiated frequency is out of the restricted band.

RF Mode	TX 802.11ax (HE40)	Channel	CH 54 : 5270 MHz
Frequency Range	1GHz ~ 40GHz	Detector Function	Peak (PK) Average (AV)

Antenna Polarity & Test Distance : Horizontal at 3 m

No	Frequency (MHz)	Emission Level (dBuV/m)	Limit (dBuV/m)	Margin (dB)	Antenna Height (m)	Table Angle (Degree)	Raw Value (dBuV)	Correction Factor (dB/m)
1	5150.00	59.8 PK	74.0	-14.2	1.19 H	165	46.9	12.9
2	5150.00	47.6 AV	54.0	-6.4	1.19 H	165	34.7	12.9
3	*5270.00	102.0 PK			1.19 H	165	59.7	42.3
4	*5270.00	90.6 AV			1.19 H	165	48.3	42.3
5	#10540.00	64.0 PK	68.2	-4.2	1.86 H	217	40.9	23.1

Antenna Polarity & Test Distance : Vertical at 3 m

No	Frequency (MHz)	Emission Level (dBuV/m)	Limit (dBuV/m)	Margin (dB)	Antenna Height (m)	Table Angle (Degree)	Raw Value (dBuV)	Correction Factor (dB/m)
1	5150.00	60.7 PK	74.0	-13.3	1.64 V	159	47.8	12.9
2	5150.00	48.3 AV	54.0	-5.7	1.64 V	159	35.4	12.9
3	*5270.00	105.6 PK			1.64 V	159	63.3	42.3
4	*5270.00	93.4 AV			1.64 V	159	51.1	42.3
5	#10540.00	64.4 PK	68.2	-3.8	2.31 V	326	41.3	23.1

Remarks:

1. Emission Level(dBuV/m) = Raw Value(dBuV) + Correction Factor(dB/m)
2. Correction Factor(dB/m) = Antenna Factor(dB/m) + Cable Factor(dB) – Pre-Amplifier Factor(dB)
3. Margin value = Emission Level – Limit value
4. The other emission levels were very low against the limit.
5. " * " : Fundamental frequency.
6. " # " : The radiated frequency is out of the restricted band.

RF Mode	TX 802.11ax (HE40)	Channel	CH 62 : 5310 MHz
Frequency Range	1GHz ~ 40GHz	Detector Function	Peak (PK) Average (AV)

Antenna Polarity & Test Distance : Horizontal at 3 m

No	Frequency (MHz)	Emission Level (dBuV/m)	Limit (dBuV/m)	Margin (dB)	Antenna Height (m)	Table Angle (Degree)	Raw Value (dBuV)	Correction Factor (dB/m)
1	*5310.00	101.7 PK			1.22 H	163	59.3	42.4
2	*5310.00	90.0 AV			1.22 H	163	47.6	42.4
3	5350.00	62.2 PK	74.0	-11.8	1.22 H	163	49.2	13.0
4	5350.00	48.1 AV	54.0	-5.9	1.22 H	163	35.1	13.0
5	10620.00	64.2 PK	74.0	-9.8	1.99 H	214	40.8	23.4
6	10620.00	49.7 AV	54.0	-4.3	1.99 H	214	26.3	23.4

Antenna Polarity & Test Distance : Vertical at 3 m

No	Frequency (MHz)	Emission Level (dBuV/m)	Limit (dBuV/m)	Margin (dB)	Antenna Height (m)	Table Angle (Degree)	Raw Value (dBuV)	Correction Factor (dB/m)
1	*5310.00	105.3 PK			1.66 V	160	62.9	42.4
2	*5310.00	93.5 AV			1.66 V	160	51.1	42.4
3	5350.00	62.8 PK	74.0	-11.2	1.66 V	160	49.8	13.0
4	5350.00	48.7 AV	54.0	-5.3	1.66 V	160	35.7	13.0
5	10620.00	64.7 PK	74.0	-9.3	2.41 V	329	41.3	23.4
6	10620.00	50.2 AV	54.0	-3.8	2.41 V	329	26.8	23.4

Remarks:

1. Emission Level(dBuV/m) = Raw Value(dBuV) + Correction Factor(dB/m)
2. Correction Factor(dB/m) = Antenna Factor(dB/m) + Cable Factor(dB) – Pre-Amplifier Factor(dB)
3. Margin value = Emission Level – Limit value
4. The other emission levels were very low against the limit.
5. " * ": Fundamental frequency.

RF Mode	TX 802.11ax (HE40)	Channel	CH 102 : 5510 MHz
Frequency Range	1GHz ~ 40GHz	Detector Function	Peak (PK) Average (AV)

Antenna Polarity & Test Distance : Horizontal at 3 m

No	Frequency (MHz)	Emission Level (dBuV/m)	Limit (dBuV/m)	Margin (dB)	Antenna Height (m)	Table Angle (Degree)	Raw Value (dBuV)	Correction Factor (dB/m)
1	5460.00	61.3 PK	74.0	-12.7	1.11 H	184	47.9	13.4
2	5460.00	49.1 AV	54.0	-4.9	1.11 H	184	35.7	13.4
3	#5470.00	61.9 PK	68.2	-6.3	1.11 H	184	48.3	13.6
4	*5510.00	103.8 PK			1.11 H	184	60.6	43.2
5	*5510.00	90.9 AV			1.11 H	184	47.7	43.2
6	11020.00	64.6 PK	74.0	-9.4	1.97 H	226	40.3	24.3
7	11020.00	50.9 AV	54.0	-3.1	1.97 H	226	26.6	24.3

Antenna Polarity & Test Distance : Vertical at 3 m

No	Frequency (MHz)	Emission Level (dBuV/m)	Limit (dBuV/m)	Margin (dB)	Antenna Height (m)	Table Angle (Degree)	Raw Value (dBuV)	Correction Factor (dB/m)
1	5460.00	62.0 PK	74.0	-12.0	2.62 V	145	48.6	13.4
2	5460.00	49.8 AV	54.0	-4.2	2.62 V	145	36.4	13.4
3	#5470.00	62.9 PK	68.2	-5.3	2.62 V	145	49.3	13.6
4	*5510.00	107.6 PK			2.62 V	145	64.4	43.2
5	*5510.00	94.7 AV			2.62 V	145	51.5	43.2
6	11020.00	65.2 PK	74.0	-8.8	2.46 V	327	40.9	24.3
7	11020.00	51.4 AV	54.0	-2.6	2.46 V	327	27.1	24.3

Remarks:

1. Emission Level(dBuV/m) = Raw Value(dBuV) + Correction Factor(dB/m)
2. Correction Factor(dB/m) = Antenna Factor(dB/m) + Cable Factor(dB) – Pre-Amplifier Factor(dB)
3. Margin value = Emission Level – Limit value
4. The other emission levels were very low against the limit.
5. " * ": Fundamental frequency.
6. " # ": The radiated frequency is out of the restricted band.

RF Mode	TX 802.11ax (HE40)	Channel	CH 110 : 5550 MHz
Frequency Range	1GHz ~ 40GHz	Detector Function	Peak (PK) Average (AV)

Antenna Polarity & Test Distance : Horizontal at 3 m

No	Frequency (MHz)	Emission Level (dBuV/m)	Limit (dBuV/m)	Margin (dB)	Antenna Height (m)	Table Angle (Degree)	Raw Value (dBuV)	Correction Factor (dB/m)
1	*5550.00	103.9 PK			1.17 H	187	60.7	43.2
2	*5550.00	91.0 AV			1.17 H	187	47.8	43.2
3	11100.00	64.6 PK	74.0	-9.4	1.94 H	223	40.3	24.3
4	11100.00	50.8 AV	54.0	-3.2	1.94 H	223	26.5	24.3

Antenna Polarity & Test Distance : Vertical at 3 m

No	Frequency (MHz)	Emission Level (dBuV/m)	Limit (dBuV/m)	Margin (dB)	Antenna Height (m)	Table Angle (Degree)	Raw Value (dBuV)	Correction Factor (dB/m)
1	*5550.00	107.7 PK			2.53 V	148	64.5	43.2
2	*5550.00	94.9 AV			2.53 V	148	51.7	43.2
3	11100.00	65.2 PK	74.0	-8.8	2.46 V	331	40.9	24.3
4	11100.00	51.4 AV	54.0	-2.6	2.46 V	331	27.1	24.3

Remarks:

1. Emission Level(dBuV/m) = Raw Value(dBuV) + Correction Factor(dB/m)
2. Correction Factor(dB/m) = Antenna Factor(dB/m) + Cable Factor(dB) – Pre-Amplifier Factor(dB)
3. Margin value = Emission Level – Limit value
4. The other emission levels were very low against the limit.
5. " * " : Fundamental frequency.

RF Mode	TX 802.11ax (HE40)	Channel	CH 134 : 5670 MHz
Frequency Range	1GHz ~ 40GHz	Detector Function	Peak (PK) Average (AV)

Antenna Polarity & Test Distance : Horizontal at 3 m

No	Frequency (MHz)	Emission Level (dBuV/m)	Limit (dBuV/m)	Margin (dB)	Antenna Height (m)	Table Angle (Degree)	Raw Value (dBuV)	Correction Factor (dB/m)
1	*5670.00	103.5 PK			1.17 H	174	60.4	43.1
2	*5670.00	90.5 AV			1.17 H	174	47.4	43.1
3	#5725.00	61.4 PK	68.2	-6.8	1.17 H	174	47.7	13.7
4	11340.00	65.5 PK	74.0	-8.5	2.02 H	235	40.4	25.1
5	11340.00	51.9 AV	54.0	-2.1	2.02 H	235	26.8	25.1

Antenna Polarity & Test Distance : Vertical at 3 m

No	Frequency (MHz)	Emission Level (dBuV/m)	Limit (dBuV/m)	Margin (dB)	Antenna Height (m)	Table Angle (Degree)	Raw Value (dBuV)	Correction Factor (dB/m)
1	*5670.00	107.2 PK			2.46 V	143	64.1	43.1
2	*5670.00	94.3 AV			2.46 V	143	51.2	43.1
3	#5725.00	62.0 PK	68.2	-6.2	2.46 V	143	48.3	13.7
4	11340.00	65.9 PK	74.0	-8.1	2.55 V	331	40.8	25.1
5	11340.00	52.2 AV	54.0	-1.8	2.55 V	331	27.1	25.1

Remarks:

1. Emission Level(dBuV/m) = Raw Value(dBuV) + Correction Factor(dB/m)
2. Correction Factor(dB/m) = Antenna Factor(dB/m) + Cable Factor(dB) – Pre-Amplifier Factor(dB)
3. Margin value = Emission Level – Limit value
4. The other emission levels were very low against the limit.
5. " * " : Fundamental frequency.
6. " # " : The radiated frequency is out of the restricted band.

RF Mode	TX 802.11ax (HE40)	Channel	CH 142 : 5710 MHz
Frequency Range	1GHz ~ 40GHz	Detector Function	Peak (PK) Average (AV)

Antenna Polarity & Test Distance : Horizontal at 3 m

No	Frequency (MHz)	Emission Level (dBuV/m)	Limit (dBuV/m)	Margin (dB)	Antenna Height (m)	Table Angle (Degree)	Raw Value (dBuV)	Correction Factor (dB/m)
1	#5470.00	61.2 PK	68.2	-7.0	1.14 H	186	47.6	13.6
2	*5710.00	103.7 PK			1.14 H	186	60.5	43.2
3	*5710.00	90.7 AV			1.14 H	186	47.5	43.2
4	#5850.00	62.1 PK	68.2	-6.1	1.14 H	186	47.8	14.3
5	11420.00	65.7 PK	74.0	-8.3	1.98 H	225	40.4	25.3
6	11420.00	51.9 AV	54.0	-2.1	1.98 H	225	26.6	25.3

Antenna Polarity & Test Distance : Vertical at 3 m

No	Frequency (MHz)	Emission Level (dBuV/m)	Limit (dBuV/m)	Margin (dB)	Antenna Height (m)	Table Angle (Degree)	Raw Value (dBuV)	Correction Factor (dB/m)
1	#5470.00	61.9 PK	68.2	-6.3	2.56 V	147	48.3	13.6
2	*5710.00	107.4 PK			2.56 V	147	64.2	43.2
3	*5710.00	94.6 AV			2.56 V	147	51.4	43.2
4	#5850.00	62.8 PK	68.2	-5.4	2.56 V	147	48.5	14.3
5	11340.00	65.5 PK	74.0	-8.5	2.51 V	237	40.4	25.1
6	11340.00	51.9 AV	54.0	-2.1	2.51 V	237	26.8	25.1

Remarks:

1. Emission Level(dBuV/m) = Raw Value(dBuV) + Correction Factor(dB/m)
2. Correction Factor(dB/m) = Antenna Factor(dB/m) + Cable Factor(dB) – Pre-Amplifier Factor(dB)
3. Margin value = Emission Level – Limit value
4. The other emission levels were very low against the limit.
5. " * " : Fundamental frequency.
6. " # " : The radiated frequency is out of the restricted band.

RF Mode	TX 802.11ax (HE40)	Channel	CH 151 : 5755 MHz
Frequency Range	1GHz ~ 40GHz	Detector Function	Peak (PK) Average (AV)

Antenna Polarity & Test Distance : Horizontal at 3 m

No	Frequency (MHz)	Emission Level (dBuV/m)	Limit (dBuV/m)	Margin (dB)	Antenna Height (m)	Table Angle (Degree)	Raw Value (dBuV)	Correction Factor (dB/m)
1	#5612.80	61.9 PK	68.2	-6.3	1.13 H	185	48.4	13.5
2	*5755.00	102.7 PK			1.13 H	185	59.1	43.6
3	*5755.00	89.7 AV			1.13 H	185	46.1	43.6
4	#5938.00	63.3 PK	68.2	-4.9	1.13 H	185	48.9	14.4
5	11510.00	65.6 PK	74.0	-8.4	2.07 H	236	40.4	25.2
6	11510.00	51.9 AV	54.0	-2.1	2.07 H	236	26.7	25.2

Antenna Polarity & Test Distance : Vertical at 3 m

No	Frequency (MHz)	Emission Level (dBuV/m)	Limit (dBuV/m)	Margin (dB)	Antenna Height (m)	Table Angle (Degree)	Raw Value (dBuV)	Correction Factor (dB/m)
1	#5605.20	61.1 PK	68.2	-7.1	2.41 V	144	47.7	13.4
2	*5755.00	106.4 PK			2.41 V	144	62.8	43.6
3	*5755.00	93.5 AV			2.41 V	144	49.9	43.6
4	#5992.00	62.2 PK	68.2	-6.0	2.41 V	144	47.9	14.3
5	11510.00	66.1 PK	74.0	-7.9	2.39 V	322	40.9	25.2
6	11510.00	52.0 AV	54.0	-2.0	2.39 V	322	26.8	25.2

Remarks:

1. Emission Level(dBuV/m) = Raw Value(dBuV) + Correction Factor(dB/m)
2. Correction Factor(dB/m) = Antenna Factor(dB/m) + Cable Factor(dB) – Pre-Amplifier Factor(dB)
3. Margin value = Emission Level – Limit value
4. The other emission levels were very low against the limit.
5. " * " : Fundamental frequency.
6. " # " : The radiated frequency is out of the restricted band.

RF Mode	TX 802.11ax (HE40)	Channel	CH 159 : 5795 MHz
Frequency Range	1GHz ~ 40GHz	Detector Function	Peak (PK) Average (AV)

Antenna Polarity & Test Distance : Horizontal at 3 m

No	Frequency (MHz)	Emission Level (dBuV/m)	Limit (dBuV/m)	Margin (dB)	Antenna Height (m)	Table Angle (Degree)	Raw Value (dBuV)	Correction Factor (dB/m)
1	#5647.20	61.8 PK	68.2	-6.4	1.14 H	174	48.4	13.4
2	*5795.00	102.6 PK			1.14 H	174	58.7	43.9
3	*5795.00	89.7 AV			1.14 H	174	45.8	43.9
4	#5954.00	63.6 PK	68.2	-4.6	1.14 H	174	49.2	14.4
5	11590.00	65.2 PK	74.0	-8.8	1.92 H	223	40.3	24.9
6	11590.00	51.4 AV	54.0	-2.6	1.92 H	223	26.5	24.9

Antenna Polarity & Test Distance : Vertical at 3 m

No	Frequency (MHz)	Emission Level (dBuV/m)	Limit (dBuV/m)	Margin (dB)	Antenna Height (m)	Table Angle (Degree)	Raw Value (dBuV)	Correction Factor (dB/m)
1	#5618.80	62.1 PK	68.2	-6.1	2.56 V	149	48.6	13.5
2	*5795.00	106.3 PK			2.56 V	149	62.4	43.9
3	*5795.00	93.5 AV			2.56 V	149	49.6	43.9
4	#5960.40	62.8 PK	68.2	-5.4	2.56 V	149	48.4	14.4
5	11590.00	65.8 PK	74.0	-8.2	2.39 V	324	40.9	24.9
6	11590.00	52.1 AV	54.0	-1.9	2.39 V	324	27.2	24.9

Remarks:

1. Emission Level(dBuV/m) = Raw Value(dBuV) + Correction Factor(dB/m)
2. Correction Factor(dB/m) = Antenna Factor(dB/m) + Cable Factor(dB) – Pre-Amplifier Factor(dB)
3. Margin value = Emission Level – Limit value
4. The other emission levels were very low against the limit.
5. " * " : Fundamental frequency.
6. " # " : The radiated frequency is out of the restricted band.

RF Mode	TX 802.11ax (HE80)	Channel	CH 42 : 5210 MHz
Frequency Range	1GHz ~ 40GHz	Detector Function	Peak (PK) Average (AV)

Antenna Polarity & Test Distance : Horizontal at 3 m

No	Frequency (MHz)	Emission Level (dBuV/m)	Limit (dBuV/m)	Margin (dB)	Antenna Height (m)	Table Angle (Degree)	Raw Value (dBuV)	Correction Factor (dB/m)
1	5150.00	60.5 PK	74.0	-13.5	1.17 H	174	47.6	12.9
2	5150.00	48.0 AV	54.0	-6.0	1.17 H	174	35.1	12.9
3	*5210.00	100.3 PK			1.17 H	174	58.1	42.2
4	*5210.00	87.5 AV			1.17 H	174	45.3	42.2
5	#10420.00	63.1 PK	68.2	-5.1	1.98 H	236	40.2	22.9

Antenna Polarity & Test Distance : Vertical at 3 m

No	Frequency (MHz)	Emission Level (dBuV/m)	Limit (dBuV/m)	Margin (dB)	Antenna Height (m)	Table Angle (Degree)	Raw Value (dBuV)	Correction Factor (dB/m)
1	5150.00	61.6 PK	74.0	-12.4	1.47 V	162	48.7	12.9
2	5150.00	48.5 AV	54.0	-5.5	1.47 V	162	35.6	12.9
3	*5210.00	104.1 PK			1.47 V	162	61.9	42.2
4	*5210.00	91.2 AV			1.47 V	162	49.0	42.2
5	#10420.00	63.6 PK	68.2	-4.6	2.43 V	331	40.7	22.9

Remarks:

1. Emission Level(dBuV/m) = Raw Value(dBuV) + Correction Factor(dB/m)
2. Correction Factor(dB/m) = Antenna Factor(dB/m) + Cable Factor(dB) – Pre-Amplifier Factor(dB)
3. Margin value = Emission Level – Limit value
4. The other emission levels were very low against the limit.
5. " * " : Fundamental frequency.
6. " # " : The radiated frequency is out of the restricted band.

RF Mode	TX 802.11ax (HE80)	Channel	CH 58 : 5290 MHz
Frequency Range	1GHz ~ 40GHz	Detector Function	Peak (PK) Average (AV)

Antenna Polarity & Test Distance : Horizontal at 3 m

No	Frequency (MHz)	Emission Level (dBuV/m)	Limit (dBuV/m)	Margin (dB)	Antenna Height (m)	Table Angle (Degree)	Raw Value (dBuV)	Correction Factor (dB/m)
1	*5290.00	99.2 PK			1.17 H	169	56.9	42.3
2	*5290.00	87.4 AV			1.17 H	169	45.1	42.3
3	5350.00	62.2 PK	74.0	-11.8	1.17 H	169	49.2	13.0
4	5350.00	48.1 AV	54.0	-5.9	1.17 H	169	35.1	13.0
5	#10580.00	64.1 PK	68.2	-4.1	1.99 H	213	40.7	23.4

Antenna Polarity & Test Distance : Vertical at 3 m

No	Frequency (MHz)	Emission Level (dBuV/m)	Limit (dBuV/m)	Margin (dB)	Antenna Height (m)	Table Angle (Degree)	Raw Value (dBuV)	Correction Factor (dB/m)
1	*5290.00	102.8 PK			1.67 V	160	60.5	42.3
2	*5290.00	90.3 AV			1.67 V	160	48.0	42.3
3	5350.00	62.7 PK	74.0	-11.3	1.67 V	160	49.7	13.0
4	5350.00	48.6 AV	54.0	-5.4	1.67 V	160	35.6	13.0
5	#10580.00	64.9 PK	68.2	-3.3	2.44 V	320	41.5	23.4

Remarks:

1. Emission Level(dBuV/m) = Raw Value(dBuV) + Correction Factor(dB/m)
2. Correction Factor(dB/m) = Antenna Factor(dB/m) + Cable Factor(dB) – Pre-Amplifier Factor(dB)
3. Margin value = Emission Level – Limit value
4. The other emission levels were very low against the limit.
5. " * " : Fundamental frequency.
6. " # " : The radiated frequency is out of the restricted band.

RF Mode	TX 802.11ax (HE80)	Channel	CH 106 : 5530 MHz
Frequency Range	1GHz ~ 40GHz	Detector Function	Peak (PK) Average (AV)

Antenna Polarity & Test Distance : Horizontal at 3 m

No	Frequency (MHz)	Emission Level (dBuV/m)	Limit (dBuV/m)	Margin (dB)	Antenna Height (m)	Table Angle (Degree)	Raw Value (dBuV)	Correction Factor (dB/m)
1	5460.00	61.0 PK	74.0	-13.0	1.19 H	178	47.6	13.4
2	5460.00	49.0 AV	54.0	-5.0	1.19 H	178	35.6	13.4
3	#5470.00	62.1 PK	68.2	-6.1	1.19 H	178	48.5	13.6
4	*5530.00	100.7 PK			1.19 H	178	57.5	43.2
5	*5530.00	87.8 AV			1.19 H	178	44.6	43.2
6	#5725.00	62.1 PK	68.2	-6.1	1.19 H	178	48.4	13.7
7	11060.00	64.6 PK	74.0	-9.4	1.97 H	225	40.3	24.3
8	11060.00	50.8 AV	54.0	-3.2	1.97 H	225	26.5	24.3

Antenna Polarity & Test Distance : Vertical at 3 m

No	Frequency (MHz)	Emission Level (dBuV/m)	Limit (dBuV/m)	Margin (dB)	Antenna Height (m)	Table Angle (Degree)	Raw Value (dBuV)	Correction Factor (dB/m)
1	5460.00	62.2 PK	74.0	-11.8	2.55 V	145	48.8	13.4
2	5460.00	50.0 AV	54.0	-4.0	2.55 V	145	36.6	13.4
3	#5470.00	63.4 PK	68.2	-4.8	2.55 V	145	49.8	13.6
4	*5530.00	104.7 PK			2.55 V	145	61.5	43.2
5	*5530.00	91.8 AV			2.55 V	145	48.6	43.2
6	#5725.00	62.9 PK	68.2	-5.3	2.55 V	145	49.2	13.7
7	11060.00	65.0 PK	74.0	-9.0	2.54 V	331	40.7	24.3
8	11060.00	51.1 AV	54.0	-2.9	2.54 V	331	26.8	24.3

Remarks:

1. Emission Level(dBuV/m) = Raw Value(dBuV) + Correction Factor(dB/m)
2. Correction Factor(dB/m) = Antenna Factor(dB/m) + Cable Factor(dB) – Pre-Amplifier Factor(dB)
3. Margin value = Emission Level – Limit value
4. The other emission levels were very low against the limit.
5. " * ": Fundamental frequency.
6. " # ": The radiated frequency is out of the restricted band.

RF Mode	TX 802.11ax (HE80)	Channel	CH 122 : 5610 MHz
Frequency Range	1GHz ~ 40GHz	Detector Function	Peak (PK) Average (AV)

Antenna Polarity & Test Distance : Horizontal at 3 m

No	Frequency (MHz)	Emission Level (dBuV/m)	Limit (dBuV/m)	Margin (dB)	Antenna Height (m)	Table Angle (Degree)	Raw Value (dBuV)	Correction Factor (dB/m)
1	5460.00	60.9 PK	74.0	-13.1	1.17 H	172	47.5	13.4
2	5460.00	48.5 AV	54.0	-5.5	1.17 H	172	35.1	13.4
3	#5470.00	61.9 PK	68.2	-6.3	1.17 H	172	48.3	13.6
4	*5610.00	101.2 PK			1.17 H	172	58.1	43.1
5	*5610.00	88.3 AV			1.17 H	172	45.2	43.1
6	#5725.00	61.8 PK	68.2	-6.4	1.17 H	172	48.1	13.7
7	11220.00	64.8 PK	74.0	-9.2	2.03 H	235	40.2	24.6
8	11220.00	51.0 AV	54.0	-3.0	2.03 H	235	26.4	24.6

Antenna Polarity & Test Distance : Vertical at 3 m

No	Frequency (MHz)	Emission Level (dBuV/m)	Limit (dBuV/m)	Margin (dB)	Antenna Height (m)	Table Angle (Degree)	Raw Value (dBuV)	Correction Factor (dB/m)
1	5460.00	61.7 PK	74.0	-12.3	2.54 V	147	48.3	13.4
2	5460.00	49.2 AV	54.0	-4.8	2.54 V	147	35.8	13.4
3	#5470.00	62.4 PK	68.2	-5.8	2.54 V	147	48.8	13.6
4	*5610.00	105.2 PK			2.54 V	147	62.1	43.1
5	*5610.00	92.1 AV			2.54 V	147	49.0	43.1
6	#5725.00	62.3 PK	68.2	-5.9	2.54 V	147	48.6	13.7
7	11220.00	65.4 PK	74.0	-8.6	2.67 V	338	40.8	24.6
8	11220.00	51.6 AV	54.0	-2.4	2.67 V	338	27.0	24.6

Remarks:

1. Emission Level(dBuV/m) = Raw Value(dBuV) + Correction Factor(dB/m)
2. Correction Factor(dB/m) = Antenna Factor(dB/m) + Cable Factor(dB) – Pre-Amplifier Factor(dB)
3. Margin value = Emission Level – Limit value
4. The other emission levels were very low against the limit.
5. " * ": Fundamental frequency.
6. " # ": The radiated frequency is out of the restricted band.

RF Mode	TX 802.11ax (HE80)	Channel	CH 138 : 5690 MHz
Frequency Range	1GHz ~ 40GHz	Detector Function	Peak (PK) Average (AV)

Antenna Polarity & Test Distance : Horizontal at 3 m

No	Frequency (MHz)	Emission Level (dBuV/m)	Limit (dBuV/m)	Margin (dB)	Antenna Height (m)	Table Angle (Degree)	Raw Value (dBuV)	Correction Factor (dB/m)
1	#5470.00	61.0 PK	68.2	-7.2	1.15 H	181	47.4	13.6
2	*5690.00	99.3 PK			1.15 H	181	56.2	43.1
3	*5690.00	86.5 AV			1.15 H	181	43.4	43.1
4	#5850.00	62.1 PK	68.2	-6.1	1.15 H	181	47.8	14.3
5	11380.00	65.5 PK	74.0	-8.5	2.03 H	227	40.3	25.2
6	11380.00	51.8 AV	54.0	-2.2	2.03 H	227	26.6	25.2

Antenna Polarity & Test Distance : Vertical at 3 m

No	Frequency (MHz)	Emission Level (dBuV/m)	Limit (dBuV/m)	Margin (dB)	Antenna Height (m)	Table Angle (Degree)	Raw Value (dBuV)	Correction Factor (dB/m)
1	#5470.00	61.8 PK	68.2	-6.4	2.49 V	145	48.2	13.6
2	*5690.00	103.3 PK			2.49 V	145	60.2	43.1
3	*5690.00	90.4 AV			2.49 V	145	47.3	43.1
4	#5850.00	62.8 PK	68.2	-5.4	2.49 V	145	48.5	14.3
5	11380.00	65.9 PK	74.0	-8.1	2.56 V	334	40.7	25.2
6	11380.00	52.0 AV	54.0	-2.0	2.56 V	334	26.8	25.2

Remarks:

1. Emission Level(dBuV/m) = Raw Value(dBuV) + Correction Factor(dB/m)
2. Correction Factor(dB/m) = Antenna Factor(dB/m) + Cable Factor(dB) – Pre-Amplifier Factor(dB)
3. Margin value = Emission Level – Limit value
4. The other emission levels were very low against the limit.
5. " * ": Fundamental frequency.
6. " # ": The radiated frequency is out of the restricted band.

RF Mode	TX 802.11ax (HE80)	Channel	CH 155 : 5775 MHz
Frequency Range	1GHz ~ 40GHz	Detector Function	Peak (PK) Average (AV)

Antenna Polarity & Test Distance : Horizontal at 3 m

No	Frequency (MHz)	Emission Level (dBuV/m)	Limit (dBuV/m)	Margin (dB)	Antenna Height (m)	Table Angle (Degree)	Raw Value (dBuV)	Correction Factor (dB/m)
1	#5612.80	61.9 PK	68.2	-6.3	1.15 H	173	48.4	13.5
2	*5775.00	99.5 PK			1.15 H	173	55.7	43.8
3	*5775.00	86.6 AV			1.15 H	173	42.8	43.8
4	#5941.60	62.7 PK	68.2	-5.5	1.15 H	173	48.3	14.4
5	11550.00	65.4 PK	74.0	-8.6	1.96 H	225	40.3	25.1
6	11550.00	51.5 AV	54.0	-2.5	1.96 H	225	26.4	25.1

Antenna Polarity & Test Distance : Vertical at 3 m

No	Frequency (MHz)	Emission Level (dBuV/m)	Limit (dBuV/m)	Margin (dB)	Antenna Height (m)	Table Angle (Degree)	Raw Value (dBuV)	Correction Factor (dB/m)
1	#5640.00	61.9 PK	68.2	-6.3	2.50 V	145	48.4	13.5
2	*5775.00	103.3 PK			2.50 V	145	59.5	43.8
3	*5775.00	90.4 AV			2.50 V	145	46.6	43.8
4	#5934.00	62.8 PK	68.2	-5.4	2.50 V	145	48.4	14.4
5	11550.00	65.9 PK	74.0	-8.1	2.43 V	330	40.8	25.1
6	11550.00	52.0 AV	54.0	-2.0	2.43 V	330	26.9	25.1

Remarks:

1. Emission Level(dBuV/m) = Raw Value(dBuV) + Correction Factor(dB/m)
2. Correction Factor(dB/m) = Antenna Factor(dB/m) + Cable Factor(dB) – Pre-Amplifier Factor(dB)
3. Margin value = Emission Level – Limit value
4. The other emission levels were very low against the limit.
5. " * ": Fundamental frequency.
6. " # ": The radiated frequency is out of the restricted band.

Below 1GHz Worst-Case Data:

RF Mode	TX 802.11a	Channel	CH 116 : 5580 MHz
Frequency Range	9kHz ~ 1GHz	Detector Function	Quasi-Peak (QP)
Test Mode	A		

Antenna Polarity & Test Distance : Horizontal at 3 m								
No	Frequency (MHz)	Emission Level (dBuV/m)	Limit (dBuV/m)	Margin (dB)	Antenna Height (m)	Table Angle (Degree)	Raw Value (dBuV)	Correction Factor (dB/m)
1	109.54	26.3 QP	43.5	-17.2	1.25 H	157	38.4	-12.1
2	224.00	30.8 QP	46.0	-15.2	1.25 H	228	42.3	-11.5
3	311.30	34.4 QP	46.0	-11.6	1.00 H	228	41.8	-7.4
4	602.30	31.5 QP	46.0	-14.5	1.50 H	228	33.4	-1.9
5	769.14	34.1 QP	46.0	-11.9	1.00 H	173	32.1	2.0
6	856.44	35.7 QP	46.0	-10.3	1.25 H	235	31.9	3.8

Remarks:

1. Emission Level(dBuV/m) = Raw Value(dBuV) + Correction Factor(dB/m).
2. Correction Factor(dB/m) = Antenna Factor(dB/m) + Cable Factor(dB) – Pre-Amplifier Factor(dB).
3. The other emission levels were very low against the limit of frequency range 30MHz ~ 1000MHz.
4. Margin value = Emission Level – Limit value.
5. The emission levels were very low against the limit of frequency range 9kHz ~ 30MHz: the amplitude of spurious emissions attenuated more than 20 dB below the permissible value to be report.

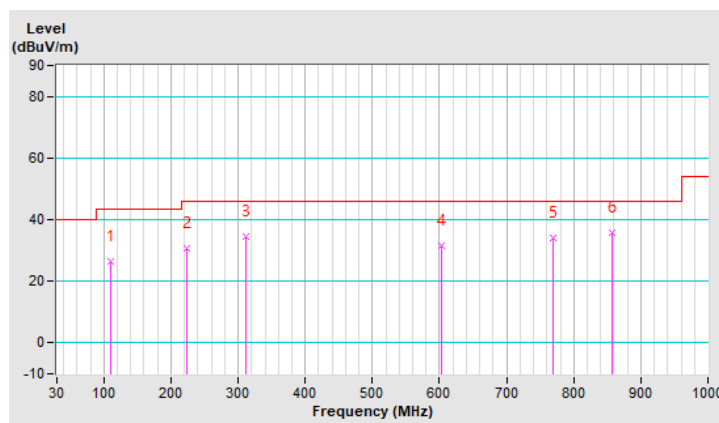

RF Mode	TX 802.11a	Channel	CH 116 : 5580 MHz
Frequency Range	9kHz ~ 1GHz	Detector Function	Quasi-Peak (QP)
Test Mode	A		

Antenna Polarity & Test Distance : Vertical at 3 m								
No	Frequency (MHz)	Emission Level (dBuV/m)	Limit (dBuV/m)	Margin (dB)	Antenna Height (m)	Table Angle (Degree)	Raw Value (dBuV)	Correction Factor (dB/m)
1	33.88	28.9 QP	40.0	-11.1	1.00 V	339	39.0	-10.1
2	107.60	30.5 QP	43.5	-13.0	1.00 V	186	42.7	-12.2
3	291.90	34.3 QP	46.0	-11.7	1.25 V	155	42.1	-7.8
4	650.80	32.3 QP	46.0	-13.7	1.50 V	68	33.1	-0.8
5	858.38	36.8 QP	46.0	-9.2	1.00 V	67	33.0	3.8
6	961.20	38.8 QP	54.0	-15.2	1.00 V	74	32.8	6.0

Remarks:

1. Emission Level(dBuV/m) = Raw Value(dBuV) + Correction Factor(dB/m).
2. Correction Factor(dB/m) = Antenna Factor(dB/m) + Cable Factor(dB) – Pre-Amplifier Factor(dB).
3. The other emission levels were very low against the limit of frequency range 30MHz ~ 1000MHz.
4. Margin value = Emission Level – Limit value.
5. The emission levels were very low against the limit of frequency range 9kHz ~ 30MHz: the amplitude of spurious emissions attenuated more than 20 dB below the permissible value to be report.

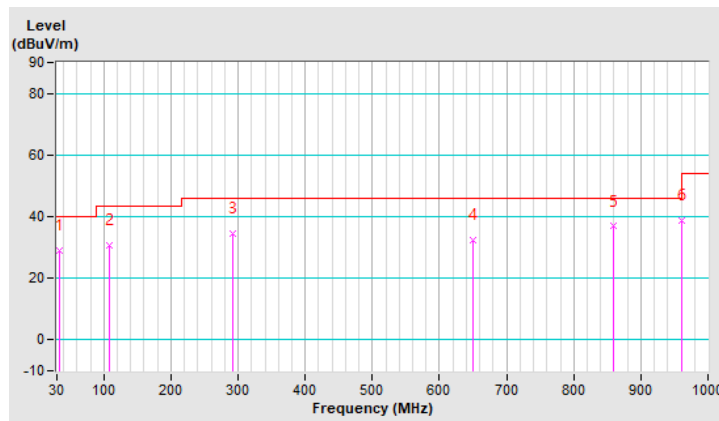

RF Mode	TX 802.11a	Channel	CH 116 : 5580 MHz
Frequency Range	9kHz ~ 1GHz	Detector Function	Quasi-Peak (QP)
Test Mode	B		

Antenna Polarity & Test Distance : Horizontal at 3 m								
No	Frequency (MHz)	Emission Level (dBuV/m)	Limit (dBuV/m)	Margin (dB)	Antenna Height (m)	Table Angle (Degree)	Raw Value (dBuV)	Correction Factor (dB/m)
1	43.58	25.8 QP	40.0	-14.2	1.50 H	224	34.8	-9.0
2	111.48	26.4 QP	43.5	-17.1	1.00 H	123	38.3	-11.9
3	243.40	29.8 QP	46.0	-16.2	1.25 H	226	39.6	-9.8
4	315.18	30.9 QP	46.0	-15.1	1.00 H	226	38.2	-7.3
5	499.48	30.2 QP	46.0	-15.8	1.25 H	225	34.1	-3.9
6	780.78	32.1 QP	46.0	-13.9	1.00 H	300	29.6	2.5

Remarks:

1. Emission Level(dBuV/m) = Raw Value(dBuV) + Correction Factor(dB/m).
2. Correction Factor(dB/m) = Antenna Factor(dB/m) + Cable Factor(dB) – Pre-Amplifier Factor(dB).
3. The other emission levels were very low against the limit of frequency range 30MHz ~ 1000MHz.
4. Margin value = Emission Level – Limit value.
5. The emission levels were very low against the limit of frequency range 9kHz ~ 30MHz: the amplitude of spurious emissions attenuated more than 20 dB below the permissible value to be report.

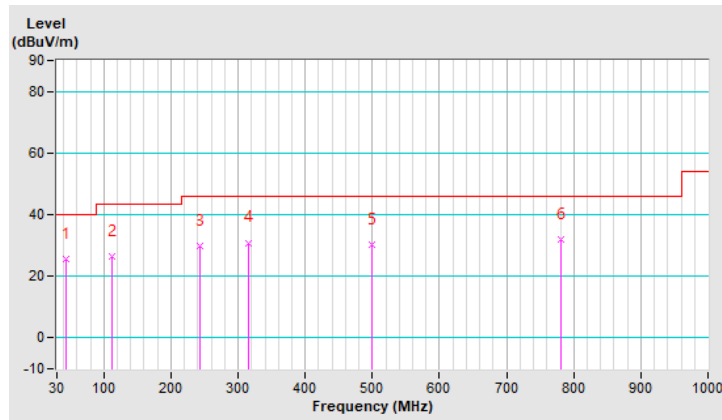

RF Mode	TX 802.11a	Channel	CH 116 : 5580 MHz
Frequency Range	9kHz ~ 1GHz	Detector Function	Quasi-Peak (QP)
Test Mode	B		

Antenna Polarity & Test Distance : Vertical at 3 m								
No	Frequency (MHz)	Emission Level (dBuV/m)	Limit (dBuV/m)	Margin (dB)	Antenna Height (m)	Table Angle (Degree)	Raw Value (dBuV)	Correction Factor (dB/m)
1	30.00	31.3 QP	40.0	-8.7	1.25 V	155	41.5	-10.2
2	76.56	37.9 QP	40.0	-2.1	1.50 V	329	50.0	-12.1
3	227.88	30.6 QP	46.0	-15.4	1.50 V	317	42.0	-11.4
4	307.42	36.4 QP	46.0	-9.6	1.00 V	321	43.8	-7.4
5	580.96	32.1 QP	46.0	-13.9	1.00 V	329	34.9	-2.8
6	974.78	34.4 QP	54.0	-19.6	1.25 V	42	28.2	6.2

Remarks:

1. Emission Level(dBuV/m) = Raw Value(dBuV) + Correction Factor(dB/m).
2. Correction Factor(dB/m) = Antenna Factor(dB/m) + Cable Factor(dB) – Pre-Amplifier Factor(dB).
3. The other emission levels were very low against the limit of frequency range 30MHz ~ 1000MHz.
4. Margin value = Emission Level – Limit value.
5. The emission levels were very low against the limit of frequency range 9kHz ~ 30MHz: the amplitude of spurious emissions attenuated more than 20 dB below the permissible value to be report.

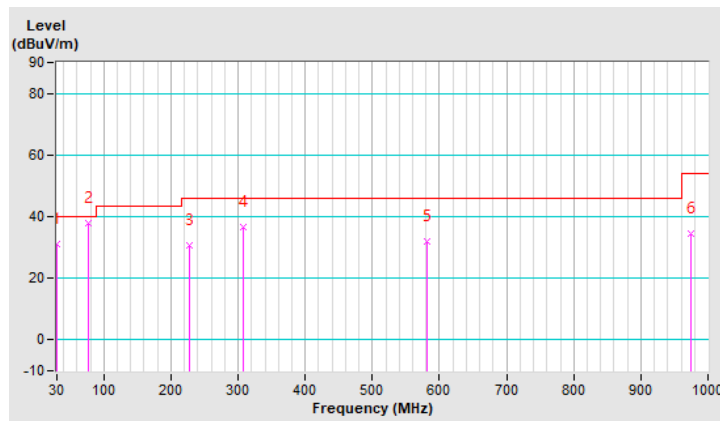

4.2 Conducted Emission Measurement

4.2.1 Limits of Conducted Emission Measurement

Frequency (MHz)	Conducted Limit (dBuV)	
	Quasi-peak	Average
0.15 - 0.5	66 - 56	56 - 46
0.50 - 5.0	56	46
5.0 - 30.0	60	50

Note: 1. The lower limit shall apply at the transition frequencies.

2. The limit decreases in line with the logarithm of the frequency in the range of 0.15 to 0.50MHz.

4.2.2 Test Instruments

Description & Manufacturer	Model No.	Serial No.	Cal. Date	Cal. Due
Test Receiver ROHDE & SCHWARZ	ESCI	100613	Dec. 03, 2021	Dec. 02, 2022
RF signal cable Woken	5D-FB	Cable-cond1-01	Jan. 15, 2022	Jan. 14, 2023
LISN ROHDE & SCHWARZ (EUT)	ENV216	101826	Mar. 14, 2022	Mar. 13, 2023
LISN ROHDE & SCHWARZ (Peripheral)	ESH3-Z5	100311	Sep. 07, 2021	Sep. 06, 2022
Software ADT	BV ADT_Cond_ V7.3.7.4	NA	NA	NA

Note: 1. The calibration interval of the above test instruments is 12 months and the calibrations are traceable to NML/ROC and NIST/USA.

2. The test was performed in HwaYa Shielded Room 1(Conduction 1).

3. The VCCI Site Registration No. is C-12040.

4. Tested date: Jul. 17, 2022

4.2.3 Test Procedures

- The EUT was placed 0.4 meters from the conducting wall of the shielded room with EUT being connected to the power mains through a line impedance stabilization network (LISN). Other support units were connected to the power mains through another LISN. The two LISNs provide 50 ohm/ 50uH of coupling impedance for the measuring instrument.
- Both lines of the power mains connected to the EUT were checked for maximum conducted interference.
- The frequency range from 150kHz to 30MHz was searched. Emission levels under (Limit - 20dB) was not recorded.

Note: The resolution bandwidth and video bandwidth of test receiver is 9kHz for quasi-peak detection (QP) and average detection (AV) at frequency 0.15MHz-30MHz.

4.2.4 Deviation from Test Standard

No deviation.

4.2.5 Test Setup

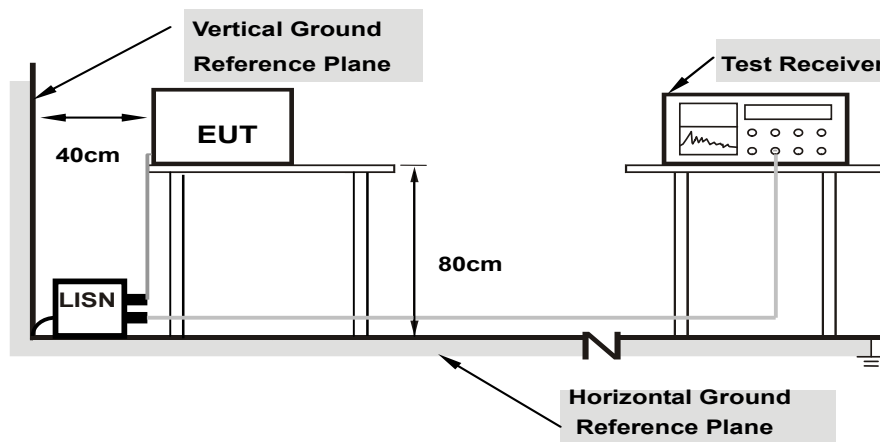

Note: 1.Support units were connected to second LISN.

For the actual test configuration, please refer to the attached file (Test Setup Photo).

4.2.6 EUT Operating Conditions

Same as 4.1.6.

4.2.7 Test Results

Worst-case data:

802.11a

Phase	Line (L)	Detector Function	Quasi-Peak (QP) / Average (AV)
Test Mode	A		

No	Freq. [MHz]	Corr. Factor (dB)	Reading Value		Emission Level		Limit		Margin	
			[dB (uV)]		[dB (uV)]		[dB (uV)]		(dB)	
			Q.P.	AV.	Q.P.	AV.	Q.P.	AV.	Q.P.	AV.
1	0.16579	9.63	34.93	20.74	44.56	30.37	65.17	55.17	-20.61	-24.80
2	0.18600	9.63	27.22	11.03	36.85	20.66	64.21	54.21	-27.36	-33.55
3	0.21400	9.64	27.51	14.56	37.15	24.20	63.05	53.05	-25.90	-28.85
4	3.52200	9.74	24.37	16.49	34.11	26.23	56.00	46.00	-21.89	-19.77
5	4.91800	9.76	18.09	12.72	27.85	22.48	56.00	46.00	-28.15	-23.52
6	21.78600	9.87	17.27	7.96	27.14	17.83	60.00	50.00	-32.86	-32.17

Remarks:

1. Q.P. and AV. are abbreviations of quasi-peak and average individually.
2. The emission levels of other frequencies were very low against the limit.
3. Margin value = Emission level - Limit value
4. Correction factor = Insertion loss + Cable loss
5. Emission Level = Correction Factor + Reading Value.

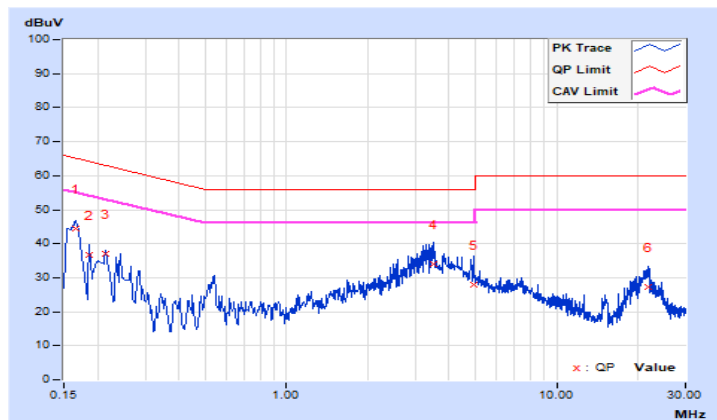

Phase	Neutral (N)	Detector Function	Quasi-Peak (QP) / Average (AV)
Test Mode	A		

No	Freq. [MHz]	Corr. Factor (dB)	Reading Value [dB (uV)]		Emission Level [dB (uV)]		Limit [dB (uV)]		Margin (dB)	
			Q.P.	AV.	Q.P.	AV.	Q.P.	AV.	Q.P.	AV.
			1	0.15000	9.62	33.81	17.86	43.43	27.48	66.00
2	0.16535	9.63	35.10	21.26	44.73	30.89	65.19	55.19	-20.46	-24.30
3	0.19400	9.64	29.50	13.21	39.14	22.85	63.86	53.86	-24.72	-31.01
4	3.44600	9.74	25.22	16.79	34.96	26.53	56.00	46.00	-21.04	-19.47
5	3.95800	9.75	21.75	15.88	31.50	25.63	56.00	46.00	-24.50	-20.37
6	21.91000	9.89	20.46	5.20	30.35	15.09	60.00	50.00	-29.65	-34.91

Remarks:

1. Q.P. and AV. are abbreviations of quasi-peak and average individually.
2. The emission levels of other frequencies were very low against the limit.
3. Margin value = Emission level - Limit value
4. Correction factor = Insertion loss + Cable loss
5. Emission Level = Correction Factor + Reading Value.

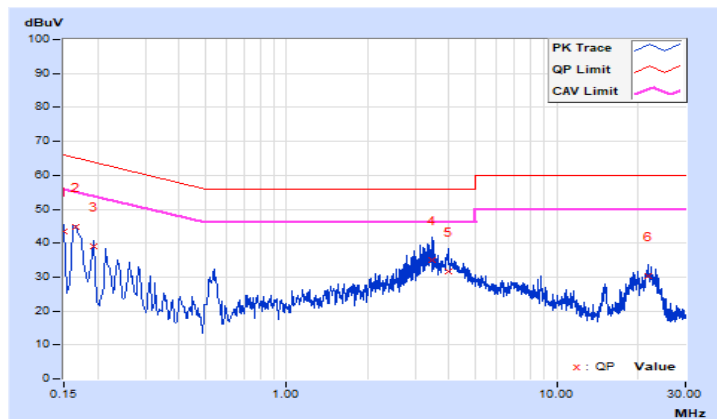

Phase	Line (L)	Detector Function	Quasi-Peak (QP) / Average (AV)
Test Mode	B		

No	Freq. [MHz]	Corr. Factor (dB)	Reading Value [dB (uV)]		Emission Level [dB (uV)]		Limit [dB (uV)]		Margin (dB)	
			Q.P.	AV.	Q.P.	AV.	Q.P.	AV.	Q.P.	AV.
			1	0.16799	9.63	30.94	16.11	40.57	25.74	65.06
2	0.20600	9.64	31.63	16.25	41.27	25.89	63.37	53.37	-22.10	-27.48
3	0.23800	9.65	26.98	13.07	36.63	22.72	62.17	52.17	-25.54	-29.45
4	3.43800	9.74	27.20	17.30	36.94	27.04	56.00	46.00	-19.06	-18.96
5	4.41000	9.75	26.31	17.64	36.06	27.39	56.00	46.00	-19.94	-18.61
6	21.79000	9.87	20.95	8.39	30.82	18.26	60.00	50.00	-29.18	-31.74

Remarks:

1. Q.P. and AV. are abbreviations of quasi-peak and average individually.
2. The emission levels of other frequencies were very low against the limit.
3. Margin value = Emission level - Limit value
4. Correction factor = Insertion loss + Cable loss
5. Emission Level = Correction Factor + Reading Value.

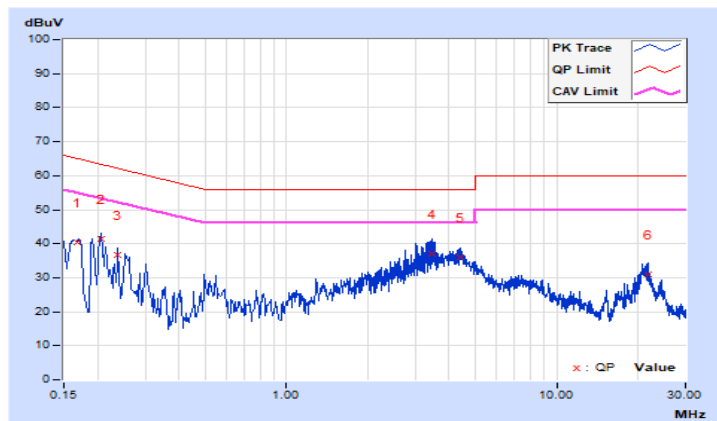

Phase	Neutral (N)	Detector Function	Quasi-Peak (QP) / Average (AV)
Test Mode	B		

No	Freq. [MHz]	Corr. Factor (dB)	Reading Value [dB (uV)]		Emission Level [dB (uV)]		Limit [dB (uV)]		Margin (dB)	
			Q.P.	AV.	Q.P.	AV.	Q.P.	AV.	Q.P.	AV.
			1	0.15000	9.62	29.30	16.21	38.92	25.83	66.00
2	0.16600	9.63	39.73	26.86	49.36	36.49	65.16	55.16	-15.80	-18.67
3	0.21400	9.64	30.21	15.08	39.85	24.72	63.05	53.05	-23.20	-28.33
4	3.33000	9.74	27.61	18.06	37.35	27.80	56.00	46.00	-18.65	-18.20
5	4.22200	9.75	26.00	19.69	35.75	29.44	56.00	46.00	-20.25	-16.56
6	21.75400	9.89	21.40	8.58	31.29	18.47	60.00	50.00	-28.71	-31.53

Remarks:

1. Q.P. and AV. are abbreviations of quasi-peak and average individually.
2. The emission levels of other frequencies were very low against the limit.
3. Margin value = Emission level - Limit value
4. Correction factor = Insertion loss + Cable loss
5. Emission Level = Correction Factor + Reading Value.

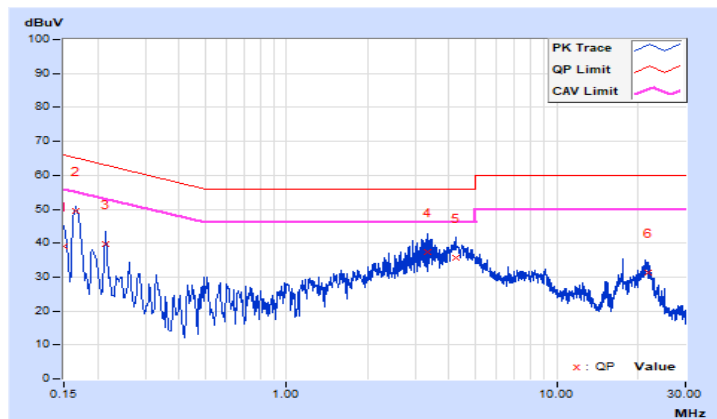

4.3 Transmit Power Measurement

4.3.1 Limits of Transmit Power Measurement

Operation Band	EUT Category		Limit
U-NII-1		Outdoor Access Point	1 Watt (30 dBm) (Max. e.i.r.p ≤ 125mW(21 dBm) at any elevation angle above 30 degrees as measured from the horizon)
		Fixed point-to-point Access Point	1 Watt (30 dBm)
		Indoor Access Point	1 Watt (30 dBm)
	√	Mobile and Portable client device	250mW (24 dBm)
U-NII-2A	√		250mW (24 dBm) or 11 dBm+10 log B*
U-NII-2C	√		250mW (24 dBm) or 11 dBm+10 log B*
U-NII-3	√		1 Watt (30 dBm)

*B is the 26 dB emission bandwidth in megahertz

Per KDB 662911 Method of conducted output power measurement on IEEE 802.11 devices,

If antenna gains are not equal, the user may use either of the following methods to calculate directional gain, provided that each transmit antenna is driven by only one spatial stream:

- Directional gain may be calculated by using the formulas applicable to equal gain antennas with GANT set equal to the gain of the antenna having the highest gain; or,

$$\bullet \text{ DirectionalGain} = 10 \cdot \log \left[\frac{\sum_{j=1}^{N_{SS}} \left\{ \sum_{k=1}^{N_{ANT}} g_{j,k} \right\}^2}{N_{ANT}} \right]$$

where

Each antenna is driven by no more than one spatial stream;

N_{SS} = the number of independent spatial streams of data;

N_{ANT} = the total number of antennas

$g_{j,k} = 10^{G_k/20}$ if the k th antenna is being fed by spatial stream j , or zero if it is not;

G_k is the gain in dBi of the k th antenna.

4.3.2 Test Setup

For Power Output

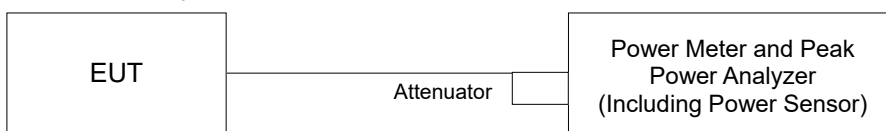

For 26dB Bandwidth and power output of transmission above 5.725 GHz where the EBW crosses 5.725 GHz

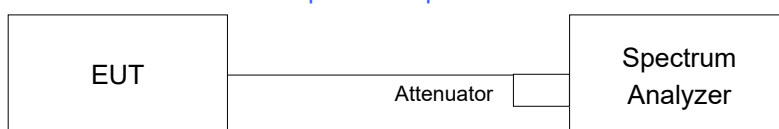

4.3.3 Test Instruments

Refer to section 4.1.2 to get information of above instrument.

4.3.4 Test Procedure

For Average Power Measurement

Method PM is used to perform output power measurement, trigger and gating function of wide band power meter is enabled to measure max output power of TX on burst and set the detector to average. Duty factor is not added to measured value.

For transmission above 5.725 GHz where the EBW crosses 5.725 GHz

For channel aggregation (channel 138, 142, 144) measurement refer to KDB 789033 D02 General UNII Test Procedures New Rules v02r01 Section II E 2 b) method SA-1.

For 26dB Bandwidth

- a. Set RBW = approximately 1% of the emission bandwidth.
- b. Set the VBW > RBW.
- c. Detector = Peak.
- d. Trace mode = max hold.
- e. Measure the maximum width of the emission that is 26 dB down from the peak of the emission. Compare this with the RBW setting of the analyzer. Readjust RBW and repeat measurement as needed until the RBW/EBW ratio is approximately 1%.

4.3.5 Deviation from Test Standard

No deviation.

4.3.6 EUT Operating Conditions

The software provided by client to enable the EUT under transmission condition continuously at lowest, middle and highest channel frequencies individually.

4.3.7 Test Result

Power Output:

802.11a

Chan.	Freq. (MHz)	Average Power (dBm)		Total Power (mW)	Total Power (dBm)	Power Limit (dBm)	Pass / Fail
		Chain 0	Chain 1				
36	5180	13.55	13.57	45.397	16.57	24.00	Pass
40	5200	13.82	13.98	49.103	16.91	24.00	Pass
48	5240	12.54	12.99	37.854	15.78	24.00	Pass
52	5260	13.49	13.40	44.213	16.46	24.00	Pass
60	5300	13.79	13.69	47.322	16.75	24.00	Pass
64	5320	13.94	14.01	49.951	16.99	24.00	Pass
100	5500	13.90	13.85	48.813	16.89	24.00	Pass
116	5580	13.79	13.74	47.592	16.78	24.00	Pass
140	5700	13.80	13.77	47.812	16.80	24.00	Pass
144	5720 (For U-NII-2C)	12.61	12.48	37.129	15.70	23.57	Pass
144	5720 (For U-NII-3)	5.91	5.74	7.902	8.98	30.00	Pass
149	5745	13.46	13.87	46.560	16.68	30.00	Pass
157	5785	13.48	13.84	46.495	16.67	30.00	Pass
165	5825	12.61	13.02	38.284	15.83	30.00	Pass

Note:

1. 5180-5250MHz: Directional Gain = 5.21dBi < 6dBi, so the power limit not need to reduce.
2. 5250-5320MHz: Directional Gain = 5.71dBi < 6dBi, so the power limit not need to reduce.
3. 5500-5720MHz: Directional Gain = 5.32dBi < 6dBi, so the power limit not need to reduce.
4. 5745-5825MHz: Directional Gain = 5.56dBi < 6dBi, so the power limit not need to reduce.

For U-NII-2A, U-NII-2C Band:

Chain 0

1. 11dBm + 10log (27.23) = 25.35 > 24dBm
2. 11dBm + 10log (27.02) = 25.31 > 24dBm
3. 11dBm + 10log (37.76) = 26.77 > 24dBm
4. 11dBm + 10log (26.83) = 25.28 > 24dBm
5. 11dBm + 10log (27.29) = 25.36 > 24dBm
6. 11dBm + 10log (29.42) = 25.68 > 24dBm
7. 11dBm + 10log (5725.00 - 5706.34) = 23.70 < 24dBm

Chain 1

1. 11dBm + 10log (27.59) = 25.40 > 24dBm
2. 11dBm + 10log (26.41) = 25.21 > 24dBm
3. 11dBm + 10log (37.08) = 26.69 > 24dBm
4. 11dBm + 10log (26.32) = 25.20 > 24dBm
5. 11dBm + 10log (26.88) = 25.29 > 24dBm
6. 11dBm + 10log (27.69) = 25.42 > 24dBm
7. 11dBm + 10log (5725.00 - 5706.90) = 23.57 < 24dBm

802.11ax (HE20)

Chan.	Freq. (MHz)	Average Power (dBm)		Total Power (mW)	Total Power (dBm)	Power Limit (dBm)	Pass / Fail
		Chain 0	Chain 1				
36	5180	13.02	12.85	39.320	15.95	24.00	Pass
40	5200	13.08	13.02	40.368	16.06	24.00	Pass
48	5240	13.49	12.79	41.347	16.16	24.00	Pass
52	5260	13.49	12.79	41.347	16.16	24.00	Pass
60	5300	13.12	13.32	41.990	16.23	24.00	Pass
64	5320	13.08	13.40	42.201	16.25	24.00	Pass
100	5500	13.49	12.88	41.745	16.21	24.00	Pass
116	5580	13.32	13.02	41.523	16.18	24.00	Pass
140	5700	13.34	13.03	41.668	16.20	24.00	Pass
144	5720 (For U-NII-2C)	12.69	11.79	35.162	15.46	23.67	Pass
144	5720 (For U-NII-3)	6.96	6.04	9.379	9.72	30.00	Pass
149	5745	12.83	12.99	39.093	15.92	30.00	Pass
157	5785	12.67	13.02	38.537	15.86	30.00	Pass
165	5825	12.02	12.11	32.178	15.08	30.00	Pass

Note:

1. 5180-5250MHz: Directional Gain = 5.21dBi < 6dBi, so the power limit not need to reduce.
2. 5250-5320MHz: Directional Gain = 5.71dBi < 6dBi, so the power limit not need to reduce.
3. 5500-5720MHz: Directional Gain = 5.32dBi < 6dBi, so the power limit not need to reduce.
4. 5745-5825MHz: Directional Gain = 5.56dBi < 6dBi, so the power limit not need to reduce.

For U-NII-2A, U-NII-2C Band:

Chain 0

1. $11\text{dBm} + 10\log(24.23) = 24.84 > 24\text{dBm}$
2. $11\text{dBm} + 10\log(26.72) = 25.26 > 24\text{dBm}$
3. $11\text{dBm} + 10\log(24.59) = 24.90 > 24\text{dBm}$
4. $11\text{dBm} + 10\log(25.04) = 24.98 > 24\text{dBm}$
5. $11\text{dBm} + 10\log(26.32) = 25.20 > 24\text{dBm}$
6. $11\text{dBm} + 10\log(25.25) = 25.02 > 24\text{dBm}$
7. $11\text{dBm} + 10\log(5725.00 - 5706.47) = 23.67 < 24\text{dBm}$

Chain 1

1. $11\text{dBm} + 10\log(22.63) = 24.54 > 24\text{dBm}$
2. $11\text{dBm} + 10\log(25.98) = 25.14 > 24\text{dBm}$
3. $11\text{dBm} + 10\log(24.95) = 24.97 > 24\text{dBm}$
4. $11\text{dBm} + 10\log(25.68) = 25.09 > 24\text{dBm}$
5. $11\text{dBm} + 10\log(26.53) = 25.23 > 24\text{dBm}$
6. $11\text{dBm} + 10\log(25.76) = 25.10 > 24\text{dBm}$
7. $11\text{dBm} + 10\log(5725.00 - 5705.92) = 23.80 < 24\text{dBm}$

802.11ax (HE40)

Chan.	Freq. (MHz)	Average Power (dBm)		Total Power (mW)	Total Power (dBm)	Power Limit (dBm)	Pass / Fail
		Chain 0	Chain 1				
38	5190	12.85	13.22	40.265	16.05	24.00	Pass
46	5230	13.05	13.15	40.837	16.11	24.00	Pass
54	5270	13.27	13.12	41.744	16.21	24.00	Pass
62	5310	13.08	13.49	42.659	16.30	24.00	Pass
102	5510	13.29	13.19	42.175	16.25	24.00	Pass
110	5550	12.85	13.36	40.952	16.12	24.00	Pass
134	5670	13.41	12.82	41.071	16.14	24.00	Pass
142	5710 (For U-NII-2C)	12.36	12.49	35.937	15.56	24.00	Pass
142	5710 (For U-NII-3)	0.90	1.02	2.565	4.09	30.00	Pass
151	5755	12.52	13.21	38.806	15.89	30.00	Pass
159	5795	12.56	13.12	38.542	15.86	30.00	Pass

Note:

1. 5180-5250MHz: Directional Gain = 5.21dBi < 6dBi, so the power limit not need to reduce.
2. 5250-5320MHz: Directional Gain = 5.71dBi < 6dBi, so the power limit not need to reduce.
3. 5500-5720MHz: Directional Gain = 5.32dBi < 6dBi, so the power limit not need to reduce.
4. 5745-5825MHz: Directional Gain = 5.56dBi < 6dBi, so the power limit not need to reduce.

For U-NII-2A, U-NII-2C Band:

Chain 0

1. $11\text{dBm} + 10\log(40.65) = 27.09 > 24\text{dBm}$
2. $11\text{dBm} + 10\log(40.65) = 27.09 > 24\text{dBm}$
3. $11\text{dBm} + 10\log(40.84) = 27.11 > 24\text{dBm}$
4. $11\text{dBm} + 10\log(40.71) = 27.09 > 24\text{dBm}$
5. $11\text{dBm} + 10\log(40.82) = 27.10 > 24\text{dBm}$
6. $11\text{dBm} + 10\log(5725.00 - 5689.70) = 26.47 > 24\text{dBm}$

Chain 1

1. $11\text{dBm} + 10\log(40.70) = 27.09 > 24\text{dBm}$
2. $11\text{dBm} + 10\log(40.66) = 27.09 > 24\text{dBm}$
3. $11\text{dBm} + 10\log(40.79) = 27.10 > 24\text{dBm}$
4. $11\text{dBm} + 10\log(40.61) = 27.08 > 24\text{dBm}$
5. $11\text{dBm} + 10\log(40.71) = 27.09 > 24\text{dBm}$
6. $11\text{dBm} + 10\log(5725.00 - 5689.67) = 26.48 > 24\text{dBm}$

802.11ax (HE80)

Chan.	Freq. (MHz)	Average Power (dBm)		Total Power (mW)	Total Power (dBm)	Power Limit (dBm)	Pass / Fail
		Chain 0	Chain 1				
42	5210	12.76	12.85	38.155	15.82	24.00	Pass
58	5290	13.97	13.98	49.949	16.99	24.00	Pass
106	5530	14.04	13.90	49.898	16.98	24.00	Pass
122	5610	13.52	13.65	45.664	16.60	24.00	Pass
138	5690 (For U-NII-2C)	12.70	11.84	34.733	15.41	24.00	Pass
138	5690 (For U-NII-3)	-2.10	-3.12	1.131	0.54	30.00	Pass
155	5775	13.79	13.75	47.647	16.78	30.00	Pass

Note:

1. 5180-5250MHz: Directional Gain = 5.21dBi < 6dBi, so the power limit not need to reduce.
2. 5250-5320MHz: Directional Gain = 5.71dBi < 6dBi, so the power limit not need to reduce.
3. 5500-5720MHz: Directional Gain = 5.32dBi < 6dBi, so the power limit not need to reduce.
4. 5745-5825MHz: Directional Gain = 5.56dBi < 6dBi, so the power limit not need to reduce.

For U-NII-2A, U-NII-2C Band:

Chain 0

1. $11\text{dBm} + 10\log(81.04) = 30.08 > 24\text{dBm}$
2. $11\text{dBm} + 10\log(81.30) = 30.10 > 24\text{dBm}$
3. $11\text{dBm} + 10\log(81.30) = 30.10 > 24\text{dBm}$
4. $11\text{dBm} + 10\log(5725.00 - 5649.53) = 29.77 > 24\text{dBm}$

Chain 1

1. $11\text{dBm} + 10\log(80.99) = 30.08 > 24\text{dBm}$
2. $11\text{dBm} + 10\log(81.11) = 30.09 > 24\text{dBm}$
3. $11\text{dBm} + 10\log(81.11) = 30.09 > 24\text{dBm}$
4. $11\text{dBm} + 10\log(5725.00 - 5649.45) = 29.78 > 24\text{dBm}$

Straddle channel power plots:

802.11a

Chain 0

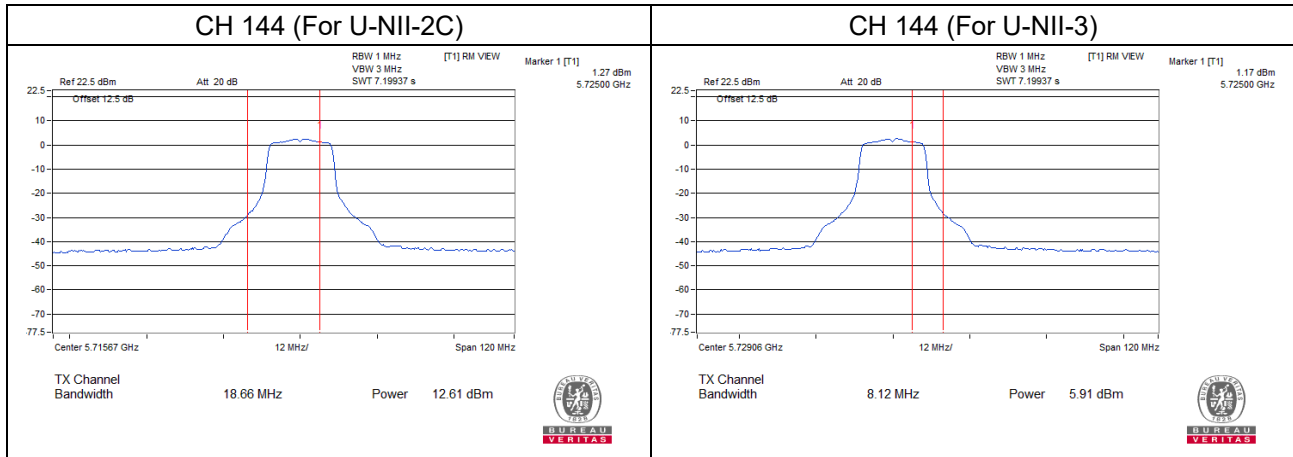

Chain 1

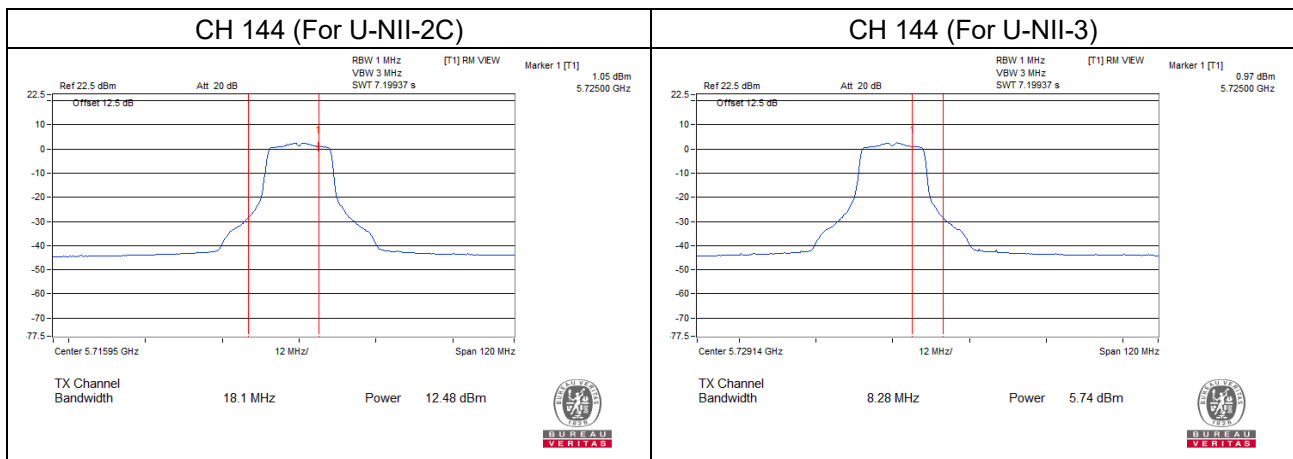

802.11ax (HE20)

Chain 0

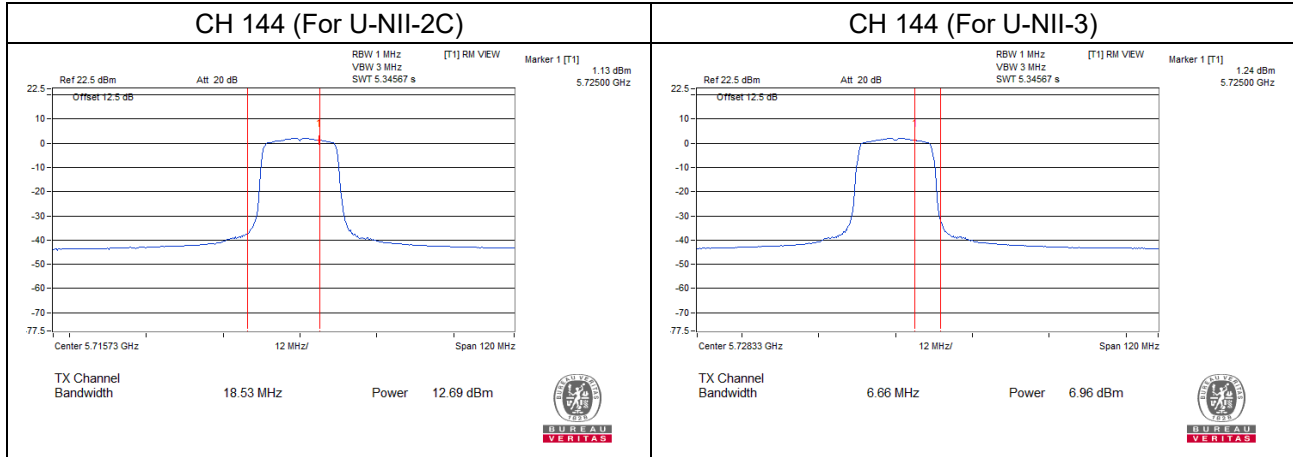

Chain 1

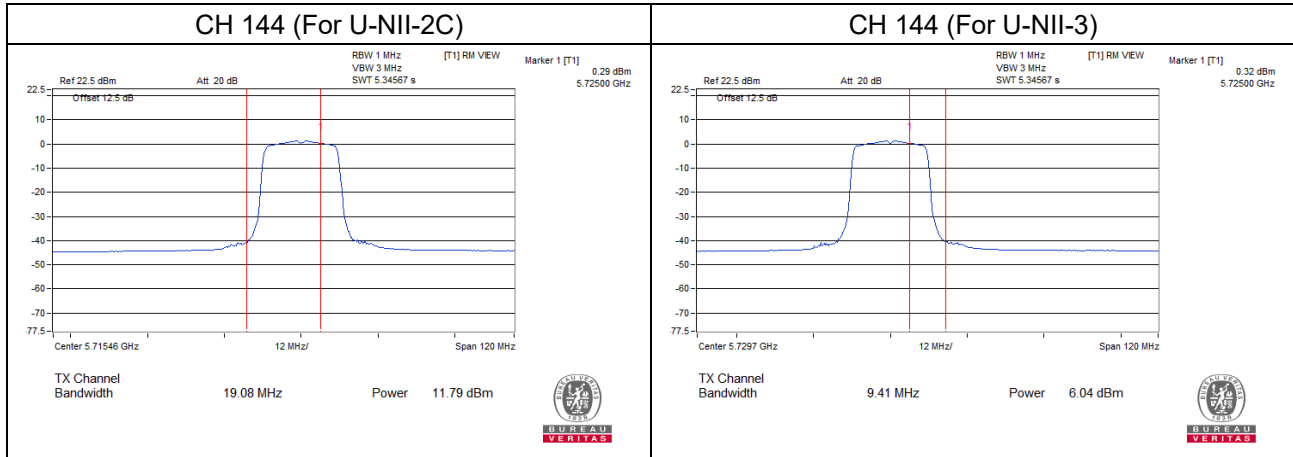

802.11ax (HE40)

Chain 0

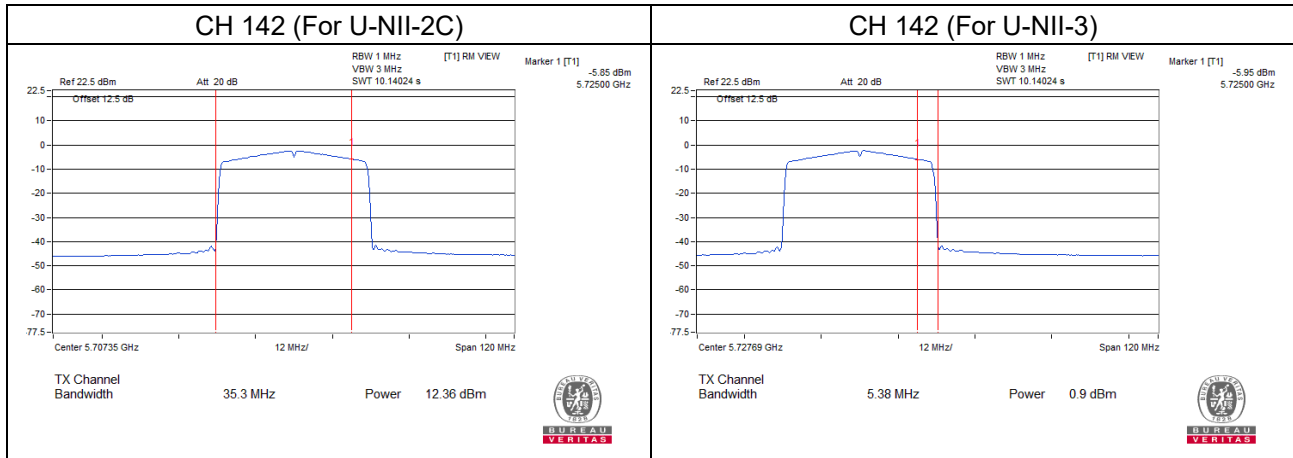

Chain 1

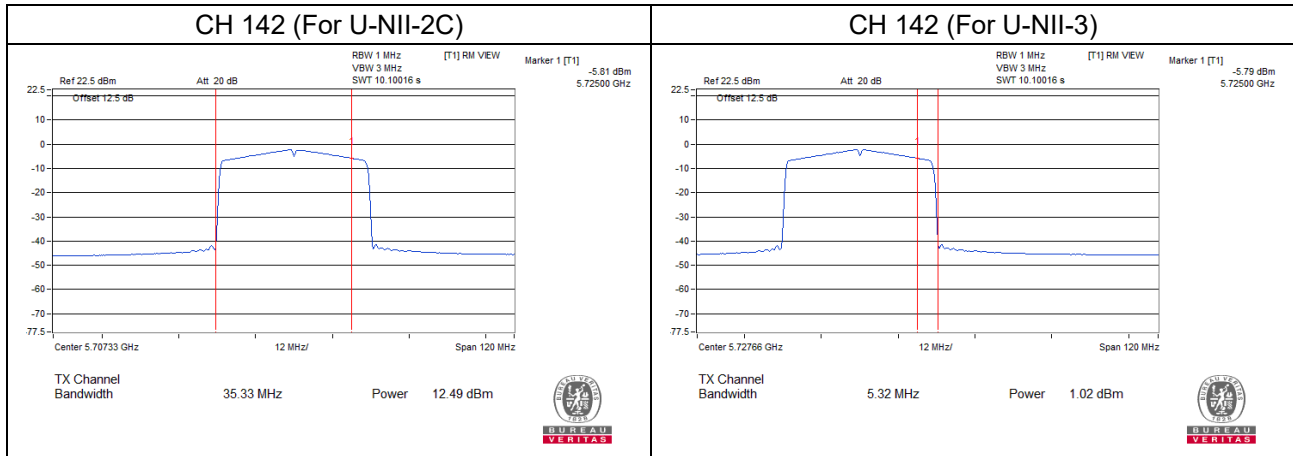

802.11ax (HE80)
Chain 0

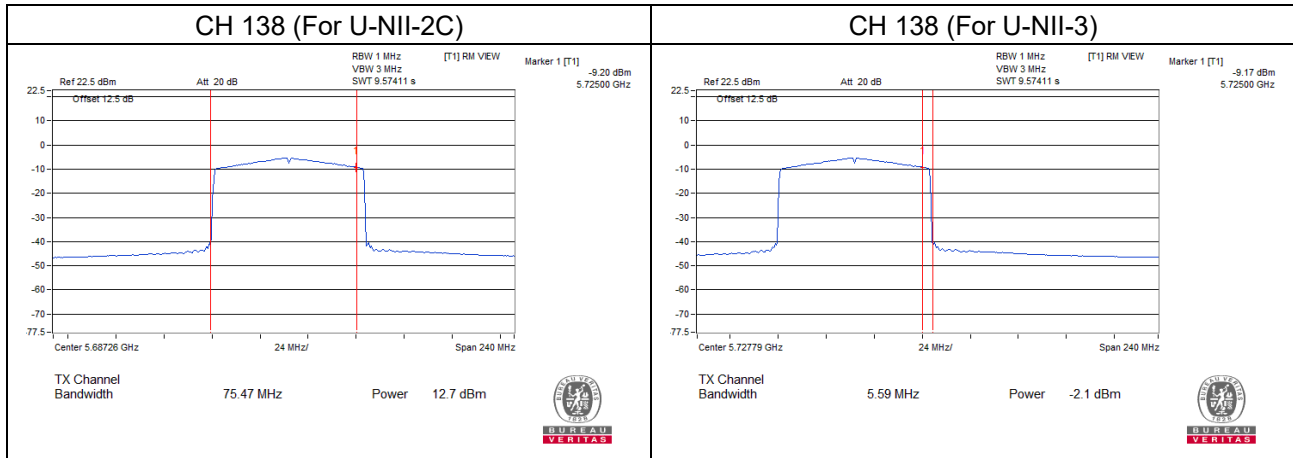

Chain 1

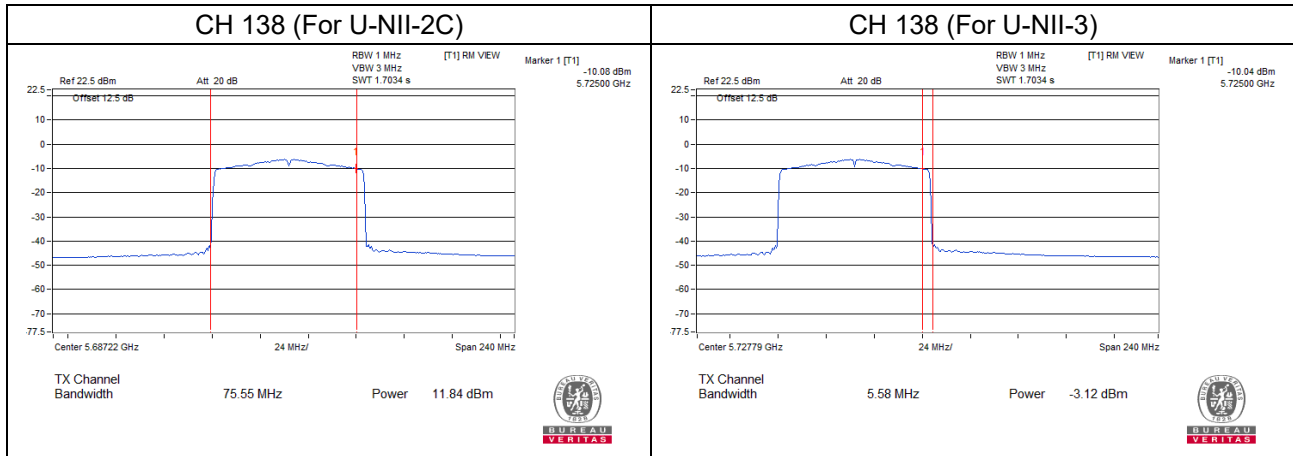

26dB Bandwidth:

802.11a

Chan.	Freq. (MHz)	26dBc Bandwidth (MHz)	
		Chain 0	Chain 1
52	5260	27.23	27.59
60	5300	27.02	26.41
64	5320	37.76	37.08
100	5500	26.83	26.32
116	5580	27.29	26.88
140	5700	29.42	27.69
144	5720 (For U-NII-2C)	18.66	18.10

For CH144 (U-NII-2C Band): The 26dBc bandwidth below 5725MHz = 5725MHz - Marker 1

802.11ax (HE20)

Chan.	Freq. (MHz)	26dBc Bandwidth (MHz)	
		Chain 0	Chain 1
52	5260	24.23	22.63
60	5300	26.72	25.98
64	5320	24.59	24.95
100	5500	25.04	25.68
116	5580	26.32	26.53
140	5700	25.25	25.76
144	5720 (For U-NII-2C)	18.53	19.08

For CH144 (U-NII-2C Band): The 26dBc bandwidth below 5725MHz = 5725MHz - Marker 1

802.11ax (HE40)

Chan.	Freq. (MHz)	26dBc Bandwidth (MHz)	
		Chain 0	Chain 1
54	5270	40.65	40.70
62	5310	40.65	40.66
102	5510	40.84	40.79
110	5550	40.71	40.61
134	5670	40.82	40.71
142	5710 (For U-NII-2C)	35.30	35.33

For CH142 (U-NII-2C Band): The 26dBc bandwidth below 5725MHz = 5725MHz - Marker 1

802.11ax (HE80)

Chan.	Freq. (MHz)	26dBc Bandwidth (MHz)	
		Chain 0	Chain 1
58	5290	81.04	80.99
106	5530	81.30	81.11
122	5610	81.30	81.11
138	5690 (For U-NII-2C)	75.47	75.55

For CH138 (U-NII-2C Band): The 26dBc bandwidth below 5725MHz = 5725MHz - Marker 1

Spectrum Plot of Worst Value

802.11a

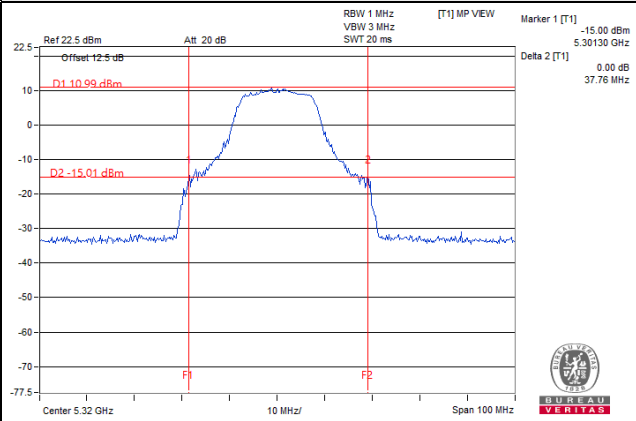

802.11ax (HE20)

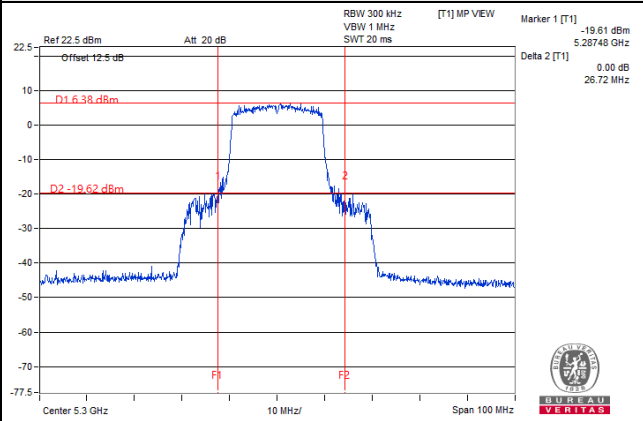

802.11ax (HE40)

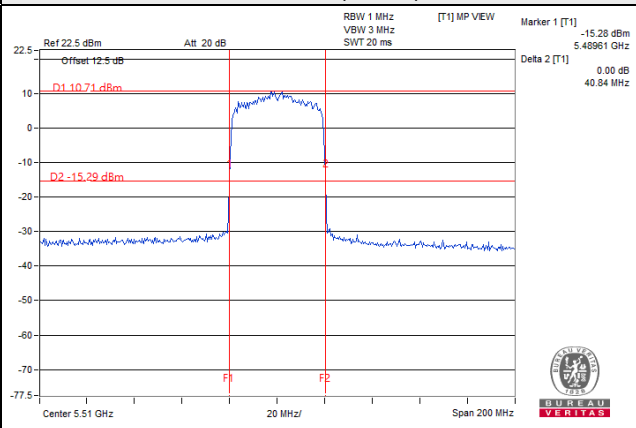

802.11ax (HE80)

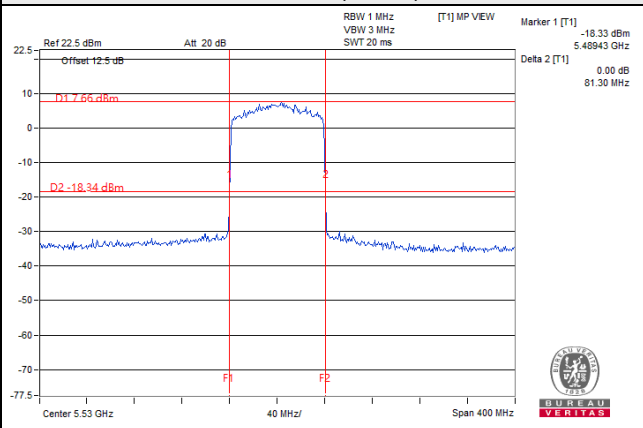

EUT Average Power

802.11a

Frequency Band (MHz)	Max. Power	
	Output Power (mW)	Output Power (dBm)
5250~5350	49.951	16.99
5470~5725	48.813	16.89

802.11ax (HE20)

Frequency Band (MHz)	Max. Power	
	Output Power (mW)	Output Power (dBm)
5250~5350	42.201	16.25
5470~5725	41.745	16.21

802.11ax (HE40)

Frequency Band (MHz)	Max. Power	
	Output Power (mW)	Output Power (dBm)
5250~5350	42.659	16.30
5470~5725	42.175	16.25

802.11ax (HE80)

Frequency Band (MHz)	Max. Power	
	Output Power (mW)	Output Power (dBm)
5250~5350	49.949	16.99
5470~5725	49.898	16.98

4.4 Occupied Bandwidth Measurement

4.4.1 Test Setup

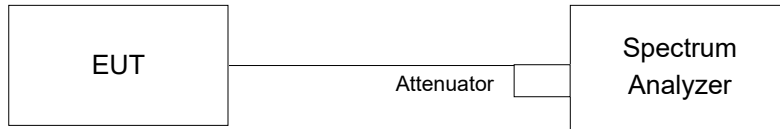

4.4.2 Test Instruments

Refer to section 4.1.2 to get information of above instrument.

4.4.3 Test Procedure

The transmitter output was connected to the spectrum analyzer through an attenuator. The bandwidth of the fundamental frequency was measured by spectrum analyzer with resolution bandwidth in the range of 1% to 5% of the anticipated emission bandwidth, and a video bandwidth at least 3x the resolution bandwidth and set the detector to sampling. The width of a frequency band such that, below the lower and above the upper frequency limits, the mean powers emitted are each equal to a specified percentage 0.5 % of the total mean power of a given emission.

4.4.4 Test Result

802.11a

Chan.	Freq. (MHz)	Occupied Bandwidth (MHz)	
		Chain 0	Chain 1
36	5180	17.40	17.52
40	5200	17.40	17.40
48	5240	16.80	16.68
52	5260	17.40	17.64
60	5300	17.40	17.52
64	5320	17.64	17.52
100	5500	17.40	17.64
116	5580	17.40	17.40
140	5700	17.52	17.64
144	5720 (For U-NII-2C)	13.76	13.76
144	5720 (For U-NII-3)	3.64	3.64
149	5745	17.40	17.40
157	5785	17.40	17.52
165	5825	17.40	17.16

For CH144 (U-NII-2C Band): The Occupied bandwidth below 5725MHz = 5725MHz - Temp 1

For CH144 (U-NII-3 Band): The Occupied bandwidth above 5725MHz = Temp 2 - 5725MHz

802.11ax (HE20)

Chan.	Freq. (MHz)	Occupied Bandwidth (MHz)	
		Chain 0	Chain 1
36	5180	19.08	19.08
40	5200	19.20	19.20
48	5240	18.84	18.84
52	5260	19.08	19.20
60	5300	19.08	19.20
64	5320	19.08	19.08
100	5500	19.20	19.32
116	5580	19.08	19.08
140	5700	19.08	19.08
144	5720 (For U-NII-2C)	14.60	14.60
144	5720 (For U-NII-3)	4.60	4.48
149	5745	19.08	19.20
157	5785	19.20	19.20
165	5825	19.08	19.08

For CH144 (U-NII-2C Band): The Occupied bandwidth below 5725MHz = 5725MHz - Temp 1

For CH144 (U-NII-3 Band): The Occupied bandwidth above 5725MHz = Temp 2 - 5725MHz

802.11ax (HE40)

Chan.	Freq. (MHz)	Occupied Bandwidth (MHz)	
		Chain 0	Chain 1
38	5190	37.68	37.68
46	5230	37.92	37.68
54	5270	37.68	37.80
62	5310	37.68	37.68
102	5510	37.68	37.80
110	5550	37.68	37.92
134	5670	37.44	37.92
142	5710 (For U-NII-2C)	33.96	33.96
142	5710 (For U-NII-3)	3.72	3.72
151	5755	37.92	37.68
159	5795	37.68	37.68

For CH142 (U-NII-2C Band): The Occupied bandwidth below 5725MHz = 5725MHz - Temp 1

For CH142 (U-NII-3 Band): The Occupied bandwidth above 5725MHz = Temp 2 - 5725MHz

802.11ax (HE80)

Chan.	Freq. (MHz)	Occupied Bandwidth (MHz)	
		Chain 0	Chain 1
42	5210	76.80	76.80
58	5290	76.80	77.04
106	5530	77.28	76.80
122	5610	76.80	76.80
138	5690 (For U-NII-2C)	73.88	73.88
138	5690 (For U-NII-3)	3.40	3.40
155	5775	76.80	77.04

For CH138 (U-NII-2C Band): The Occupied bandwidth below 5725MHz = 5725MHz - Temp 1

For CH138 (U-NII-3 Band): The Occupied bandwidth above 5725MHz = Temp 2 - 5725MHz

Spectrum Plot of Worst Value

802.11a

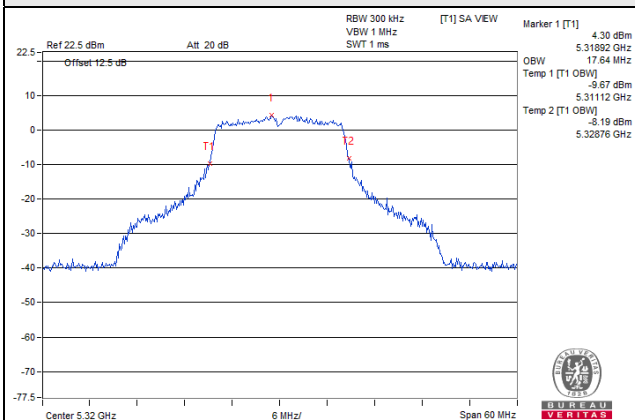

802.11ax (HE20)

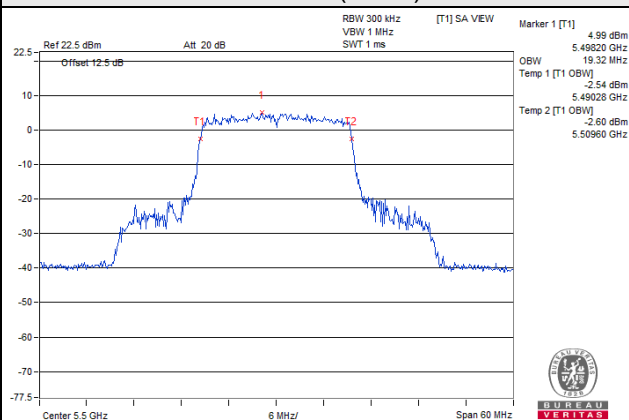

802.11ax (HE40)

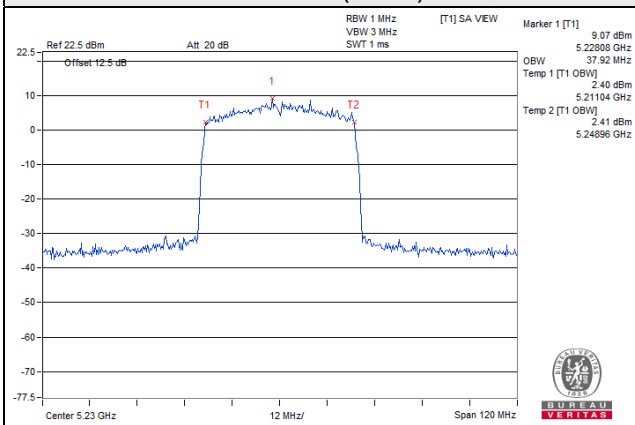

802.11ax (HE80)

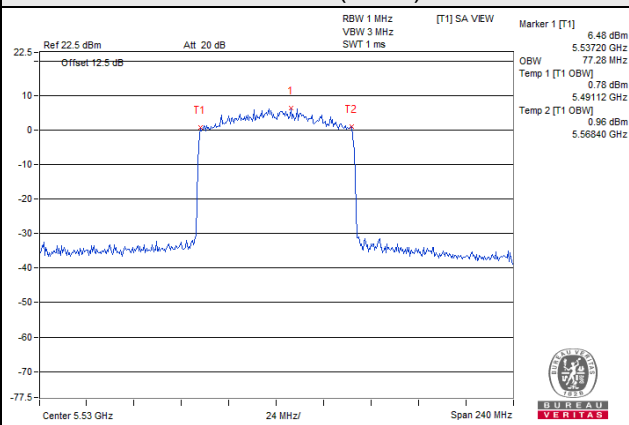

Spectrum Plot for near By DFS Band

802.11a / Chain 0 / CH 48

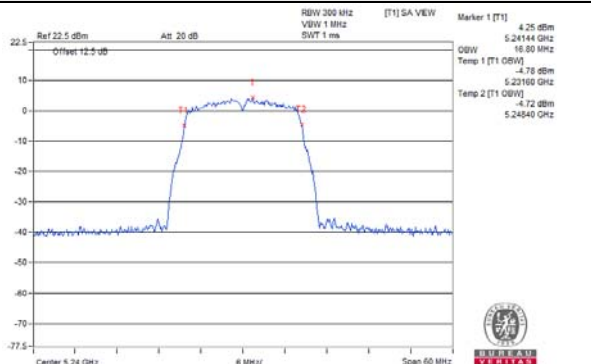

802.11a / Chain 1 / CH 48

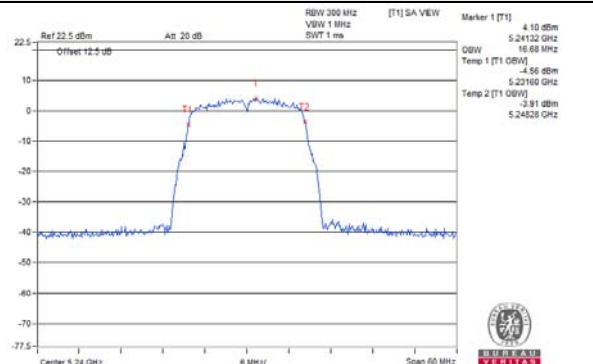

802.11ax (HE20) / Chain 0 / CH 48

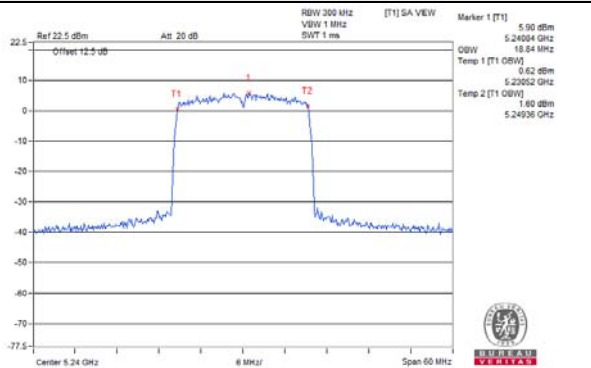

802.11ax (HE20) / Chain 1 / CH 48

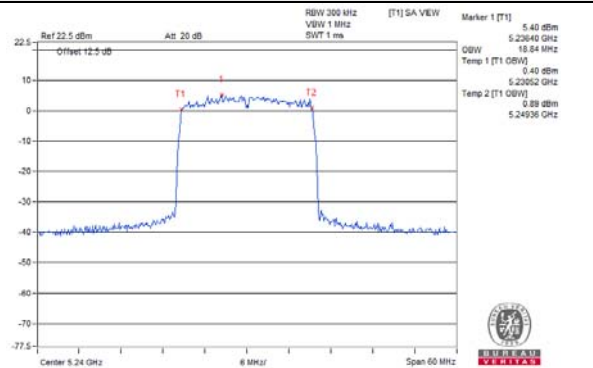

802.11ax (HE40) / Chain 0 / CH 46

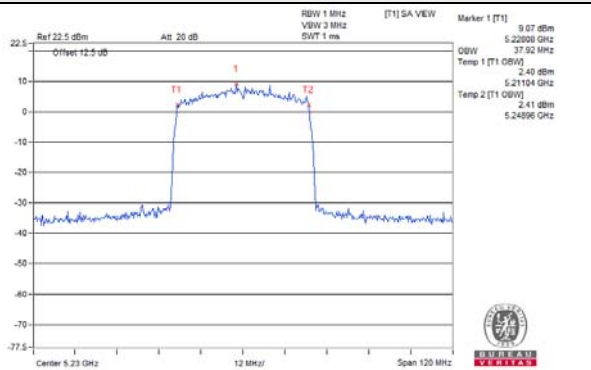

802.11ax (HE40) / Chain 1 / CH 46

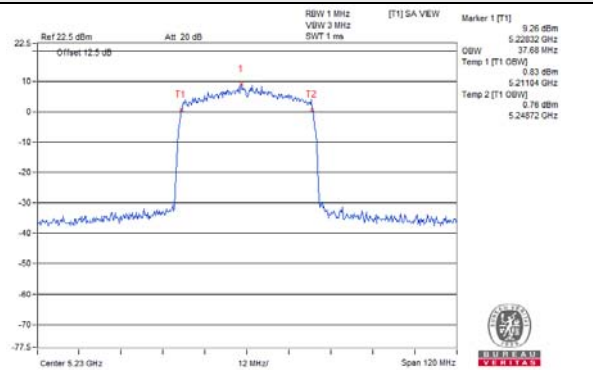

802.11ax (HE80) / Chain 0 / CH 42

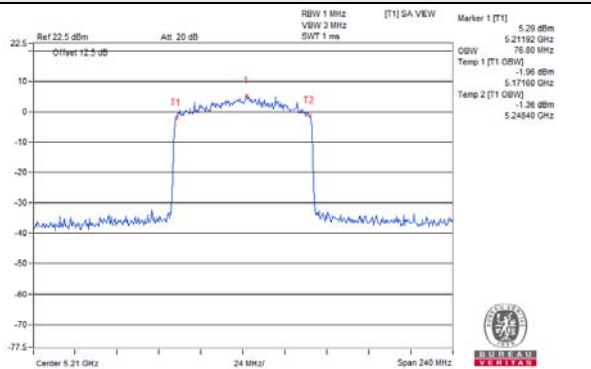

802.11ax (HE80) / Chain 1 / CH 42

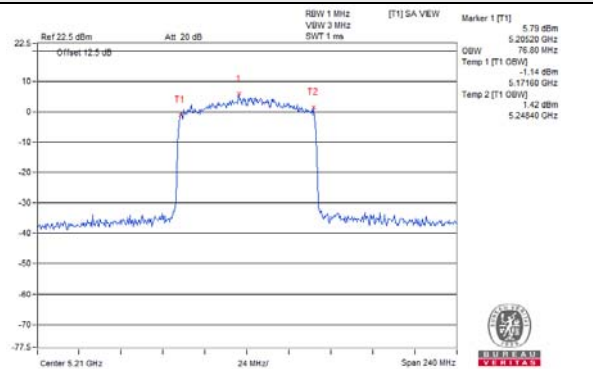

Spectrum Plot for near By DFS Band

802.11a / Chain 0 / CH 149

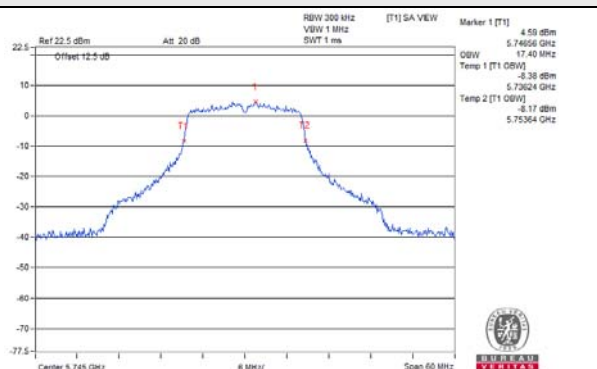

802.11a / Chain 1 / CH 149

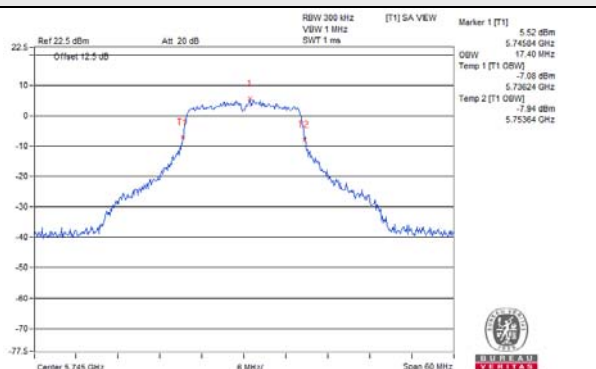

802.11ax (HE20) / Chain 0 / CH 149

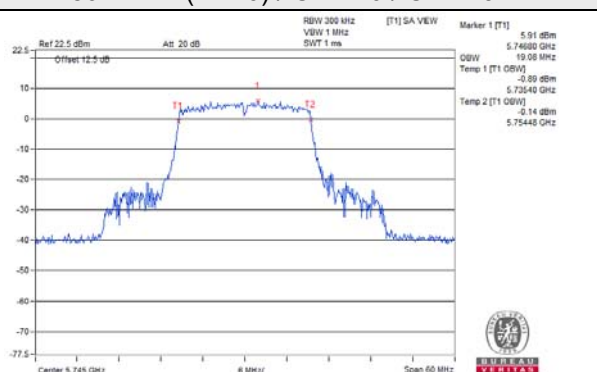

802.11ax (HE20) / Chain 1 / CH 149

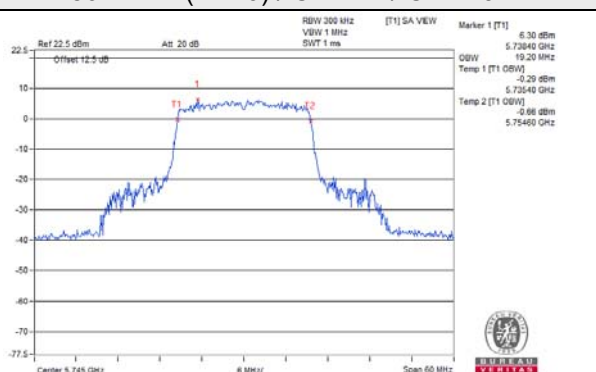

802.11ax (HE40) / Chain 0 / CH 151

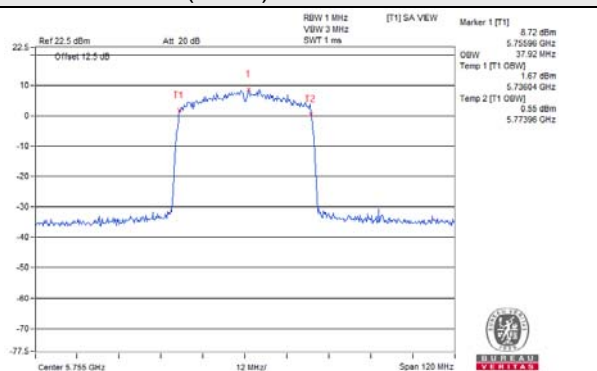

802.11ax (HE40) / Chain 1 / CH 151

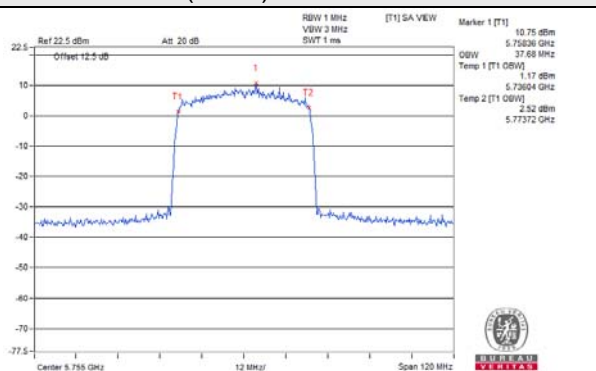

802.11ax (HE80) / Chain 0 / CH 155

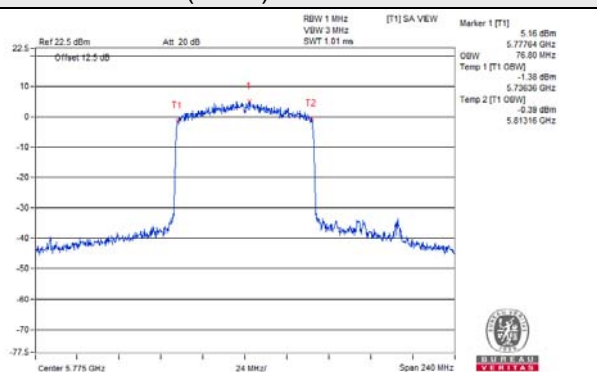

802.11ax (HE80) / Chain 1 / CH 155

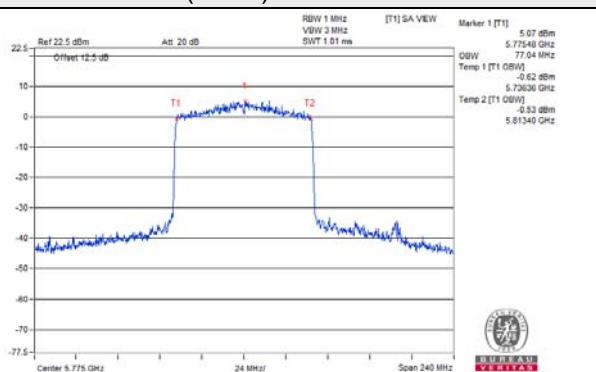

4.5 Peak Power Spectral Density Measurement

4.5.1 Limits of Peak Power Spectral Density Measurement

Operation Band	EUT Category		Limit
U-NII-1		Outdoor Access Point	17dBm/ MHz
		Fixed point-to-point Access Point	
		Indoor Access Point	
	√	Mobile and Portable client device	11dBm/ MHz
U-NII-2A	√		11dBm/ MHz
U-NII-2C	√		11dBm/ MHz
U-NII-3	√		30dBm/ 500kHz

Per KDB 662911 D01 Multiple Transmitter Output Method of conducted output power measurement on IEEE 802.11 devices,

If antenna gains are not equal, the user may use either of the following methods to calculate directional gain, provided that each transmit antenna is driven by only one spatial stream:

- Directional gain may be calculated by using the formulas applicable to equal gain antennas with GANT set equal to the gain of the antenna having the highest gain; or,

$$\bullet \text{ Directional Gain} = 10 \cdot \log \left[\frac{\sum_{j=1}^{N_{SS}} \left\{ \sum_{k=1}^{N_{ANT}} g_{j,k} \right\}^2}{N_{ANT}} \right]$$

where

Each antenna is driven by no more than one spatial stream;

N_{SS} = the number of independent spatial streams of data;

N_{ANT} = the total number of antennas

$g_{j,k} = 10^{G_k/20}$ if the k th antenna is being fed by spatial stream j , or zero if it is not;

G_k is the gain in dBi of the k th antenna.

4.5.2 Test Setup

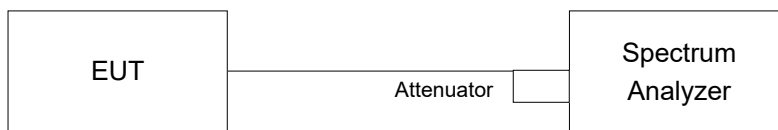

4.5.3 Test Instruments

Refer to section 4.1.2 to get information of above instrument.

4.5.4 Test Procedures

For U-NII-1, U-NII-2A and U-NII-2C band:

Duty cycle of test signal is < 98%

Using method SA-2

- a. Set span to encompass the entire emission bandwidth (EBW) of the signal.
- b. Set RBW = 1MHz, Set VBW \geq 3 MHz, Detector = RMS
- c. Set Channel power measure = 1MHz
- d. Sweep time = auto, trigger set to "free run".
- e. Trace average at least 100 traces in power averaging mode.
- f. Record the max value and add $10 \log (1/\text{duty cycle})$

For U-NII-3 band:

Duty cycle of test signal is < 98%

- a. Set span to encompass the entire emission bandwidth (EBW) of the signal.
- b. Set RBW = 300 kHz, Set VBW \geq 1 MHz, Detector = RMS
- c. Use the peak marker function to determine the maximum power level in any 300 kHz band segment within the fundamental EBW.
- d. Scale the observed power level to an equivalent value in 500 kHz by adjusting (increasing) the measured power by a bandwidth correction factor (BWCF) where $\text{BWCF} = 10\log(500 \text{ kHz} / 300 \text{ kHz})$
- e. Sweep time = auto, trigger set to "free run".
- f. Trace average at least 100 traces in power averaging mode.
- g. Record the max value and add $10 \log (1/\text{duty cycle})$

4.5.5 Deviation from Test Standard

No deviation.

4.5.6 EUT Operating Conditions

Same as 4.3.6.

4.5.7 Test Results

For U-NII-1, U-NII-2A and U-NII-2C band:

802.11a

Chan.	Freq. (MHz)	PSD w/o Duty Factor (dBm/MHz)		Duty Factor (dB)	Total PSD with Duty Factor (dBm/MHz)	Max. Limit (dBm/MHz)	Pass / Fail
		Chain 0	Chain 1				
36	5180	0.30	0.44	0.14	3.52	11.00	Pass
40	5200	0.71	0.38	0.14	3.70	11.00	Pass
48	5240	-0.56	0.03	0.14	2.90	11.00	Pass
52	5260	0.80	-0.07	0.14	3.54	11.00	Pass
60	5300	0.94	-0.06	0.14	3.62	11.00	Pass
64	5320	0.31	0.61	0.14	3.61	11.00	Pass
100	5500	0.50	0.47	0.14	3.64	11.00	Pass
116	5580	0.59	0.41	0.14	3.65	11.00	Pass
140	5700	0.59	0.28	0.14	3.59	11.00	Pass
144	5720 (For U-NII-2C)	0.66	0.37	0.14	3.67	11.00	Pass

Note:

- Method E) 2) a) of power density measurement of KDB 662911 is using for calculating total power density. Total power density is summing entire spectra across corresponding frequency bins on the various outputs by computer.
- 5180-5250MHz: Directional Gain = 5.21dBi < 6dBi, so the power density limit not need to reduce.
- 5250-5320MHz: Directional Gain = 5.71dBi < 6dBi, so the power density limit not need to reduce.
- 5500-5720MHz: Directional Gain = 5.32dBi < 6dBi, so the power density limit not need to reduce.
- Refer to section 3.3 for duty cycle spectrum plot.

802.11ax (HE20)

Chan.	Freq. (MHz)	PSD w/o Duty Factor (dBm/MHz)		Duty Factor (dB)	Total PSD with Duty Factor (dBm/MHz)	Max. Limit (dBm/MHz)	Pass / Fail
		Chain 0	Chain 1				
36	5180	0.03	-0.03	0.19	3.20	11.00	Pass
40	5200	0.07	0.04	0.19	3.26	11.00	Pass
48	5240	0.48	-0.26	0.19	3.33	11.00	Pass
52	5260	0.61	-0.33	0.19	3.37	11.00	Pass
60	5300	0.07	0.32	0.19	3.40	11.00	Pass
64	5320	0.72	-0.11	0.19	3.53	11.00	Pass
100	5500	0.62	-0.24	0.19	3.41	11.00	Pass
116	5580	0.27	0.00	0.19	3.34	11.00	Pass
140	5700	0.33	0.06	0.19	3.40	11.00	Pass
144	5720 (For U-NII-2C)	0.50	0.06	0.19	3.49	11.00	Pass

Note:

- Method E) 2) a) of power density measurement of KDB 662911 is using for calculating total power density. Total power density is summing entire spectra across corresponding frequency bins on the various outputs by computer.
- 5180-5250MHz: Directional Gain = 5.21dBi < 6dBi, so the power density limit not need to reduce.
- 5250-5320MHz: Directional Gain = 5.71dBi < 6dBi, so the power density limit not need to reduce.
- 5500-5720MHz: Directional Gain = 5.32dBi < 6dBi, so the power density limit not need to reduce.
- Refer to section 3.3 for duty cycle spectrum plot.

802.11ax (HE40)

Chan.	Freq. (MHz)	PSD w/o Duty Factor (dBm/MHz)		Duty Factor (dB)	Total PSD with Duty Factor (dBm/MHz)	Max. Limit (dBm/MHz)	Pass / Fail
		Chain 0	Chain 1				
38	5190	-3.06	-2.87	0.12	0.17	11.00	Pass
46	5230	-2.96	-2.78	0.12	0.26	11.00	Pass
54	5270	-2.86	-2.86	0.12	0.27	11.00	Pass
62	5310	-2.94	-2.41	0.12	0.46	11.00	Pass
102	5510	-3.00	-3.15	0.12	0.06	11.00	Pass
110	5550	-3.16	-2.66	0.12	0.23	11.00	Pass
134	5670	-2.93	-3.61	0.12	-0.13	11.00	Pass
142	5710 (For U-NII-2C)	-2.79	-2.75	0.12	0.36	11.00	Pass

Note:

- Method E) 2) a) of power density measurement of KDB 662911 is using for calculating total power density. Total power density is summing entire spectra across corresponding frequency bins on the various outputs by computer.
- 5180-5250MHz: Directional Gain = 5.21dBi < 6dBi, so the power density limit not need to reduce.
- 5250-5320MHz: Directional Gain = 5.71dBi < 6dBi, so the power density limit not need to reduce.
- 5500-5720MHz: Directional Gain = 5.32dBi < 6dBi, so the power density limit not need to reduce.
- Refer to section 3.3 for duty cycle spectrum plot.

802.11ax (HE80)

Chan.	Freq. (MHz)	PSD w/o Duty Factor (dBm/MHz)		Duty Factor (dB)	Total PSD with Duty Factor (dBm/MHz)	Max. Limit (dBm/MHz)	Pass / Fail
		Chain 0	Chain 1				
42	5210	-6.03	-5.90	0.11	-2.84	11.00	Pass
58	5290	-5.34	-5.55	0.11	-2.32	11.00	Pass
106	5530	-5.19	-5.61	0.11	-2.27	11.00	Pass
122	5610	-5.86	-5.73	0.11	-2.67	11.00	Pass
138	5690 (For U-NII-2C)	-5.78	-6.97	0.11	-3.21	11.00	Pass

Note:

- Method E) 2) a) of power density measurement of KDB 662911 is using for calculating total power density. Total power density is summing entire spectra across corresponding frequency bins on the various outputs by computer.
- 5180-5250MHz: Directional Gain = 5.21dBi < 6dBi, so the power density limit not need to reduce.
- 5250-5320MHz: Directional Gain = 5.71dBi < 6dBi, so the power density limit not need to reduce.
- 5500-5720MHz: Directional Gain = 5.32dBi < 6dBi, so the power density limit not need to reduce.
- Refer to section 3.3 for duty cycle spectrum plot.

Spectrum Plot of Worst Value

802.11a / Chain 0 / CH 60

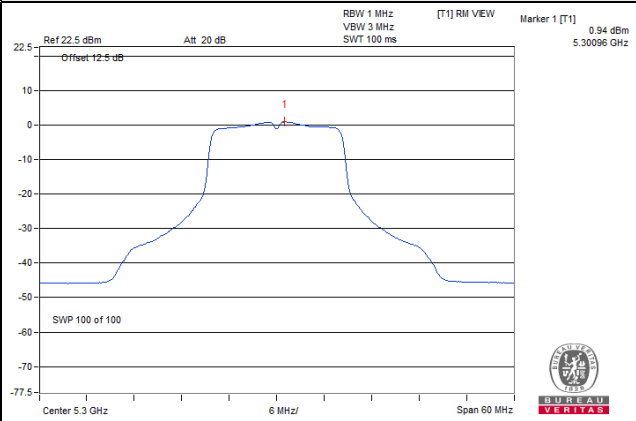

802.11ax (HE20) / Chain 0 / CH 64

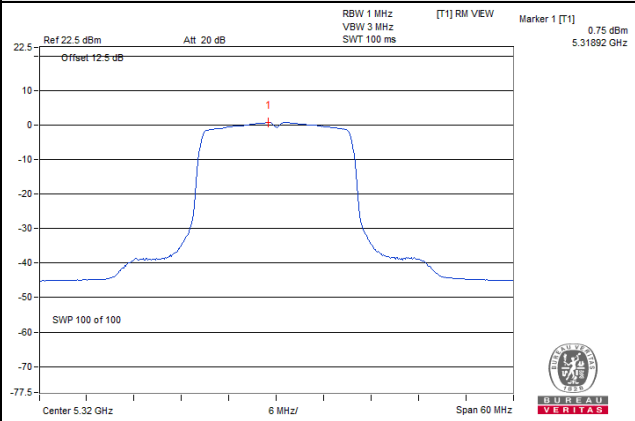

802.11ax (HE40) / Chain 1 / CH 62

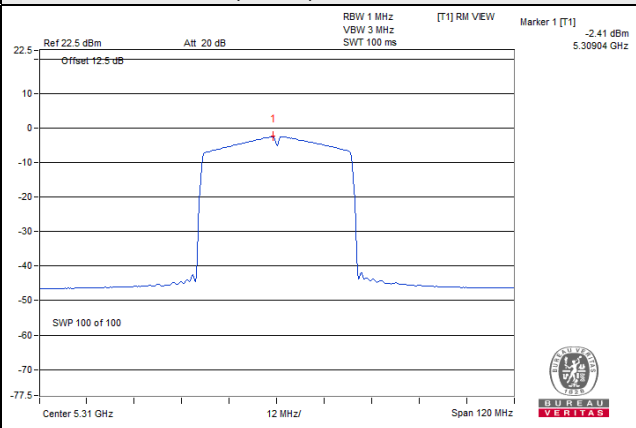

802.11ax (HE80) / Chain 0 / CH 106

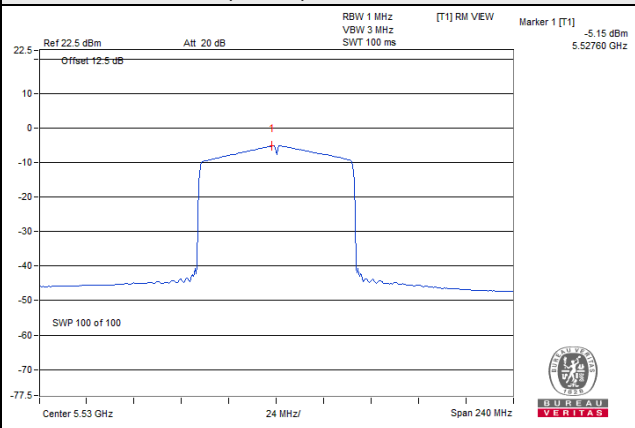

For U-NII-3 band:

802.11a

TX chain	Chan.	Freq. (MHz)	PSD W/O Duty Factor		10 log (N=2) dB	Duty Factor (dB)	Total PSD With Duty Factor (dBm/500kHz)	Limit (dBm/500kHz)	Pass / Fail
			(dBm/300kHz)	(dBm/500kHz)					
0	144	5720 (For U-NII-3)	-9.05	-6.83	3.01	0.14	-3.68	30.00	Pass
	149	5745	-8.62	-6.4	3.01	0.14	-3.25	30.00	Pass
	157	5785	-8.56	-6.34	3.01	0.14	-3.19	30.00	Pass
	165	5825	-8.88	-6.66	3.01	0.14	-3.51	30.00	Pass
1	144	5720 (For U-NII-3)	-9.39	-7.17	3.01	0.14	-4.02	30.00	Pass
	149	5745	-8.28	-6.06	3.01	0.14	-2.91	30.00	Pass
	157	5785	-7.98	-5.76	3.01	0.14	-2.61	30.00	Pass
	165	5825	-8.59	-6.37	3.01	0.14	-3.22	30.00	Pass

Note:

- Method E) 2) c) of power density measurement of KDB 662911 is using for calculating total power density, Measure value and add $10 \log (N_{ANT})$ dB.
- Directional gain = 5.56dBi < 6dBi, so the power density limit not need to reduce.
- Refer to section 3.3 for duty cycle spectrum plot.

802.11ax (HE20)

TX chain	Chan.	Freq. (MHz)	PSD W/O Duty Factor		10 log (N=2) dB	Duty Factor (dB)	Total PSD With Duty Factor (dBm/500kHz)	Limit (dBm/500kHz)	Pass / Fail
			(dBm/300kHz)	(dBm/500kHz)					
0	144	5720 (For U-NII-3)	-9.57	-7.35	3.01	0.19	-4.15	30.00	Pass
	149	5745	-8.81	-6.59	3.01	0.19	-3.39	30.00	Pass
	157	5785	-8.82	-6.6	3.01	0.19	-3.4	30.00	Pass
	165	5825	-9.46	-7.24	3.01	0.19	-4.04	30.00	Pass
1	144	5720 (For U-NII-3)	-10.08	-7.86	3.01	0.19	-4.66	30.00	Pass
	149	5745	-8.56	-6.34	3.01	0.19	-3.14	30.00	Pass
	157	5785	-8.59	-6.37	3.01	0.19	-3.17	30.00	Pass
	165	5825	-9.23	-7.01	3.01	0.19	-3.81	30.00	Pass

Note:

- Method E) 2) c) of power density measurement of KDB 662911 is using for calculating total power density, Measure value and add $10 \log (N_{ANT})$ dB.
- Directional gain = 5.56dBi < 6dBi, so the power density limit not need to reduce.
- Refer to section 3.3 for duty cycle spectrum plot.

802.11ax (HE40)

TX chain	Chan.	Freq. (MHz)	PSD W/O Duty Factor		10 log (N=2) dB	Duty Factor (dB)	Total PSD With Duty Factor (dBm/500kHz)	Limit (dBm/500kHz)	Pass / Fail
			(dBm/300kHz)	(dBm/500kHz)					
0	142	5710 (For U-NII-3)	-15.56	-13.34	3.01	0.12	-10.21	30.00	Pass
	151	5755	-11.67	-9.45	3.01	0.12	-6.32	30.00	Pass
	159	5795	-11.57	-9.35	3.01	0.12	-6.22	30.00	Pass
	142	5710 (For U-NII-3)	-15.59	-13.37	3.01	0.12	-10.24	30.00	Pass
	151	5755	-11.22	-9.00	3.01	0.12	-5.87	30.00	Pass
	159	5795	-11.25	-9.03	3.01	0.12	-5.90	30.00	Pass

Note:

1. Method E) 2) c) of power density measurement of KDB 662911 is using for calculating total power density, Measure value and add 10 log (N_{ANT}) dB.
2. Directional gain = 5.56dBi < 6dBi, so the power density limit not need to reduce.
3. Refer to section 3.3 for duty cycle spectrum plot.

802.11ax (HE80)

TX chain	Chan.	Freq. (MHz)	PSD W/O Duty Factor		10 log (N=2) dB	Duty Factor (dB)	Total PSD With Duty Factor (dBm/500kHz)	Limit (dBm/500kHz)	Pass / Fail
			(dBm/300kHz)	(dBm/500kHz)					
0	138	5690 (For U-NII-3)	-18.77	-16.55	3.01	0.11	-13.43	30.00	Pass
	155	5775	-13.99	-11.77	3.01	0.11	-8.65	30.00	Pass
1	138	5690 (For U-NII-3)	-19.89	-17.67	3.01	0.11	-14.55	30.00	Pass
	155	5775	-13.84	-11.62	3.01	0.11	-8.50	30.00	Pass

Note:

1. Method E) 2) c) of power density measurement of KDB 662911 is using for calculating total power density, Measure value and add 10 log (N_{ANT}) dB.
2. Directional gain = 5.56dBi < 6dBi, so the power density limit not need to reduce.
3. Refer to section 3.3 for duty cycle spectrum plot.

Spectrum Plot of Worst Value

802.11a

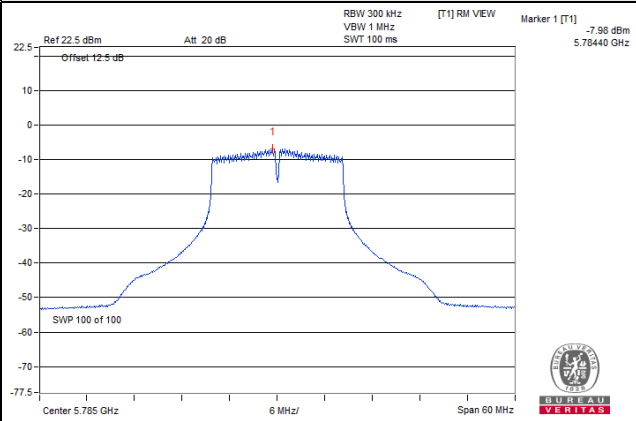

802.11ax (HE20)

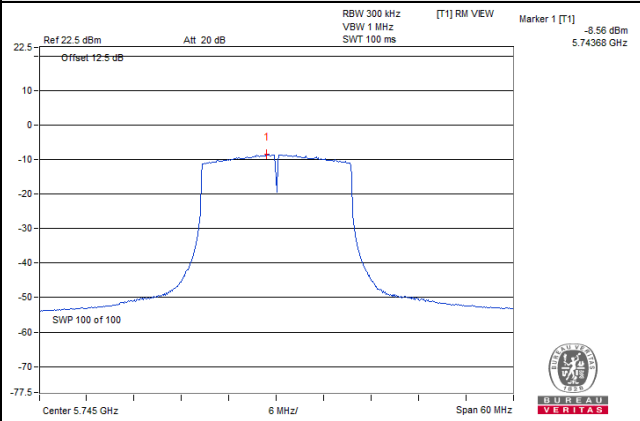

802.11ax (HE40)

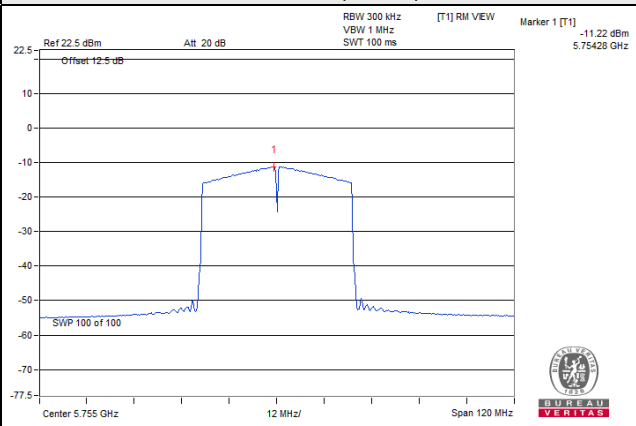

802.11ax (HE80)

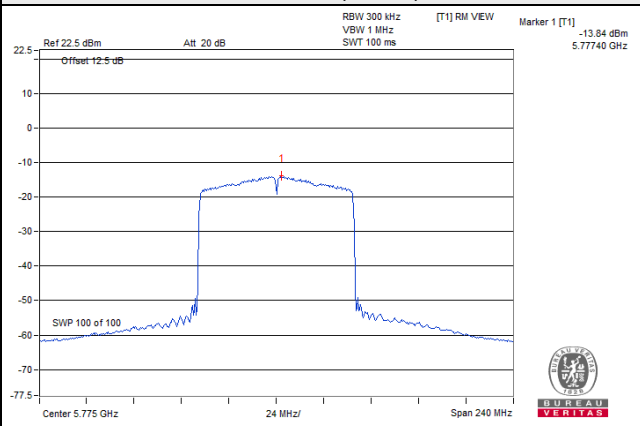

4.6 Frequency Stability

4.6.1 Limits of Frequency Stability Measurement

The frequency of the carrier signal shall be maintained within band of operation

4.6.2 Test Setup

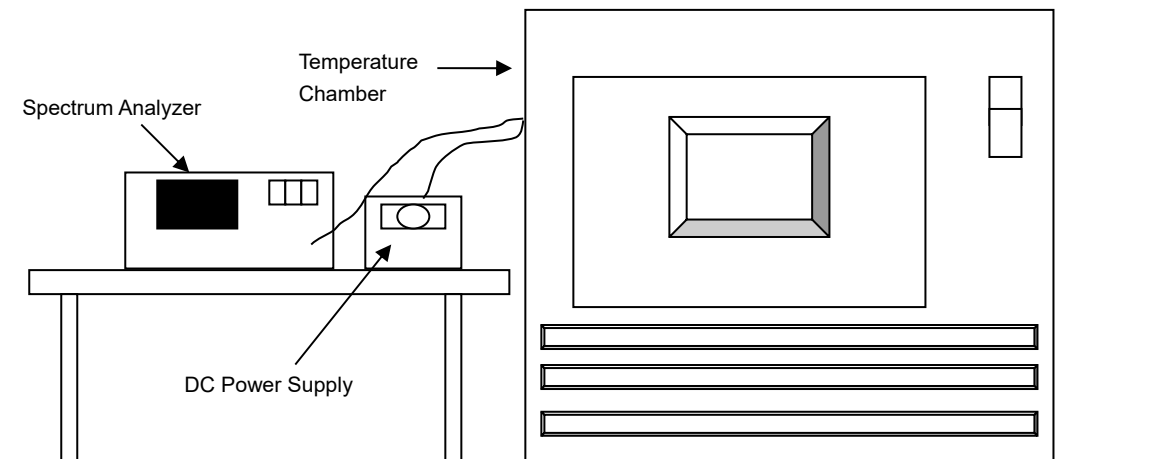

4.6.3 Test Instruments

Description & Manufacturer	Model No.	Serial No.	Cal. Date	Cal. Due
Spectrum Analyzer ROHDE & SCHWARZ	FSP40	100040	Sep. 15, 2021	Sep. 14, 2022
WIT Standard Temperature And Humidity Chamber	TH-4S-C	W981030	May 30, 2022	May 29, 2023
Digital Multimeter Fluke	87-III	70360742	Jun. 23, 2022	Jun. 22, 2023
DC Power Supply Topward	6603D	700637	NA	NA

Note: 1. The calibration interval of the above test instruments is 12 months and the calibrations are traceable to NML/ROC and NIST/USA.

2. Tested data: Jul. 15, 2022

4.6.4 Test Procedure

- The EUT was placed inside the environmental test chamber and powered by nominal DC voltage.
- Turn the EUT on and couple its output to a spectrum analyzer.
- Turn the EUT off and set the chamber to the highest temperature specified.
- Allow sufficient time (approximately 30 min) for the temperature of the chamber to stabilize, turn the EUT on and measure the operating frequency after 2, 5, and 10 minutes.
- Repeat step d with every 10 degrees reduction until the lowest temperature achieved.
- The test chamber was allowed to stabilize at +20 degree C for a minimum of 30 minutes. The supply voltage was then adjusted on the EUT from 85% to 115% and the frequency record.

4.6.5 Deviation from Test Standard

No deviation.

4.6.6 EUT Operating Condition

Set the EUT transmit at un-modulation mode to test frequency stability.

4.6.7 Test Results

Frequency Stability Versus Temp.									
Operating Frequency: 5180MHz									
Temp. (°C)	Power Supply (Vdc)	0 Minute		2 Minute		5 Minute		10 Minute	
		Measured Frequency (MHz)	Result	Measured Frequency (MHz)	Result	Measured Frequency (MHz)	Result	Measured Frequency (MHz)	Result
40	5	5180.0259	Pass	5180.0247	Pass	5180.0216	Pass	5180.0258	Pass
30	5	5180.0122	Pass	5180.0080	Pass	5180.0115	Pass	5180.0114	Pass
20	5	5180.0027	Pass	5180.0054	Pass	5180.0025	Pass	5180.0037	Pass
10	5	5180.0140	Pass	5180.0157	Pass	5180.0143	Pass	5180.0147	Pass
0	5	5179.9791	Pass	5179.9789	Pass	5179.9783	Pass	5179.9749	Pass

Frequency Stability Versus Voltage									
Operating Frequency: 5180MHz									
Temp. (°C)	Power Supply (Vdc)	0 Minute		2 Minute		5 Minute		10 Minute	
		Measured Frequency (MHz)	Result	Measured Frequency (MHz)	Result	Measured Frequency (MHz)	Result	Measured Frequency (MHz)	Result
20	5.75	5180.0118	Pass	5180.0140	Pass	5180.0112	Pass	5180.0118	Pass
	5.00	5180.0027	Pass	5180.0054	Pass	5180.0025	Pass	5180.0037	Pass
	4.25	5179.9995	Pass	5179.9998	Pass	5180.0013	Pass	5179.9982	Pass

4.7 6dB Bandwidth Measurement

4.7.1 Limits of 6dB Bandwidth Measurement

The minimum of 6dB Bandwidth Measurement is 0.5MHz.

4.7.2 Test Setup

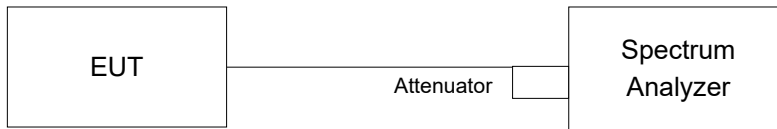

4.7.3 Test Instruments

Refer to section 4.1.2 to get information of above instrument.

4.7.4 Test Procedure

- Set resolution bandwidth (RBW) = 100kHz
- Set the video bandwidth (VBW) $\geq 3 \times$ RBW, Detector = Peak.
- Trace mode = max hold.
- Sweep = auto couple.
- Measure the maximum width of the emission that is constrained by the frequencies associated with the two amplitude points (upper and lower) that are attenuated by 6 dB relative to the maximum level measured in the fundamental emission

4.7.5 Deviation from Test Standard

No deviation.

4.7.6 EUT Operating Condition

The software provided by client to enable the EUT under transmission condition continuously at lowest, middle and highest channel frequencies individually.

4.7.7 Test Results

802.11a

Channel	Frequency (MHz)	6dB Bandwidth (MHz)		Minimum Limit (MHz)	Pass / Fail
		Chain 0	Chain 1		
144	5720 (For U-NII-3)	3.16	3.15	0.50	Pass
149	5745	16.37	16.35	0.50	Pass
157	5785	16.34	16.32	0.50	Pass
165	5825	16.37	16.32	0.50	Pass

For CH144 (U-NII-3 Band): The 6dB bandwidth above 5725MHz = Marker 1 + Delta 2 - 5725MHz

802.11ax (HE20)

Channel	Frequency (MHz)	6dB Bandwidth (MHz)		Minimum Limit (MHz)	Pass / Fail
		Chain 0	Chain 1		
144	5720 (For U-NII-3)	4.45	4.45	0.50	Pass
149	5745	18.99	18.88	0.50	Pass
157	5785	18.92	18.84	0.50	Pass
165	5825	19.00	18.94	0.50	Pass

For CH144 (U-NII-3 Band): The 6dB bandwidth above 5725MHz = Marker 1 + Delta 2 - 5725MHz

802.11ax (HE40)

Channel	Frequency (MHz)	6dB Bandwidth (MHz)		Minimum Limit (MHz)	Pass / Fail
		Chain 0	Chain 1		
142	5710 (For U-NII-3)	3.03	2.64	0.50	Pass
151	5755	35.30	35.28	0.50	Pass
159	5795	35.78	35.29	0.50	Pass

For CH142 (U-NII-3 Band): The 6dB bandwidth above 5725MHz = Marker 1 + Delta 2 - 5725MHz

802.11ax (HE80)

Channel	Frequency (MHz)	6dB Bandwidth (MHz)		Minimum Limit (MHz)	Pass / Fail
		Chain 0	Chain 1		
138	5690 (For U-NII-3)	2.74	2.72	0.50	Pass
155	5775	77.33	76.16	0.50	Pass

For CH138 (U-NII-3 Band): The 6dB bandwidth above 5725MHz = Marker 1 + Delta 2 - 5725MHz

Spectrum Plot of Worst Value

802.11a

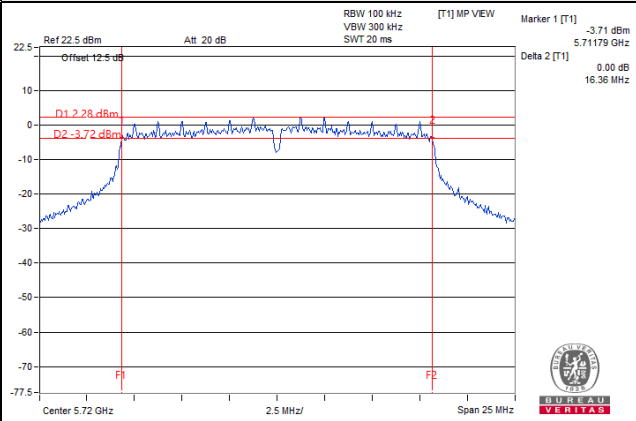

802.11ax (HE20)

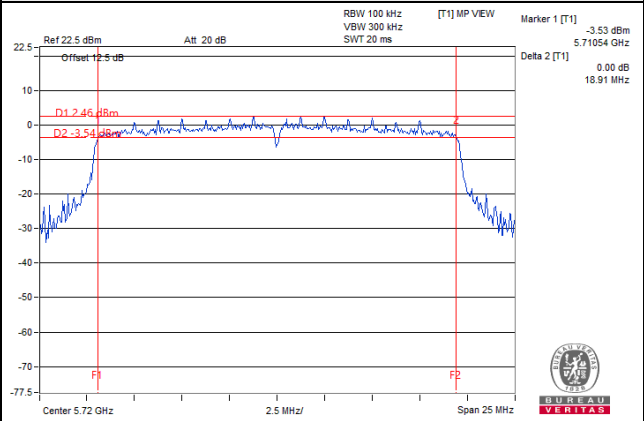

802.11ax (HE40)

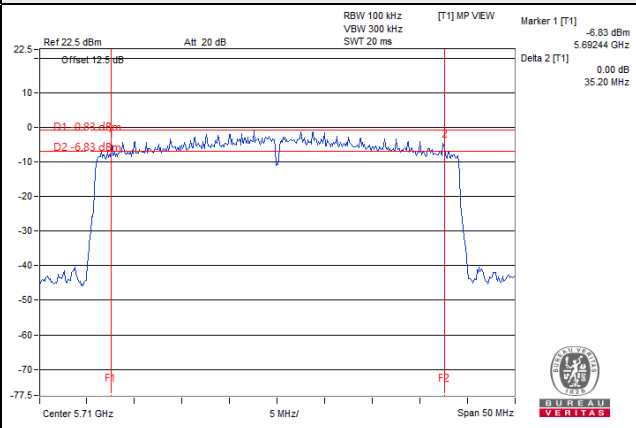

802.11ax (HE80)

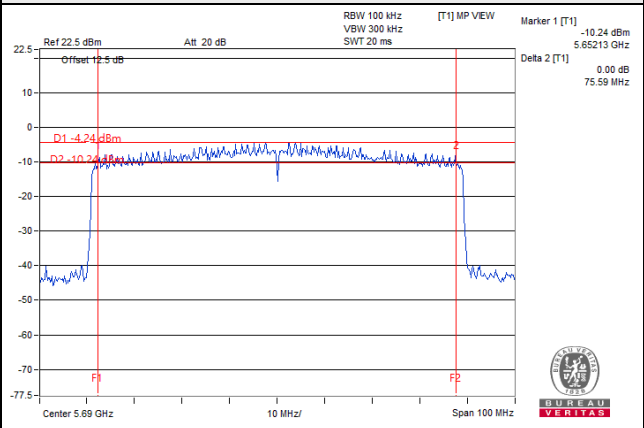

5 Pictures of Test Arrangements

Please refer to the attached file (Test Setup Photo).

Annex A - Radiated Out of Band Emission (OOBE) Measurement (For U-NII-3 band)

802.11a CH 149 : 5745 MHz

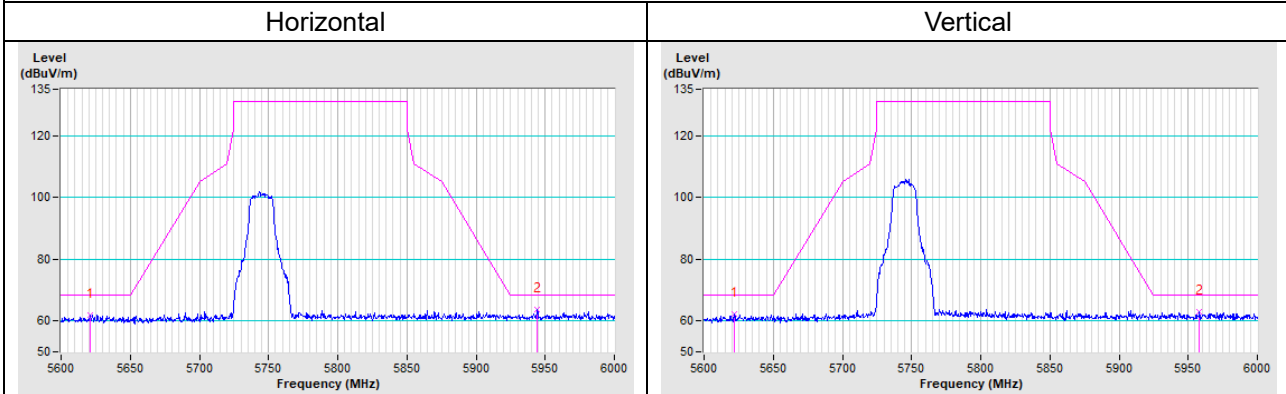

802.11a CH 157 : 5785 MHz

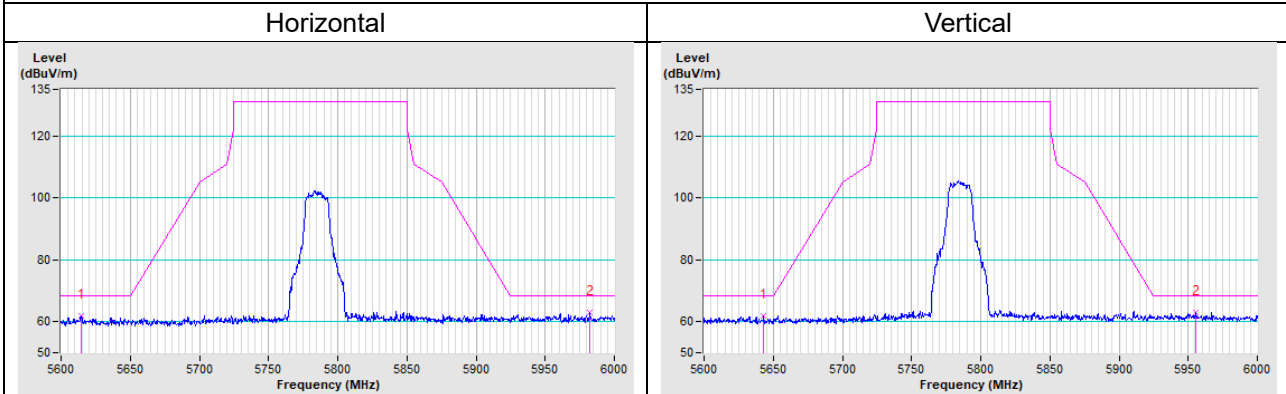

802.11a CH 165 : 5825 MHz

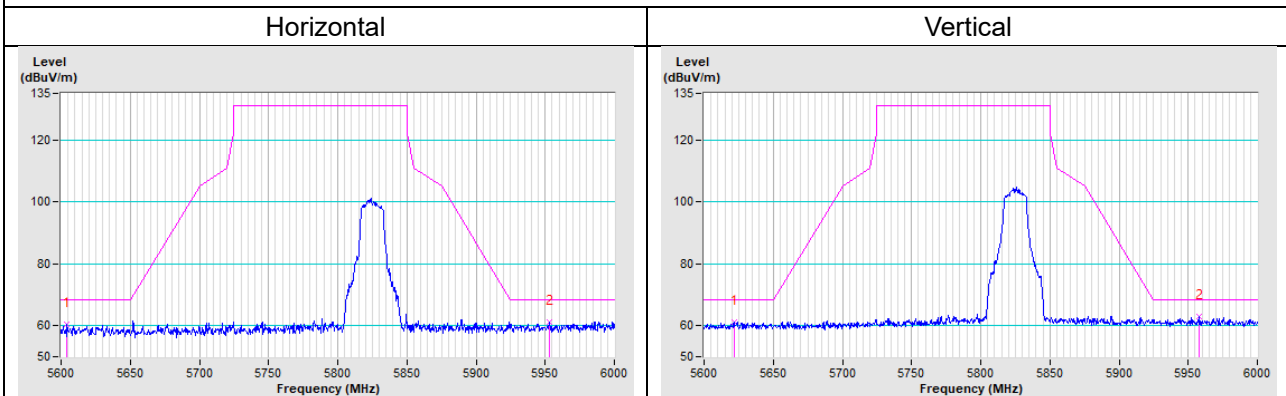

802.11ax (HE20) CH 149 : 5745 MHz

Horizontal

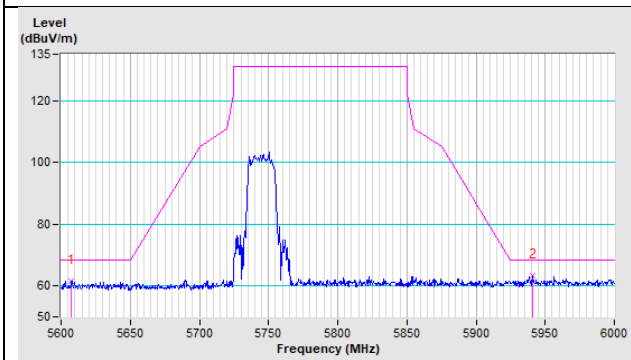

Vertical

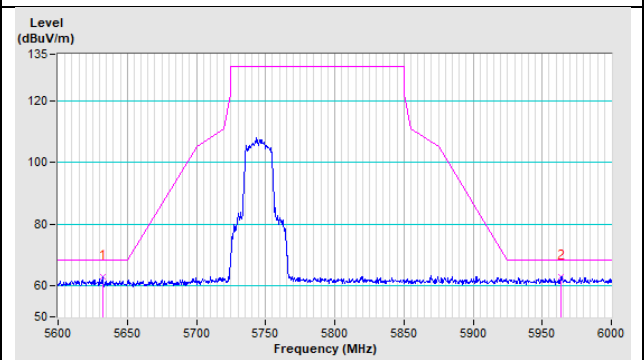

802.11ax (HE20) CH 157 : 5785 MHz

Horizontal

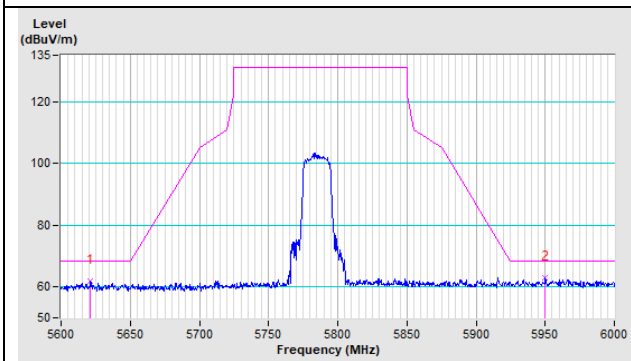

Vertical

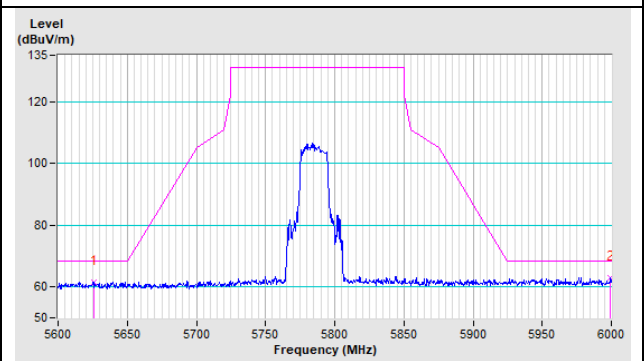

802.11ax (HE20) CH 165 : 5825 MHz

Horizontal

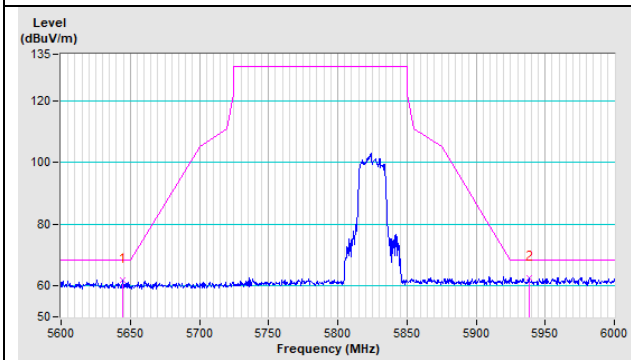

Vertical

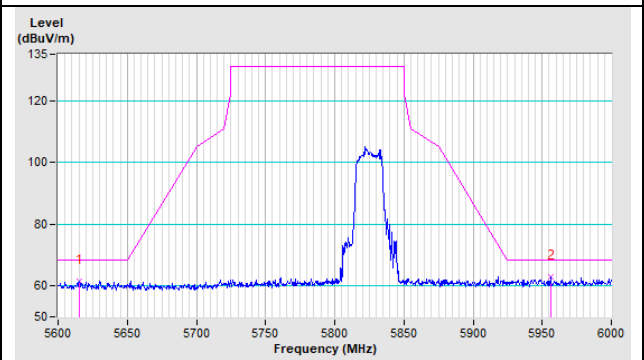

802.11ax (HE40) CH 151 : 5755 MHz

Horizontal

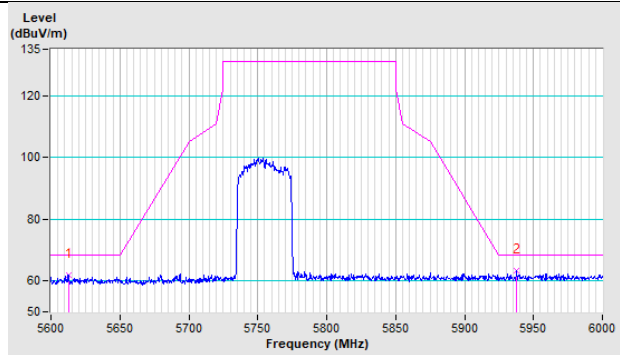

Vertical

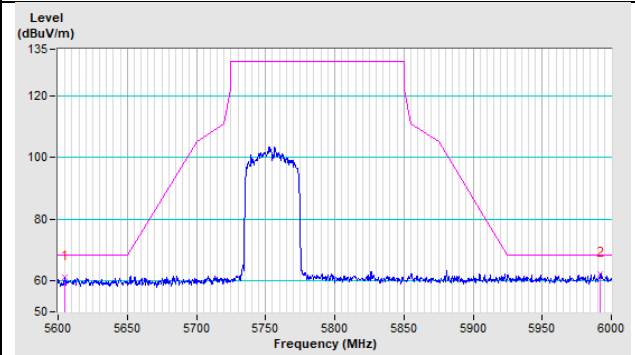

802.11ax (HE40) CH 159 : 5795 MHz

Horizontal

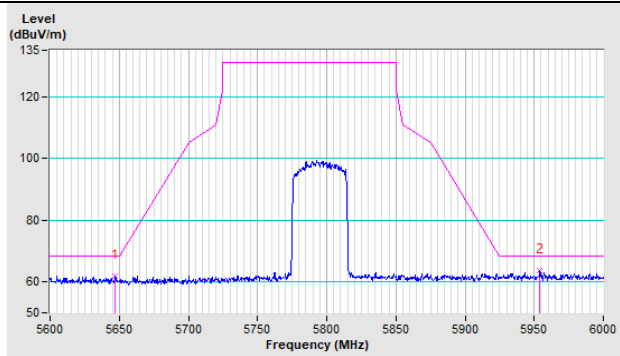

Vertical

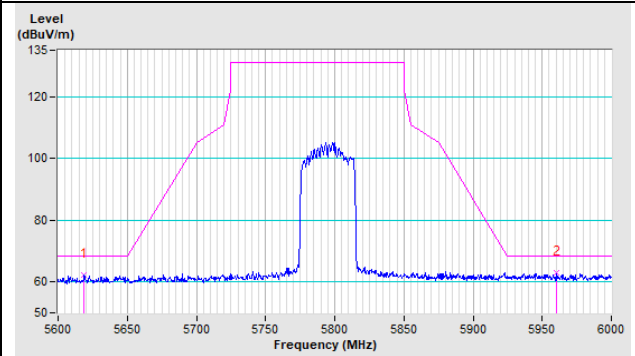

802.11ax (HE80) CH 155 : 5775 MHz

Horizontal

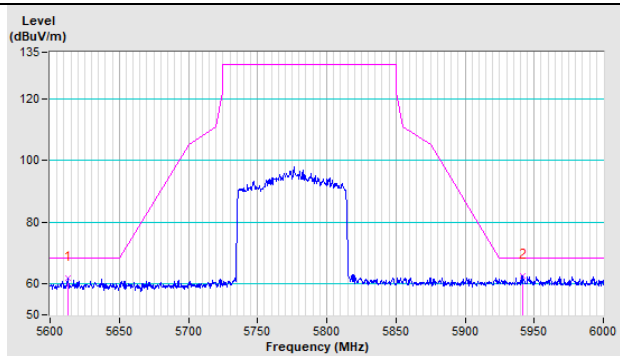

Vertical

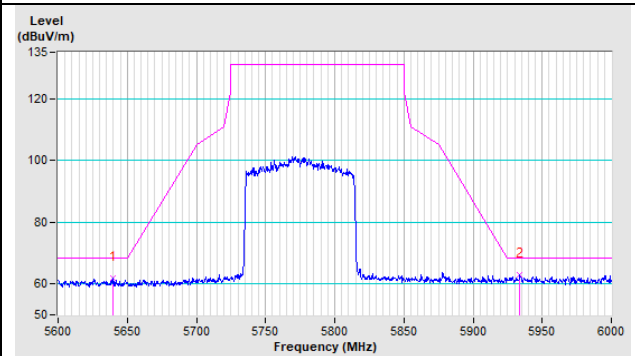

Annex B - Band Edge Measurement

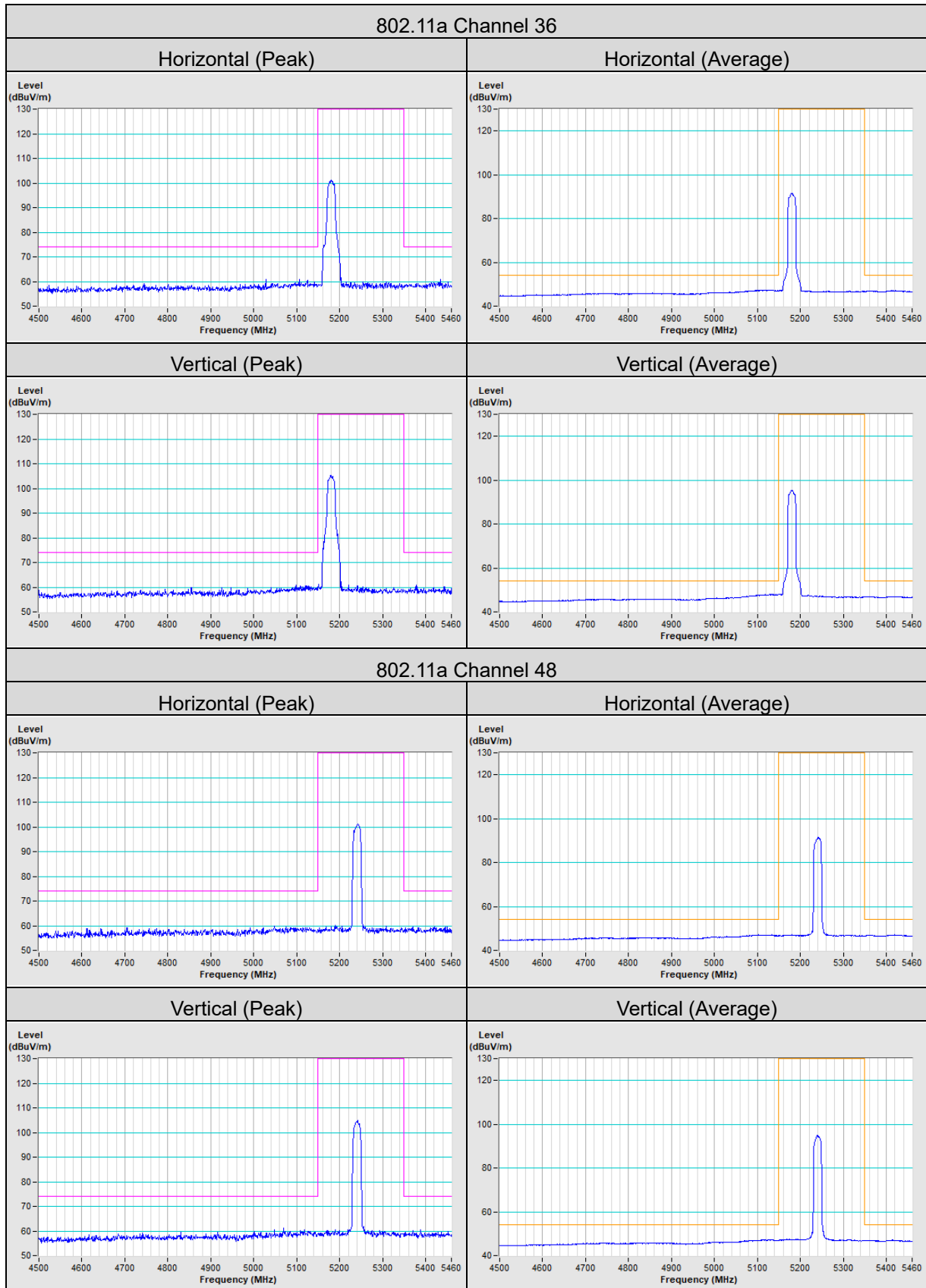

802.11a Channel 52

Horizontal (Peak)

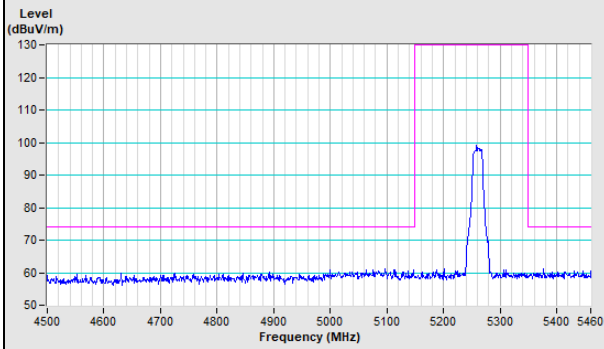

Horizontal (Average)

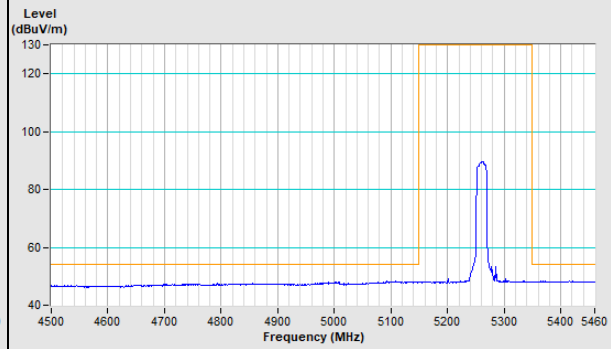

Vertical (Peak)

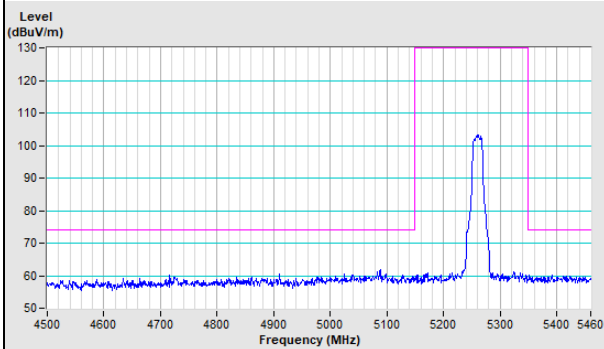

Vertical (Average)

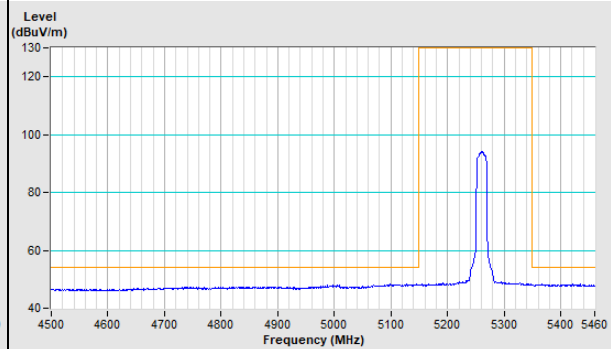

802.11a Channel 64

Horizontal (Peak)

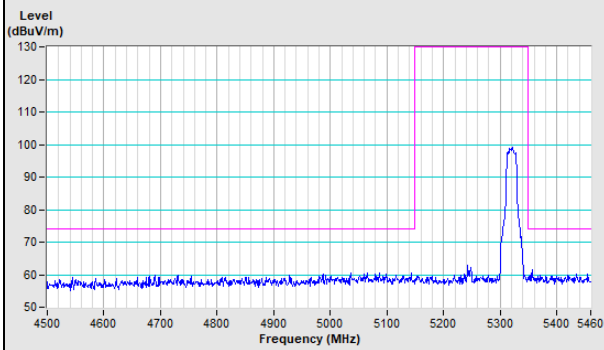

Horizontal (Average)

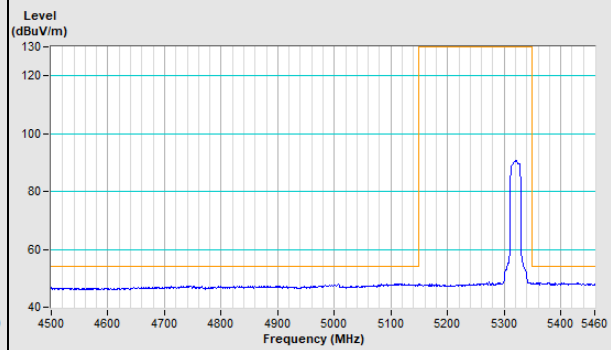

Vertical (Peak)

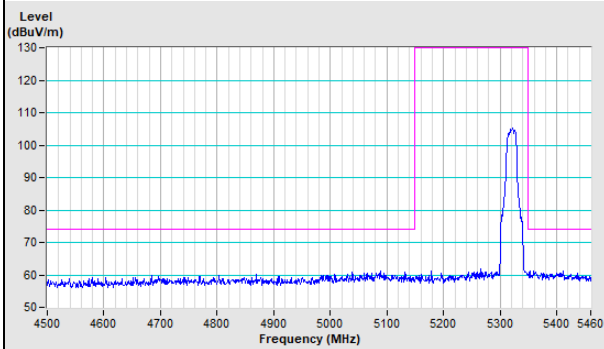

Vertical (Average)

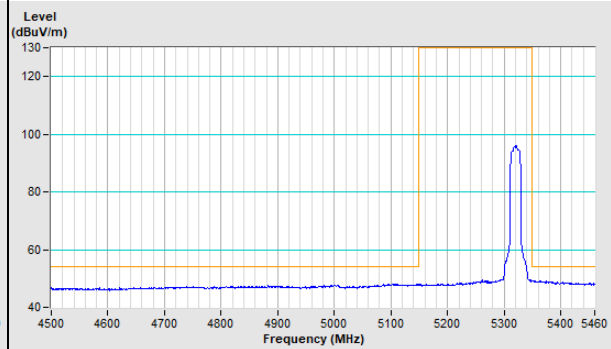

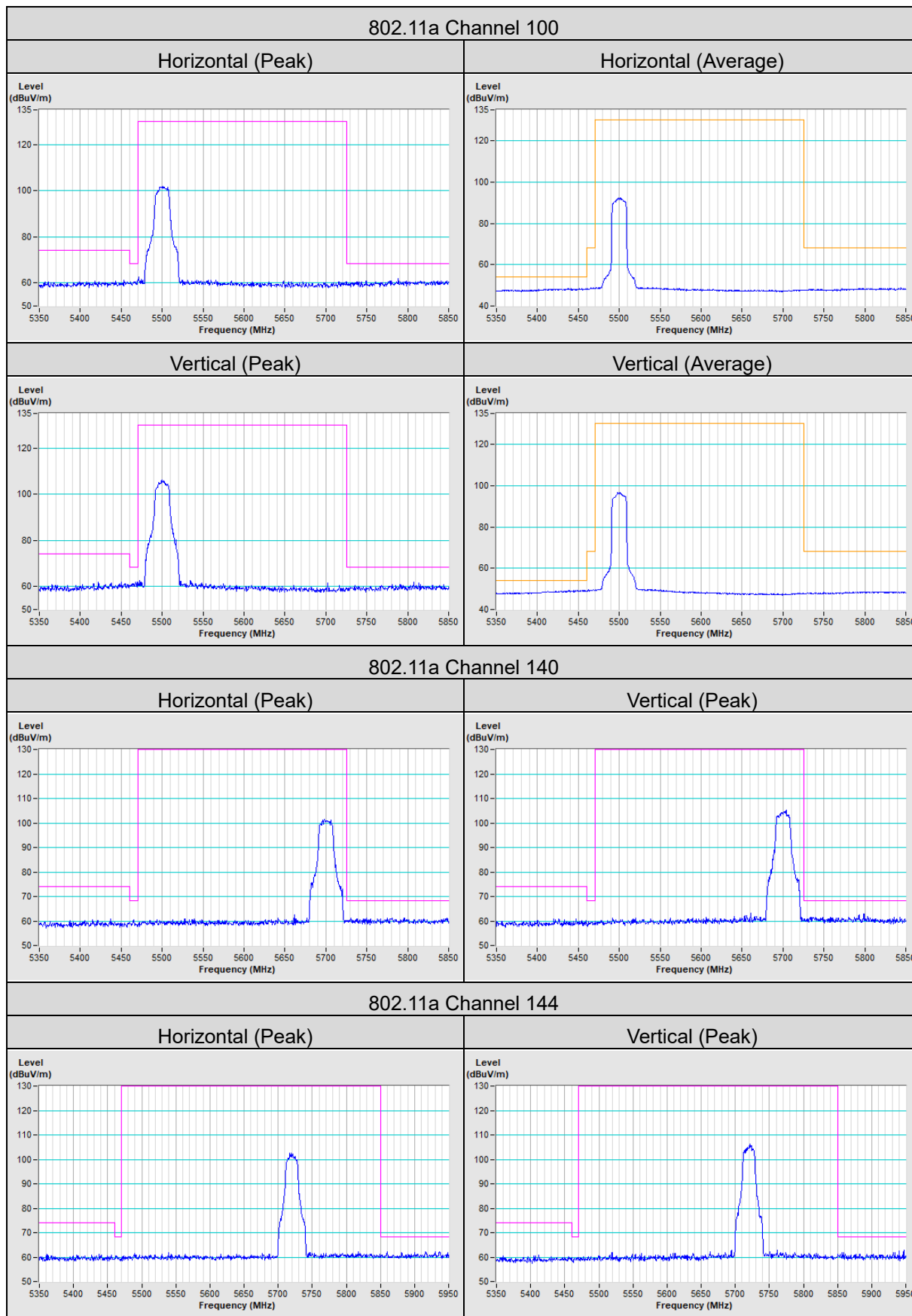

802.11ax (HE20) Channel 36

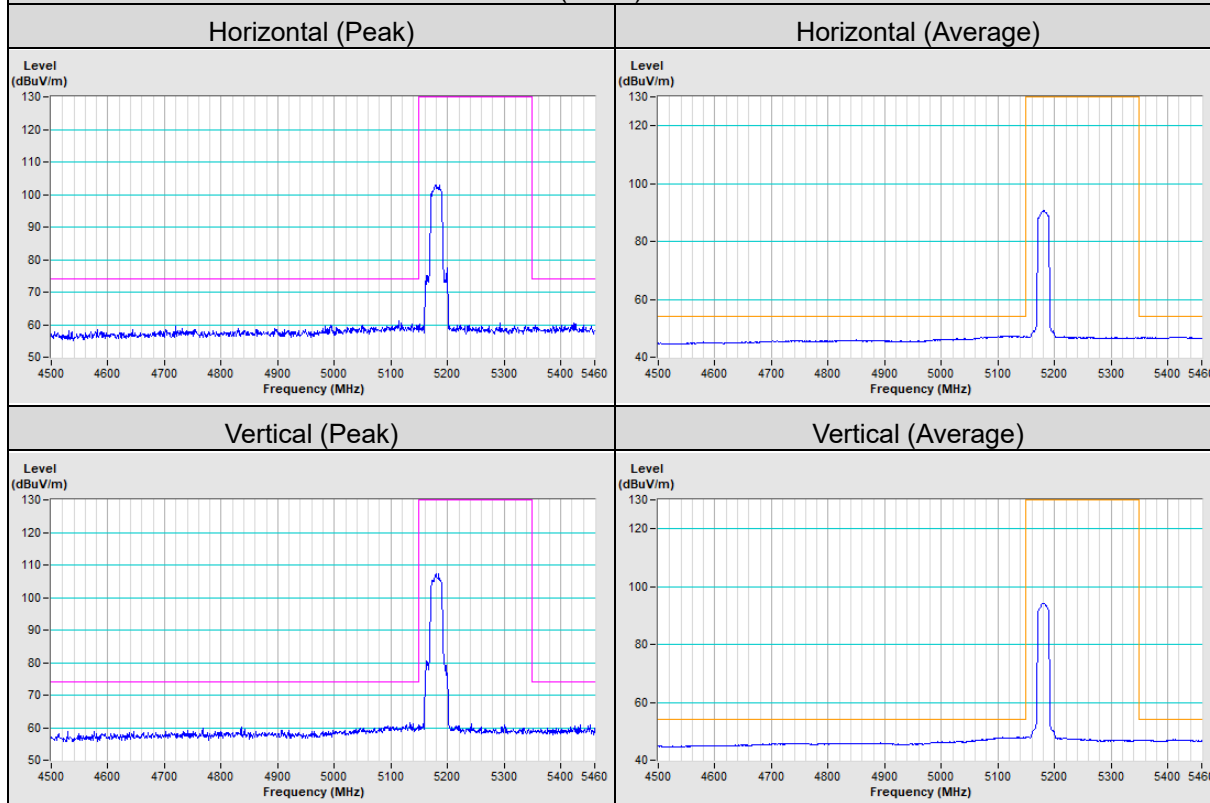

802.11ax (HE20) Channel 48

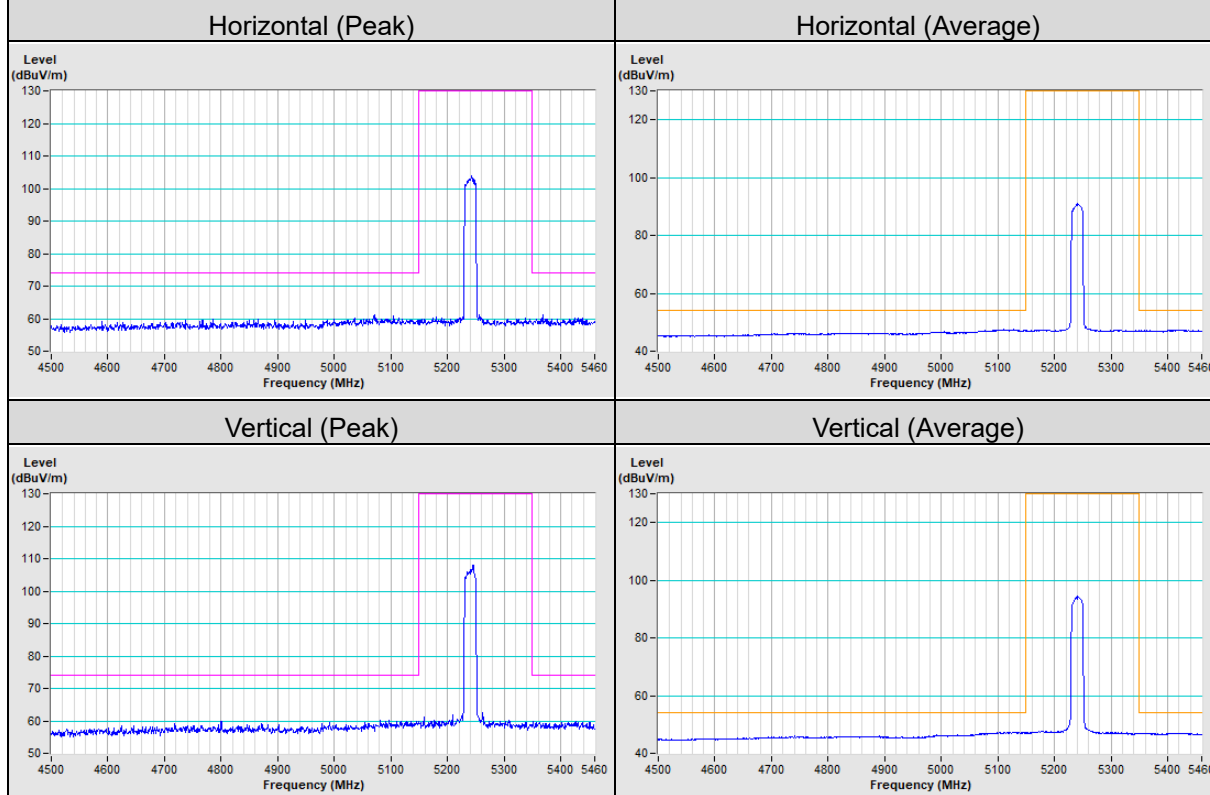

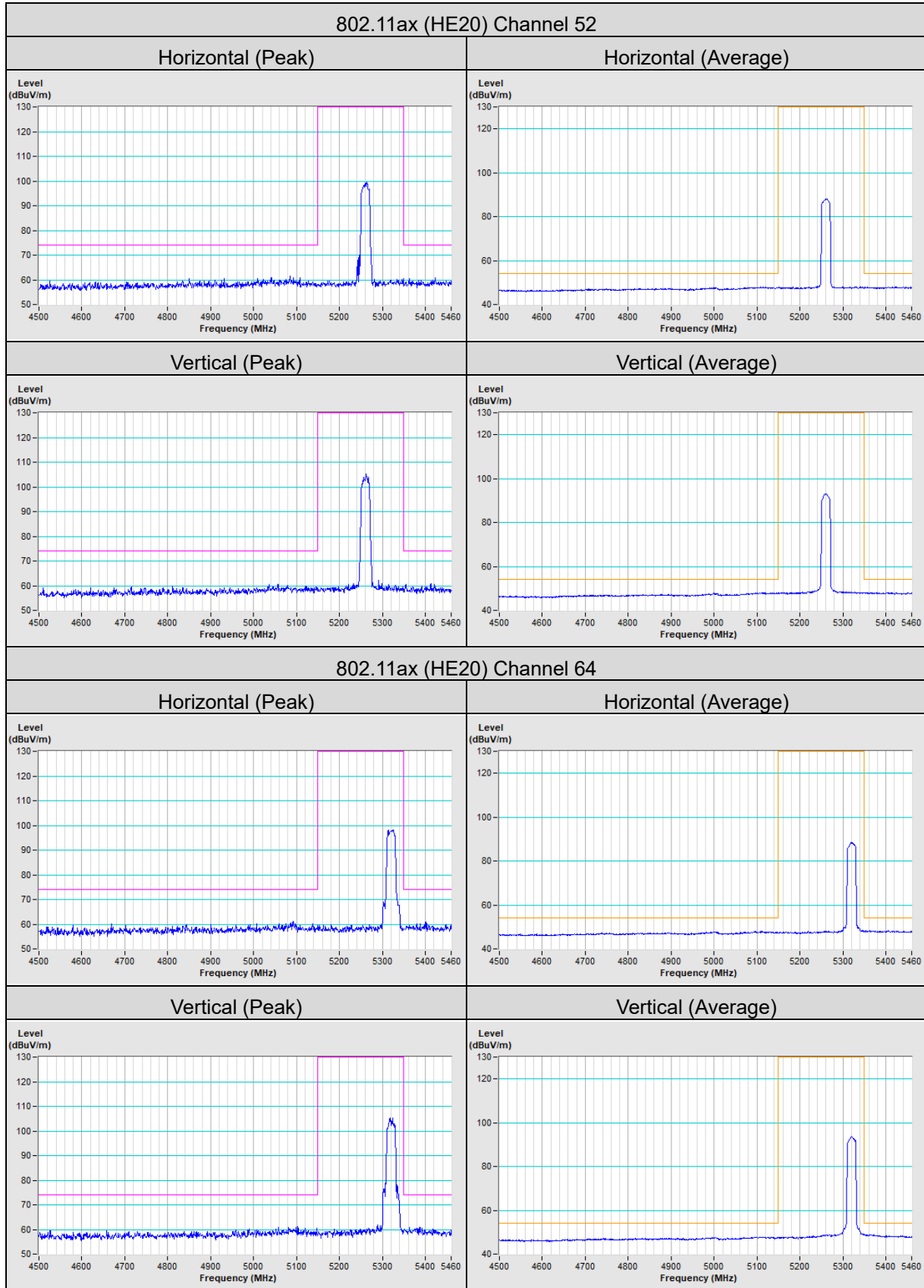

802.11ax (HE20) Channel 100

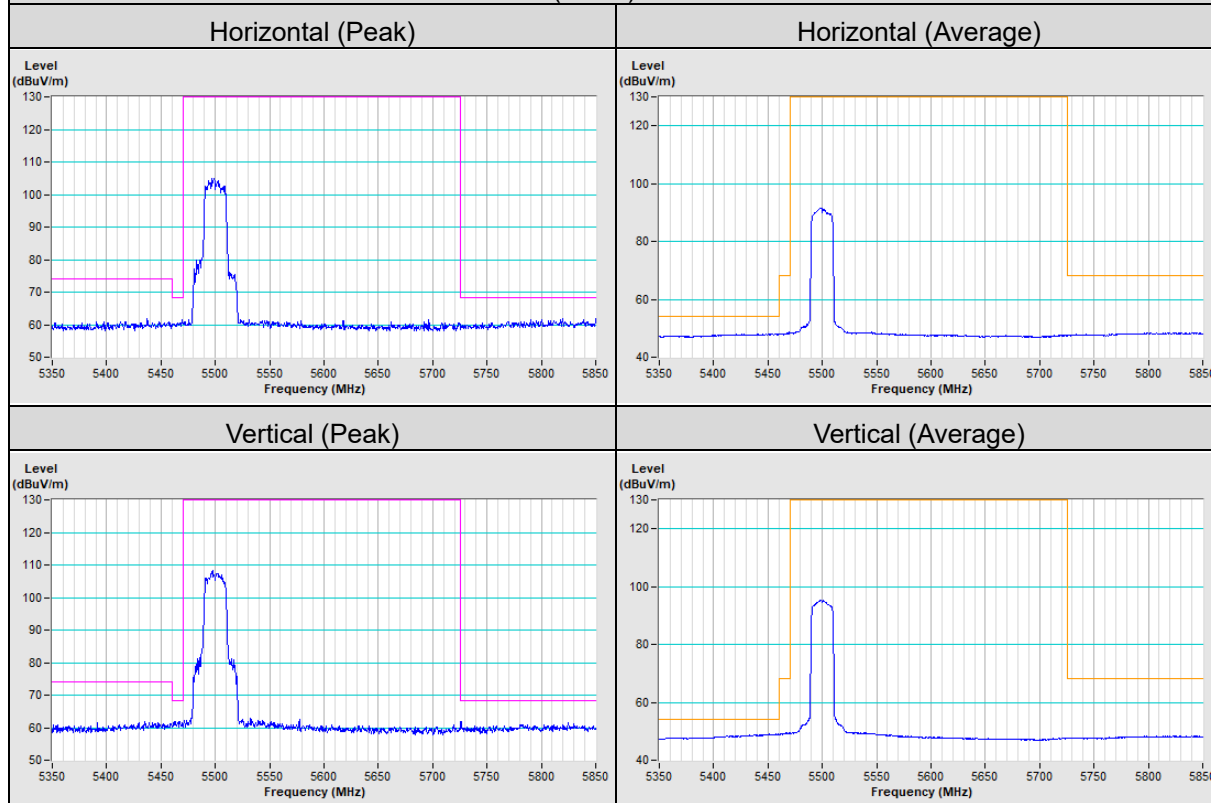

802.11ax (HE20) Channel 140

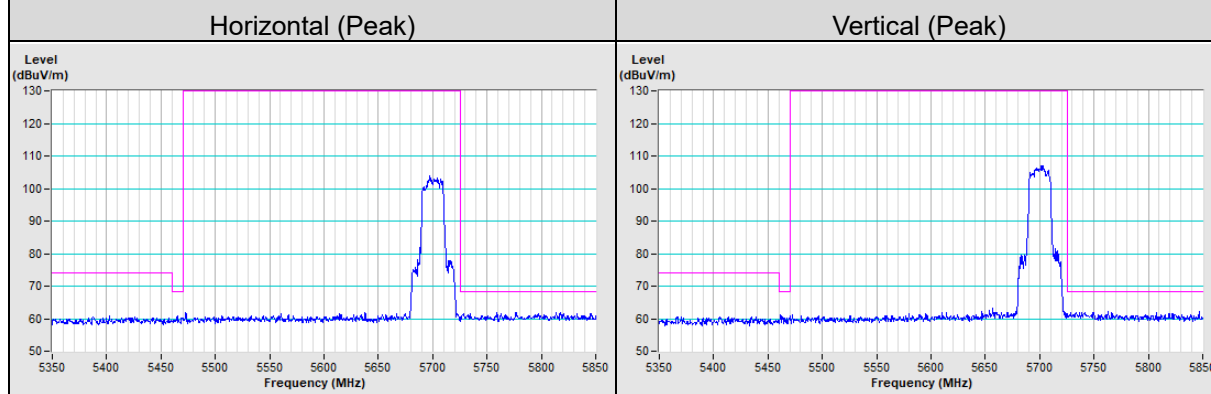

802.11ax (HE20) Channel 144

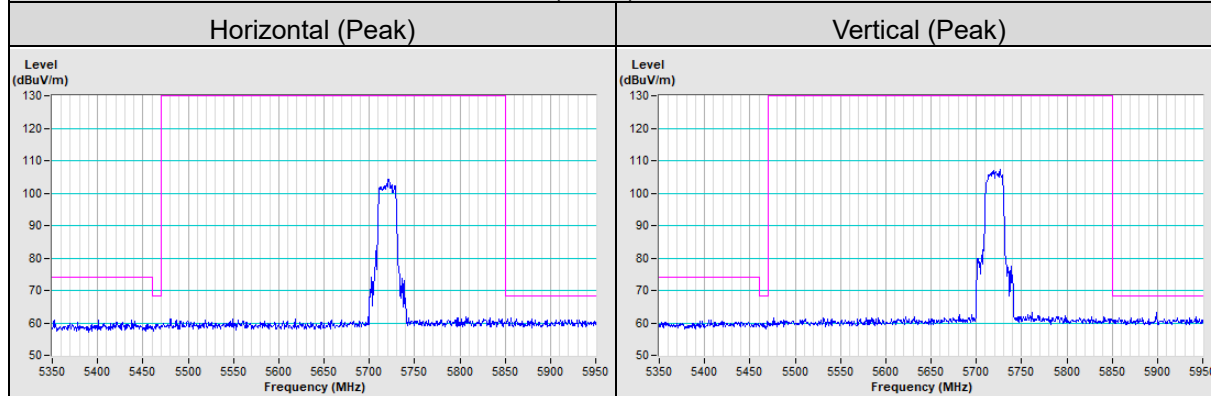

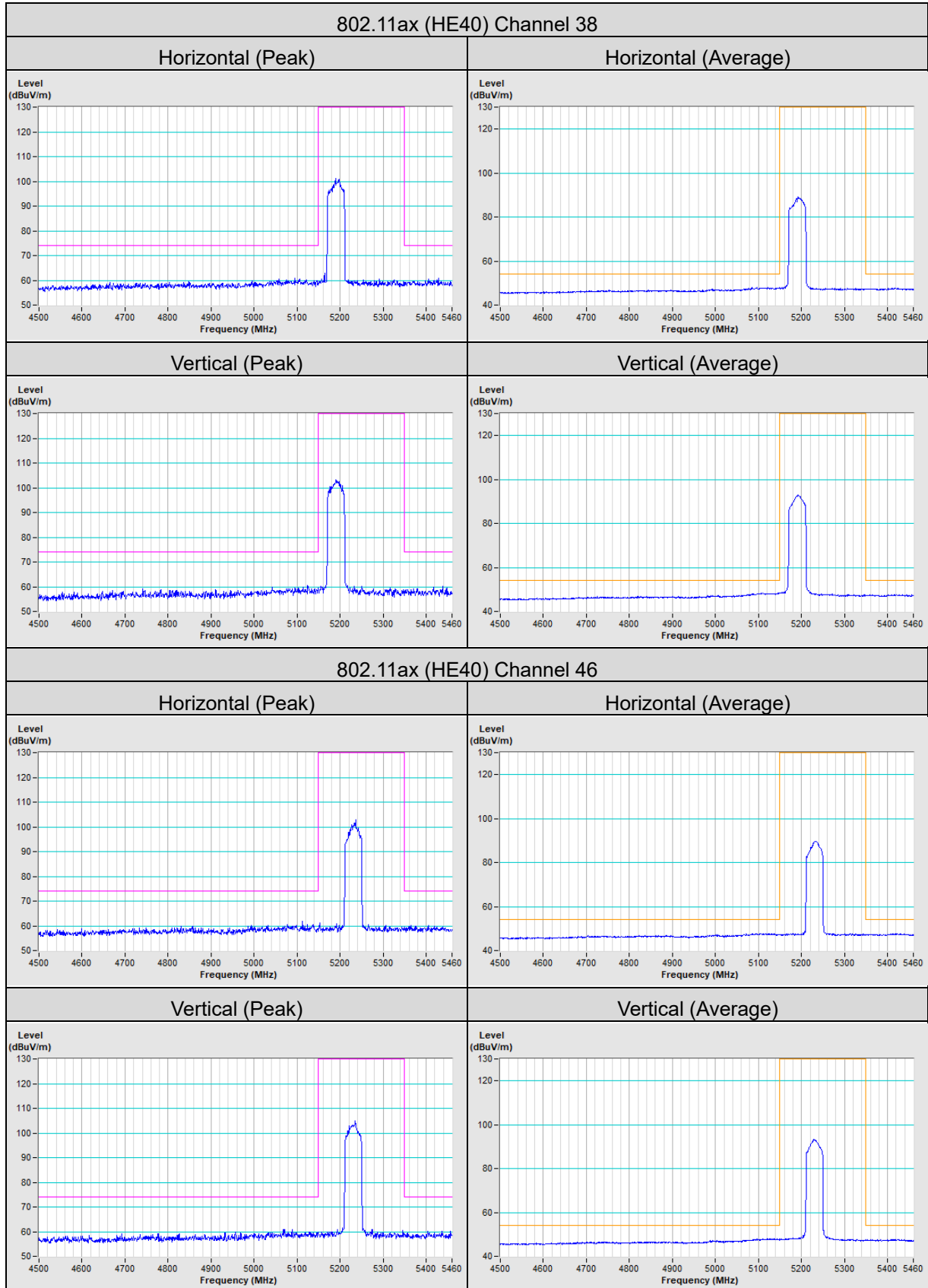

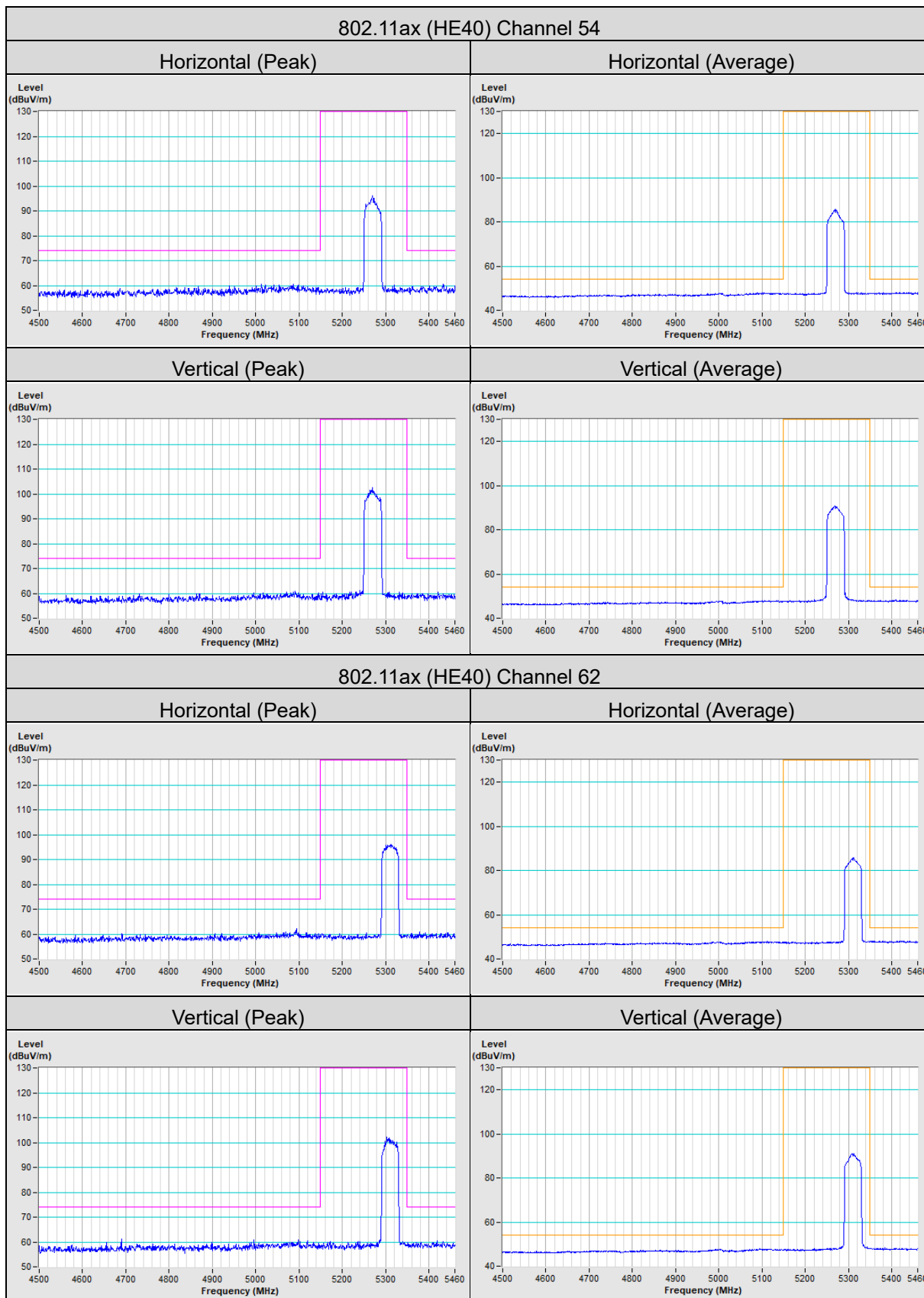

802.11ax (HE40) Channel 102

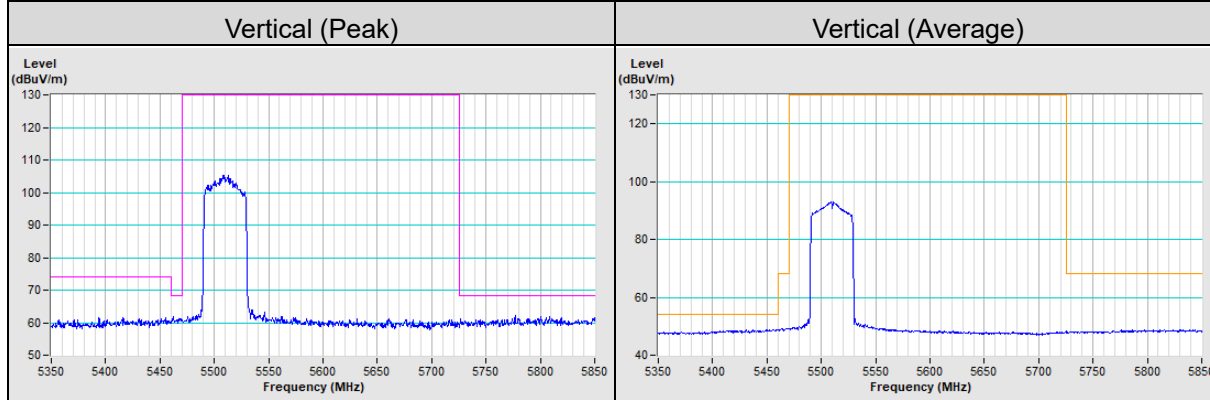
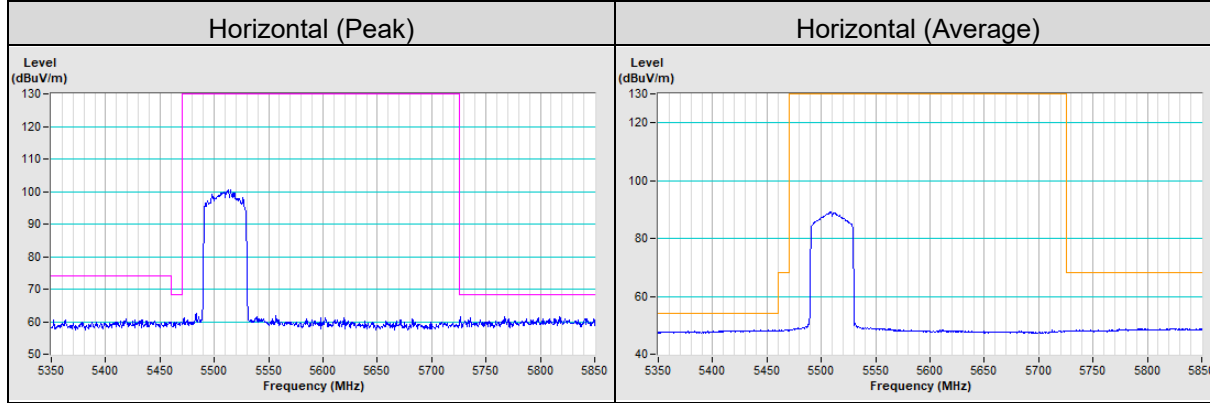

802.11ax (HE40) Channel 134

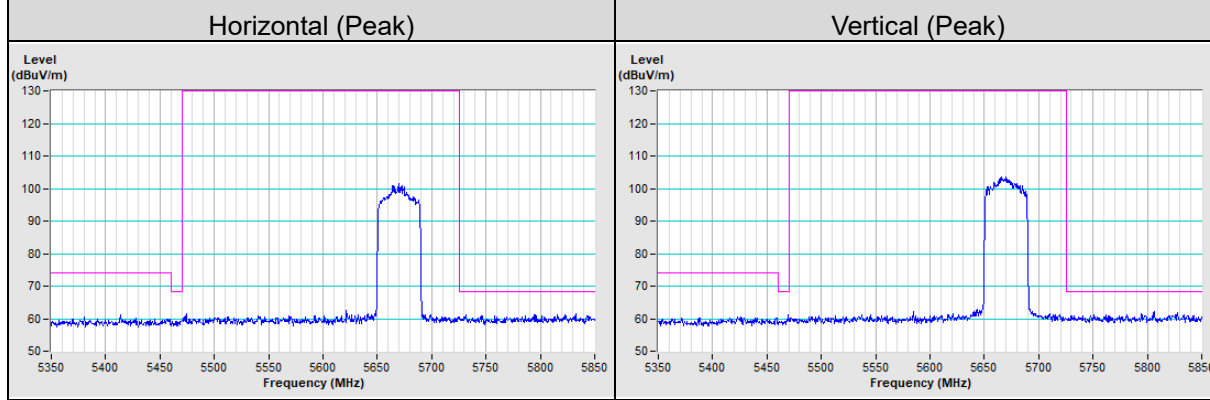

802.11ax (HE40) Channel 142

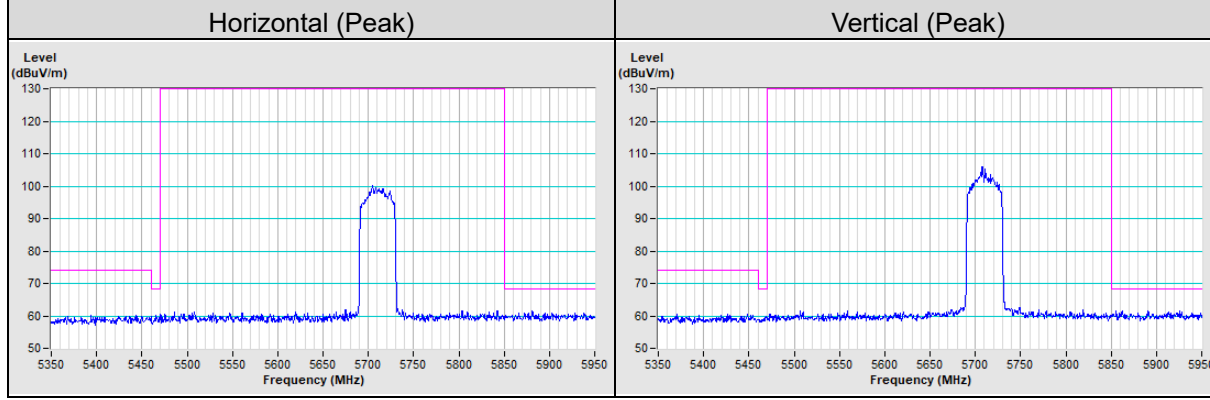

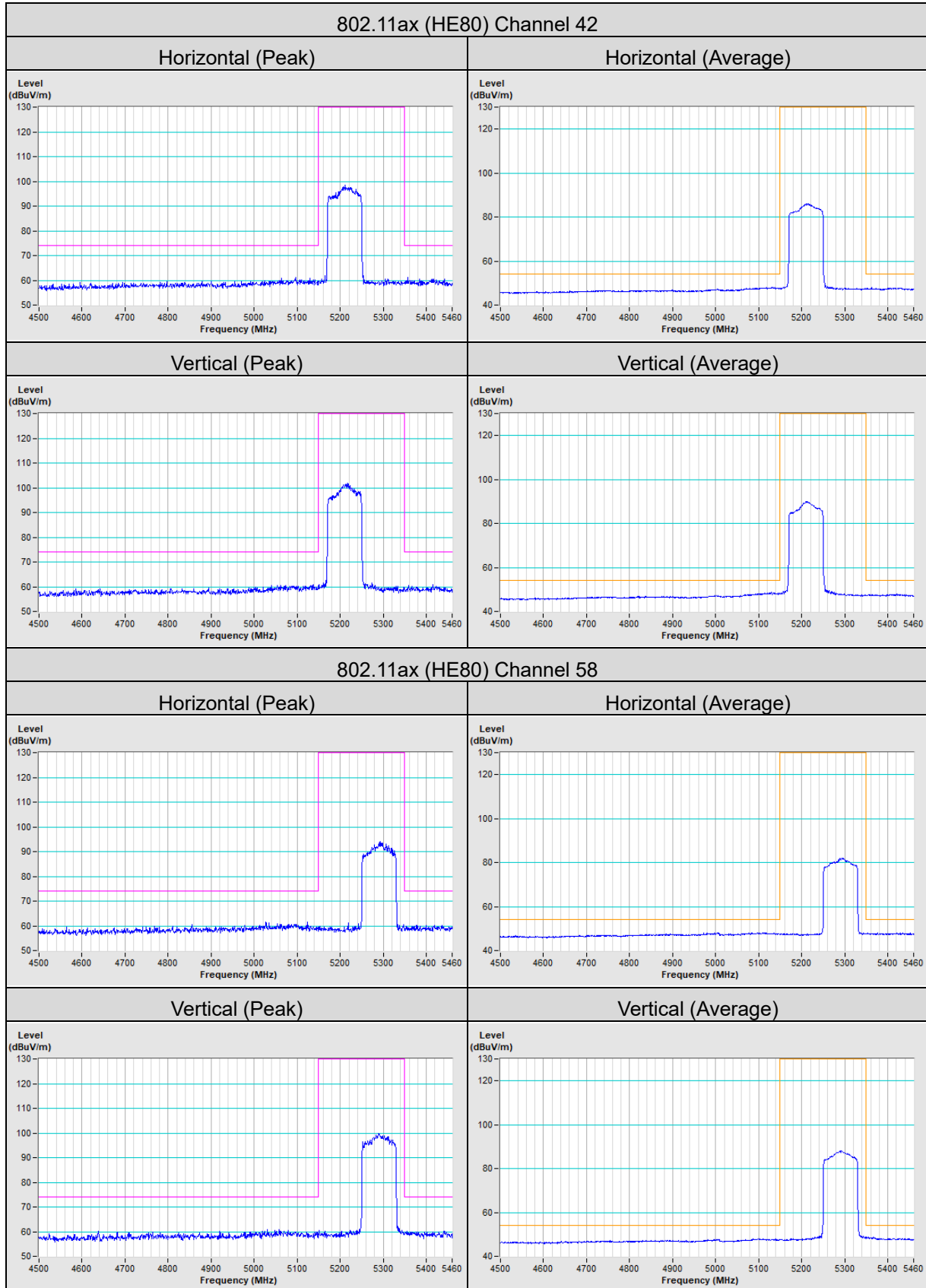

802.11ax (HE80) Channel 106

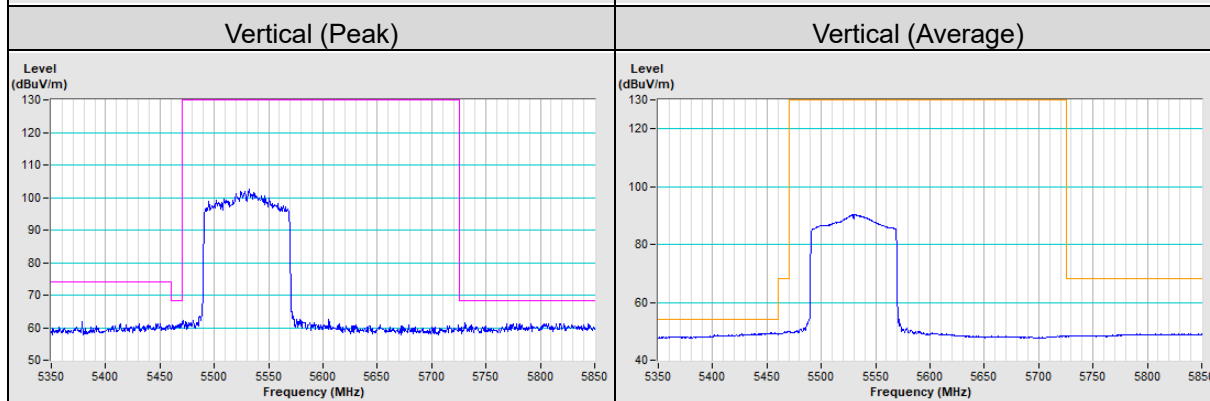
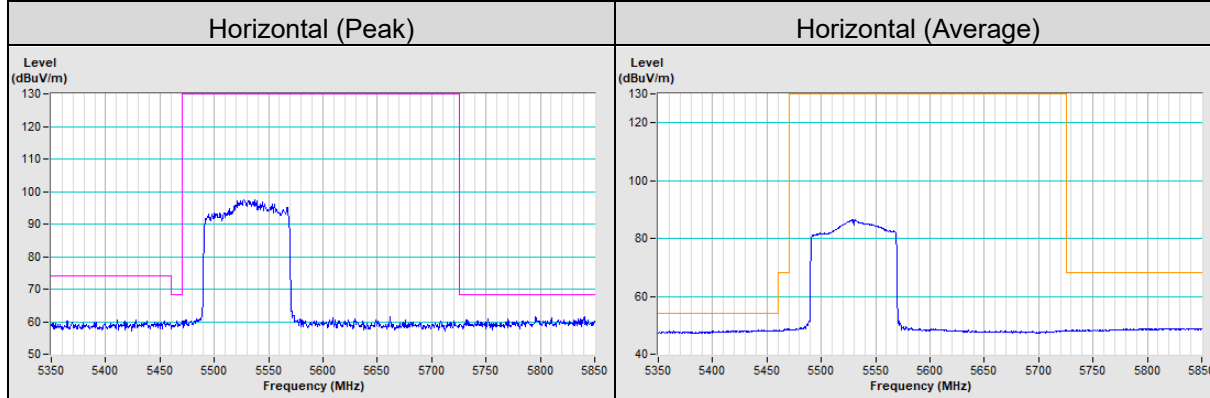

802.11ax (HE80) Channel 122

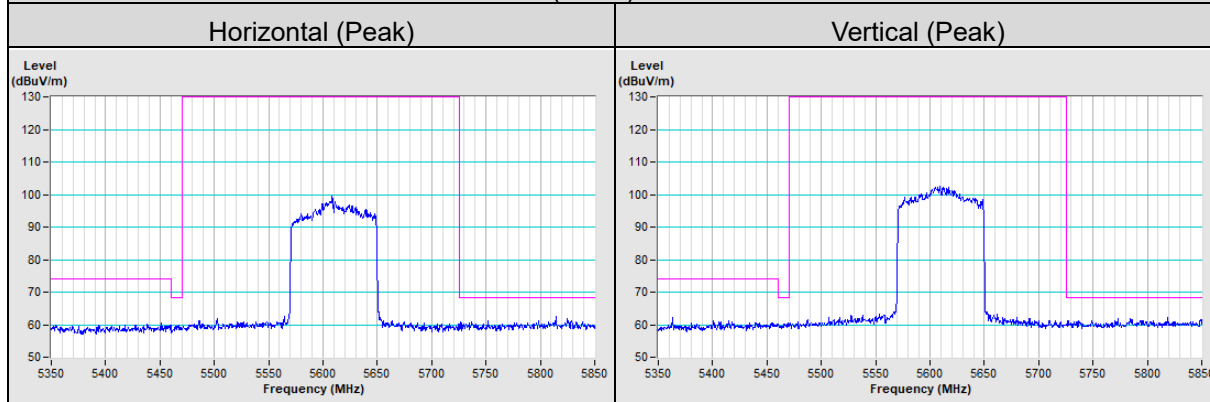

802.11ax (HE80) Channel 138

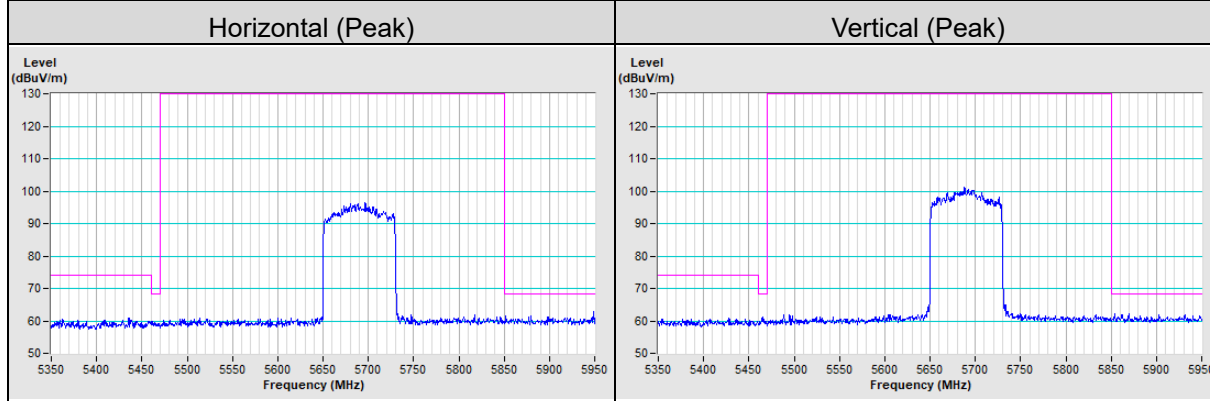

Appendix – Information of the Testing Laboratories

We, Bureau Veritas Consumer Products Services (H.K.) Ltd., Taoyuan Branch, were founded in 1988 to provide our best service in EMC, Radio, Telecom and Safety consultation. Our laboratories are FCC recognized accredited test firms and accredited and approved according to ISO/IEC 17025.

If you have any comments, please feel free to contact us at the following:

Lin Kou EMC/RF Lab

Tel: 886-2-26052180

Fax: 886-2-26051924

Hsin Chu EMC/RF/Telecom Lab

Tel: 886-3-6668565

Fax: 886-3-6668323

Hwa Ya EMC/RF/Safety

Tel: 886-3-3183232

Fax: 886-3-3270892

Email: service.adt@tw.bureauveritas.com

Web Site: www.bureauveritas-adt.com

The address and road map of all our labs can be found in our web site also.

--- END ---