

TEST REPORT

CERTIFICATE OF CONFORMITY

Standard: 47 CFR FCC Part 15, Subpart E (Section 15.407)

Report No.: RFBBQZ-WTW-P22090848-4

FCC ID: PY322100563

Product: Mesh WiFi 6E Router

Brand: NETGEAR

Model No.: MR90

Received Date: 2023/1/31

Test Date: 2023/3/13 ~ 2023/5/22

Issued Date: 2023/5/31

Applicant: NETGEAR, Inc.

Address: 350 East Plumeria Drive San Jose, CA 95134

Issued By: Bureau Veritas Consumer Products Services (H.K.) Ltd., Taoyuan Branch
Hsin Chu Laboratory

Lab Address: E-2, No.1, Li Hsin 1st Road, Hsinchu Science Park, Hsinchu City 300, Taiwan

Test Location: E-2, No.1, Li Hsin 1st Road, Hsinchu Science Park, Hsinchu City 300, Taiwan

FCC Registration / 723255 / TW2022

Designation Number:

Approved by: _____, **Date:** 2023/5/31
May Chen / Manager

This test report consists of 212 pages in total. It may be duplicated completely for legal use with the approval of the applicant. It should not be reproduced except in full, without the written approval of our laboratory. The test results in the report only apply to the tested sample. The test results in this report are traceable to the national or international standards.

Prepared by : Phoenix Huang / Specialist



This report is governed by, and incorporates by reference, the Conditions of Testing as posted at the date of issuance of this report at <http://www.bureauveritas.com/home/about-us-our-business/cps/about-us/terms-conditions/> and is intended for your exclusive use. Any copying or replication of this report to or for any other person or entity, or use of our name or trademark, is permitted only with our prior written permission. This report sets forth our findings solely with respect to the test samples identified herein. The results set forth in this report are not indicative or representative of the quality or characteristics of the lot from which a test sample was taken or any similar or identical product unless specifically and expressly noted. Our report includes all of the tests requested by you and the results thereof based upon the information that you provided to us. Measurement uncertainty is only provided upon request for accredited tests. Statements of conformity are based on simple acceptance criteria without taking measurement uncertainty into account, unless otherwise requested in writing. You have 60 days from date of issuance of this report to notify us of any material error or omission caused by our negligence or if you require measurement uncertainty; provided, however, that such notice shall be in writing and shall specifically address the issue you wish to raise. A failure to raise such issue within the prescribed time shall constitute your unqualified acceptance of the completeness of this report, the tests conducted and the correctness of the report contents.

Table of Contents

Release Control Record	4
1 Certificate	5
2 Summary of Test Results	6
2.1 Measurement Uncertainty	6
2.2 Supplementary Information	6
3 General Information	7
3.1 General Description of EUT	7
3.2 Antenna Description of EUT	9
3.3 Channel List	10
3.4 Test Mode Applicability and Tested Channel Detail	12
3.5 Duty Cycle of Test Signal	15
3.6 Test Program Used and Operation Descriptions	19
3.7 Connection Diagram of EUT and Peripheral Devices	19
3.8 Configuration of Peripheral Devices and Cable Connections	20
4 Test Instruments	21
4.1 RF Output Power	21
4.2 Power Spectral Density	21
4.3 Emission Bandwidth	21
4.4 In-Band Emission Mask	21
4.5 Occupied Bandwidth	22
4.6 Frequency Stability	22
4.7 Contention-based Protocol	22
4.8 AC Power Conducted Emissions	23
4.9 Unwanted Emissions below 1 GHz	24
4.10 Unwanted Emissions above 1 GHz	25
5 Limits of Test Items	26
5.1 RF Output Power	26
5.2 Power Spectral Density	26
5.3 Emission Bandwidth	26
5.4 In-Band Emission Mask	26
5.5 Occupied Bandwidth	26
5.6 Frequency Stability	26
5.7 Contention-based Protocol	27
5.8 AC Power Conducted Emissions	27
5.9 Unwanted Emissions below 1 GHz	27
5.10 Unwanted Emissions above 1 GHz	28
6 Test Arrangements	29
6.1 RF Output Power	29
6.1.1 Test Setup	29
6.1.2 Test Procedure	29
6.2 Power Spectral Density	30
6.2.1 Test Setup	30
6.2.2 Test Procedure	30
6.3 Emission Bandwidth	31
6.3.1 Test Setup	31
6.3.2 Test Procedure	31
6.4 In-Band Emission Mask	31
6.4.1 Test Setup	31
6.4.2 Test Procedure	31
6.5 Occupied Bandwidth	32
6.5.1 Test Setup	32
6.5.2 Test Procedure	32
6.6 Frequency Stability	32
6.6.1 Test Setup	32



6.6.2	Test Procedure	32
6.7	Contention-based Protocol	33
6.7.1	Test Setup	33
6.7.2	Test Procedure	33
6.8	AC Power Conducted Emissions	34
6.8.1	Test Setup	34
6.8.2	Test Procedure	34
6.9	Unwanted Emissions below 1 GHz	35
6.9.1	Test Setup	35
6.9.2	Test Procedure	36
6.10	Unwanted Emissions above 1 GHz	37
6.10.1	Test Setup	37
6.10.2	Test Procedure	37
7	Test Results of Test Item	38
7.1	RF Output Power	38
7.2	Power Spectral Density	50
7.3	Emission Bandwidth	63
7.4	In-Band Emission Mask	66
7.5	Occupied Bandwidth	84
7.6	Frequency Stability	87
7.7	Contention-based Protocol	88
7.8	AC Power Conducted Emissions	97
7.9	Unwanted Emissions below 1 GHz	99
7.10	Unwanted Emissions above 1 GHz	101
8	Operational Restrictions for 6 GHz U-NII Devices	210
9	Pictures of Test Arrangements	211
10	Information of the Testing Laboratories	212



Release Control Record

Issue No.	Description	Date Issued
RFBBQZ-WTW-P22090848-4	Original release.	2023/5/31

1 Certificate

Product: Mesh WiFi 6E Router

Brand: NETGEAR

Test Model: MR90

Sample Status: Engineering sample

Applicant: NETGEAR, Inc.

Test Date: 2023/3/13 ~ 2023/5/22

Standard: 47 CFR FCC Part 15, Subpart E (Section 15.407)

Measurement ANSI C63.10-2013

procedure:

KDB 987594 D02 U-NII 6 GHz EMC Measurement v01v01

KDB 789033 D02 General UNII Test Procedure New Rules v02r01

KDB 662911 D01 Multiple Transmitter Output v02r01

The above equipment has been tested by **Bureau Veritas Consumer Products Services (H.K.) Ltd., Taoyuan Branch**, and found compliance with the requirement of the above standards. The test record, data evaluation & Equipment Under Test (EUT) configurations represented herein are true and accurate accounts of the measurements of the sample's RF characteristics under the conditions specified in this report.

2 Summary of Test Results

47 CFR FCC Part 15, Subpart E (Section 15.407)			
Clause	Test Item	Result	Remark
15.407(a)(5)	RF Output Power	Pass	Meet the requirement of limit.
15.407(a)(5)	Power Spectral Density	Pass	Meet the requirement of limit.
15.407(a)(10)	Occupied Bandwidth	Pass	Meet the requirement of limit.
15.407(b)(9)	AC Power Conducted Emissions	Pass	Minimum passing margin is -6.75 dB at 0.35068 MHz
15.407(b)(9)	Unwanted Emissions below 1 GHz	Pass	Minimum passing margin is -6.0 dB at 63.83 MHz
15.407(b)(6) 15.407(b)(10)	Unwanted Emissions above 1 GHz	Pass	Minimum passing margin is -0.2 dB at 7125.00 MHz
15.407(b)(7)	In-Band Emission Mask	Pass	Meet the requirement of limit.
15.407(d)(6)	Contention-based Protocol	Pass	Meet the requirement of limit.
15.407(g)	Frequency Stability	Pass	Meet the requirement of limit.
15.407(d)	Operational restrictions for 6 GHz U-NII devices	Pass	Declaration by applicant.
15.203	Antenna Requirement	Pass	Antenna connector is ipex(MHF) not a standard connector.
---	Emission Bandwidth	-	Reference only.

Note: Determining compliance based on the results of the compliance measurement, not taking into account measurement instrumentation uncertainty.

2.1 Measurement Uncertainty

Where relevant, the following measurement uncertainty levels have been estimated for tests performed on the EUT as specified in CISPR 16-4-2:

Measurement	Specification	Expanded Uncertainty (k=2) (±)
AC Power Conducted Emissions	150 kHz ~ 30 MHz	1.9 dB
Unwanted Emissions below 1 GHz	9 kHz ~ 30 MHz	3.1 dB
	30 MHz ~ 1 GHz	5.5 dB
Unwanted Emissions above 1 GHz	1 GHz ~ 18 GHz	5.1 dB
	18 GHz ~ 40 GHz	5.3 dB

The other instruments specified are routine verified to remain within the calibrated levels, no measurement uncertainty is required to be calculated.

2.2 Supplementary Information

There is not any deviation from the test standards for the test method, and no modifications required for compliance.

3 General Information

3.1 General Description of EUT

Product	Mesh WiFi 6E Router
Brand	NETGEAR
Test Model	MR90
Status of EUT	Engineering sample
Power Supply Rating	Refer to Note
Modulation Type	64QAM, 16QAM, QPSK, BPSK for OFDM 1024QAM for OFDMA in 11ax mode
Modulation Technology	OFDM, OFDMA
Transfer Rate	802.11a: up to 54 Mbps 802.11ax: up to 2401.9 Mbps
Operating Frequency	6.115 GHz ~ 6.415 GHz 6.435 GHz ~ 6.525 GHz 6.535 GHz ~ 6.865 GHz 6.875 GHz ~ 7.115 GHz
Number of Channel	802.11a, 802.11ax (HE20): 51 802.11ax (HE40): 25 802.11ax (HE80): 12 802.11ax (HE160): 6
Output Power	<p>CDD Mode: 6.115 GHz ~ 6.415 GHz : EIRP: 336.512 mW (25.27 dBm) 6.435 GHz ~ 6.525 GHz : EIRP: 336.512 mW (25.27 dBm) 6.535 GHz ~ 6.865 GHz : EIRP: 328.852 mW (25.17 dBm) 6.875 GHz ~ 7.115 GHz : EIRP: 336.512 mW (25.27 dBm)</p> <p>Beamforming(2T1S) Mode: 6.115 GHz ~ 6.415 GHz : EIRP: 509.331 mW (27.07 dBm) 6.435 GHz ~ 6.525 GHz : EIRP: 486.407 mW (26.87 dBm) 6.535 GHz ~ 6.865 GHz : EIRP: 475.335 mW (26.77 dBm) 6.875 GHz ~ 7.115 GHz : EIRP: 497.737 mW (26.97 dBm)</p> <p>SM-MIMO(2T2S) Mode: 6.115 GHz ~ 6.415 GHz : EIRP: 486.407 mW (26.87 dBm) 6.435 GHz ~ 6.525 GHz : EIRP: 486.407 mW (26.87 dBm) 6.535 GHz ~ 6.865 GHz : EIRP: 475.335 mW (26.77 dBm) 6.875 GHz ~ 7.115 GHz : EIRP: 497.737 mW (26.97 dBm)</p> <p>Beamforming(2T2S) Mode: 6.115 GHz ~ 6.415 GHz : EIRP: 475.335 mW (26.77 dBm) 6.435 GHz ~ 6.525 GHz : EIRP: 475.335 mW (26.77 dBm) 6.535 GHz ~ 6.865 GHz : EIRP: 464.515 mW (26.67 dBm) 6.875 GHz ~ 7.115 GHz : EIRP: 475.335 mW (26.77 dBm)</p>
EUT Category	Indoor AP

Note:

1. Simultaneously transmission condition.

Condition	Technology		
1	WLAN 2.4GHz	WLAN 5GHz	WLAN 6GHz

Note: The emission of the simultaneous operation has been evaluated and no non-compliance was found.

2. The EUT uses following accessories.

AC Adapter 1		
Brand	Model	Specification
NETGEAR	2AED030FC	Part Number: 332-11595-01 AC Input: 100-120V~60Hz Max 1.0A DC Output: 12V, 2.5A DC Output Cable: unshielded, 1.8m without core
AC Adapter 2		
Brand	Model	Specification
NETGEAR	ADS-40FPC-12 12030E	Part Number: 332-11585-02 AC Input: 100-120V~50/60Hz 1.0A DC Output: 12V, 2.5A DC Output Cable: unshielded, 1.8m without core
Ethernet Cable		
Brand	Model	Specification
NETGEAR	312-10138-01	Signal Line : 2m, Unshielded

3. The above EUT information is declared by manufacturer and for more detailed features description, please refers to the manufacturer's specifications or user's manual.

3.2 Antenna Description of EUT

1. The antenna information is listed as below.

Antenna NO.	RF Chain NO.	Antenna Net Gain(dBi)	Frequency range (GHz)	Antenna Type	Connector Type
2G	2G-0	2.15	2.4~2.4835	PIFA	ipex(MHF)
DB1	2G-1	2.21	2.4~2.4835	PIFA	ipex(MHF)
DB2	2G-2	2.29	2.4~2.4835	PIFA	ipex(MHF)
5G1	5G-0	2.38	5.15~5.25	PIFA	ipex(MHF)
		2.38	5.25~5.35		
		2.65	5.47~5.725		
		2.69	5.725~5.85		
		2.69	5.85~5.895		
5G2	5G-1	2.49	5.15~5.25	PIFA	ipex(MHF)
		2.49	5.25~5.35		
		2.81	5.47~5.725		
		2.54	5.725~5.85		
		2.54	5.85~5.895		
DB1	6G-0	2.85	5.925~6.425	PIFA	ipex(MHF)
		2.89	6.425~6.525		
		2.89	6.525~6.875		
		2.93	6.875~7.125		
DB2	6G-1	2.98	5.925~6.425	PIFA	ipex(MHF)
		2.87	6.425~6.525		
		2.87	6.525~6.875		
		2.99	6.875~7.125		

* Detail antenna specification please refer to antenna datasheet and/or antenna measurement report.

2. The EUT incorporates a MIMO function:

6 GHz Band		
Modulation Mode	TX & RX Configuration	
802.11a	2TX	2RX
802.11ax (HE20)	2TX	2RX
802.11ax (HE40)	2TX	2RX
802.11ax (HE80)	2TX	2RX
802.11ax (HE160)	2TX	2RX

Note:

- All of modulation mode support beamforming function except 802.11a modulation mode.
- The EUT support Beamforming and CDD mode, therefore both mode were investigated and the worst case scenario was identified. The worst case data were presented in test report.
- For 802.11ax, the EUT not support Partial RU.
- The EUT device modulation technique OFDMA does not support channel puncturing/bandwidth reduction mechanisms.

3.3 Channel List

U-NII-5:

16 channels are provided for 802.11a, 802.11ax (HE20):

Channel	Frequency	Channel	Frequency	Channel	Frequency	Channel	Frequency
33	6115 MHz	37	6135 MHz	41	6155 MHz	45	6175 MHz
49	6195 MHz	53	6215 MHz	57	6235 MHz	61	6255 MHz
65	6275 MHz	69	6295 MHz	73	6315 MHz	77	6335 MHz
81	6355 MHz	85	6375 MHz	89	6395 MHz	93	6415MHz

8 channels are provided for 802.11ax (HE40):

Channel	Frequency	Channel	Frequency	Channel	Frequency	Channel	Frequency
35	6125 MHz	43	6165 MHz	51	6205 MHz	59	6245 MHz
67	6285MHz	75	6325 MHz	83	6365 MHz	91	6405 MHz

4 channels are provided for 802.11ax (HE80):

Channel	Frequency	Channel	Frequency	Channel	Frequency	Channel	Frequency
39	6145 MHz	55	6225 MHz	71	6305 MHz	87	6385 MHz

2 channels are provided for 802.11ax (HE160):

Channel	Frequency	Channel	Frequency
47	6185 MHz	79	6345 MHz

U-NII-6:

5 channels are provided for 802.11a, 802.11ax (HE20):

Channel	Frequency	Channel	Frequency	Channel	Frequency	Channel	Frequency
97	6435 MHz	101	6455 MHz	105	6475 MHz	109	6495 MHz
113	6515 MHz						

3 channels are provided for 802.11ax (HE40):

Channel	Frequency	Channel	Frequency	Channel	Frequency
99	6445 MHz	107	6485 MHz	*115	6525 MHz

1 channel is provided for 802.11ax (HE80):

Channel	Frequency
103	6465 MHz

1 channel is provided for 802.11ax (HE160):

Channel	Frequency
*111	6505 MHz

U-NII-7:

17 channels are provided for 802.11a, 802.11ax (HE20):

Channel	Frequency	Channel	Frequency	Channel	Frequency	Channel	Frequency
117	6535 MHz	121	6555 MHz	125	6575 MHz	129	6595 MHz
133	6615 MHz	137	6635 MHz	141	6655 MHz	145	6675 MHz
149	6695 MHz	153	6715 MHz	157	6735 MHz	161	6755 MHz
165	6775 MHz	169	6795 MHz	173	6815 MHz	177	6835 MHz
181	6855 MHz						

8 channels are provided for 802.11ax (HE40):

Channel	Frequency	Channel	Frequency	Channel	Frequency	Channel	Frequency
123	6565 MHz	131	6605 MHz	139	6645 MHz	147	6685 MHz
155	6725 MHz	163	6765 MHz	171	6805 MHz	179	6845 MHz

5 channels are provided for 802.11ax (HE80):

Channel	Frequency	Channel	Frequency	Channel	Frequency	Channel	Frequency
*119	6545 MHz	135	6625 MHz	151	6705 MHz	167	6785 MHz
*183	6865 MHz						

2 channels are provided for 802.11ax (HE160):

Channel	Frequency	Channel	Frequency
143	6665 MHz	175	*6825 MHz

U-NII-8:

13 channels are provided for 802.11a, 802.11ax (HE20):

Channel	Frequency	Channel	Frequency	Channel	Frequency	Channel	Frequency
185	6875 MHz	189	6895 MHz	193	6915 MHz	197	6935 MHz
201	6955 MHz	205	6975 MHz	209	6995 MHz	213	7015 MHz
217	7035 MHz	221	7055 MHz	225	7075 MHz	229	7095 MHz
233	7115 MHz						

6 channels are provided for 802.11ax (HE40):

Channel	Frequency	Channel	Frequency	Channel	Frequency	Channel	Frequency
187	6885 MHz	195	6925 MHz	203	6965 MHz	211	7005 MHz
219	7045 MHz	227	7085 MHz				

2 channels are provided for 802.11ax (HE80):

Channel	Frequency	Channel	Frequency
199	6945 MHz	215	7025 MHz

1 channel is provided for 802.11ax (HE160):

Channel	Frequency
207	6985 MHz

Note: * mean these are straddle channels.

3.4 Test Mode Applicability and Tested Channel Detail

Pre-Scan:	<ol style="list-style-type: none"> The AC Adapter has the following models: Adapter1: 2AED030FC / Adapter2: ADS-40FPC-12 12030E. Pre-scan these models of AC Adapters and find the worst case as a representative test condition. Pre-Scan has been conducted to determine the worst-case mode from all possible combinations between available modulations, data rates and antenna ports (if EUT with antenna diversity architecture).
Worst Case:	<ol style="list-style-type: none"> AC Adapter Worst Condition: Adapter1: 2AED030FC The EUT is usually used lying flat and was therefore chosen for Unwanted Emission testing.

Following channel(s) was (were) selected for the final test as listed below:

Test Item	Mode	Signal Mode	Tested Channel	Modulation	Data Rate Parameter
RF Output Power / Power Spectral Density	802.11a	CDD	33, 61, 93, 97, 105, 113, 117, 149, 181, 185, 209, 233	BPSK	6Mb/s
	802.11ax (HE20)	CDD / Beamforming(2T1S) / SM-MIMO(2T2S) / Beamforming(2T2S)	33, 61, 93, 97, 105, 113, 117, 149, 181, 185, 209, 229, 233	BPSK	MCS0
	802.11ax (HE40)	CDD / Beamforming(2T1S) / SM-MIMO(2T2S) / Beamforming(2T2S)	35, 59, 91, 99, 107, 115, 123, 155, 179, 187, 211, 227	BPSK	MCS0
	802.11ax (HE80)	CDD / Beamforming(2T1S) / SM-MIMO(2T2S) / Beamforming(2T2S)	39, 55, 87, 103, 119, 151, 183, 199, 215	BPSK	MCS0
	802.11ax (HE160)	CDD / Beamforming(2T1S) / SM-MIMO(2T2S) / Beamforming(2T2S)	47, 79, 111, 143, 175, 207	BPSK	MCS0
Emission Bandwidth	802.11a	CDD	33, 61, 93, 97, 105, 113, 117, 149, 181, 185, 209, 233	BPSK	6Mb/s
	802.11ax (HE20)	CDD	33, 61, 93, 97, 105, 113, 117, 149, 181, 185, 209, 229, 233	BPSK	MCS0
	802.11ax (HE40)	CDD	35, 59, 91, 99, 107, 115, 123, 155, 179, 187, 211, 227	BPSK	MCS0
	802.11ax (HE80)	CDD	39, 55, 87, 103, 119, 151, 183, 199, 215	BPSK	MCS0
	802.11ax (HE160)	CDD	47, 79, 111, 143, 175, 207	BPSK	MCS0
In-Band Emission Mask	802.11a	CDD	33, 61, 93, 97, 105, 113, 117, 149, 181, 185, 209, 233	BPSK	6Mb/s

Test Item	Mode	Signal Mode	Tested Channel	Modulation	Data Rate Parameter
	802.11ax (HE20)	CDD	33, 61, 93, 97, 105, 113, 117, 149, 181, 185, 209, 229, 233	BPSK	MCS0
	802.11ax (HE40)	CDD	35, 59, 91, 99, 107, 115, 123, 155, 179, 187, 211, 227	BPSK	MCS0
	802.11ax (HE80)	CDD	39, 55, 87, 103, 119, 151, 183, 199, 215	BPSK	MCS0
	802.11ax (HE160)	CDD	47, 79, 111, 143, 175, 207	BPSK	MCS0
Occupied Bandwidth	802.11a	CDD	33, 61, 93, 97, 105, 113, 117, 149, 181, 185, 209, 233	BPSK	6Mb/s
	802.11ax (HE20)	CDD	33, 61, 93, 97, 105, 113, 117, 149, 181, 185, 209, 229, 233	BPSK	MCS0
	802.11ax (HE40)	CDD	35, 59, 91, 99, 107, 115, 123, 155, 179, 187, 211, 227	BPSK	MCS0
	802.11ax (HE80)	CDD	39, 55, 87, 103, 119, 151, 183, 199, 215	BPSK	MCS0
	802.11ax (HE160)	CDD	47, 79, 111, 143, 175, 207	BPSK	MCS0
Frequency Stability	802.11a	CDD	33	un-modulation	-
Contention-based Protocol	802.11ax (HE20)	CDD	33, 97, 129, 193	BPSK	MCS0
	802.11ax (HE160)	CDD	47, 111, 143, 207	BPSK	MCS0
AC Power Conducted Emissions	802.11ax (HE160)	CDD	79	BPSK	MCS0
Unwanted Emissions below 1 GHz	802.11ax (HE160)	CDD	79	BPSK	MCS0

Test Item	Mode	Signal Mode	Tested Channel	Modulation	Data Rate Parameter
Unwanted Emissions above 1 GHz	802.11a	CDD	33, 61, 93, 97, 105, 113, 117, 149, 181, 185, 209, 233	BPSK	6Mb/s
	802.11ax (HE20)	CDD	33, 61, 93, 97, 105, 113, 117, 149, 181, 185, 209, 229, 233	BPSK	MCS0
	802.11ax (HE40)	CDD	35, 59, 91, 99, 107, 115, 123, 155, 179, 187, 211, 227	BPSK	MCS0
	802.11ax (HE80)	CDD	39, 55, 87, 103, 119, 151, 183, 199, 215	BPSK	MCS0
	802.11ax (HE160)	CDD	47, 79, 111, 143, 175, 207	BPSK	MCS0

3.5 Duty Cycle of Test Signal

- 802.11a CDD: Duty cycle = 1.588 ms / 1.617 ms x 100% = 98.2%
- 802.11ax (HE20) CDD: Duty cycle = 2.168 ms / 2.2 ms x 100% = 98.5%
- 802.11ax (HE40) CDD: Duty cycle = 2.154 ms / 2.185 ms x 100% = 98.6%
- 802.11ax (HE80) CDD: Duty cycle = 2.143 ms / 2.171 ms x 100% = 98.7%
- 802.11ax (HE160) CDD: Duty cycle = 2.143 ms / 2.171 ms x 100% = 98.7%
- 802.11ax (HE20) Beamforming: Duty cycle = 3.025 ms / 3.052 ms x 100% = 99.1%
- 802.11ax (HE40) Beamforming: Duty cycle = 3.011 ms / 3.038 ms x 100% = 99.1%
- 802.11ax (HE80) Beamforming: Duty cycle = 2.997 ms / 2.998 ms x 100% = 99.9%
- 802.11ax (HE160) Beamforming: Duty cycle = 2.997 ms / 3.027 ms x 100% = 99.0%

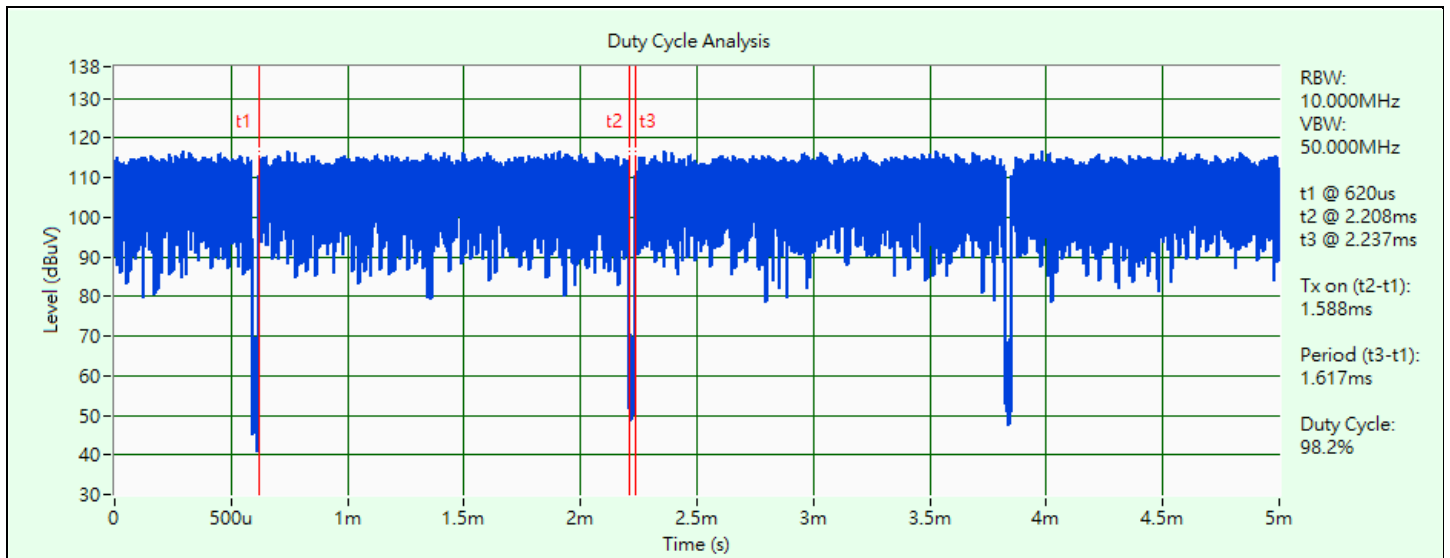

802.11a CDD

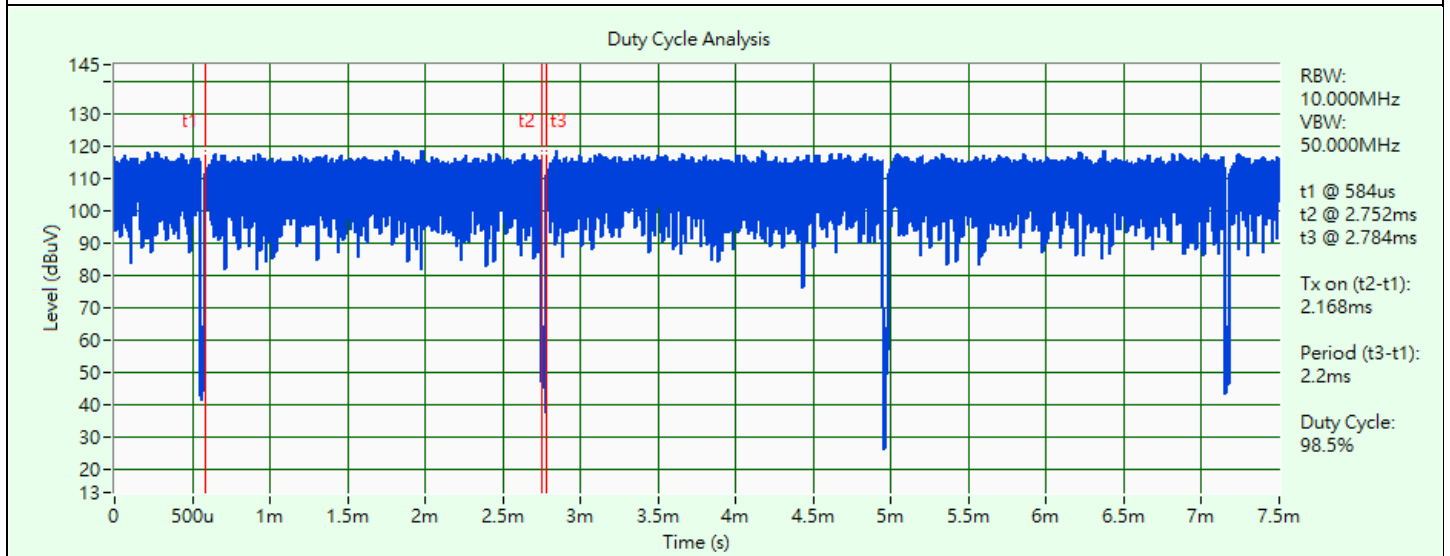

802.11ax (HE20) CDD

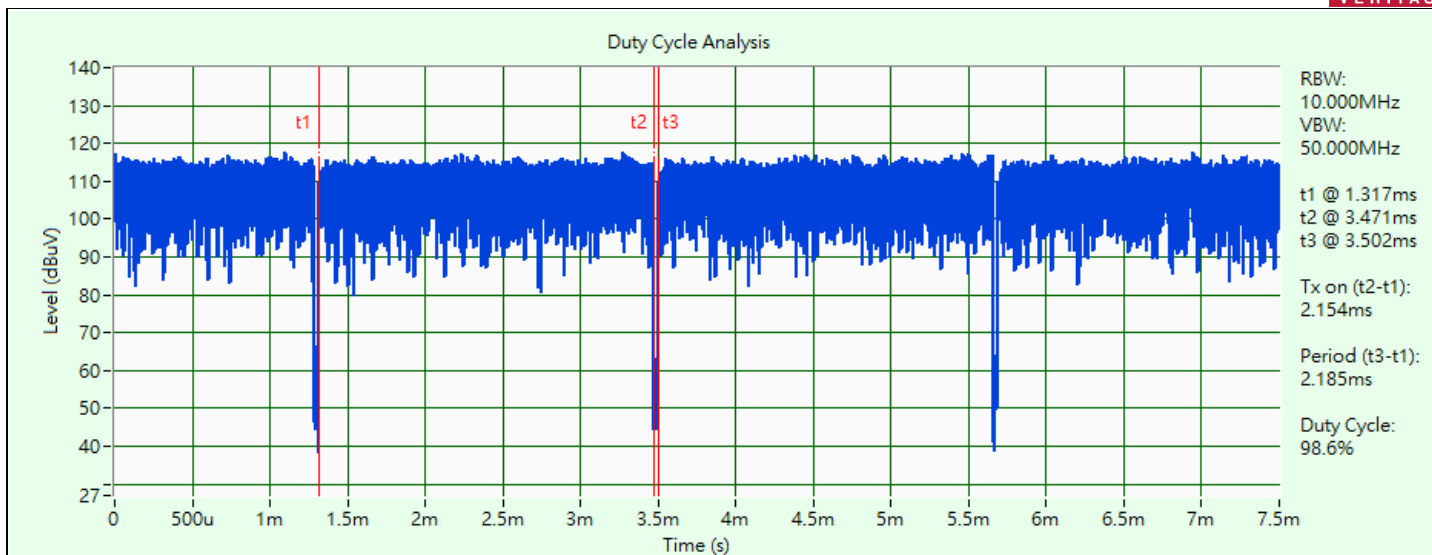

802.11ax (HE40) CDD

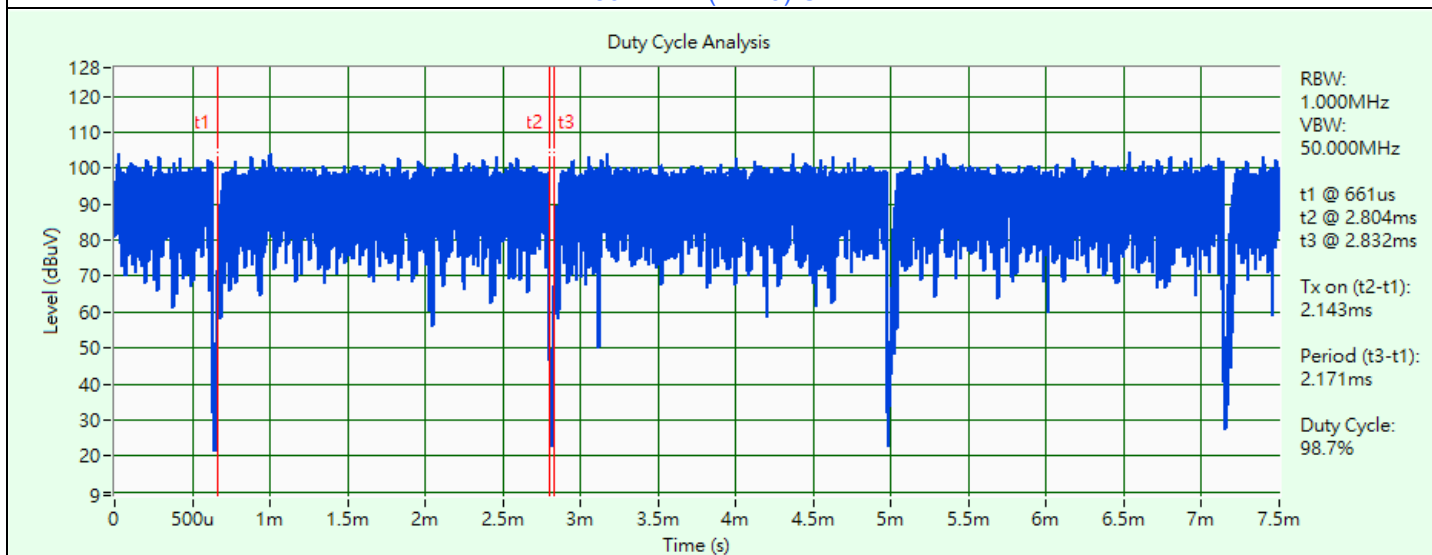

802.11ax (HE80) CDD

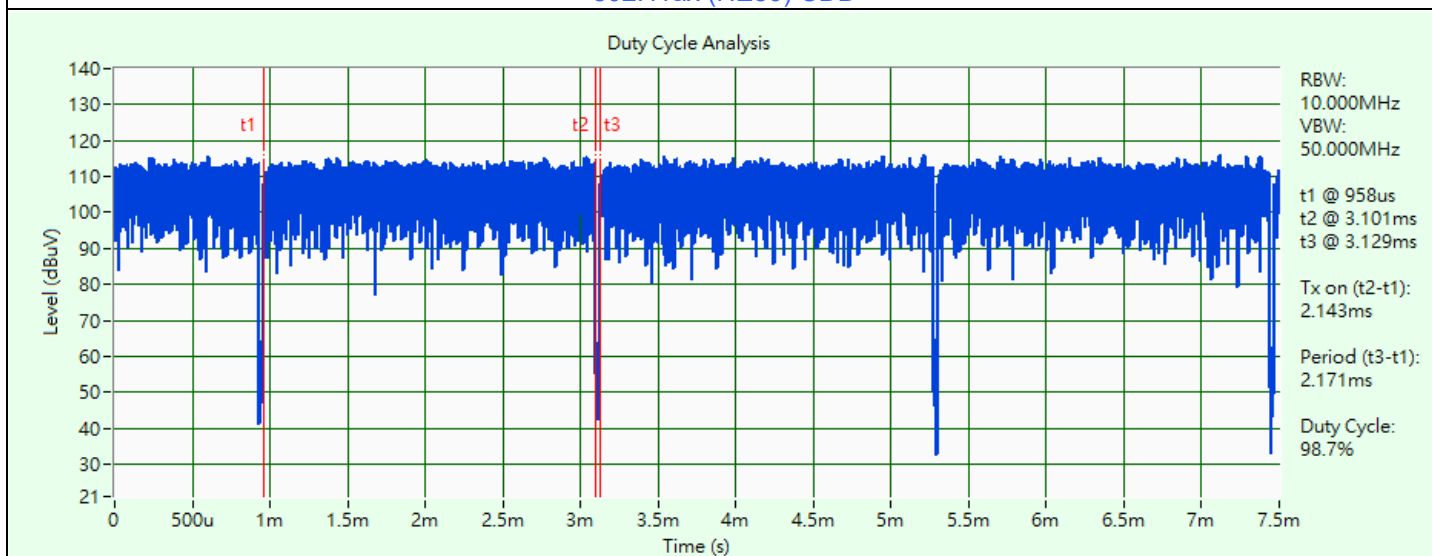

802.11ax (HE160) CDD

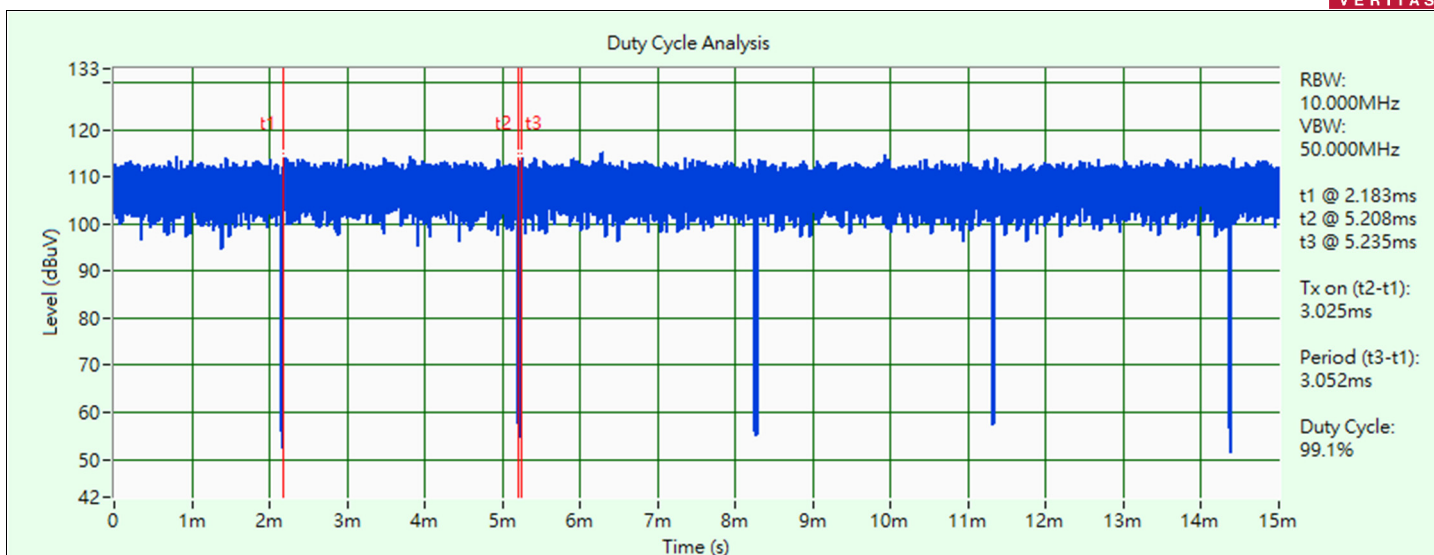

802.11ax (HE20) Beamforming

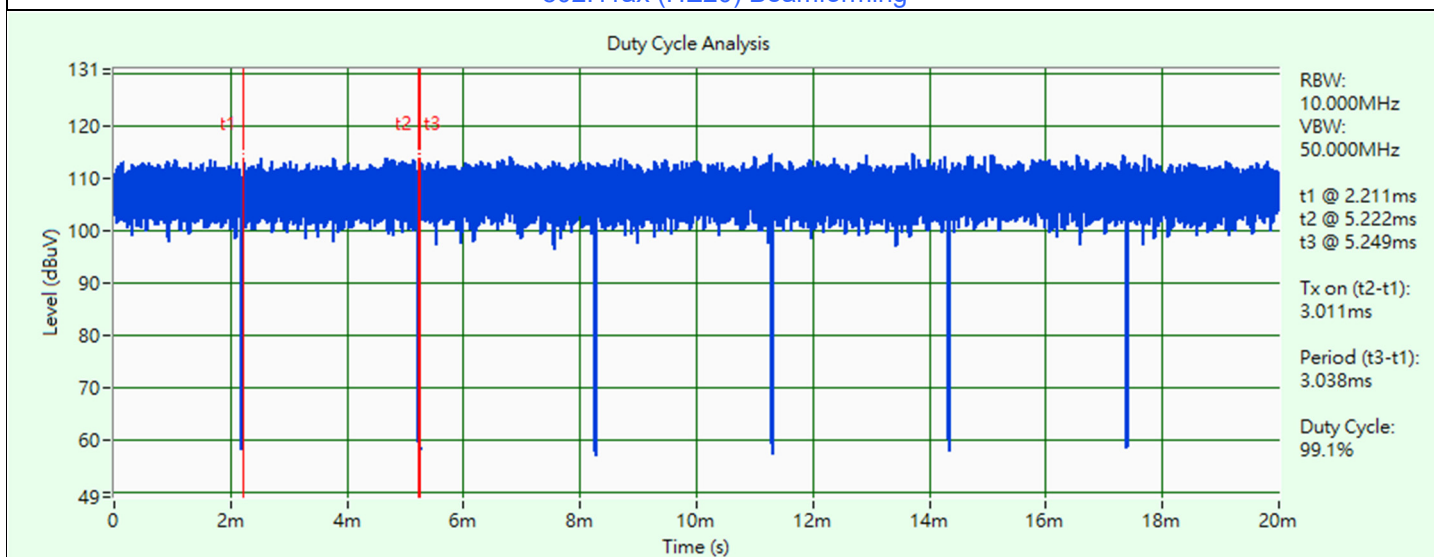

802.11ax (HE40) Beamforming

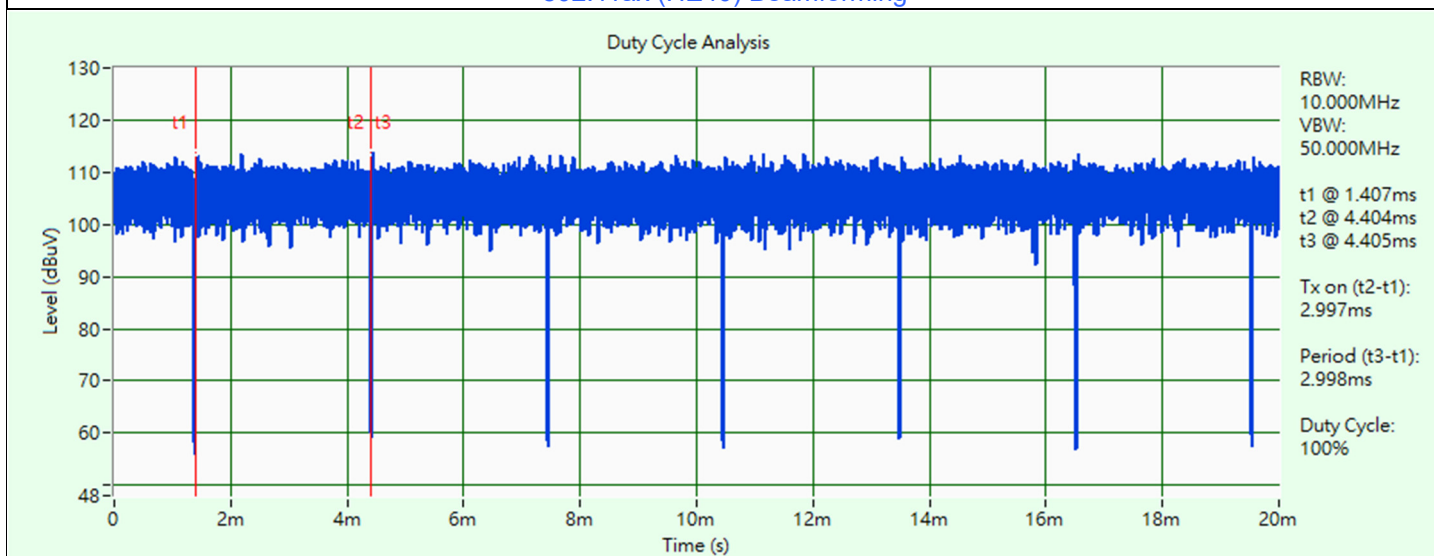

802.11ax (HE80) Beamforming

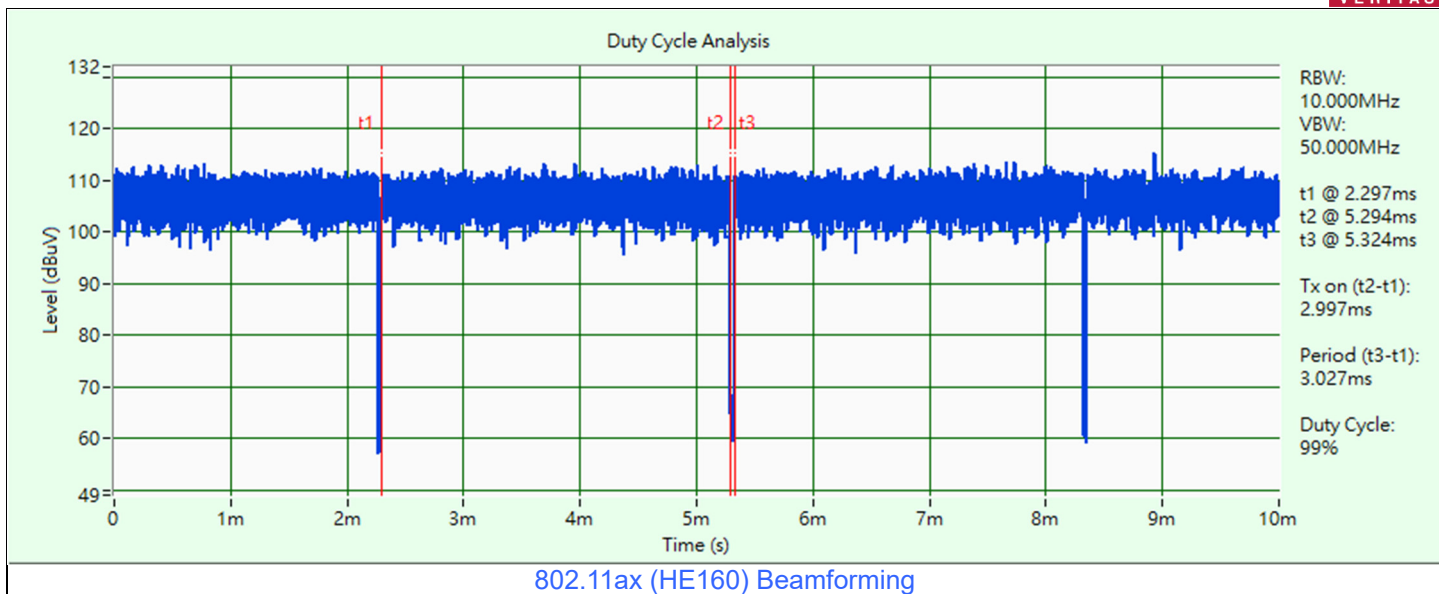

3.6 Test Program Used and Operation Descriptions

Controlling software (accessMTool_REL_3_3_0_1 has been activated to set the EUT under transmission condition continuously at specific channel frequency.

3.7 Connection Diagram of EUT and Peripheral Devices

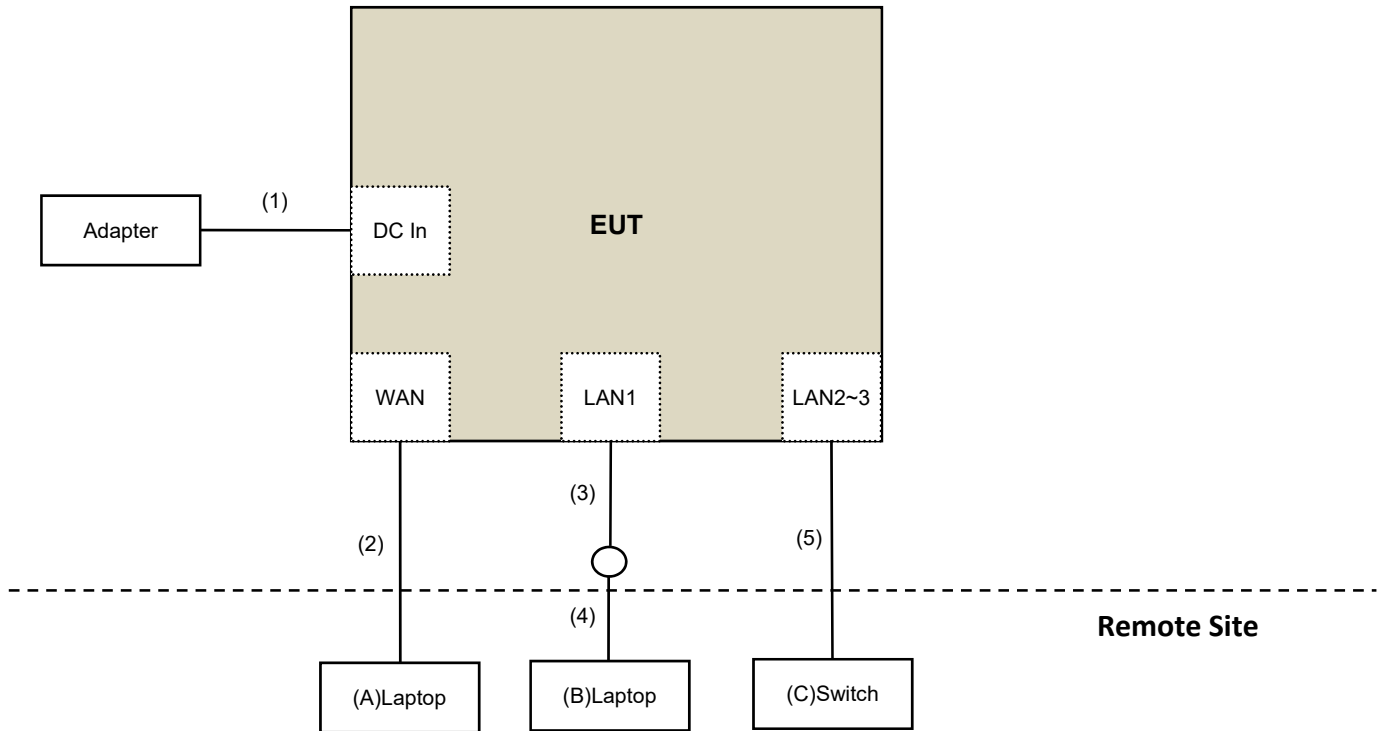

3.8 Configuration of Peripheral Devices and Cable Connections

ID	Product	Brand	Model No.	Serial No.	FCC ID	Remarks
A	Laptop	Lenovo	20U5S01X00 L14	PF-28LKK7	N/A	Provided by Lab
B	Laptop	Lenovo	20U5S01X00 L14	PF-1ANPYA	N/A	Provided by Lab
C	Switch	D-Link	DGS-1005D	DR8WC92000523	N/A	Provided by Lab

ID	Cable Descriptions	Qty.	Length (m)	Shielding (Yes/No)	Cores (Qty.)	Remarks
1	DC Cable	1	1.8	No	0	Supplied by applicant
2	RJ45	1	10	No	0	Provided by Lab
3	RJ45	1	2	No	0	Supplied by applicant
4	RJ45	1	10	No	0	Provided by Lab
5	RJ45	2	10	No	0	Provided by Lab

4 Test Instruments

The calibration interval of the all test instruments are 12 months and the calibrations are traceable to NML/ROC and NIST/USA.

4.1 RF Output Power

Description Manufacturer	Model No.	Serial No.	Calibrated Date	Calibrated Until
Boresight Antenna Tower & Turn Table Max-Full	MF-7802BS	MF780208530	N/A	N/A
Horn Antenna Schwarzbeck	BBHA 9120D	9120D-783	2022/11/13	2023/11/12
Pre_Amplifier EMCI	EMC12630SE	980688	2022/10/4	2023/10/3
RF Cable-Frequency Range : 1- 26.5GHz EMCI	EMC104-SM-SM-1200	160922	2022/12/15	2023/12/14
RF Coaxial Cable EMCI	EMC104-SM-SM-2000	180502	2022/4/25	2023/4/24
	EMC104-SM-SM-6000	210704	2022/11/4	2023/11/3
Software	ADT_Radiated_V8.7.08	N/A	N/A	N/A
Spectrum Analyzer KEYSIGHT	N9030B	MY57142938	2022/4/26	2023/4/25

Notes:

1. The test was performed in 966 Chamber No. 4.
2. Tested Date: 2023/3/15

4.2 Power Spectral Density

Refer to section 4.1 to get information of the instruments.

4.3 Emission Bandwidth

Description Manufacturer	Model No.	Serial No.	Calibrated Date	Calibrated Until
Attenuator WOKEN	MDCS18N-10	MDCS18N-10-01	2022/4/5	2023/4/4
Software	ADT_RF Test Software V6.6.5.4	N/A	N/A	N/A
Spectrum Analyzer Keysight	N9020B	MY60112409	2023/2/18	2024/2/17

Notes:

1. The test was performed in Oven room 2.
2. Tested Date: 2023/3/15

4.4 In-Band Emission Mask

Refer to section 4.3 to get information of the instruments.

4.5 Occupied Bandwidth

Refer to section 4.3 to get information of the instruments.

4.6 Frequency Stability

Description Manufacturer	Model No.	Serial No.	Calibrated Date	Calibrated Until
AC Power Source GOOD WILL	6905S	1991551	N/A	N/A
Attenuator WOKEN	MDCS18N-10	MDCS18N-10-01	2022/4/5	2023/4/4
Software	ADT_RF Test Software V6.6.5.4	N/A	N/A	N/A
Spectrum Analyzer Keysight	N9020B	MY60112409	2023/2/18	2024/2/17
Temperature & Humidity Chamber Giant Force	GTH-150-40-SP-AR	MAA0812-008	2022/12/26	2023/12/25
True RMS Clamp Meter Fluke	325	31130711WS	2022/6/9	2023/6/8

Notes:

1. The test was performed in Oven room 2.
2. Tested Date: 2023/3/15

4.7 Contention-based Protocol

Description Manufacturer	Model No.	Serial No.	Calibrated Date	Calibrated Until
Combiner Mini-Circuits	ZFRSC-123-S+	F698501347_01	2022/12/28	2023/12/27
		F698501347_02	2022/12/15	2023/12/14
Frequency Extender KEYSIGHT	N5182BX07	MY59360198	2022/10/14	2023/10/13
MXG X-Series RF Vector Signal Generator Keysight	N5182B	MY53052647	2022/11/8	2023/11/7
PXA Signal Analyzer Keysight	N9030A	MY55410176	2022/6/21	2023/6/20
Spectrum Analyzer R&S	FSV40	101516	2023/2/10	2024/2/9

Notes:

1. The test was performed in Adaptivity room.
2. Tested Date: 2023/5/22

4.8 AC Power Conducted Emissions

Description Manufacturer	Model No.	Serial No.	Calibrated Date	Calibrated Until
50 ohm terminal resistance	N/A	EMC-01	2022/9/27	2023/9/26
Fixed attenuator STI	STI02-2200-10	005	2022/8/24	2023/8/23
LISN R&S	ESH3-Z5	848773/004	2022/10/18	2023/10/17
RF Coaxial Cable JYEBO	5D-FB	COCCAB-001	2022/8/24	2023/8/23
Software BVADT	BVADT_Cond_V7.3.7.4	N/A	N/A	N/A
TEST RECEIVER R&S	ESCS 30	847124/029	2022/10/14	2023/10/13

Notes:

1. The test was performed in Conduction 1
2. Tested Date: 2023/3/13

4.9 Unwanted Emissions below 1 GHz

Description Manufacturer	Model No.	Serial No.	Calibrated Date	Calibrated Until
Boresight Antenna Tower & Turn Table Max-Full	MF-7802BS	MF780208530	N/A	N/A
Fixed attenuator Mini-Circuits	UNAT-5+	PAD-ATT5-03	2022/12/28	2023/12/27
LOOP ANTENNA Electro-Metrics	EM-6879	264	2022/3/18	2023/3/17
Pre_Amplifier Agilent	8447D	2944A10636	2022/3/19	2023/3/18
Pre_Amplifier EMCI	EMC330N	980701	2023/2/18	2024/2/17
RF Coaxial Cable COMMATE/PEWC	8D	966-4-1	2023/2/18	2024/2/17
		966-4-2	2023/2/18	2024/2/17
		966-4-3	2023/2/18	2024/2/17
RF Coaxial Cable JYEBO	5D-FB	LOOPCAB-001	2022/12/19	2023/12/18
		LOOPCAB-002	2022/12/19	2023/12/18
Software	ADT_Radiated_V8.7.08	N/A	N/A	N/A
Spectrum Analyzer KEYSIGHT	N9030B	MY57142938	2022/4/26	2023/4/25
Trilog Broadband Antenna Schwarzbeck	VULB 9168	9168-406	2022/10/21	2023/10/20

Notes:

1. The test was performed in 966 Chamber No. 4.
2. Tested Date: 2023/3/15

4.10 Unwanted Emissions above 1 GHz

Description Manufacturer	Model No.	Serial No.	Calibrated Date	Calibrated Until
Boresight Antenna Tower & Turn Table Max-Full	MF-7802BS	MF780208530	N/A	N/A
Horn Antenna Schwarzbeck	BBHA 9120D	9120D-783	2022/11/13	2023/11/12
	BBHA 9170	9170-739	2022/11/13	2023/11/12
Pre_Amplifier EMCI	EMC12630SE	980688	2022/10/4	2023/10/3
	EMC184045SE	980387	2022/12/28	2023/12/27
RF Cable-Frequency Range : 1- 26.5GHz EMCI	EMC104-SM-SM-1200	160922	2022/12/15	2023/12/14
RF Cable-Frequency range: 1- 40GHz EMCI	EMC102-KM-KM-1200	160924	2022/12/28	2023/12/27
RF Coaxial Cable EMCI	EMC-KM-KM-4000	200214	2023/2/20	2024/2/19
	EMC104-SM-SM-2000	180502	2022/4/25	2023/4/24
	EMC104-SM-SM-6000	210704	2022/11/4	2023/11/3
Software	ADT_Radiated_V8.7.08	N/A	N/A	N/A
Spectrum Analyzer KEYSIGHT	N9030B	MY57142938	2022/4/26	2023/4/25

Notes:

1. The test was performed in 966 Chamber No. 4.
2. Tested Date: 2023/3/15

5 Limits of Test Items

5.1 RF Output Power

Operation Band	EUT Category	Limit
		Max Average Power
U-NII-5 U-NII-6 U-NII-7 U-NII-8	Indoor AP	EIRP 30 dBm

5.2 Power Spectral Density

Operation Band	EUT Category	Limit
		Peak Power Density
U-NII-5 U-NII-6 U-NII-7 U-NII-8	Indoor AP	EIRP 5 dBm/MHz

5.3 Emission Bandwidth

The results are for reference only.

5.4 In-Band Emission Mask

Test Item	Frequencies (MHz)	(X) dBc* ¹
Emission Mask	At 1 MHz outside of channel edge	20
	At one channel bandwidth from the channel center* ²	28
	At one- and one-half times the channel bandwidth away from channel center* ³	40
	More than one- and one-half times the channel bandwidth	40

*¹ : The power spectral density must be suppressed by "x" dB

*² : At frequencies between one megahertz outside an unlicensed device's channel edge and one channel bandwidth from the center of the channel, the limits must be linearly interpolated between 20 dB and 28 dB suppression,

*³ : At frequencies between one and one- and one-half times an unlicensed device's channel bandwidth, the limits must be linearly interpolated between 28 dB and 40 dB suppression.

5.5 Occupied Bandwidth

The maximum transmitter channel bandwidth for U-NII devices in the 5.925-7.125 GHz band is 320 MHz.

5.6 Frequency Stability

The frequency of the carrier signal shall be maintained within band of operation.

5.7 Contention-based Protocol

Unlicensed indoor low-power devices must detect co-channel radio frequency power that is at least -62 dBm (The threshold is referenced to a 0 dBi antenna gain.) or lower. Additionally, indoor low-power devices must detect co-channel energy with 90% or greater certainty.

5.8 AC Power Conducted Emissions

Frequency (MHz)	Conducted Limit (dBuV)	
	Quasi-peak	Average
0.15 - 0.5	66 - 56	56 - 46
0.50 - 5.0	56	46
5.0 - 30.0	60	50

Notes:

1. The lower limit shall apply at the transition frequencies.
2. The limit decreases in line with the logarithm of the frequency in the range of 0.15 to 0.50 MHz.

5.9 Unwanted Emissions below 1 GHz

Radiated emissions which fall in the restricted bands must comply with the radiated emission limits specified as below table.

Frequencies (MHz)	Field Strength (microvolts/meter)	Measurement Distance (meters)
0.009 ~ 0.490	2400/F(kHz)	300
0.490 ~ 1.705	24000/F(kHz)	30
1.705 ~ 30.0	30	30
30 ~ 88	100	3
88 ~ 216	150	3
216 ~ 960	200	3
Above 960	500	3

Notes:

1. The lower limit shall apply at the transition frequencies.
2. Emission level (dBuV/m) = 20 log Emission level (uV/m).

5.10 Unwanted Emissions above 1 GHz

Radiated emissions which fall in the restricted bands must comply with the radiated emission limits specified as below table.

Frequencies (MHz)	Field Strength (microvolts/meter)	Measurement Distance (meters)
Above 960	500	3

Notes:

1. The lower limit shall apply at the transition frequencies.
2. Emission level (dBuV/m) = 20 log Emission level (uV/m).
3. For frequencies above 1000 MHz, the field strength limits are based on average detector, however, the peak field strength of any emission shall not exceed the maximum permitted average limits, specified above by more than 20 dB under any condition of modulation.

Limits of unwanted emission out of the restricted bands

Frequencies (MHz)	EIRP Limit	Equivalent Field Strength at 3 m
5925 MHz > F > 7125 MHz	Peak: -7 (dBm/MHz)	88.2 (dBuV/m)
	Average: -27 (dBm/MHz)	68.2 (dBuV/m)

Note: The following formula is used to convert the equipment isotropic radiated power (eirp) to field strength:

$$E = \frac{1000000 \sqrt{30P}}{3} \mu\text{V/m, where P is the eirp (Watts).}$$

6 Test Arrangements

6.1 RF Output Power

6.1.1 Test Setup

Radiated Measurement Method

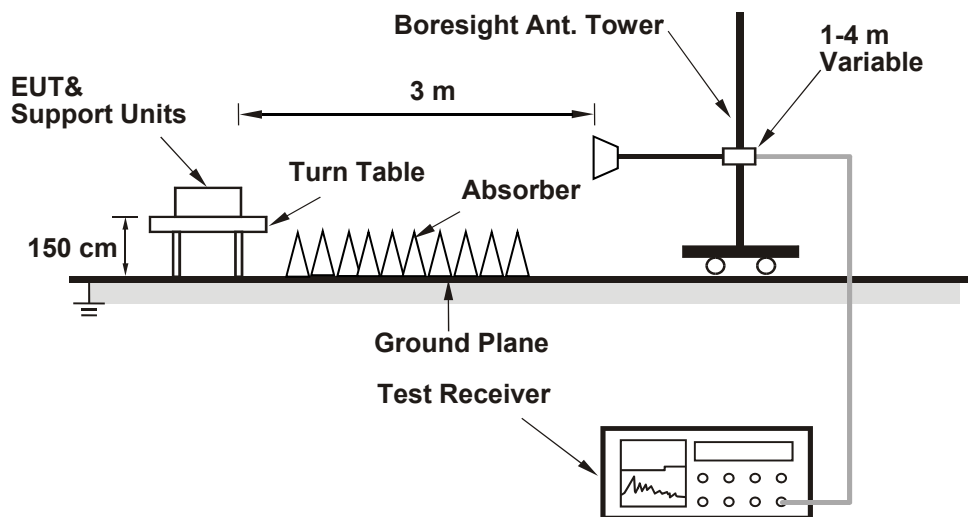

6.1.2 Test Procedure

Radiated Measurement Method

- The EUT was placed on the top of a rotating table 1.5 meters above the ground at 3 meter chamber room for test. The table was rotated 360 degrees to determine the position of the highest radiation.
- The EUT was set 3 meters away from the interference-receiving antenna, which was mounted on the top of a variable-height antenna tower.
- The height of antenna is varied from one meter to four meters above the ground to determine the maximum value of the field strength. Both horizontal and vertical polarizations of the antenna are set to make the measurement.
- Perform a field strength measurement and record the worse read value, is the field strength value via a spectrum reading obtained corrected for antenna factor, cable loss and pre-amplifier factor and then mathematically convert the measured field strength level to EIRP level.
- Follow ANSI C63.10 section 12.7.3, $EIRP \text{ Value (dBm)} = \text{Field Strength Value (dBuV / m)} + \text{Correction Factor @ 3 m}$.
- $\text{Correction Factor (dB) @ 3 m} = 20\log(D) - 104.77 = -95.23 \text{ dB}$; where D is the measurement distance @3 m.

Spectrum analyzer setting as below:

Method SA-1

- Set span to encompass the entire emission bandwidth (EBW) of the signal.
- Set RBW = 1 MHz, Set VBW \geq 3 MHz, Detector = RMS
- Sweep points $\geq [2 \times \text{span} / \text{RBW}]$. (This gives bin-to-bin spacing $\leq \text{RBW} / 2$, so that narrowband signals are not lost between frequency bins.)
- Sweep time = auto, trigger set to "free run".
- Trace average at least 100 traces in power averaging mode.
- Record the max value

Note: When measuring power, use compute power by integrating the spectrum across the 26 dB EBW or 99% OBW of the signal using the instrument's band power measurement function, with band limits set equal to the EBW or OBW band edges. If the instrument does not have a band power function, then sum the spectrum levels (in power units) at 1 MHz intervals extending across the 26 dB EBW or 99% OBW of the spectrum.

6.2 Power Spectral Density

6.2.1 Test Setup

Radiated Measurement Method

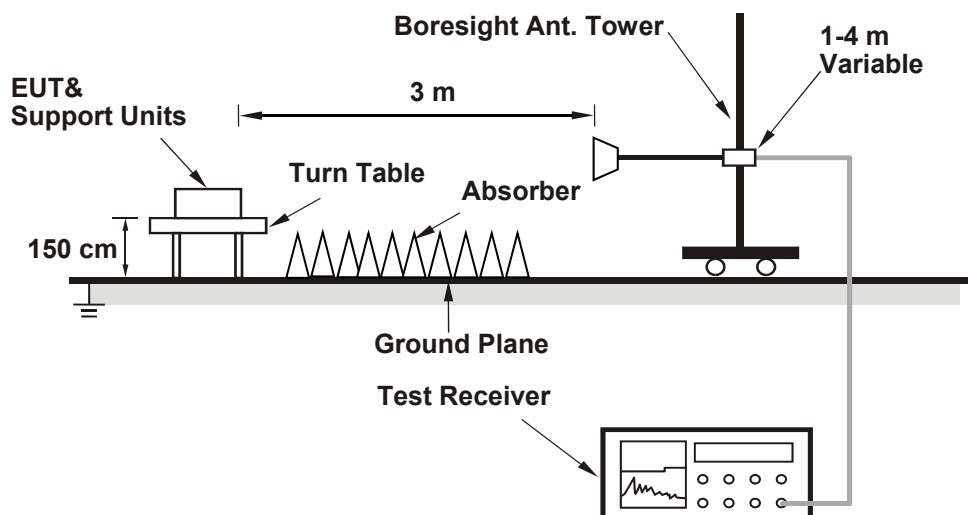

6.2.2 Test Procedure

Radiated Measurement Method

- The EUT was placed on the top of a rotating table 1.5 meters above the ground at 3 meter chamber room for test. The table was rotated 360 degrees to determine the position of the highest radiation.
- The EUT was set 3 meters away from the interference-receiving antenna, which was mounted on the top of a variable-height antenna tower.
- The height of antenna is varied from one meter to four meters above the ground to determine the maximum value of the field strength. Both horizontal and vertical polarizations of the antenna are set to make the measurement.
- Perform a field strength measurement and record the worse read value, is the field strength value via a spectrum reading obtained corrected for antenna factor, cable loss and pre-amplifier factor and then mathematically convert the measured field strength level to EIRP level.
- Follow ANSI C63.10 section 12.7.3, $EIRP \text{ Value (dBm)} = \text{Field Strength Value (dBuV/m)} + \text{Correction Factor @ 3 m}$.
- $\text{Correction Factor (dB) @ 3 m} = 20\log(D) - 104.77$; where D is the measurement distance @3 m = -95.23 dB

Spectrum analyzer setting as below:

Method SA-1

- Set span to encompass the entire emission bandwidth (EBW) of the signal.
- Set RBW = 1 MHz, Set VBW \geq 3 MHz, Detector = RMS
- Sweep points $\geq [2 \times \text{span} / \text{RBW}]$. (This gives bin-to-bin spacing \leq RBW / 2, so that narrowband signals are not lost between frequency bins.)
- Sweep time = auto, trigger set to "free run".
- Trace average at least 100 traces in power averaging mode.
- Record the max value

6.3 Emission Bandwidth

6.3.1 Test Setup

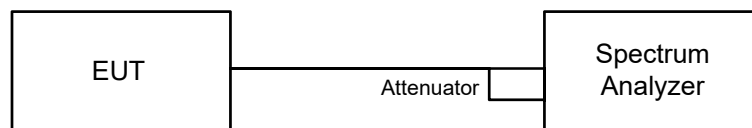

6.3.2 Test Procedure

- Set RBW = approximately 1% of the emission bandwidth.
- Set the VBW > RBW.
- Detector = Peak.
- Trace mode = max hold.
- Measure the maximum width of the emission that is 26 dB down from the peak of the emission. Compare this with the RBW setting of the analyzer. Readjust RBW and repeat measurement as needed until the RBW/EBW ratio is approximately 1%.

6.4 In-Band Emission Mask

6.4.1 Test Setup

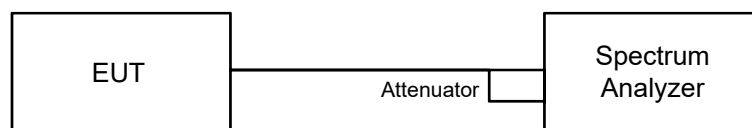

6.4.2 Test Procedure

- Connect output of the antenna port to a spectrum analyzer and adjust appropriate attenuation.
- Measure the 26 dB EBW using the test procedure 12.4.1 of ANSI C63.10-2013. (Determine the channel edge.)
- Measure the power spectral density (for emissions mask reference) using the following procedure:
 - Set the span to encompass the entire 26 dB EBW of the signal.
 - Set RBW = same RBW used for 26 dB EBW measurement.
 - Set VBW $\geq [3 \times \text{RBW}]$.
 - Number of points in sweep $\geq [2 \times \text{span} / \text{RBW}]$.
 - Sweep time = auto.
 - Detector = RMS (i.e., power averaging).
 - Trace average at least 100 traces in power averaging (rms) mode.
 - Use the peak search function on the instrument to find the peak of the spectrum.
- Using the measuring equipment limit line function, develop the emissions mask based on the following requirements. The emissions power spectral density must be reduced below the peak power spectral density (in dB) as follows:
 - Suppressed by 20 dB at 1 MHz outside of the channel edge. (The channel edge is defined as the 26-dB point on either side of the carrier center frequency.)
 - Suppressed by 28 dB at one channel bandwidth from the channel center.
 - Suppressed by 40 dB at one- and one-half times the channel bandwidth from the channel center.
- Adjust the span to encompass the entire mask as necessary and clear trace.
- Trace average at least 100 traces in power averaging (rms) mode.
- Adjust the reference level as necessary so that the crest of the channel touches the top of the emission mask

6.5 Occupied Bandwidth

6.5.1 Test Setup

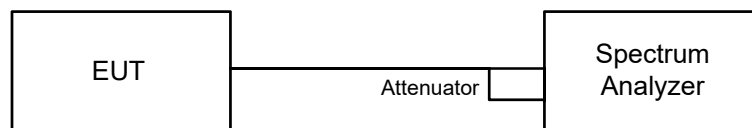

6.5.2 Test Procedure

The transmitter output was connected to the spectrum analyzer through an attenuator. The bandwidth of the fundamental frequency was measured by spectrum analyzer with resolution bandwidth in the range of 1% to 5% of the anticipated emission bandwidth, and a video bandwidth at least 3x the resolution bandwidth and set the detector to Sampling. The width of a frequency band such that, below the lower and above the upper frequency limits, the mean powers emitted are each equal to a specified percentage 0.5% of the total mean power of a given emission.

6.6 Frequency Stability

6.6.1 Test Setup

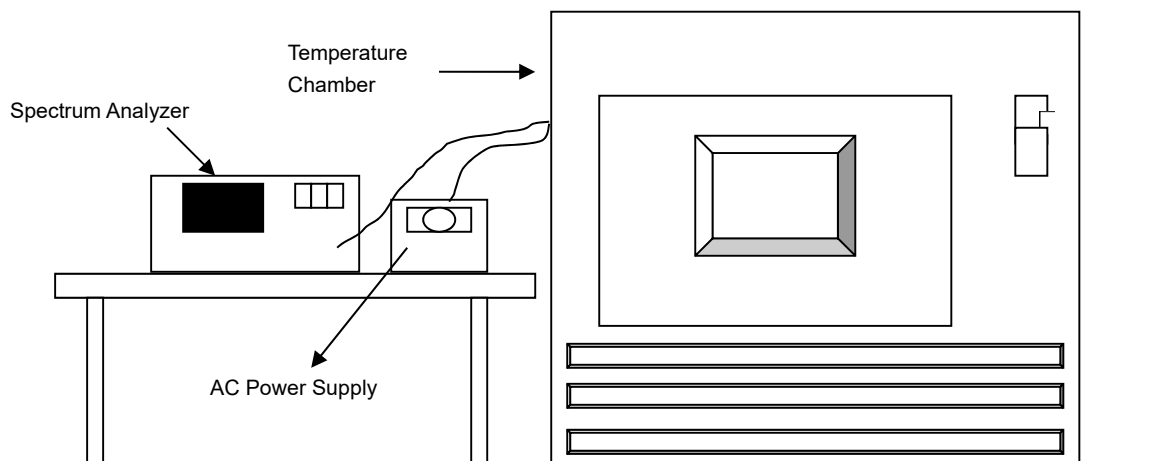

6.6.2 Test Procedure

- The EUT was placed inside the environmental test chamber and powered by nominal AC voltage.
- Turn the EUT on and couple its output to a spectrum analyzer.
- Turn the EUT off and set the chamber to the highest temperature specified.
- Allow sufficient time (approximately 30 min) for the temperature of the chamber to stabilize, turn the EUT on and measure the operating frequency after 2, 5, and 10 Minutes.
- Repeat step (d) with the temperature chamber set to the next desired temperature until measurements down to the lowest specified temperature have been completed.
- The test chamber was allowed to stabilize at +20 degree C for a minimum of 30 Minutes. The supply voltage was then adjusted on the EUT from 85% to 115% and the frequency record.

6.7 Contention-based Protocol

6.7.1 Test Setup

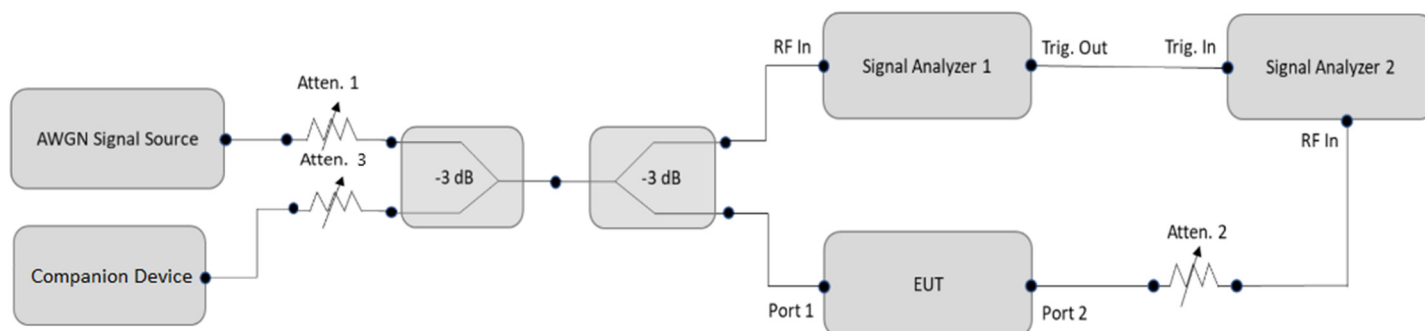

6.7.2 Test Procedure

- Set the signal analyzer center frequency to the nominal EUT channel center frequency. The span range of the signal analyzer shall be between two times and five times the OBW of the EUT. Connect the output port of the EUT to the signal analyzer 2. Ensure that the attenuator 2 provides enough attenuation to not overload the signal analyzer 2 receiver.
- Monitoring the signal analyzer 2, verify the EUT is operating and transmitting with the parameters (set as following section 4.7.5 EUT operating condition).
- Determine number of times detection threshold test as following table,

If	Number of Tests	Placement of Incumbent Transmission
$BW_{EUT} \leq BW_{Inc}$	Once	Same as EUT transmission
$BW_{Inc} < BW_{EUT} \leq 2x BW_{Inc}$	Once	Contained within BW_{EUT}
$2x BW_{Inc} < BW_{EUT} \leq 4x BW_{Inc}$	Twice. (Incumbent transmission is contained within BW_{EUT})	Closely to the lower edge and upper edge of the EUT Channel
$BW_{EUT} > 4x BW_{Inc}$	Three times	Closely to the lower edge, in the middle and upper edge of the EUT Channel

- Using an AWGN signal source, generate (but do not transmit, i.e., RF OFF) a 10 MHz-wide AWGN signal. Use step c table to determine the center frequency of the 10 MHz AWGN signal relative to the EUT's channel bandwidth and center frequency.
- Set the AWGN signal power to an extremely low level (more than 20 dB below the -62 dBm threshold). Connect the AWGN signal source, via a 3-dB splitter, to the signal analyzer 1 and the EUT.
- Transmit the AWGN signal (RF ON) and verify its characteristics on the signal analyzer 1.
- Monitor the signal analyzer 2 to verify if the AWGN signal has been detected and the EUT has ceased transmission. If the EUT continues to transmit, then incrementally increase the AWGN signal power level until the EUT stops transmitting.
- (Including all losses in the RF paths) Determine and record the AWGN signal power level (at the EUT's antenna port) at which the EUT ceased transmission. Repeat the procedure at least 10 times to verify the EUT can detect an AWGN signal with 90% (or better) level of certainty.
- Refer to step c table to determine number of times the detection threshold testing needs to be repeated. If testing is required more than once, then go back to step d, choose a different center frequency for the AWGN signal and repeat the process.

6.8 AC Power Conducted Emissions

6.8.1 Test Setup

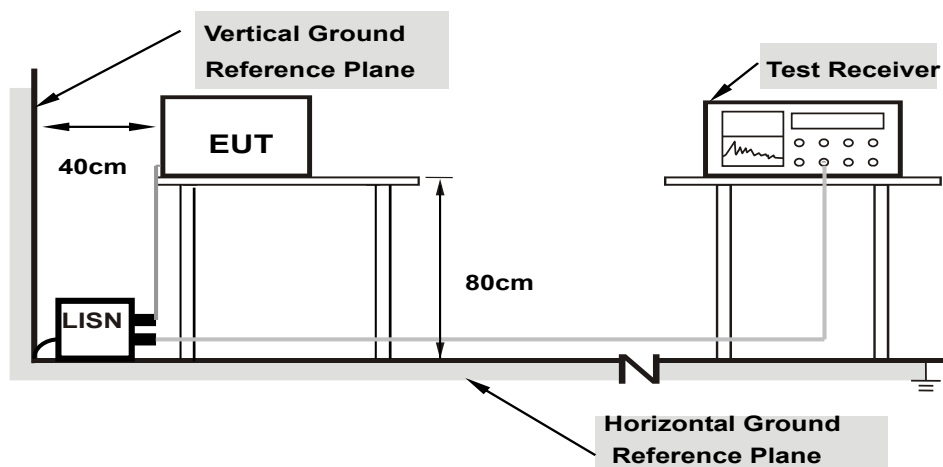

Note: 1.Support units were connected to second LISN.

For the actual test configuration, please refer to the attached file (Test Setup Photo).

6.8.2 Test Procedure

- The EUT was placed on a 0.8 meter to the top of table and placed 0.4 meters from the conducting wall of the shielded room with EUT being connected to the power mains through a line impedance stabilization network (LISN). Other support units were connected to the power mains through another LISN. The two LISNs provide 50 ohm/ 50 uH of coupling impedance for the measuring instrument.
- Both lines of the power mains connected to the EUT were checked for maximum conducted interference.
- The frequency range from 150 kHz to 30 MHz was searched. Emission levels under (Limit – 20 dB) was not recorded.

Note: The resolution bandwidth and video bandwidth of test receiver is 9 kHz for quasi-peak detection (QP) and average detection (AV) at frequency 0.15 MHz-30 MHz.

6.9 Unwanted Emissions below 1 GHz

6.9.1 Test Setup

For Radiated emission below 30 MHz

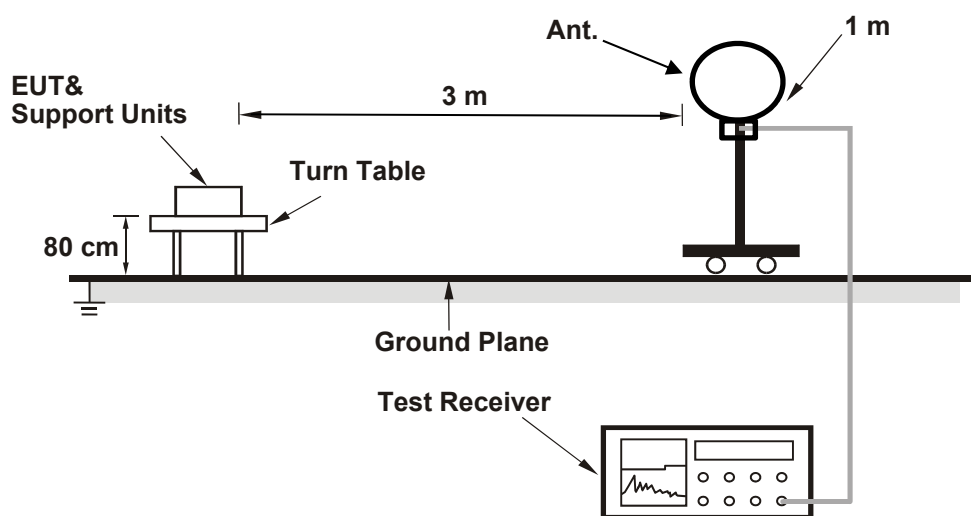

For Radiated emission above 30 MHz

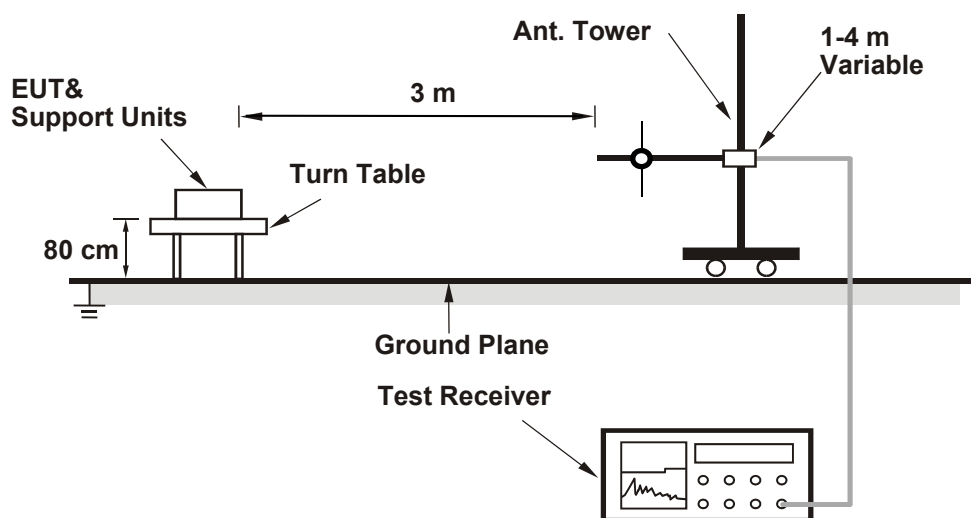

For the actual test configuration, please refer to the attached file (Test Setup Photo).

6.9.2 Test Procedure

For Radiated emission below 30 MHz

- a. The EUT was placed on the top of a rotating table 0.8 meters above the ground at 3 meter chamber room for test. The table was rotated 360 degrees to determine the position of the highest radiation.
- b. The EUT was set 3 meters away from the interference-receiving antenna, which was mounted on the top of a variable-height antenna tower.
- c. Parallel, perpendicular, and ground-parallel orientations of the antenna are set to make the measurement.
- d. For each suspected emission, the EUT was arranged to its worst case and the rotatable table was turned from 0 degrees to 360 degrees to find the maximum reading.
- e. The test-receiver system was set to Quasi-Peak Detect Function and Specified Bandwidth with Maximum Hold Mode, except for the frequency band (9 kHz to 90 kHz and 110 kHz to 490 kHz) set to average detect function and peak detect function.

Notes:

1. The resolution bandwidth and video bandwidth of test receiver/spectrum analyzer is 200 Hz at frequency below 150 kHz.
2. The resolution bandwidth and video bandwidth of test receiver/spectrum analyzer is 9 kHz or 10 kHz at frequency (150 kHz to 30 MHz).
3. All modes of operation were investigated and the worst-case emissions are reported.

For Radiated emission above 30 MHz

- a. The EUT was placed on the top of a rotating table 0.8 meters above the ground at 3 meter chamber room for test. The table was rotated 360 degrees to determine the position of the highest radiation.
- b. The EUT was set 3 meters away from the interference-receiving antenna, which was mounted on the top of a variable-height antenna tower.
- c. The height of antenna is varied from one meter to four meters above the ground to determine the maximum value of the field strength. Both horizontal and vertical polarizations of the antenna are set to make the measurement.
- d. For each suspected emission, the EUT was arranged to its worst case and then the antenna was tuned to heights from 1 meter to 4 meters and the rotatable table was turned from 0 degrees to 360 degrees to find the maximum reading.
- e. The test-receiver system was set to quasi-peak detect function and specified bandwidth with maximum hold mode when the test frequency is below 1 GHz.

Notes:

1. The resolution bandwidth and video bandwidth of test receiver/spectrum analyzer is 120 kHz for Quasi-peak detection (QP) at frequency below 1 GHz.
2. All modes of operation were investigated and the worst-case emissions are reported.

6.10 Unwanted Emissions above 1 GHz

6.10.1 Test Setup

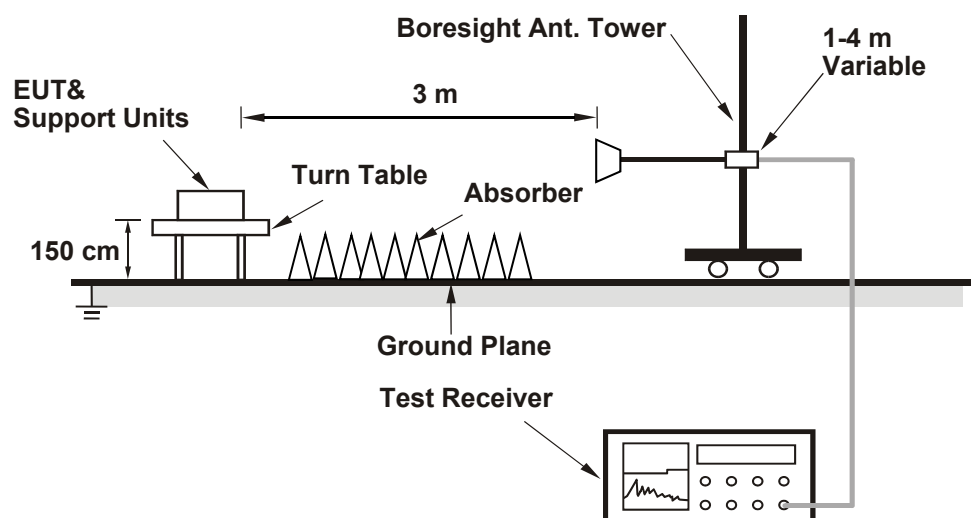

For the actual test configuration, please refer to the attached file (Test Setup Photo).

6.10.2 Test Procedure

- The EUT was placed on the top of a rotating table 1.5 meters above the ground at 3 meter chamber room for test. The table was rotated 360 degrees to determine the position of the highest radiation.
- The EUT was set 3 meters away from the interference-receiving antenna, which was mounted on the top of a variable-height antenna tower.
- The height of antenna is varied from one meter to four meters above the ground to determine the maximum value of the field strength. Both horizontal and vertical polarizations of the antenna are set to make the measurement.
- For each suspected emission, the EUT was arranged to its worst case and then the antenna was tuned to heights from 1 meter to 4 meters and the rotatable table was turned from 0 degrees to 360 degrees to find the maximum reading.
- The test-receiver system was set to peak and average detects function and specified bandwidth with maximum hold mode when the test frequency is above 1 GHz. If the peak reading value also meets average limit, measurement with the average detector is unnecessary.

Notes:

- The resolution bandwidth of test receiver/spectrum analyzer is 1 MHz and the video bandwidth is 3 MHz for Peak detection (PK) and Average detection (AV) at frequency above 1 GHz.
- For fundamental and harmonic signal measurement, the resolution bandwidth of test receiver/spectrum analyzer is 1 MHz and the video bandwidth is $\geq 1/T$ (Duty cycle $< 98\%$) or 10 Hz (Duty cycle $\geq 98\%$) for Average detection (AV) at frequency above 1 GHz.
- All modes of operation were investigated and the worst-case emissions are reported.

7 Test Results of Test Item

7.1 RF Output Power

Input Power:	120 Vac, 60 Hz	Environmental Conditions:	25°C, 60% RH	Tested By:	John Peng
--------------	----------------	---------------------------	--------------	------------	-----------

802.11a CDD

Chan.	Chan. Freq. (MHz)	Field Strength (dBuV/m)	Correction Factor (dB)	EIRP (mW)	EIRP (dBm)	EIRP Limit (dBm)	Test Result
33	6115	111.60	-95.23	43.351	16.37	30	Pass
61	6255	112.00	-95.23	47.534	16.77	30	Pass
93	6415	111.70	-95.23	44.361	16.47	30	Pass
97	6435	111.70	-95.23	44.361	16.47	30	Pass
105	6475	111.80	-95.23	45.394	16.57	30	Pass
113	6515	111.70	-95.23	44.361	16.47	30	Pass
117	6535	112.00	-95.23	47.534	16.77	30	Pass
149	6695	111.70	-95.23	44.361	16.47	30	Pass
181	6855	112.00	-95.23	47.534	16.77	30	Pass
185	6875	111.80	-95.23	45.394	16.57	30	Pass
209	6995	111.90	-95.23	46.452	16.67	30	Pass
233	7115	111.70	-95.23	44.361	16.47	30	Pass

802.11ax (HE20) CDD

Chan.	Chan. Freq. (MHz)	Field Strength (dBuV/m)	Correction Factor (dB)	EIRP (mW)	EIRP (dBm)	EIRP Limit (dBm)	Test Result
33	6115	112.30	-95.23	50.933	17.07	30	Pass
61	6255	112.40	-95.23	52.119	17.17	30	Pass
93	6415	112.50	-95.23	53.333	17.27	30	Pass
97	6435	112.40	-95.23	52.119	17.17	30	Pass
105	6475	112.30	-95.23	50.933	17.07	30	Pass
113	6515	112.40	-95.23	52.119	17.17	30	Pass
117	6535	112.20	-95.23	49.774	16.97	30	Pass
149	6695	112.40	-95.23	52.119	17.17	30	Pass
181	6855	112.70	-95.23	55.847	17.47	30	Pass
185	6875	112.40	-95.23	52.119	17.17	30	Pass
209	6995	112.10	-95.23	48.641	16.87	30	Pass
229	7095	112.60	-95.23	54.576	17.37	30	Pass
233	7115	96.20	-95.23	1.25	0.97	30	Pass

802.11ax (HE40) CDD

Chan.	Chan. Freq. (MHz)	Field Strength (dBuV/m)	Correction Factor (dB)	EIRP (mW)	EIRP (dBm)	EIRP Limit (dBm)	Test Result
35	6125	114.80	-95.23	90.573	19.57	30	Pass
59	6245	114.80	-95.23	90.573	19.57	30	Pass
91	6405	114.60	-95.23	86.497	19.37	30	Pass
99	6445	114.70	-95.23	88.512	19.47	30	Pass
107	6485	114.70	-95.23	88.512	19.47	30	Pass
115	6525	114.40	-95.23	82.604	19.17	30	Pass
123	6565	114.70	-95.23	88.512	19.47	30	Pass
155	6725	114.70	-95.23	88.512	19.47	30	Pass
179	6845	114.70	-95.23	88.512	19.47	30	Pass
187	6885	114.50	-95.23	84.528	19.27	30	Pass
211	7005	114.80	-95.23	90.573	19.57	30	Pass
227	7085	114.70	-95.23	88.512	19.47	30	Pass

802.11ax (HE80) CDD

Chan.	Chan. Freq. (MHz)	Field Strength (dBuV/m)	Correction Factor (dB)	EIRP (mW)	EIRP (dBm)	EIRP Limit (dBm)	Test Result
39	6145	117.00	-95.23	150.314	21.77	30	Pass
55	6225	117.00	-95.23	150.314	21.77	30	Pass
87	6385	117.10	-95.23	153.815	21.87	30	Pass
103	6465	117.00	-95.23	150.314	21.77	30	Pass
119	6545	117.20	-95.23	157.398	21.97	30	Pass
151	6705	117.10	-95.23	153.815	21.87	30	Pass
183	6865	117.20	-95.23	157.398	21.97	30	Pass
199	6945	117.20	-95.23	157.398	21.97	30	Pass
215	7025	117.30	-95.23	161.065	22.07	30	Pass

802.11ax (HE160) CDD

Chan.	Chan. Freq. (MHz)	Field Strength (dBuV/m)	Correction Factor (dB)	EIRP (mW)	EIRP (dBm)	EIRP Limit (dBm)	Test Result
47	6185	120.10	-95.23	306.902	24.87	30	Pass
79	6345	120.50	-95.23	336.512	25.27	30	Pass
111	6505	120.50	-95.23	336.512	25.27	30	Pass
143	6665	120.30	-95.23	321.366	25.07	30	Pass
175	6825	120.40	-95.23	328.852	25.17	30	Pass
207	6985	120.50	-95.23	336.512	25.27	30	Pass

Spectrum Plot of Worst Value

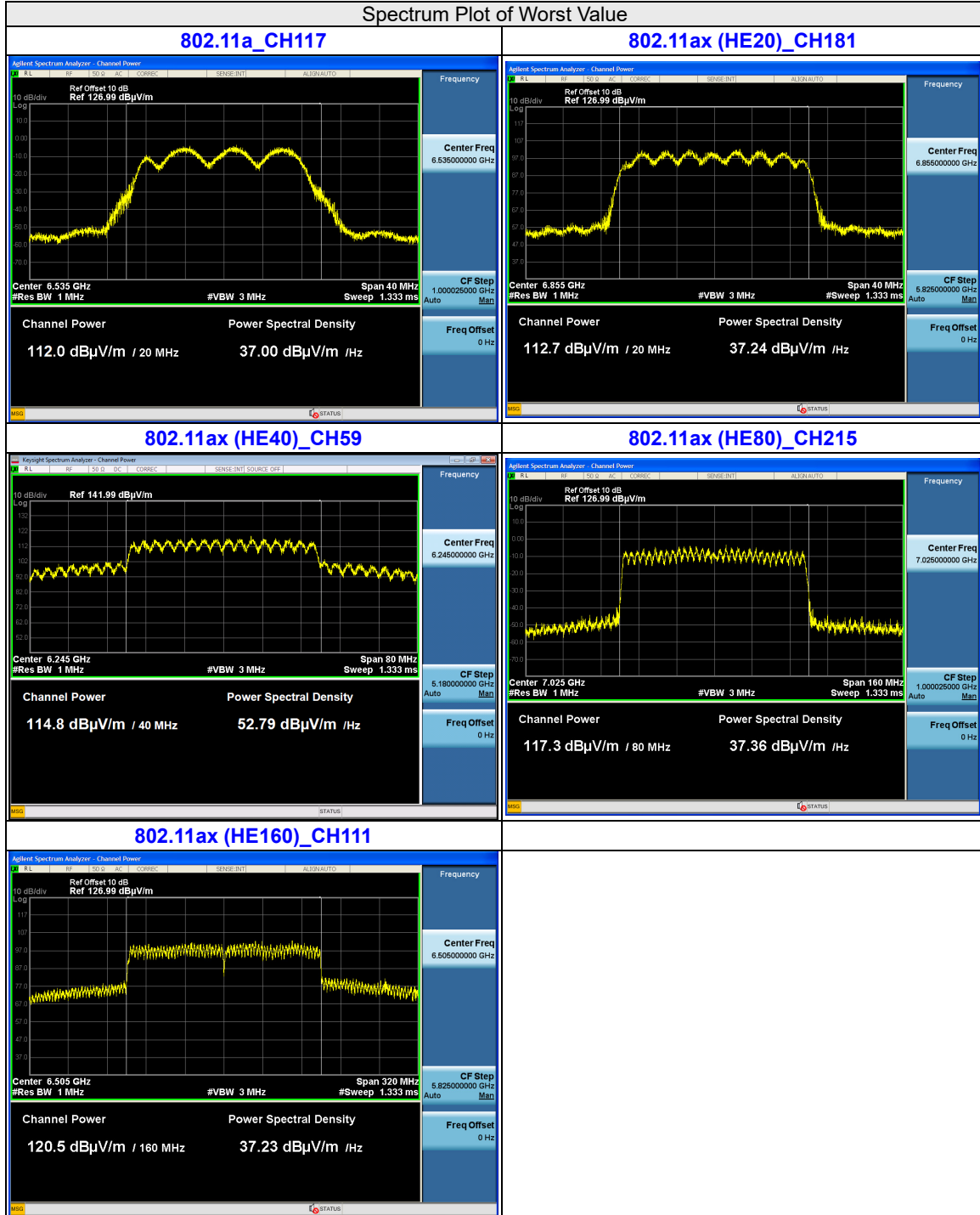

802.11ax (HE20) Beamforming_2T1S

Chan.	Chan. Freq. (MHz)	Field Strength (dBuV/m)	Correction Factor (dB)	EIRP (mW)	EIRP (dBm)	EIRP Limit (dBm)	Test Result
33	6115	113.90	-95.23	73.621	18.67	30	Pass
61	6255	114.30	-95.23	80.724	19.07	30	Pass
93	6415	114.30	-95.23	80.724	19.07	30	Pass
97	6435	114.20	-95.23	78.886	18.97	30	Pass
105	6475	114.10	-95.23	77.09	18.87	30	Pass
113	6515	113.90	-95.23	73.621	18.67	30	Pass
117	6535	113.80	-95.23	71.945	18.57	30	Pass
149	6695	114.10	-95.23	77.09	18.87	30	Pass
181	6855	114.20	-95.23	78.886	18.97	30	Pass
185	6875	114.20	-95.23	78.886	18.97	30	Pass
209	6995	114.00	-95.23	75.336	18.77	30	Pass
229	7095	114.30	-95.23	80.724	19.07	30	Pass
233	7115	97.90	-95.23	1.849	2.67	30	Pass

802.11ax (HE40) Beamforming_2T1S

Chan.	Chan. Freq. (MHz)	Field Strength (dBuV/m)	Correction Factor (dB)	EIRP (mW)	EIRP (dBm)	EIRP Limit (dBm)	Test Result
35	6125	116.50	-95.23	133.968	21.27	30	Pass
59	6245	116.40	-95.23	130.918	21.17	30	Pass
91	6405	116.30	-95.23	127.938	21.07	30	Pass
99	6445	116.60	-95.23	137.088	21.37	30	Pass
107	6485	116.60	-95.23	137.088	21.37	30	Pass
115	6525	116.30	-95.23	127.938	21.07	30	Pass
123	6565	116.40	-95.23	130.918	21.17	30	Pass
155	6725	116.20	-95.23	125.026	20.97	30	Pass
179	6845	116.50	-95.23	133.968	21.27	30	Pass
187	6885	116.10	-95.23	122.18	20.87	30	Pass
211	7005	116.70	-95.23	140.281	21.47	30	Pass
227	7085	116.30	-95.23	127.938	21.07	30	Pass

802.11ax (HE80) Beamforming_2T1S

Chan.	Chan. Freq. (MHz)	Field Strength (dBuV/m)	Correction Factor (dB)	EIRP (mW)	EIRP (dBm)	EIRP Limit (dBm)	Test Result
39	6145	118.80	-95.23	227.51	23.57	30	Pass
55	6225	118.70	-95.23	222.331	23.47	30	Pass
87	6385	119.00	-95.23	238.232	23.77	30	Pass
103	6465	118.80	-95.23	227.51	23.57	30	Pass
119	6545	118.80	-95.23	227.51	23.57	30	Pass
151	6705	118.70	-95.23	222.331	23.47	30	Pass
183	6865	118.80	-95.23	227.51	23.57	30	Pass
199	6945	119.00	-95.23	238.232	23.77	30	Pass
215	7025	119.10	-95.23	243.781	23.87	30	Pass

802.11ax (HE160) Beamforming_2T1S

Chan.	Chan. Freq. (MHz)	Field Strength (dBuV/m)	Correction Factor (dB)	EIRP (mW)	EIRP (dBm)	EIRP Limit (dBm)	Test Result
47	6185	121.70	-95.23	443.609	26.47	30	Pass
79	6345	122.30	-95.23	509.331	27.07	30	Pass
111	6505	122.10	-95.23	486.407	26.87	30	Pass
143	6665	121.90	-95.23	464.515	26.67	30	Pass
175	6825	122.00	-95.23	475.335	26.77	30	Pass
207	6985	122.20	-95.23	497.737	26.97	30	Pass

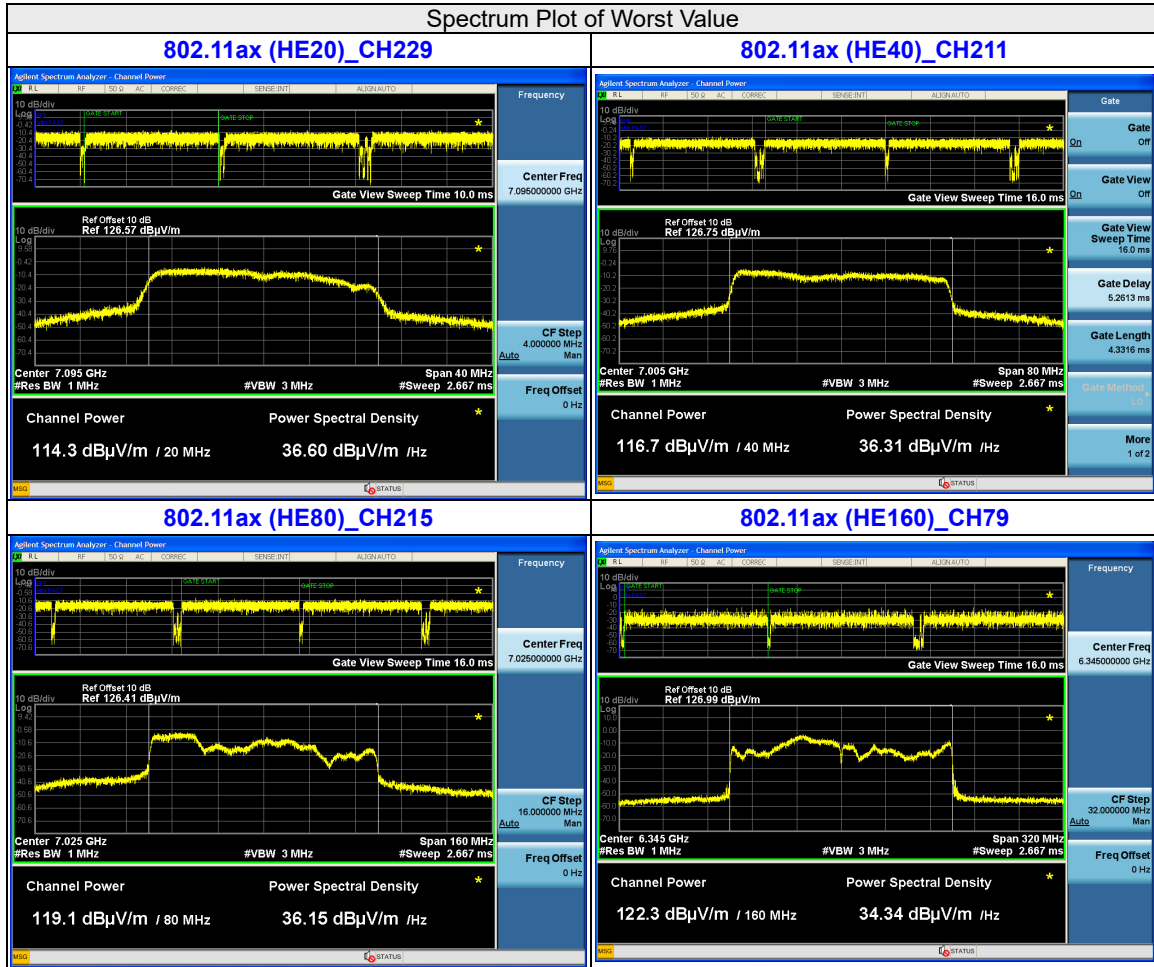

802.11ax (HE20) SM-MIMO_2T2S

Chan.	Chan. Freq. (MHz)	Field Strength (dBuV/m)	Correction Factor (dB)	EIRP (mW)	EIRP (dBm)	EIRP Limit (dBm)	Test Result
33	6115	113.30	-95.23	64.121	18.07	30	Pass
61	6255	113.10	-95.23	61.235	17.87	30	Pass
93	6415	113.30	-95.23	64.121	18.07	30	Pass
97	6435	113.50	-95.23	67.143	18.27	30	Pass
105	6475	113.50	-95.23	67.143	18.27	30	Pass
113	6515	113.50	-95.23	67.143	18.27	30	Pass
117	6535	113.30	-95.23	64.121	18.07	30	Pass
149	6695	113.40	-95.23	65.615	18.17	30	Pass
181	6855	113.30	-95.23	64.121	18.07	30	Pass
185	6875	113.30	-95.23	64.121	18.07	30	Pass
209	6995	113.30	-95.23	64.121	18.07	30	Pass
229	7095	113.60	-95.23	68.707	18.37	30	Pass
233	7115	99.40	-95.23	2.612	4.17	30	Pass

802.11ax (HE40) SM-MIMO_2T2S

Chan.	Chan. Freq. (MHz)	Field Strength (dBuV/m)	Correction Factor (dB)	EIRP (mW)	EIRP (dBm)	EIRP Limit (dBm)	Test Result
35	6125	116.30	-95.23	127.938	21.07	30	Pass
59	6245	116.30	-95.23	127.938	21.07	30	Pass
91	6405	116.00	-95.23	119.399	20.77	30	Pass
99	6445	116.10	-95.23	122.18	20.87	30	Pass
107	6485	116.20	-95.23	125.026	20.97	30	Pass
115	6525	116.20	-95.23	125.026	20.97	30	Pass
123	6565	116.10	-95.23	122.18	20.87	30	Pass
155	6725	116.00	-95.23	119.399	20.77	30	Pass
179	6845	116.00	-95.23	119.399	20.77	30	Pass
187	6885	115.90	-95.23	116.681	20.67	30	Pass
211	7005	115.90	-95.23	116.681	20.67	30	Pass
227	7085	116.30	-95.23	127.938	21.07	30	Pass



802.11ax (HE80) SM-MIMO_2T2S

Chan.	Chan. Freq. (MHz)	Field Strength (dBuV/m)	Correction Factor (dB)	EIRP (mW)	EIRP (dBm)	EIRP Limit (dBm)	Test Result
39	6145	119.40	-95.23	261.216	24.17	30	Pass
55	6225	119.20	-95.23	249.459	23.97	30	Pass
87	6385	119.30	-95.23	255.27	24.07	30	Pass
103	6465	119.40	-95.23	261.216	24.17	30	Pass
119	6545	119.40	-95.23	261.216	24.17	30	Pass
151	6705	119.30	-95.23	255.27	24.07	30	Pass
183	6865	119.20	-95.23	249.459	23.97	30	Pass
199	6945	119.20	-95.23	249.459	23.97	30	Pass
215	7025	119.30	-95.23	255.27	24.07	30	Pass

802.11ax (HE160) SM-MIMO_2T2S

Chan.	Chan. Freq. (MHz)	Field Strength (dBuV/m)	Correction Factor (dB)	EIRP (mW)	EIRP (dBm)	EIRP Limit (dBm)	Test Result
47	6185	121.90	-95.23	464.515	26.67	30	Pass
79	6345	122.10	-95.23	486.407	26.87	30	Pass
111	6505	122.10	-95.23	486.407	26.87	30	Pass
143	6665	122.00	-95.23	475.335	26.77	30	Pass
175	6825	122.00	-95.23	475.335	26.77	30	Pass
207	6985	122.20	-95.23	497.737	26.97	30	Pass

Spectrum Plot of Worst Value

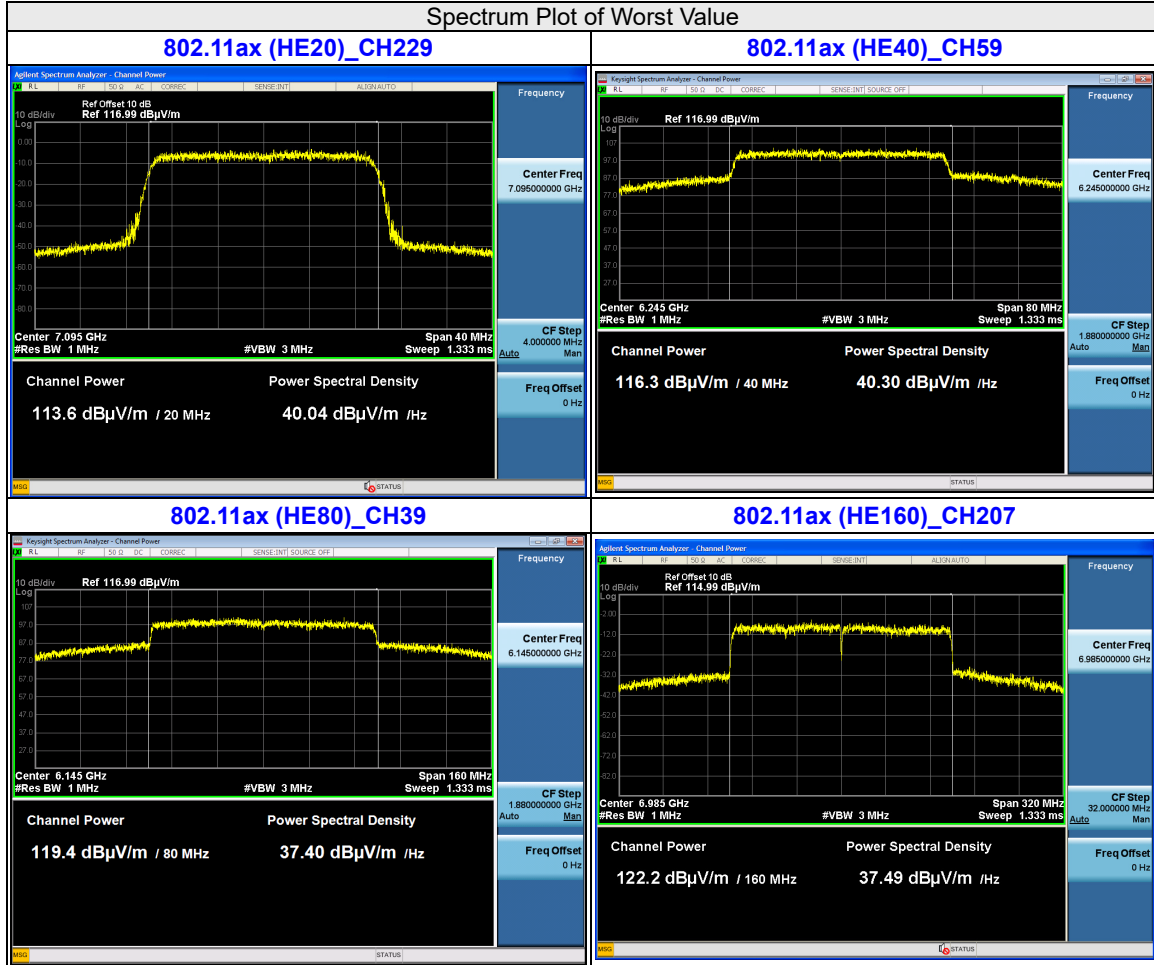

802.11ax (HE20) Beamforming_2T2S

Chan.	Chan. Freq. (MHz)	Field Strength (dBuV/m)	Correction Factor (dB)	EIRP (mW)	EIRP (dBm)	EIRP Limit (dBm)	Test Result
33	6115	113.20	-95.23	62.661	17.97	30	Pass
61	6255	113.00	-95.23	59.841	17.77	30	Pass
93	6415	113.20	-95.23	62.661	17.97	30	Pass
97	6435	113.40	-95.23	65.615	18.17	30	Pass
105	6475	113.40	-95.23	65.615	18.17	30	Pass
113	6515	113.40	-95.23	65.615	18.17	30	Pass
117	6535	113.20	-95.23	62.661	17.97	30	Pass
149	6695	113.30	-95.23	64.121	18.07	30	Pass
181	6855	113.20	-95.23	62.661	17.97	30	Pass
185	6875	113.20	-95.23	62.661	17.97	30	Pass
209	6995	113.10	-95.23	61.235	17.87	30	Pass
229	7095	113.50	-95.23	67.143	18.27	30	Pass
233	7115	99.30	-95.23	2.553	4.07	30	Pass

802.11ax (HE40) Beamforming_2T2S

Chan.	Chan. Freq. (MHz)	Field Strength (dBuV/m)	Correction Factor (dB)	EIRP (mW)	EIRP (dBm)	EIRP Limit (dBm)	Test Result
35	6125	116.10	-95.23	122.18	20.87	30	Pass
59	6245	116.10	-95.23	122.18	20.87	30	Pass
91	6405	115.90	-95.23	116.681	20.67	30	Pass
99	6445	116.00	-95.23	119.399	20.77	30	Pass
107	6485	116.00	-95.23	119.399	20.77	30	Pass
115	6525	116.10	-95.23	122.18	20.87	30	Pass
123	6565	116.00	-95.23	119.399	20.77	30	Pass
155	6725	115.90	-95.23	116.681	20.67	30	Pass
179	6845	115.90	-95.23	116.681	20.67	30	Pass
187	6885	115.80	-95.23	114.025	20.57	30	Pass
211	7005	115.80	-95.23	114.025	20.57	30	Pass
227	7085	116.20	-95.23	125.026	20.97	30	Pass

802.11ax (HE80) Beamforming_2T2S

Chan.	Chan. Freq. (MHz)	Field Strength (dBuV/m)	Correction Factor (dB)	EIRP (mW)	EIRP (dBm)	EIRP Limit (dBm)	Test Result
39	6145	119.20	-95.23	249.459	23.97	30	Pass
55	6225	119.10	-95.23	243.781	23.87	30	Pass
87	6385	119.20	-95.23	249.459	23.97	30	Pass
103	6465	119.30	-95.23	255.27	24.07	30	Pass
119	6545	119.30	-95.23	255.27	24.07	30	Pass
151	6705	119.20	-95.23	249.459	23.97	30	Pass
183	6865	119.10	-95.23	243.781	23.87	30	Pass
199	6945	119.10	-95.23	243.781	23.87	30	Pass
215	7025	119.20	-95.23	249.459	23.97	30	Pass

802.11ax (HE160) Beamforming_2T2S

Chan.	Chan. Freq. (MHz)	Field Strength (dBuV/m)	Correction Factor (dB)	EIRP (mW)	EIRP (dBm)	EIRP Limit (dBm)	Test Result
47	6185	121.80	-95.23	453.942	26.57	30	Pass
79	6345	122.00	-95.23	475.335	26.77	30	Pass
111	6505	122.00	-95.23	475.335	26.77	30	Pass
143	6665	121.90	-95.23	464.515	26.67	30	Pass
175	6825	121.90	-95.23	464.515	26.67	30	Pass
207	6985	122.00	-95.23	475.335	26.77	30	Pass

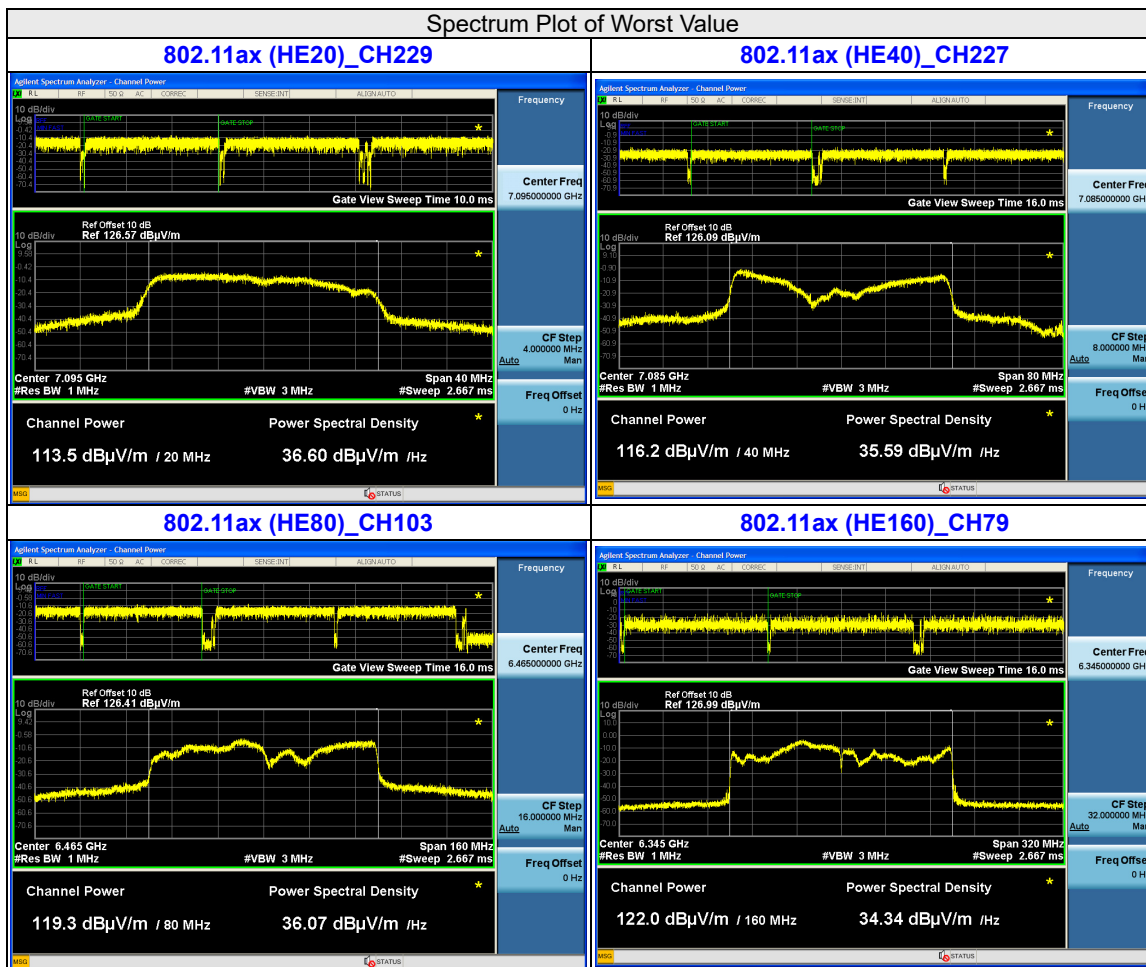

7.2 Power Spectral Density

Input Power:	120 Vac, 60 Hz	Environmental Conditions:	25°C, 60% RH	Tested By:	John Peng
--------------	----------------	---------------------------	--------------	------------	-----------

802.11a CDD

Chan.	Chan. Freq. (MHz)	Field Strength (dBuV/m)	Correction Factor (dB)	EIRP PSD (dBm/MHz)	EIRP PSD Limit (dBm/MHz)	Test Result
33	6115	100.12	-95.23	4.89	5	Pass
61	6255	100.13	-95.23	4.90	5	Pass
93	6415	100.13	-95.23	4.90	5	Pass
97	6435	100.16	-95.23	4.93	5	Pass
105	6475	100.14	-95.23	4.91	5	Pass
113	6515	100.12	-95.23	4.89	5	Pass
117	6535	100.15	-95.23	4.92	5	Pass
149	6695	100.14	-95.23	4.91	5	Pass
181	6855	100.16	-95.23	4.93	5	Pass
185	6875	100.13	-95.23	4.90	5	Pass
209	6995	100.16	-95.23	4.93	5	Pass
233	7115	100.16	-95.23	4.93	5	Pass

802.11ax (HE20) CDD

Chan.	Chan. Freq. (MHz)	Field Strength (dBuV/m)	Correction Factor (dB)	EIRP PSD (dBm/MHz)	EIRP PSD Limit (dBm/MHz)	Test Result
33	6115	100.12	-95.23	4.89	5	Pass
61	6255	100.06	-95.23	4.83	5	Pass
93	6415	100.11	-95.23	4.88	5	Pass
97	6435	100.12	-95.23	4.89	5	Pass
105	6475	100.15	-95.23	4.92	5	Pass
113	6515	100.14	-95.23	4.91	5	Pass
117	6535	100.05	-95.23	4.82	5	Pass
149	6695	100.09	-95.23	4.86	5	Pass
181	6855	100.15	-95.23	4.91	5	Pass
185	6875	100.12	-95.23	4.89	5	Pass
209	6995	100.05	-95.23	4.82	5	Pass
229	7095	100.16	-95.23	4.93	5	Pass
233	7115	87.63	-95.23	-7.60	5	Pass

802.11ax (HE40) CDD

Chan.	Chan. Freq. (MHz)	Field Strength (dBuV/m)	Correction Factor (dB)	EIRP PSD (dBm/MHz)	EIRP PSD Limit (dBm/MHz)	Test Result
35	6125	100.13	-95.23	4.90	5	Pass
59	6245	100.08	-95.23	4.85	5	Pass
91	6405	100.11	-95.23	4.88	5	Pass
99	6445	100.06	-95.23	4.83	5	Pass
107	6485	100.13	-95.23	4.90	5	Pass
115	6525	100.01	-95.23	4.78	5	Pass
123	6565	100.07	-95.23	4.84	5	Pass
155	6725	100.05	-95.23	4.82	5	Pass
179	6845	100.12	-95.23	4.89	5	Pass
187	6885	100.14	-95.23	4.91	5	Pass
211	7005	100.06	-95.23	4.83	5	Pass
227	7085	100.13	-95.23	4.90	5	Pass

802.11ax (HE80) CDD

Chan.	Chan. Freq. (MHz)	Field Strength (dBuV/m)	Correction Factor (dB)	EIRP PSD (dBm/MHz)	EIRP PSD Limit (dBm/MHz)	Test Result
39	6145	100.16	-95.23	4.93	5	Pass
55	6225	100.11	-95.23	4.88	5	Pass
87	6385	100.14	-95.23	4.91	5	Pass
103	6465	100.08	-95.23	4.85	5	Pass
119	6545	100.12	-95.23	4.89	5	Pass
151	6705	100.09	-95.23	4.86	5	Pass
183	6865	100.07	-95.23	4.84	5	Pass
199	6945	100.12	-95.23	4.89	5	Pass
215	7025	100.15	-95.23	4.92	5	Pass

802.11ax (HE160) CDD

Chan.	Chan. Freq. (MHz)	Field Strength (dBuV/m)	Correction Factor (dB)	EIRP PSD (dBm/MHz)	EIRP PSD Limit (dBm/MHz)	Test Result
47	6185	100.11	-95.23	4.88	5	Pass
79	6345	100.13	-95.23	4.90	5	Pass
111	6505	100.15	-95.23	4.92	5	Pass
143	6665	100.08	-95.23	4.85	5	Pass
175	6825	100.19	-95.23	4.96	5	Pass
207	6985	100.20	-95.23	4.97	5	Pass