



# FCC RADIO TEST REPORT

**FCC ID** : PY321100529  
**Equipment** : Netgear 5G MHS Travel Router  
**Brand Name** : Netgear  
**Model Name** : MR6500  
**Applicant** : Netgear Inc  
350 E. Plumeria Drive, San Jose, CA  
95134, United States  
**Manufacturer** : Netgear Inc  
350 E. Plumeria Drive, San Jose, CA  
95134, United States  
**Standard** : FCC 47 CFR Part 2, 22(H), 24(E), 27

The product was received on Oct. 25, 2021 and testing was performed from Oct. 27, 2021 to Dec. 18, 2021. We, Sporton International Inc. EMC & Wireless Communications Laboratory, would like to declare that the tested sample has been evaluated in accordance with the test procedures given in ANSI / TIA-603-E and has been in compliance with the applicable technical standards.

The test results in this report apply exclusively to the tested model / sample. Without written approval of Sporton International Inc. EMC & Wireless Communications Laboratory, the test report shall not be reproduced except in full.

*Louis Wu*

Approved by: Louis Wu

**Sporton International Inc. EMC & Wireless Communications Laboratory**  
No. 52, Huaya 1st Rd., Guishan Dist., Taoyuan City 333, Taiwan (R.O.C.)



## Table of Contents

History of this test report.....	3
Summary of Test Result.....	4
<b>1 General Description .....</b>	<b>6</b>
1.1 Product Feature of Equipment Under Test.....	6
1.2 Modification of EUT .....	6
1.3 Testing Location .....	7
1.4 Applicable Standards.....	7
<b>2 Test Configuration of Equipment Under Test .....</b>	<b>8</b>
2.1 Test Mode.....	8
2.2 Connection Diagram of Test System.....	10
2.3 Support Unit used in test configuration and system .....	10
2.4 Measurement Results Explanation Example.....	10
2.5 Frequency List of Low/Middle/High Channels .....	11
<b>3 Conducted Test Items.....</b>	<b>13</b>
3.1 Measuring Instruments .....	13
3.2 Conducted Output Power and ERP/EIRP .....	14
3.3 Peak-to-Average Ratio .....	15
3.4 Occupied Bandwidth.....	16
3.5 Conducted Band Edge .....	17
3.6 Conducted Spurious Emission .....	19
3.7 Frequency Stability .....	20
<b>4 Radiated Test Items .....</b>	<b>21</b>
4.1 Measuring Instruments .....	21
4.2 Radiated Spurious Emission Measurement .....	23
<b>5 List of Measuring Equipment.....</b>	<b>24</b>
<b>6 Uncertainty of Evaluation.....</b>	<b>26</b>
<b>Appendix A. Test Results of Conducted Test</b>	
<b>Appendix B. Test Results of Radiated Test</b>	
<b>Appendix C. Test Setup Photographs</b>	





## Summary of Test Result

Report Clause	Ref Std. Clause	Test Items	Result (PASS/FAIL)	Remark
3.2	§2.1046	Conducted Output Power	Reporting only	-
	§22.913 (a)(2)	Effective Radiated Power (n5)	Pass	
	§27.50 (c)(10)	Effective Radiated Power (n12)		
	§24.232 (c)	Equivalent Isotropic Radiated Power (n2)		
	§27.50 (d)(4)	Equivalent Isotropic Radiated Power (n66)		
3.3	§24.232 (d) §27.50 (d)(5)	Peak-to-Average Ratio	Pass	-
3.4	§2.1049	Occupied Bandwidth	Reporting only	-
3.5	§2.1051 §22.917 (a) §24.238 (a) §27.53 (g) §27.53 (h)	Conducted Band Edge Measurement (n2) (n5) (n12) (n66)	Pass	-
3.6	§2.1051 §22.917 (a) §24.238 (a) §27.53 (g) §27.53 (h)	Conducted Spurious Emission (n2) (n5) (n12) (n66)	Pass	-
3.7	§2.1055 §22.355 §24.235 §27.54	Frequency Stability Temperature & Voltage	Pass	-



Report Clause	Ref Std. Clause	Test Items	Result (PASS/FAIL)	Remark
4.2	§2.1053 §22.917 (a) §24.238 (a) §27.53 (g) §27.53 (h)	Radiated Spurious Emission (n2) (n5) (n12) (n66)	Pass	Under limit 17.94 dB at 2104.000 MHz

**Declaration of Conformity:**

The test results with all measurement uncertainty excluded are presented in accordance with the regulation limits or requirements declared by manufacturers.

**Comments and Explanations:**

The declared of product specification for EUT presented in the report are provided by the manufacturer, and the manufacturer takes all the responsibilities for the accuracy of product specification.

**Reviewed by: William Chen**

**Report Producer: Celery Wei**



# 1 General Description

## 1.1 Product Feature of Equipment Under Test

LTE/5G NR, Wi-Fi 2.4GHz 802.11b/g/n/ac/ax, Wi-Fi 5GHz 802.11a/n/ac/ax, Wi-Fi 6GHz 802.11a/n/ac/ax, and GNSS

Product Feature	
Antenna Type	WWAN: <Ant. 1>: Monopole Antenna <Ant. 2>: Monopole Antenna WLAN: <Ant. 3>: Monopole Antenna <Ant. 4>: Monopole Antenna GPS: PIFA Antenna

**Remark:** The above EUT's information was declared by manufacturer. Please refer to Comments and Explanations in report summary.

Antenna Information	
Internal Antenna Gain	<Ant. 1>: 5G NR n2: 0.67 dBi 5G NR n5: -0.88 dBi 5G NR n12: -0.83 dBi 5G NR n66: 0.67 dBi <Ant. 2>: 5G NR n2: 0.45 dBi 5G NR n5: -1.60 dBi 5G NR n66: 0.54 dBi
External Antenna Gain	<Ant. 1>: 5G NR n2: 4.00 dBi 5G NR n5: 4.00 dBi 5G NR n12: 4.00 dBi 5G NR n66: 4.00 dBi <Ant. 2>: 5G NR n2: 4.00 dBi 5G NR n5: 4.00 dBi 5G NR n66: 4.00 dBi
External Connector	TS9

**Remark:**

1. TS9 connector is for the external antennas, while the external antennas are connected, RF outputs are switched from internal antenna 1/2 to the external one.
2. The maximum antenna gain allowed for the external antenna is limited by the numbers in the table, and also illustrated in the user manual.

## 1.2 Modification of EUT

No modifications are made to the EUT during all test items.



### 1.3 Testing Location

<b>Test Site</b>	Sporton International Inc. EMC & Wireless Communications Laboratory
<b>Test Site Location</b>	No.52, Huaya 1st Rd., Guishan Dist., Taoyuan City 333, Taiwan (R.O.C.) TEL: +886-3-327-3456 FAX: +886-3-328-4978
<b>Test Site No.</b>	<b>Sporton Site No.</b>
	TH03-HY
<b>Test Engineer</b>	Sherry Wu
<b>Temperature (°C)</b>	22.5~24.5
<b>Relative Humidity (%)</b>	49~61

<b>Test Site</b>	Sporton International Inc. Wensan Laboratory
<b>Test Site Location</b>	No.58, Aly. 75, Ln. 564, Wenhua 3rd, Rd., Guishan Dist., Taoyuan City 333010, Taiwan (R.O.C.) TEL: +886-3-327-0868 FAX: +886-3-327-0855
<b>Test Site No.</b>	<b>Sporton Site No.</b>
	03CH16-HY (TAF Code: 3786)
<b>Test Engineer</b>	Karl Hou and Andy Yang
<b>Temperature (°C)</b>	18~25
<b>Relative Humidity (%)</b>	50~65
<b>Remark</b>	The Radiated Spurious Emission test item subcontracted to Sporton International Inc. Wensan Laboratory

**Note:** The test site complies with ANSI C63.4 2014 requirement.

FCC Designation No.: TW1190 and TW3786

### 1.4 Applicable Standards

According to the specifications of the manufacturer, the EUT must comply with the requirements of the following standards:

- ♦ ANSI C63.26-2015
- ♦ ANSI / TIA-603-E
- ♦ FCC 47 CFR Part 2, 22(H), 24(E), 27
- ♦ FCC KDB 971168 D01 Power Meas. License Digital Systems v03r01
- ♦ FCC KDB 412172 D01 Determining ERP and EIRP v01r01
- ♦ FCC KDB 414788 D01 Radiated Test Site v01r01.

**Remark:**

1. All test items were verified and recorded according to the standards and without any deviation during the test.
2. This EUT has also been tested and complied with the requirements of FCC Part 15, Subpart B, recorded in a separate test report.
3. The TAF code is not including all the FCC KDB listed without accreditation.



## 2 Test Configuration of Equipment Under Test

### 2.1 Test Mode

Antenna port conducted and radiated test items listed below are performed according to KDB 971168 D01 Power Meas. License Digital Systems v03r01 with maximum output power.

For radiated measurement, the measured emission level of the EUT was maximized by rotating the EUT on a turntable, adjusting the orientation of the EUT and EUT antenna in three orthogonal axis (X: flat, Y: portrait, Z: landscape), and adjusting the measurement antenna orientation, following C63.26 exploratory test procedures and find

**(X Plane with Adapter : <Ant. 1>:** 5G NR n5, n12; **<Ant. 2>:** 5G NR n66; **<Ant. 1+2>:** EN-DC 12A\_n5, 5A\_n2, 12A\_n2, 14A\_n2; **<Ant. 2+1>:** EN-DC 66A\_n2, 30A\_n2, 2A\_n66, 30A\_n66, 2A\_n12, 30A\_n12, 66A\_n12

**Y Plane with Adapter : <Ant. 2>:** 5G NR n2; **<Ant. 1+2>:** EN-DC 5A\_n66, 12A\_n66, EN-DC 14A\_n66

**Z Plane with Adapter : <Ant. 2+1>:** EN-DC 2A\_n5, 30A\_n5, 66A\_n5) as worst plane.

Test Items	NR Band	Bandwidth (MHz)							Modulation					RB #			Test Channel		
		5	10	15	20	30	40	50	PI/2 BPSK	QPSK	16QAM	64QAM	256QAM	1	Half	Full	L	M	H
Max. Output Power	n2	v	v	v	v	-	-	-	v	v	v	v	v	v	v	v	v	v	v
	n5	v	v	v	v	-	-	-	v	v	v	v	v	v	v	v	v	v	v
	n12	v	v	v	-	-	-	-	v	v	v	v	v	v	v	v	v	v	v
	n66	v	v	v	v	v	v	-	v	v	v	v	v	v	v	v	v	v	v
Peak-to-Ave rage Ratio	n2				v	-	-	-	v	v	v	v	v			v			v
	n5				v	-	-	-	v	v	v	v	v			v			v
	n12			v	-	-	-	-	v	v	v	v	v			v			v
	n66				v	v	v	-	v	v	v	v	v			v			v
26dB and 99% Bandwidth	n2	v	v	v	v	-	-	-	v	v	v	v	v			v			v
	n5	v	v	v	v	-	-	-	v	v	v	v	v			v			v
	n12	v	v	v	-	-	-	-	v	v	v	v	v			v			v
	n66	v	v	v	v	v	v	-	v	v	v	v	v			v			v
Conducted Band Edge	n2	v	v	v	v	-	-	-	v	v	v	v	v	v		v	v		v
	n5	v	v	v	v	-	-	-	v	v	v	v	v	v		v	v		v
	n12	v	v	v	-	-	-	-	v	v	v	v	v	v		v	v		v
	n66	v	v	v	v	v	v	-	v	v	v	v	v	v		v	v		v
Conducted Spurious Emission	n2	v				-	-	-		v				v			v	v	v
	n5	v				-	-	-		v				v			v	v	v
	n12	v			-	-	-	-		v				v			v	v	v
	n66	v						-		v				v			v	v	v





Test Items	NR Band	Bandwidth (MHz)							Modulation					RB #			Test Channel			
		5	10	15	20	30	40	50	PI/2 BPSK	QPSK	16QAM	64QAM	256QAM	1	Half	Full	L	M	H	
Frequency Stability	n2				v	-	-	-	v								v		v	
	n5				v	-	-	-	v								v		v	
	n12			v	-	-	-	-	v								v		v	
	n66				v			-	v								v		v	
E.R.P / E.I.R.P	n2	v	v	v	v	-	-	-	v	v	v	v	v		Max. Power					
	n5	v	v	v	v	-	-	-	v	v	v	v	v							
	n12	v	v	v	-	-	-	-	v	v	v	v	v							
	n66	v	v	v	v	v	v	-	v	v	v	v	v							
Radiated Spurious Emission	n2	Worst Case														v	v	v		
	n5	Worst Case														v	v	v		
	n12	Worst Case														v	v	v		
	n66	Worst Case														v	v	v		
Remark	<ol style="list-style-type: none"> <li>The mark "v " means that this configuration is chosen for testing</li> <li>The mark "- " means that this bandwidth is not supported.</li> <li>The device is investigated from 30MHz to 10 times of fundamental signal for radiated spurious emission test under different RB size/offset and modulations in exploratory test. Subsequently, only the worst case emissions are reported.</li> <li>Test combination is EN-DC 12A_n5A, 5A_n12A, 12A_n2A, 5A_n66A, 12A_n66A, 14A_n66A, 66A_n2A, 30A_n2A, 2A_n66A, 30A_n66A, 2A_n12A, 30A_n12A, 2A_n66A, 2A_n5A, 30A_n5A, 66A_n5A, 2A_n12A, 30A_n12A, 66A_n12A..</li> <li>For radiated measurement, pre-scanned in two modes, DFT-s OFDM and CP OFDM. The worst cases (DFT-s OFDM) were recorded in this report, the worst modes of FR1 and LTE for simultaneous transmission were verified and compliant.</li> <li>All the radiated test cases were performed with Adapter 1.</li> </ol>																			

## 2.2 Connection Diagram of Test System

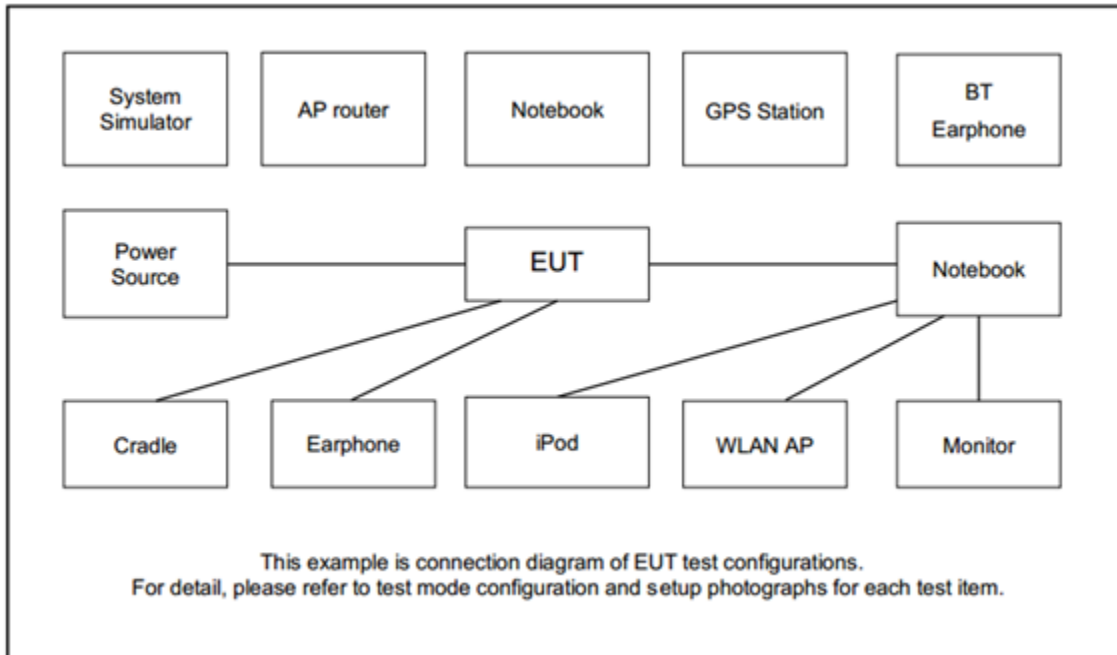

## 2.3 Support Unit used in test configuration and system

Item	Equipment	Trade Name	Model No.	FCC ID	Data Cable	Power Cord
1.	System Simulator	Anritsu	MT8821C	N/A	N/A	Unshielded, 1.8 m
2.	5G Wireless Test Platform	Keysight	MT8000A	N/A	N/A	Unshielded, 1.8m

## 2.4 Measurement Results Explanation Example

### For all conducted test items:

The offset level is set in the spectrum analyzer to compensate the RF cable loss and attenuator factor between EUT conducted output port and spectrum analyzer. With the offset compensation, the spectrum analyzer reading level is exactly the EUT RF output level.

The spectrum analyzer offset is derived from RF cable loss and attenuator factor.

*Offset = RF cable loss + attenuator factor.*

Following shows an offset computation example with cable loss 4.2 dB and 10dB attenuator.

Example :

$$\begin{aligned} \text{Offset(dB)} &= \text{RF cable loss(dB)} + \text{attenuator factor(dB)}. \\ &= 4.2 + 10 = 14.2 \text{ (dB)} \end{aligned}$$



### 2.5 Frequency List of Low/Middle/High Channels

5G NR Band n2 Channel and Frequency List				
BW [MHz]	Channel/Frequency(MHz)	Lowest	Middle	Highest
20	Channel	372000	376000	380000
	Frequency	1860	1880	1900
15	Channel	371500	376000	380500
	Frequency	1857.5	1880	1902.5
10	Channel	371000	376000	381000
	Frequency	1855	1880	1905
5	Channel	370500	376000	381500
	Frequency	1852.5	1880	1907.5

5G NR Band n5 Channel and Frequency List				
BW [MHz]	Channel/Frequency(MHz)	Lowest	Middle	Highest
20	Channel	166800	167300	167800
	Frequency	834	836.5	839
15	Channel	166300	167300	168300
	Frequency	831.5	836.5	841.5
10	Channel	165800	167300	168800
	Frequency	829	836.5	844
5	Channel	165300	167300	169300
	Frequency	826.5	836.5	846.5

5G NR Band n12 Channel and Frequency List				
BW [MHz]	Channel/Frequency(MHz)	Lowest	Middle	Highest
15	Channel	141300	141500	141700
	Frequency	706.5	707.5	708.5
10	Channel	140800	141500	142200
	Frequency	704	707.5	711
5	Channel	140300	141500	142700
	Frequency	701.5	707.5	713.5



5G NR Band n66 Channel and Frequency List				
BW [MHz]	Channel/Frequency(MHz)	Lowest	Middle	Highest
40	Channel	346000	349000	352000
	Frequency	1730	1745	1760
30	Channel	345000	349000	353000
	Frequency	1725	1745	1765
20	Channel	344000	349000	354000
	Frequency	1720	1745	1770
15	Channel	343500	349000	354500
	Frequency	1717.5	1745	1772.5
10	Channel	343000	349000	355000
	Frequency	1715	1745	1775
5	Channel	342500	349000	355500
	Frequency	1712.5	1745	1777.5

### 3 Conducted Test Items

#### 3.1 Measuring Instruments

See list of measuring instruments of this test report.

##### 3.1.1 Test Setup

##### 3.1.2 Conducted Output Power

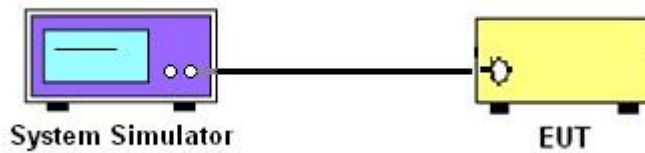

##### 3.1.3 Peak-to-Average Ratio, Occupied Bandwidth ,Conducted Band-Edge and Conducted Spurious Emission

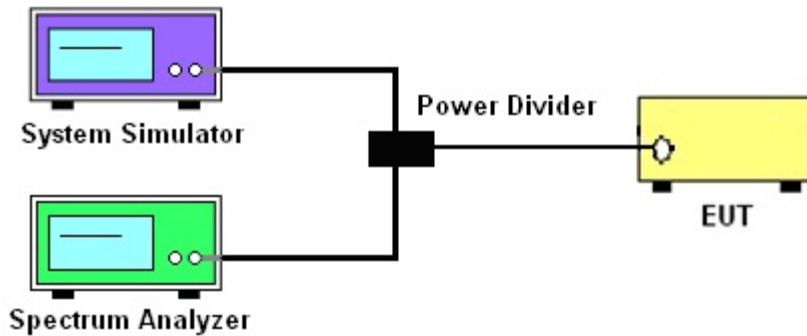

##### 3.1.4 Frequency Stability

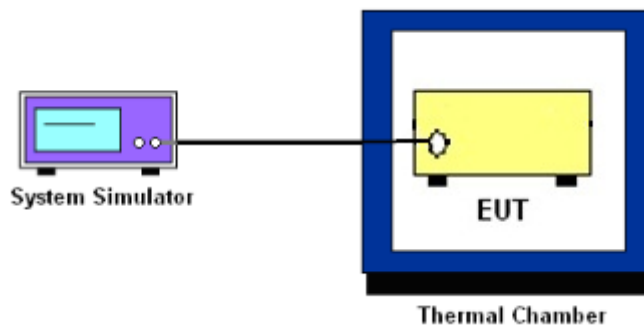

##### 3.1.5 Test Result of Conducted Test

Please refer to Appendix A.



## 3.2 Conducted Output Power and ERP/EIRP

### 3.2.1 Description of the Conducted Output Power Measurement and ERP/EIRP Measurement

A system simulator was used to establish communication with the EUT. Its parameters were set to force the EUT transmitting at maximum output power. The measured power in the radio frequency on the transmitter output terminals shall be reported.

The ERP of mobile transmitters must not exceed 7 Watts for 5G NR n5

The ERP of mobile transmitters must not exceed 3 Watts for 5G NR n12.

The EIRP of mobile transmitters must not exceed 2 Watts for 5G NR n2.

The EIRP of mobile transmitters must not exceed 1 Watts for 5G NR n66

According to KDB 412172 D01 Power Approach,

$EIRP = P_T + G_T - L_C$ ,  $ERP = EIRP - 2.15$ , where

$P_T$  = transmitter output power in dBm

$G_T$  = gain of the transmitting antenna in dBi

$L_C$  = signal attenuation in the connecting cable between the transmitter and antenna in dB

### 3.2.2 Test Procedures

1. The transmitter output port was connected to the system simulator.
2. Set EUT at maximum power through the system simulator.
3. Select lowest, middle, and highest channels for each band and different modulation.
4. Measure and record the power level from the system simulator.



## **3.3 Peak-to-Average Ratio**

### **3.3.1 Description of the PAR Measurement**

Power Complementary Cumulative Distribution Function (CCDF) curves provide a means for characterizing the power peaks of a digitally modulated signal on a statistical basis. A CCDF curve depicts the probability of the peak signal amplitude exceeding the average power level. Most contemporary measurement instrumentation include the capability to produce CCDF curves for an input signal provided that the instrument's resolution bandwidth can be set wide enough to accommodate the entire input signal bandwidth. In measuring transmissions in this band using an average power technique, the peak-to-average ratio (PAR) of the transmission may not exceed 13 dB.

### **3.3.2 Test Procedures**

The testing follows ANSI C63.26-2015 Section 5.2.6

1. The EUT was connected to spectrum and system simulator via a power divider.
2. Set the CCDF (Complementary Cumulative Distribution Function) option in spectrum analyzer.
3. The highest RF powers were measured and recorded the maximum PAPR level associated with a probability of 0.1 %.
4. Record the deviation as Peak to Average Ratio.



## **3.4 Occupied Bandwidth**

### **3.4.1 Description of Occupied Bandwidth Measurement**

The occupied bandwidth is the width of a frequency band such that, below the lower and above the upper frequency limits, the mean powers emitted are each equal to a specified percentage 0.5% of the total mean transmitted power.

The 26 dB emission bandwidth is defined as the frequency range between two points, one above and one below the carrier frequency, at which the spectral density of the emission is attenuated 26 dB below the maximum in-band spectral density of the modulated signal. Spectral density (power per unit bandwidth) is to be measured with a detector of resolution bandwidth equal to approximately 1.0% of the emission bandwidth.

### **3.4.2 Test Procedures**

The testing follows ANSI C63.26-2015 Section 5.4.3 (26dB) and Section 5.4.4 (99OB)

1. The EUT was connected to spectrum analyzer and system simulator via a power divider.
2. The spectrum analyzer center frequency is set to the nominal EUT channel center frequency. The span range for the spectrum analyzer shall be between two and five times the anticipated OBW.
3. The nominal resolution bandwidth (RBW) shall be in the range of 1 to 5 % of the anticipated OBW, and the VBW shall be at least 3 times the RBW.
4. Set the detection mode to peak, and the trace mode to max hold.
5. Determine the reference value: Set the EUT to transmit a modulated signal. Allow the trace to stabilize. Set the spectrum analyzer marker to the highest level of the displayed trace.  
(this is the reference value)
6. Determine the “-26 dB down amplitude” as equal to (Reference Value – X).
7. Place two markers, one at the lowest and the other at the highest frequency of the envelope of the spectral display such that each marker is at or slightly below the “-X dB down amplitude” determined in step 6. If a marker is below this “-X dB down amplitude” value it shall be placed as close as possible to this value. The OBW is the positive frequency difference between the two markers.
8. Use the 99 % power bandwidth function of the spectrum analyzer and report the measured bandwidth.





### 3.5 Conducted Band Edge

#### 3.5.1 Description of Conducted Band Edge Measurement

22.917(a)

For operations in the 824 – 849 MHz band, the FCC limit is  $43 + 10\log_{10}(P[\text{Watts}])$  dB below the transmitter power  $P(\text{Watts})$  in a 100kHz bandwidth. However, in the 1MHz bands immediately outside and adjacent to the licensee's frequency block, a resolution bandwidth of at least one percent of the emission bandwidth of the fundamental emission of the transmitter may be employed.

24.238 (a)

For operations in the 1850-1910 and 1930-1990 MHz band, the FCC limit is  $43 + 10\log_{10}(P[\text{Watts}])$  dB below the transmitter power  $P(\text{Watts})$  in a 1MHz bandwidth. However, in the 1 MHz bands immediately outside and adjacent to the frequency block a resolution bandwidth of at least one percent of the emission bandwidth of the fundamental emission of the transmitter may be employed.

27.53 (g)

For operations in the 600MHz band and 698-746 MHz band, the FCC limit is  $43 + 10\log_{10}(P[\text{Watts}])$  dB below the transmitter power  $P(\text{Watts})$  in a 100 kHz bandwidth. However, in the 100 kilohertz bands immediately outside and adjacent to a licensee's frequency block, a resolution bandwidth of at least 30 kHz may be employed.

27.53 (h)

For operations in the 1710 – 1755 MHz band, 1755-1780 MHz, the FCC limit is  $43 + 10\log_{10}(P[\text{Watts}])$  dB below the transmitter power  $P(\text{Watts})$  in a 1 MHz bandwidth. However, in the 1MHz bands immediately outside and adjacent to the licensee's frequency block, a resolution bandwidth of at least one percent of the emission bandwidth of the fundamental emission of the transmitter may be employed.



### **3.5.2 Test Procedures**

The testing follows FCC KDB 971168 D01 v03r01 Section 6.1.

1. The EUT was connected to spectrum analyzer and system simulator via a power divider.
2. The band edges of low and high channels for the highest RF powers were measured.
3. Set RBW  $\geq$  1% EBW in the 1MHz band immediately outside and adjacent to the band edge.
4. Beyond the 1 MHz band from the band edge, RBW=1MHz was used.
5. Set spectrum analyzer with RMS detector.
6. The RF fundamental frequency should be excluded against the limit line in the operating frequency band.
7. Checked that all the results comply with the emission limit line.

The limit line is derived from  $43 + 10\log(P)$ dB below the transmitter power P(Watts)

For 5G NR n7

The other 40 dB, and 55 dB have additionally applied same calculation above.



## 3.6 Conducted Spurious Emission

### 3.6.1 Description of Conducted Spurious Emission Measurement

The power of any emission outside of the authorized operating frequency ranges must be lower than the transmitter power (P) by a factor of at least  $43 + 10 \log (P)$  dB.

### 3.6.2 Test Procedures

The testing follows FCC KDB 971168 D01 v03r01 Section 6.1.

1. The EUT was connected to spectrum analyzer and system simulator via a power divider.
2. The RF output of EUT was connected to the spectrum analyzer by RF cable and attenuator. The path loss was compensated to the results for each measurement.
3. The middle channel for the highest RF power within the transmitting frequency was measured.
4. The conducted spurious emission for the whole frequency range was taken.
5. Make the measurement with the spectrum analyzer's RBW = 1MHz, VBW = 3MHz.
6. Set spectrum analyzer with RMS detector.
7. Taking the record of maximum spurious emission.
8. The RF fundamental frequency should be excluded against the limit line in the operating frequency band.
9. The limit line is derived from  $43 + 10\log(P)$ dB below the transmitter power P(Watts)  
For 5G NR n7, n38, n41  
The limit line is derived from  $55 + 10\log(P)$ dB below the transmitter power P(Watts)



### 3.7 Frequency Stability

#### 3.7.1 Description of Frequency Stability Measurement

22.355

The frequency stability shall be measured by variation of ambient temperature and variation of primary supply voltage to ensure that the fundamental emission stays within the authorized frequency block. The frequency stability of the transmitter shall be maintained within  $\pm 0.00025\%$  ( $\pm 2.5\text{ppm}$ ) of the center frequency.

24.235 & 27.54

The frequency stability shall be sufficient to ensure that the fundamental emission stays within the authorized frequency block.

#### 3.7.2 Test Procedures for Temperature Variation

The testing follows FCC KDB 971168 D01 v03r01 Section 9.0.

1. The EUT was set up in the thermal chamber and connected with the system simulator.
2. With power OFF, the temperature was decreased to  $-30^{\circ}\text{C}$  and the EUT was stabilized before testing. Power was applied and the maximum change in frequency was recorded within one minute.
3. With power OFF, the temperature was raised in  $10^{\circ}\text{C}$  step up to  $50^{\circ}\text{C}$ . The EUT was stabilized at each step for at least half an hour. Power was applied and the maximum frequency change was recorded within one minute.

#### 3.7.3 Test Procedures for Voltage Variation

The testing follows FCC KDB 971168 D01 v03r01 Section 9.0.

1. The EUT was placed in a temperature chamber at  $20\pm 5^{\circ}\text{C}$  and connected with the system simulator.
2. The power supply voltage to the EUT was varied from 85% to 115% of the nominal value measured at the input to the EUT.
3. The variation in frequency was measured for the worst case.

## 4 Radiated Test Items

### 4.1 Measuring Instruments

See list of measuring instruments of this test report.

#### 4.1.1 Test Setup

For radiated emissions below 30MHz

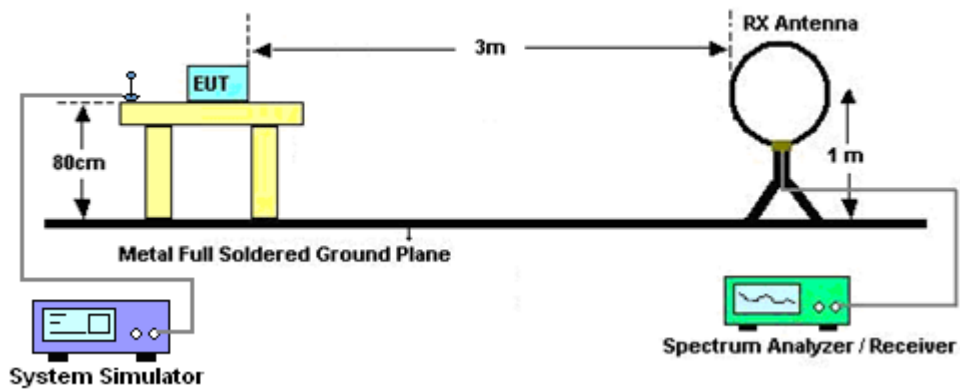

For radiated test from 30MHz to 1GHz

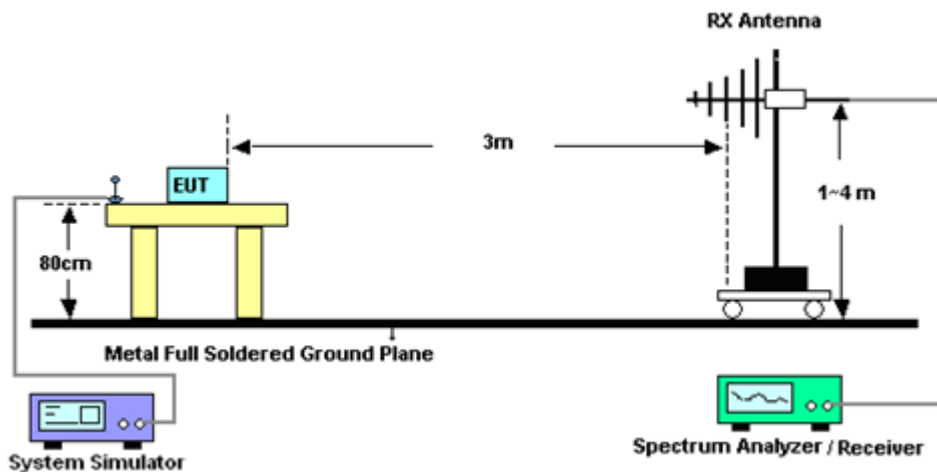

For radiated test from 1GHz to 18GHz

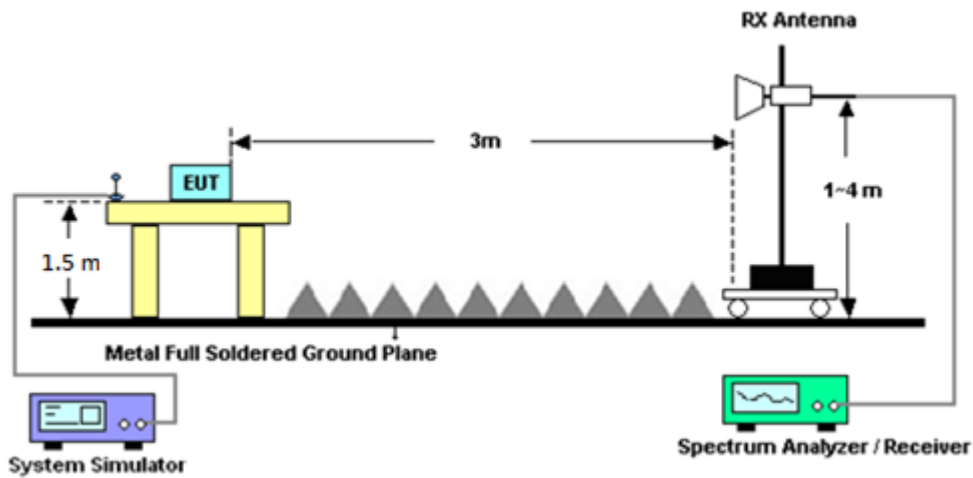

For radiated test above 18GHz

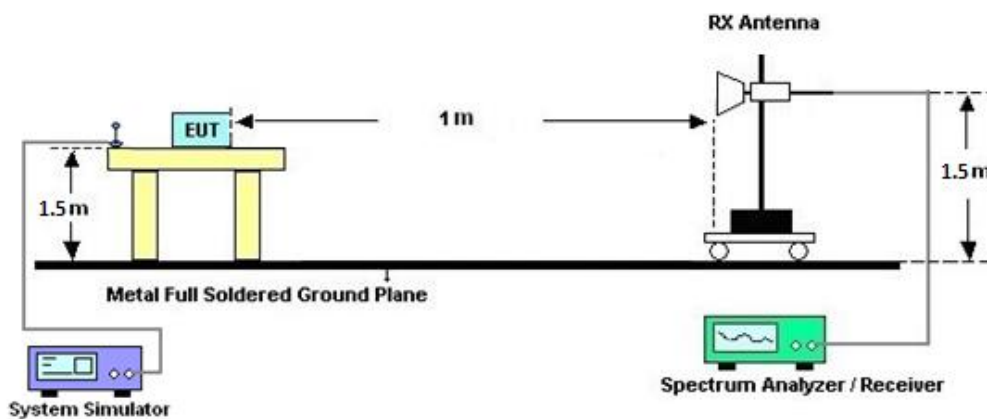

### 4.1.2 Test Result of Radiated Test

Please refer to Appendix B.

**Note:**

The low frequency, which started from 9 kHz to 30MHz, was pre-scanned and the result which was 20dB lower than the limit line was not reported.

There is adequate comparison measurement of both open-field test site and alternative test site - semi-Anechoic chamber according to 414788 D01 Radiated Test Site v01r01, and the result came out very similar.



## 4.2 Radiated Spurious Emission Measurement

### 4.2.1 Description of Radiated Spurious Emission Measurement

The radiated spurious emission was measured by substitution method according to ANSI / TIA-603-E. The power of any emission outside of the authorized operating frequency ranges must be attenuated below the transmitter power (P) by a factor of at least  $43 + 10 \log (P)$  dB.

### 4.2.2 Test Procedures

The testing follows FCC KDB 971168 D01 v03r01 Section 7 and ANSI / TIA-603-E Section 2.2.12.

1. The EUT was placed on a turntable with 0.8 meter for frequency below 1GHz and 1.5 meter for frequency above 1GHz respectively above ground.
2. The EUT was set 3 meters from the receiving antenna, which was mounted on the antenna tower.
3. The table was rotated 360 degrees to determine the position of the highest spurious emission.
4. The height of the receiving antenna is varied between one meter and four meters to search the maximum spurious emission for both horizontal and vertical polarizations.
5. Make the measurement with the spectrum analyzer's RBW = 1MHz, VBW = 3MHz, taking the record of maximum spurious emission.
6. A horn antenna was substituted in place of the EUT and was driven by a signal generator.
7. Tune the output power of signal generator to the same emission level with EUT maximum spurious emission.
8. Taking the record of output power at antenna port.
9. Repeat step 7 to step 8 for another polarization.
10. The RF fundamental frequency should be excluded against the limit line in the operating frequency band.

The limit line is derived from  $43 + 10\log(P)$ dB below the transmitter power P(Watts)



## 5 List of Measuring Equipment

Instrument	Brand Name	Model No.	Serial No.	Characteristics	Calibration Date	Test Date	Due Date	Remark
Loop Antenna	Rohde & Schwarz	HFH2-Z2	100488	9 kHz~30 MHz	Sep. 07, 2021	Oct. 29, 2021~ Dec. 18, 2021	Sep. 06, 2022	Radiation (03CH16-HY)
SHF-EHF Horn Antenna	SCHWARZBECK	BBHA9170	00991	18GHz~40GHz	May 12, 2021	Oct. 29, 2021~ Dec. 03, 2021	May 11, 2022	Radiation (03CH16-HY)
SHF-EHF Horn Antenna	SCHWARZBECK	BBHA9170	BBHA91705 76	18GHz~40GHz	May 21, 2021	Oct. 29, 2021~ Dec. 03, 2021	May 20, 2022	Radiation (03CH16-HY)
Spectrum Analyzer	Keysight	N9010A	MY54200486	10Hz~44GHz	Oct. 15, 2021	Oct. 29, 2021~ Dec. 18, 2021	Oct. 14, 2022	Radiation (03CH16-HY)
Preamplifier	EMEC	EM18G40G	060801	18GHz~40GHz	Jun. 22, 2021	Oct. 29, 2021~ Dec. 18, 2021	Jun. 21, 2022	Radiation (03CH16-HY)
RF Cable	HUBER + SUHNER	SUCOFLEX 102	804011/2,80 4012/2	18-40G	Jan. 04, 2021	Oct. 29, 2021~ Dec. 18, 2021	Jan. 03, 2022	Radiation (03CH16-HY)
Signal Generator	Agilent	MG3694C	163401	0.1Hz~40GHz	Jan. 31, 2021	Oct. 29, 2021~ Dec. 18, 2021	Jan. 30, 2022	Radiation (03CH16-HY)
Bilog Antenna	TESEQ	CBL 6111D & 00800N1D01N -06	41912 & 05	30MHz to 1GHz	Feb. 08, 2021	Oct. 29, 2021~ Dec. 18, 2021	Feb. 07, 2022	Radiation (03CH16-HY)
Bilog Antenna	TESEQ	CBL 6111D & 00802N1D01N -06	47020 & 06	30MHz to 1GHz	Oct. 09, 2021	Oct. 29, 2021~ Dec. 18, 2021	Oct. 08, 2022	Radiation (03CH16-HY)
Horn Antenna	SCHWARZBECK	BBHA 9120 D	9120D-1522	1G~18GHz	Oct. 12, 2021	Oct. 29, 2021~ Dec. 18, 2021	Oct. 11, 2022	Radiation (03CH16-HY)
Horn Antenna	SCHWARZBECK	BBHA 9120 D	9120D-1212	1G~18GHz	May 18, 2021	Oct. 29, 2021~ Dec. 18, 2021	May 18, 2022	Radiation (03CH16-HY)
Amplifier	SONOMA	310N	371607	9kHz~1G	Jul. 05, 2021	Oct. 29, 2021~ Dec. 18, 2021	Jul. 04, 2022	Radiation (03CH16-HY)
Amplifier	EMCI	EMC051845S E	980729	1-18GHz	Jul. 09, 2021	Dec. 17, 2021~ Dec. 18, 2021	Jul. 08, 2022	Radiation (03CH16-HY)
Amplifier	Jet-Power	JPA0118-55-30 3	1710001800 054001	1-18GHz	Jun. 16, 2021	Oct. 29, 2021~ Dec. 03, 2021	Jun. 15, 2022	Radiation (03CH16-HY)
Preamplifier	Keysight	83017A	MY53270264	1GHz~26.5GHz	Dec. 10, 2020	Oct. 29, 2021~ Dec. 03, 2021	Dec. 09, 2021	Radiation (03CH16-HY)
Preamplifier	Keysight	83017A	MY53270264	1GHz~26.5GHz	Dec. 09, 2021	Dec. 17, 2021~ Dec. 18, 2021	Dec. 08, 2022	Radiation (03CH16-HY)
EMI Test Receiver	Keysight	N9038A	MY57290111	3Hz~26.5GHz	Dec.11, 2020	Oct. 29, 2021~ Dec. 03, 2021	Dec. 10, 2021	Radiation (03CH16-HY)
EMI Test Receiver	Keysight	N9038A	MY59053012	3Hz~26.5GHz	Nov. 18, 2021	Dec. 17, 2021~ Dec. 18, 2021	Nov. 17, 2022	Radiation (03CH16-HY)
RF Cable	HUBER + SUHNER	SUCOFLEX 104	MY11680/4P E	NA	Aug. 28, 2021	Oct. 29, 2021~ Dec. 18, 2021	Aug. 27, 2022	Radiation (03CH16-HY)
RF Cable	HUBER + SUHNER	SUCOFLEX 104	MY11688/4P E	NA	Aug. 28, 2021	Oct. 29, 2021~ Dec. 18, 2021	Aug. 27, 2022	Radiation (03CH16-HY)
RF Cable	HUBER + SUHNER	SUCOFLEX 102	EC-A5-300-5 757	NA	Aug. 28, 2021	Oct. 29, 2021~ Dec. 18, 2021	Aug. 27, 2022	Radiation (03CH16-HY)
Software	Audix	E3 6.2009-8-24	RK-001136	N/A	N/A	Oct. 29, 2021~ Dec. 18, 2021	N/A	Radiation (03CH16-HY)
Controller	ChainTek	3000-1	N/A	Control Turn table & Ant Mast	N/A	Oct. 29, 2021~ Dec. 18, 2021	N/A	Radiation (03CH16-HY)
Antenna Mast	ChainTek	MBS-520-1	N/A	1m~4m	N/A	Oct. 29, 2021~ Dec. 18, 2021	N/A	Radiation (03CH16-HY)
Turn Table	ChainTek	T-200-S-1	N/A	0~360 Degree	N/A	Oct. 29, 2021~ Dec. 18, 2021	N/A	Radiation (03CH16-HY)





Instrument	Brand Name	Model No.	Serial No.	Characteristics	Calibration Date	Test Date	Due Date	Remark
Programmable Power Supply	GW Instek	PSS-2005	EL890001	50Hz~60Hz	Oct. 06, 2021	Oct. 27, 2021~ Nov. 30, 2021	Oct. 05, 2022	Conducted (TH03-HY)
Signal Analyzer	Rohde & Schwarz	FSV3044	101048	10Hz~44GHz	Apr. 20, 2021	Oct. 27, 2021~ Nov. 30, 2021	Apr. 19, 2022	Conducted (TH03-HY)
Thermal Chamber	ESPEC	SH-641	92013720	-40°C ~90°C	Sep. 09, 2021	Oct. 27, 2021~ Nov. 30, 2021	Sep. 08, 2022	Conducted (TH03-HY)
Hygrometer	Testo	608-H11	3489324	NA	Mar. 01, 2021	Oct. 27, 2021~ Nov. 30, 2021	Feb. 28, 2022	Conducted (TH03-HY)
Base Station (Measure)	Anritsu	MT8821C	6261849015	LTE	Oct. 06, 2021	Oct. 27, 2021~ Nov. 30, 2021	Oct. 05, 2022	Conducted (TH03-HY)
Base Station (Measure)	Anritsu	MT8000A	6262012917	FR1	Jan. 07, 2021	Oct. 27, 2021~ Nov. 30, 2021	Jan. 06, 2022	Conducted (TH03-HY)



## 6 Uncertainty of Evaluation

### Uncertainty of Radiated Emission Measurement (30 MHz ~ 1000 MHz)

Measuring Uncertainty for a Level of Confidence of 95% ( $U = 2Uc(y)$ )	2.86 dB
-------------------------------------------------------------------------	---------

### Uncertainty of Radiated Emission Measurement (1 GHz ~ 18 GHz)

Measuring Uncertainty for a Level of Confidence of 95% ( $U = 2Uc(y)$ )	3.68 dB
-------------------------------------------------------------------------	---------

### Uncertainty of Radiated Emission Measurement (18 GHz ~ 40 GHz)

Measuring Uncertainty for a Level of Confidence of 95% ( $U = 2Uc(y)$ )	4.00 dB
-------------------------------------------------------------------------	---------



## Appendix A. Test Results of Conducted Test

### Conducted Output Power(Average power) and ERP/EIRP

<Ant. 1>

NR n2 Maximum Average Power [dBm] (GT - LC = 4 dB)								
BW [MHz]	RB Size	RB Offset	Mod	Lowest	Middle	Highest	EIRP (dBm)	EIRP(W)
5	1	1	PI/2 BPSK	23.27	23.41	23.65	27.75	0.5957
5	1	23		23.15	23.75	23.44		
5	12	6		23.24	23.41	23.54		
5	1	0		22.60	22.87	22.84		
5	1	24		22.78	22.96	23.02		
5	25	0		22.87	23.18	22.81		
5	1	1	QPSK	23.33	23.29	23.52		
5	1	23		23.26	23.65	23.47		
5	12	6		23.29	23.64	23.56		
5	1	0		22.22	22.69	22.51		
5	1	24		22.14	22.66	22.29		
5	25	0		22.09	22.55	22.72		
5	1	1	16-QAM	22.52	22.24	22.60	26.60	0.4571
5	1	1	64-QAM	20.31	21.11	21.30		
5	1	1	256-QAM	18.23	18.28	18.64		
Limit	EIRP < 2W			Result			Pass	

NR n2 Maximum Average Power [dBm] (GT - LC = 4 dB)								
BW [MHz]	RB Size	RB Offset	Mod	Lowest	Middle	Highest	EIRP (dBm)	EIRP(W)
10	1	1	PI/2 BPSK	23.44	23.52	23.53	27.77	0.5984
10	1	50		23.24	23.47	23.45		
10	25	12		23.26	23.59	23.52		
10	1	0		22.52	22.95	23.13		
10	1	51		22.73	22.98	22.95		
10	50	0		22.60	23.14	23.01		
10	1	1	QPSK	23.23	23.48	23.46		
10	1	50		23.38	23.45	23.48		
10	25	12		23.35	23.77	23.56		
10	1	0		22.36	22.45	22.36		
10	1	51		22.20	22.53	22.63		
10	50	0		22.27	22.55	22.64		
10	1	1	16-QAM	22.74	22.45	22.65	26.74	0.4721
10	1	1	64-QAM	20.35	21.42	21.09		
10	1	1	256-QAM	18.23	18.41	18.37		
Limit	EIRP < 2W			Result			Pass	



NR n2 Maximum Average Power [dBm] (GT - LC = 4 dB)								
BW [MHz]	RB Size	RB Offset	Mod	Lowest	Middle	Highest	EIRP (dBm)	EIRP(W)
15	1	1	PI/2 BPSK	23.40	23.45	23.43	27.77	0.5984
15	1	77		23.06	23.39	23.53		
15	36	18		23.15	23.77	23.40		
15	1	0		22.60	23.05	23.17		
15	1	78		22.74	22.90	22.97		
15	75	0		22.60	23.21	22.92		
15	1	1	QPSK	23.33	23.28	23.34		
15	1	77		23.18	23.51	23.34		
15	36	18		23.40	23.77	23.55		
15	1	0		22.27	22.68	22.42		
15	1	78		22.19	22.66	22.45		
15	75	0		22.17	22.38	22.36		
15	1	1	16-QAM	22.40	22.54	22.59	26.59	0.456
15	1	1	64-QAM	20.23	21.10	21.22		
15	1	1	256-QAM	18.05	18.54	18.30		
Limit	EIRP < 2W			Result			Pass	

NR n2 Maximum Average Power [dBm] (GT - LC = 4 dB)								
BW [MHz]	RB Size	RB Offset	Mod	Lowest	Middle	Highest	EIRP (dBm)	EIRP(W)
20	1	1	PI/2 BPSK	23.26	23.36	23.07	27.71	0.5902
20	1	104		22.85	23.32	23.22		
20	50	25		22.94	23.71	23.24		
20	1	0		22.30	23.05	22.83		
20	1	105		22.73	22.71	22.84		
20	100	0		22.25	23.15	22.58		
20	1	1	QPSK	22.93	23.15	23.16		
20	1	104		23.07	23.19	23.24		
20	50	25		23.32	23.45	23.20		
20	1	0		22.09	22.44	22.11		
20	1	105		22.02	22.66	22.08		
20	100	0		21.79	22.22	22.16		
20	1	1	16-QAM	22.32	22.24	22.45	26.45	0.4416
20	1	1	64-QAM	20.10	20.72	20.88		
20	1	1	256-QAM	18.02	18.49	18.30		
Limit	EIRP < 2W			Result			Pass	



NR n5 Maximum Average Power [dBm] (GT - LC = 4 dB)								
BW [MHz]	RB Size	RB Offset	Mod	Lowest	Middle	Highest	ERP (dBm)	ERP(W)
5	1	1	PI/2 BPSK	23.25	23.26	23.34	25.22	0.3327
5	1	23		23.16	23.28	23.37		
5	12	6		23.13	23.22	23.34		
5	1	0		22.66	22.64	22.78		
5	1	24		22.67	22.65	22.81		
5	25	0		22.65	22.77	22.84		
5	1	1	QPSK	23.17	23.25	23.34		
5	1	23		23.05	23.28	23.37		
5	12	6		23.11	23.20	23.36		
5	1	0		22.12	22.21	22.32		
5	1	24		22.14	22.23	22.31		
5	25	0		22.11	22.21	22.35		
5	1	1	16-QAM	22.22	22.13	22.24	24.09	0.2564
5	1	1	64-QAM	20.72	20.88	20.96		
5	1	1	256-QAM	18.75	18.20	18.34		
Limit	ERP < 7W			Result			Pass	

NR n5 Maximum Average Power [dBm] (GT - LC = 4 dB)								
BW [MHz]	RB Size	RB Offset	Mod	Lowest	Middle	Highest	ERP (dBm)	ERP(W)
10	1	1	PI/2 BPSK	23.15	23.24	23.26	25.16	0.3281
10	1	50		23.19	23.27	23.25		
10	25	12		23.19	23.29	23.28		
10	1	0		22.63	22.58	22.66		
10	1	51		22.59	22.71	22.61		
10	50	0		22.69	22.75	22.78		
10	1	1	QPSK	23.10	23.27	23.14		
10	1	50		23.14	23.31	23.15		
10	25	12		23.19	23.29	23.27		
10	1	0		22.10	22.17	22.11		
10	1	51		22.09	22.17	22.17		
10	50	0		22.18	22.25	22.25		
10	1	1	16-QAM	22.10	22.52	22.19	24.37	0.2735
10	1	1	64-QAM	20.79	20.35	20.52		
10	1	1	256-QAM	18.11	18.16	18.74		
Limit	ERP < 7W			Result			Pass	



NR n5 Maximum Average Power [dBm] (GT - LC = 4 dB)								
BW [MHz]	RB Size	RB Offset	Mod	Lowest	Middle	Highest	ERP (dBm)	ERP(W)
15	1	1	PI/2 BPSK	23.20	23.35	23.32	25.24	0.3342
15	1	77		23.22	23.37	23.31		
15	36	18		23.39	23.32	23.34		
15	1	0		22.63	22.90	22.75		
15	1	78		22.69	22.79	22.75		
15	75	0		22.79	22.84	22.82		
15	1	1	QPSK	23.18	23.22	23.31		
15	1	77		23.19	23.27	23.30		
15	36	18		23.33	23.37	23.36		
15	1	0		22.16	22.26	22.27		
15	1	78		22.12	22.26	22.25		
15	75	0		22.30	22.20	22.34		
15	1	1	16-QAM	22.18	22.40	22.31	24.25	0.2661
15	1	1	64-QAM	20.67	20.82	20.76		
15	1	1	256-QAM	18.79	18.88	18.87		
Limit	ERP < 7W			Result			Pass	

NR n5 Maximum Average Power [dBm] (GT - LC = 4 dB)								
BW [MHz]	RB Size	RB Offset	Mod	Lowest	Middle	Highest	ERP (dBm)	ERP(W)
20	1	1	PI/2 BPSK	23.06	23.18	23.33	25.20	0.3311
20	1	104		23.25	23.16	23.26		
20	50	25		23.34	23.33	23.30		
20	1	0		22.62	22.62	22.65		
20	1	105		22.75	22.66	22.73		
20	100	0		22.78	22.72	22.74		
20	1	1	QPSK	23.07	23.16	23.15		
20	1	104		23.20	23.19	23.25		
20	50	25		23.35	23.30	23.30		
20	1	0		22.02	22.15	22.14		
20	1	105		22.20	22.11	22.30		
20	100	0		22.31	22.26	22.27		
20	1	1	16-QAM	22.14	22.12	22.07	23.99	0.2506
20	1	1	64-QAM	21.23	20.77	20.64		
20	1	1	256-QAM	18.75	18.75	18.77		
Limit	ERP < 7W			Result			Pass	



NR n12 Maximum Average Power [dBm] (GT - LC = 4 dB)										
BW [MHz]	RB Size	RB Offset	Mod	Lowest	Middle	Highest	ERP (dBm)	ERP(W)		
5	1	1	PI/2 BPSK	23.17	23.20	23.13	25.22	0.3327		
5	1	23		23.21	23.21	23.18				
5	12	6		23.25	23.37	23.14				
5	1	0		22.68	22.64	22.65				
5	1	24		22.71	22.70	22.64				
5	25	0		22.74	22.76	22.64				
5	1	1	QPSK	23.14	23.26	23.20			24.09	0.2564
5	1	23		23.16	23.23	23.26				
5	12	6		23.24	23.32	23.14				
5	1	0		22.11	22.14	22.14				
5	1	24		22.12	22.19	22.17				
5	25	0		22.25	22.30	22.14				
5	1	1	16-QAM	22.13	22.15	22.24	24.09	0.2564		
5	1	1	64-QAM	20.69	20.86	20.72				
5	1	1	256-QAM	18.70	18.70	18.66				
Limit	ERP < 3W			Result			Pass			

NR n12 Maximum Average Power [dBm] (GT - LC = 4 dB)										
BW [MHz]	RB Size	RB Offset	Mod	Lowest	Middle	Highest	ERP (dBm)	ERP(W)		
10	1	1	PI/2 BPSK	23.15	23.31	23.31	25.16	0.3281		
10	1	50		23.16	23.17	23.24				
10	25	12		23.18	23.28	23.19				
10	1	0		22.66	22.73	22.81				
10	1	51		22.64	22.65	22.66				
10	50	0		22.67	22.78	22.70				
10	1	1	QPSK	23.15	23.25	23.21			24.15	0.26
10	1	50		23.18	23.14	23.10				
10	25	12		23.18	23.27	23.18				
10	1	0		22.12	22.17	22.22				
10	1	51		22.19	22.10	22.12				
10	50	0		22.20	22.26	22.19				
10	1	1	16-QAM	22.12	22.30	22.25	24.15	0.26		
10	1	1	64-QAM	20.72	20.80	20.80				
10	1	1	256-QAM	18.65	18.72	18.70				
Limit	ERP < 3W			Result			Pass			



NR n12 Maximum Average Power [dBm] (GT - LC = 4 dB)										
BW [MHz]	RB Size	RB Offset	Mod	Lowest	Middle	Highest	ERP (dBm)	ERP(W)		
15	1	1	PI/2 BPSK	23.33	23.32	23.29	25.26	0.3357		
15	1	77		23.24	23.25	23.29				
15	36	18		23.39	23.37	23.30				
15	1	0		22.84	22.86	22.82				
15	1	78		22.76	22.71	22.78				
15	75	0		22.92	22.89	22.85				
15	1	1	QPSK	23.33	23.34	23.40			24.35	0.2723
15	1	77		23.20	23.30	23.26				
15	36	18		23.41	23.40	23.36				
15	1	0		22.30	22.29	22.27				
15	1	78		22.22	22.16	22.23				
15	75	0		22.40	22.40	22.35				
15	1	1	16-QAM	22.50	22.43	22.36	24.35	0.2723		
15	1	1	64-QAM	20.92	20.87	20.85				
15	1	1	256-QAM	19.03	19.00	18.92				
Limit	ERP < 3W			Result			Pass			





NR n66 Maximum Average Power [dBm] (GT - LC = 4 dB)								
BW [MHz]	RB Size	RB Offset	Mod	Lowest	Middle	Highest	EIRP (dBm)	EIRP(W)
5	1	1	PI/2 BPSK	22.69	22.78	23.49	27.60	0.5754
5	1	23		23.33	23.21	23.19		
5	12	6		22.76	23.15	23.19		
5	1	0		22.50	22.35	22.56		
5	1	24		22.50	22.73	22.61		
5	25	0		22.78	22.97	22.90		
5	1	1	QPSK	22.92	22.63	23.35		
5	1	23		22.76	23.28	23.40		
5	12	6		22.84	22.88	23.60		
5	1	0		21.86	21.60	22.17		
5	1	24		21.89	22.29	22.45		
5	25	0		21.90	22.27	22.69		
5	1	1	16-QAM	21.67	22.24	22.10	26.24	0.4207
5	1	1	64-QAM	20.43	20.37	20.73		
5	1	1	256-QAM	18.39	18.52	18.82		
Limit	EIRP < 1W			Result			Pass	

NR n66 Maximum Average Power [dBm] (GT - LC = 4 dB)								
BW [MHz]	RB Size	RB Offset	Mod	Lowest	Middle	Highest	EIRP (dBm)	EIRP(W)
10	1	1	PI/2 BPSK	22.93	22.76	23.36	27.73	0.5929
10	1	50		23.01	23.16	23.27		
10	25	12		22.94	22.91	23.22		
10	1	0		22.44	22.47	22.38		
10	1	51		22.50	22.89	22.68		
10	50	0		22.75	22.94	22.78		
10	1	1	QPSK	22.97	22.95	23.15		
10	1	50		23.13	23.40	23.42		
10	25	12		22.82	22.97	23.73		
10	1	0		21.90	21.47	21.98		
10	1	51		22.03	22.41	22.61		
10	50	0		22.06	21.95	22.65		
10	1	1	16-QAM	21.76	22.04	22.16	26.16	0.4130
10	1	1	64-QAM	20.56	20.35	20.90		
10	1	1	256-QAM	18.23	18.70	18.93		
Limit	EIRP < 1W			Result			Pass	



NR n66 Maximum Average Power [dBm] (GT - LC = 4 dB)								
BW [MHz]	RB Size	RB Offset	Mod	Lowest	Middle	Highest	EIRP (dBm)	EIRP(W)
15	1	1	PI/2 BPSK	22.80	22.98	23.23	27.57	0.5715
15	1	77		23.25	23.05	23.34		
15	36	18		22.91	23.18	23.53		
15	1	0		22.18	22.65	22.42		
15	1	78		22.69	22.76	22.72		
15	75	0		22.62	23.08	22.87		
15	1	1	QPSK	22.92	22.67	23.29		
15	1	77		23.05	23.21	23.17		
15	36	18		23.08	22.98	23.57		
15	1	0		21.77	21.66	22.11		
15	1	78		21.92	22.23	22.56		
15	75	0		21.99	22.29	22.55		
15	1	1	16-QAM	21.58	22.16	22.24	26.24	0.4207
15	1	1	64-QAM	20.33	20.31	20.75		
15	1	1	256-QAM	18.26	18.49	18.96		
Limit	EIRP < 1W			Result			Pass	

NR n66 Maximum Average Power [dBm] (GT - LC = 4 dB)								
BW [MHz]	RB Size	RB Offset	Mod	Lowest	Middle	Highest	EIRP (dBm)	EIRP(W)
20	1	1	PI/2 BPSK	22.71	22.80	23.36	27.54	0.5675
20	1	104		23.27	23.31	23.39		
20	50	25		22.80	23.20	23.43		
20	1	0		22.35	22.36	22.29		
20	1	105		22.69	22.97	22.47		
20	100	0		22.71	22.82	22.85		
20	1	1	QPSK	23.00	22.83	23.47		
20	1	104		23.05	23.35	23.33		
20	50	25		23.02	23.18	23.54		
20	1	0		21.68	21.64	22.07		
20	1	105		22.18	22.49	22.36		
20	100	0		21.99	22.23	22.73		
20	1	1	16-QAM	21.69	22.24	22.33	26.33	0.4295
20	1	1	64-QAM	20.61	20.45	20.73		
20	1	1	256-QAM	18.48	18.64	18.76		
Limit	EIRP < 1W			Result			Pass	



NR n66 Maximum Average Power [dBm] (GT - LC = 4 dB)										
BW [MHz]	RB Size	RB Offset	Mod	Lowest	Middle	Highest	EIRP (dBm)	EIRP(W)		
30	1	1	PI/2 BPSK	23.04	23.12	23.56	27.58	0.5728		
30	1	158		23.35	23.44	23.58				
30	80	40		23.16	23.29	23.55				
30	1	0		22.50	22.72	22.61				
30	1	159		22.79	23.09	22.78				
30	160	0		22.81	23.16	22.97				
30	1	1	QPSK	23.07	22.95	23.50			26.50	0.4467
30	1	158		23.15	23.52	23.50				
30	80	40		23.18	23.28	23.49				
30	1	0		22.00	21.86	22.24				
30	1	159		22.27	22.59	22.67				
30	160	0		22.30	22.33	22.77				
30	1	1	16-QAM	21.97	22.26	22.50	26.50	0.4467		
30	1	1	64-QAM	20.62	20.64	21.12				
30	1	1	256-QAM	18.60	18.75	19.05				
Limit	EIRP < 1W			Result			Pass			

NR n66 Maximum Average Power [dBm] (GT - LC = 4 dB)										
BW [MHz]	RB Size	RB Offset	Mod	Lowest	Middle	Highest	EIRP (dBm)	EIRP(W)		
40	1	1	PI/2 BPSK	22.96	23.35	23.52	27.86	0.6109		
40	1	214		23.27	23.37	23.50				
40	108	54		23.30	23.33	23.86				
40	1	0		22.68	22.58	22.74				
40	1	215		23.00	22.88	23.13				
40	216	0		22.49	22.86	22.84				
40	1	1	QPSK	23.00	22.98	23.48			26.39	0.4355
40	1	214		23.11	23.27	23.50				
40	108	54		23.21	23.16	23.72				
40	1	0		21.85	21.84	22.16				
40	1	215		22.31	22.27	22.32				
40	216	0		22.43	22.21	22.68				
40	1	1	16-QAM	21.91	22.39	22.37	26.39	0.4355		
40	1	1	64-QAM	20.57	20.67	21.08				
40	1	1	256-QAM	18.37	18.52	19.05				
Limit	EIRP < 1W			Result			Pass			



<Ant. 2>

NR n2 Maximum Average Power [dBm] (GT - LC = 4 dB)								
BW [MHz]	RB Size	RB Offset	Mod	Lowest	Middle	Highest	EIRP (dBm)	EIRP(W)
5	1	1	PI/2 BPSK	23.26	23.58	23.48	27.60	0.5754
5	1	23		23.21	23.51	23.38		
5	12	6		23.29	23.56	23.55		
5	1	0		22.76	23.11	22.94		
5	1	24		22.73	23.04	22.87		
5	25	0		22.85	23.09	23.07		
5	1	1	QPSK	23.36	23.60	23.59		
5	1	23		23.27	23.50	23.49		
5	12	6		23.34	23.53	23.57		
5	1	0		22.34	22.60	22.53		
5	1	24		22.25	22.51	22.45		
5	25	0		22.33	22.58	22.54		
5	1	1	16-QAM	22.74	22.56	22.60	26.74	0.4721
5	1	1	64-QAM	20.53	21.33	21.07		
5	1	1	256-QAM	18.33	18.55	19.20		
Limit	EIRP < 2W			Result			Pass	

NR n2 Maximum Average Power [dBm] (GT - LC = 4 dB)								
BW [MHz]	RB Size	RB Offset	Mod	Lowest	Middle	Highest	EIRP (dBm)	EIRP(W)
10	1	1	PI/2 BPSK	23.33	23.57	23.70	27.70	0.5888
10	1	50		23.26	23.50	23.55		
10	25	12		23.35	23.61	23.66		
10	1	0		22.84	23.02	23.17		
10	1	51		22.75	23.04	23.05		
10	50	0		22.84	23.10	23.11		
10	1	1	QPSK	23.35	23.58	23.57		
10	1	50		23.24	23.48	23.40		
10	25	12		23.32	23.61	23.61		
10	1	0		22.37	22.52	22.61		
10	1	51		22.25	22.51	22.45		
10	50	0		22.34	22.56	22.63		
10	1	1	16-QAM	22.33	22.85	22.70	26.85	0.4842
10	1	1	64-QAM	21.10	20.67	21.20		
10	1	1	256-QAM	18.33	18.50	19.11		
Limit	EIRP < 2W			Result			Pass	



NR n2 Maximum Average Power [dBm] (GT - LC = 4 dB)										
BW [MHz]	RB Size	RB Offset	Mod	Lowest	Middle	Highest	EIRP (dBm)	EIRP(W)		
15	1	1	PI/2 BPSK	23.45	23.75	23.71	27.84	0.6081		
15	1	77		23.44	23.77	23.64				
15	36	18		23.41	23.79	23.67				
15	1	0		22.90	23.24	23.21				
15	1	78		22.94	23.23	23.13				
15	75	0		22.91	23.21	23.17				
15	1	1	QPSK	23.39	23.63	23.72			26.77	0.4753
15	1	77		23.42	23.82	23.67				
15	36	18		23.42	23.84	23.70				
15	1	0		22.40	22.78	22.68				
15	1	78		22.44	22.78	22.69				
15	75	0		22.41	22.71	22.72				
15	1	1	16-QAM	22.77	22.60	22.69	26.77	0.4753		
15	1	1	64-QAM	20.56	21.42	21.30				
15	1	1	256-QAM	18.39	18.65	18.64				
Limit	EIRP < 2W			Result			Pass			

NR n2 Maximum Average Power [dBm] (GT - LC = 4 dB)										
BW [MHz]	RB Size	RB Offset	Mod	Lowest	Middle	Highest	EIRP (dBm)	EIRP(W)		
20	1	1	PI/2 BPSK	23.40	23.62	23.73	27.81	0.6039		
20	1	104		23.51	23.78	23.66				
20	50	25		23.37	23.79	23.70				
20	1	0		22.90	23.11	23.23				
20	1	105		23.03	23.24	23.14				
20	100	0		22.87	23.28	23.18				
20	1	1	QPSK	23.31	23.52	23.72			26.70	0.4677
20	1	104		23.45	23.79	23.62				
20	50	25		23.36	23.81	23.74				
20	1	0		22.31	22.67	22.81				
20	1	105		22.43	22.81	22.62				
20	100	0		22.45	22.69	22.71				
20	1	1	16-QAM	22.40	22.70	22.69	26.70	0.4677		
20	1	1	64-QAM	20.72	21.36	20.45				
20	1	1	256-QAM	18.80	19.10	19.27				
Limit	EIRP < 2W			Result			Pass			



NR n5 Maximum Average Power [dBm] (GT - LC = 4 dB)								
BW [MHz]	RB Size	RB Offset	Mod	Lowest	Middle	Highest	ERP (dBm)	ERP(W)
5	1	1	PI/2 BPSK	22.98	23.21	23.29	25.15	0.3273
5	1	23		23.10	23.12	22.97		
5	12	6		23.29	23.24	23.20		
5	1	0		22.30	22.61	22.58		
5	1	24		22.33	22.69	22.67		
5	25	0		22.76	22.84	22.71		
5	1	1	QPSK	23.15	23.13	22.98		
5	1	23		23.10	23.26	23.04		
5	12	6		23.30	22.99	23.08		
5	1	0		22.09	22.03	22.13		
5	1	24		21.98	21.99	22.24		
5	25	0		22.15	21.99	22.28		
5	1	1	16-QAM	22.02	22.19	22.31	24.16	0.2606
5	1	1	64-QAM	20.28	20.80	20.37		
5	1	1	256-QAM	18.62	18.84	18.78		
Limit	ERP < 7W			Result			Pass	

NR n5 Maximum Average Power [dBm] (GT - LC = 4 dB)								
BW [MHz]	RB Size	RB Offset	Mod	Lowest	Middle	Highest	ERP (dBm)	ERP(W)
10	1	1	PI/2 BPSK	23.02	22.96	23.11	25.02	0.3177
10	1	50		23.04	23.12	22.97		
10	25	12		23.12	23.04	22.97		
10	1	0		22.52	22.72	22.41		
10	1	51		22.35	22.75	22.60		
10	50	0		22.40	22.68	22.55		
10	1	1	QPSK	22.86	23.05	23.17		
10	1	50		23.08	23.08	23.11		
10	25	12		23.06	23.02	23.06		
10	1	0		22.06	22.25	22.14		
10	1	51		21.98	22.10	22.08		
10	50	0		22.00	22.06	22.26		
10	1	1	16-QAM	22.03	22.31	22.08	24.16	0.2606
10	1	1	64-QAM	20.28	20.70	20.52		
10	1	1	256-QAM	18.62	18.85	18.70		
Limit	ERP < 7W			Result			Pass	



NR n5 Maximum Average Power [dBm] (GT - LC = 4 dB)								
BW [MHz]	RB Size	RB Offset	Mod	Lowest	Middle	Highest	ERP (dBm)	ERP(W)
15	1	1	PI/2 BPSK	23.08	23.07	23.29	25.19	0.3304
15	1	77		23.17	23.07	23.24		
15	36	18		23.28	23.24	22.96		
15	1	0		22.39	22.74	22.50		
15	1	78		22.65	22.55	22.64		
15	75	0		22.43	22.62	22.43		
15	1	1	QPSK	22.94	22.91	22.99		
15	1	77		22.96	23.08	23.07		
15	36	18		23.32	23.34	23.13		
15	1	0		21.87	22.00	22.04		
15	1	78		21.92	21.90	22.21		
15	75	0		22.17	21.85	22.21		
15	1	1	16-QAM	21.96	22.38	22.27	24.23	0.2649
15	1	1	64-QAM	20.41	20.66	20.68		
15	1	1	256-QAM	18.74	18.55	18.71		
Limit	ERP < 7W			Result			Pass	

NR n5 Maximum Average Power [dBm] (GT - LC = 4 dB)								
BW [MHz]	RB Size	RB Offset	Mod	Lowest	Middle	Highest	ERP (dBm)	ERP(W)
20	1	1	PI/2 BPSK	22.88	23.22	23.22	25.07	0.3214
20	1	104		23.11	23.02	23.02		
20	50	25		23.16	22.86	22.75		
20	1	0		22.21	22.39	22.31		
20	1	105		22.51	22.43	22.45		
20	100	0		22.29	22.52	22.43		
20	1	1	QPSK	22.89	22.71	22.92		
20	1	104		22.82	22.79	22.75		
20	50	25		22.96	22.98	22.80		
20	1	0		21.63	21.65	21.75		
20	1	105		21.92	21.59	22.03		
20	100	0		21.93	21.55	22.03		
20	1	1	16-QAM	21.74	21.99	21.96	23.84	0.2421
20	1	1	64-QAM	20.09	20.39	20.43		
20	1	1	256-QAM	18.41	18.36	18.71		
Limit	ERP < 7W			Result			Pass	



NR n66 Maximum Average Power [dBm] (GT - LC = 4 dB)										
BW [MHz]	RB Size	RB Offset	Mod	Lowest	Middle	Highest	EIRP (dBm)	EIRP(W)		
5	1	1	PI/2 BPSK	23.04	23.55	23.69	27.77	0.5984		
5	1	23		23.15	23.63	23.77				
5	12	6		23.11	23.55	23.72				
5	1	0		22.56	23.01	23.18				
5	1	24		22.61	23.12	23.24				
5	25	0		22.70	23.12	23.24				
5	1	1	QPSK	23.10	23.53	23.61			26.74	0.4721
5	1	23		23.17	23.44	23.70				
5	12	6		23.10	23.54	23.73				
5	1	0		22.05	22.49	22.64				
5	1	24		22.12	22.61	22.72				
5	25	0		22.21	22.54	22.74				
5	1	1	16-QAM	22.01	22.52	22.74	26.74	0.4721		
5	1	1	64-QAM	20.64	21.07	21.20				
5	1	1	256-QAM	18.58	19.05	19.16				
Limit	EIRP < 1W			Result			Pass			

NR n66 Maximum Average Power [dBm] (GT - LC = 4 dB)										
BW [MHz]	RB Size	RB Offset	Mod	Lowest	Middle	Highest	EIRP (dBm)	EIRP(W)		
10	1	1	PI/2 BPSK	23.17	23.48	23.66	27.78	0.5998		
10	1	50		23.33	23.61	23.74				
10	25	12		23.25	23.58	23.78				
10	1	0		22.61	22.96	23.15				
10	1	51		22.82	23.09	23.31				
10	50	0		22.78	23.05	23.29				
10	1	1	QPSK	23.14	23.51	23.71			26.80	0.4786
10	1	50		23.32	23.53	23.76				
10	25	12		23.27	23.56	23.76				
10	1	0		22.10	22.43	22.53				
10	1	51		22.28	22.54	22.76				
10	50	0		22.28	22.54	22.79				
10	1	1	16-QAM	22.17	22.63	22.80	26.80	0.4786		
10	1	1	64-QAM	20.72	21.20	21.26				
10	1	1	256-QAM	18.69	19.11	19.32				
Limit	EIRP < 1W			Result			Pass			





NR n66 Maximum Average Power [dBm] (GT - LC = 4 dB)										
BW [MHz]	RB Size	RB Offset	Mod	Lowest	Middle	Highest	EIRP (dBm)	EIRP(W)		
15	1	1	PI/2 BPSK	23.19	23.66	23.66	27.77	0.5984		
15	1	77		23.46	23.69	23.77				
15	36	18		23.32	23.75	23.68				
15	1	0		22.68	23.16	23.20				
15	1	78		23.01	23.18	23.27				
15	75	0		22.81	23.26	23.29				
15	1	1	QPSK	23.13	23.58	23.60			26.57	0.4539
15	1	77		23.44	23.68	23.77				
15	36	18		23.31	23.75	23.70				
15	1	0		22.11	22.55	22.56				
15	1	78		22.44	22.67	22.81				
15	75	0		22.35	22.77	22.75				
15	1	1	16-QAM	22.30	22.57	22.50	26.57	0.4539		
15	1	1	64-QAM	20.76	21.14	21.18				
15	1	1	256-QAM	18.72	19.14	19.10				
Limit	EIRP < 1W			Result			Pass			

NR n66 Maximum Average Power [dBm] (GT - LC = 4 dB)										
BW [MHz]	RB Size	RB Offset	Mod	Lowest	Middle	Highest	EIRP (dBm)	EIRP(W)		
20	1	1	PI/2 BPSK	22.21	23.56	23.68	27.78	0.5998		
20	1	104		23.51	23.68	23.78				
20	50	25		23.35	23.70	23.76				
20	1	0		22.67	23.06	23.19				
20	1	105		23.05	23.16	23.31				
20	100	0		22.89	23.22	23.27				
20	1	1	QPSK	23.16	23.52	23.60			26.72	0.4699
20	1	104		23.51	23.62	23.70				
20	50	25		23.30	23.75	23.73				
20	1	0		22.16	22.53	22.61				
20	1	105		22.50	22.63	22.70				
20	100	0		22.36	22.74	22.75				
20	1	1	16-QAM	22.20	22.48	22.72	26.72	0.4699		
20	1	1	64-QAM	21.31	20.99	20.85				
20	1	1	256-QAM	18.75	19.06	19.14				
Limit	EIRP < 1W			Result			Pass			



NR n66 Maximum Average Power [dBm] (GT - LC = 4 dB)										
BW [MHz]	RB Size	RB Offset	Mod	Lowest	Middle	Highest	EIRP (dBm)	EIRP(W)		
30	1	1	PI/2 BPSK	23.37	23.58	23.78	27.97	0.6266		
30	1	158		23.73	23.75	23.97				
30	80	40		23.59	23.76	23.93				
30	1	0		22.83	23.08	23.30				
30	1	159		23.20	23.28	23.46				
30	160	0		23.11	23.31	23.45				
30	1	1	QPSK	23.29	23.58	23.82			26.82	0.4808
30	1	158		23.65	23.76	23.92				
30	80	40		23.62	23.78	23.95				
30	1	0		22.32	22.58	22.78				
30	1	159		22.64	22.81	22.95				
30	160	0		22.64	22.79	23.01				
30	1	1	16-QAM	22.37	22.61	22.82	26.82	0.4808		
30	1	1	64-QAM	21.00	21.12	21.38				
30	1	1	256-QAM	18.92	19.11	19.45				
Limit	EIRP < 1W			Result			Pass			

NR n66 Maximum Average Power [dBm] (GT - LC = 4 dB)										
BW [MHz]	RB Size	RB Offset	Mod	Lowest	Middle	Highest	EIRP (dBm)	EIRP(W)		
40	1	1	PI/2 BPSK	23.16	23.51	23.59	27.88	0.6138		
40	1	214		23.64	23.84	23.88				
40	108	54		23.51	23.79	23.85				
40	1	0		22.67	23.00	23.10				
40	1	215		23.14	23.32	23.38				
40	216	0		23.00	23.25	23.30				
40	1	1	QPSK	23.18	23.44	23.64			26.75	0.4732
40	1	214		23.66	23.74	23.86				
40	108	54		23.53	23.77	23.85				
40	1	0		22.15	22.46	22.57				
40	1	215		22.68	22.77	22.84				
40	216	0		22.51	22.80	22.85				
40	1	1	16-QAM	22.18	22.56	22.75	26.75	0.4732		
40	1	1	64-QAM	20.66	21.22	21.16				
40	1	1	256-QAM	20.73	19.10	19.23				
Limit	EIRP < 1W			Result			Pass			



# FR1 n2

## Peak-to-Average Ratio

Mode	FR1 n2 / 20MHz / DFT-S OFDM				
Mod.	PI/2 BPSK	QPSK	16QAM	64QAM	Limit: 13dB
RB Size	Full RB	Full RB	Full RB	Full RB	Result
Middle CH	4.12	4.86	5.86	6.34	PASS
Mode	FR1 n2 / 20MHz / DFT-S OFDM				
Mod.	256QAM				Limit: 13dB
RB Size	Full RB				Result
Middle CH	6.72				PASS



FR1 n2 / 20MHz / DFT-S OFDM / Middle Channel / Full RB

PI/2 BPSK

QPSK

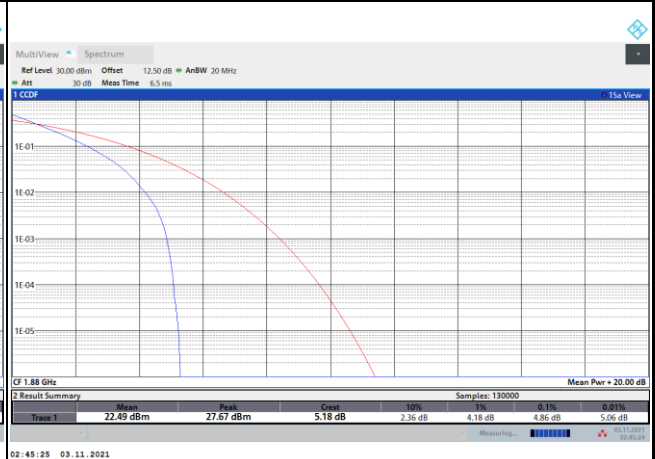
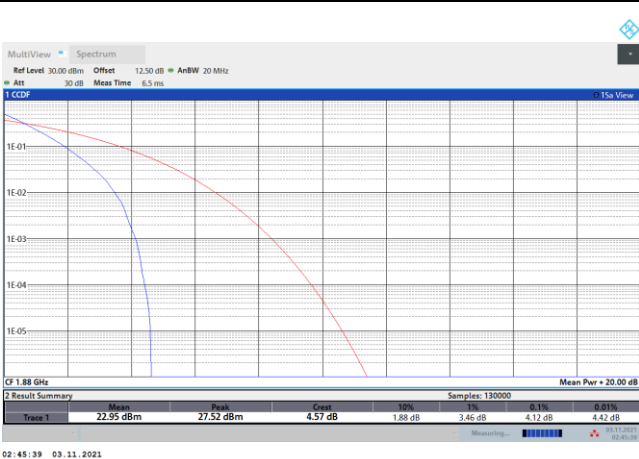

16QAM

64QAM

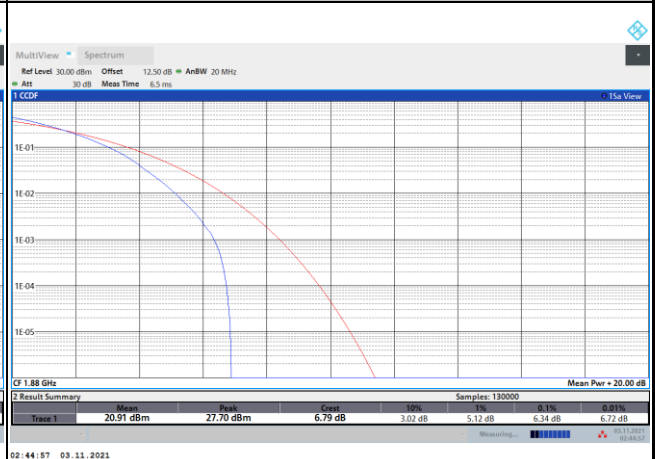
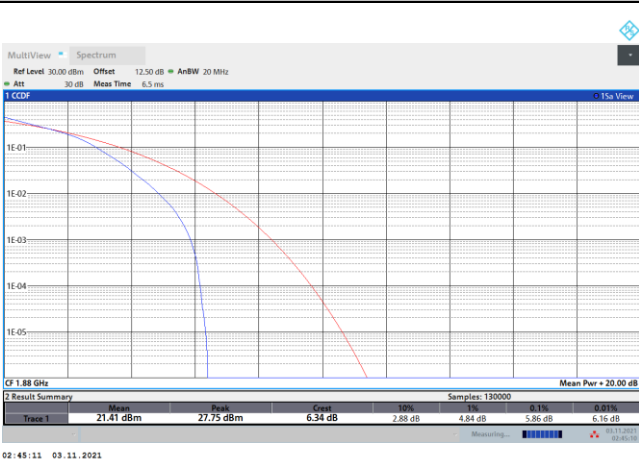

256QAM

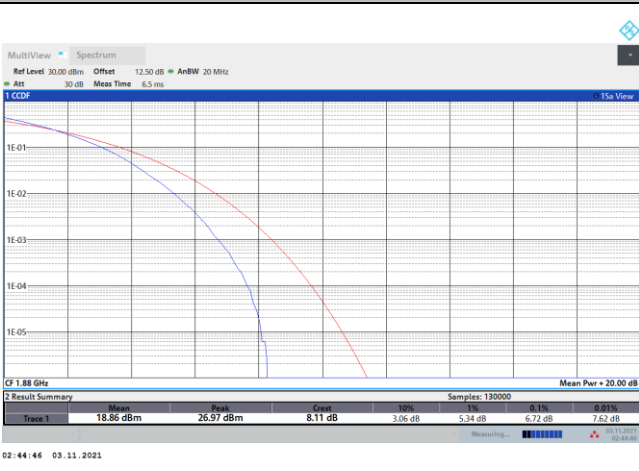



**26dB Bandwidth**

Mode	FR1 n2 : 26dB BW(MHz) / DFT-S OFDM							
BW	5MHz		10MHz		15MHz		20MHz	
Mod.	PI/2 BPSK		PI/2 BPSK		PI/2 BPSK		PI/2 BPSK	
Middle CH	5.00		9.55		14.42		18.94	

Mode	FR1 n2 : 26dB BW(MHz) / CP OFDM							
BW	5MHz		10MHz		15MHz		20MHz	
Mod.	QPSK	16QAM	QPSK	16QAM	QPSK	16QAM	QPSK	16QAM
Middle CH	5.09	5.12	9.91	9.91	15.07	15.16	20.06	20.06
Mod.	64QAM	256QAM	64QAM	256QAM	64QAM	256QAM	64QAM	256QAM
Middle CH	5.08	4.99	10.01	9.93	15.13	15.04	19.86	19.94



FR1 n2 / 5MHz / DFT-S OFDM / Middle Channel / Full RB

PI/2 BPSK

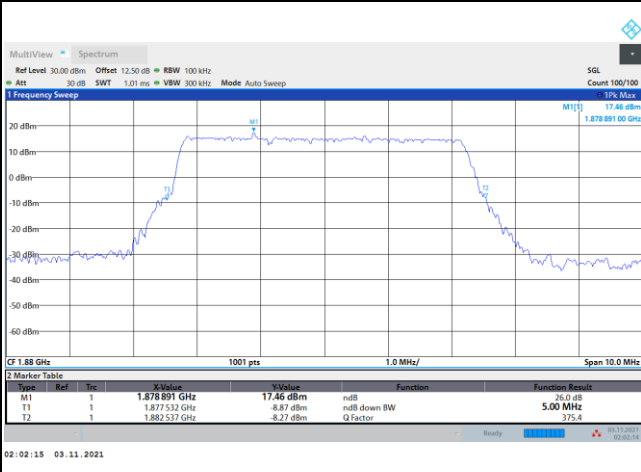

FR1 n2 / 5MHz / CP OFDM / Middle Channel / Full RB

QPSK

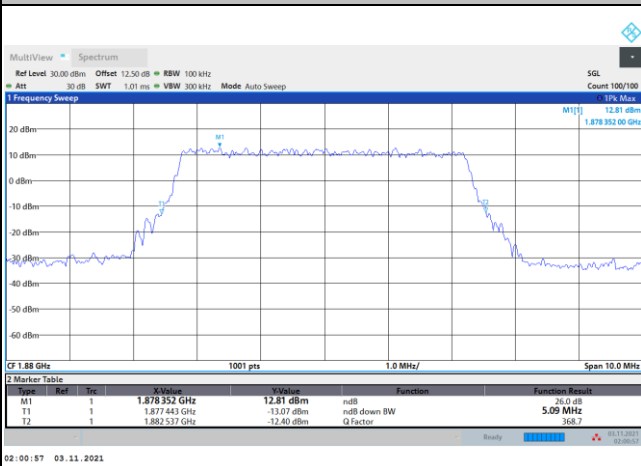

16QAM

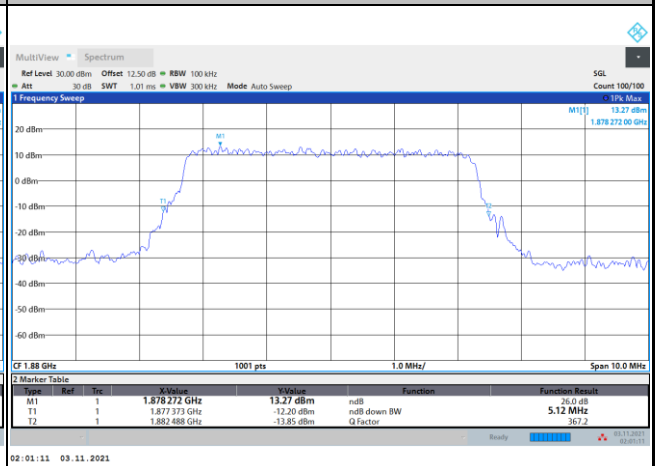

64QAM

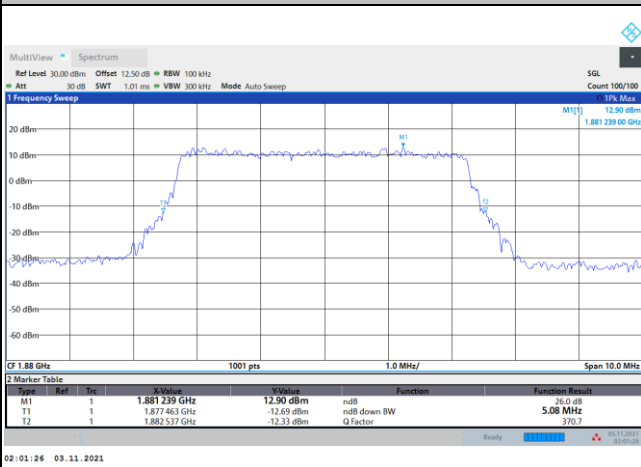

256QAM

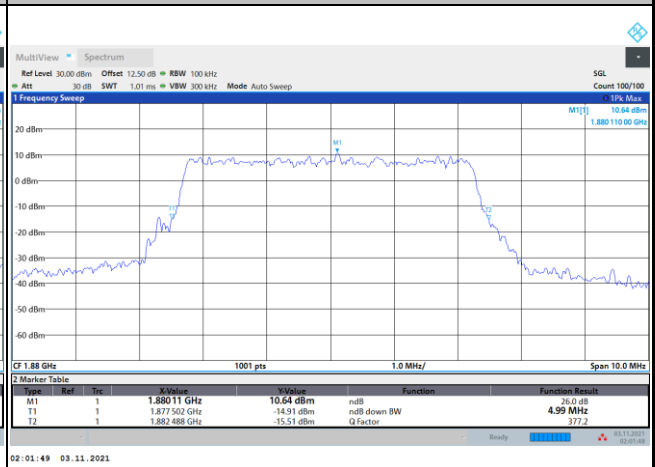



FR1 n2 / 10MHz / DFT-S OFDM / Middle Channel / Full RB

PI/2 BPSK

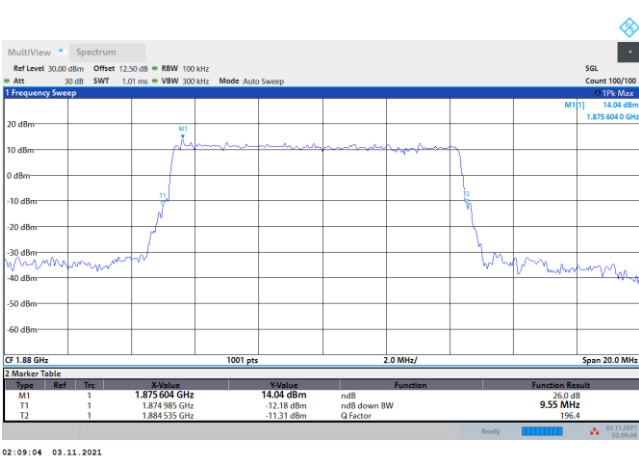

FR1 n2 / 10MHz / CP OFDM / Middle Channel / Full RB

QPSK

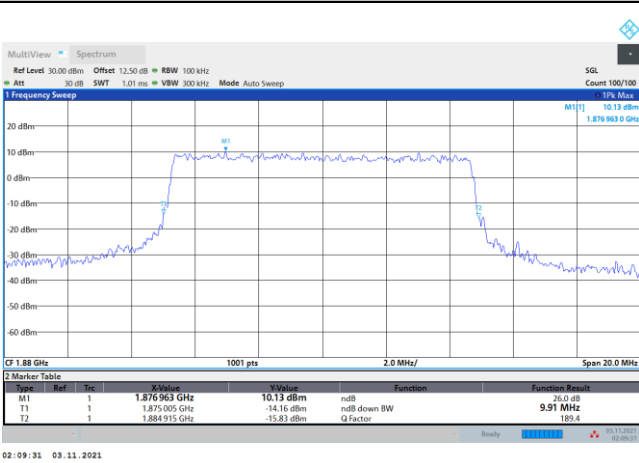

16QAM

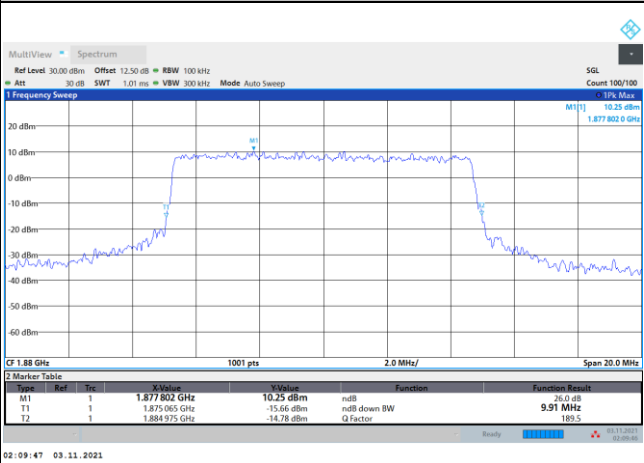

64QAM

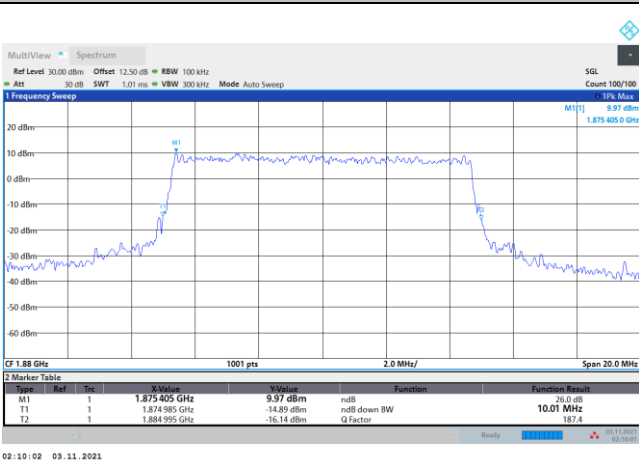

256QAM

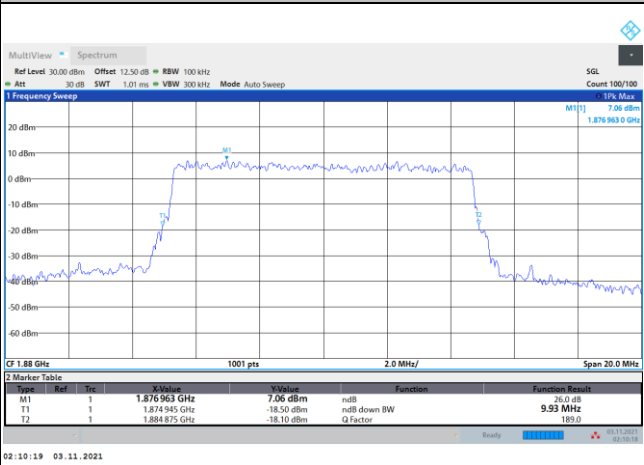



FR1 n2 / 15MHz / DFT-S OFDM / Middle Channel / Full RB

PI/2 BPSK

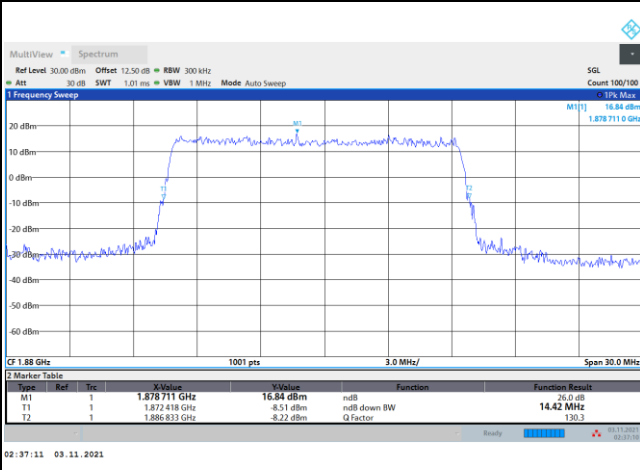

FR1 n2 / 15MHz / CP OFDM / Middle Channel / Full RB

QPSK

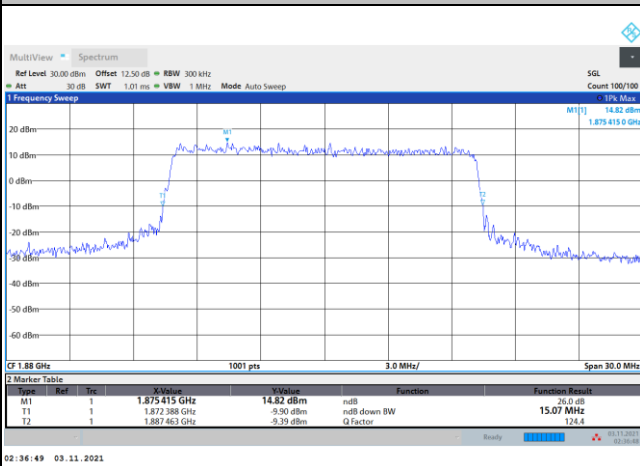

16QAM

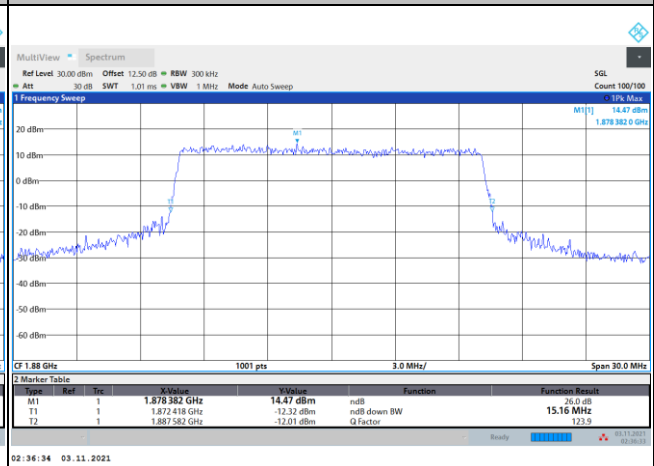

64QAM

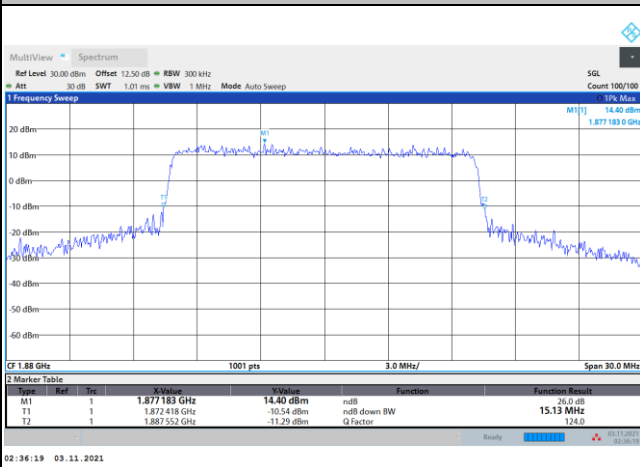

256QAM

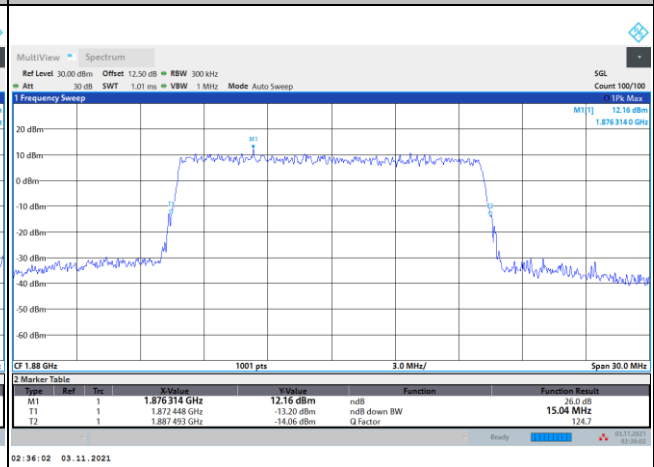





FR1 n2 / 20MHz / DFT-S OFDM / Middle Channel / Full RB

PI/2 BPSK

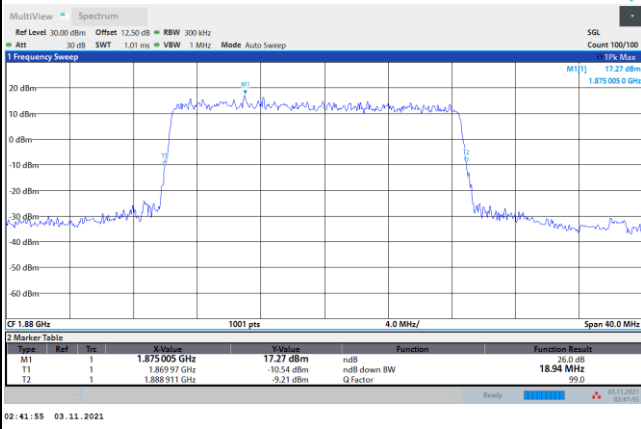

FR1 n2 / 20MHz / CP OFDM / Middle Channel / Full RB

QPSK

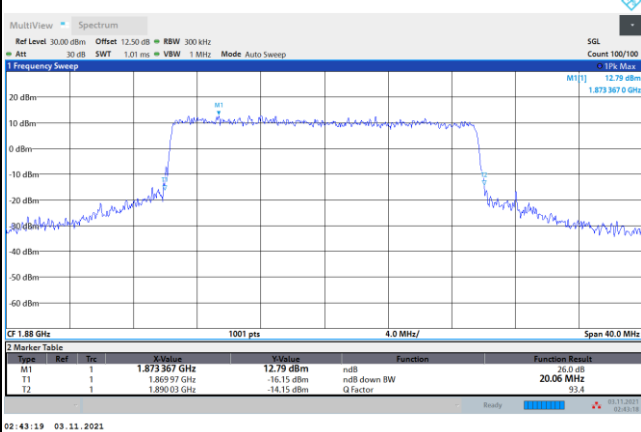

16QAM

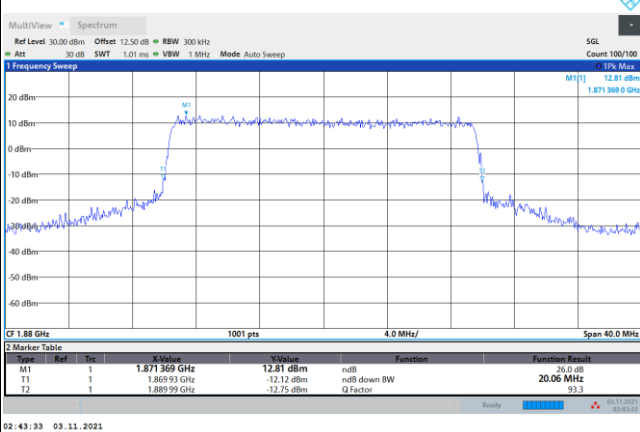

64QAM

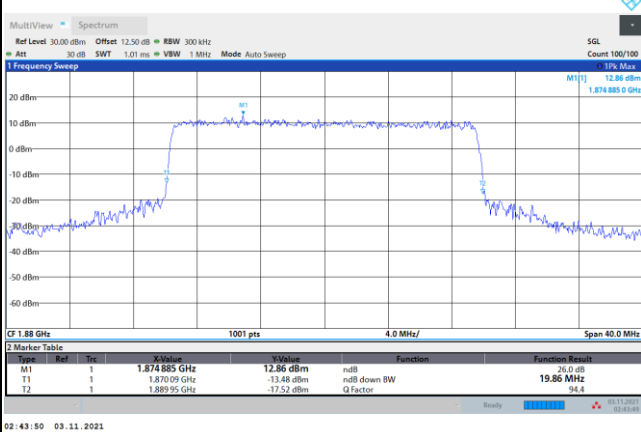

256QAM

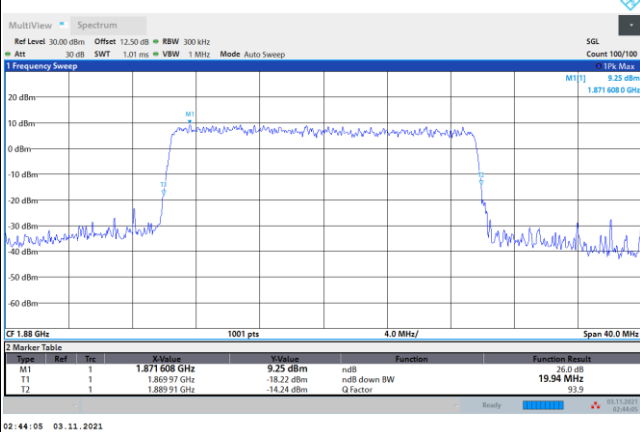



**Occupied Bandwidth**

Mode	FR1 n2 : 99%OBW(MHz) / DFT-S OFDM							
BW	5MHz		10MHz		15MHz		20MHz	
Mod.	PI/2 BPSK		PI/2 BPSK		PI/2 BPSK		PI/2 BPSK	
Middle CH	4.48		8.96		13.49		17.92	

Mode	FR1 n2 : 99%OBW (MHz) / CP OFDM							
BW	5MHz		10MHz		15MHz		20MHz	
Mod.	QPSK	16QAM	QPSK	16QAM	QPSK	16QAM	QPSK	16QAM
Middle CH	4.50	4.51	9.32	9.30	14.16	14.14	18.97	18.95
Mod.	64QAM	256QAM	64QAM	256QAM	64QAM	256QAM	64QAM	256QAM
Middle CH	4.49	4.50	9.29	9.30	14.13	14.12	18.94	18.92



FR1 n2 / 5MHz / DFT-S OFDM / Middle Channel / Full RB

PI/2 BPSK

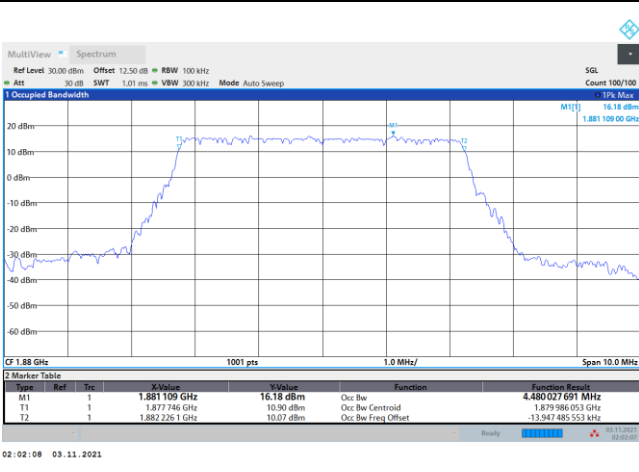

FR1 n2 / 5MHz / CP OFDM / Middle Channel / Full RB

QPSK

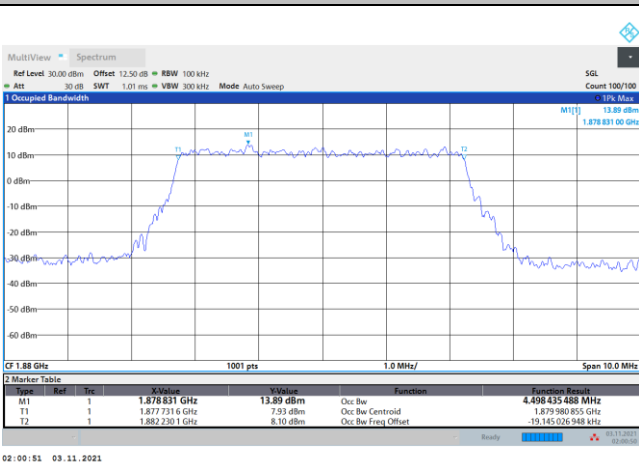

16QAM

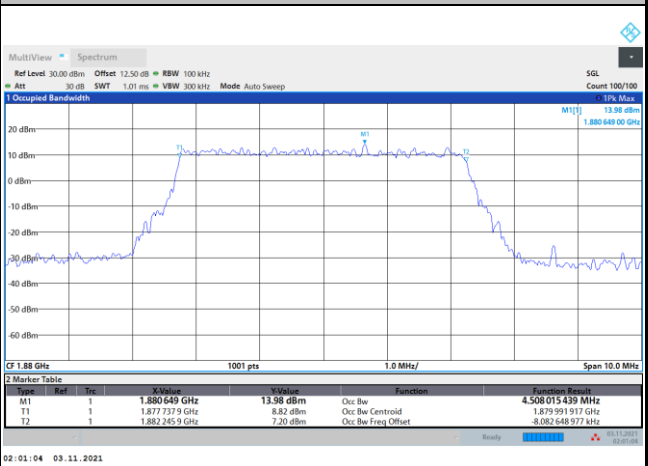

64QAM

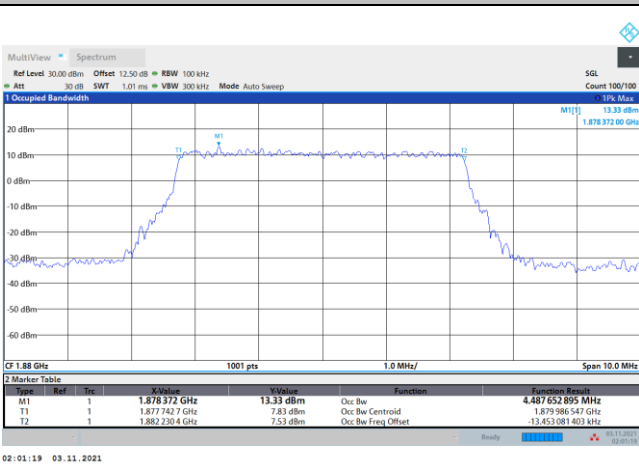

256QAM

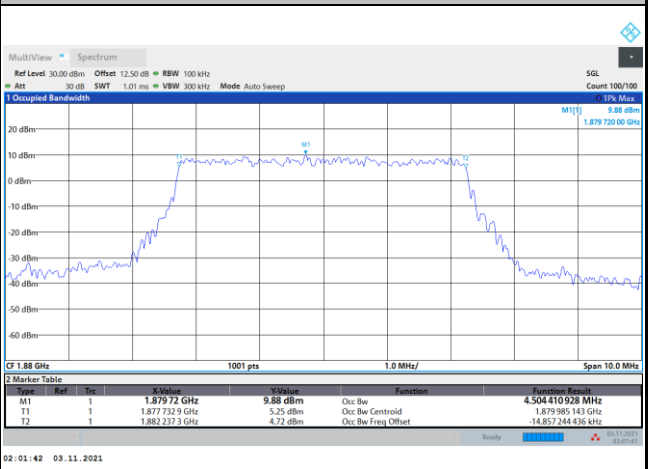



FR1 n2 / 10MHz / DFT-S OFDM / Middle Channel / Full RB

PI/2 BPSK

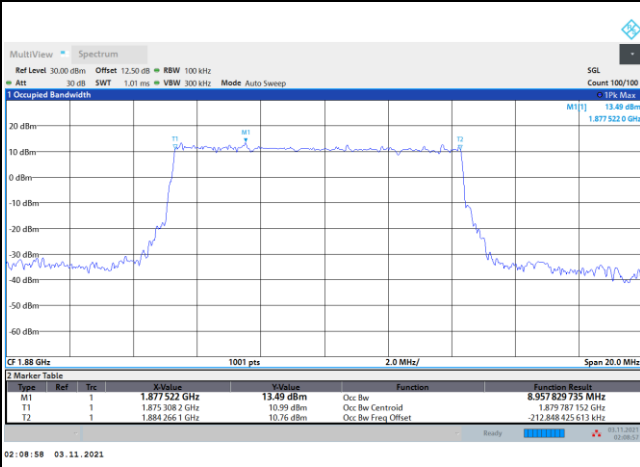

FR1 n2 / 10MHz / CP OFDM / Middle Channel / Full RB

QPSK

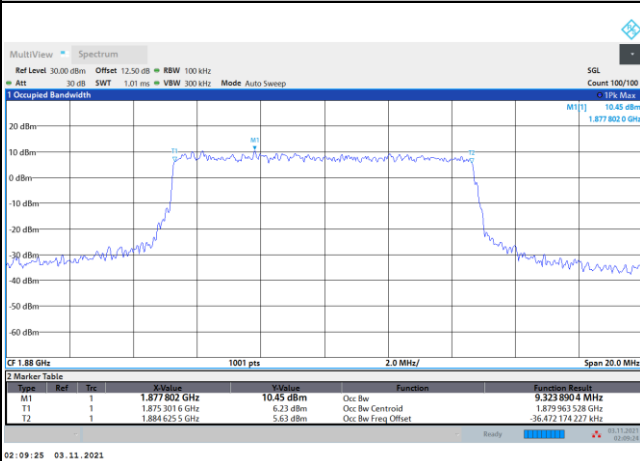

16QAM

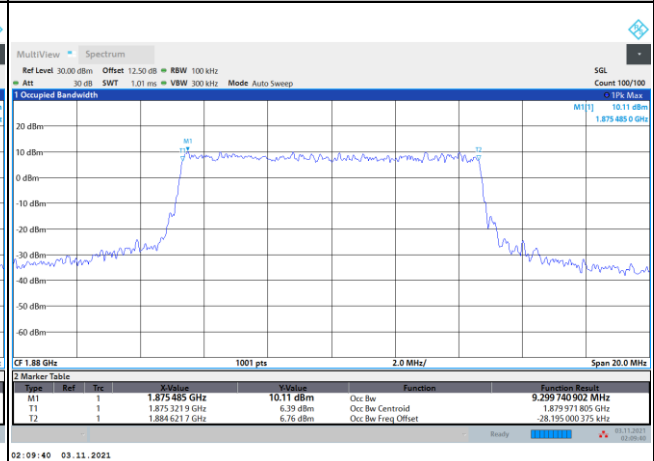

64QAM

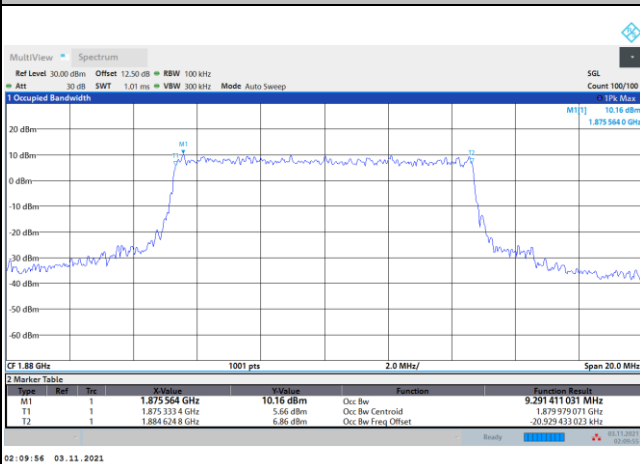

256QAM

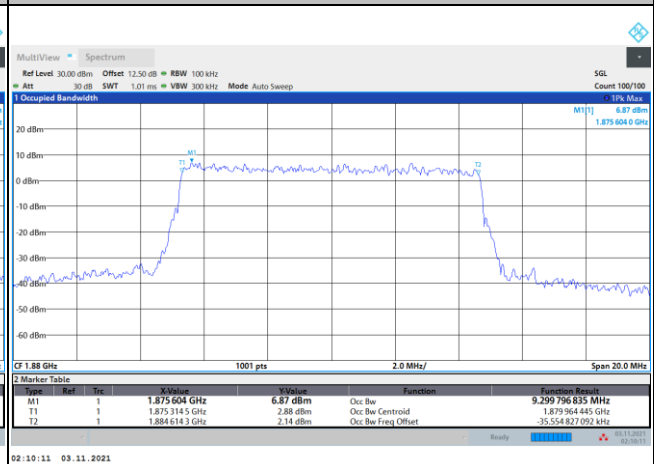



FR1 n2 / 15MHz / DFT-S OFDM / Middle Channel / Full RB

PI/2 BPSK

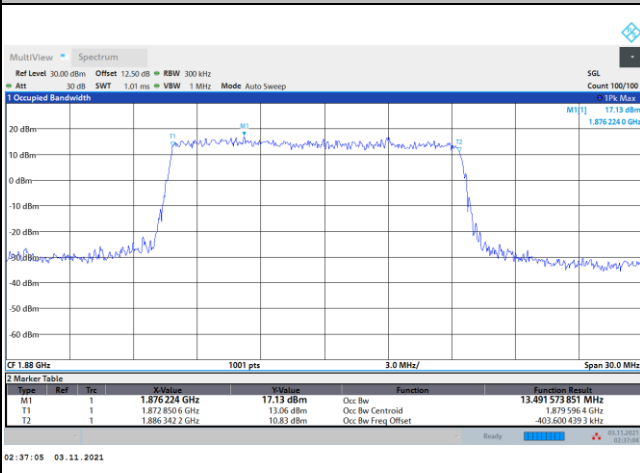

FR1 n2 / 15MHz / CP OFDM / Middle Channel / Full RB

QPSK

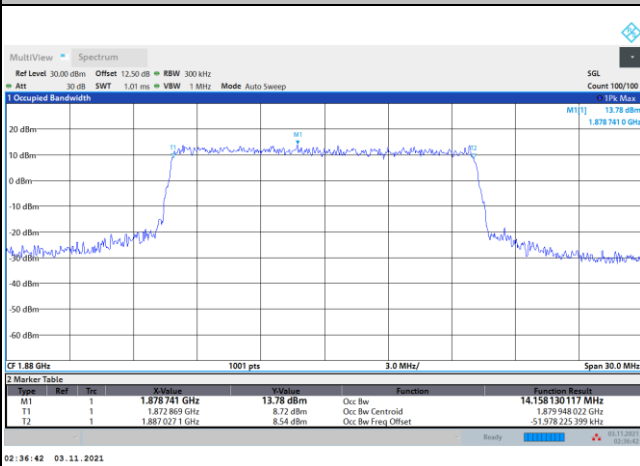

16QAM

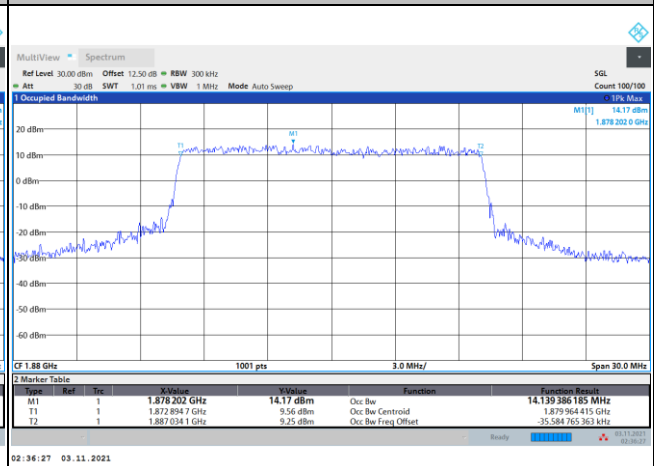

64QAM

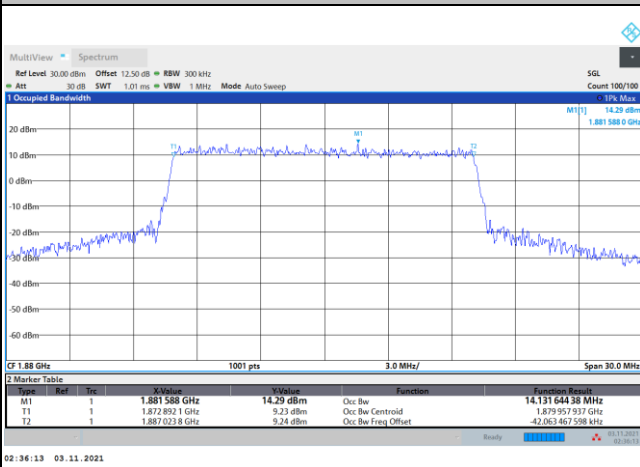

256QAM

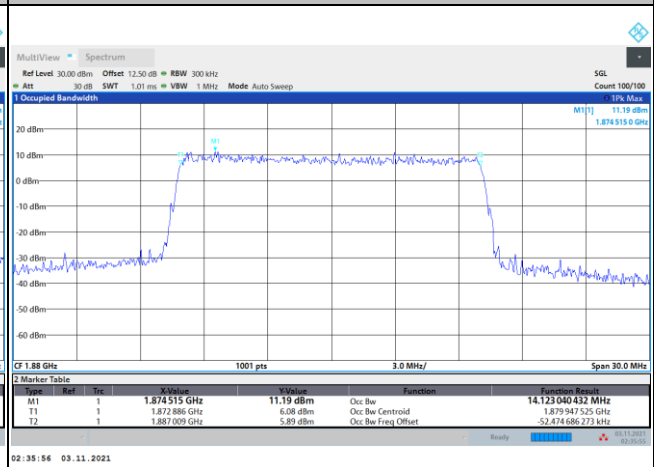



FR1 n2 / 20MHz / DFT-S OFDM / Middle Channel / Full RB

PI/2 BPSK

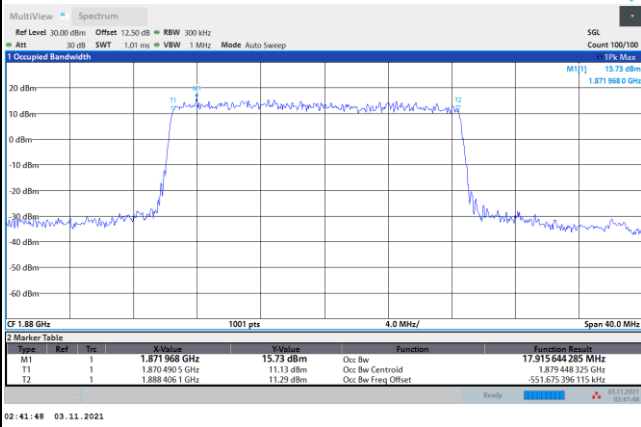

FR1 n2 / 20MHz / CP OFDM / Middle Channel / Full RB

QPSK

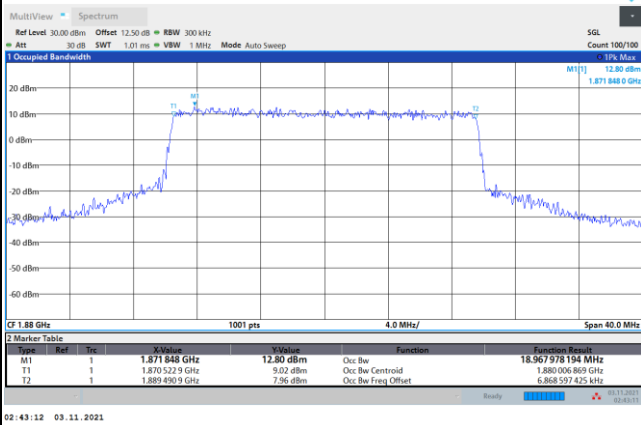

16QAM

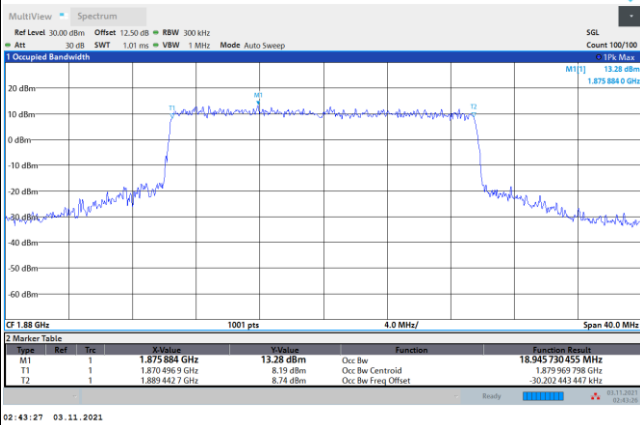

64QAM

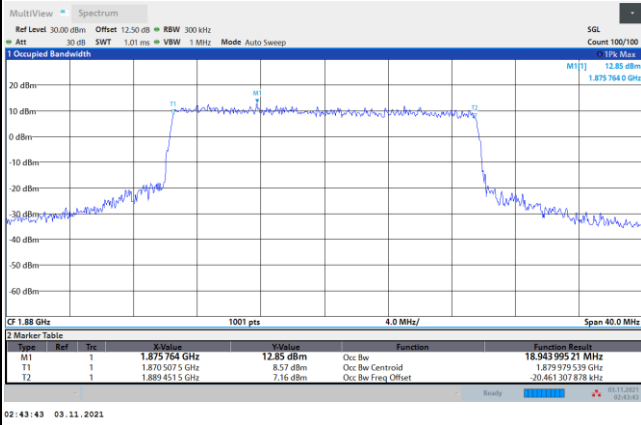

256QAM





# Conducted Band Edge

## FR1 n2 / 5MHz / DFT-S OFDM / PI/2 BPSK

### Lowest Band Edge / 1RB0

### Highest Band Edge / 1RBmax

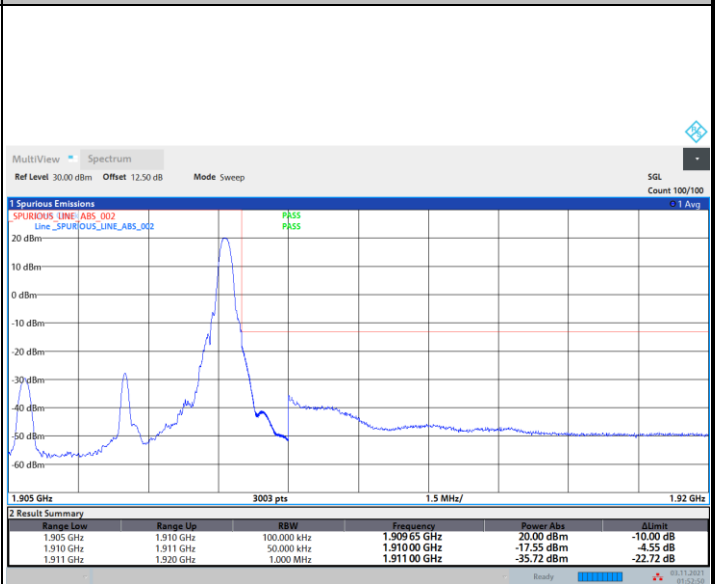
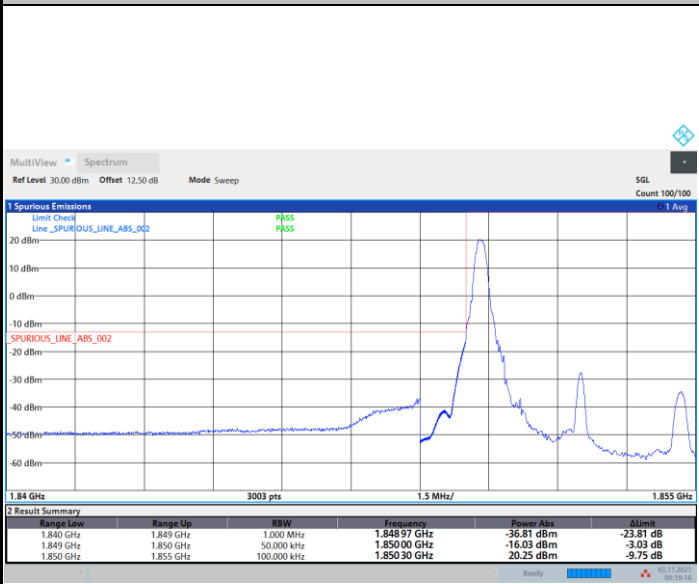

### Lowest Band Edge / Full RB

### Highest Band Edge / Full RB

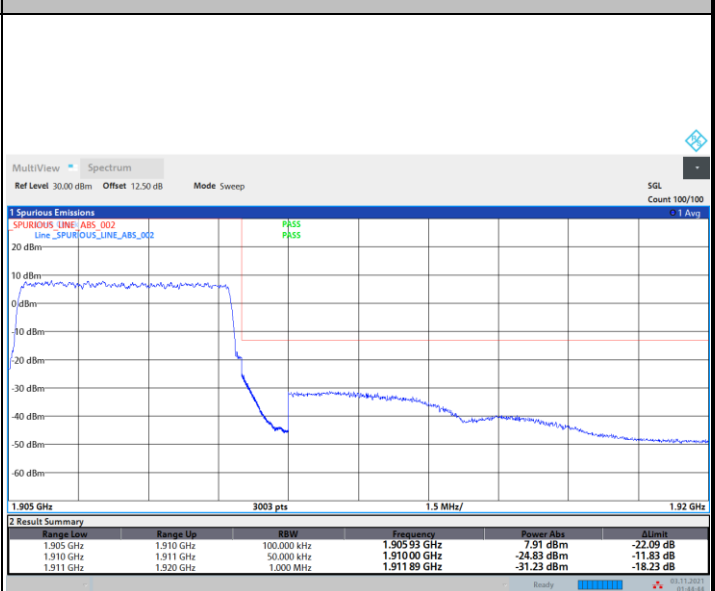
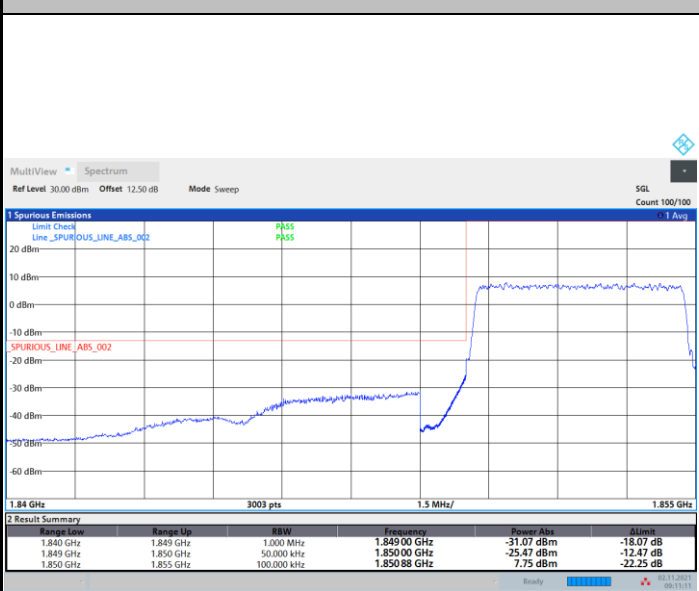



FR1 n2 / 5MHz / DFT-S OFDM / QPSK

Lowest Band Edge / 1RB0

Highest Band Edge / 1RBmax

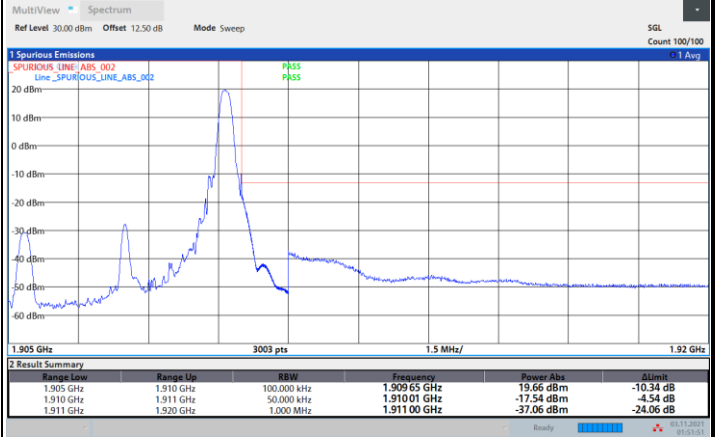
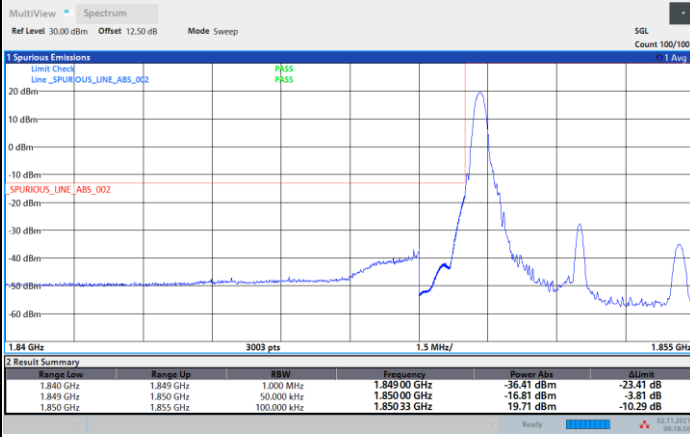

Lowest Band Edge / Full RB

Highest Band Edge / Full RB

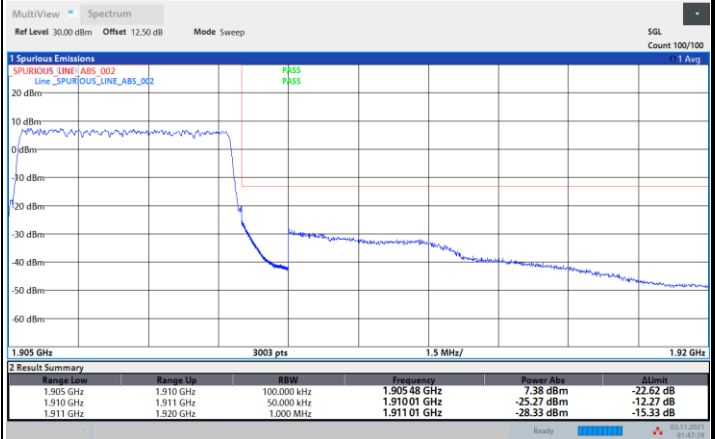
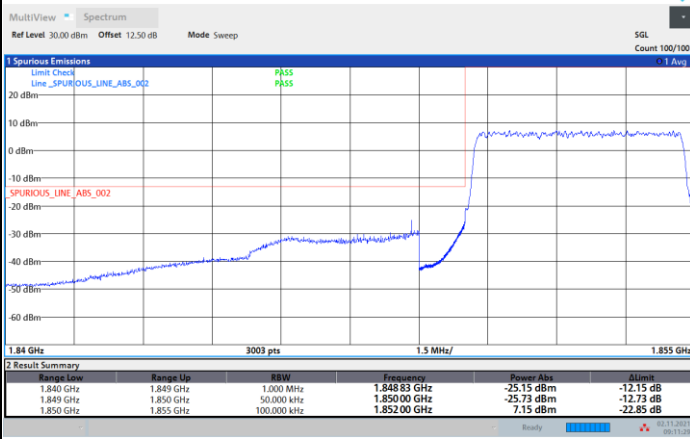





FR1 n2 / 5MHz / DFT-S OFDM / 16QAM

Lowest Band Edge / 1RB0

Highest Band Edge / 1RBmax

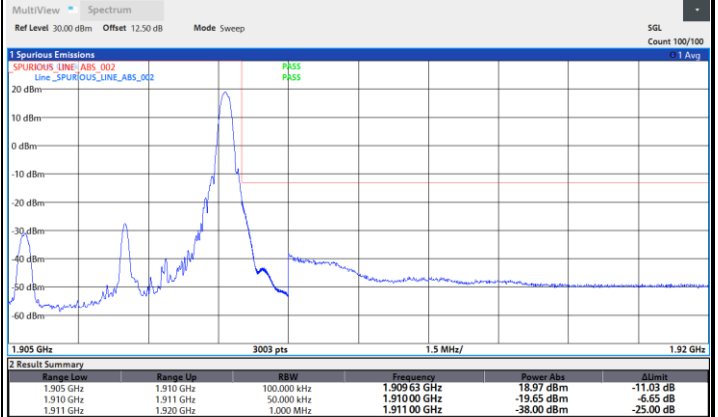
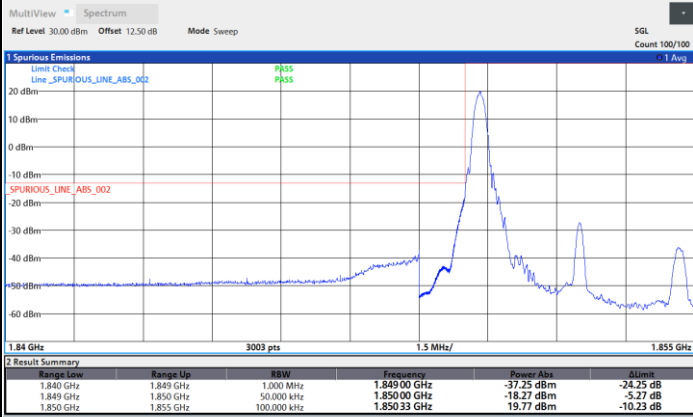

09:18:07 02.11.2021

01:51:13 03.11.2021

Lowest Band Edge / Full RB

Highest Band Edge / Full RB

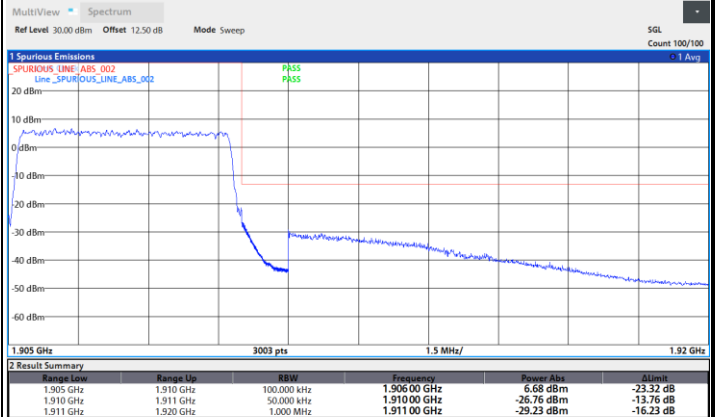
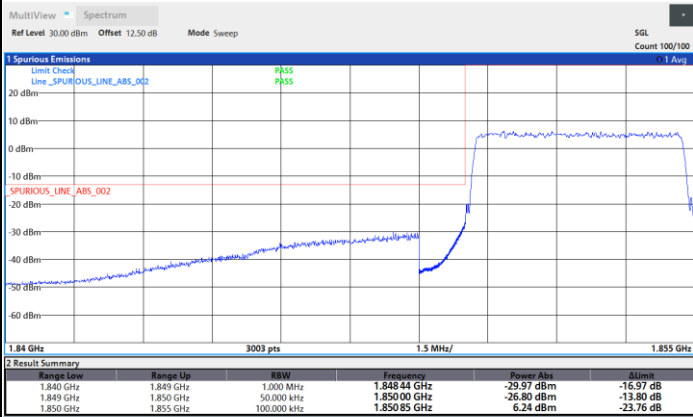

09:15:00 02.11.2021

01:48:42 03.11.2021



FR1 n2 / 5MHz / DFT-S OFDM / 64QAM

Lowest Band Edge / 1RB0

Highest Band Edge / 1RBmax

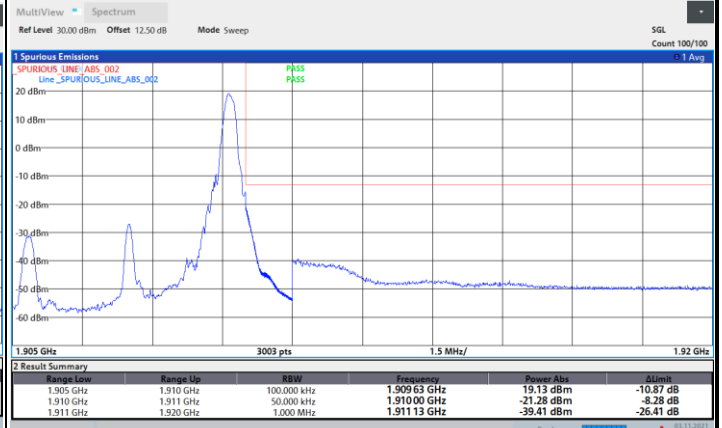
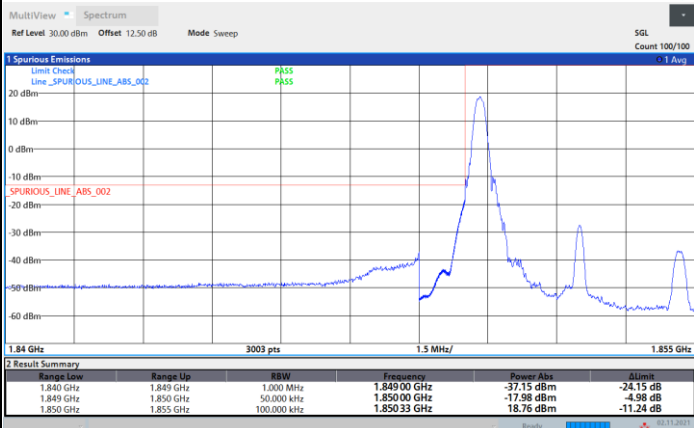

Lowest Band Edge / Full RB

Highest Band Edge / Full RB

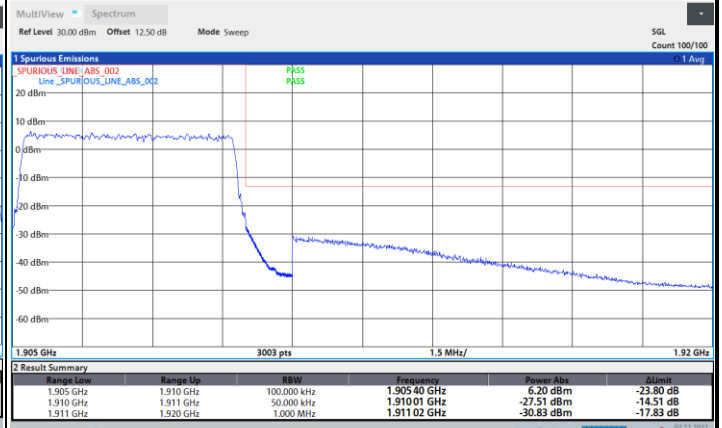
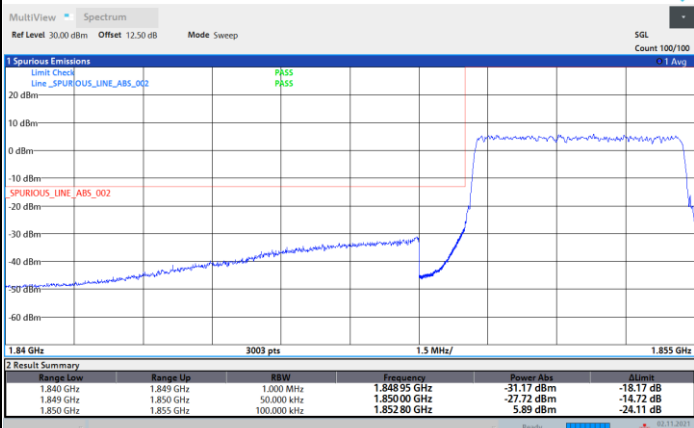



FR1 n2 / 5MHz / DFT-S OFDM / 256QAM

Lowest Band Edge / 1RB0

Highest Band Edge / 1RBmax

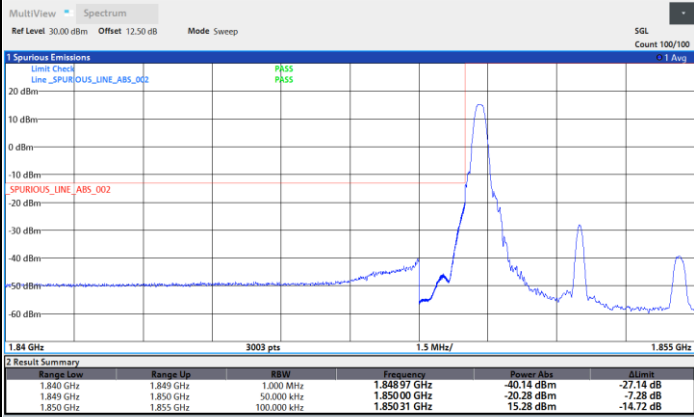

09:19:48 02.11.2021

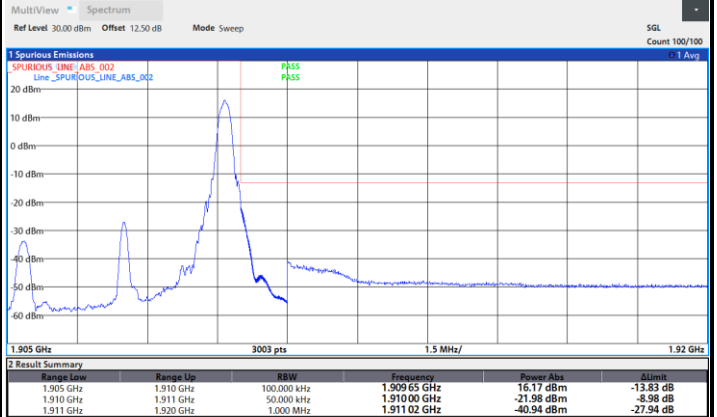

01:53:38 03.11.2021

Lowest Band Edge / Full RB

Highest Band Edge / Full RB

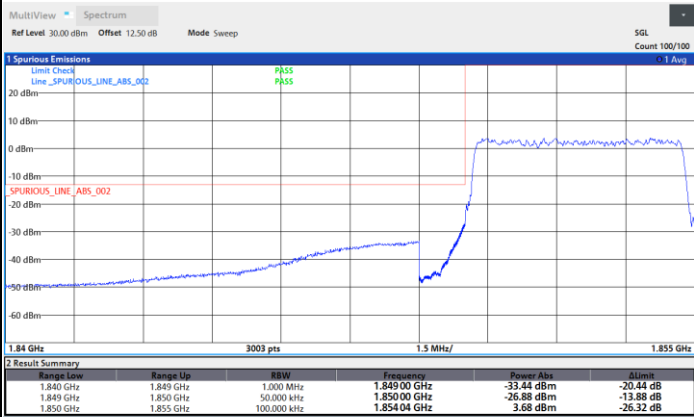

09:20:07 02.11.2021

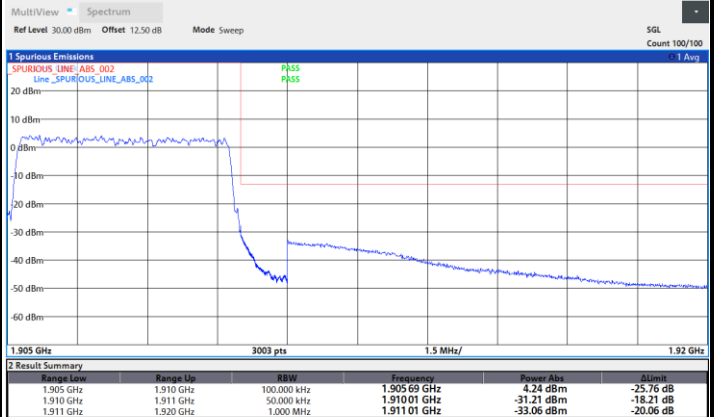

01:54:56 03.11.2021



FR1 n2 / 5MHz / CP OFDM / QPSK / Full RB

Lowest Band Edge

Highest Band Edge

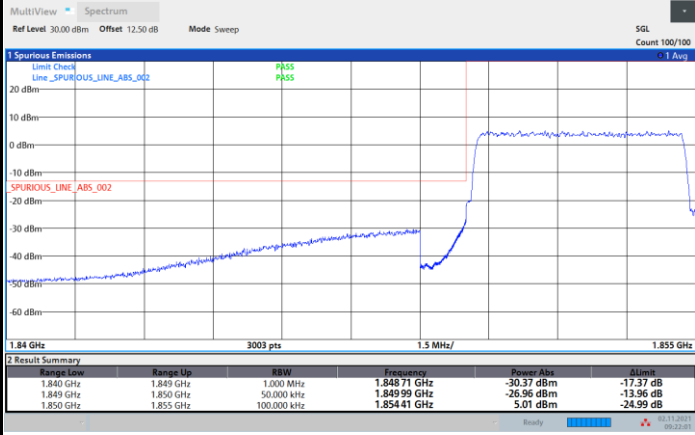

09:22:01 02.11.2021

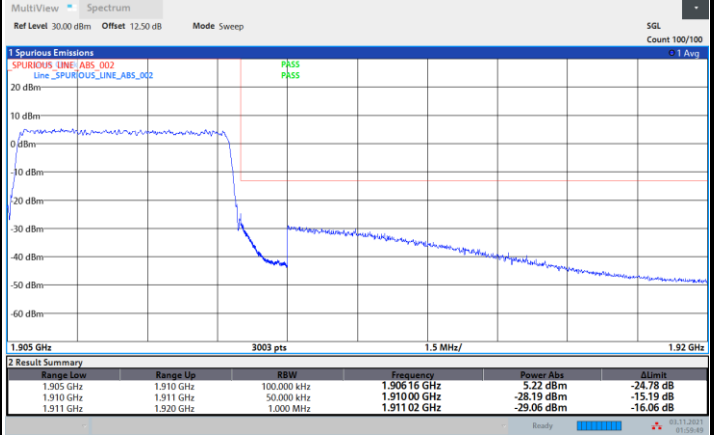

01:59:50 03.11.2021



FR1 n2 / 10MHz / DFT-s-OFDM / PI/2 BPSK / Full RB

Lowest Band Edge

Highest Band Edge

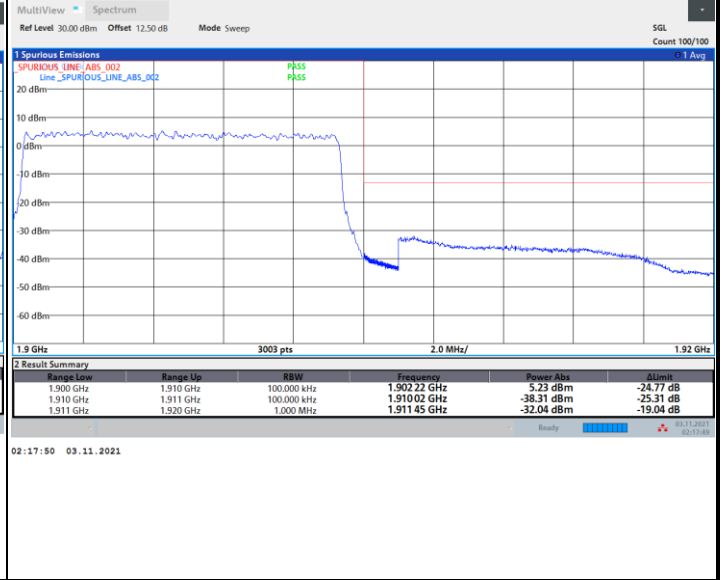
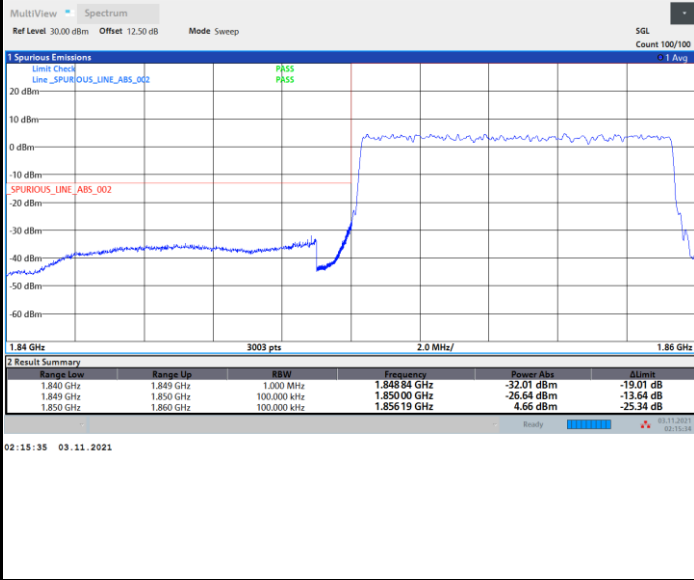



FR1 n2 / 10MHz / DFT-s-OFDM / QPSK / Full RB

Lowest Band Edge

Highest Band Edge

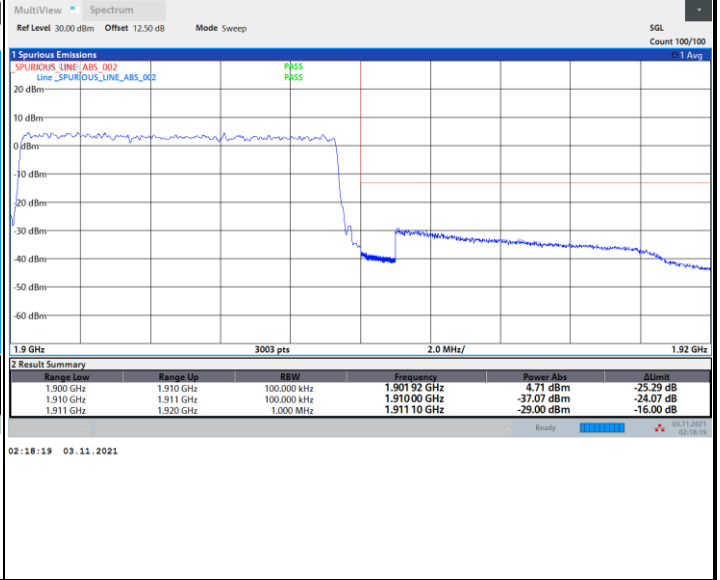
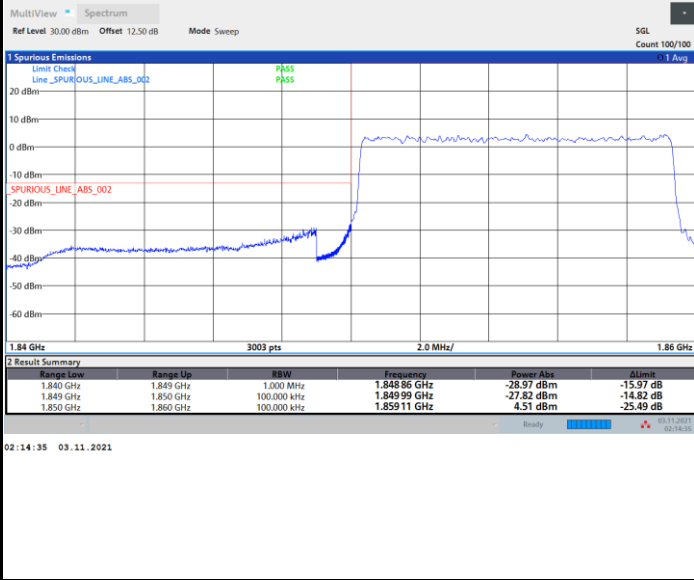



FR1 n2 / 10MHz / DFT-s-OFDM / 16QAM / Full RB

Lowest Band Edge

Highest Band Edge

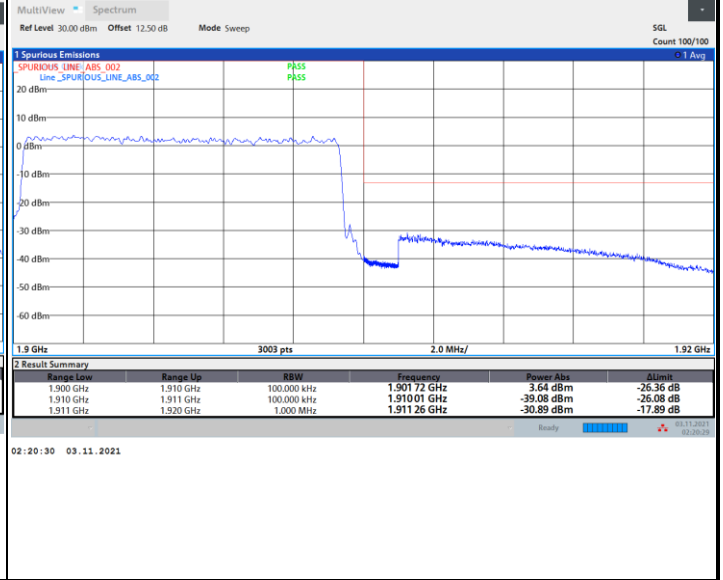
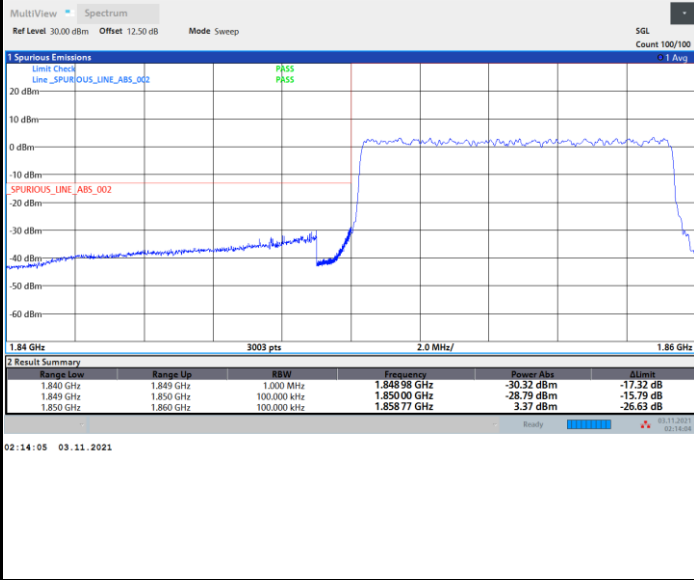



FR1 n2 / 10MHz / DFT-s-OFDM / 64QAM / Full RB

Lowest Band Edge

Highest Band Edge

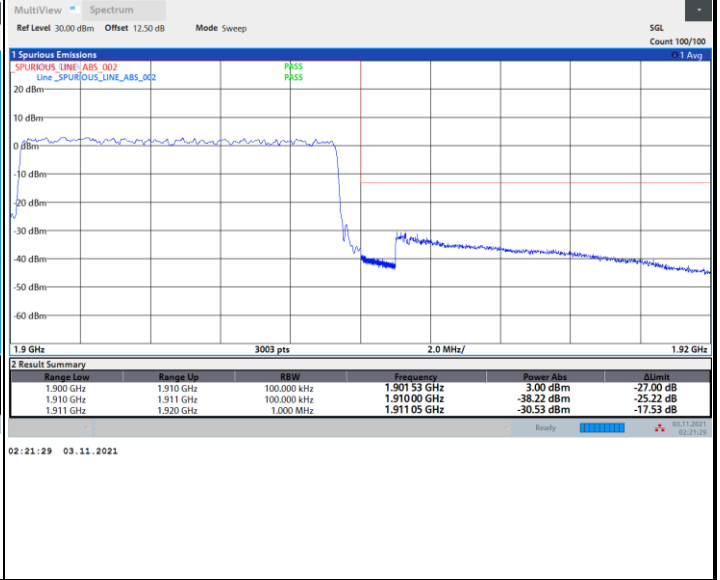
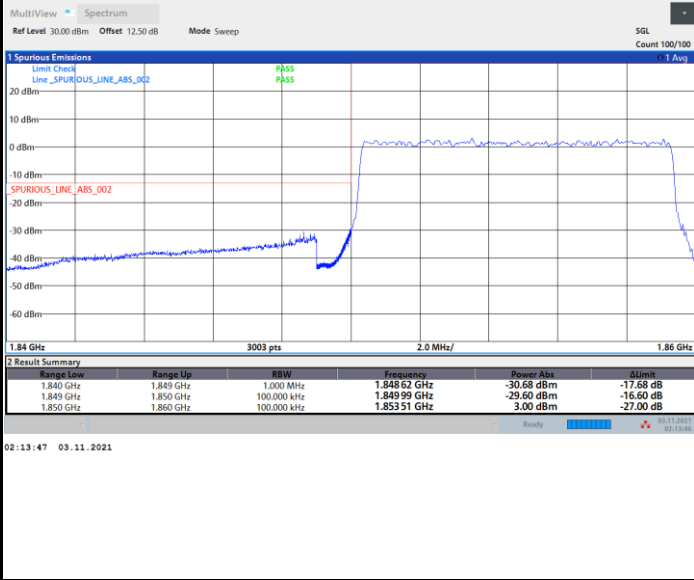





FR1 n2 / 10MHz / DFT-s-OFDM / 256QAM / Full RB

Lowest Band Edge

Highest Band Edge

