

## DFS Test Report

**Report No.:** RFBBQZ-WTW-P22010396-2

**FCC ID:** PY322100555

**Test Model:** RAX50v2

**Series Model:** XR1000v2

**Received Date:** 2022/1/25

**Test Date:** 2022/3/18 ~ 2022/3/27

**Issued Date:** 2022/5/13

**Applicant and** NETGEAR, Inc.

**Manufacturer:**

**Address:** 350 East Plumeria Drive San Jose, CA 95134

**Issued By:** Bureau Veritas Consumer Products Services (H.K.) Ltd., Taoyuan Branch  
Hsin Chu Laboratory

**Lab Address:** E-2, No.1, Li Hsin 1st Road, Hsinchu Science Park, Hsinchu City 300, Taiwan

**Test Location:** E-2, No.1, Li Hsin 1st Road, Hsinchu Science Park, Hsinchu City 300, Taiwan

**FCC Registration /**  
**Designation Number:** 723255 / TW2022



This report is for your exclusive use. Any copying or replication of this report to or for any other person or entity, or use of our name or trademark, is permitted only with our prior written permission. This report sets forth our findings solely with respect to the test samples identified herein. The results set forth in this report are not indicative or representative of the quality or characteristics of the lot from which a test sample was taken or any similar or identical product unless specifically and expressly noted. Our report includes all of the tests requested by you and the results thereof based upon the information that you provided to us. You have 60 days from date of issuance of this report to notify us of any material error or omission caused by our negligence, provided, however, that such notice shall be in writing and shall specifically address the issue you wish to raise. A failure to raise such issue within the prescribed time shall constitute your unqualified acceptance of the completeness of this report, the tests conducted and the correctness of the report contents. Unless specific mention, the uncertainty of measurement has been explicitly taken into account to declare the compliance or non-compliance to the specification.

## Table of Contents

<b>Release Control Record .....</b>	<b>3</b>
<b>1 Certificate of Conformity .....</b>	<b>4</b>
<b>2 EUT Information .....</b>	<b>5</b>
2.1 Operating Frequency Bands and Mode of EUT .....	5
2.2 EUT Software and Firmware Version .....	5
2.3 Description of Available Antennas to the EUT .....	5
2.4 EUT Maximum and Minimum Conducted Power .....	6
2.5 EUT Maximum and Minimum EIRP Power .....	6
2.6 Transmit Power Control (TPC) .....	7
2.7 Statement of Manufacturer .....	7
<b>3. U-NII DFS Rule Requirements .....</b>	<b>8</b>
3.1 Working Modes and Required Test Items .....	8
3.2 Test Limits and Radar Signal Parameters .....	9
<b>4. Test &amp; Support Equipment List .....</b>	<b>12</b>
4.1 Test Instruments .....	12
4.2 Description of Support Units .....	12
<b>5. Test Procedure .....</b>	<b>13</b>
5.1 DFS Measurement System .....	13
5.2 Calibration of DFS Detection Threshold Level .....	14
5.3 Deviation from Test Standard .....	14
5.4 Radiated Test Setup Configuration .....	15
<b>6. Test Results .....</b>	<b>16</b>
6.1 Summary of Test Results .....	16
6.2 Test Results .....	17
6.2.1 Test Mode: Device operating in Master Mode .....	17
6.2.2 U-NII Detection Bandwidth .....	22
6.2.3 Channel Availability Check Time .....	32
6.2.4 Channel Closing Transmission and Channel Move Time .....	34
6.2.5 Non- Occupancy Period .....	69
<b>7. Information of the Testing Laboratories .....</b>	<b>71</b>
<b>APPENDIX-A .....</b>	<b>72</b>



### Release Control Record

Issue No.	Description	Date Issued
RFBBQZ-WTW-P22010396-2	Original release.	2022/5/13

## 1 Certificate of Conformity

**Product:** NIGHTHAWK AX6 AX5400 6-Stream WiFi Router,  
NIGHTHAWK Pro Gaming Router

**Brand:** NETGEAR

**Test Model:** RAX50v2

**Series Model:** XR1000v2

**Sample Status:** Engineering sample

**Applicant and**

**Manufacturer:** NETGEAR, Inc.

**Test Date:** 2022/3/18 ~ 2022/3/27

**Standards:** FCC Part 15, Subpart E (Section 15.407)

**References Test Guidance:** KDB 905462 D02 UNII DFS Compliance Procedures New Rules v02

The above equipment has been tested by **Bureau Veritas Consumer Products Services (H.K.) Ltd., Taoyuan Branch**, and found compliance with the requirement of the above standards. The test record, data evaluation & Equipment Under Test (EUT) configurations represented herein are true and accurate accounts of the measurements of the sample's EMC characteristics under the conditions specified in this report.

**Prepared by :** Vivian Huang , **Date:** 2022/5/13  
Vivian Huang / Specialist

**Approved by :** [Signature] , **Date:** 2022/5/13  
May Chen / Manager

## 2 EUT Information

### 2.1 Operating Frequency Bands and Mode of EUT

Table 1: Operating Frequency Bands and Mode of EUT

Operational Mode	Operating Frequency Range	
	5250~5350MHz	5470~5725MHz
Master	✓	✓

### 2.2 EUT Software and Firmware Version

Table 2: The EUT Software/Firmware Version

No.	Product	Model No.	Software/Firmware Version
1	NIGHTHAWK AX6 AX5400 6-Stream WiFi Router	RAX50v2	V1.1.0.5_2.15.1

### 2.3 Description of Available Antennas to the EUT

Table 3: Antenna List

Model: RAX50v2, XR1000v2			
Frequency Range (GHz)	Directional Antenna Gain (dBi)	Antenna Type	Antenna Connector
2.4~2.4835	3.73	Dipole	R-SMA
5.15 ~ 5.25	6.65		
5.25 ~ 5.35	6.69		
5.47 ~ 5.725	6.27		
5.725 ~ 5.85	6.57		
Model: RAX43v2			
Frequency Range (GHz)	Directional Antenna Gain (dBi)	Antenna Type	Antenna Connector
2.4~2.4835	3.73	Dipole	R-SMA
5.15 ~ 5.25	5.87		
5.25 ~ 5.35	6.4		
5.47 ~ 5.725	6.16		
5.725 ~ 5.85	6.18		

Note: More detailed information, please refer to antenna specification.

## 2.4 EUT Maximum and Minimum Conducted Power

Table 4: The Measured Conducted Output Power

### CDD Mode

Frequency Band (MHz)	MAX. Power		MIN. Power	
	Output Power (mW)	Output Power (dBm)	Output Power (mW)	Output Power (dBm)
5250~5350	247.599	23.94	62.23	17.94
5470~5725	243.967	23.87	61.235	17.87

### Beamforming Mode

Frequency Band (MHz)	MAX. Power		MIN. Power	
	Output Power (mW)	Output Power (dBm)	Output Power (mW)	Output Power (dBm)
5250~5350	213.155	23.29	53.58	17.29
5470~5725	214.256	23.31	53.827	17.31

## 2.5 EUT Maximum and Minimum EIRP Power

Table 5: The EIRP Output Power List

### CDD Mode

Frequency Band (MHz)	MAX. EIRP Power		MIN. EIRP Power	
	Output Power (mW)	Output Power (dBm)	Output Power (mW)	Output Power (dBm)
5250~5350	498.884	26.98	125.314	20.98
5470~5725	512.861	27.1	128.825	21.1

### Beamforming Mode

Frequency Band (MHz)	MAX. EIRP Power		MIN. EIRP Power	
	Output Power (mW)	Output Power (dBm)	Output Power (mW)	Output Power (dBm)
5250~5350	995.405	29.98	250.035	23.98
5470~5725	907.821	29.58	228.034	23.58

## 2.6 Transmit Power Control (TPC)

U-NII devices operating in the 5.25-5.35 GHz band and the 5.47-5.725 GHz band shall employ a TPC mechanism. The U-NII device is required to have the capability to operate at least 6 dB below the mean EIRP value of 30 dBm. A TPC mechanism is not required for systems with an e.i.r.p. of less than 500 mW.

Applicable	EIRP	FCC 15.407 (h)(1)
√	>500mW	The TPC mechanism is required for system with an EIRP of above 500mW
	<500mW	The TPC mechanism is not required for system with an EIRP of less 500mW

The UUT can adjust a transmitter's output power based on the signal level present at the receiver. TPC is auto controlled by software.

## 2.7 Statement of Manufacturer

Manufacturer statement confirming that information regarding the parameters of the detected Radar Waveforms is not available to the end user.

### 3. U-NII DFS Rule Requirements

#### 3.1 Working Modes and Required Test Items

The manufacturer shall state whether the UUT is capable of operating as a Master and/or a Client. If the UUT is capable of operating in more than one operating mode then each operating mode shall be tested separately. See tables 6 and 7 for the applicability of DFS requirements for each of the operational modes.

Table 6: Applicability of DFS Requirements Prior to Use a Channel

Requirement	Operational Mode		
	Master	Client without radar detection	Client with radar detection
Non-Occupancy Period	✓	✓ note	✓
DFS Detection Threshold	✓	Not required	✓
Channel Availability Check Time	✓	Not required	Not required
U-NII Detection Bandwidth	✓	Not required	✓

Note: Per KDB 905462 D03 UNII Clients Without Radar Detection New Rules v01r02 section (b)(5/6), If the client moves with the master, the device is considered compliant if nothing appears in the client non-occupancy period test. For devices that shut down (rather than moving channels), no beacons should appear. An analyzer plot that contains a single 30-minute sweep on the original channel.

Table 7: Applicability of DFS Requirements during Normal Operation

Requirement	Operational Mode	
	Master or Client with radar detection	Client without radar detection
DFS Detection Threshold	✓	Not required
Channel Closing Transmission Time	✓	✓
Channel Move Time	✓	✓
U-NII Detection Bandwidth	✓	Not required

Additional requirements for devices with multiple bandwidth modes	Master or Client with radar detection	Client without radar detection
U-NII Detection Bandwidth and Statistical Performance Check	All BW modes must be tested	Not required
Channel Move Time and Channel Closing Transmission Time	Test using widest BW mode available	Test using the widest BW mode available for the link
All other tests	Any single BW mode	Not required

Note: Frequencies selected for statistical performance check (Section 7.8.4) should include several frequencies within the radar detection bandwidth and frequencies near the edge of the radar detection bandwidth. For 802.11 devices it is suggested to select frequencies in each of the bonded 20 MHz channels and the channel center frequency.



### 3.2 Test Limits and Radar Signal Parameters

#### Detection Threshold Values

Table 8: DFS Detection Thresholds for Master Devices and Client Devices with Radar Detection

Maximum Transmit Power	Value (See Notes 1, 2, and 3)
EIRP $\geq$ 200 milliwatt	-64 dBm
EIRP < 200 milliwatt and power spectral density < 10 dBm/MHz	-62 dBm
EIRP < 200 milliwatt that do not meet the power spectral density requirement	-64 dBm

Note 1: This is the level at the input of the receiver assuming a 0 dBi receive antenna.

Note 2: Throughout these test procedures an additional 1 dB has been added to the amplitude of the test transmission waveforms to account for variations in measurement equipment. This will ensure that the test signal is at or above the detection threshold level to trigger a DFS response.

Note 3: EIRP is based on the highest antenna gain. For MIMO devices refer to KDB Publication 662911 D01.

Table 9: DFS Response Requirement Values

Parameter	Value
Non-occupancy period	Minimum 30 minutes
Channel Availability Check Time	60 seconds
Channel Move Time	10 seconds See Note 1.
Channel Closing Transmission Time	200 milliseconds + an aggregate of 60 milliseconds over remaining 10 second period. See Notes 1 and 2.
U-NII Detection Bandwidth	Minimum 100% of the U-NII 99% transmission power bandwidth. See Note 3

Note 1: Channel Move Time and the Channel Closing Transmission Time should be performed with Radar Type 0. The measurement timing begins at the end of the Radar Type 0 burst.

Note 2: The Channel Closing Transmission Time is comprised of 200 milliseconds starting at the beginning of the Channel Move Time plus any additional intermittent control signals required to facilitate a Channel move (an aggregate of 60 milliseconds) during the remainder of the 10 second period. The aggregate duration of control signals will not count quiet periods in between transmissions.

Note 3: During the U-NII Detection Bandwidth detection test, radar type 0 should be used. For each frequency step the minimum percentage of detection is 90 percent. Measurements are performed with no data traffic.

### Parameters of DFS Test Signals

Step intervals of 0.1 microsecond for Pulse Width, 1 microsecond for PRI, 1 MHz for chirp width and 1 for the number of pulses will be utilized for the random determination of specific test waveforms.

Table 10: Short Pulse Radar Test Waveforms

Radar Type	Pulse Width (μsec)	PRI (μsec)	Number of Pulses	Minimum Percentage of Successful Detection	Minimum Number of Trials
0	1	1428	18	See Note 1	See Note 1
1	1	Test A 15 unique PRI values randomly selected from the list of 23 PRI values	Roundup $\left\{ \left( \frac{1}{360} \right) \cdot \left( \frac{19 \cdot 10^6}{\text{PRI}_{\mu\text{sec}}} \right) \right\}$	60%	30
		15 unique PRI values randomly selected within the range of 518~3066 μsec with a minimum of 1 μsec, excluding PRI values selected in Test A			
2	1-5	150-230	23-29	60%	30
3	6-10	200-500	16-18	60%	30
4	11-20	200-500	12-16	60%	30
Aggregate (Radar Types 1-4)				80%	120
Note 1: Short Pulse Radar Type 0 should be used for the detection bandwidth test, channel move time, and channel closing time tests.					

Table 11: Long Pulse Radar Test Waveform

Radar Type	Pulse Width (μsec)	Chirp Width (MHz)	PRI (μsec)	Number of Pulses Per Burst	Number of Bursts	Minimum Percentage of Successful Detection	Minimum Number of Trials
5	50-100	5-20	1000-2000	1-3	8-20	80%	30

Three subsets of trials will be performed with a minimum of ten trials per subset. The subset of trials differ in where the Long Pulse Type 5 Signal is tuned in frequency.

- a) the Channel center frequency
- b) tuned frequencies such that 90% of the Long Pulse Type 5 frequency modulation is within the low edge of the UUT Occupied Bandwidth
- c) tuned frequencies such that 90% of the Long Pulse Type 5 frequency modulation is within the high edge of the UUT Occupied Bandwidth

It include 10 trails for every subset, the formula as below,

For subset case 1: the center frequency of the signal generator will remain fixed at the center of the UUT Channel.

For subset case 2: to retain 90% frequency overlap between the radar signal and the UUT Occupied Bandwidth, the center frequency of the signal generator will vary for each of the ten trials in subset case 2. The center frequency of the signal generator for each trial is calculated by:

$$FL+(0.4*Chirp\ Width\ [in\ MHz])$$

For subset case 3: to retain 90% frequency overlap between the radar signal and the UUT Occupied Bandwidth, the center frequency of the signal generator will vary for each of the ten trials in subset case 3. The center frequency of the signal generator for each trial is calculated by:

$$FH-(0.4*Chirp\ Width\ [in\ MHz])$$

Table 12: Frequency Hopping Radar Test Waveform

Radar Type	Pulse Width (μsec)	PRI (μsec)	Pulses per Hop	Hopping Rate (kHz)	Hopping Sequence Length (msec)	Minimum Percentage of Successful Detection	Minimum Number of Trials
6	1	333	9	0.333	300	70%	30

#### 4. Test & Support Equipment List

##### 4.1 Test Instruments

Table 13: Test Instruments List

DESCRIPTION & MANUFACTURER	MODEL NO.	SERIAL NO.	CALIBRATED DATE	CALIBRATED UNTIL
Spectrum Analyzer R&S	FSV40	101516	2022/3/7	2023/3/6
MXG X-Series RF Vector Signal Generator Agilent	N5182B	MY53051263	2021/8/31	2022/8/30
Horn Antenna ChamPro	1018G	0001	2021/11/14	2022/11/13
DFS Control Box	BV-DFS-CB	001	2021/11/26	2022/11/25

- NOTE:**
1. The test was performed in DFS-1 room.
  2. The calibration interval of the above test instruments is 12 months and the calibrations are traceable to NML/ROC and NIST/USA.
  3. Tested Date: 2022/3/18 ~ 2022/3/27

##### 4.2 Description of Support Units

Table 14: Support Unit Information

No.	Product	Brand	Model No.	FCC ID	Spec
1	Wireless-AX6000 Dual Band Gigabit Router	ASUS	RT-AX88U	MSQ-RTAXHP00	The maximum EIRP is 29.97 dBm, Antenna Gain is 2.24dBi

**NOTE:** This device was functioned as a  Master  Client device during the DFS test.

Table 15: Software/Firmware Information

No.	Product	Model No.	Software/Firmware Version
1	Wireless-AX6000 Dual Band Gigabit Router	RT-AX88U	3.0.0.4.386

## 5. Test Procedure

### 5.1 DFS Measurement System

A complete DFS Measurement System consists of two subsystems: (1) the Radar Signal Generating system and (2) the Traffic Monitoring system. The control PC is necessary for generating the Radar waveforms in Table 10, 11 and 12. The traffic monitoring subsystem is specified to the type of unit under test (UUT).

#### Radiated Setup Configuration of DFS Measurement System

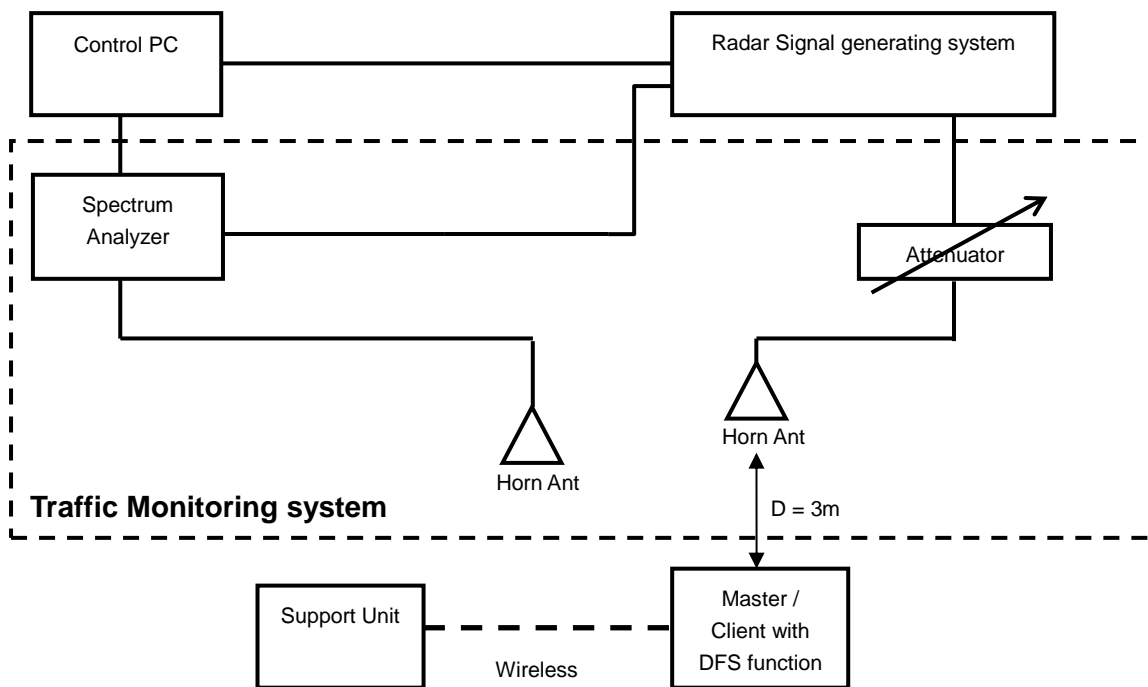

#### Channel Loading

System testing will be performed with channel-loading using means appropriate to the data types that are used by the unlicensed device. The following requirements apply:

a)	The data file must be of a type that is typical for the device (i.e., MPEG-2, MPEG-4, WAV, MP3, MP4, AVI, etc.) and must generally be transmitting in a streaming mode.	
b)	Software to ping the client is permitted to simulate data transfer but must have random ping intervals.	
c)	Timing plots are required with calculations demonstrating a minimum channel loading of approximately 17% or greater.	✓
d)	Unicast or Multicast protocols are preferable but other protocols may be used. The appropriate protocol used must be described in the test procedures.	

## 5.2 Calibration of DFS Detection Threshold Level

The measured channel is chosen from the operating channels of the UUT within the 5250-5350MHz or 5470-5725MHz and using the all bandwidth mode available for the link. The radar signal was the same as transmitted channels, and injected into the antenna of AP (master) or Client Device with Radar Detection, measured the channel closing transmission time and channel move time.

### Radiated setup configuration of Calibration of DFS Detection Threshold Level

The radar signal generate system is generating waveform pattern of radar types. The amplitude of the radar signal generator system is adjusted to yield a level of  $-64$  dBm as measured on the spectrum analyzer. The interference detection threshold level is lower than  $-64$ dBm hence it provides margin to the limit.

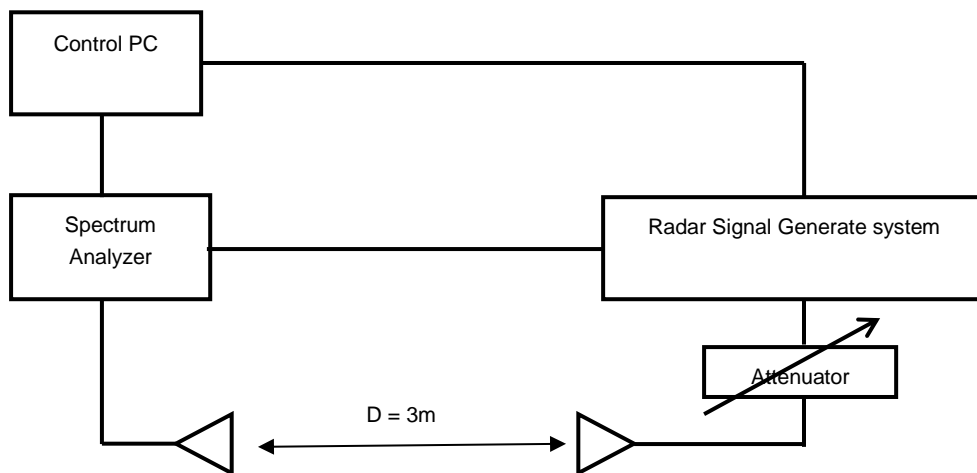

## 5.3 Deviation from Test Standard

No deviation.

## 5.4 Radiated Test Setup Configuration

### Master mode

The EUT is a U-NII Device operating in Master mode. The radar test signals are injected into the Master Device.

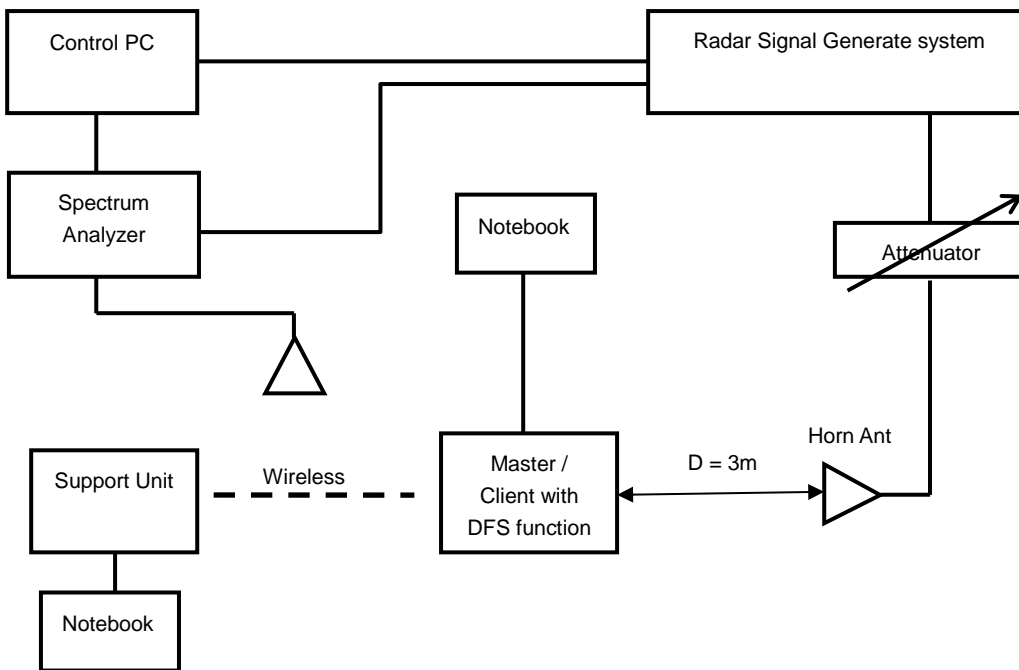

Note: The UUT main beam of the antenna is directly toward the radar emitter during testing.

## 6. Test Results

### 6.1 Summary of Test Results

Clause	Test Parameter	Remarks	Pass/Fail
15.407	DFS Detection Threshold	Applicable	Pass
15.407	Channel Availability Check Time	Applicable	Pass
15.407	Channel Move Time	Applicable	Pass
15.407	Channel Closing Transmission Time	Applicable	Pass
15.407	Non- Occupancy Period	Applicable	Pass
15.407	U-NII Detection Bandwidth and Statistical Performance Check	Applicable	Pass

Note:

1. Determining compliance based on the results of the compliance measurement, not taking into account measurement instrumentation uncertainty.
2. This device does not support "802.11ax Channel Puncturing" function.



## 6.2 Test Results

### 6.2.1 Test Mode: Device operating in Master Mode

The radar test waveforms are injected into the Master.  
 This test was investigated for different bandwidth (20MHz · 40MHz · 80MHz and 160MHz).  
 The following plots was done on 160MHz as a representative.

#### DFS Detection Threshold

For detection threshold level of -64dBm, the tested level is lower than required level for 1dB, hence it provides margin to the limit.

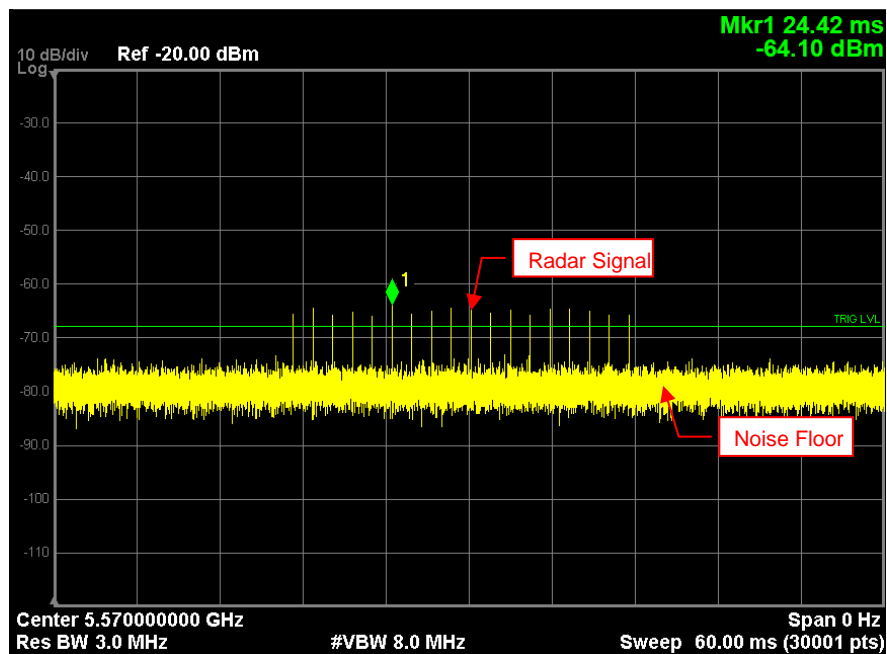

Radar Signal 0

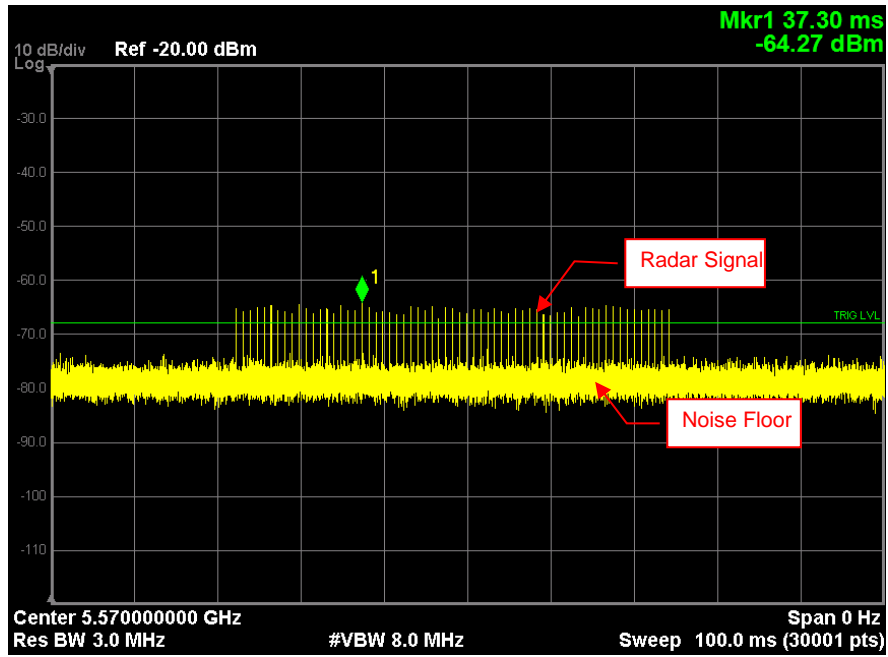

Radar Signal 1 (Test A)

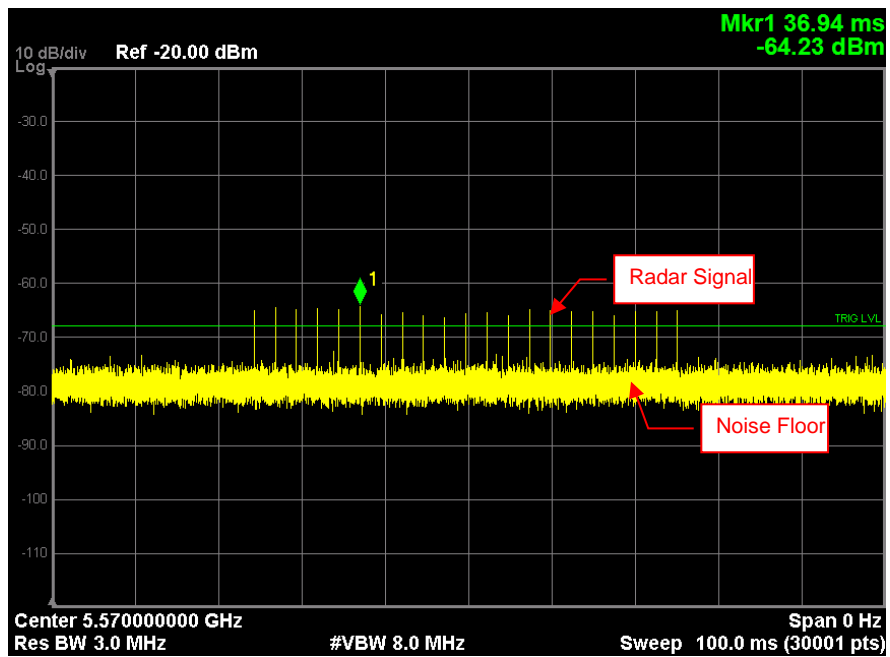

Radar Signal 1 (Test B)

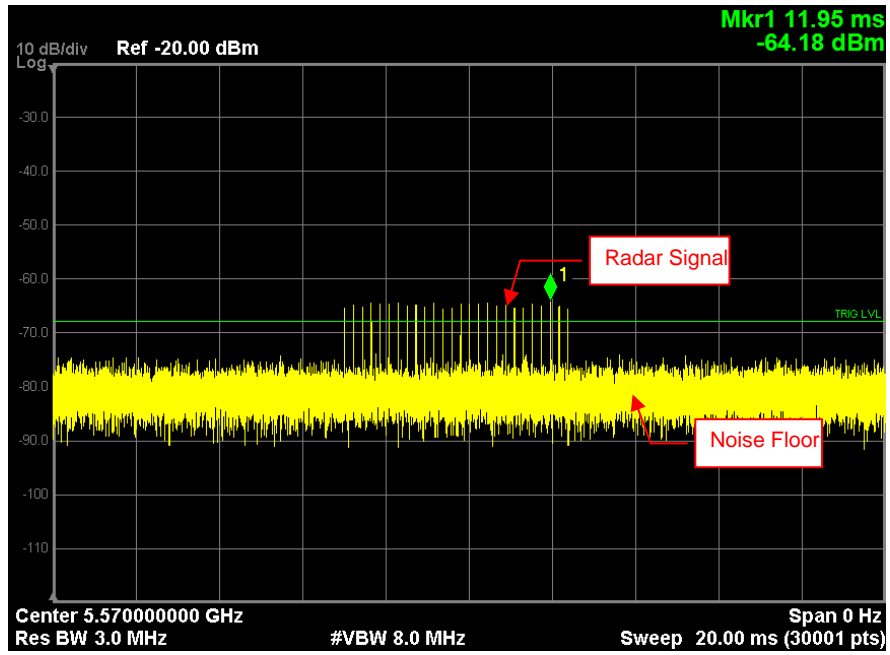

Radar Signal 2

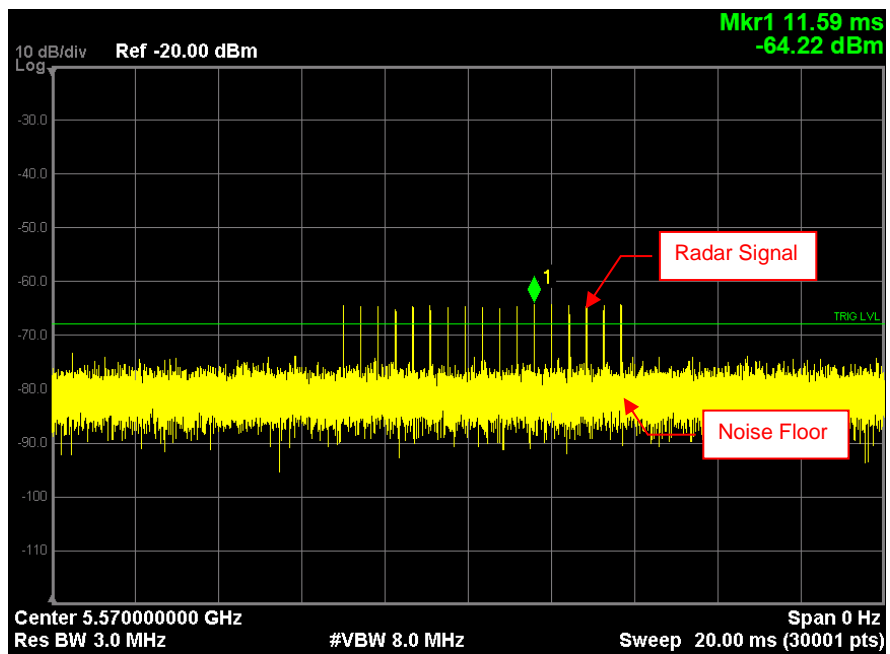

Radar Signal 3

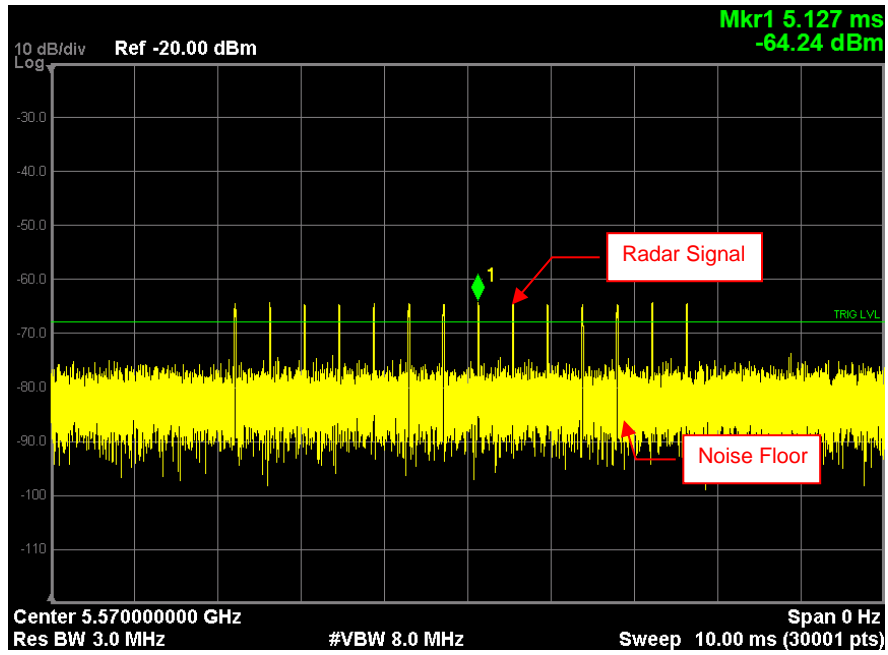

Single Burst of Radar Signal 4

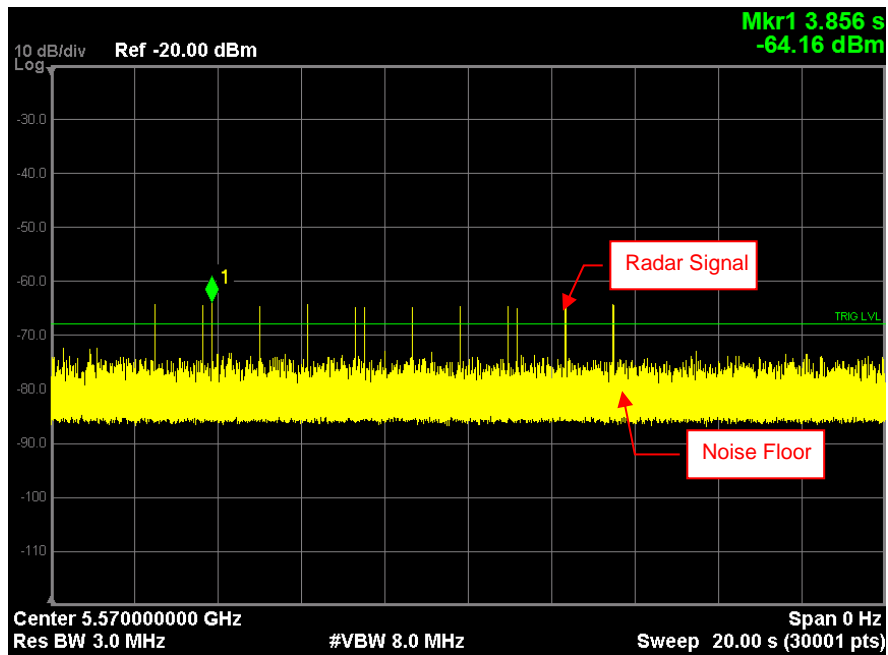

Radar Signal 5

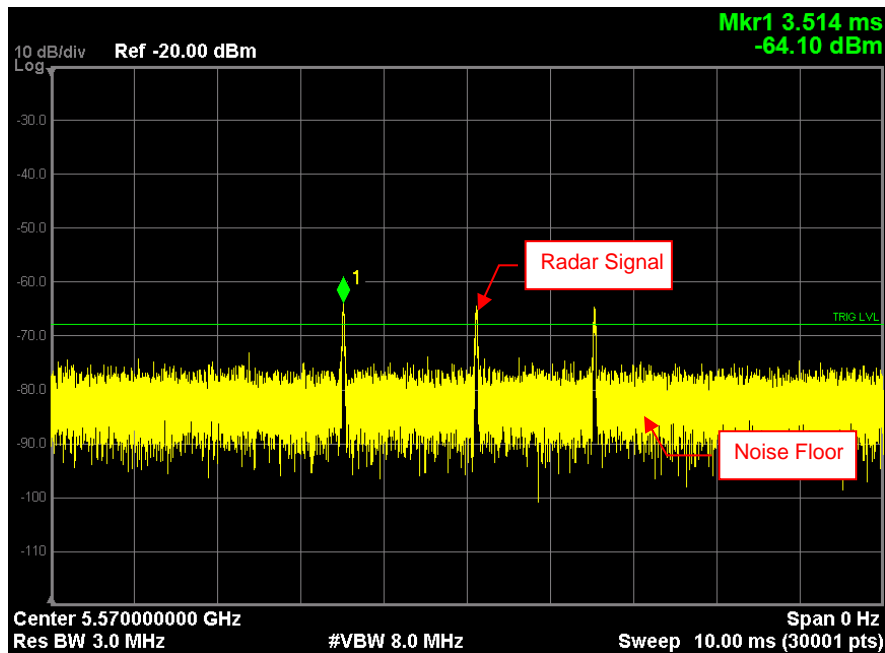

Single Burst of Radar Signal 5

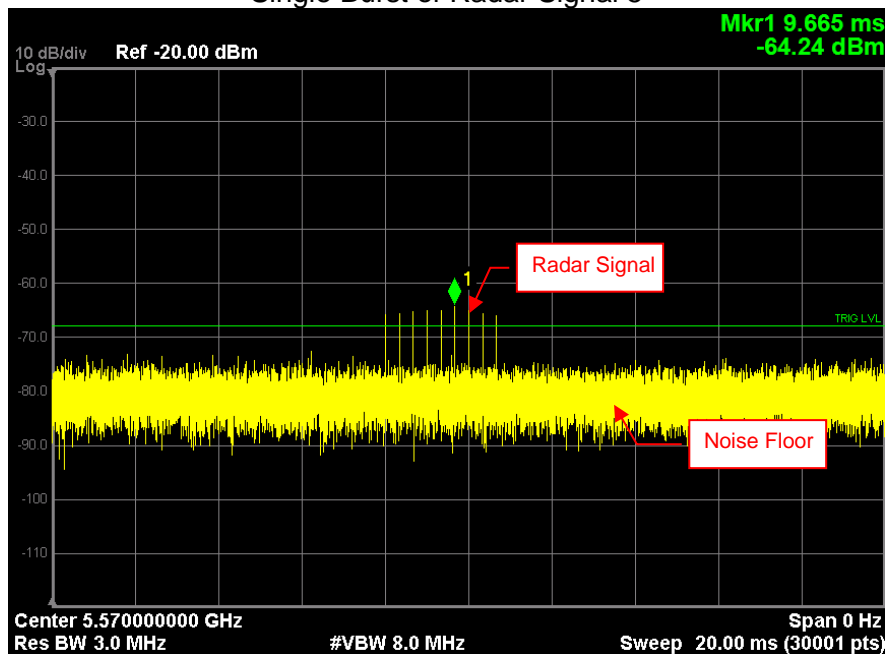

Radar Signal 6

6.2.2 U-NII Detection Bandwidth

802.11ax (HE20)

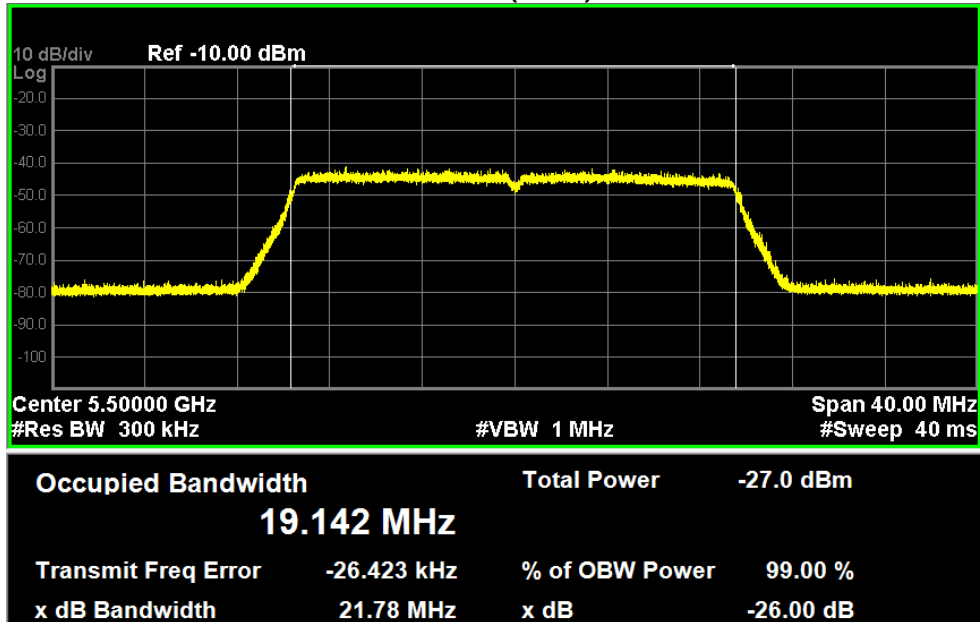

U-NII 99% Channel bandwidth

802.11ax (HE40)

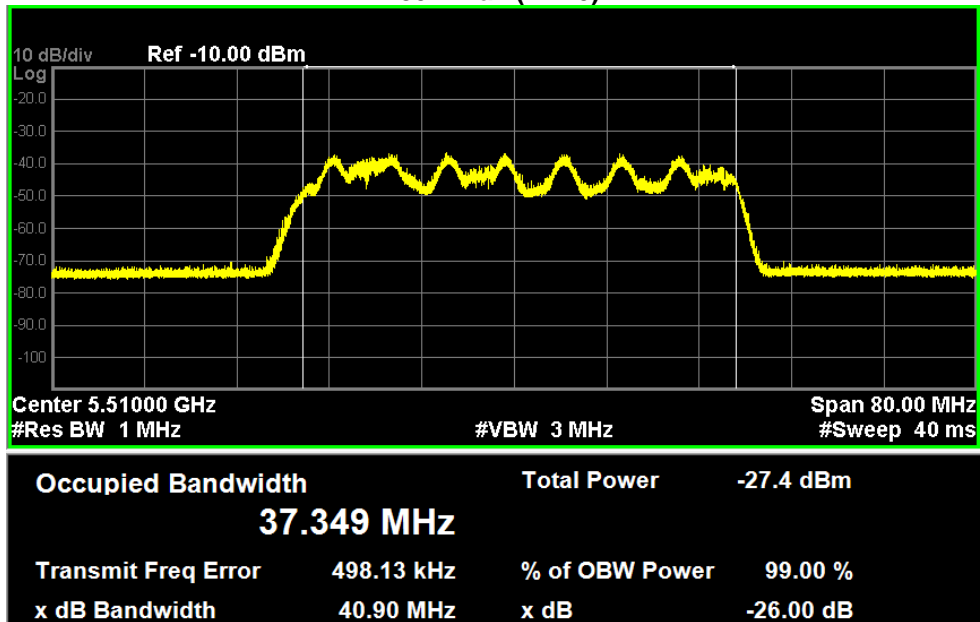

U-NII 99% Channel bandwidth



### 802.11ax (HE80)

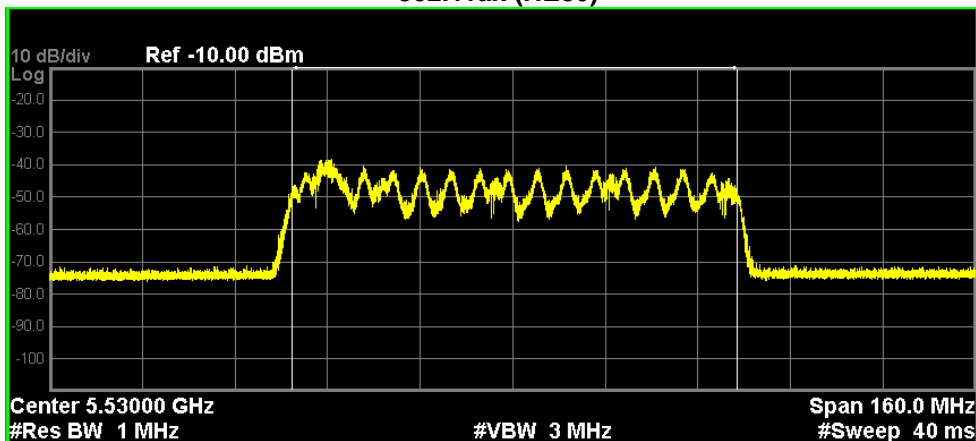

<b>Occupied Bandwidth</b>	<b>Total Power</b>	<b>-28.1 dBm</b>	
<b>76.887 MHz</b>			
Transmit Freq Error	319.97 kHz	% of OBW Power	99.00 %
x dB Bandwidth	80.98 MHz	x dB	-26.00 dB

U-NII 99% Channel bandwidth

### 802.11ax (HE160)

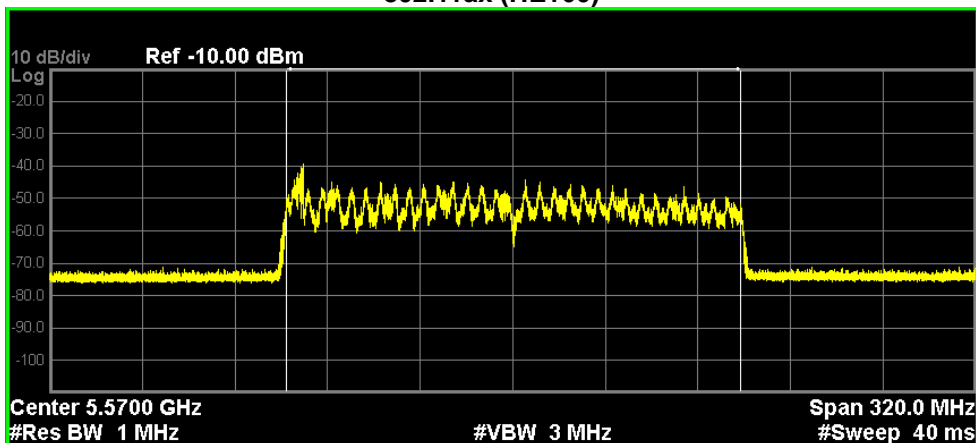

<b>Occupied Bandwidth</b>	<b>Total Power</b>	<b>-30.0 dBm</b>	
<b>157.02 MHz</b>			
Transmit Freq Error	240.55 kHz	% of OBW Power	99.00 %
x dB Bandwidth	160.6 MHz	x dB	-26.00 dB

U-NII 99% Channel bandwidth

**Detection Bandwidth Test - 802.11ax (HE20)**  
 Radar Type 0  
 EUT Frequency: 5500MHz  
 EUT 99% Power bandwidth: 19.142MHz  
 Detection bandwidth limit (100% of EUT 99% Power bandwidth): 19.142MHz  
 Detection bandwidth (5510(FH) – 5490(FL)) : 20MHz  
 Test Result : PASS

Radar Frequency (MHz)	Trial Number / Detection										Detection Rate (%)
	1	2	3	4	5	6	7	8	9	10	
5490(FL)	Yes	Yes	Yes	Yes	Yes	Yes	Yes	Yes	Yes	Yes	100
5491	Yes	Yes	No	Yes	Yes	Yes	Yes	Yes	Yes	Yes	90
5492	Yes	Yes	Yes	Yes	Yes	Yes	Yes	Yes	Yes	Yes	100
5493	Yes	Yes	Yes	Yes	Yes	Yes	Yes	Yes	No	Yes	90
5494	Yes	Yes	Yes	Yes	Yes	Yes	Yes	Yes	Yes	Yes	100
5495	Yes	Yes	Yes	Yes	Yes	Yes	Yes	Yes	Yes	Yes	100
5496	Yes	Yes	Yes	Yes	Yes	Yes	Yes	Yes	Yes	Yes	100
5497	Yes	Yes	Yes	Yes	Yes	Yes	Yes	Yes	Yes	Yes	100
5498	Yes	Yes	Yes	Yes	Yes	Yes	Yes	Yes	Yes	Yes	100
5499	Yes	Yes	Yes	Yes	Yes	Yes	Yes	Yes	Yes	Yes	100
5500	No	Yes	Yes	Yes	Yes	Yes	Yes	Yes	Yes	Yes	90
5501	Yes	Yes	Yes	Yes	Yes	Yes	Yes	Yes	Yes	Yes	100
5502	Yes	Yes	Yes	Yes	Yes	Yes	Yes	Yes	Yes	Yes	100
5503	Yes	Yes	Yes	Yes	Yes	Yes	Yes	Yes	Yes	Yes	100
5504	Yes	Yes	Yes	Yes	Yes	Yes	Yes	Yes	Yes	Yes	100
5505	Yes	Yes	Yes	Yes	Yes	Yes	Yes	Yes	Yes	Yes	100
5506	Yes	Yes	Yes	Yes	Yes	Yes	Yes	Yes	Yes	Yes	100
5507	Yes	Yes	Yes	Yes	Yes	Yes	Yes	Yes	Yes	Yes	100
5508	Yes	Yes	Yes	Yes	Yes	Yes	Yes	Yes	Yes	Yes	100
5509	Yes	Yes	Yes	Yes	Yes	Yes	Yes	Yes	Yes	Yes	100
5510(FH)	Yes	Yes	No	Yes	Yes	Yes	Yes	Yes	Yes	Yes	90





Detection Bandwidth Test - **802.11ax (HE40)**  
 Radar Type 0  
 EUT Frequency: 5510MHz  
 EUT 99% Power bandwidth: 37.349MHz  
 Detection bandwidth limit (100% of EUT 99% Power bandwidth): 37.349MHz  
 Detection bandwidth (5529(FH) – 5491(FL)) : 38MHz  
 Test Result : PASS

Radar Frequency (MHz)	Trial Number / Detection										Detection Rate (%)
	1	2	3	4	5	6	7	8	9	10	
5491(FL)	Yes	Yes	Yes	No	Yes	Yes	Yes	Yes	Yes	Yes	90
5492	Yes	Yes	Yes	Yes	Yes	Yes	Yes	Yes	Yes	Yes	100
5493	Yes	Yes	Yes	Yes	Yes	Yes	Yes	Yes	Yes	Yes	100
5494	Yes	Yes	Yes	Yes	Yes	Yes	Yes	Yes	Yes	Yes	100
5495	Yes	Yes	Yes	Yes	Yes	Yes	Yes	Yes	Yes	Yes	100
5496	Yes	Yes	Yes	Yes	Yes	Yes	Yes	Yes	Yes	Yes	100
5497	Yes	Yes	Yes	Yes	Yes	Yes	Yes	Yes	Yes	Yes	100
5498	Yes	Yes	Yes	Yes	Yes	Yes	Yes	Yes	Yes	Yes	100
5499	Yes	Yes	Yes	Yes	Yes	Yes	Yes	Yes	Yes	Yes	100
5500	Yes	Yes	Yes	Yes	Yes	Yes	Yes	Yes	Yes	Yes	100
5501	Yes	Yes	Yes	Yes	Yes	Yes	Yes	Yes	Yes	Yes	100
5502	Yes	Yes	Yes	Yes	Yes	Yes	Yes	Yes	Yes	Yes	100
5503	Yes	Yes	Yes	Yes	Yes	Yes	Yes	Yes	Yes	Yes	100
5504	Yes	Yes	Yes	Yes	Yes	Yes	Yes	Yes	Yes	Yes	100
5505	Yes	Yes	Yes	Yes	Yes	Yes	Yes	No	Yes	Yes	90
5506	Yes	Yes	Yes	Yes	Yes	Yes	Yes	Yes	Yes	Yes	100
5507	Yes	Yes	Yes	Yes	Yes	Yes	Yes	Yes	Yes	Yes	100
5508	Yes	Yes	Yes	Yes	Yes	Yes	Yes	Yes	Yes	Yes	100
5509	Yes	Yes	Yes	Yes	Yes	Yes	Yes	Yes	Yes	Yes	100
5510	Yes	Yes	Yes	Yes	Yes	Yes	Yes	Yes	Yes	Yes	100
5511	Yes	Yes	Yes	Yes	Yes	Yes	Yes	Yes	Yes	Yes	100
5512	Yes	Yes	Yes	Yes	Yes	Yes	Yes	Yes	Yes	Yes	100
5513	Yes	Yes	Yes	Yes	Yes	Yes	Yes	Yes	Yes	Yes	100
5514	Yes	Yes	Yes	Yes	Yes	Yes	Yes	Yes	Yes	Yes	100
5515	Yes	Yes	Yes	Yes	Yes	Yes	Yes	Yes	Yes	Yes	100
5516	Yes	Yes	Yes	Yes	Yes	Yes	Yes	Yes	Yes	Yes	100
5517	Yes	Yes	Yes	Yes	Yes	Yes	Yes	Yes	Yes	Yes	100
5518	Yes	Yes	Yes	Yes	Yes	Yes	Yes	Yes	Yes	Yes	100
5519	Yes	Yes	Yes	Yes	Yes	Yes	Yes	Yes	Yes	Yes	100
5520	Yes	Yes	Yes	Yes	Yes	Yes	Yes	Yes	Yes	Yes	100
5521	Yes	Yes	Yes	Yes	Yes	Yes	Yes	Yes	Yes	Yes	100
5522	Yes	Yes	Yes	Yes	Yes	Yes	Yes	Yes	No	Yes	90
5523	Yes	Yes	Yes	Yes	Yes	Yes	Yes	Yes	Yes	Yes	100
5524	Yes	Yes	Yes	Yes	Yes	Yes	Yes	Yes	Yes	Yes	100
5525	Yes	Yes	Yes	Yes	Yes	Yes	Yes	Yes	Yes	Yes	100
5526	Yes	Yes	Yes	Yes	Yes	Yes	Yes	Yes	Yes	Yes	100
5527	Yes	Yes	Yes	Yes	Yes	Yes	Yes	Yes	Yes	Yes	100
5528	Yes	Yes	Yes	Yes	Yes	Yes	Yes	Yes	Yes	Yes	100
5529(FH)	Yes	Yes	Yes	Yes	Yes	Yes	Yes	Yes	Yes	Yes	100



Detection Bandwidth Test - **802.11ax (HE80)**  
 Radar Type 0  
 EUT Frequency: 5530MHz  
 EUT 99% Power bandwidth: 76.887MHz  
 Detection bandwidth limit (100% of EUT 99% Power bandwidth): 76.887MHz  
 Detection bandwidth (5569(FH) – 5491(FL)) : 78MHz  
 Test Result : PASS

Radar Frequency (MHz)	Trial Number / Detection										Detection Rate (%)
	1	2	3	4	5	6	7	8	9	10	
5491(FL)	Yes	Yes	Yes	Yes	Yes	Yes	Yes	Yes	Yes	Yes	100
5492	Yes	Yes	Yes	Yes	Yes	Yes	Yes	Yes	Yes	Yes	100
5493	Yes	Yes	Yes	Yes	Yes	Yes	Yes	Yes	Yes	Yes	100
5494	Yes	Yes	Yes	Yes	Yes	Yes	Yes	Yes	Yes	Yes	100
5495	Yes	Yes	Yes	Yes	Yes	Yes	Yes	Yes	Yes	Yes	100
5496	Yes	Yes	Yes	Yes	Yes	No	Yes	Yes	Yes	Yes	90
5497	Yes	Yes	Yes	Yes	Yes	Yes	Yes	Yes	Yes	Yes	100
5498	Yes	Yes	Yes	Yes	Yes	Yes	Yes	Yes	Yes	Yes	100
5499	Yes	Yes	Yes	Yes	Yes	Yes	Yes	Yes	Yes	Yes	100
5500	Yes	Yes	Yes	Yes	Yes	Yes	Yes	Yes	Yes	Yes	100
5501	Yes	Yes	Yes	Yes	Yes	Yes	Yes	Yes	Yes	Yes	100
5502	Yes	Yes	Yes	Yes	Yes	Yes	Yes	Yes	Yes	Yes	100
5503	Yes	Yes	Yes	Yes	Yes	Yes	Yes	Yes	Yes	Yes	100
5504	Yes	Yes	Yes	Yes	Yes	Yes	Yes	Yes	Yes	Yes	100
5505	Yes	Yes	Yes	Yes	Yes	Yes	Yes	Yes	Yes	Yes	100
5506	Yes	Yes	Yes	Yes	Yes	Yes	Yes	Yes	Yes	Yes	100
5507	Yes	Yes	Yes	Yes	Yes	Yes	Yes	Yes	Yes	Yes	100
5508	Yes	Yes	Yes	Yes	Yes	Yes	Yes	Yes	Yes	Yes	100
5509	Yes	Yes	Yes	Yes	Yes	Yes	Yes	Yes	Yes	Yes	100
5510	Yes	Yes	Yes	Yes	Yes	Yes	Yes	No	Yes	Yes	90
5511	Yes	Yes	Yes	Yes	Yes	Yes	Yes	Yes	Yes	Yes	100
5512	Yes	Yes	Yes	Yes	Yes	Yes	Yes	Yes	Yes	Yes	100
5513	Yes	Yes	Yes	Yes	Yes	Yes	Yes	Yes	Yes	Yes	100
5514	Yes	Yes	Yes	Yes	Yes	Yes	Yes	Yes	Yes	Yes	100
5515	Yes	Yes	Yes	Yes	Yes	Yes	Yes	Yes	Yes	Yes	100
5516	Yes	Yes	Yes	Yes	Yes	Yes	Yes	Yes	Yes	Yes	100
5517	Yes	Yes	Yes	Yes	Yes	Yes	Yes	Yes	Yes	Yes	100
5518	Yes	Yes	Yes	Yes	Yes	Yes	Yes	Yes	Yes	Yes	100
5519	Yes	Yes	Yes	Yes	Yes	Yes	Yes	Yes	Yes	Yes	100
5520	Yes	Yes	Yes	Yes	Yes	Yes	Yes	Yes	Yes	Yes	100
5521	Yes	Yes	Yes	Yes	Yes	Yes	Yes	Yes	Yes	Yes	100
5522	Yes	Yes	Yes	Yes	Yes	Yes	Yes	Yes	Yes	Yes	100
5523	Yes	Yes	Yes	Yes	Yes	Yes	Yes	Yes	Yes	Yes	100
5524	Yes	Yes	Yes	Yes	Yes	Yes	Yes	Yes	Yes	Yes	100
5525	Yes	Yes	Yes	Yes	Yes	Yes	Yes	Yes	Yes	Yes	100
5526	Yes	Yes	Yes	Yes	Yes	Yes	Yes	Yes	Yes	Yes	100
5527	Yes	Yes	Yes	Yes	Yes	Yes	Yes	Yes	Yes	Yes	100
5528	Yes	Yes	Yes	Yes	Yes	Yes	Yes	Yes	Yes	Yes	100
5529	Yes	Yes	Yes	Yes	Yes	Yes	Yes	Yes	Yes	Yes	100
5530	Yes	Yes	Yes	Yes	Yes	Yes	Yes	Yes	Yes	Yes	100
5531	Yes	Yes	Yes	Yes	Yes	Yes	Yes	Yes	Yes	Yes	100
5532	Yes	Yes	Yes	Yes	Yes	Yes	Yes	Yes	Yes	Yes	100
5533	Yes	Yes	Yes	Yes	Yes	Yes	Yes	Yes	Yes	Yes	100
5534	Yes	Yes	Yes	Yes	Yes	Yes	Yes	Yes	Yes	Yes	100
5535	Yes	Yes	Yes	Yes	Yes	Yes	Yes	Yes	Yes	Yes	100
5536	Yes	Yes	Yes	Yes	Yes	Yes	Yes	Yes	Yes	Yes	100



5537	Yes	Yes	Yes	Yes	Yes	Yes	Yes	Yes	Yes	Yes	100
5538	Yes	Yes	Yes	Yes	Yes	Yes	Yes	Yes	Yes	Yes	100
5539	Yes	Yes	Yes	Yes	Yes	Yes	Yes	Yes	Yes	Yes	100
5540	Yes	Yes	Yes	Yes	Yes	Yes	Yes	Yes	Yes	Yes	100
5541	Yes	Yes	Yes	Yes	Yes	Yes	Yes	Yes	Yes	Yes	100
5542	Yes	Yes	Yes	Yes	Yes	Yes	Yes	Yes	Yes	Yes	100
5543	Yes	Yes	Yes	Yes	Yes	Yes	Yes	Yes	Yes	Yes	100
5544	Yes	Yes	Yes	Yes	Yes	Yes	Yes	Yes	Yes	Yes	100
5545	Yes	Yes	Yes	Yes	Yes	Yes	Yes	Yes	Yes	Yes	100
5546	Yes	Yes	Yes	Yes	Yes	Yes	Yes	Yes	Yes	Yes	100
5547	Yes	Yes	Yes	Yes	Yes	Yes	Yes	Yes	Yes	Yes	100
5548	Yes	Yes	Yes	Yes	Yes	Yes	Yes	Yes	Yes	Yes	100
5549	Yes	Yes	Yes	Yes	Yes	Yes	Yes	Yes	Yes	Yes	100
5550	Yes	Yes	Yes	Yes	Yes	Yes	Yes	Yes	Yes	Yes	100
5551	Yes	Yes	Yes	Yes	Yes	Yes	Yes	Yes	Yes	Yes	100
5552	Yes	Yes	Yes	Yes	Yes	Yes	Yes	Yes	Yes	Yes	100
5553	Yes	Yes	Yes	Yes	Yes	Yes	Yes	Yes	Yes	Yes	100
5554	Yes	Yes	Yes	Yes	Yes	Yes	Yes	Yes	Yes	Yes	100
5555	Yes	Yes	Yes	Yes	Yes	Yes	Yes	Yes	Yes	Yes	100
5556	Yes	Yes	Yes	Yes	Yes	Yes	Yes	Yes	Yes	Yes	100
5557	Yes	Yes	Yes	Yes	Yes	Yes	Yes	Yes	Yes	Yes	100
5558	Yes	Yes	Yes	Yes	Yes	Yes	Yes	Yes	Yes	Yes	100
5559	Yes	Yes	Yes	Yes	Yes	Yes	Yes	Yes	Yes	Yes	100
5560	Yes	Yes	Yes	Yes	Yes	Yes	Yes	Yes	Yes	Yes	100
5561	Yes	Yes	Yes	Yes	Yes	Yes	Yes	Yes	Yes	Yes	100
5562	Yes	Yes	Yes	Yes	Yes	Yes	Yes	Yes	Yes	Yes	100
5563	Yes	No	Yes	Yes	Yes	Yes	Yes	Yes	Yes	Yes	90
5564	Yes	Yes	Yes	Yes	Yes	Yes	Yes	Yes	Yes	Yes	100
5565	Yes	Yes	Yes	Yes	Yes	Yes	Yes	Yes	Yes	Yes	100
5566	Yes	Yes	Yes	Yes	Yes	Yes	Yes	Yes	Yes	Yes	100
5567	Yes	Yes	Yes	Yes	Yes	Yes	Yes	Yes	Yes	Yes	100
5568	Yes	Yes	Yes	Yes	Yes	Yes	Yes	Yes	Yes	Yes	100
5569(FH)	Yes	Yes	Yes	Yes	Yes	Yes	Yes	Yes	Yes	Yes	100

**Detection Bandwidth Test - 802.11ax (HE160)**

Radar Type 0

EUT Frequency: 5570MHz

EUT 99% Power bandwidth: 157.02MHz

Detection bandwidth limit (100% of EUT 99% Power bandwidth): 157.02MHz

Detection bandwidth (5649(FH) – 5491(FL)) : 158MHz

Test Result : PASS

Radar Frequency (MHz)	Trial Number / Detection										Detection Rate (%)
	1	2	3	4	5	6	7	8	9	10	
5491(FL)	Yes	Yes	Yes	Yes	Yes	No	Yes	Yes	Yes	Yes	90
5492	Yes	No	Yes	Yes	Yes	Yes	Yes	Yes	Yes	Yes	90
5493	Yes	Yes	Yes	Yes	Yes	Yes	Yes	Yes	Yes	Yes	100
5494	Yes	Yes	Yes	Yes	Yes	Yes	Yes	Yes	Yes	Yes	100
5495	Yes	Yes	Yes	Yes	Yes	Yes	Yes	Yes	Yes	Yes	100
5496	Yes	Yes	Yes	Yes	Yes	Yes	Yes	Yes	Yes	Yes	100
5497	Yes	Yes	Yes	Yes	Yes	Yes	Yes	Yes	Yes	Yes	100
5498	Yes	Yes	Yes	Yes	Yes	Yes	Yes	Yes	Yes	Yes	100
5499	Yes	Yes	Yes	Yes	Yes	Yes	Yes	Yes	Yes	Yes	100
5500	Yes	Yes	Yes	Yes	Yes	Yes	Yes	Yes	Yes	Yes	100
5501	Yes	Yes	Yes	Yes	Yes	Yes	Yes	Yes	Yes	Yes	100
5502	Yes	Yes	Yes	Yes	Yes	Yes	Yes	Yes	Yes	Yes	100
5503	Yes	Yes	Yes	Yes	Yes	Yes	Yes	Yes	Yes	Yes	100
5504	Yes	Yes	Yes	Yes	Yes	Yes	Yes	Yes	Yes	Yes	100
5505	Yes	Yes	Yes	Yes	Yes	Yes	Yes	Yes	Yes	Yes	100
5506	Yes	Yes	Yes	Yes	Yes	Yes	Yes	Yes	Yes	Yes	100
5507	Yes	Yes	Yes	Yes	Yes	Yes	Yes	Yes	Yes	Yes	100
5508	Yes	Yes	Yes	Yes	Yes	Yes	Yes	Yes	Yes	Yes	100
5509	Yes	Yes	Yes	Yes	Yes	Yes	Yes	Yes	Yes	Yes	100
5510	Yes	Yes	Yes	Yes	Yes	Yes	Yes	Yes	Yes	Yes	100
5511	Yes	Yes	Yes	Yes	Yes	Yes	Yes	Yes	Yes	Yes	100
5512	Yes	Yes	Yes	Yes	Yes	Yes	Yes	Yes	Yes	Yes	100
5513	Yes	Yes	Yes	Yes	Yes	Yes	Yes	Yes	Yes	Yes	100
5514	Yes	Yes	Yes	Yes	Yes	Yes	Yes	Yes	Yes	Yes	100
5515	Yes	Yes	Yes	Yes	Yes	Yes	Yes	Yes	Yes	Yes	100
5516	Yes	Yes	Yes	Yes	Yes	Yes	Yes	Yes	Yes	Yes	100
5517	Yes	Yes	Yes	Yes	Yes	Yes	Yes	Yes	Yes	Yes	100
5518	Yes	Yes	Yes	Yes	Yes	Yes	Yes	Yes	Yes	Yes	100
5519	Yes	Yes	Yes	Yes	Yes	Yes	Yes	Yes	Yes	Yes	100
5520	Yes	Yes	Yes	Yes	Yes	Yes	Yes	Yes	Yes	Yes	100
5521	Yes	Yes	Yes	Yes	Yes	Yes	Yes	Yes	Yes	Yes	100
5522	Yes	Yes	Yes	Yes	Yes	Yes	Yes	Yes	Yes	Yes	100
5523	Yes	Yes	Yes	Yes	Yes	Yes	Yes	Yes	Yes	Yes	100
5524	Yes	Yes	Yes	Yes	Yes	Yes	Yes	Yes	Yes	Yes	100
5525	Yes	Yes	Yes	Yes	Yes	Yes	Yes	Yes	Yes	Yes	100
5526	Yes	Yes	Yes	Yes	Yes	Yes	Yes	Yes	Yes	Yes	100
5527	Yes	Yes	Yes	Yes	Yes	Yes	Yes	Yes	Yes	Yes	100
5528	Yes	Yes	Yes	Yes	Yes	Yes	Yes	Yes	Yes	Yes	100
5529	Yes	Yes	Yes	Yes	Yes	Yes	Yes	Yes	Yes	Yes	100
5530	Yes	Yes	Yes	Yes	Yes	Yes	Yes	Yes	Yes	Yes	100
5531	Yes	Yes	Yes	Yes	Yes	Yes	Yes	Yes	Yes	Yes	100
5532	Yes	Yes	Yes	Yes	Yes	Yes	Yes	Yes	Yes	Yes	100
5533	Yes	Yes	Yes	Yes	Yes	Yes	Yes	Yes	Yes	Yes	100
5534	Yes	Yes	Yes	Yes	Yes	Yes	Yes	Yes	Yes	Yes	100
5535	Yes	Yes	Yes	Yes	Yes	Yes	Yes	Yes	Yes	Yes	100







5646	Yes	Yes	Yes	Yes	Yes	Yes	Yes	Yes	Yes	Yes	100
5647	Yes	Yes	Yes	Yes	Yes	Yes	Yes	Yes	Yes	Yes	100
5648	Yes	Yes	Yes	Yes	Yes	Yes	Yes	Yes	Yes	Yes	100
5649(FH)	Yes	Yes	Yes	Yes	Yes	Yes	Yes	Yes	Yes	Yes	90

### 6.2.3 Channel Availability Check Time

If the EUT successfully detected the radar burst, it should be observed as the EUT has no transmissions occurred until the EUT starts transmitting on another channel.

Timing of Radar Signal	Observation	
	EUT	Spectrum Analyzer
Within 1 to 6 second	Detected	No transmissions
Within 54 to 60 second	Detected	No transmissions

### Initial Channel Availability Check Time

#### Channel Availability Check

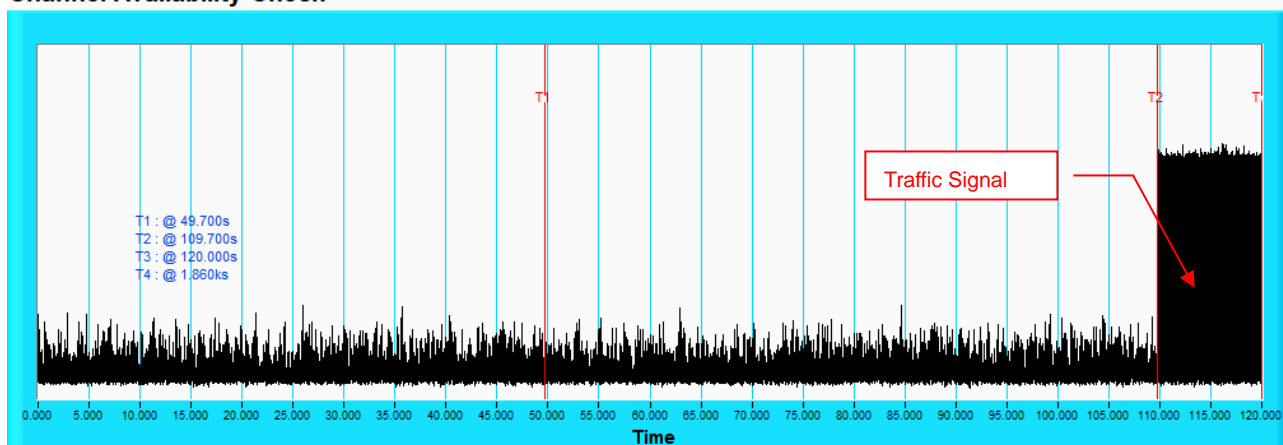

**NOTE:** T1 denotes the end of power-up time period is 49.7<sup>th</sup> second. T2 denotes the end of Channel Availability Check time is 109.7<sup>th</sup> second. Channel Availability Check time is equal to (T2 – T1) 60 seconds.



### Radar Burst at the Beginning of the Channel Availability Check Time

#### Channel Availability Check

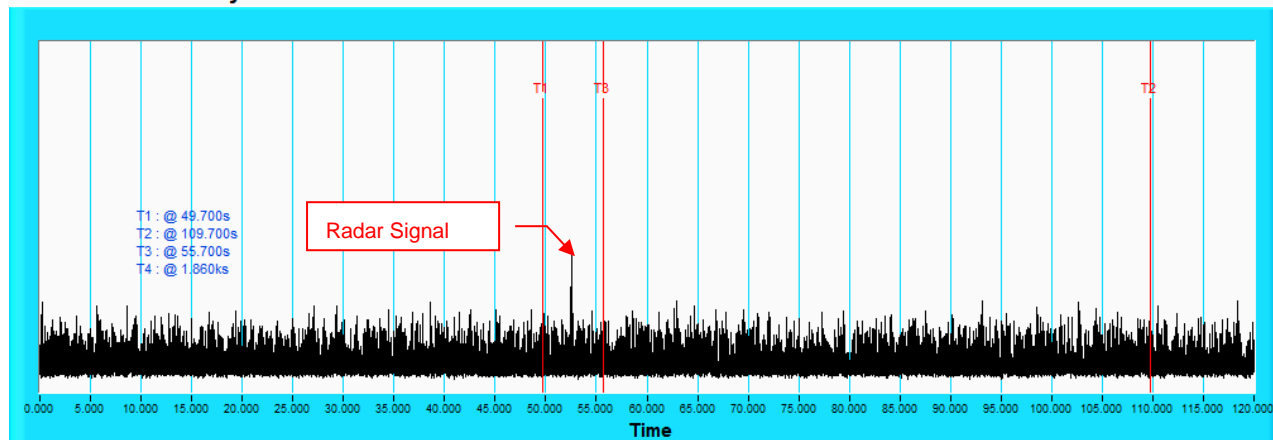

**NOTE:** T1 denotes the end of power up time period is 49.7<sup>th</sup> second. T3 denotes 55.7<sup>th</sup> second and the radar burst was commenced within a 6 second window starting from the end of power-up sequence. T2 denotes the 109.7<sup>th</sup> second.

### Radar Burst at the End of the Channel Availability Check Time

#### Channel Availability Check

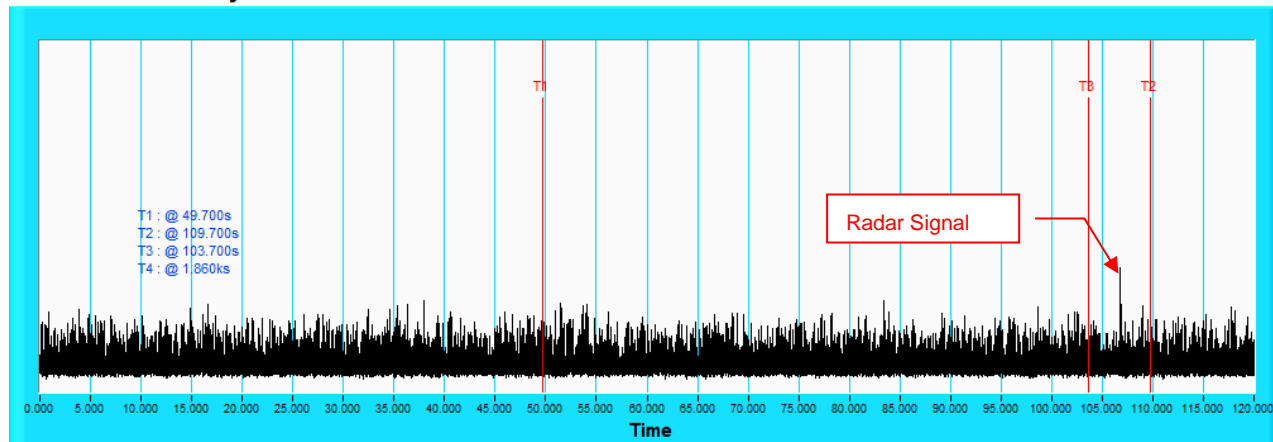

**NOTE:** T1 denotes the end of power up time period is 49.7<sup>th</sup> second. T2 denotes 109.7<sup>th</sup> second and the radar burst was commenced within 54<sup>th</sup> second to 60<sup>th</sup> second window starting from the end of power-up sequence. T3 denotes the 103.7<sup>th</sup> second.

## 6.2.4 Channel Closing Transmission and Channel Move Time

### Wireless Traffic Loading

#### 802.11ax (HE20)

##### Duty Cycle

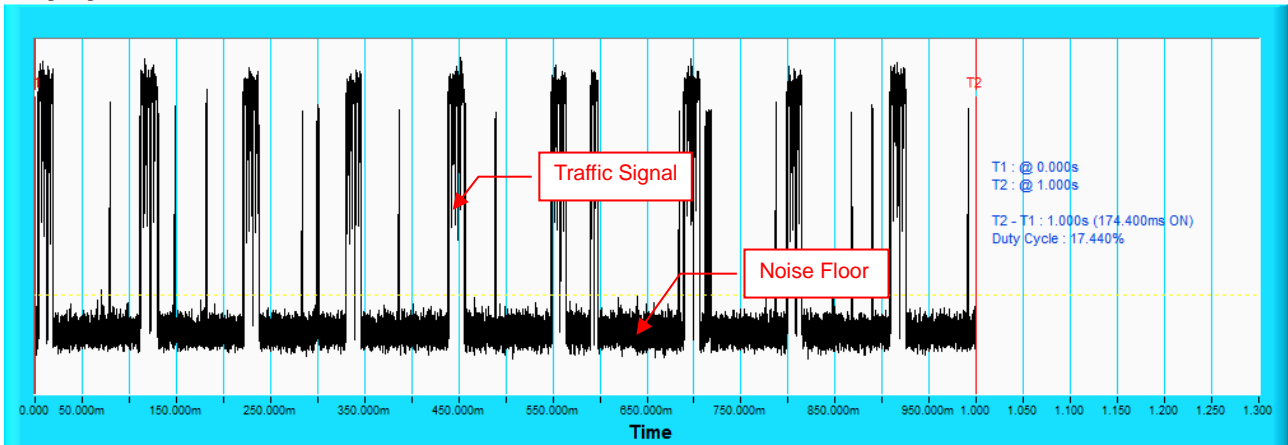

#### 802.11ax (HE40)

##### Duty Cycle

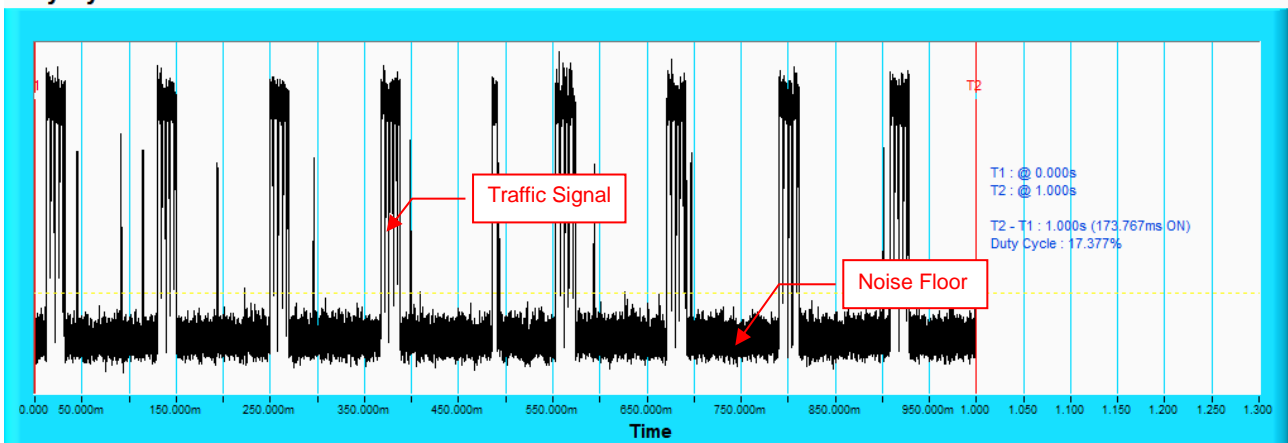

#### 802.11ax (HE80)

##### Duty Cycle

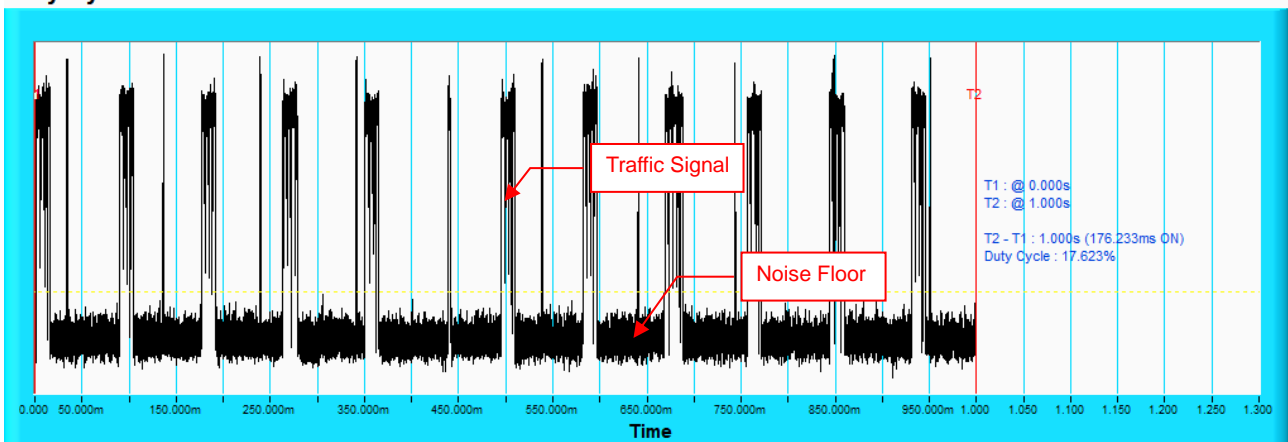



### 802.11ax (HE160)

#### Duty Cycle

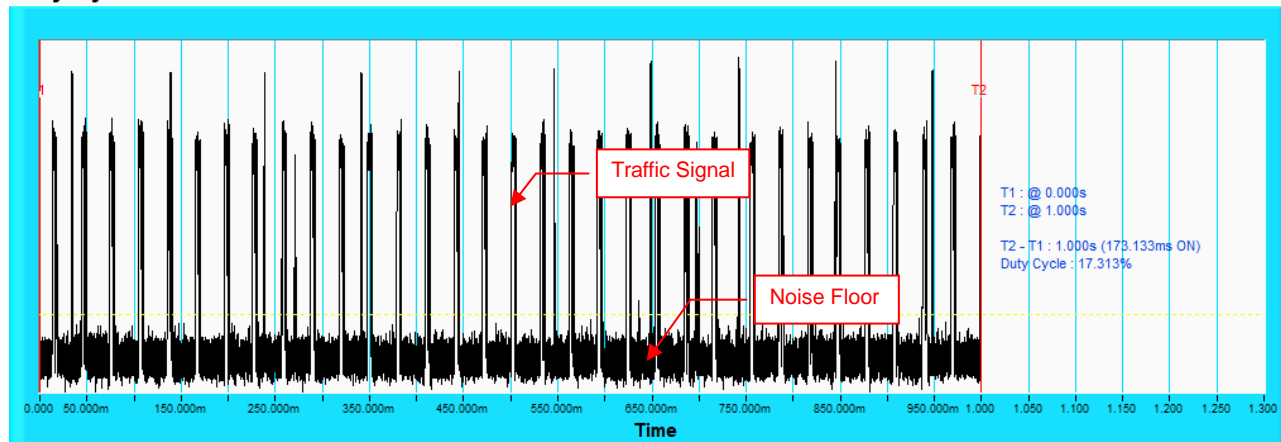

**802.11ax (HE20)**

**Table 1: Short Pulse Radar Test Waveforms**

Radar Type	Pulse Width (μsec)	PRI (μsec)	Number of Pulses	Number of Trials(Times)	Percentage of Successful Detection (%)
1	Test A 15 unique PRI values randomly selected from the list of 23 PRI values	Roundup $\left\{ \left( \frac{1}{360} \right) \cdot \left( \frac{19 \cdot 10^6}{\text{PRI}_{\mu\text{sec}}} \right) \right\}$	18	30	90
	15 unique PRI values randomly selected within the range of 518~3066 μsec with a minimum of 1 μsec, excluding PRI values selected in Test A				
2	1-5	150-230	23-29	30	76.6
3	6-10	200-500	16-18	30	83.3
4	11-20	200-500	12-16	30	80
Aggregate (Radar Types 1-4)				120	82.4

**Table 2: Long Pulse Radar Test Waveform**

Radar Type	Pulse Width (μsec)	Chirp Width (MHz)	PRI (μsec)	Number of Pulses per Burst	Number of Bursts	Number of Trials(Times)	Percentage of Successful Detection (%)
5	50-100	5-20	1000-2000	1-3	8-20	30	90

**Table 3: Frequency Hopping Radar Test Waveform**

Radar Type	Pulse Width (μsec)	PRI (μsec)	Pulses per Hop	Hopping Rate (kHz)	Hopping Sequence Length (msec)	Number of Trials(Times)	Percentage of Successful Detection (%)
6	1	333	9	0.333	300	30	90

802.11ax (HE40)

Table 1: Short Pulse Radar Test Waveforms

Radar Type	Pulse Width (μsec)	PRI (μsec)	Number of Pulses	Number of Trials(Times)	Percentage of Successful Detection (%)
1	Test A 15 unique PRI values randomly selected from the list of 23 PRI values	Roundup $\left\{ \left( \frac{1}{360} \right) \cdot \left( \frac{19 \cdot 10^6}{\text{PRI}_{\mu\text{sec}}} \right) \right\}$	18	30	90
	15 unique PRI values randomly selected within the range of 518~3066 μsec with a minimum of 1 μsec, excluding PRI values selected in Test A				
2	1-5	150-230	23-29	30	86.6
3	6-10	200-500	16-18	30	80
4	11-20	200-500	12-16	30	76.6
Aggregate (Radar Types 1-4)				120	83.3

Table 2: Long Pulse Radar Test Waveform

Radar Type	Pulse Width (μsec)	Chirp Width (MHz)	PRI (μsec)	Number of Pulses per Burst	Number of Bursts	Number of Trials(Times)	Percentage of Successful Detection (%)
5	50-100	5-20	1000-2000	1-3	8-20	30	93.3

Table 3: Frequency Hopping Radar Test Waveform

Radar Type	Pulse Width (μsec)	PRI (μsec)	Pulses per Hop	Hopping Rate (kHz)	Hopping Sequence Length (msec)	Number of Trials(Times)	Percentage of Successful Detection (%)
6	1	333	9	0.333	300	30	93.3

802.11ax (HE80)

Table 1: Short Pulse Radar Test Waveforms

Radar Type	Pulse Width (μsec)	PRI (μsec)	Number of Pulses	Number of Trials(Times)	Percentage of Successful Detection (%)
1	Test A 15 unique PRI values randomly selected from the list of 23 PRI values	Roundup $\left\{ \left( \frac{1}{360} \right) \cdot \left( \frac{19 \cdot 10^6}{\text{PRI}_{\mu\text{sec}}} \right) \right\}$	18	30	90
	15 unique PRI values randomly selected within the range of 518~3066 μ sec with a minimum of 1 μ sec, excluding PRI values selected in Test A				
2	1-5	150-230	23-29	30	80
3	6-10	200-500	16-18	30	76.6
4	11-20	200-500	12-16	30	80
Aggregate (Radar Types 1-4)				120	81.6

Table 2: Long Pulse Radar Test Waveform

Radar Type	Pulse Width (μsec)	Chirp Width (MHz)	PRI (μsec)	Number of Pulses per Burst	Number of Bursts	Number of Trials(Times)	Percentage of Successful Detection (%)
5	50-100	5-20	1000-2000	1-3	8-20	30	86.6

Table 3: Frequency Hopping Radar Test Waveform

Radar Type	Pulse Width (μsec)	PRI (μsec)	Pulses per Hop	Hopping Rate (kHz)	Hopping Sequence Length (msec)	Number of Trials(Times)	Percentage of Successful Detection (%)
6	1	333	9	0.333	300	30	86.6

**802.11ax (HE160)**
**Table 1: Short Pulse Radar Test Waveforms**

Radar Type	Pulse Width (μsec)	PRI (μsec)	Number of Pulses	Number of Trials(Times)	Percentage of Successful Detection (%)
1	Test A 15 unique PRI values randomly selected from the list of 23 PRI values	Roundup $\left\{ \left( \frac{1}{360} \right) \cdot \left( \frac{19 \cdot 10^6}{\text{PRI}_{\mu\text{sec}}} \right) \right\}$	18	30	90
	15 unique PRI values randomly selected within the range of 518~3066 μ sec with a minimum of 1 μ sec, excluding PRI values selected in Test A				
2	1-5	150-230	23-29	30	76.6
3	6-10	200-500	16-18	30	83.3
4	11-20	200-500	12-16	30	76.6
Aggregate (Radar Types 1-4)				120	81.6

**Table 2: Long Pulse Radar Test Waveform**

Radar Type	Pulse Width (μsec)	Chirp Width (MHz)	PRI (μsec)	Number of Pulses per Burst	Number of Bursts	Number of Trials(Times)	Percentage of Successful Detection (%)
5	50-100	5-20	1000-2000	1-3	8-20	30	80

**Table 3: Frequency Hopping Radar Test Waveform**

Radar Type	Pulse Width (μsec)	PRI (μsec)	Pulses per Hop	Hopping Rate (kHz)	Hopping Sequence Length (msec)	Number of Trials(Times)	Percentage of Successful Detection (%)
6	1	333	9	0.333	300	30	90

## 802.11ax (HE160)

### Radar signal 0

#### Channel Closing Transmission Time & Channel Move Time

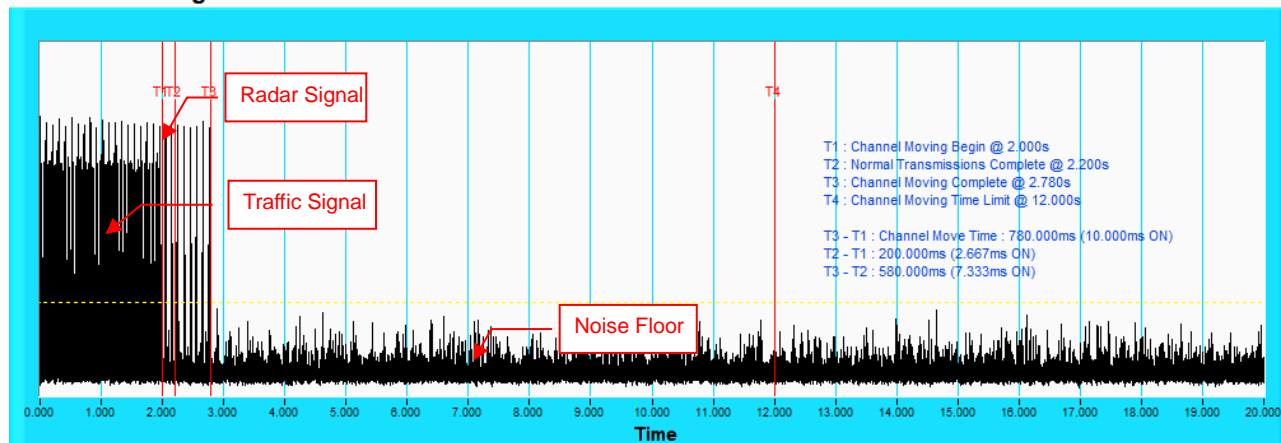

**NOTE:** T1 denotes the start of Channel Move Time upon the end of the last Radar burst. T2 denotes the data transmission time of 200ms from T1. T3 denotes the end of Channel Move Time. T4 denotes the 10 second from T1 to observe the aggregate duration of transmissions.

#### Channel Closing Transmission Time & Channel Move Time

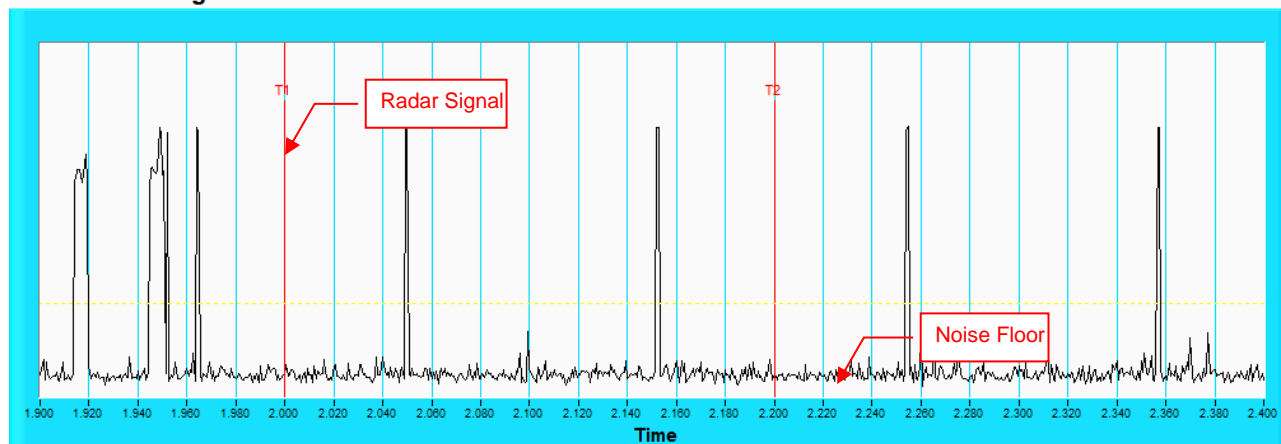

**NOTE:** Zoom in of the first 500ms after radar signal applied.



### Radar signal 1 Channel Closing Transmission Time & Channel Move Time

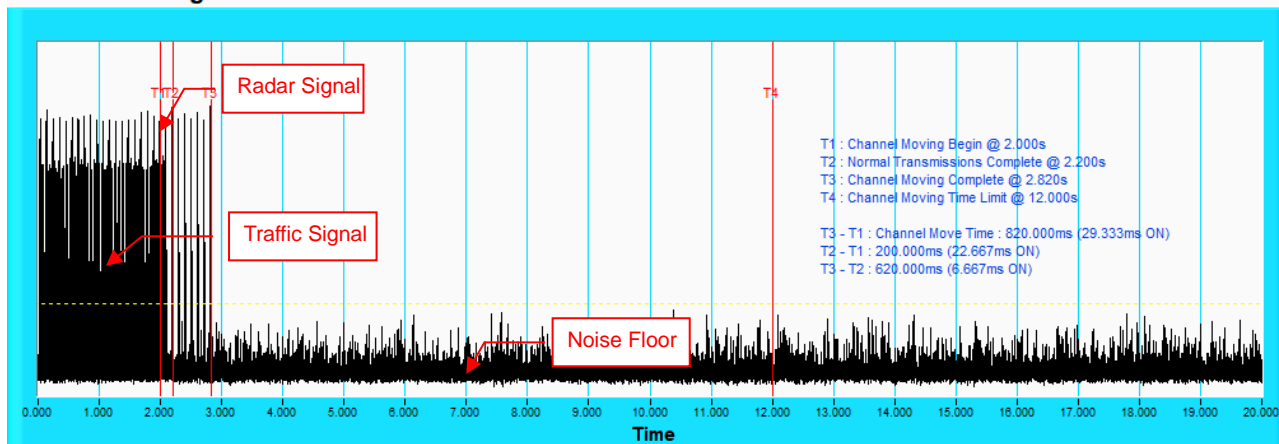

**NOTE:** T1 denotes the start of Channel Move Time upon the end of the last Radar burst. T2 denotes the data transmission time of 200ms from T1. T3 denotes the end of Channel Move Time. T4 denotes the 10 second from T1 to observe the aggregate duration of transmissions.

### Channel Closing Transmission Time & Channel Move Time

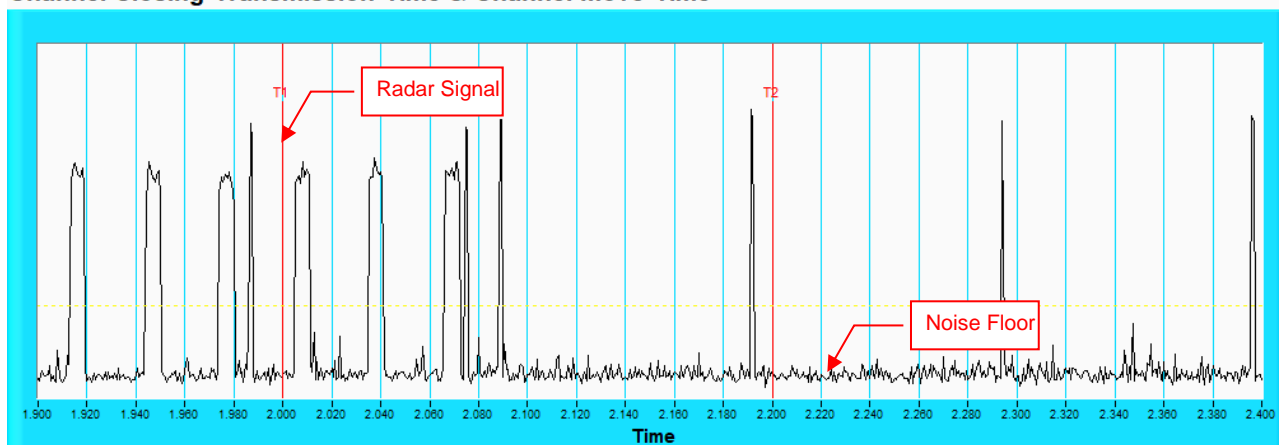

**NOTE:** Zoom in of the first 500ms after radar signal applied.

### Radar signal 2

#### Channel Closing Transmission Time & Channel Move Time

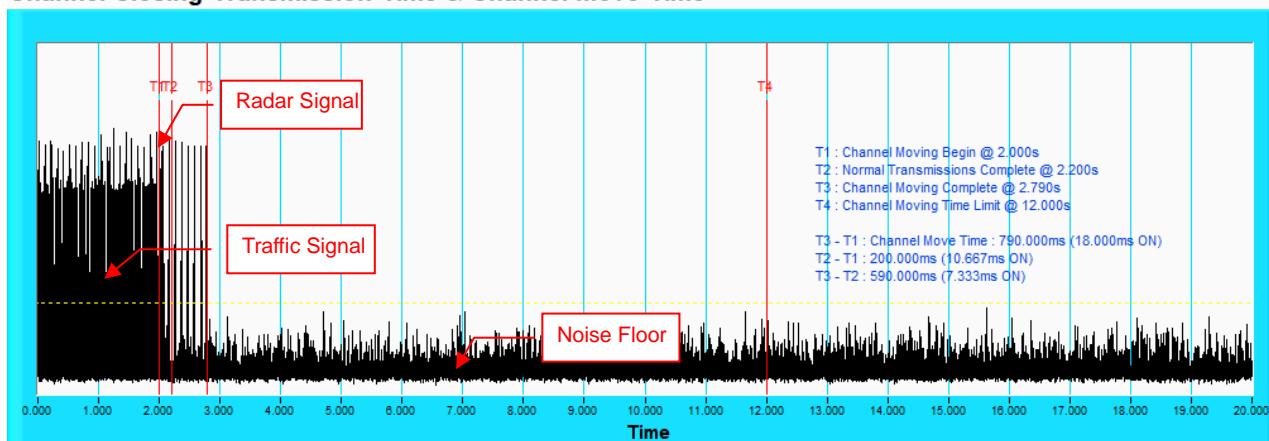

**NOTE:** T1 denotes the start of Channel Move Time upon the end of the last Radar burst. T2 denotes the data transmission time of 200ms from T1. T3 denotes the end of Channel Move Time. T4 denotes the 10 second from T1 to observe the aggregate duration of transmissions.

#### Channel Closing Transmission Time & Channel Move Time

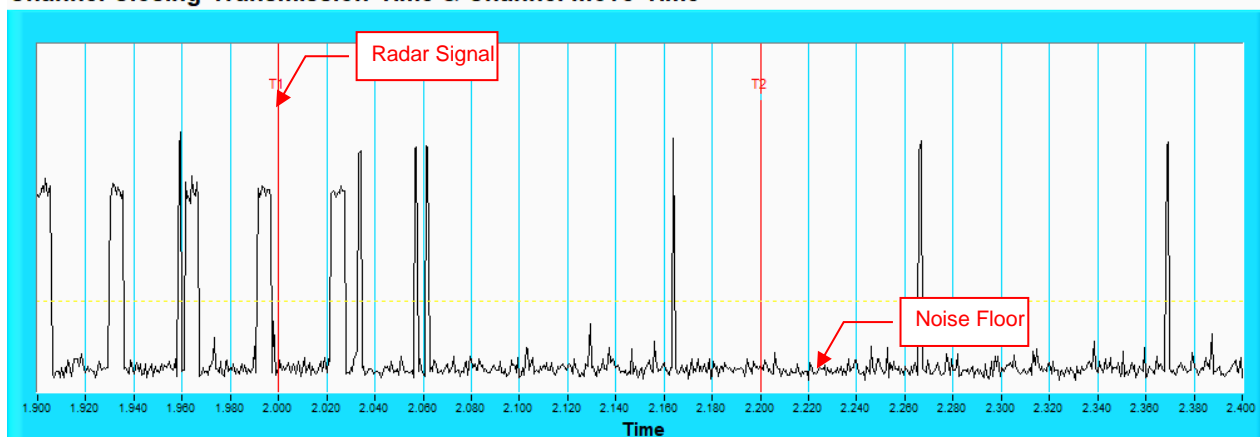

**NOTE:** Zoom in of the first 500ms after radar signal applied.

### Radar signal 3

#### Channel Closing Transmission Time & Channel Move Time

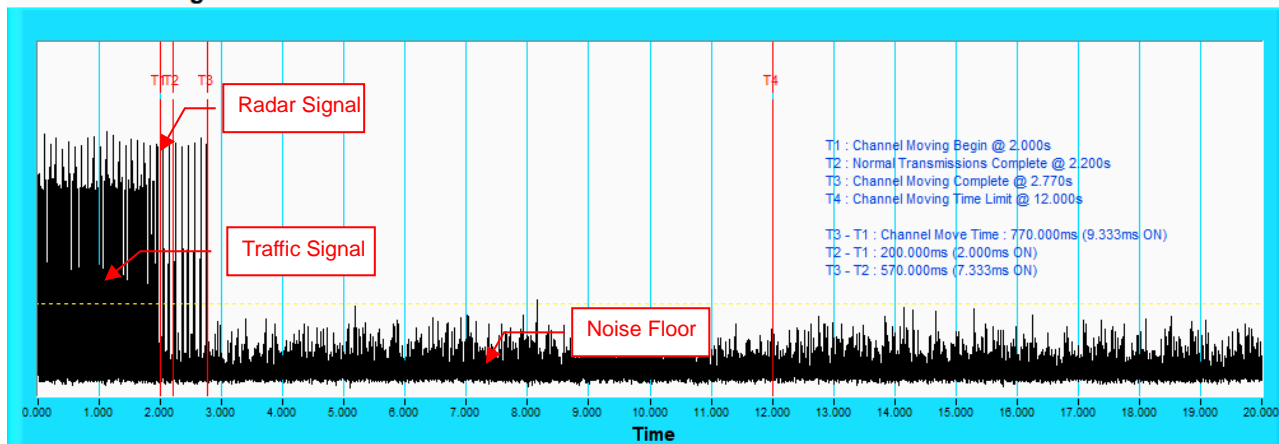

**NOTE:** T1 denotes the start of Channel Move Time upon the end of the last Radar burst. T2 denotes the data transmission time of 200ms from T1. T3 denotes the end of Channel Move Time. T4 denotes the 10 second from T1 to observe the aggregate duration of transmissions.

#### Channel Closing Transmission Time & Channel Move Time

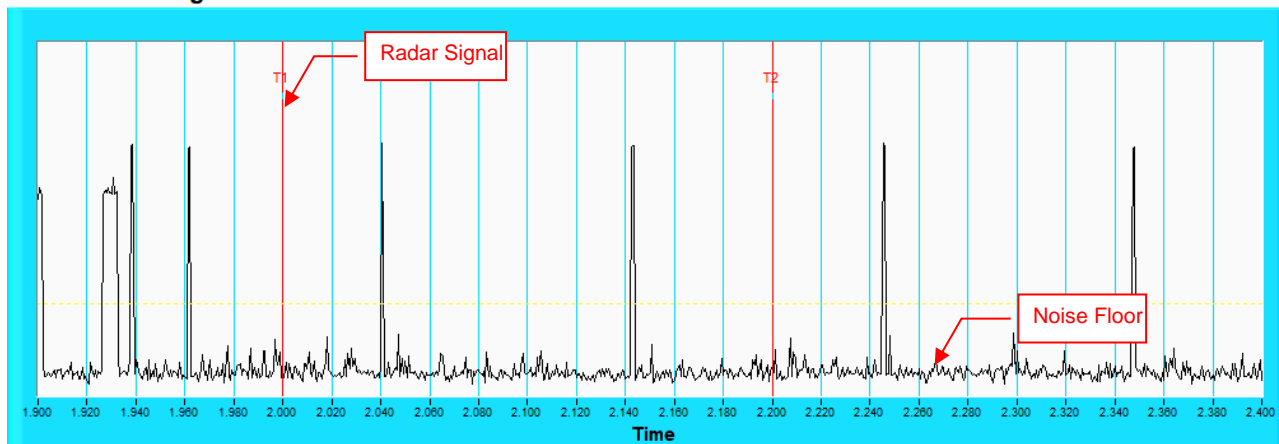

**NOTE:** Zoom in of the first 500ms after radar signal applied.

### Radar signal 4

#### Channel Closing Transmission Time & Channel Move Time

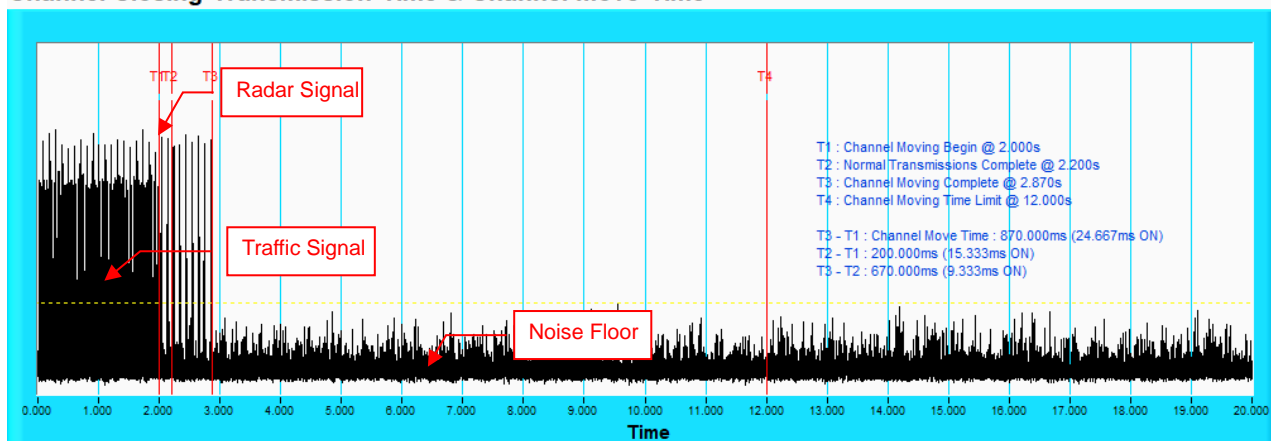

**NOTE:** T1 denotes the start of Channel Move Time upon the end of the last Radar burst. T2 denotes the data transmission time of 200ms from T1. T3 denotes the end of Channel Move Time. T4 denotes the 10 second from T1 to observe the aggregate duration of transmissions.

#### Channel Closing Transmission Time & Channel Move Time

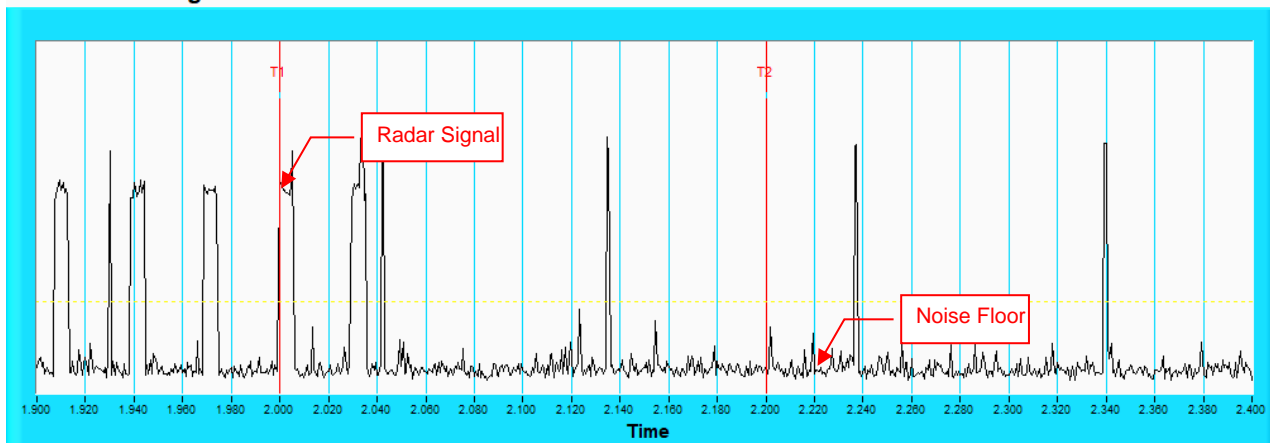

**NOTE:** Zoom in of the first 500ms after radar signal applied.

## 802.11ax (HE20)

### Type 1 Radar Statistical Performances

Trial #	Test Frequency (MHz)	Pulse Repetition Frequency Number (1 to 23)	Pulse Repetition Frequency (pps)	Pulses per Burst	Pulse Repetition Interval (µsec)	Detection
1	5500	17	1193	63	838	Yes
2	5501	23	326.2	18	3066	Yes
3	5507	1	1931	102	518	Yes
4	5490	11	1393	74	718	Yes
5	5501	12	1355	72	738	Yes
6	5493	10	1433	76	698	Yes
7	5496	15	1253	67	798	Yes
8	5496	13	1319	70	758	Yes
9	5496	4	1730	92	578	Yes
10	5507	8	1520	81	658	Yes
11	5499	22	1066	57	938	No
12	5505	20	1114	59	898	Yes
13	5492	19	1139	61	878	Yes
14	5491	14	1285	68	778	Yes
15	5501	6	1618	86	618	Yes
16	5509	-	393.5	21	2541	Yes
17	5495	-	685.4	37	1459	Yes
18	5503	-	669.8	36	1493	Yes
19	5495	-	379.2	21	2637	Yes
20	5505	-	588.9	32	1698	No
21	5497	-	753.6	40	1327	Yes
22	5509	-	409.7	22	2441	Yes
23	5507	-	489.5	26	2043	No
24	5503	-	1647	87	607	Yes
25	5491	-	901.7	48	1109	Yes
26	5508	-	1024	55	977	Yes
27	5505	-	990.1	53	1010	Yes
28	5494	-	905.8	48	1104	Yes
29	5509	-	604.2	32	1655	Yes
30	5498	-	585.5	31	1708	Yes
Detection Rate : 90%						

Note. " - " : 15 unique PRI values randomly selected within the range of 518-3066 µsec, with a minimum increment of 1µsec, excluding PRI values selected in Test A

## 802.11ax (HE20)

### Type 2 Radar Statistical Performances

Trial #	Test Frequency (MHz)	Pulses per Burst	Pulse Width(us)	PRI(us)	Detection
1	5500	26	2.8	215	No
2	5498	29	4.5	230	No
3	5506	29	4.9	187	No
4	5493	27	3.8	164	Yes
5	5506	29	4.7	219	Yes
6	5492	23	1.3	228	Yes
7	5506	24	2	174	No
8	5509	23	1.4	208	No
9	5494	24	1.9	163	No
10	5510	28	4.1	152	Yes
11	5505	24	1.9	179	Yes
12	5491	28	4.1	170	Yes
13	5500	27	3.8	190	Yes
14	5491	29	4.9	172	Yes
15	5498	24	2.1	177	Yes
16	5499	29	4.5	191	Yes
17	5502	26	2.9	165	Yes
18	5497	25	2.5	159	Yes
19	5505	25	2.4	184	Yes
20	5505	27	3.6	218	Yes
21	5506	29	4.9	192	Yes
22	5495	23	1.5	171	Yes
23	5499	28	3.9	198	Yes
24	5492	27	3.5	157	Yes
25	5493	25	2.6	160	Yes
26	5501	24	1.8	211	Yes
27	5490	23	1.2	150	Yes
28	5492	23	1.1	226	Yes
29	5503	29	4.6	194	No
30	5505	28	4.3	199	Yes

Detection Rate : 76.6%

## 802.11ax (HE20)

### Type 3 Radar Statistical Performances

Trial #	Test Frequency (MHz)	Pulses per Burst	Pulse Width(us)	PRI(us)	Detection
1	5500	17	7.8	417	No
2	5492	18	9.5	460	Yes
3	5504	18	9.9	499	Yes
4	5504	18	8.8	356	Yes
5	5502	18	9.7	293	Yes
6	5495	16	6.3	340	No
7	5509	16	7	223	Yes
8	5500	16	6.4	461	Yes
9	5502	16	6.9	445	Yes
10	5505	18	9.1	273	No
11	5502	16	6.9	234	Yes
12	5493	18	9.1	342	Yes
13	5506	18	8.8	479	Yes
14	5504	18	9.9	495	Yes
15	5494	16	7.1	472	Yes
16	5495	18	9.5	408	Yes
17	5493	17	7.9	203	Yes
18	5493	17	7.5	478	Yes
19	5490	17	7.4	244	Yes
20	5496	17	8.6	285	Yes
21	5500	18	9.9	422	Yes
22	5505	16	6.5	369	Yes
23	5509	18	8.9	367	Yes
24	5502	17	8.5	295	Yes
25	5510	17	7.6	300	Yes
26	5498	16	6.8	233	No
27	5507	16	6.2	238	No
28	5504	16	6.1	403	Yes
29	5491	18	9.6	372	Yes
30	5497	18	9.3	358	Yes

Detection Rate : 83.3%

## 802.11ax (HE20)

### Type 4 Radar Statistical Performances

Trial #	Test Frequency (MHz)	Pulses per Burst	Pulse Width(us)	PRI(us)	Detection
1	5500	14	15	417	Yes
2	5503	16	18.8	460	No
3	5508	16	19.8	499	Yes
4	5500	15	17.2	356	Yes
5	5494	16	19.2	293	Yes
6	5505	12	11.6	340	No
7	5501	13	13.3	223	Yes
8	5504	12	11.9	461	Yes
9	5499	13	13	445	Yes
10	5497	15	18	273	Yes
11	5496	13	13	234	No
12	5497	15	17.8	342	Yes
13	5510	15	17.2	479	Yes
14	5496	16	19.8	495	Yes
15	5498	13	13.5	472	Yes
16	5494	16	18.8	408	Yes
17	5507	14	15.3	203	Yes
18	5493	13	14.4	478	No
19	5499	13	14.2	244	Yes
20	5501	15	16.8	285	No
21	5501	16	19.8	422	Yes
22	5507	12	12.2	369	Yes
23	5508	15	17.5	367	Yes
24	5496	15	16.6	295	Yes
25	5510	14	14.6	300	No
26	5504	13	12.8	233	Yes
27	5494	12	11.4	238	Yes
28	5507	12	11.2	403	Yes
29	5509	16	19.1	372	Yes
30	5509	16	18.3	358	Yes

Detection Rate : 80%



## 802.11ax (HE20)

Type 5 Radar Statistical Performances				
Trial #	Minimum Chirp Width(MHz)	Chirp Center Frequency(MHz)	Test Signal Name	Detection
1	17	5500	LP_Signal_01	Yes
2	6	5500	LP_Signal_02	Yes
3	20	5500	LP_Signal_03	Yes
4	9	5500	LP_Signal_04	Yes
5	10	5500	LP_Signal_05	Yes
6	18	5500	LP_Signal_06	No
7	18	5500	LP_Signal_07	Yes
8	5	5500	LP_Signal_08	Yes
9	13	5500	LP_Signal_09	Yes
10	16	5500	LP_Signal_10	Yes
11	7	5493	LP_Signal_11	Yes
12	10	5494	LP_Signal_12	Yes
13	6	5492	LP_Signal_13	Yes
14	10	5494	LP_Signal_14	Yes
15	9	5494	LP_Signal_15	Yes
16	6	5492	LP_Signal_16	Yes
17	18	5497	LP_Signal_17	Yes
18	17	5497	LP_Signal_18	Yes
19	13	5495	LP_Signal_19	Yes
20	5	5492	LP_Signal_20	Yes
21	20	5502	LP_Signal_21	Yes
22	17	5503	LP_Signal_22	Yes
23	15	5504	LP_Signal_23	Yes
24	7	5507	LP_Signal_24	Yes
25	12	5505	LP_Signal_25	No
26	19	5502	LP_Signal_26	No
27	9	5506	LP_Signal_27	Yes
28	12	5505	LP_Signal_28	Yes
29	14	5504	LP_Signal_29	Yes
30	15	5504	LP_Signal_30	Yes
				Detection Rate : 90%

Note: The Long Pulse Radar pattern shown in Appendix A.1

## 802.11ax (HE20)

Type 6 Radar Statistical Performances					
Trial #	Pulses per Burst	Pulse Width(us)	PRI(us)	Hopping Frequency Sequence Name	Detection
1	9	1	333.3	HOP_FREQ_SEQ_01	Yes
2	9	1	333.3	HOP_FREQ_SEQ_02	Yes
3	9	1	333.3	HOP_FREQ_SEQ_03	Yes
4	9	1	333.3	HOP_FREQ_SEQ_04	Yes
5	9	1	333.3	HOP_FREQ_SEQ_05	Yes
6	9	1	333.3	HOP_FREQ_SEQ_06	Yes
7	9	1	333.3	HOP_FREQ_SEQ_07	Yes
8	9	1	333.3	HOP_FREQ_SEQ_08	Yes
9	9	1	333.3	HOP_FREQ_SEQ_09	No
10	9	1	333.3	HOP_FREQ_SEQ_10	No
11	9	1	333.3	HOP_FREQ_SEQ_11	Yes
12	9	1	333.3	HOP_FREQ_SEQ_12	Yes
13	9	1	333.3	HOP_FREQ_SEQ_13	Yes
14	9	1	333.3	HOP_FREQ_SEQ_14	Yes
15	9	1	333.3	HOP_FREQ_SEQ_15	Yes
16	9	1	333.3	HOP_FREQ_SEQ_16	Yes
17	9	1	333.3	HOP_FREQ_SEQ_17	Yes
18	9	1	333.3	HOP_FREQ_SEQ_18	Yes
19	9	1	333.3	HOP_FREQ_SEQ_19	Yes
20	9	1	333.3	HOP_FREQ_SEQ_20	Yes
21	9	1	333.3	HOP_FREQ_SEQ_21	Yes
22	9	1	333.3	HOP_FREQ_SEQ_22	Yes
23	9	1	333.3	HOP_FREQ_SEQ_23	Yes
24	9	1	333.3	HOP_FREQ_SEQ_24	Yes
25	9	1	333.3	HOP_FREQ_SEQ_25	Yes
26	9	1	333.3	HOP_FREQ_SEQ_26	Yes
27	9	1	333.3	HOP_FREQ_SEQ_27	No
28	9	1	333.3	HOP_FREQ_SEQ_28	Yes
29	9	1	333.3	HOP_FREQ_SEQ_29	Yes
30	9	1	333.3	HOP_FREQ_SEQ_30	Yes
Detection Rate : 90%					

Note: The Frequency Hopping Radar pattern shown in Appendix A.2



### 802.11ax (HE40)

#### Type 1 Radar Statistical Performances

Trial #	Test Frequency (MHz)	Pulse Repetition Frequency Number (1 to 23)	Pulse Repetition Frequency (pps)	Pulses per Burst	Pulse Repetition Interval (µsec)	Detection
1	5510	17	1193	63	838	Yes
2	5520	23	326.2	18	3066	Yes
3	5500	1	1931	102	518	Yes
4	5500	11	1393	74	718	Yes
5	5517	12	1355	72	738	Yes
6	5492	10	1433	76	698	Yes
7	5501	15	1253	67	798	Yes
8	5503	13	1319	70	758	Yes
9	5507	4	1730	92	578	Yes
10	5500	8	1520	81	658	Yes
11	5520	22	1066	57	938	Yes
12	5496	20	1114	59	898	Yes
13	5503	19	1139	61	878	Yes
14	5492	14	1285	68	778	Yes
15	5507	6	1618	86	618	Yes
16	5529	-	393.5	21	2541	Yes
17	5496	-	685.4	37	1459	Yes
18	5494	-	669.8	36	1493	Yes
19	5525	-	379.2	21	2637	Yes
20	5492	-	588.9	32	1698	Yes
21	5521	-	753.6	40	1327	Yes
22	5492	-	409.7	22	2441	Yes
23	5503	-	489.5	26	2043	Yes
24	5518	-	1647	87	607	No
25	5523	-	901.7	48	1109	No
26	5495	-	1024	55	977	No
27	5509	-	990.1	53	1010	Yes
28	5493	-	905.8	48	1104	Yes
29	5529	-	604.2	32	1655	Yes
30	5494	-	585.5	31	1708	Yes

Detection Rate : 90%

Note. " - " : 15 unique PRI values randomly selected within the range of 518-3066 µsec, with a minimum increment of 1µsec, excluding PRI values selected in Test A

## 802.11ax (HE40)

Type 2 Radar Statistical Performances					
Trial #	Test Frequency (MHz)	Pulses per Burst	Pulse Width(us)	PRI(us)	Detection
1	5510	26	2.8	215	Yes
2	5520	29	4.5	230	No
3	5500	29	4.9	187	Yes
4	5521	27	3.8	164	Yes
5	5508	29	4.7	219	No
6	5527	23	1.3	228	Yes
7	5511	24	2	174	No
8	5492	23	1.4	208	Yes
9	5521	24	1.9	163	No
10	5516	28	4.1	152	Yes
11	5528	24	1.9	179	Yes
12	5499	28	4.1	170	Yes
13	5516	27	3.8	190	Yes
14	5493	29	4.9	172	Yes
15	5514	24	2.1	177	Yes
16	5491	29	4.5	191	Yes
17	5529	26	2.9	165	Yes
18	5520	25	2.5	159	Yes
19	5509	25	2.4	184	Yes
20	5516	27	3.6	218	Yes
21	5513	29	4.9	192	Yes
22	5503	23	1.5	171	Yes
23	5493	28	3.9	198	Yes
24	5526	27	3.5	157	Yes
25	5511	25	2.6	160	Yes
26	5508	24	1.8	211	Yes
27	5513	23	1.2	150	Yes
28	5529	23	1.1	226	Yes
29	5498	29	4.6	194	Yes
30	5495	28	4.3	199	Yes

Detection Rate : 86.6%

## 802.11ax (HE40)

### Type 3 Radar Statistical Performances

Trial #	Test Frequency (MHz)	Pulses per Burst	Pulse Width(us)	PRI(us)	Detection
1	5510	17	7.8	417	Yes
2	5520	18	9.5	460	Yes
3	5500	18	9.9	499	Yes
4	5507	18	8.8	356	Yes
5	5491	18	9.7	293	Yes
6	5520	16	6.3	340	Yes
7	5509	16	7	223	Yes
8	5502	16	6.4	461	No
9	5529	16	6.9	445	No
10	5525	18	9.1	273	No
11	5515	16	6.9	234	Yes
12	5502	18	9.1	342	Yes
13	5502	18	8.8	479	Yes
14	5504	18	9.9	495	No
15	5510	16	7.1	472	Yes
16	5509	18	9.5	408	Yes
17	5507	17	7.9	203	Yes
18	5522	17	7.5	478	No
19	5515	17	7.4	244	Yes
20	5496	17	8.6	285	Yes
21	5507	18	9.9	422	Yes
22	5501	16	6.5	369	Yes
23	5496	18	8.9	367	Yes
24	5495	17	8.5	295	Yes
25	5497	17	7.6	300	Yes
26	5520	16	6.8	233	Yes
27	5504	16	6.2	238	Yes
28	5515	16	6.1	403	No
29	5512	18	9.6	372	Yes
30	5500	18	9.3	358	Yes

Detection Rate : 80%

## 802.11ax (HE40)

### Type 4 Radar Statistical Performances

Trial #	Test Frequency (MHz)	Pulses per Burst	Pulse Width(us)	PRI(us)	Detection
1	5510	14	15	417	Yes
2	5520	16	18.8	460	Yes
3	5500	16	19.8	499	Yes
4	5494	15	17.2	356	Yes
5	5529	16	19.2	293	No
6	5512	12	11.6	340	Yes
7	5523	13	13.3	223	Yes
8	5514	12	11.9	461	Yes
9	5507	13	13	445	Yes
10	5515	15	18	273	Yes
11	5510	13	13	234	No
12	5525	15	17.8	342	Yes
13	5493	15	17.2	479	Yes
14	5508	16	19.8	495	Yes
15	5511	13	13.5	472	Yes
16	5504	16	18.8	408	No
17	5510	14	15.3	203	Yes
18	5508	13	14.4	478	Yes
19	5496	13	14.2	244	No
20	5517	15	16.8	285	No
21	5502	16	19.8	422	Yes
22	5516	12	12.2	369	Yes
23	5526	15	17.5	367	No
24	5515	15	16.6	295	Yes
25	5527	14	14.6	300	Yes
26	5499	13	12.8	233	No
27	5519	12	11.4	238	Yes
28	5514	12	11.2	403	Yes
29	5522	16	19.1	372	Yes
30	5516	16	18.3	358	Yes

Detection Rate : 76.6%



### 802.11ax (HE40)

Type 5 Radar Statistical Performances				
Trial #	Minimum Chirp Width(MHz)	Chirp Center Frequency(MHz)	Test Signal Name	Detection
1	12	5510	LP_Signal_01	Yes
2	16	5510	LP_Signal_02	Yes
3	9	5510	LP_Signal_03	No
4	8	5510	LP_Signal_04	No
5	11	5510	LP_Signal_05	Yes
6	16	5510	LP_Signal_06	Yes
7	18	5510	LP_Signal_07	Yes
8	14	5510	LP_Signal_08	Yes
9	15	5510	LP_Signal_09	Yes
10	5	5510	LP_Signal_10	Yes
11	17	5498	LP_Signal_11	Yes
12	10	5495	LP_Signal_12	Yes
13	9	5495	LP_Signal_13	Yes
14	5	5493	LP_Signal_14	Yes
15	14	5497	LP_Signal_15	Yes
16	16	5497	LP_Signal_16	Yes
17	15	5497	LP_Signal_17	Yes
18	10	5495	LP_Signal_18	Yes
19	17	5498	LP_Signal_19	Yes
20	13	5496	LP_Signal_20	Yes
21	7	5526	LP_Signal_21	Yes
22	20	5521	LP_Signal_22	Yes
23	7	5526	LP_Signal_23	Yes
24	9	5525	LP_Signal_24	Yes
25	10	5525	LP_Signal_25	Yes
26	16	5523	LP_Signal_26	Yes
27	20	5521	LP_Signal_27	Yes
28	5	5527	LP_Signal_28	Yes
29	6	5527	LP_Signal_29	Yes
30	19	5521	LP_Signal_30	Yes

Detection Rate : 93.3%

Note: The Long Pulse Radar pattern shown in Appendix A.1



### 802.11ax (HE40)

Type 6 Radar Statistical Performances					
Trial #	Pulses per Burst	Pulse Width(us)	PRI(us)	Hopping Frequency Sequence Name	Detection
1	9	1	333.3	HOP_FREQ_SEQ_01	Yes
2	9	1	333.3	HOP_FREQ_SEQ_02	Yes
3	9	1	333.3	HOP_FREQ_SEQ_03	Yes
4	9	1	333.3	HOP_FREQ_SEQ_04	Yes
5	9	1	333.3	HOP_FREQ_SEQ_05	Yes
6	9	1	333.3	HOP_FREQ_SEQ_06	Yes
7	9	1	333.3	HOP_FREQ_SEQ_07	Yes
8	9	1	333.3	HOP_FREQ_SEQ_08	Yes
9	9	1	333.3	HOP_FREQ_SEQ_09	Yes
10	9	1	333.3	HOP_FREQ_SEQ_10	Yes
11	9	1	333.3	HOP_FREQ_SEQ_11	Yes
12	9	1	333.3	HOP_FREQ_SEQ_12	Yes
13	9	1	333.3	HOP_FREQ_SEQ_13	Yes
14	9	1	333.3	HOP_FREQ_SEQ_14	Yes
15	9	1	333.3	HOP_FREQ_SEQ_15	Yes
16	9	1	333.3	HOP_FREQ_SEQ_16	Yes
17	9	1	333.3	HOP_FREQ_SEQ_17	No
18	9	1	333.3	HOP_FREQ_SEQ_18	Yes
19	9	1	333.3	HOP_FREQ_SEQ_19	Yes
20	9	1	333.3	HOP_FREQ_SEQ_20	Yes
21	9	1	333.3	HOP_FREQ_SEQ_21	Yes
22	9	1	333.3	HOP_FREQ_SEQ_22	Yes
23	9	1	333.3	HOP_FREQ_SEQ_23	Yes
24	9	1	333.3	HOP_FREQ_SEQ_24	Yes
25	9	1	333.3	HOP_FREQ_SEQ_25	Yes
26	9	1	333.3	HOP_FREQ_SEQ_26	Yes
27	9	1	333.3	HOP_FREQ_SEQ_27	Yes
28	9	1	333.3	HOP_FREQ_SEQ_28	No
29	9	1	333.3	HOP_FREQ_SEQ_29	Yes
30	9	1	333.3	HOP_FREQ_SEQ_30	Yes

Detection Rate : 93.3%

Note: The Frequency Hopping Radar pattern shown in Appendix A.2



## 802.11ax (HE80)

### Type 1 Radar Statistical Performances

Trial #	Test Frequency (MHz)	Pulse Repetition Frequency Number (1 to 23)	Pulse Repetition Frequency (pps)	Pulses per Burst	Pulse Repetition Interval (µsec)	Detection
1	5530	17	1193	63	838	Yes
2	5540	23	326.2	18	3066	Yes
3	5560	1	1931	102	518	Yes
4	5520	11	1393	74	718	Yes
5	5500	12	1355	72	738	Yes
6	5564	10	1433	76	698	Yes
7	5552	15	1253	67	798	Yes
8	5519	13	1319	70	758	Yes
9	5528	4	1730	92	578	Yes
10	5496	8	1520	81	658	No
11	5560	22	1066	57	938	No
12	5540	20	1114	59	898	Yes
13	5493	19	1139	61	878	Yes
14	5560	14	1285	68	778	Yes
15	5512	6	1618	86	618	Yes
16	5543	-	393.5	21	2541	Yes
17	5548	-	685.4	37	1459	Yes
18	5562	-	669.8	36	1493	Yes
19	5532	-	379.2	21	2637	Yes
20	5531	-	588.9	32	1698	Yes
21	5503	-	753.6	40	1327	Yes
22	5558	-	409.7	22	2441	Yes
23	5520	-	489.5	26	2043	No
24	5536	-	1647	87	607	Yes
25	5565	-	901.7	48	1109	Yes
26	5553	-	1024	55	977	Yes
27	5492	-	990.1	53	1010	Yes
28	5553	-	905.8	48	1104	Yes
29	5503	-	604.2	32	1655	Yes
30	5540	-	585.5	31	1708	Yes

Detection Rate : 90%

Note. " - " : 15 unique PRI values randomly selected within the range of 518-3066 µsec, with a minimum increment of 1µsec, excluding PRI values selected in Test A

## 802.11ax (HE80)

Type 2 Radar Statistical Performances					
Trial #	Test Frequency (MHz)	Pulses per Burst	Pulse Width(us)	PRI(us)	Detection
1	5530	26	2.8	215	Yes
2	5540	29	4.5	230	Yes
3	5560	29	4.9	187	Yes
4	5520	27	3.8	164	Yes
5	5500	29	4.7	219	Yes
6	5547	23	1.3	228	No
7	5550	24	2	174	Yes
8	5498	23	1.4	208	Yes
9	5513	24	1.9	163	No
10	5536	28	4.1	152	No
11	5561	24	1.9	179	Yes
12	5507	28	4.1	170	No
13	5557	27	3.8	190	Yes
14	5547	29	4.9	172	Yes
15	5564	24	2.1	177	Yes
16	5557	29	4.5	191	Yes
17	5504	26	2.9	165	Yes
18	5537	25	2.5	159	Yes
19	5501	25	2.4	184	No
20	5512	27	3.6	218	Yes
21	5533	29	4.9	192	Yes
22	5510	23	1.5	171	Yes
23	5499	28	3.9	198	No
24	5528	27	3.5	157	Yes
25	5557	25	2.6	160	Yes
26	5505	24	1.8	211	Yes
27	5565	23	1.2	150	Yes
28	5533	23	1.1	226	Yes
29	5526	29	4.6	194	Yes
30	5502	28	4.3	199	Yes
					Detection Rate : 80%

## 802.11ax (HE80)

Type 3 Radar Statistical Performances					
Trial #	Test Frequency (MHz)	Pulses per Burst	Pulse Width(us)	PRI(us)	Detection
1	5530	17	7.8	417	No
2	5540	18	9.5	460	Yes
3	5560	18	9.9	499	Yes
4	5520	18	8.8	356	Yes
5	5500	18	9.7	293	Yes
6	5505	16	6.3	340	Yes
7	5506	16	7	223	Yes
8	5539	16	6.4	461	Yes
9	5530	16	6.9	445	No
10	5547	18	9.1	273	Yes
11	5495	16	6.9	234	No
12	5494	18	9.1	342	Yes
13	5540	18	8.8	479	No
14	5499	18	9.9	495	Yes
15	5496	16	7.1	472	Yes
16	5520	18	9.5	408	Yes
17	5541	17	7.9	203	Yes
18	5569	17	7.5	478	Yes
19	5515	17	7.4	244	Yes
20	5511	17	8.6	285	No
21	5556	18	9.9	422	Yes
22	5514	16	6.5	369	Yes
23	5502	18	8.9	367	Yes
24	5492	17	8.5	295	Yes
25	5529	17	7.6	300	No
26	5506	16	6.8	233	Yes
27	5547	16	6.2	238	Yes
28	5536	16	6.1	403	Yes
29	5506	18	9.6	372	No
30	5528	18	9.3	358	Yes

Detection Rate : 76.6%

## 802.11ax (HE80)

Type 4 Radar Statistical Performances					
Trial #	Test Frequency (MHz)	Pulses per Burst	Pulse Width(us)	PRI(us)	Detection
1	5530	14	15	417	No
2	5540	16	18.8	460	Yes
3	5560	16	19.8	499	Yes
4	5520	15	17.2	356	Yes
5	5500	16	19.2	293	Yes
6	5566	12	11.6	340	Yes
7	5566	13	13.3	223	Yes
8	5496	12	11.9	461	Yes
9	5511	13	13	445	Yes
10	5562	15	18	273	No
11	5552	13	13	234	No
12	5505	15	17.8	342	Yes
13	5553	15	17.2	479	Yes
14	5505	16	19.8	495	No
15	5531	13	13.5	472	Yes
16	5562	16	18.8	408	Yes
17	5498	14	15.3	203	Yes
18	5531	13	14.4	478	Yes
19	5519	13	14.2	244	No
20	5557	15	16.8	285	Yes
21	5551	16	19.8	422	Yes
22	5513	12	12.2	369	Yes
23	5514	15	17.5	367	Yes
24	5536	15	16.6	295	Yes
25	5503	14	14.6	300	Yes
26	5539	13	12.8	233	Yes
27	5523	12	11.4	238	Yes
28	5558	12	11.2	403	Yes
29	5550	16	19.1	372	Yes
30	5511	16	18.3	358	No
Detection Rate : 80%					



## 802.11ax (HE80)

Type 5 Radar Statistical Performances				
Trial #	Minimum Chirp Width(MHz)	Chirp Center Frequency(MHz)	Test Signal Name	Detection
1	7	5530	LP_Signal_01	Yes
2	10	5530	LP_Signal_02	Yes
3	14	5530	LP_Signal_03	Yes
4	7	5530	LP_Signal_04	No
5	12	5530	LP_Signal_05	Yes
6	14	5530	LP_Signal_06	No
7	19	5530	LP_Signal_07	Yes
8	6	5530	LP_Signal_08	Yes
9	16	5530	LP_Signal_09	Yes
10	10	5530	LP_Signal_10	Yes
11	11	5495	LP_Signal_11	Yes
12	11	5495	LP_Signal_12	Yes
13	12	5496	LP_Signal_13	Yes
14	16	5497	LP_Signal_14	Yes
15	19	5499	LP_Signal_15	Yes
16	10	5495	LP_Signal_16	Yes
17	11	5495	LP_Signal_17	Yes
18	19	5499	LP_Signal_18	Yes
19	5	5493	LP_Signal_19	Yes
20	5	5493	LP_Signal_20	Yes
21	11	5565	LP_Signal_21	Yes
22	8	5566	LP_Signal_22	Yes
23	16	5563	LP_Signal_23	No
24	11	5565	LP_Signal_24	Yes
25	8	5566	LP_Signal_25	No
26	12	5564	LP_Signal_26	Yes
27	16	5563	LP_Signal_27	Yes
28	14	5563	LP_Signal_28	Yes
29	14	5563	LP_Signal_29	Yes
30	7	5566	LP_Signal_30	Yes

Detection Rate : 86.6%

Note: The Long Pulse Radar pattern shown in Appendix A.1



### 802.11ax (HE80)

Type 6 Radar Statistical Performances					
Trial #	Pulses per Burst	Pulse Width(us)	PRI(us)	Hopping Frequency Sequence Name	Detection
1	9	1	333.3	HOP_FREQ_SEQ_01	Yes
2	9	1	333.3	HOP_FREQ_SEQ_02	Yes
3	9	1	333.3	HOP_FREQ_SEQ_03	Yes
4	9	1	333.3	HOP_FREQ_SEQ_04	Yes
5	9	1	333.3	HOP_FREQ_SEQ_05	Yes
6	9	1	333.3	HOP_FREQ_SEQ_06	No
7	9	1	333.3	HOP_FREQ_SEQ_07	Yes
8	9	1	333.3	HOP_FREQ_SEQ_08	No
9	9	1	333.3	HOP_FREQ_SEQ_09	Yes
10	9	1	333.3	HOP_FREQ_SEQ_10	Yes
11	9	1	333.3	HOP_FREQ_SEQ_11	Yes
12	9	1	333.3	HOP_FREQ_SEQ_12	Yes
13	9	1	333.3	HOP_FREQ_SEQ_13	Yes
14	9	1	333.3	HOP_FREQ_SEQ_14	Yes
15	9	1	333.3	HOP_FREQ_SEQ_15	Yes
16	9	1	333.3	HOP_FREQ_SEQ_16	Yes
17	9	1	333.3	HOP_FREQ_SEQ_17	Yes
18	9	1	333.3	HOP_FREQ_SEQ_18	Yes
19	9	1	333.3	HOP_FREQ_SEQ_19	Yes
20	9	1	333.3	HOP_FREQ_SEQ_20	Yes
21	9	1	333.3	HOP_FREQ_SEQ_21	No
22	9	1	333.3	HOP_FREQ_SEQ_22	No
23	9	1	333.3	HOP_FREQ_SEQ_23	Yes
24	9	1	333.3	HOP_FREQ_SEQ_24	Yes
25	9	1	333.3	HOP_FREQ_SEQ_25	Yes
26	9	1	333.3	HOP_FREQ_SEQ_26	Yes
27	9	1	333.3	HOP_FREQ_SEQ_27	Yes
28	9	1	333.3	HOP_FREQ_SEQ_28	Yes
29	9	1	333.3	HOP_FREQ_SEQ_29	Yes
30	9	1	333.3	HOP_FREQ_SEQ_30	Yes

Detection Rate : 86.6%

Note: The Frequency Hopping Radar pattern shown in Appendix A.2



### 802.11ax (HE160)

#### Type 1 Radar Statistical Performances

Trial #	Test Frequency (MHz)	Pulse Repetition Frequency Number (1 to 23)	Pulse Repetition Frequency (pps)	Pulses per Burst	Pulse Repetition Interval (µsec)	Detection
1	5570	17	1193	63	838	Yes
2	5580	23	326.2	18	3066	Yes
3	5600	1	1931	102	518	Yes
4	5560	11	1393	74	718	No
5	5540	12	1355	72	738	Yes
6	5546	10	1433	76	698	Yes
7	5507	15	1253	67	798	Yes
8	5635	13	1319	70	758	Yes
9	5592	4	1730	92	578	Yes
10	5609	8	1520	81	658	Yes
11	5567	22	1066	57	938	Yes
12	5571	20	1114	59	898	Yes
13	5557	19	1139	61	878	Yes
14	5592	14	1285	68	778	Yes
15	5567	6	1618	86	618	Yes
16	5516	-	393.5	21	2541	Yes
17	5589	-	685.4	37	1459	Yes
18	5525	-	669.8	36	1493	No
19	5520	-	379.2	21	2637	Yes
20	5545	-	588.9	32	1698	Yes
21	5544	-	753.6	40	1327	Yes
22	5493	-	409.7	22	2441	Yes
23	5538	-	489.5	26	2043	Yes
24	5551	-	1647	87	607	Yes
25	5522	-	901.7	48	1109	Yes
26	5614	-	1024	55	977	Yes
27	5522	-	990.1	53	1010	Yes
28	5499	-	905.8	48	1104	No
29	5624	-	604.2	32	1655	Yes
30	5593	-	585.5	31	1708	Yes

Detection Rate : 90%

Note. " - " : 15 unique PRI values randomly selected within the range of 518-3066 µsec, with a minimum increment of 1µsec, excluding PRI values selected in Test A



### 802.11ax (HE160)

Type 2 Radar Statistical Performances					
Trial #	Test Frequency (MHz)	Pulses per Burst	Pulse Width(us)	PRI(us)	Detection
1	5570	26	2.8	215	Yes
2	5580	29	4.5	230	Yes
3	5600	29	4.9	187	Yes
4	5560	27	3.8	164	No
5	5540	29	4.7	219	Yes
6	5539	23	1.3	228	Yes
7	5496	24	2	174	Yes
8	5493	23	1.4	208	Yes
9	5552	24	1.9	163	Yes
10	5612	28	4.1	152	No
11	5571	24	1.9	179	Yes
12	5592	28	4.1	170	Yes
13	5593	27	3.8	190	Yes
14	5598	29	4.9	172	Yes
15	5570	24	2.1	177	Yes
16	5515	29	4.5	191	Yes
17	5606	26	2.9	165	Yes
18	5506	25	2.5	159	Yes
19	5615	25	2.4	184	Yes
20	5605	27	3.6	218	Yes
21	5577	29	4.9	192	Yes
22	5584	23	1.5	171	No
23	5603	28	3.9	198	No
24	5635	27	3.5	157	Yes
25	5644	25	2.6	160	Yes
26	5514	24	1.8	211	No
27	5506	23	1.2	150	Yes
28	5566	23	1.1	226	No
29	5494	29	4.6	194	No
30	5570	28	4.3	199	Yes

Detection Rate : 76.6%



## 802.11ax (HE160)

Type 3 Radar Statistical Performances					
Trial #	Test Frequency (MHz)	Pulses per Burst	Pulse Width(us)	PRI(us)	Detection
1	5570	17	7.8	417	Yes
2	5580	18	9.5	460	Yes
3	5600	18	9.9	499	No
4	5560	18	8.8	356	Yes
5	5540	18	9.7	293	Yes
6	5579	16	6.3	340	Yes
7	5556	16	7	223	Yes
8	5610	16	6.4	461	Yes
9	5554	16	6.9	445	Yes
10	5559	18	9.1	273	Yes
11	5520	16	6.9	234	Yes
12	5512	18	9.1	342	No
13	5597	18	8.8	479	No
14	5574	18	9.9	495	Yes
15	5544	16	7.1	472	Yes
16	5641	18	9.5	408	Yes
17	5625	17	7.9	203	No
18	5553	17	7.5	478	No
19	5572	17	7.4	244	Yes
20	5498	17	8.6	285	Yes
21	5505	18	9.9	422	Yes
22	5569	16	6.5	369	Yes
23	5505	18	8.9	367	Yes
24	5511	17	8.5	295	Yes
25	5617	17	7.6	300	Yes
26	5624	16	6.8	233	Yes
27	5523	16	6.2	238	Yes
28	5500	16	6.1	403	Yes
29	5619	18	9.6	372	Yes
30	5583	18	9.3	358	Yes
Detection Rate : 83.3%					



### 802.11ax (HE160)

Type 4 Radar Statistical Performances					
Trial #	Test Frequency (MHz)	Pulses per Burst	Pulse Width(us)	PRI(us)	Detection
1	5570	14	15	417	Yes
2	5580	16	18.8	460	Yes
3	5600	16	19.8	499	No
4	5560	15	17.2	356	Yes
5	5540	16	19.2	293	No
6	5614	12	11.6	340	Yes
7	5519	13	13.3	223	Yes
8	5628	12	11.9	461	Yes
9	5622	13	13	445	Yes
10	5547	15	18	273	Yes
11	5551	13	13	234	Yes
12	5641	15	17.8	342	Yes
13	5511	15	17.2	479	Yes
14	5598	16	19.8	495	No
15	5644	13	13.5	472	No
16	5579	16	18.8	408	Yes
17	5582	14	15.3	203	Yes
18	5497	13	14.4	478	Yes
19	5540	13	14.2	244	Yes
20	5596	15	16.8	285	Yes
21	5504	16	19.8	422	No
22	5631	12	12.2	369	No
23	5628	15	17.5	367	Yes
24	5509	15	16.6	295	Yes
25	5624	14	14.6	300	Yes
26	5541	13	12.8	233	Yes
27	5622	12	11.4	238	No
28	5517	12	11.2	403	Yes
29	5545	16	19.1	372	Yes
30	5494	16	18.3	358	Yes

Detection Rate : 76.6%



### 802.11ax (HE160)

Type 5 Radar Statistical Performances				
Trial #	Minimum Chirp Width(MHz)	Chirp Center Frequency(MHz)	Test Signal Name	Detection
1	12	5570	LP_Signal_01	Yes
2	18	5570	LP_Signal_02	Yes
3	20	5570	LP_Signal_03	No
4	16	5570	LP_Signal_04	Yes
5	19	5570	LP_Signal_05	Yes
6	6	5570	LP_Signal_06	Yes
7	9	5570	LP_Signal_07	Yes
8	6	5570	LP_Signal_08	Yes
9	8	5570	LP_Signal_09	Yes
10	17	5570	LP_Signal_10	Yes
11	8	5494	LP_Signal_11	No
12	17	5498	LP_Signal_12	Yes
13	16	5497	LP_Signal_13	Yes
14	20	5499	LP_Signal_14	Yes
15	9	5495	LP_Signal_15	Yes
16	18	5498	LP_Signal_16	Yes
17	12	5496	LP_Signal_17	Yes
18	11	5495	LP_Signal_18	Yes
19	10	5495	LP_Signal_19	No
20	15	5497	LP_Signal_20	No
21	20	5641	LP_Signal_21	Yes
22	7	5646	LP_Signal_22	Yes
23	16	5643	LP_Signal_23	Yes
24	14	5643	LP_Signal_24	Yes
25	11	5645	LP_Signal_25	Yes
26	8	5646	LP_Signal_26	Yes
27	5	5647	LP_Signal_27	No
28	5	5647	LP_Signal_28	No
29	19	5641	LP_Signal_29	Yes
30	17	5642	LP_Signal_30	Yes

Detection Rate : 80%

Note: The Long Pulse Radar pattern shown in Appendix A.1

## 802.11ax (HE160)

Type 6 Radar Statistical Performances					
Trial #	Pulses per Burst	Pulse Width(us)	PRI(us)	Hopping Frequency Sequence Name	Detection
1	9	1	333.3	HOP_FREQ_SEQ_01	Yes
2	9	1	333.3	HOP_FREQ_SEQ_02	Yes
3	9	1	333.3	HOP_FREQ_SEQ_03	No
4	9	1	333.3	HOP_FREQ_SEQ_04	Yes
5	9	1	333.3	HOP_FREQ_SEQ_05	Yes
6	9	1	333.3	HOP_FREQ_SEQ_06	Yes
7	9	1	333.3	HOP_FREQ_SEQ_07	Yes
8	9	1	333.3	HOP_FREQ_SEQ_08	No
9	9	1	333.3	HOP_FREQ_SEQ_09	Yes
10	9	1	333.3	HOP_FREQ_SEQ_10	Yes
11	9	1	333.3	HOP_FREQ_SEQ_11	Yes
12	9	1	333.3	HOP_FREQ_SEQ_12	Yes
13	9	1	333.3	HOP_FREQ_SEQ_13	Yes
14	9	1	333.3	HOP_FREQ_SEQ_14	Yes
15	9	1	333.3	HOP_FREQ_SEQ_15	Yes
16	9	1	333.3	HOP_FREQ_SEQ_16	Yes
17	9	1	333.3	HOP_FREQ_SEQ_17	Yes
18	9	1	333.3	HOP_FREQ_SEQ_18	Yes
19	9	1	333.3	HOP_FREQ_SEQ_19	Yes
20	9	1	333.3	HOP_FREQ_SEQ_20	Yes
21	9	1	333.3	HOP_FREQ_SEQ_21	Yes
22	9	1	333.3	HOP_FREQ_SEQ_22	Yes
23	9	1	333.3	HOP_FREQ_SEQ_23	Yes
24	9	1	333.3	HOP_FREQ_SEQ_24	Yes
25	9	1	333.3	HOP_FREQ_SEQ_25	Yes
26	9	1	333.3	HOP_FREQ_SEQ_26	No
27	9	1	333.3	HOP_FREQ_SEQ_27	Yes
28	9	1	333.3	HOP_FREQ_SEQ_28	Yes
29	9	1	333.3	HOP_FREQ_SEQ_29	Yes
30	9	1	333.3	HOP_FREQ_SEQ_30	Yes
Detection Rate : 90%					

Note: The Frequency Hopping Radar pattern shown in Appendix A.2

### 6.2.5 Non-Occupancy Period

1) Test results demonstrating an associated client link is established with the master on a test frequency.

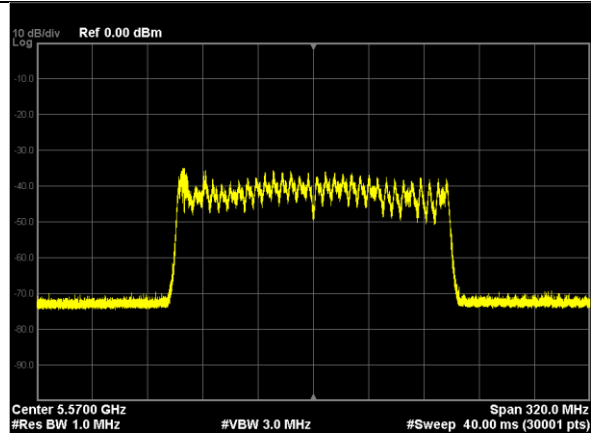

EUT (master) links with Client on 5570MHz

2) The master and DFS-certified client device are associated, and system testing will be performed with channel-loading for a non-occupancy period test.

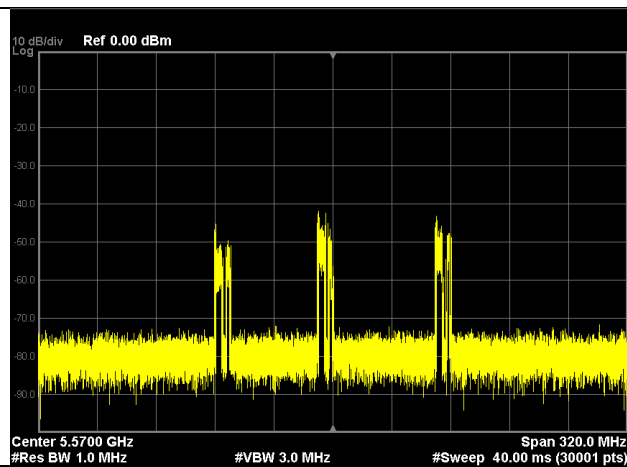

Client performed with channel-loading via master.

3). The device transmits one type of radar as specified in the DFS Order.

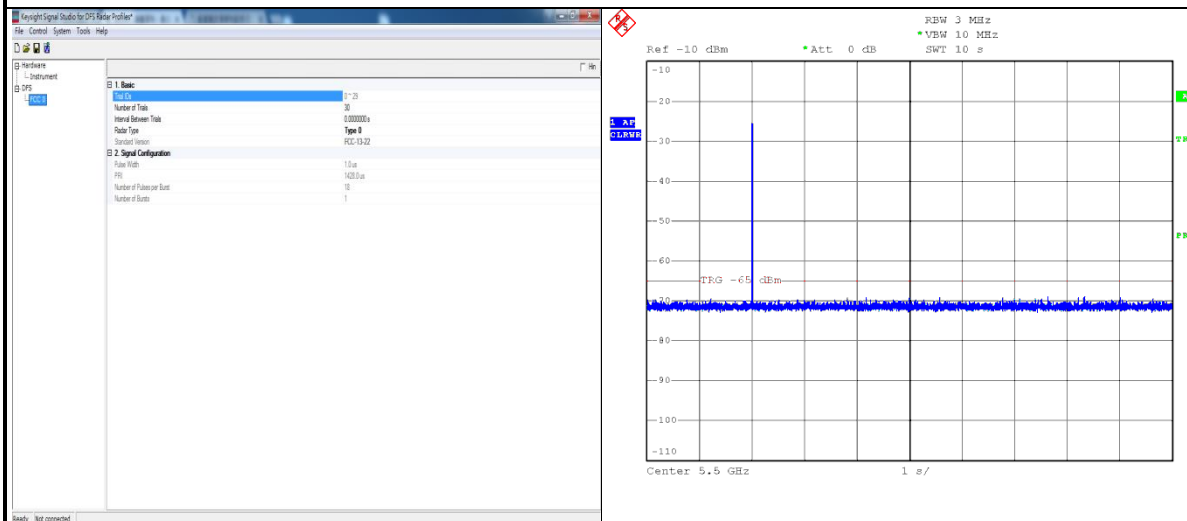

Radar 0 is used to test during DFS testing.

4) The test frequency has been monitored to ensure no transmission of any type has occurred for 30 minutes;

Note: If the client moves with the master, the device is considered compliant if nothing appears in the client non-occupancy period test. For devices that shut down (rather than moving channels), no beacons should appear;

5) An analyzer plot that contains a single 30-minute sweep on the original test frequency.

#### Non - Occupancy Period

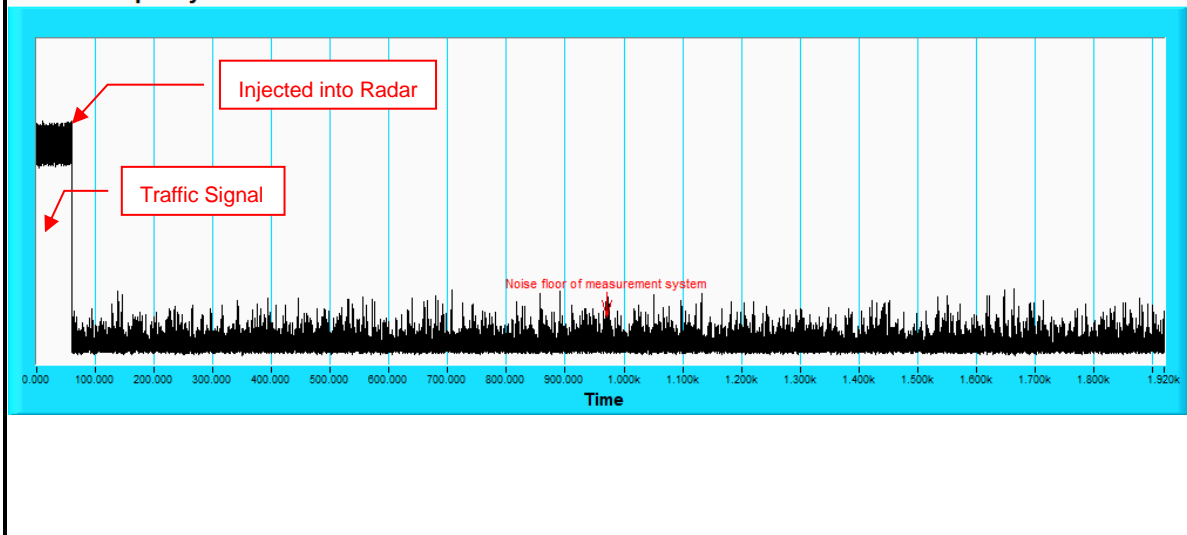

## 7. Information of the Testing Laboratories

We, Bureau Veritas Consumer Products Services (H.K.) Ltd., Taoyuan Branch, were founded in 1988 to provide our best service in EMC, Radio, Telecom and Safety consultation. Our laboratories are accredited and approved according to ISO/IEC 17025.

If you have any comments, please feel free to contact us at the following:

**Lin Kou EMC/RF Lab:**

Tel: 886-2-26052180

Fax: 886-2-26051924

**Hsin Chu EMC/RF/Telecom Lab:**

Tel: 886-3-6668565

Fax: 886-3-6668323

**Hwa Ya EMC/RF/Safety Lab:**

Tel: 886-3-3183232

Fax: 886-3-3270892

**Email:** [service.adt@tw.bureauveritas.com](mailto:service.adt@tw.bureauveritas.com)

**Web Site:** [www.bureauveritas-adt.com](http://www.bureauveritas-adt.com)

The address and road map of all our labs can be found in our web site also.

## APPENDIX-A

### RADAR TEST SIGNAL

#### A.1 The Long Pulse Radar Pattern

#### BW20

Long Pulse Radar Test Signal						
Test Signal Name: LP_Signal_01						
Number of Bursts in Trial: 18						
Burst	Pulses per Burst	Chrip (MHz)	Pulse Width(us)	PRI-1 (us)	PRI-2 (us)	PRI-3 (us)
1	3	17	88.7	1855	1442	1709
2	1	17	53.1	1611	-	-
3	3	17	100	1657	1306	1836
4	1	17	64.3	1294	-	-
5	2	17	67.9	1851	1744	-
6	3	17	92.9	1059	1667	1286
7	3	17	91.1	1272	1277	1961
8	1	17	52.9	1913	-	-
9	2	17	75.7	1219	1532	-
10	3	17	85.9	1819	1814	1553
11	1	17	56.3	1083	-	-
12	2	17	66.8	1704	1821	-
13	1	17	53.3	1740	-	-
14	2	17	68.3	1346	1996	-
15	1	17	64	1619	-	-
16	1	17	56.1	1349	-	-
17	3	17	93.4	1678	1480	1916
18	3	17	88.8	1399	1062	1613
19	-	-	-	-	-	-
20	-	-	-	-	-	-





Long Pulse Radar Test Signal

Test Signal Name: LP\_Signal\_02

Number of Bursts in Trial: 8

Burst	Pulses per Burst	Chrip (MHz)	Pulse Width(us)	PRI-1 (us)	PRI-2 (us)	PRI-3 (us)
1	2	6	77.3	1146	1462	-
2	1	6	51.5	1043	-	-
3	3	6	99.3	1210	1076	1956
4	3	6	88.8	1697	1371	1918
5	2	6	82.7	1459	1866	-
6	1	6	56.8	1142	-	-
7	2	6	73.1	1566	1826	-
8	3	6	95.3	1896	1363	1201
9	-	-	-	-	-	-
10	-	-	-	-	-	-
11	-	-	-	-	-	-
12	-	-	-	-	-	-
13	-	-	-	-	-	-
14	-	-	-	-	-	-
15	-	-	-	-	-	-
16	-	-	-	-	-	-
17	-	-	-	-	-	-
18	-	-	-	-	-	-
19	-	-	-	-	-	-
20	-	-	-	-	-	-

Long Pulse Radar Test Signal

Test Signal Name: LP\_Signal\_03

Number of Bursts in Trial: 20

Burst	Pulses per Burst	Chrip (MHz)	Pulse Width(us)	PRI-1 (us)	PRI-2 (us)	PRI-3 (us)
1	1	20	62.9	1555	-	-
2	2	20	72	1612	1650	-
3	2	20	80.3	1160	1089	-
4	2	20	82.6	1568	1490	-
5	2	20	83	1485	1395	-
6	2	20	81.4	1636	1187	-
7	1	20	52.1	1625	-	-
8	3	20	85.9	1126	1468	1601
9	3	20	86.8	1767	1759	1489
10	3	20	87.7	1862	1595	1477
11	1	20	59.3	1129	-	-
12	2	20	70.2	1617	1586	-
13	1	20	57.9	1905	-	-
14	1	20	56.8	1534	-	-
15	2	20	73.8	1735	1854	-
16	3	20	94.3	1053	1778	1035
17	2	20	79.9	1370	1715	-
18	1	20	54	1097	-	-
19	1	20	64.3	1452	-	-
20	2	20	78	1216	1239	-

Long Pulse Radar Test Signal

Test Signal Name: LP\_Signal\_04

Number of Bursts in Trial: 11

Burst	Pulses per Burst	Chrip (MHz)	Pulse Width(us)	PRI-1 (us)	PRI-2 (us)	PRI-3 (us)
1	3	9	90.7	1626	1730	1722
2	2	9	76.9	1668	1846	-
3	3	9	94.4	1561	1314	1184
4	2	9	67	1293	1398	-
5	2	9	71.3	1796	1052	-
6	3	9	90.9	1067	1407	1756
7	3	9	88.3	1861	1078	1736
8	2	9	77.3	1033	1829	-
9	1	9	50.5	1186	-	-
10	3	9	99.9	1287	1008	1701
11	2	9	70.5	1432	1872	-
12	-	-	-	-	-	-
13	-	-	-	-	-	-
14	-	-	-	-	-	-
15	-	-	-	-	-	-
16	-	-	-	-	-	-
17	-	-	-	-	-	-
18	-	-	-	-	-	-
19	-	-	-	-	-	-
20	-	-	-	-	-	-



Long Pulse Radar Test Signal

Test Signal Name: LP\_Signal\_05

Number of Bursts in Trial: 12

Burst	Pulses per Burst	Chrip (MHz)	Pulse Width(us)	PRI-1 (us)	PRI-2 (us)	PRI-3 (us)
1	3	10	93.1	1070	1163	1282
2	3	10	91.2	1016	1385	1781
3	2	10	72.6	1386	1012	-
4	2	10	80	1140	1180	-
5	2	10	69.1	1886	1570	-
6	2	10	72.6	1303	1402	-
7	3	10	93.2	1865	1337	1311
8	1	10	52.8	1254	-	-
9	2	10	74.9	1711	1630	-
10	1	10	64.6	1869	-	-
11	2	10	67.4	1107	1971	-
12	2	10	81.6	1183	1665	-
13	-	-	-	-	-	-
14	-	-	-	-	-	-
15	-	-	-	-	-	-
16	-	-	-	-	-	-
17	-	-	-	-	-	-
18	-	-	-	-	-	-
19	-	-	-	-	-	-
20	-	-	-	-	-	-

Long Pulse Radar Test Signal

Test Signal Name: LP\_Signal\_06

Number of Bursts in Trial: 19

Burst	Pulses per Burst	Chrip (MHz)	Pulse Width(us)	PRI-1 (us)	PRI-2 (us)	PRI-3 (us)
1	2	18	76.3	1440	1696	-
2	3	18	96.8	1967	1969	1414
3	2	18	73.1	1944	1367	-
4	2	18	80.8	1383	1304	-
5	2	18	70.4	1382	1664	-
6	2	18	77.8	1273	1936	-
7	1	18	54.9	1648	-	-
8	1	18	58.9	1616	-	-
9	2	18	78.6	1681	1194	-
10	3	18	92.6	1166	1985	1427
11	3	18	95.2	1576	1086	1673
12	1	18	54.6	1643	-	-
13	3	18	86	1178	1224	1203
14	2	18	77.6	1309	1263	-
15	1	18	63.2	1300	-	-
16	1	18	61.2	1202	-	-
17	3	18	92.2	1116	1948	1318
18	3	18	93.2	1175	1213	1472
19	2	18	74.9	1881	1094	-
20	-	-	-	-	-	-

Long Pulse Radar Test Signal

Test Signal Name: LP\_Signal\_07

Number of Bursts in Trial: 18

Burst	Pulses per Burst	Chrip (MHz)	Pulse Width(us)	PRI-1 (us)	PRI-2 (us)	PRI-3 (us)
1	3	18	85.4	1899	1957	1649
2	3	18	87	1983	1777	1984
3	2	18	67.2	1506	1428	-
4	1	18	66.3	1805	-	-
5	2	18	79.1	1453	1238	-
6	3	18	85.4	1117	1610	1547
7	2	18	76.8	1579	1530	-
8	1	18	54.7	1164	-	-
9	2	18	71.6	1327	1335	-
10	3	18	86.7	1410	1241	1330
11	1	18	51.2	1441	-	-
12	3	18	89.5	1721	1724	1540
13	1	18	63.3	1891	-	-
14	2	18	73.2	1392	1718	-
15	3	18	95.4	1197	1639	1242
16	2	18	68	1952	1883	-
17	2	18	70.2	1185	1497	-
18	3	18	98.2	1002	1131	1082
19	-	-	-	-	-	-
20	-	-	-	-	-	-



Long Pulse Radar Test Signal

Test Signal Name: LP\_Signal\_08

Number of Bursts in Trial: 8

Burst	Pulses per Burst	Chrip (MHz)	Pulse Width(us)	PRI-1 (us)	PRI-2 (us)	PRI-3 (us)
1	1	5	60	1963	-	-
2	2	5	67.8	1889	1236	-
3	3	5	99.5	1351	1858	1124
4	3	5	95.6	1661	1605	1875
5	3	5	90.9	1789	1907	1065
6	3	5	92	1962	1356	1518
7	1	5	50.4	1564	-	-
8	3	5	96	1848	1276	1168
9	-	-	-	-	-	-
10	-	-	-	-	-	-
11	-	-	-	-	-	-
12	-	-	-	-	-	-
13	-	-	-	-	-	-
14	-	-	-	-	-	-
15	-	-	-	-	-	-
16	-	-	-	-	-	-
17	-	-	-	-	-	-
18	-	-	-	-	-	-
19	-	-	-	-	-	-
20	-	-	-	-	-	-



Long Pulse Radar Test Signal

Test Signal Name: LP\_Signal\_09

Number of Bursts in Trial: 14

Burst	Pulses per Burst	Chrip (MHz)	Pulse Width(us)	PRI-1 (us)	PRI-2 (us)	PRI-3 (us)
1	2	13	67.9	1831	1585	-
2	3	13	94.1	1292	1893	1249
3	3	13	91.5	1467	1446	1362
4	1	13	59.4	1840	-	-
5	2	13	81.9	1713	1279	-
6	1	13	60.7	1412	-	-
7	2	13	81.8	1622	1813	-
8	3	13	89.7	1834	1741	1189
9	2	13	82	1521	1435	-
10	3	13	94.7	1090	1845	1809
11	1	13	59.1	1103	-	-
12	2	13	80.5	1590	1138	-
13	3	13	94.1	1174	1232	1285
14	3	13	95.5	1808	1795	1557
15	-	-	-	-	-	-
16	-	-	-	-	-	-
17	-	-	-	-	-	-
18	-	-	-	-	-	-
19	-	-	-	-	-	-
20	-	-	-	-	-	-



Long Pulse Radar Test Signal

Test Signal Name: LP\_Signal\_10

Number of Bursts in Trial: 17

Burst	Pulses per Burst	Chrip (MHz)	Pulse Width(us)	PRI-1 (us)	PRI-2 (us)	PRI-3 (us)
1	3	16	93.7	1946	1460	1659
2	2	16	73	1215	1243	-
3	2	16	83.3	1982	1507	-
4	2	16	72.3	1128	1329	-
5	2	16	77.3	1278	1843	-
6	1	16	53.1	1331	-	-
7	2	16	81.9	1029	1921	-
8	2	16	81.5	1041	1533	-
9	3	16	90.7	1526	1247	1606
10	1	16	59.6	1761	-	-
11	3	16	93	1797	1679	1864
12	1	16	63	1473	-	-
13	2	16	82.1	1849	1061	-
14	2	16	75.3	1080	1079	-
15	2	16	75.5	1728	1305	-
16	3	16	89.8	1046	1162	1960
17	3	16	96.1	1218	1717	1066
18	-	-	-	-	-	-
19	-	-	-	-	-	-
20	-	-	-	-	-	-

Long Pulse Radar Test Signal

Test Signal Name: LP\_Signal\_11

Number of Bursts in Trial: 9

Burst	Pulses per Burst	Chrip (MHz)	Pulse Width(us)	PRI-1 (us)	PRI-2 (us)	PRI-3 (us)
1	2	7	75.2	1419	1583	-
2	1	7	65.8	1945	-	-
3	2	7	83.1	1965	1176	-
4	2	7	67.4	1456	1024	-
5	2	7	82.8	1748	1853	-
6	1	7	63.3	1073	-	-
7	1	7	62.2	1347	-	-
8	1	7	54.7	1465	-	-
9	3	7	90.6	1623	1484	1951
10	-	-	-	-	-	-
11	-	-	-	-	-	-
12	-	-	-	-	-	-
13	-	-	-	-	-	-
14	-	-	-	-	-	-
15	-	-	-	-	-	-
16	-	-	-	-	-	-
17	-	-	-	-	-	-
18	-	-	-	-	-	-
19	-	-	-	-	-	-
20	-	-	-	-	-	-

Long Pulse Radar Test Signal

Test Signal Name: LP\_Signal\_12

Number of Bursts in Trial: 12

Burst	Pulses per Burst	Chrip (MHz)	Pulse Width(us)	PRI-1 (us)	PRI-2 (us)	PRI-3 (us)
1	1	10	57.6	1842	-	-
2	2	10	73.6	1698	1479	-
3	3	10	91.2	1319	1958	1364
4	1	10	50.7	1542	-	-
5	1	10	58.8	1641	-	-
6	3	10	89.8	1365	1772	1565
7	1	10	54.1	1731	-	-
8	1	10	64.6	1137	-	-
9	2	10	74.2	1887	1448	-
10	2	10	76.4	1647	1558	-
11	1	10	62.2	1563	-	-
12	2	10	68.6	1495	1597	-
13	-	-	-	-	-	-
14	-	-	-	-	-	-
15	-	-	-	-	-	-
16	-	-	-	-	-	-
17	-	-	-	-	-	-
18	-	-	-	-	-	-
19	-	-	-	-	-	-
20	-	-	-	-	-	-

Long Pulse Radar Test Signal

Test Signal Name: LP\_Signal\_13

Number of Bursts in Trial: 8

Burst	Pulses per Burst	Chrip (MHz)	Pulse Width(us)	PRI-1 (us)	PRI-2 (us)	PRI-3 (us)
1	1	6	64.6	1233	-	-
2	3	6	97.4	1890	1832	1438
3	1	6	64.1	1104	-	-
4	3	6	86.5	1847	1719	1220
5	1	6	53.3	1345	-	-
6	2	6	81.8	1264	1638	-
7	1	6	66.4	1599	-	-
8	2	6	68.9	1802	1123	-
9	-	-	-	-	-	-
10	-	-	-	-	-	-
11	-	-	-	-	-	-
12	-	-	-	-	-	-
13	-	-	-	-	-	-
14	-	-	-	-	-	-
15	-	-	-	-	-	-
16	-	-	-	-	-	-
17	-	-	-	-	-	-
18	-	-	-	-	-	-
19	-	-	-	-	-	-
20	-	-	-	-	-	-

Long Pulse Radar Test Signal

Test Signal Name: LP\_Signal\_14

Number of Bursts in Trial: 12

Burst	Pulses per Burst	Chrip (MHz)	Pulse Width(us)	PRI-1 (us)	PRI-2 (us)	PRI-3 (us)
1	2	10	78.6	1600	1546	-
2	1	10	56.5	1578	-	-
3	1	10	64.2	1762	-	-
4	3	10	92.3	1560	1031	1674
5	3	10	98.6	1653	1803	1047
6	3	10	84	1044	1132	1058
7	1	10	64.7	1425	-	-
8	1	10	61	1334	-	-
9	2	10	78.1	1461	1902	-
10	1	10	60.9	1240	-	-
11	1	10	59.7	1281	-	-
12	2	10	71.1	1770	1503	-
13	-	-	-	-	-	-
14	-	-	-	-	-	-
15	-	-	-	-	-	-
16	-	-	-	-	-	-
17	-	-	-	-	-	-
18	-	-	-	-	-	-
19	-	-	-	-	-	-
20	-	-	-	-	-	-

Long Pulse Radar Test Signal

Test Signal Name: LP\_Signal\_15

Number of Bursts in Trial: 11

Burst	Pulses per Burst	Chrip (MHz)	Pulse Width(us)	PRI-1 (us)	PRI-2 (us)	PRI-3 (us)
1	2	9	67.5	1338	1852	-
2	3	9	86.8	1344	1776	1504
3	3	9	95.5	1888	1941	1225
4	1	9	58.2	1822	-	-
5	3	9	90.3	1544	1217	1997
6	3	9	89.9	1222	1492	1284
7	1	9	50.7	1788	-	-
8	1	9	53.2	1297	-	-
9	1	9	58.9	1799	-	-
10	2	9	67.5	1800	1259	-
11	1	9	51	1434	-	-
12	-	-	-	-	-	-
13	-	-	-	-	-	-
14	-	-	-	-	-	-
15	-	-	-	-	-	-
16	-	-	-	-	-	-
17	-	-	-	-	-	-
18	-	-	-	-	-	-
19	-	-	-	-	-	-
20	-	-	-	-	-	-

Long Pulse Radar Test Signal

Test Signal Name: LP\_Signal\_16

Number of Bursts in Trial: 9

Burst	Pulses per Burst	Chrip (MHz)	Pulse Width(us)	PRI-1 (us)	PRI-2 (us)	PRI-3 (us)
1	3	6	99.1	1879	1246	1716
2	2	6	77.5	1171	1474	-
3	2	6	77.4	1548	1575	-
4	1	6	60.6	1874	-	-
5	2	6	68.4	1015	1098	-
6	2	6	68.9	1739	1036	-
7	2	6	80.9	1596	1173	-
8	2	6	79.4	1122	1200	-
9	2	6	81.5	1280	1528	-
10	-	-	-	-	-	-
11	-	-	-	-	-	-
12	-	-	-	-	-	-
13	-	-	-	-	-	-
14	-	-	-	-	-	-
15	-	-	-	-	-	-
16	-	-	-	-	-	-
17	-	-	-	-	-	-
18	-	-	-	-	-	-
19	-	-	-	-	-	-
20	-	-	-	-	-	-

Long Pulse Radar Test Signal

Test Signal Name: LP\_Signal\_17

Number of Bursts in Trial: 19

Burst	Pulses per Burst	Chrip (MHz)	Pulse Width(us)	PRI-1 (us)	PRI-2 (us)	PRI-3 (us)
1	3	18	95.8	1580	1332	1358
2	3	18	85.9	1760	1644	1181
3	1	18	61.9	1734	-	-
4	1	18	51.1	1221	-	-
5	1	18	59.3	1355	-	-
6	3	18	99	1964	1598	1783
7	1	18	52.1	1499	-	-
8	2	18	74.9	1223	1628	-
9	2	18	75.1	1261	1932	-
10	3	18	93.1	1415	1458	1573
11	3	18	86.6	1973	1747	1214
12	1	18	63.3	1885	-	-
13	2	18	66.7	1032	1469	-
14	3	18	91.2	1470	1114	1155
15	1	18	51.1	1811	-	-
16	2	18	77.8	1169	1817	-
17	1	18	51.8	1257	-	-
18	1	18	55.8	1571	-	-
19	3	18	96.2	1055	1188	1652
20	-	-	-	-	-	-



Long Pulse Radar Test Signal

Test Signal Name: LP\_Signal\_18

Number of Bursts in Trial: 18

Burst	Pulses per Burst	Chrip (MHz)	Pulse Width(us)	PRI-1 (us)	PRI-2 (us)	PRI-3 (us)
1	1	17	63.5	1109	-	-
2	2	17	81.1	1732	1752	-
3	1	17	63.2	1266	-	-
4	1	17	59.9	1019	-	-
5	1	17	61.1	1529	-	-
6	1	17	55.4	1987	-	-
7	1	17	65.2	1536	-	-
8	1	17	64.7	1974	-	-
9	2	17	71.2	1680	1663	-
10	2	17	73.3	1408	1313	-
11	3	17	96.3	1411	1812	1804
12	3	17	92.1	1360	1443	1437
13	3	17	97.2	1567	1120	1077
14	2	17	81.5	1255	1211	-
15	2	17	78.2	1562	1656	-
16	2	17	75.3	1708	1703	-
17	2	17	81.6	1156	1085	-
18	2	17	74.8	1642	1979	-
19	-	-	-	-	-	-
20	-	-	-	-	-	-

Long Pulse Radar Test Signal

Test Signal Name: LP\_Signal\_19

Number of Bursts in Trial: 15

Burst	Pulses per Burst	Chrip (MHz)	Pulse Width(us)	PRI-1 (us)	PRI-2 (us)	PRI-3 (us)
1	3	13	94.4	1833	1007	1784
2	3	13	99	1992	1212	1388
3	3	13	91.4	1226	1729	1310
4	3	13	87.8	1884	1063	1167
5	2	13	75.8	1148	1463	-
6	2	13	78.1	1912	1574	-
7	1	13	65.8	1714	-	-
8	2	13	80.9	1710	1970	-
9	3	13	87.8	1105	1403	1159
10	2	13	82.3	1429	1572	-
11	3	13	86.4	1691	1268	1482
12	2	13	76.2	1377	1981	-
13	2	13	82.9	1206	1632	-
14	1	13	66.6	1069	-	-
15	1	13	63.1	1685	-	-
16	-	-	-	-	-	-
17	-	-	-	-	-	-
18	-	-	-	-	-	-
19	-	-	-	-	-	-
20	-	-	-	-	-	-



Long Pulse Radar Test Signal

Test Signal Name: LP\_Signal\_20

Number of Bursts in Trial: 8

Burst	Pulses per Burst	Chrip (MHz)	Pulse Width(us)	PRI-1 (us)	PRI-2 (us)	PRI-3 (us)
1	3	5	84.7	1688	1426	1535
2	1	5	65.9	1030	-	-
3	1	5	50.4	1738	-	-
4	2	5	82.5	1511	1991	-
5	2	5	75.9	1193	1725	-
6	1	5	50.8	1933	-	-
7	3	5	95.7	1478	1882	1234
8	3	5	94.1	1050	1689	1333
9	-	-	-	-	-	-
10	-	-	-	-	-	-
11	-	-	-	-	-	-
12	-	-	-	-	-	-
13	-	-	-	-	-	-
14	-	-	-	-	-	-
15	-	-	-	-	-	-
16	-	-	-	-	-	-
17	-	-	-	-	-	-
18	-	-	-	-	-	-
19	-	-	-	-	-	-
20	-	-	-	-	-	-

Long Pulse Radar Test Signal

Test Signal Name: LP\_Signal\_21

Number of Bursts in Trial: 20

Burst	Pulses per Burst	Chrip (MHz)	Pulse Width(us)	PRI-1 (us)	PRI-2 (us)	PRI-3 (us)
1	3	20	84.3	1475	1581	1068
2	2	20	81	1720	1637	-
3	1	20	51.6	1256	-	-
4	2	20	78.8	1290	1785	-
5	1	20	50.9	1839	-	-
6	3	20	89.4	1750	1229	1798
7	2	20	81.8	1593	1056	-
8	3	20	88.5	1252	1694	1496
9	1	20	65.9	1516	-	-
10	2	20	69.5	1151	1502	-
11	1	20	52.9	1769	-	-
12	1	20	57.5	1100	-	-
13	1	20	56.9	1350	-	-
14	1	20	54.8	1179	-	-
15	2	20	75.7	1028	1149	-
16	1	20	55.2	1917	-	-
17	3	20	85.1	1787	1654	1726
18	3	20	94.1	1088	1510	1315
19	2	20	80.2	1501	1670	-
20	2	20	67.6	1228	1915	-

Long Pulse Radar Test Signal

Test Signal Name: LP\_Signal\_22

Number of Bursts in Trial: 18

Burst	Pulses per Burst	Chrip (MHz)	Pulse Width(us)	PRI-1 (us)	PRI-2 (us)	PRI-3 (us)
1	2	17	83	1955	1990	-
2	2	17	78.4	1133	1629	-
3	3	17	95	1270	1368	1587
4	3	17	90.4	1559	1745	1929
5	2	17	79.6	1483	1773	-
6	2	17	79	1481	1514	-
7	1	17	62.4	1923	-	-
8	1	17	65.6	1134	-	-
9	2	17	77.8	1209	1763	-
10	3	17	92.8	1742	1904	1042
11	1	17	55.7	1420	-	-
12	2	17	74	1706	1366	-
13	3	17	98.7	1235	1827	1901
14	1	17	54.8	1602	-	-
15	1	17	57.1	1487	-	-
16	1	17	56.8	1631	-	-
17	2	17	74.2	1049	1336	-
18	3	17	99.3	1231	1378	1512
19	-	-	-	-	-	-
20	-	-	-	-	-	-

Long Pulse Radar Test Signal

Test Signal Name: LP\_Signal\_23

Number of Bursts in Trial: 16

Burst	Pulses per Burst	Chrip (MHz)	Pulse Width(us)	PRI-1 (us)	PRI-2 (us)	PRI-3 (us)
1	1	15	64.9	1914	-	-
2	3	15	91.6	1733	1343	1633
3	1	15	56	1556	-	-
4	3	15	93.9	1525	1244	1161
5	2	15	70.5	1418	1190	-
6	1	15	56.7	1627	-	-
7	2	15	80	1328	1248	-
8	1	15	59.1	2000	-	-
9	1	15	56.1	1676	-	-
10	2	15	79.9	1658	1702	-
11	3	15	90.2	1940	1251	1727
12	3	15	95.2	1816	1975	1954
13	3	15	97.5	1205	1191	1322
14	2	15	81.8	1895	1298	-
15	2	15	70.7	1445	1635	-
16	2	15	78.1	1755	1323	-
17	-	-	-	-	-	-
18	-	-	-	-	-	-
19	-	-	-	-	-	-
20	-	-	-	-	-	-

Long Pulse Radar Test Signal

Test Signal Name: LP\_Signal\_24

Number of Bursts in Trial: 9

Burst	Pulses per Burst	Chrip (MHz)	Pulse Width(us)	PRI-1 (us)	PRI-2 (us)	PRI-3 (us)
1	1	7	61.1	1387	-	-
2	1	7	55.8	1592	-	-
3	3	7	86	1764	1299	1928
4	1	7	61.2	1295	-	-
5	3	7	99.3	1655	1589	1045
6	2	7	71.9	1471	1204	-
7	2	7	77	1863	1906	-
8	1	7	66.1	1758	-	-
9	1	7	60.6	1820	-	-
10	-	-	-	-	-	-
11	-	-	-	-	-	-
12	-	-	-	-	-	-
13	-	-	-	-	-	-
14	-	-	-	-	-	-
15	-	-	-	-	-	-
16	-	-	-	-	-	-
17	-	-	-	-	-	-
18	-	-	-	-	-	-
19	-	-	-	-	-	-
20	-	-	-	-	-	-

Long Pulse Radar Test Signal

Test Signal Name: LP\_Signal\_25

Number of Bursts in Trial: 14

Burst	Pulses per Burst	Chrip (MHz)	Pulse Width(us)	PRI-1 (us)	PRI-2 (us)	PRI-3 (us)
1	2	12	73.1	1106	1953	-
2	1	12	63.8	1524	-	-
3	2	12	78.9	1005	1324	-
4	1	12	58.8	1144	-	-
5	1	12	52	1121	-	-
6	3	12	97.7	1450	1624	1977
7	2	12	68.9	1026	1039	-
8	2	12	81.1	1198	1949	-
9	3	12	85.8	1792	1373	1125
10	2	12	79.2	1552	1040	-
11	3	12	88.7	1354	1369	1372
12	1	12	61.6	2000	-	-
13	3	12	89.1	1522	1004	1172
14	1	12	57.8	1325	-	-
15	-	-	-	-	-	-
16	-	-	-	-	-	-
17	-	-	-	-	-	-
18	-	-	-	-	-	-
19	-	-	-	-	-	-
20	-	-	-	-	-	-





Long Pulse Radar Test Signal

Test Signal Name: LP\_Signal\_26

Number of Bursts in Trial: 19

Burst	Pulses per Burst	Chrip (MHz)	Pulse Width(us)	PRI-1 (us)	PRI-2 (us)	PRI-3 (us)
1	3	19	88.3	1577	1707	1006
2	1	19	60.4	1520	-	-
3	2	19	70.5	1699	1352	-
4	2	19	72.8	1690	1422	-
5	2	19	82.6	1143	1341	-
6	2	19	75.5	1152	1660	-
7	2	19	82.6	1011	1993	-
8	3	19	95.4	1591	1230	1447
9	2	19	73.9	1018	1307	-
10	1	19	53.3	1994	-	-
11	2	19	70.6	1621	1880	-
12	3	19	93.8	1196	1416	1009
13	1	19	51.2	1790	-	-
14	2	19	70.8	1972	1531	-
15	1	19	62.9	1541	-	-
16	1	19	50	1774	-	-
17	3	19	93	1340	1227	1101
18	1	19	64.5	1545	-	-
19	3	19	89.9	1857	1810	1908
20	-	-	-	-	-	-



Long Pulse Radar Test Signal

Test Signal Name: LP\_Signal\_27

Number of Bursts in Trial: 11

Burst	Pulses per Burst	Chrip (MHz)	Pulse Width(us)	PRI-1 (us)	PRI-2 (us)	PRI-3 (us)
1	2	9	83.2	1081	1275	-
2	3	9	97.4	1868	1118	1154
3	3	9	92.9	1607	1207	1723
4	1	9	51	1897	-	-
5	1	9	50.2	1523	-	-
6	1	9	54.1	1768	-	-
7	2	9	82.2	1271	1828	-
8	2	9	71.2	1920	1640	-
9	1	9	64.1	1910	-	-
10	1	9	61.6	1115	-	-
11	1	9	52.6	1995	-	-
12	-	-	-	-	-	-
13	-	-	-	-	-	-
14	-	-	-	-	-	-
15	-	-	-	-	-	-
16	-	-	-	-	-	-
17	-	-	-	-	-	-
18	-	-	-	-	-	-
19	-	-	-	-	-	-
20	-	-	-	-	-	-

Long Pulse Radar Test Signal

Test Signal Name: LP\_Signal\_28

Number of Bursts in Trial: 13

Burst	Pulses per Burst	Chrip (MHz)	Pulse Width(us)	PRI-1 (us)	PRI-2 (us)	PRI-3 (us)
1	2	12	82	1135	1361	-
2	1	12	66.5	1265	-	-
3	2	12	72	1396	1342	-
4	3	12	98.1	1986	1182	1684
5	3	12	97.7	1136	1894	1876
6	1	12	50.8	1308	-	-
7	2	12	78.7	1348	1927	-
8	3	12	99.1	1150	1669	1830
9	3	12	94.4	1357	1048	1537
10	3	12	90.7	1102	1466	1147
11	2	12	78.1	1543	1645	-
12	2	12	77.7	1302	1359	-
13	3	12	90	1998	1794	1153
14	-	-	-	-	-	-
15	-	-	-	-	-	-
16	-	-	-	-	-	-
17	-	-	-	-	-	-
18	-	-	-	-	-	-
19	-	-	-	-	-	-
20	-	-	-	-	-	-

Long Pulse Radar Test Signal

Test Signal Name: LP\_Signal\_29

Number of Bursts in Trial: 15

Burst	Pulses per Burst	Chrip (MHz)	Pulse Width(us)	PRI-1 (us)	PRI-2 (us)	PRI-3 (us)
1	2	14	75.6	1837	1551	-
2	3	14	88.3	1925	1339	1687
3	1	14	58.2	1258	-	-
4	3	14	96.5	1013	1253	1978
5	3	14	98.1	1075	1430	1947
6	2	14	68.1	1208	1051	-
7	3	14	85.7	1245	1455	1870
8	3	14	86.2	1931	1262	1498
9	2	14	74.1	1413	1517	-
10	2	14	71.7	1841	1027	-
11	1	14	55.9	1269	-	-
12	1	14	60.5	1943	-	-
13	3	14	95.5	1815	1749	1775
14	1	14	59.4	1119	-	-
15	2	14	70.2	1037	1999	-
16	-	-	-	-	-	-
17	-	-	-	-	-	-
18	-	-	-	-	-	-
19	-	-	-	-	-	-
20	-	-	-	-	-	-

Long Pulse Radar Test Signal

Test Signal Name: LP\_Signal\_30

Number of Bursts in Trial: 16

Burst	Pulses per Burst	Chrip (MHz)	Pulse Width(us)	PRI-1 (us)	PRI-2 (us)	PRI-3 (us)
1	2	15	68.7	1515	1939	-
2	1	15	50.3	1753	-	-
3	1	15	54.2	1892	-	-
4	2	15	68.5	1326	1404	-
5	3	15	83.8	1449	1296	1871
6	2	15	71.2	1609	1064	-
7	2	15	71.3	1431	1406	-
8	1	15	54	1165	-	-
9	2	15	71.7	1439	1353	-
10	1	15	53.2	1424	-	-
11	2	15	73.1	1818	1807	-
12	1	15	62.1	1671	-	-
13	2	15	71.4	1824	1686	-
14	3	15	93.9	1867	1603	1108
15	2	15	70.1	1539	1112	-
16	3	15	99.2	1423	1988	1751
17	-	-	-	-	-	-
18	-	-	-	-	-	-
19	-	-	-	-	-	-
20	-	-	-	-	-	-

**BW40**

Long Pulse Radar Test Signal

Test Signal Name: LP\_Signal\_01

Number of Bursts in Trial: 14

Burst	Pulses per Burst	Chrip (MHz)	Pulse Width(us)	PRI-1 (us)	PRI-2 (us)	PRI-3 (us)
1	2	12	73.8	1073	1713	-
2	3	12	85.2	1207	1828	1620
3	1	12	64.4	1691	-	-
4	1	12	60.3	1775	-	-
5	2	12	71.1	1989	1229	-
6	3	12	86.2	1788	1134	1384
7	3	12	92.8	1757	1984	1778
8	2	12	78.7	1920	1540	-
9	2	12	81.4	1393	1130	-
10	1	12	51.8	1021	-	-
11	3	12	87.9	1260	1473	1243
12	2	12	68.1	1461	1634	-
13	1	12	62.7	1854	-	-
14	1	12	52.4	1145	-	-
15	-	-	-	-	-	-
16	-	-	-	-	-	-
17	-	-	-	-	-	-
18	-	-	-	-	-	-
19	-	-	-	-	-	-
20	-	-	-	-	-	-

Long Pulse Radar Test Signal

Test Signal Name: LP\_Signal\_02

Number of Bursts in Trial: 17

Burst	Pulses per Burst	Chrip (MHz)	Pulse Width(us)	PRI-1 (us)	PRI-2 (us)	PRI-3 (us)
1	2	16	79	1523	1645	-
2	3	16	87.2	1009	1085	1169
3	2	16	82.5	1543	1538	-
4	2	16	67.8	1642	1459	-
5	3	16	89.5	1179	1797	1764
6	2	16	75.8	1014	1030	-
7	1	16	59	1908	-	-
8	3	16	99.3	1682	1722	1177
9	1	16	58.7	1616	-	-
10	1	16	64.1	1186	-	-
11	2	16	67.2	1007	1591	-
12	3	16	84.7	1481	1923	1855
13	3	16	99.8	1470	1748	1447
14	1	16	50.8	1019	-	-
15	1	16	54.5	1799	-	-
16	3	16	95	1252	1344	1956
17	3	16	99.2	1218	1094	1472
18	-	-	-	-	-	-
19	-	-	-	-	-	-
20	-	-	-	-	-	-

Long Pulse Radar Test Signal

Test Signal Name: LP\_Signal\_03

Number of Bursts in Trial: 11

Burst	Pulses per Burst	Chrip (MHz)	Pulse Width(us)	PRI-1 (us)	PRI-2 (us)	PRI-3 (us)
1	3	9	100	1595	1705	1361
2	2	9	83.2	1851	1368	-
3	3	9	97.2	1483	1567	1563
4	3	9	94	1741	1710	1084
5	1	9	57.1	1763	-	-
6	2	9	82.1	1160	1712	-
7	2	9	76.9	1002	1496	-
8	3	9	85.1	1396	1062	1617
9	1	9	62.3	1789	-	-
10	2	9	69.3	1858	1987	-
11	2	9	69.3	1029	1015	-
12	-	-	-	-	-	-
13	-	-	-	-	-	-
14	-	-	-	-	-	-
15	-	-	-	-	-	-
16	-	-	-	-	-	-
17	-	-	-	-	-	-
18	-	-	-	-	-	-
19	-	-	-	-	-	-
20	-	-	-	-	-	-





Long Pulse Radar Test Signal

Test Signal Name: LP\_Signal\_04

Number of Bursts in Trial: 10

Burst	Pulses per Burst	Chrip (MHz)	Pulse Width(us)	PRI-1 (us)	PRI-2 (us)	PRI-3 (us)
1	3	8	87.3	1941	1435	1728
2	1	8	55	1336	-	-
3	1	8	51.5	1551	-	-
4	2	8	74.2	1791	1913	-
5	3	8	93.8	1727	1648	1742
6	3	8	84	1660	1474	1440
7	3	8	88.4	1288	1909	1739
8	2	8	76.5	1188	1036	-
9	2	8	73.6	1092	1887	-
10	3	8	93.7	1471	1824	1032
11	-	-	-	-	-	-
12	-	-	-	-	-	-
13	-	-	-	-	-	-
14	-	-	-	-	-	-
15	-	-	-	-	-	-
16	-	-	-	-	-	-
17	-	-	-	-	-	-
18	-	-	-	-	-	-
19	-	-	-	-	-	-
20	-	-	-	-	-	-

Long Pulse Radar Test Signal

Test Signal Name: LP\_Signal\_05

Number of Bursts in Trial: 13

Burst	Pulses per Burst	Chrip (MHz)	Pulse Width(us)	PRI-1 (us)	PRI-2 (us)	PRI-3 (us)
1	1	11	65.3	1857	-	-
2	2	11	68.9	1059	1100	-
3	3	11	90.7	1001	1629	1150
4	2	11	74.6	1245	1132	-
5	2	11	76.5	1837	1237	-
6	1	11	50.3	1374	-	-
7	3	11	93.2	1535	1225	1502
8	3	11	86.4	1356	1991	1590
9	3	11	86.4	1501	1951	1706
10	3	11	91.9	1248	1843	1182
11	2	11	74.1	1176	1307	-
12	3	11	86.4	1217	1268	1935
13	1	11	52.6	1304	-	-
14	-	-	-	-	-	-
15	-	-	-	-	-	-
16	-	-	-	-	-	-
17	-	-	-	-	-	-
18	-	-	-	-	-	-
19	-	-	-	-	-	-
20	-	-	-	-	-	-

Long Pulse Radar Test Signal

Test Signal Name: LP\_Signal\_06

Number of Bursts in Trial: 17

Burst	Pulses per Burst	Chrip (MHz)	Pulse Width(us)	PRI-1 (us)	PRI-2 (us)	PRI-3 (us)
1	3	16	87.9	1696	1985	1064
2	3	16	85	1979	1272	1922
3	1	16	65.5	1510	-	-
4	1	16	58.5	1482	-	-
5	2	16	71.8	1898	1156	-
6	1	16	55	1072	-	-
7	1	16	55.6	1276	-	-
8	2	16	82.7	1618	1655	-
9	2	16	77.1	1845	1902	-
10	1	16	56.5	1115	-	-
11	3	16	89.8	1086	1444	1680
12	1	16	61.9	1560	-	-
13	1	16	53.7	1151	-	-
14	1	16	62.5	1550	-	-
15	3	16	93	1232	1221	1322
16	3	16	91	1743	1168	1822
17	1	16	65.8	1323	-	-
18	-	-	-	-	-	-
19	-	-	-	-	-	-
20	-	-	-	-	-	-

Long Pulse Radar Test Signal

Test Signal Name: LP\_Signal\_07

Number of Bursts in Trial: 19

Burst	Pulses per Burst	Chrip (MHz)	Pulse Width(us)	PRI-1 (us)	PRI-2 (us)	PRI-3 (us)
1	1	18	62.5	1242	-	-
2	2	18	78.1	1438	1261	-
3	2	18	71.3	1337	1087	-
4	1	18	55.4	1534	-	-
5	3	18	84.6	1345	1430	1885
6	1	18	64.2	1441	-	-
7	1	18	56.5	1371	-	-
8	2	18	69.4	1333	1407	-
9	2	18	80.7	1102	1564	-
10	2	18	81.7	1849	1113	-
11	3	18	83.8	1016	1425	1166
12	3	18	98.7	1429	1640	1943
13	2	18	75.9	1542	1408	-
14	2	18	77.4	1241	1505	-
15	3	18	95.2	1974	1295	1816
16	1	18	50.9	1641	-	-
17	1	18	52.3	1780	-	-
18	1	18	63.7	1872	-	-
19	3	18	89.3	1860	1083	1399
20	-	-	-	-	-	-

Long Pulse Radar Test Signal

Test Signal Name: LP\_Signal\_08

Number of Bursts in Trial: 15

Burst	Pulses per Burst	Chrip (MHz)	Pulse Width(us)	PRI-1 (us)	PRI-2 (us)	PRI-3 (us)
1	2	14	78.2	1215	1274	-
2	2	14	75.4	1120	1751	-
3	1	14	66.5	1793	-	-
4	2	14	71.5	1852	1066	-
5	2	14	68	1258	1457	-
6	1	14	60.9	1463	-	-
7	3	14	88.2	1076	1819	1525
8	1	14	62.4	1952	-	-
9	1	14	50.9	1192	-	-
10	1	14	62.6	1201	-	-
11	2	14	72.8	1126	1357	-
12	3	14	87.9	1627	1458	1880
13	1	14	50.1	1802	-	-
14	3	14	95.4	1928	1324	1947
15	2	14	70.5	1619	1562	-
16	-	-	-	-	-	-
17	-	-	-	-	-	-
18	-	-	-	-	-	-
19	-	-	-	-	-	-
20	-	-	-	-	-	-



Long Pulse Radar Test Signal

Test Signal Name: LP\_Signal\_09

Number of Bursts in Trial: 16

Burst	Pulses per Burst	Chrip (MHz)	Pulse Width(us)	PRI-1 (us)	PRI-2 (us)	PRI-3 (us)
1	2	15	79.4	1891	1692	-
2	3	15	96.1	1424	1325	1175
3	1	15	65	1500	-	-
4	3	15	97.2	1770	1740	1005
5	1	15	53.2	1135	-	-
6	2	15	70.8	1809	1081	-
7	1	15	58.9	1668	-	-
8	3	15	89.2	1526	1111	1649
9	3	15	91.2	1664	1414	1303
10	2	15	73.4	1063	1317	-
11	2	15	71.8	1997	1313	-
12	3	15	84.1	1686	1609	1633
13	1	15	51.1	1061	-	-
14	2	15	79.2	1755	1803	-
15	3	15	94.6	1380	1140	1044
16	1	15	61	1465	-	-
17	-	-	-	-	-	-
18	-	-	-	-	-	-
19	-	-	-	-	-	-
20	-	-	-	-	-	-

Long Pulse Radar Test Signal

Test Signal Name: LP\_Signal\_10

Number of Bursts in Trial: 8

Burst	Pulses per Burst	Chrip (MHz)	Pulse Width(us)	PRI-1 (us)	PRI-2 (us)	PRI-3 (us)
1	1	5	51.3	1829	-	-
2	3	5	98.9	1897	1346	1605
3	1	5	53.7	1498	-	-
4	1	5	62.8	1900	-	-
5	3	5	90.4	1730	1986	1008
6	3	5	96	1433	1187	1808
7	1	5	56.5	1654	-	-
8	1	5	53.3	1398	-	-
9	-	-	-	-	-	-
10	-	-	-	-	-	-
11	-	-	-	-	-	-
12	-	-	-	-	-	-
13	-	-	-	-	-	-
14	-	-	-	-	-	-
15	-	-	-	-	-	-
16	-	-	-	-	-	-
17	-	-	-	-	-	-
18	-	-	-	-	-	-
19	-	-	-	-	-	-
20	-	-	-	-	-	-

Long Pulse Radar Test Signal

Test Signal Name: LP\_Signal\_11

Number of Bursts in Trial: 17

Burst	Pulses per Burst	Chrip (MHz)	Pulse Width(us)	PRI-1 (us)	PRI-2 (us)	PRI-3 (us)
1	3	17	94.6	1504	1284	1273
2	3	17	96.4	1224	1105	1725
3	1	17	51.8	1931	-	-
4	1	17	55.6	1269	-	-
5	1	17	56.7	1976	-	-
6	1	17	57.9	1911	-	-
7	3	17	93.9	1026	1761	1754
8	3	17	83.7	1841	1388	1366
9	1	17	53.3	1257	-	-
10	1	17	55.4	1518	-	-
11	3	17	98.1	1671	1046	1193
12	3	17	99.2	1104	1861	1434
13	3	17	85.9	1972	1503	1916
14	1	17	55.1	1792	-	-
15	1	17	60.4	1623	-	-
16	2	17	68.4	1929	1821	-
17	2	17	69.3	1211	1883	-
18	-	-	-	-	-	-
19	-	-	-	-	-	-
20	-	-	-	-	-	-





Long Pulse Radar Test Signal

Test Signal Name: LP\_Signal\_12

Number of Bursts in Trial: 12

Burst	Pulses per Burst	Chrip (MHz)	Pulse Width(us)	PRI-1 (us)	PRI-2 (us)	PRI-3 (us)
1	3	10	86.3	1342	1681	1601
2	2	10	75.4	1420	1865	-
3	3	10	98.1	1394	1622	1406
4	3	10	96.2	1942	1708	1053
5	2	10	76.9	1689	1932	-
6	3	10	87.1	1329	1807	1362
7	2	10	83.2	1732	1926	-
8	1	10	56.4	1784	-	-
9	1	10	51.6	2000	-	-
10	2	10	71.4	1998	1330	-
11	3	10	89.1	1514	1485	1582
12	3	10	96.4	1143	1576	1847
13	-	-	-	-	-	-
14	-	-	-	-	-	-
15	-	-	-	-	-	-
16	-	-	-	-	-	-
17	-	-	-	-	-	-
18	-	-	-	-	-	-
19	-	-	-	-	-	-
20	-	-	-	-	-	-

Long Pulse Radar Test Signal

Test Signal Name: LP\_Signal\_13

Number of Bursts in Trial: 11

Burst	Pulses per Burst	Chrip (MHz)	Pulse Width(us)	PRI-1 (us)	PRI-2 (us)	PRI-3 (us)
1	2	9	82.6	1970	1494	-
2	2	9	80.1	1946	1173	-
3	3	9	83.4	1028	1283	1863
4	3	9	89.5	1693	1253	1153
5	1	9	61.7	1338	-	-
6	1	9	52.6	1267	-	-
7	1	9	56.9	1774	-	-
8	2	9	69	1899	1263	-
9	1	9	53.2	1695	-	-
10	2	9	82.5	1866	1172	-
11	2	9	83.3	1716	1428	-
12	-	-	-	-	-	-
13	-	-	-	-	-	-
14	-	-	-	-	-	-
15	-	-	-	-	-	-
16	-	-	-	-	-	-
17	-	-	-	-	-	-
18	-	-	-	-	-	-
19	-	-	-	-	-	-
20	-	-	-	-	-	-



Long Pulse Radar Test Signal

Test Signal Name: LP\_Signal\_14

Number of Bursts in Trial: 8

Burst	Pulses per Burst	Chrip (MHz)	Pulse Width(us)	PRI-1 (us)	PRI-2 (us)	PRI-3 (us)
1	2	5	79.5	1401	1823	-
2	3	5	88.2	1107	1040	1353
3	2	5	80.8	1737	1873	-
4	3	5	95.8	1566	1729	1812
5	2	5	81.1	1796	1117	-
6	3	5	95.4	1558	1006	1769
7	2	5	75.1	1679	1584	-
8	3	5	96.2	1528	1630	1578
9	-	-	-	-	-	-
10	-	-	-	-	-	-
11	-	-	-	-	-	-
12	-	-	-	-	-	-
13	-	-	-	-	-	-
14	-	-	-	-	-	-
15	-	-	-	-	-	-
16	-	-	-	-	-	-
17	-	-	-	-	-	-
18	-	-	-	-	-	-
19	-	-	-	-	-	-
20	-	-	-	-	-	-

Long Pulse Radar Test Signal

Test Signal Name: LP\_Signal\_15

Number of Bursts in Trial: 15

Burst	Pulses per Burst	Chrip (MHz)	Pulse Width(us)	PRI-1 (us)	PRI-2 (us)	PRI-3 (us)
1	3	14	88.4	1293	1249	1653
2	3	14	85.4	1720	1703	1417
3	3	14	93.5	1469	1831	1869
4	1	14	54.1	1963	-	-
5	2	14	70.6	1181	1110	-
6	1	14	58.5	1390	-	-
7	1	14	57.2	1382	-	-
8	2	14	67.6	1598	1189	-
9	1	14	59.3	1208	-	-
10	2	14	68.6	1669	1573	-
11	3	14	99.3	1400	1826	1907
12	1	14	55	1683	-	-
13	3	14	86.5	1050	1296	1919
14	1	14	54.8	1577	-	-
15	3	14	87.3	1699	1409	1491
16	-	-	-	-	-	-
17	-	-	-	-	-	-
18	-	-	-	-	-	-
19	-	-	-	-	-	-
20	-	-	-	-	-	-



Long Pulse Radar Test Signal

Test Signal Name: LP\_Signal\_16

Number of Bursts in Trial: 17

Burst	Pulses per Burst	Chrip (MHz)	Pulse Width(us)	PRI-1 (us)	PRI-2 (us)	PRI-3 (us)
1	2	16	70.7	1183	1112	-
2	2	16	75.3	1524	1975	-
3	1	16	64.6	1771	-	-
4	1	16	59.6	1122	-	-
5	2	16	74.2	1955	1827	-
6	1	16	52.5	1559	-	-
7	1	16	53.5	1879	-	-
8	3	16	99.5	1131	1726	1395
9	1	16	66	1038	-	-
10	1	16	53.8	1901	-	-
11	3	16	92.2	1782	1715	1108
12	2	16	68.6	1082	1476	-
13	1	16	57.9	1638	-	-
14	3	16	96.2	1643	1790	1636
15	3	16	91.3	1282	1343	1548
16	1	16	52	1814	-	-
17	1	16	61	1539	-	-
18	-	-	-	-	-	-
19	-	-	-	-	-	-
20	-	-	-	-	-	-

Long Pulse Radar Test Signal

Test Signal Name: LP\_Signal\_17

Number of Bursts in Trial: 16

Burst	Pulses per Burst	Chrip (MHz)	Pulse Width(us)	PRI-1 (us)	PRI-2 (us)	PRI-3 (us)
1	2	15	76.5	1299	1694	-
2	2	15	75.2	1945	1650	-
3	1	15	50.6	1874	-	-
4	1	15	61	1555	-	-
5	3	15	89.1	1798	1835	1719
6	2	15	76	1833	1223	-
7	1	15	62.7	1734	-	-
8	2	15	81	1098	1936	-
9	1	15	54.4	1037	-	-
10	3	15	85	1581	1058	1762
11	3	15	97.6	1995	1109	1460
12	1	15	50.3	1198	-	-
13	1	15	54	1613	-	-
14	2	15	77.4	1065	1236	-
15	3	15	96.8	1529	1056	1402
16	2	15	74.7	1088	1806	-
17	-	-	-	-	-	-
18	-	-	-	-	-	-
19	-	-	-	-	-	-
20	-	-	-	-	-	-

Long Pulse Radar Test Signal

Test Signal Name: LP\_Signal\_18

Number of Bursts in Trial: 12

Burst	Pulses per Burst	Chrip (MHz)	Pulse Width(us)	PRI-1 (us)	PRI-2 (us)	PRI-3 (us)
1	1	10	50.9	1537	-	-
2	1	10	60	1372	-	-
3	2	10	70.5	1767	1615	-
4	1	10	66.4	1800	-	-
5	3	10	85.7	1364	1801	1067
6	1	10	50.9	1203	-	-
7	3	10	93.7	1996	1354	1881
8	3	10	84.9	1724	1448	1864
9	3	10	85.9	1596	1890	1917
10	2	10	77.5	1101	1557	-
11	1	10	50.3	1597	-	-
12	2	10	78.5	1379	1519	-
13	-	-	-	-	-	-
14	-	-	-	-	-	-
15	-	-	-	-	-	-
16	-	-	-	-	-	-
17	-	-	-	-	-	-
18	-	-	-	-	-	-
19	-	-	-	-	-	-
20	-	-	-	-	-	-

Long Pulse Radar Test Signal

Test Signal Name: LP\_Signal\_19

Number of Bursts in Trial: 18

Burst	Pulses per Burst	Chrip (MHz)	Pulse Width(us)	PRI-1 (us)	PRI-2 (us)	PRI-3 (us)
1	3	17	89.9	1422	1776	1096
2	3	17	99.3	1043	1270	1089
3	2	17	71.5	1673	1163	-
4	2	17	68.1	1702	1080	-
5	1	17	66.5	1097	-	-
6	3	17	88.3	1238	1119	1139
7	2	17	78.5	1389	1199	-
8	1	17	61.2	1959	-	-
9	1	17	54.1	1442	-	-
10	2	17	76.3	1676	1114	-
11	2	17	81.6	1977	1127	-
12	3	17	99.4	1468	1133	1644
13	1	17	51.9	1490	-	-
14	2	17	78.7	1439	1589	-
15	2	17	69.7	1316	1331	-
16	2	17	67.5	1281	1157	-
17	1	17	55.9	1068	-	-
18	3	17	99.2	1453	1054	1049
19	-	-	-	-	-	-
20	-	-	-	-	-	-



Long Pulse Radar Test Signal

Test Signal Name: LP\_Signal\_20

Number of Bursts in Trial: 14

Burst	Pulses per Burst	Chrip (MHz)	Pulse Width(us)	PRI-1 (us)	PRI-2 (us)	PRI-3 (us)
1	1	13	62	1895	-	-
2	2	13	76.4	1477	1375	-
3	3	13	95.4	1358	1456	1745
4	3	13	93.9	1773	1190	1556
5	1	13	57	1646	-	-
6	3	13	86.1	1154	1144	1123
7	2	13	70.8	1328	1423	-
8	3	13	85.7	1148	1707	1078
9	2	13	75.3	1667	1746	-
10	2	13	75.5	1204	1466	-
11	2	13	81.6	1334	1588	-
12	1	13	65.7	1231	-	-
13	2	13	75.1	1499	1662	-
14	1	13	61.6	1071	-	-
15	-	-	-	-	-	-
16	-	-	-	-	-	-
17	-	-	-	-	-	-
18	-	-	-	-	-	-
19	-	-	-	-	-	-
20	-	-	-	-	-	-

Long Pulse Radar Test Signal

Test Signal Name: LP\_Signal\_21

Number of Bursts in Trial: 10

Burst	Pulses per Burst	Chrip (MHz)	Pulse Width(us)	PRI-1 (us)	PRI-2 (us)	PRI-3 (us)
1	2	7	75.6	1511	1966	-
2	3	7	84.3	1162	1834	1625
3	3	7	91.1	1704	1039	1674
4	1	7	55.1	1747	-	-
5	1	7	63.5	1259	-	-
6	2	7	79.4	1675	1948	-
7	3	7	83.8	1914	1052	1099
8	1	7	65.7	1842	-	-
9	3	7	98.9	1484	1921	1219
10	3	7	85.6	1894	1159	1195
11	-	-	-	-	-	-
12	-	-	-	-	-	-
13	-	-	-	-	-	-
14	-	-	-	-	-	-
15	-	-	-	-	-	-
16	-	-	-	-	-	-
17	-	-	-	-	-	-
18	-	-	-	-	-	-
19	-	-	-	-	-	-
20	-	-	-	-	-	-

Long Pulse Radar Test Signal

Test Signal Name: LP\_Signal\_22

Number of Bursts in Trial: 20

Burst	Pulses per Burst	Chrip (MHz)	Pulse Width(us)	PRI-1 (us)	PRI-2 (us)	PRI-3 (us)
1	2	20	70.6	1415	1214	-
2	2	20	74.7	1234	1290	-
3	2	20	78.4	1777	1405	-
4	2	20	71.2	1048	1455	-
5	1	20	64.5	1161	-	-
6	1	20	57	1536	-	-
7	2	20	81.3	1264	1093	-
8	2	20	76.2	1452	1128	-
9	2	20	79	1497	1103	-
10	3	20	86.8	1205	1608	1522
11	1	20	65.4	1352	-	-
12	2	20	73.9	1749	1319	-
13	2	20	83.2	1836	1632	-
14	3	20	96.1	1546	1840	1973
15	3	20	92.3	1626	1121	1930
16	3	20	85.4	1532	1486	1635
17	3	20	97.4	1868	1419	1348
18	2	20	80.9	1347	1572	-
19	1	20	62.9	1381	-	-
20	1	20	52.9	1786	-	-



Long Pulse Radar Test Signal

Test Signal Name: LP\_Signal\_23

Number of Bursts in Trial: 10

Burst	Pulses per Burst	Chrip (MHz)	Pulse Width(us)	PRI-1 (us)	PRI-2 (us)	PRI-3 (us)
1	2	7	79.7	1045	1312	-
2	3	7	88.5	1871	1999	1804
3	1	7	51.1	1606	-	-
4	2	7	69.9	1516	1280	-
5	2	7	73.7	1670	1289	-
6	2	7	67.6	1180	1051	-
7	3	7	87.6	1886	1967	1521
8	1	7	64.5	1418	-	-
9	1	7	54	1602	-	-
10	2	7	76.5	1637	1018	-
11	-	-	-	-	-	-
12	-	-	-	-	-	-
13	-	-	-	-	-	-
14	-	-	-	-	-	-
15	-	-	-	-	-	-
16	-	-	-	-	-	-
17	-	-	-	-	-	-
18	-	-	-	-	-	-
19	-	-	-	-	-	-
20	-	-	-	-	-	-



Long Pulse Radar Test Signal

Test Signal Name: LP\_Signal\_24

Number of Bursts in Trial: 11

Burst	Pulses per Burst	Chrip (MHz)	Pulse Width(us)	PRI-1 (us)	PRI-2 (us)	PRI-3 (us)
1	1	9	65.3	1202	-	-
2	3	9	96.3	1666	1118	1271
3	2	9	77.5	1250	1285	-
4	1	9	59.8	1750	-	-
5	2	9	73.3	1210	1934	-
6	2	9	82.4	1758	1138	-
7	1	9	57.7	1527	-	-
8	3	9	99.6	1403	1146	1574
9	2	9	71.1	1171	1867	-
10	2	9	68.3	1239	1206	-
11	3	9	94.3	1152	1933	1892
12	-	-	-	-	-	-
13	-	-	-	-	-	-
14	-	-	-	-	-	-
15	-	-	-	-	-	-
16	-	-	-	-	-	-
17	-	-	-	-	-	-
18	-	-	-	-	-	-
19	-	-	-	-	-	-
20	-	-	-	-	-	-

Long Pulse Radar Test Signal

Test Signal Name: LP\_Signal\_25

Number of Bursts in Trial: 12

Burst	Pulses per Burst	Chrip (MHz)	Pulse Width(us)	PRI-1 (us)	PRI-2 (us)	PRI-3 (us)
1	1	10	55.4	1981	-	-
2	3	10	86.8	1968	1547	1363
3	3	10	88.4	1017	1656	1862
4	3	10	96.3	1025	1954	1158
5	1	10	51.6	1718	-	-
6	1	10	51	1944	-	-
7	3	10	95.1	1611	1075	1940
8	1	10	62.9	1612	-	-
9	2	10	78.1	1815	1013	-
10	2	10	82.1	1450	1969	-
11	1	10	52.9	1698	-	-
12	1	10	52.8	1034	-	-
13	-	-	-	-	-	-
14	-	-	-	-	-	-
15	-	-	-	-	-	-
16	-	-	-	-	-	-
17	-	-	-	-	-	-
18	-	-	-	-	-	-
19	-	-	-	-	-	-
20	-	-	-	-	-	-



Long Pulse Radar Test Signal

Test Signal Name: LP\_Signal\_26

Number of Bursts in Trial: 17

Burst	Pulses per Burst	Chrip (MHz)	Pulse Width(us)	PRI-1 (us)	PRI-2 (us)	PRI-3 (us)
1	3	16	95.9	1359	1090	1965
2	1	16	55.8	1980	-	-
3	2	16	82.1	1768	1004	-
4	2	16	73.6	1594	1487	-
5	1	16	58.4	1467	-	-
6	3	16	97.5	1723	1391	1684
7	3	16	96.9	1554	1185	1988
8	2	16	69.4	1125	1607	-
9	2	16	66.7	1549	1805	-
10	2	16	72.1	1783	1672	-
11	1	16	52.4	1256	-	-
12	2	16	71.5	1478	1575	-
13	2	16	69.2	1579	1091	-
14	3	16	96.4	1663	1194	1174
15	2	16	73.4	1265	1553	-
16	2	16	72.8	1665	1903	-
17	1	16	59.9	1604	-	-
18	-	-	-	-	-	-
19	-	-	-	-	-	-
20	-	-	-	-	-	-

Long Pulse Radar Test Signal

Test Signal Name: LP\_Signal\_27

Number of Bursts in Trial: 20

Burst	Pulses per Burst	Chrip (MHz)	Pulse Width(us)	PRI-1 (us)	PRI-2 (us)	PRI-3 (us)
1	2	20	77.7	1308	1315	-
2	3	20	97.8	1136	1688	1446
3	1	20	59.8	1844	-	-
4	3	20	94.7	1142	1129	1291
5	1	20	58.7	1810	-	-
6	2	20	74.3	1012	1427	-
7	1	20	51.6	1918	-	-
8	1	20	62.7	1209	-	-
9	2	20	73.7	1294	1568	-
10	2	20	72	1454	1677	-
11	1	20	66.6	1585	-	-
12	3	20	92.6	1226	1200	1832
13	1	20	51.6	1367	-	-
14	2	20	75.9	1397	1785	-
15	3	20	94.5	1830	1155	1949
16	1	20	62.3	1287	-	-
17	3	20	93.5	1517	1254	1279
18	2	20	81.7	1910	1011	-
19	1	20	53.9	1462	-	-
20	3	20	91.2	1794	1531	1870





Long Pulse Radar Test Signal

Test Signal Name: LP\_Signal\_28

Number of Bursts in Trial: 8

Burst	Pulses per Burst	Chrip (MHz)	Pulse Width(us)	PRI-1 (us)	PRI-2 (us)	PRI-3 (us)
1	1	5	58.8	1306	-	-
2	3	5	99.3	1978	1027	1350
3	1	5	52	1386	-	-
4	2	5	74.2	1278	1222	-
5	3	5	98.9	1915	1760	1652
6	2	5	77.6	1042	1733	-
7	2	5	83.3	1255	1766	-
8	3	5	84.4	1912	1326	1493
9	-	-	-	-	-	-
10	-	-	-	-	-	-
11	-	-	-	-	-	-
12	-	-	-	-	-	-
13	-	-	-	-	-	-
14	-	-	-	-	-	-
15	-	-	-	-	-	-
16	-	-	-	-	-	-
17	-	-	-	-	-	-
18	-	-	-	-	-	-
19	-	-	-	-	-	-
20	-	-	-	-	-	-

Long Pulse Radar Test Signal

Test Signal Name: LP\_Signal\_29

Number of Bursts in Trial: 9

Burst	Pulses per Burst	Chrip (MHz)	Pulse Width(us)	PRI-1 (us)	PRI-2 (us)	PRI-3 (us)
1	2	6	66.8	1982	1878	-
2	2	6	77	2000	1247	-
3	1	6	55.2	1925	-	-
4	2	6	77.7	1896	1003	-
5	2	6	72.2	1850	1983	-
6	1	6	52.9	1765	-	-
7	1	6	50.4	1994	-	-
8	3	6	84.3	1302	1369	1600
9	3	6	93.2	1492	1779	1332
10	-	-	-	-	-	-
11	-	-	-	-	-	-
12	-	-	-	-	-	-
13	-	-	-	-	-	-
14	-	-	-	-	-	-
15	-	-	-	-	-	-
16	-	-	-	-	-	-
17	-	-	-	-	-	-
18	-	-	-	-	-	-
19	-	-	-	-	-	-
20	-	-	-	-	-	-

Long Pulse Radar Test Signal

Test Signal Name: LP\_Signal\_30

Number of Bursts in Trial: 19

Burst	Pulses per Burst	Chrip (MHz)	Pulse Width(us)	PRI-1 (us)	PRI-2 (us)	PRI-3 (us)
1	1	19	58.1	1376	-	-
2	3	19	87.2	1587	1277	1811
3	2	19	81.6	1164	1530	-
4	2	19	80.4	1413	1884	-
5	1	19	60.8	1055	-	-
6	3	19	84.8	1960	1731	1700
7	2	19	75.5	1958	1544	-
8	2	19	80.3	1022	1106	-
9	2	19	76.8	1533	1661	-
10	1	19	65	1141	-	-
11	3	19	96.3	1124	1856	1033
12	1	19	57.9	1443	-	-
13	1	19	59.2	1305	-	-
14	2	19	75.8	1927	1772	-
15	1	19	64.7	1541	-	-
16	2	19	69.4	1246	1825	-
17	2	19	81.6	1230	1571	-
18	1	19	51.1	1320	-	-
19	2	19	78.4	1950	1651	-
20	-	-	-	-	-	-



**BW80**

Long Pulse Radar Test Signal

Test Signal Name: LP\_Signal\_01

Number of Bursts in Trial: 10

Burst	Pulses per Burst	Chrip (MHz)	Pulse Width(us)	PRI-1 (us)	PRI-2 (us)	PRI-3 (us)
1	1	7	58.8	1293	-	-
2	2	7	67.2	1731	1960	-
3	2	7	79	1043	1583	-
4	1	7	56.3	1074	-	-
5	2	7	74.3	1714	1429	-
6	2	7	79.4	1609	1083	-
7	3	7	94.4	1958	1101	1226
8	1	7	54.4	1947	-	-
9	3	7	87.1	1277	1626	1167
10	2	7	67.7	1820	1477	-
11	-	-	-	-	-	-
12						
13						
14	-	-	-	-	-	-
15	-	-	-	-	-	-
16	-	-	-	-	-	-
17	-	-	-	-	-	-
18	-	-	-	-	-	-
19	-	-	-	-	-	-
20	-	-	-	-	-	-

Long Pulse Radar Test Signal

Test Signal Name: LP\_Signal\_02

Number of Bursts in Trial: 12

Burst	Pulses per Burst	Chrip (MHz)	Pulse Width(us)	PRI-1 (us)	PRI-2 (us)	PRI-3 (us)
1	2	10	69.4	1974	1961	-
2	2	10	69.5	1140	1656	-
3	2	10	72	1863	1564	-
4	3	10	86.6	1887	1299	1953
5	3	10	94	1547	1148	1570
6	2	10	68.2	1409	1353	-
7	2	10	71.7	1909	1632	-
8	3	10	96.8	1337	1052	1212
9	1	10	51.6	1879	-	-
10	1	10	50	1483	-	-
11	2	10	68.8	1094	1738	-
12	1	10	59.6	1408	-	-
13	-	-	-	-	-	-
14	-	-	-	-	-	-
15	-	-	-	-	-	-
16	-	-	-	-	-	-
17	-	-	-	-	-	-
18	-	-	-	-	-	-
19	-	-	-	-	-	-
20	-	-	-	-	-	-



Long Pulse Radar Test Signal

Test Signal Name: LP\_Signal\_03

Number of Bursts in Trial: 15

Burst	Pulses per Burst	Chrip (MHz)	Pulse Width(us)	PRI-1 (us)	PRI-2 (us)	PRI-3 (us)
1	3	14	84.8	2000	1985	1126
2	2	14	71.3	1309	1366	-
3	1	14	61.3	1230	-	-
4	2	14	74.2	1450	1356	-
5	3	14	86.7	1907	1599	1390
6	2	14	79.7	1406	1328	-
7	2	14	78.9	1097	1734	-
8	1	14	57.3	1698	-	-
9	1	14	65.3	1028	-	-
10	2	14	68.5	1763	1135	-
11	1	14	64.1	1461	-	-
12	1	14	58.5	1515	-	-
13	1	14	51	1549	-	-
14	2	14	76.7	1750	1319	-
15	1	14	54.8	1315	-	-
16	-	-	-	-	-	-
17	-	-	-	-	-	-
18	-	-	-	-	-	-
19	-	-	-	-	-	-
20	-	-	-	-	-	-

Long Pulse Radar Test Signal

Test Signal Name: LP\_Signal\_04

Number of Bursts in Trial: 9

Burst	Pulses per Burst	Chrip (MHz)	Pulse Width(us)	PRI-1 (us)	PRI-2 (us)	PRI-3 (us)
1	3	7	83.6	1942	1574	1208
2	1	7	62.1	1943	-	-
3	2	7	67.8	1247	1407	-
4	1	7	64.7	1118	-	-
5	3	7	94.4	1657	1248	1116
6	3	7	94.8	1834	1012	1243
7	1	7	55.9	1840	-	-
8	3	7	88.9	1467	1757	1756
9	2	7	70.5	1772	1479	-
10	-	-	-	-	-	-
11	-	-	-	-	-	-
12	-	-	-	-	-	-
13	-	-	-	-	-	-
14	-	-	-	-	-	-
15	-	-	-	-	-	-
16	-	-	-	-	-	-
17	-	-	-	-	-	-
18	-	-	-	-	-	-
19	-	-	-	-	-	-
20	-	-	-	-	-	-

Long Pulse Radar Test Signal

Test Signal Name: LP\_Signal\_05

Number of Bursts in Trial: 12

Burst	Pulses per Burst	Chrip (MHz)	Pulse Width(us)	PRI-1 (us)	PRI-2 (us)	PRI-3 (us)
1	2	12	82.3	1451	1235	-
2	3	12	86	1809	1996	1426
3	2	12	75.9	1658	1495	-
4	3	12	96.5	1415	1660	1445
5	3	12	92.4	1272	1751	1080
6	1	12	60.6	1234	-	-
7	2	12	80.8	1902	1939	-
8	3	12	99.3	1038	1176	1301
9	2	12	82.5	1045	1802	-
10	1	12	57.7	1838	-	-
11	3	12	95.1	1933	1619	1730
12	1	12	50.1	1762	-	-
13	-	-	-	-	-	-
14	-	-	-	-	-	-
15	-	-	-	-	-	-
16	-	-	-	-	-	-
17	-	-	-	-	-	-
18	-	-	-	-	-	-
19	-	-	-	-	-	-
20	-	-	-	-	-	-



Long Pulse Radar Test Signal

Test Signal Name: LP\_Signal\_06

Number of Bursts in Trial: 15

Burst	Pulses per Burst	Chrip (MHz)	Pulse Width(us)	PRI-1 (us)	PRI-2 (us)	PRI-3 (us)
1	3	14	92.8	1541	1350	1159
2	1	14	64.7	1633	-	-
3	2	14	75.6	1355	1920	-
4	2	14	79.7	1458	1249	-
5	1	14	52.4	1414	-	-
6	1	14	50.8	1914	-	-
7	1	14	55.3	1711	-	-
8	1	14	63.5	1500	-	-
9	3	14	85.5	1983	1182	1976
10	2	14	67.3	1833	1497	-
11	1	14	63.3	1923	-	-
12	3	14	88.1	1134	1394	1769
13	3	14	84.7	1847	1241	1260
14	3	14	83.8	1411	1748	1039
15	3	14	85.4	1018	1908	1372
16	-	-	-	-	-	-
17	-	-	-	-	-	-
18	-	-	-	-	-	-
19	-	-	-	-	-	-
20	-	-	-	-	-	-

Long Pulse Radar Test Signal

Test Signal Name: LP\_Signal\_07

Number of Bursts in Trial: 19

Burst	Pulses per Burst	Chrip (MHz)	Pulse Width(us)	PRI-1 (us)	PRI-2 (us)	PRI-3 (us)
1	2	19	74.5	1348	1113	-
2	1	19	64.8	1371	-	-
3	2	19	78.8	1980	1569	-
4	2	19	82.5	1556	1791	-
5	3	19	90.8	1015	1950	1685
6	2	19	77.3	1302	1857	-
7	3	19	95.7	1002	1898	1899
8	3	19	97.4	1518	1873	1216
9	3	19	92.9	1866	1510	1514
10	2	19	81.5	1358	1921	-
11	2	19	68.8	1875	1693	-
12	2	19	76.1	1399	1469	-
13	1	19	53.4	1387	-	-
14	2	19	77.7	1865	1204	-
15	1	19	51.8	1765	-	-
16	3	19	94.2	1132	1488	1717
17	3	19	97.2	1851	1811	1746
18	3	19	88.5	1396	1121	1501
19	1	19	62	1507	-	-
20	-	-	-	-	-	-



Long Pulse Radar Test Signal

Test Signal Name: LP\_Signal\_08

Number of Bursts in Trial: 9

Burst	Pulses per Burst	Chrip (MHz)	Pulse Width(us)	PRI-1 (us)	PRI-2 (us)	PRI-3 (us)
1	2	6	75.1	1470	1308	-
2	1	6	50	1198	-	-
3	2	6	68.8	1536	1349	-
4	1	6	65.1	1286	-	-
5	1	6	53.4	1614	-	-
6	3	6	88	1852	1223	1168
7	1	6	65.1	1245	-	-
8	2	6	83.3	1800	1238	-
9	1	6	55.4	1622	-	-
10	-	-	-	-	-	-
11	-	-	-	-	-	-
12	-	-	-	-	-	-
13	-	-	-	-	-	-
14	-	-	-	-	-	-
15	-	-	-	-	-	-
16	-	-	-	-	-	-
17	-	-	-	-	-	-
18	-	-	-	-	-	-
19	-	-	-	-	-	-
20	-	-	-	-	-	-

Long Pulse Radar Test Signal

Test Signal Name: LP\_Signal\_09

Number of Bursts in Trial: 17

Burst	Pulses per Burst	Chrip (MHz)	Pulse Width(us)	PRI-1 (us)	PRI-2 (us)	PRI-3 (us)
1	1	16	65	1755	-	-
2	2	16	72.7	1741	1785	-
3	3	16	87.8	1149	1056	1493
4	1	16	61.8	1284	-	-
5	1	16	58.6	1175	-	-
6	2	16	75.3	1825	1009	-
7	1	16	56.2	1732	-	-
8	3	16	84.4	1292	1989	1605
9	1	16	53.6	1332	-	-
10	2	16	75.3	1482	1023	-
11	1	16	54.2	1455	-	-
12	2	16	72.8	2000	1342	-
13	3	16	97.1	1199	1158	1890
14	2	16	67.3	1035	1818	-
15	2	16	82.7	1611	1558	-
16	3	16	98.2	1252	1651	1922
17	3	16	83.7	1174	1878	1889
18	-	-	-	-	-	-
19	-	-	-	-	-	-
20	-	-	-	-	-	-



Long Pulse Radar Test Signal

Test Signal Name: LP\_Signal\_10

Number of Bursts in Trial: 12

Burst	Pulses per Burst	Chrip (MHz)	Pulse Width(us)	PRI-1 (us)	PRI-2 (us)	PRI-3 (us)
1	2	10	74.8	1064	1888	-
2	1	10	51.8	1543	-	-
3	3	10	85.8	1526	1813	1330
4	3	10	83.7	1795	1166	1460
5	2	10	73.1	1703	1975	-
6	1	10	66.2	1229	-	-
7	3	10	99.7	1324	1374	1972
8	2	10	72.7	1555	1476	-
9	1	10	58.7	1000	-	-
10	3	10	85.3	1431	1936	1439
11	1	10	55.7	1261	-	-
12	3	10	99.8	1102	1901	1997
13	-	-	-	-	-	-
14	-	-	-	-	-	-
15	-	-	-	-	-	-
16	-	-	-	-	-	-
17	-	-	-	-	-	-
18	-	-	-	-	-	-
19	-	-	-	-	-	-
20	-	-	-	-	-	-

Long Pulse Radar Test Signal

Test Signal Name: LP\_Signal\_11

Number of Bursts in Trial: 13

Burst	Pulses per Burst	Chrip (MHz)	Pulse Width(us)	PRI-1 (us)	PRI-2 (us)	PRI-3 (us)
1	2	11	75.4	1463	1677	-
2	3	11	94.5	1525	1211	1617
3	2	11	75.7	1202	1963	-
4	3	11	94.1	1645	1684	1191
5	3	11	90.2	1595	1200	1720
6	2	11	82.4	1722	1776	-
7	2	11	70.2	1579	1655	-
8	3	11	93.7	1635	1788	1862
9	1	11	56.9	1087	-	-
10	2	11	67.5	1552	1225	-
11	2	11	78.2	1228	1828	-
12	2	11	71.5	1250	1789	-
13	2	11	67.4	1298	1010	-
14	-	-	-	-	-	-
15	-	-	-	-	-	-
16	-	-	-	-	-	-
17	-	-	-	-	-	-
18	-	-	-	-	-	-
19	-	-	-	-	-	-
20	-	-	-	-	-	-

Long Pulse Radar Test Signal

Test Signal Name: LP\_Signal\_12

Number of Bursts in Trial: 13

Burst	Pulses per Burst	Chrip (MHz)	Pulse Width(us)	PRI-1 (us)	PRI-2 (us)	PRI-3 (us)
1	3	11	90.6	1770	1184	1671
2	2	11	71.9	1745	1314	-
3	3	11	84.3	1906	1666	1100
4	3	11	89.3	1438	1221	1886
5	2	11	78.1	1767	1537	-
6	2	11	82.8	1502	1739	-
7	3	11	86.1	1351	1530	1652
8	2	11	66.9	1590	1637	-
9	2	11	69.8	1109	1194	-
10	1	11	63.1	1808	-	-
11	1	11	63.2	1904	-	-
12	3	11	97.5	1357	1186	1354
13	2	11	71.8	1965	1259	-
14	-	-	-	-	-	-
15	-	-	-	-	-	-
16	-	-	-	-	-	-
17	-	-	-	-	-	-
18	-	-	-	-	-	-
19	-	-	-	-	-	-
20	-	-	-	-	-	-

Long Pulse Radar Test Signal

Test Signal Name: LP\_Signal\_13

Number of Bursts in Trial: 13

Burst	Pulses per Burst	Chrip (MHz)	Pulse Width(us)	PRI-1 (us)	PRI-2 (us)	PRI-3 (us)
1	3	12	91.9	1987	1209	1849
2	1	12	56.4	1117	-	-
3	3	12	88.2	1992	1491	1128
4	3	12	89.2	1607	1275	1594
5	3	12	99.9	1565	1596	1404
6	3	12	90	1815	1804	1291
7	1	12	50.5	1412	-	-
8	3	12	84.7	1480	1728	1215
9	2	12	78.3	1152	1581	-
10	2	12	80.8	1793	1417	-
11	2	12	78.6	1462	1814	-
12	2	12	78.7	1504	1081	-
13	1	12	56.8	1786	-	-
14	-	-	-	-	-	-
15	-	-	-	-	-	-
16	-	-	-	-	-	-
17	-	-	-	-	-	-
18	-	-	-	-	-	-
19	-	-	-	-	-	-
20	-	-	-	-	-	-



Long Pulse Radar Test Signal

Test Signal Name: LP\_Signal\_14

Number of Bursts in Trial: 17

Burst	Pulses per Burst	Chrip (MHz)	Pulse Width(us)	PRI-1 (us)	PRI-2 (us)	PRI-3 (us)
1	3	16	85	1141	1876	1339
2	1	16	62.5	1736	-	-
3	1	16	54.4	1615	-	-
4	2	16	76.7	1304	1568	-
5	1	16	57.2	1701	-	-
6	2	16	73.7	1079	1774	-
7	1	16	64.3	1540	-	-
8	1	16	66.3	1382	-	-
9	2	16	82.6	1214	1924	-
10	3	16	94.4	1435	1941	1692
11	1	16	65.3	1034	-	-
12	3	16	83.4	1691	1959	1145
13	2	16	80.7	1845	1311	-
14	1	16	52.5	1723	-	-
15	2	16	69.7	1760	1271	-
16	2	16	82.8	1037	1859	-
17	1	16	55.5	1662	-	-
18	-	-	-	-	-	-
19	-	-	-	-	-	-
20	-	-	-	-	-	-

Long Pulse Radar Test Signal

Test Signal Name: LP\_Signal\_15

Number of Bursts in Trial: 19

Burst	Pulses per Burst	Chrip (MHz)	Pulse Width(us)	PRI-1 (us)	PRI-2 (us)	PRI-3 (us)
1	2	19	81.4	1994	1327	-
2	1	19	62.4	1276	-	-
3	3	19	96.7	1123	1968	1210
4	2	19	68.4	1824	1668	-
5	3	19	90.5	1092	1588	1754
6	1	19	63.7	1333	-	-
7	1	19	55.5	1112	-	-
8	2	19	67.8	1869	1115	-
9	2	19	67.6	1077	1437	-
10	3	19	88.2	1338	1481	1855
11	2	19	71	1995	1098	-
12	2	19	82.7	1810	1990	-
13	1	19	62.3	1318	-	-
14	3	19	91.2	1940	1368	1624
15	1	19	55.6	1646	-	-
16	1	19	60.5	1054	-	-
17	2	19	71.2	1381	1452	-
18	3	19	97.9	1856	1213	1422
19	2	19	73.6	1104	1345	-
20	-	-	-	-	-	-

Long Pulse Radar Test Signal

Test Signal Name: LP\_Signal\_16

Number of Bursts in Trial: 12

Burst	Pulses per Burst	Chrip (MHz)	Pulse Width(us)	PRI-1 (us)	PRI-2 (us)	PRI-3 (us)
1	1	10	62.4	1787	-	-
2	3	10	93.1	1487	1610	1831
3	1	10	55.8	1823	-	-
4	3	10	89.6	1900	1031	1910
5	2	10	83.1	1613	1359	-
6	1	10	55.4	1796	-	-
7	1	10	59.3	1063	-	-
8	1	10	62.1	1492	-	-
9	2	10	72.8	1316	1443	-
10	1	10	55.7	1195	-	-
11	2	10	69.2	1884	1680	-
12	3	10	87.5	1727	1244	1551
13	-	-	-	-	-	-
14	-	-	-	-	-	-
15	-	-	-	-	-	-
16	-	-	-	-	-	-
17	-	-	-	-	-	-
18	-	-	-	-	-	-
19	-	-	-	-	-	-
20	-	-	-	-	-	-

Long Pulse Radar Test Signal

Test Signal Name: LP\_Signal\_17

Number of Bursts in Trial: 13

Burst	Pulses per Burst	Chrip (MHz)	Pulse Width(us)	PRI-1 (us)	PRI-2 (us)	PRI-3 (us)
1	2	11	80.8	1777	1618	-
2	1	11	51.8	1848	-	-
3	2	11	72.7	1520	1984	-
4	3	11	99.4	1954	1846	1647
5	1	11	66.2	1022	-	-
6	2	11	82.1	1927	1835	-
7	3	11	88.5	1326	1867	1106
8	3	11	94.5	1916	1005	1842
9	3	11	98.8	1060	1885	1288
10	3	11	99	1832	1133	1306
11	1	11	58.9	1201	-	-
12	3	11	89.7	1874	1336	1545
13	3	11	85.5	1227	1024	1496
14	-	-	-	-	-	-
15	-	-	-	-	-	-
16	-	-	-	-	-	-
17	-	-	-	-	-	-
18	-	-	-	-	-	-
19	-	-	-	-	-	-
20	-	-	-	-	-	-



Long Pulse Radar Test Signal

Test Signal Name: LP\_Signal\_18

Number of Bursts in Trial: 20

Burst	Pulses per Burst	Chrip (MHz)	Pulse Width(us)	PRI-1 (us)	PRI-2 (us)	PRI-3 (us)
1	3	19	93.4	1222	1490	1119
2	3	19	83.6	1237	1138	1971
3	2	19	70.3	1172	1163	-
4	1	19	53.2	1661	-	-
5	1	19	59.7	1957	-	-
6	2	19	72.9	1153	1385	-
7	1	19	59.4	1744	-	-
8	1	19	54.7	1257	-	-
9	3	19	96.2	1970	1058	1026
10	2	19	70.3	1591	1290	-
11	1	19	62.5	1893	-	-
12	2	19	75.5	1082	1764	-
13	2	19	72.8	1076	1180	-
14	1	19	63.5	1150	-	-
15	1	19	62.9	1513	-	-
16	2	19	81.2	1616	1048	-
17	1	19	51.6	1280	-	-
18	2	19	82.7	1485	1020	-
19	1	19	62.1	1164	-	-
20	3	19	98.5	1346	1681	1644



Long Pulse Radar Test Signal

Test Signal Name: LP\_Signal\_19

Number of Bursts in Trial: 8

Burst	Pulses per Burst	Chrip (MHz)	Pulse Width(us)	PRI-1 (us)	PRI-2 (us)	PRI-3 (us)
1	1	5	50.7	1233	-	-
2	3	5	90.2	1665	1706	1099
3	2	5	80.8	1817	1107	-
4	3	5	89.6	1710	1444	1544
5	3	5	91.8	1775	1640	1090
6	3	5	89.5	1124	1999	1883
7	2	5	78.5	1532	1321	-
8	2	5	82.8	1659	1300	-
9	-	-	-	-	-	-
10	-	-	-	-	-	-
11	-	-	-	-	-	-
12	-	-	-	-	-	-
13	-	-	-	-	-	-
14	-	-	-	-	-	-
15	-	-	-	-	-	-
16	-	-	-	-	-	-
17	-	-	-	-	-	-
18	-	-	-	-	-	-
19	-	-	-	-	-	-
20	-	-	-	-	-	-



Long Pulse Radar Test Signal

Test Signal Name: LP\_Signal\_20

Number of Bursts in Trial: 8

Burst	Pulses per Burst	Chrip (MHz)	Pulse Width(us)	PRI-1 (us)	PRI-2 (us)	PRI-3 (us)
1	1	5	53.4	1794	-	-
2	2	5	74.8	1489	1915	-
3	1	5	63.5	1473	-	-
4	3	5	84.2	1687	1218	1383
5	1	5	66.2	1344	-	-
6	1	5	54.1	1343	-	-
7	3	5	89.8	1509	1264	1178
8	2	5	71.9	1273	1593	-
9	-	-	-	-	-	-
10	-	-	-	-	-	-
11	-	-	-	-	-	-
12	-	-	-	-	-	-
13	-	-	-	-	-	-
14	-	-	-	-	-	-
15	-	-	-	-	-	-
16	-	-	-	-	-	-
17	-	-	-	-	-	-
18	-	-	-	-	-	-
19	-	-	-	-	-	-
20	-	-	-	-	-	-

Long Pulse Radar Test Signal

Test Signal Name: LP\_Signal\_21

Number of Bursts in Trial: 12

Burst	Pulses per Burst	Chrip (MHz)	Pulse Width(us)	PRI-1 (us)	PRI-2 (us)	PRI-3 (us)
1	3	11	89.1	1712	1011	1872
2	1	11	58.8	1205	-	-
3	1	11	63.1	1312	-	-
4	2	11	82.9	1918	1410	-
5	1	11	59.7	1442	-	-
6	2	11	82.8	1340	1310	-
7	3	11	84.7	1013	1139	1930
8	2	11	81.6	1548	1347	-
9	1	11	60.2	1584	-	-
10	2	11	73.9	1499	1634	-
11	3	11	93.4	1881	1379	1864
12	2	11	68.5	1160	1991	-
13	-	-	-	-	-	-
14	-	-	-	-	-	-
15	-	-	-	-	-	-
16	-	-	-	-	-	-
17	-	-	-	-	-	-
18	-	-	-	-	-	-
19	-	-	-	-	-	-
20	-	-	-	-	-	-



Long Pulse Radar Test Signal

Test Signal Name: LP\_Signal\_22

Number of Bursts in Trial: 10

Burst	Pulses per Burst	Chrip (MHz)	Pulse Width(us)	PRI-1 (us)	PRI-2 (us)	PRI-3 (us)
1	2	8	75.5	1830	1546	-
2	1	8	63.2	1506	-	-
3	3	8	97.1	1752	1979	1559
4	1	8	66.2	1192	-	-
5	3	8	96.8	1949	1826	1219
6	3	8	91.3	1317	1008	1812
7	3	8	84.7	1071	1498	1522
8	1	8	53.1	1524	-	-
9	1	8	52.7	1582	-	-
10	2	8	80.7	1562	1612	-
11	-	-	-	-	-	-
12	-	-	-	-	-	-
13	-	-	-	-	-	-
14	-	-	-	-	-	-
15	-	-	-	-	-	-
16	-	-	-	-	-	-
17	-	-	-	-	-	-
18	-	-	-	-	-	-
19	-	-	-	-	-	-
20	-	-	-	-	-	-



Long Pulse Radar Test Signal

Test Signal Name: LP\_Signal\_23

Number of Bursts in Trial: 17

Burst	Pulses per Burst	Chrip (MHz)	Pulse Width(us)	PRI-1 (us)	PRI-2 (us)	PRI-3 (us)
1	1	16	61.5	1391	-	-
2	2	16	70.3	1402	1578	-
3	3	16	94.4	1154	1523	1044
4	2	16	76.7	1203	1740	-
5	1	16	51.3	1792	-	-
6	2	16	71.3	1352	1919	-
7	1	16	56.8	1676	-	-
8	2	16	78.3	1367	1068	-
9	1	16	59.2	1535	-	-
10	2	16	68.7	1768	1190	-
11	2	16	73.8	1713	1036	-
12	3	16	91.1	1369	1716	1095
13	3	16	92.2	1274	1267	1050
14	3	16	92.9	1042	1623	1335
15	2	16	69.6	1627	1571	-
16	2	16	79.2	1575	1753	-
17	3	16	88.7	1550	1147	1363
18	-	-	-	-	-	-
19	-	-	-	-	-	-
20	-	-	-	-	-	-

Long Pulse Radar Test Signal

Test Signal Name: LP\_Signal\_24

Number of Bursts in Trial: 13

Burst	Pulses per Burst	Chrip (MHz)	Pulse Width(us)	PRI-1 (us)	PRI-2 (us)	PRI-3 (us)
1	2	11	67.9	1946	1179	-
2	1	11	55.4	1853	-	-
3	3	11	99.3	1398	1423	1631
4	2	11	79.4	1177	1690	-
5	2	11	67.8	1003	1892	-
6	3	11	96.1	1648	1694	1055
7	1	11	60	1689	-	-
8	1	11	57.2	1521	-	-
9	3	11	90.2	1905	1678	1183
10	2	11	77.8	1707	1860	-
11	3	11	97.3	1600	1232	1322
12	3	11	87.4	1683	1870	1130
13	2	11	75	1446	1131	-
14	-	-	-	-	-	-
15	-	-	-	-	-	-
16	-	-	-	-	-	-
17	-	-	-	-	-	-
18	-	-	-	-	-	-
19	-	-	-	-	-	-
20	-	-	-	-	-	-

Long Pulse Radar Test Signal

Test Signal Name: LP\_Signal\_25

Number of Bursts in Trial: 10

Burst	Pulses per Burst	Chrip (MHz)	Pulse Width(us)	PRI-1 (us)	PRI-2 (us)	PRI-3 (us)
1	2	8	69.4	1512	1305	-
2	3	8	86.6	1170	1236	1169
3	2	8	69.1	1395	1165	-
4	1	8	58.3	1806	-	-
5	3	8	97.4	1977	1161	1726
6	3	8	92.8	1951	1682	1088
7	3	8	88.5	1718	1780	1389
8	2	8	83	1926	1586	-
9	2	8	81.5	1265	1533	-
10	1	8	63.4	1880	-	-
11	-	-	-	-	-	-
12	-	-	-	-	-	-
13	-	-	-	-	-	-
14	-	-	-	-	-	-
15	-	-	-	-	-	-
16	-	-	-	-	-	-
17	-	-	-	-	-	-
18	-	-	-	-	-	-
19	-	-	-	-	-	-
20	-	-	-	-	-	-

Long Pulse Radar Test Signal

Test Signal Name: LP\_Signal\_26

Number of Bursts in Trial: 14

Burst	Pulses per Burst	Chrip (MHz)	Pulse Width(us)	PRI-1 (us)	PRI-2 (us)	PRI-3 (us)
1	2	12	74.7	1294	1401	-
2	2	12	81.9	1122	1146	-
3	1	12	64.7	1508	-	-
4	2	12	74.7	1638	1400	-
5	3	12	94.8	1016	1801	1969
6	3	12	84.5	1773	1091	1868
7	2	12	71.1	1955	1877	-
8	1	12	54.2	1188	-	-
9	3	12	96.6	1295	1424	1440
10	2	12	67.5	1453	1025	-
11	1	12	52.5	1925	-	-
12	2	12	66.8	1142	1580	-
13	3	12	97.8	1850	1729	1807
14	1	12	53.5	1105	-	-
15	-	-	-	-	-	-
16	-	-	-	-	-	-
17	-	-	-	-	-	-
18	-	-	-	-	-	-
19	-	-	-	-	-	-
20	-	-	-	-	-	-

Long Pulse Radar Test Signal

Test Signal Name: LP\_Signal\_27

Number of Bursts in Trial: 17

Burst	Pulses per Burst	Chrip (MHz)	Pulse Width(us)	PRI-1 (us)	PRI-2 (us)	PRI-3 (us)
1	1	16	51.2	1278	-	-
2	3	16	93.7	1432	1231	1436
3	2	16	74.3	1111	1621	-
4	3	16	84.4	1066	1030	1871
5	2	16	69.5	1224	1484	-
6	1	16	61.1	1220	-	-
7	3	16	93.5	1428	1093	1061
8	1	16	59.5	1047	-	-
9	3	16	90.9	1254	1242	1903
10	3	16	84.3	1628	1993	1185
11	3	16	99.3	1421	1799	1468
12	3	16	87.2	1531	1127	1572
13	2	16	72	1816	1173	-
14	3	16	83.8	1937	1303	1778
15	3	16	95.5	1197	1256	1944
16	2	16	76.9	1511	1829	-
17	3	16	90.8	1858	1296	1843
18	-	-	-	-	-	-
19	-	-	-	-	-	-
20	-	-	-	-	-	-

Long Pulse Radar Test Signal

Test Signal Name: LP\_Signal\_28

Number of Bursts in Trial: 15

Burst	Pulses per Burst	Chrip (MHz)	Pulse Width(us)	PRI-1 (us)	PRI-2 (us)	PRI-3 (us)
1	1	14	55.6	1329	-	-
2	3	14	86.5	1986	1360	1759
3	3	14	92	1679	1447	1672
4	2	14	74.6	1125	1705	-
5	3	14	97.6	1403	1654	1563
6	1	14	53.1	1696	-	-
7	2	14	71.3	1454	1266	-
8	1	14	65.2	1313	-	-
9	2	14	72.8	1567	1053	-
10	2	14	69	1931	1253	-
11	2	14	73.6	1474	1601	-
12	1	14	50.7	1239	-	-
13	2	14	69.8	1597	1196	-
14	2	14	72.4	1650	1006	-
15	1	14	52.6	1466	-	-
16	-	-	-	-	-	-
17	-	-	-	-	-	-
18	-	-	-	-	-	-
19	-	-	-	-	-	-
20	-	-	-	-	-	-



Long Pulse Radar Test Signal

Test Signal Name: LP\_Signal\_29

Number of Bursts in Trial: 15

Burst	Pulses per Burst	Chrip (MHz)	Pulse Width(us)	PRI-1 (us)	PRI-2 (us)	PRI-3 (us)
1	3	14	88.9	1620	1425	1069
2	1	14	65.6	1459	-	-
3	1	14	57.1	1246	-	-
4	1	14	53.6	1988	-	-
5	2	14	68.5	1630	1392	-
6	1	14	54	1688	-	-
7	1	14	63.5	1472	-	-
8	2	14	70.3	1070	1441	-
9	2	14	69.9	1803	1001	-
10	1	14	65.1	1376	-	-
11	3	14	91	1932	1004	1598
12	2	14	80.4	1790	1641	-
13	2	14	75.4	1604	1323	-
14	1	14	57.6	1418	-	-
15	1	14	62.5	1240	-	-
16	-	-	-	-	-	-
17	-	-	-	-	-	-
18	-	-	-	-	-	-
19	-	-	-	-	-	-
20	-	-	-	-	-	-





Long Pulse Radar Test Signal

Test Signal Name: LP\_Signal\_30

Number of Bursts in Trial: 9

Burst	Pulses per Burst	Chrip (MHz)	Pulse Width(us)	PRI-1 (us)	PRI-2 (us)	PRI-3 (us)
1	3	7	87.3	1917	1784	1702
2	1	7	58.7	1370	-	-
3	2	7	69.7	1649	1320	-
4	2	7	76.8	1700	1285	-
5	3	7	97	1837	1089	1576
6	2	7	80.3	1078	1341	-
7	1	7	55.7	1695	-	-
8	2	7	78.9	1021	1821	-
9	1	7	53.7	1602	-	-
10	-	-	-	-	-	-
11	-	-	-	-	-	-
12	-	-	-	-	-	-
13	-	-	-	-	-	-
14	-	-	-	-	-	-
15	-	-	-	-	-	-
16	-	-	-	-	-	-
17	-	-	-	-	-	-
18	-	-	-	-	-	-
19	-	-	-	-	-	-
20	-	-	-	-	-	-



**BW160**

Long Pulse Radar Test Signal

Test Signal Name: LP\_Signal\_01

Number of Bursts in Trial: 13

Burst	Pulses per Burst	Chrip (MHz)	Pulse Width(us)	PRI-1 (us)	PRI-2 (us)	PRI-3 (us)
1	2	12	72.3	1755	1674	-
2	3	12	93.3	1628	1167	1284
3	3	12	98.4	1837	1798	1519
4	3	12	84.5	1613	1145	1805
5	3	12	95.2	1476	1854	1395
6	1	12	53.7	1358	-	-
7	1	12	63.2	1487	-	-
8	1	12	55.4	1756	-	-
9	1	12	61.2	1050	-	-
10	3	12	89	1609	1244	1978
11	1	12	61.4	1617	-	-
12	3	12	87.9	1036	1397	1221
13	3	12	84.5	1597	1420	1855
14	-	-	-	-	-	-
15	-	-	-	-	-	-
16	-	-	-	-	-	-
17	-	-	-	-	-	-
18	-	-	-	-	-	-
19	-	-	-	-	-	-
20	-	-	-	-	-	-



Long Pulse Radar Test Signal

Test Signal Name: LP\_Signal\_02

Number of Bursts in Trial: 19

Burst	Pulses per Burst	Chrip (MHz)	Pulse Width(us)	PRI-1 (us)	PRI-2 (us)	PRI-3 (us)
1	3	18	98.8	2000	1421	1218
2	1	18	63.9	1982	-	-
3	3	18	92.9	1852	1405	1622
4	2	18	73.9	1102	1012	-
5	2	18	68.8	1924	1823	-
6	2	18	67.8	1692	1643	-
7	2	18	82.4	1510	1761	-
8	3	18	98.6	1461	1615	1561
9	1	18	56.8	1013	-	-
10	3	18	86.2	1290	1785	1120
11	2	18	80.9	1791	1542	-
12	2	18	70.1	1496	1591	-
13	1	18	60	1138	-	-
14	1	18	52.5	1638	-	-
15	1	18	51.4	1231	-	-
16	3	18	94.6	1948	1689	1417
17	3	18	90.6	1945	1774	1445
18	3	18	86.8	1929	1076	1626
19	2	18	76.5	1449	1775	-
20	-	-	-	-	-	-



Long Pulse Radar Test Signal

Test Signal Name: LP\_Signal\_03

Number of Bursts in Trial: 20

Burst	Pulses per Burst	Chrip (MHz)	Pulse Width(us)	PRI-1 (us)	PRI-2 (us)	PRI-3 (us)
1	1	20	55.3	1256	-	-
2	2	20	73.5	1475	1085	-
3	1	20	60.5	1229	-	-
4	1	20	52.6	1919	-	-
5	1	20	51.8	1603	-	-
6	3	20	92.5	1468	1109	1577
7	1	20	64.8	1784	-	-
8	1	20	58.5	1915	-	-
9	2	20	75.4	1584	1130	-
10	1	20	61	1323	-	-
11	3	20	88.1	1880	1885	1678
12	2	20	73.8	1739	1514	-
13	1	20	55.1	1810	-	-
14	3	20	99	1737	1719	1034
15	1	20	50.9	1387	-	-
16	1	20	50.4	1275	-	-
17	3	20	91	1700	1738	1316
18	1	20	65.3	1534	-	-
19	3	20	95.6	1792	1937	1819
20	2	20	66.9	1770	1529	-

Long Pulse Radar Test Signal

Test Signal Name: LP\_Signal\_04

Number of Bursts in Trial: 16

Burst	Pulses per Burst	Chrip (MHz)	Pulse Width(us)	PRI-1 (us)	PRI-2 (us)	PRI-3 (us)
1	2	16	78.4	1900	1706	-
2	2	16	82.9	1313	1579	-
3	1	16	50.8	1990	-	-
4	1	16	65.5	1382	-	-
5	1	16	57.1	1282	-	-
6	2	16	67.5	1314	1702	-
7	1	16	64.3	1286	-	-
8	3	16	85.1	1105	1540	1147
9	1	16	51.2	1815	-	-
10	1	16	61.7	1504	-	-
11	1	16	60.8	1592	-	-
12	2	16	70.7	1112	1894	-
13	1	16	52.2	1291	-	-
14	3	16	84.9	1441	1095	1644
15	2	16	82.5	1156	1732	-
16	1	16	61	1795	-	-
17	-	-	-	-	-	-
18	-	-	-	-	-	-
19	-	-	-	-	-	-
20	-	-	-	-	-	-

Long Pulse Radar Test Signal

Test Signal Name: LP\_Signal\_05

Number of Bursts in Trial: 19

Burst	Pulses per Burst	Chrip (MHz)	Pulse Width(us)	PRI-1 (us)	PRI-2 (us)	PRI-3 (us)
1	3	19	88.2	1296	1994	1980
2	1	19	61.3	1018	-	-
3	3	19	91.1	1047	1179	1365
4	2	19	81.4	1160	1779	-
5	1	19	53.9	1428	-	-
6	1	19	59.3	1708	-	-
7	1	19	57	1587	-	-
8	3	19	87.6	1078	1844	1283
9	2	19	68.7	1453	1825	-
10	1	19	62.3	1927	-	-
11	2	19	75.7	1459	1471	-
12	2	19	71.2	1905	1489	-
13	1	19	59.1	1710	-	-
14	1	19	52.1	1308	-	-
15	1	19	60.5	1087	-	-
16	2	19	79.3	1828	1889	-
17	3	19	95	1139	1432	1588
18	2	19	69.9	1466	1838	-
19	3	19	98.1	1107	1419	1909
20						



Long Pulse Radar Test Signal

Test Signal Name: LP\_Signal\_06

Number of Bursts in Trial: 8

Burst	Pulses per Burst	Chrip (MHz)	Pulse Width(us)	PRI-1 (us)	PRI-2 (us)	PRI-3 (us)
1	2	6	72.5	1890	1292	-
2	2	6	72.6	1794	1408	-
3	3	6	95.1	1093	1310	1776
4	3	6	95.6	1225	1694	1778
5	3	6	84.4	1219	1640	1879
6	2	6	78.2	1448	1505	-
7	2	6	79.8	1930	1144	-
8	1	6	57.3	1021	-	-
9	-	-	-	-	-	-
10	-	-	-	-	-	-
11	-	-	-	-	-	-
12	-	-	-	-	-	-
13	-	-	-	-	-	-
14	-	-	-	-	-	-
15	-	-	-	-	-	-
16	-	-	-	-	-	-
17	-	-	-	-	-	-
18	-	-	-	-	-	-
19	-	-	-	-	-	-
20	-	-	-	-	-	-

Long Pulse Radar Test Signal

Test Signal Name: LP\_Signal\_07

Number of Bursts in Trial: 11

Burst	Pulses per Burst	Chrip (MHz)	Pulse Width(us)	PRI-1 (us)	PRI-2 (us)	PRI-3 (us)
1	1	9	63.6	1490	-	-
2	1	9	50.1	1714	-	-
3	2	9	67.4	1605	1352	-
4	2	9	71.6	1431	1658	-
5	2	9	70.3	1281	1007	-
6	1	9	66.4	1015	-	-
7	3	9	90	1197	1005	1918
8	1	9	62.2	1153	-	-
9	2	9	79.6	1247	1295	-
10	2	9	74.3	1518	1646	-
11	1	9	64.1	1305	-	-
12	-	-	-	-	-	-
13	-	-	-	-	-	-
14	-	-	-	-	-	-
15	-	-	-	-	-	-
16	-	-	-	-	-	-
17	-	-	-	-	-	-
18	-	-	-	-	-	-
19	-	-	-	-	-	-
20	-	-	-	-	-	-





Long Pulse Radar Test Signal

Test Signal Name: LP\_Signal\_08

Number of Bursts in Trial: 9

Burst	Pulses per Burst	Chrip (MHz)	Pulse Width(us)	PRI-1 (us)	PRI-2 (us)	PRI-3 (us)
1	1	6	63	1460	-	-
2	2	6	69.1	1943	1619	-
3	2	6	75.8	1000	1230	-
4	1	6	63.3	1620	-	-
5	3	6	96.8	1846	1213	1425
6	3	6	94.8	1122	1024	1920
7	3	6	91.8	1634	1991	1960
8	3	6	93.1	1424	1406	1744
9	2	6	76	1687	1763	-
10	-	-	-	-	-	-
11	-	-	-	-	-	-
12	-	-	-	-	-	-
13	-	-	-	-	-	-
14	-	-	-	-	-	-
15	-	-	-	-	-	-
16	-	-	-	-	-	-
17	-	-	-	-	-	-
18	-	-	-	-	-	-
19	-	-	-	-	-	-
20	-	-	-	-	-	-

Long Pulse Radar Test Signal

Test Signal Name: LP\_Signal\_09

Number of Bursts in Trial: 10

Burst	Pulses per Burst	Chrip (MHz)	Pulse Width(us)	PRI-1 (us)	PRI-2 (us)	PRI-3 (us)
1	3	8	99.1	1635	1214	1201
2	1	8	51.2	1989	-	-
3	2	8	81.6	1817	1152	-
4	2	8	75.7	1816	1596	-
5	2	8	82.3	1783	1375	-
6	3	8	86.8	1649	1690	1434
7	1	8	60	1055	-	-
8	3	8	88.4	1136	1235	1868
9	3	8	93.1	1559	1813	1222
10	1	8	65.7	1503	-	-
11	-	-	-	-	-	-
12	-	-	-	-	-	-
13	-	-	-	-	-	-
14	-	-	-	-	-	-
15	-	-	-	-	-	-
16	-	-	-	-	-	-
17	-	-	-	-	-	-
18	-	-	-	-	-	-
19	-	-	-	-	-	-
20	-	-	-	-	-	-

Long Pulse Radar Test Signal

Test Signal Name: LP\_Signal\_10

Number of Bursts in Trial: 18

Burst	Pulses per Burst	Chrip (MHz)	Pulse Width(us)	PRI-1 (us)	PRI-2 (us)	PRI-3 (us)
1	1	17	56.7	1263	-	-
2	1	17	53.2	1462	-	-
3	2	17	74.1	1180	1344	-
4	1	17	52	1269	-	-
5	3	17	93.5	1841	1931	1863
6	3	17	87.4	1972	1210	1610
7	1	17	51.3	1208	-	-
8	3	17	90.7	1608	1302	1759
9	1	17	55.4	1509	-	-
10	1	17	54.8	1253	-	-
11	2	17	69.1	1961	1499	-
12	3	17	89.9	1069	1717	1176
13	2	17	80.9	1315	1904	-
14	1	17	55	1553	-	-
15	2	17	80.8	1134	1439	-
16	1	17	56.9	1987	-	-
17	2	17	79	1106	1602	-
18	3	17	96.8	1874	1118	1595
19	-	-	-	-	-	-
20	-	-	-	-	-	-



Long Pulse Radar Test Signal

Test Signal Name: LP\_Signal\_11

Number of Bursts in Trial: 10

Burst	Pulses per Burst	Chrip (MHz)	Pulse Width(us)	PRI-1 (us)	PRI-2 (us)	PRI-3 (us)
1	1	8	59.3	1126	-	-
2	3	8	98.4	1164	1660	1258
3	1	8	50.7	1351	-	-
4	3	8	92.6	1458	1173	1209
5	3	8	85.1	1474	1843	1374
6	1	8	53.8	1547	-	-
7	1	8	58.2	1833	-	-
8	1	8	62.4	1108	-	-
9	2	8	68.6	1869	1947	-
10	3	8	91.7	1321	1912	1443
11	-	-	-	-	-	-
12	-	-	-	-	-	-
13	-	-	-	-	-	-
14	-	-	-	-	-	-
15	-	-	-	-	-	-
16	-	-	-	-	-	-
17	-	-	-	-	-	-
18	-	-	-	-	-	-
19	-	-	-	-	-	-
20	-	-	-	-	-	-

Long Pulse Radar Test Signal

Test Signal Name: LP\_Signal\_12

Number of Bursts in Trial: 17

Burst	Pulses per Burst	Chrip (MHz)	Pulse Width(us)	PRI-1 (us)	PRI-2 (us)	PRI-3 (us)
1	3	17	89.3	1766	1771	1623
2	3	17	83.5	1196	1410	1834
3	1	17	56.3	1913	-	-
4	1	17	51.6	1835	-	-
5	2	17	69.1	1333	1348	-
6	1	17	63.9	1583	-	-
7	2	17	67.5	1973	1142	-
8	1	17	60.9	1799	-	-
9	3	17	88.9	1178	1625	1851
10	2	17	67	1866	1908	-
11	2	17	82.4	1041	1010	-
12	2	17	76	1932	1512	-
13	3	17	95.4	1098	1278	1217
14	1	17	54	1494	-	-
15	3	17	86.4	1582	1979	1238
16	3	17	88.3	1551	1251	1294
17	1	17	56.8	1319	-	-
18	-	-	-	-	-	-
19	-	-	-	-	-	-
20	-	-	-	-	-	-

Long Pulse Radar Test Signal

Test Signal Name: LP\_Signal\_13

Number of Bursts in Trial: 16

Burst	Pulses per Burst	Chrip (MHz)	Pulse Width(us)	PRI-1 (us)	PRI-2 (us)	PRI-3 (us)
1	1	16	59.1	1452	-	-
2	2	16	70.3	1722	1113	-
3	2	16	76.5	1394	1543	-
4	3	16	94.9	1044	1887	1983
5	2	16	75.4	1858	1131	-
6	1	16	57.8	1089	-	-
7	1	16	63.3	1037	-	-
8	2	16	79.1	1389	1165	-
9	3	16	94.8	1383	1882	1986
10	1	16	65	1600	-	-
11	1	16	64.1	1589	-	-
12	2	16	68.2	1268	1787	-
13	2	16	70.3	1048	1631	-
14	3	16	93.9	1418	1954	1353
15	2	16	81.1	1662	1331	-
16	2	16	68.7	1680	1733	-
17	-	-	-	-	-	-
18	-	-	-	-	-	-
19	-	-	-	-	-	-
20	-	-	-	-	-	-

Long Pulse Radar Test Signal

Test Signal Name: LP\_Signal\_14

Number of Bursts in Trial: 20

Burst	Pulses per Burst	Chrip (MHz)	Pulse Width(us)	PRI-1 (us)	PRI-2 (us)	PRI-3 (us)
1	1	20	59.6	1570	-	-
2	1	20	51.4	1571	-	-
3	2	20	71.9	1059	1463	-
4	3	20	98.5	1667	1707	1558
5	2	20	67.5	1888	1339	-
6	2	20	70.7	1681	1663	-
7	2	20	67	1575	1936	-
8	3	20	87.5	1956	1995	1506
9	2	20	69.9	1998	1578	-
10	2	20	68	1606	1693	-
11	1	20	62	1630	-	-
12	1	20	64.3	1311	-	-
13	2	20	83.3	1731	1655	-
14	1	20	52.9	1958	-	-
15	3	20	96.7	1312	1415	1975
16	1	20	56.2	1790	-	-
17	3	20	96.8	1682	1974	1545
18	3	20	97	1735	1396	1427
19	3	20	99.1	1114	1827	1782
20	3	20	92.1	1023	1330	1500

Long Pulse Radar Test Signal

Test Signal Name: LP\_Signal\_15

Number of Bursts in Trial: 11

Burst	Pulses per Burst	Chrip (MHz)	Pulse Width(us)	PRI-1 (us)	PRI-2 (us)	PRI-3 (us)
1	3	9	92.1	1337	1233	1636
2	3	9	96.9	1727	1248	1170
3	1	9	63.8	1081	-	-
4	2	9	75.7	1205	1380	-
5	3	9	93.1	1056	1416	1116
6	2	9	72.6	1299	1916	-
7	2	9	74.4	1740	1673	-
8	3	9	99	1356	1901	1450
9	1	9	53.4	1486	-	-
10	3	9	92.7	1182	1911	1992
11	2	9	68.5	1697	1227	-
12	-	-	-	-	-	-
13	-	-	-	-	-	-
14	-	-	-	-	-	-
15	-	-	-	-	-	-
16	-	-	-	-	-	-
17	-	-	-	-	-	-
18	-	-	-	-	-	-
19	-	-	-	-	-	-
20	-	-	-	-	-	-



Long Pulse Radar Test Signal

Test Signal Name: LP\_Signal\_16

Number of Bursts in Trial: 19

Burst	Pulses per Burst	Chrip (MHz)	Pulse Width(us)	PRI-1 (us)	PRI-2 (us)	PRI-3 (us)
1	2	18	73.2	1907	1191	-
2	1	18	51.3	1764	-	-
3	1	18	57.2	1965	-	-
4	3	18	85.7	1647	1026	1632
5	1	18	52.6	1789	-	-
6	1	18	64.4	1586	-	-
7	3	18	89.8	1341	1976	1435
8	3	18	89.3	1572	1195	1379
9	3	18	88.4	1857	1309	1942
10	1	18	53.3	1574	-	-
11	3	18	89.1	1672	1875	1071
12	2	18	74.9	1952	1598	-
13	1	18	57.4	1549	-	-
14	3	18	95.8	1057	1151	1082
15	3	18	99	1115	1117	1741
16	3	18	95.8	1242	1127	1028
17	3	18	91.9	1480	1899	1250
18	2	18	68.3	1370	1103	-
19	1	18	57.9	1865	-	-
20	-	-	-	-	-	-



Long Pulse Radar Test Signal

Test Signal Name: LP\_Signal\_17

Number of Bursts in Trial: 14

Burst	Pulses per Burst	Chrip (MHz)	Pulse Width(us)	PRI-1 (us)	PRI-2 (us)	PRI-3 (us)
1	2	12	71.5	1903	1440	-
2	2	12	73.4	1686	1538	-
3	3	12	94.8	1279	1481	1257
4	3	12	89	1873	1043	1601
5	2	12	76.7	1891	1677	-
6	1	12	62.8	1413	-	-
7	3	12	87.6	1226	1472	1552
8	3	12	96.3	1808	1277	1541
9	1	12	55.3	1404	-	-
10	3	12	95	1922	1950	1119
11	3	12	96.4	1092	1401	1881
12	2	12	68.1	1255	1223	-
13	3	12	84.1	1072	1086	1715
14	2	12	77.3	1752	1264	-
15	-	-	-	-	-	-
16	-	-	-	-	-	-
17	-	-	-	-	-	-
18	-	-	-	-	-	-
19	-	-	-	-	-	-
20	-	-	-	-	-	-

Long Pulse Radar Test Signal

Test Signal Name: LP\_Signal\_18

Number of Bursts in Trial: 12

Burst	Pulses per Burst	Chrip (MHz)	Pulse Width(us)	PRI-1 (us)	PRI-2 (us)	PRI-3 (us)
1	3	11	99.6	1307	1027	1403
2	3	11	88.8	1839	1336	1473
3	1	11	63	1661	-	-
4	2	11	76	1793	1158	-
5	2	11	67.2	1171	1926	-
6	3	11	94.1	1762	1743	1254
7	3	11	91.8	1354	1058	1502
8	1	11	56.9	1133	-	-
9	1	11	57.7	1149	-	-
10	1	11	60.6	1189	-	-
11	3	11	88.7	1971	1508	1065
12	1	11	53	1734	-	-
13	-	-	-	-	-	-
14	-	-	-	-	-	-
15	-	-	-	-	-	-
16	-	-	-	-	-	-
17	-	-	-	-	-	-
18	-	-	-	-	-	-
19	-	-	-	-	-	-
20	-	-	-	-	-	-

Long Pulse Radar Test Signal

Test Signal Name: LP\_Signal\_19

Number of Bursts in Trial: 12

Burst	Pulses per Burst	Chrip (MHz)	Pulse Width(us)	PRI-1 (us)	PRI-2 (us)	PRI-3 (us)
1	2	10	71.9	1368	1917	-
2	1	10	56.4	1886	-	-
3	2	10	79.9	1757	1566	-
4	3	10	94.2	1020	1243	1928
5	2	10	76.8	1154	1872	-
6	2	10	82.5	1633	1576	-
7	2	10	80.7	1665	1262	-
8	3	10	95.6	1848	1326	1132
9	2	10	71.2	1804	1372	-
10	3	10	95.2	1830	1521	1616
11	2	10	78.4	1546	1161	-
12	1	10	62.3	1068	-	-
13	-	-	-	-	-	-
14	-	-	-	-	-	-
15	-	-	-	-	-	-
16	-	-	-	-	-	-
17	-	-	-	-	-	-
18	-	-	-	-	-	-
19	-	-	-	-	-	-
20	-	-	-	-	-	-

Long Pulse Radar Test Signal

Test Signal Name: LP\_Signal\_20

Number of Bursts in Trial: 16

Burst	Pulses per Burst	Chrip (MHz)	Pulse Width(us)	PRI-1 (us)	PRI-2 (us)	PRI-3 (us)
1	2	15	80.6	1777	1523	-
2	2	15	72.9	1198	1712	-
3	1	15	65	1207	-	-
4	2	15	68.2	1181	1174	-
5	3	15	84.4	1346	1329	1355
6	3	15	94.4	1022	1914	2000
7	3	15	92.1	1892	1536	1393
8	3	15	85.3	1483	1384	1362
9	1	15	55	1525	-	-
10	3	15	97.7	1442	1200	1046
11	1	15	57.8	1516	-	-
12	1	15	57	1864	-	-
13	3	15	85.9	1030	1042	1051
14	2	15	69.7	1691	1964	-
15	2	15	74.6	1246	1426	-
16	2	15	74.2	1614	1562	-
17	-	-	-	-	-	-
18	-	-	-	-	-	-
19	-	-	-	-	-	-
20	-	-	-	-	-	-

Long Pulse Radar Test Signal

Test Signal Name: LP\_Signal\_21

Number of Bursts in Trial: 20

Burst	Pulses per Burst	Chrip (MHz)	Pulse Width(us)	PRI-1 (us)	PRI-2 (us)	PRI-3 (us)
1	1	20	66.1	1669	-	-
2	1	20	64.5	1414	-	-
3	1	20	65.6	1347	-	-
4	3	20	84.2	1135	1163	1934
5	1	20	50.2	1332	-	-
6	2	20	73.6	1016	1861	-
7	3	20	91	1511	1155	1814
8	2	20	81.2	1902	1391	-
9	1	20	66.3	1728	-	-
10	1	20	61.2	1696	-	-
11	2	20	68.2	1169	1557	-
12	1	20	63.9	1548	-	-
13	3	20	87.5	1345	1188	1011
14	3	20	88.5	1648	1493	1399
15	1	20	56.1	1679	-	-
16	1	20	54.3	1729	-	-
17	1	20	60.4	1993	-	-
18	1	20	50.7	1772	-	-
19	3	20	95.5	1957	1465	1166
20	3	20	94.4	1216	1862	1668

Long Pulse Radar Test Signal

Test Signal Name: LP\_Signal\_22

Number of Bursts in Trial: 9

Burst	Pulses per Burst	Chrip (MHz)	Pulse Width(us)	PRI-1 (us)	PRI-2 (us)	PRI-3 (us)
1	2	7	79.1	1703	1045	-
2	2	7	73.6	1276	1666	-
3	2	7	72.6	1607	1895	-
4	1	7	63.4	1451	-	-
5	2	7	68.6	1711	1801	-
6	1	7	53.4	1328	-	-
7	3	7	98.1	1008	1539	1032
8	2	7	74.3	1357	1977	-
9	3	7	98.6	1893	1236	1411
10	-	-	-	-	-	-
11	-	-	-	-	-	-
12	-	-	-	-	-	-
13	-	-	-	-	-	-
14	-	-	-	-	-	-
15	-	-	-	-	-	-
16	-	-	-	-	-	-
17	-	-	-	-	-	-
18	-	-	-	-	-	-
19	-	-	-	-	-	-
20	-	-	-	-	-	-

Long Pulse Radar Test Signal

Test Signal Name: LP\_Signal\_23

Number of Bursts in Trial: 17

Burst	Pulses per Burst	Chrip (MHz)	Pulse Width(us)	PRI-1 (us)	PRI-2 (us)	PRI-3 (us)
1	2	16	72.9	1327	1684	-
2	1	16	58.2	1704	-	-
3	1	16	57	1999	-	-
4	1	16	57.8	1141	-	-
5	1	16	56.4	1716	-	-
6	2	16	79.4	1388	1285	-
7	1	16	56.7	1507	-	-
8	2	16	79.5	1062	1001	-
9	3	16	94.3	1129	1705	1769
10	1	16	62	1654	-	-
11	1	16	57	1533	-	-
12	2	16	81.9	1361	1742	-
13	3	16	83.9	1017	1111	1373
14	1	16	51.9	1359	-	-
15	2	16	73.2	1140	1641	-
16	2	16	76.2	1988	1484	-
17	2	16	78.1	1698	1829	-
18	-	-	-	-	-	-
19	-	-	-	-	-	-
20	-	-	-	-	-	-





Long Pulse Radar Test Signal

Test Signal Name: LP\_Signal\_24

Number of Bursts in Trial: 16

Burst	Pulses per Burst	Chrip (MHz)	Pulse Width(us)	PRI-1 (us)	PRI-2 (us)	PRI-3 (us)
1	3	14	97.8	1402	1676	1807
2	1	14	66.5	1168	-	-
3	3	14	91.5	1019	1985	1100
4	1	14	53.5	1204	-	-
5	3	14	96.6	1241	1765	1378
6	3	14	85.2	1856	1524	1501
7	2	14	74.3	1033	1604	-
8	2	14	80.3	1385	1261	-
9	3	14	95.2	1532	1709	1301
10	3	14	92.5	1871	1593	1749
11	3	14	91.9	1293	1412	1724
12	1	14	52.2	1298	-	-
13	1	14	65.5	1650	-	-
14	3	14	96.9	1867	1004	1259
15	2	14	75.6	1446	1966	-
16	1	14	66.6	1923	-	-
17	-	-	-	-	-	-
18	-	-	-	-	-	-
19	-	-	-	-	-	-
20	-	-	-	-	-	-

Long Pulse Radar Test Signal

Test Signal Name: LP\_Signal\_25

Number of Bursts in Trial: 13

Burst	Pulses per Burst	Chrip (MHz)	Pulse Width(us)	PRI-1 (us)	PRI-2 (us)	PRI-3 (us)
1	2	11	82.6	1349	1573	-
2	3	11	93.4	1594	1563	1183
3	1	11	52.9	1725	-	-
4	1	11	61.1	1187	-	-
5	1	11	56	1515	-	-
6	2	11	81	1809	1877	-
7	1	11	59	1469	-	-
8	3	11	99.5	1831	1845	1438
9	2	11	74.9	1273	1535	-
10	1	11	66.1	1252	-	-
11	3	11	88.7	1157	1860	1997
12	3	11	88.4	1969	1407	1091
13	1	11	62.4	1699	-	-
14	-	-	-	-	-	-
15	-	-	-	-	-	-
16	-	-	-	-	-	-
17	-	-	-	-	-	-
18	-	-	-	-	-	-
19	-	-	-	-	-	-
20	-	-	-	-	-	-

Long Pulse Radar Test Signal

Test Signal Name: LP\_Signal\_26

Number of Bursts in Trial: 10

Burst	Pulses per Burst	Chrip (MHz)	Pulse Width(us)	PRI-1 (us)	PRI-2 (us)	PRI-3 (us)
1	3	8	95.2	1002	1821	1527
2	2	8	71.7	1840	1035	-
3	3	8	99.4	1289	1177	1656
4	3	8	87.2	1786	1736	1925
5	3	8	90.5	1751	1803	1701
6	1	8	55.6	1067	-	-
7	2	8	81.5	1390	1946	-
8	2	8	82.8	1718	1245	-
9	3	8	95.1	1212	1713	1070
10	2	8	76.3	1317	1695	-
11	-	-	-	-	-	-
12	-	-	-	-	-	-
13	-	-	-	-	-	-
14	-	-	-	-	-	-
15	-	-	-	-	-	-
16	-	-	-	-	-	-
17	-	-	-	-	-	-
18	-	-	-	-	-	-
19	-	-	-	-	-	-
20	-	-	-	-	-	-



Long Pulse Radar Test Signal

Test Signal Name: LP\_Signal\_27

Number of Bursts in Trial: 8

Burst	Pulses per Burst	Chrip (MHz)	Pulse Width(us)	PRI-1 (us)	PRI-2 (us)	PRI-3 (us)
1	2	5	73	1237	1485	-
2	2	5	82.7	1824	1750	-
3	2	5	77.5	1436	1398	-
4	1	5	61.3	1303	-	-
5	3	5	87	1618	1675	1753
6	1	5	64.8	1215	-	-
7	2	5	77.2	1146	1280	-
8	2	5	78.7	1567	1400	-
9	-	-	-	-	-	-
10	-	-	-	-	-	-
11	-	-	-	-	-	-
12	-	-	-	-	-	-
13	-	-	-	-	-	-
14	-	-	-	-	-	-
15	-	-	-	-	-	-
16	-	-	-	-	-	-
17	-	-	-	-	-	-
18	-	-	-	-	-	-
19	-	-	-	-	-	-
20	-	-	-	-	-	-



Long Pulse Radar Test Signal

Test Signal Name: LP\_Signal\_28

Number of Bursts in Trial: 8

Burst	Pulses per Burst	Chrip (MHz)	Pulse Width(us)	PRI-1 (us)	PRI-2 (us)	PRI-3 (us)
1	1	5	65.2	1186	-	-
2	2	5	81.4	1193	1271	-
3	1	5	65.2	1556	-	-
4	1	5	51.2	1820	-	-
5	1	5	58.5	1381	-	-
6	2	5	70.2	1624	1564	-
7	1	5	65	1060	-	-
8	2	5	72.1	1364	1099	-
9	-	-	-	-	-	-
10	-	-	-	-	-	-
11	-	-	-	-	-	-
12	-	-	-	-	-	-
13	-	-	-	-	-	-
14	-	-	-	-	-	-
15	-	-	-	-	-	-
16	-	-	-	-	-	-
17	-	-	-	-	-	-
18	-	-	-	-	-	-
19	-	-	-	-	-	-
20	-	-	-	-	-	-

Long Pulse Radar Test Signal

Test Signal Name: LP\_Signal\_29

Number of Bursts in Trial: 19

Burst	Pulses per Burst	Chrip (MHz)	Pulse Width(us)	PRI-1 (us)	PRI-2 (us)	PRI-3 (us)
1	2	19	66.8	1876	1342	-
2	1	19	57.4	1206	-	-
3	3	19	92.1	1454	1079	1482
4	2	19	78.6	1726	1066	-
5	2	19	80.4	1498	1611	-
6	3	19	96.6	1495	1671	1123
7	3	19	85.9	1800	1232	1159
8	2	19	67.9	1847	1128	-
9	3	19	100	1260	1970	1064
10	2	19	70.8	1639	1796	-
11	3	19	92.5	1080	1367	1780
12	1	19	65	1921	-	-
13	2	19	75	1324	1429	-
14	3	19	91.2	1334	1464	1340
15	3	19	94.1	1386	1747	1409
16	3	19	83.9	1544	1318	1530
17	3	19	87.6	1377	1110	1239
18	2	19	67	1392	1745	-
19	2	19	79.9	1343	1194	-
20	-	-	-	-	-	-

Long Pulse Radar Test Signal

Test Signal Name: LP\_Signal\_30

Number of Bursts in Trial: 18

Burst	Pulses per Burst	Chrip (MHz)	Pulse Width(us)	PRI-1 (us)	PRI-2 (us)	PRI-3 (us)
1	2	17	78.4	1272	1101	-
2	2	17	78.5	1967	1366	-
3	2	17	69.7	1038	1083	-
4	2	17	72.1	1371	1422	-
5	3	17	84.7	1883	1063	1721
6	3	17	97.8	1897	1760	1651
7	3	17	87.5	1304	1457	1955
8	2	17	73.5	1685	1488	-
9	1	17	56.9	1996	-	-
10	3	17	97.2	1369	1376	1025
11	3	17	94	1568	1944	1806
12	1	17	63.1	1569	-	-
13	2	17	79.2	1802	1555	-
14	2	17	72.2	1531	1470	-
15	2	17	68.4	1288	1659	-
16	3	17	88.9	1832	1768	1287
17	2	17	74.1	1014	1723	-
18	3	17	90.8	1537	1423	1006
19	-	-	-	-	-	-
20	-	-	-	-	-	-



### A.2 Frequency Hopping Radar Pattern

Hopping Frequency Sequence Name: HOP\_FREQ\_SEQ\_01

Frequency (MHz)	0	1	2	3	4
0	5558	5323	5719	5591	5368
5	5694	5637	5476	5532	5528
10	5456	5354	5585	5301	5530
15	5262	5450	5625	5691	5417
20	5706	5415	5294	5377	5685
25	5254	5302	5258	5677	5600
30	5384	5487	5429	5382	5652
35	5256	5263	5717	5306	5408
40	5290	5665	5548	5460	5555
45	5286	5401	5393	5592	5675
50	5464	5690	5250	5406	5577
55	5520	5601	5479	5305	5642
60	5293	5698	5404	5633	5400
65	5611	5434	5270	5431	5452
70	5682	5569	5383	5318	5661
75	5379	5338	5576	5643	5291
80	5390	5511	5629	5536	5707
85	5253	5489	5724	5627	5271
90	5607	5590	5695	5539	5411
95	5388	5606	5523	5546	5355

Hopping Frequency Sequence Name: HOP\_FREQ\_SEQ\_02

Frequency (MHz)	0	1	2	3	4
0	5338	5562	5655	5277	5588
5	5358	5659	5551	5695	5260
10	5387	5618	5626	5399	5253
15	5577	5261	5609	5617	5581
20	5397	5286	5350	5573	5678
25	5365	5521	5336	5300	5566
30	5557	5270	5633	5307	5568
35	5473	5448	5506	5652	5259
40	5325	5719	5648	5287	5594
45	5528	5615	5518	5511	5487
50	5582	5462	5452	5482	5415
55	5619	5362	5405	5544	5377
60	5706	5685	5546	5311	5703
65	5591	5507	5354	5530	5682
70	5705	5500	5460	5410	5704
75	5400	5572	5550	5635	5331
80	5442	5543	5401	5296	5433
85	5351	5455	5607	5441	5284
90	5449	5701	5713	5274	5407
95	5255	5505	5569	5323	5262





Hopping Frequency Sequence Name: HOP\_FREQ\_SEQ\_03

Frequency (MHz)	0	1	2	3	4
0	5593	5326	5591	5438	5430
5	5400	5584	5626	5383	5467
10	5318	5407	5667	5594	5572
15	5341	5704	5356	5306	5625
20	5650	5338	5375	5323	5364
25	5530	5568	5370	5342	5552
30	5514	5485	5310	5602	5707
35	5564	5659	5663	5573	5408
40	5657	5413	5284	5523	5508
45	5698	5576	5277	5361	5638
50	5503	5668	5713	5466	5365
55	5316	5595	5363	5348	5360
60	5491	5618	5529	5534	5317
65	5456	5390	5265	5372	5399
70	5589	5309	5386	5369	5692
75	5396	5531	5412	5441	5464
80	5614	5546	5314	5550	5475
85	5395	5532	5647	5391	5719
90	5699	5631	5521	5262	5336
95	5403	5451	5329	5460	5504

Hopping Frequency Sequence Name: HOP\_FREQ\_SEQ\_04

Frequency (MHz)	0	1	2	3	4
0	5276	5565	5527	5502	5650
5	5442	5606	5701	5546	5296
10	5627	5671	5708	5314	5593
15	5429	5259	5459	5254	5518
20	5633	5341	5376	5367	5252
25	5479	5404	5481	5441	5471
30	5603	5559	5325	5371	5655
35	5612	5337	5577	5412	5588
40	5595	5653	5281	5355	5488
45	5306	5537	5617	5639	5712
50	5339	5554	5282	5536	5410
55	5553	5270	5310	5560	5319
60	5489	5540	5533	5450	5615
65	5405	5426	5572	5264	5288
70	5575	5362	5622	5716	5539
75	5512	5664	5454	5299	5611
80	5686	5449	5689	5374	5267
85	5440	5446	5305	5370	5556
90	5250	5258	5513	5538	5317
95	5320	5301	5430	5432	5280



Hopping Frequency Sequence Name: HOP\_FREQ\_SEQ\_05

Frequency (MHz)	0	1	2	3	4
0	5531	5329	5463	5663	5492
5	5484	5301	5612	5503	5558
10	5557	5274	5509	5614	5517
15	5386	5465	5299	5710	5544
20	5507	5317	5456	5269	5615
25	5331	5499	5455	5341	5523
30	5330	5428	5343	5711	5620
35	5413	5271	5408	5587	5491
40	5251	5671	5436	5321	5278
45	5284	5468	5389	5595	5670
50	5429	5588	5515	5605	5371
55	5262	5257	5266	5602	5500
60	5379	5668	5521	5705	5478
65	5354	5365	5307	5534	5566
70	5640	5561	5606	5385	5716
75	5581	5685	5360	5585	5493
80	5344	5564	5260	5687	5608
85	5352	5337	5459	5308	5400
90	5553	5665	5721	5353	5298
95	5555	5372	5304	5296	5312

Hopping Frequency Sequence Name: HOP\_FREQ\_SEQ\_06

Frequency (MHz)	0	1	2	3	4
0	5311	5568	5399	5349	5712
5	5623	5553	5376	5300	5710
10	5392	5346	5315	5704	5635
15	5508	5513	5344	5427	5552
20	5576	5258	5448	5717	5406
25	5658	5605	5559	5375	5565
30	5316	5385	5558	5485	5343
35	5459	5301	5265	5502	5279
40	5374	5561	5275	5591	5472
45	5653	5723	5464	5691	5656
50	5460	5560	5676	5357	5556
55	5690	5673	5639	5650	5395
60	5423	5686	5579	5469	5542
65	5303	5401	5614	5329	5272
70	5547	5609	5709	5692	5540
75	5557	5480	5253	5474	5596
80	5674	5516	5627	5698	5352
85	5470	5397	5554	5273	5354
90	5388	5411	5359	5655	5600
95	5572	5669	5291	5638	5487



Hopping Frequency Sequence Name: HOP\_FREQ\_SEQ\_07

Frequency (MHz)	0	1	2	3	4
0	5566	5332	5335	5510	5554
5	5665	5478	5451	5463	5539
10	5323	5610	5453	5327	5656
15	5596	5640	5671	5389	5716
20	5560	5267	5296	5537	5690
25	5294	5607	5333	5663	5409
30	5704	5680	5342	5298	5637
35	5638	5691	5550	5572	5418
40	5416	5501	5362	5312	5326
45	5369	5520	5428	5555	5614
50	5301	5581	5718	5392	5707
55	5646	5383	5523	5545	5405
60	5492	5304	5368	5518	5502
65	5415	5365	5252	5437	5349
70	5696	5309	5630	5709	5558
75	5668	5499	5526	5600	5299
80	5455	5373	5687	5297	5316
85	5338	5505	5255	5360	5271
90	5616	5477	5683	5576	5263
95	5440	5686	5482	5567	5270

Hopping Frequency Sequence Name: HOP\_FREQ\_SEQ\_08

Frequency (MHz)	0	1	2	3	4
0	5724	5571	5271	5671	5299
5	5707	5500	5526	5626	5254
10	5399	5494	5522	5677	5684
15	5292	5337	5433	5471	5336
20	5712	5529	5663	5560	5459
25	5536	5443	5666	5416	5411
30	5361	5258	5641	5368	5668
35	5330	5340	5542	5250	5469
40	5366	5449	5311	5638	5672
45	5257	5468	5594	5568	5283
50	5260	5681	5467	5464	5498
55	5689	5484	5410	5350	5328
60	5458	5566	5676	5376	5656
65	5491	5353	5478	5616	5310
70	5644	5398	5720	5442	5436
75	5625	5322	5553	5383	5502
80	5613	5633	5629	5420	5581
85	5359	5406	5266	5371	5675
90	5721	5703	5537	5465	5627
95	5369	5694	5407	5447	5316



Hopping Frequency Sequence Name: HOP\_FREQ\_SEQ\_09

Frequency (MHz)	0	1	2	3	4
0	5504	5335	5682	5357	5519
5	5371	5425	5601	5692	5478
10	5563	5663	5535	5717	5698
15	5297	5322	5402	5382	5625
20	5479	5502	5653	5618	5636
25	5448	5408	5264	5493	5477
30	5313	5555	5256	5631	5656
35	5397	5257	5261	5346	5341
40	5654	5709	5363	5281	5291
45	5721	5255	5310	5258	5470
50	5269	5334	5349	5407	5314
55	5446	5418	5688	5508	5455
60	5562	5415	5355	5279	5629
65	5404	5389	5412	5488	5383
70	5550	5602	5337	5634	5620
75	5417	5367	5365	5432	5547
80	5561	5499	5430	5633	5568
85	5558	5449	5410	5498	5701
90	5431	5377	5679	5720	5592
95	5434	5606	5472	5405	5648

Hopping Frequency Sequence Name: HOP\_FREQ\_SEQ\_10

Frequency (MHz)	0	1	2	3	4
0	5284	5574	5618	5518	5361
5	5413	5447	5676	5380	5307
10	5494	5452	5576	5437	5719
15	5288	5449	5408	5427	5342
20	5487	5571	5691	5610	5609
25	5714	5260	5467	5597	5511
30	5444	5688	5371	5337	5476
35	5536	5348	5532	5499	5255
40	5493	5708	5601	5474	5360
45	5685	5271	5329	5363	5620
50	5346	5445	5385	5438	5705
55	5258	5634	5372	5403	5327
60	5426	5594	5580	5300	5586
65	5552	5350	5590	5351	5698
70	5653	5434	5340	5483	5596
75	5376	5388	5631	5495	5557
80	5711	5624	5496	5625	5410
85	5443	5275	5414	5364	5424
90	5480	5646	5464	5262	5647
95	5418	5261	5488	5575	5615



Hopping Frequency Sequence Name: HOP\_FREQ\_SEQ\_11

Frequency (MHz)	0	1	2	3	4
0	5539	5338	5554	5582	5581
5	5455	5372	5276	5543	5514
10	5425	5617	5535	5265	5376
15	5576	5511	5375	5534	5398
20	5262	5632	5699	5602	5587
25	5670	5701	5545	5494	5430
30	5645	5586	5489	5674	5675
35	5536	5328	5274	5644	5332
40	5413	5714	5357	5517	5251
45	5412	5416	5410	5600	5524
50	5436	5527	5528	5580	5347
55	5326	5593	5397	5723	5270
60	5720	5418	5378	5393	5523
65	5387	5530	5448	5615	5316
70	5671	5440	5475	5335	5683
75	5508	5299	5476	5334	5555
80	5371	5400	5687	5493	5345
85	5439	5349	5406	5370	5282
90	5415	5519	5719	5286	5486
95	5680	5346	5279	5702	5402

Hopping Frequency Sequence Name: HOP\_FREQ\_SEQ\_12

Frequency (MHz)	0	1	2	3	4
0	5319	5577	5490	5268	5423
5	5497	5394	5351	5706	5721
10	5259	5602	5658	5255	5286
15	5464	5703	5614	5420	5251
20	5406	5331	5573	5691	5555
25	5536	5301	5330	5579	5704
30	5263	5494	5717	5627	5599
35	5427	5655	5496	5477	5382
40	5451	5446	5495	5332	5469
45	5297	5476	5700	5487	5713
50	5524	5535	5280	5308	5343
55	5271	5377	5532	5287	5250
60	5679	5339	5472	5265	5340
65	5418	5485	5657	5443	5656
70	5294	5652	5628	5345	5457
75	5586	5665	5467	5372	5540
80	5439	5666	5369	5562	5722
85	5292	5442	5492	5617	5606
90	5585	5393	5282	5483	5629
95	5349	5306	5633	5690	5334



Hopping Frequency Sequence Name: HOP\_FREQ\_SEQ\_13

Frequency (MHz)	0	1	2	3	4
0	5477	5341	5426	5429	5643
5	5636	5319	5297	5453	5665
10	5391	5699	5450	5307	5552
15	5355	5717	5465	5443	5414
20	5497	5514	5305	5528	5281
25	5388	5504	5434	5613	5578
30	5683	5559	5444	5415	5692
35	5381	5718	5492	5580	5569
40	5582	5579	5318	5622	5448
45	5375	5686	5293	5522	5562
50	5352	5401	5538	5327	5371
55	5626	5709	5498	5637	5506
60	5697	5707	5557	5602	5285
65	5340	5421	5362	5572	5610
70	5696	5543	5408	5427	5253
75	5524	5273	5488	5438	5363
80	5678	5631	5435	5390	5260
85	5342	5508	5279	5590	5420
90	5262	5616	5651	5694	5410
95	5337	5467	5527	5328	5409

Hopping Frequency Sequence Name: HOP\_FREQ\_SEQ\_14

Frequency (MHz)	0	1	2	3	4
0	5257	5580	5362	5590	5485
5	5678	5341	5501	5460	5282
10	5499	5655	5265	5645	5328
15	5543	5385	5345	5510	5325
20	5566	5552	5297	5644	5337
25	5707	5635	5647	5717	5669
30	5516	5659	5664	5512	5520
35	5334	5288	5355	5483	5421
40	5662	5256	5387	5445	5682
45	5569	5661	5351	5478	5449
50	5606	5577	5589	5416	5375
55	5315	5339	5663	5688	5456
60	5652	5486	5428	5706	5638
65	5370	5398	5307	5502	5251
70	5546	5403	5687	5493	5296
75	5534	5419	5615	5313	5320
80	5498	5720	5447	5392	5374
85	5555	5691	5306	5601	5588
90	5427	5451	5425	5685	5651
95	5308	5283	5701	5410	5404



Hopping Frequency Sequence Name: HOP\_FREQ\_SEQ\_15

Frequency (MHz)	0	1	2	3	4
0	5512	5441	5298	5276	5705
5	5720	5363	5576	5623	5489
10	5430	5444	5403	5365	5349
15	5631	5351	5458	5449	5333
20	5257	5493	5386	5474	5435
25	5664	5264	5681	5284	5558
30	5473	5399	5341	5710	5562
35	5425	5559	5508	5494	5260
40	5367	5669	5627	5442	5611
45	5549	5269	5409	5531	5714
50	5482	5278	5640	5505	5673
55	5637	5527	5617	5306	5653
60	5659	5289	5552	5694	5318
65	5274	5364	5319	5337	5614
70	5297	5302	5323	5712	5581
75	5379	5646	5416	5677	5400
80	5392	5326	5445	5484	5658
85	5384	5272	5452	5566	5423
90	5464	5280	5471	5607	5622
95	5630	5340	5447	5532	5615

Hopping Frequency Sequence Name: HOP\_FREQ\_SEQ\_16

Frequency (MHz)	0	1	2	3	4
0	5292	5680	5709	5437	5547
5	5287	5288	5651	5311	5696
10	5361	5330	5444	5463	5370
15	5719	5639	5454	5503	5641
20	5341	5423	5434	5378	5447
25	5323	5516	5638	5368	5715
30	5326	5430	5517	5590	5530
35	5701	5452	5661	5408	5671
40	5450	5607	5295	5439	5443
45	5529	5352	5584	5601	5358
50	5691	5496	5581	5571	5472
55	5533	5321	5717	5625	5652
60	5695	5662	5268	5373	5349
65	5567	5483	5395	5698	5649
70	5258	5605	5334	5536	5723
75	5381	5436	5551	5721	5467
80	5623	5606	5415	5388	5379
85	5712	5478	5636	5613	5656
90	5512	5449	5558	5502	5546
95	5718	5572	5498	5707	5509



Hopping Frequency Sequence Name: HOP\_FREQ\_SEQ\_17

Frequency (MHz)	0	1	2	3	4
0	5450	5444	5645	5598	5292
5	5426	5310	5251	5377	5525
10	5670	5594	5485	5658	5391
15	5332	5291	5557	5548	5358
20	5252	5492	5472	5467	5420
25	5589	5465	5269	5274	5433
30	5387	5257	5267	5350	5365
35	5704	5723	5339	5322	5510
40	5533	5545	5535	5372	5509
45	5435	5428	5637	5709	5630
50	5305	5697	5686	5504	5407
55	5584	5457	5478	5641	5388
60	5692	5409	5656	5459	5286
65	5564	5684	5652	5657	5681
70	5362	5324	5546	5482	5715
75	5309	5378	5662	5526	5475
80	5256	5430	5676	5326	5619
85	5593	5297	5461	5575	5500
90	5691	5346	5392	5496	5255
95	5360	5460	5338	5333	5385

Hopping Frequency Sequence Name: HOP\_FREQ\_SEQ\_18

Frequency (MHz)	0	1	2	3	4
0	5705	5683	5581	5284	5609
5	5468	5710	5326	5540	5257
10	5601	5383	5526	5378	5412
15	5323	5418	5660	5593	5550
20	5260	5658	5413	5459	5393
25	5477	5317	5472	5673	5308
30	5507	5322	5344	5516	5548
35	5504	5320	5519	5589	5711
40	5349	5616	5483	5300	5530
45	5301	5489	5518	5486	5690
50	5278	5488	5331	5318	5394
55	5520	5372	5382	5401	5475
60	5579	5572	5529	5289	5684
65	5686	5641	5348	5391	5254
70	5564	5636	5292	5277	5506
75	5685	5523	5650	5437	5343
80	5576	5559	5263	5404	5387
85	5438	5570	5696	5384	5258
90	5496	5491	5625	5627	5654
95	5592	5612	5449	5590	5591





Hopping Frequency Sequence Name: HOP\_FREQ\_SEQ\_19

Frequency (MHz)	0	1	2	3	4
0	5485	5447	5517	5348	5354
5	5510	5257	5401	5703	5464
10	5532	5647	5567	5573	5433
15	5411	5448	5288	5541	5267
20	5268	5252	5548	5366	5365
25	5266	5675	5302	5342	5549
30	5308	5301	5687	5668	5368
35	5546	5315	5722	5663	5321
40	5421	5443	5527	5608	5469
45	5601	5543	5364	5507	5369
50	5483	5343	5694	5707	5336
55	5591	5307	5446	5708	5262
60	5571	5693	5702	5630	5412
65	5590	5384	5698	5621	5367
70	5330	5278	5280	5355	5661
75	5482	5619	5324	5580	5353
80	5669	5519	5568	5275	5674
85	5429	5326	5498	5665	5564
90	5338	5506	5656	5253	5536
95	5679	5609	5667	5565	5487

Hopping Frequency Sequence Name: HOP\_FREQ\_SEQ\_20

Frequency (MHz)	0	1	2	3	4
0	5265	5686	5453	5509	5671
5	5552	5657	5476	5391	5293
10	5366	5436	5608	5454	5499
15	5575	5294	5586	5459	5654
20	5418	5392	5637	5339	5631
25	5593	5403	5406	5376	5688
30	5672	5258	5330	5442	5566
35	5685	5502	5683	5420	5636
40	5404	5359	5524	5537	5449
45	5684	5505	5321	5430	5715
50	5669	5641	5638	5290	5306
55	5601	5320	5362	5427	5516
60	5525	5528	5576	5710	5539
65	5323	5433	5416	5645	5402
70	5264	5380	5679	5441	5491
75	5444	5723	5605	5304	5300
80	5635	5595	5272	5394	5332
85	5643	5461	5382	5529	5389
90	5514	5346	5259	5598	5691
95	5722	5549	5385	5365	5655



Hopping Frequency Sequence Name: HOP\_FREQ\_SEQ\_21

Frequency (MHz)	0	1	2	3	4
0	5520	5450	5389	5670	5416
5	5691	5679	5551	5554	5500
10	5297	5322	5649	5391	5475
15	5587	5702	5397	5631	5651
20	5662	5487	5333	5629	5312
25	5519	5445	5606	5510	5410
30	5255	5561	5690	5545	5594
35	5386	5349	5593	5479	5550
40	5438	5675	5448	5521	5369
45	5332	5292	5563	5277	5695
50	5591	5384	5471	5283	5367
55	5485	5608	5719	5496	5420
60	5291	5394	5592	5461	5357
65	5451	5619	5436	5488	5359
70	5265	5686	5351	5571	5250
75	5383	5528	5613	5400	5460
80	5564	5294	5285	5317	5556
85	5324	5658	5269	5589	5477
90	5343	5430	5712	5511	5535
95	5678	5325	5302	5630	5722

Hopping Frequency Sequence Name: HOP\_FREQ\_SEQ\_22

Frequency (MHz)	0	1	2	3	4
0	5678	5689	5325	5356	5258
5	5604	5626	5620	5707	5703
10	5586	5690	5496	5578	5354
15	5500	5579	5465	5670	5653
20	5274	5718	5382	5310	5394
25	5712	5711	5444	5297	5547
30	5647	5285	5368	5584	5488
35	5306	5275	5348	5561	5277
40	5667	5613	5688	5615	5298
45	5312	5375	5524	5330	5582
50	5370	5560	5522	5372	5665
55	5429	5321	5673	5686	5617
60	5262	5523	5282	5406	5664
65	5565	5637	5437	5395	5475
70	5629	5643	5333	5483	5280
75	5492	5359	5332	5684	5364
80	5537	5427	5337	5721	5266
85	5309	5710	5424	5484	5669
90	5362	5532	5676	5271	5569
95	5463	5357	5614	5656	5701



Hopping Frequency Sequence Name: HOP\_FREQ\_SEQ\_23

Frequency (MHz)	0	1	2	3	4
0	5458	5453	5261	5517	5478
5	5300	5626	5701	5308	5536
10	5537	5375	5353	5306	5666
15	5481	5603	5624	5657	5581
20	5722	5312	5710	5355	5673
25	5721	5440	5340	5436	5604
30	5500	5520	5404	5530	5397
35	5643	5501	5475	5591	5275
40	5551	5356	5612	5702	5292
45	5582	5383	5372	5573	5461
50	5488	5276	5509	5627	5304
55	5708	5652	5447	5448	5593
60	5675	5511	5460	5483	5334
65	5307	5373	5432	5337	5319
70	5486	5468	5318	5301	5707
75	5345	5314	5406	5641	5504
80	5613	5266	5544	5386	5705
85	5348	5451	5255	5366	5374
90	5506	5446	5299	5412	5598
95	5554	5583	5489	5349	5494

Hopping Frequency Sequence Name: HOP\_FREQ\_SEQ\_24

Frequency (MHz)	0	1	2	3	4
0	5713	5692	5672	5678	5320
5	5342	5551	5301	5471	5268
10	5468	5639	5394	5501	5538
15	5279	5511	5706	5669	5374
20	5589	5413	5253	5324	5328
25	5464	5670	5643	5444	5415
30	5478	5325	5561	5618	5294
35	5602	5488	5439	5276	5389
40	5430	5358	5489	5596	5609
45	5534	5272	5541	5640	5436
50	5259	5597	5437	5624	5550
55	5311	5695	5697	5581	5494
60	5255	5582	5306	5612	5393
65	5425	5457	5661	5432	5370
70	5517	5265	5710	5409	5305
75	5453	5277	5648	5352	5626
80	5326	5566	5719	5469	5638
85	5321	5613	5583	5507	5481
90	5573	5399	5699	5531	5380
95	5540	5605	5555	5316	5467



Hopping Frequency Sequence Name: HOP\_FREQ\_SEQ\_25

Frequency (MHz)	0	1	2	3	4
0	5493	5456	5608	5364	5540
5	5481	5573	5376	5634	5475
10	5302	5428	5435	5696	5559
15	5367	5638	5712	5714	5566
20	5597	5482	5669	5316	5301
25	5352	5522	5371	5548	5449
30	5520	5311	5518	5358	5446
35	5422	5333	5579	5710	5429
40	5400	5366	5441	5427	5361
45	5606	5463	5252	5624	5601
50	5489	5524	5473	5613	5675
55	5261	5512	5542	5410	5535
60	5684	5452	5553	5338	5257
65	5327	5500	5484	5381	5406
70	5349	5513	5578	5388	5589
75	5420	5711	5617	5472	5672
80	5307	5343	5660	5630	5408
85	5532	5635	5516	5470	5673
90	5538	5353	5273	5386	5574
95	5487	5567	5430	5663	5447

Hopping Frequency Sequence Name: HOP\_FREQ\_SEQ\_26

Frequency (MHz)	0	1	2	3	4
0	5651	5695	5544	5428	5382
5	5523	5498	5451	5700	5304
10	5708	5314	5476	5319	5580
15	5455	5290	5340	5662	5283
20	5508	5648	5707	5405	5274
25	5715	5471	5574	5483	5562
30	5675	5475	5573	5717	5375
35	5670	5506	5582	5680	5621
40	5365	5601	5603	5295	5659
45	5542	5252	5251	5350	5335
50	5486	5501	5489	5399	5271
55	5524	5467	5564	5250	5446
60	5685	5330	5345	5559	5694
65	5650	5374	5592	5529	5396
70	5288	5673	5411	5572	5692
75	5632	5711	5419	5364	5530
80	5293	5406	5404	5720	5568
85	5386	5392	5511	5369	5676
90	5447	5577	5647	5423	5323
95	5468	5682	5452	5641	5635



Hopping Frequency Sequence Name: HOP\_FREQ\_SEQ\_27

Frequency (MHz)	0	1	2	3	4
0	5431	5459	5480	5589	5602
5	5565	5520	5526	5388	5511
10	5639	5578	5517	5514	5601
15	5446	5417	5443	5707	5475
20	5516	5339	5648	5397	5722
25	5506	5323	5680	5378	5701
30	5564	5432	5313	5469	5440
35	5286	5399	5357	5703	5519
40	5704	5303	5269	5697	5699
45	5590	5315	5717	5498	5676
50	5603	5490	5302	5439	5633
55	5333	5689	5495	5596	5632
60	5325	5396	5551	5392	5508
65	5279	5381	5391	5497	5360
70	5692	5372	5629	5458	5712
75	5386	5275	5308	5667	5261
80	5280	5419	5493	5485	5371
85	5358	5291	5398	5545	5310
90	5464	5253	5718	5305	5426
95	5288	5664	5636	5675	5359

Hopping Frequency Sequence Name: HOP\_FREQ\_SEQ\_28

Frequency (MHz)	0	1	2	3	4
0	5686	5698	5416	5275	5444
5	5607	5445	5601	5551	5718
10	5473	5367	5558	5709	5622
15	5534	5544	5546	5277	5667
20	5524	5408	5589	5486	5695
25	5394	5650	5482	5268	5550
30	5389	5431	5621	5260	5653
35	5474	5670	5510	5714	5358
40	5312	5619	5509	5694	5628
45	5570	5398	5300	5466	5479
50	5666	5353	5528	5456	5402
55	5397	5304	5384	5369	5250
60	5322	5270	5325	5377	5435
65	5703	5320	5492	5346	5702
70	5251	5588	5427	5529	5347
75	5527	5418	5448	5328	5343
80	5723	5620	5553	5677	5409
85	5644	5586	5716	5501	5511
90	5481	5687	5712	5616	5284
95	5401	5631	5699	5374	5662



Hopping Frequency Sequence Name: HOP\_FREQ\_SEQ\_29

Frequency (MHz)	0	1	2	3	4
0	5466	5462	5352	5436	5664
5	5271	5467	5676	5714	5450
10	5404	5631	5599	5429	5643
15	5622	5574	5649	5322	5384
20	5435	5530	5478	5668	5660
25	5611	5586	5585	5310	5439
30	5346	5646	5395	5458	5317
35	5565	5663	5628	5672	5492
40	5557	5274	5691	5460	5550
45	5481	5261	5604	5353	5258
50	5367	5279	5590	5254	5494
55	5581	5340	5379	5487	5690
60	5632	5300	5381	5652	5356
65	5433	5578	5488	5320	5551
70	5702	5299	5380	5328	5304
75	5431	5704	5406	5526	5443
80	5700	5516	5297	5679	5363
85	5417	5309	5507	5296	5595
90	5267	5696	5514	5263	5535
95	5684	5613	5529	5445	5548

Hopping Frequency Sequence Name: HOP\_FREQ\_SEQ\_30

Frequency (MHz)	0	1	2	3	4
0	5721	5323	5288	5597	5506
5	5313	5392	5276	5305	5279
10	5335	5420	5640	5624	5664
15	5710	5701	5655	5270	5673
20	5443	5643	5568	5567	5641
25	5548	5451	5339	5312	5619
30	5449	5425	5303	5386	5547
35	5278	5359	5656	5438	5542
40	5608	5575	5495	5417	5688
45	5389	5530	5564	5319	5657
50	5618	5609	5543	5455	5328
55	5480	5683	5587	5400	5311
60	5508	5652	5257	5464	5601
65	5327	5258	5654	5381	5415
70	5678	5409	5268	5500	5718
75	5309	5556	5541	5582	5566
80	5523	5638	5700	5401	5576
85	5489	5414	5665	5507	5571
90	5513	5453	5653	5540	5612
95	5322	5302	5509	5620	5504

--- END ---