

FCC Test Report

Report No.: RFBBQZ-WTW-P21091048-4

FCC ID: PY321300545

Test Model: RAXE300

Received Date: Jul. 01, 2021

Test Date: Aug. 05 ~ Dec. 07, 2021

Issued Date: Dec. 24, 2021

Applicant and Manufacturer: NETGEAR, INC.

Address: 350 East Plumeria Drive, San Jose, CA 95134, USA

Issued By: Bureau Veritas Consumer Products Services (H.K.) Ltd., Taoyuan Branch
Lin Kou Laboratories

Lab Address: No. 47-2, 14th Ling, Chia Pau Vil., Lin Kou Dist., New Taipei City, Taiwan

Test Location: No. 19, Hwa Ya 2nd Rd., Wen Hwa Vil., Kwei Shan Dist., Taoyuan City
33383, Taiwan

**FCC Registration /
Designation Number:** 788550 / TW0003



This report is for your exclusive use. Any copying or replication of this report to or for any other person or entity, or use of our name or trademark, is permitted only with our prior written permission. This report sets forth our findings solely with respect to the test samples identified herein. The results set forth in this report are not indicative or representative of the quality or characteristics of the lot from which a test sample was taken or any similar or identical product specifically and expressly noted. Our report includes all of the tests requested by you and the results thereof based upon the information that you provided to us. You have 60 days from date of issuance of this report to notify us of any material error or omission caused by our negligence, provided, however, that such notice shall be in writing and shall specifically address the issue you wish to raise. A failure to raise such issue within the prescribed time shall constitute your unqualified acceptance of the completeness of this report, the tests conducted and the correctness of the report contents. Unless specific mention, the uncertainty of measurement has been explicitly taken into account to declare the compliance or non-compliance to the specification.

Table of Contents

Release Control Record	4
1 Certificate of Conformity	5
2 Summary of Test Results	6
2.1 Measurement Uncertainty.....	6
2.2 Modification Record.....	6
3 General Information	7
3.1 General Description of EUT.....	7
3.2 Description of Test Modes.....	9
3.2.1 Test Mode Applicability and Tested Channel Detail.....	11
3.3 Duty Cycle of Test Signal.....	15
3.4 Description of Support Units.....	17
3.4.1 Configuration of System under Test.....	17
3.5 General Description of Applied Standards and References.....	18
4 Test Types and Results	19
4.1 Radiated Emission and Bandedge Measurement.....	19
4.1.1 Limits of Radiated Emission and Bandedge Measurement.....	19
4.1.2 Test Instruments.....	20
4.1.3 Test Procedures.....	21
4.1.4 Deviation from Test Standard.....	22
4.1.5 Test Setup.....	22
4.1.6 EUT Operating Conditions.....	23
4.1.7 Test Results.....	24
4.2 In-Band Emission (Mask) Measurement.....	127
4.2.1 Limits of In-Band Emission (Mask) Measurement.....	127
4.2.2 Test Setup.....	127
4.2.3 Test Instruments.....	127
4.2.4 Test Procedure.....	128
4.2.5 EUT Operating Condition.....	128
4.2.6 Test Results.....	129
4.3 Conducted Emission Measurement.....	171
4.3.1 Limits of Conducted Emission Measurement.....	171
4.3.2 Test Instruments.....	171
4.3.3 Test Procedures.....	172
4.3.4 Deviation from Test Standard.....	172
4.3.5 Test Setup.....	172
4.3.6 EUT Operating Conditions.....	172
4.3.7 Test Results.....	173
4.4 Transmit Power Measurement.....	177
4.4.1 Limits of Transmit Power Measurement.....	177
4.4.2 Test Setup.....	177
4.4.3 Test Instruments.....	177
4.4.4 Test Procedure.....	178
4.4.5 Deviation from Test Standard.....	178
4.4.6 EUT Operating Conditions.....	178
4.4.7 Test Result.....	179
4.5 Emission Bandwidth Measurement.....	185
4.5.1 Test Setup.....	185
4.5.2 Test Instruments.....	185
4.5.3 Test Procedure.....	185
4.5.4 Test Result.....	186
4.6 Peak Power Spectral Density Measurement.....	216
4.6.1 Limits of Peak Power Spectral Density Measurement.....	216
4.6.2 Test Setup.....	216

4.6.3	Test Instruments	216
4.6.4	Test Procedures.....	217
4.6.5	Deviation from Test Standard	217
4.6.6	EUT Operating Conditions.....	217
4.6.7	Test Results	218
4.7	Contention Based Protocol Measurement	224
4.7.1	Limits of Contention Based Protocol Measurement	224
4.7.2	Test Setup.....	224
4.7.3	Test Instruments	224
4.7.4	Test Procedure	225
4.7.5	EUT Operating Condition	225
4.7.6	Test Results	226
4.8	Frequency Stability.....	235
4.8.1	Limits of Frequency Stability Measurement	235
4.8.2	Test Setup.....	235
4.8.3	Test Instruments	235
4.8.4	Test Procedure	235
4.8.5	Deviation from Test Standard	236
4.8.6	EUT Operating Condition	236
4.8.7	Test Results	236
4.9	Operational Restrictions for 6 GHz U-NII Devices	237
4.9.1	Limits of Operational Restrictions for 6 GHz U-NII Devices.....	237
4.9.2	Test Setup.....	237
4.9.3	Test Instruments	237
4.9.4	Test Procedure	237
4.9.5	Test Results	237
5	Pictures of Test Arrangements.....	238
	Annex A - Band Edge Measurement.....	239
	Appendix – Information of the Testing Laboratories	249

Release Control Record

Issue No.	Description	Date Issued
RFBBQZ-WTW-P21091048-4	Original release.	Dec. 24, 2021

1 Certificate of Conformity

Product: NIGHTHAWK AXE7800 Tri-Band WiFi 6E Router

Brand: NETGEAR

Test Model: RAXE300

Sample Status: Engineering sample

Applicant and Manufacturer: NETGEAR, INC.

Test Date: Aug. 05 ~ Dec. 07, 2021

Standards: 47 CFR FCC Part 15, Subpart E (Section 15.407)
ANSI C63.10:2013

The above equipment has been tested by **Bureau Veritas Consumer Products Services (H.K.) Ltd., Taoyuan Branch**, and found compliance with the requirement of the above standards. The test record, data evaluation & Equipment Under Test (EUT) configurations represented herein are true and accurate accounts of the measurements of the sample's RF characteristics under the conditions specified in this report.

Prepared by : Pettie Chen , **Date:** Dec. 24, 2021
Pettie Chen / Senior Specialist

Approved by : Jeremy Lin , **Date:** Dec. 24, 2021
Jeremy Lin / Project Engineer

2 Summary of Test Results

47 CFR FCC Part 15, Subpart E (Section 15.407)			
FCC Clause	Test Item	Result	Remarks
15.407(b)(9)	AC Power Conducted Emissions	Pass	Meet the requirement of limit. Minimum passing margin is -8.43dB at 0.39800MHz.
15.407(b)(6)(9)	Radiated Emissions	Pass	Meet the requirement of limit. Minimum passing margin is -0.2dB at 7125.00MHz.
15.407(b)(7)	In-Band Emission (Mask)	Pass	Meet the requirement of limit.
15.407(a)(5)	Max Average Transmit Power	Pass	Meet the requirement of limit.
15.407(a)(10)	Emission Bandwidth Measurement	Pass	Meet the requirement of limit.
15.407(a)(5)	Peak Power Spectral Density	Pass	Meet the requirement of limit.
15.407 (d)(6)	Contention-based Protocol.	Pass	Meet the requirement of limit.
15.407(g)	Frequency Stability	Pass	Meet the requirement of limit.
15.407(a)(7)(8)	Dual Client- Proper Power Adjustment	N/A	Device associates with low power indoor AP only.
15.407(d)(5)	Operational restrictions for 6 GHz U-NII devices	Pass	Declaration by applicant
15.203	Antenna Requirement	Pass	Antenna connector is i-pex not a standard connector.

Note: Determining compliance based on the results of the compliance measurement, not taking into account measurement instrumentation uncertainty.

2.1 Measurement Uncertainty

Where relevant, the following measurement uncertainty levels have been estimated for tests performed on the EUT as specified in CISPR 16-4-2:

Measurement	Frequency	Expanded Uncertainty (k=2) (\pm)
Conducted Emissions at mains ports	150kHz ~ 30MHz	2.79 dB
Radiated Emissions up to 1 GHz	9kHz ~ 30MHz	3.04 dB
	30MHz ~ 200MHz	3.63 dB
	200MHz ~ 1000MHz	3.64 dB
Radiated Emissions above 1 GHz	1GHz ~ 18GHz	2.29 dB
	18GHz ~ 40GHz	2.29 dB

2.2 Modification Record

There were no modifications required for compliance.

3 General Information

3.1 General Description of EUT

Product	NIGHTHAWK AXE7800 Tri-Band WiFi 6E Router
Brand	NETGEAR
Test Model	RAXE300
Sample Status	Engineering sample
Power Supply Rating	12Vdc (adapter)
Modulation Type	256QAM, 64QAM, 16QAM, QPSK, BPSK for OFDM 1024QAM, 256QAM, 64QAM, 16QAM, QPSK, BPSK for OFDMA
Modulation Technology	OFDM, OFDMA
Transfer Rate	802.11a: 54/48/36/24/18/12/9/6Mbps 802.11n: up to 300Mbps 802.11ac: up to 1733.3Mbps 802.11ax: up to 2401.9Mbps
Operating Frequency	5955 ~ 6415MHz, 6435 ~ 6525MHz, 6525 ~ 6875MHz, 6875 ~ 7115MHz
Number of Channel	802.11a/ax (HE20): 59 802.11ax (HE40): 29 802.11ax (HE80): 14 802.11ax (HE160): 7
Output EIRP Power	Nss 1 5955 ~ 6415MHz: 27.94dBm / 622.300mW 6435 ~ 6525MHz: 28.54dBm / 714.496mW 6525 ~ 6875MHz: 26.89dBm / 488.652mW 6875 ~ 7115MHz: 26.31dBm / 427.563mW Nss 2 5955 ~ 6415MHz: 27.98dBm / 628.058mW 6435 ~ 6525MHz: 28.57dBm / 719.449mW 6525 ~ 6875MHz: 26.97dBm / 497.737mW 6875 ~ 7115MHz: 26.71dBm / 468.813mW
Antenna Type	Refer to note
Antenna Connector	Refer to note
Accessory Device	Adapter
Cable Supplied	1.95m non-shielded RJ45 cable without core

Note:

1. The EUT has three different sources, after pretest the main source was the worst case for final test.

Option	Source	difference
Option A	Main	USB IC and USB layout
Option B	2nd	
Option C	3rd	

2. The EUT incorporates a MIMO function. Physically, the EUT provides 2 completed transmitters and 2 receivers.

Modulation Mode	TX Function	Non-Beamforming Mode	Beamforming Mode
802.11a	2TX (Nss 1)	Support	Not Support
802.11ax (HE20)	2TX (Nss 1 / Nss 2)	Support	Support
802.11ax (HE40)	2TX (Nss 1 / Nss 2)	Support	Support
802.11ax (HE80)	2TX (Nss 1 / Nss 2)	Support	Support
802.11ax (HE160)	2TX (Nss 1 / Nss 2)	Support	Support

* For 802.11ax, Beamforming mode is the worst case for final tests after pretesting.

3. The EUT uses following adapters.

Adapter 1	
Brand	Netgear
Model	AD2150F10
P/N	332-11494-02
Input Power	100-120Vac ~50/60Hz; 1A
Output Power	12Vdc, 35A
Power line	1.78m cable without core

Adapter 2	
Brand	Netgear
Model	ADS-45FI-12 12042EPCU-L
P/N	332-11526-02
Input Power	100~120 Vac; ~60 Hz; 1.5 A
Output Power	12Vdc, 3.5A
Power line	1.84m cable without core

4. The antenna information is listed as below.

Type	Connector	Gain (dBi)			
		5955-6415MHz	6435-6525MHz	6525-6875MHz	6875-7115MHz
Dipole	ipex	2.90	1.90	2.10	2.10
Dipole	ipex	2.70	1.70	2.00	2.20

* The detailed antenna information, please refer to the Operational Description-Antenna Specification report.

3.2 Description of Test Modes

For 5925 ~ 6425MHz (U-NII-5 band)

24 channels are provided for 802.11a, 802.11ax (HE20):

Channel	Frequency	Channel	Frequency	Channel	Frequency	Channel	Frequency
1	5955 MHz	5	5975 MHz	9	5995 MHz	13	6015 MHz
17	6035 MHz	21	6055 MHz	25	6075 MHz	29	6095 MHz
33	6115 MHz	37	6135 MHz	41	6155 MHz	45	6175 MHz
49	6195 MHz	53	6215 MHz	57	6235 MHz	61	6255 MHz
65	6275 MHz	69	6295 MHz	73	6315 MHz	77	6335 MHz
81	6355 MHz	85	6375 MHz	89	6395 MHz	93	6415 MHz

12 channels are provided for 802.11ax (HE40):

Channel	Frequency	Channel	Frequency	Channel	Frequency	Channel	Frequency
3	5965 MHz	11	6005 MHz	19	6045 MHz	27	6085 MHz
35	6125 MHz	43	6165 MHz	51	6205 MHz	59	6245 MHz
67	6285 MHz	75	6325 MHz	83	6365 MHz	91	6405 MHz

6 channel is provided for 802.11ax (HE80):

Channel	Frequency	Channel	Frequency	Channel	Frequency	Channel	Frequency
7	5985 MHz	23	6065 MHz	39	6145 MHz	55	6225 MHz
71	6305 MHz	87	6385 MHz				

3 channels are provided for 802.11ax (HE160):

Channel	Frequency	Channel	Frequency	Channel	Frequency
15	6025 MHz	47	6185 MHz	79	6345 MHz

For 6425 ~ 6525MHz (U-NII-6 band)

5 channels are provided for 802.11a, 802.11ax (HE20):

Channel	Frequency	Channel	Frequency	Channel	Frequency	Channel	Frequency
97	6435 MHz	101	6455 MHz	105	6475 MHz	109	6495 MHz
113	6515 MHz						

3 channels are provided for 802.11ax (HE40):

Channel	Frequency	Channel	Frequency	Channel	Frequency
99	6445 MHz	107	6485 MHz	*115	6525 MHz

2 channel are provided for 802.11ax (HE80):

Channel	Frequency	Channel	Frequency
103	6465 MHz	*119	6545 MHz

1 channel is provided for 802.11ax (HE160):

Channel	Frequency
*111	6505 MHz

For 6525 ~ 6875MHz (U-NII-7 band)

18 channels are provided for 802.11a, 802.11ax (HE20):

Channel	Frequency	Channel	Frequency	Channel	Frequency	Channel	Frequency
117	6535 MHz	121	6555 MHz	125	6575 MHz	129	6595 MHz
133	6615 MHz	137	6635 MHz	141	6655 MHz	145	6675 MHz
149	6695 MHz	153	6715 MHz	157	6735 MHz	161	6755 MHz
165	6775 MHz	169	6795 MHz	173	6815 MHz	177	6835 MHz
181	6855 MHz	*185	6875 MHz				

9 channels are provided for 802.11ax (HE40):

Channel	Frequency	Channel	Frequency	Channel	Frequency	Channel	Frequency
123	6565 MHz	131	6605 MHz	139	6645 MHz	147	6685 MHz
155	6725 MHz	163	6765 MHz	171	6805 MHz	179	6845 MHz
*187	6885 MHz						

4 channels are provided for 802.11ax (HE80):

Channel	Frequency	Channel	Frequency	Channel	Frequency	Channel	Frequency
135	6625 MHz	151	6705 MHz	167	6785 MHz	*183	6865 MHz

2 channels are provided for 802.11ax (HE160):

Channel	Frequency	Channel	Frequency
143	6665 MHz	*175	6825 MHz

For 6875 ~ 7125MHz (U-NII-8 band):

12 channels are provided for 802.11a, 802.11ax (HE20):

Channel	Frequency	Channel	Frequency	Channel	Frequency	Channel	Frequency
189	6895 MHz	193	6915 MHz	197	6935 MHz	201	6955 MHz
205	6975 MHz	209	6995 MHz	213	7015 MHz	217	7035 MHz
221	7055 MHz	225	7075 MHz	229	7095 MHz	233	7115 MHz

5 channels are provided for 802.11ax (HE40):

Channel	Frequency	Channel	Frequency	Channel	Frequency
195	6925 MHz	203	6965 MHz	211	7005 MHz
219	7045 MHz	227	7085 MHz		

2 channel is provided for 802.11ax (HE80):

Channel	Frequency	Channel	Frequency
199	6945 MHz	215	7025 MHz

1 channel is provided for 802.11ax (HE160):

Channel	Frequency
207	6985 MHz

Note: * mean this's straddle channel.

3.2.1 Test Mode Applicability and Tested Channel Detail

EUT Configure Mode	Applicable to						Description
	RE \geq 1G	RE<1G	IBE	PLC	CBP	APCM	
A	√	√	√	√	√	√	Powered by adapter 1
B	-	√	-	√	-	-	Powered by adapter 2

Where **RE \geq 1G**: Radiated Emission above 1GHz
RE<1G: Radiated Emission below 1GHz
PLC: Power Line Conducted Emission
APCM: Antenna Port Conducted Measurement
IBE: In-Band Emission (MASK)
CBP:Contention Based Protocol

Note:

- The EUT had been pre-tested on the positioned of each 3 axis. The worst case was found when positioned on **X-plane**.
- Radiated emission test (below 1GHz) and power line conducted emission test items chosen the worst maximum power.

Radiated Emission Measurement (Above 1GHz):

- Pre-Scan has been conducted to determine the worst-case mode from all possible combinations between available modulations, data rates and antenna ports (if EUT with antenna diversity architecture).
- Following channel(s) was (were) selected for the final test as listed below.

EUT Configure Mode	Mode	Frequency Band (MHz)	Available Channel	Tested Channel	Modulation Technology	Modulation Type	Data Rate Parameter
A	802.11a	5955-6415	1 to 93	1, 61, 93	OFDM	BPSK	6Mb/s
		6435-6525	97 to 113	97, 105, 113	OFDM	BPSK	6Mb/s
		6525-6855	117 to 185	117, 153, 181, 185	OFDM	BPSK	6Mb/s
		6875-7115	185 to 233	185, 213, 229, 233	OFDM	BPSK	6Mb/s
A	802.11ax (HE20)	5955-6415	1 to 93	1, 61, 93	OFDMA	BPSK	MCS0
		6435-6525	97 to 113	97, 105, 113	OFDMA	BPSK	MCS0
		6525-6855	117 to 185	117, 153, 181, 185	OFDMA	BPSK	MCS0
		6875-7115	185 to 233	185, 213, 229, 233	OFDMA	BPSK	MCS0
A	802.11ax (HE40)	5955-6415	3 to 91	3, 59, 91	OFDMA	BPSK	MCS0
		6435-6525	99 to 115	99, 107, 115	OFDMA	BPSK	MCS0
		6525-6855	115 to 187	115, 123, 155, 179, 187	OFDMA	BPSK	MCS0
		6875-7115	187 to 227	187, 211, 227	OFDMA	BPSK	MCS0
A	802.11ax (HE80)	5955-6415	7 to 87	7, 55, 87	OFDMA	BPSK	MCS0
		6435-6525	103 to 119	103, 119	OFDMA	BPSK	MCS0
		6525-6855	119 to 183	119, 135, 151, 167, 183	OFDMA	BPSK	MCS0
		6875-7115	183 to 215	183, 199, 215	OFDMA	BPSK	MCS0
A	802.11ax (HE160)	5955-6415	15 to 79	15, 47, 79	OFDMA	BPSK	MCS0
		6435-6525	111	111	OFDMA	BPSK	MCS0
		6525-6855	143 to 175	143, 175	OFDMA	BPSK	MCS0
		6875-7115	207	207	OFDMA	BPSK	MCS0

Radiated Emission Measurement (Below 1GHz):

- Pre-Scan has been conducted to determine the worst-case mode from all possible combinations between available modulations, data rates and antenna ports (if EUT with antenna diversity architecture).
- Following channel(s) was (were) selected for the final test as listed below.

EUT Configure Mode	Mode	Frequency Band (MHz)	Available Channel	Tested Channel	Modulation Technology	Modulation Type	Data Rate Parameter
A, B	802.11ax (HE20)	5955-6415	1 to 93	233	OFDMA	BPSK	MCS0
		6435-6525	97 to 113		OFDMA	BPSK	MCS0
		6525-6855	117 to 185		OFDMA	BPSK	MCS0
		6875-7115	185 to 233		OFDMA	BPSK	MCS0

In-Band Emission (MASK) Measurement:

EUT Configure Mode	Mode	Frequency Band (MHz)	Available Channel	Tested Channel	Modulation Technology	Modulation Type	Data Rate Parameter
A	802.11a	5955-6415	1 to 93	1, 61, 93	OFDM	BPSK	6Mb/s
		6435-6525	97 to 113	97, 105, 113	OFDM	BPSK	6Mb/s
		6525-6855	117 to 185	117, 153, 181, 185	OFDM	BPSK	6Mb/s
		6875-7115	185 to 233	185, 213, 229, 233	OFDM	BPSK	6Mb/s
A	802.11ax (HE20)	5955-6415	1 to 93	1, 61, 93	OFDMA	BPSK	MCS0
		6435-6525	97 to 113	97, 105, 113	OFDMA	BPSK	MCS0
		6525-6855	117 to 185	117, 153, 181, 185	OFDMA	BPSK	MCS0
		6875-7115	185 to 233	185, 213, 229, 233	OFDMA	BPSK	MCS0
A	802.11ax (HE40)	5955-6415	3 to 91	3, 59, 91	OFDMA	BPSK	MCS0
		6435-6525	99 to 115	99, 107, 115	OFDMA	BPSK	MCS0
		6525-6855	115 to 187	115, 123, 155, 179, 187	OFDMA	BPSK	MCS0
		6875-7115	187 to 227	187, 211, 227	OFDMA	BPSK	MCS0
A	802.11ax (HE80)	5955-6415	7 to 87	7, 55, 87	OFDMA	BPSK	MCS0
		6435-6525	103 to 119	103, 119	OFDMA	BPSK	MCS0
		6525-6855	119 to 183	119, 135, 151, 167, 183	OFDMA	BPSK	MCS0
		6875-7115	183 to 215	183, 199, 215	OFDMA	BPSK	MCS0
A	802.11ax (HE160)	5955-6415	15 to 79	15, 47, 79	OFDMA	BPSK	MCS0
		6435-6525	111	111	OFDMA	BPSK	MCS0
		6525-6855	143 to 175	143, 175	OFDMA	BPSK	MCS0
		6875-7115	207	207	OFDMA	BPSK	MCS0

Power Line Conducted Emission Measurement:

- Pre-Scan has been conducted to determine the worst-case mode from all possible combinations between available modulations, data rates and antenna ports (if EUT with antenna diversity architecture).
- Following channel(s) was (were) selected for the final test as listed below.

EUT Configure Mode	Mode	Frequency Band (MHz)	Available Channel	Tested Channel	Modulation Technology	Modulation Type	Data Rate Parameter
A, B	802.11ax (HE20)	5955-6415	1 to 93	233	OFDMA	BPSK	MCS0
		6435-6525	97 to 113		OFDMA	BPSK	MCS0
		6525-6855	117 to 185		OFDMA	BPSK	MCS0
		6875-7115	185 to 233		OFDMA	BPSK	MCS0

Antenna Port Conducted Measurement:

- This item includes all test value of each mode, but only includes spectrum plot of worst value of each mode.
- Pre-Scan has been conducted to determine the worst-case mode from all possible combinations between available modulations, data rates and antenna ports (if EUT with antenna diversity architecture).
- Following channel(s) was (were) selected for the final test as listed below.

EUT Configure Mode	Mode	Frequency Band (MHz)	Available Channel	Tested Channel	Modulation Technology	Modulation Type	Data Rate Parameter
A	802.11a	5955-6415	1 to 93	1, 61, 93	OFDM	BPSK	6Mb/s
		6435-6525	97 to 113	97, 105, 113	OFDM	BPSK	6Mb/s
		6525-6855	117 to 185	117, 153, 181, 185	OFDM	BPSK	6Mb/s
		6875-7115	185 to 233	185, 213, 229, 233	OFDM	BPSK	6Mb/s
A	802.11ax (HE20)	5955-6415	1 to 93	1, 61, 93	OFDMA	BPSK	MCS0
		6435-6525	97 to 113	97, 105, 113	OFDMA	BPSK	MCS0
		6525-6855	117 to 185	117, 153, 181, 185	OFDMA	BPSK	MCS0
		6875-7115	185 to 233	185, 213, 229, 233	OFDMA	BPSK	MCS0
A	802.11ax (HE40)	5955-6415	3 to 91	3, 59, 91	OFDMA	BPSK	MCS0
		6435-6525	99 to 115	99, 107, 115	OFDMA	BPSK	MCS0
		6525-6855	115 to 187	115, 123, 155, 179, 187	OFDMA	BPSK	MCS0
		6875-7115	187 to 227	187, 211, 227	OFDMA	BPSK	MCS0
A	802.11ax (HE80)	5955-6415	7 to 87	7, 55, 87	OFDMA	BPSK	MCS0
		6435-6525	103 to 119	103, 119	OFDMA	BPSK	MCS0
		6525-6855	119 to 183	119, 135, 151, 167, 183	OFDMA	BPSK	MCS0
		6875-7115	183 to 215	183, 199, 215	OFDMA	BPSK	MCS0
A	802.11ax (HE160)	5955-6415	15 to 79	15, 47, 79	OFDMA	BPSK	MCS0
		6435-6525	111	111	OFDMA	BPSK	MCS0
		6525-6855	143 to 175	143, 175	OFDMA	BPSK	MCS0
		6875-7115	207	207	OFDMA	BPSK	MCS0

Contention Based Protocol Measurement:

- Pre-Scan has been conducted to determine the worst-case mode from all possible combinations between available modulations, data rates and antenna ports (if EUT with antenna diversity architecture).
- Following channel(s) was (were) selected for the final test as listed below.

EUT Configure Mode	Mode	Frequency Band (MHz)	Available Channel	Tested Channel	Modulation Technology	Modulation Type	Data Rate Parameter
A	802.11ax (HE20)	5955-6415	1 to 93	45	OFDMA	BPSK	MCS0
		6435-6525	97 to 113	97	OFDMA	BPSK	MCS0
		6525-6855	117 to 185	149	OFDMA	BPSK	MCS0
		6875-7115	185 to 233	209	OFDMA	BPSK	MCS0
A	802.11ax (HE160)	5955-6415	15 to 79	47	OFDMA	BPSK	MCS0
		6435-6525	111	111	OFDMA	BPSK	MCS0
		6525-6855	143 to 175	143	OFDMA	BPSK	MCS0
		6875-7115	207	207	OFDMA	BPSK	MCS0

Test Condition:

Applicable to	Environmental Conditions	Input Power	Tested by
RE \geq 1G	25deg. C, 70%RH	120Vac, 60Hz	Luis Lee
	25deg. C, 66%RH		Titan Hsu
RE<1G	23deg. C, 66%RH	120Vac, 60Hz	Titan Hsu
PLC	25deg. C, 75%RH	120Vac, 60Hz	Greg Lin
	23deg. C, 66%RH		Titan Hsu
APCM	25deg. C, 60%RH	120Vac, 60Hz	Jisyong Wang

3.3 Duty Cycle of Test Signal

Nss 1

Duty cycle of test signal is < 98%, duty factor is required.

802.11a: Duty cycle = $2.052/2.18 = 0.941$, Duty factor = $10 * \log(1/0.941) = 0.26$

802.11ax (HE20): Duty cycle = $5.235/5.37 = 0.975$, Duty factor = $10 * \log(1/0.975) = 0.11$

802.11ax (HE40): Duty cycle = $5.215/5.36 = 0.973$, Duty factor = $10 * \log(1/0.973) = 0.12$

802.11ax (HE80): Duty cycle = $2.682/2.807 = 0.955$, Duty factor = $10 * \log(1/0.955) = 0.20$

802.11ax (HE160): Duty cycle = $3.555/3.692 = 0.963$, Duty factor = $10 * \log(1/0.963) = 0.16$



Nss 2

Duty cycle of test signal is < 98%, duty factor is required.

802.11ax (HE20): Duty cycle = 5.24/5.375 = 0.975, Duty factor = $10 * \log(1/0.975) = 0.11$

802.11ax (HE40): Duty cycle = 5.25/5.372 = 0.977, Duty factor = $10 * \log(1/0.977) = 0.10$

802.11ax (HE80): Duty cycle = 2.690/2.817 = 0.955, Duty factor = $10 * \log(1/0.955) = 0.20$

802.11ax (HE160): Duty cycle = 3.548/3.668 = 0.967, Duty factor = $10 * \log(1/0.967) = 0.14$

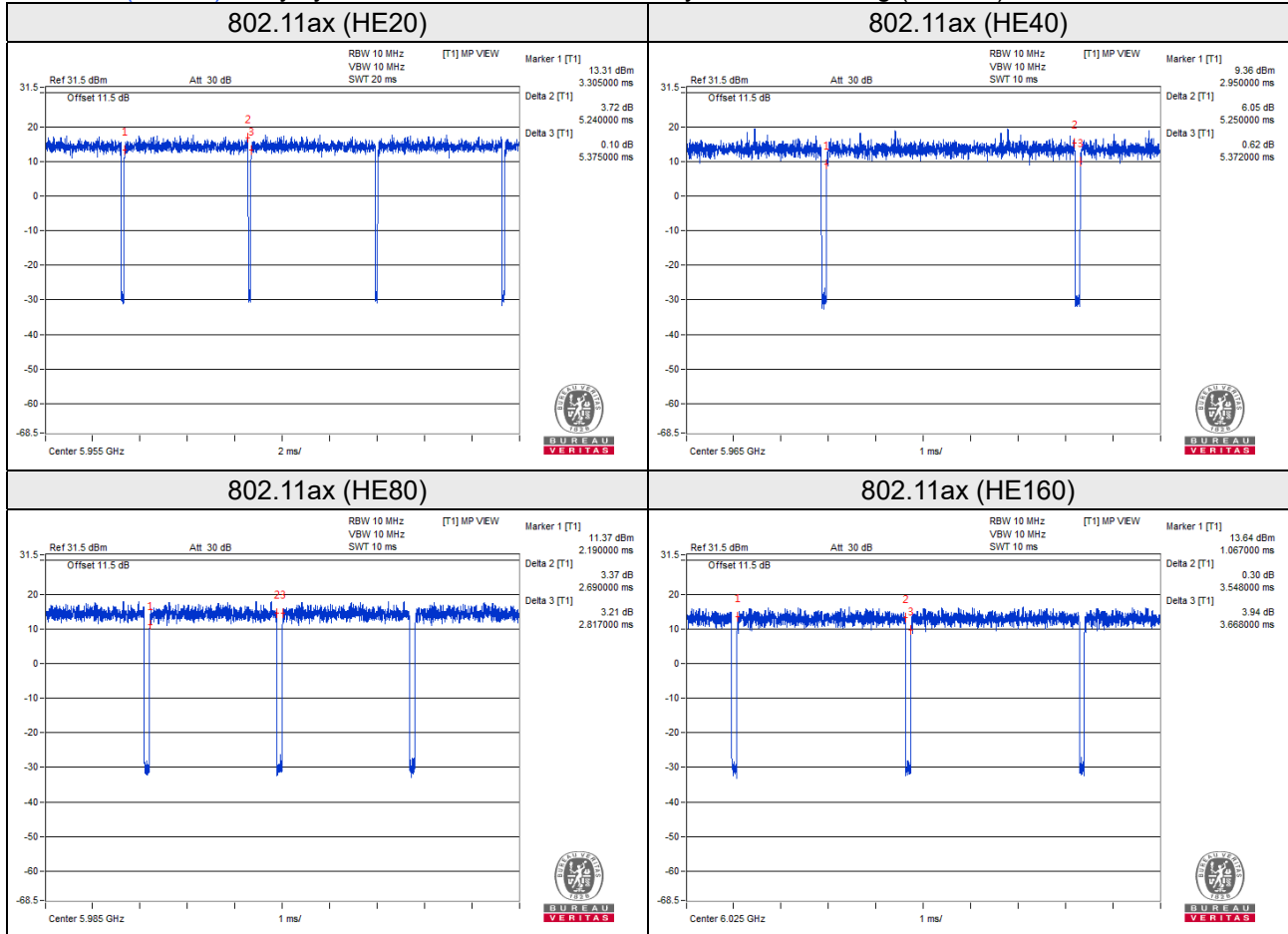

3.4 Description of Support Units

The EUT has been tested as an independent unit together with other necessary accessories or support units. The following support units or accessories were used to form a representative test configuration during the tests.

ID	Product	Brand	Model No.	Serial No.	FCC ID	Remarks
A.	Notebook	DELL	E5410	1HC2XM1	FCC DoC Approved	-
B.	Load	NA	NA	NA	NA	-
C.	Load	NA	NA	NA	NA	-
D.	Flash	SanDisk	SDDDC3-032G	NA	NA	-

Note:

1. All power cords of the above support units are non-shielded (1.8m).
2. Item A acted as a communication partner to transfer data.

ID	Cable Descriptions	Qty.	Length (m)	Shielding (Yes/No)	Cores (Qty.)	Remarks
1.	LAN cable	4	1.5	N	0	RJ45, Cat5e
2.	LAN cable	1	1.5	N	0	RJ45, Cat5e
3.	LAN cable	1	6	N	0	RJ45, Cat5e

3.4.1 Configuration of System under Test

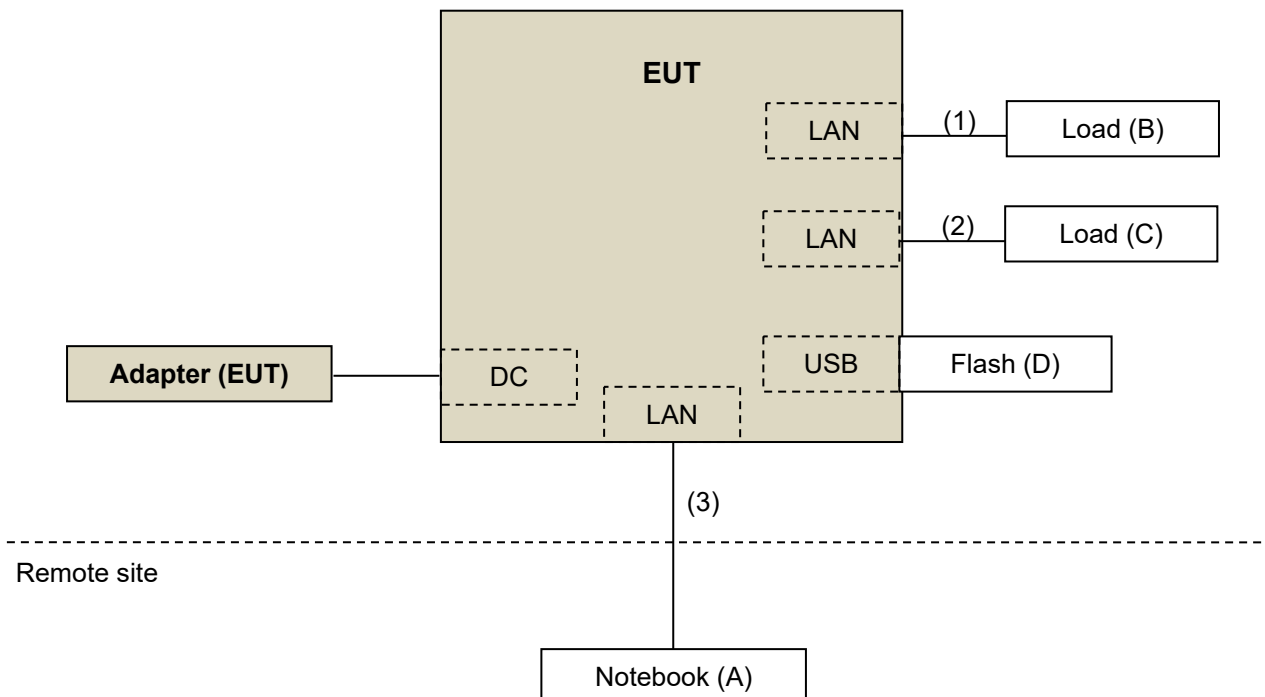

3.5 General Description of Applied Standards and References

The EUT is a RF Product. According to the specifications of the manufacturer, it must comply with the requirements of the following standards and references:

Test standard:

FCC Part 15, Subpart E (15.407)

ANSI C63.10:2013

All test items have been performed and recorded as per the above standards.

References Test Guidance:

KDB 987594 D02 EMC Measurement v01r01

KDB 789033 D02 General UNII Test Procedure New Rules v02r01

KDB 662911 D01 Multiple Transmitter Output v02r01

All test items have been performed as a reference to the above KDB test guidance.

4 Test Types and Results

4.1 Radiated Emission and Bandedge Measurement

4.1.1 Limits of Radiated Emission and Bandedge Measurement

Radiated emissions which fall in the restricted bands must comply with the radiated emission limits specified as below table.

Frequencies (MHz)	Field Strength (microvolts/meter)	Measurement Distance (meters)
0.009 ~ 0.490	2400/F(kHz)	300
0.490 ~ 1.705	24000/F(kHz)	30
1.705 ~ 30.0	30	30
30 ~ 88	100	3
88 ~ 216	150	3
216 ~ 960	200	3
Above 960	500	3

Note:

1. The lower limit shall apply at the transition frequencies.
2. Emission level (dBuV/m) = 20 log Emission level (uV/m).
3. For frequencies above 1000MHz, the field strength limits are based on average detector, however, the peak field strength of any emission shall not exceed the maximum permitted average limits, specified above by more than 20dB under any condition of modulation.

Limits of unwanted emission out of the restricted bands

Frequencies (MHz)	EIRP Limit	Equivalent Field Strength at 3m
5925MHz > F > 7125MHz	Peak:-7 (dBm/MHz)	88.2(dBμV/m)
	Average: -27 (dBm/MHz)	68.2(dBμV/m)

Note: The following formula is used to convert the equipment isotropic radiated power (eirp) to field strength:

$$E = \frac{1000000\sqrt{30P}}{3} \mu\text{V/m, where P is the eirp (Watts).}$$

4.1.2 Test Instruments

Description & Manufacturer	Model No.	Serial No.	Cal. Date	Cal. Due
Test Receiver ROHDE & SCHWARZ	ESCI	100424	Dec. 31, 2020	Dec. 30, 2021
Spectrum Analyzer ROHDE & SCHWARZ	FSP40	100040	Sep. 15, 2021	Sep. 14, 2022
BILOG Antenna SCHWARZBECK	VULB9168	1214	Nov. 04, 2020 Oct. 28, 2021	Nov. 03, 2021 Oct. 27, 2022
HORN Antenna RF SPIN	DRH18-E	210104A18E	Jan. 08, 2021	Jan. 07, 2022
HORN Antenna SCHWARZBECK	BBHA 9170	9170-1049	Dec. 09, 2020	Dec. 08, 2021
Loop Antenna TESEQ	HLA 6121	45745	Jul. 06, 2020 Jul. 21, 2021	Jul. 05, 2021 Jul. 20, 2022
Preamplifier Agilent (Below 1GHz)	8447D	2944A10631	Jun. 05, 2021	Jun. 04, 2022
Preamplifier KEYSIGHT (Above 1GHz)	83017A	MY53270295	Jun. 05, 2021	Jun. 04, 2022
RF Coaxial Cable WOKEN With 5dB PAD	8D-FB	Cable-CH4-01	Jul. 24, 2021	Jul. 23, 2022
RF Coaxial Cable EMCI	EMC102-KM-KM-3000	150929	Jul. 24, 2021	Jul. 23, 2022
RF Coaxial Cable EMCI	EMC102-KM-KM-600	150928	Jul. 24, 2021	Jul. 23, 2022
RF signal cable HUBER+SUHNER	SUCOFLEX 104	MY 13380+295012/04	Jun. 05, 2021	Jun. 04, 2022
RF signal cable HUBER+SUHNER	SUCOFLEX 104	Cable-CH4-03 (250724)	Jun. 05, 2021	Jun. 04, 2022
Software BV ADT	ADT_Radiated_V7.6.15.9.5	NA	NA	NA
Antenna Tower inn-co GmbH	MA 4000	010303	NA	NA
Antenna Tower Controller BV ADT	AT100	AT93021703	NA	NA
Turn Table BV ADT	TT100	TT93021703	NA	NA
Turn Table Controller BV ADT	SC100	SC93021703	NA	NA
Peak Power Analyzer KEYSIGHT	8990B	MY51000485	Jan. 19, 2021	Jan. 18, 2022
Wideband Power Sensor KEYSIGHT	N1923A	MY58020002	Jan. 11, 2021	Jan. 10, 2022
Boresight Antenna Fixture	FBA-01	FBA-SIP01	NA	NA
Pre-amplifier (18GHz-40GHz) EMC	EMC184045B	980175	Sep. 04, 2021	Sep. 03, 2022

Note: 1. The calibration interval of the above test instruments is 12 months and the calibrations are traceable to NML/ROC and NIST/USA.
2. The test was performed in HwaYa Chamber 4.

4.1.3 Test Procedures

For Radiated emission below 30MHz

- a. The EUT was placed on the top of a rotating table 0.8 meters above the ground at a 3 meter chamber room. The table was rotated 360 degrees to determine the position of the highest radiation.
- b. The EUT was set 3 meters away from the interference-receiving antenna, which was mounted on the top of a variable-height antenna tower.
- c. Parallel, perpendicular, and ground-parallel orientations of the antenna are set to make the measurement.
- d. For each suspected emission, the EUT was arranged to its worst case and the rotatable table was turned from 0 degrees to 360 degrees to find the maximum reading.
- e. The test-receiver system was set to Quasi-Peak Detect Function and Specified Bandwidth with Maximum Hold Mode.

Note:

1. The resolution bandwidth and video bandwidth of test receiver/spectrum analyzer is 9kHz at frequency below 30MHz.

For Radiated emission above 30MHz

- a. The EUT was placed on the top of a rotating table 0.8 meters (for 30MHz ~ 1GHz) / 1.5 meters (for above 1GHz) above the ground at 3 meter chamber room for test. The table was rotated 360 degrees to determine the position of the highest radiation.
- b. The EUT was set 3 meters away from the interference-receiving antenna, which was mounted on the top of a variable-height antenna tower.
- c. The height of antenna is varied from one meter to four meters above the ground to determine the maximum value of the field strength. Both horizontal and vertical polarizations of the antenna are set to make the measurement.
- d. For each suspected emission, the EUT was arranged to its worst case and then the antenna was tuned to heights from 1 meter to 4 meters and the rotatable table was turned from 0 degrees to 360 degrees to find the maximum reading.
- e. The test-receiver system was set to quasi-peak detect function and specified bandwidth with maximum hold mode when the test frequency is below 1 GHz.
- f. The test-receiver system was set to peak and average detect function and specified bandwidth with maximum hold mode when the test frequency is above 1 GHz. If the peak reading value also meets average limit, measurement with the average detector is unnecessary.

Note:

1. The resolution bandwidth and video bandwidth of test receiver/spectrum analyzer is 120kHz for Quasi-peak detection (QP) at frequency below 1GHz.
2. The resolution bandwidth of test receiver/spectrum analyzer is 1 MHz and the video bandwidth is 3 MHz for Peak detection (PK) at frequency above 1GHz.

3. The resolution bandwidth of test receiver/spectrum analyzer is 1MHz and the video bandwidth is $\geq 1/T$ (Duty cycle $< 98\%$) or 10Hz (Duty cycle $\geq 98\%$) for Average detection (AV) at frequency above 1GHz.

Nss 1

(802.11a: RBW = 1MHz, VBW = 1kHz; 802.11ax (HE20): RBW = 1MHz, VBW = 1kHz; 802.11ax (HE40): RBW = 1MHz, VBW = 1kHz; 802.11ax (HE80): RBW = 1MHz, VBW = 1kHz; 802.11ax (HE160): RBW = 1MHz, VBW = 1kHz)

Nss 2

(802.11ax (HE20): RBW = 1MHz, VBW = 1kHz; 802.11ax (HE40): RBW = 1MHz, VBW = 1kHz; 802.11ax (HE80): RBW = 1MHz, VBW = 1kHz; 802.11ax (HE160): RBW = 1MHz, VBW = 1kHz)

4. All modes of operation were investigated and the worst-case emissions are reported.

4.1.4 Deviation from Test Standard

No deviation.

4.1.5 Test Setup

For Radiated emission below 30MHz

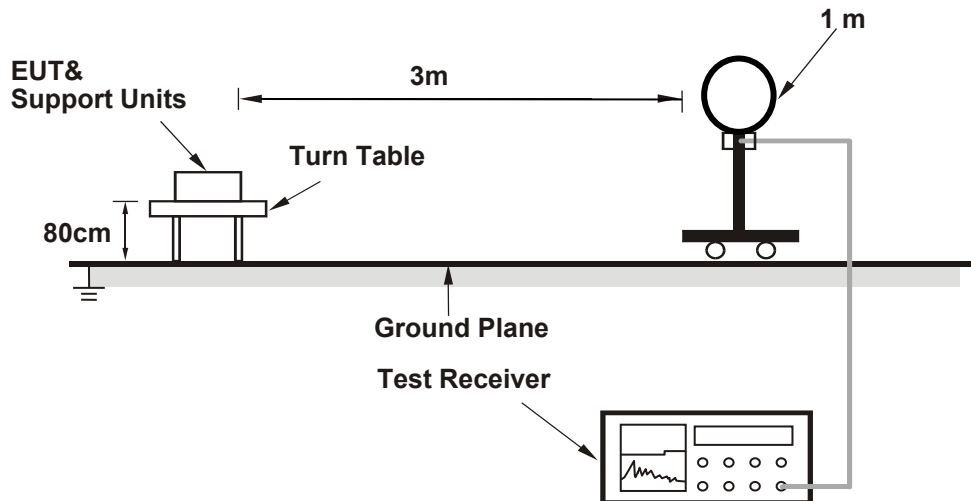

For Radiated emission 30MHz to 1GHz

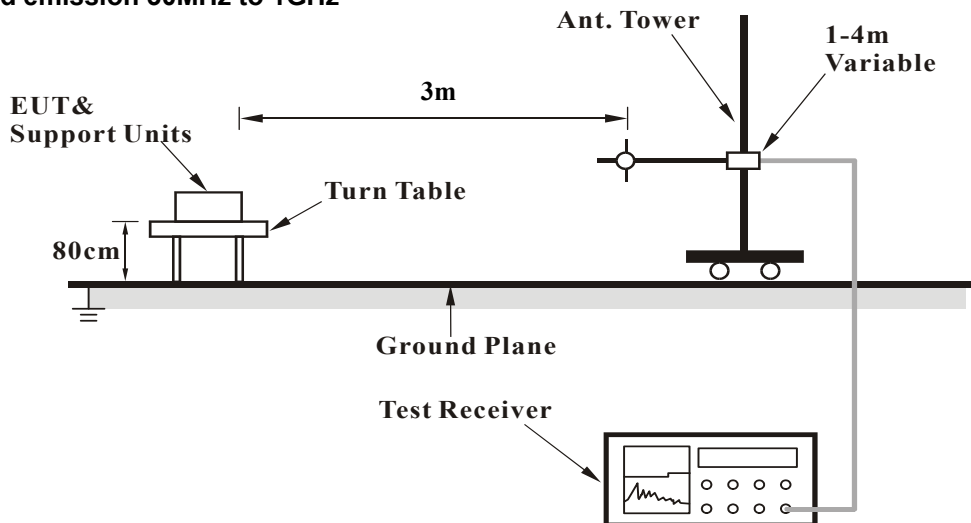

For Radiated emission above 1GHz

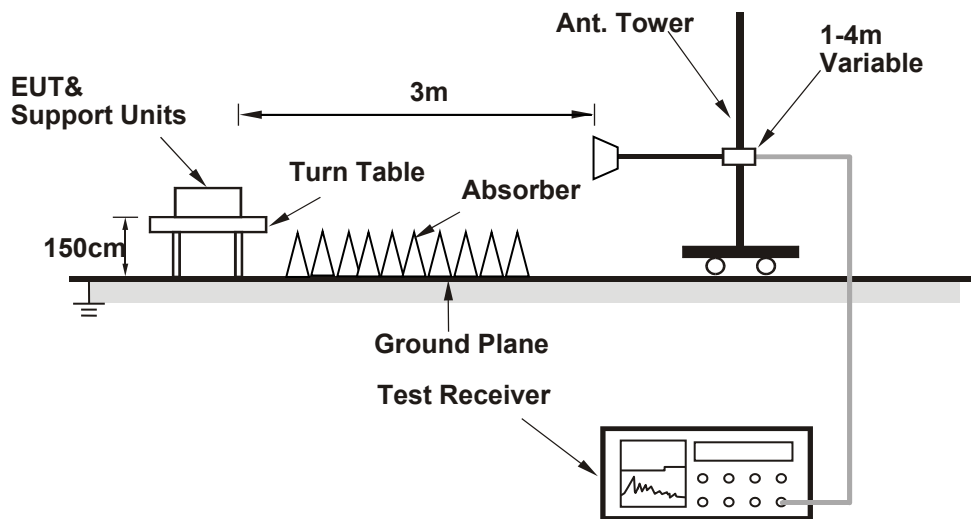

For the actual test configuration, please refer to the attached file (Test Setup Photo).

4.1.6 EUT Operating Conditions

- a. Placed the EUT on the testing table.
- b. Prepared a notebook to act as a communication partner and placed it outside of testing area.
- c. The communication partner connected with EUT via a RJ45 cable and ran a test program (provided by manufacturer) to enable EUT under transmission condition continuously at specific channel frequency.
- d. The communication partner sent data to EUT by command "PING".

4.1.7 Test Results

Above 1GHz data:

Nss 1

RF Mode	TX 802.11a 6G	Channel	CH 1 : 5955 MHz
Frequency Range	1GHz ~ 40GHz	Detector Function	Peak (PK) Average (AV)

Antenna Polarity & Test Distance : Horizontal at 3 m								
No	Frequency (MHz)	Emission Level (dBuV/m)	Limit (dBuV/m)	Margin (dB)	Antenna Height (m)	Table Angle (Degree)	Raw Value (dBuV)	Correction Factor (dB/m)
1	#5925.00	58.6 PK	88.2	-29.6	1.45 H	260	44.2	14.4
2	#5925.00	48.7 AV	68.2	-19.5	1.45 H	260	34.3	14.4
3	*5955.00	96.2 PK			1.45 H	260	51.9	44.3
4	*5955.00	86.7 AV			1.45 H	260	42.4	44.3
5	11910.00	61.3 PK	74.0	-12.7	2.64 H	155	38.4	22.9
6	11910.00	49.4 AV	54.0	-4.6	2.64 H	155	26.5	22.9
Antenna Polarity & Test Distance : Vertical at 3 m								
No	Frequency (MHz)	Emission Level (dBuV/m)	Limit (dBuV/m)	Margin (dB)	Antenna Height (m)	Table Angle (Degree)	Raw Value (dBuV)	Correction Factor (dB/m)
1	#5925.00	60.1 PK	88.2	-28.1	2.38 V	194	45.7	14.4
2	#5925.00	48.9 AV	68.2	-19.3	2.38 V	194	34.5	14.4
3	*5955.00	107.2 PK			2.38 V	194	62.9	44.3
4	*5955.00	97.0 AV			2.38 V	194	52.7	44.3
5	11910.00	61.4 PK	74.0	-12.6	2.36 V	114	38.5	22.9
6	11910.00	49.6 AV	54.0	-4.4	2.36 V	114	26.7	22.9

Remarks:

1. Emission Level(dBuV/m) = Raw Value(dBuV) + Correction Factor(dB/m).
2. Correction Factor(dB/m) = Antenna Factor(dB/m) + Cable Factor(dB) – Pre-Amplifier Factor(dB).
3. Margin value = Emission Level – Limit value.
4. The other emission levels were very low against the limit.
5. " * " : Fundamental frequency.
6. " # " : The radiated frequency is out of the restricted band.

RF Mode	TX 802.11a 6G	Channel	CH 61 : 6255 MHz
Frequency Range	1GHz ~ 40GHz	Detector Function	Peak (PK) Average (AV)

Antenna Polarity & Test Distance : Horizontal at 3 m								
No	Frequency (MHz)	Emission Level (dBuV/m)	Limit (dBuV/m)	Margin (dB)	Antenna Height (m)	Table Angle (Degree)	Raw Value (dBuV)	Correction Factor (dB/m)
1	*6255.00	97.2 PK			1.88 H	258	52.3	44.9
2	*6255.00	87.7 AV			1.88 H	258	42.8	44.9
3	12510.00	62.3 PK	74.0	-11.7	2.30 H	148	39.9	22.4
4	12510.00	48.9 AV	54.0	-5.1	2.30 H	148	26.5	22.4
Antenna Polarity & Test Distance : Vertical at 3 m								
No	Frequency (MHz)	Emission Level (dBuV/m)	Limit (dBuV/m)	Margin (dB)	Antenna Height (m)	Table Angle (Degree)	Raw Value (dBuV)	Correction Factor (dB/m)
1	*6255.00	108.1 PK			1.79 V	6	63.2	44.9
2	*6255.00	98.3 AV			1.79 V	6	53.4	44.9
3	12510.00	63.6 PK	74.0	-10.4	1.94 V	151	41.2	22.4
4	12510.00	49.3 AV	54.0	-4.7	1.94 V	151	26.9	22.4

Remarks:

1. Emission Level(dBuV/m) = Raw Value(dBuV) + Correction Factor(dB/m).
2. Correction Factor(dB/m) = Antenna Factor(dB/m) + Cable Factor(dB) – Pre-Amplifier Factor(dB).
3. Margin value = Emission Level – Limit value.
4. The other emission levels were very low against the limit.
5. " * " : Fundamental frequency.

RF Mode	TX 802.11a 6G	Channel	CH 93 : 6415 MHz
Frequency Range	1GHz ~ 40GHz	Detector Function	Peak (PK) Average (AV)

Antenna Polarity & Test Distance : Horizontal at 3 m								
No	Frequency (MHz)	Emission Level (dBuV/m)	Limit (dBuV/m)	Margin (dB)	Antenna Height (m)	Table Angle (Degree)	Raw Value (dBuV)	Correction Factor (dB/m)
1	*6415.00	98.2 PK			1.92 H	259	52.3	45.9
2	*6415.00	88.7 AV			1.92 H	259	42.8	45.9
3	#12830.00	62.9 PK	88.2	-25.3	2.31 H	144	39.8	23.1
4	#12830.00	49.5 AV	68.2	-18.7	2.31 H	144	26.4	23.1
Antenna Polarity & Test Distance : Vertical at 3 m								
No	Frequency (MHz)	Emission Level (dBuV/m)	Limit (dBuV/m)	Margin (dB)	Antenna Height (m)	Table Angle (Degree)	Raw Value (dBuV)	Correction Factor (dB/m)
1	*6415.00	107.6 PK			2.24 V	4	61.7	45.9
2	*6415.00	98.4 AV			2.24 V	4	52.5	45.9
3	#12830.00	64.5 PK	88.2	-23.7	1.82 V	156	41.4	23.1
4	#12830.00	50.4 AV	68.2	-17.8	1.82 V	156	27.3	23.1

Remarks:

1. Emission Level(dBuV/m) = Raw Value(dBuV) + Correction Factor(dB/m).
2. Correction Factor(dB/m) = Antenna Factor(dB/m) + Cable Factor(dB) – Pre-Amplifier Factor(dB).
3. Margin value = Emission Level – Limit value.
4. The other emission levels were very low against the limit.
5. " * " : Fundamental frequency.
6. " # " : The radiated frequency is out of the restricted band.

RF Mode	TX 802.11a 6G	Channel	CH 97 : 6435 MHz
Frequency Range	1GHz ~ 40GHz	Detector Function	Peak (PK) Average (AV)

Antenna Polarity & Test Distance : Horizontal at 3 m								
No	Frequency (MHz)	Emission Level (dBuV/m)	Limit (dBuV/m)	Margin (dB)	Antenna Height (m)	Table Angle (Degree)	Raw Value (dBuV)	Correction Factor (dB/m)
1	*6435.00	98.3 PK			2.83 H	205	52.3	46.0
2	*6435.00	88.4 AV			2.83 H	205	42.4	46.0
3	#12870.00	62.6 PK	88.2	-25.6	2.75 H	169	39.5	23.1
4	#12870.00	49.4 AV	68.2	-18.8	2.75 H	169	26.3	23.1
Antenna Polarity & Test Distance : Vertical at 3 m								
No	Frequency (MHz)	Emission Level (dBuV/m)	Limit (dBuV/m)	Margin (dB)	Antenna Height (m)	Table Angle (Degree)	Raw Value (dBuV)	Correction Factor (dB/m)
1	*6435.00	107.7 PK			2.24 V	22	61.7	46.0
2	*6435.00	98.2 AV			2.24 V	22	52.2	46.0
3	#12870.00	62.3 PK	88.2	-25.9	2.80 V	265	39.2	23.1
4	#12870.00	49.8 AV	68.2	-18.4	2.80 V	265	26.7	23.1

Remarks:

1. Emission Level(dBuV/m) = Raw Value(dBuV) + Correction Factor(dB/m).
2. Correction Factor(dB/m) = Antenna Factor(dB/m) + Cable Factor(dB) – Pre-Amplifier Factor(dB).
3. Margin value = Emission Level – Limit value.
4. The other emission levels were very low against the limit.
5. " * " : Fundamental frequency.
6. " # " : The radiated frequency is out of the restricted band.

RF Mode	TX 802.11a 6G	Channel	CH 105 : 6475 MHz
Frequency Range	1GHz ~ 40GHz	Detector Function	Peak (PK) Average (AV)

Antenna Polarity & Test Distance : Horizontal at 3 m								
No	Frequency (MHz)	Emission Level (dBuV/m)	Limit (dBuV/m)	Margin (dB)	Antenna Height (m)	Table Angle (Degree)	Raw Value (dBuV)	Correction Factor (dB/m)
1	*6475.00	99.3 PK			2.56 H	215	53.1	46.2
2	*6475.00	88.9 AV			2.56 H	215	42.7	46.2
3	#12950.00	62.4 PK	88.2	-25.8	2.66 H	169	39.3	23.1
4	#12950.00	49.4 AV	68.2	-18.8	2.66 H	169	26.3	23.1
Antenna Polarity & Test Distance : Vertical at 3 m								
No	Frequency (MHz)	Emission Level (dBuV/m)	Limit (dBuV/m)	Margin (dB)	Antenna Height (m)	Table Angle (Degree)	Raw Value (dBuV)	Correction Factor (dB/m)
1	*6475.00	107.5 PK			2.17 V	22	61.3	46.2
2	*6475.00	98.3 AV			2.17 V	22	52.1	46.2
3	#12950.00	62.8 PK	88.2	-25.4	2.84 V	277	39.7	23.1
4	#12950.00	50.3 AV	68.2	-17.9	2.84 V	277	27.2	23.1

Remarks:

1. Emission Level(dBuV/m) = Raw Value(dBuV) + Correction Factor(dB/m).
2. Correction Factor(dB/m) = Antenna Factor(dB/m) + Cable Factor(dB) – Pre-Amplifier Factor(dB).
3. Margin value = Emission Level – Limit value.
4. The other emission levels were very low against the limit.
5. " * " : Fundamental frequency.
6. " # " : The radiated frequency is out of the restricted band.

RF Mode	TX 802.11a 6G	Channel	CH 113 : 6515 MHz
Frequency Range	1GHz ~ 40GHz	Detector Function	Peak (PK) Average (AV)

Antenna Polarity & Test Distance : Horizontal at 3 m								
No	Frequency (MHz)	Emission Level (dBuV/m)	Limit (dBuV/m)	Margin (dB)	Antenna Height (m)	Table Angle (Degree)	Raw Value (dBuV)	Correction Factor (dB/m)
1	*6515.00	100.6 PK			2.56 H	208	54.2	46.4
2	*6515.00	90.1 AV			2.56 H	208	43.7	46.4
3	#13030.00	62.6 PK	88.2	-25.6	2.77 H	173	39.3	23.3
4	#13030.00	49.6 AV	68.2	-18.6	2.77 H	173	26.3	23.3
Antenna Polarity & Test Distance : Vertical at 3 m								
No	Frequency (MHz)	Emission Level (dBuV/m)	Limit (dBuV/m)	Margin (dB)	Antenna Height (m)	Table Angle (Degree)	Raw Value (dBuV)	Correction Factor (dB/m)
1	*6515.00	107.5 PK			2.40 V	22	61.1	46.4
2	*6515.00	98.3 AV			2.40 V	22	51.9	46.4
3	#13030.00	62.9 PK	88.2	-25.3	2.93 V	246	39.6	23.3
4	#13030.00	50.1 AV	68.2	-18.1	2.93 V	246	26.8	23.3

Remarks:

1. Emission Level(dBuV/m) = Raw Value(dBuV) + Correction Factor(dB/m).
2. Correction Factor(dB/m) = Antenna Factor(dB/m) + Cable Factor(dB) – Pre-Amplifier Factor(dB).
3. Margin value = Emission Level – Limit value.
4. The other emission levels were very low against the limit.
5. " * " : Fundamental frequency.
6. " # " : The radiated frequency is out of the restricted band.

RF Mode	TX 802.11a 6G	Channel	CH 117 : 6535 MHz
Frequency Range	1GHz ~ 40GHz	Detector Function	Peak (PK) Average (AV)

Antenna Polarity & Test Distance : Horizontal at 3 m								
No	Frequency (MHz)	Emission Level (dBuV/m)	Limit (dBuV/m)	Margin (dB)	Antenna Height (m)	Table Angle (Degree)	Raw Value (dBuV)	Correction Factor (dB/m)
1	*6535.00	97.6 PK			2.66 H	202	51.1	46.5
2	*6535.00	87.9 AV			2.66 H	202	41.4	46.5
3	#13070.00	62.5 PK	88.2	-25.7	2.75 H	175	39.2	23.3
4	#13070.00	49.4 AV	68.2	-18.8	2.75 H	175	26.1	23.3
Antenna Polarity & Test Distance : Vertical at 3 m								
No	Frequency (MHz)	Emission Level (dBuV/m)	Limit (dBuV/m)	Margin (dB)	Antenna Height (m)	Table Angle (Degree)	Raw Value (dBuV)	Correction Factor (dB/m)
1	*6535.00	107.8 PK			2.42 V	8	61.3	46.5
2	*6535.00	98.7 AV			2.42 V	8	52.2	46.5
3	#13070.00	62.9 PK	88.2	-25.3	2.83 V	264	39.6	23.3
4	#13070.00	50.3 AV	68.2	-17.9	2.83 V	264	27.0	23.3

Remarks:

1. Emission Level(dBuV/m) = Raw Value(dBuV) + Correction Factor(dB/m).
2. Correction Factor(dB/m) = Antenna Factor(dB/m) + Cable Factor(dB) – Pre-Amplifier Factor(dB).
3. Margin value = Emission Level – Limit value.
4. The other emission levels were very low against the limit.
5. " * " : Fundamental frequency.
6. " # " : The radiated frequency is out of the restricted band.

RF Mode	TX 802.11a 6G	Channel	CH 153 : 6715 MHz
Frequency Range	1GHz ~ 40GHz	Detector Function	Peak (PK) Average (AV)

Antenna Polarity & Test Distance : Horizontal at 3 m								
No	Frequency (MHz)	Emission Level (dBuV/m)	Limit (dBuV/m)	Margin (dB)	Antenna Height (m)	Table Angle (Degree)	Raw Value (dBuV)	Correction Factor (dB/m)
1	*6715.00	97.1 PK			2.82 H	212	50.3	46.8
2	*6715.00	87.0 AV			2.82 H	212	40.2	46.8
3	#13430.00	63.7 PK	88.2	-24.5	2.69 H	158	39.3	24.4
4	#13430.00	50.5 AV	68.2	-17.7	2.69 H	158	26.1	24.4
Antenna Polarity & Test Distance : Vertical at 3 m								
No	Frequency (MHz)	Emission Level (dBuV/m)	Limit (dBuV/m)	Margin (dB)	Antenna Height (m)	Table Angle (Degree)	Raw Value (dBuV)	Correction Factor (dB/m)
1	*6715.00	107.8 PK			2.52 V	359	61.0	46.8
2	*6715.00	98.8 AV			2.52 V	359	52.0	46.8
3	#13430.00	64.1 PK	88.2	-24.1	2.94 V	213	39.7	24.4
4	#13430.00	51.2 AV	68.2	-17.0	2.94 V	213	26.8	24.4

Remarks:

1. Emission Level(dBuV/m) = Raw Value(dBuV) + Correction Factor(dB/m).
2. Correction Factor(dB/m) = Antenna Factor(dB/m) + Cable Factor(dB) – Pre-Amplifier Factor(dB).
3. Margin value = Emission Level – Limit value.
4. The other emission levels were very low against the limit.
5. " * " : Fundamental frequency.
6. " # " : The radiated frequency is out of the restricted band.

RF Mode	TX 802.11a 6G	Channel	CH 181 : 6855 MHz
Frequency Range	1GHz ~ 40GHz	Detector Function	Peak (PK) Average (AV)

Antenna Polarity & Test Distance : Horizontal at 3 m								
No	Frequency (MHz)	Emission Level (dBuV/m)	Limit (dBuV/m)	Margin (dB)	Antenna Height (m)	Table Angle (Degree)	Raw Value (dBuV)	Correction Factor (dB/m)
1	*6855.00	98.2 PK			2.85 H	221	51.2	47.0
2	*6855.00	87.6 AV			2.85 H	221	40.6	47.0
3	#13710.00	64.1 PK	88.2	-24.1	2.77 H	169	39.1	25.0
4	#13710.00	51.1 AV	68.2	-17.1	2.77 H	169	26.1	25.0
Antenna Polarity & Test Distance : Vertical at 3 m								
No	Frequency (MHz)	Emission Level (dBuV/m)	Limit (dBuV/m)	Margin (dB)	Antenna Height (m)	Table Angle (Degree)	Raw Value (dBuV)	Correction Factor (dB/m)
1	*6855.00	108.1 PK			2.49 V	2	61.1	47.0
2	*6855.00	98.3 AV			2.49 V	2	51.3	47.0
3	#13710.00	64.6 PK	88.2	-23.6	2.69 V	247	39.6	25.0
4	#13710.00	51.5 AV	68.2	-16.7	2.69 V	247	26.5	25.0

Remarks:

1. Emission Level(dBuV/m) = Raw Value(dBuV) + Correction Factor(dB/m).
2. Correction Factor(dB/m) = Antenna Factor(dB/m) + Cable Factor(dB) – Pre-Amplifier Factor(dB).
3. Margin value = Emission Level – Limit value.
4. The other emission levels were very low against the limit.
5. " * " : Fundamental frequency.
6. " # " : The radiated frequency is out of the restricted band.

RF Mode	TX 802.11a 6G	Channel	CH 185 : 6875 MHz
Frequency Range	1GHz ~ 40GHz	Detector Function	Peak (PK) Average (AV)

Antenna Polarity & Test Distance : Horizontal at 3 m								
No	Frequency (MHz)	Emission Level (dBuV/m)	Limit (dBuV/m)	Margin (dB)	Antenna Height (m)	Table Angle (Degree)	Raw Value (dBuV)	Correction Factor (dB/m)
1	*6875.00	101.0 PK			3.23 H	218	53.8	47.2
2	*6875.00	91.6 AV			3.23 H	218	44.4	47.2
3	#13750.00	64.3 PK	88.2	-23.9	2.85 H	182	39.3	25.0
4	#13750.00	50.9 AV	68.2	-17.3	2.85 H	182	25.9	25.0
Antenna Polarity & Test Distance : Vertical at 3 m								
No	Frequency (MHz)	Emission Level (dBuV/m)	Limit (dBuV/m)	Margin (dB)	Antenna Height (m)	Table Angle (Degree)	Raw Value (dBuV)	Correction Factor (dB/m)
1	*6875.00	107.8 PK			2.55 V	6	60.6	47.2
2	*6875.00	98.5 AV			2.55 V	6	51.3	47.2
3	#13750.00	63.6 PK	88.2	-24.6	2.69 V	283	38.6	25.0
4	#13750.00	50.4 AV	68.2	-17.8	2.69 V	283	25.4	25.0

Remarks:

1. Emission Level(dBuV/m) = Raw Value(dBuV) + Correction Factor(dB/m).
2. Correction Factor(dB/m) = Antenna Factor(dB/m) + Cable Factor(dB) – Pre-Amplifier Factor(dB).
3. Margin value = Emission Level – Limit value.
4. The other emission levels were very low against the limit.
5. " * " : Fundamental frequency.
6. " # " : The radiated frequency is out of the restricted band.

RF Mode	TX 802.11a 6G	Channel	CH 213 : 7015 MHz
Frequency Range	1GHz ~ 40GHz	Detector Function	Peak (PK) Average (AV)

Antenna Polarity & Test Distance : Horizontal at 3 m								
No	Frequency (MHz)	Emission Level (dBuV/m)	Limit (dBuV/m)	Margin (dB)	Antenna Height (m)	Table Angle (Degree)	Raw Value (dBuV)	Correction Factor (dB/m)
1	*7015.00	100.4 PK			3.08 H	213	52.3	48.1
2	*7015.00	91.5 AV			3.08 H	213	43.4	48.1
3	#14030.00	64.9 PK	88.2	-23.3	2.85 H	175	39.2	25.7
4	#14030.00	51.9 AV	68.2	-16.3	2.85 H	175	26.2	25.7
Antenna Polarity & Test Distance : Vertical at 3 m								
No	Frequency (MHz)	Emission Level (dBuV/m)	Limit (dBuV/m)	Margin (dB)	Antenna Height (m)	Table Angle (Degree)	Raw Value (dBuV)	Correction Factor (dB/m)
1	*7015.00	107.9 PK			2.69 V	9	59.8	48.1
2	*7015.00	98.4 AV			2.69 V	9	50.3	48.1
3	#14030.00	64.5 PK	88.2	-23.7	2.83 V	272	38.8	25.7
4	#14030.00	52.0 AV	68.2	-16.2	2.83 V	272	26.3	25.7

Remarks:

1. Emission Level(dBuV/m) = Raw Value(dBuV) + Correction Factor(dB/m).
2. Correction Factor(dB/m) = Antenna Factor(dB/m) + Cable Factor(dB) – Pre-Amplifier Factor(dB).
3. Margin value = Emission Level – Limit value.
4. The other emission levels were very low against the limit.
5. " * " : Fundamental frequency.
6. " # " : The radiated frequency is out of the restricted band.

RF Mode	TX 802.11a 6G	Channel	CH 229 : 7095 MHz
Frequency Range	1GHz ~ 40GHz	Detector Function	Peak (PK) Average (AV)

Antenna Polarity & Test Distance : Horizontal at 3 m								
No	Frequency (MHz)	Emission Level (dBuV/m)	Limit (dBuV/m)	Margin (dB)	Antenna Height (m)	Table Angle (Degree)	Raw Value (dBuV)	Correction Factor (dB/m)
1	*7095.00	102.0 PK			3.18 H	212	53.6	48.4
2	*7095.00	92.9 AV			3.18 H	212	44.5	48.4
3	#14190.00	65.2 PK	88.2	-23.0	2.77 H	183	39.1	26.1
4	#14190.00	52.4 AV	68.2	-15.8	2.77 H	183	26.3	26.1
Antenna Polarity & Test Distance : Vertical at 3 m								
No	Frequency (MHz)	Emission Level (dBuV/m)	Limit (dBuV/m)	Margin (dB)	Antenna Height (m)	Table Angle (Degree)	Raw Value (dBuV)	Correction Factor (dB/m)
1	*7095.00	107.8 PK			2.46 V	8	59.4	48.4
2	*7095.00	98.6 AV			2.46 V	8	50.2	48.4
3	#14190.00	64.7 PK	88.2	-23.5	2.70 V	235	38.6	26.1
4	#14190.00	52.9 AV	68.2	-15.3	2.70 V	235	26.8	26.1

Remarks:

1. Emission Level(dBuV/m) = Raw Value(dBuV) + Correction Factor(dB/m).
2. Correction Factor(dB/m) = Antenna Factor(dB/m) + Cable Factor(dB) – Pre-Amplifier Factor(dB).
3. Margin value = Emission Level – Limit value.
4. The other emission levels were very low against the limit.
5. " * " : Fundamental frequency.
6. " # " : The radiated frequency is out of the restricted band.

RF Mode	TX 802.11a 6G	Channel	CH 233 : 7115 MHz
Frequency Range	1GHz ~ 40GHz	Detector Function	Peak (PK) Average (AV)

Antenna Polarity & Test Distance : Horizontal at 3 m								
No	Frequency (MHz)	Emission Level (dBuV/m)	Limit (dBuV/m)	Margin (dB)	Antenna Height (m)	Table Angle (Degree)	Raw Value (dBuV)	Correction Factor (dB/m)
1	*7115.00	99.8 PK			3.15 H	212	51.2	48.6
2	*7115.00	91.5 AV			3.15 H	212	42.9	48.6
3	#7125.00	81.8 PK	88.2	-6.4	3.15 H	212	63.7	18.1
4	#7125.00	58.6 AV	68.2	-9.6	3.15 H	212	40.5	18.1
5	#14230.00	64.7 PK	88.2	-23.5	2.83 H	191	38.5	26.2
6	#14230.00	52.3 AV	68.2	-15.9	2.83 H	191	26.1	26.2

Antenna Polarity & Test Distance : Vertical at 3 m								
No	Frequency (MHz)	Emission Level (dBuV/m)	Limit (dBuV/m)	Margin (dB)	Antenna Height (m)	Table Angle (Degree)	Raw Value (dBuV)	Correction Factor (dB/m)
1	*7115.00	106.1 PK			2.46 V	20	57.5	48.6
2	*7115.00	96.7 AV			2.46 V	20	48.1	48.6
3	#7125.00	87.9 PK	88.2	-0.3	2.46 V	20	69.8	18.1
4	#7125.00	61.7 AV	68.2	-6.5	2.46 V	20	43.6	18.1
5	#14230.00	65.0 PK	88.2	-23.2	2.46 V	20	38.8	26.2
6	#14230.00	52.2 AV	68.2	-16.0	2.46 V	20	26.0	26.2

Remarks:

1. Emission Level(dBuV/m) = Raw Value(dBuV) + Correction Factor(dB/m).
2. Correction Factor(dB/m) = Antenna Factor(dB/m) + Cable Factor(dB) – Pre-Amplifier Factor(dB).
3. Margin value = Emission Level – Limit value.
4. The other emission levels were very low against the limit.
5. " * " : Fundamental frequency.
6. " # " : The radiated frequency is out of the restricted band.

RF Mode	TX 802.11ax (HE20)	Channel	CH 1 : 5955 MHz
Frequency Range	1GHz ~ 40GHz	Detector Function	Peak (PK) Average (AV)

Antenna Polarity & Test Distance : Horizontal at 3 m								
No	Frequency (MHz)	Emission Level (dBuV/m)	Limit (dBuV/m)	Margin (dB)	Antenna Height (m)	Table Angle (Degree)	Raw Value (dBuV)	Correction Factor (dB/m)
1	#5925.00	59.9 PK	88.2	-28.3	1.49 H	262	45.5	14.4
2	#5925.00	48.9 AV	68.2	-19.3	1.49 H	262	34.5	14.4
3	*5955.00	98.5 PK			1.49 H	262	54.2	44.3
4	*5955.00	86.3 AV			1.49 H	262	42.0	44.3
5	11910.00	61.2 PK	74.0	-12.8	2.68 H	149	38.3	22.9
6	11910.00	49.4 AV	54.0	-4.6	2.68 H	149	26.5	22.9

Antenna Polarity & Test Distance : Vertical at 3 m								
No	Frequency (MHz)	Emission Level (dBuV/m)	Limit (dBuV/m)	Margin (dB)	Antenna Height (m)	Table Angle (Degree)	Raw Value (dBuV)	Correction Factor (dB/m)
1	#5925.00	60.2 PK	88.2	-28.0	2.38 V	193	45.8	14.4
2	#5925.00	49.0 AV	68.2	-19.2	2.38 V	193	34.6	14.4
3	*5955.00	105.4 PK			2.38 V	193	61.1	44.3
4	*5955.00	94.1 AV			2.38 V	193	49.8	44.3
5	11910.00	61.3 PK	74.0	-12.7	2.17 V	124	38.4	22.9
6	11910.00	49.5 AV	54.0	-4.5	2.17 V	124	26.6	22.9

Remarks:

1. Emission Level(dBuV/m) = Raw Value(dBuV) + Correction Factor(dB/m).
2. Correction Factor(dB/m) = Antenna Factor(dB/m) + Cable Factor(dB) – Pre-Amplifier Factor(dB).
3. Margin value = Emission Level – Limit value.
4. The other emission levels were very low against the limit.
5. " * " : Fundamental frequency.
6. " # " : The radiated frequency is out of the restricted band.

RF Mode	TX 802.11ax (HE20)	Channel	CH 61 : 6255 MHz
Frequency Range	1GHz ~ 40GHz	Detector Function	Peak (PK) Average (AV)

Antenna Polarity & Test Distance : Horizontal at 3 m								
No	Frequency (MHz)	Emission Level (dBuV/m)	Limit (dBuV/m)	Margin (dB)	Antenna Height (m)	Table Angle (Degree)	Raw Value (dBuV)	Correction Factor (dB/m)
1	*6255.00	99.7 PK			1.92 H	247	54.8	44.9
2	*6255.00	87.5 AV			1.92 H	247	42.6	44.9
3	12510.00	62.2 PK	74.0	-11.8	1.73 H	210	39.8	22.4
4	12510.00	48.7 AV	54.0	-5.3	1.73 H	210	26.3	22.4
Antenna Polarity & Test Distance : Vertical at 3 m								
No	Frequency (MHz)	Emission Level (dBuV/m)	Limit (dBuV/m)	Margin (dB)	Antenna Height (m)	Table Angle (Degree)	Raw Value (dBuV)	Correction Factor (dB/m)
1	*6255.00	111.1 PK			2.02 V	0	66.2	44.9
2	*6255.00	98.6 AV			2.02 V	0	53.7	44.9
3	12510.00	63.4 PK	74.0	-10.6	1.85 V	132	41.0	22.4
4	12510.00	50.0 AV	54.0	-4.0	1.85 V	132	27.6	22.4

Remarks:

1. Emission Level(dBuV/m) = Raw Value(dBuV) + Correction Factor(dB/m).
2. Correction Factor(dB/m) = Antenna Factor(dB/m) + Cable Factor(dB) – Pre-Amplifier Factor(dB).
3. Margin value = Emission Level – Limit value.
4. The other emission levels were very low against the limit.
5. " * " : Fundamental frequency.

RF Mode	TX 802.11ax (HE20)	Channel	CH 93 : 6415 MHz
Frequency Range	1GHz ~ 40GHz	Detector Function	Peak (PK) Average (AV)

Antenna Polarity & Test Distance : Horizontal at 3 m								
No	Frequency (MHz)	Emission Level (dBuV/m)	Limit (dBuV/m)	Margin (dB)	Antenna Height (m)	Table Angle (Degree)	Raw Value (dBuV)	Correction Factor (dB/m)
1	*6415.00	100.8 PK			1.92 H	257	54.9	45.9
2	*6415.00	88.4 AV			1.92 H	257	42.5	45.9
3	#12830.00	62.9 PK	88.2	-25.3	1.77 H	214	39.8	23.1
4	#12830.00	49.6 AV	68.2	-18.6	1.77 H	214	26.5	23.1
Antenna Polarity & Test Distance : Vertical at 3 m								
No	Frequency (MHz)	Emission Level (dBuV/m)	Limit (dBuV/m)	Margin (dB)	Antenna Height (m)	Table Angle (Degree)	Raw Value (dBuV)	Correction Factor (dB/m)
1	*6415.00	110.7 PK			2.01 V	3	64.8	45.9
2	*6415.00	98.2 AV			2.01 V	3	52.3	45.9
3	#12830.00	65.4 PK	88.2	-22.8	1.71 V	169	42.3	23.1
4	#12830.00	50.9 AV	68.2	-17.3	1.71 V	169	27.8	23.1

Remarks:

1. Emission Level(dBuV/m) = Raw Value(dBuV) + Correction Factor(dB/m).
2. Correction Factor(dB/m) = Antenna Factor(dB/m) + Cable Factor(dB) – Pre-Amplifier Factor(dB).
3. Margin value = Emission Level – Limit value.
4. The other emission levels were very low against the limit.
5. " * " : Fundamental frequency.
6. " # " : The radiated frequency is out of the restricted band.

RF Mode	TX 802.11ax (HE20)	Channel	CH 97 : 6435 MHz
Frequency Range	1GHz ~ 40GHz	Detector Function	Peak (PK) Average (AV)

Antenna Polarity & Test Distance : Horizontal at 3 m								
No	Frequency (MHz)	Emission Level (dBuV/m)	Limit (dBuV/m)	Margin (dB)	Antenna Height (m)	Table Angle (Degree)	Raw Value (dBuV)	Correction Factor (dB/m)
1	*6435.00	102.0 PK			2.54 H	209	56.0	46.0
2	*6435.00	89.4 AV			2.54 H	209	43.4	46.0
3	#12870.00	62.6 PK	88.2	-25.6	2.69 H	168	39.5	23.1
4	#12870.00	49.5 AV	68.2	-18.7	2.69 H	168	26.4	23.1
Antenna Polarity & Test Distance : Vertical at 3 m								
No	Frequency (MHz)	Emission Level (dBuV/m)	Limit (dBuV/m)	Margin (dB)	Antenna Height (m)	Table Angle (Degree)	Raw Value (dBuV)	Correction Factor (dB/m)
1	*6435.00	111.5 PK			2.24 V	19	65.5	46.0
2	*6435.00	98.4 AV			2.24 V	19	52.4	46.0
3	#12870.00	63.5 PK	88.2	-24.7	2.63 V	242	40.4	23.1
4	#12870.00	50.2 AV	68.2	-18.0	2.63 V	242	27.1	23.1

Remarks:

1. Emission Level(dBuV/m) = Raw Value(dBuV) + Correction Factor(dB/m).
2. Correction Factor(dB/m) = Antenna Factor(dB/m) + Cable Factor(dB) – Pre-Amplifier Factor(dB).
3. Margin value = Emission Level – Limit value.
4. The other emission levels were very low against the limit.
5. " * " : Fundamental frequency.
6. " # " : The radiated frequency is out of the restricted band.

RF Mode	TX 802.11ax (HE20)	Channel	CH 105 : 6475 MHz
Frequency Range	1GHz ~ 40GHz	Detector Function	Peak (PK) Average (AV)

Antenna Polarity & Test Distance : Horizontal at 3 m								
No	Frequency (MHz)	Emission Level (dBuV/m)	Limit (dBuV/m)	Margin (dB)	Antenna Height (m)	Table Angle (Degree)	Raw Value (dBuV)	Correction Factor (dB/m)
1	*6475.00	102.6 PK			2.51 H	208	56.4	46.2
2	*6475.00	89.9 AV			2.51 H	208	43.7	46.2
3	#12950.00	62.4 PK	88.2	-25.8	2.71 H	165	39.3	23.1
4	#12950.00	49.4 AV	68.2	-18.8	2.71 H	165	26.3	23.1
Antenna Polarity & Test Distance : Vertical at 3 m								
No	Frequency (MHz)	Emission Level (dBuV/m)	Limit (dBuV/m)	Margin (dB)	Antenna Height (m)	Table Angle (Degree)	Raw Value (dBuV)	Correction Factor (dB/m)
1	*6475.00	111.1 PK			2.33 V	19	64.9	46.2
2	*6475.00	98.3 AV			2.33 V	19	52.1	46.2
3	#12950.00	63.5 PK	88.2	-24.7	2.42 V	295	40.4	23.1
4	#12950.00	50.7 AV	68.2	-17.5	2.42 V	295	27.6	23.1

Remarks:

1. Emission Level(dBuV/m) = Raw Value(dBuV) + Correction Factor(dB/m).
2. Correction Factor(dB/m) = Antenna Factor(dB/m) + Cable Factor(dB) – Pre-Amplifier Factor(dB).
3. Margin value = Emission Level – Limit value.
4. The other emission levels were very low against the limit.
5. " * " : Fundamental frequency.
6. " # " : The radiated frequency is out of the restricted band.

RF Mode	TX 802.11ax (HE20)	Channel	CH 113 : 6515 MHz
Frequency Range	1GHz ~ 40GHz	Detector Function	Peak (PK) Average (AV)

Antenna Polarity & Test Distance : Horizontal at 3 m								
No	Frequency (MHz)	Emission Level (dBuV/m)	Limit (dBuV/m)	Margin (dB)	Antenna Height (m)	Table Angle (Degree)	Raw Value (dBuV)	Correction Factor (dB/m)
1	*6515.00	102.3 PK			2.53 H	209	55.9	46.4
2	*6515.00	89.6 AV			2.53 H	209	43.2	46.4
3	#13030.00	62.6 PK	88.2	-25.6	2.75 H	168	39.3	23.3
4	#13030.00	49.3 AV	68.2	-18.9	2.75 H	168	26.0	23.3
Antenna Polarity & Test Distance : Vertical at 3 m								
No	Frequency (MHz)	Emission Level (dBuV/m)	Limit (dBuV/m)	Margin (dB)	Antenna Height (m)	Table Angle (Degree)	Raw Value (dBuV)	Correction Factor (dB/m)
1	*6515.00	110.1 PK			2.31 V	21	63.7	46.4
2	*6515.00	97.8 AV			2.31 V	21	51.4	46.4
3	#13030.00	63.4 PK	88.2	-24.8	2.63 V	224	40.1	23.3
4	#13030.00	50.1 AV	68.2	-18.1	2.63 V	224	26.8	23.3

Remarks:

1. Emission Level(dBuV/m) = Raw Value(dBuV) + Correction Factor(dB/m).
2. Correction Factor(dB/m) = Antenna Factor(dB/m) + Cable Factor(dB) – Pre-Amplifier Factor(dB).
3. Margin value = Emission Level – Limit value.
4. The other emission levels were very low against the limit.
5. " * " : Fundamental frequency.
6. " # " : The radiated frequency is out of the restricted band.

RF Mode	TX 802.11ax (HE20)	Channel	CH 117 : 6535 MHz
Frequency Range	1GHz ~ 40GHz	Detector Function	Peak (PK) Average (AV)

Antenna Polarity & Test Distance : Horizontal at 3 m								
No	Frequency (MHz)	Emission Level (dBuV/m)	Limit (dBuV/m)	Margin (dB)	Antenna Height (m)	Table Angle (Degree)	Raw Value (dBuV)	Correction Factor (dB/m)
1	*6535.00	99.3 PK			2.65 H	205	52.8	46.5
2	*6535.00	86.5 AV			2.65 H	205	40.0	46.5
3	#13070.00	62.4 PK	88.2	-25.8	2.68 H	165	39.1	23.3
4	#13070.00	49.6 AV	68.2	-18.6	2.68 H	165	26.3	23.3
Antenna Polarity & Test Distance : Vertical at 3 m								
No	Frequency (MHz)	Emission Level (dBuV/m)	Limit (dBuV/m)	Margin (dB)	Antenna Height (m)	Table Angle (Degree)	Raw Value (dBuV)	Correction Factor (dB/m)
1	*6535.00	111.2 PK			2.57 V	11	64.7	46.5
2	*6535.00	98.7 AV			2.57 V	11	52.2	46.5
3	#13070.00	62.9 PK	88.2	-25.3	2.66 V	278	39.6	23.3
4	#13070.00	50.2 AV	68.2	-18.0	2.66 V	278	26.9	23.3

Remarks:

1. Emission Level(dBuV/m) = Raw Value(dBuV) + Correction Factor(dB/m).
2. Correction Factor(dB/m) = Antenna Factor(dB/m) + Cable Factor(dB) – Pre-Amplifier Factor(dB).
3. Margin value = Emission Level – Limit value.
4. The other emission levels were very low against the limit.
5. " * " : Fundamental frequency.
6. " # " : The radiated frequency is out of the restricted band.

RF Mode	TX 802.11ax (HE20)	Channel	CH 153 : 6715 MHz
Frequency Range	1GHz ~ 40GHz	Detector Function	Peak (PK) Average (AV)

Antenna Polarity & Test Distance : Horizontal at 3 m								
No	Frequency (MHz)	Emission Level (dBuV/m)	Limit (dBuV/m)	Margin (dB)	Antenna Height (m)	Table Angle (Degree)	Raw Value (dBuV)	Correction Factor (dB/m)
1	*6715.00	99.0 PK			2.67 H	215	52.2	46.8
2	*6715.00	85.8 AV			2.67 H	215	39.0	46.8
3	#13070.00	62.6 PK	88.2	-25.6	2.74 H	169	39.3	23.3
4	#13070.00	49.6 AV	68.2	-18.6	2.74 H	169	26.3	23.3
Antenna Polarity & Test Distance : Vertical at 3 m								
No	Frequency (MHz)	Emission Level (dBuV/m)	Limit (dBuV/m)	Margin (dB)	Antenna Height (m)	Table Angle (Degree)	Raw Value (dBuV)	Correction Factor (dB/m)
1	*6715.00	111.6 PK			2.57 V	7	64.8	46.8
2	*6715.00	99.0 AV			2.57 V	7	52.2	46.8
3	#13430.00	64.1 PK	88.2	-24.1	2.73 V	262	39.7	24.4
4	#13430.00	51.0 AV	68.2	-17.2	2.73 V	262	26.6	24.4

Remarks:

1. Emission Level(dBuV/m) = Raw Value(dBuV) + Correction Factor(dB/m).
2. Correction Factor(dB/m) = Antenna Factor(dB/m) + Cable Factor(dB) – Pre-Amplifier Factor(dB).
3. Margin value = Emission Level – Limit value.
4. The other emission levels were very low against the limit.
5. " * " : Fundamental frequency.
6. " # " : The radiated frequency is out of the restricted band.

RF Mode	TX 802.11ax (HE20)	Channel	CH 181 : 6855 MHz
Frequency Range	1GHz ~ 40GHz	Detector Function	Peak (PK) Average (AV)

Antenna Polarity & Test Distance : Horizontal at 3 m								
No	Frequency (MHz)	Emission Level (dBuV/m)	Limit (dBuV/m)	Margin (dB)	Antenna Height (m)	Table Angle (Degree)	Raw Value (dBuV)	Correction Factor (dB/m)
1	*6855.00	99.3 PK			2.71 H	226	52.3	47.0
2	*6855.00	86.2 AV			2.71 H	226	39.2	47.0
3	#13710.00	64.3 PK	88.2	-23.9	2.72 H	167	39.3	25.0
4	#13710.00	51.2 AV	68.2	-17.0	2.72 H	167	26.2	25.0
Antenna Polarity & Test Distance : Vertical at 3 m								
No	Frequency (MHz)	Emission Level (dBuV/m)	Limit (dBuV/m)	Margin (dB)	Antenna Height (m)	Table Angle (Degree)	Raw Value (dBuV)	Correction Factor (dB/m)
1	*6855.00	110.0 PK			2.56 V	3	63.0	47.0
2	*6855.00	98.2 AV			2.56 V	3	51.2	47.0
3	#13710.00	64.8 PK	88.2	-23.4	2.55 V	264	39.8	25.0
4	#13710.00	52.2 AV	68.2	-16.0	2.55 V	264	27.2	25.0

Remarks:

1. Emission Level(dBuV/m) = Raw Value(dBuV) + Correction Factor(dB/m).
2. Correction Factor(dB/m) = Antenna Factor(dB/m) + Cable Factor(dB) – Pre-Amplifier Factor(dB).
3. Margin value = Emission Level – Limit value.
4. The other emission levels were very low against the limit.
5. " * " : Fundamental frequency.
6. " # " : The radiated frequency is out of the restricted band.

RF Mode	TX 802.11ax (HE20)	Channel	CH 185 : 6875 MHz
Frequency Range	1GHz ~ 40GHz	Detector Function	Peak (PK) Average (AV)

Antenna Polarity & Test Distance : Horizontal at 3 m								
No	Frequency (MHz)	Emission Level (dBuV/m)	Limit (dBuV/m)	Margin (dB)	Antenna Height (m)	Table Angle (Degree)	Raw Value (dBuV)	Correction Factor (dB/m)
1	*6875.00	105.0 PK			3.28 H	215	57.8	47.2
2	*6875.00	93.2 AV			3.28 H	215	46.0	47.2
3	#13750.00	64.2 PK	88.2	-24.0	2.75 H	169	39.2	25.0
4	#13750.00	51.3 AV	68.2	-16.9	2.75 H	169	26.3	25.0
Antenna Polarity & Test Distance : Vertical at 3 m								
No	Frequency (MHz)	Emission Level (dBuV/m)	Limit (dBuV/m)	Margin (dB)	Antenna Height (m)	Table Angle (Degree)	Raw Value (dBuV)	Correction Factor (dB/m)
1	*6875.00	110.3 PK			2.54 V	8	63.1	47.2
2	*6875.00	98.9 AV			2.54 V	8	51.7	47.2
3	#13750.00	64.7 PK	88.2	-23.5	2.86 V	271	39.7	25.0
4	#13750.00	51.8 AV	68.2	-16.4	2.86 V	271	26.8	25.0

Remarks:

1. Emission Level(dBuV/m) = Raw Value(dBuV) + Correction Factor(dB/m).
2. Correction Factor(dB/m) = Antenna Factor(dB/m) + Cable Factor(dB) – Pre-Amplifier Factor(dB).
3. Margin value = Emission Level – Limit value.
4. The other emission levels were very low against the limit.
5. " * " : Fundamental frequency.
6. " # " : The radiated frequency is out of the restricted band.

RF Mode	TX 802.11ax (HE20)	Channel	CH 213 : 7015 MHz
Frequency Range	1GHz ~ 40GHz	Detector Function	Peak (PK) Average (AV)

Antenna Polarity & Test Distance : Horizontal at 3 m								
No	Frequency (MHz)	Emission Level (dBuV/m)	Limit (dBuV/m)	Margin (dB)	Antenna Height (m)	Table Angle (Degree)	Raw Value (dBuV)	Correction Factor (dB/m)
1	*7015.00	102.1 PK			3.04 H	215	54.0	48.1
2	*7015.00	92.1 AV			3.04 H	215	44.0	48.1
3	#14030.00	64.8 PK	88.2	-23.4	2.81 H	173	39.1	25.7
4	#14030.00	51.9 AV	68.2	-16.3	2.81 H	173	26.2	25.7
Antenna Polarity & Test Distance : Vertical at 3 m								
No	Frequency (MHz)	Emission Level (dBuV/m)	Limit (dBuV/m)	Margin (dB)	Antenna Height (m)	Table Angle (Degree)	Raw Value (dBuV)	Correction Factor (dB/m)
1	*7015.00	111.1 PK			2.33 V	9	63.0	48.1
2	*7015.00	98.6 AV			2.33 V	9	50.5	48.1
3	#14030.00	64.9 PK	88.2	-23.3	2.84 V	263	39.2	25.7
4	#14030.00	52.1 AV	68.2	-16.1	2.84 V	263	26.4	25.7

Remarks:

1. Emission Level(dBuV/m) = Raw Value(dBuV) + Correction Factor(dB/m).
2. Correction Factor(dB/m) = Antenna Factor(dB/m) + Cable Factor(dB) – Pre-Amplifier Factor(dB).
3. Margin value = Emission Level – Limit value.
4. The other emission levels were very low against the limit.
5. " * " : Fundamental frequency.
6. " # " : The radiated frequency is out of the restricted band.

RF Mode	TX 802.11ax (HE20)	Channel	CH 229 : 7095 MHz
Frequency Range	1GHz ~ 40GHz	Detector Function	Peak (PK) Average (AV)

Antenna Polarity & Test Distance : Horizontal at 3 m								
No	Frequency (MHz)	Emission Level (dBuV/m)	Limit (dBuV/m)	Margin (dB)	Antenna Height (m)	Table Angle (Degree)	Raw Value (dBuV)	Correction Factor (dB/m)
1	*7095.00	104.4 PK			3.02 H	216	56.0	48.4
2	*7095.00	92.9 AV			3.02 H	216	44.5	48.4
3	#14190.00	64.9 PK	88.2	-23.3	2.86 H	176	38.8	26.1
4	#14190.00	52.3 AV	68.2	-15.9	2.86 H	176	26.2	26.1
Antenna Polarity & Test Distance : Vertical at 3 m								
No	Frequency (MHz)	Emission Level (dBuV/m)	Limit (dBuV/m)	Margin (dB)	Antenna Height (m)	Table Angle (Degree)	Raw Value (dBuV)	Correction Factor (dB/m)
1	*7095.00	110.9 PK			2.71 V	358	62.5	48.4
2	*7095.00	98.1 AV			2.71 V	358	49.7	48.4
3	#14190.00	64.4 PK	88.2	-23.8	2.99 V	264	38.3	26.1
4	#14190.00	52.6 AV	68.2	-15.6	2.99 V	264	26.5	26.1

Remarks:

1. Emission Level(dBuV/m) = Raw Value(dBuV) + Correction Factor(dB/m).
2. Correction Factor(dB/m) = Antenna Factor(dB/m) + Cable Factor(dB) – Pre-Amplifier Factor(dB).
3. Margin value = Emission Level – Limit value.
4. The other emission levels were very low against the limit.
5. " * " : Fundamental frequency.
6. " # " : The radiated frequency is out of the restricted band.

RF Mode	TX 802.11ax (HE20)	Channel	CH 233 : 7115 MHz
Frequency Range	1GHz ~ 40GHz	Detector Function	Peak (PK) Average (AV)

Antenna Polarity & Test Distance : Horizontal at 3 m								
No	Frequency (MHz)	Emission Level (dBuV/m)	Limit (dBuV/m)	Margin (dB)	Antenna Height (m)	Table Angle (Degree)	Raw Value (dBuV)	Correction Factor (dB/m)
1	*7115.00	88.2 PK			3.15 H	213	39.6	48.6
2	*7115.00	77.7 AV			3.15 H	213	29.1	48.6
3	#7125.00	75.5 PK	88.2	-12.7	3.15 H	213	57.4	18.1
4	#7125.00	64.9 AV	68.2	-3.3	3.15 H	213	46.8	18.1
5	#14230.00	63.3 PK	88.2	-24.9	2.85 H	167	37.1	26.2
6	#14230.00	51.8 AV	68.2	-16.4	2.85 H	167	25.6	26.2

Antenna Polarity & Test Distance : Vertical at 3 m								
No	Frequency (MHz)	Emission Level (dBuV/m)	Limit (dBuV/m)	Margin (dB)	Antenna Height (m)	Table Angle (Degree)	Raw Value (dBuV)	Correction Factor (dB/m)
1	*7115.00	92.5 PK			2.33 V	6	43.9	48.6
2	*7115.00	80.1 AV			2.33 V	6	31.5	48.6
3	#7125.00	80.2 PK	88.2	-8.0	2.33 V	6	62.1	18.1
4	#7125.00	68.0 AV	68.2	-0.2	2.33 V	6	49.9	18.1
5	#14230.00	63.2 PK	88.2	-25.0	2.72 V	235	37.0	26.2
6	#14230.00	52.0 AV	68.2	-16.2	2.72 V	235	25.8	26.2

Remarks:

1. Emission Level(dBuV/m) = Raw Value(dBuV) + Correction Factor(dB/m).
2. Correction Factor(dB/m) = Antenna Factor(dB/m) + Cable Factor(dB) – Pre-Amplifier Factor(dB).
3. Margin value = Emission Level – Limit value.
4. The other emission levels were very low against the limit.
5. " * " : Fundamental frequency.
6. " # " : The radiated frequency is out of the restricted band.

RF Mode	TX 802.11ax (HE40)	Channel	CH 3 : 5965 MHz
Frequency Range	1GHz ~ 40GHz	Detector Function	Peak (PK) Average (AV)

Antenna Polarity & Test Distance : Horizontal at 3 m								
No	Frequency (MHz)	Emission Level (dBuV/m)	Limit (dBuV/m)	Margin (dB)	Antenna Height (m)	Table Angle (Degree)	Raw Value (dBuV)	Correction Factor (dB/m)
1	#5925.00	60.0 PK	88.2	-28.2	1.45 H	259	45.6	14.4
2	#5925.00	49.0 AV	68.2	-19.2	1.45 H	259	34.6	14.4
3	*5965.00	96.5 PK			1.45 H	259	52.2	44.3
4	*5965.00	85.8 AV			1.45 H	259	41.5	44.3
5	11930.00	61.1 PK	74.0	-12.9	2.58 H	153	38.2	22.9
6	11930.00	49.3 AV	54.0	-4.7	2.58 H	153	26.4	22.9

Antenna Polarity & Test Distance : Vertical at 3 m								
No	Frequency (MHz)	Emission Level (dBuV/m)	Limit (dBuV/m)	Margin (dB)	Antenna Height (m)	Table Angle (Degree)	Raw Value (dBuV)	Correction Factor (dB/m)
1	#5925.00	60.2 PK	88.2	-28.0	2.68 V	202	45.8	14.4
2	#5925.00	49.0 AV	68.2	-19.2	2.68 V	202	34.6	14.4
3	*5965.00	104.8 PK			2.68 V	202	60.5	44.3
4	*5965.00	94.2 AV			2.68 V	202	49.9	44.3
5	11930.00	61.3 PK	74.0	-12.7	2.14 V	129	38.4	22.9
6	11930.00	49.5 AV	54.0	-4.5	2.14 V	129	26.6	22.9

Remarks:

1. Emission Level(dBuV/m) = Raw Value(dBuV) + Correction Factor(dB/m).
2. Correction Factor(dB/m) = Antenna Factor(dB/m) + Cable Factor(dB) – Pre-Amplifier Factor(dB).
3. Margin value = Emission Level – Limit value.
4. The other emission levels were very low against the limit.
5. " * " : Fundamental frequency.
6. " # " : The radiated frequency is out of the restricted band.

RF Mode	TX 802.11ax (HE40)	Channel	CH 59 : 6245 MHz
Frequency Range	1GHz ~ 40GHz	Detector Function	Peak (PK) Average (AV)

Antenna Polarity & Test Distance : Horizontal at 3 m								
No	Frequency (MHz)	Emission Level (dBuV/m)	Limit (dBuV/m)	Margin (dB)	Antenna Height (m)	Table Angle (Degree)	Raw Value (dBuV)	Correction Factor (dB/m)
1	*6245.00	98.9 PK			1.50 H	207	54.0	44.9
2	*6245.00	85.9 AV			1.50 H	207	41.0	44.9
3	12490.00	60.4 PK	74.0	-13.6	2.55 H	169	38.0	22.4
4	12490.00	48.7 AV	54.0	-5.3	2.55 H	169	26.3	22.4
Antenna Polarity & Test Distance : Vertical at 3 m								
No	Frequency (MHz)	Emission Level (dBuV/m)	Limit (dBuV/m)	Margin (dB)	Antenna Height (m)	Table Angle (Degree)	Raw Value (dBuV)	Correction Factor (dB/m)
1	*6245.00	110.9 PK			2.30 V	14	66.0	44.9
2	*6245.00	98.7 AV			2.30 V	14	53.8	44.9
3	12490.00	62.3 PK	74.0	-11.7	2.14 V	182	39.9	22.4
4	12490.00	49.5 AV	54.0	-4.5	2.14 V	182	27.1	22.4

Remarks:

1. Emission Level(dBuV/m) = Raw Value(dBuV) + Correction Factor(dB/m).
2. Correction Factor(dB/m) = Antenna Factor(dB/m) + Cable Factor(dB) – Pre-Amplifier Factor(dB).
3. Margin value = Emission Level – Limit value.
4. The other emission levels were very low against the limit.
5. " * " : Fundamental frequency.

RF Mode	TX 802.11ax (HE40)	Channel	CH 91 : 6405 MHz
Frequency Range	1GHz ~ 40GHz	Detector Function	Peak (PK) Average (AV)

Antenna Polarity & Test Distance : Horizontal at 3 m								
No	Frequency (MHz)	Emission Level (dBuV/m)	Limit (dBuV/m)	Margin (dB)	Antenna Height (m)	Table Angle (Degree)	Raw Value (dBuV)	Correction Factor (dB/m)
1	*6405.00	97.9 PK			1.50 H	5	52.1	45.8
2	*6405.00	84.9 AV			1.50 H	5	39.1	45.8
3	#12810.00	61.2 PK	88.2	-27.0	2.69 H	159	38.1	23.1
4	#12810.00	49.4 AV	68.2	-18.8	2.69 H	159	26.3	23.1
Antenna Polarity & Test Distance : Vertical at 3 m								
No	Frequency (MHz)	Emission Level (dBuV/m)	Limit (dBuV/m)	Margin (dB)	Antenna Height (m)	Table Angle (Degree)	Raw Value (dBuV)	Correction Factor (dB/m)
1	*6405.00	110.7 PK			2.43 V	5	64.9	45.8
2	*6405.00	98.6 AV			2.43 V	5	52.8	45.8
3	#12810.00	63.4 PK	88.2	-24.8	2.05 V	152	40.3	23.1
4	#12810.00	50.9 AV	68.2	-17.3	2.05 V	152	27.8	23.1

Remarks:

1. Emission Level(dBuV/m) = Raw Value(dBuV) + Correction Factor(dB/m).
2. Correction Factor(dB/m) = Antenna Factor(dB/m) + Cable Factor(dB) – Pre-Amplifier Factor(dB).
3. Margin value = Emission Level – Limit value.
4. The other emission levels were very low against the limit.
5. " * " : Fundamental frequency.
6. " # " : The radiated frequency is out of the restricted band.

RF Mode	TX 802.11ax (HE40)	Channel	CH 99 : 6445 MHz
Frequency Range	1GHz ~ 40GHz	Detector Function	Peak (PK) Average (AV)

Antenna Polarity & Test Distance : Horizontal at 3 m								
No	Frequency (MHz)	Emission Level (dBuV/m)	Limit (dBuV/m)	Margin (dB)	Antenna Height (m)	Table Angle (Degree)	Raw Value (dBuV)	Correction Factor (dB/m)
1	*6445.00	101.9 PK			2.44 H	211	55.9	46.0
2	*6445.00	89.0 AV			2.44 H	211	43.0	46.0
3	#12890.00	62.6 PK	88.2	-25.6	2.75 H	174	39.5	23.1
4	#12890.00	49.6 AV	68.2	-18.6	2.75 H	174	26.5	23.1
Antenna Polarity & Test Distance : Vertical at 3 m								
No	Frequency (MHz)	Emission Level (dBuV/m)	Limit (dBuV/m)	Margin (dB)	Antenna Height (m)	Table Angle (Degree)	Raw Value (dBuV)	Correction Factor (dB/m)
1	*6445.00	110.2 PK			2.25 V	18	64.2	46.0
2	*6445.00	98.6 AV			2.25 V	18	52.6	46.0
3	#12890.00	63.5 PK	88.2	-24.7	2.83 V	251	40.4	23.1
4	#12890.00	50.9 AV	68.2	-17.3	2.83 V	251	27.8	23.1

Remarks:

1. Emission Level(dBuV/m) = Raw Value(dBuV) + Correction Factor(dB/m).
2. Correction Factor(dB/m) = Antenna Factor(dB/m) + Cable Factor(dB) – Pre-Amplifier Factor(dB).
3. Margin value = Emission Level – Limit value.
4. The other emission levels were very low against the limit.
5. " * " : Fundamental frequency.
6. " # " : The radiated frequency is out of the restricted band.

RF Mode	TX 802.11ax (HE40)	Channel	CH 107 : 6485 MHz
Frequency Range	1GHz ~ 40GHz	Detector Function	Peak (PK) Average (AV)

Antenna Polarity & Test Distance : Horizontal at 3 m								
No	Frequency (MHz)	Emission Level (dBuV/m)	Limit (dBuV/m)	Margin (dB)	Antenna Height (m)	Table Angle (Degree)	Raw Value (dBuV)	Correction Factor (dB/m)
1	*6485.00	101.7 PK			2.38 H	212	55.5	46.2
2	*6485.00	88.7 AV			2.38 H	212	42.5	46.2
3	#12970.00	62.5 PK	88.2	-25.7	2.72 H	166	39.3	23.2
4	#12970.00	49.4 AV	68.2	-18.8	2.72 H	166	26.2	23.2
Antenna Polarity & Test Distance : Vertical at 3 m								
No	Frequency (MHz)	Emission Level (dBuV/m)	Limit (dBuV/m)	Margin (dB)	Antenna Height (m)	Table Angle (Degree)	Raw Value (dBuV)	Correction Factor (dB/m)
1	*6485.00	111.0 PK			2.58 V	5	64.8	46.2
2	*6485.00	98.7 AV			2.58 V	5	52.5	46.2
3	#12970.00	63.2 PK	88.2	-25.0	2.39 V	245	40.0	23.2
4	#12970.00	50.9 AV	68.2	-17.3	2.39 V	245	27.7	23.2

Remarks:

1. Emission Level(dBuV/m) = Raw Value(dBuV) + Correction Factor(dB/m).
2. Correction Factor(dB/m) = Antenna Factor(dB/m) + Cable Factor(dB) – Pre-Amplifier Factor(dB).
3. Margin value = Emission Level – Limit value.
4. The other emission levels were very low against the limit.
5. " * " : Fundamental frequency.
6. " # " : The radiated frequency is out of the restricted band.

RF Mode	TX 802.11ax (HE40)	Channel	CH 115 : 6525 MHz
Frequency Range	1GHz ~ 40GHz	Detector Function	Peak (PK) Average (AV)

Antenna Polarity & Test Distance : Horizontal at 3 m								
No	Frequency (MHz)	Emission Level (dBuV/m)	Limit (dBuV/m)	Margin (dB)	Antenna Height (m)	Table Angle (Degree)	Raw Value (dBuV)	Correction Factor (dB/m)
1	*6525.00	102.2 PK			2.52 H	210	55.7	46.5
2	*6525.00	89.8 AV			2.52 H	210	43.3	46.5
3	#13050.00	62.7 PK	88.2	-25.5	2.69 H	167	39.4	23.3
4	#13050.00	49.7 AV	68.2	-18.5	2.69 H	167	26.4	23.3
Antenna Polarity & Test Distance : Vertical at 3 m								
No	Frequency (MHz)	Emission Level (dBuV/m)	Limit (dBuV/m)	Margin (dB)	Antenna Height (m)	Table Angle (Degree)	Raw Value (dBuV)	Correction Factor (dB/m)
1	*6525.00	110.1 PK			2.57 V	4	63.6	46.5
2	*6525.00	98.3 AV			2.57 V	4	51.8	46.5
3	#13050.00	62.9 PK	88.2	-25.3	2.84 V	236	39.6	23.3
4	#13050.00	50.5 AV	68.2	-17.7	2.84 V	236	27.2	23.3

Remarks:

1. Emission Level(dBuV/m) = Raw Value(dBuV) + Correction Factor(dB/m).
2. Correction Factor(dB/m) = Antenna Factor(dB/m) + Cable Factor(dB) – Pre-Amplifier Factor(dB).
3. Margin value = Emission Level – Limit value.
4. The other emission levels were very low against the limit.
5. " * " : Fundamental frequency.
6. " # " : The radiated frequency is out of the restricted band.

RF Mode	TX 802.11ax (HE40)	Channel	CH 123 : 6565 MHz
Frequency Range	1GHz ~ 40GHz	Detector Function	Peak (PK) Average (AV)

Antenna Polarity & Test Distance : Horizontal at 3 m								
No	Frequency (MHz)	Emission Level (dBuV/m)	Limit (dBuV/m)	Margin (dB)	Antenna Height (m)	Table Angle (Degree)	Raw Value (dBuV)	Correction Factor (dB/m)
1	*6565.00	102.4 PK			2.66 H	208	55.8	46.6
2	*6565.00	89.4 AV			2.66 H	208	42.8	46.6
3	#13130.00	62.8 PK	88.2	-25.4	2.69 H	168	39.3	23.5
4	#13130.00	49.6 AV	68.2	-18.6	2.69 H	168	26.1	23.5
Antenna Polarity & Test Distance : Vertical at 3 m								
No	Frequency (MHz)	Emission Level (dBuV/m)	Limit (dBuV/m)	Margin (dB)	Antenna Height (m)	Table Angle (Degree)	Raw Value (dBuV)	Correction Factor (dB/m)
1	*6565.00	111.1 PK			2.63 V	3	64.5	46.6
2	*6565.00	98.7 AV			2.63 V	3	52.1	46.6
3	#13130.00	63.5 PK	88.2	-24.7	2.86 V	277	40.0	23.5
4	#13130.00	50.5 AV	68.2	-17.7	2.86 V	277	27.0	23.5

Remarks:

1. Emission Level(dBuV/m) = Raw Value(dBuV) + Correction Factor(dB/m).
2. Correction Factor(dB/m) = Antenna Factor(dB/m) + Cable Factor(dB) – Pre-Amplifier Factor(dB).
3. Margin value = Emission Level – Limit value.
4. The other emission levels were very low against the limit.
5. " * " : Fundamental frequency.
6. " # " : The radiated frequency is out of the restricted band.

RF Mode	TX 802.11ax (HE40)	Channel	CH 155 : 6725 MHz
Frequency Range	1GHz ~ 40GHz	Detector Function	Peak (PK) Average (AV)

Antenna Polarity & Test Distance : Horizontal at 3 m								
No	Frequency (MHz)	Emission Level (dBuV/m)	Limit (dBuV/m)	Margin (dB)	Antenna Height (m)	Table Angle (Degree)	Raw Value (dBuV)	Correction Factor (dB/m)
1	*6725.00	101.2 PK			2.61 H	216	54.4	46.8
2	*6725.00	88.2 AV			2.61 H	216	41.4	46.8
3	#13450.00	63.7 PK	88.2	-24.5	2.75 H	171	39.3	24.4
4	#13450.00	50.7 AV	68.2	-17.5	2.75 H	171	26.3	24.4
Antenna Polarity & Test Distance : Vertical at 3 m								
No	Frequency (MHz)	Emission Level (dBuV/m)	Limit (dBuV/m)	Margin (dB)	Antenna Height (m)	Table Angle (Degree)	Raw Value (dBuV)	Correction Factor (dB/m)
1	*6725.00	111.1 PK			2.76 V	2	64.3	46.8
2	*6725.00	98.5 AV			2.76 V	2	51.7	46.8
3	#13450.00	64.2 PK	88.2	-24.0	2.81 V	223	39.8	24.4
4	#13450.00	51.0 AV	68.2	-17.2	2.81 V	223	26.6	24.4

Remarks:

1. Emission Level(dBuV/m) = Raw Value(dBuV) + Correction Factor(dB/m).
2. Correction Factor(dB/m) = Antenna Factor(dB/m) + Cable Factor(dB) – Pre-Amplifier Factor(dB).
3. Margin value = Emission Level – Limit value.
4. The other emission levels were very low against the limit.
5. " * " : Fundamental frequency.
6. " # " : The radiated frequency is out of the restricted band.

RF Mode	TX 802.11ax (HE40)	Channel	CH 179 : 6845 MHz
Frequency Range	1GHz ~ 40GHz	Detector Function	Peak (PK) Average (AV)

Antenna Polarity & Test Distance : Horizontal at 3 m								
No	Frequency (MHz)	Emission Level (dBuV/m)	Limit (dBuV/m)	Margin (dB)	Antenna Height (m)	Table Angle (Degree)	Raw Value (dBuV)	Correction Factor (dB/m)
1	*6845.00	102.2 PK			2.83 H	222	55.2	47.0
2	*6845.00	89.4 AV			2.83 H	222	42.4	47.0
3	#13690.00	64.2 PK	88.2	-24.0	2.66 H	168	39.3	24.9
4	#13690.00	51.1 AV	68.2	-17.1	2.66 H	168	26.2	24.9
Antenna Polarity & Test Distance : Vertical at 3 m								
No	Frequency (MHz)	Emission Level (dBuV/m)	Limit (dBuV/m)	Margin (dB)	Antenna Height (m)	Table Angle (Degree)	Raw Value (dBuV)	Correction Factor (dB/m)
1	*6845.00	111.1 PK			2.57 V	1	64.1	47.0
2	*6845.00	98.8 AV			2.57 V	1	51.8	47.0
3	#13690.00	65.2 PK	88.2	-23.0	2.95 V	263	40.3	24.9
4	#13690.00	51.8 AV	68.2	-16.4	2.95 V	263	26.9	24.9

Remarks:

1. Emission Level(dBuV/m) = Raw Value(dBuV) + Correction Factor(dB/m).
2. Correction Factor(dB/m) = Antenna Factor(dB/m) + Cable Factor(dB) – Pre-Amplifier Factor(dB).
3. Margin value = Emission Level – Limit value.
4. The other emission levels were very low against the limit.
5. " * " : Fundamental frequency.
6. " # " : The radiated frequency is out of the restricted band.

RF Mode	TX 802.11ax (HE40)	Channel	CH 187 : 6885 MHz
Frequency Range	1GHz ~ 40GHz	Detector Function	Peak (PK) Average (AV)

Antenna Polarity & Test Distance : Horizontal at 3 m								
No	Frequency (MHz)	Emission Level (dBuV/m)	Limit (dBuV/m)	Margin (dB)	Antenna Height (m)	Table Angle (Degree)	Raw Value (dBuV)	Correction Factor (dB/m)
1	*6885.00	106.1 PK			2.99 H	219	58.8	47.3
2	*6885.00	94.6 AV			2.99 H	219	47.3	47.3
3	#13770.00	64.3 PK	88.2	-23.9	2.86 H	182	39.2	25.1
4	#13770.00	51.4 AV	68.2	-16.8	2.86 H	182	26.3	25.1
Antenna Polarity & Test Distance : Vertical at 3 m								
No	Frequency (MHz)	Emission Level (dBuV/m)	Limit (dBuV/m)	Margin (dB)	Antenna Height (m)	Table Angle (Degree)	Raw Value (dBuV)	Correction Factor (dB/m)
1	*6885.00	111.4 PK			2.78 V	4	64.1	47.3
2	*6885.00	98.9 AV			2.78 V	4	51.6	47.3
3	#13770.00	65.5 PK	88.2	-22.7	2.89 V	263	40.4	25.1
4	#13770.00	52.0 AV	68.2	-16.2	2.89 V	263	26.9	25.1

Remarks:

1. Emission Level(dBuV/m) = Raw Value(dBuV) + Correction Factor(dB/m).
2. Correction Factor(dB/m) = Antenna Factor(dB/m) + Cable Factor(dB) – Pre-Amplifier Factor(dB).
3. Margin value = Emission Level – Limit value.
4. The other emission levels were very low against the limit.
5. " * " : Fundamental frequency.
6. " # " : The radiated frequency is out of the restricted band.

RF Mode	TX 802.11ax (HE40)	Channel	CH 211 : 7005 MHz
Frequency Range	1GHz ~ 40GHz	Detector Function	Peak (PK) Average (AV)

Antenna Polarity & Test Distance : Horizontal at 3 m								
No	Frequency (MHz)	Emission Level (dBuV/m)	Limit (dBuV/m)	Margin (dB)	Antenna Height (m)	Table Angle (Degree)	Raw Value (dBuV)	Correction Factor (dB/m)
1	*7005.00	106.8 PK			2.96 H	215	58.7	48.1
2	*7005.00	95.4 AV			2.96 H	215	47.3	48.1
3	#14010.00	64.9 PK	88.2	-23.3	2.88 H	169	39.2	25.7
4	#14010.00	52.0 AV	68.2	-16.2	2.88 H	169	26.3	25.7
Antenna Polarity & Test Distance : Vertical at 3 m								
No	Frequency (MHz)	Emission Level (dBuV/m)	Limit (dBuV/m)	Margin (dB)	Antenna Height (m)	Table Angle (Degree)	Raw Value (dBuV)	Correction Factor (dB/m)
1	*7005.00	110.4 PK			2.52 V	6	62.3	48.1
2	*7005.00	98.5 AV			2.52 V	6	50.4	48.1
3	#14010.00	65.2 PK	88.2	-23.0	2.85 V	247	39.5	25.7
4	#14010.00	52.3 AV	68.2	-15.9	2.85 V	247	26.6	25.7

Remarks:

1. Emission Level(dBuV/m) = Raw Value(dBuV) + Correction Factor(dB/m).
2. Correction Factor(dB/m) = Antenna Factor(dB/m) + Cable Factor(dB) – Pre-Amplifier Factor(dB).
3. Margin value = Emission Level – Limit value.
4. The other emission levels were very low against the limit.
5. " * " : Fundamental frequency.
6. " # " : The radiated frequency is out of the restricted band.

RF Mode	TX 802.11ax (HE40)	Channel	CH 227 : 7085 MHz
Frequency Range	1GHz ~ 40GHz	Detector Function	Peak (PK) Average (AV)

Antenna Polarity & Test Distance : Horizontal at 3 m								
No	Frequency (MHz)	Emission Level (dBuV/m)	Limit (dBuV/m)	Margin (dB)	Antenna Height (m)	Table Angle (Degree)	Raw Value (dBuV)	Correction Factor (dB/m)
1	*7085.00	105.5 PK			3.01 H	217	57.1	48.4
2	*7085.00	95.4 AV			3.01 H	217	47.0	48.4
3	#7125.00	66.0 PK	88.2	-22.2	3.01 H	217	47.9	18.1
4	#7125.00	53.7 AV	68.2	-14.5	3.01 H	217	35.6	18.1
5	#14170.00	65.3 PK	88.2	-22.9	2.69 H	182	39.2	26.1
6	#14170.00	52.2 AV	68.2	-16.0	2.69 H	182	26.1	26.1

Antenna Polarity & Test Distance : Vertical at 3 m								
No	Frequency (MHz)	Emission Level (dBuV/m)	Limit (dBuV/m)	Margin (dB)	Antenna Height (m)	Table Angle (Degree)	Raw Value (dBuV)	Correction Factor (dB/m)
1	*7085.00	110.8 PK			2.55 V	10	62.4	48.4
2	*7085.00	98.6 AV			2.55 V	10	50.2	48.4
3	#7125.00	67.3 PK	88.2	-20.9	2.55 V	10	49.2	18.1
4	#7125.00	56.5 AV	68.2	-11.7	2.55 V	10	38.4	18.1
5	#14170.00	65.5 PK	88.2	-22.7	2.74 V	283	39.4	26.1
6	#14170.00	52.4 AV	68.2	-15.8	2.74 V	283	26.3	26.1

Remarks:

1. Emission Level(dBuV/m) = Raw Value(dBuV) + Correction Factor(dB/m).
2. Correction Factor(dB/m) = Antenna Factor(dB/m) + Cable Factor(dB) – Pre-Amplifier Factor(dB).
3. Margin value = Emission Level – Limit value.
4. The other emission levels were very low against the limit.
5. " * " : Fundamental frequency.
6. " # " : The radiated frequency is out of the restricted band.

RF Mode	TX 802.11ax (HE80)	Channel	CH 7 : 5985 MHz
Frequency Range	1GHz ~ 40GHz	Detector Function	Peak (PK) Average (AV)

Antenna Polarity & Test Distance : Horizontal at 3 m								
No	Frequency (MHz)	Emission Level (dBuV/m)	Limit (dBuV/m)	Margin (dB)	Antenna Height (m)	Table Angle (Degree)	Raw Value (dBuV)	Correction Factor (dB/m)
1	#5925.00	60.0 PK	88.2	-28.2	1.62 H	258	45.6	14.4
2	#5925.00	49.1 AV	68.2	-19.1	1.62 H	258	34.7	14.4
3	*5985.00	98.8 PK			1.62 H	258	54.5	44.3
4	*5985.00	86.8 AV			1.62 H	258	42.5	44.3
5	11970.00	61.1 PK	74.0	-12.9	2.66 H	154	38.2	22.9
6	11970.00	49.7 AV	54.0	-4.3	2.66 H	154	26.8	22.9

Antenna Polarity & Test Distance : Vertical at 3 m								
No	Frequency (MHz)	Emission Level (dBuV/m)	Limit (dBuV/m)	Margin (dB)	Antenna Height (m)	Table Angle (Degree)	Raw Value (dBuV)	Correction Factor (dB/m)
1	#5925.00	60.3 PK	88.2	-27.9	2.75 V	201	45.9	14.4
2	#5925.00	49.2 AV	68.2	-19.0	2.75 V	201	34.8	14.4
3	*5985.00	106.3 PK			2.75 V	201	62.0	44.3
4	*5985.00	94.6 AV			2.75 V	201	50.3	44.3
5	11970.00	61.3 PK	74.0	-12.7	2.03 V	152	38.4	22.9
6	11970.00	49.8 AV	54.0	-4.2	2.03 V	152	26.9	22.9

Remarks:

1. Emission Level(dBuV/m) = Raw Value(dBuV) + Correction Factor(dB/m).
2. Correction Factor(dB/m) = Antenna Factor(dB/m) + Cable Factor(dB) – Pre-Amplifier Factor(dB).
3. Margin value = Emission Level – Limit value.
4. The other emission levels were very low against the limit.
5. " * " : Fundamental frequency.
6. " # " : The radiated frequency is out of the restricted band.

RF Mode	TX 802.11ax (HE80)	Channel	CH 55 : 6225 MHz
Frequency Range	1GHz ~ 40GHz	Detector Function	Peak (PK) Average (AV)

Antenna Polarity & Test Distance : Horizontal at 3 m								
No	Frequency (MHz)	Emission Level (dBuV/m)	Limit (dBuV/m)	Margin (dB)	Antenna Height (m)	Table Angle (Degree)	Raw Value (dBuV)	Correction Factor (dB/m)
1	*6225.00	98.6 PK			1.49 H	207	53.8	44.8
2	*6225.00	86.4 AV			1.49 H	207	41.6	44.8
3	12450.00	60.6 PK	74.0	-13.4	2.72 H	169	38.2	22.4
4	12450.00	48.5 AV	54.0	-5.5	2.72 H	169	26.1	22.4
Antenna Polarity & Test Distance : Vertical at 3 m								
No	Frequency (MHz)	Emission Level (dBuV/m)	Limit (dBuV/m)	Margin (dB)	Antenna Height (m)	Table Angle (Degree)	Raw Value (dBuV)	Correction Factor (dB/m)
1	*6225.00	110.9 PK			2.29 V	18	66.1	44.8
2	*6225.00	98.3 AV			2.29 V	18	53.5	44.8
3	12450.00	62.1 PK	74.0	-11.9	2.24 V	196	39.7	22.4
4	12450.00	49.8 AV	54.0	-4.2	2.24 V	196	27.4	22.4

Remarks:

1. Emission Level(dBuV/m) = Raw Value(dBuV) + Correction Factor(dB/m).
2. Correction Factor(dB/m) = Antenna Factor(dB/m) + Cable Factor(dB) – Pre-Amplifier Factor(dB).
3. Margin value = Emission Level – Limit value.
4. The other emission levels were very low against the limit.
5. " * " : Fundamental frequency.

RF Mode	TX 802.11ax (HE80)	Channel	CH 87 : 6385 MHz
Frequency Range	1GHz ~ 40GHz	Detector Function	Peak (PK) Average (AV)

Antenna Polarity & Test Distance : Horizontal at 3 m								
No	Frequency (MHz)	Emission Level (dBuV/m)	Limit (dBuV/m)	Margin (dB)	Antenna Height (m)	Table Angle (Degree)	Raw Value (dBuV)	Correction Factor (dB/m)
1	*6385.00	98.5 PK			1.47 H	7	52.8	45.7
2	*6385.00	85.9 AV			1.47 H	7	40.2	45.7
3	#12770.00	61.5 PK	88.2	-26.7	2.72 H	172	38.5	23.0
4	#12770.00	49.3 AV	68.2	-18.9	2.72 H	172	26.3	23.0
Antenna Polarity & Test Distance : Vertical at 3 m								
No	Frequency (MHz)	Emission Level (dBuV/m)	Limit (dBuV/m)	Margin (dB)	Antenna Height (m)	Table Angle (Degree)	Raw Value (dBuV)	Correction Factor (dB/m)
1	*6385.00	110.5 PK			2.25 V	3	64.8	45.7
2	*6385.00	98.4 AV			2.25 V	3	52.7	45.7
3	#12770.00	63.2 PK	88.2	-25.0	2.17 V	182	40.2	23.0
4	#12770.00	50.7 AV	68.2	-17.5	2.17 V	182	27.7	23.0

Remarks:

1. Emission Level(dBuV/m) = Raw Value(dBuV) + Correction Factor(dB/m).
2. Correction Factor(dB/m) = Antenna Factor(dB/m) + Cable Factor(dB) – Pre-Amplifier Factor(dB).
3. Margin value = Emission Level – Limit value.
4. The other emission levels were very low against the limit.
5. " * " : Fundamental frequency.
6. " # " : The radiated frequency is out of the restricted band.

RF Mode	TX 802.11ax (HE80)	Channel	CH 103 : 6465 MHz
Frequency Range	1GHz ~ 40GHz	Detector Function	Peak (PK) Average (AV)

Antenna Polarity & Test Distance : Horizontal at 3 m								
No	Frequency (MHz)	Emission Level (dBuV/m)	Limit (dBuV/m)	Margin (dB)	Antenna Height (m)	Table Angle (Degree)	Raw Value (dBuV)	Correction Factor (dB/m)
1	*6465.00	102.0 PK			2.48 H	211	55.9	46.1
2	*6465.00	88.8 AV			2.48 H	211	42.7	46.1
3	#12930.00	62.4 PK	88.2	-25.8	2.65 H	168	39.3	23.1
4	#12930.00	49.2 AV	68.2	-19.0	2.65 H	168	26.1	23.1
Antenna Polarity & Test Distance : Vertical at 3 m								
No	Frequency (MHz)	Emission Level (dBuV/m)	Limit (dBuV/m)	Margin (dB)	Antenna Height (m)	Table Angle (Degree)	Raw Value (dBuV)	Correction Factor (dB/m)
1	*6465.00	110.4 PK			2.30 V	20	64.3	46.1
2	*6465.00	98.5 AV			2.30 V	20	52.4	46.1
3	#12930.00	63.4 PK	88.2	-24.8	2.88 V	245	40.3	23.1
4	#12930.00	50.7 AV	68.2	-17.5	2.88 V	245	27.6	23.1

Remarks:

1. Emission Level(dBuV/m) = Raw Value(dBuV) + Correction Factor(dB/m).
2. Correction Factor(dB/m) = Antenna Factor(dB/m) + Cable Factor(dB) – Pre-Amplifier Factor(dB).
3. Margin value = Emission Level – Limit value.
4. The other emission levels were very low against the limit.
5. " * " : Fundamental frequency.
6. " # " : The radiated frequency is out of the restricted band.

RF Mode	TX 802.11ax (HE80)	Channel	CH 119 : 6545 MHz
Frequency Range	1GHz ~ 40GHz	Detector Function	Peak (PK) Average (AV)

Antenna Polarity & Test Distance : Horizontal at 3 m								
No	Frequency (MHz)	Emission Level (dBuV/m)	Limit (dBuV/m)	Margin (dB)	Antenna Height (m)	Table Angle (Degree)	Raw Value (dBuV)	Correction Factor (dB/m)
1	*6545.00	102.9 PK			2.60 H	212	56.3	46.6
2	*6545.00	89.2 AV			2.60 H	212	42.6	46.6
3	#13090.00	62.6 PK	88.2	-25.6	2.72 H	171	39.3	23.3
4	#13090.00	49.6 AV	68.2	-18.6	2.72 H	171	26.3	23.3
Antenna Polarity & Test Distance : Vertical at 3 m								
No	Frequency (MHz)	Emission Level (dBuV/m)	Limit (dBuV/m)	Margin (dB)	Antenna Height (m)	Table Angle (Degree)	Raw Value (dBuV)	Correction Factor (dB/m)
1	*6545.00	111.7 PK			2.63 V	10	65.1	46.6
2	*6545.00	98.6 AV			2.63 V	10	52.0	46.6
3	#13090.00	63.6 PK	88.2	-24.6	2.78 V	221	40.3	23.3
4	#13090.00	50.8 AV	68.2	-17.4	2.78 V	221	27.5	23.3

Remarks:

1. Emission Level(dBuV/m) = Raw Value(dBuV) + Correction Factor(dB/m).
2. Correction Factor(dB/m) = Antenna Factor(dB/m) + Cable Factor(dB) – Pre-Amplifier Factor(dB).
3. Margin value = Emission Level – Limit value.
4. The other emission levels were very low against the limit.
5. " * " : Fundamental frequency.
6. " # " : The radiated frequency is out of the restricted band.

RF Mode	TX 802.11ax (HE80)	Channel	CH 135 : 6625 MHz
Frequency Range	1GHz ~ 40GHz	Detector Function	Peak (PK) Average (AV)

Antenna Polarity & Test Distance : Horizontal at 3 m								
No	Frequency (MHz)	Emission Level (dBuV/m)	Limit (dBuV/m)	Margin (dB)	Antenna Height (m)	Table Angle (Degree)	Raw Value (dBuV)	Correction Factor (dB/m)
1	*6625.00	101.6 PK			2.51 H	210	55.0	46.6
2	*6625.00	89.0 AV			2.51 H	210	42.4	46.6
3	13250.00	62.9 PK	74.0	-11.1	2.69 H	164	39.3	23.6
4	13250.00	49.9 AV	54.0	-4.1	2.69 H	164	26.3	23.6
Antenna Polarity & Test Distance : Vertical at 3 m								
No	Frequency (MHz)	Emission Level (dBuV/m)	Limit (dBuV/m)	Margin (dB)	Antenna Height (m)	Table Angle (Degree)	Raw Value (dBuV)	Correction Factor (dB/m)
1	*6625.00	111.5 PK			2.57 V	352	64.9	46.6
2	*6625.00	98.8 AV			2.57 V	352	52.2	46.6
3	13250.00	63.7 PK	74.0	-10.3	2.88 V	263	40.1	23.6
4	13250.00	50.5 AV	54.0	-3.5	2.88 V	263	26.9	23.6

Remarks:

1. Emission Level(dBuV/m) = Raw Value(dBuV) + Correction Factor(dB/m).
2. Correction Factor(dB/m) = Antenna Factor(dB/m) + Cable Factor(dB) – Pre-Amplifier Factor(dB).
3. Margin value = Emission Level – Limit value.
4. The other emission levels were very low against the limit.
5. " * " : Fundamental frequency.

RF Mode	TX 802.11ax (HE80)	Channel	CH 151 : 6705 MHz
Frequency Range	1GHz ~ 40GHz	Detector Function	Peak (PK) Average (AV)

Antenna Polarity & Test Distance : Horizontal at 3 m								
No	Frequency (MHz)	Emission Level (dBuV/m)	Limit (dBuV/m)	Margin (dB)	Antenna Height (m)	Table Angle (Degree)	Raw Value (dBuV)	Correction Factor (dB/m)
1	*6705.00	102.0 PK			2.52 H	208	55.2	46.8
2	*6705.00	88.6 AV			2.52 H	208	41.8	46.8
3	#13410.00	63.7 PK	88.2	-24.5	2.78 H	169	39.3	24.4
4	#13410.00	50.7 AV	68.2	-17.5	2.78 H	169	26.3	24.4
Antenna Polarity & Test Distance : Vertical at 3 m								
No	Frequency (MHz)	Emission Level (dBuV/m)	Limit (dBuV/m)	Margin (dB)	Antenna Height (m)	Table Angle (Degree)	Raw Value (dBuV)	Correction Factor (dB/m)
1	*6705.00	112.3 PK			2.69 V	3	65.5	46.8
2	*6705.00	98.9 AV			2.69 V	3	52.1	46.8
3	#13410.00	64.7 PK	88.2	-23.5	2.72 V	253	40.3	24.4
4	#13410.00	51.6 AV	68.2	-16.6	2.72 V	253	27.2	24.4

Remarks:

1. Emission Level(dBuV/m) = Raw Value(dBuV) + Correction Factor(dB/m).
2. Correction Factor(dB/m) = Antenna Factor(dB/m) + Cable Factor(dB) – Pre-Amplifier Factor(dB).
3. Margin value = Emission Level – Limit value.
4. The other emission levels were very low against the limit.
5. " * " : Fundamental frequency.
6. " # " : The radiated frequency is out of the restricted band.

RF Mode	TX 802.11ax (HE80)	Channel	CH 167 : 6785 MHz
Frequency Range	1GHz ~ 40GHz	Detector Function	Peak (PK) Average (AV)

Antenna Polarity & Test Distance : Horizontal at 3 m								
No	Frequency (MHz)	Emission Level (dBuV/m)	Limit (dBuV/m)	Margin (dB)	Antenna Height (m)	Table Angle (Degree)	Raw Value (dBuV)	Correction Factor (dB/m)
1	*6785.00	100.8 PK			2.70 H	212	53.9	46.9
2	*6785.00	88.0 AV			2.70 H	212	41.1	46.9
3	#13570.00	63.9 PK	88.2	-24.3	2.69 H	168	39.3	24.6
4	#13570.00	50.7 AV	68.2	-17.5	2.69 H	168	26.1	24.6
Antenna Polarity & Test Distance : Vertical at 3 m								
No	Frequency (MHz)	Emission Level (dBuV/m)	Limit (dBuV/m)	Margin (dB)	Antenna Height (m)	Table Angle (Degree)	Raw Value (dBuV)	Correction Factor (dB/m)
1	*6785.00	111.3 PK			2.71 V	3	64.4	46.9
2	*6785.00	98.6 AV			2.71 V	3	51.7	46.9
3	#13570.00	64.0 PK	88.2	-24.2	2.64 V	273	39.4	24.6
4	#13570.00	51.3 AV	68.2	-16.9	2.64 V	273	26.7	24.6

Remarks:

1. Emission Level(dBuV/m) = Raw Value(dBuV) + Correction Factor(dB/m).
2. Correction Factor(dB/m) = Antenna Factor(dB/m) + Cable Factor(dB) – Pre-Amplifier Factor(dB).
3. Margin value = Emission Level – Limit value.
4. The other emission levels were very low against the limit.
5. " * " : Fundamental frequency.
6. " # " : The radiated frequency is out of the restricted band.

RF Mode	TX 802.11ax (HE80)	Channel	CH 183 : 6865 MHz
Frequency Range	1GHz ~ 40GHz	Detector Function	Peak (PK) Average (AV)

Antenna Polarity & Test Distance : Horizontal at 3 m								
No	Frequency (MHz)	Emission Level (dBuV/m)	Limit (dBuV/m)	Margin (dB)	Antenna Height (m)	Table Angle (Degree)	Raw Value (dBuV)	Correction Factor (dB/m)
1	*6865.00	101.5 PK			2.75 H	169	54.4	47.1
2	*6865.00	89.2 AV			2.75 H	169	42.1	47.1
3	#13730.00	64.3 PK	88.2	-23.9	2.68 H	165	39.3	25.0
4	#13730.00	51.1 AV	68.2	-17.1	2.68 H	165	26.1	25.0
Antenna Polarity & Test Distance : Vertical at 3 m								
No	Frequency (MHz)	Emission Level (dBuV/m)	Limit (dBuV/m)	Margin (dB)	Antenna Height (m)	Table Angle (Degree)	Raw Value (dBuV)	Correction Factor (dB/m)
1	*6865.00	111.0 PK			2.59 V	3	63.9	47.1
2	*6865.00	98.1 AV			2.59 V	3	51.0	47.1
3	#13730.00	63.7 PK	88.2	-24.5	2.43 V	276	38.7	25.0
4	#13730.00	51.4 AV	68.2	-16.8	2.43 V	276	26.4	25.0

Remarks:

1. Emission Level(dBuV/m) = Raw Value(dBuV) + Correction Factor(dB/m).
2. Correction Factor(dB/m) = Antenna Factor(dB/m) + Cable Factor(dB) – Pre-Amplifier Factor(dB).
3. Margin value = Emission Level – Limit value.
4. The other emission levels were very low against the limit.
5. " * " : Fundamental frequency.
6. " # " : The radiated frequency is out of the restricted band.

RF Mode	TX 802.11ax (HE80)	Channel	CH 199 : 6945 MHz
Frequency Range	1GHz ~ 40GHz	Detector Function	Peak (PK) Average (AV)

Antenna Polarity & Test Distance : Horizontal at 3 m								
No	Frequency (MHz)	Emission Level (dBuV/m)	Limit (dBuV/m)	Margin (dB)	Antenna Height (m)	Table Angle (Degree)	Raw Value (dBuV)	Correction Factor (dB/m)
1	*6945.00	105.7 PK			2.96 H	217	57.8	47.9
2	*6945.00	95.8 AV			2.96 H	217	47.9	47.9
3	#13890.00	64.4 PK	88.2	-23.8	2.69 H	182	39.2	25.2
4	#13890.00	51.4 AV	68.2	-16.8	2.69 H	182	26.2	25.2
Antenna Polarity & Test Distance : Vertical at 3 m								
No	Frequency (MHz)	Emission Level (dBuV/m)	Limit (dBuV/m)	Margin (dB)	Antenna Height (m)	Table Angle (Degree)	Raw Value (dBuV)	Correction Factor (dB/m)
1	*6945.00	111.0 PK			2.55 V	6	63.1	47.9
2	*6945.00	98.7 AV			2.55 V	6	50.8	47.9
3	#13890.00	65.6 PK	88.2	-22.6	2.85 V	243	40.4	25.2
4	#13890.00	52.0 AV	68.2	-16.2	2.85 V	243	26.8	25.2

Remarks:

1. Emission Level(dBuV/m) = Raw Value(dBuV) + Correction Factor(dB/m).
2. Correction Factor(dB/m) = Antenna Factor(dB/m) + Cable Factor(dB) – Pre-Amplifier Factor(dB).
3. Margin value = Emission Level – Limit value.
4. The other emission levels were very low against the limit.
5. " * " : Fundamental frequency.
6. " # " : The radiated frequency is out of the restricted band.

RF Mode	TX 802.11ax (HE80)	Channel	CH 215 : 7025 MHz
Frequency Range	1GHz ~ 40GHz	Detector Function	Peak (PK) Average (AV)

Antenna Polarity & Test Distance : Horizontal at 3 m								
No	Frequency (MHz)	Emission Level (dBuV/m)	Limit (dBuV/m)	Margin (dB)	Antenna Height (m)	Table Angle (Degree)	Raw Value (dBuV)	Correction Factor (dB/m)
1	*7025.00	106.6 PK			3.11 H	217	58.5	48.1
2	*7025.00	95.5 AV			3.11 H	217	47.4	48.1
3	#7125.00	65.5 PK	88.2	-22.7	3.11 H	217	47.4	18.1
4	#7125.00	53.9 AV	68.2	-14.3	3.11 H	217	35.8	18.1
5	#14050.00	64.8 PK	88.2	-23.4	2.79 H	173	39.1	25.7
6	#14050.00	51.9 AV	68.2	-16.3	2.79 H	173	26.2	25.7

Antenna Polarity & Test Distance : Vertical at 3 m								
No	Frequency (MHz)	Emission Level (dBuV/m)	Limit (dBuV/m)	Margin (dB)	Antenna Height (m)	Table Angle (Degree)	Raw Value (dBuV)	Correction Factor (dB/m)
1	*7025.00	110.7 PK			2.54 V	11	62.6	48.1
2	*7025.00	98.8 AV			2.54 V	11	50.7	48.1
3	#7125.00	65.9 PK	88.2	-22.3	2.54 V	11	47.8	18.1
4	#7125.00	55.7 AV	68.2	-12.5	2.54 V	11	37.6	18.1
5	#14050.00	65.0 PK	88.2	-23.2	2.65 V	273	39.3	25.7
6	#14050.00	52.1 AV	68.2	-16.1	2.65 V	273	26.4	25.7

Remarks:

1. Emission Level(dBuV/m) = Raw Value(dBuV) + Correction Factor(dB/m).
2. Correction Factor(dB/m) = Antenna Factor(dB/m) + Cable Factor(dB) – Pre-Amplifier Factor(dB).
3. Margin value = Emission Level – Limit value.
4. The other emission levels were very low against the limit.
5. " * " : Fundamental frequency.
6. " # " : The radiated frequency is out of the restricted band.

RF Mode	TX 802.11ax (HE160)	Channel	CH 15 : 6025 MHz
Frequency Range	1GHz ~ 40GHz	Detector Function	Peak (PK) Average (AV)

Antenna Polarity & Test Distance : Horizontal at 3 m								
No	Frequency (MHz)	Emission Level (dBuV/m)	Limit (dBuV/m)	Margin (dB)	Antenna Height (m)	Table Angle (Degree)	Raw Value (dBuV)	Correction Factor (dB/m)
1	#5925.00	66.8 PK	88.2	-21.4	1.62 H	258	52.4	14.4
2	#5925.00	50.3 AV	68.2	-17.9	1.62 H	258	35.9	14.4
3	*6025.00	97.2 PK			1.62 H	258	52.9	44.3
4	*6025.00	85.3 AV			1.62 H	258	41.0	44.3
5	12050.00	61.2 PK	74.0	-12.8	2.69 H	158	38.5	22.7
6	12050.00	49.4 AV	54.0	-4.6	2.69 H	158	26.7	22.7

Antenna Polarity & Test Distance : Vertical at 3 m								
No	Frequency (MHz)	Emission Level (dBuV/m)	Limit (dBuV/m)	Margin (dB)	Antenna Height (m)	Table Angle (Degree)	Raw Value (dBuV)	Correction Factor (dB/m)
1	#5925.00	71.8 PK	88.2	-16.4	2.28 V	200	57.4	14.4
2	#5925.00	51.2 AV	68.2	-17.0	2.28 V	200	36.8	14.4
3	*6025.00	104.6 PK			2.28 V	200	60.3	44.3
4	*6025.00	92.5 AV			2.28 V	200	48.2	44.3
5	12050.00	61.3 PK	74.0	-12.7	2.26 V	124	38.6	22.7
6	12050.00	49.5 AV	54.0	-4.5	2.26 V	124	26.8	22.7

Remarks:

1. Emission Level(dBuV/m) = Raw Value(dBuV) + Correction Factor(dB/m).
2. Correction Factor(dB/m) = Antenna Factor(dB/m) + Cable Factor(dB) – Pre-Amplifier Factor(dB).
3. Margin value = Emission Level – Limit value.
4. The other emission levels were very low against the limit.
5. " * " : Fundamental frequency.
6. " # " : The radiated frequency is out of the restricted band.

RF Mode	TX 802.11ax (HE160)	Channel	CH 47 : 6185 MHz
Frequency Range	1GHz ~ 40GHz	Detector Function	Peak (PK) Average (AV)

Antenna Polarity & Test Distance : Horizontal at 3 m								
No	Frequency (MHz)	Emission Level (dBuV/m)	Limit (dBuV/m)	Margin (dB)	Antenna Height (m)	Table Angle (Degree)	Raw Value (dBuV)	Correction Factor (dB/m)
1	#5925.00	61.9 PK	88.2	-26.3	1.49 H	207	47.5	14.4
2	#5925.00	48.9 AV	68.2	-19.3	1.49 H	207	34.5	14.4
3	*6185.00	99.4 PK			1.49 H	207	54.7	44.7
4	*6185.00	86.2 AV			1.49 H	207	41.5	44.7
5	12370.00	60.4 PK	74.0	-13.6	2.66 H	165	38.0	22.4
6	12370.00	48.5 AV	54.0	-5.5	2.66 H	165	26.1	22.4

Antenna Polarity & Test Distance : Vertical at 3 m								
No	Frequency (MHz)	Emission Level (dBuV/m)	Limit (dBuV/m)	Margin (dB)	Antenna Height (m)	Table Angle (Degree)	Raw Value (dBuV)	Correction Factor (dB/m)
1	#5925.00	51.0 PK	88.2	-37.2	1.67 V	7	36.6	14.4
2	#5925.00	41.2 AV	68.2	-27.0	1.67 V	7	26.8	14.4
3	*6185.00	111.3 PK			1.67 V	7	66.6	44.7
4	*6185.00	98.6 AV			1.67 V	7	53.9	44.7
5	12370.00	63.0 PK	74.0	-11.0	2.24 V	186	40.6	22.4
6	12370.00	50.5 AV	54.0	-3.5	2.24 V	186	28.1	22.4

Remarks:

1. Emission Level(dBuV/m) = Raw Value(dBuV) + Correction Factor(dB/m).
2. Correction Factor(dB/m) = Antenna Factor(dB/m) + Cable Factor(dB) – Pre-Amplifier Factor(dB).
3. Margin value = Emission Level – Limit value.
4. The other emission levels were very low against the limit.
5. " * ": Fundamental frequency.

RF Mode	TX 802.11ax (HE160)	Channel	CH 79 : 6345 MHz
Frequency Range	1GHz ~ 40GHz	Detector Function	Peak (PK) Average (AV)

Antenna Polarity & Test Distance : Horizontal at 3 m								
No	Frequency (MHz)	Emission Level (dBuV/m)	Limit (dBuV/m)	Margin (dB)	Antenna Height (m)	Table Angle (Degree)	Raw Value (dBuV)	Correction Factor (dB/m)
1	*6345.00	98.8 PK			1.38 H	207	53.4	45.4
2	*6345.00	87.0 AV			1.38 H	207	41.6	45.4
3	12690.00	60.9 PK	74.0	-13.1	2.69 H	163	38.2	22.7
4	12690.00	49.0 AV	54.0	-5.0	2.69 H	163	26.3	22.7
Antenna Polarity & Test Distance : Vertical at 3 m								
No	Frequency (MHz)	Emission Level (dBuV/m)	Limit (dBuV/m)	Margin (dB)	Antenna Height (m)	Table Angle (Degree)	Raw Value (dBuV)	Correction Factor (dB/m)
1	*6345.00	111.8 PK			1.83 V	7	66.4	45.4
2	*6345.00	98.3 AV			1.83 V	7	52.9	45.4
3	12690.00	63.0 PK	74.0	-11.0	2.11 V	193	40.3	22.7
4	12690.00	50.4 AV	54.0	-3.6	2.11 V	193	27.7	22.7

Remarks:

1. Emission Level(dBuV/m) = Raw Value(dBuV) + Correction Factor(dB/m).
2. Correction Factor(dB/m) = Antenna Factor(dB/m) + Cable Factor(dB) – Pre-Amplifier Factor(dB).
3. Margin value = Emission Level – Limit value.
4. The other emission levels were very low against the limit.
5. " * " : Fundamental frequency.

RF Mode	TX 802.11ax (HE160)	Channel	CH 111 : 6505 MHz
Frequency Range	1GHz ~ 40GHz	Detector Function	Peak (PK) Average (AV)

Antenna Polarity & Test Distance : Horizontal at 3 m								
No	Frequency (MHz)	Emission Level (dBuV/m)	Limit (dBuV/m)	Margin (dB)	Antenna Height (m)	Table Angle (Degree)	Raw Value (dBuV)	Correction Factor (dB/m)
1	*6505.00	103.1 PK			2.56 H	210	56.8	46.3
2	*6505.00	90.7 AV			2.56 H	210	44.4	46.3
3	#13010.00	62.7 PK	88.2	-25.5	2.73 H	173	39.5	23.2
4	#13010.00	49.6 AV	68.2	-18.6	2.73 H	173	26.4	23.2
Antenna Polarity & Test Distance : Vertical at 3 m								
No	Frequency (MHz)	Emission Level (dBuV/m)	Limit (dBuV/m)	Margin (dB)	Antenna Height (m)	Table Angle (Degree)	Raw Value (dBuV)	Correction Factor (dB/m)
1	*6505.00	110.4 PK			2.65 V	1	64.1	46.3
2	*6505.00	98.5 AV			2.65 V	1	52.2	46.3
3	#13010.00	63.7 PK	88.2	-24.5	2.66 V	281	40.5	23.2
4	#13010.00	51.0 AV	68.2	-17.2	2.66 V	281	27.8	23.2

Remarks:

1. Emission Level(dBuV/m) = Raw Value(dBuV) + Correction Factor(dB/m).
2. Correction Factor(dB/m) = Antenna Factor(dB/m) + Cable Factor(dB) – Pre-Amplifier Factor(dB).
3. Margin value = Emission Level – Limit value.
4. The other emission levels were very low against the limit.
5. " * " : Fundamental frequency.
6. " # " : The radiated frequency is out of the restricted band.

RF Mode	TX 802.11ax (HE160)	Channel	CH 143 : 6665 MHz
Frequency Range	1GHz ~ 40GHz	Detector Function	Peak (PK) Average (AV)

Antenna Polarity & Test Distance : Horizontal at 3 m								
No	Frequency (MHz)	Emission Level (dBuV/m)	Limit (dBuV/m)	Margin (dB)	Antenna Height (m)	Table Angle (Degree)	Raw Value (dBuV)	Correction Factor (dB/m)
1	*6665.00	101.1 PK			2.64 H	207	54.4	46.7
2	*6665.00	88.9 AV			2.64 H	207	42.2	46.7
3	13330.00	63.4 PK	74.0	-10.6	2.75 H	173	39.5	23.9
4	13330.00	50.2 AV	54.0	-3.8	2.75 H	173	26.3	23.9
Antenna Polarity & Test Distance : Vertical at 3 m								
No	Frequency (MHz)	Emission Level (dBuV/m)	Limit (dBuV/m)	Margin (dB)	Antenna Height (m)	Table Angle (Degree)	Raw Value (dBuV)	Correction Factor (dB/m)
1	*6665.00	110.9 PK			2.64 V	355	64.2	46.7
2	*6665.00	98.5 AV			2.64 V	355	51.8	46.7
3	13330.00	63.5 PK	74.0	-10.5	2.84 V	265	39.6	23.9
4	13330.00	50.8 AV	54.0	-3.2	2.84 V	265	26.9	23.9

Remarks:

1. Emission Level(dBuV/m) = Raw Value(dBuV) + Correction Factor(dB/m).
2. Correction Factor(dB/m) = Antenna Factor(dB/m) + Cable Factor(dB) – Pre-Amplifier Factor(dB).
3. Margin value = Emission Level – Limit value.
4. The other emission levels were very low against the limit.
5. " * " : Fundamental frequency.

RF Mode	TX 802.11ax (HE160)	Channel	CH 175 : 6825 MHz
Frequency Range	1GHz ~ 40GHz	Detector Function	Peak (PK) Average (AV)

Antenna Polarity & Test Distance : Horizontal at 3 m								
No	Frequency (MHz)	Emission Level (dBuV/m)	Limit (dBuV/m)	Margin (dB)	Antenna Height (m)	Table Angle (Degree)	Raw Value (dBuV)	Correction Factor (dB/m)
1	*6825.00	101.3 PK			2.78 H	224	54.4	46.9
2	*6825.00	87.9 AV			2.78 H	224	41.0	46.9
3	#13650.00	63.9 PK	88.2	-24.3	2.69 H	168	39.2	24.7
4	#13650.00	51.0 AV	68.2	-17.2	2.69 H	168	26.3	24.7
Antenna Polarity & Test Distance : Vertical at 3 m								
No	Frequency (MHz)	Emission Level (dBuV/m)	Limit (dBuV/m)	Margin (dB)	Antenna Height (m)	Table Angle (Degree)	Raw Value (dBuV)	Correction Factor (dB/m)
1	*6825.00	111.4 PK			2.64 V	3	64.5	46.9
2	*6825.00	98.5 AV			2.64 V	3	51.6	46.9
3	#13650.00	65.0 PK	88.2	-23.2	2.66 V	235	40.3	24.7
4	#13650.00	52.1 AV	68.2	-16.1	2.66 V	235	27.4	24.7

Remarks:

1. Emission Level(dBuV/m) = Raw Value(dBuV) + Correction Factor(dB/m).
2. Correction Factor(dB/m) = Antenna Factor(dB/m) + Cable Factor(dB) – Pre-Amplifier Factor(dB).
3. Margin value = Emission Level – Limit value.
4. The other emission levels were very low against the limit.
5. " * " : Fundamental frequency.
6. " # " : The radiated frequency is out of the restricted band.

RF Mode	TX 802.11ax (HE160)	Channel	CH 207 : 6985 MHz
Frequency Range	1GHz ~ 40GHz	Detector Function	Peak (PK) Average (AV)

Antenna Polarity & Test Distance : Horizontal at 3 m								
No	Frequency (MHz)	Emission Level (dBuV/m)	Limit (dBuV/m)	Margin (dB)	Antenna Height (m)	Table Angle (Degree)	Raw Value (dBuV)	Correction Factor (dB/m)
1	*6985.00	105.2 PK			3.04 H	218	57.2	48.0
2	*6985.00	93.4 AV			3.04 H	218	45.4	48.0
3	#7125.00	69.4 PK	88.2	-18.8	3.04 H	218	51.3	18.1
4	#7125.00	54.7 AV	68.2	-13.5	3.04 H	218	36.6	18.1
5	#13970.00	64.8 PK	88.2	-23.4	2.69 H	172	39.2	25.6
6	#13970.00	51.8 AV	68.2	-16.4	2.69 H	172	26.2	25.6

Antenna Polarity & Test Distance : Vertical at 3 m								
No	Frequency (MHz)	Emission Level (dBuV/m)	Limit (dBuV/m)	Margin (dB)	Antenna Height (m)	Table Angle (Degree)	Raw Value (dBuV)	Correction Factor (dB/m)
1	*6985.00	111.1 PK			2.43 V	8	63.1	48.0
2	*6985.00	98.4 AV			2.43 V	8	50.4	48.0
3	#7125.00	76.9 PK	88.2	-11.3	2.43 V	8	58.8	18.1
4	#7125.00	57.9 AV	68.2	-10.3	2.43 V	8	39.8	18.1
5	#13970.00	66.1 PK	88.2	-22.1	2.69 V	272	40.5	25.6
6	#13970.00	52.9 AV	68.2	-15.3	2.69 V	272	27.3	25.6

Remarks:

1. Emission Level(dBuV/m) = Raw Value(dBuV) + Correction Factor(dB/m).
2. Correction Factor(dB/m) = Antenna Factor(dB/m) + Cable Factor(dB) – Pre-Amplifier Factor(dB).
3. Margin value = Emission Level – Limit value.
4. The other emission levels were very low against the limit.
5. " * " : Fundamental frequency.
6. " # " : The radiated frequency is out of the restricted band.

Nss 2

RF Mode	TX 802.11ax (HE20)	Channel	CH 1 : 5955 MHz
Frequency Range	1GHz ~ 40GHz	Detector Function	Peak (PK) Average (AV)

Antenna Polarity & Test Distance : Horizontal at 3 m								
No	Frequency (MHz)	Emission Level (dBuV/m)	Limit (dBuV/m)	Margin (dB)	Antenna Height (m)	Table Angle (Degree)	Raw Value (dBuV)	Correction Factor (dB/m)
1	#5925.00	59.9 PK	88.2	-28.3	1.62 H	257	45.5	14.4
2	#5925.00	48.7 AV	68.2	-19.5	1.62 H	257	34.3	14.4
3	*5955.00	99.6 PK			1.62 H	257	55.3	44.3
4	*5955.00	88.1 AV			1.62 H	257	43.8	44.3
5	11910.00	61.4 PK	74.0	-12.6	2.63 H	155	38.5	22.9
6	11910.00	49.6 AV	54.0	-4.4	2.63 H	155	26.7	22.9

Antenna Polarity & Test Distance : Vertical at 3 m								
No	Frequency (MHz)	Emission Level (dBuV/m)	Limit (dBuV/m)	Margin (dB)	Antenna Height (m)	Table Angle (Degree)	Raw Value (dBuV)	Correction Factor (dB/m)
1	#5925.00	60.2 PK	88.2	-28.0	2.17 V	197	45.8	14.4
2	#5925.00	49.0 AV	68.2	-19.2	2.17 V	197	34.6	14.4
3	*5955.00	107.1 PK			2.17 V	197	62.8	44.3
4	*5955.00	94.8 AV			2.17 V	197	50.5	44.3
5	11910.00	61.5 PK	74.0	-12.5	2.29 V	174	38.6	22.9
6	11910.00	49.7 AV	54.0	-4.3	2.29 V	174	26.8	22.9

Remarks:

1. Emission Level(dBuV/m) = Raw Value(dBuV) + Correction Factor(dB/m).
2. Correction Factor(dB/m) = Antenna Factor(dB/m) + Cable Factor(dB) – Pre-Amplifier Factor(dB).
3. Margin value = Emission Level – Limit value.
4. The other emission levels were very low against the limit.
5. " * " : Fundamental frequency.
6. " # " : The radiated frequency is out of the restricted band.

RF Mode	TX 802.11ax (HE20)	Channel	CH 61 : 6255 MHz
Frequency Range	1GHz ~ 40GHz	Detector Function	Peak (PK) Average (AV)

Antenna Polarity & Test Distance : Horizontal at 3 m								
No	Frequency (MHz)	Emission Level (dBuV/m)	Limit (dBuV/m)	Margin (dB)	Antenna Height (m)	Table Angle (Degree)	Raw Value (dBuV)	Correction Factor (dB/m)
1	*6255.00	101.2 PK			1.44 H	208	56.3	44.9
2	*6255.00	88.2 AV			1.44 H	208	43.3	44.9
3	12510.00	60.6 PK	74.0	-13.4	2.59 H	163	38.2	22.4
4	12510.00	48.6 AV	54.0	-5.4	2.59 H	163	26.2	22.4
Antenna Polarity & Test Distance : Vertical at 3 m								
No	Frequency (MHz)	Emission Level (dBuV/m)	Limit (dBuV/m)	Margin (dB)	Antenna Height (m)	Table Angle (Degree)	Raw Value (dBuV)	Correction Factor (dB/m)
1	*6255.00	111.5 PK			1.67 V	35	66.6	44.9
2	*6255.00	98.7 AV			1.67 V	35	53.8	44.9
3	12510.00	64.0 PK	74.0	-10.0	2.11 V	172	41.6	22.4
4	12510.00	50.9 AV	54.0	-3.1	2.11 V	172	28.5	22.4

Remarks:

1. Emission Level(dBuV/m) = Raw Value(dBuV) + Correction Factor(dB/m).
2. Correction Factor(dB/m) = Antenna Factor(dB/m) + Cable Factor(dB) – Pre-Amplifier Factor(dB).
3. Margin value = Emission Level – Limit value.
4. The other emission levels were very low against the limit.
5. " * " : Fundamental frequency.

RF Mode	TX 802.11ax (HE20)	Channel	CH 93 : 6415 MHz
Frequency Range	1GHz ~ 40GHz	Detector Function	Peak (PK) Average (AV)

Antenna Polarity & Test Distance : Horizontal at 3 m								
No	Frequency (MHz)	Emission Level (dBuV/m)	Limit (dBuV/m)	Margin (dB)	Antenna Height (m)	Table Angle (Degree)	Raw Value (dBuV)	Correction Factor (dB/m)
1	*6415.00	100.9 PK			1.37 H	208	55.0	45.9
2	*6415.00	87.7 AV			1.37 H	208	41.8	45.9
3	#12830.00	61.4 PK	88.2	-26.8	2.62 H	168	38.3	23.1
4	#12830.00	49.4 AV	68.2	-18.8	2.62 H	168	26.3	23.1
Antenna Polarity & Test Distance : Vertical at 3 m								
No	Frequency (MHz)	Emission Level (dBuV/m)	Limit (dBuV/m)	Margin (dB)	Antenna Height (m)	Table Angle (Degree)	Raw Value (dBuV)	Correction Factor (dB/m)
1	*6415.00	111.9 PK			2.26 V	3	66.0	45.9
2	*6415.00	98.6 AV			2.26 V	3	52.7	45.9
3	#12830.00	63.6 PK	88.2	-24.6	1.98 V	186	40.5	23.1
4	#12830.00	50.8 AV	68.2	-17.4	1.98 V	186	27.7	23.1

Remarks:

1. Emission Level(dBuV/m) = Raw Value(dBuV) + Correction Factor(dB/m).
2. Correction Factor(dB/m) = Antenna Factor(dB/m) + Cable Factor(dB) – Pre-Amplifier Factor(dB).
3. Margin value = Emission Level – Limit value.
4. The other emission levels were very low against the limit.
5. " * " : Fundamental frequency.
6. " # " : The radiated frequency is out of the restricted band.

RF Mode	TX 802.11ax (HE20)	Channel	CH 97 : 6435 MHz
Frequency Range	1GHz ~ 40GHz	Detector Function	Peak (PK) Average (AV)

Antenna Polarity & Test Distance : Horizontal at 3 m								
No	Frequency (MHz)	Emission Level (dBuV/m)	Limit (dBuV/m)	Margin (dB)	Antenna Height (m)	Table Angle (Degree)	Raw Value (dBuV)	Correction Factor (dB/m)
1	*6435.00	103.2 PK			2.53 H	207	57.2	46.0
2	*6435.00	90.3 AV			2.53 H	207	44.3	46.0
3	#12870.00	62.6 PK	88.2	-25.6	2.73 H	171	39.5	23.1
4	#12870.00	49.6 AV	68.2	-18.6	2.73 H	171	26.5	23.1
Antenna Polarity & Test Distance : Vertical at 3 m								
No	Frequency (MHz)	Emission Level (dBuV/m)	Limit (dBuV/m)	Margin (dB)	Antenna Height (m)	Table Angle (Degree)	Raw Value (dBuV)	Correction Factor (dB/m)
1	*6435.00	111.3 PK			2.21 V	22	65.3	46.0
2	*6435.00	98.0 AV			2.21 V	22	52.0	46.0
3	#12870.00	63.3 PK	88.2	-24.9	2.77 V	235	40.2	23.1
4	#12870.00	50.6 AV	68.2	-17.6	2.77 V	235	27.5	23.1

Remarks:

1. Emission Level(dBuV/m) = Raw Value(dBuV) + Correction Factor(dB/m).
2. Correction Factor(dB/m) = Antenna Factor(dB/m) + Cable Factor(dB) – Pre-Amplifier Factor(dB).
3. Margin value = Emission Level – Limit value.
4. The other emission levels were very low against the limit.
5. " * " : Fundamental frequency.
6. " # " : The radiated frequency is out of the restricted band.

RF Mode	TX 802.11ax (HE20)	Channel	CH 105 : 6475 MHz
Frequency Range	1GHz ~ 40GHz	Detector Function	Peak (PK) Average (AV)

Antenna Polarity & Test Distance : Horizontal at 3 m								
No	Frequency (MHz)	Emission Level (dBuV/m)	Limit (dBuV/m)	Margin (dB)	Antenna Height (m)	Table Angle (Degree)	Raw Value (dBuV)	Correction Factor (dB/m)
1	*6475.00	104.1 PK			2.56 H	210	57.9	46.2
2	*6475.00	91.1 AV			2.56 H	210	44.9	46.2
3	#12950.00	62.4 PK	88.2	-25.8	2.66 H	168	39.3	23.1
4	#12950.00	49.4 AV	68.2	-18.8	2.66 H	168	26.3	23.1
Antenna Polarity & Test Distance : Vertical at 3 m								
No	Frequency (MHz)	Emission Level (dBuV/m)	Limit (dBuV/m)	Margin (dB)	Antenna Height (m)	Table Angle (Degree)	Raw Value (dBuV)	Correction Factor (dB/m)
1	*6475.00	111.9 PK			2.41 V	23	65.7	46.2
2	*6475.00	98.6 AV			2.41 V	23	52.4	46.2
3	#12950.00	63.1 PK	88.2	-25.1	2.86 V	233	40.0	23.1
4	#12950.00	50.4 AV	68.2	-17.8	2.86 V	233	27.3	23.1

Remarks:

1. Emission Level(dBuV/m) = Raw Value(dBuV) + Correction Factor(dB/m).
2. Correction Factor(dB/m) = Antenna Factor(dB/m) + Cable Factor(dB) – Pre-Amplifier Factor(dB).
3. Margin value = Emission Level – Limit value.
4. The other emission levels were very low against the limit.
5. " * " : Fundamental frequency.
6. " # " : The radiated frequency is out of the restricted band.

RF Mode	TX 802.11ax (HE20)	Channel	CH 113 : 6515 MHz
Frequency Range	1GHz ~ 40GHz	Detector Function	Peak (PK) Average (AV)

Antenna Polarity & Test Distance : Horizontal at 3 m								
No	Frequency (MHz)	Emission Level (dBuV/m)	Limit (dBuV/m)	Margin (dB)	Antenna Height (m)	Table Angle (Degree)	Raw Value (dBuV)	Correction Factor (dB/m)
1	*6515.00	104.2 PK			2.42 H	208	57.8	46.4
2	*6515.00	91.1 AV			2.42 H	208	44.7	46.4
3	#13030.00	62.6 PK	88.2	-25.6	2.72 H	173	39.3	23.3
4	#13030.00	49.6 AV	68.2	-18.6	2.72 H	173	26.3	23.3
Antenna Polarity & Test Distance : Vertical at 3 m								
No	Frequency (MHz)	Emission Level (dBuV/m)	Limit (dBuV/m)	Margin (dB)	Antenna Height (m)	Table Angle (Degree)	Raw Value (dBuV)	Correction Factor (dB/m)
1	*6515.00	111.3 PK			2.41 V	11	64.9	46.4
2	*6515.00	98.6 AV			2.41 V	11	52.2	46.4
3	#13030.00	63.3 PK	88.2	-24.9	2.86 V	241	40.0	23.3
4	#13030.00	50.7 AV	68.2	-17.5	2.86 V	241	27.4	23.3

Remarks:

1. Emission Level(dBuV/m) = Raw Value(dBuV) + Correction Factor(dB/m).
2. Correction Factor(dB/m) = Antenna Factor(dB/m) + Cable Factor(dB) – Pre-Amplifier Factor(dB).
3. Margin value = Emission Level – Limit value.
4. The other emission levels were very low against the limit.
5. " * " : Fundamental frequency.
6. " # " : The radiated frequency is out of the restricted band.

RF Mode	TX 802.11ax (HE20)	Channel	CH 117 : 6535 MHz
Frequency Range	1GHz ~ 40GHz	Detector Function	Peak (PK) Average (AV)

Antenna Polarity & Test Distance : Horizontal at 3 m								
No	Frequency (MHz)	Emission Level (dBuV/m)	Limit (dBuV/m)	Margin (dB)	Antenna Height (m)	Table Angle (Degree)	Raw Value (dBuV)	Correction Factor (dB/m)
1	*6535.00	104.4 PK			2.70 H	207	57.9	46.5
2	*6535.00	91.1 AV			2.70 H	207	44.6	46.5
3	#13070.00	62.6 PK	88.2	-25.6	2.78 H	172	39.3	23.3
4	#13070.00	49.6 AV	68.2	-18.6	2.78 H	172	26.3	23.3
Antenna Polarity & Test Distance : Vertical at 3 m								
No	Frequency (MHz)	Emission Level (dBuV/m)	Limit (dBuV/m)	Margin (dB)	Antenna Height (m)	Table Angle (Degree)	Raw Value (dBuV)	Correction Factor (dB/m)
1	*6535.00	111.5 PK			2.66 V	14	65.0	46.5
2	*6535.00	98.4 AV			2.66 V	14	51.9	46.5
3	#13070.00	62.9 PK	88.2	-25.3	2.74 V	261	39.6	23.3
4	#13070.00	49.9 AV	68.2	-18.3	2.74 V	261	26.6	23.3

Remarks:

1. Emission Level(dBuV/m) = Raw Value(dBuV) + Correction Factor(dB/m).
2. Correction Factor(dB/m) = Antenna Factor(dB/m) + Cable Factor(dB) – Pre-Amplifier Factor(dB).
3. Margin value = Emission Level – Limit value.
4. The other emission levels were very low against the limit.
5. " * " : Fundamental frequency.
6. " # " : The radiated frequency is out of the restricted band.

RF Mode	TX 802.11ax (HE20)	Channel	CH 153 : 6715 MHz
Frequency Range	1GHz ~ 40GHz	Detector Function	Peak (PK) Average (AV)

Antenna Polarity & Test Distance : Horizontal at 3 m								
No	Frequency (MHz)	Emission Level (dBuV/m)	Limit (dBuV/m)	Margin (dB)	Antenna Height (m)	Table Angle (Degree)	Raw Value (dBuV)	Correction Factor (dB/m)
1	*6715.00	104.2 PK			2.64 H	214	57.4	46.8
2	*6715.00	90.9 AV			2.64 H	214	44.1	46.8
3	#13070.00	62.6 PK	88.2	-25.6	2.65 H	163	39.3	23.3
4	#13070.00	49.6 AV	68.2	-18.6	2.65 H	163	26.3	23.3
Antenna Polarity & Test Distance : Vertical at 3 m								
No	Frequency (MHz)	Emission Level (dBuV/m)	Limit (dBuV/m)	Margin (dB)	Antenna Height (m)	Table Angle (Degree)	Raw Value (dBuV)	Correction Factor (dB/m)
1	*6715.00	110.4 PK			2.65 V	2	63.6	46.8
2	*6715.00	98.8 AV			2.65 V	2	52.0	46.8
3	#13430.00	64.7 PK	88.2	-23.5	2.86 V	253	40.3	24.4
4	#13430.00	51.8 AV	68.2	-16.4	2.86 V	253	27.4	24.4

Remarks:

1. Emission Level(dBuV/m) = Raw Value(dBuV) + Correction Factor(dB/m).
2. Correction Factor(dB/m) = Antenna Factor(dB/m) + Cable Factor(dB) – Pre-Amplifier Factor(dB).
3. Margin value = Emission Level – Limit value.
4. The other emission levels were very low against the limit.
5. " * " : Fundamental frequency.
6. " # " : The radiated frequency is out of the restricted band.

RF Mode	TX 802.11ax (HE20)	Channel	CH 181 : 6855 MHz
Frequency Range	1GHz ~ 40GHz	Detector Function	Peak (PK) Average (AV)

Antenna Polarity & Test Distance : Horizontal at 3 m								
No	Frequency (MHz)	Emission Level (dBuV/m)	Limit (dBuV/m)	Margin (dB)	Antenna Height (m)	Table Angle (Degree)	Raw Value (dBuV)	Correction Factor (dB/m)
1	*6855.00	103.8 PK			2.68 H	224	56.8	47.0
2	*6855.00	90.2 AV			2.68 H	224	43.2	47.0
3	#13710.00	64.3 PK	88.2	-23.9	2.72 H	168	39.3	25.0
4	#13710.00	51.3 AV	68.2	-16.9	2.72 H	168	26.3	25.0
Antenna Polarity & Test Distance : Vertical at 3 m								
No	Frequency (MHz)	Emission Level (dBuV/m)	Limit (dBuV/m)	Margin (dB)	Antenna Height (m)	Table Angle (Degree)	Raw Value (dBuV)	Correction Factor (dB/m)
1	*6855.00	110.7 PK			2.52 V	1	63.7	47.0
2	*6855.00	98.2 AV			2.52 V	1	51.2	47.0
3	#13710.00	64.9 PK	88.2	-23.3	2.92 V	234	39.9	25.0
4	#13710.00	51.3 AV	68.2	-16.9	2.92 V	234	26.3	25.0

Remarks:

1. Emission Level(dBuV/m) = Raw Value(dBuV) + Correction Factor(dB/m).
2. Correction Factor(dB/m) = Antenna Factor(dB/m) + Cable Factor(dB) – Pre-Amplifier Factor(dB).
3. Margin value = Emission Level – Limit value.
4. The other emission levels were very low against the limit.
5. " * " : Fundamental frequency.
6. " # " : The radiated frequency is out of the restricted band.

RF Mode	TX 802.11ax (HE20)	Channel	CH 185 : 6875 MHz
Frequency Range	1GHz ~ 40GHz	Detector Function	Peak (PK) Average (AV)

Antenna Polarity & Test Distance : Horizontal at 3 m								
No	Frequency (MHz)	Emission Level (dBuV/m)	Limit (dBuV/m)	Margin (dB)	Antenna Height (m)	Table Angle (Degree)	Raw Value (dBuV)	Correction Factor (dB/m)
1	*6875.00	103.7 PK			3.22 H	214	56.5	47.2
2	*6875.00	93.3 AV			3.22 H	214	46.1	47.2
3	#14190.00	65.3 PK	88.2	-22.9	2.88 H	175	39.2	26.1
4	#14190.00	52.4 AV	68.2	-15.8	2.88 H	175	26.3	26.1
Antenna Polarity & Test Distance : Vertical at 3 m								
No	Frequency (MHz)	Emission Level (dBuV/m)	Limit (dBuV/m)	Margin (dB)	Antenna Height (m)	Table Angle (Degree)	Raw Value (dBuV)	Correction Factor (dB/m)
1	*6875.00	111.9 PK			2.54 V	357	64.7	47.2
2	*6875.00	98.7 AV			2.54 V	357	51.5	47.2
3	#14190.00	66.5 PK	88.2	-21.7	2.83 V	262	40.4	26.1
4	#14190.00	53.1 AV	68.2	-15.1	2.83 V	262	27.0	26.1

Remarks:

1. Emission Level(dBuV/m) = Raw Value(dBuV) + Correction Factor(dB/m).
2. Correction Factor(dB/m) = Antenna Factor(dB/m) + Cable Factor(dB) – Pre-Amplifier Factor(dB).
3. Margin value = Emission Level – Limit value.
4. The other emission levels were very low against the limit.
5. " * " : Fundamental frequency.
6. " # " : The radiated frequency is out of the restricted band.

RF Mode	TX 802.11ax (HE20)	Channel	CH 213 : 7015 MHz
Frequency Range	1GHz ~ 40GHz	Detector Function	Peak (PK) Average (AV)

Antenna Polarity & Test Distance : Horizontal at 3 m								
No	Frequency (MHz)	Emission Level (dBuV/m)	Limit (dBuV/m)	Margin (dB)	Antenna Height (m)	Table Angle (Degree)	Raw Value (dBuV)	Correction Factor (dB/m)
1	*7015.00	107.0 PK			2.94 H	215	58.9	48.1
2	*7015.00	96.0 AV			2.94 H	215	47.9	48.1
3	#14030.00	65.0 PK	88.2	-23.2	2.82 H	169	39.3	25.7
4	#14030.00	51.8 AV	68.2	-16.4	2.82 H	169	26.1	25.7
Antenna Polarity & Test Distance : Vertical at 3 m								
No	Frequency (MHz)	Emission Level (dBuV/m)	Limit (dBuV/m)	Margin (dB)	Antenna Height (m)	Table Angle (Degree)	Raw Value (dBuV)	Correction Factor (dB/m)
1	*7015.00	111.5 PK			2.52 V	6	63.4	48.1
2	*7015.00	98.7 AV			2.52 V	6	50.6	48.1
3	#14030.00	65.6 PK	88.2	-22.6	2.86 V	257	39.9	25.7
4	#14030.00	52.0 AV	68.2	-16.2	2.86 V	257	26.3	25.7

Remarks:

1. Emission Level(dBuV/m) = Raw Value(dBuV) + Correction Factor(dB/m).
2. Correction Factor(dB/m) = Antenna Factor(dB/m) + Cable Factor(dB) – Pre-Amplifier Factor(dB).
3. Margin value = Emission Level – Limit value.
4. The other emission levels were very low against the limit.
5. " * " : Fundamental frequency.
6. " # " : The radiated frequency is out of the restricted band.

RF Mode	TX 802.11ax (HE20)	Channel	CH 229 : 7095 MHz
Frequency Range	1GHz ~ 40GHz	Detector Function	Peak (PK) Average (AV)

Antenna Polarity & Test Distance : Horizontal at 3 m								
No	Frequency (MHz)	Emission Level (dBuV/m)	Limit (dBuV/m)	Margin (dB)	Antenna Height (m)	Table Angle (Degree)	Raw Value (dBuV)	Correction Factor (dB/m)
1	*7095.00	108.0 PK			3.03 H	216	59.6	48.4
2	*7095.00	96.4 AV			3.03 H	216	48.0	48.4
3	#14190.00	65.2 PK	88.2	-23.0	2.68 H	163	39.1	26.1
4	#14190.00	52.4 AV	68.2	-15.8	2.68 H	163	26.3	26.1
Antenna Polarity & Test Distance : Vertical at 3 m								
No	Frequency (MHz)	Emission Level (dBuV/m)	Limit (dBuV/m)	Margin (dB)	Antenna Height (m)	Table Angle (Degree)	Raw Value (dBuV)	Correction Factor (dB/m)
1	*7095.00	111.6 PK			2.45 V	9	63.2	48.4
2	*7095.00	98.7 AV			2.45 V	9	50.3	48.4
3	#14190.00	65.9 PK	88.2	-22.3	2.88 V	279	39.8	26.1
4	#14190.00	53.4 AV	68.2	-14.8	2.88 V	279	27.3	26.1

Remarks:

1. Emission Level(dBuV/m) = Raw Value(dBuV) + Correction Factor(dB/m).
2. Correction Factor(dB/m) = Antenna Factor(dB/m) + Cable Factor(dB) – Pre-Amplifier Factor(dB).
3. Margin value = Emission Level – Limit value.
4. The other emission levels were very low against the limit.
5. " * " : Fundamental frequency.
6. " # " : The radiated frequency is out of the restricted band.

RF Mode	TX 802.11ax (HE20)	Channel	CH 233 : 7115 MHz
Frequency Range	1GHz ~ 40GHz	Detector Function	Peak (PK) Average (AV)

Antenna Polarity & Test Distance : Horizontal at 3 m								
No	Frequency (MHz)	Emission Level (dBuV/m)	Limit (dBuV/m)	Margin (dB)	Antenna Height (m)	Table Angle (Degree)	Raw Value (dBuV)	Correction Factor (dB/m)
1	*7115.00	88.1 PK			2.87 H	219	39.5	48.6
2	*7115.00	76.3 AV			2.87 H	219	27.7	48.6
3	#7125.00	73.3 PK	88.2	-14.9	2.87 H	219	55.2	18.1
4	#7125.00	62.7 AV	68.2	-5.5	2.87 H	219	44.6	18.1
5	#14230.00	64.3 PK	88.2	-23.9	2.82 H	169	38.1	26.2
6	#14230.00	52.2 AV	68.2	-16.0	2.82 H	169	26.0	26.2

Antenna Polarity & Test Distance : Vertical at 3 m								
No	Frequency (MHz)	Emission Level (dBuV/m)	Limit (dBuV/m)	Margin (dB)	Antenna Height (m)	Table Angle (Degree)	Raw Value (dBuV)	Correction Factor (dB/m)
1	*7115.00	91.4 PK			2.16 V	5	42.8	48.6
2	*7115.00	78.9 AV			2.16 V	5	30.3	48.6
3	#7125.00	79.3 PK	88.2	-8.9	2.16 V	5	61.2	18.1
4	#7125.00	67.9 AV	68.2	-0.3	2.16 V	5	49.8	18.1
5	#14230.00	64.4 PK	88.2	-23.8	2.85 V	244	38.2	26.2
6	#14230.00	52.3 AV	68.2	-15.9	2.85 V	244	26.1	26.2

Remarks:

1. Emission Level(dBuV/m) = Raw Value(dBuV) + Correction Factor(dB/m).
2. Correction Factor(dB/m) = Antenna Factor(dB/m) + Cable Factor(dB) – Pre-Amplifier Factor(dB).
3. Margin value = Emission Level – Limit value.
4. The other emission levels were very low against the limit.
5. " * " : Fundamental frequency.
6. " # " : The radiated frequency is out of the restricted band.

RF Mode	TX 802.11ax (HE40)	Channel	CH 3 : 5965 MHz
Frequency Range	1GHz ~ 40GHz	Detector Function	Peak (PK) Average (AV)

Antenna Polarity & Test Distance : Horizontal at 3 m								
No	Frequency (MHz)	Emission Level (dBuV/m)	Limit (dBuV/m)	Margin (dB)	Antenna Height (m)	Table Angle (Degree)	Raw Value (dBuV)	Correction Factor (dB/m)
1	#5925.00	60.0 PK	88.2	-28.2	1.56 H	257	45.6	14.4
2	#5925.00	48.6 AV	68.2	-19.6	1.56 H	257	34.2	14.4
3	*5965.00	99.3 PK			1.56 H	257	55.0	44.3
4	*5965.00	88.1 AV			1.56 H	257	43.8	44.3
5	11930.00	61.5 PK	74.0	-12.5	2.64 H	158	38.6	22.9
6	11930.00	49.4 AV	54.0	-4.6	2.64 H	158	26.5	22.9

Antenna Polarity & Test Distance : Vertical at 3 m								
No	Frequency (MHz)	Emission Level (dBuV/m)	Limit (dBuV/m)	Margin (dB)	Antenna Height (m)	Table Angle (Degree)	Raw Value (dBuV)	Correction Factor (dB/m)
1	#5925.00	60.2 PK	88.2	-28.0	2.15 V	196	45.8	14.4
2	#5925.00	48.8 AV	68.2	-19.4	2.15 V	196	34.4	14.4
3	*5965.00	107.2 PK			2.15 V	196	62.9	44.3
4	*5965.00	95.8 AV			2.15 V	196	51.5	44.3
5	11930.00	61.7 PK	74.0	-12.3	2.33 V	162	38.8	22.9
6	11930.00	49.4 AV	54.0	-4.6	2.33 V	162	26.5	22.9

Remarks:

1. Emission Level(dBuV/m) = Raw Value(dBuV) + Correction Factor(dB/m).
2. Correction Factor(dB/m) = Antenna Factor(dB/m) + Cable Factor(dB) – Pre-Amplifier Factor(dB).
3. Margin value = Emission Level – Limit value.
4. The other emission levels were very low against the limit.
5. " * " : Fundamental frequency.
6. " # " : The radiated frequency is out of the restricted band.

RF Mode	TX 802.11ax (HE40)	Channel	CH 59 : 6245 MHz
Frequency Range	1GHz ~ 40GHz	Detector Function	Peak (PK) Average (AV)

Antenna Polarity & Test Distance : Horizontal at 3 m								
No	Frequency (MHz)	Emission Level (dBuV/m)	Limit (dBuV/m)	Margin (dB)	Antenna Height (m)	Table Angle (Degree)	Raw Value (dBuV)	Correction Factor (dB/m)
1	*6245.00	98.8 PK			1.40 H	359	53.9	44.9
2	*6245.00	85.8 AV			1.40 H	359	40.9	44.9
3	12490.00	60.6 PK	74.0	-13.4	2.66 H	168	38.2	22.4
4	12490.00	48.7 AV	54.0	-5.3	2.66 H	168	26.3	22.4
Antenna Polarity & Test Distance : Vertical at 3 m								
No	Frequency (MHz)	Emission Level (dBuV/m)	Limit (dBuV/m)	Margin (dB)	Antenna Height (m)	Table Angle (Degree)	Raw Value (dBuV)	Correction Factor (dB/m)
1	*6245.00	110.4 PK			2.22 V	13	65.5	44.9
2	*6245.00	98.7 AV			2.22 V	13	53.8	44.9
3	12490.00	62.5 PK	74.0	-11.5	2.14 V	173	40.1	22.4
4	12490.00	49.4 AV	54.0	-4.6	2.14 V	173	27.0	22.4

Remarks:

1. Emission Level(dBuV/m) = Raw Value(dBuV) + Correction Factor(dB/m).
2. Correction Factor(dB/m) = Antenna Factor(dB/m) + Cable Factor(dB) – Pre-Amplifier Factor(dB).
3. Margin value = Emission Level – Limit value.
4. The other emission levels were very low against the limit.
5. " * ": Fundamental frequency.

RF Mode	TX 802.11ax (HE40)	Channel	CH 91 : 6405 MHz
Frequency Range	1GHz ~ 40GHz	Detector Function	Peak (PK) Average (AV)

Antenna Polarity & Test Distance : Horizontal at 3 m								
No	Frequency (MHz)	Emission Level (dBuV/m)	Limit (dBuV/m)	Margin (dB)	Antenna Height (m)	Table Angle (Degree)	Raw Value (dBuV)	Correction Factor (dB/m)
1	*6405.00	100.5 PK			1.39 H	5	54.7	45.8
2	*6405.00	87.4 AV			1.39 H	5	41.6	45.8
3	#12810.00	61.3 PK	88.2	-26.9	2.72 H	169	38.2	23.1
4	#12810.00	49.3 AV	68.2	-18.9	2.72 H	169	26.2	23.1
Antenna Polarity & Test Distance : Vertical at 3 m								
No	Frequency (MHz)	Emission Level (dBuV/m)	Limit (dBuV/m)	Margin (dB)	Antenna Height (m)	Table Angle (Degree)	Raw Value (dBuV)	Correction Factor (dB/m)
1	*6405.00	110.7 PK			2.18 V	5	64.9	45.8
2	*6405.00	98.5 AV			2.18 V	5	52.7	45.8
3	#12810.00	63.1 PK	88.2	-25.1	2.05 V	188	40.0	23.1
4	#12810.00	50.3 AV	68.2	-17.9	2.05 V	188	27.2	23.1

Remarks:

1. Emission Level(dBuV/m) = Raw Value(dBuV) + Correction Factor(dB/m).
2. Correction Factor(dB/m) = Antenna Factor(dB/m) + Cable Factor(dB) – Pre-Amplifier Factor(dB).
3. Margin value = Emission Level – Limit value.
4. The other emission levels were very low against the limit.
5. " * " : Fundamental frequency.
6. " # " : The radiated frequency is out of the restricted band.

RF Mode	TX 802.11ax (HE40)	Channel	CH 99 : 6445 MHz
Frequency Range	1GHz ~ 40GHz	Detector Function	Peak (PK) Average (AV)

Antenna Polarity & Test Distance : Horizontal at 3 m								
No	Frequency (MHz)	Emission Level (dBuV/m)	Limit (dBuV/m)	Margin (dB)	Antenna Height (m)	Table Angle (Degree)	Raw Value (dBuV)	Correction Factor (dB/m)
1	*6445.00	104.1 PK			2.61 H	208	58.1	46.0
2	*6445.00	90.9 AV			2.61 H	208	44.9	46.0
3	#12890.00	62.4 PK	88.2	-25.8	2.73 H	175	39.3	23.1
4	#12890.00	49.3 AV	68.2	-18.9	2.73 H	175	26.2	23.1
Antenna Polarity & Test Distance : Vertical at 3 m								
No	Frequency (MHz)	Emission Level (dBuV/m)	Limit (dBuV/m)	Margin (dB)	Antenna Height (m)	Table Angle (Degree)	Raw Value (dBuV)	Correction Factor (dB/m)
1	*6445.00	110.6 PK			2.40 V	21	64.6	46.0
2	*6445.00	98.3 AV			2.40 V	21	52.3	46.0
3	#12890.00	63.2 PK	88.2	-25.0	2.92 V	271	40.1	23.1
4	#12890.00	51.0 AV	68.2	-17.2	2.92 V	271	27.9	23.1

Remarks:

1. Emission Level(dBuV/m) = Raw Value(dBuV) + Correction Factor(dB/m).
2. Correction Factor(dB/m) = Antenna Factor(dB/m) + Cable Factor(dB) – Pre-Amplifier Factor(dB).
3. Margin value = Emission Level – Limit value.
4. The other emission levels were very low against the limit.
5. " * " : Fundamental frequency.
6. " # " : The radiated frequency is out of the restricted band.

RF Mode	TX 802.11ax (HE40)	Channel	CH 107 : 6485 MHz
Frequency Range	1GHz ~ 40GHz	Detector Function	Peak (PK) Average (AV)

Antenna Polarity & Test Distance : Horizontal at 3 m								
No	Frequency (MHz)	Emission Level (dBuV/m)	Limit (dBuV/m)	Margin (dB)	Antenna Height (m)	Table Angle (Degree)	Raw Value (dBuV)	Correction Factor (dB/m)
1	*6485.00	104.3 PK			2.40 H	212	58.1	46.2
2	*6485.00	90.6 AV			2.40 H	212	44.4	46.2
3	#12970.00	62.7 PK	88.2	-25.5	2.75 H	173	39.5	23.2
4	#12970.00	49.7 AV	68.2	-18.5	2.75 H	173	26.5	23.2
Antenna Polarity & Test Distance : Vertical at 3 m								
No	Frequency (MHz)	Emission Level (dBuV/m)	Limit (dBuV/m)	Margin (dB)	Antenna Height (m)	Table Angle (Degree)	Raw Value (dBuV)	Correction Factor (dB/m)
1	*6485.00	111.1 PK			2.33 V	19	64.9	46.2
2	*6485.00	98.3 AV			2.33 V	19	52.1	46.2
3	#12970.00	62.8 PK	88.2	-25.4	2.89 V	224	39.6	23.2
4	#12970.00	50.2 AV	68.2	-18.0	2.89 V	224	27.0	23.2

Remarks:

1. Emission Level(dBuV/m) = Raw Value(dBuV) + Correction Factor(dB/m).
2. Correction Factor(dB/m) = Antenna Factor(dB/m) + Cable Factor(dB) – Pre-Amplifier Factor(dB).
3. Margin value = Emission Level – Limit value.
4. The other emission levels were very low against the limit.
5. " * " : Fundamental frequency.
6. " # " : The radiated frequency is out of the restricted band.

RF Mode	TX 802.11ax (HE40)	Channel	CH 115 : 6525 MHz
Frequency Range	1GHz ~ 40GHz	Detector Function	Peak (PK) Average (AV)

Antenna Polarity & Test Distance : Horizontal at 3 m								
No	Frequency (MHz)	Emission Level (dBuV/m)	Limit (dBuV/m)	Margin (dB)	Antenna Height (m)	Table Angle (Degree)	Raw Value (dBuV)	Correction Factor (dB/m)
1	*6525.00	105.1 PK			2.54 H	207	58.6	46.5
2	*6525.00	91.7 AV			2.54 H	207	45.2	46.5
3	#13050.00	62.6 PK	88.2	-25.6	2.69 H	168	39.3	23.3
4	#13050.00	49.6 AV	68.2	-18.6	2.69 H	168	26.3	23.3
Antenna Polarity & Test Distance : Vertical at 3 m								
No	Frequency (MHz)	Emission Level (dBuV/m)	Limit (dBuV/m)	Margin (dB)	Antenna Height (m)	Table Angle (Degree)	Raw Value (dBuV)	Correction Factor (dB/m)
1	*6525.00	110.9 PK			2.31 V	26	64.4	46.5
2	*6525.00	98.4 AV			2.31 V	26	51.9	46.5
3	#13050.00	63.0 PK	88.2	-25.2	2.86 V	232	39.7	23.3
4	#13050.00	50.2 AV	68.2	-18.0	2.86 V	232	26.9	23.3

Remarks:

1. Emission Level(dBuV/m) = Raw Value(dBuV) + Correction Factor(dB/m).
2. Correction Factor(dB/m) = Antenna Factor(dB/m) + Cable Factor(dB) – Pre-Amplifier Factor(dB).
3. Margin value = Emission Level – Limit value.
4. The other emission levels were very low against the limit.
5. " * " : Fundamental frequency.
6. " # " : The radiated frequency is out of the restricted band.

RF Mode	TX 802.11ax (HE40)	Channel	CH 123 : 6565 MHz
Frequency Range	1GHz ~ 40GHz	Detector Function	Peak (PK) Average (AV)

Antenna Polarity & Test Distance : Horizontal at 3 m								
No	Frequency (MHz)	Emission Level (dBuV/m)	Limit (dBuV/m)	Margin (dB)	Antenna Height (m)	Table Angle (Degree)	Raw Value (dBuV)	Correction Factor (dB/m)
1	*6565.00	105.0 PK			2.64 H	207	58.4	46.6
2	*6565.00	91.5 AV			2.64 H	207	44.9	46.6
3	#13130.00	62.9 PK	88.2	-25.3	2.66 H	169	39.4	23.5
4	#13130.00	49.8 AV	68.2	-18.4	2.66 H	169	26.3	23.5
Antenna Polarity & Test Distance : Vertical at 3 m								
No	Frequency (MHz)	Emission Level (dBuV/m)	Limit (dBuV/m)	Margin (dB)	Antenna Height (m)	Table Angle (Degree)	Raw Value (dBuV)	Correction Factor (dB/m)
1	*6565.00	110.8 PK			2.59 V	358	64.2	46.6
2	*6565.00	98.6 AV			2.59 V	358	52.0	46.6
3	#13130.00	63.8 PK	88.2	-24.4	2.53 V	265	40.3	23.5
4	#13130.00	50.1 AV	68.2	-18.1	2.53 V	265	26.6	23.5

Remarks:

1. Emission Level(dBuV/m) = Raw Value(dBuV) + Correction Factor(dB/m).
2. Correction Factor(dB/m) = Antenna Factor(dB/m) + Cable Factor(dB) – Pre-Amplifier Factor(dB).
3. Margin value = Emission Level – Limit value.
4. The other emission levels were very low against the limit.
5. " * " : Fundamental frequency.
6. " # " : The radiated frequency is out of the restricted band.

RF Mode	TX 802.11ax (HE40)	Channel	CH 155 : 6725 MHz
Frequency Range	1GHz ~ 40GHz	Detector Function	Peak (PK) Average (AV)

Antenna Polarity & Test Distance : Horizontal at 3 m								
No	Frequency (MHz)	Emission Level (dBuV/m)	Limit (dBuV/m)	Margin (dB)	Antenna Height (m)	Table Angle (Degree)	Raw Value (dBuV)	Correction Factor (dB/m)
1	*6725.00	103.7 PK			2.70 H	208	56.9	46.8
2	*6725.00	90.3 AV			2.70 H	208	43.5	46.8
3	#13450.00	63.4 PK	88.2	-24.8	2.72 H	168	39.0	24.4
4	#13450.00	50.6 AV	68.2	-17.6	2.72 H	168	26.2	24.4
Antenna Polarity & Test Distance : Vertical at 3 m								
No	Frequency (MHz)	Emission Level (dBuV/m)	Limit (dBuV/m)	Margin (dB)	Antenna Height (m)	Table Angle (Degree)	Raw Value (dBuV)	Correction Factor (dB/m)
1	*6725.00	111.3 PK			2.70 V	0	64.5	46.8
2	*6725.00	98.6 AV			2.70 V	0	51.8	46.8
3	#13450.00	64.2 PK	88.2	-24.0	2.88 V	263	39.8	24.4
4	#13450.00	50.6 AV	68.2	-17.6	2.88 V	263	26.2	24.4

Remarks:

1. Emission Level(dBuV/m) = Raw Value(dBuV) + Correction Factor(dB/m).
2. Correction Factor(dB/m) = Antenna Factor(dB/m) + Cable Factor(dB) – Pre-Amplifier Factor(dB).
3. Margin value = Emission Level – Limit value.
4. The other emission levels were very low against the limit.
5. " * " : Fundamental frequency.
6. " # " : The radiated frequency is out of the restricted band.

RF Mode	TX 802.11ax (HE40)	Channel	CH 179 : 6845 MHz
Frequency Range	1GHz ~ 40GHz	Detector Function	Peak (PK) Average (AV)

Antenna Polarity & Test Distance : Horizontal at 3 m								
No	Frequency (MHz)	Emission Level (dBuV/m)	Limit (dBuV/m)	Margin (dB)	Antenna Height (m)	Table Angle (Degree)	Raw Value (dBuV)	Correction Factor (dB/m)
1	*6845.00	105.0 PK			2.85 H	222	58.0	47.0
2	*6845.00	91.4 AV			2.85 H	222	44.4	47.0
3	#13690.00	64.2 PK	88.2	-24.0	2.72 H	168	39.3	24.9
4	#13690.00	51.2 AV	68.2	-17.0	2.72 H	168	26.3	24.9
Antenna Polarity & Test Distance : Vertical at 3 m								
No	Frequency (MHz)	Emission Level (dBuV/m)	Limit (dBuV/m)	Margin (dB)	Antenna Height (m)	Table Angle (Degree)	Raw Value (dBuV)	Correction Factor (dB/m)
1	*6845.00	110.8 PK			2.58 V	4	63.8	47.0
2	*6845.00	98.5 AV			2.58 V	4	51.5	47.0
3	#13690.00	64.6 PK	88.2	-23.6	2.83 V	266	39.7	24.9
4	#13690.00	51.1 AV	68.2	-17.1	2.83 V	266	26.2	24.9

Remarks:

1. Emission Level(dBuV/m) = Raw Value(dBuV) + Correction Factor(dB/m).
2. Correction Factor(dB/m) = Antenna Factor(dB/m) + Cable Factor(dB) – Pre-Amplifier Factor(dB).
3. Margin value = Emission Level – Limit value.
4. The other emission levels were very low against the limit.
5. " * " : Fundamental frequency.
6. " # " : The radiated frequency is out of the restricted band.

RF Mode	TX 802.11ax (HE40)	Channel	CH 187 : 6885 MHz
Frequency Range	1GHz ~ 40GHz	Detector Function	Peak (PK) Average (AV)

Antenna Polarity & Test Distance : Horizontal at 3 m								
No	Frequency (MHz)	Emission Level (dBuV/m)	Limit (dBuV/m)	Margin (dB)	Antenna Height (m)	Table Angle (Degree)	Raw Value (dBuV)	Correction Factor (dB/m)
1	*6885.00	108.4 PK			2.98 H	219	61.1	47.3
2	*6885.00	96.0 AV			2.98 H	219	48.7	47.3
3	#13770.00	64.3 PK	88.2	-23.9	2.81 H	172	39.2	25.1
4	#13770.00	51.3 AV	68.2	-16.9	2.81 H	172	26.2	25.1
Antenna Polarity & Test Distance : Vertical at 3 m								
No	Frequency (MHz)	Emission Level (dBuV/m)	Limit (dBuV/m)	Margin (dB)	Antenna Height (m)	Table Angle (Degree)	Raw Value (dBuV)	Correction Factor (dB/m)
1	*6885.00	111.2 PK			2.58 V	8	63.9	47.3
2	*6885.00	98.5 AV			2.58 V	8	51.2	47.3
3	#13770.00	65.6 PK	88.2	-22.6	2.76 V	253	40.5	25.1
4	#13770.00	52.7 AV	68.2	-15.5	2.76 V	253	27.6	25.1

Remarks:

1. Emission Level(dBuV/m) = Raw Value(dBuV) + Correction Factor(dB/m).
2. Correction Factor(dB/m) = Antenna Factor(dB/m) + Cable Factor(dB) – Pre-Amplifier Factor(dB).
3. Margin value = Emission Level – Limit value.
4. The other emission levels were very low against the limit.
5. " * " : Fundamental frequency.
6. " # " : The radiated frequency is out of the restricted band.

RF Mode	TX 802.11ax (HE40)	Channel	CH 211 : 7005 MHz
Frequency Range	1GHz ~ 40GHz	Detector Function	Peak (PK) Average (AV)

Antenna Polarity & Test Distance : Horizontal at 3 m								
No	Frequency (MHz)	Emission Level (dBuV/m)	Limit (dBuV/m)	Margin (dB)	Antenna Height (m)	Table Angle (Degree)	Raw Value (dBuV)	Correction Factor (dB/m)
1	*7005.00	106.7 PK			2.99 H	216	58.6	48.1
2	*7005.00	95.9 AV			2.99 H	216	47.8	48.1
3	#14010.00	64.9 PK	88.2	-23.3	2.69 H	183	39.2	25.7
4	#14010.00	51.9 AV	68.2	-16.3	2.69 H	183	26.2	25.7
Antenna Polarity & Test Distance : Vertical at 3 m								
No	Frequency (MHz)	Emission Level (dBuV/m)	Limit (dBuV/m)	Margin (dB)	Antenna Height (m)	Table Angle (Degree)	Raw Value (dBuV)	Correction Factor (dB/m)
1	*7005.00	111.0 PK			2.58 V	11	62.9	48.1
2	*7005.00	98.4 AV			2.58 V	11	50.3	48.1
3	#14010.00	66.0 PK	88.2	-22.2	2.78 V	260	40.3	25.7
4	#14010.00	52.3 AV	68.2	-15.9	2.78 V	260	26.6	25.7

Remarks:

1. Emission Level(dBuV/m) = Raw Value(dBuV) + Correction Factor(dB/m).
2. Correction Factor(dB/m) = Antenna Factor(dB/m) + Cable Factor(dB) – Pre-Amplifier Factor(dB).
3. Margin value = Emission Level – Limit value.
4. The other emission levels were very low against the limit.
5. " * " : Fundamental frequency.
6. " # " : The radiated frequency is out of the restricted band.

RF Mode	TX 802.11ax (HE40)	Channel	CH 227 : 7085 MHz
Frequency Range	1GHz ~ 40GHz	Detector Function	Peak (PK) Average (AV)

Antenna Polarity & Test Distance : Horizontal at 3 m								
No	Frequency (MHz)	Emission Level (dBuV/m)	Limit (dBuV/m)	Margin (dB)	Antenna Height (m)	Table Angle (Degree)	Raw Value (dBuV)	Correction Factor (dB/m)
1	*7085.00	107.5 PK			2.93 H	217	59.1	48.4
2	*7085.00	96.2 AV			2.93 H	217	47.8	48.4
3	#7125.00	64.7 PK	88.2	-23.5	2.93 H	217	46.6	18.1
4	#7125.00	53.6 AV	68.2	-14.6	2.93 H	217	35.5	18.1
5	#14170.00	65.4 PK	88.2	-22.8	2.77 H	183	39.3	26.1
6	#14170.00	52.3 AV	68.2	-15.9	2.77 H	183	26.2	26.1

Antenna Polarity & Test Distance : Vertical at 3 m								
No	Frequency (MHz)	Emission Level (dBuV/m)	Limit (dBuV/m)	Margin (dB)	Antenna Height (m)	Table Angle (Degree)	Raw Value (dBuV)	Correction Factor (dB/m)
1	*7085.00	110.8 PK			2.33 V	11	62.4	48.4
2	*7085.00	97.8 AV			2.33 V	11	49.4	48.4
3	#7125.00	67.6 PK	88.2	-20.6	2.33 V	11	49.5	18.1
4	#7125.00	56.4 AV	68.2	-11.8	2.33 V	11	38.3	18.1
5	#14170.00	66.2 PK	88.2	-22.0	2.71 V	253	40.1	26.1
6	#14170.00	52.7 AV	68.2	-15.5	2.71 V	253	26.6	26.1

Remarks:

1. Emission Level(dBuV/m) = Raw Value(dBuV) + Correction Factor(dB/m).
2. Correction Factor(dB/m) = Antenna Factor(dB/m) + Cable Factor(dB) – Pre-Amplifier Factor(dB).
3. Margin value = Emission Level – Limit value.
4. The other emission levels were very low against the limit.
5. " * " : Fundamental frequency.
6. " # " : The radiated frequency is out of the restricted band.

RF Mode	TX 802.11ax (HE80)	Channel	CH 7 : 5985 MHz
Frequency Range	1GHz ~ 40GHz	Detector Function	Peak (PK) Average (AV)

Antenna Polarity & Test Distance : Horizontal at 3 m								
No	Frequency (MHz)	Emission Level (dBuV/m)	Limit (dBuV/m)	Margin (dB)	Antenna Height (m)	Table Angle (Degree)	Raw Value (dBuV)	Correction Factor (dB/m)
1	#5925.00	59.9 PK	88.2	-28.3	1.55 H	256	45.5	14.4
2	#5925.00	48.8 AV	68.2	-19.4	1.55 H	256	34.4	14.4
3	*5985.00	101.2 PK			1.55 H	256	56.9	44.3
4	*5985.00	88.1 AV			1.55 H	256	43.8	44.3
5	11970.00	61.3 PK	74.0	-12.7	2.59 H	157	38.4	22.9
6	11970.00	49.5 AV	54.0	-4.5	2.59 H	157	26.6	22.9

Antenna Polarity & Test Distance : Vertical at 3 m								
No	Frequency (MHz)	Emission Level (dBuV/m)	Limit (dBuV/m)	Margin (dB)	Antenna Height (m)	Table Angle (Degree)	Raw Value (dBuV)	Correction Factor (dB/m)
1	#5925.00	60.1 PK	88.2	-28.1	2.20 V	194	45.7	14.4
2	#5925.00	48.9 AV	68.2	-19.3	2.20 V	194	34.5	14.4
3	*5985.00	108.0 PK			2.20 V	194	63.7	44.3
4	*5985.00	95.3 AV			2.20 V	194	51.0	44.3
5	11970.00	61.5 PK	74.0	-12.5	2.11 V	136	38.6	22.9
6	11970.00	49.7 AV	54.0	-4.3	2.11 V	136	26.8	22.9

Remarks:

1. Emission Level(dBuV/m) = Raw Value(dBuV) + Correction Factor(dB/m).
2. Correction Factor(dB/m) = Antenna Factor(dB/m) + Cable Factor(dB) – Pre-Amplifier Factor(dB).
3. Margin value = Emission Level – Limit value.
4. The other emission levels were very low against the limit.
5. " * " : Fundamental frequency.
6. " # " : The radiated frequency is out of the restricted band.

RF Mode	TX 802.11ax (HE80)	Channel	CH 55 : 6225 MHz
Frequency Range	1GHz ~ 40GHz	Detector Function	Peak (PK) Average (AV)

Antenna Polarity & Test Distance : Horizontal at 3 m								
No	Frequency (MHz)	Emission Level (dBuV/m)	Limit (dBuV/m)	Margin (dB)	Antenna Height (m)	Table Angle (Degree)	Raw Value (dBuV)	Correction Factor (dB/m)
1	*6225.00	100.9 PK			1.47 H	207	56.1	44.8
2	*6225.00	88.4 AV			1.47 H	207	43.6	44.8
3	12450.00	60.7 PK	74.0	-13.3	2.73 H	165	38.3	22.4
4	12450.00	48.6 AV	54.0	-5.4	2.73 H	165	26.2	22.4
Antenna Polarity & Test Distance : Vertical at 3 m								
No	Frequency (MHz)	Emission Level (dBuV/m)	Limit (dBuV/m)	Margin (dB)	Antenna Height (m)	Table Angle (Degree)	Raw Value (dBuV)	Correction Factor (dB/m)
1	*6225.00	111.5 PK			2.18 V	7	66.7	44.8
2	*6225.00	98.3 AV			2.18 V	7	53.5	44.8
3	12450.00	62.8 PK	74.0	-11.2	2.13 V	199	40.4	22.4
4	12450.00	50.0 AV	54.0	-4.0	2.13 V	199	27.6	22.4

Remarks:

1. Emission Level(dBuV/m) = Raw Value(dBuV) + Correction Factor(dB/m).
2. Correction Factor(dB/m) = Antenna Factor(dB/m) + Cable Factor(dB) – Pre-Amplifier Factor(dB).
3. Margin value = Emission Level – Limit value.
4. The other emission levels were very low against the limit.
5. " * " : Fundamental frequency.

RF Mode	TX 802.11ax (HE80)	Channel	CH 87 : 6385 MHz
Frequency Range	1GHz ~ 40GHz	Detector Function	Peak (PK) Average (AV)

Antenna Polarity & Test Distance : Horizontal at 3 m								
No	Frequency (MHz)	Emission Level (dBuV/m)	Limit (dBuV/m)	Margin (dB)	Antenna Height (m)	Table Angle (Degree)	Raw Value (dBuV)	Correction Factor (dB/m)
1	*6385.00	100.6 PK			1.54 H	207	54.9	45.7
2	*6385.00	88.0 AV			1.54 H	207	42.3	45.7
3	#12770.00	61.3 PK	88.2	-26.9	2.71 H	173	38.3	23.0
4	#12770.00	49.2 AV	68.2	-19.0	2.71 H	173	26.2	23.0
Antenna Polarity & Test Distance : Vertical at 3 m								
No	Frequency (MHz)	Emission Level (dBuV/m)	Limit (dBuV/m)	Margin (dB)	Antenna Height (m)	Table Angle (Degree)	Raw Value (dBuV)	Correction Factor (dB/m)
1	*6385.00	111.5 PK			2.40 V	1	65.8	45.7
2	*6385.00	98.5 AV			2.40 V	1	52.8	45.7
3	#12770.00	63.3 PK	88.2	-24.9	2.26 V	198	40.3	23.0
4	#12770.00	50.2 AV	68.2	-18.0	2.26 V	198	27.2	23.0

Remarks:

1. Emission Level(dBuV/m) = Raw Value(dBuV) + Correction Factor(dB/m).
2. Correction Factor(dB/m) = Antenna Factor(dB/m) + Cable Factor(dB) – Pre-Amplifier Factor(dB).
3. Margin value = Emission Level – Limit value.
4. The other emission levels were very low against the limit.
5. " * " : Fundamental frequency.
6. " # " : The radiated frequency is out of the restricted band.

RF Mode	TX 802.11ax (HE80)	Channel	CH 103 : 6465 MHz
Frequency Range	1GHz ~ 40GHz	Detector Function	Peak (PK) Average (AV)

Antenna Polarity & Test Distance : Horizontal at 3 m								
No	Frequency (MHz)	Emission Level (dBuV/m)	Limit (dBuV/m)	Margin (dB)	Antenna Height (m)	Table Angle (Degree)	Raw Value (dBuV)	Correction Factor (dB/m)
1	*6465.00	102.7 PK			2.46 H	218	56.6	46.1
2	*6465.00	90.2 AV			2.46 H	218	44.1	46.1
3	#12930.00	62.4 PK	88.2	-25.8	2.69 H	165	39.3	23.1
4	#12930.00	49.4 AV	68.2	-18.8	2.69 H	165	26.3	23.1
Antenna Polarity & Test Distance : Vertical at 3 m								
No	Frequency (MHz)	Emission Level (dBuV/m)	Limit (dBuV/m)	Margin (dB)	Antenna Height (m)	Table Angle (Degree)	Raw Value (dBuV)	Correction Factor (dB/m)
1	*6465.00	113.0 PK			2.62 V	357	66.9	46.1
2	*6465.00	98.9 AV			2.62 V	357	52.8	46.1
3	#12930.00	62.8 PK	88.2	-25.4	2.92 V	240	39.7	23.1
4	#12930.00	50.6 AV	68.2	-17.6	2.92 V	240	27.5	23.1

Remarks:

1. Emission Level(dBuV/m) = Raw Value(dBuV) + Correction Factor(dB/m).
2. Correction Factor(dB/m) = Antenna Factor(dB/m) + Cable Factor(dB) – Pre-Amplifier Factor(dB).
3. Margin value = Emission Level – Limit value.
4. The other emission levels were very low against the limit.
5. " * " : Fundamental frequency.
6. " # " : The radiated frequency is out of the restricted band.

RF Mode	TX 802.11ax (HE80)	Channel	CH 119 : 6545 MHz
Frequency Range	1GHz ~ 40GHz	Detector Function	Peak (PK) Average (AV)

Antenna Polarity & Test Distance : Horizontal at 3 m								
No	Frequency (MHz)	Emission Level (dBuV/m)	Limit (dBuV/m)	Margin (dB)	Antenna Height (m)	Table Angle (Degree)	Raw Value (dBuV)	Correction Factor (dB/m)
1	*6545.00	103.9 PK			2.56 H	215	57.3	46.6
2	*6545.00	90.9 AV			2.56 H	215	44.3	46.6
3	#13090.00	62.8 PK	88.2	-25.4	1.00 H	26	39.5	23.3
4	#13090.00	49.7 AV	68.2	-18.5	1.00 H	26	26.4	23.3
Antenna Polarity & Test Distance : Vertical at 3 m								
No	Frequency (MHz)	Emission Level (dBuV/m)	Limit (dBuV/m)	Margin (dB)	Antenna Height (m)	Table Angle (Degree)	Raw Value (dBuV)	Correction Factor (dB/m)
1	*6545.00	112.0 PK			2.63 V	6	65.4	46.6
2	*6545.00	98.7 AV			2.63 V	6	52.1	46.6
3	#13090.00	63.5 PK	88.2	-24.7	2.62 V	259	40.2	23.3
4	#13090.00	50.6 AV	68.2	-17.6	2.62 V	259	27.3	23.3

Remarks:

1. Emission Level(dBuV/m) = Raw Value(dBuV) + Correction Factor(dB/m).
2. Correction Factor(dB/m) = Antenna Factor(dB/m) + Cable Factor(dB) – Pre-Amplifier Factor(dB).
3. Margin value = Emission Level – Limit value.
4. The other emission levels were very low against the limit.
5. " * " : Fundamental frequency.
6. " # " : The radiated frequency is out of the restricted band.

RF Mode	TX 802.11ax (HE80)	Channel	CH 135 : 6625 MHz
Frequency Range	1GHz ~ 40GHz	Detector Function	Peak (PK) Average (AV)

Antenna Polarity & Test Distance : Horizontal at 3 m								
No	Frequency (MHz)	Emission Level (dBuV/m)	Limit (dBuV/m)	Margin (dB)	Antenna Height (m)	Table Angle (Degree)	Raw Value (dBuV)	Correction Factor (dB/m)
1	*6625.00	103.4 PK			2.66 H	207	56.8	46.6
2	*6625.00	90.9 AV			2.66 H	207	44.3	46.6
3	13250.00	62.9 PK	74.0	-11.1	2.69 H	168	39.3	23.6
4	13250.00	50.0 AV	54.0	-4.0	2.69 H	168	26.4	23.6
Antenna Polarity & Test Distance : Vertical at 3 m								
No	Frequency (MHz)	Emission Level (dBuV/m)	Limit (dBuV/m)	Margin (dB)	Antenna Height (m)	Table Angle (Degree)	Raw Value (dBuV)	Correction Factor (dB/m)
1	*6625.00	112.3 PK			2.58 V	357	65.7	46.6
2	*6625.00	98.4 AV			2.58 V	357	51.8	46.6
3	13250.00	63.9 PK	74.0	-10.1	2.66 V	273	40.3	23.6
4	13250.00	51.1 AV	54.0	-2.9	2.66 V	273	27.5	23.6

Remarks:

1. Emission Level(dBuV/m) = Raw Value(dBuV) + Correction Factor(dB/m).
2. Correction Factor(dB/m) = Antenna Factor(dB/m) + Cable Factor(dB) – Pre-Amplifier Factor(dB).
3. Margin value = Emission Level – Limit value.
4. The other emission levels were very low against the limit.
5. " * " : Fundamental frequency.

RF Mode	TX 802.11ax (HE80)	Channel	CH 151 : 6705 MHz
Frequency Range	1GHz ~ 40GHz	Detector Function	Peak (PK) Average (AV)

Antenna Polarity & Test Distance : Horizontal at 3 m								
No	Frequency (MHz)	Emission Level (dBuV/m)	Limit (dBuV/m)	Margin (dB)	Antenna Height (m)	Table Angle (Degree)	Raw Value (dBuV)	Correction Factor (dB/m)
1	*6705.00	103.8 PK			2.66 H	215	57.0	46.8
2	*6705.00	90.8 AV			2.66 H	215	44.0	46.8
3	#13410.00	63.7 PK	88.2	-24.5	2.73 H	168	39.3	24.4
4	#13410.00	50.6 AV	68.2	-17.6	2.73 H	168	26.2	24.4
Antenna Polarity & Test Distance : Vertical at 3 m								
No	Frequency (MHz)	Emission Level (dBuV/m)	Limit (dBuV/m)	Margin (dB)	Antenna Height (m)	Table Angle (Degree)	Raw Value (dBuV)	Correction Factor (dB/m)
1	*6705.00	112.3 PK			2.68 V	4	65.5	46.8
2	*6705.00	98.3 AV			2.68 V	4	51.5	46.8
3	#13410.00	64.7 PK	88.2	-23.5	2.84 V	262	40.3	24.4
4	#13410.00	51.7 AV	68.2	-16.5	2.84 V	262	27.3	24.4

Remarks:

1. Emission Level(dBuV/m) = Raw Value(dBuV) + Correction Factor(dB/m).
2. Correction Factor(dB/m) = Antenna Factor(dB/m) + Cable Factor(dB) – Pre-Amplifier Factor(dB).
3. Margin value = Emission Level – Limit value.
4. The other emission levels were very low against the limit.
5. " * " : Fundamental frequency.
6. " # " : The radiated frequency is out of the restricted band.

RF Mode	TX 802.11ax (HE80)	Channel	CH 167 : 6785 MHz
Frequency Range	1GHz ~ 40GHz	Detector Function	Peak (PK) Average (AV)

Antenna Polarity & Test Distance : Horizontal at 3 m								
No	Frequency (MHz)	Emission Level (dBuV/m)	Limit (dBuV/m)	Margin (dB)	Antenna Height (m)	Table Angle (Degree)	Raw Value (dBuV)	Correction Factor (dB/m)
1	*6785.00	103.5 PK			2.67 H	218	56.6	46.9
2	*6785.00	90.6 AV			2.67 H	218	43.7	46.9
3	#13570.00	63.9 PK	88.2	-24.3	2.75 H	169	39.3	24.6
4	#13570.00	50.9 AV	68.2	-17.3	2.75 H	169	26.3	24.6
Antenna Polarity & Test Distance : Vertical at 3 m								
No	Frequency (MHz)	Emission Level (dBuV/m)	Limit (dBuV/m)	Margin (dB)	Antenna Height (m)	Table Angle (Degree)	Raw Value (dBuV)	Correction Factor (dB/m)
1	*6785.00	112.0 PK			2.69 V	1	65.1	46.9
2	*6785.00	98.4 AV			2.69 V	1	51.5	46.9
3	#13570.00	64.1 PK	88.2	-24.1	2.63 V	291	39.5	24.6
4	#13570.00	51.4 AV	68.2	-16.8	2.63 V	291	26.8	24.6

Remarks:

1. Emission Level(dBuV/m) = Raw Value(dBuV) + Correction Factor(dB/m).
2. Correction Factor(dB/m) = Antenna Factor(dB/m) + Cable Factor(dB) – Pre-Amplifier Factor(dB).
3. Margin value = Emission Level – Limit value.
4. The other emission levels were very low against the limit.
5. " * " : Fundamental frequency.
6. " # " : The radiated frequency is out of the restricted band.

RF Mode	TX 802.11ax (HE80)	Channel	CH 183 : 6865 MHz
Frequency Range	1GHz ~ 40GHz	Detector Function	Peak (PK) Average (AV)

Antenna Polarity & Test Distance : Horizontal at 3 m								
No	Frequency (MHz)	Emission Level (dBuV/m)	Limit (dBuV/m)	Margin (dB)	Antenna Height (m)	Table Angle (Degree)	Raw Value (dBuV)	Correction Factor (dB/m)
1	*6865.00	103.5 PK			2.66 H	224	56.4	47.1
2	*6865.00	90.9 AV			2.66 H	224	43.8	47.1
3	#13730.00	64.3 PK	88.2	-23.9	2.72 H	173	39.3	25.0
4	#13730.00	51.1 AV	68.2	-17.1	2.72 H	173	26.1	25.0
Antenna Polarity & Test Distance : Vertical at 3 m								
No	Frequency (MHz)	Emission Level (dBuV/m)	Limit (dBuV/m)	Margin (dB)	Antenna Height (m)	Table Angle (Degree)	Raw Value (dBuV)	Correction Factor (dB/m)
1	*6865.00	110.9 PK			2.64 V	8	63.8	47.1
2	*6865.00	98.1 AV			2.64 V	8	51.0	47.1
3	#13730.00	65.3 PK	88.2	-22.9	2.94 V	278	40.3	25.0
4	#13730.00	51.9 AV	68.2	-16.3	2.94 V	278	26.9	25.0

Remarks:

1. Emission Level(dBuV/m) = Raw Value(dBuV) + Correction Factor(dB/m).
2. Correction Factor(dB/m) = Antenna Factor(dB/m) + Cable Factor(dB) – Pre-Amplifier Factor(dB).
3. Margin value = Emission Level – Limit value.
4. The other emission levels were very low against the limit.
5. " * " : Fundamental frequency.
6. " # " : The radiated frequency is out of the restricted band.

RF Mode	TX 802.11ax (HE80)	Channel	CH 199 : 6945 MHz
Frequency Range	1GHz ~ 40GHz	Detector Function	Peak (PK) Average (AV)

Antenna Polarity & Test Distance : Horizontal at 3 m								
No	Frequency (MHz)	Emission Level (dBuV/m)	Limit (dBuV/m)	Margin (dB)	Antenna Height (m)	Table Angle (Degree)	Raw Value (dBuV)	Correction Factor (dB/m)
1	*6945.00	107.8 PK			3.07 H	215	59.9	47.9
2	*6945.00	96.5 AV			3.07 H	215	48.6	47.9
3	#13890.00	64.5 PK	88.2	-23.7	2.69 H	172	39.3	25.2
4	#13890.00	51.6 AV	68.2	-16.6	2.69 H	172	26.4	25.2
Antenna Polarity & Test Distance : Vertical at 3 m								
No	Frequency (MHz)	Emission Level (dBuV/m)	Limit (dBuV/m)	Margin (dB)	Antenna Height (m)	Table Angle (Degree)	Raw Value (dBuV)	Correction Factor (dB/m)
1	*6945.00	111.1 PK			2.82 V	6	63.2	47.9
2	*6945.00	98.5 AV			2.82 V	6	50.6	47.9
3	#13890.00	65.6 PK	88.2	-22.6	2.74 V	268	40.4	25.2
4	#13890.00	52.5 AV	68.2	-15.7	2.74 V	268	27.3	25.2

Remarks:

1. Emission Level(dBuV/m) = Raw Value(dBuV) + Correction Factor(dB/m).
2. Correction Factor(dB/m) = Antenna Factor(dB/m) + Cable Factor(dB) – Pre-Amplifier Factor(dB).
3. Margin value = Emission Level – Limit value.
4. The other emission levels were very low against the limit.
5. " * " : Fundamental frequency.
6. " # " : The radiated frequency is out of the restricted band.

RF Mode	TX 802.11ax (HE80)	Channel	CH 215 : 7025 MHz
Frequency Range	1GHz ~ 40GHz	Detector Function	Peak (PK) Average (AV)

Antenna Polarity & Test Distance : Horizontal at 3 m								
No	Frequency (MHz)	Emission Level (dBuV/m)	Limit (dBuV/m)	Margin (dB)	Antenna Height (m)	Table Angle (Degree)	Raw Value (dBuV)	Correction Factor (dB/m)
1	*7025.00	108.5 PK			2.96 H	213	60.4	48.1
2	*7025.00	96.1 AV			2.96 H	213	48.0	48.1
3	#7125.00	66.9 PK	88.2	-21.3	2.96 H	213	48.8	18.1
4	#7125.00	54.0 AV	68.2	-14.2	2.96 H	213	35.9	18.1
5	#14050.00	65.2 PK	88.2	-23.0	2.86 H	181	39.5	25.7
6	#14050.00	52.0 AV	68.2	-16.2	2.86 H	181	26.3	25.7

Antenna Polarity & Test Distance : Vertical at 3 m								
No	Frequency (MHz)	Emission Level (dBuV/m)	Limit (dBuV/m)	Margin (dB)	Antenna Height (m)	Table Angle (Degree)	Raw Value (dBuV)	Correction Factor (dB/m)
1	*7025.00	112.5 PK			2.56 V	357	64.4	48.1
2	*7025.00	98.7 AV			2.56 V	357	50.6	48.1
3	#7125.00	66.4 PK	88.2	-21.8	2.56 V	357	48.3	18.1
4	#7125.00	55.9 AV	68.2	-12.3	2.56 V	357	37.8	18.1
5	#14050.00	65.9 PK	88.2	-22.3	2.77 V	283	40.2	25.7
6	#14050.00	52.3 AV	68.2	-15.9	2.77 V	283	26.6	25.7

Remarks:

1. Emission Level(dBuV/m) = Raw Value(dBuV) + Correction Factor(dB/m).
2. Correction Factor(dB/m) = Antenna Factor(dB/m) + Cable Factor(dB) – Pre-Amplifier Factor(dB).
3. Margin value = Emission Level – Limit value.
4. The other emission levels were very low against the limit.
5. " * " : Fundamental frequency.
6. " # " : The radiated frequency is out of the restricted band.

RF Mode	TX 802.11ax (HE160)	Channel	CH 15 : 6025 MHz
Frequency Range	1GHz ~ 40GHz	Detector Function	Peak (PK) Average (AV)

Antenna Polarity & Test Distance : Horizontal at 3 m								
No	Frequency (MHz)	Emission Level (dBuV/m)	Limit (dBuV/m)	Margin (dB)	Antenna Height (m)	Table Angle (Degree)	Raw Value (dBuV)	Correction Factor (dB/m)
1	#5925.00	74.0 PK	88.2	-14.2	1.80 H	256	59.6	14.4
2	#5925.00	54.9 AV	68.2	-13.3	1.80 H	256	40.5	14.4
3	*6025.00	98.5 PK			1.80 H	256	54.2	44.3
4	*6025.00	85.9 AV			1.80 H	256	41.6	44.3
5	12050.00	61.4 PK	74.0	-12.6	2.84 H	132	38.7	22.7
6	12050.00	49.5 AV	54.0	-4.5	2.84 H	132	26.8	22.7

Antenna Polarity & Test Distance : Vertical at 3 m								
No	Frequency (MHz)	Emission Level (dBuV/m)	Limit (dBuV/m)	Margin (dB)	Antenna Height (m)	Table Angle (Degree)	Raw Value (dBuV)	Correction Factor (dB/m)
1	#5925.00	78.4 PK	88.2	-9.8	2.13 V	192	64.0	14.4
2	#5925.00	58.6 AV	68.2	-9.6	2.13 V	192	44.2	14.4
3	*6025.00	108.1 PK			2.13 V	192	63.8	44.3
4	*6025.00	93.1 AV			2.13 V	192	48.8	44.3
5	12050.00	61.5 PK	74.0	-12.5	2.31 V	117	38.8	22.7
6	12050.00	49.6 AV	54.0	-4.4	2.31 V	117	26.9	22.7

Remarks:

1. Emission Level(dBuV/m) = Raw Value(dBuV) + Correction Factor(dB/m).
2. Correction Factor(dB/m) = Antenna Factor(dB/m) + Cable Factor(dB) – Pre-Amplifier Factor(dB).
3. Margin value = Emission Level – Limit value.
4. The other emission levels were very low against the limit.
5. " * " : Fundamental frequency.
6. " # " : The radiated frequency is out of the restricted band.

RF Mode	TX 802.11ax (HE160)	Channel	CH 47 : 6185 MHz
Frequency Range	1GHz ~ 40GHz	Detector Function	Peak (PK) Average (AV)

Antenna Polarity & Test Distance : Horizontal at 3 m								
No	Frequency (MHz)	Emission Level (dBuV/m)	Limit (dBuV/m)	Margin (dB)	Antenna Height (m)	Table Angle (Degree)	Raw Value (dBuV)	Correction Factor (dB/m)
1	#5925.00	62.0 PK	88.2	-26.2	1.49 H	207	47.6	14.4
2	#5925.00	48.9 AV	68.2	-19.3	1.49 H	207	34.5	14.4
3	*6185.00	101.1 PK			1.49 H	207	56.4	44.7
4	*6185.00	87.8 AV			1.49 H	207	43.1	44.7
5	11910.00	61.4 PK	74.0	-12.6	2.75 H	164	38.5	22.9
6	11910.00	49.3 AV	54.0	-4.7	2.75 H	164	26.4	22.9

Antenna Polarity & Test Distance : Vertical at 3 m								
No	Frequency (MHz)	Emission Level (dBuV/m)	Limit (dBuV/m)	Margin (dB)	Antenna Height (m)	Table Angle (Degree)	Raw Value (dBuV)	Correction Factor (dB/m)
1	#5925.00	64.8 PK	88.2	-23.4	2.23 V	6	50.4	14.4
2	#5925.00	53.3 AV	68.2	-14.9	2.23 V	6	38.9	14.4
3	*6185.00	111.9 PK			2.23 V	6	67.2	44.7
4	*6185.00	99.6 AV			2.23 V	6	54.9	44.7
5	11910.00	62.5 PK	74.0	-11.5	1.84 V	270	39.6	22.9
6	11910.00	49.7 AV	54.0	-4.3	1.84 V	270	26.8	22.9

Remarks:

1. Emission Level(dBuV/m) = Raw Value(dBuV) + Correction Factor(dB/m).
2. Correction Factor(dB/m) = Antenna Factor(dB/m) + Cable Factor(dB) – Pre-Amplifier Factor(dB).
3. Margin value = Emission Level – Limit value.
4. The other emission levels were very low against the limit.
5. " * ": Fundamental frequency.

RF Mode	TX 802.11ax (HE160)	Channel	CH 79 : 6345 MHz
Frequency Range	1GHz ~ 40GHz	Detector Function	Peak (PK) Average (AV)

Antenna Polarity & Test Distance : Horizontal at 3 m								
No	Frequency (MHz)	Emission Level (dBuV/m)	Limit (dBuV/m)	Margin (dB)	Antenna Height (m)	Table Angle (Degree)	Raw Value (dBuV)	Correction Factor (dB/m)
1	*6345.00	101.0 PK			1.55 H	207	55.6	45.4
2	*6345.00	88.7 AV			1.55 H	207	43.3	45.4
3	12690.00	61.1 PK	74.0	-12.9	2.76 H	169	38.4	22.7
4	12690.00	49.0 AV	54.0	-5.0	2.76 H	169	26.3	22.7
Antenna Polarity & Test Distance : Vertical at 3 m								
No	Frequency (MHz)	Emission Level (dBuV/m)	Limit (dBuV/m)	Margin (dB)	Antenna Height (m)	Table Angle (Degree)	Raw Value (dBuV)	Correction Factor (dB/m)
1	*6345.00	112.1 PK			2.17 V	13	66.7	45.4
2	*6345.00	98.3 AV			2.17 V	13	52.9	45.4
3	12690.00	63.1 PK	74.0	-10.9	1.88 V	263	40.4	22.7
4	12690.00	49.9 AV	54.0	-4.1	1.88 V	263	27.2	22.7

Remarks:

1. Emission Level(dBuV/m) = Raw Value(dBuV) + Correction Factor(dB/m).
2. Correction Factor(dB/m) = Antenna Factor(dB/m) + Cable Factor(dB) – Pre-Amplifier Factor(dB).
3. Margin value = Emission Level – Limit value.
4. The other emission levels were very low against the limit.
5. " * " : Fundamental frequency.

RF Mode	TX 802.11ax (HE160)	Channel	CH 111 : 6505 MHz
Frequency Range	1GHz ~ 40GHz	Detector Function	Peak (PK) Average (AV)

Antenna Polarity & Test Distance : Horizontal at 3 m								
No	Frequency (MHz)	Emission Level (dBuV/m)	Limit (dBuV/m)	Margin (dB)	Antenna Height (m)	Table Angle (Degree)	Raw Value (dBuV)	Correction Factor (dB/m)
1	*6505.00	105.5 PK			2.55 H	208	59.2	46.3
2	*6505.00	92.3 AV			2.55 H	208	46.0	46.3
3	#13010.00	62.6 PK	88.2	-25.6	2.69 H	169	39.4	23.2
4	#13010.00	49.5 AV	68.2	-18.7	2.69 H	169	26.3	23.2
Antenna Polarity & Test Distance : Vertical at 3 m								
No	Frequency (MHz)	Emission Level (dBuV/m)	Limit (dBuV/m)	Margin (dB)	Antenna Height (m)	Table Angle (Degree)	Raw Value (dBuV)	Correction Factor (dB/m)
1	*6505.00	110.8 PK			2.67 V	9	64.5	46.3
2	*6505.00	98.4 AV			2.67 V	9	52.1	46.3
3	#13010.00	64.1 PK	88.2	-24.1	2.92 V	264	40.9	23.2
4	#13010.00	51.4 AV	68.2	-16.8	2.92 V	264	28.2	23.2

Remarks:

1. Emission Level(dBuV/m) = Raw Value(dBuV) + Correction Factor(dB/m).
2. Correction Factor(dB/m) = Antenna Factor(dB/m) + Cable Factor(dB) – Pre-Amplifier Factor(dB).
3. Margin value = Emission Level – Limit value.
4. The other emission levels were very low against the limit.
5. " * " : Fundamental frequency.
6. " # " : The radiated frequency is out of the restricted band.

RF Mode	TX 802.11ax (HE160)	Channel	CH 143 : 6665 MHz
Frequency Range	1GHz ~ 40GHz	Detector Function	Peak (PK) Average (AV)

Antenna Polarity & Test Distance : Horizontal at 3 m								
No	Frequency (MHz)	Emission Level (dBuV/m)	Limit (dBuV/m)	Margin (dB)	Antenna Height (m)	Table Angle (Degree)	Raw Value (dBuV)	Correction Factor (dB/m)
1	*6665.00	102.2 PK			2.61 H	207	55.5	46.7
2	*6665.00	89.0 AV			2.61 H	207	42.3	46.7
3	13330.00	63.2 PK	74.0	-10.8	2.68 H	168	39.3	23.9
4	13330.00	50.1 AV	54.0	-3.9	2.68 H	168	26.2	23.9
Antenna Polarity & Test Distance : Vertical at 3 m								
No	Frequency (MHz)	Emission Level (dBuV/m)	Limit (dBuV/m)	Margin (dB)	Antenna Height (m)	Table Angle (Degree)	Raw Value (dBuV)	Correction Factor (dB/m)
1	*6665.00	111.1 PK			2.69 V	355	64.4	46.7
2	*6665.00	98.5 AV			2.69 V	355	51.8	46.7
3	13330.00	64.2 PK	74.0	-9.8	2.48 V	266	40.3	23.9
4	13330.00	50.9 AV	54.0	-3.1	2.48 V	266	27.0	23.9

Remarks:

1. Emission Level(dBuV/m) = Raw Value(dBuV) + Correction Factor(dB/m).
2. Correction Factor(dB/m) = Antenna Factor(dB/m) + Cable Factor(dB) – Pre-Amplifier Factor(dB).
3. Margin value = Emission Level – Limit value.
4. The other emission levels were very low against the limit.
5. " * " : Fundamental frequency.

RF Mode	TX 802.11ax (HE160)	Channel	CH 175 : 6825 MHz
Frequency Range	1GHz ~ 40GHz	Detector Function	Peak (PK) Average (AV)

Antenna Polarity & Test Distance : Horizontal at 3 m								
No	Frequency (MHz)	Emission Level (dBuV/m)	Limit (dBuV/m)	Margin (dB)	Antenna Height (m)	Table Angle (Degree)	Raw Value (dBuV)	Correction Factor (dB/m)
1	*6825.00	101.5 PK			2.70 H	224	54.6	46.9
2	*6825.00	88.2 AV			2.70 H	224	41.3	46.9
3	#13650.00	64.0 PK	88.2	-24.2	2.66 H	169	39.3	24.7
4	#13650.00	50.8 AV	68.2	-17.4	2.66 H	169	26.1	24.7
Antenna Polarity & Test Distance : Vertical at 3 m								
No	Frequency (MHz)	Emission Level (dBuV/m)	Limit (dBuV/m)	Margin (dB)	Antenna Height (m)	Table Angle (Degree)	Raw Value (dBuV)	Correction Factor (dB/m)
1	*6825.00	111.1 PK			2.64 V	0	64.2	46.9
2	*6825.00	97.9 AV			2.64 V	0	51.0	46.9
3	#13650.00	64.3 PK	88.2	-23.9	2.94 V	283	39.6	24.7
4	#13650.00	51.2 AV	68.2	-17.0	2.94 V	283	26.5	24.7

Remarks:

1. Emission Level(dBuV/m) = Raw Value(dBuV) + Correction Factor(dB/m).
2. Correction Factor(dB/m) = Antenna Factor(dB/m) + Cable Factor(dB) – Pre-Amplifier Factor(dB).
3. Margin value = Emission Level – Limit value.
4. The other emission levels were very low against the limit.
5. " * " : Fundamental frequency.
6. " # " : The radiated frequency is out of the restricted band.

RF Mode	TX 802.11ax (HE160)	Channel	CH 207 : 6985 MHz
Frequency Range	1GHz ~ 40GHz	Detector Function	Peak (PK) Average (AV)

Antenna Polarity & Test Distance : Horizontal at 3 m								
No	Frequency (MHz)	Emission Level (dBuV/m)	Limit (dBuV/m)	Margin (dB)	Antenna Height (m)	Table Angle (Degree)	Raw Value (dBuV)	Correction Factor (dB/m)
1	*6985.00	107.7 PK			2.99 H	218	59.7	48.0
2	*6985.00	96.5 AV			2.99 H	218	48.5	48.0
3	#7125.00	79.0 PK	88.2	-9.2	2.99 H	218	60.9	18.1
4	#7125.00	61.5 AV	68.2	-6.7	2.99 H	218	43.4	18.1
5	#13970.00	64.9 PK	88.2	-23.3	2.82 H	173	39.3	25.6
6	#13970.00	51.9 AV	68.2	-16.3	2.82 H	173	26.3	25.6

Antenna Polarity & Test Distance : Vertical at 3 m								
No	Frequency (MHz)	Emission Level (dBuV/m)	Limit (dBuV/m)	Margin (dB)	Antenna Height (m)	Table Angle (Degree)	Raw Value (dBuV)	Correction Factor (dB/m)
1	*6985.00	112.0 PK			2.45 V	8	64.0	48.0
2	*6985.00	98.6 AV			2.45 V	8	50.6	48.0
3	#7125.00	85.9 PK	88.2	-2.3	2.45 V	8	67.8	18.1
4	#7125.00	64.4 AV	68.2	-3.8	2.45 V	8	46.3	18.1
5	#13970.00	66.2 PK	88.2	-22.0	2.95 V	273	40.6	25.6
6	#13970.00	53.1 AV	68.2	-15.1	2.95 V	273	27.5	25.6

Remarks:

1. Emission Level(dBuV/m) = Raw Value(dBuV) + Correction Factor(dB/m).
2. Correction Factor(dB/m) = Antenna Factor(dB/m) + Cable Factor(dB) – Pre-Amplifier Factor(dB).
3. Margin value = Emission Level – Limit value.
4. The other emission levels were very low against the limit.
5. " * " : Fundamental frequency.
6. " # " : The radiated frequency is out of the restricted band.

Below 1GHz Worst-Case Data:

Nss 1

RF Mode	TX 802.11ax (HE20)	Channel	CH 233 : 7115 MHz
Frequency Range	30MHz ~ 1GHz	Detector Function	Quasi-Peak (QP)
Test Mode	A		

Antenna Polarity & Test Distance : Horizontal at 3 m								
No	Frequency (MHz)	Emission Level (dBuV/m)	Limit (dBuV/m)	Margin (dB)	Antenna Height (m)	Table Angle (Degree)	Raw Value (dBuV)	Correction Factor (dB/m)
1	106.63	27.7 QP	43.5	-15.8	1.00 H	199	40.3	-12.6
2	164.83	26.4 QP	43.5	-17.1	1.00 H	284	35.5	-9.1
3	247.28	24.5 QP	46.0	-21.5	1.00 H	14	34.2	-9.7
4	385.02	30.1 QP	46.0	-15.9	1.00 H	217	36.4	-6.3
5	477.17	32.5 QP	46.0	-13.5	1.00 H	197	37.0	-4.5
6	625.58	33.9 QP	46.0	-12.1	1.00 H	266	35.3	-1.4

Remarks:

1. Emission Level(dBuV/m) = Raw Value(dBuV) + Correction Factor(dB/m).
2. Correction Factor(dB/m) = Antenna Factor(dB/m) + Cable Factor(dB) – Pre-Amplifier Factor(dB).
3. The other emission levels were very low against the limit of frequency range 30MHz ~ 1000MHz.
4. Margin value = Emission Level – Limit value.
5. The emission levels were very low against the limit of frequency range 9kHz ~ 30MHz: the amplitude of spurious emissions attenuated more than 20 dB below the permissible value to be report.

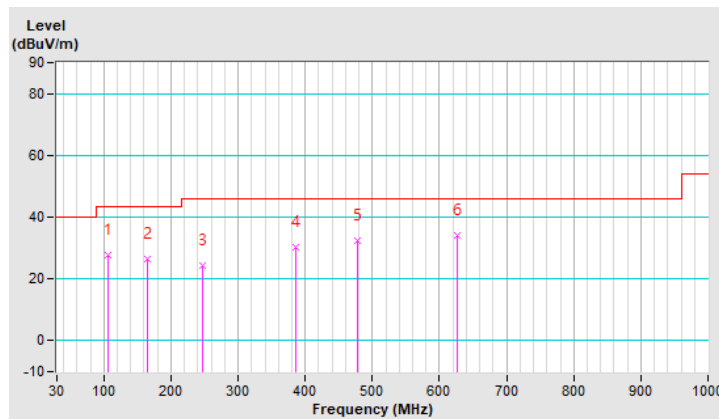

RF Mode	TX 802.11ax (HE20)	Channel	CH 233 : 7115 MHz
Frequency Range	30MHz ~ 1GHz	Detector Function	Quasi-Peak (QP)
Test Mode	A		

Antenna Polarity & Test Distance : Vertical at 3 m								
No	Frequency (MHz)	Emission Level (dBuV/m)	Limit (dBuV/m)	Margin (dB)	Antenna Height (m)	Table Angle (Degree)	Raw Value (dBuV)	Correction Factor (dB/m)
1	123.12	28.5 QP	43.5	-15.0	1.50 V	155	39.5	-11.0
2	237.58	26.7 QP	46.0	-19.3	1.50 V	155	37.1	-10.4
3	363.68	39.5 QP	46.0	-6.5	1.00 V	190	46.1	-6.6
4	472.32	33.8 QP	46.0	-12.2	1.50 V	130	38.4	-4.6
5	530.52	30.2 QP	46.0	-15.8	1.00 V	190	33.9	-3.7
6	625.58	33.0 QP	46.0	-13.0	1.00 V	247	34.4	-1.4

Remarks:

1. Emission Level(dBuV/m) = Raw Value(dBuV) + Correction Factor(dB/m).
2. Correction Factor(dB/m) = Antenna Factor(dB/m) + Cable Factor(dB) – Pre-Amplifier Factor(dB).
3. The other emission levels were very low against the limit of frequency range 30MHz ~ 1000MHz.
4. Margin value = Emission Level – Limit value.
5. The emission levels were very low against the limit of frequency range 9kHz ~ 30MHz: the amplitude of spurious emissions attenuated more than 20 dB below the permissible value to be report.

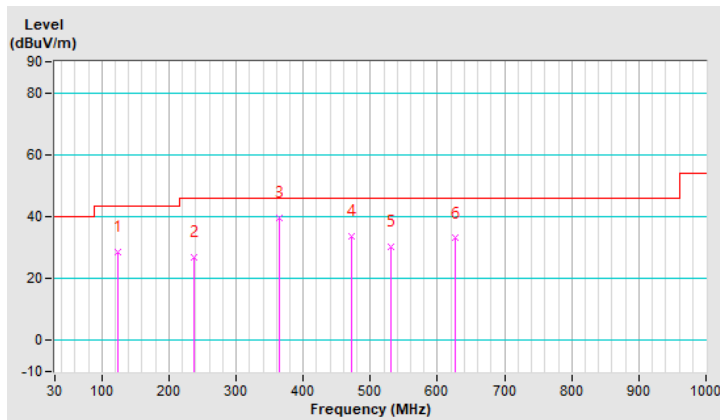

RF Mode	TX 802.11ax (HE20)	Channel	CH 233 : 7115 MHz
Frequency Range	30MHz ~ 1GHz	Detector Function	Quasi-Peak (QP)
Test Mode	B		

Antenna Polarity & Test Distance : Horizontal at 3 m								
No	Frequency (MHz)	Emission Level (dBuV/m)	Limit (dBuV/m)	Margin (dB)	Antenna Height (m)	Table Angle (Degree)	Raw Value (dBuV)	Correction Factor (dB/m)
1	64.92	30.40 QP	40.00	-9.60	1.50 H	233	40.45	-10.05
2	76.56	32.08 QP	40.00	-7.92	1.50 H	234	44.21	-12.13
3	128.94	38.95 QP	43.50	-4.55	1.50 H	243	49.18	-10.23
4	165.80	31.82 QP	43.50	-11.68	1.50 H	277	40.73	-8.91
5	472.32	37.83 QP	46.00	-8.17	1.50 H	195	42.30	-4.47
6	701.24	32.98 QP	46.00	-13.02	1.00 H	62	33.19	-0.21

Remarks:

1. Emission Level(dBuV/m) = Raw Value(dBuV) + Correction Factor(dB/m).
2. Correction Factor(dB/m) = Antenna Factor(dB/m) + Cable Factor(dB) – Pre-Amplifier Factor(dB).
3. The other emission levels were very low against the limit of frequency range 30MHz ~ 1000MHz.
4. Margin value = Emission Level – Limit value.
5. The emission levels were very low against the limit of frequency range 9kHz ~ 30MHz: the amplitude of spurious emissions attenuated more than 20 dB below the permissible value to be report.

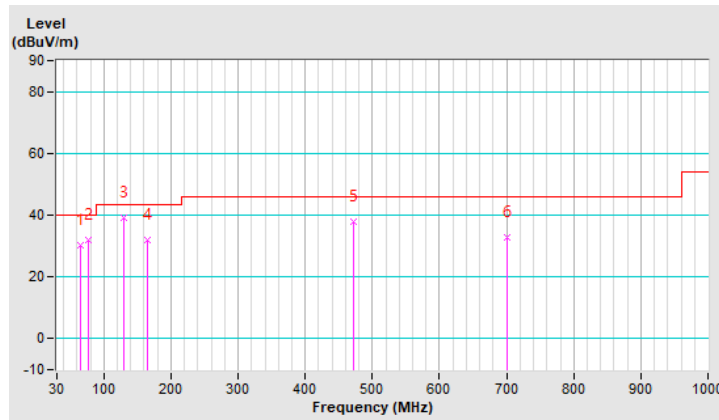

RF Mode	TX 802.11ax (HE20)	Channel	CH 233 : 7115 MHz
Frequency Range	30MHz ~ 1GHz	Detector Function	Quasi-Peak (QP)
Test Mode	B		

Antenna Polarity & Test Distance : Vertical at 3 m								
No	Frequency (MHz)	Emission Level (dBuV/m)	Limit (dBuV/m)	Margin (dB)	Antenna Height (m)	Table Angle (Degree)	Raw Value (dBuV)	Correction Factor (dB/m)
1	115.36	39.70 QP	43.50	-3.80	1.00 V	324	51.26	-11.56
2	208.48	30.60 QP	43.50	-12.90	1.00 V	247	42.27	-11.67
3	239.52	34.14 QP	46.00	-11.86	1.00 V	188	44.16	-10.02
4	282.20	34.94 QP	46.00	-11.06	1.00 V	247	42.91	-7.97
5	369.50	34.11 QP	46.00	-11.89	1.00 V	60	40.47	-6.36
6	476.20	32.24 QP	46.00	-13.76	1.50 V	289	36.65	-4.41

Remarks:

1. Emission Level(dBuV/m) = Raw Value(dBuV) + Correction Factor(dB/m).
2. Correction Factor(dB/m) = Antenna Factor(dB/m) + Cable Factor(dB) – Pre-Amplifier Factor(dB).
3. The other emission levels were very low against the limit of frequency range 30MHz ~ 1000MHz.
4. Margin value = Emission Level – Limit value.
5. The emission levels were very low against the limit of frequency range 9kHz ~ 30MHz: the amplitude of spurious emissions attenuated more than 20 dB below the permissible value to be report.

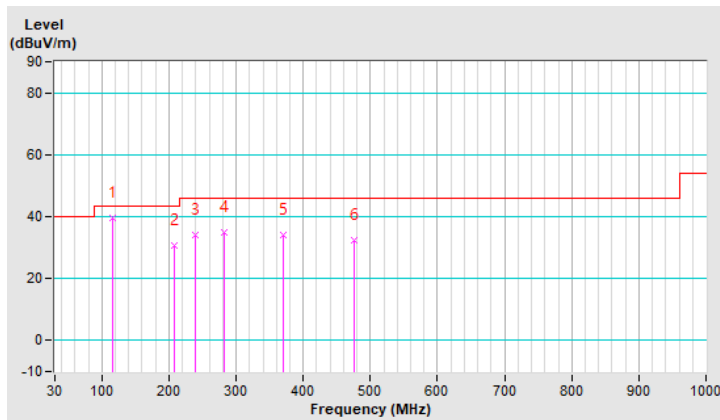

4.2 In-Band Emission (Mask) Measurement

4.2.1 Limits of In-Band Emission (Mask) Measurement

Test Item	Frequencies (MHz)	(X) dBc ^{*1}
Emission Mask	At 1 MHz outside of channel edge	20
	At one channel bandwidth from the channel center ^{*2}	28
	At one- and one-half times the channel bandwidth away from channel center ^{*3}	40
	More than one- and one-half times the channel bandwidth	40

*1 : The power spectral density must be suppressed by "x" dB

*2 : At frequencies between one megahertz outside an unlicensed device's channel edge and one channel bandwidth from the center of the channel, the limits must be linearly interpolated between 20 dB and 28 dB suppression,

*3 : At frequencies between one and one- and one-half times an unlicensed device's channel bandwidth, the limits must be linearly interpolated between 28 dB and 40 dB suppression.

4.2.2 Test Setup

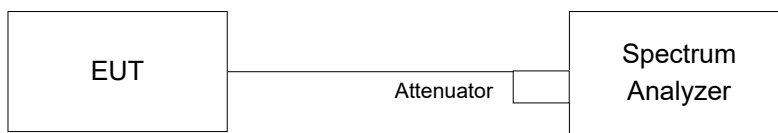

4.2.3 Test Instruments

Refer to section 4.1.2 to get information of above instrument.

4.2.4 Test Procedure

- a. Connect output of the antenna port to a spectrum analyzer and adjust appropriate attenuation.
- b. Measure the 26 dB EBW using the test procedure 12.4.1 of ANSI C63.10-2013. (Determine the channel edge.)
- c. Measure the power spectral density (for emissions mask reference) using the following procedure:
 - a) Set the span to encompass the entire 26 dB EBW of the signal.
 - b) Set RBW = same RBW used for 26 dB EBW measurement.
 - c) Set VBW $\geq 3 \times$ RBW
 - d) Number of points in sweep $\geq [2 \times \text{span} / \text{RBW}]$.
 - e) Sweep time = auto.
 - f) Detector = RMS (i.e., power averaging)
 - g) Trace average at least 100 traces in power averaging (rms) mode.
 - h) Use the peak search function on the instrument to find the peak of the spectrum.
- d. Using the measuring equipment limit line function, develop the emissions mask based on the following requirements. The emissions power spectral density must be reduced below the peak power spectral density (in dB) as follows:
 - a) Suppressed by 20 dB at 1 MHz outside of the channel edge. (The channel edge is defined as the 26-dB point on either side of the carrier center frequency.)
 - b) Suppressed by 28 dB at one channel bandwidth from the channel center.
 - c) Suppressed by 40 dB at one- and one-half times the channel bandwidth from the channel center.
- e. Adjust the span to encompass the entire mask as necessary and clear trace.
- f. Trace average at least 100 traces in power averaging (rms) mode.
- g. Adjust the reference level as necessary so that the crest of the channel touches the top of the emission mask

4.2.5 EUT Operating Condition

The software provided by client to enable the EUT under transmission condition continuously at lowest, middle and highest channel frequencies individually.

4.2.6 Test Results

Nss 1

802.11a_Chain 0

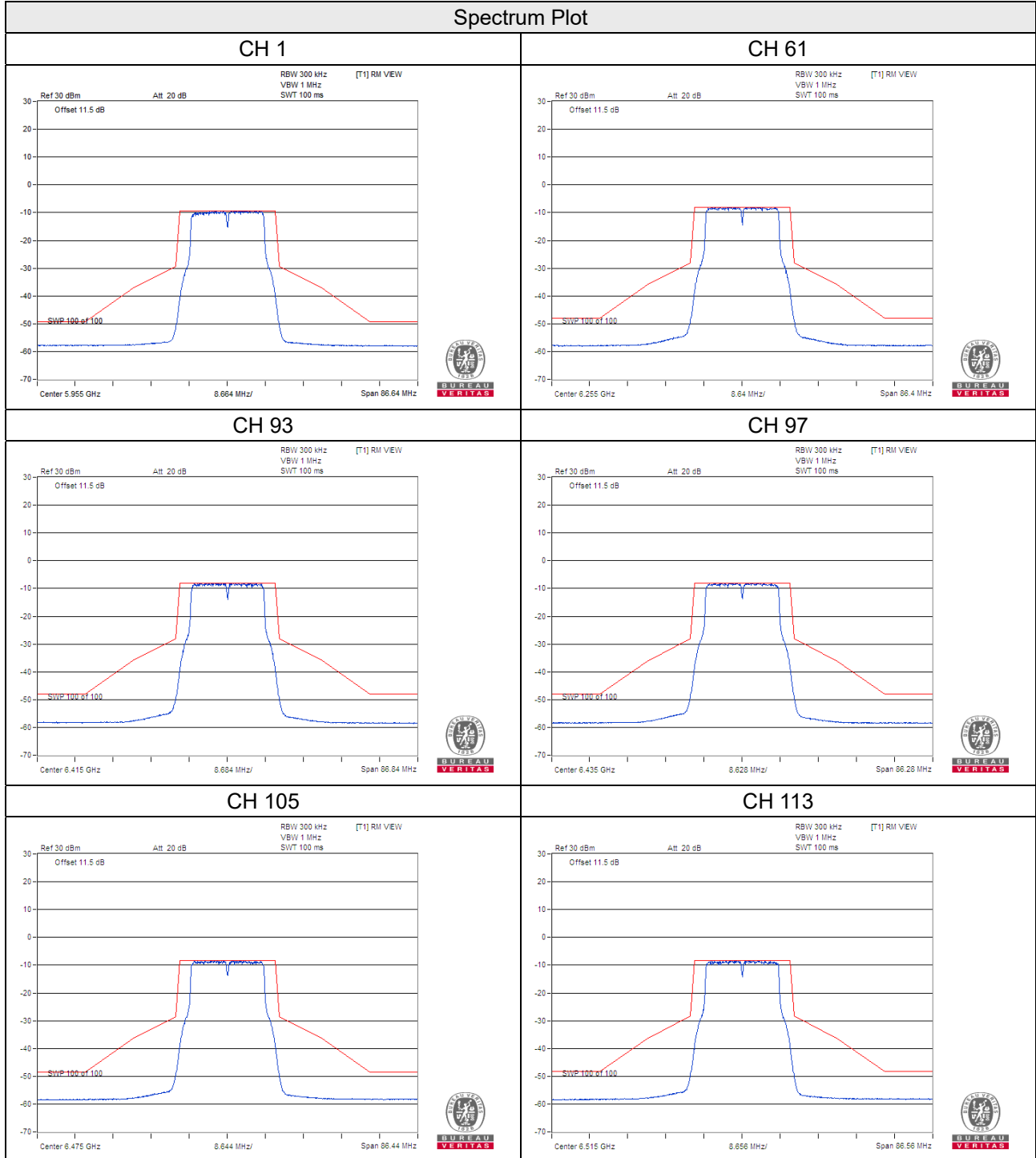

Spectrum Plot

CH 117

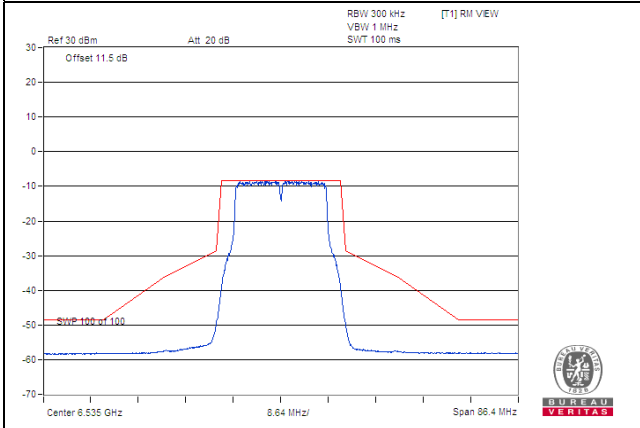

CH 153

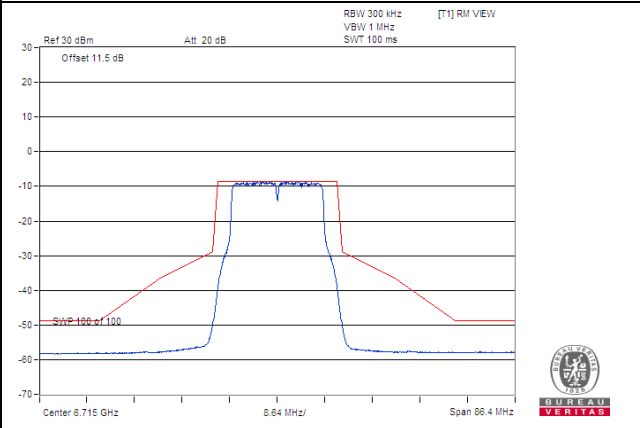

CH 181

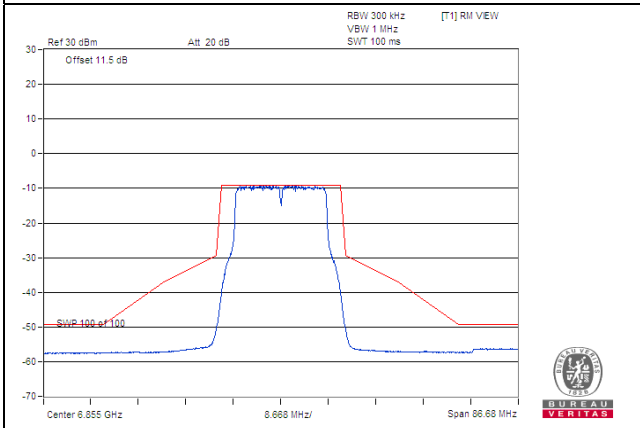

CH 185

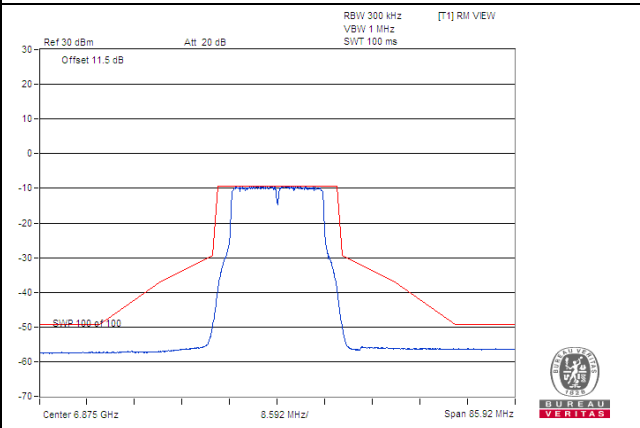

CH 213

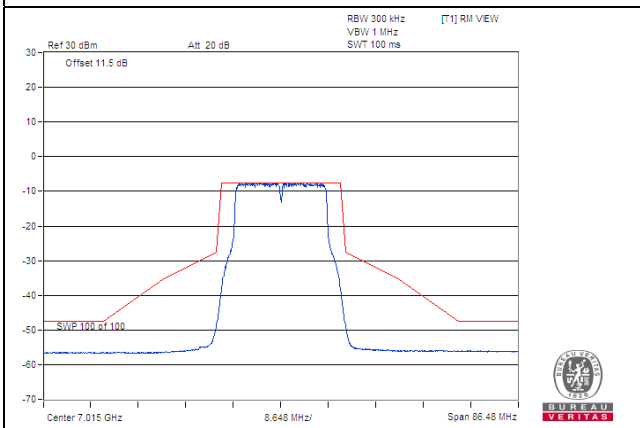

CH 229

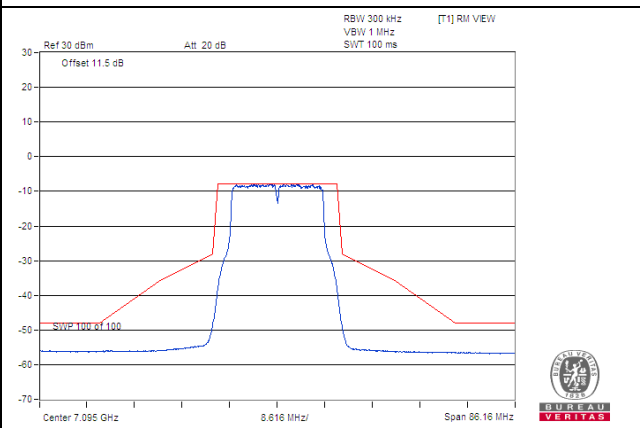

Spectrum Plot

CH 233

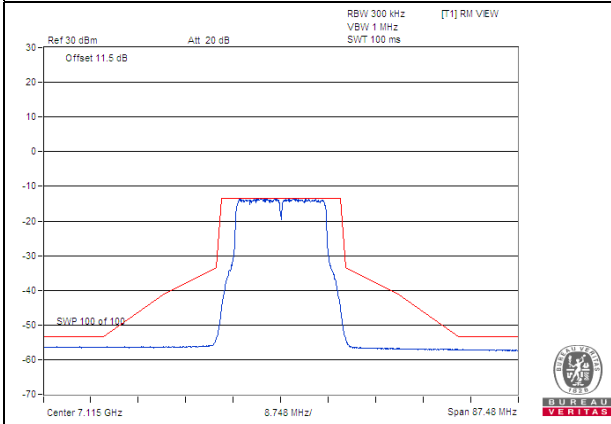

802.11a_Chain 1

Spectrum Plot

CH 1

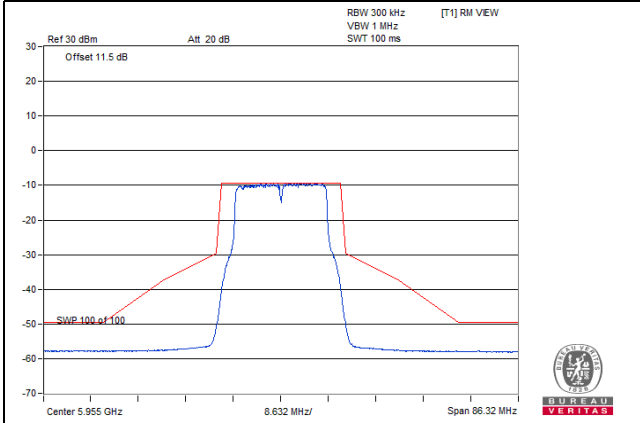

CH 61

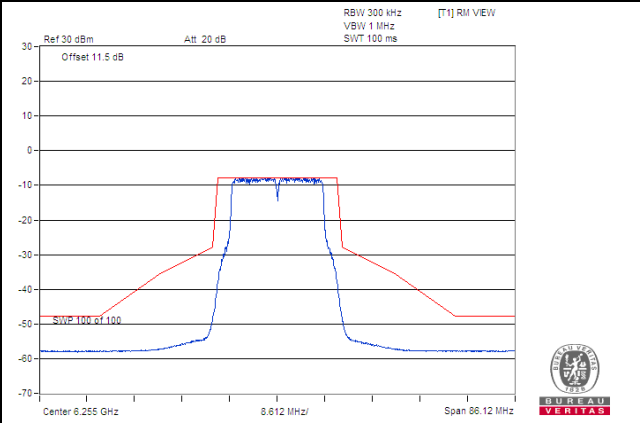

CH 93

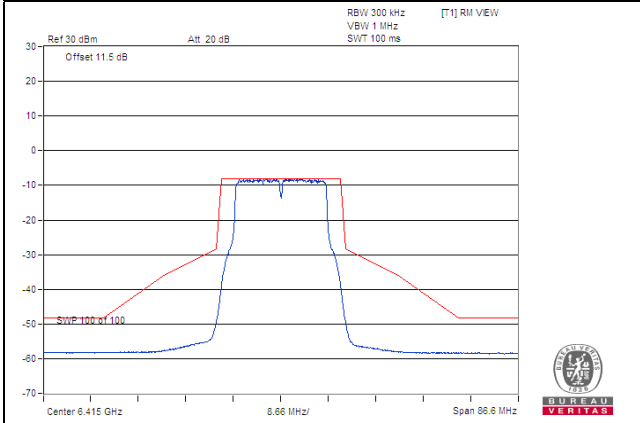

CH 97

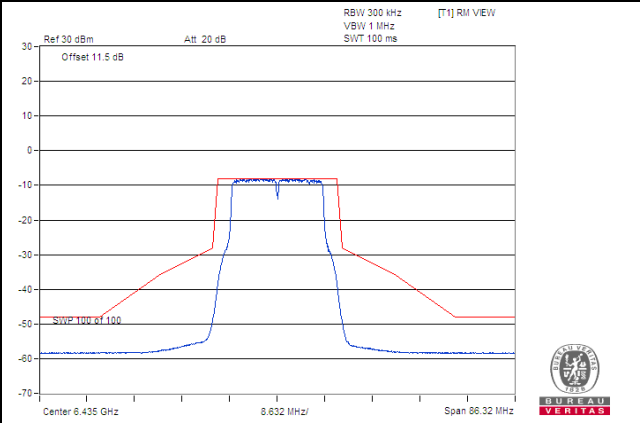

CH 105

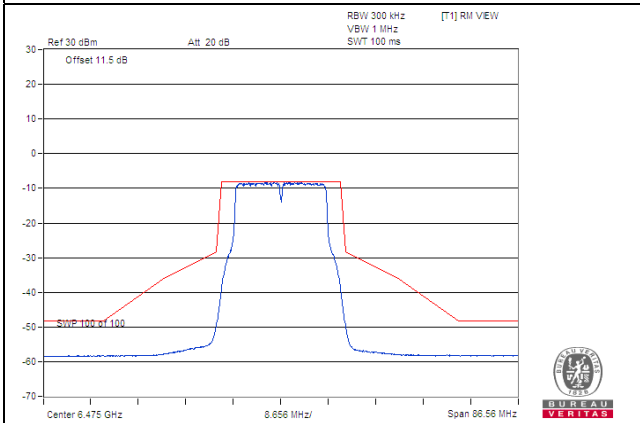

CH 113

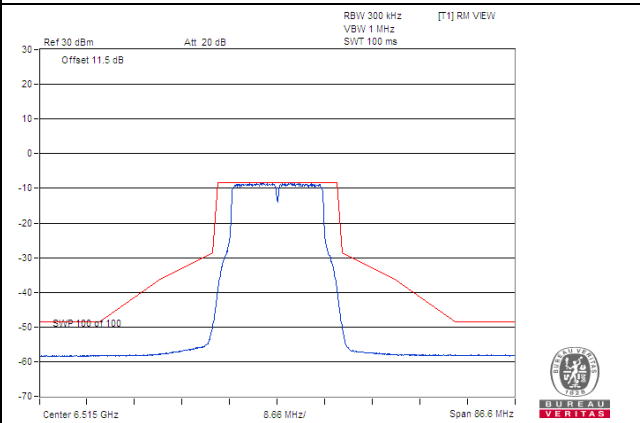

Spectrum Plot

CH 117

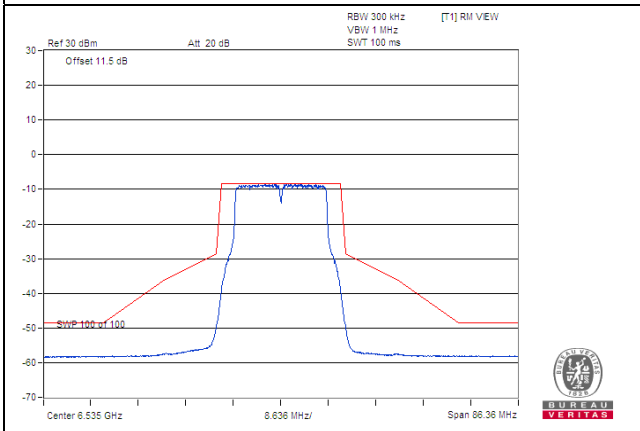

CH 153

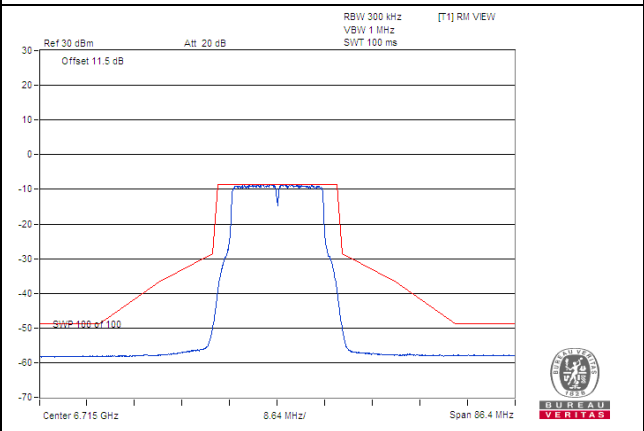

CH 181

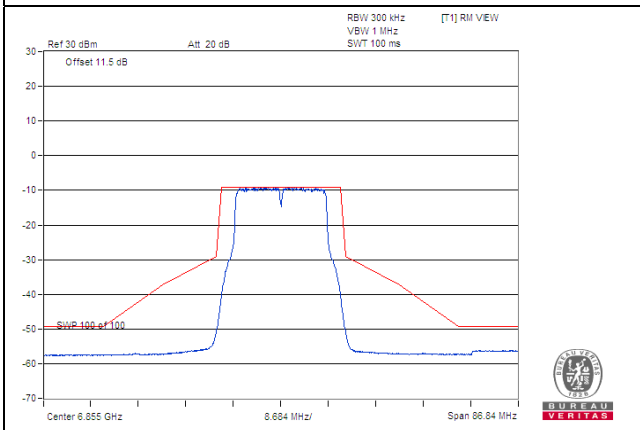

CH 185

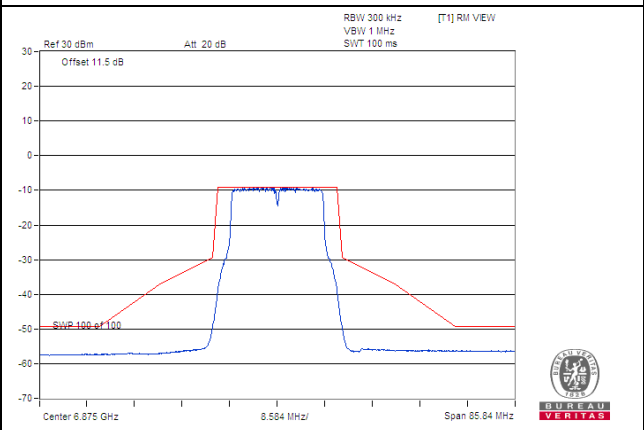

CH 213

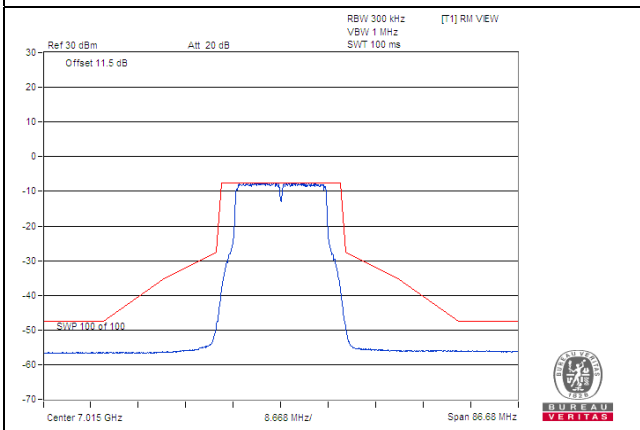

CH 229

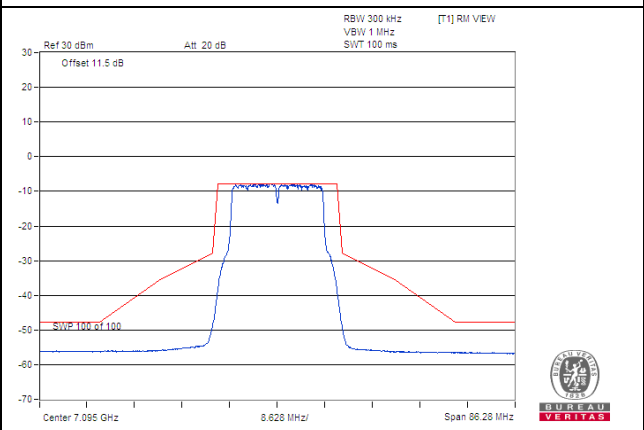

Spectrum Plot

CH 233

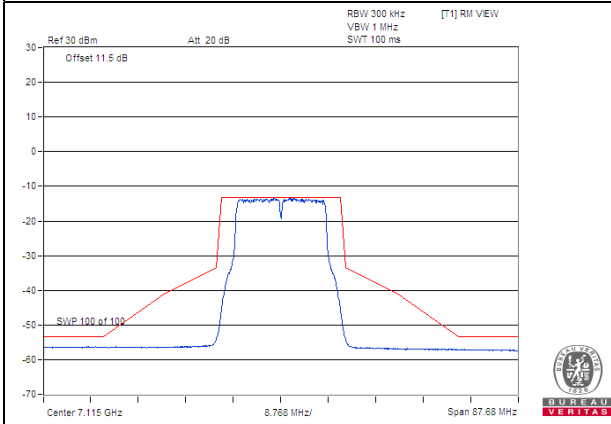

802.11ax (HE20)_Chain 0

Spectrum Plot

CH 1

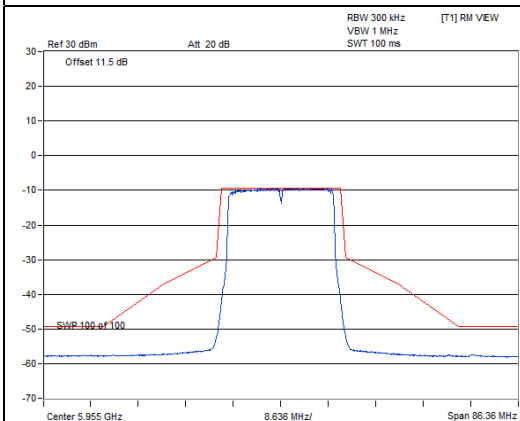

CH 61

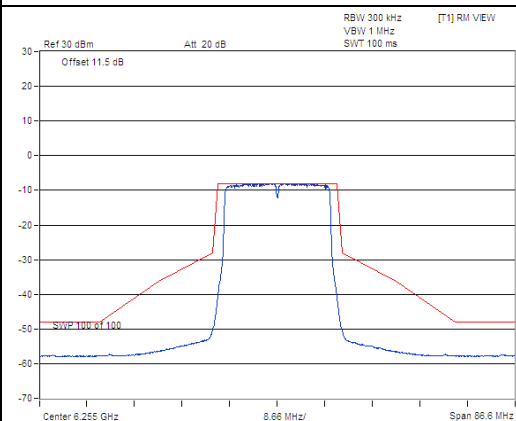

CH 93

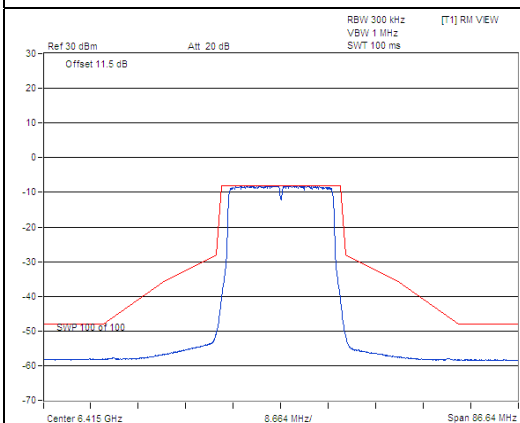

CH 97

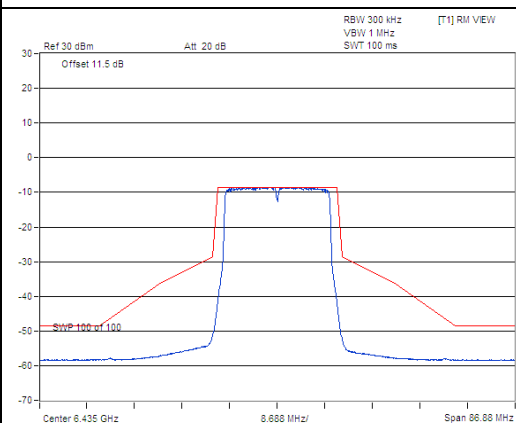

CH 105

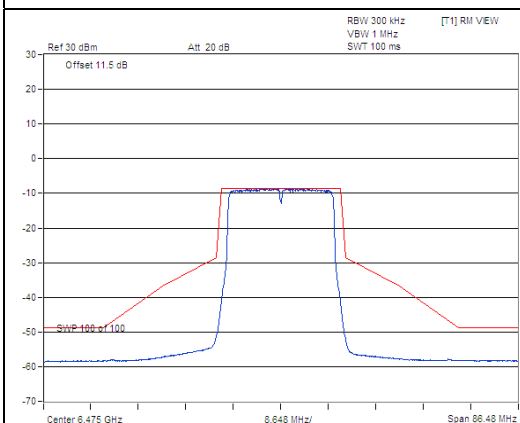

CH 113

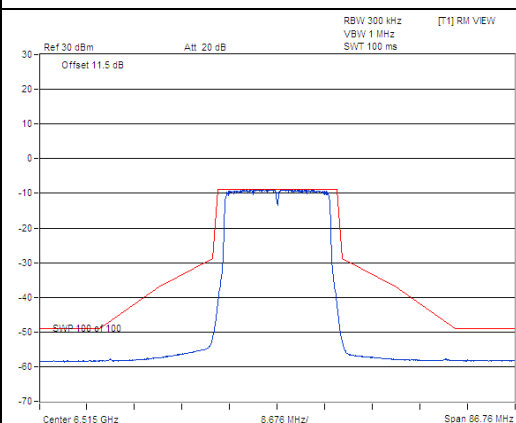

Spectrum Plot

CH 117

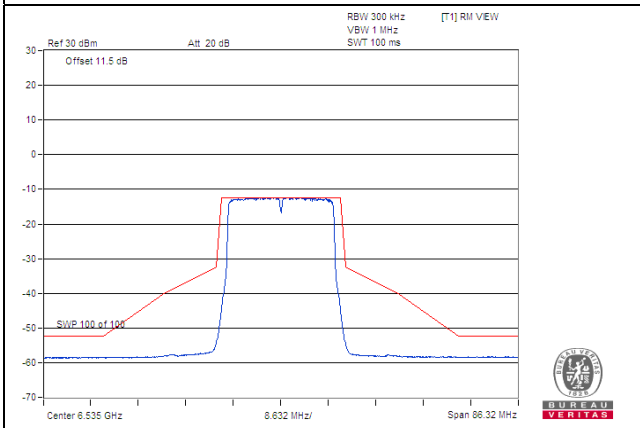

CH 153

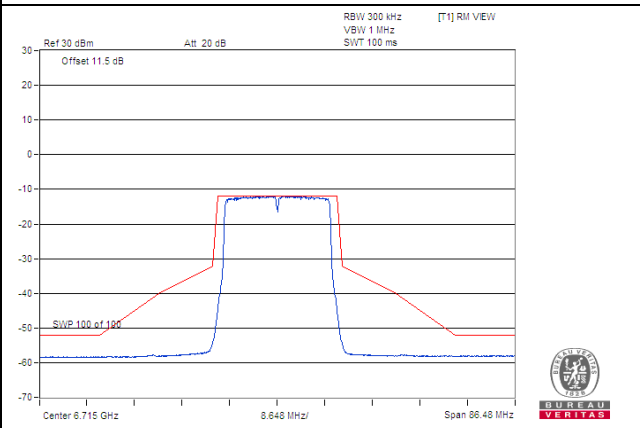

CH 181

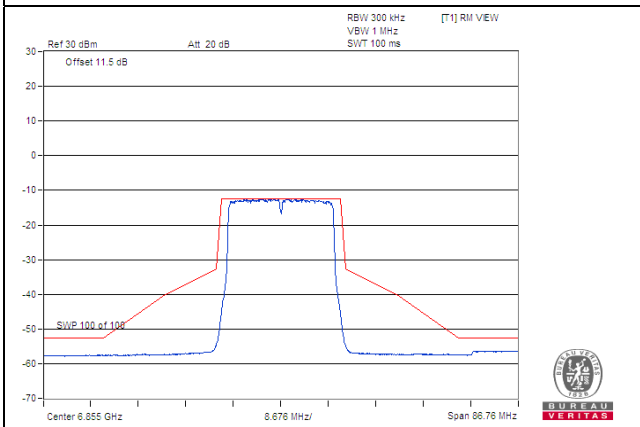

CH 185

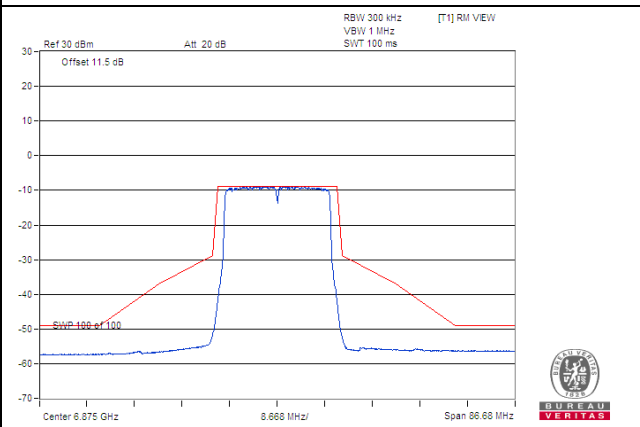

CH 213

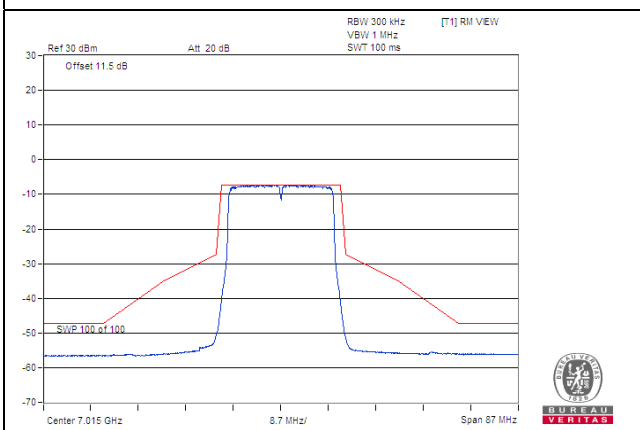

CH 229

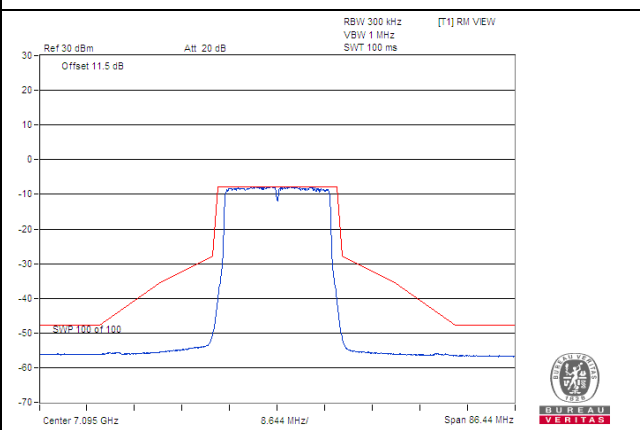

Spectrum Plot

CH 233

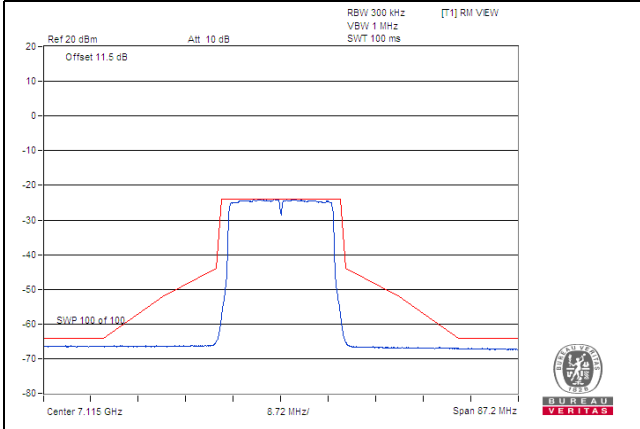

802.11ax (HE20)_Chain 1

Spectrum Plot

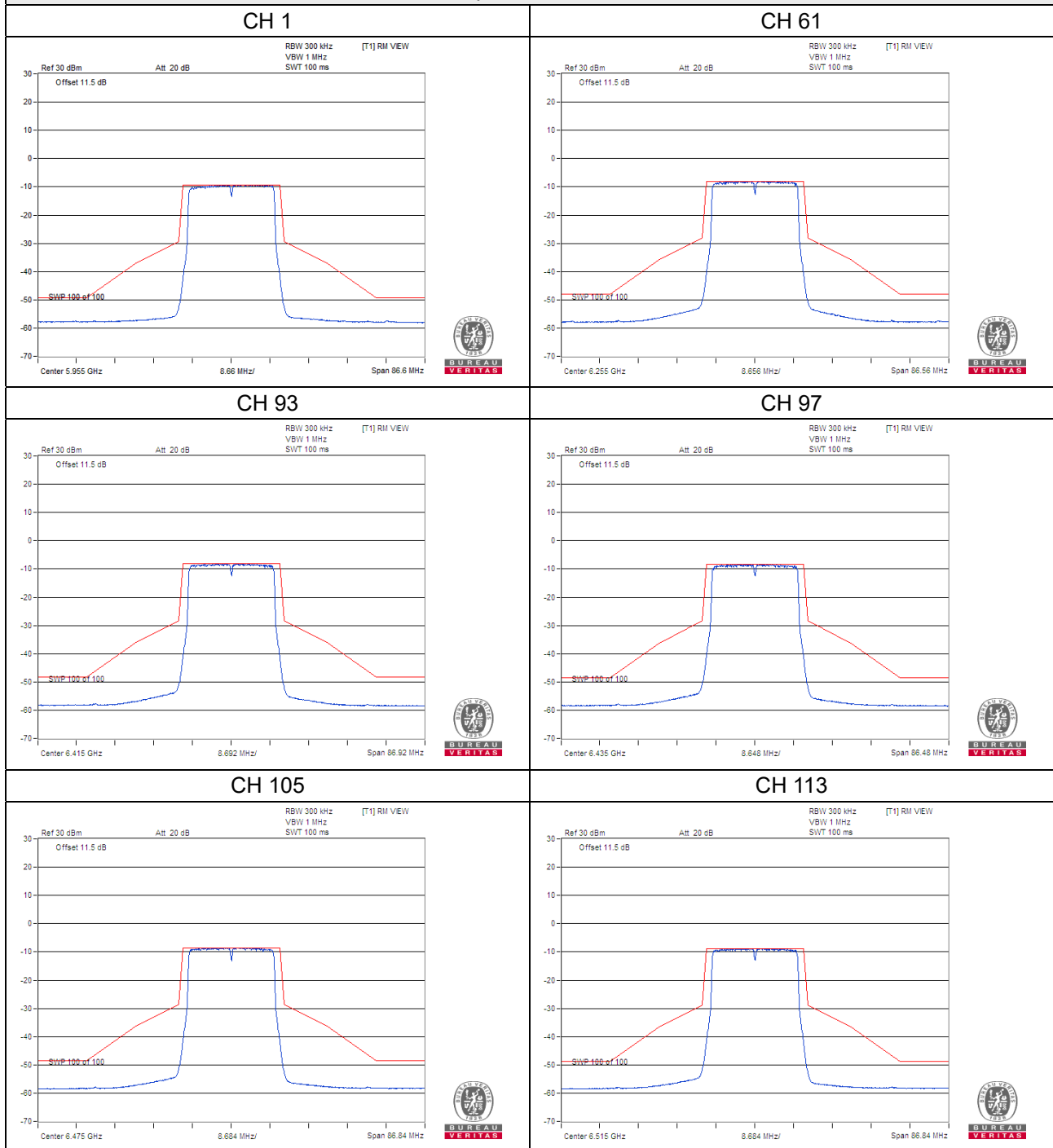

Spectrum Plot

CH 117

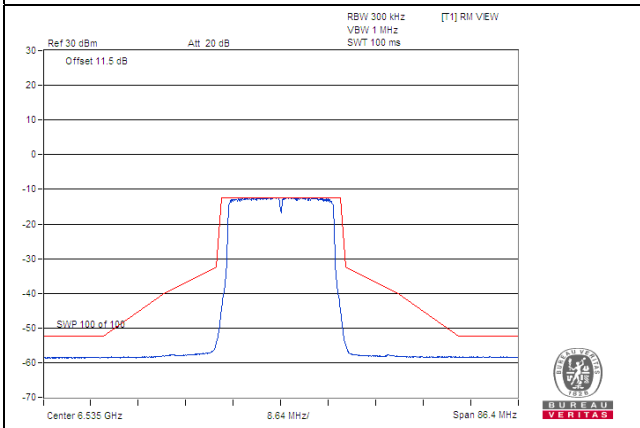

CH 153

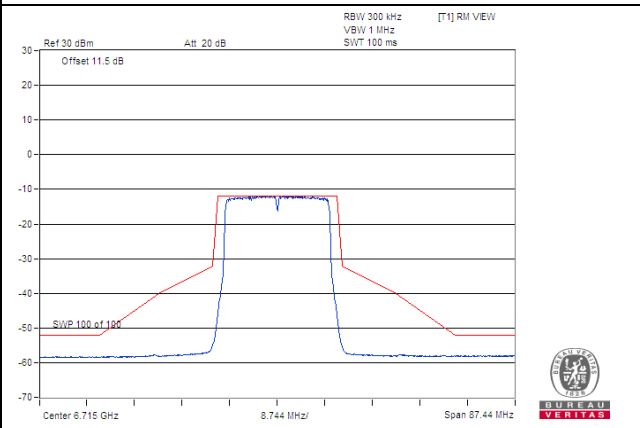

CH 181

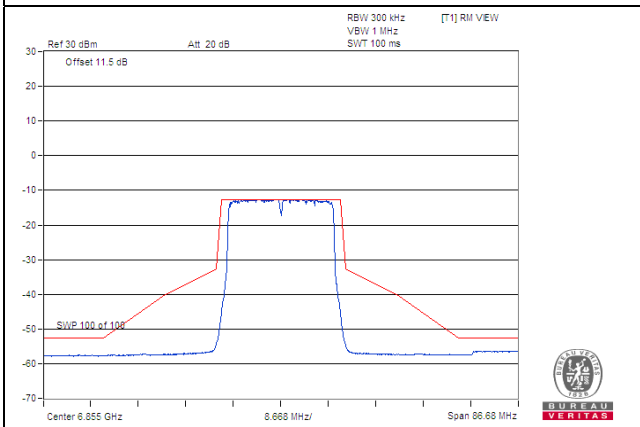

CH 185

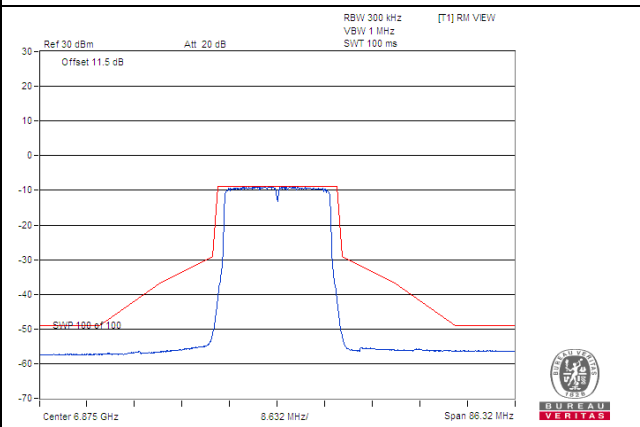

CH 213

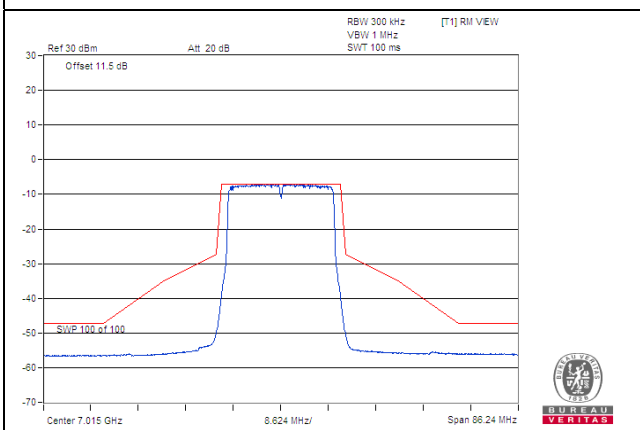

CH 229

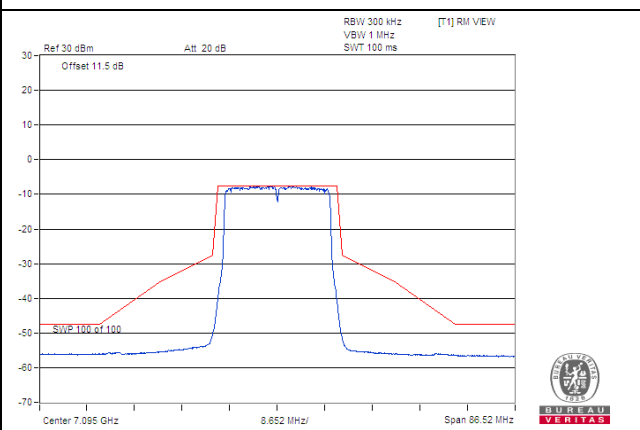

Spectrum Plot

CH 233

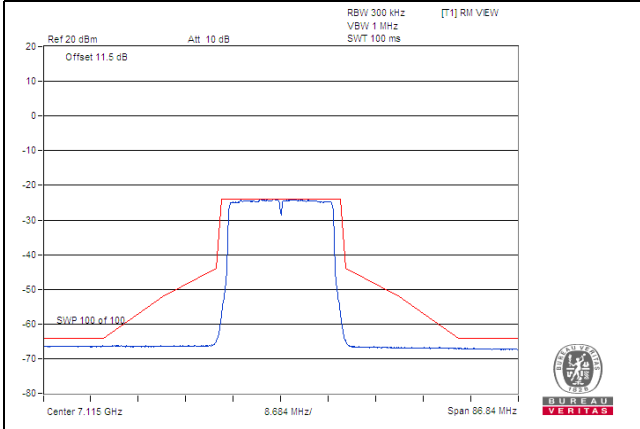

802.11ax (HE40)_Chain 0

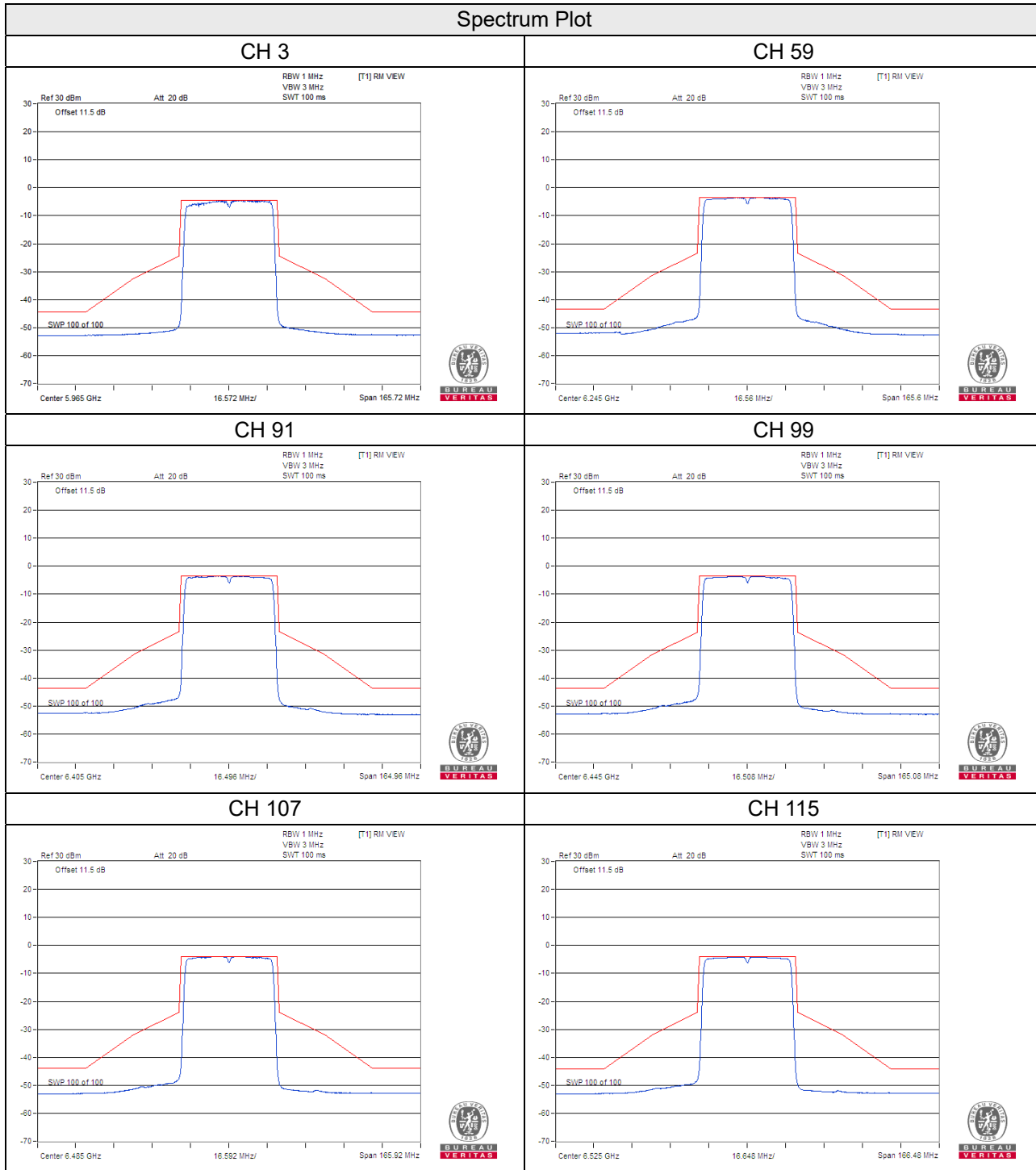

Spectrum Plot

CH 123

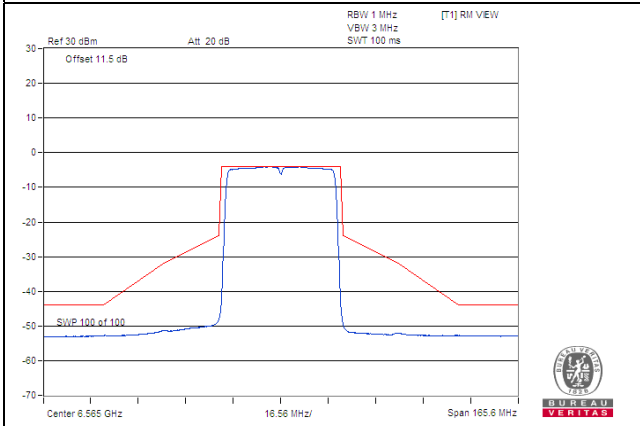

CH 155

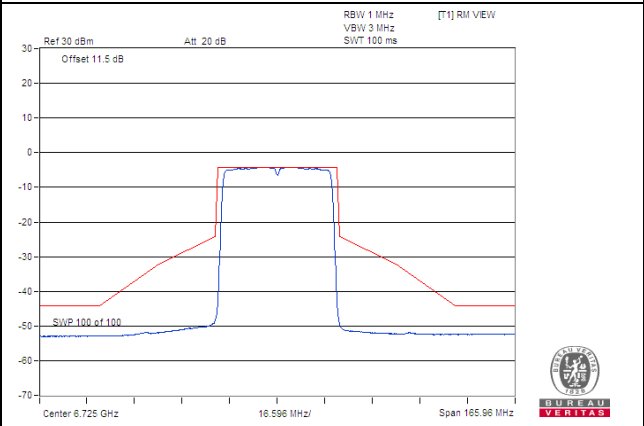

CH 179

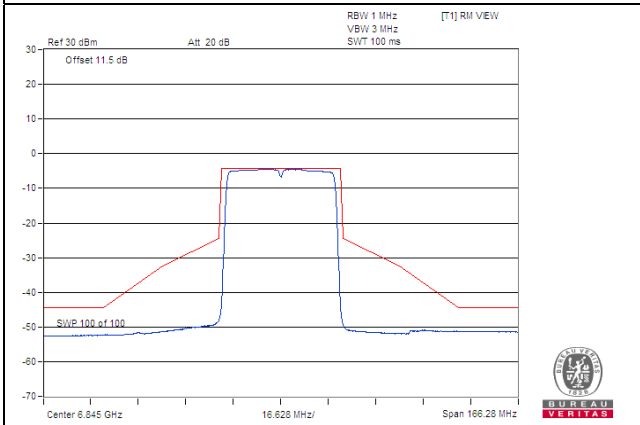

CH 187

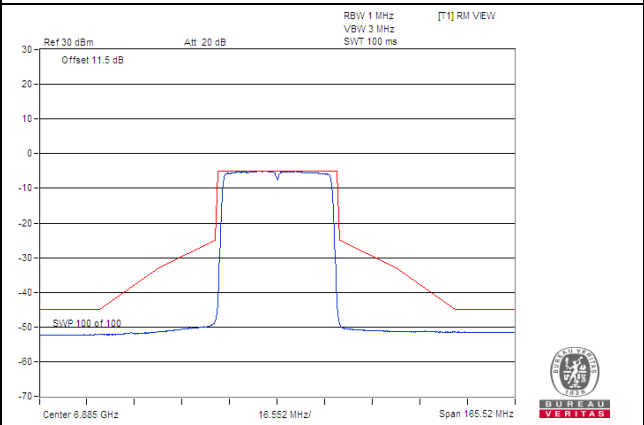

CH 211

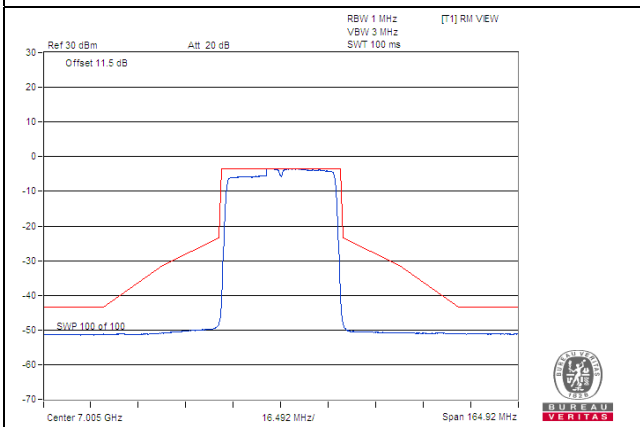

CH 227

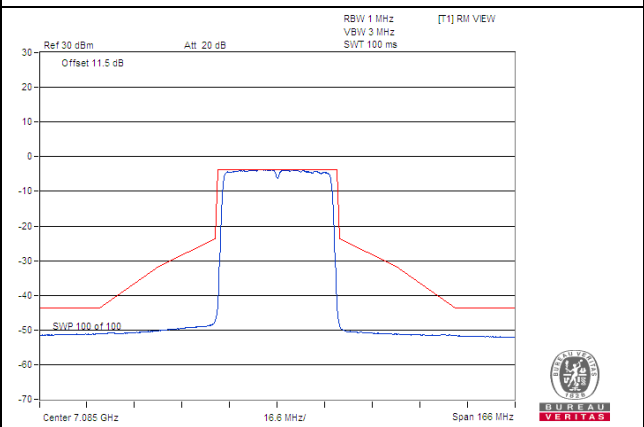

802.11ax (HE40)_Chain 1

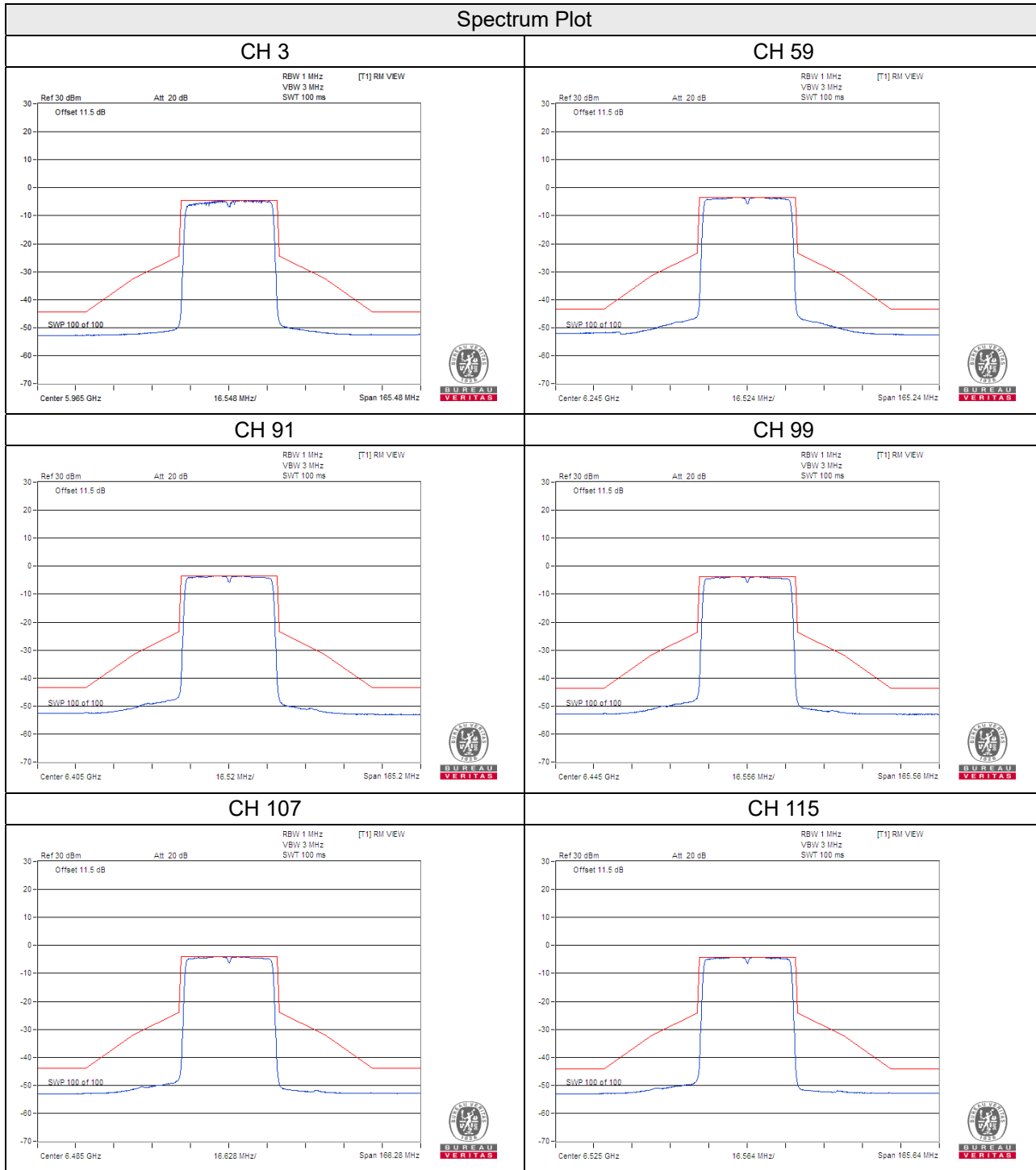

Spectrum Plot

CH 123

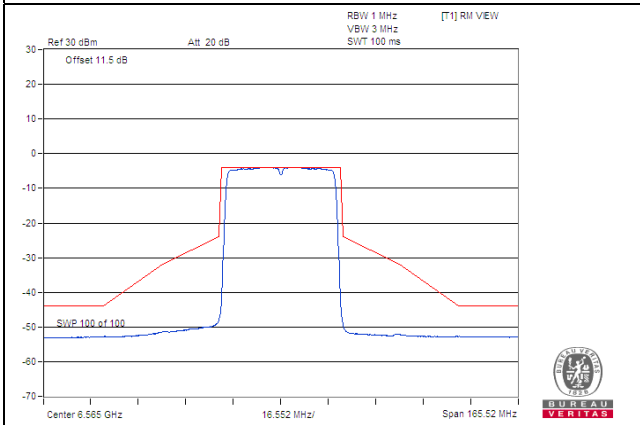

CH 155

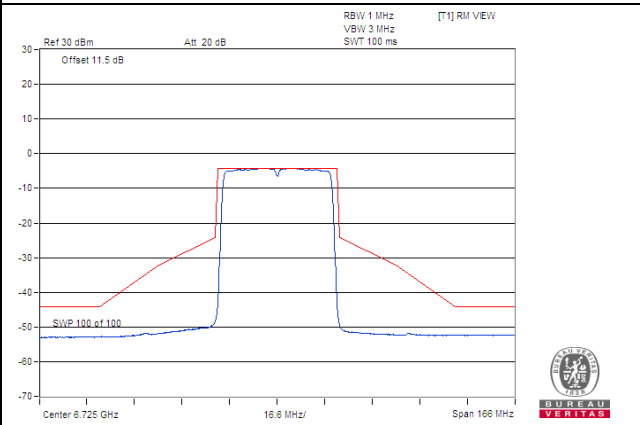

CH 179

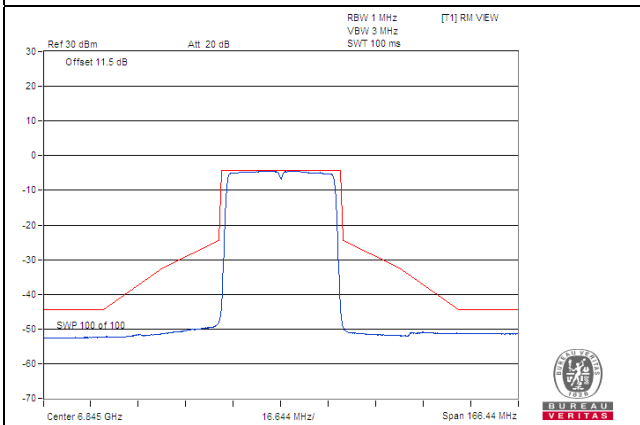

CH 187

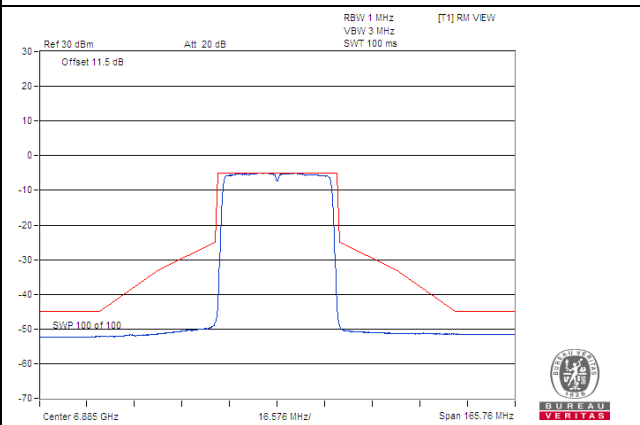

CH 211

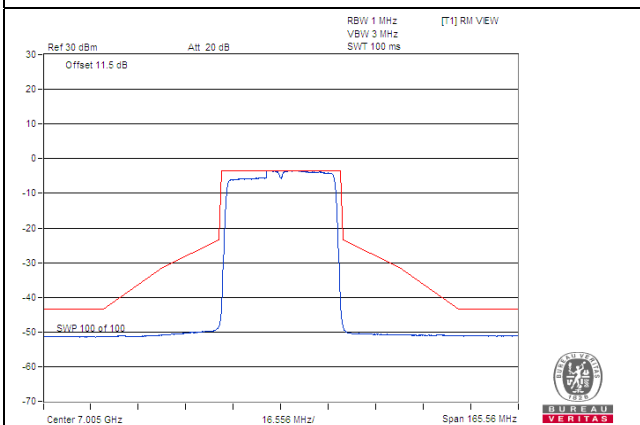

CH 227

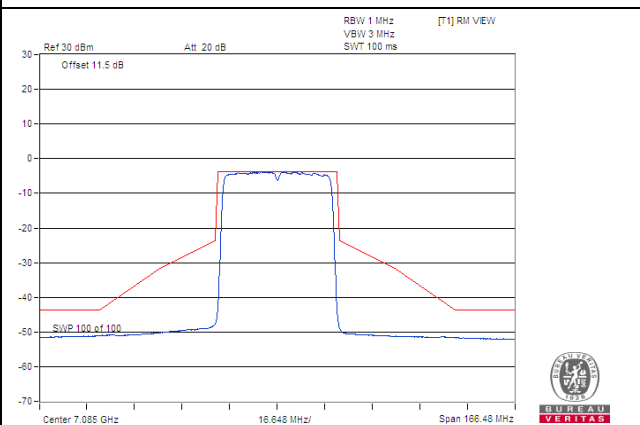

802.11ax (HE80)_Chain 0

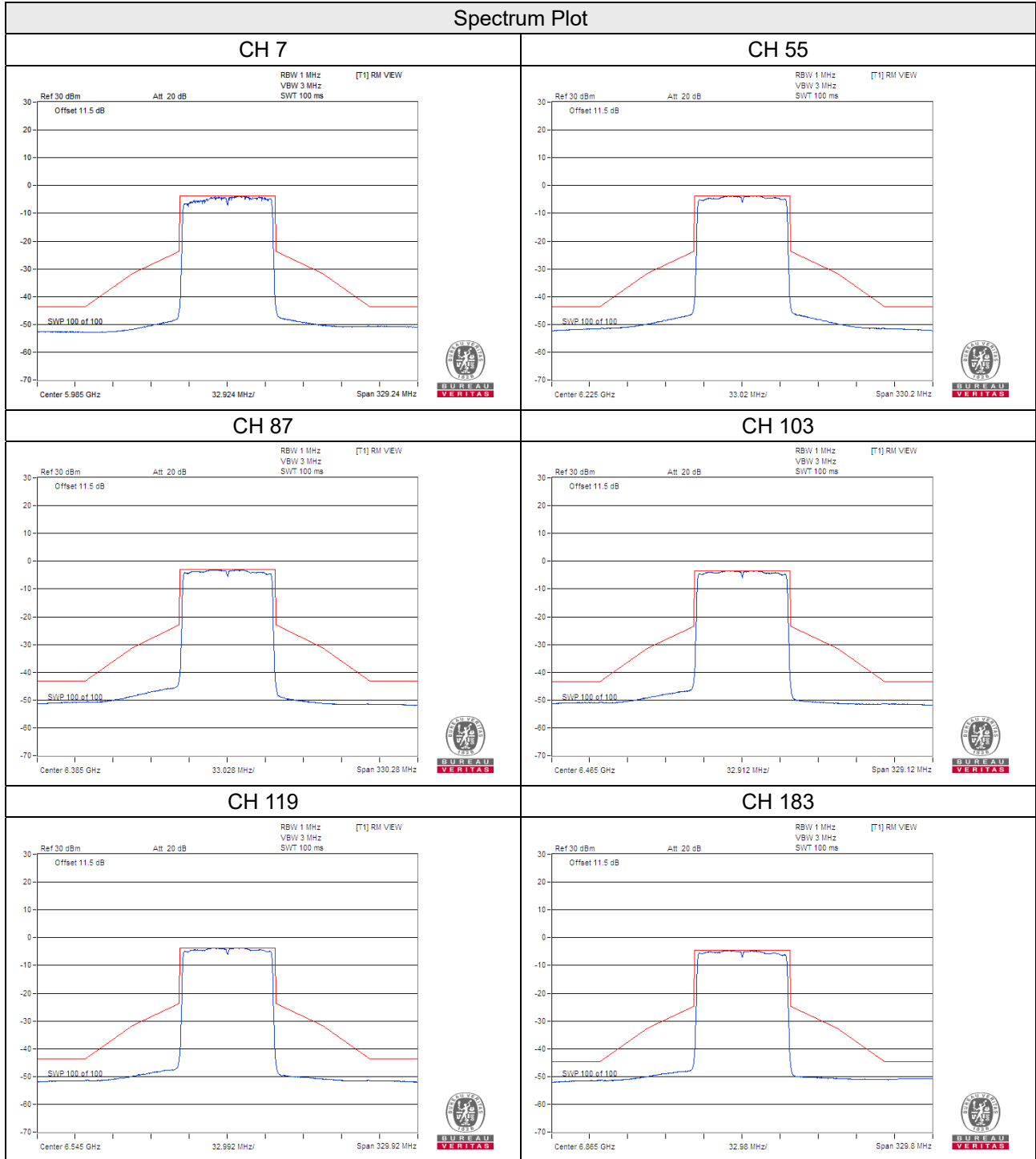

Spectrum Plot

CH 199

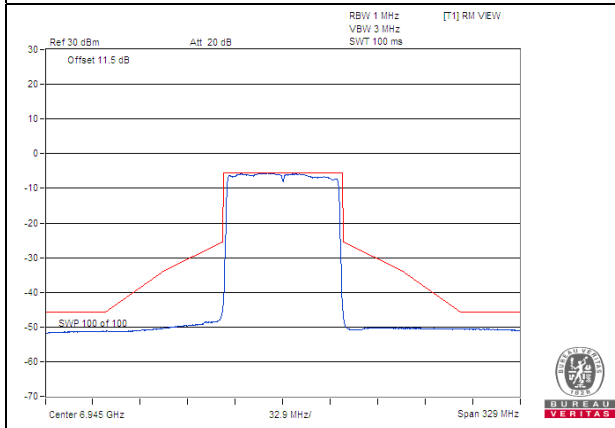

CH 215

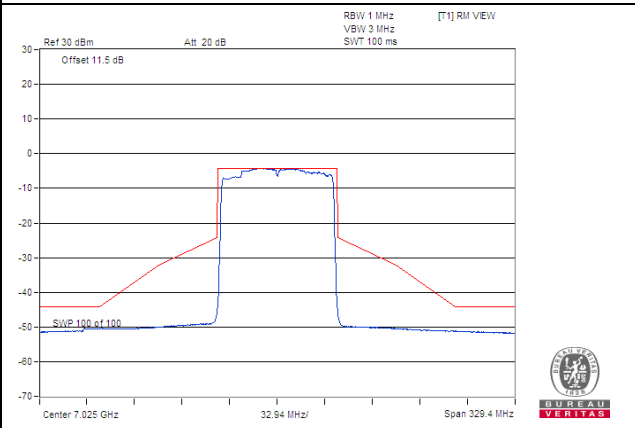

802.11ax (HE80)_Chain 1

Spectrum Plot

CH 7

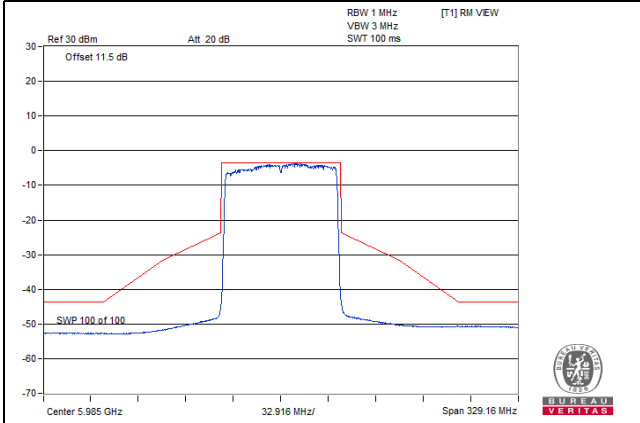

CH 55

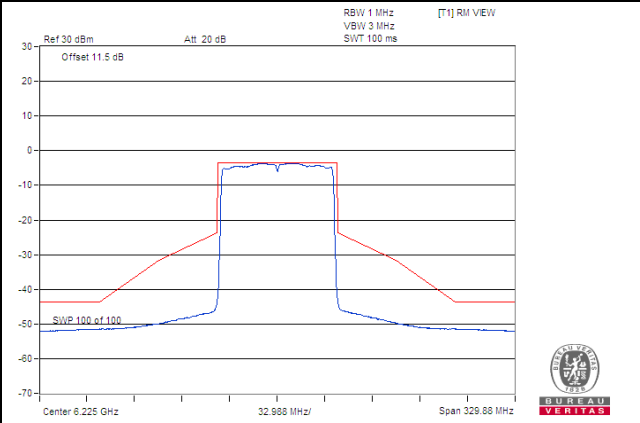

CH 87

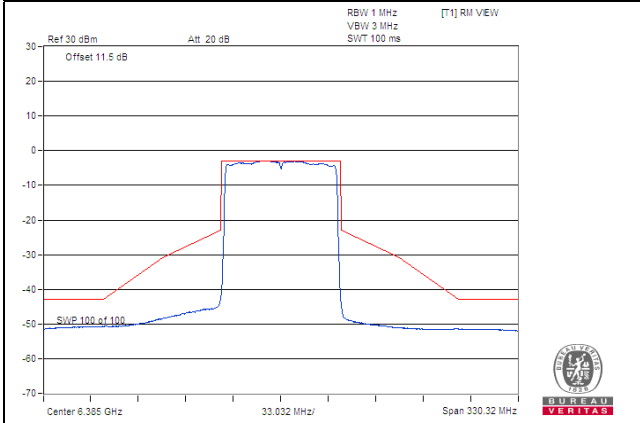

CH 103

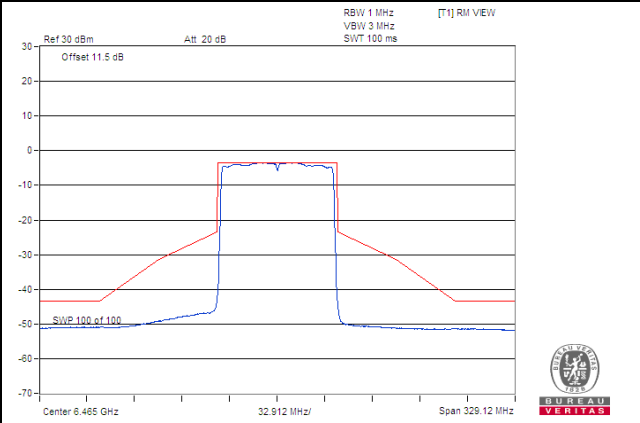

CH 119

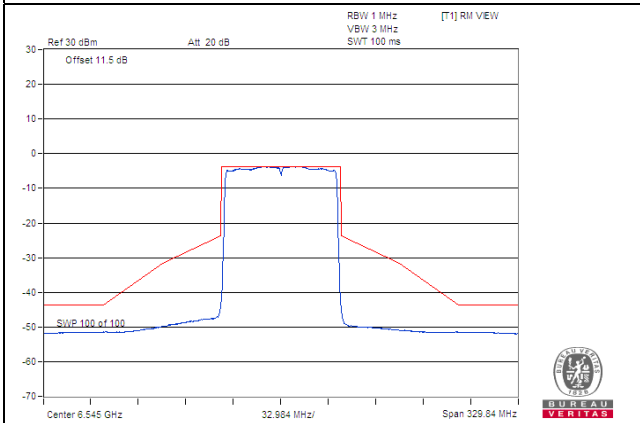

CH 183

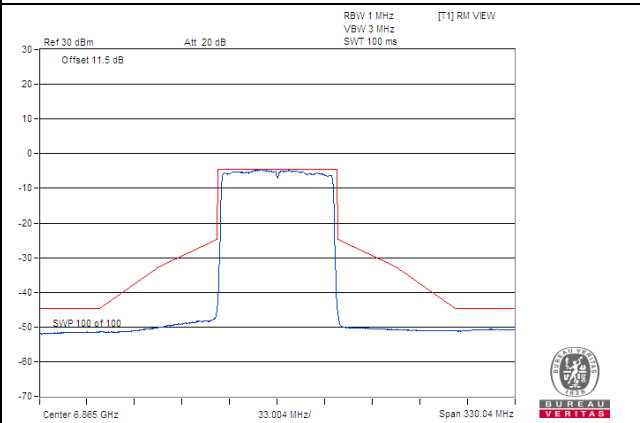

Spectrum Plot

CH 199

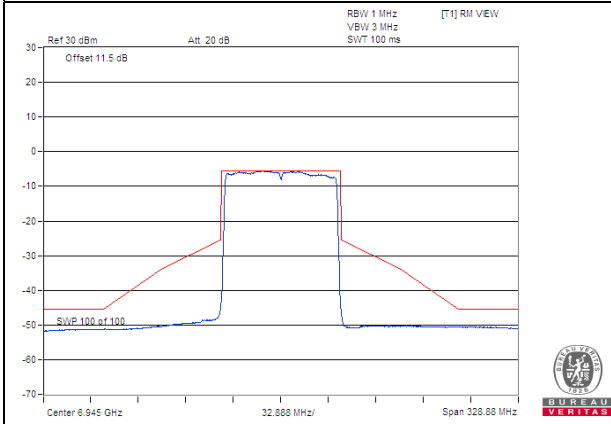

CH 215

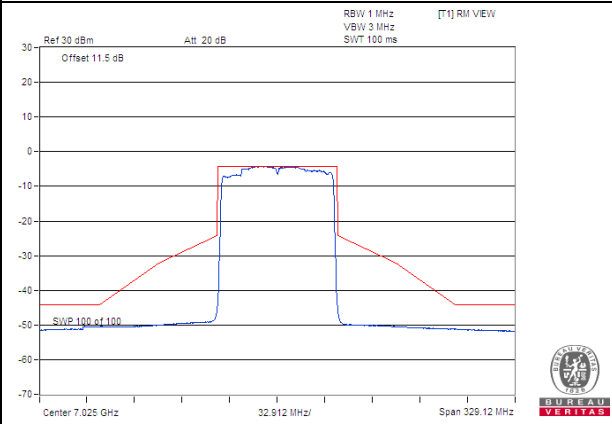

802.11ax (HE160)_Chain 0

Spectrum Plot

CH 15

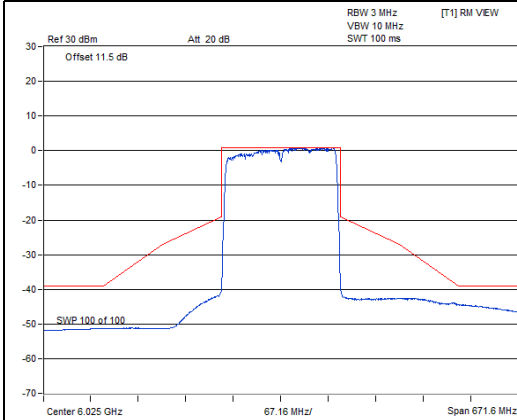

CH 47

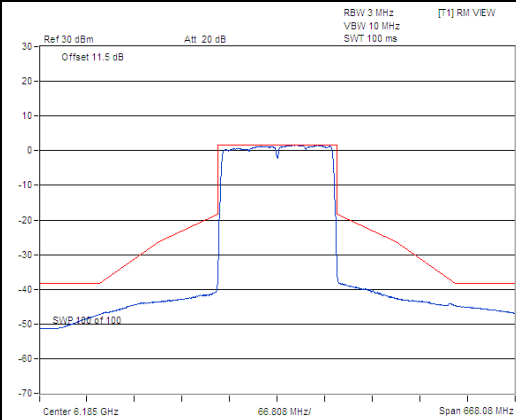

CH 79

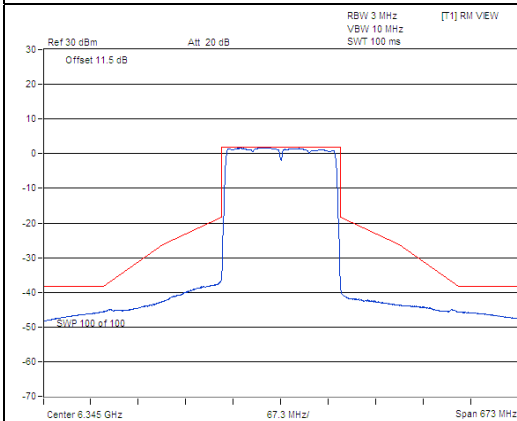

CH 111

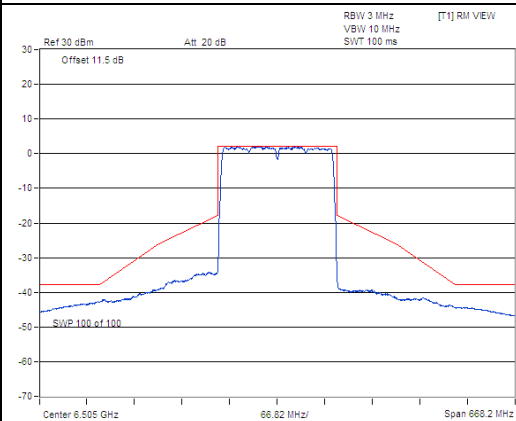

CH 143

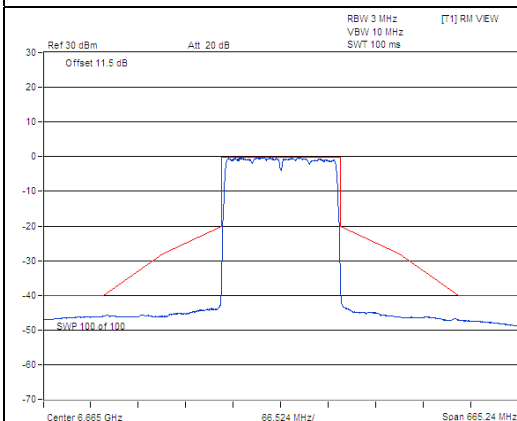

CH 175

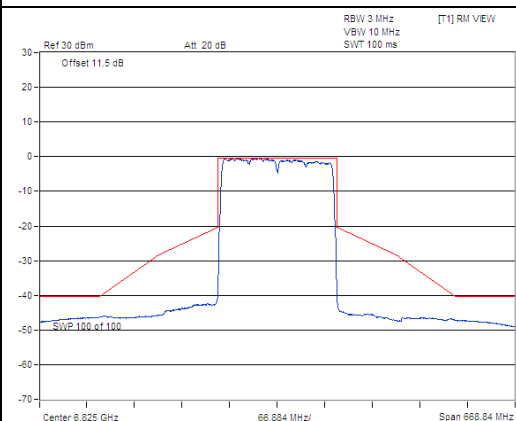

Spectrum Plot

CH 207

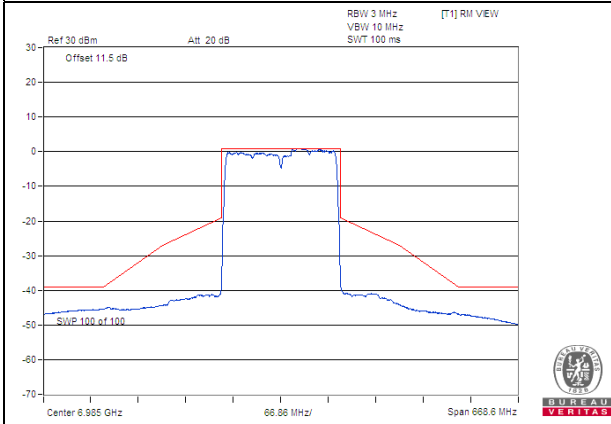

802.11ax (HE160)_Chain 1

Spectrum Plot

CH 15

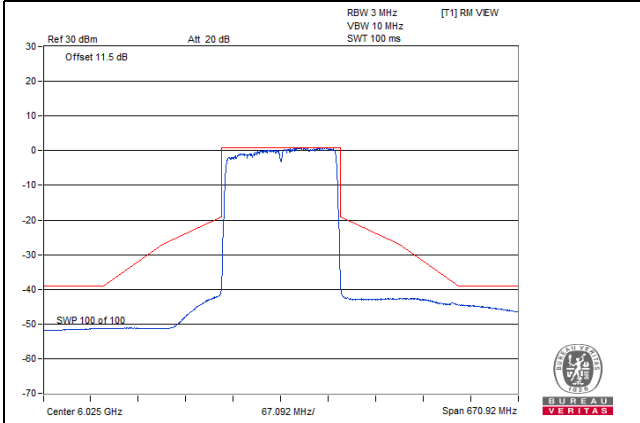

CH 47

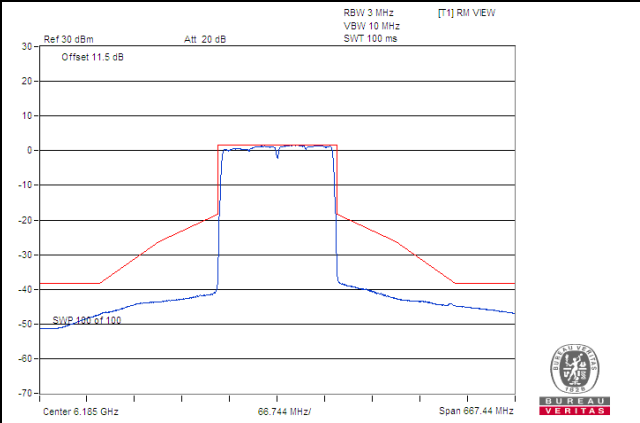

CH 79

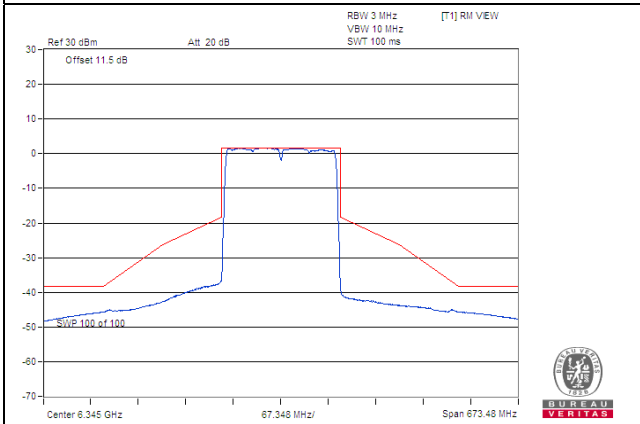

CH 111

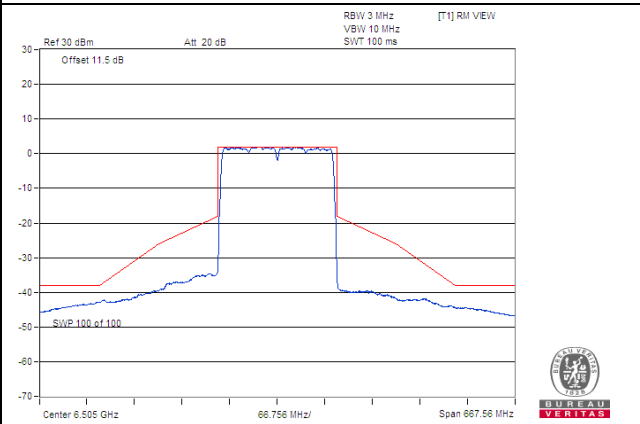

CH 143

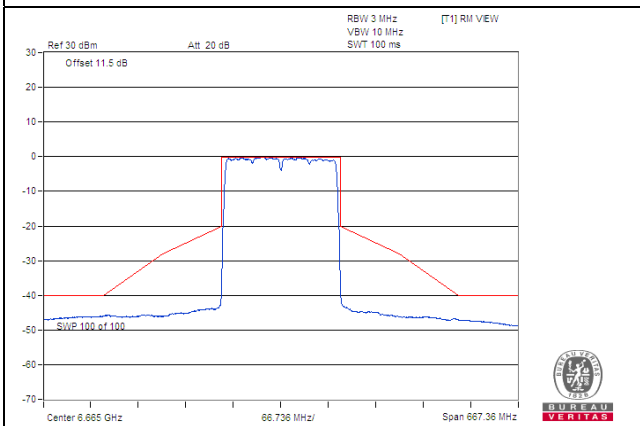

CH 175

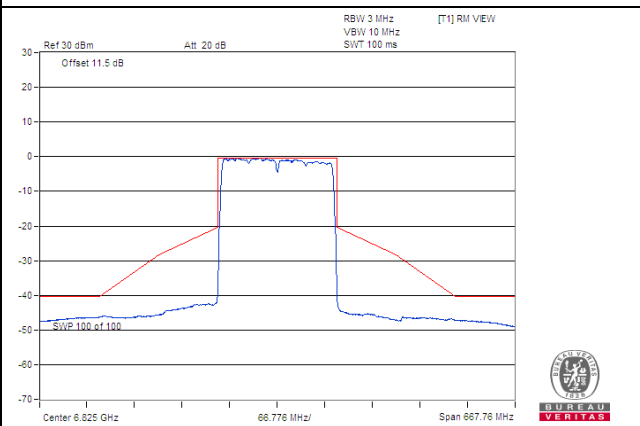

Spectrum Plot

CH 207

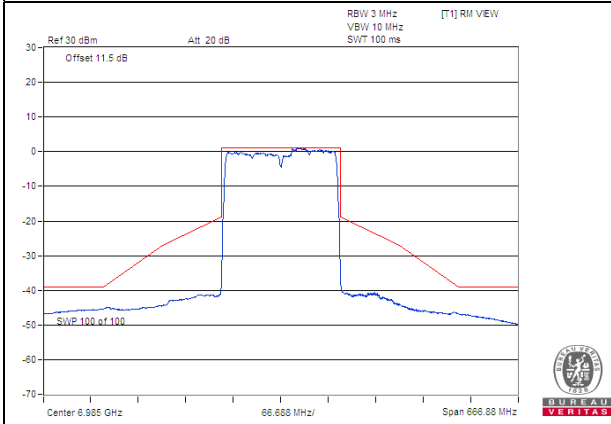

Nss 2

802.11ax (HE20)_Chain 0

Spectrum Plot

CH 1

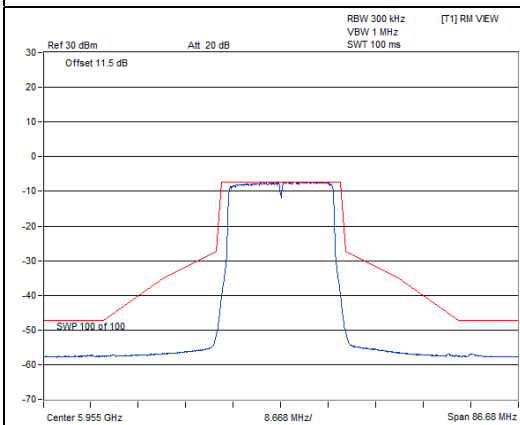

CH 61

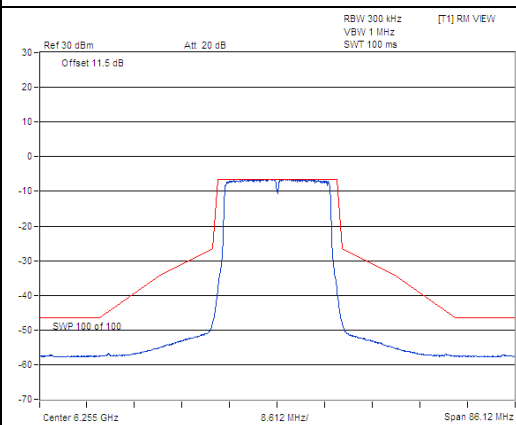

CH 93

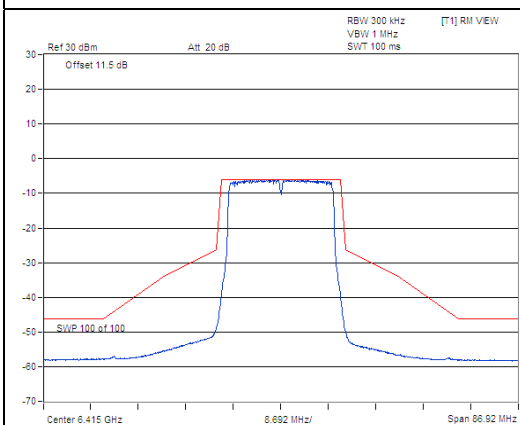

CH 97

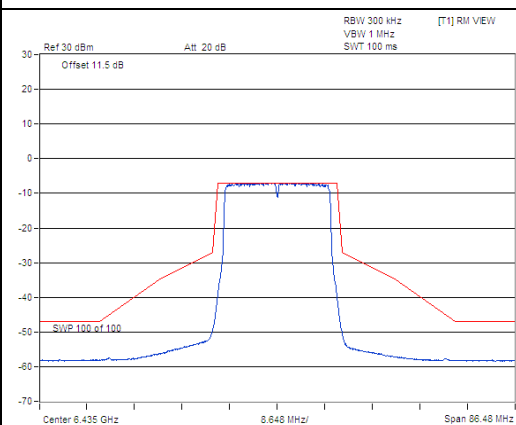

CH 105

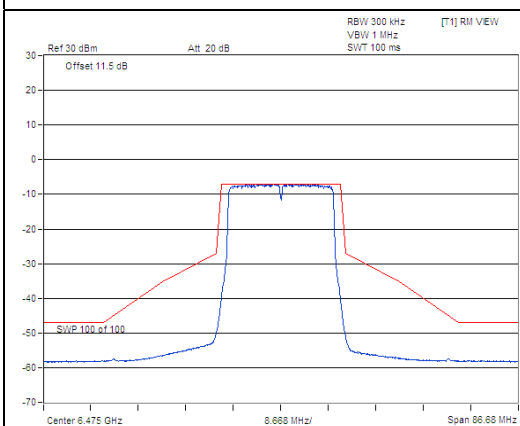

CH 113

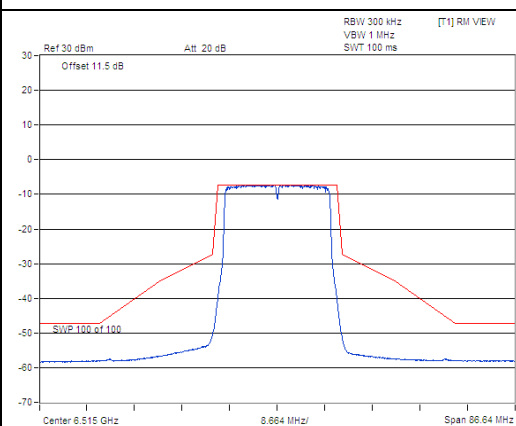

Spectrum Plot

CH 117

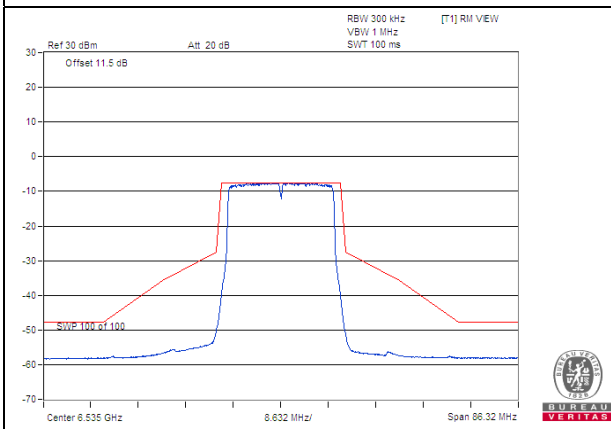

CH 153

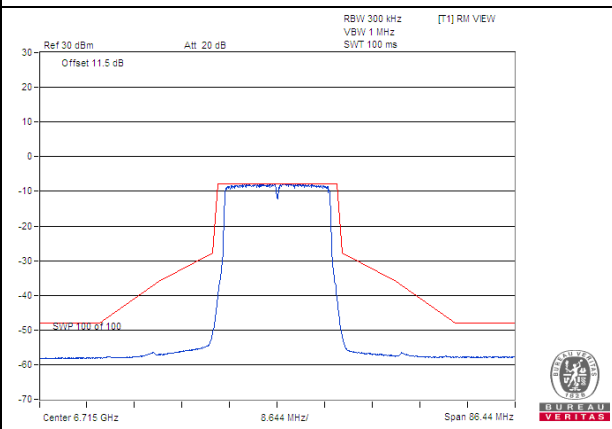

CH 181

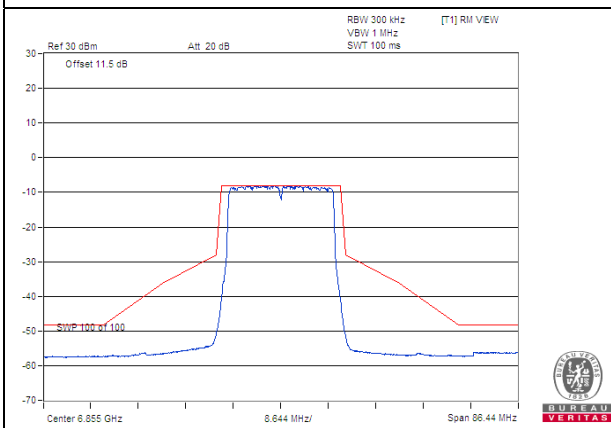

CH 185

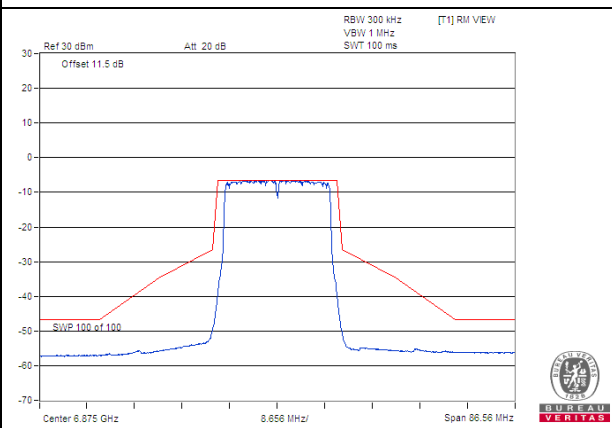

CH 213

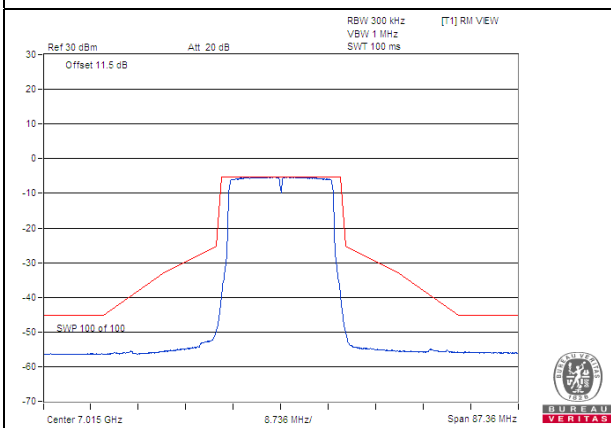

CH 229

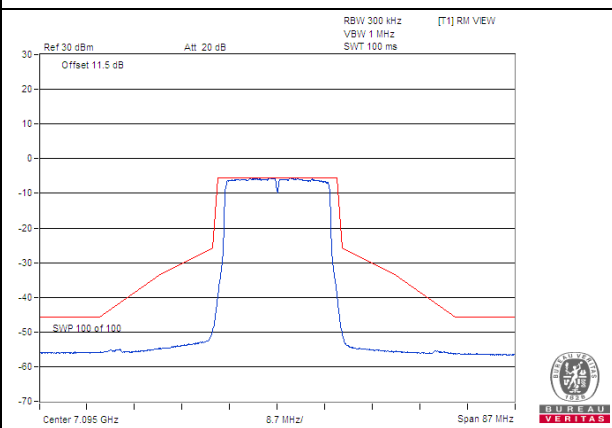

Spectrum Plot

CH 233

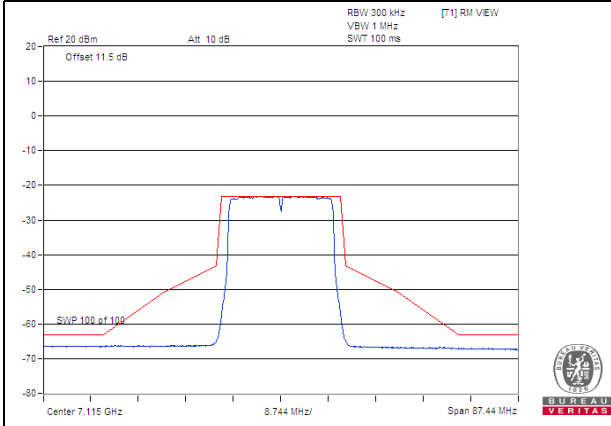

802.11ax (HE20)_Chain 1

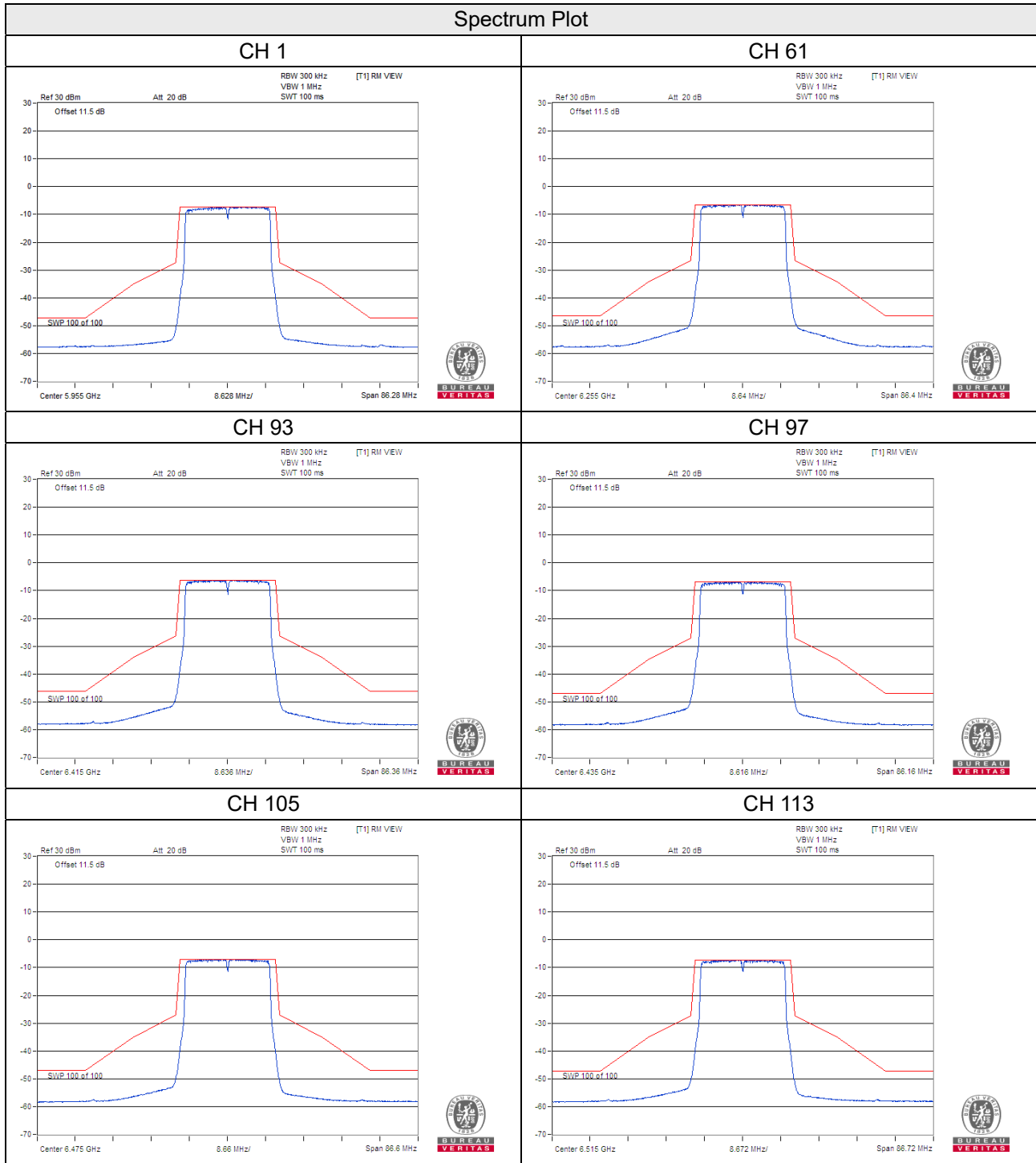

Spectrum Plot

CH 117

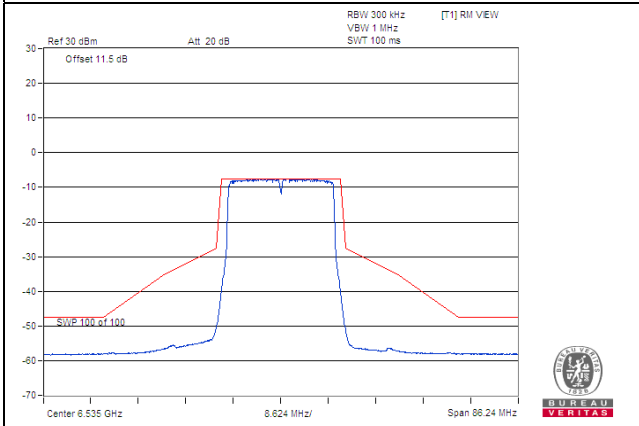

CH 153

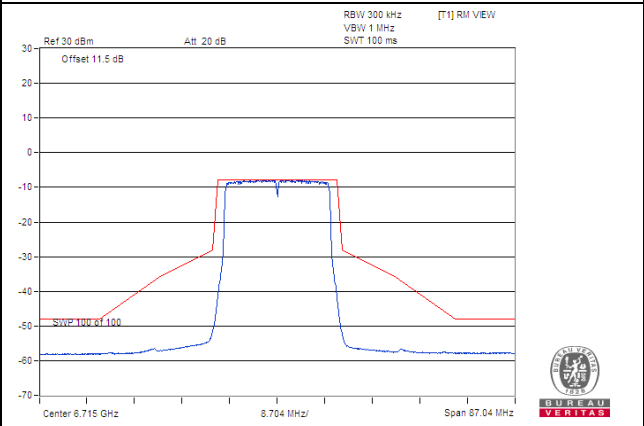

CH 181

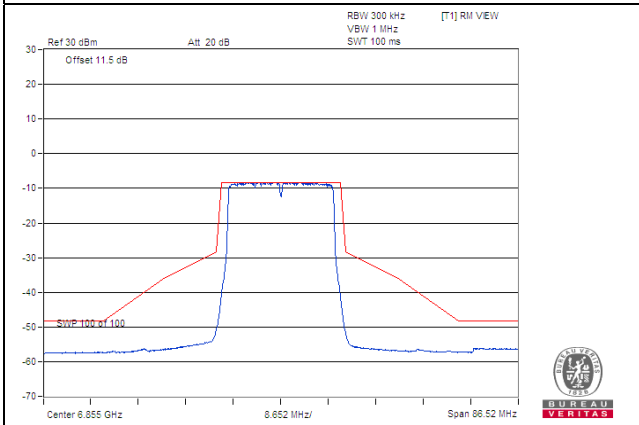

CH 185

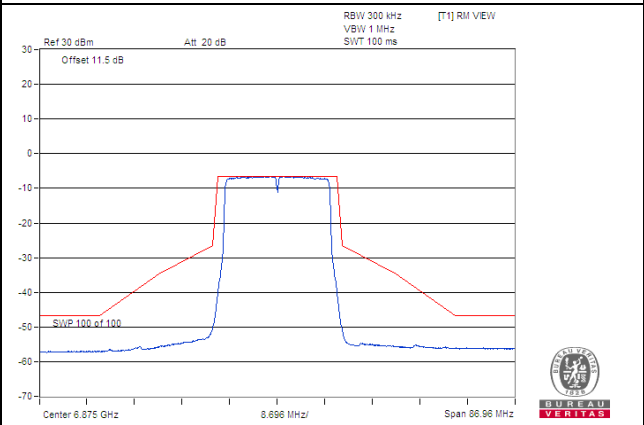

CH 213

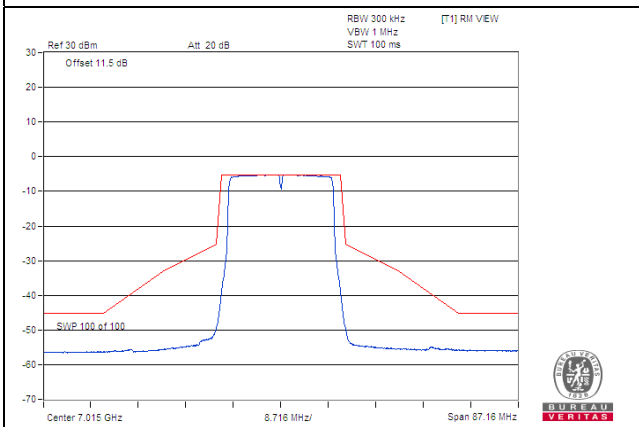

CH 229

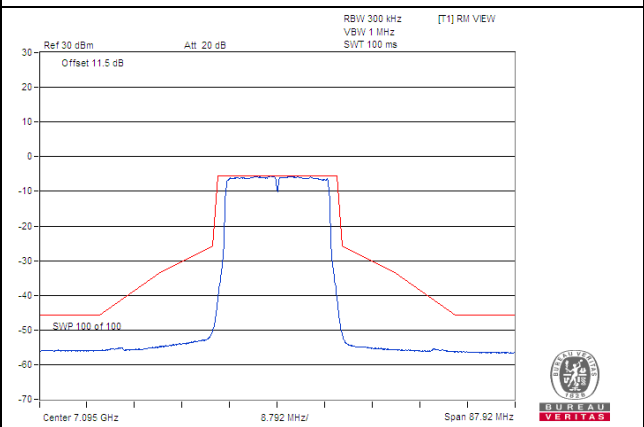

Spectrum Plot

CH 233

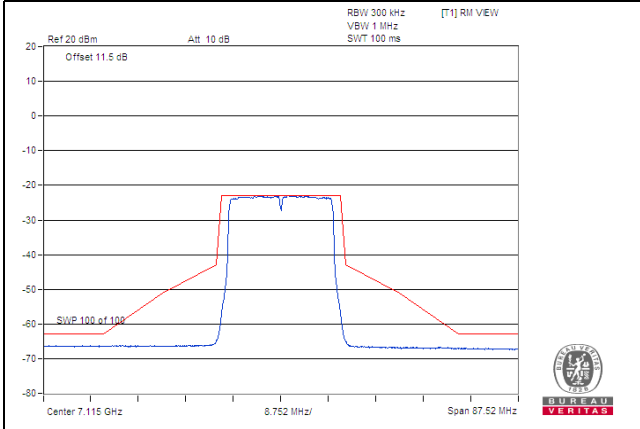

802.11ax (HE40)_Chain 0

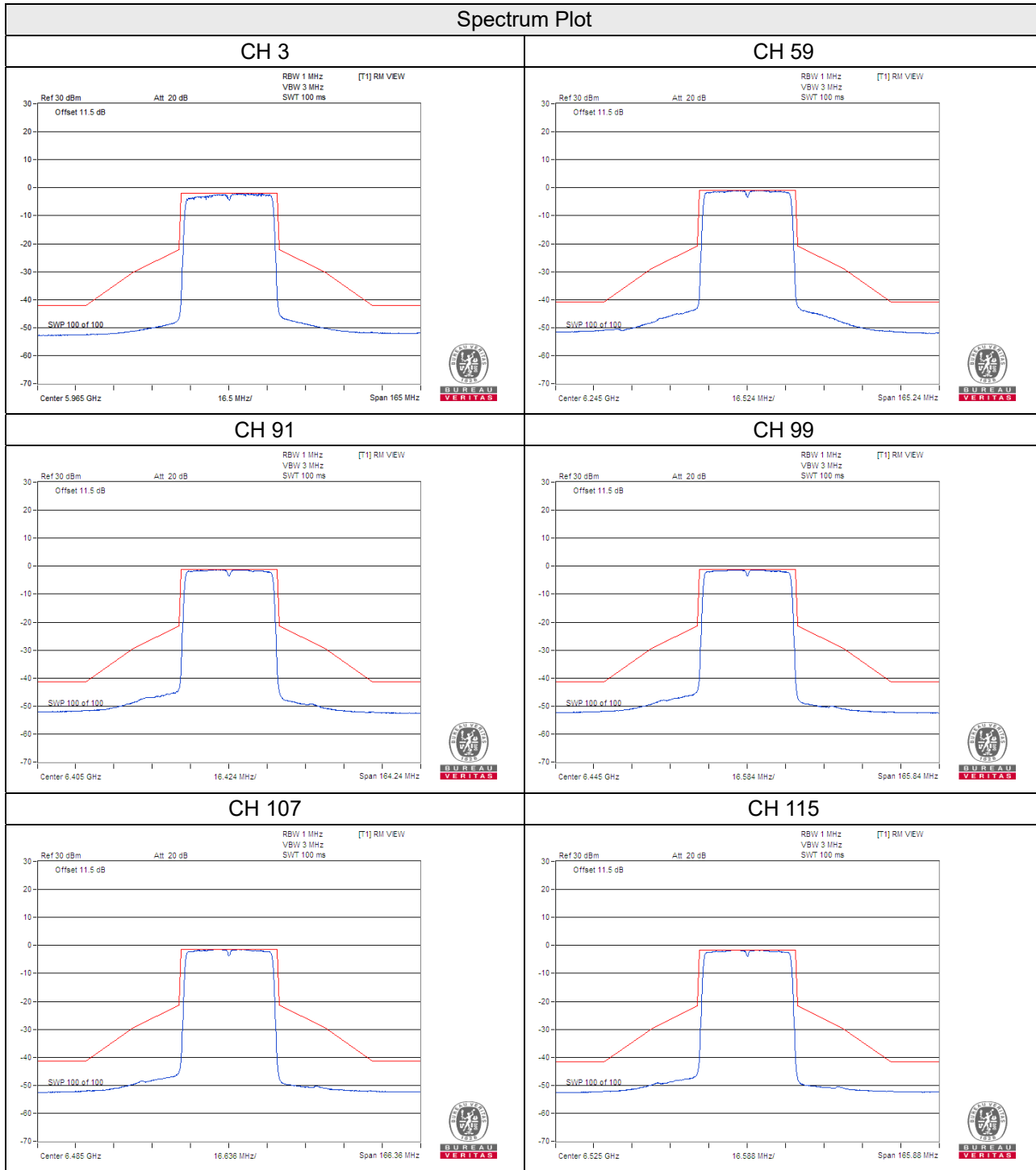

Spectrum Plot

CH 123

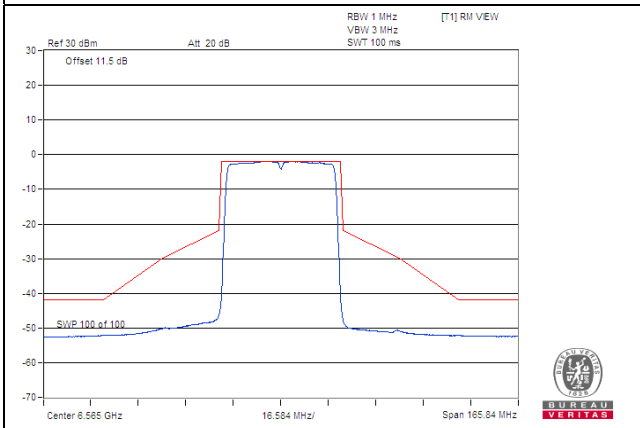

CH 155

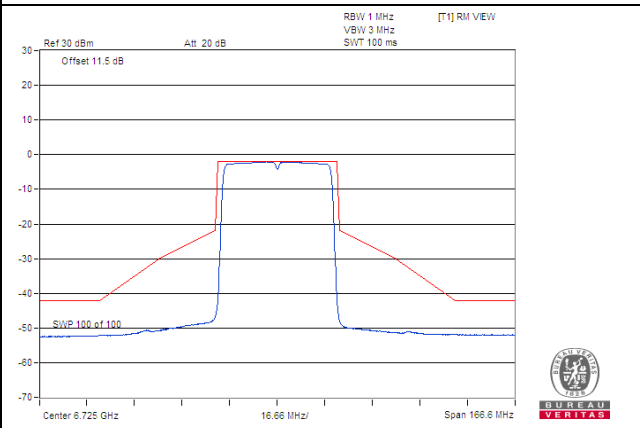

CH 179

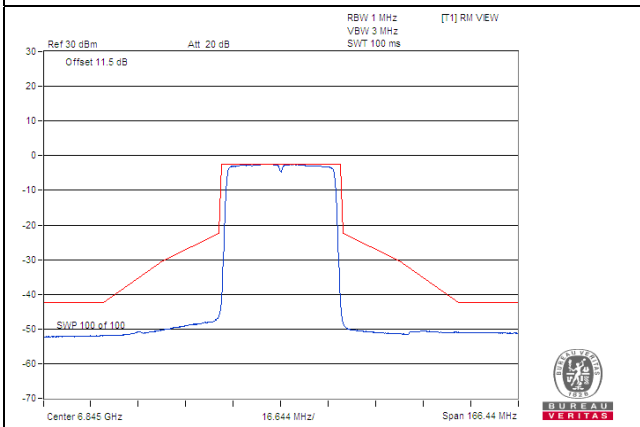

CH 187

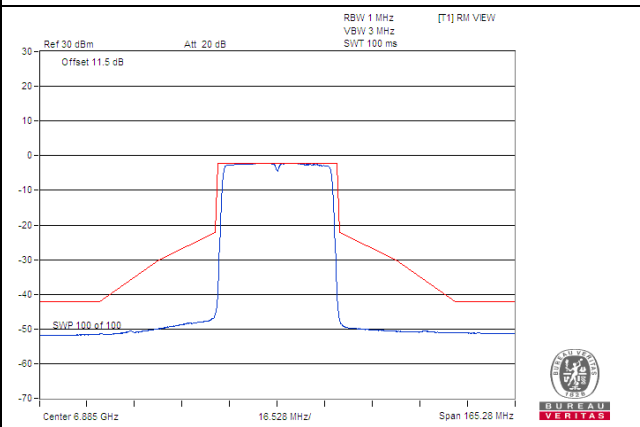

CH 211

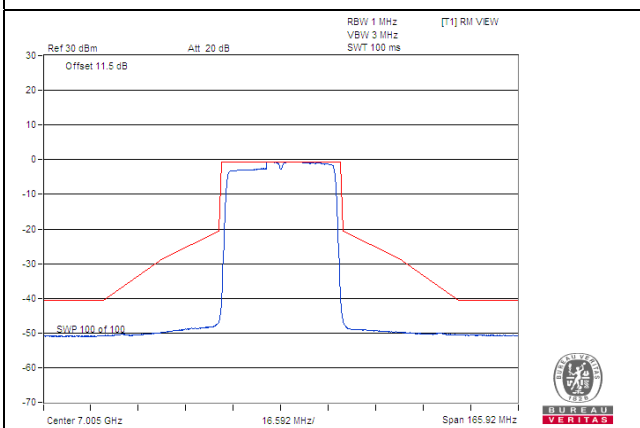

CH 227

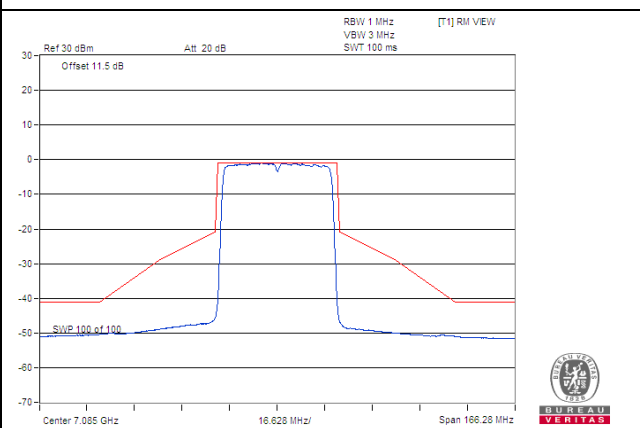

802.11ax (HE40)_Chain 1

Spectrum Plot

CH 3

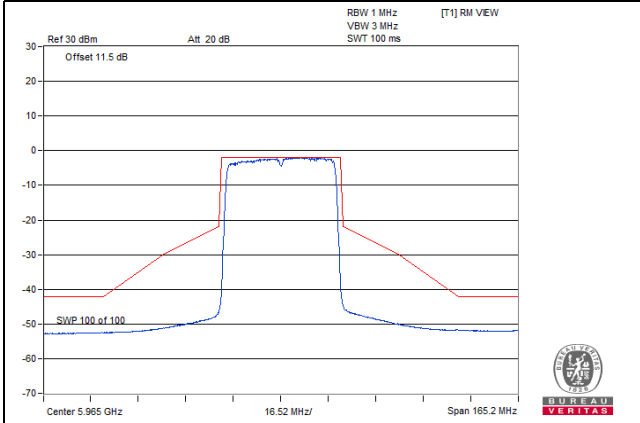

CH 59

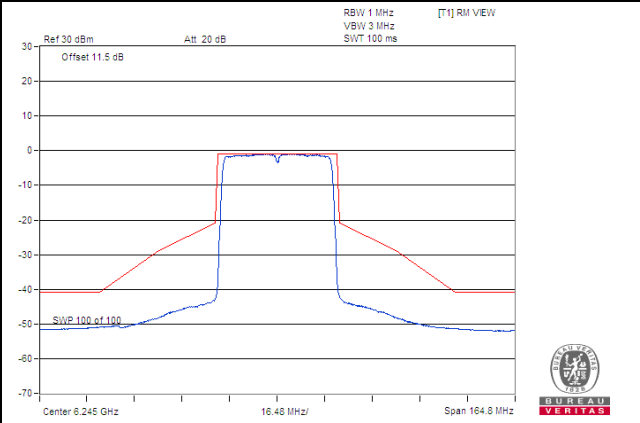

CH 91

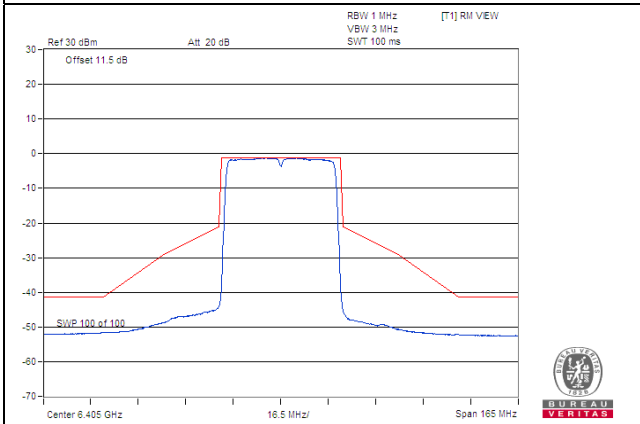

CH 99

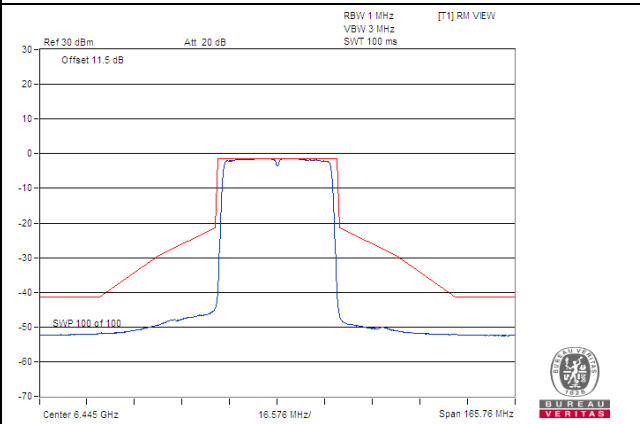

CH 107

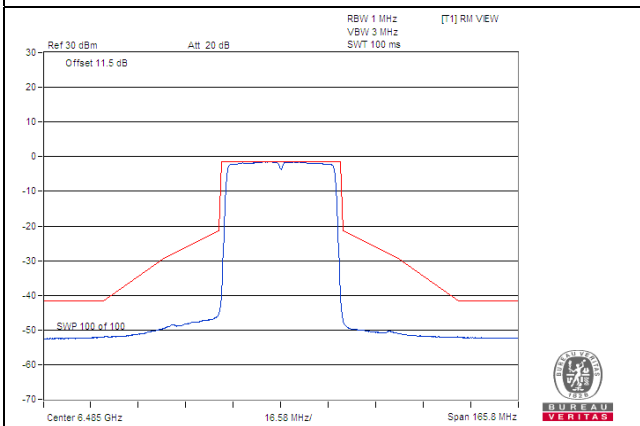

CH 115

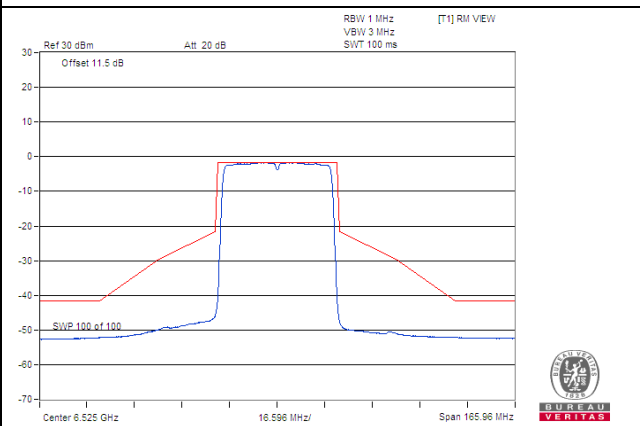

Spectrum Plot

CH 123

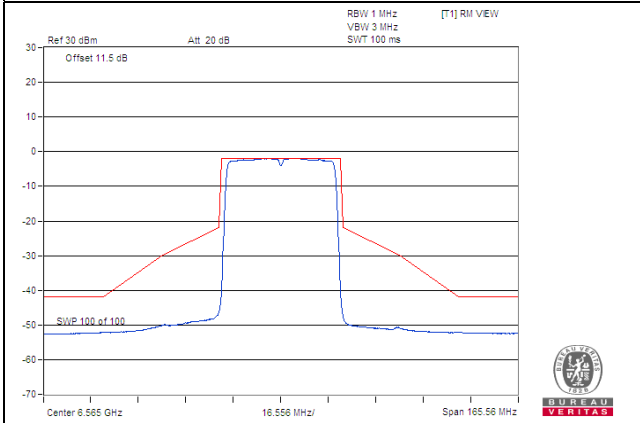

CH 155

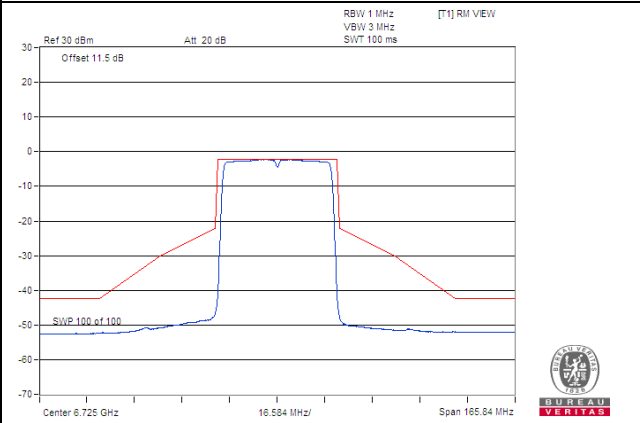

CH 179

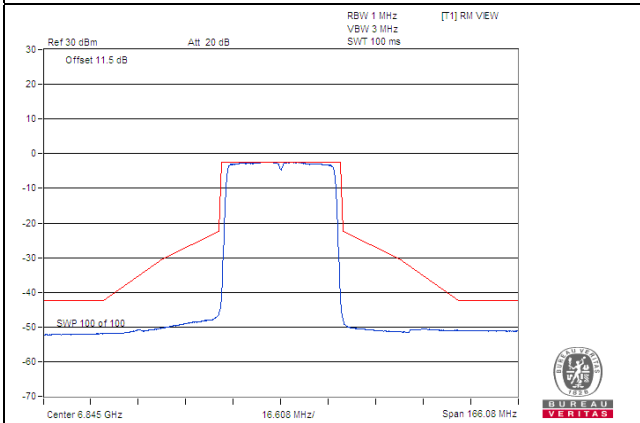

CH 187

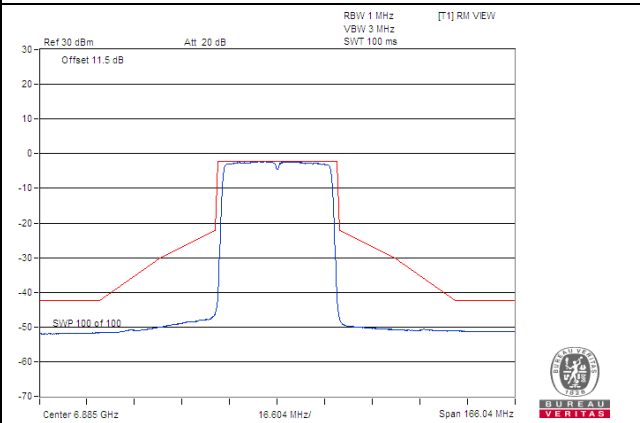

CH 211

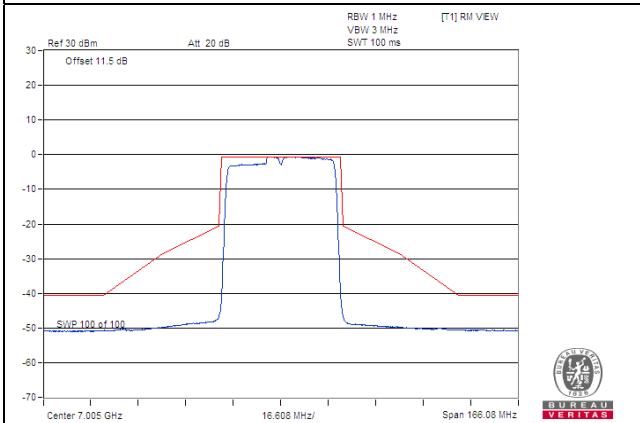

CH 227

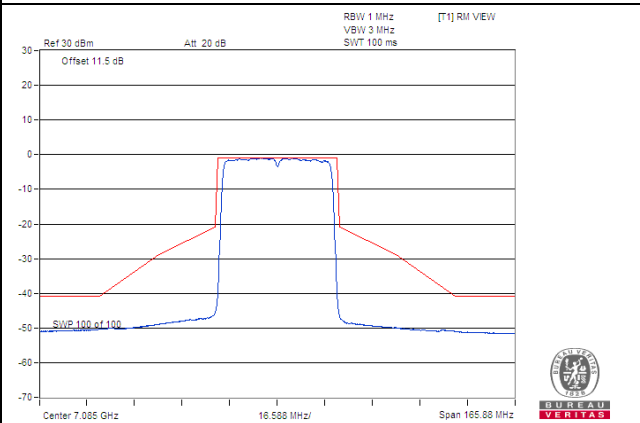

802.11ax (HE80)_Chain 0

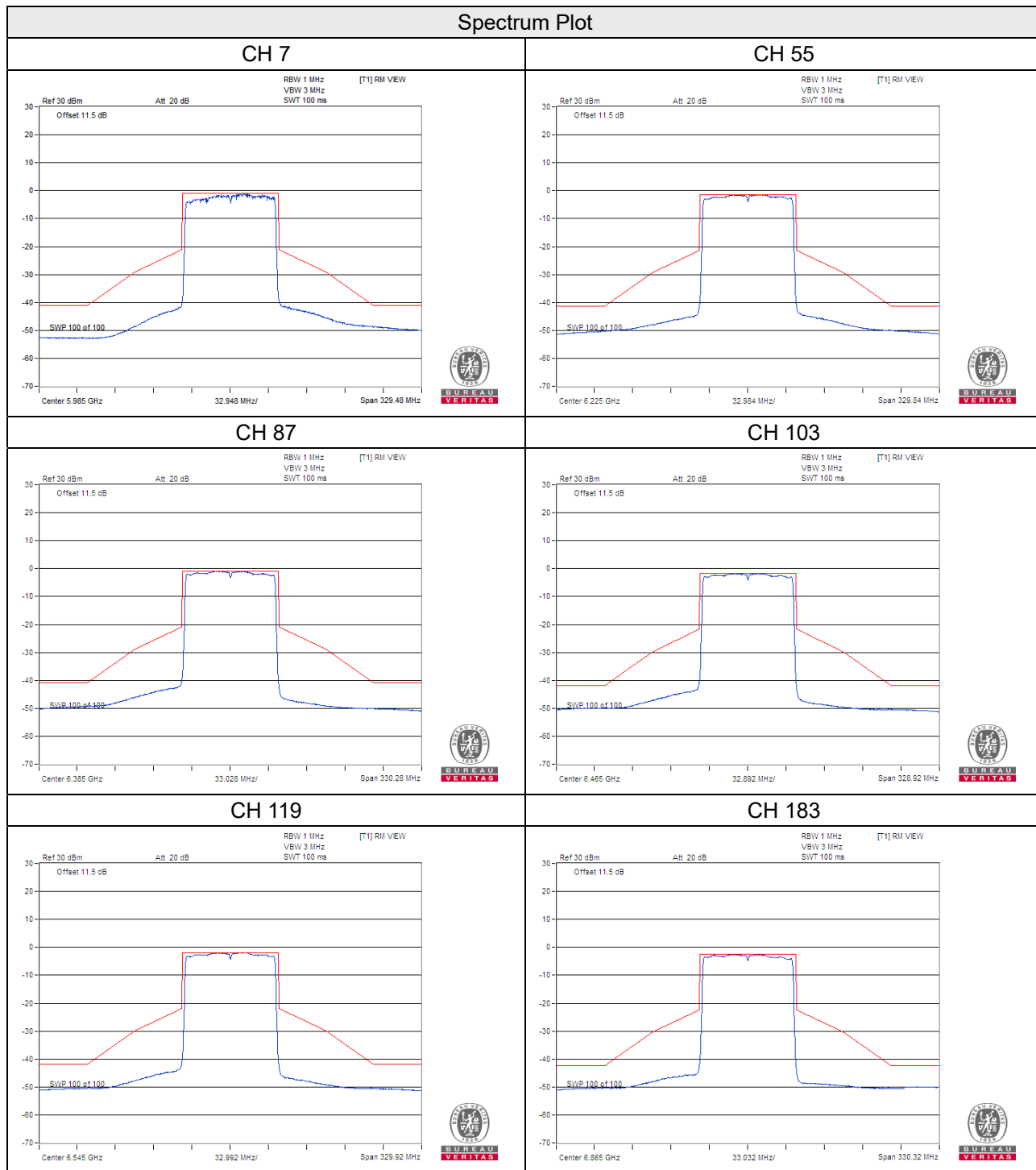

Spectrum Plot

CH 199

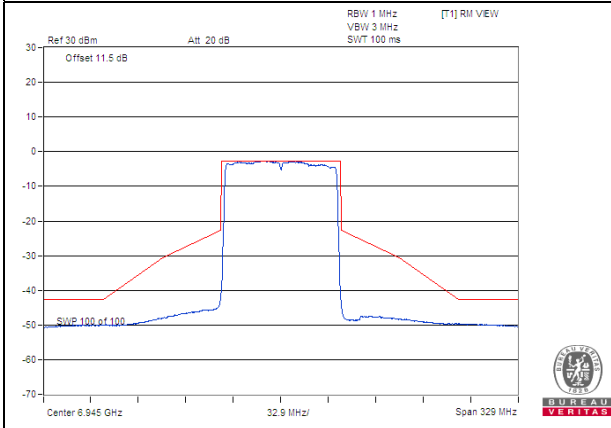

CH 215

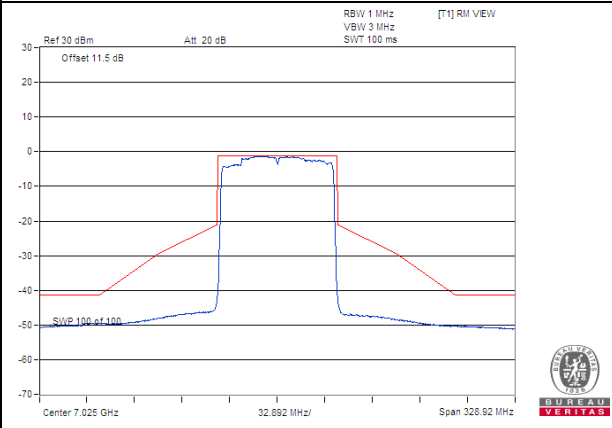

802.11ax (HE80)_Chain 1

Spectrum Plot

CH 7

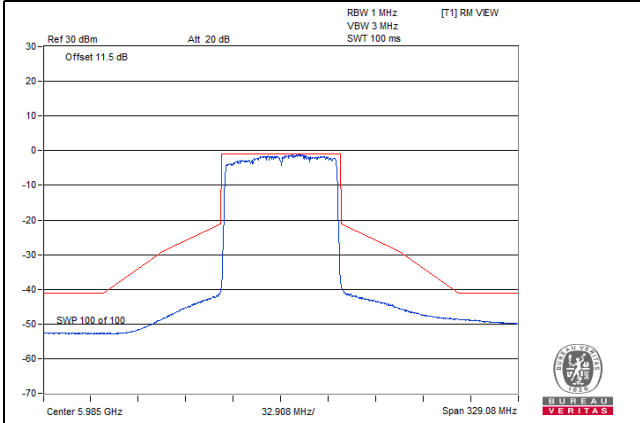

CH 55

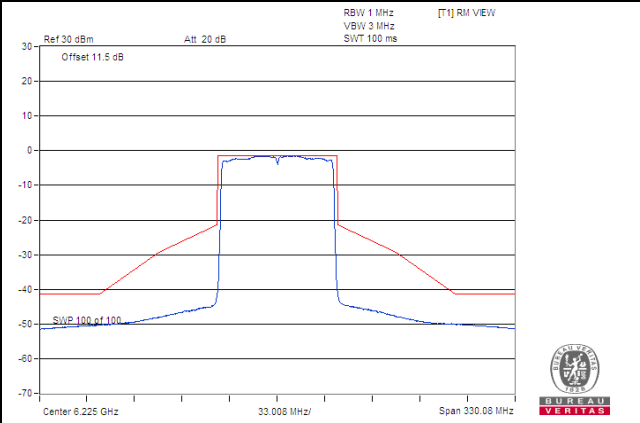

CH 87

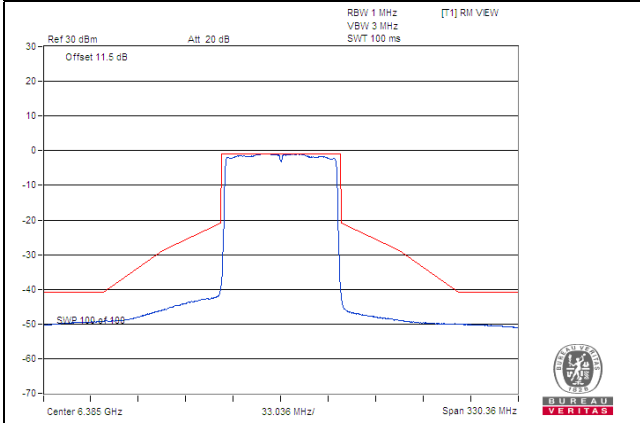

CH 103

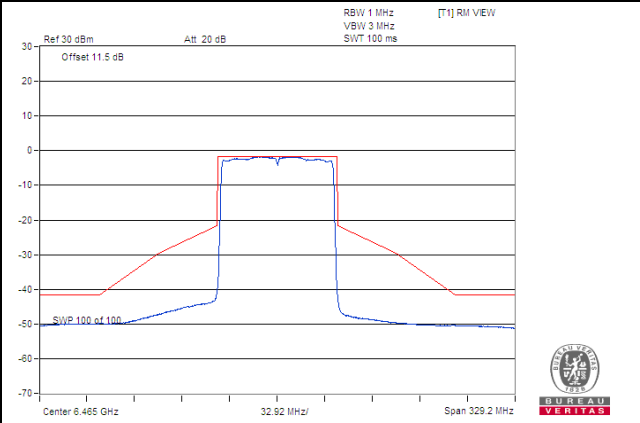

CH 119

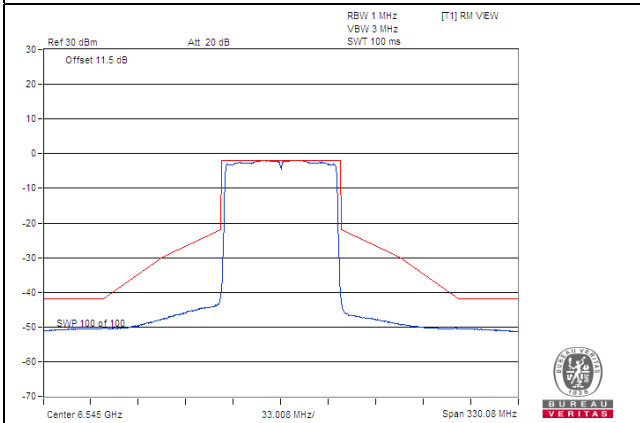

CH 183

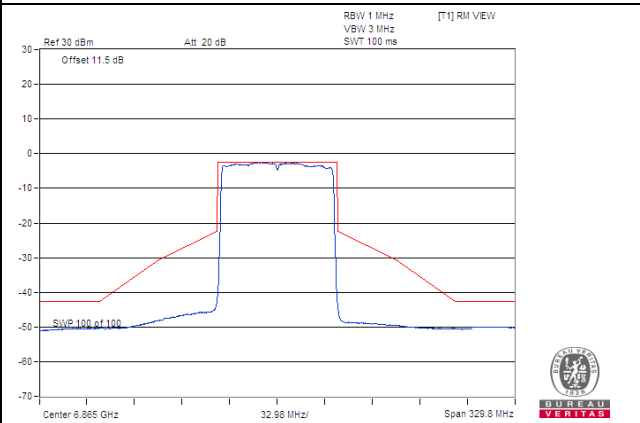

Spectrum Plot

CH 199

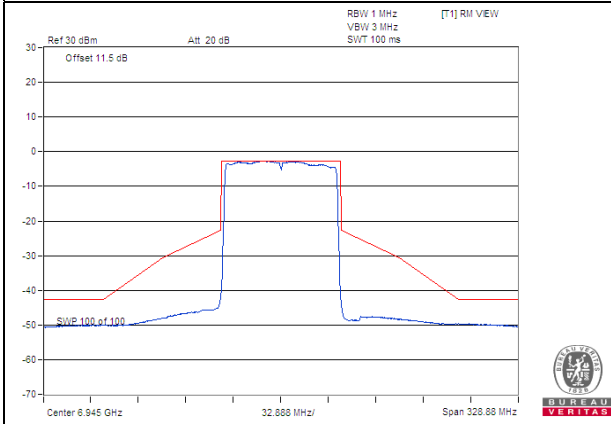

CH 215

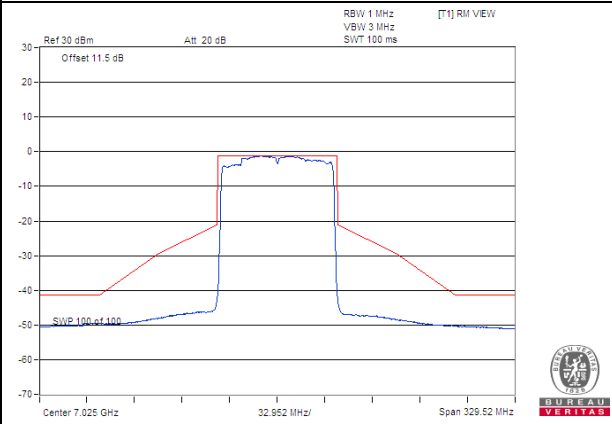

802.11ax (HE160)_Chain 0

Spectrum Plot

CH 15

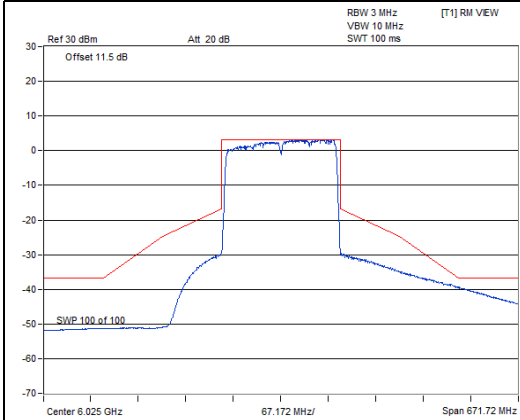

CH 47

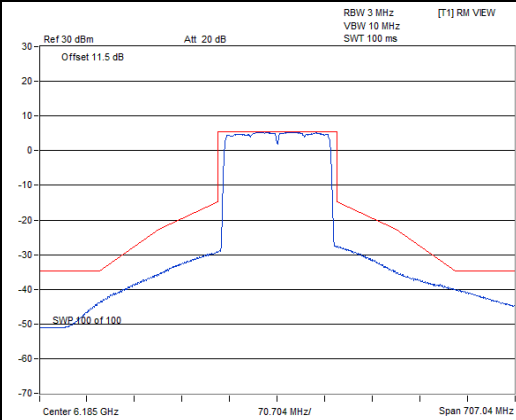

CH 79

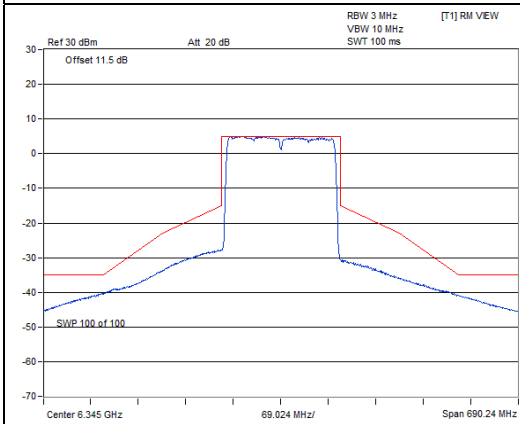

CH 111

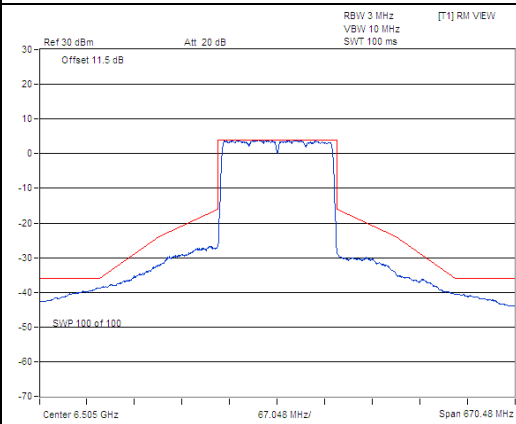

CH 143

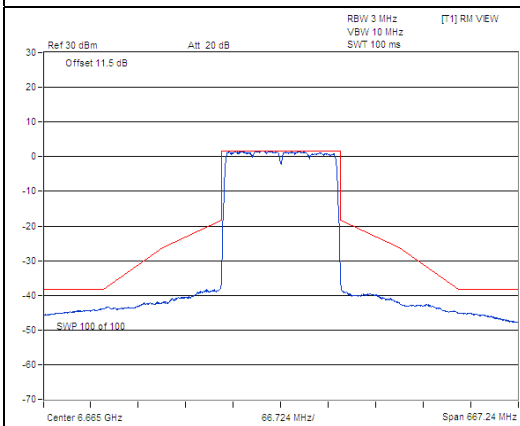

CH 175

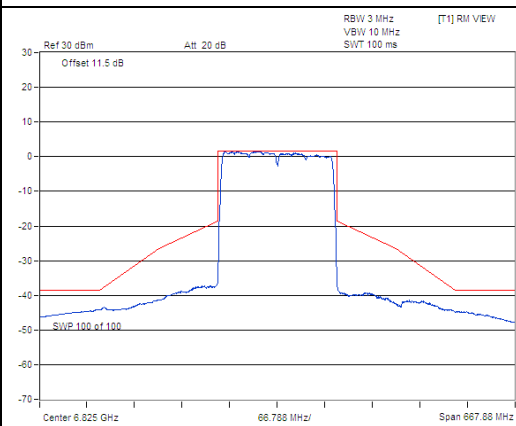

Spectrum Plot

CH 207

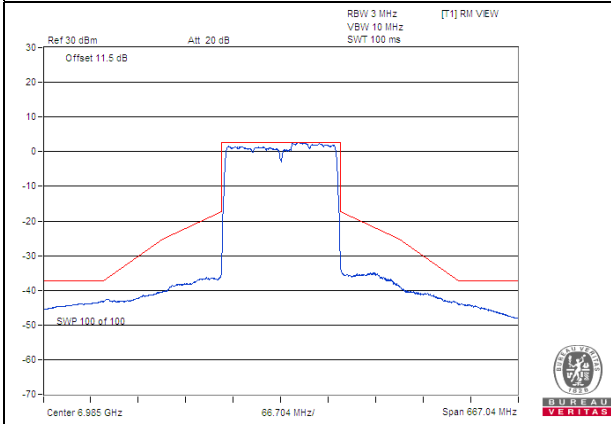

802.11ax (HE160)_Chain 1

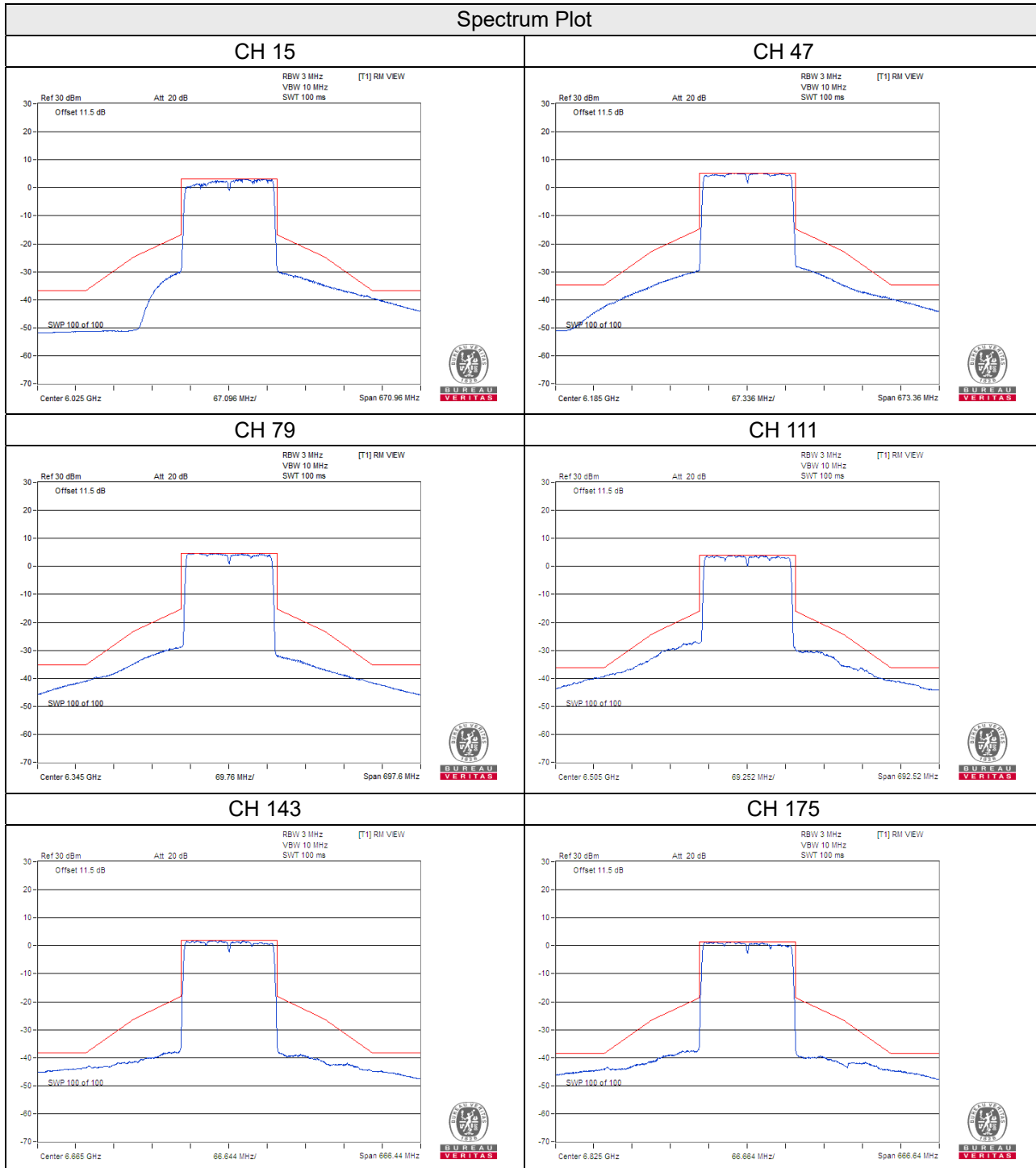

Spectrum Plot

CH 207

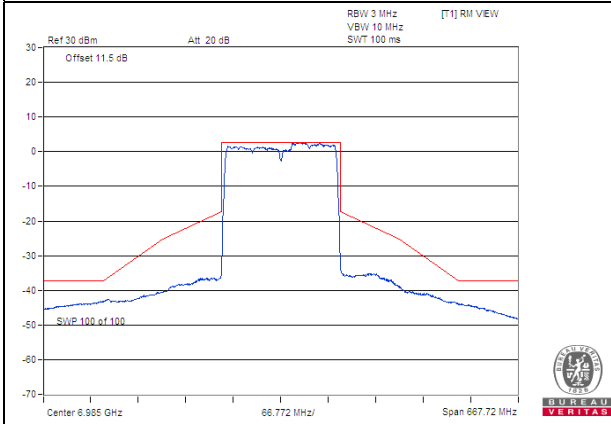

4.3 Conducted Emission Measurement

4.3.1 Limits of Conducted Emission Measurement

Frequency (MHz)	Conducted Limit (dBuV)	
	Quasi-peak	Average
0.15 - 0.5	66 - 56	56 - 46
0.50 - 5.0	56	46
5.0 - 30.0	60	50

Note: 1. The lower limit shall apply at the transition frequencies.

2. The limit decreases in line with the logarithm of the frequency in the range of 0.15 to 0.50MHz.

4.3.2 Test Instruments

Test Date: Nov. 02 ~ Nov. 12, 2021

Description & Manufacturer	Model No.	Serial No.	Cal. Date	Cal. Due
Test Receiver ROHDE & SCHWARZ	ESR3	102412	Jan. 29, 2021	Jan. 28, 2022
RF signal cable (with 10dB PAD) Woken	5D-FB	Cable-cond2-01	Sep. 04, 2021	Sep. 03, 2022
LISN ROHDE & SCHWARZ (EUT)	ESH2-Z5	100100	Jan. 28, 2021	Jan. 27, 2022
LISN ROHDE & SCHWARZ (Peripheral)	ESH3-Z5	100312	Sep. 17, 2021	Sep. 16, 2022
Software ADT	BV ADT_Cond_ V7.3.7.4	NA	NA	NA

Note: 1. The calibration interval of the above test instruments is 12 months and the calibrations are traceable to NML/ROC and NIST/USA.

2. The test was performed in HwaYa Shielded Room 2 (Conduction 2).

3. The VCCI Site Registration No. is C-12047.

4.3.3 Test Procedures

- The EUT was placed 0.4 meters from the conducting wall of the shielded room with EUT being connected to the power mains through a line impedance stabilization network (LISN). Other support units were connected to the power mains through another LISN. The two LISNs provide 50 ohm/ 50uH of coupling impedance for the measuring instrument.
- Both lines of the power mains connected to the EUT were checked for maximum conducted interference.
- The frequency range from 150kHz to 30MHz was searched. Emission levels under (Limit - 20dB) was not recorded.

Note: The resolution bandwidth and video bandwidth of test receiver is 9kHz for quasi-peak detection (QP) and average detection (AV) at frequency 0.15MHz-30MHz.

4.3.4 Deviation from Test Standard

No deviation.

4.3.5 Test Setup

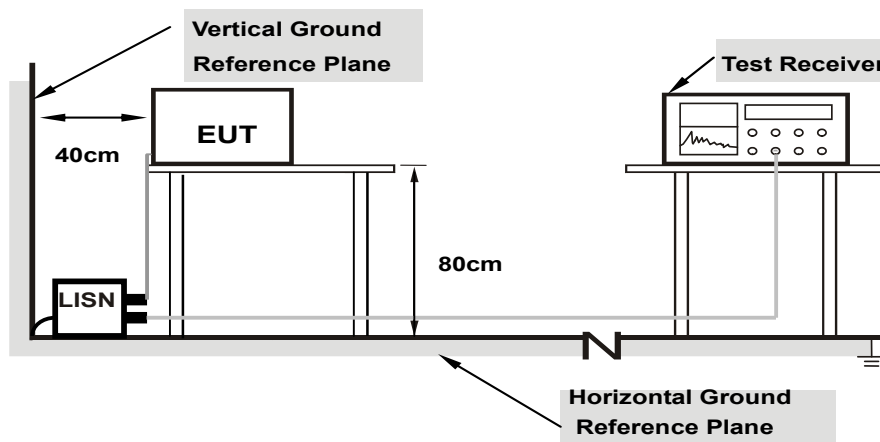

Note: 1.Support units were connected to second LISN.

For the actual test configuration, please refer to the attached file (Test Setup Photo).

4.3.6 EUT Operating Conditions

Same as 4.1.6.

4.3.7 Test Results

Worst-case data:

Nss 1

802.11ax (HE20)

Phase	Line (L)	Detector Function	Quasi-Peak (QP) / Average (AV)
Test Mode	A		

No	Freq. [MHz]	Corr. Factor (dB)	Reading Value		Emission Level		Limit		Margin	
			[dB (uV)]		[dB (uV)]		[dB (uV)]		(dB)	
			Q.P.	AV.	Q.P.	AV.	Q.P.	AV.	Q.P.	AV.
1	0.15391	9.76	31.47	19.47	41.23	29.23	65.79	55.79	-24.56	-26.56
2	0.17346	9.76	34.35	20.20	44.11	29.96	64.79	54.79	-20.68	-24.83
3	0.20865	9.77	27.99	14.25	37.76	24.02	63.26	53.26	-25.50	-29.24
4	0.57619	9.85	14.52	3.14	24.37	12.99	56.00	46.00	-31.63	-33.01
5	4.20858	9.98	17.66	5.26	27.64	15.24	56.00	46.00	-28.36	-30.76
6	9.84680	10.06	18.11	11.09	28.17	21.15	60.00	50.00	-31.83	-28.85

Remarks:

1. Q.P. and AV. are abbreviations of quasi-peak and average individually.
2. The emission levels of other frequencies were very low against the limit.
3. Margin value = Emission level - Limit value
4. Correction factor = Insertion loss + Cable loss
5. Emission Level = Correction Factor + Reading Value.

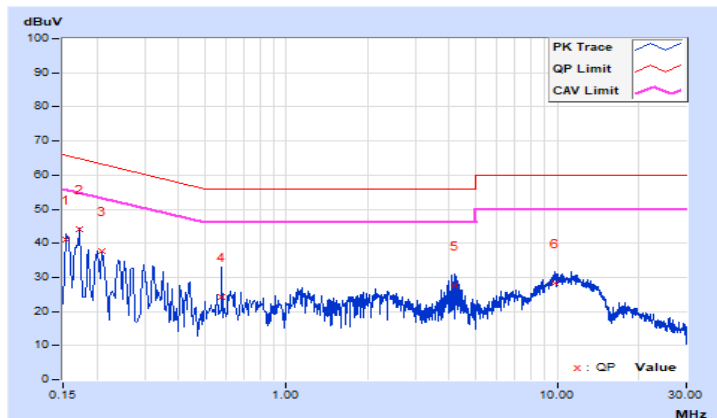

Phase	Neutral (N)	Detector Function	Quasi-Peak (QP) / Average (AV)
Test Mode	A		

No	Freq. [MHz]	Corr. Factor (dB)	Reading Value [dB (uV)]		Emission Level [dB (uV)]		Limit [dB (uV)]		Margin (dB)	
			Q.P.	AV.	Q.P.	AV.	Q.P.	AV.	Q.P.	AV.
			1	0.15782	9.81	35.93	17.82	45.74	27.63	65.58
2	0.19692	9.83	27.03	10.96	36.86	20.79	63.74	53.74	-26.88	-32.95
3	0.23993	9.84	23.05	9.85	32.89	19.69	62.10	52.10	-29.21	-32.41
4	0.76387	9.94	19.14	4.44	29.08	14.38	56.00	46.00	-26.92	-31.62
5	4.25159	10.04	16.26	4.69	26.30	14.73	56.00	46.00	-29.70	-31.27
6	9.74905	10.14	16.95	9.83	27.09	19.97	60.00	50.00	-32.91	-30.03

Remarks:

1. Q.P. and AV. are abbreviations of quasi-peak and average individually.
2. The emission levels of other frequencies were very low against the limit.
3. Margin value = Emission level - Limit value
4. Correction factor = Insertion loss + Cable loss
5. Emission Level = Correction Factor + Reading Value.

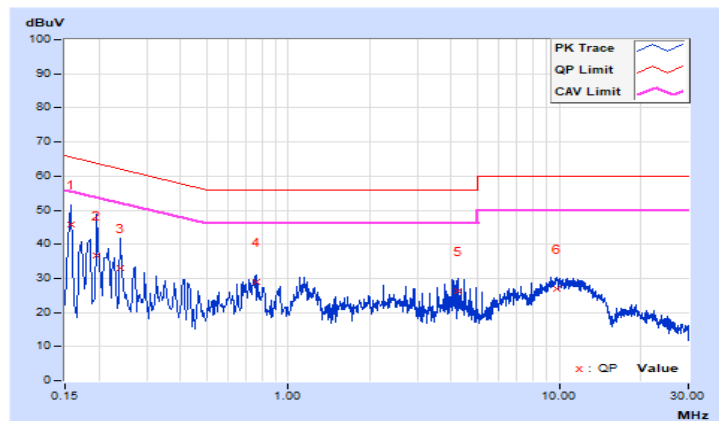

Phase	Line (L)	Detector Function	Quasi-Peak (QP) / Average (AV)
Test Mode	B		

No	Freq. [MHz]	Corr. Factor (dB)	Reading Value [dB (uV)]		Emission Level [dB (uV)]		Limit [dB (uV)]		Margin (dB)	
			Q.P.	AV.	Q.P.	AV.	Q.P.	AV.	Q.P.	AV.
			1	0.17000	9.76	33.18	18.57	42.94	28.33	64.96
2	0.22200	9.78	26.44	15.21	36.22	24.99	62.74	52.74	-26.52	-27.75
3	0.43000	9.83	33.07	25.48	42.90	35.31	57.25	47.25	-14.35	-11.94
4	1.00200	9.91	20.47	14.74	30.38	24.65	56.00	46.00	-25.62	-21.35
5	2.57800	9.95	16.99	11.47	26.94	21.42	56.00	46.00	-29.06	-24.58
6	6.30200	10.01	20.73	13.16	30.74	23.17	60.00	50.00	-29.26	-26.83

Remarks:

1. Q.P. and AV. are abbreviations of quasi-peak and average individually.
2. The emission levels of other frequencies were very low against the limit.
3. Margin value = Emission level - Limit value
4. Correction factor = Insertion loss + Cable loss
5. Emission Level = Correction Factor + Reading Value.

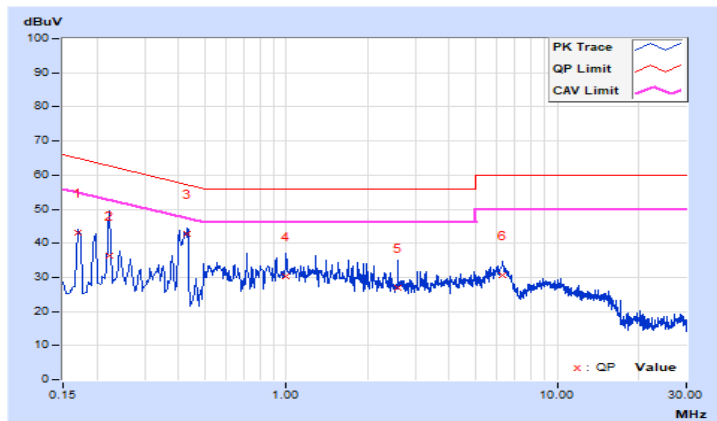

Phase	Neutral (N)	Detector Function	Quasi-Peak (QP) / Average (AV)
Test Mode	B		

No	Freq. [MHz]	Corr. Factor (dB)	Reading Value [dB (uV)]		Emission Level [dB (uV)]		Limit [dB (uV)]		Margin (dB)	
			Q.P.	AV.	Q.P.	AV.	Q.P.	AV.	Q.P.	AV.
			1	0.16105	9.81	37.56	21.51	47.37	31.32	65.41
2	0.18200	9.82	34.10	19.45	43.92	29.27	64.39	54.39	-20.47	-25.12
3	0.32600	9.87	27.76	22.21	37.63	32.08	59.55	49.55	-21.92	-17.47
4	0.39800	9.90	34.52	29.57	44.42	39.47	57.90	47.90	-13.48	-8.43
5	1.63400	9.98	18.06	12.36	28.04	22.34	56.00	46.00	-27.96	-23.66
6	5.92600	10.07	15.16	8.70	25.23	18.77	60.00	50.00	-34.77	-31.23

Remarks:

1. Q.P. and AV. are abbreviations of quasi-peak and average individually.
2. The emission levels of other frequencies were very low against the limit.
3. Margin value = Emission level - Limit value
4. Correction factor = Insertion loss + Cable loss
5. Emission Level = Correction Factor + Reading Value.

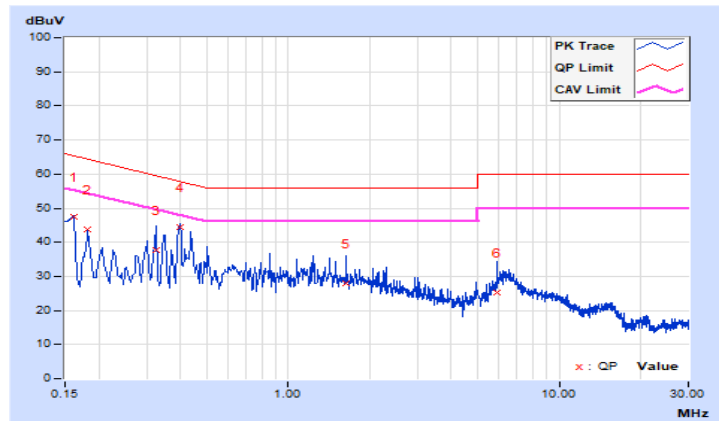

4.4 Transmit Power Measurement

4.4.1 Limits of Transmit Power Measurement

Operation Band	EUT Category	Limit
		Max Average Power
U-NII-5 U-NII-6 U-NII-7 U-NII-8	Low Power - Indoor AP (Master)	EIRP 30 dBm

4.4.2 Test Setup

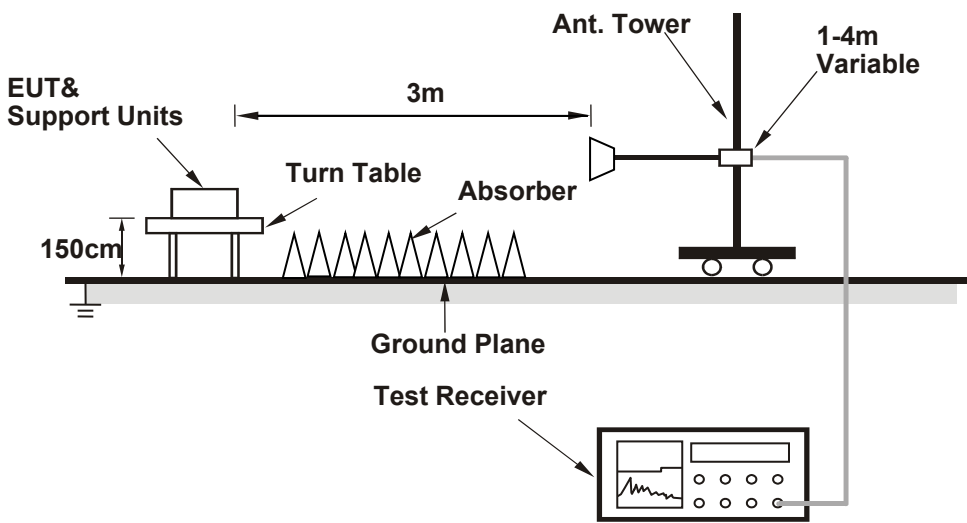

4.4.3 Test Instruments

Refer to section 4.1.2 to get information of above instrument.

4.4.4 Test Procedure

- a. The EUT was placed on the top of a rotating table 1.5 meters above the ground at 3 meter chamber room for test. The table was rotated 360 degrees to determine the position of the highest radiation.
- b. The EUT was set 3 meters away from the interference-receiving antenna, which was mounted on the top of a variable-height antenna tower.
- c. The height of antenna is varied from one meter to four meters above the ground to determine the maximum value of the field strength. Both horizontal and vertical polarizations of the antenna are set to make the measurement.
- d. Perform a field strength measurement and record the worse read value, is the field strength value via a spectrum reading obtained corrected for antenna factor, cable loss and pre-amplifier factor and then mathematically convert the measured field strength level to EIRP level.
- e. Follow ANSI 63.10 and KDB 412172 D01 v01r01, EIRP Value (dBm) = Field Strength Value (dB μ V/m) + Correction Factor @ 3m.
- f. Correction Factor (dB) @ 3m = $20\log(D) - 104.7$; where D is the measurement distance @3m = -95.15dB

4.4.5 Deviation from Test Standard

No deviation.

4.4.6 EUT Operating Conditions

The software provided by client to enable the EUT under transmission condition continuously at lowest, middle and highest channel frequencies individually.

4.4.7 Test Result

Nss 1

Non-Beamforming Mode

802.11a

Chan.	Chan. Freq. (MHz)	Field Strength (dBuV/m)	Correction Factor (dB)	EIRP (mW)	EIRP (dBm)	EIRP Limit (dBm)	Pass / Fail
1	5955	111.95	-95.15	47.863	16.80	30.00	Pass
61	6255	111.88	-95.15	47.098	16.73	30.00	Pass
93	6415	111.65	-95.15	44.668	16.50	30.00	Pass
97	6435	111.59	-95.15	44.055	16.44	30.00	Pass
105	6475	111.60	-95.15	44.157	16.45	30.00	Pass
113	6515	111.57	-95.15	43.853	16.42	30.00	Pass
117	6535	111.22	-95.15	40.458	16.07	30.00	Pass
153	6715	111.67	-95.15	44.875	16.52	30.00	Pass
181	6855	111.91	-95.15	47.424	16.76	30.00	Pass
185	6875	111.81	-95.15	46.345	16.66	30.00	Pass
213	7015	111.56	-95.15	43.752	16.41	30.00	Pass
229	7095	111.33	-95.15	41.495	16.18	30.00	Pass
233	7115	106.82	-95.15	14.689	11.67	30.00	Pass

Beamforming Mode

802.11ax (HE20)

Chan.	Chan. Freq. (MHz)	Field Strength (dBuV/m)	Correction Factor (dB)	EIRP (mW)	EIRP (dBm)	EIRP Limit (dBm)	Pass / Fail
1	5955	113.98	-95.15	76.384	18.83	30.00	Pass
61	6255	113.81	-95.15	73.451	18.66	30.00	Pass
93	6415	113.94	-95.15	75.683	18.79	30.00	Pass
97	6435	113.26	-95.15	64.714	18.11	30.00	Pass
105	6475	113.32	-95.15	65.615	18.17	30.00	Pass
113	6515	113.30	-95.15	65.313	18.15	30.00	Pass
117	6535	113.00	-95.15	60.954	17.85	30.00	Pass
153	6715	113.30	-95.15	65.313	18.15	30.00	Pass
181	6855	113.20	-95.15	63.826	18.05	30.00	Pass
185	6875	113.41	-95.15	66.988	18.26	30.00	Pass
213	7015	113.27	-95.15	64.863	18.12	30.00	Pass
229	7095	113.17	-95.15	63.387	18.02	30.00	Pass
233	7115	94.92	-95.15	0.948	-0.23	30.00	Pass

Beamforming Mode

802.11ax (HE40)

Chan.	Chan. Freq. (MHz)	Field Strength (dBuV/m)	Correction Factor (dB)	EIRP (mW)	EIRP (dBm)	EIRP Limit (dBm)	Pass / Fail
3	5965	116.69	-95.15	142.561	21.54	30.00	Pass
59	6245	116.94	-95.15	151.008	21.79	30.00	Pass
91	6405	116.55	-95.15	138.038	21.40	30.00	Pass
99	6445	116.15	-95.15	125.893	21.00	30.00	Pass
107	6485	116.41	-95.15	133.660	21.26	30.00	Pass
115	6525	115.76	-95.15	115.080	20.61	30.00	Pass
123	6565	116.10	-95.15	124.451	20.95	30.00	Pass
155	6725	116.04	-95.15	122.744	20.89	30.00	Pass
179	6845	116.48	-95.15	135.831	21.33	30.00	Pass
187	6885	115.61	-95.15	111.173	20.46	30.00	Pass
211	7005	115.40	-95.15	105.925	20.25	30.00	Pass
227	7085	115.30	-95.15	103.514	20.15	30.00	Pass

Beamforming Mode

802.11ax (HE80)

Chan.	Chan. Freq. (MHz)	Field Strength (dBuV/m)	Correction Factor (dB)	EIRP (mW)	EIRP (dBm)	EIRP Limit (dBm)	Pass / Fail
7	5985	119.79	-95.15	291.072	24.64	30.00	Pass
55	6225	119.86	-95.15	295.801	24.71	30.00	Pass
87	6385	119.82	-95.15	293.089	24.67	30.00	Pass
103	6465	118.67	-95.15	224.905	23.52	30.00	Pass
119	6545	118.99	-95.15	242.103	23.84	30.00	Pass
135	6625	118.39	-95.15	210.863	23.24	30.00	Pass
151	6705	118.40	-95.15	211.349	23.25	30.00	Pass
167	6785	119.27	-95.15	258.226	24.12	30.00	Pass
183	6865	119.34	-95.15	262.422	24.19	30.00	Pass
199	6945	117.79	-95.15	183.654	22.64	30.00	Pass
215	7025	117.52	-95.15	172.584	22.37	30.00	Pass

Beamforming Mode

802.11ax (HE160)

Chan.	Chan. Freq. (MHz)	Field Strength (dBuV/m)	Correction Factor (dB)	EIRP (mW)	EIRP (dBm)	EIRP Limit (dBm)	Pass / Fail
15	6025	122.84	-95.15	587.489	27.69	30.00	Pass
47	6185	122.87	-95.15	591.562	27.72	30.00	Pass
79	6345	123.09	-95.15	622.300	27.94	30.00	Pass
111	6505	123.69	-95.15	714.496	28.54	30.00	Pass
143	6665	122.04	-95.15	488.652	26.89	30.00	Pass
175	6825	121.79	-95.15	461.318	26.64	30.00	Pass
207	6985	121.46	-95.15	427.563	26.31	30.00	Pass

Nss 2

Beamforming Mode

802.11ax (HE20)

Chan.	Chan. Freq. (MHz)	Field Strength (dBuV/m)	Correction Factor (dB)	EIRP (mW)	EIRP (dBm)	EIRP Limit (dBm)	Pass / Fail
1	5955	114.18	-95.15	79.983	19.03	30.00	Pass
61	6255	113.82	-95.15	73.621	18.67	30.00	Pass
93	6415	114.00	-95.15	76.736	18.85	30.00	Pass
97	6435	113.28	-95.15	65.013	18.13	30.00	Pass
105	6475	113.37	-95.15	66.374	18.22	30.00	Pass
113	6515	113.37	-95.15	66.374	18.22	30.00	Pass
117	6535	113.04	-95.15	61.518	17.89	30.00	Pass
153	6715	113.33	-95.15	65.766	18.18	30.00	Pass
181	6855	113.22	-95.15	64.121	18.07	30.00	Pass
185	6875	114.09	-95.15	78.343	18.94	30.00	Pass
213	7015	113.83	-95.15	73.79	18.68	30.00	Pass
229	7095	113.93	-95.15	75.509	18.78	30.00	Pass
233	7115	93.83	-95.15	0.738	-1.32	30.00	Pass

Beamforming Mode

802.11ax (HE40)

Chan.	Chan. Freq. (MHz)	Field Strength (dBuV/m)	Correction Factor (dB)	EIRP (mW)	EIRP (dBm)	EIRP Limit (dBm)	Pass / Fail
3	5965	116.91	-95.15	149.968	21.76	30.00	Pass
59	6245	117.01	-95.15	153.462	21.86	30.00	Pass
91	6405	116.60	-95.15	139.637	21.45	30.00	Pass
99	6445	116.18	-95.15	126.765	21.03	30.00	Pass
107	6485	116.47	-95.15	135.519	21.32	30.00	Pass
115	6525	115.82	-95.15	116.681	20.67	30.00	Pass
123	6565	116.15	-95.15	125.893	21.00	30.00	Pass
155	6725	116.10	-95.15	124.451	20.95	30.00	Pass
179	6845	116.53	-95.15	137.404	21.38	30.00	Pass
187	6885	116.88	-95.15	148.936	21.73	30.00	Pass
211	7005	116.37	-95.15	132.434	21.22	30.00	Pass
227	7085	116.44	-95.15	134.586	21.29	30.00	Pass

Beamforming Mode

802.11ax (HE80)

Chan.	Chan. Freq. (MHz)	Field Strength (dBuV/m)	Correction Factor (dB)	EIRP (mW)	EIRP (dBm)	EIRP Limit (dBm)	Pass / Fail
7	5985	119.89	-95.15	297.852	24.74	30.00	Pass
55	6225	119.91	-95.15	299.226	24.76	30.00	Pass
87	6385	119.87	-95.15	296.483	24.72	30.00	Pass
103	6465	118.72	-95.15	227.51	23.57	30.00	Pass
119	6545	119.07	-95.15	246.604	23.92	30.00	Pass
135	6625	118.45	-95.15	213.796	23.30	30.00	Pass
151	6705	118.46	-95.15	214.289	23.31	30.00	Pass
167	6785	119.31	-95.15	260.615	24.16	30.00	Pass
183	6865	119.40	-95.15	266.073	24.25	30.00	Pass
199	6945	119.19	-95.15	253.513	24.04	30.00	Pass
215	7025	118.89	-95.15	236.592	23.74	30.00	Pass

Beamforming Mode

802.11ax (HE160)

Chan.	Chan. Freq. (MHz)	Field Strength (dBuV/m)	Correction Factor (dB)	EIRP (mW)	EIRP (dBm)	EIRP Limit (dBm)	Pass / Fail
15	6025	122.86	-95.15	590.201	27.71	30.00	Pass
47	6185	122.89	-95.15	594.292	27.74	30.00	Pass
79	6345	123.13	-95.15	628.058	27.98	30.00	Pass
111	6505	123.72	-95.15	719.449	28.57	30.00	Pass
143	6665	122.12	-95.15	497.737	26.97	30.00	Pass
175	6825	121.84	-95.15	466.659	26.69	30.00	Pass
207	6985	121.86	-95.15	468.813	26.71	30.00	Pass

Spectrum Plot of Worst Value

802.11a

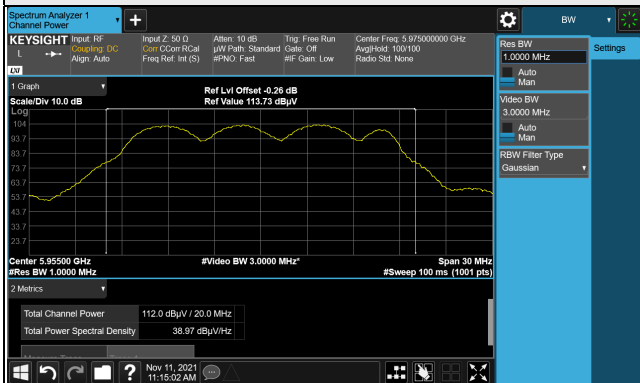

802.11ax (HE20)

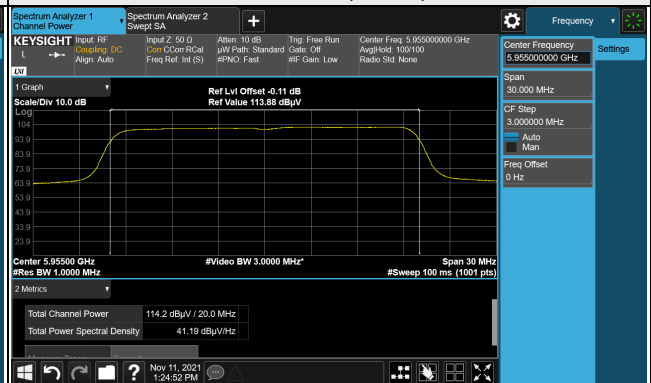

802.11ax (HE40)



802.11ax (HE80)

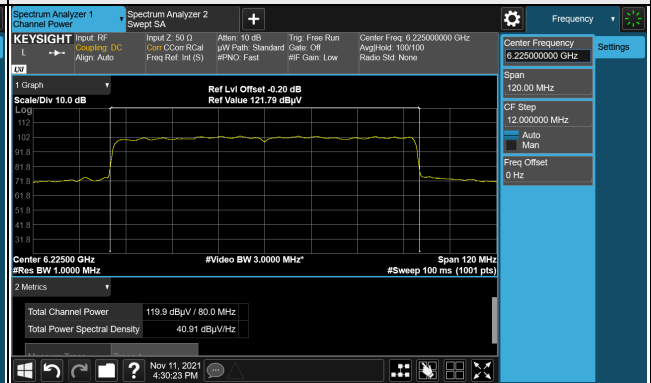

802.11ax (HE160)

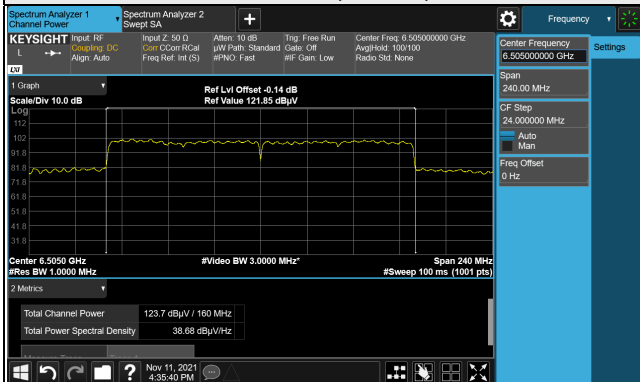

4.5 Emission Bandwidth Measurement

4.5.1 Test Setup

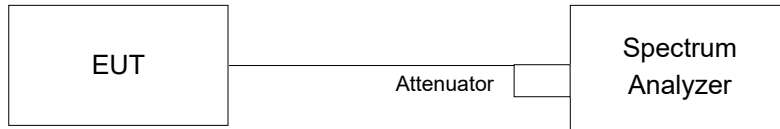

4.5.2 Test Instruments

Refer to section 4.1.2 to get information of above instrument.

4.5.3 Test Procedure

For 99% Occupied Bandwidth

The transmitter output was connected to the spectrum analyzer through an attenuator. The bandwidth of the fundamental frequency was measured by spectrum analyzer with resolution bandwidth in the range of 1% to 5% of the anticipated emission bandwidth, and a video bandwidth at least 3x the resolution bandwidth and set the detector to sampling. The width of a frequency band such that, below the lower and above the upper frequency limits, the mean powers emitted are each equal to a specified percentage 0.5 %of the total mean power of a given emission.

For 26dB Bandwidth

- Set RBW = approximately 1% of the emission bandwidth.
- Set the VBW > RBW.
- Detector = Peak.
- Trace mode = max hold.
- Measure the maximum width of the emission that is 26 dB down from the peak of the emission. Compare this with the RBW setting of the analyzer. Readjust RBW and repeat measurement as needed until the RBW/EBW ratio is approximately 1%.

4.5.4 Test Result

99% Occupied Bandwidth

Nss 1

802.11a

Chan.	Freq. (MHz)	Occupied Bandwidth (MHz)		
		Chain 0	Chain 1	Limit (MHz)
1	5955	16.78	16.78	320
61	6255	16.86	16.86	320
93	6415	16.80	16.80	320
97	6435	16.86	16.86	320
105	6475	16.80	16.80	320
113	6515	16.80	16.80	320
117	6535	16.86	16.86	320
153	6715	16.80	16.80	320
181	6855	16.80	16.80	320
185	6875	16.78	16.86	320
213	7015	16.80	16.92	320
229	7095	16.78	16.78	320
233	7115	16.92	16.92	320

802.11ax (HE20)

Chan.	Freq. (MHz)	Occupied Bandwidth (MHz)		
		Chain 0	Chain 1	Limit (MHz)
1	5955	19.14	19.05	320
61	6255	19.14	19.14	320
93	6415	19.20	19.20	320
97	6435	19.14	19.14	320
105	6475	19.20	19.20	320
113	6515	19.20	19.20	320
117	6535	19.14	19.14	320
153	6715	19.20	19.20	320
181	6855	19.08	19.20	320
185	6875	19.14	19.14	320
213	7015	19.20	19.20	320
229	7095	19.20	19.08	320
233	7115	19.22	19.14	320

802.11ax (HE40)

Chan.	Freq. (MHz)	Occupied Bandwidth (MHz)		
		Chain 0	Chain 1	Limit (MHz)
3	5965	38.43	38.43	320
59	6245	37.68	37.68	320
91	6405	37.68	37.68	320
99	6445	38.60	38.26	320
107	6485	37.92	37.92	320
115	6525	37.92	37.92	320
123	6565	38.26	38.43	320
155	6725	37.92	37.92	320
179	6845	37.68	37.92	320
187	6885	38.43	38.43	320
211	7005	37.92	37.68	320
227	7085	37.68	37.68	320

802.11ax (HE80)

Chan.	Freq. (MHz)	Occupied Bandwidth (MHz)		
		Chain 0	Chain 1	Limit (MHz)
7	5985	77.91	78.26	320
55	6225	76.80	76.80	320
87	6385	77.28	77.28	320
103	6465	78.26	78.26	320
119	6545	77.28	76.80	320
135	6625	78.60	78.60	320
151	6705	78.60	78.26	320
167	6785	78.60	77.92	320
183	6865	77.28	77.28	320
199	6945	78.26	78.26	320
215	7025	77.28	76.80	320

802.11ax (HE160)

Chan.	Freq. (MHz)	Occupied Bandwidth (MHz)		
		Chain 0	Chain 1	Limit (MHz)
15	6025	156.52	155.82	320
47	6185	157.22	156.52	320
79	6345	156.48	156.48	320
111	6505	156.52	156.52	320
143	6665	156.52	156.52	320
175	6825	156.48	156.48	320
207	6985	156.52	156.52	320

Spectrum Plot of Max. Value

802.11a_Chain 0 / CH 61 (U-NII-5 Band)

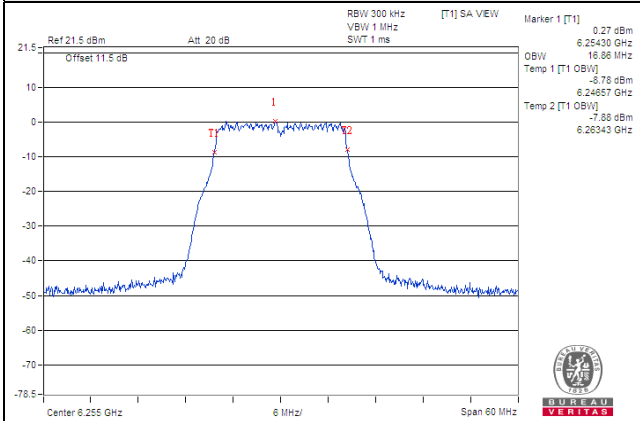

802.11a_Chain 0 / CH 97 (U-NII-6 Band)

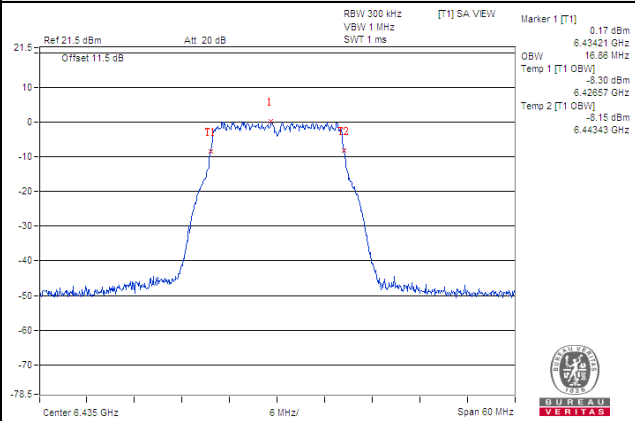

802.11a_Chain 0 / CH 117 (U-NII-7 Band)

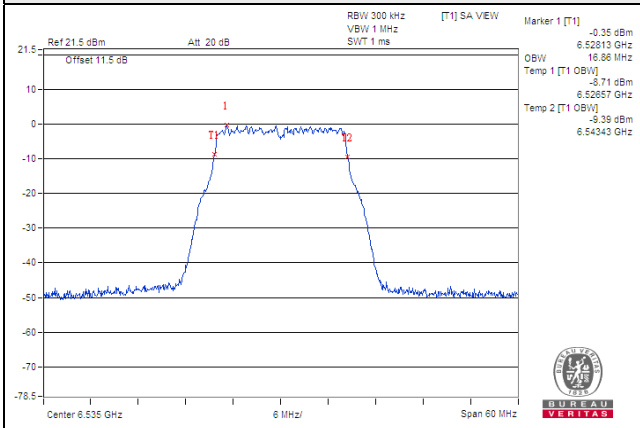

802.11a_Chain 1 / CH 213 (U-NII-8 Band)

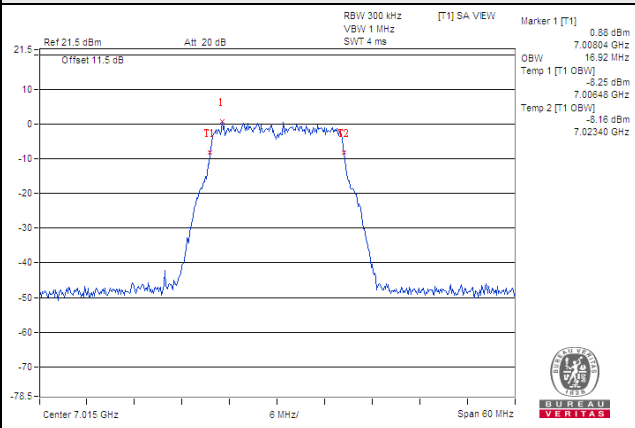

Spectrum Plot of Max. Value

802.11ax (HE20)_Chain 1 / CH 93 (U-NII-5 Band)

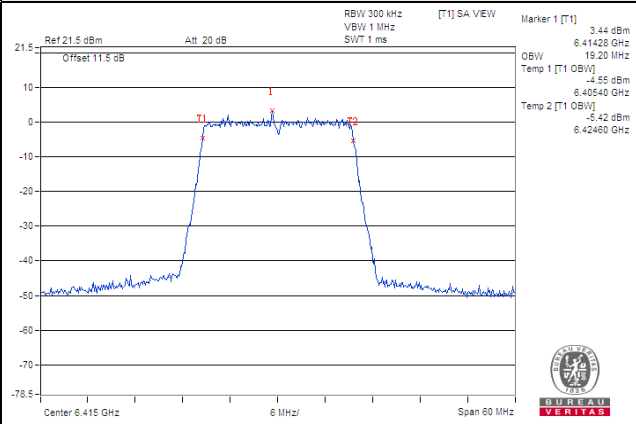

802.11ax (HE20)_Chain 0 / CH105 (U-NII-6 Band)

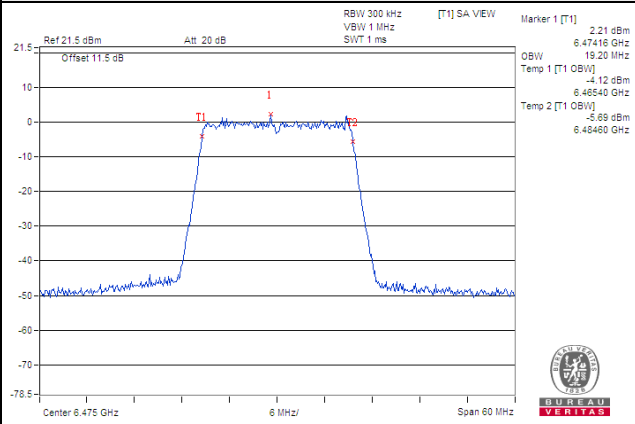

802.11ax (HE20)_Chain 1 / CH 153 (U-NII-7 Band)

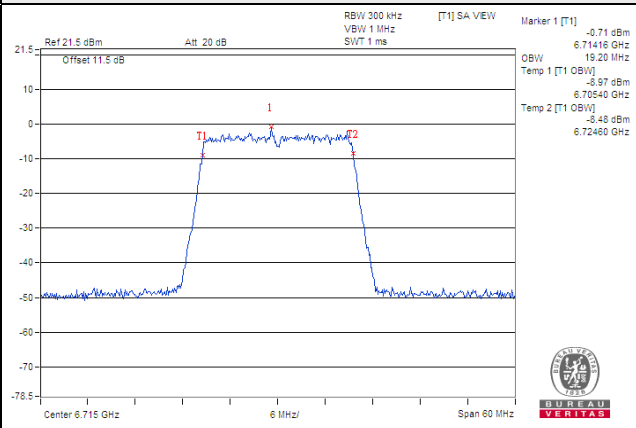

802.11ax (HE20)_Chain 0 / CH 233 (U-NII-8 Band)

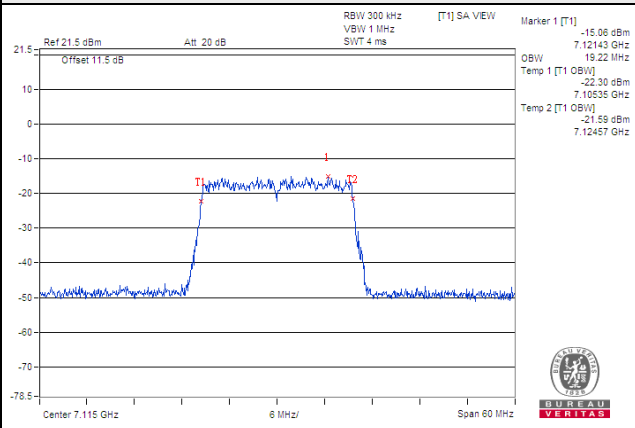

Spectrum Plot of Max. Value

802.11ax (HE40)_Chain 0 / CH 3 (U-NII-5 Band)

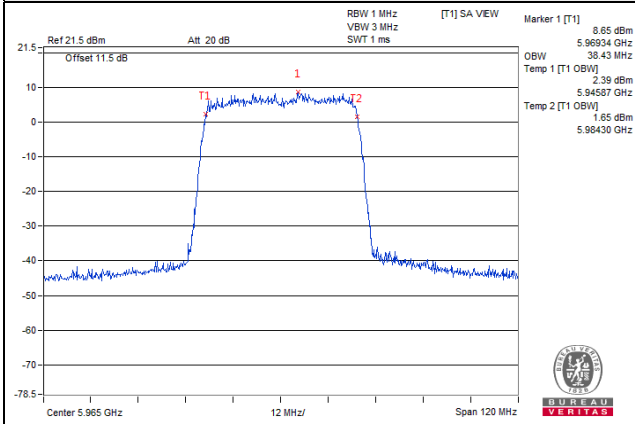

802.11ax (HE40)_Chain 0 / CH 99 (U-NII-6 Band)

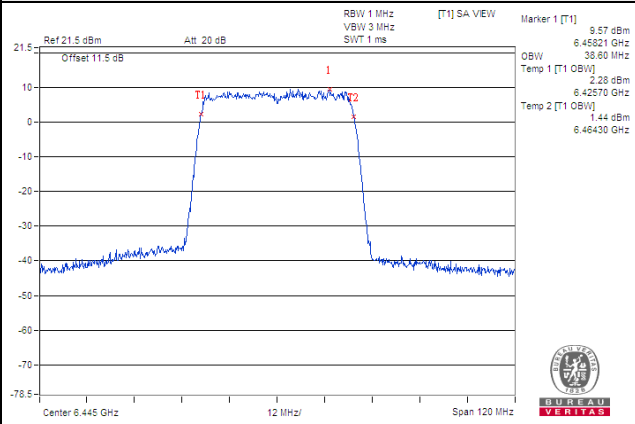

802.11ax (HE40)_Chain 0 / CH 187 (U-NII-7 Band)

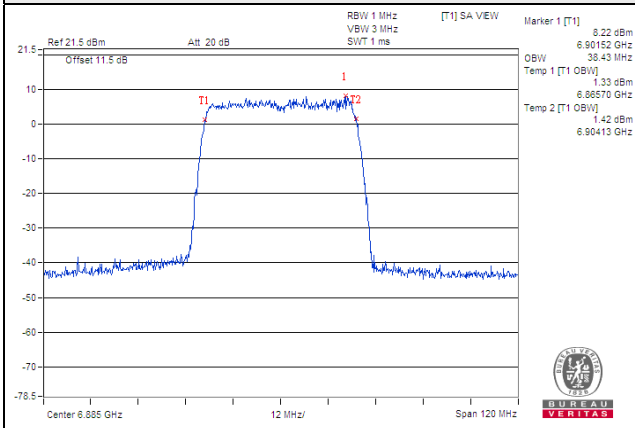

802.11ax (HE40)_Chain 0 / CH 211 (U-NII-8 Band)

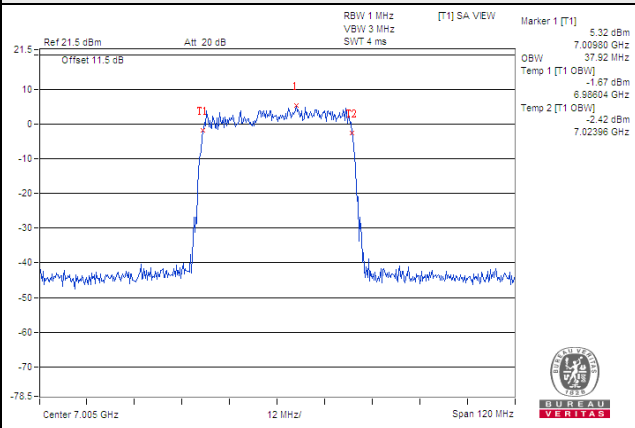

Spectrum Plot of Max. Value

802.11ax (HE80)_Chain 0 / CH 7 (U-NII-5 Band)

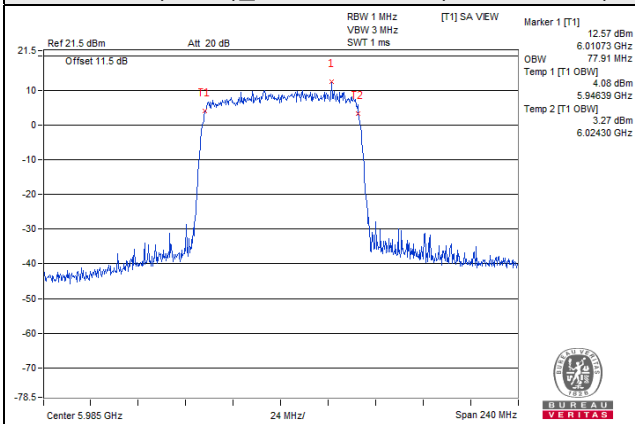

802.11ax (HE80)_Chain 0 / CH 103 (U-NII-6 Band)

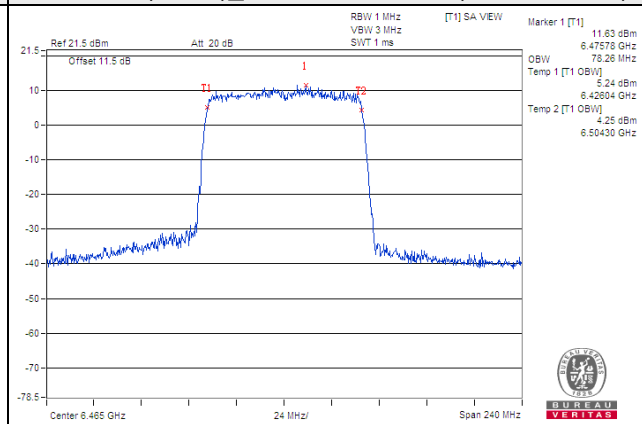

802.11ax (HE80)_Chain 0 / CH135 (U-NII-7 Band)

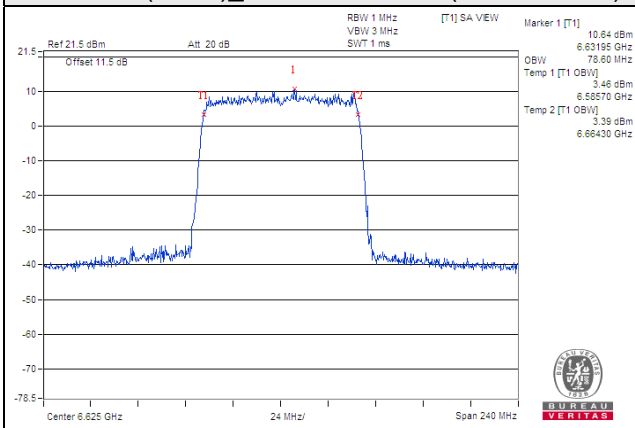

802.11ax (HE80)_Chain 0 / CH 199 (U-NII-8 Band)

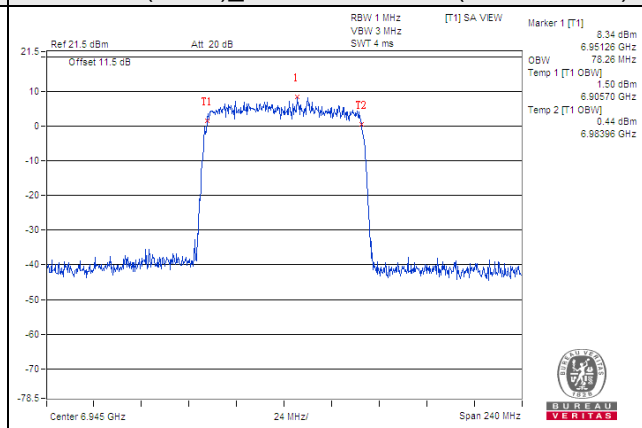

Spectrum Plot of Max. Value

802.11ax (HE160)_Chain 0 / CH 47 (U-NII-5 Band)

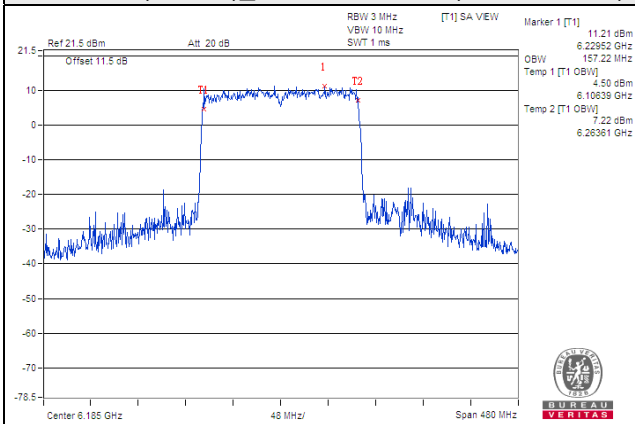

802.11ax (HE160)_Chain 0 / CH 111 (U-NII-6 Band)

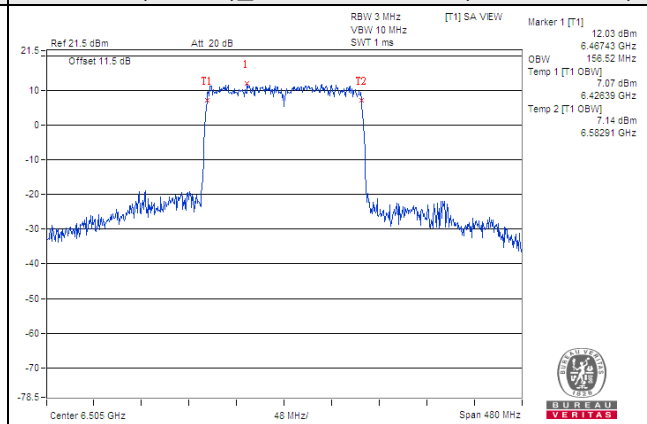

802.11ax (HE160)_Chain 0 / CH143 (U-NII-7 Band)

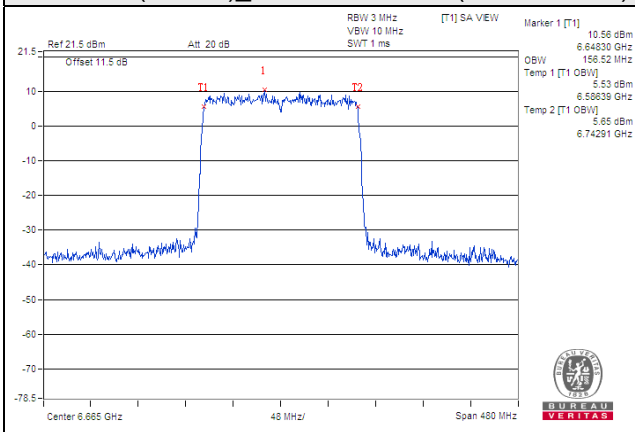

802.11ax (HE160)_Chain 0 / CH 207 (U-NII-8 Band)

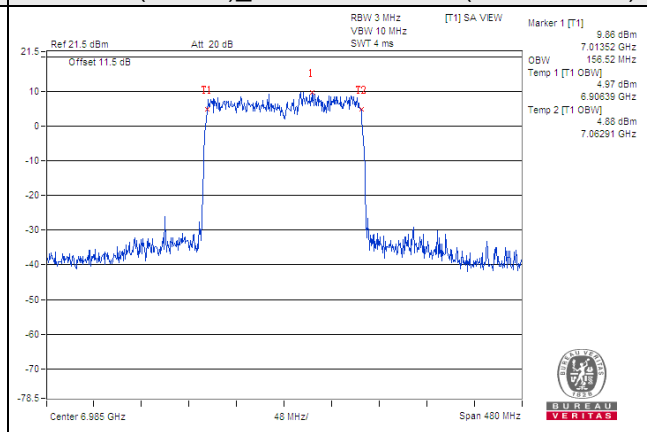

Nss 2

802.11ax (HE20)

Chan.	Freq. (MHz)	Occupied Bandwidth (MHz)		
		Chain 0	Chain 1	Limit (MHz)
1	5955	19.14	19.14	320
61	6255	19.22	19.22	320
93	6415	19.20	19.20	320
97	6435	19.14	19.14	320
105	6475	19.20	19.08	320
113	6515	19.08	19.20	320
117	6535	19.14	19.14	320
153	6715	19.08	19.08	320
181	6855	19.08	19.08	320
185	6875	19.14	19.14	320
213	7015	19.08	19.20	320
229	7095	19.08	19.20	320
233	7115	19.14	19.14	320

802.11ax (HE40)

Chan.	Freq. (MHz)	Occupied Bandwidth (MHz)		
		Chain 0	Chain 1	Limit (MHz)
3	5965	38.43	38.43	320
59	6245	37.92	37.68	320
91	6405	37.68	37.68	320
99	6445	38.43	37.92	320
107	6485	37.92	37.92	320
115	6525	37.92	37.92	320
123	6565	38.43	38.60	320
155	6725	37.92	37.92	320
179	6845	37.92	37.68	320
187	6885	38.60	38.60	320
211	7005	37.68	37.92	320
227	7085	38.16	37.68	320

802.11ax (HE80)

Chan.	Freq. (MHz)	Occupied Bandwidth (MHz)		
		Chain 0	Chain 1	Limit (MHz)
7	5985	78.26	78.26	320
55	6225	77.28	77.28	320
87	6385	77.76	76.80	320
103	6465	77.22	77.22	320
119	6545	76.80	77.28	320
135	6625	78.26	78.26	320
151	6705	78.60	78.60	320
167	6785	78.26	78.26	320
183	6865	77.28	77.28	320
199	6945	78.26	78.26	320
215	7025	77.28	76.80	320

802.11ax (HE160)

Chan.	Freq. (MHz)	Occupied Bandwidth (MHz)		
		Chain 0	Chain 1	Limit (MHz)
15	6025	155.83	155.83	320
47	6185	155.82	157.22	320
79	6345	156.48	156.52	320
111	6505	156.52	156.52	320
143	6665	156.52	155.82	320
175	6825	156.48	155.52	320
207	6985	156.52	156.52	320

Spectrum Plot of Max. Value

802.11ax (HE20)_Chain 0 / CH 61 (U-NII-5 Band)

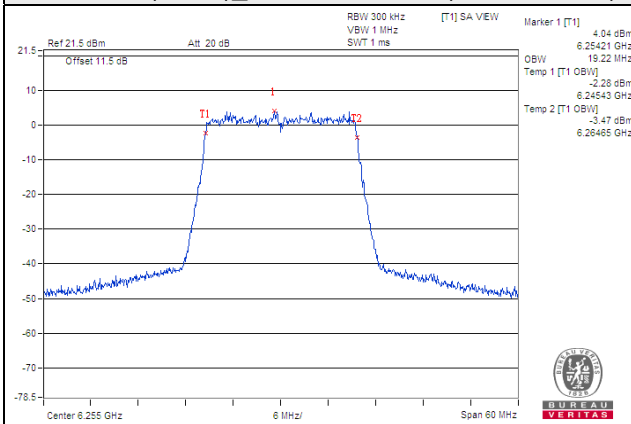

802.11ax (HE20)_Chain 0 / CH 105 (U-NII-6 Band)

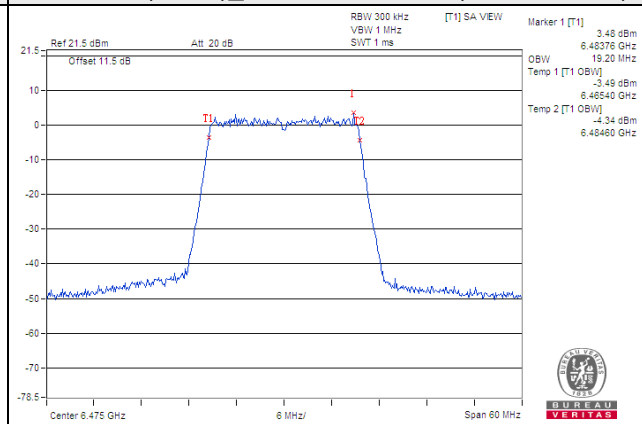

802.11ax (HE20)_Chain 0 / CH 117 (U-NII-7 Band)

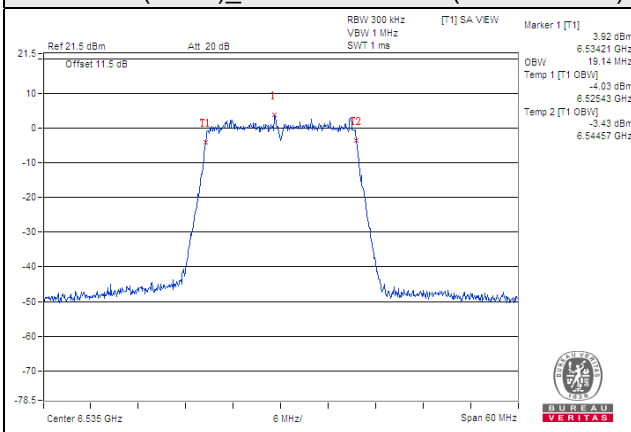

802.11ax (HE20)_Chain 1 / CH 213 (U-NII-8 Band)

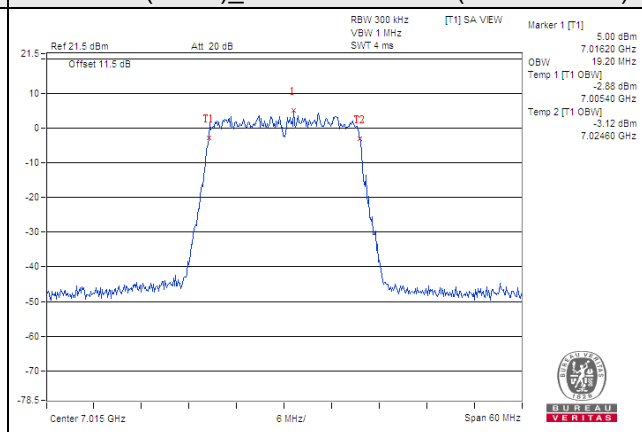

Spectrum Plot of Max. Value

802.11ax (HE40)_Chain 0 / CH 3 (U-NII-5 Band)

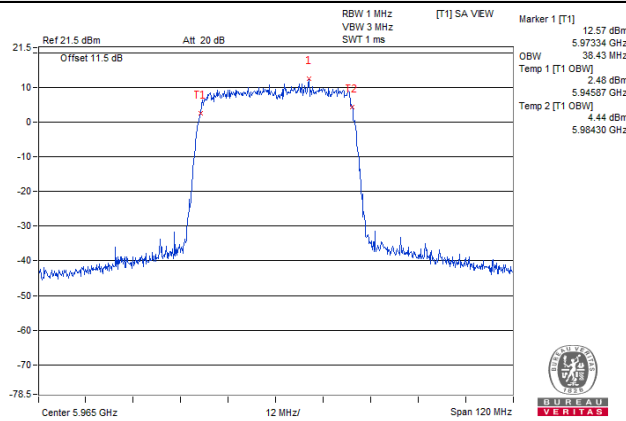

802.11ax (HE40)_Chain 0 / CH 99 (U-NII-6 Band)

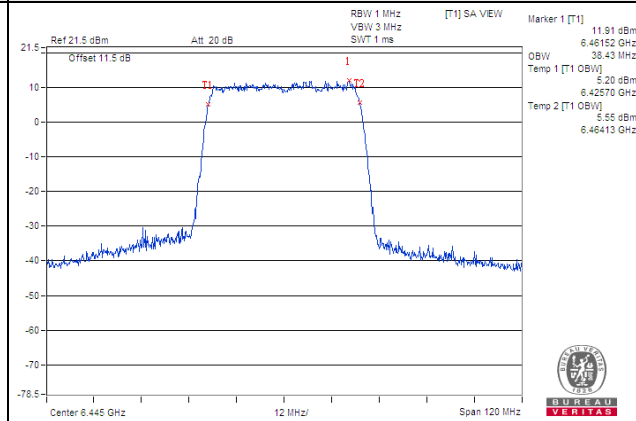

802.11ax (HE40)_Chain 1 / CH 123 (U-NII-7 Band)

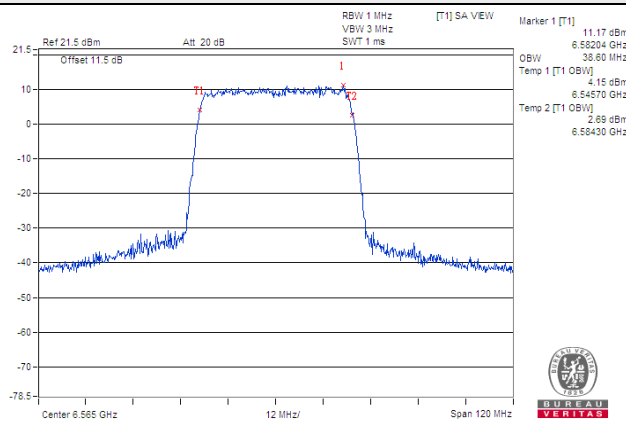

802.11ax (HE40)_Chain 0 / CH 227 (U-NII-8 Band)

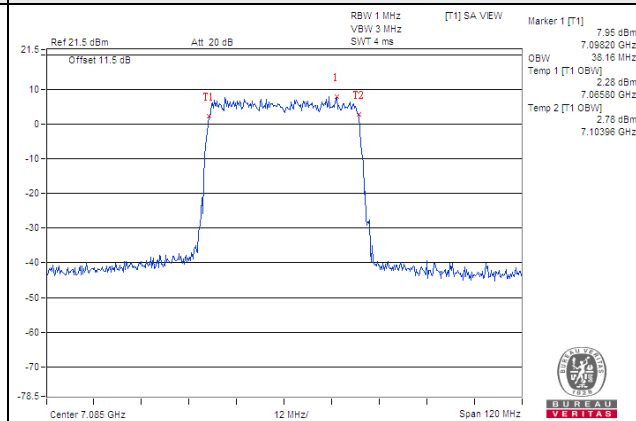

Spectrum Plot of Max. Value

802.11ax (HE80)_Chain 0 / CH 7 (U-NII-5 Band)

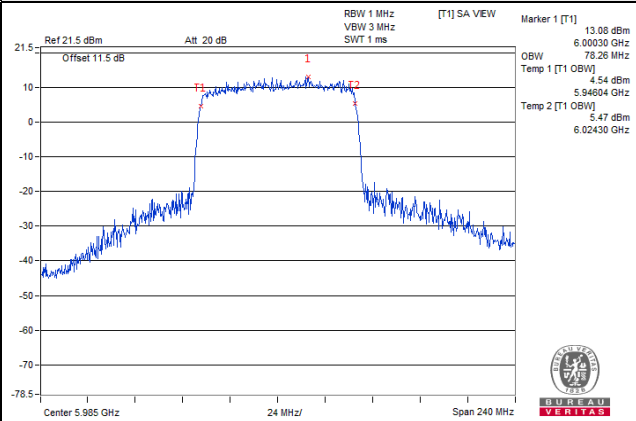

802.11ax (HE80)_Chain 1 / CH 119 (U-NII-6 Band)

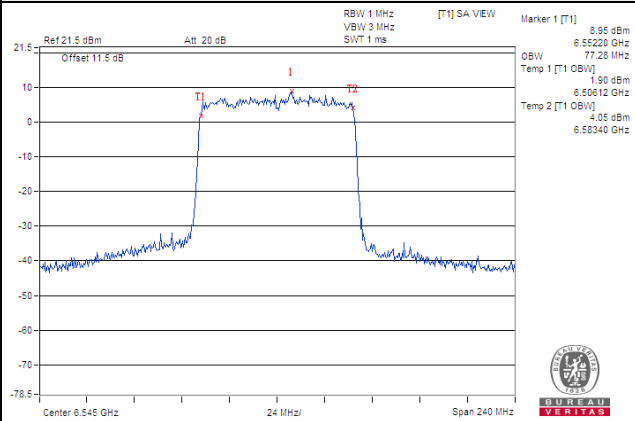

802.11ax (HE80)_Chain 0 / CH 151 (U-NII-7 Band)

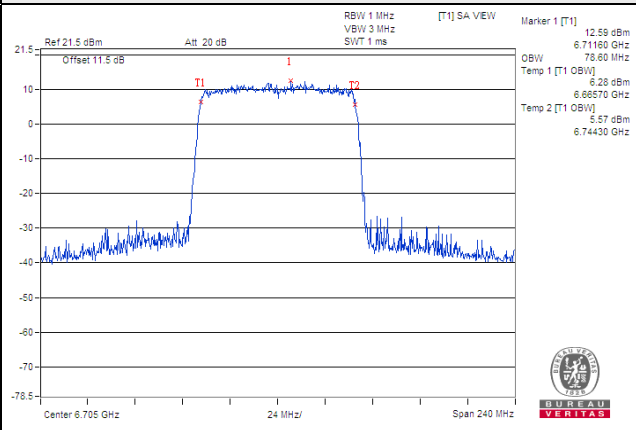

802.11ax (HE80)_Chain 0 / CH 199 (U-NII-8 Band)

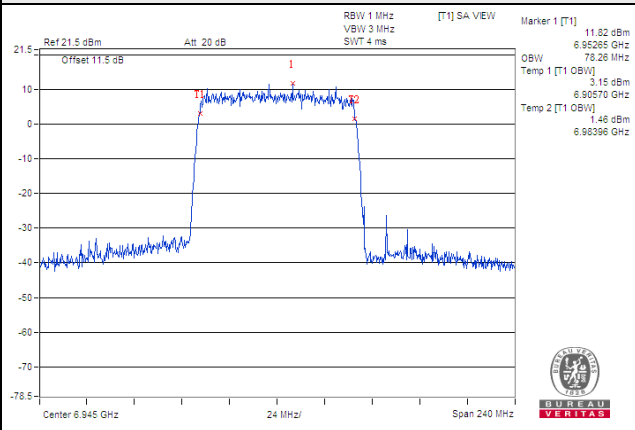

Spectrum Plot of Max. Value

802.11ax (HE160)_Chain 1 / CH 47 (U-NII-5 Band)

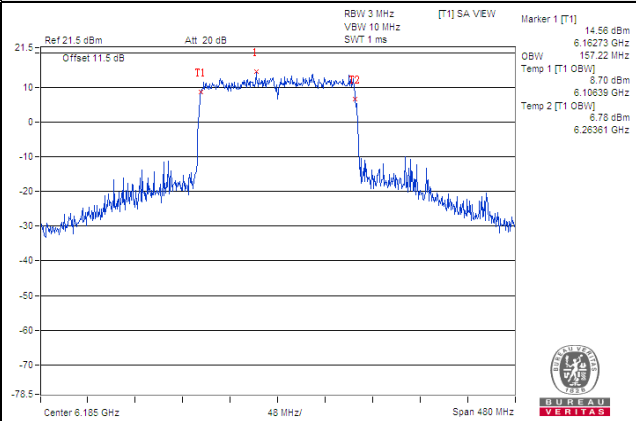

802.11ax (HE160)_Chain 0 / CH 111 (U-NII-6 Band)

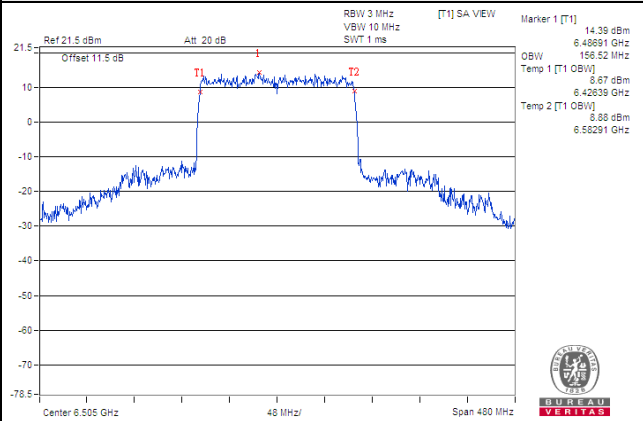

802.11ax (HE160)_Chain 0 / CH 143 (U-NII-7 Band)

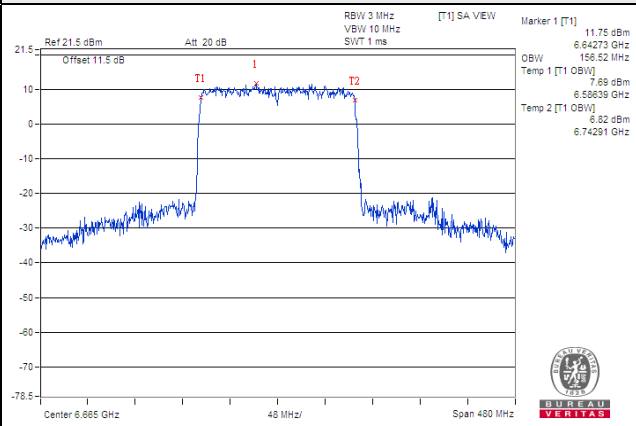

802.11ax (HE160)_Chain 0 / CH 207 (U-NII-8 Band)

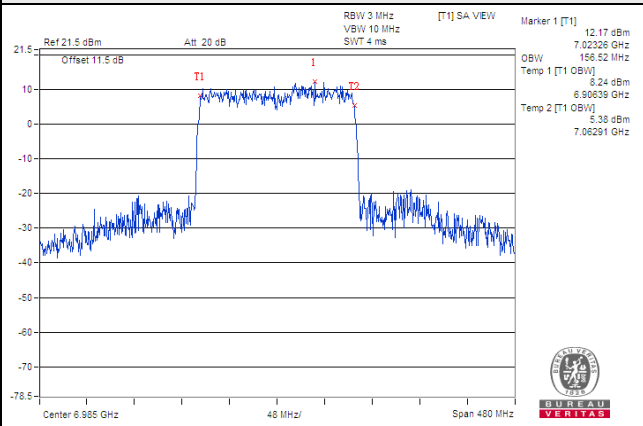

26dB Bandwidth

Nss 1

802.11a

Chan.	Freq. (MHz)	26dB Bandwidth (MHz)		
		Chain 0	Chain 1	Limit (MHz)
1	5955	21.66	21.58	320
61	6255	21.60	21.53	320
93	6415	21.71	21.65	320
97	6435	21.57	21.58	320
105	6475	21.61	21.64	320
113	6515	21.64	21.65	320
117	6535	21.60	21.59	320
153	6715	21.60	21.60	320
181	6855	21.67	21.71	320
185	6875	21.48	21.46	320
213	7015	21.62	21.67	320
229	7095	21.54	21.57	320
233	7115	21.87	21.92	320

802.11ax (HE20)

Chan.	Freq. (MHz)	26dB Bandwidth (MHz)		
		Chain 0	Chain 1	Limit (MHz)
1	5955	21.59	21.65	320
61	6255	21.65	21.64	320
93	6415	21.66	21.73	320
97	6435	21.72	21.62	320
105	6475	21.62	21.71	320
113	6515	21.69	21.71	320
117	6535	21.58	21.60	320
153	6715	21.62	21.86	320
181	6855	21.69	21.67	320
185	6875	21.67	21.58	320
213	7015	21.75	21.56	320
229	7095	21.61	21.63	320
233	7115	21.80	21.71	320

802.11ax (HE40)

Chan.	Freq. (MHz)	26dB Bandwidth (MHz)		
		Chain 0	Chain 1	Limit (MHz)
3	5965	41.43	41.37	320
59	6245	41.40	41.31	320
91	6405	41.24	41.30	320
99	6445	41.27	41.39	320
107	6485	41.48	41.57	320
115	6525	41.62	41.41	320
123	6565	41.40	41.38	320
155	6725	41.49	41.50	320
179	6845	41.57	41.61	320
187	6885	41.38	41.44	320
211	7005	41.23	41.39	320
227	7085	41.50	41.62	320

802.11ax (HE80)

Chan.	Freq. (MHz)	26dB Bandwidth (MHz)		
		Chain 0	Chain 1	Limit (MHz)
7	5985	82.31	82.29	320
55	6225	82.55	82.47	320
87	6385	82.57	82.58	320
103	6465	82.28	82.28	320
119	6545	82.48	82.46	320
135	6625	82.26	82.26	320
151	6705	82.29	82.21	320
167	6785	82.31	82.24	320
183	6865	82.45	82.51	320
199	6945	82.25	82.22	320
215	7025	82.35	82.28	320

802.11ax (HE160)

Chan.	Freq. (MHz)	26dB Bandwidth (MHz)		
		Chain 0	Chain 1	Limit (MHz)
15	6025	167.90	167.73	320
47	6185	167.02	166.86	320
79	6345	168.25	168.37	320
111	6505	167.05	166.89	320
143	6665	166.31	166.84	320
175	6825	167.21	166.94	320
207	6985	167.15	166.72	320

Spectrum Plot of Max. Value

802.11a_Chain 0 / CH 93 (U-NII-5 Band)

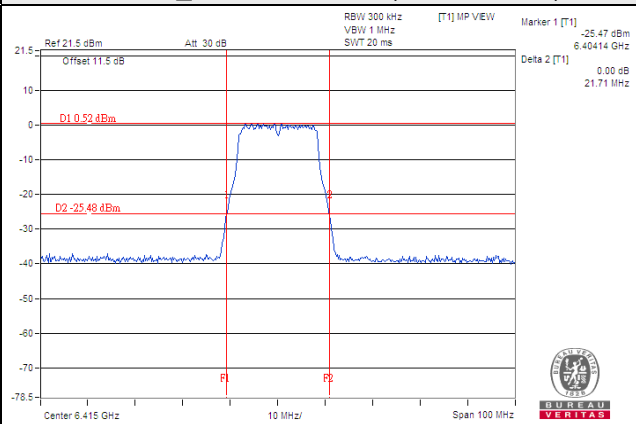

802.11a_Chain 1 / CH 113 (U-NII-6 Band)

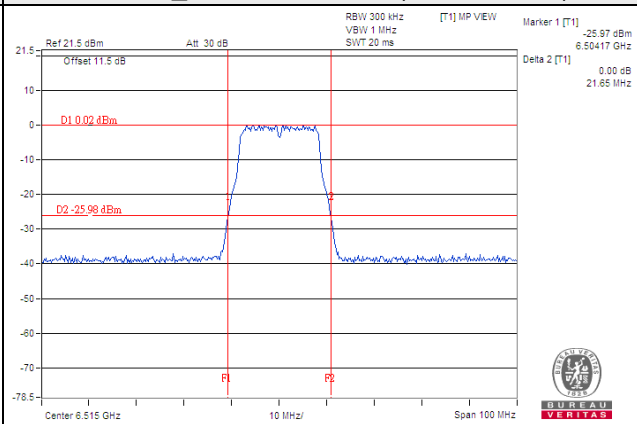

802.11a_Chain 1 / CH 181 (U-NII-7 Band)

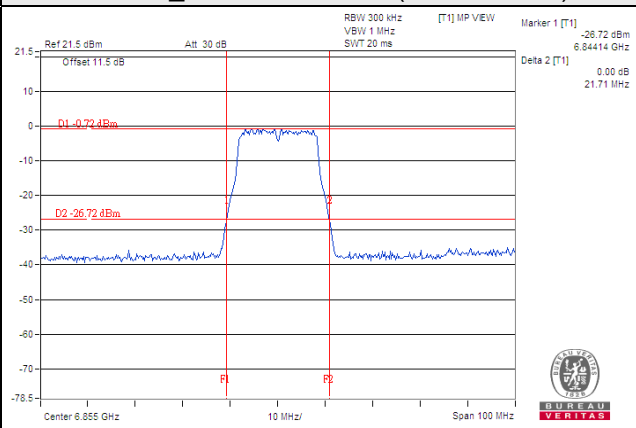

802.11a_Chain 1 / CH 233 (U-NII-8 Band)

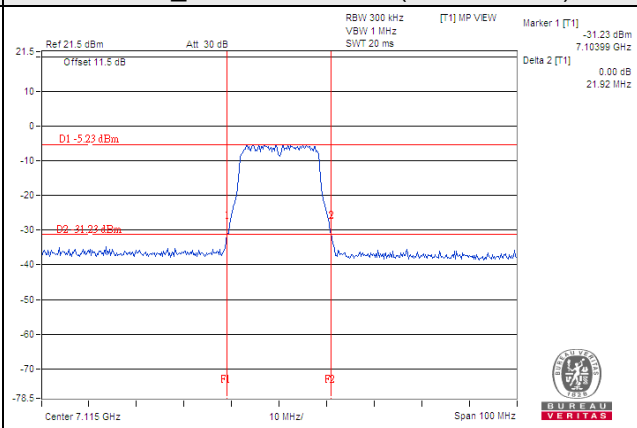

Spectrum Plot of Max. Value

802.11ax (HE20)_Chain 1 / CH 93 (U-NII-5 Band)

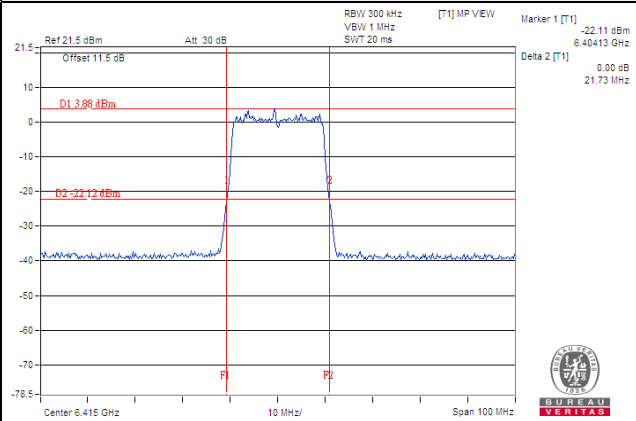

802.11ax (HE20)_Chain 0 / CH 97 (U-NII-6 Band)

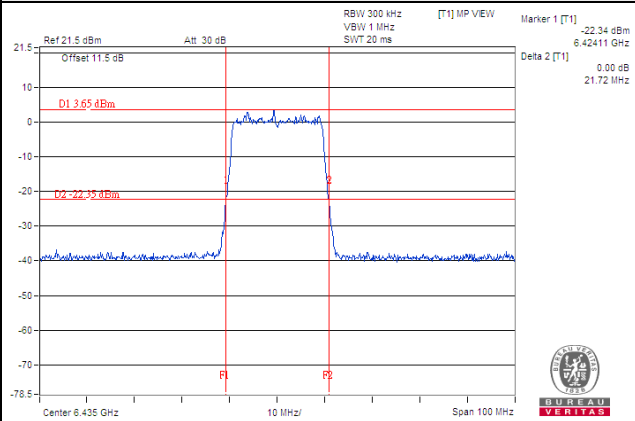

802.11ax (HE20)_Chain 1 / CH 153 (U-NII-7 Band)

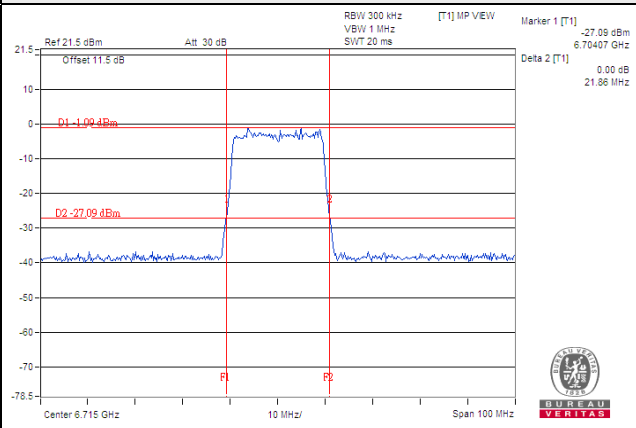

802.11ax (HE20)_Chain 0 / CH 233 (U-NII-8 Band)

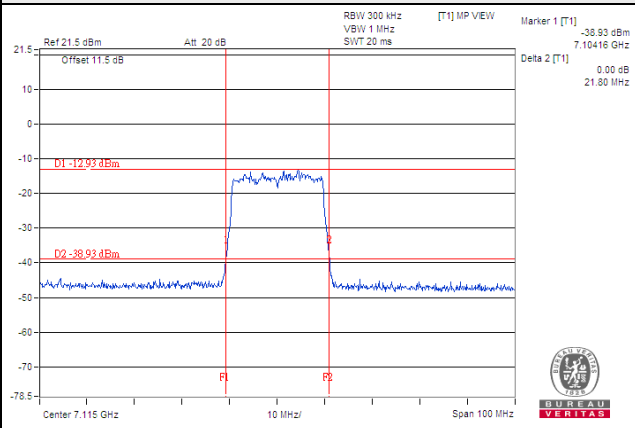

Spectrum Plot of Max. Value

802.11ax (HE40)_Chain 0 / CH 3 (U-NII-5 Band)

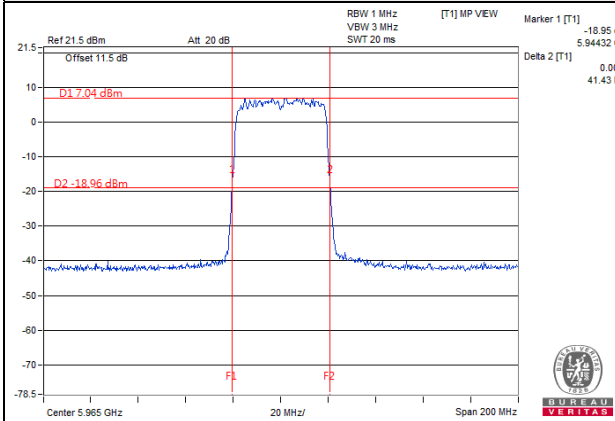

802.11ax (HE40)_Chain 0 / CH 115 (U-NII-6 Band)

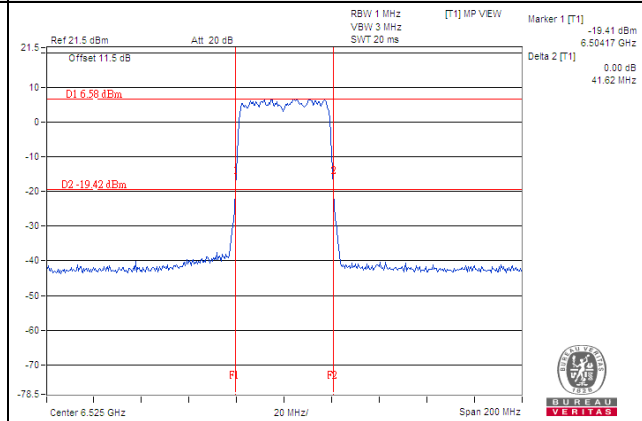

802.11ax (HE40)_Chain 1 / CH 179 (U-NII-7 Band)

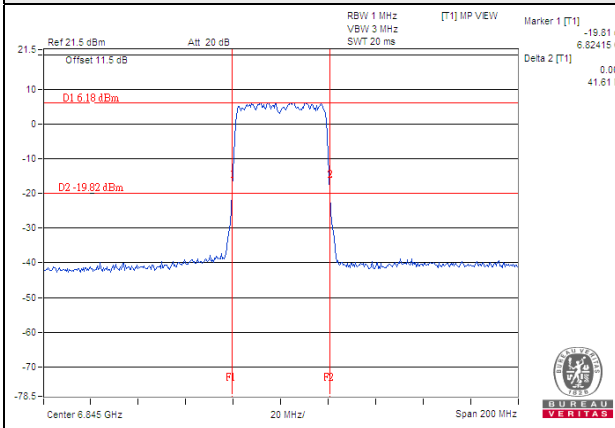

802.11ax (HE40)_Chain 1 / CH 227 (U-NII-8 Band)

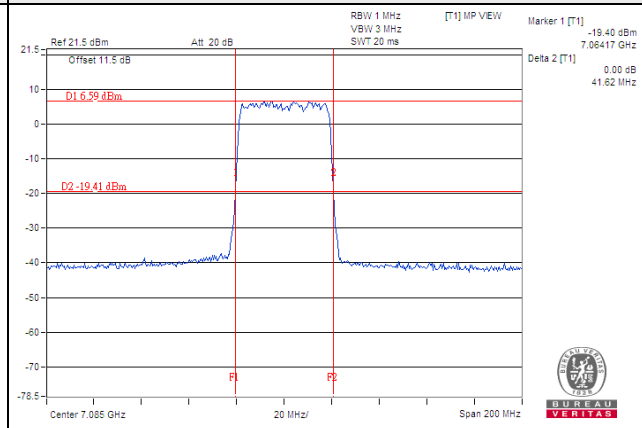

Spectrum Plot of Max. Value

802.11ax (HE80)_Chain 1 / CH 87 (U-NII-5 Band)

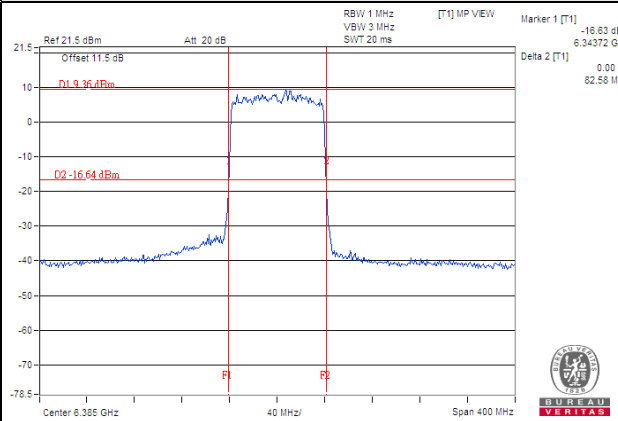

802.11ax (HE80)_Chain 0 / CH 119 (U-NII-6 Band)

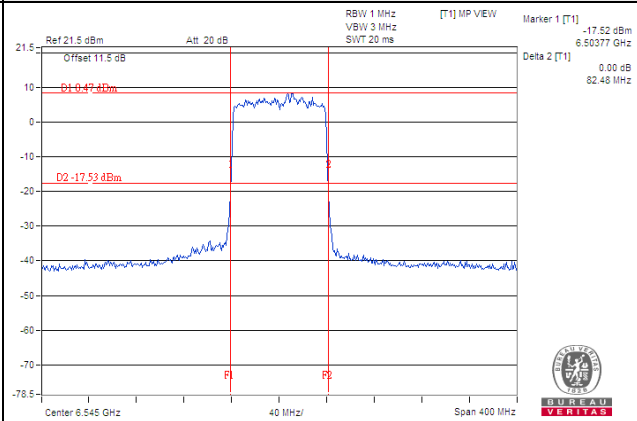

802.11ax (HE80)_Chain 1 / CH 183 (U-NII-7 Band)

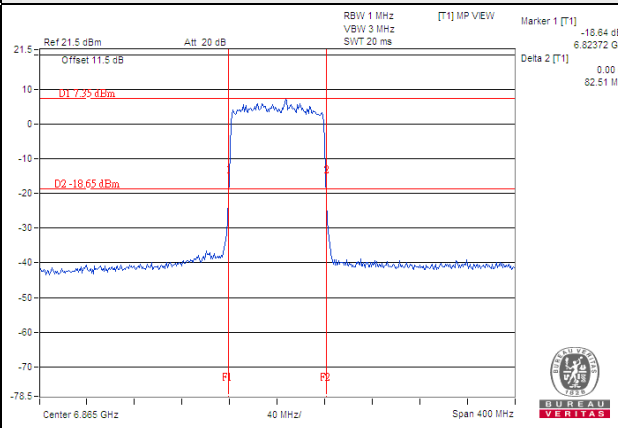

802.11ax (HE80)_Chain 0 / CH 215 (U-NII-8 Band)

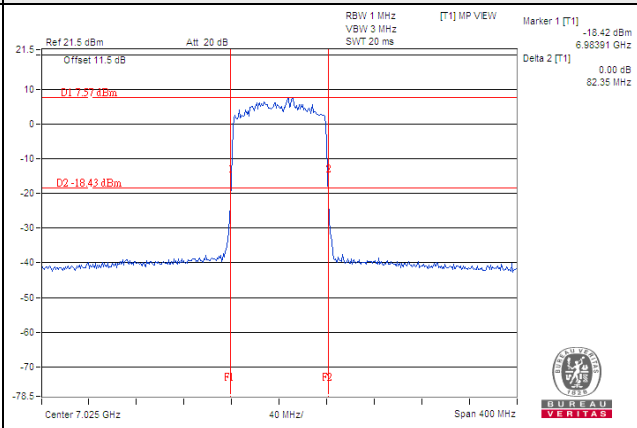

Spectrum Plot of Max. Value

802.11ax (HE160)_Chain 1 / CH 79 (U-NII-5 Band)

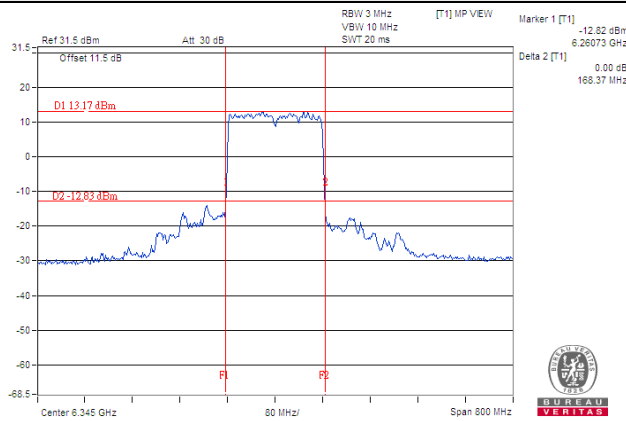

802.11ax (HE160)_Chain 0 / CH 111 (U-NII-6 Band)

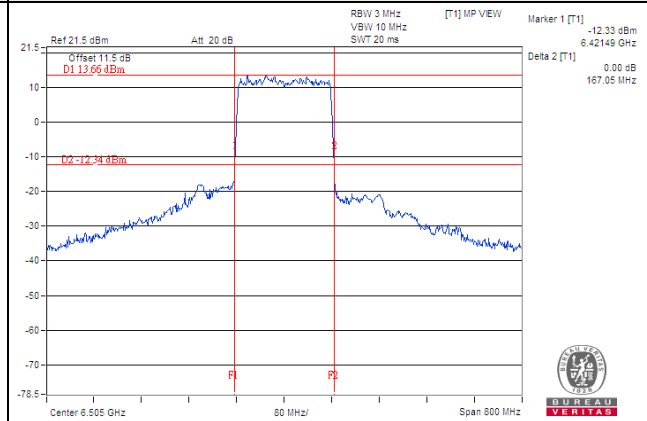

802.11ax (HE160)_Chain 0 / CH 175 (U-NII-7 Band)

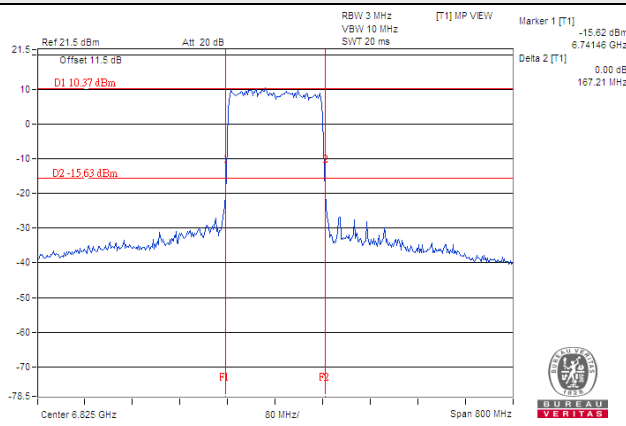

802.11ax (HE160)_Chain 0 / CH 207 (U-NII-8 Band)

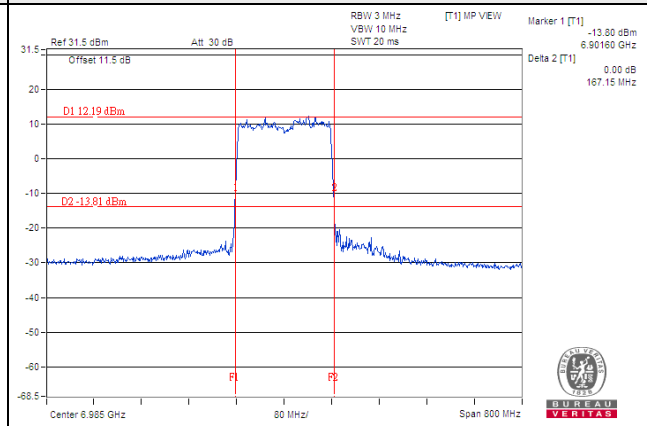

Nss 2

802.11ax (HE20)

Chan.	Freq. (MHz)	26dB Bandwidth (MHz)		
		Chain 0	Chain 1	Limit (MHz)
1	5955	21.67	21.57	320
61	6255	21.53	21.60	320
93	6415	21.73	21.59	320
97	6435	21.62	21.54	320
105	6475	21.67	21.65	320
113	6515	21.66	21.68	320
117	6535	21.58	21.56	320
153	6715	21.61	21.76	320
181	6855	21.61	21.63	320
185	6875	21.64	21.74	320
213	7015	21.84	21.79	320
229	7095	21.75	21.98	320
233	7115	21.86	21.88	320

802.11ax (HE40)

Chan.	Freq. (MHz)	26dB Bandwidth (MHz)		
		Chain 0	Chain 1	Limit (MHz)
3	5965	41.25	41.30	320
59	6245	41.31	41.20	320
91	6405	41.06	41.25	320
99	6445	41.46	41.44	320
107	6485	41.59	41.45	320
115	6525	41.47	41.49	320
123	6565	41.46	41.39	320
155	6725	41.65	41.46	320
179	6845	41.61	41.52	320
187	6885	41.32	41.51	320
211	7005	41.48	41.52	320
227	7085	41.57	41.47	320

802.11ax (HE80)

Chan.	Freq. (MHz)	26dB Bandwidth (MHz)		
		Chain 0	Chain 1	Limit (MHz)
7	5985	82.37	82.27	320
55	6225	82.46	82.52	320
87	6385	82.57	82.59	320
103	6465	82.23	82.30	320
119	6545	82.48	82.52	320
135	6625	82.21	82.22	320
151	6705	82.27	82.19	320
167	6785	82.24	82.21	320
183	6865	82.58	82.45	320
199	6945	82.25	82.22	320
215	7025	82.23	82.38	320

802.11ax (HE160)

Chan.	Freq. (MHz)	26dB Bandwidth (MHz)		
		Chain 0	Chain 1	Limit (MHz)
15	6025	167.93	167.74	320
47	6185	268.90	269.29	320
79	6345	289.05	288.81	320
111	6505	167.62	173.13	320
143	6665	166.81	166.61	320
175	6825	166.97	166.66	320
207	6985	166.76	166.93	320

Spectrum Plot of Max. Value

802.11ax (HE20)_Chain 0 / CH 93 (U-NII-5 Band)

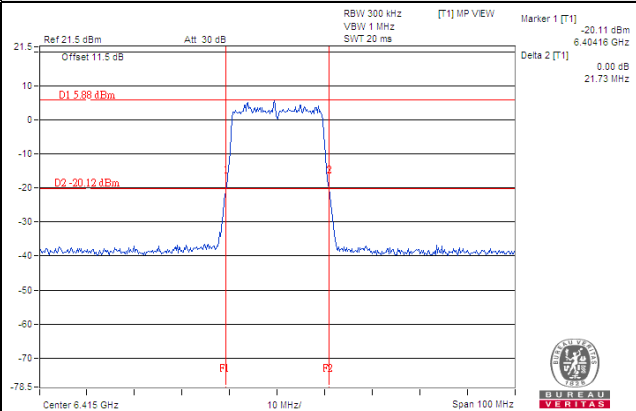

802.11ax (HE20)_Chain 1 / CH 113 (U-NII-6 Band)

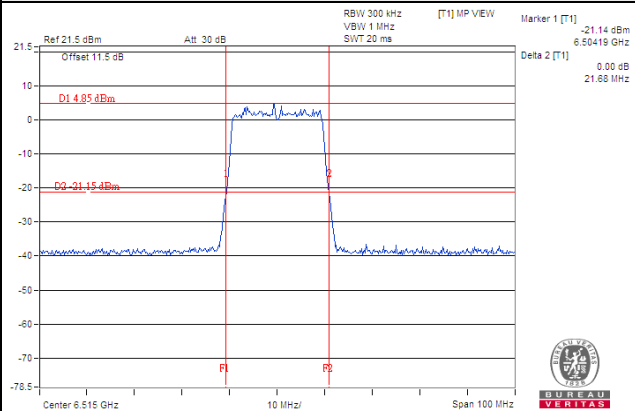

802.11ax (HE20)_Chain 1 / CH153 (U-NII-7 Band)

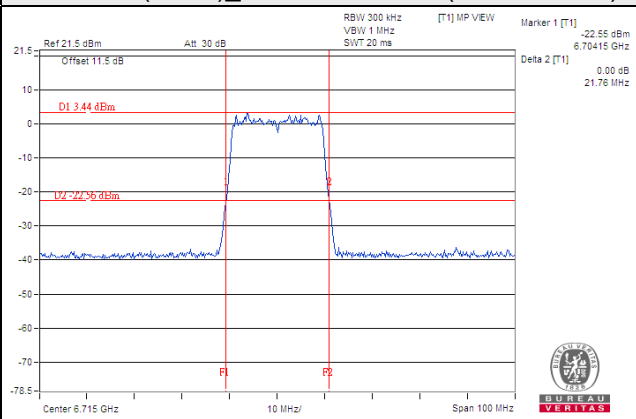

802.11ax (HE20)_Chain 1 / CH 229 (U-NII-8 Band)

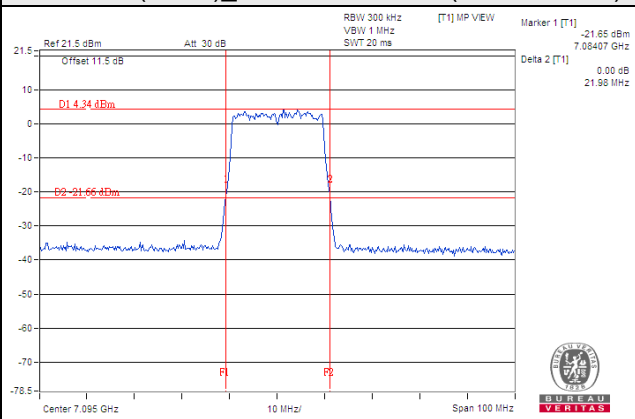

Spectrum Plot of Max. Value

802.11ax (HE40)_Chain 0 / CH 59 (U-NII-5 Band)

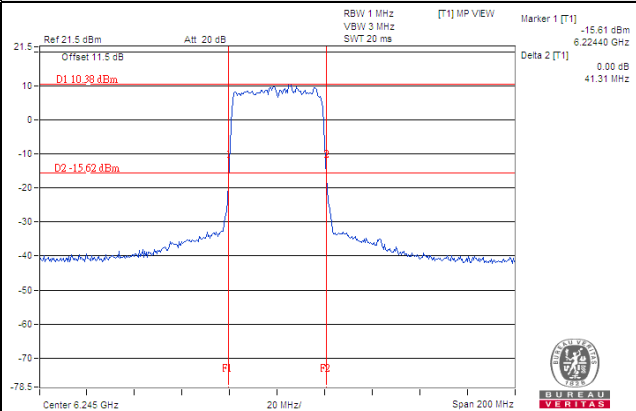

802.11ax (HE40)_Chain 0 / CH 107 (U-NII-6 Band)

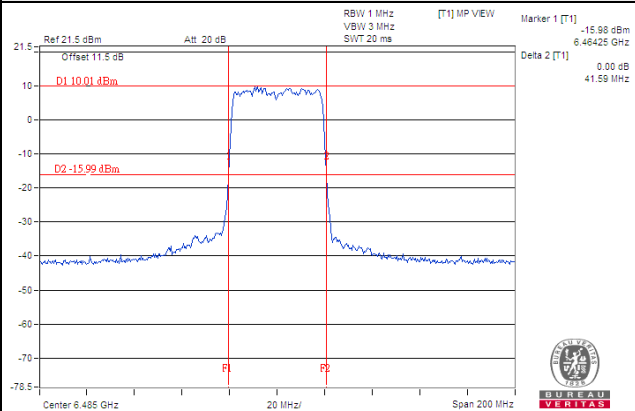

802.11ax (HE40)_Chain 0 / CH 155 (U-NII-7 Band)

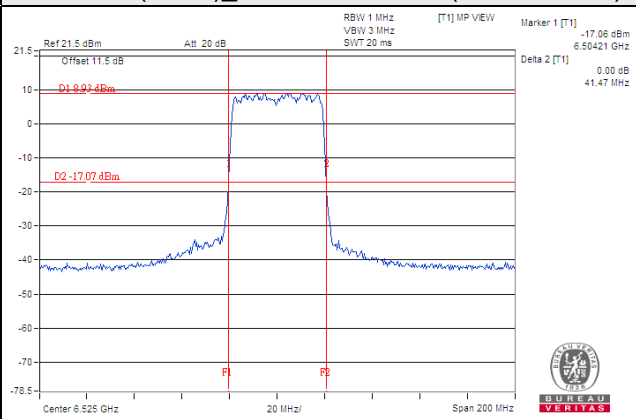

802.11ax (HE40)_Chain 0 / CH 227 (U-NII-8 Band)

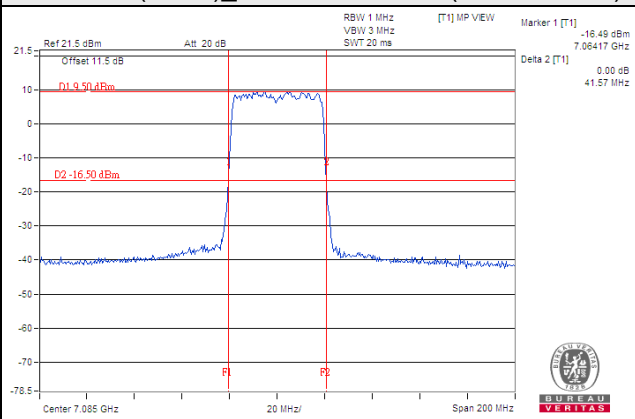

Spectrum Plot of Max. Value

802.11ax (HE80)_Chain 1 / CH 87 (U-NII-5 Band)

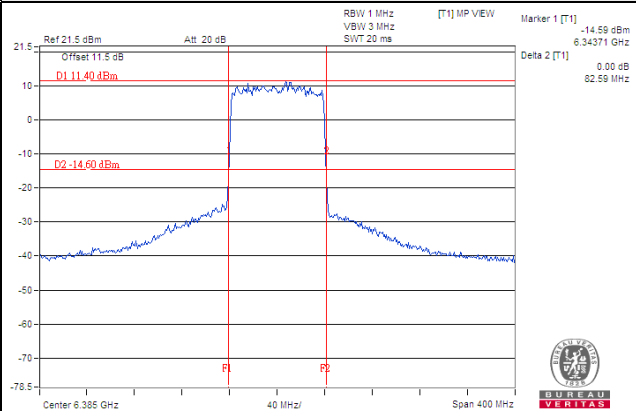

802.11ax (HE80)_Chain 1 / CH 119 (U-NII-6 Band)

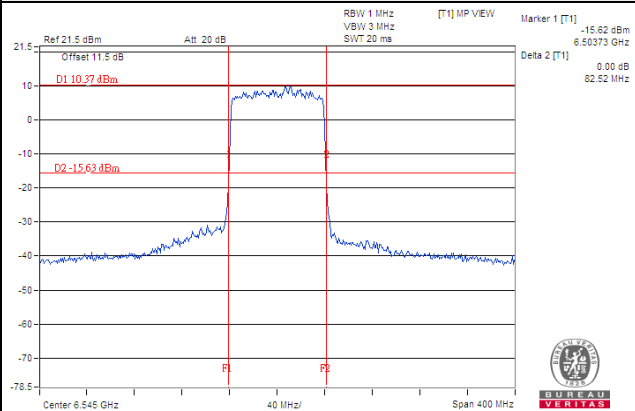

802.11ax (HE80)_Chain 0 / CH 183 (U-NII-7 Band)

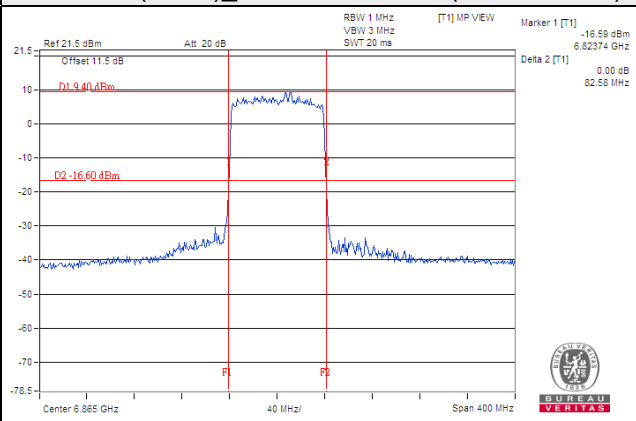

802.11ax (HE80)_Chain 1 / CH 215 (U-NII-8 Band)

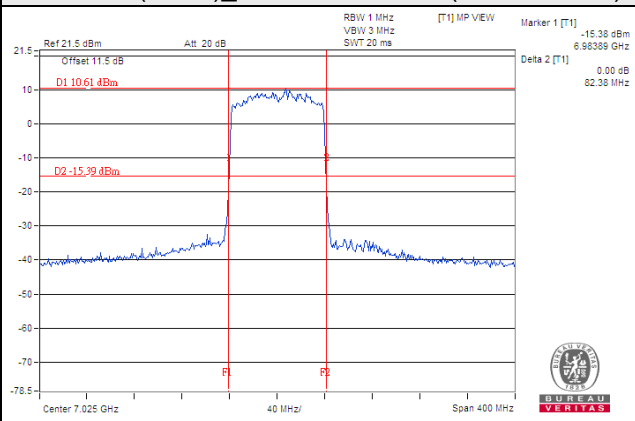

Spectrum Plot of Max. Value

802.11ax (HE160)_Chain 0 / CH 79 (U-NII-5 Band)

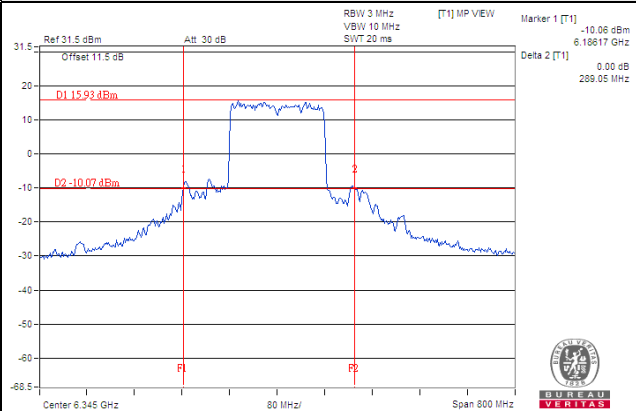

802.11ax (HE160)_Chain 1 / CH 111 (U-NII-6 Band)

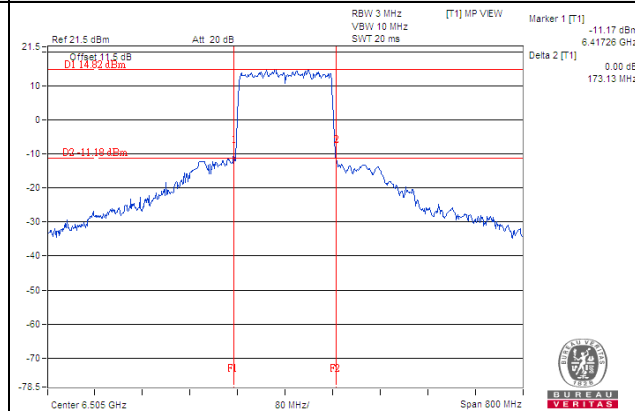

802.11ax (HE160)_Chain 0 / CH 175 (U-NII-7 Band)

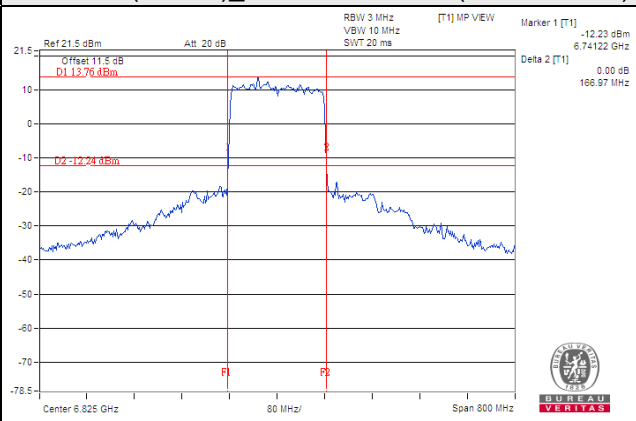

802.11ax (HE160)_Chain 1 / CH 207 (U-NII-8 Band)

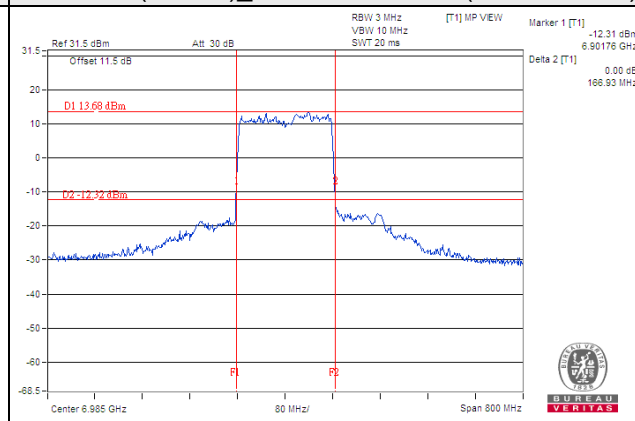

4.6 Peak Power Spectral Density Measurement

4.6.1 Limits of Peak Power Spectral Density Measurement

Operation Band	EUT Category	Limit
		Peak Power Density (EIRP)
U-NII-5 U-NII-6 U-NII-7 U-NII-8	Low Power - Indoor AP (Master)	5 dBm/MHz

4.6.2 Test Setup

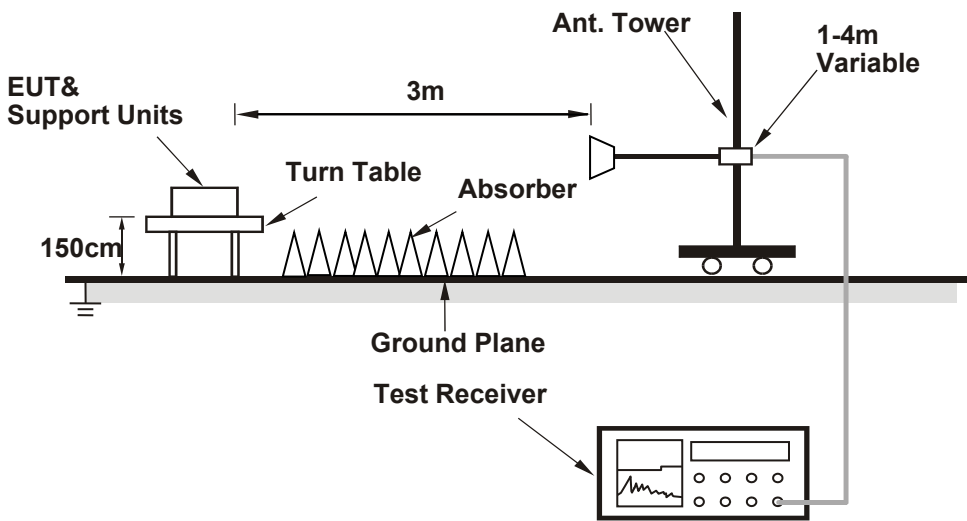

4.6.3 Test Instruments

Refer to section 4.1.2 to get information of above instrument.

4.6.4 Test Procedures

- a. The EUT was placed on the top of a rotating table 1.5 meters above the ground at 3 meter chamber room for test. The table was rotated 360 degrees to determine the position of the highest radiation.
- b. The EUT was set 3 meters away from the interference-receiving antenna, which was mounted on the top of a variable-height antenna tower.
- c. The height of antenna is varied from one meter to four meters above the ground to determine the maximum value of the field strength. Both horizontal and vertical polarizations of the antenna are set to make the measurement.
- d. Perform a field strength measurement and record the worse read value, is the field strength value via a spectrum reading obtained corrected for antenna factor, cable loss and pre-amplifier factor and then mathematically convert the measured field strength level to EIRP level.
- e. Follow ANSI 63.10 and KDB 412172 D01 v01r01, $EIRP \text{ Value (dBm)} = \text{Field Strength Value (dB}\mu\text{V/m)} + \text{Correction Factor @ 3m}$.
- f. $\text{Correction Factor (dB) @ 3m} = 20\log(D) - 104.7$; where D is the measurement distance @3m=-95.15dB

Note: Spectrum analyzer setting as below:

Method SA-2

1. Set span to encompass the entire emission bandwidth (EBW) of the signal.
2. Set RBW = 1 MHz, Set VBW \geq 3 MHz, Detector = RMS
3. Sweep time = auto, trigger set to "free run" .
4. Trace average at least 100 traces in power averaging mode.
5. Record the max value and add $10 \log (1/\text{duty cycle})$

4.6.5 Deviation from Test Standard

No deviation.

4.6.6 EUT Operating Conditions

Same as 4.3.6.

4.6.7 Test Results

Nss 1

Non-Beamforming Mode

802.11a

Chan.	Chan. Freq. (MHz)	Field Strength (dBuV/m)	Correction Factor (dB)	Duty Factor (dB)	EIRP PSD (dBm/MHz)	EIRP PSD Limit (dBm/MHz)	Pass / Fail
1	5955	100.06	-95.15	0.26	4.91	5.00	Pass
61	6255	100.03	-95.15	0.26	4.88	5.00	Pass
93	6415	99.99	-95.15	0.26	4.84	5.00	Pass
97	6435	100.09	-95.15	0.26	4.94	5.00	Pass
105	6475	99.84	-95.15	0.26	4.69	5.00	Pass
113	6515	99.77	-95.15	0.26	4.62	5.00	Pass
117	6535	100.07	-95.15	0.26	4.92	5.00	Pass
153	6715	99.94	-95.15	0.26	4.79	5.00	Pass
181	6855	99.81	-95.15	0.26	4.66	5.00	Pass
185	6875	100.10	-95.15	0.26	4.95	5.00	Pass
213	7015	100.05	-95.15	0.26	4.90	5.00	Pass
229	7095	100.08	-95.15	0.26	4.93	5.00	Pass
233	7115	95.10	-95.15	0.26	-0.05	5.00	Pass

*The duty factor is included in the field strength.

Beamforming Mode

802.11ax (HE20)

Chan.	Chan. Freq. (MHz)	Field Strength (dBuV/m)	Correction Factor (dB)	Duty Factor (dB)	EIRP PSD (dBm/MHz)	EIRP PSD Limit (dBm/MHz)	Pass / Fail
1	5955	99.90	-95.15	0.11	4.75	5.00	Pass
61	6255	99.97	-95.15	0.11	4.82	5.00	Pass
93	6415	99.85	-95.15	0.11	4.70	5.00	Pass
97	6435	99.78	-95.15	0.11	4.63	5.00	Pass
105	6475	99.67	-95.15	0.11	4.52	5.00	Pass
113	6515	99.64	-95.15	0.11	4.49	5.00	Pass
117	6535	99.99	-95.15	0.11	4.84	5.00	Pass
153	6715	99.98	-95.15	0.11	4.83	5.00	Pass
181	6855	99.69	-95.15	0.11	4.54	5.00	Pass
185	6875	99.92	-95.15	0.11	4.77	5.00	Pass
213	7015	99.73	-95.15	0.11	4.58	5.00	Pass
229	7095	99.84	-95.15	0.11	4.69	5.00	Pass
233	7115	81.48	-95.15	0.11	-13.67	5.00	Pass

*The duty factor is included in the field strength.

Beamforming Mode

802.11ax (HE40)

Chan.	Chan. Freq. (MHz)	Field Strength (dBuV/m)	Correction Factor (dB)	Duty Factor (dB)	EIRP PSD (dBm/MHz)	EIRP PSD Limit (dBm/MHz)	Pass / Fail
3	5965	99.81	-95.15	0.12	4.66	5.00	Pass
59	6245	99.71	-95.15	0.12	4.56	5.00	Pass
91	6405	99.86	-95.15	0.12	4.71	5.00	Pass
99	6445	99.95	-95.15	0.12	4.80	5.00	Pass
107	6485	99.82	-95.15	0.12	4.67	5.00	Pass
115	6525	99.71	-95.15	0.12	4.56	5.00	Pass
123	6565	99.86	-95.15	0.12	4.71	5.00	Pass
155	6725	99.77	-95.15	0.12	4.62	5.00	Pass
179	6845	99.95	-95.15	0.12	4.80	5.00	Pass
187	6885	100.07	-95.15	0.12	4.92	5.00	Pass
211	7005	99.77	-95.15	0.12	4.62	5.00	Pass
227	7085	99.74	-95.15	0.12	4.59	5.00	Pass

*The duty factor is included in the field strength.

Beamforming Mode

802.11ax (HE80)

Chan.	Chan. Freq. (MHz)	Field Strength (dBuV/m)	Correction Factor (dB)	Duty Factor (dB)	EIRP PSD (dBm/MHz)	EIRP PSD Limit (dBm/MHz)	Pass / Fail
7	5985	99.96	-95.15	0.2	4.81	5.00	Pass
55	6225	99.78	-95.15	0.2	4.63	5.00	Pass
87	6385	99.90	-95.15	0.2	4.75	5.00	Pass
103	6465	99.75	-95.15	0.2	4.60	5.00	Pass
119	6545	100.03	-95.15	0.2	4.88	5.00	Pass
135	6625	99.98	-95.15	0.2	4.83	5.00	Pass
151	6705	99.74	-95.15	0.2	4.59	5.00	Pass
167	6785	100.03	-95.15	0.2	4.88	5.00	Pass
183	6865	99.80	-95.15	0.2	4.65	5.00	Pass
199	6945	99.88	-95.15	0.2	4.73	5.00	Pass
215	7025	100.00	-95.15	0.2	4.85	5.00	Pass

*The duty factor is included in the field strength.

Beamforming Mode

802.11ax (HE160)

Chan.	Chan. Freq. (MHz)	Field Strength (dBuV/m)	Correction Factor (dB)	Duty Factor (dB)	EIRP PSD (dBm/MHz)	EIRP PSD Limit (dBm/MHz)	Pass / Fail
15	6025	99.91	-95.15	0.16	4.76	5.00	Pass
47	6185	99.95	-95.15	0.16	4.80	5.00	Pass
79	6345	99.72	-95.15	0.16	4.57	5.00	Pass
111	6505	99.69	-95.15	0.16	4.54	5.00	Pass
143	6665	99.80	-95.15	0.16	4.65	5.00	Pass
175	6825	99.77	-95.15	0.16	4.62	5.00	Pass
207	6985	99.80	-95.15	0.16	4.65	5.00	Pass

*The duty factor is included in the field strength.

Nss 2

Beamforming Mode

802.11ax (HE20)

Chan.	Chan. Freq. (MHz)	Field Strength (dBuV/m)	Correction Factor (dB)	Duty Factor (dB)	EIRP PSD (dBm/MHz)	EIRP PSD Limit (dBm/MHz)	Pass / Fail
1	5955	99.81	-95.15	0.11	4.66	5.00	Pass
61	6255	99.80	-95.15	0.11	4.65	5.00	Pass
93	6415	99.87	-95.15	0.11	4.72	5.00	Pass
97	6435	99.60	-95.15	0.11	4.45	5.00	Pass
105	6475	99.82	-95.15	0.11	4.67	5.00	Pass
113	6515	99.81	-95.15	0.11	4.66	5.00	Pass
117	6535	99.59	-95.15	0.11	4.44	5.00	Pass
153	6715	100.06	-95.15	0.11	4.91	5.00	Pass
181	6855	99.62	-95.15	0.11	4.47	5.00	Pass
185	6875	100.03	-95.15	0.11	4.88	5.00	Pass
213	7015	99.87	-95.15	0.11	4.72	5.00	Pass
229	7095	100.01	-95.15	0.11	4.86	5.00	Pass
233	7115	79.79	-95.15	0.11	-15.36	5.00	Pass

*The duty factor is included in the field strength.

Beamforming Mode

802.11ax (HE40)

Chan.	Chan. Freq. (MHz)	Field Strength (dBuV/m)	Correction Factor (dB)	Duty Factor (dB)	EIRP PSD (dBm/MHz)	EIRP PSD Limit (dBm/MHz)	Pass / Fail
3	5965	99.79	-95.15	0.1	4.64	5.00	Pass
59	6245	99.82	-95.15	0.1	4.67	5.00	Pass
91	6405	99.72	-95.15	0.1	4.57	5.00	Pass
99	6445	99.75	-95.15	0.1	4.60	5.00	Pass
107	6485	99.85	-95.15	0.1	4.70	5.00	Pass
115	6525	99.87	-95.15	0.1	4.72	5.00	Pass
123	6565	99.84	-95.15	0.1	4.69	5.00	Pass
155	6725	99.81	-95.15	0.1	4.66	5.00	Pass
179	6845	99.87	-95.15	0.1	4.72	5.00	Pass
187	6885	99.96	-95.15	0.1	4.81	5.00	Pass
211	7005	99.75	-95.15	0.1	4.60	5.00	Pass
227	7085	99.82	-95.15	0.1	4.67	5.00	Pass

*The duty factor is included in the field strength.

Beamforming Mode

802.11ax (HE80)

Chan.	Chan. Freq. (MHz)	Field Strength (dBuV/m)	Correction Factor (dB)	Duty Factor (dB)	EIRP PSD (dBm/MHz)	EIRP PSD Limit (dBm/MHz)	Pass / Fail
7	5985	99.83	-95.15	0.2	4.68	5.00	Pass
55	6225	99.85	-95.15	0.2	4.70	5.00	Pass
87	6385	99.83	-95.15	0.2	4.68	5.00	Pass
103	6465	99.87	-95.15	0.2	4.72	5.00	Pass
119	6545	99.95	-95.15	0.2	4.80	5.00	Pass
135	6625	99.98	-95.15	0.2	4.83	5.00	Pass
151	6705	99.88	-95.15	0.2	4.73	5.00	Pass
167	6785	100.00	-95.15	0.2	4.85	5.00	Pass
183	6865	99.75	-95.15	0.2	4.60	5.00	Pass
199	6945	99.83	-95.15	0.2	4.68	5.00	Pass
215	7025	100.04	-95.15	0.2	4.89	5.00	Pass

*The duty factor is included in the field strength.

Beamforming Mode

802.11ax (HE160)

Chan.	Chan. Freq. (MHz)	Field Strength (dBuV/m)	Correction Factor (dB)	Duty Factor (dB)	EIRP PSD (dBm/MHz)	EIRP PSD Limit (dBm/MHz)	Pass / Fail
15	6025	99.80	-95.15	0.14	4.65	5.00	Pass
47	6185	99.83	-95.15	0.14	4.68	5.00	Pass
79	6345	99.87	-95.15	0.14	4.72	5.00	Pass
111	6505	99.79	-95.15	0.14	4.64	5.00	Pass
143	6665	99.77	-95.15	0.14	4.62	5.00	Pass
175	6825	99.81	-95.15	0.14	4.66	5.00	Pass
207	6985	100.05	-95.15	0.14	4.90	5.00	Pass

*The duty factor is included in the field strength.

Spectrum Plot of Worst Value

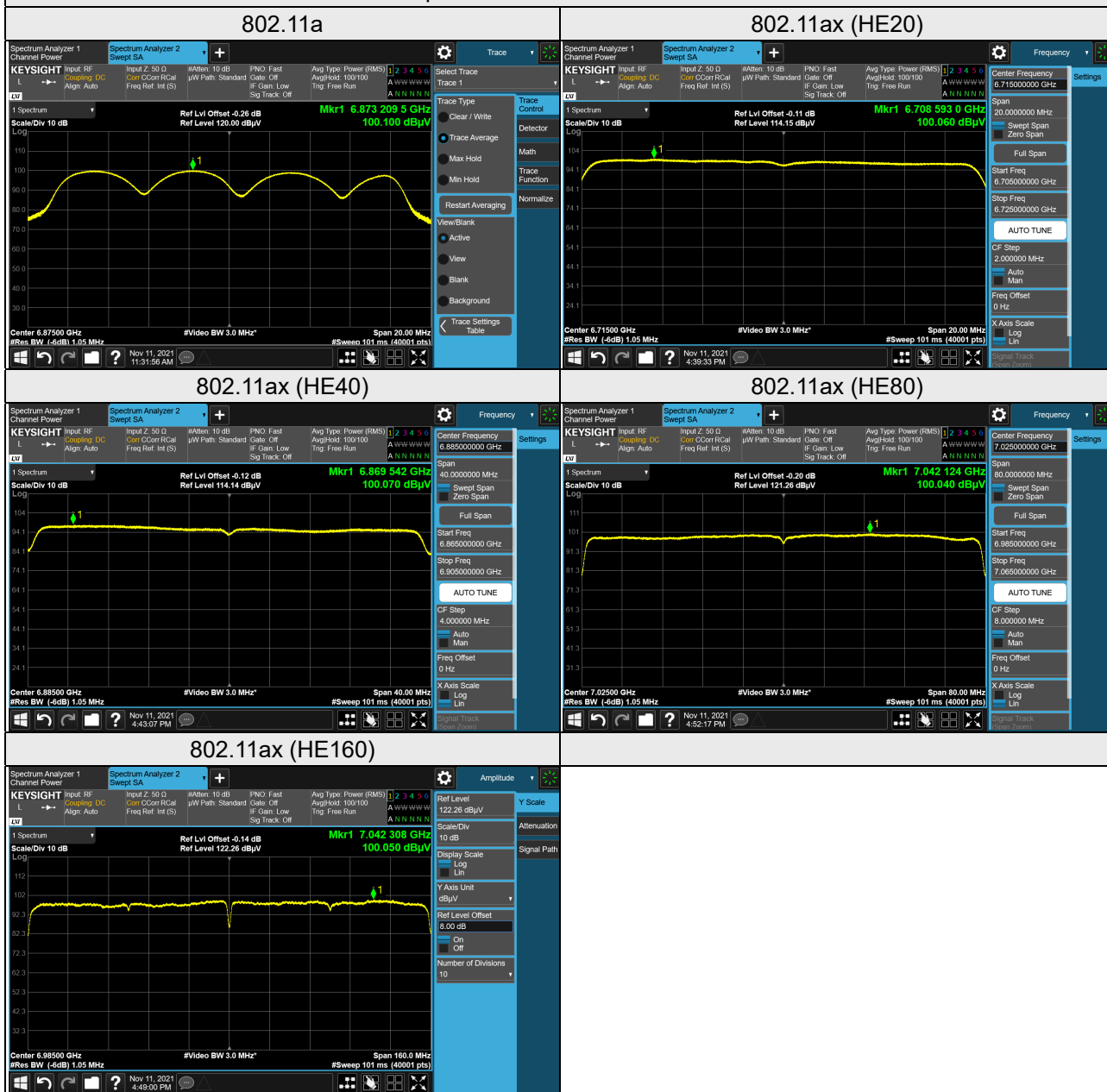

4.7 Contention Based Protocol Measurement

4.7.1 Limits of Contention Based Protocol Measurement

Unlicensed indoor low-power devices must detect co-channel radio frequency power that is at least -62 dBm (The threshold is referenced to a 0 dBi antenna gain.) or lower. Additionally, indoor low-power devices must detect co-channel energy with 90% or greater certainty.

4.7.2 Test Setup

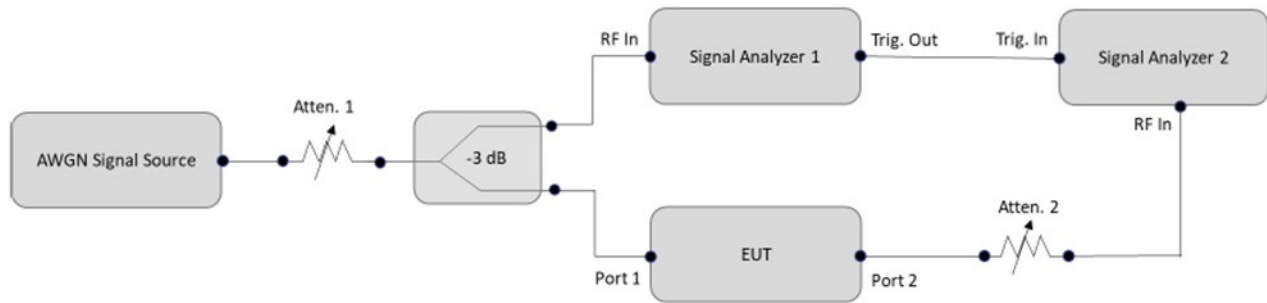

4.7.3 Test Instruments

Description & Manufacturer	Model No.	Serial No.	Cal. Date	Cal. Due
Spectrum Analyzer R&S	FSW	102023	Nov. 10, 2020	Nov. 09, 2021
			Nov. 10, 2021	Nov. 09, 2022
Spectrum Analyzer R&S	FSV40	101516	Mar. 08, 2021	Mar. 07, 2022
MXG X-Series RF Vector Signal Generator Agilent	N5182B	MY59100182	Apr. 22, 2021	Apr. 21, 2022
N5182BU KEYSIGHT	N5182BX07	MY59360203	Dec. 10, 2020	Dec. 09, 2021
Power Splitter/combiner Mini-Circuits	ZFRSC-123-S+	F698501347_01	Jan. 27, 2021	Jan. 26, 2022

- Note: 1. The test was performed in Femtocell room.
 2. The calibration interval of the above test instruments is 12 months and the calibrations are traceable to NML/ROC and NIST/USA.

4.7.4 Test Procedure

- Set the signal analyzer center frequency to the nominal EUT channel center frequency. The span range of the signal analyzer shall be between two times and five times the OBW of the EUT. Connect the output port of the EUT to the signal analyzer 2. Ensure that the attenuator 2 provides enough attenuation to not overload the signal analyzer 2 receiver.
- Monitoring the signal analyzer 2, verify the EUT is operating and transmitting with the parameters (set as following section 4.7.5 EUT operating condition).
- Determine number of times detection threshold test as following table,

If	Number of Tests	Placement of Incumbent Transmission
$BW_{EUT} \leq BW_{Inc}$	Once	Same as EUT transmission
$BW_{Inc} < BW_{EUT} \leq 2x BW_{Inc}$	Once	Contained within BW_{EUT}
$2x BW_{Inc} < BW_{EUT} \leq 4x BW_{Inc}$	Twice. (Incumbent transmission is contained within BW_{EUT})	Closely to the lower edge and upper edge of the EUT Channel
$BW_{EUT} > 4x BW_{Inc}$	Three times	Closely to the lower edge ,in the middle and upper edge of the EUT Channel

- Using an AWGN signal source, generate (but do not transmit, i.e., RF OFF) a 10 MHz-wide AWGN signal. Use step c table to determine the center frequency of the 10 MHz AWGN signal relative to the EUT's channel bandwidth and center frequency.
- Set the AWGN signal power to an extremely low level (more than 20 dB below the -62 dBm threshold). Connect the AWGN signal source, via a 3-dB splitter, to the signal analyzer 1 and the EUT.
- Transmit the AWGN signal (RF ON) and verify its characteristics on the signal analyzer 1.
- Monitor the signal analyzer 2 to verify if the AWGN signal has been detected and the EUT has ceased transmission. If the EUT continues to transmit, then incrementally increase the AWGN signal power level until the EUT stops transmitting.
- (Including all losses in the RF paths) Determine and record the AWGN signal power level (at the EUT's antenna port) at which the EUT ceased transmission. Repeat the procedure at least 10 times to verify the EUT can detect an AWGN signal with 90% (or better) level of certainty.
- Refer to step c table to determine number of times the detection threshold testing needs to be repeated. If testing is required more than once, then go back to step d, choose a different center frequency for the AWGN signal and repeat the process.

4.7.5 EUT Operating Condition

Set the EUT to transmit with a constant duty cycle and relative operating parameters which including power level, operating frequency, modulation and bandwidth.

4.7.6 Test Results

UNII Band 5:

Operation Mode	Channel Bandwidth (MHz)	Channel Number	Channel Freq. (MHz)	AWGN Signal Freq. (MHz)	Incumbent Signal Level (dBm)	Number of Times	Number of Detected	Detection Rate	Minimum Limit	Test Result	Minimum Detection Level (dBm)	EUT Status
802.11ax	20	53	6215	6215	-62.02	10	10	100%	90%	Pass	-69	Detection first starts
	160	47	6185	6110	-62.01	10	10	100%	90%	Pass	-65	Detection first starts
				6185	-62.01	10	10	100%	90%	Pass	-65	Detection first starts
				6260	-62.02	10	10	100%	90%	Pass	-65	Detection first starts

Note: Detection criterion = -62 dBm + Gain (2.7 dBi) = -59.3 dBm

UNII Band 6:

Operation Mode	Channel Bandwidth (MHz)	Channel Number	Channel Freq. (MHz)	AWGN Signal Freq. (MHz)	Incumbent Signal Level (dBm)	Number of Times	Number of Detected	Detection Rate	Minimum Limit	Test Result	Minimum Detection Level (dBm)	EUT Status
802.11ax	20	101	6455	6455	-62.02	10	10	100%	90%	Pass	-69	Detection first starts
	160	111	6505	6430	-62.03	10	10	100%	90%	Pass	-65	Detection first starts
				6505	-62.02	10	10	100%	90%	Pass	-65	Detection first starts
				6580	-62.02	10	10	100%	90%	Pass	-65	Detection first starts

Note: Detection criterion = -62 dBm + Gain (1.7 dBi) = -60.3 dBm

UNII Band 7:

Operation Mode	Channel Bandwidth (MHz)	Channel Number	Channel Freq. (MHz)	AWGN Signal Freq. (MHz)	Incumbent Signal Level (dBm)	Number of Times	Number of Detected	Detection Rate	Minimum Limit	Test Result	Minimum Detection Level (dBm)	EUT Status
802.11ax	20	133	6615	6615	-62.01	10	10	100%	90%	Pass	-69	Detection first starts
	160	143	6665	6590	-62.02	10	10	100%	90%	Pass	-65	Detection first starts
				6665	-62.02	10	10	100%	90%	Pass	-65	Detection first starts
				6740	-62.01	10	10	100%	90%	Pass	-65	Detection first starts

Note: Detection criterion = -62 dBm + Gain (2 dBi) = -60 dBm

UNII Band 8:

Operation Mode	Channel Bandwidth (MHz)	Channel Number	Channel Freq. (MHz)	AWGN Signal Freq. (MHz)	Incumbent Signal Level (dBm)	Number of Times	Number of Detected	Detection Rate	Minimum Limit	Test Result	Minimum Detection Level (dBm)	EUT Status
802.11ax	20	197	6935	6935	-62.01	10	10	100%	90%	Pass	-69	Detection first starts
	160	207	6985	6910	-62.02	10	10	100%	90%	Pass	-65	Detection first starts
				6985	-62.03	10	10	100%	90%	Pass	-65	Detection first starts
				7060	-62.02	10	10	100%	90%	Pass	-65	Detection first starts

Note: Detection criterion = -62 dBm + Gain (2.1 dBi) = -59.9 dBm

For U-NII-5 band

Plots of EUT Tx waveform

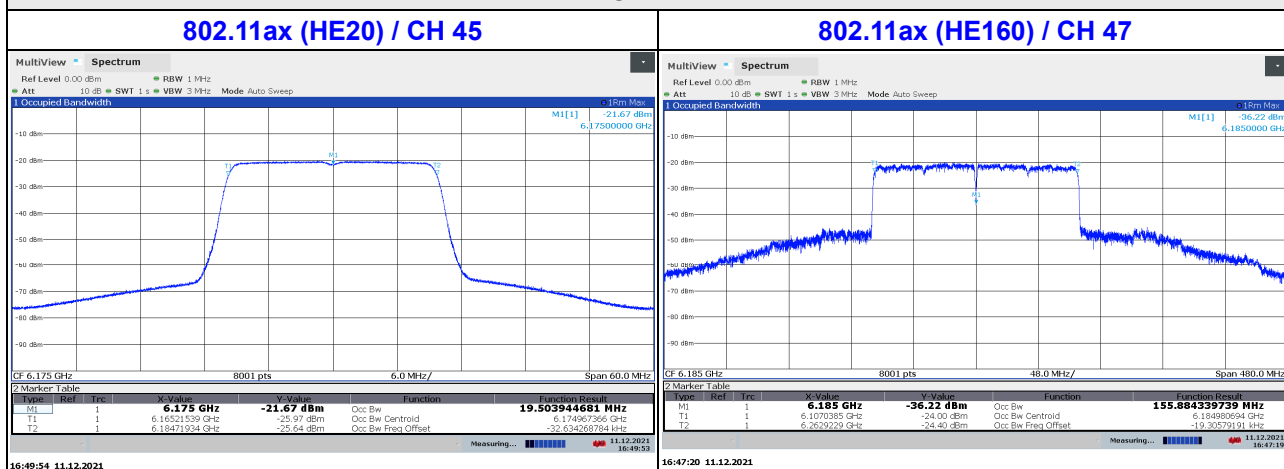

Plots of Incumbent signal (AWGN) Level

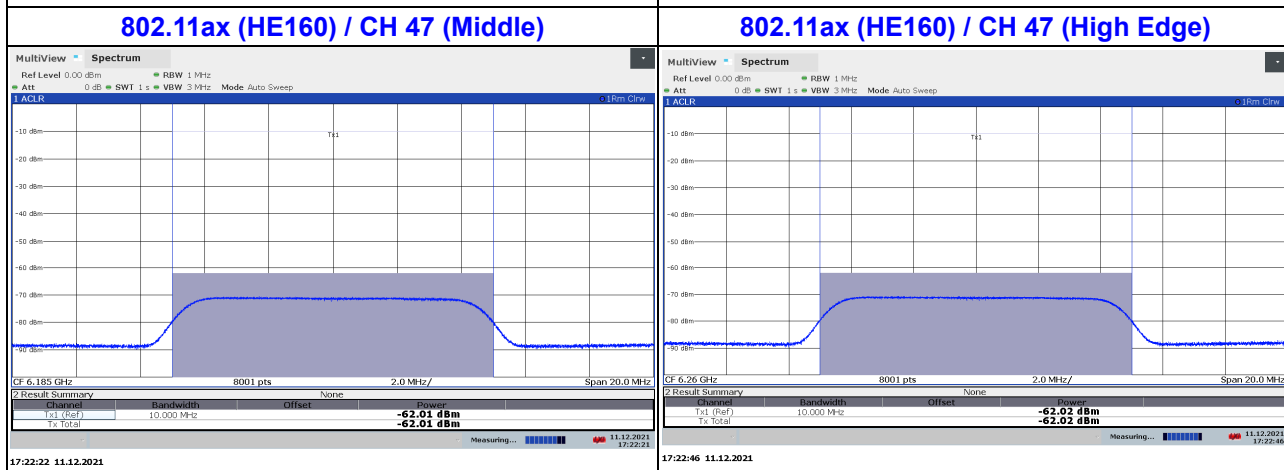
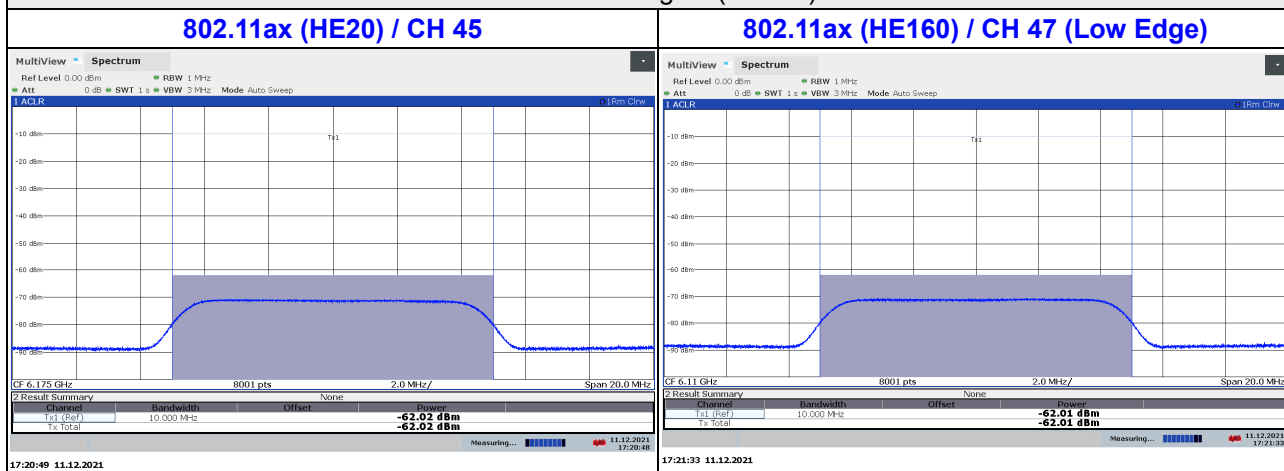

Plots of EUT ceased transmission in the time domain

802.11ax (HE20) / CH 45

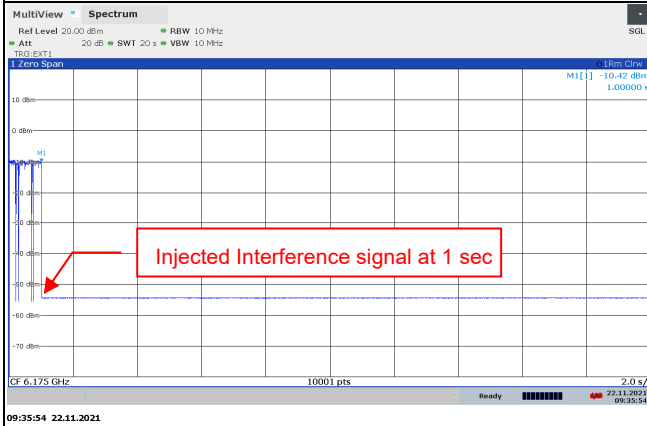

802.11ax (HE160) / CH 47 (Low Edge)

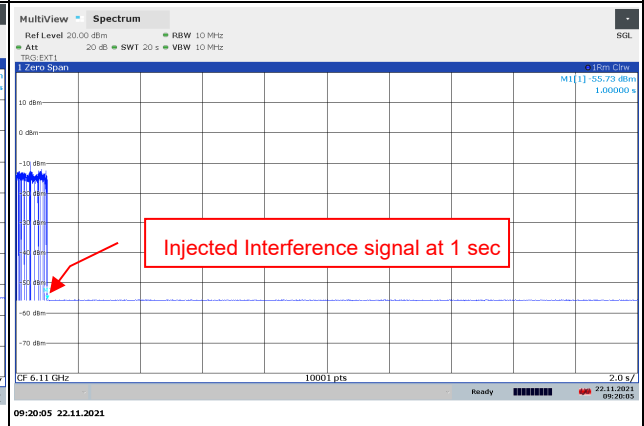

802.11ax (HE160) / CH 47 (Middle)

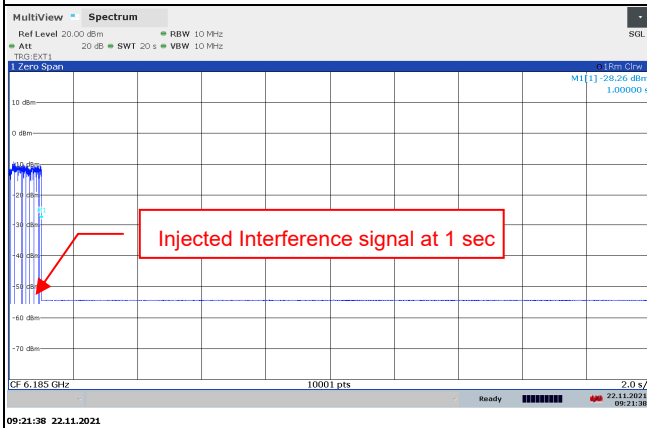

802.11ax (HE160) / CH 47 (High Edge)

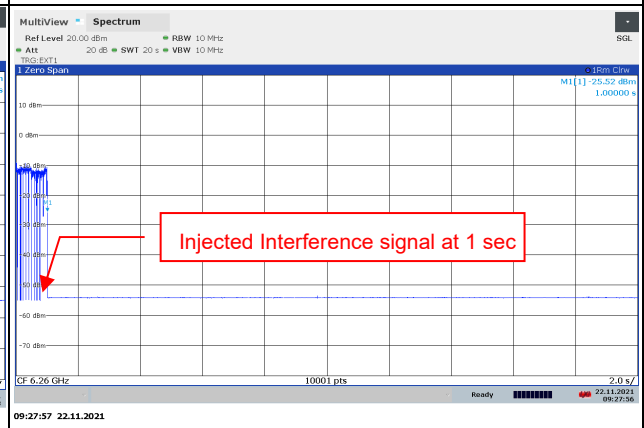

For U-NII-6 band

Plots of EUT Tx waveform

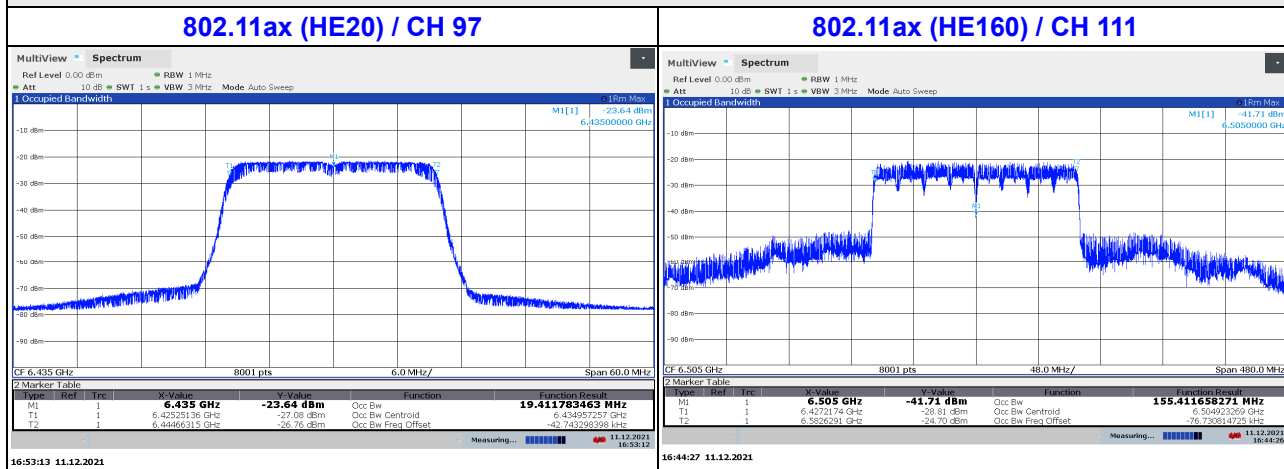

Plots of Incumbent signal (AWGN) Level

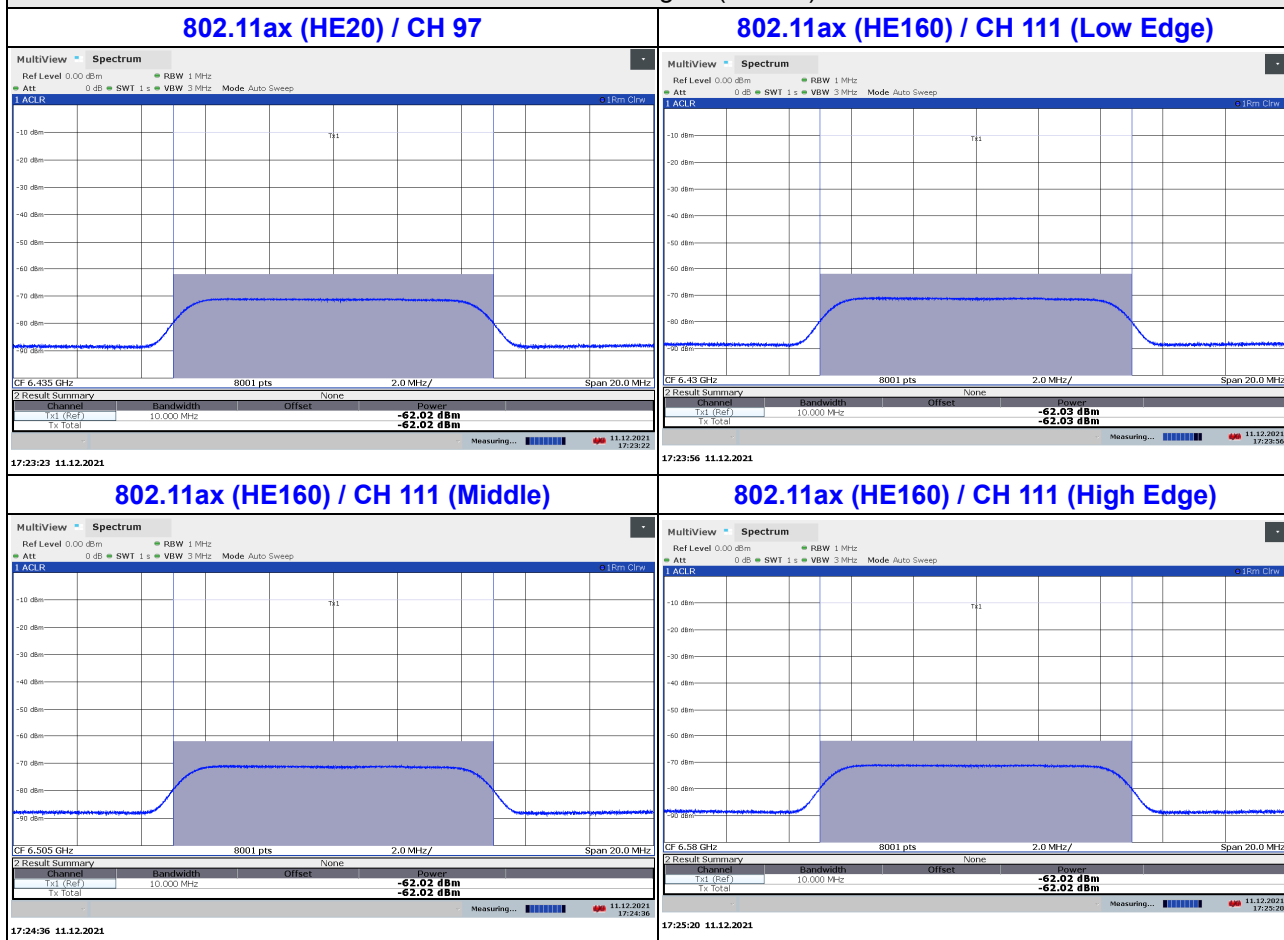

Plots of EUT ceased transmission in the time domain

802.11ax (HE20) / CH 97

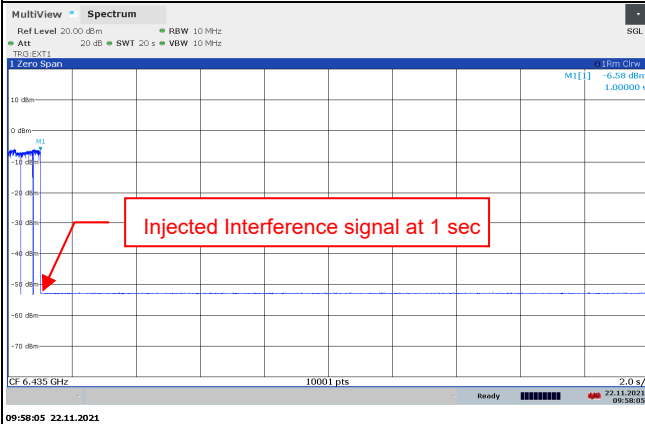

802.11ax (HE160) / CH 111 (Low Edge)

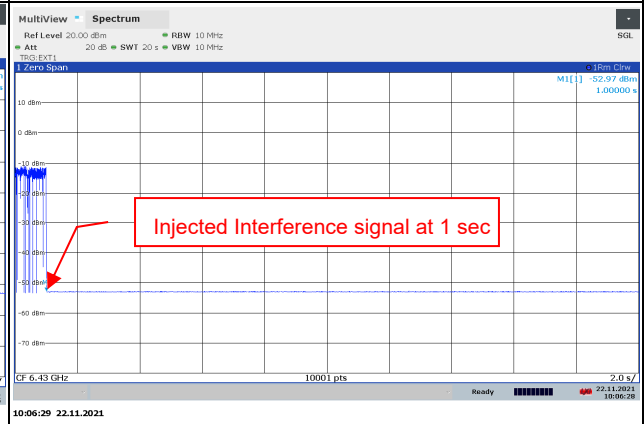

802.11ax (HE160) / CH 111 (Middle)

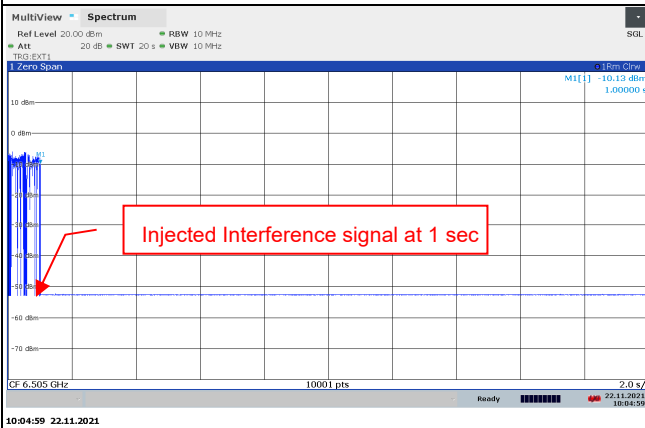

802.11ax (HE160) / CH 111 (High Edge)

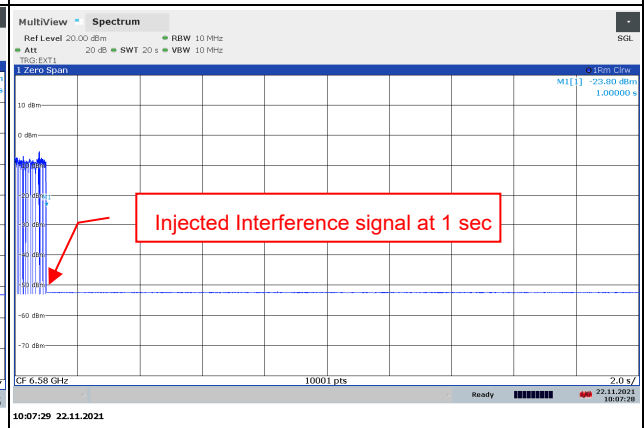

For U-NII-7 band

Plots of EUT Tx waveform

802.11ax (HE20) / CH 149

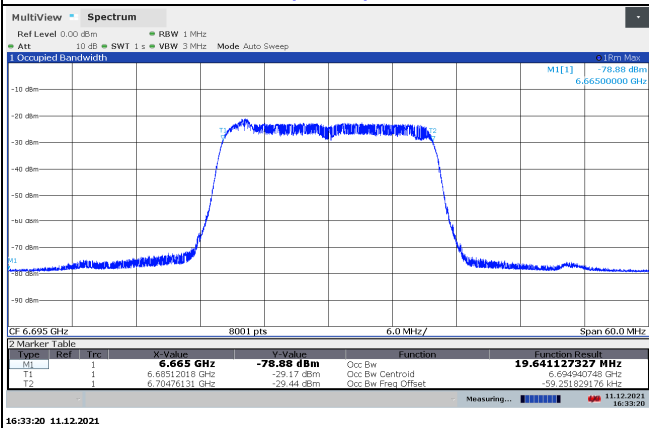

802.11ax (HE160) / CH 143

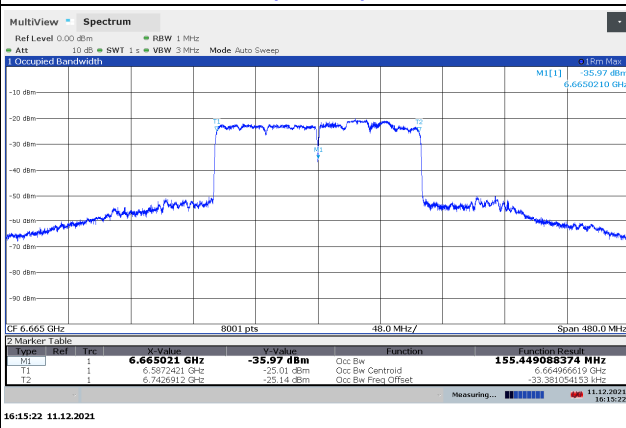

Plots of Incumbent signal (AWGN) Level

802.11ax (HE20) / CH 149

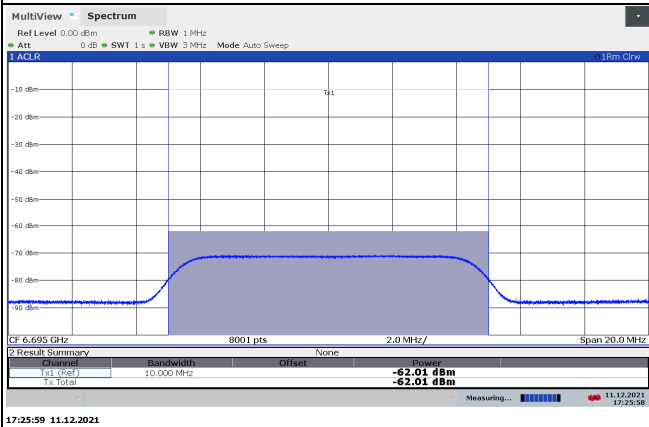

802.11ax (HE160) / CH 143 (Low Edge)

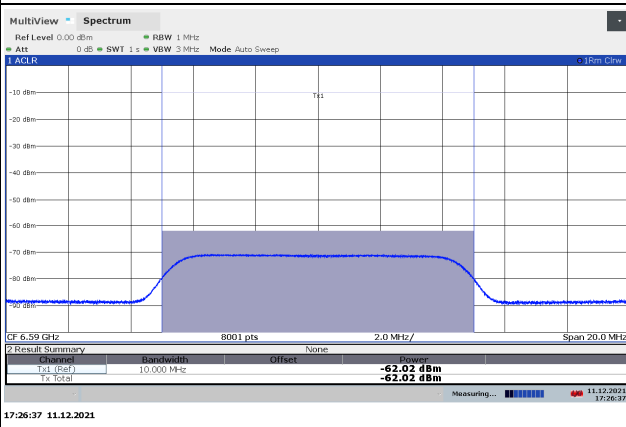

802.11ax (HE160) / CH 143 (Middle)

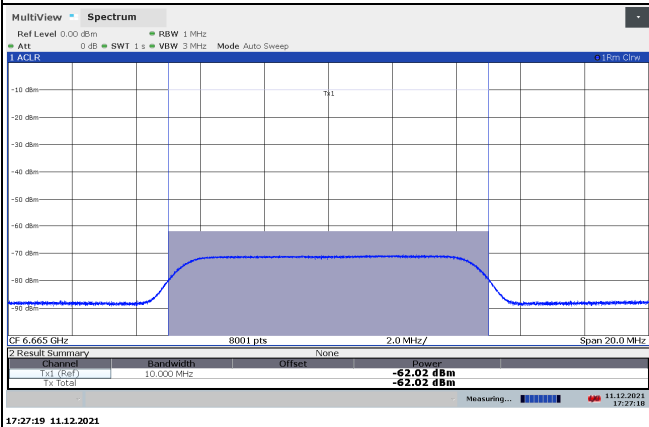

802.11ax (HE160) / CH 143 (High Edge)

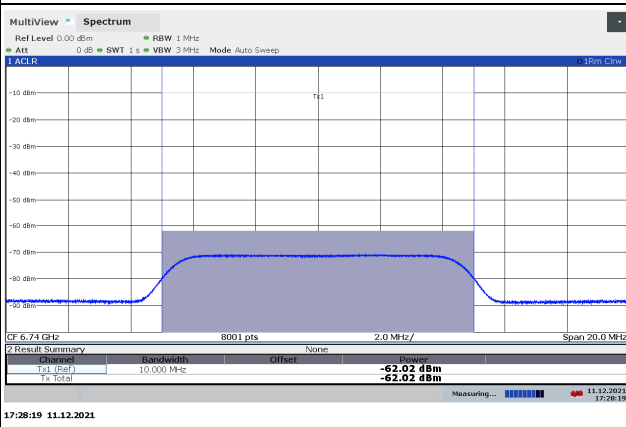

Plots of EUT ceased transmission in the time domain

802.11ax (HE20) / CH 149

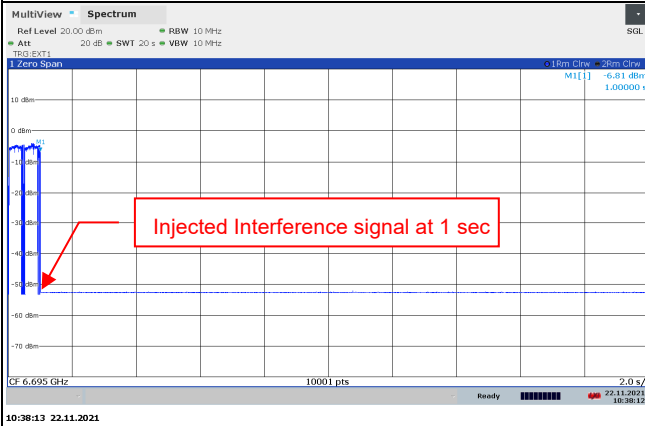

802.11ax (HE160) / CH 143 (Low Edge)

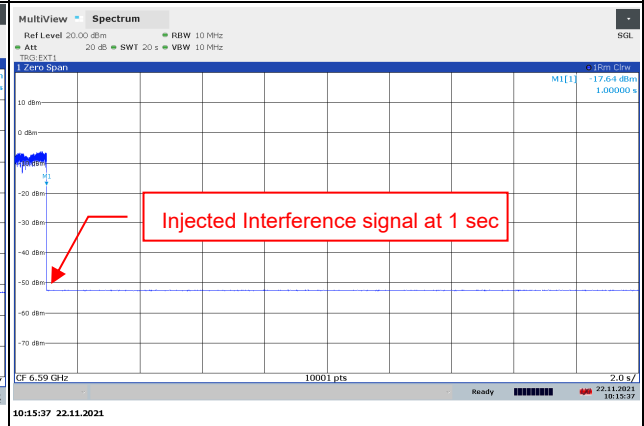

802.11ax (HE160) / CH 143 (Middle)

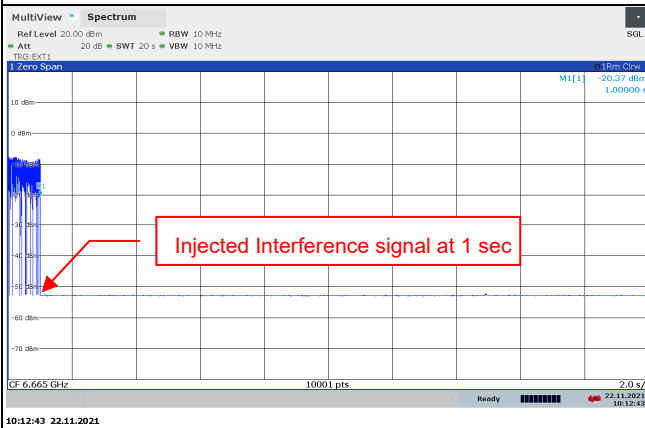

802.11ax (HE160) / CH 143 (High Edge)

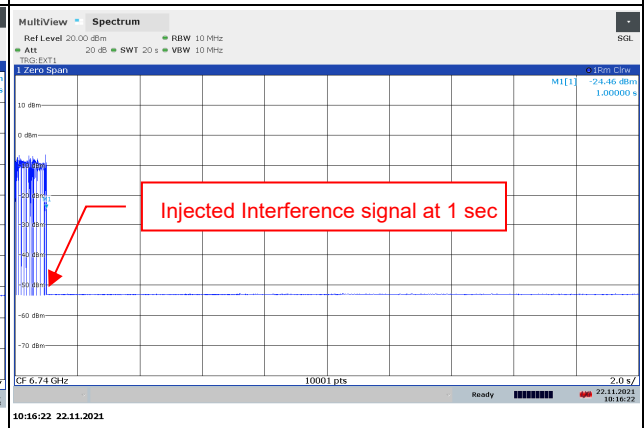

For U-NII-8 band

Plots of EUT Tx waveform

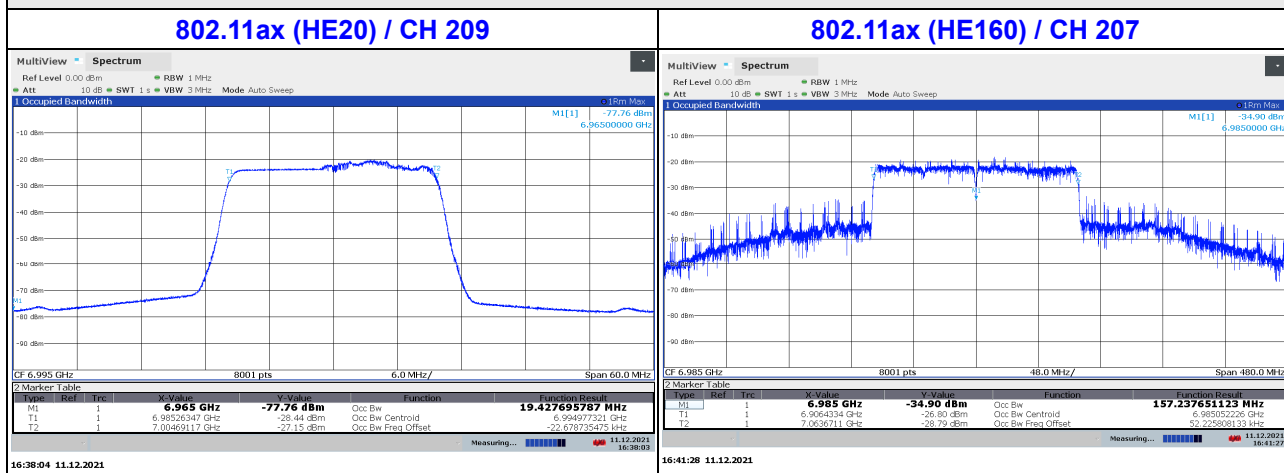

Plots of Incumbent signal (AWGN) Level

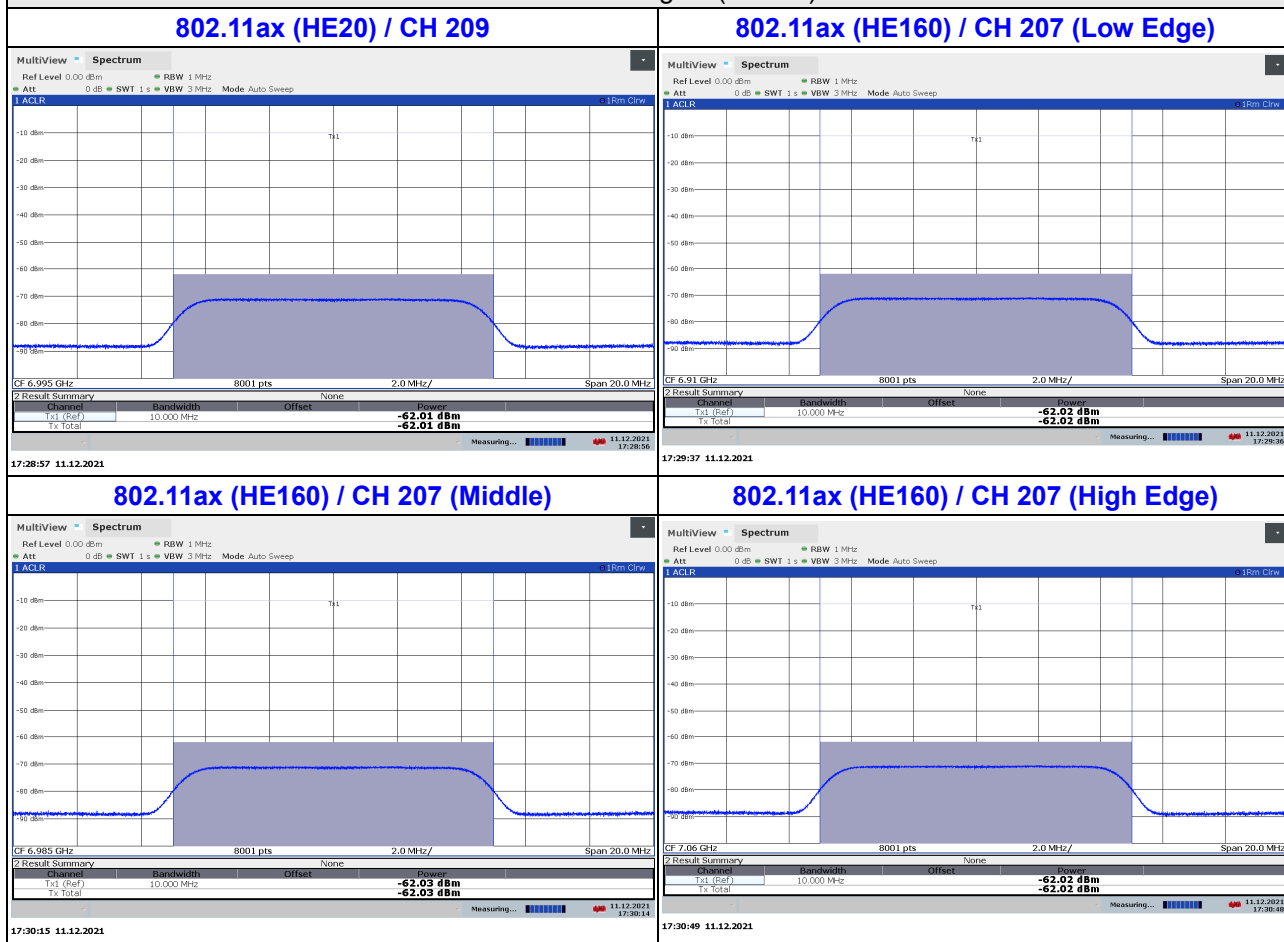

Plots of EUT ceased transmission in the time domain

802.11ax (HE160) / CH 207 (Low Edge)

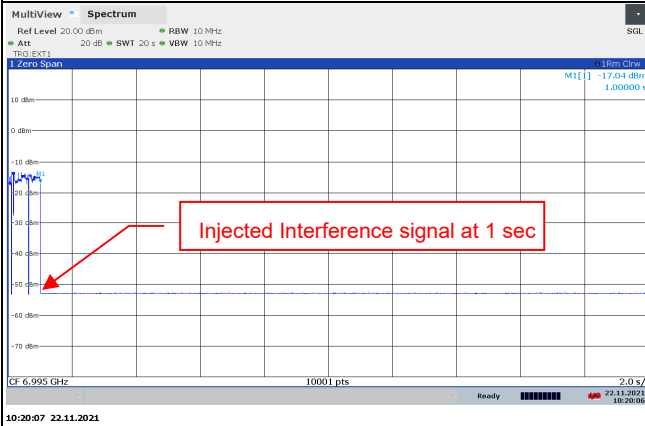

802.11ax (HE160) / CH 207 (Low Edge)

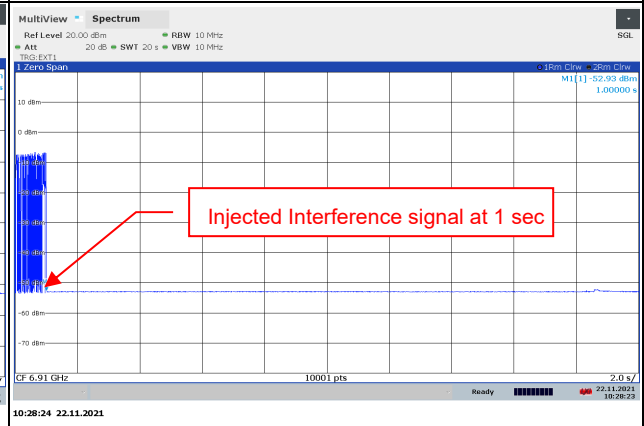

802.11ax (HE160) / CH 207 (Middle)

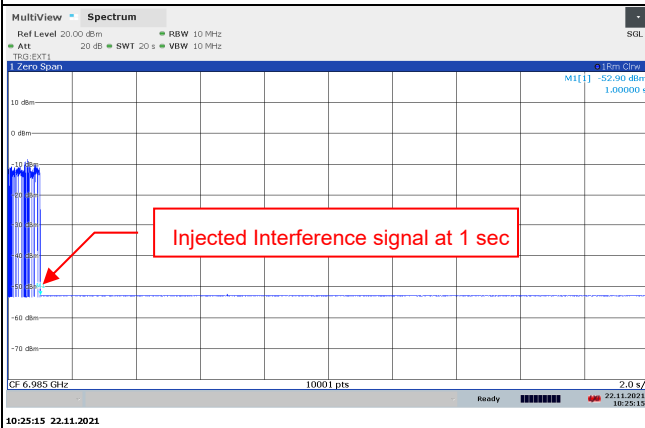

802.11ax (HE160) / CH 207 (High Edge)

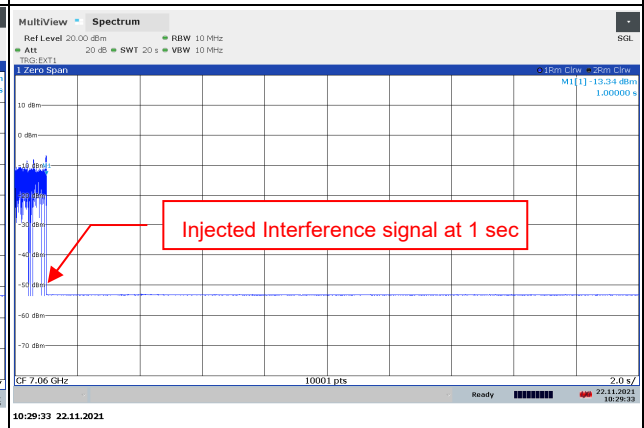

4.8 Frequency Stability

4.8.1 Limits of Frequency Stability Measurement

The frequency of the carrier signal shall be maintained within band of operation

4.8.2 Test Setup

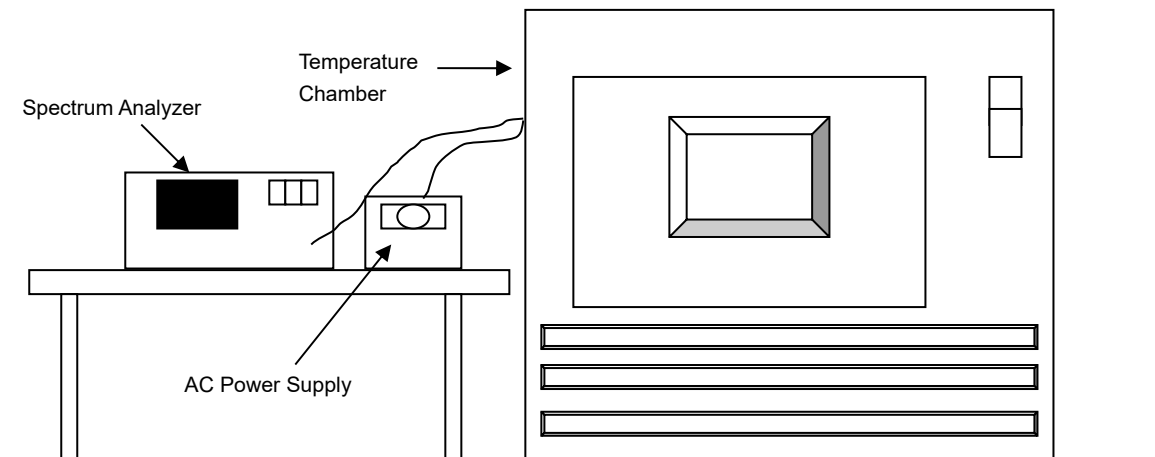

4.8.3 Test Instruments

Description & Manufacturer	Model No.	Serial No.	Cal. Date	Cal. Due
Spectrum Analyzer ROHDE & SCHWARZ	FSP40	100040	Sep. 16, 2020	Sep. 15, 2021
			Sep. 15, 2021	Sep. 14, 2022
Temperature & Humidity Chamber TERCHY	HRM-120RF	931022	Dec. 24, 2020	Dec. 23, 2021
Digital Multimeter Fluke	87-III	70360755	Jul. 08, 2021	Jul. 07, 2022
AC Power Supply Extech	CFW-105	E000603	NA	NA

Note: 1. The calibration interval of the above test instruments is 12 months and the calibrations are traceable to NML/ROC and NIST/USA.

4.8.4 Test Procedure

- The EUT was placed inside the environmental test chamber and powered by nominal AC voltage.
- Turn the EUT on and couple its output to a spectrum analyzer.
- Turn the EUT off and set the chamber to the highest temperature specified.
- Allow sufficient time (approximately 30 min) for the temperature of the chamber to stabilize, turn the EUT on and measure the operating frequency after 2, 5, and 10 minutes.
- Repeat step d with every 10 degrees reduction until the lowest temperature achieved.
- The test chamber was allowed to stabilize at +20 degree C for a minimum of 30 minutes. The supply voltage was then adjusted on the EUT from 85% to 115% and the frequency record.

4.8.5 Deviation from Test Standard

No deviation.

4.8.6 EUT Operating Condition

Set the EUT transmit at un-modulation mode to test frequency stability.

4.8.7 Test Results

Nss 1

Frequency Stability Versus Temp.									
Operating Frequency: 5955MHz									
Temp. (°C)	Power Supply (Vac)	0 Minute		2 Minute		5 Minute		10 Minute	
		Measured Frequency (MHz)	Result	Measured Frequency (MHz)	Result	Measured Frequency (MHz)	Result	Measured Frequency (MHz)	Result
40	120	5955.0230	Pass	5955.0220	Pass	5955.0272	Pass	5955.0215	Pass
30	120	5955.0244	Pass	5955.0261	Pass	5955.0258	Pass	5955.0242	Pass
20	120	5955.0161	Pass	5955.0180	Pass	5955.0170	Pass	5955.0132	Pass
10	120	5955.0281	Pass	5955.0268	Pass	5955.0243	Pass	5955.0234	Pass
0	120	5954.9936	Pass	5954.9937	Pass	5954.9929	Pass	5954.9954	Pass

Frequency Stability Versus Voltage									
Operating Frequency: 5955MHz									
Temp. (°C)	Power Supply (Vac)	0 Minute		2 Minute		5 Minute		10 Minute	
		Measured Frequency (MHz)	Result	Measured Frequency (MHz)	Result	Measured Frequency (MHz)	Result	Measured Frequency (MHz)	Result
20	138	5955.0187	Pass	5955.0179	Pass	5955.0157	Pass	5955.0184	Pass
	120	5955.0161	Pass	5955.018	Pass	5955.017	Pass	5955.0132	Pass
	102	5955.0138	Pass	5955.0161	Pass	5955.0163	Pass	5955.0135	Pass

4.9 Operational Restrictions for 6 GHz U-NII Devices

4.9.1 Limits of Operational Restrictions for 6 GHz U-NII Devices

- (1) Operation of indoor access points in the 5.925-7.125 GHz band is prohibited on oil platforms, cars, trains, boats, and aircraft, except that indoor access points are permitted to operate in the 5.925-6.425 GHz bands in large aircraft while flying above 10,000 feet.
- (2) Operation of transmitters in the 5.925-7.125 GHz band is prohibited for control of or communications with unmanned aircraft systems.
- (3) Transmitters operating under indoor access points are limited to indoor locations.
- (4) In the 5.925-7.125 GHz band, indoor access points must bear the following statement in a conspicuous location on the device and in the user's manual: FCC regulations restrict operation of this device to indoor use only. The operation of this device is prohibited on oil platforms, cars, trains, boats, and aircraft, except that operation of this device is permitted in large aircraft while flying above 10,000 feet.
- (5) In the 5.925-7.125 GHz band, Access points may connect to other access points or subordinate devices.
- (6) Indoor access points, operating in the 5.925-7.125 GHz band must employ a contention-based protocol.

4.9.2 Test Setup

N/A

4.9.3 Test Instruments

N/A

4.9.4 Test Procedure

N/A.

4.9.5 Test Results

Device is an indoor access point, all restrictions are meet the §15.407 (d) requirements. Please refer to the Attestation letter exhibit supplied within this application.

5 Pictures of Test Arrangements

Please refer to the attached file (Test Setup Photo).

Annex A - Band Edge Measurement

Nss 1

802.11a 6G Channel 1

Horizontal (Peak)

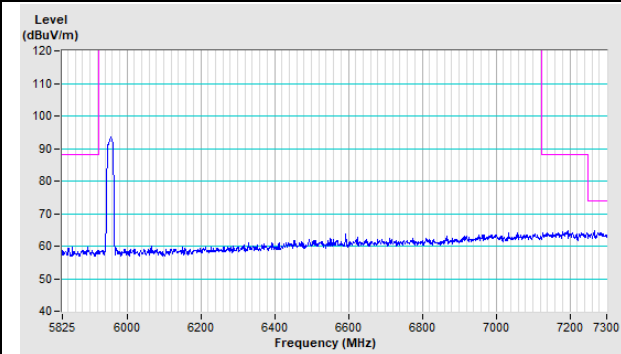

Horizontal (Average)

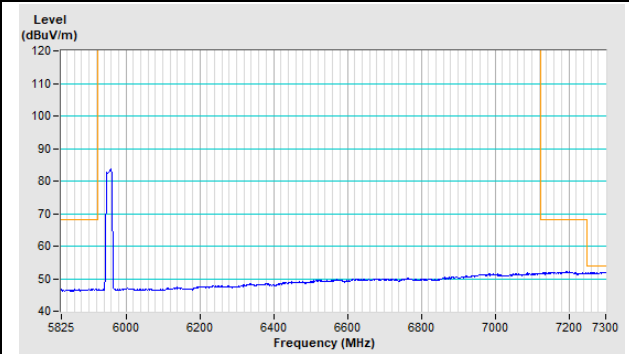

Vertical (Peak)

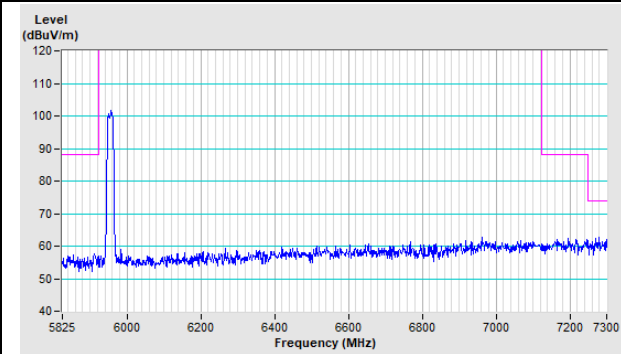

Vertical (Average)

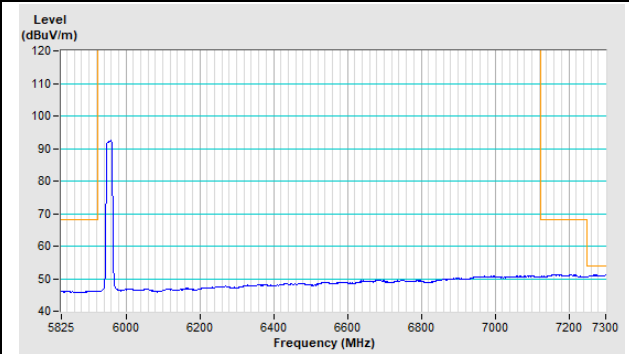

802.11a 6G Channel 233

Horizontal (Peak)

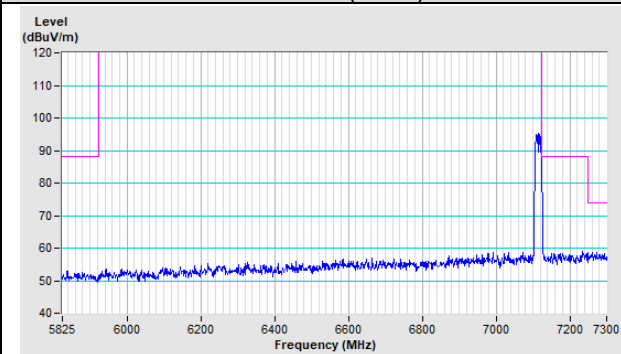

Horizontal (Average)

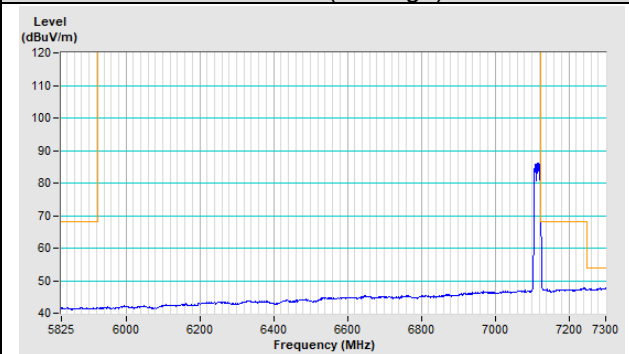

Vertical (Peak)

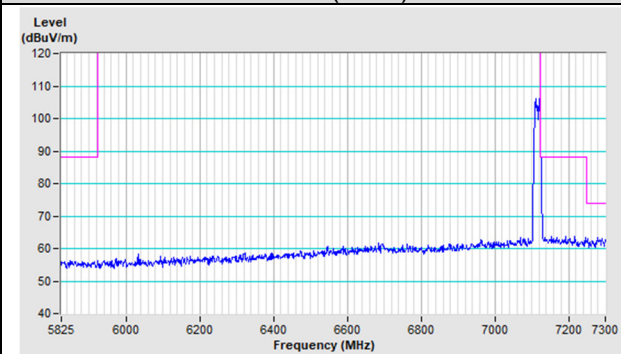

Vertical (Average)

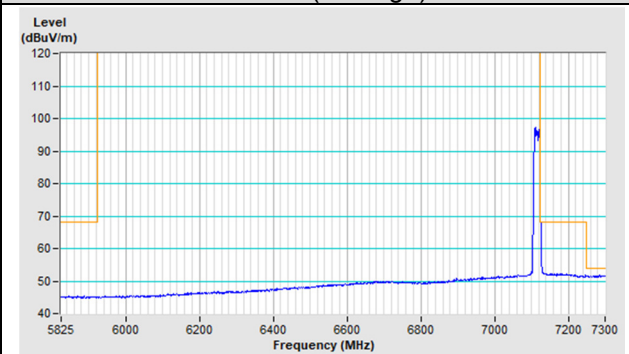

802.11ax (HE20) Channel 1

Horizontal (Peak)

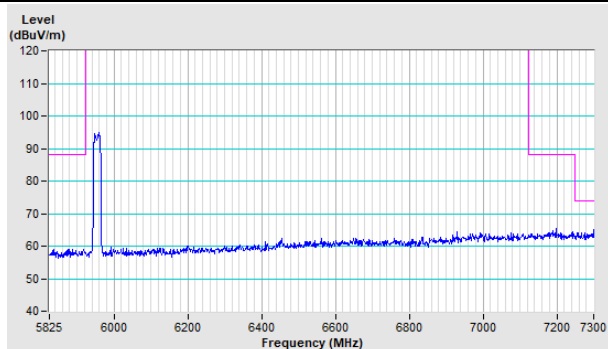

Horizontal (Average)

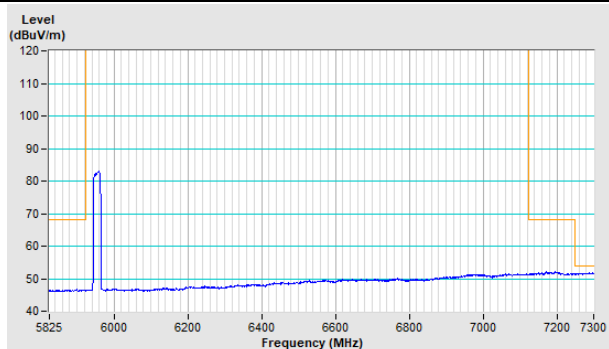

Vertical (Peak)

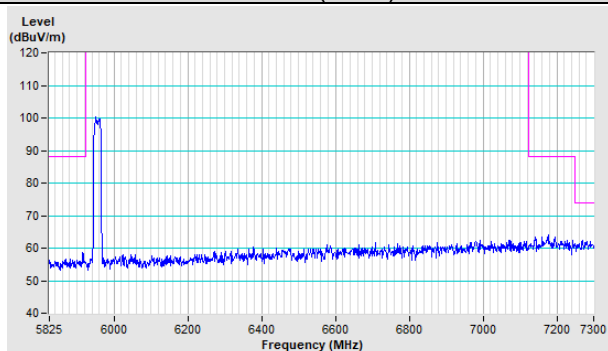

Vertical (Average)

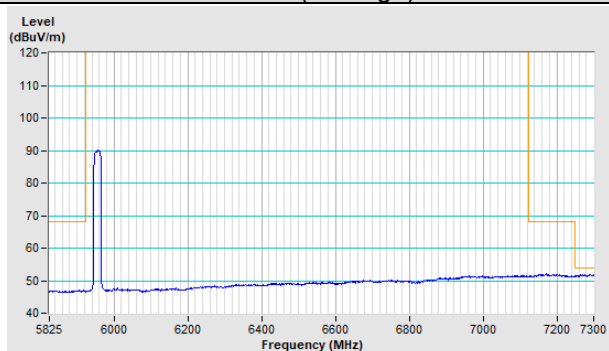

802.11ax (HE20) Channel 233

Horizontal (Peak)

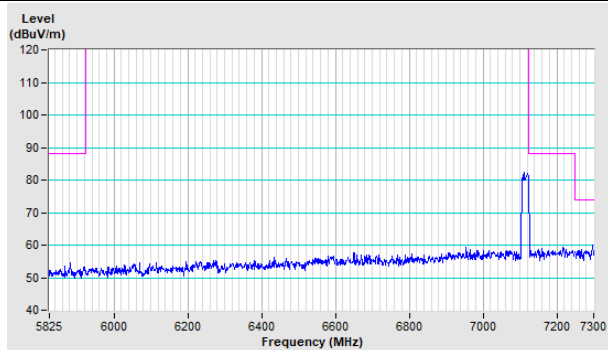

Horizontal (Average)

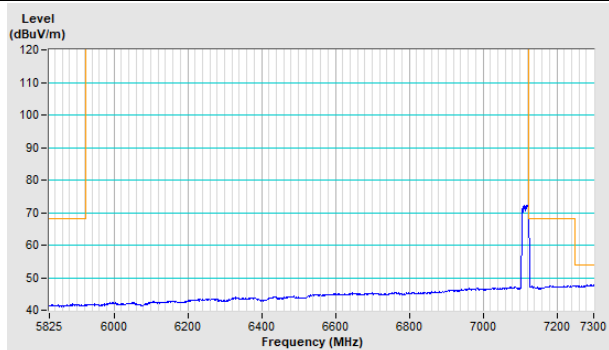

Vertical (Peak)

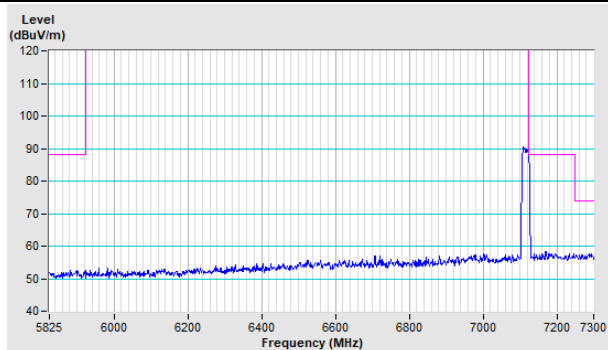

Vertical (Average)

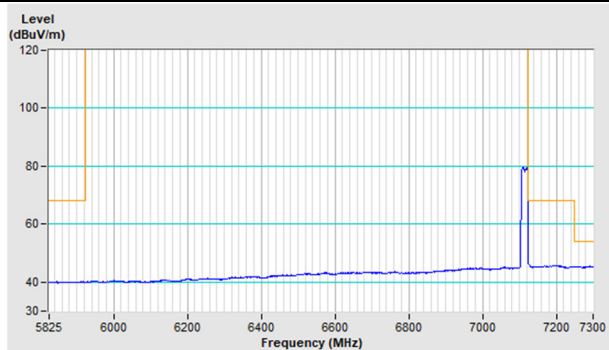

802.11ax (HE40) Channel 3

Horizontal (Peak)

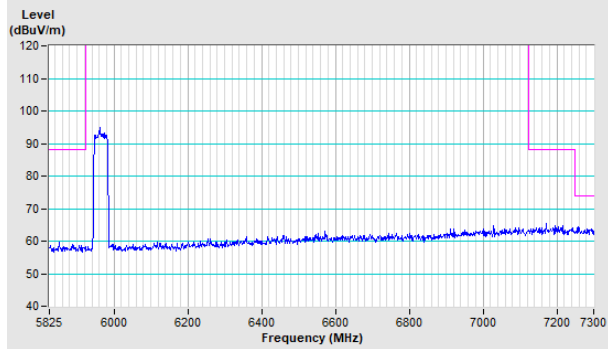

Horizontal (Average)

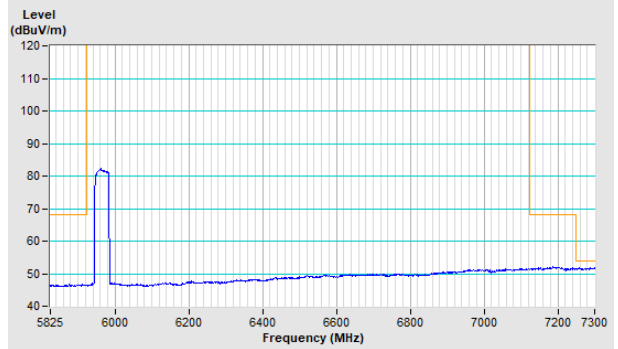

Vertical (Peak)

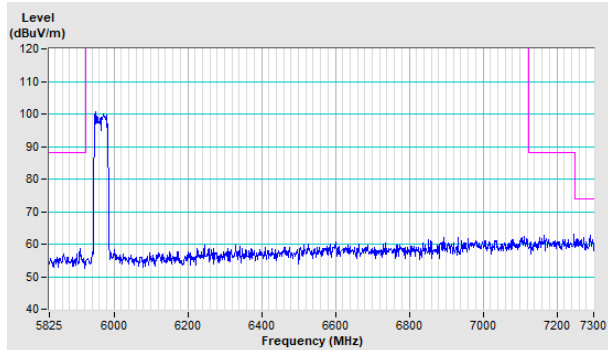

Vertical (Average)

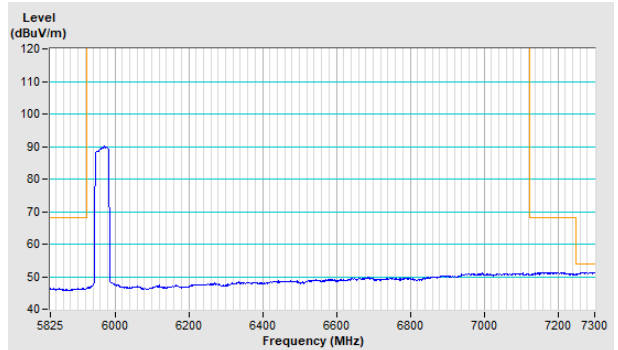

802.11ax (HE40) Channel 227

Horizontal (Peak)

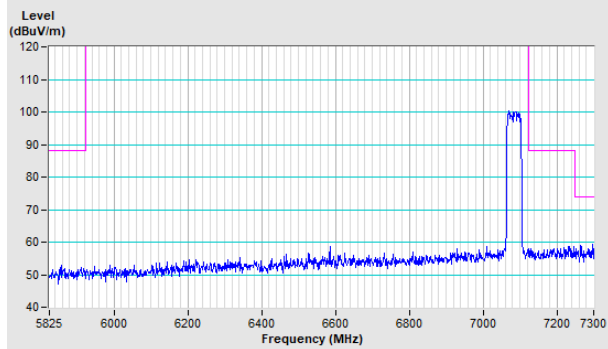

Horizontal (Average)

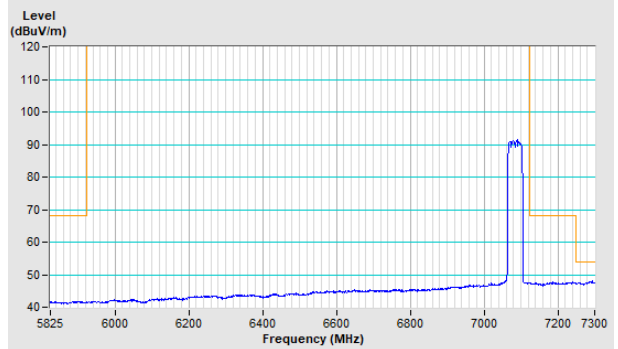

Vertical (Peak)

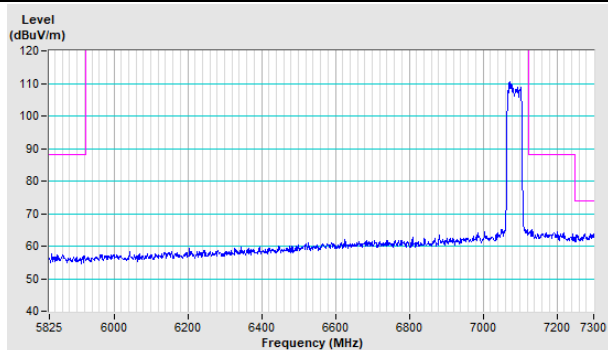

Vertical (Average)

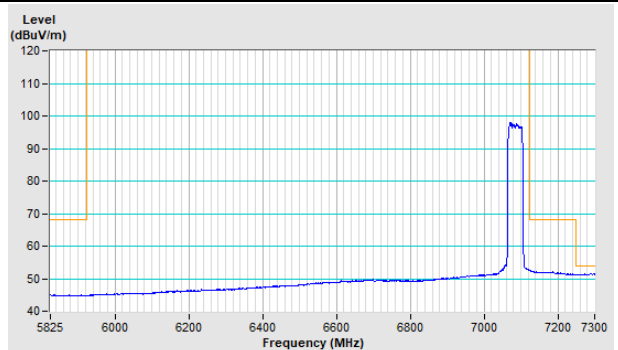

802.11ax (HE80) Channel 7

Horizontal (Peak)

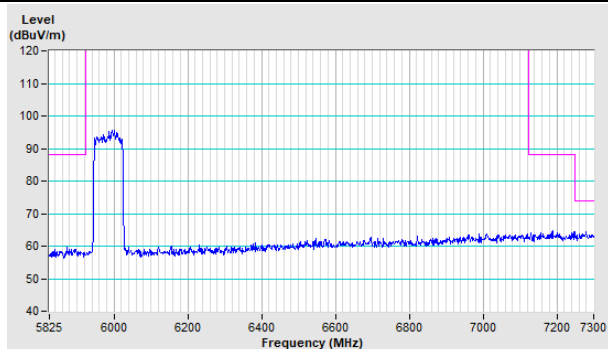

Horizontal (Average)

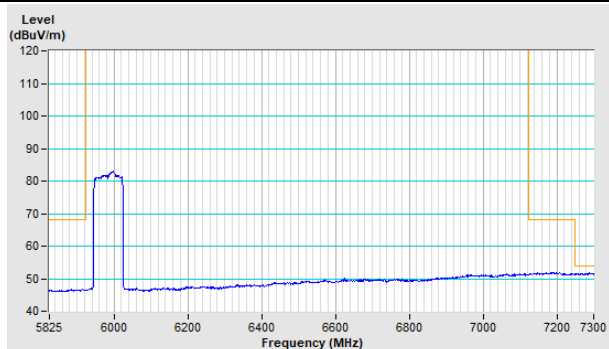

Vertical (Peak)

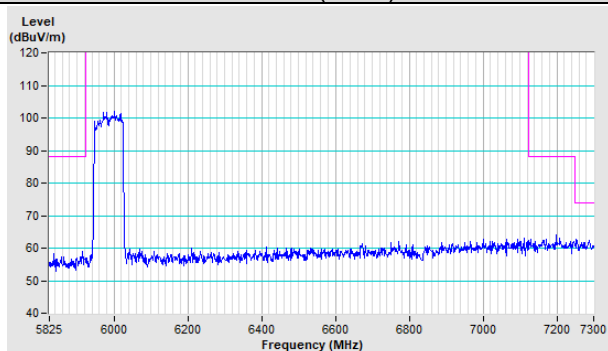

Vertical (Average)

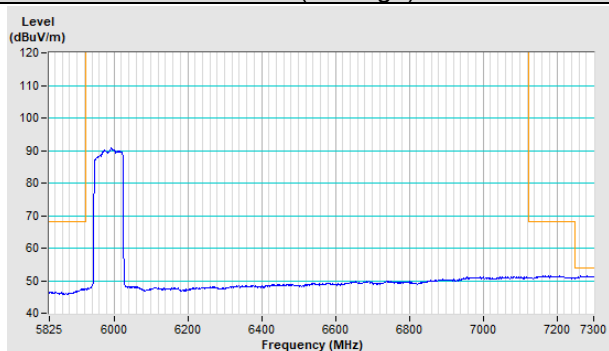

802.11ax (HE80) Channel 215

Horizontal (Peak)

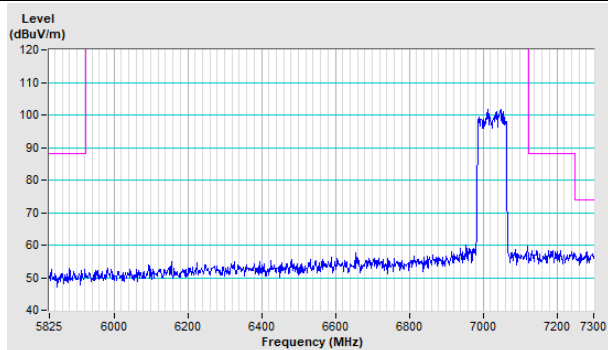

Horizontal (Average)

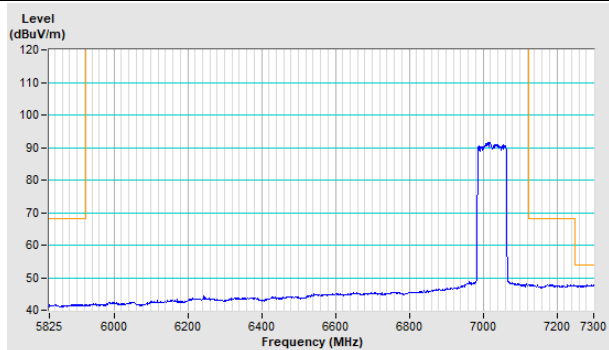

Vertical (Peak)

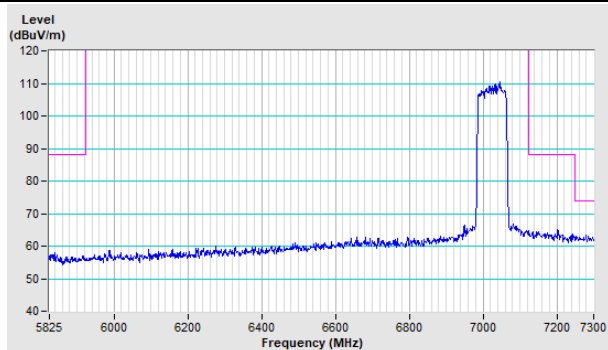

Vertical (Average)

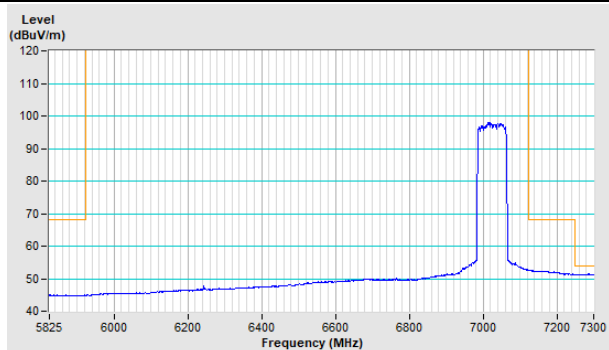

802.11ax (HE160) Channel 15

Horizontal (Peak)

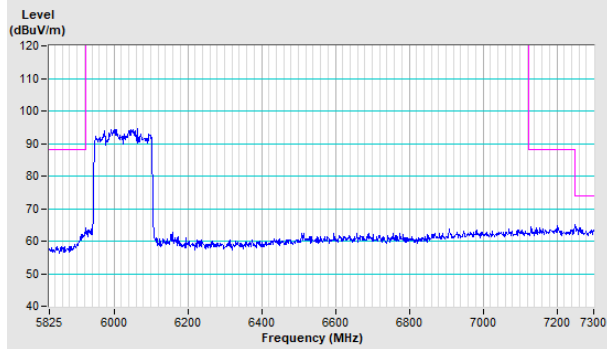

Horizontal (Average)

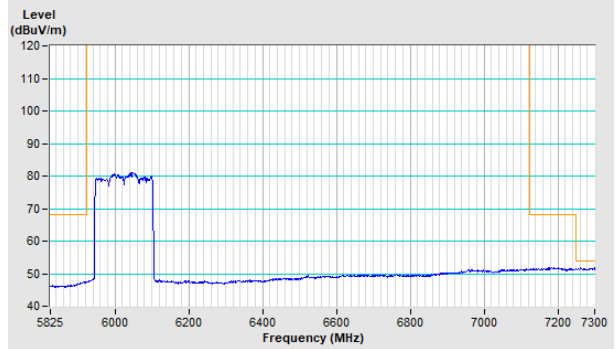

Vertical (Peak)

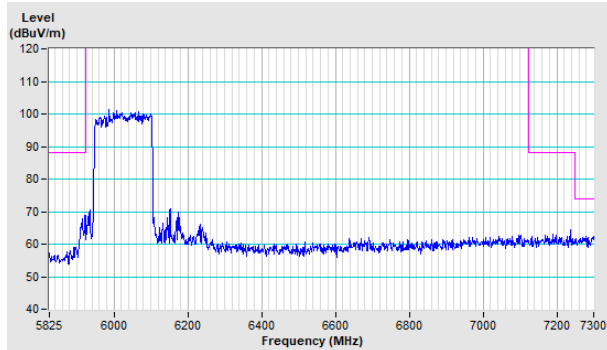

Vertical (Average)

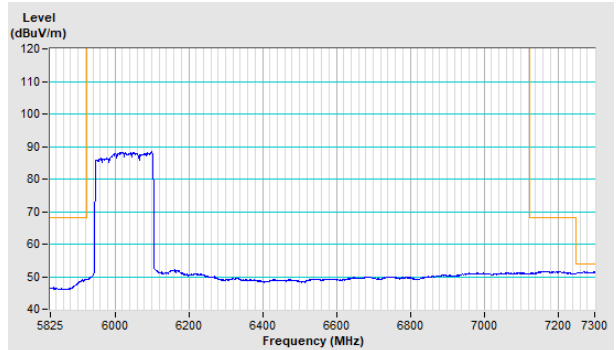

802.11ax (HE160) Channel 47

Horizontal (Peak)

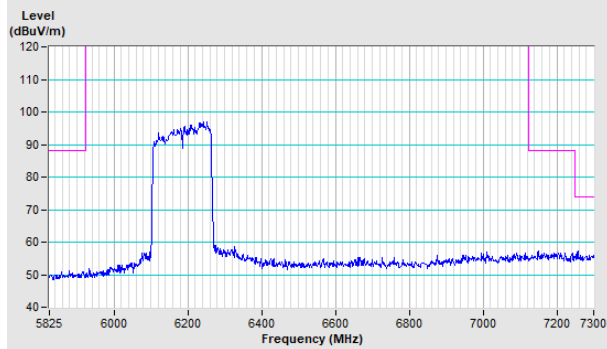

Horizontal (Average)

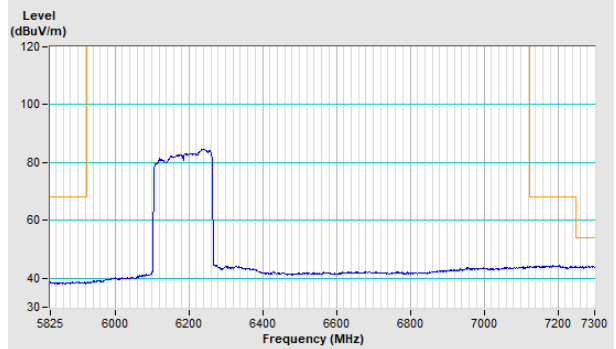

Vertical (Peak)

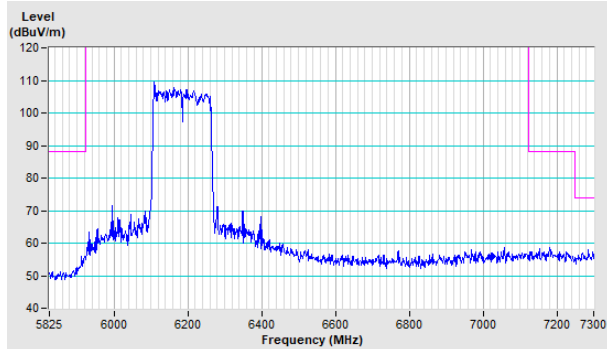

Vertical (Average)

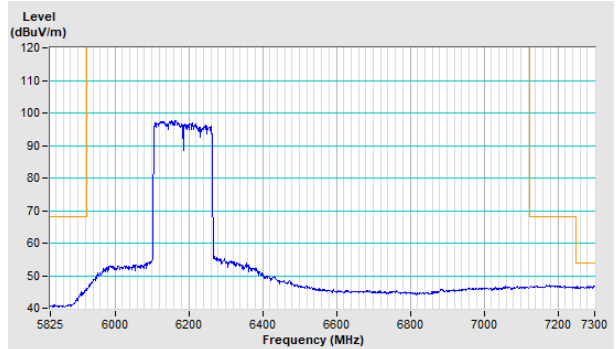

802.11ax (HE160) Channel 207

Horizontal (Peak)

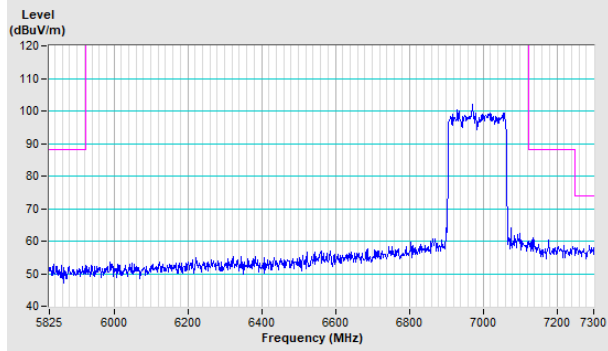

Horizontal (Average)

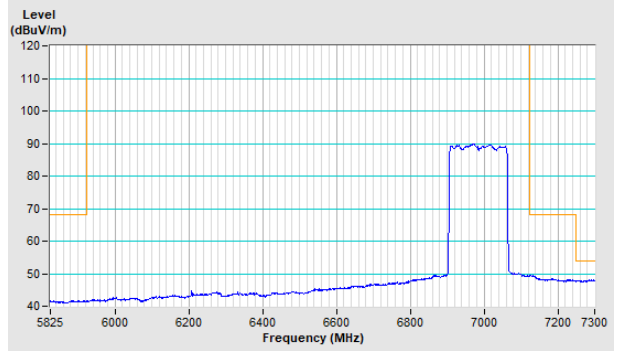

Vertical (Peak)

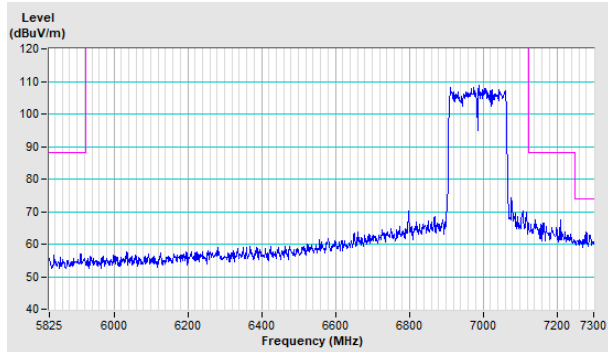

Vertical (Average)

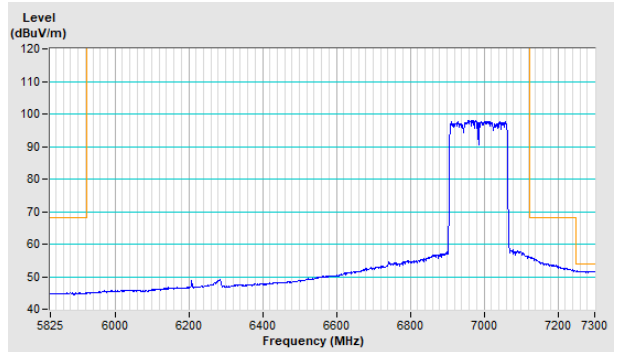

Nss 2

802.11ax (HE20) Channel 1

Horizontal (Peak)

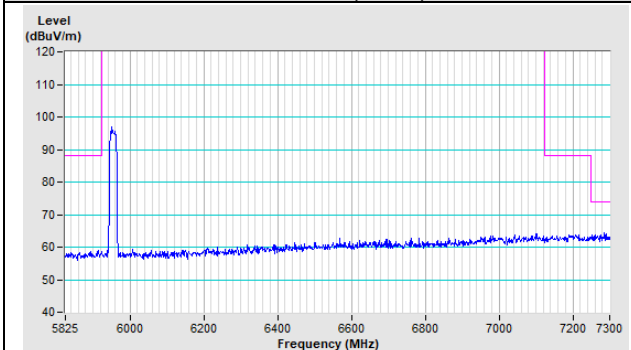

Horizontal (Average)

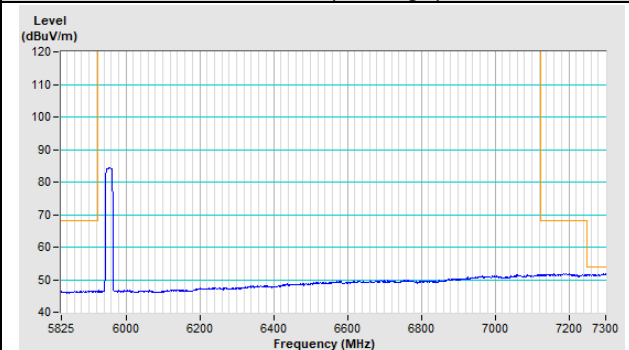

Vertical (Peak)

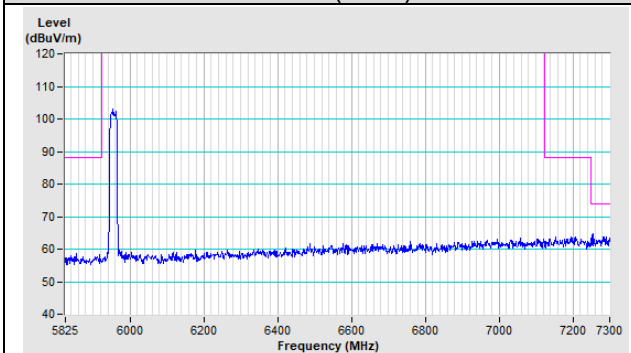

Vertical (Average)

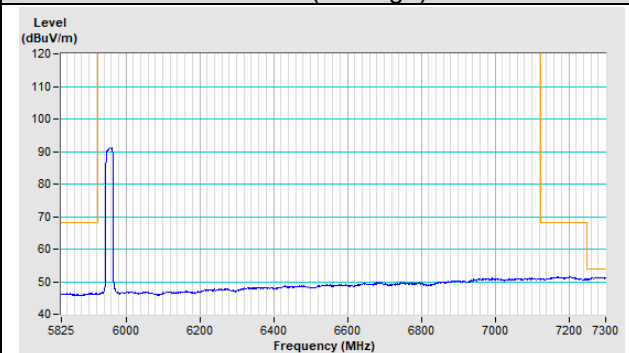

802.11ax (HE20) Channel 233

Horizontal (Peak)

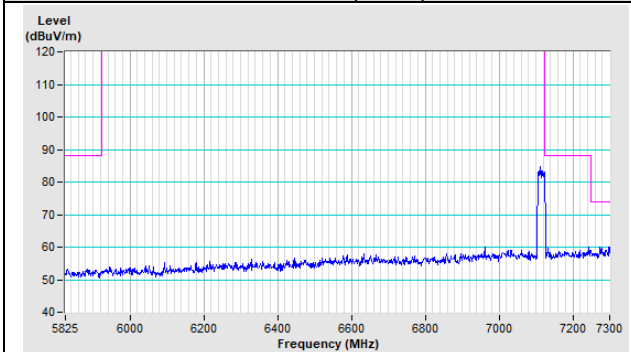

Horizontal (Average)

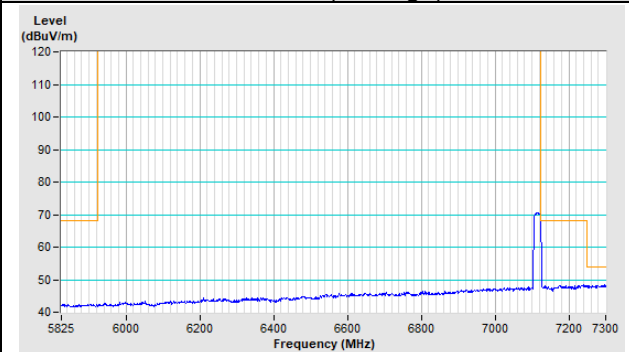

Vertical (Peak)

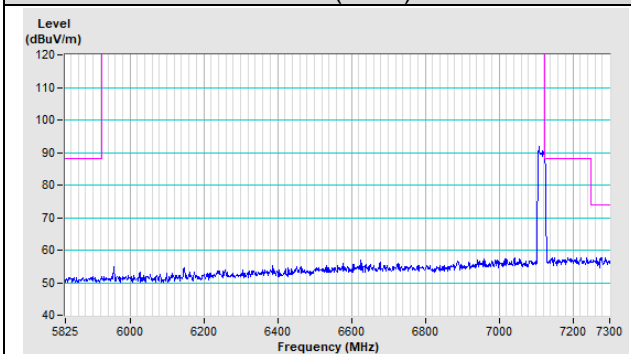

Vertical (Average)

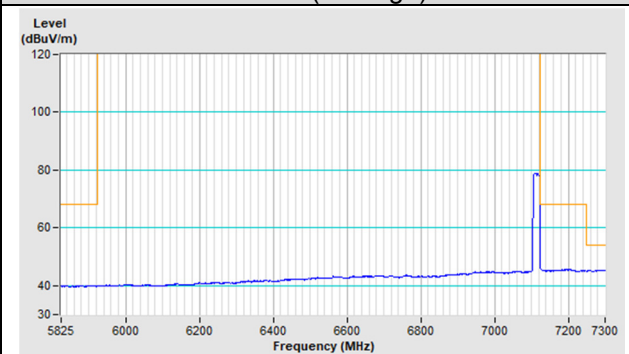

802.11ax (HE40) Channel 3

Horizontal (Peak)

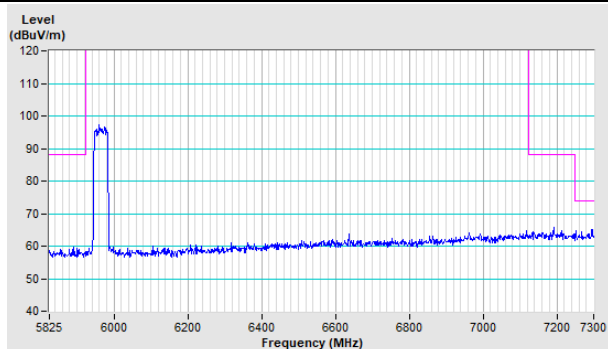

Horizontal (Average)

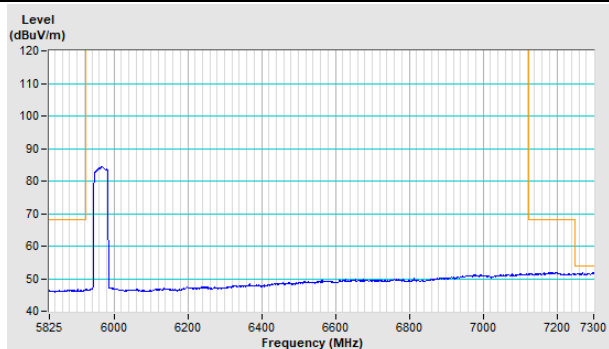

Vertical (Peak)

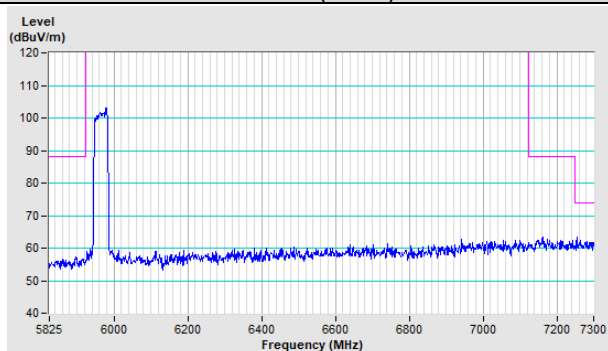

Vertical (Average)

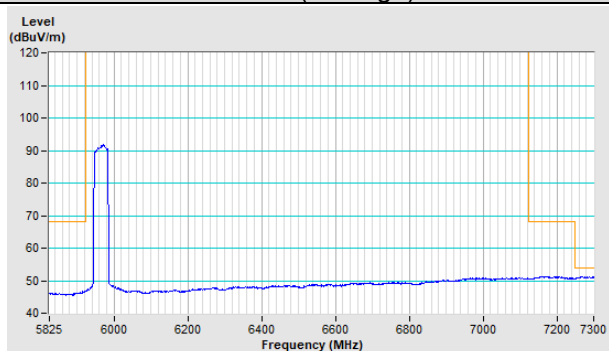

802.11ax (HE40) Channel 227

Horizontal (Peak)

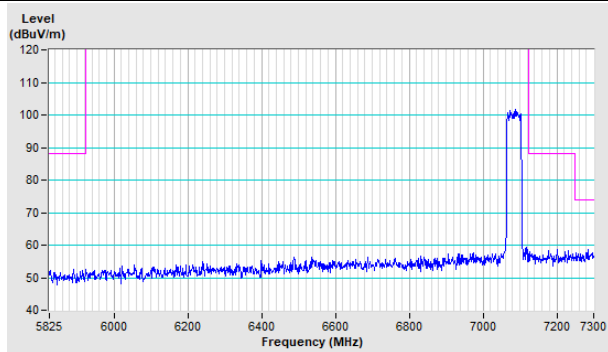

Horizontal (Average)

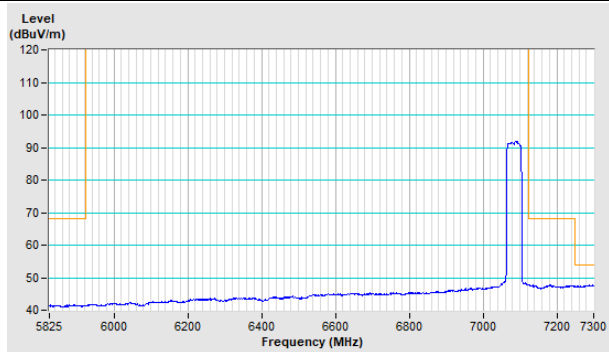

Vertical (Peak)

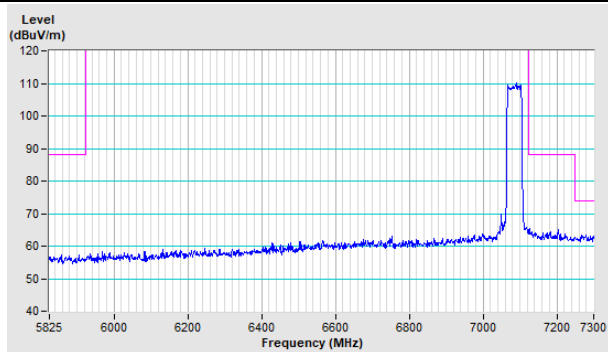

Vertical (Average)

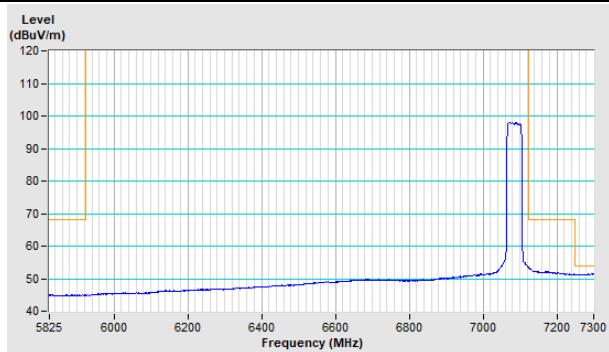

802.11ax (HE80) Channel 7

Horizontal (Peak)

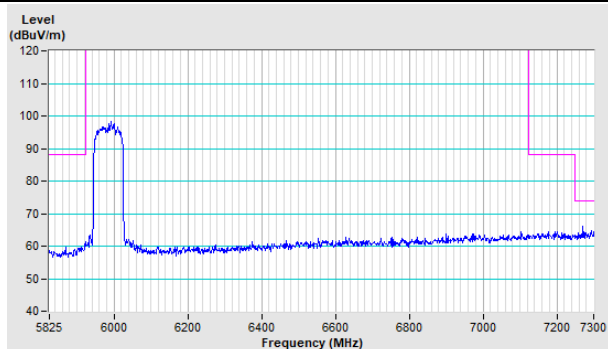

Horizontal (Average)

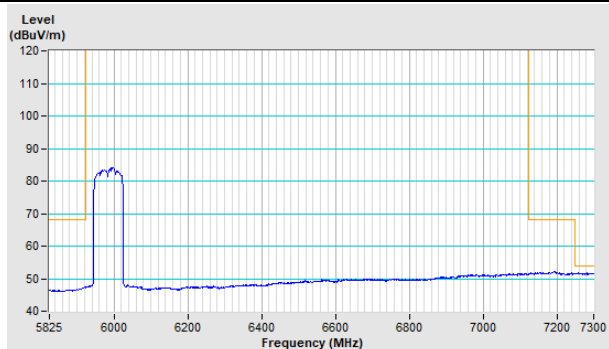

Vertical (Peak)

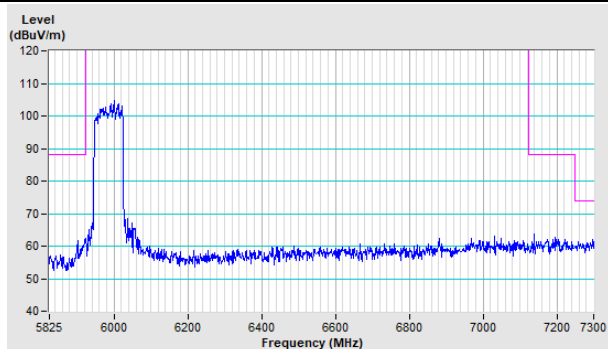

Vertical (Average)

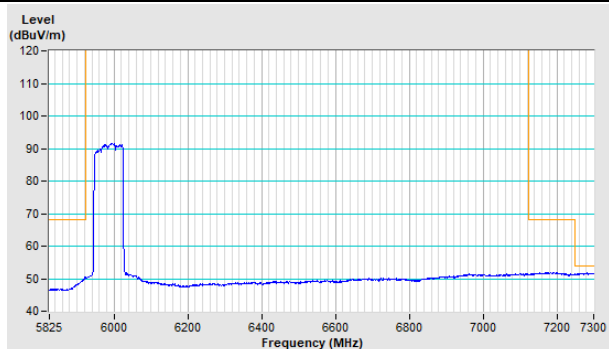

802.11ax (HE80) Channel 215

Horizontal (Peak)

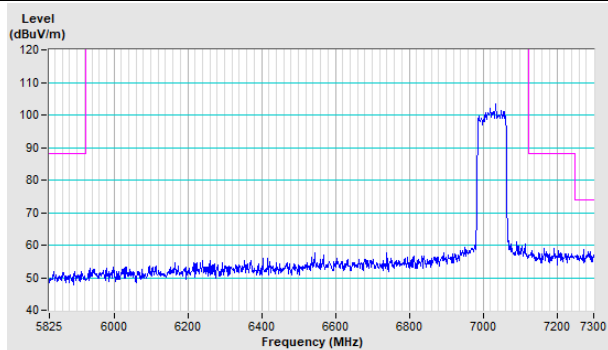

Horizontal (Average)

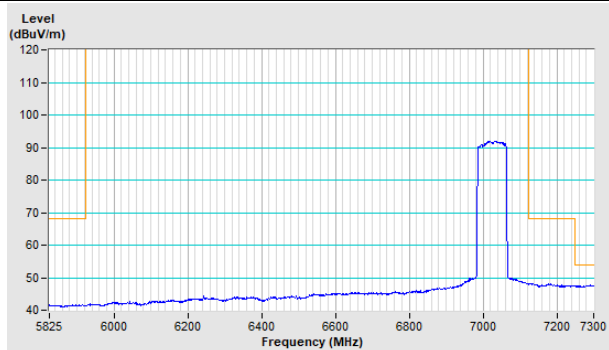

Vertical (Peak)

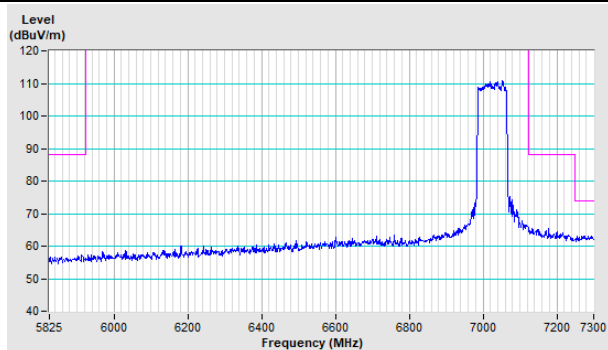

Vertical (Average)

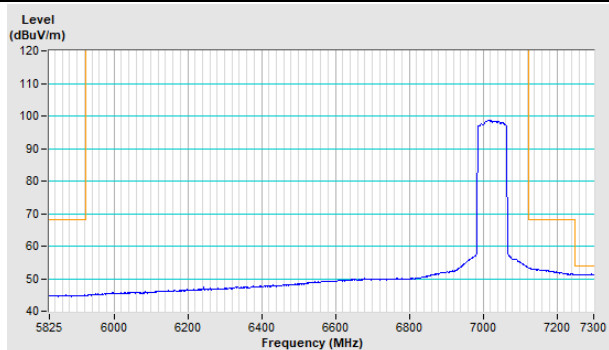

802.11ax (HE160) Channel 15

Horizontal (Peak)

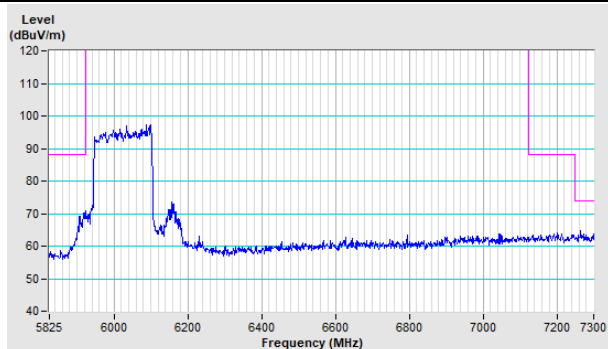

Horizontal (Average)

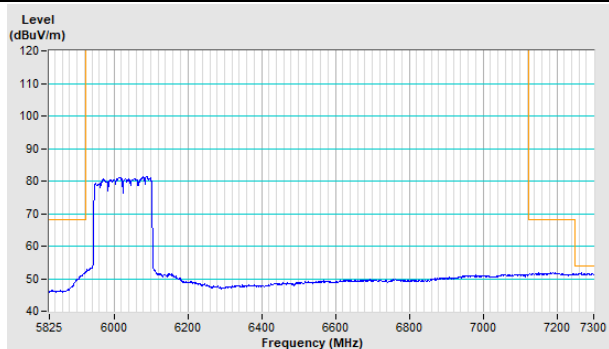

Vertical (Peak)

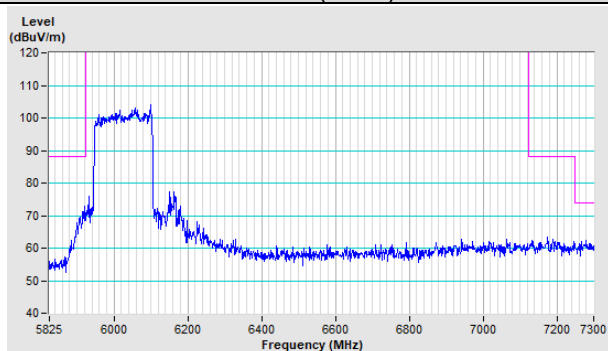

Vertical (Average)

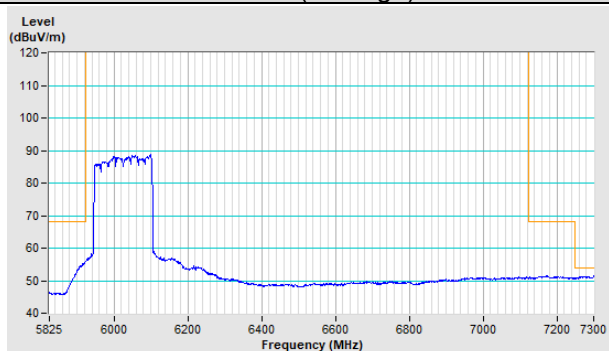

802.11ax (HE160) Channel 207

Horizontal (Peak)

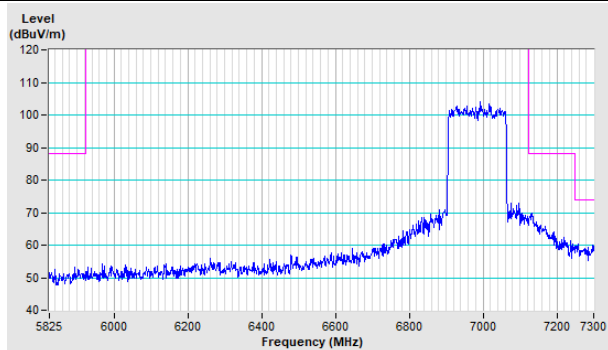

Horizontal (Average)

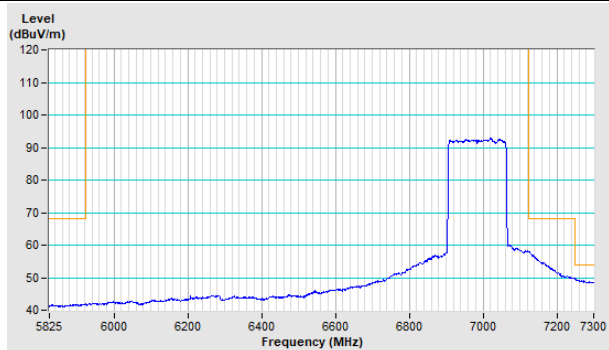

Vertical (Peak)

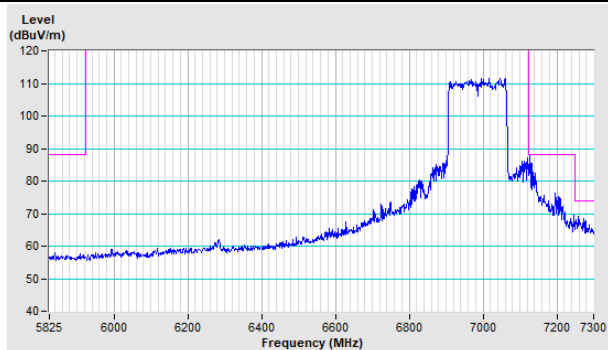

Vertical (Average)

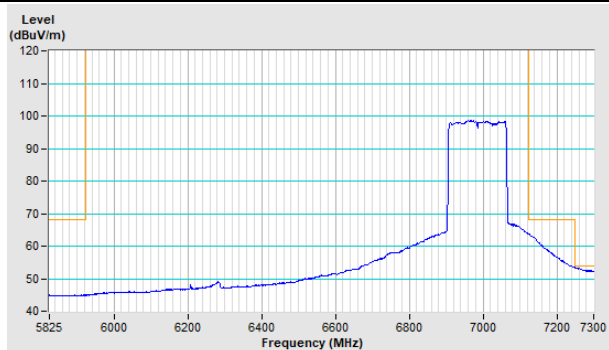

Appendix – Information of the Testing Laboratories

We, Bureau Veritas Consumer Products Services (H.K.) Ltd., Taoyuan Branch, were founded in 1988 to provide our best service in EMC, Radio, Telecom and Safety consultation. Our laboratories are FCC recognized accredited test firms and accredited and approved according to ISO/IEC 17025.

If you have any comments, please feel free to contact us at the following:

Lin Kou EMC/RF Lab

Tel: 886-2-26052180

Fax: 886-2-26051924

Hsin Chu EMC/RF/Telecom Lab

Tel: 886-3-6668565

Fax: 886-3-6668323

Hwa Ya EMC/RF/Safety

Tel: 886-3-3183232

Fax: 886-3-3270892

Email: service.adt@tw.bureauveritas.com

Web Site: www.bureauveritas-adt.com

The address and road map of all our labs can be found in our web site also.

--- END ---