

FCC Test Report (U-NII-4 Band)

Report No.: RFBBQZ-WTW-P21123590-2

FCC ID: PY321300543

Test Model: WAX615

Received Date: Nov. 11, 2021

Test Date: Nov. 16, 2021 ~ Jan. 20, 2022

Issued Date: Jan. 20, 2022

Applicant and Manufacturer: NETGEAR, INC.

Address: 350 East Plumeria Drive, San Jose, CA 95134, USA

Issued By: Bureau Veritas Consumer Products Services (H.K.) Ltd., Taoyuan Branch
Lin Kou Laboratories

Lab Address: No. 47-2, 14th Ling, Chia Pau Vil., Lin Kou Dist., New Taipei City, Taiwan

Test Location: No. 19, Hwa Ya 2nd Rd., Wen Hwa Vil., Kwei Shan Dist., Taoyuan City
33383, Taiwan

**FCC Registration /
Designation Number:** 788550 / TW0003



This report is for your exclusive use. Any copying or replication of this report to or for any other person or entity, or use of our name or trademark, is permitted only with our prior written permission. This report sets forth our findings solely with respect to the test samples identified herein. The results set forth in this report are not indicative or representative of the quality or characteristics of the lot from which a test sample was taken or any similar or identical product unless specifically and expressly noted. Our report includes all of the tests requested by you and the results thereof based upon the information that you provided to us. You have 60 days from date of issuance of this report to notify us of any material error or omission caused by our negligence, provided, however, that such notice shall be in writing and shall specifically address the issue you wish to raise. A failure to raise such issue within the prescribed time shall constitute your unqualified acceptance of the completeness of this report, the tests conducted and the correctness of the report contents. Unless specific mention, the uncertainty of measurement has been explicitly taken into account to declare the compliance or non-compliance to the specification.

Table of Contents

Release Control Record	4
1 Certificate of Conformity	5
2 Summary of Test Results	6
2.1 Measurement Uncertainty.....	6
2.2 Modification Record.....	6
3 General Information	7
3.1 General Description of EUT.....	7
3.2 Description of Test Modes.....	9
3.2.1 Test Mode Applicability and Tested Channel Detail.....	10
3.3 Duty Cycle of Test Signal.....	12
3.4 Description of Support Units.....	13
3.4.1 Configuration of System under Test.....	13
3.5 General Description of Applied Standard.....	14
4 Test Types and Results	15
4.1 Radiated Emission and Bandedge Measurement.....	15
4.1.1 Limits of Radiated Emission and Bandedge Measurement.....	15
4.1.2 Test Instruments.....	16
4.1.3 Test Procedure.....	17
4.1.4 Test Setup.....	18
4.1.5 EUT Operating Condition.....	19
4.1.6 Test Results.....	20
4.2 Conducted Emission Measurement.....	34
4.2.1 Limits of Conducted Emission Measurement.....	34
4.2.2 Test Instruments.....	34
4.2.3 Test Procedure.....	35
4.2.4 Test Setup.....	35
4.2.5 EUT Operating Condition.....	35
4.2.6 Test Results.....	36
4.3 Transmit Power Measurement.....	40
4.3.1 Limits of Transmit Power Measurement.....	40
4.3.2 Test Setup.....	40
4.3.3 Test Instruments.....	40
4.3.4 Test Procedure.....	41
4.3.5 EUT Operating Condition.....	41
4.3.6 Test Result.....	42
4.4 6dB Bandwidth Measurement.....	46
4.4.1 Limits of Emission Bandwidth Measurement.....	46
4.4.2 Test Setup.....	46
4.4.3 Test Instruments.....	46
4.4.4 Test Procedure.....	46
4.4.5 Test Results.....	47
4.5 Peak Power Spectral Density Measurement.....	49
4.5.1 Limits of Peak Power Spectral Density Measurement.....	49
4.5.2 Test Setup.....	49
4.5.3 Test Instruments.....	49
4.5.4 Test Procedure.....	50
4.5.5 EUT Operating Condition.....	50
4.5.6 Test Results.....	51
4.6 Frequency Stability Measurement.....	53
4.6.1 Limits of Frequency Stability Measurement.....	53
4.6.2 Test Setup.....	53
4.6.3 Test Instruments.....	53
4.6.4 Test Procedure.....	53

4.6.5 EUT Operating Condition	53
4.6.6 Test Results	54
4.7 Operational Restrictions for U-NII 4 Devices	55
4.7.1 Limits of Operational Restrictions for U-NII 4 Devices	55
4.7.2 Test Setup	55
4.7.3 Test Instruments	55
4.7.4 Test Procedure	55
4.7.5 Test Results	55
5 Pictures of Test Arrangements	56
Annex A – Band Edge Measurement	57
Appendix – Information of the Testing Laboratories	61



Release Control Record

Issue No.	Description	Date Issued
RFBBQZ-WTW-P21123590-2	Original release	Jan. 20, 2022

1 Certificate of Conformity

Product: Insight Managed AX3000 WiFi 6 Access Point

Brand: NETGEAR

Test Model: WAX615

Sample Status: Engineering sample

Applicant and Manufacturer: NETGEAR, INC.

Test Date: Nov. 16, 2021 ~ Jan. 20, 2022

Standard: 47 CFR FCC Part 15, Subpart E (Section 15.407)
ANSI C63.10: 2013

The above equipment has been tested by **Bureau Veritas Consumer Products Services (H.K.) Ltd., Taoyuan Branch**, and found compliance with the requirement of the above standards. The test record, data evaluation & Equipment Under Test (EUT) configurations represented herein are true and accurate accounts of the measurements of the sample's EMC characteristics under the conditions specified in this report.

Prepared by : , **Date:** Jan. 20, 2022
Polly Chien / Specialist

Approved by : , **Date:** Jan. 20, 2022
Jeremy Lin / Project Engineer

2 Summary of Test Results

47 CFR FCC Part 15, Subpart E (Section 15.407)			
FCC Clause	Test Item	Result	Remarks
15.407(b)(9)	AC Power Conducted Emissions	Pass	Meet the requirement of limit. Minimum passing margin is -9.77dB at 0.17737MHz.
15.407(b)(5)(9)	Radiated Emissions	Pass	Meet the requirement of limit. Minimum passing margin is 5643.10dB at -0.6MHz.
15.407(a)(3)	Max Average Transmit Power	Pass	Meet the requirement of limit.
15.407(a)(3)	Peak Power Spectral Density	Pass	Meet the requirement of limit.
15.407(e)	6dB Bandwidth Measurement	Pass	Meet the requirement of limit.
15.407(g)	Frequency Stability	Pass	Meet the requirement of limit.
15.403	Operational restrictions U-NII 4 devices	Pass	Declaration by applicant
15.203 or 15.403	Antenna Requirement	Pass	Antenna connector are IPEX not a standard connector.

Note:

Determining compliance based on the results of the compliance measurement, not taking into account measurement instrumentation uncertainty.

2.1 Measurement Uncertainty

Where relevant, the following measurement uncertainty levels have been estimated for tests performed on the EUT as specified in CISPR 16-4-2:

Measurement	Frequency	Expanded Uncertainty (k=2) (±)
Conducted Emissions at mains ports	150kHz ~ 30MHz	2.79 dB
Radiated Emissions up to 1 GHz	9kHz ~ 30MHz	3.04 dB
	30MHz ~ 200MHz	3.63 dB
	200MHz ~ 1000MHz	3.64 dB
Radiated Emissions above 1 GHz	1GHz ~ 18GHz	2.29 dB
	18GHz ~ 40GHz	2.29 dB

2.2 Modification Record

There were no modifications required for compliance.

3 General Information

3.1 General Description of EUT

Product	Insight Managed AX3000 WiFi 6 Access Point
Brand	NETGEAR
Test Model	WAX615
Status of EUT	Engineering sample
Power Supply Rating	12Vdc from adapter 54Vdc from PoE
Modulation Type	256QAM, 64QAM, 16QAM, QPSK, BPSK for OFDM 1024QAM, 256QAM, 64QAM, 16QAM, QPSK, BPSK for OFDMA
Modulation Technology	OFDM, OFDMA
Transfer Rate	802.11a: up to 54 Mbps 802.11n: up to 300 Mbps 802.11ac: up to 1733.3Mbps 802.11ax: up to 2401.9Mbps
Operating Frequency	5.845 ~ 5.885 GHz
Number of Channel	802.11a, 802.11n (HT20), 802.11ac (VHT20), 802.11ax (HE20): 3 802.11n (HT40), 802.11ac (VHT40), 802.11ax (HE40): 2 802.11ac (VHT80), 802.11ax (HE80): 1 802.11ac (VHT160), 802.11ax (HE160): 1
EIRP	CDD Mode: 31.17 dBm (1309.182 mW) Beamforming Mode: 32.67 dBm (1849.269 mW)
Antenna Type	Refer to note
Antenna Connector	Refer to note
Accessory Device	Refer to note
Cable Supplied	NA

Note:

- The EUT incorporates a MIMO function. Physically, the EUT provides two completed transmitters and two receivers.

Modulation Mode	Beamforming Mode	TX Function
802.11a	Not Support	2TX
802.11n (HT20)	Not Support	2TX
802.11n (HT40)	Not Support	2TX
802.11ac (VHT20)	Support	2TX
802.11ac (VHT40)	Support	2TX
802.11ac (VHT80)	Support	2TX
802.11ac (VHT160)	Support	2TX
802.11ax (HE20)	Support	2TX
802.11ax (HE40)	Support	2TX
802.11ax (HE80)	Support	2TX
802.11ax (HE160)	Support	2TX

* The bandwidth and modulation are similar for 802.11n mode for 20MHz (40MHz), 802.11ac mode for 20MHz (40MHz, 80MHz, 160MHz) and 802.11ax mode for 20MHz (40MHz, 80MHz, 160MHz). Therefore the investigated worst case is the representative mode in test report. (Final test mode refer section 3.2.1)

* For 802.11n and 802.11ac/ax, CDD mode and Beamforming mode are presented in power output test item. For other test items, Beamforming mode is the worst case for final tests after pretesting. All models are listed as below.

2. The EUT consumes power from the following adapters and POE.

Adapter 1	
Brand	Netgear
Model	ADS-40FPA-12 12030EPCU-L ADS-40FPA-12 12030EPC-L
P/N	332-11584-02
Input Power	100-120Vac ~60Hz Max. 1A
Output Power	12Vdc, 2.5A
Power line	1.8m cable without core

Adapter 2	
Brand	Netgear
Model	AD2067F10
P/N	332-10944-02
Input Power	100-120Vac ~50/60Hz Max. 1A
Output Power	12Vdc, 2.5A
Power line	1.8m cable without core

* Adapter 1 was chosen for final test and presented in the test report.

POE (for support unit only)	
Brand	Netgear
Model	GS524UP
Input Power	100–240Vac, 50–60Hz, 8–4A
Output Power	480W

3. The Antenna information is listed as below.

ANT. No.	Type	Connector	Frequency Range	Gain (dBi)
5G_0	Dipole	IPEX	5850~5895MHz	2.89
5G_1	Dipole	IPEX	5850~5895MHz	2.83

* The above Antenna information is declared by manufacturer and for more detailed features description, please refer to the manufacturer's specifications, the laboratory shall not be held responsible.

4. WLAN 2.4GHz & WLAN 5GHz technology can transmit at same time.

3.2 Description of Test Modes

U-NII-4 (5845 ~ 5885MHz)

3 channels are provided for 802.11a, 802.11n (HT20), 802.11ac (VHT20), 802.11ax (HE20):

Channel	Frequency	Channel	Frequency	Channel	Frequency
*169	5845 MHz	173	5865 MHz	177	5885 MHz

2 channels are provided for 802.11n (HT40), 802.11ac (VHT40), 802.11ax (HE40):

Channel	Frequency	Channel	Frequency
*167	5835 MHz	175	5875 MHz

1 channel is provided for 802.11ac (VHT80), 802.11ax (HE80):

Channel	Frequency
*171	5855 MHz

1 channel is provided for 802.11ac (VHT160), 802.11ax (HE160):

Channel	Frequency
*163	5815 MHz

Note: * Straddle channels.

3.2.1 Test Mode Applicability and Tested Channel Detail

EUT Configure Mode	Applicable To					Description
	RE \geq 1G	RE<1G	IBE	PLC	APCM	
A	√	√	√	√	√	Powered by adpater
B	-	√	-	√	-	Powered by POE

Where **RE \geq 1G**: Radiated Emission above 1GHz **RE<1G**: Radiated Emission below 1GHz
PLC: Power Line Conducted Emission **APCM**: Antenna Port Conducted Measurement
IBE: In-Band Emission (MASK)

Note:

1. The EUT had been pre-tested on the positioned of each 3 axis. The worst case was found when positioned on **X-plane**.
2. "-": Means no effect.
3. Radiated emission test (below 1GHz) and power line conducted emission test items chosen the worst maximum power.

Radiated Emission Measurement (Above 1GHz):

- Pre-Scan has been conducted to determine the worst-case mode from all possible combinations between available modulations, data rates and antenna ports (if EUT with antenna diversity architecture).
- Following channel(s) was (were) selected for the final test as listed below.

EUT Configure Mode	Mode	FREQ. Band (MHz)	Available Channel	Tested Channel	Modulation Technology	Modulation Type	Data Rate Parameter
A	802.11a	5845-5885	169 to 177	169, 173, 177	OFDM	BPSK	6Mb/s
A	802.11ax (HE20)	5845-5885	169 to 177	169, 173, 177	OFDMA	BPSK	MCS0
A	802.11ax (HE40)	5835-5875	167 to 175	167, 175	OFDMA	BPSK	MCS0
A	802.11ax (HE80)	5855-5855	171	171	OFDMA	BPSK	MCS0
A	802.11ax (HE160)	5815-5815	163	163	OFDMA	BPSK	MCS0

Radiated Emission Measurement (Below 1GHz):

- Pre-Scan has been conducted to determine the worst-case mode from all possible combinations between available modulations, data rates and antenna ports (if EUT with antenna diversity architecture).
- Following channel(s) was (were) selected for the final test as listed below.

EUT Configure Mode	Mode	FREQ. Band (MHz)	Available Channel	Tested Channel	Modulation Technology	Modulation Type	Data Rate Parameter
A, B	802.11ax (HE20)	5845-5885	169 to 177	173	OFDMA	BPSK	MCS0

Power Line Conducted Emission Measurement:

- Pre-Scan has been conducted to determine the worst-case mode from all possible combinations between available modulations, data rates and antenna ports (if EUT with antenna diversity architecture).
- Following channel(s) was (were) selected for the final test as listed below.

EUT Configure Mode	Mode	FREQ. Band (MHz)	Available Channel	Tested Channel	Modulation Technology	Modulation Type	Data Rate Parameter
A, B	802.11ax (HE20)	5845-5885	169 to 177	173	OFDMA	BPSK	MCS0

Antenna Port Conducted Measurement:

- This item includes all test value of each mode, but only includes spectrum plot of worst value of each mode.
- Pre-Scan has been conducted to determine the worst-case mode from all possible combinations between available modulations, data rates and antenna ports (if EUT with antenna diversity architecture).
- Following channel(s) was (were) selected for the final test as listed below.

EUT Configure Mode	Mode	FREQ. Band (MHz)	Available Channel	Tested Channel	Modulation Technology	Modulation Type	Data Rate Parameter
A	802.11a	5845-5885	169 to 177	169, 173, 177	OFDM	BPSK	6Mb/s
A	802.11ax (HE20)	5845-5885	169 to 177	169, 173, 177	OFDMA	BPSK	MCS0
A	802.11ax (HE40)	5835-5875	167 to 175	167, 175	OFDMA	BPSK	MCS0
A	802.11ax (HE80)	5855-5855	171	171	OFDMA	BPSK	MCS0
A	802.11ax (HE160)	5815-5815	163	163	OFDMA	BPSK	MCS0

Test Condition:

Applicable To	Environmental Conditions	Input Power (System)	Tested By
RE \geq 1G	23 deg. C, 66% RH	120Vac, 60Hz	Titan Hsu
RE<1G	23 deg. C, 66% RH	120Vac, 60Hz,	Titan Hsu
PLC	25 deg. C, 70% RH	120Vac, 60Hz,	Tank Wu
APCM	25 deg. C, 60% RH	120Vac, 60Hz	Ivan Tseng

3.3 Duty Cycle of Test Signal

Duty cycle of test signal is < 98 %, duty factor is required

802.11a: Duty cycle = $1.966/2.093 = 0.939$, Duty factor = $10 * \log(1/0.939) = 0.27$

802.11ax (HE20): Duty cycle = $5.416/5.948 = 0.911$, Duty factor = $10 * \log(1/0.911) = 0.41$

802.11ax (HE40): Duty cycle = $5.416/5.999 = 0.903$, Duty factor = $10 * \log(1/0.903) = 0.44$

802.11ax (HE80): Duty cycle = $5.425/5.934 = 0.914$, Duty factor = $10 * \log(1/0.914) = 0.39$

802.11ax (HE160): Duty cycle = $5.411/5.975 = 0.906$, Duty factor = $11 * \log(1/0.906) = 0.43$



3.4 Description of Support Units

The EUT has been tested as an independent unit together with other necessary accessories or support units. The following support units or accessories were used to form a representative test configuration during the tests.

ID	Product	Brand	Model No.	Serial No.	FCC ID	Remarks
A.	Notebook	DELL	E5430	2RL3YW1	FCC DoC Approved	-
B.	PoE	Netgear	GS524UP	NA	NA	Provided by client

Note:

1. All power cords of the above support units are non-shielded (1.8m).
2. Item A acted as a communication partner to transfer data.

ID	Cable Descriptions	Qty.	Length (m)	Shielding (Yes/No)	Cores (Qty.)	Remarks
1.	LAN cable	1	1.5	N	0	RJ45, Cat5e
2.	LAN cable	1	7	N	0	RJ45, Cat5e

3.4.1 Configuration of System under Test

Mode A

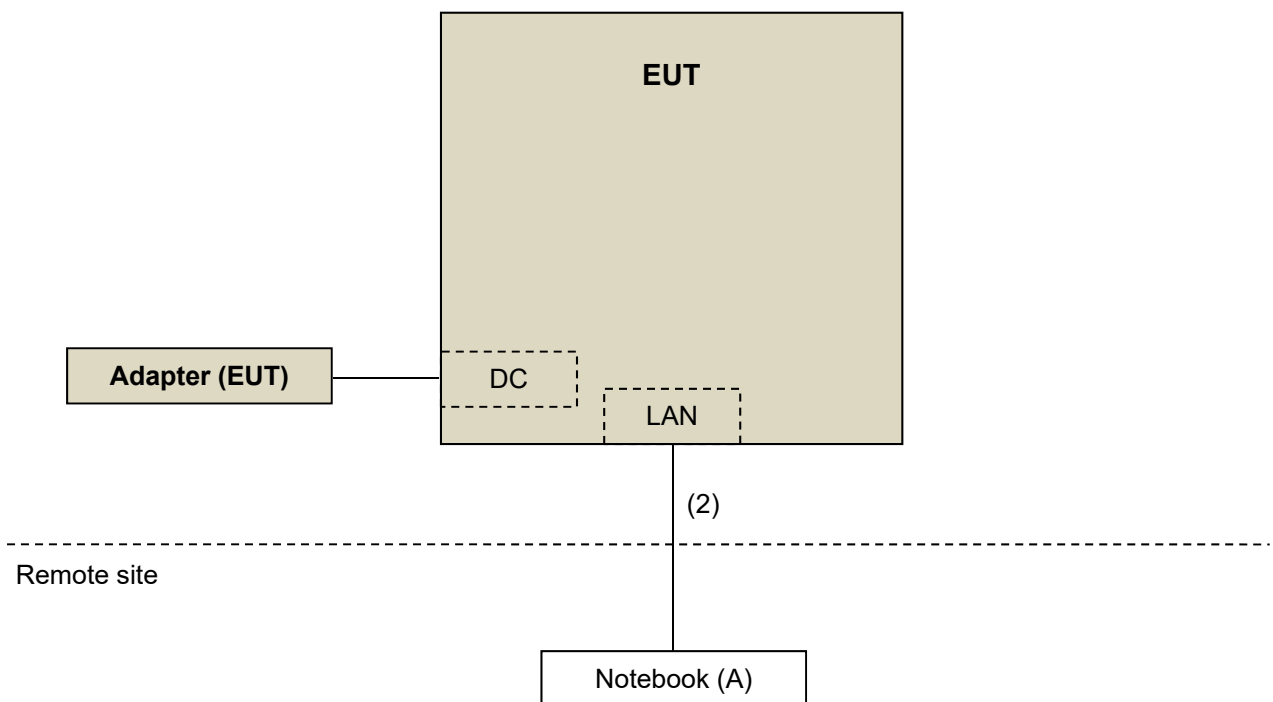

Mode B

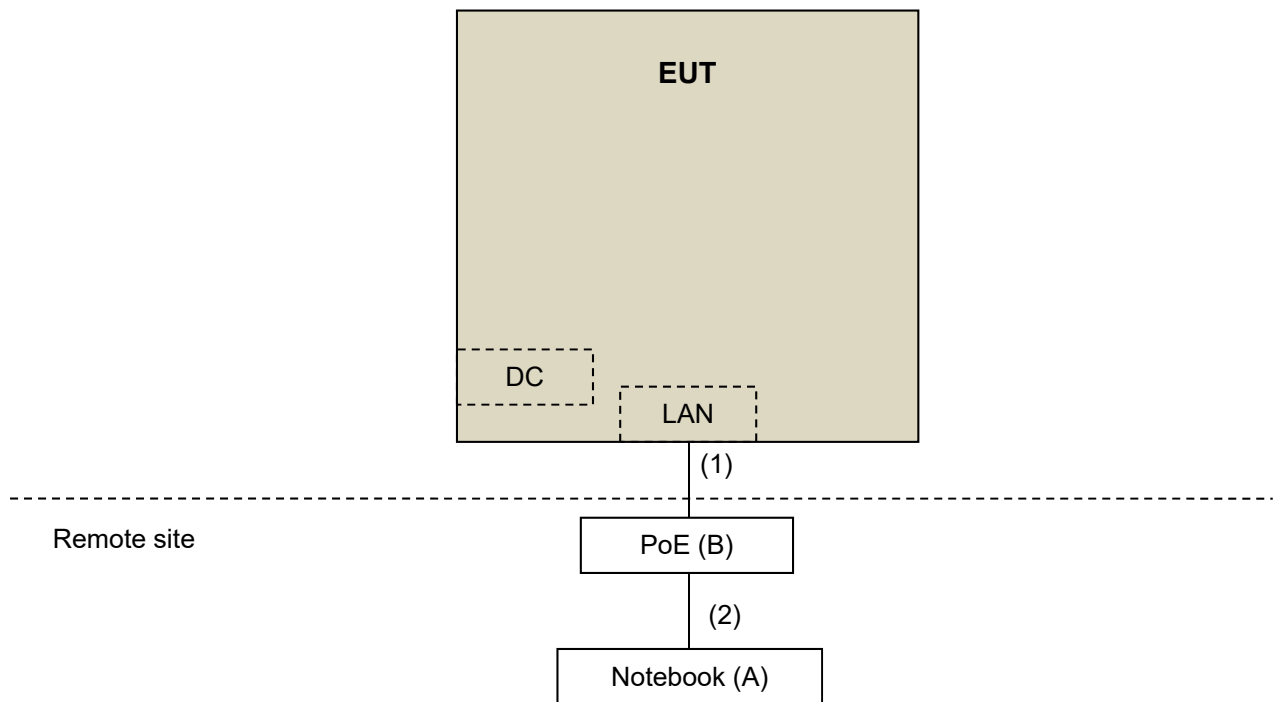

3.5 General Description of Applied Standard

The EUT is a RF Product. According to the specifications of the manufacturer, it must comply with the requirements of the following standards and references:

Test Standard:

FCC Part 15, Subpart E (15.407)

ANSI C63.10-2013

All test items have been performed and recorded as per the above standards.

References Test Guidance:

KDB 987594 D02 EMC Measurement v01r01

KDB 789033 D02 General UNII Test Procedure New Rules v02r01

KDB 662911 D01 Multiple Transmitter Output v02r01

KDB 291074 D02 EMC Measurement v01

All test items have been performed as a reference to the above KDB test guidance.

4 Test Types and Results

4.1 Radiated Emission and Bandedge Measurement

4.1.1 Limits of Radiated Emission and Bandedge Measurement

Radiated emissions which fall in the restricted bands must comply with the radiated emission limits specified as below table.

Frequencies (MHz)	Field Strength (microvolts/meter)	Measurement Distance (meters)
0.009 ~ 0.490	2400/F(kHz)	300
0.490 ~ 1.705	24000/F(kHz)	30
1.705 ~ 30.0	30	30
30 ~ 88	100	3
88 ~ 216	150	3
216 ~ 960	200	3
Above 960	500	3

NOTE:

1. The lower limit shall apply at the transition frequencies.
2. Emission level (dBuV/m) = 20 log Emission level (uV/m).
3. For frequencies above 1000MHz, the field strength limits are based on average detector, however, the peak field strength of any emission shall not exceed the maximum permitted average limits, specified above by more than 20dB under any condition of modulation.

Limits of unwanted emission out of the restricted bands

(i) For an indoor access point or subordinate device, all emissions at or above 5.895 GHz shall not exceed an e.i.r.p. of 15 dBm/MHz and shall decrease linearly to an e.i.r.p. of -7 dBm/MHz at or above 5.925 GHz.

(ii) For a client device, all emissions at or above 5.895 GHz shall not exceed an e.i.r.p. of -5 dBm/MHz and shall decrease linearly to an e.i.r.p. of -27 dBm/MHz at or above 5.925 GHz.

(iii) For a client device or indoor access point or subordinate device, all emissions below 5.725 GHz shall not exceed an e.i.r.p. of -27 dBm/MHz at 5.65 GHz increasing linearly to 10 dBm/MHz at 5.7 GHz, and from 5.7 GHz increasing linearly to a level of 15.6 dBm/MHz at 5.72 GHz, and from 5.72 GHz increasing linearly to a level of 27 dBm/MHz at 5.725 GHz.

Note:

The following formula is used to convert the equipment isotropic radiated power (eirp) to field strength:

$$E = \frac{1000000\sqrt{30P}}{3} \quad \mu\text{V/m, where P is the eirp (Watts).}$$

4.1.2 Test Instruments

Description & Manufacturer	Model No.	Serial No.	Cal. Date	Cal. Due
Test Receiver ROHDE & SCHWARZ	ESCI	100424	Dec. 31, 2020	Dec. 30, 2021
			Dec. 30, 2021	Dec. 29, 2022
Spectrum Analyzer ROHDE & SCHWARZ	FSP40	100040	Sep. 15, 2021	Sep. 14, 2022
BILOG Antenna SCHWARZBECK	VULB9168	9168-155	Nov. 01, 2021	Oct. 30, 2022
HORN Antenna SCHWARZBECK	BBHA 9120D	9120D-1170	Nov. 22, 2020	Nov. 21, 2021
			Nov. 14, 2021	Nov. 13, 2022
HORN Antenna SCHWARZBECK	BBHA 9170	BBHA9170241	Oct. 26, 2021	Oct. 25, 2022
Loop Antenna TESEQ	HLA 6121	45745	Jul. 21, 2021	Jul. 20, 2022
Preamplifier KEYSIGHT (Above 1GHz)	83017A	MY53270295	Jun. 05, 2021	Jun. 04, 2022
RF Coaxial Cable WOKEN With 5dB PAD	8D-FB	Cable-CH4-01	Jul. 24, 2021	Jul. 23, 2022
RF Coaxial Cable EMCI	EMC102-KM-KM-3000	150929	Jul. 24, 2021	Jul. 23, 2022
RF Coaxial Cable EMCI	EMC102-KM-KM-600	150928	Jul. 24, 2021	Jul. 23, 2022
RF signal cable HUBER+SUHNER	SUCOFLEX 104	MY 13380+295012/04	Jun. 05, 2021	Jun. 04, 2022
RF signal cable HUBER+SUHNER	SUCOFLEX 104	Cable-CH4-03 (250724)	Jun. 05, 2021	Jun. 04, 2022
Software BV ADT	ADT_Radiated_V7.6.15.9.5	NA	NA	NA
Antenna Tower inn-co GmbH	MA 4000	010303	NA	NA
Antenna Tower Controller BV ADT	AT100	AT93021703	NA	NA
Turn Table BV ADT	TT100	TT93021703	NA	NA
Turn Table Controller BV ADT	SC100	SC93021703	NA	NA
Boresight Antenna Fixture	FBA-01	FBA-SIP01	NA	NA
Pre-amplifier (18GHz-40GHz) EMC	EMC184045B	980175	Sep. 04, 2021	Sep. 03, 2022
USB Wideband Power Sensor KEYSIGHT	U2021XA	MY55050005/MY55190004/MY55190007/MY55210005	Jul. 12, 2021	Jul. 11, 2022

- Note: 1. The calibration interval of the above test instruments is 12 months and the calibrations are traceable to NML/ROC and NIST/USA.
 2. The test was performed in HwaYa Chamber 4.

4.1.3 Test Procedure

For Radiated emission below 30MHz

- a. The EUT was placed on the top of a rotating table 0.8 meters above the ground at a 3 meter chamber room. The table was rotated 360 degrees to determine the position of the highest radiation.
- b. The EUT was set 3 meters away from the interference-receiving antenna, which was mounted on the top of a variable-height antenna tower.
- c. Parallel, perpendicular, and ground-parallel orientations of the antenna are set to make the measurement.
- d. For each suspected emission, the EUT was arranged to its worst case and the rotatable table was turned from 0 degrees to 360 degrees to find the maximum reading.
- e. The test-receiver system was set to Quasi-Peak Detect Function and Specified Bandwidth with Maximum Hold Mode.

NOTE:

1. The resolution bandwidth and video bandwidth of test receiver/spectrum analyzer is 9kHz at frequency below 30MHz.

For Radiated emission above 30MHz

- a. The EUT was placed on the top of a rotating table 0.8 meters (for 30MHz ~ 1GHz) / 1.5 meters (for above 1GHz) above the ground at 3 meter chamber room for test. The table was rotated 360 degrees to determine the position of the highest radiation.
- b. The EUT was set 3 meters away from the interference-receiving antenna, which was mounted on the top of a variable-height antenna tower.
- c. The height of antenna is varied from one meter to four meters above the ground to determine the maximum value of the field strength. Both horizontal and vertical polarizations of the antenna are set to make the measurement.
- d. For each suspected emission, the EUT was arranged to its worst case and then the antenna was tuned to heights from 1 meter to 4 meters and the rotatable table was turned from 0 degrees to 360 degrees to find the maximum reading.
- e. The test-receiver system was set to quasi-peak detect function and specified bandwidth with maximum hold mode when the test frequency is below 1 GHz.
- f. The test-receiver system was set to peak detects function and specified bandwidth with maximum hold mode when the test frequency is above 1 GHz. If the peak reading value also meets average limit, measurement with the RMS detector is unnecessary.
- g. When operating in U-NII-4 OOB and spurious emissions are to be measured outside of the 5725-5895 MHz band. Below 5725 MHz the -27 dBm EIRP is measured with a Peak detector and above 5895 MHz it is measured with an RMS detector. If the -27 dBm EIRP limit is met with a Peak detector retesting with an RMS detector is not required.

Note:

1. The resolution bandwidth and video bandwidth of test receiver/spectrum analyzer is 120kHz for Quasi-peak detection (QP) at frequency below 1GHz.
2. The resolution bandwidth of test receiver/spectrum analyzer is 1 MHz and the video bandwidth is 3 MHz for Peak detection (PK) at frequency above 1GHz.
3. The resolution bandwidth of test receiver/spectrum analyzer is 1MHz and the video bandwidth is $\geq 1/T$ (Duty cycle < 98%) or 10Hz (Duty cycle $\geq 98\%$) for Average detection (AV) at frequency above 1GHz. (802.11a: RBW = 1MHz, VBW = 1kHz; 802.11ax (HE20): RBW = 1MHz, VBW = 1kHz; 802.11ax (HE40): RBW = 1MHz, VBW = 1kHz; 802.11ax (HE80): RBW = 1MHz, VBW = 1kHz; 802.11ax (HE160): RBW = 1MHz, VBW = 1kHz)
4. All modes of operation were investigated and the worst-case emissions are reported.

4.1.4 Test Setup

For Radiated emission below 30MHz

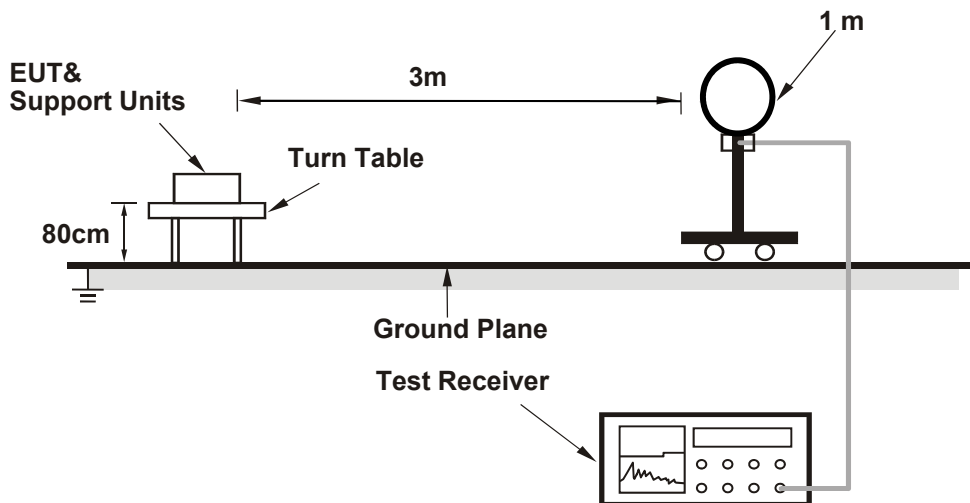

For Radiated emission 30MHz to 1GHz

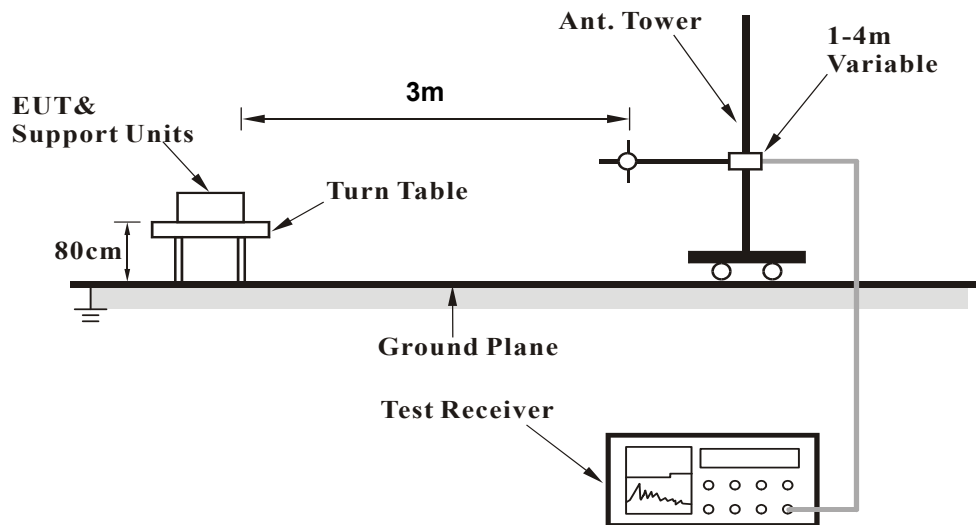

For Radiated emission above 1GHz

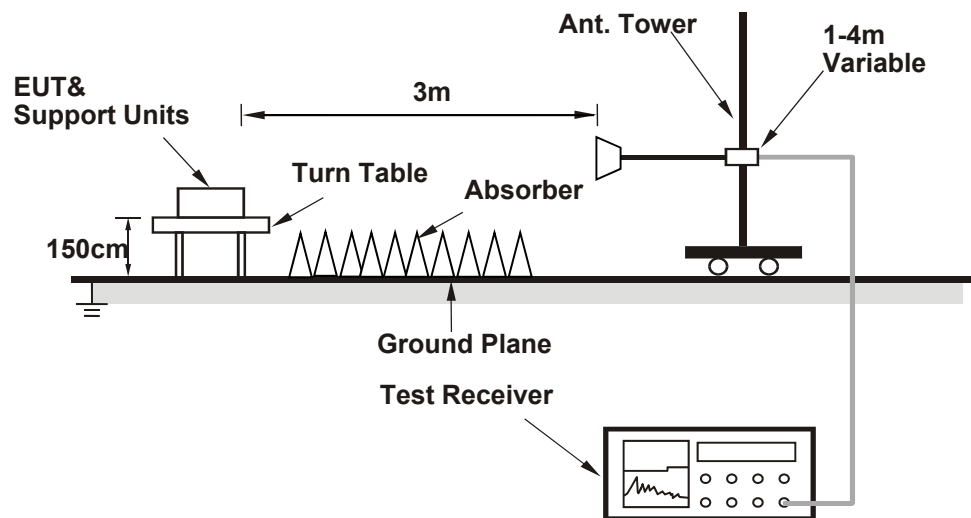

For the actual test configuration, please refer to the attached file (Test Setup Photo).

4.1.5 EUT Operating Condition

- Placed the EUT on the testing table.
- Prepared a notebook to act as a communication partner and placed it outside of testing area.
- The communication partner connected with EUT via a RJ45 cable and ran a test program (provided by manufacturer) to enable EUT under transmission condition continuously at specific channel frequency.

4.1.6 Test Results

Above 1GHz Data:

RF Mode	TX 11a 5.9G	Channel	CH 169 : 5845 MHz
Frequency Range	1GHz ~ 40GHz	Detector Function	Peak (PK) Average (AV)

Antenna Polarity & Test Distance : Horizontal at 3 m								
No	Frequency (MHz)	Emission Level (dBuV/m)	Limit (dBuV/m)	Margin (dB)	Antenna Height (m)	Table Angle (Degree)	Raw Value (dBuV)	Correction Factor (dB/m)
1	#5572.56	62.4 PK	68.2	-5.8	1.07 H	322	49.0	13.4
2	*5845.00	122.4 PK			1.07 H	322	78.6	43.8
3	*5845.00	112.7 AV			1.07 H	322	68.9	43.8
4	#5896.75	61.9 PK	108.9	-47.0	1.07 H	322	47.8	14.1
5	#5940.21	62.6 PK	88.2	-25.6	1.07 H	322	48.4	14.2
6	11690.00	64.0 PK	74.0	-10.0	2.33 H	251	39.5	24.5
7	11690.00	52.1 AV	54.0	-1.9	2.33 H	251	27.6	24.5

Antenna Polarity & Test Distance : Vertical at 3 m								
No	Frequency (MHz)	Emission Level (dBuV/m)	Limit (dBuV/m)	Margin (dB)	Antenna Height (m)	Table Angle (Degree)	Raw Value (dBuV)	Correction Factor (dB/m)
1	#5605.57	59.6 PK	68.2	-8.6	3.72 V	182	46.3	13.3
2	*5845.00	115.0 PK			3.72 V	182	71.2	43.8
3	*5845.00	105.3 AV			3.72 V	182	61.5	43.8
4	#5916.23	60.4 PK	94.6	-34.2	3.72 V	182	46.3	14.1
5	#6016.93	60.5 PK	88.2	-27.7	3.72 V	182	46.3	14.2
6	11690.00	62.7 PK	74.0	-11.3	2.12 V	302	38.2	24.5
7	11690.00	51.0 AV	54.0	-3.0	2.12 V	302	26.5	24.5

Remarks:

1. Emission Level(dBuV/m) = Raw Value(dBuV) + Correction Factor(dB/m)
2. Correction Factor(dB/m) = Antenna Factor(dB/m) + Cable Factor(dB) – Pre-Amplifier Factor(dB)
3. Margin value = Emission Level – Limit value
4. The other emission levels were very low against the limit.
5. " * ": Fundamental frequency.
6. " # ": The radiated frequency is out of the restricted band.

RF Mode	TX 11a 5.9G	Channel	CH 173 : 5865 MHz
Frequency Range	1GHz ~ 40GHz	Detector Function	Peak (PK) Average (AV)

Antenna Polarity & Test Distance : Horizontal at 3 m

No	Frequency (MHz)	Emission Level (dBuV/m)	Limit (dBuV/m)	Margin (dB)	Antenna Height (m)	Table Angle (Degree)	Raw Value (dBuV)	Correction Factor (dB/m)
1	#5648.56	61.0 PK	68.2	-7.2	1.10 H	320	47.7	13.3
2	*5865.00	121.9 PK			1.10 H	320	78.1	43.8
3	*5865.00	112.8 AV			1.10 H	320	69.0	43.8
4	#5903.40	64.9 PK	104.0	-39.1	1.10 H	320	50.8	14.1
5	#6019.54	62.7 PK	88.2	-25.5	1.10 H	320	48.5	14.2
6	11730.00	63.5 PK	74.0	-10.5	2.36 H	253	39.2	24.3
7	11730.00	51.8 AV	54.0	-2.2	2.36 H	253	27.5	24.3

Antenna Polarity & Test Distance : Vertical at 3 m

No	Frequency (MHz)	Emission Level (dBuV/m)	Limit (dBuV/m)	Margin (dB)	Antenna Height (m)	Table Angle (Degree)	Raw Value (dBuV)	Correction Factor (dB/m)
1	#5598.45	60.2 PK	68.2	-8.0	3.72 V	189	46.8	13.3
2	*5865.00	113.8 PK			3.72 V	189	70.0	43.8
3	*5865.00	104.0 AV			3.72 V	189	60.2	43.8
4	#5920.98	59.6 PK	91.1	-31.5	3.72 V	189	45.5	14.1
5	#5946.62	62.0 PK	88.2	-26.2	3.72 V	189	47.8	14.2
6	11730.00	62.3 PK	74.0	-11.7	2.05 V	308	38.0	24.3
7	11730.00	50.5 AV	54.0	-3.5	2.05 V	308	26.2	24.3

Remarks:

1. Emission Level(dBuV/m) = Raw Value(dBuV) + Correction Factor(dB/m)
2. Correction Factor(dB/m) = Antenna Factor(dB/m) + Cable Factor(dB) – Pre-Amplifier Factor(dB)
3. Margin value = Emission Level – Limit value
4. The other emission levels were very low against the limit.
5. " * ": Fundamental frequency.
6. " # ": The radiated frequency is out of the restricted band.

RF Mode	TX 11a 5.9G	Channel	CH 177 : 5885 MHz
Frequency Range	1GHz ~ 40GHz	Detector Function	Peak (PK) Average (AV)

Antenna Polarity & Test Distance : Horizontal at 3 m

No	Frequency (MHz)	Emission Level (dBuV/m)	Limit (dBuV/m)	Margin (dB)	Antenna Height (m)	Table Angle (Degree)	Raw Value (dBuV)	Correction Factor (dB/m)
1	#5648.56	61.0 PK	68.2	-7.2	1.10 H	320	47.7	13.3
2	*5885.00	122.0 PK			1.20 H	322	78.2	43.8
3	*5885.00	112.6 AV			1.20 H	322	68.8	43.8
4	#5903.40	64.9 PK	104.0	-39.1	1.10 H	320	50.8	14.1
5	#6019.54	62.7 PK	88.2	-25.5	1.10 H	320	48.5	14.2
6	11770.00	63.6 PK	74.0	-10.4	2.32 H	249	39.4	24.2
7	11770.00	51.7 AV	54.0	-2.3	2.32 H	249	27.5	24.2

Antenna Polarity & Test Distance : Vertical at 3 m

No	Frequency (MHz)	Emission Level (dBuV/m)	Limit (dBuV/m)	Margin (dB)	Antenna Height (m)	Table Angle (Degree)	Raw Value (dBuV)	Correction Factor (dB/m)
1	#5598.45	60.2 PK	68.2	-8.0	3.72 V	189	46.8	13.3
2	*5885.00	112.6 PK			3.85 V	203	68.8	43.8
3	*5885.00	103.0 AV			3.85 V	203	59.2	43.8
4	#5920.98	59.6 PK	91.1	-31.5	3.72 V	189	45.5	14.1
5	#5946.62	62.0 PK	88.2	-26.2	3.72 V	189	47.8	14.2
6	11770.00	62.8 PK	74.0	-11.2	2.08 V	311	38.6	24.2
7	11770.00	50.5 AV	54.0	-3.5	2.08 V	311	26.3	24.2

Remarks:

1. Emission Level(dBuV/m) = Raw Value(dBuV) + Correction Factor(dB/m)
2. Correction Factor(dB/m) = Antenna Factor(dB/m) + Cable Factor(dB) – Pre-Amplifier Factor(dB)
3. Margin value = Emission Level – Limit value
4. The other emission levels were very low against the limit.
5. " * ": Fundamental frequency.
6. " # ": The radiated frequency is out of the restricted band.

RF Mode	TX 802.11ax (HE20)	Channel	CH 169 : 5845 MHz
Frequency Range	1GHz ~ 40GHz	Detector Function	Peak (PK) Average (AV)

Antenna Polarity & Test Distance : Horizontal at 3 m

No	Frequency (MHz)	Emission Level (dBuV/m)	Limit (dBuV/m)	Margin (dB)	Antenna Height (m)	Table Angle (Degree)	Raw Value (dBuV)	Correction Factor (dB/m)
1	#5594.89	61.4 PK	68.2	-6.8	1.01 H	317	48.1	13.3
2	*5845.00	124.3 PK			1.01 H	317	80.5	43.8
3	*5845.00	113.0 AV			1.01 H	317	69.2	43.8
4	#5899.60	64.0 PK	106.8	-42.8	1.01 H	317	50.0	14.0
5	#5955.89	62.0 PK	88.2	-26.2	1.01 H	317	47.8	14.2
6	11690.00	64.2 PK	74.0	-9.8	2.31 H	246	39.7	24.5
7	11690.00	52.0 AV	54.0	-2.0	2.31 H	246	27.5	24.5

Antenna Polarity & Test Distance : Vertical at 3 m

No	Frequency (MHz)	Emission Level (dBuV/m)	Limit (dBuV/m)	Margin (dB)	Antenna Height (m)	Table Angle (Degree)	Raw Value (dBuV)	Correction Factor (dB/m)
1	#5573.27	60.3 PK	68.2	-7.9	3.63 V	234	47.0	13.3
2	*5845.00	117.6 PK			3.63 V	234	73.8	43.8
3	*5845.00	106.7 AV			3.63 V	234	62.9	43.8
4	#5914.80	60.0 PK	95.7	-35.7	3.63 V	234	46.0	14.0
5	#5949.95	61.1 PK	88.2	-27.1	3.63 V	234	46.9	14.2
6	11690.00	63.0 PK	74.0	-11.0	2.05 V	307	38.5	24.5
7	11690.00	51.2 AV	54.0	-2.8	2.05 V	307	26.7	24.5

Remarks:

1. Emission Level(dBuV/m) = Raw Value(dBuV) + Correction Factor(dB/m)
2. Correction Factor(dB/m) = Antenna Factor(dB/m) + Cable Factor(dB) – Pre-Amplifier Factor(dB)
3. Margin value = Emission Level – Limit value
4. The other emission levels were very low against the limit.
5. " * ": Fundamental frequency.
6. " # ": The radiated frequency is out of the restricted band.

RF Mode	TX 802.11ax (HE20)	Channel	CH 173 : 5865 MHz
Frequency Range	1GHz ~ 40GHz	Detector Function	Peak (PK) Average (AV)

Antenna Polarity & Test Distance : Horizontal at 3 m

No	Frequency (MHz)	Emission Level (dBuV/m)	Limit (dBuV/m)	Margin (dB)	Antenna Height (m)	Table Angle (Degree)	Raw Value (dBuV)	Correction Factor (dB/m)
1	#5565.20	60.8 PK	68.2	-7.4	1.36 H	318	47.4	13.4
2	*5865.00	124.0 PK			1.36 H	318	80.2	43.8
3	*5865.00	113.0 AV			1.36 H	318	69.2	43.8
4	#5898.18	74.6 PK	107.9	-33.3	1.36 H	318	60.6	14.0
5	#6000.30	61.8 PK	88.2	-26.4	1.36 H	318	47.6	14.2
6	11730.00	63.6 PK	74.0	-10.4	2.33 H	249	39.3	24.3
7	11730.00	51.9 AV	54.0	-2.1	2.33 H	249	27.6	24.3

Antenna Polarity & Test Distance : Vertical at 3 m

No	Frequency (MHz)	Emission Level (dBuV/m)	Limit (dBuV/m)	Margin (dB)	Antenna Height (m)	Table Angle (Degree)	Raw Value (dBuV)	Correction Factor (dB/m)
1	#5588.00	59.9 PK	68.2	-8.3	3.69 V	352	46.5	13.4
2	*5865.00	116.8 PK			3.69 V	252	73.0	43.8
3	*5865.00	106.2 AV			3.69 V	252	62.4	43.8
4	#5919.55	58.7 PK	92.2	-33.5	3.69 V	252	44.7	14.0
5	#6012.65	61.3 PK	88.2	-26.9	3.69 V	252	47.1	14.2
6	11730.00	62.9 PK	74.0	-11.1	2.15 V	312	38.6	24.3
7	11730.00	51.1 AV	54.0	-2.9	2.15 V	312	26.8	24.3

Remarks:

1. Emission Level(dBuV/m) = Raw Value(dBuV) + Correction Factor(dB/m)
2. Correction Factor(dB/m) = Antenna Factor(dB/m) + Cable Factor(dB) – Pre-Amplifier Factor(dB)
3. Margin value = Emission Level – Limit value
4. The other emission levels were very low against the limit.
5. " * ": Fundamental frequency.
6. " # ": The radiated frequency is out of the restricted band.

RF Mode	TX 802.11ax (HE20)	Channel	CH 177 : 5885 MHz
Frequency Range	1GHz ~ 40GHz	Detector Function	Peak (PK) Average (AV)

Antenna Polarity & Test Distance : Horizontal at 3 m

No	Frequency (MHz)	Emission Level (dBuV/m)	Limit (dBuV/m)	Margin (dB)	Antenna Height (m)	Table Angle (Degree)	Raw Value (dBuV)	Correction Factor (dB/m)
1	#5581.11	61.7 PK	68.2	-6.5	1.08 H	320	48.3	13.4
2	*5885.00	123.5 PK			1.08 H	320	79.7	43.8
3	*5885.00	113.1 AV			1.08 H	320	69.3	43.8
4	#5897.70	97.0 PK	108.2	-11.2	1.08 H	320	83.0	14.0
5	#5922.87	68.2 PK	89.8	-21.6	1.08 H	320	54.1	14.1
6	11770.00	63.4 PK	74.0	-10.6	2.33 H	251	39.2	24.2
7	11770.00	51.8 AV	54.0	-2.2	2.33 H	251	27.6	24.2

Antenna Polarity & Test Distance : Vertical at 3 m

No	Frequency (MHz)	Emission Level (dBuV/m)	Limit (dBuV/m)	Margin (dB)	Antenna Height (m)	Table Angle (Degree)	Raw Value (dBuV)	Correction Factor (dB/m)
1	#5639.77	59.8 PK	68.2	-8.4	3.52 V	246	46.4	13.4
2	*5885.00	116.3 PK			3.52 V	246	72.5	43.8
3	*5885.00	105.1 AV			3.52 V	246	61.3	43.8
4	#5916.23	61.9 PK	94.6	-32.7	3.52 V	246	47.9	14.0
5	#6020.73	62.1 PK	88.2	-26.1	3.52 V	246	47.9	14.2
6	11770.00	62.7 PK	74.0	-11.3	2.08 V	304	38.5	24.2
7	11770.00	51.0 AV	54.0	-3.0	2.08 V	304	26.8	24.2

Remarks:

1. Emission Level(dBuV/m) = Raw Value(dBuV) + Correction Factor(dB/m)
2. Correction Factor(dB/m) = Antenna Factor(dB/m) + Cable Factor(dB) – Pre-Amplifier Factor(dB)
3. Margin value = Emission Level – Limit value
4. The other emission levels were very low against the limit.
5. " * ": Fundamental frequency.
6. " # ": The radiated frequency is out of the restricted band.

RF Mode	TX 802.11ax (HE40)	Channel	CH 167 : 5835 MHz
Frequency Range	1GHz ~ 40GHz	Detector Function	Peak (PK) Average (AV)

Antenna Polarity & Test Distance : Horizontal at 3 m

No	Frequency (MHz)	Emission Level (dBuV/m)	Limit (dBuV/m)	Margin (dB)	Antenna Height (m)	Table Angle (Degree)	Raw Value (dBuV)	Correction Factor (dB/m)
1	#5640.25	62.4 PK	68.2	-5.8	1.17 H	306	49.0	13.4
2	*5835.00	121.2 PK			1.17 H	306	77.4	43.8
3	*5835.00	108.1 AV			1.17 H	306	64.3	43.8
4	#5921.93	81.9 PK	90.4	-8.5	1.17 H	306	67.8	14.1
5	#5953.27	76.2 PK	88.2	-12.0	1.17 H	306	62.0	14.2
6	11670.00	63.9 PK	74.0	-10.1	2.26 H	239	39.3	24.6
7	11670.00	51.9 AV	54.0	-2.1	2.26 H	239	27.3	24.6

Antenna Polarity & Test Distance : Vertical at 3 m

No	Frequency (MHz)	Emission Level (dBuV/m)	Limit (dBuV/m)	Margin (dB)	Antenna Height (m)	Table Angle (Degree)	Raw Value (dBuV)	Correction Factor (dB/m)
1	#5635.02	60.5 PK	68.2	-7.7	3.50 V	252	47.1	13.4
2	*5835.00	116.7 PK			3.50 V	252	72.9	43.8
3	*5835.00	105.4 AV			3.50 V	252	61.6	43.8
4	#5912.43	65.2 PK	97.4	-32.2	3.50 V	252	51.2	14.0
5	#5930.48	61.5 PK	88.2	-26.7	3.50 V	252	47.4	14.1
6	11670.00	62.8 PK	74.0	-11.2	2.05 V	309	38.2	24.6
7	11670.00	51.1 AV	54.0	-2.9	2.05 V	309	26.5	24.6

Remarks:

1. Emission Level(dBuV/m) = Raw Value(dBuV) + Correction Factor(dB/m)
2. Correction Factor(dB/m) = Antenna Factor(dB/m) + Cable Factor(dB) – Pre-Amplifier Factor(dB)
3. Margin value = Emission Level – Limit value
4. The other emission levels were very low against the limit.
5. " * ": Fundamental frequency.
6. " # ": The radiated frequency is out of the restricted band.

RF Mode	TX 802.11ax (HE40)	Channel	CH 175 : 5875 MHz
Frequency Range	1GHz ~ 40GHz	Detector Function	Peak (PK) Average (AV)

Antenna Polarity & Test Distance : Horizontal at 3 m

No	Frequency (MHz)	Emission Level (dBuV/m)	Limit (dBuV/m)	Margin (dB)	Antenna Height (m)	Table Angle (Degree)	Raw Value (dBuV)	Correction Factor (dB/m)
1	#5609.37	61.0 PK	68.2	-7.2	1.13 H	306	47.6	13.4
2	*5875.00	121.2 PK			1.13 H	306	77.4	43.8
3	*5875.00	109.2 AV			1.13 H	306	65.4	43.8
4	#5922.16	96.0 PK	110.3	-14.3	1.13 H	306	81.9	14.1
5	#5933.32	88.1 PK	108.2	-20.1	1.13 H	306	74.0	14.1
6	11750.00	63.8 PK	74.0	-10.2	2.26 H	243	39.5	24.3
7	11750.00	51.8 AV	54.0	-2.2	2.26 H	243	27.5	24.3

Antenna Polarity & Test Distance : Vertical at 3 m

No	Frequency (MHz)	Emission Level (dBuV/m)	Limit (dBuV/m)	Margin (dB)	Antenna Height (m)	Table Angle (Degree)	Raw Value (dBuV)	Correction Factor (dB/m)
1	#5643.57	60.4 PK	68.2	-7.8	3.46 V	245	47.0	13.4
2	*5875.00	116.5 PK			3.46 V	245	72.7	43.8
3	*5875.00	104.5 AV			3.46 V	245	60.7	43.8
4	#5912.43	83.9 PK	97.4	-13.5	3.46 V	245	69.9	14.0
5	#5920.98	76.2 PK	91.1	-14.9	3.46 V	245	62.1	14.1
6	#5931.90	71.6 PK	88.2	-16.6	3.46 V	245	57.5	14.1
7	11750.00	62.9 PK	74.0	-11.1	2.08 V	315	38.6	24.3
8	11750.00	51.1 AV	54.0	-2.9	2.08 V	315	26.8	24.3

Remarks:

1. Emission Level(dBuV/m) = Raw Value(dBuV) + Correction Factor(dB/m)
2. Correction Factor(dB/m) = Antenna Factor(dB/m) + Cable Factor(dB) – Pre-Amplifier Factor(dB)
3. Margin value = Emission Level – Limit value
4. The other emission levels were very low against the limit.
5. " * ": Fundamental frequency.
6. " # ": The radiated frequency is out of the restricted band.

RF Mode	TX 802.11ax (HE80)	Channel	CH 171 : 5855 MHz
Frequency Range	1GHz ~ 40GHz	Detector Function	Peak (PK) Average (AV)

Antenna Polarity & Test Distance : Horizontal at 3 m

No	Frequency (MHz)	Emission Level (dBuV/m)	Limit (dBuV/m)	Margin (dB)	Antenna Height (m)	Table Angle (Degree)	Raw Value (dBuV)	Correction Factor (dB/m)
1	#5644.52	67.4 PK	68.2	-0.8	1.17 H	305	54.0	13.4
2	*5855.00	120.0 PK			1.17 H	305	76.2	43.8
3	*5855.00	109.0 AV			1.17 H	305	65.2	43.8
4	#5923.11	88.8 PK	109.6	-20.8	1.17 H	305	74.7	14.1
5	#5931.90	87.5 PK	108.2	-20.7	1.17 H	305	73.4	14.1
6	11710.00	63.7 PK	74.0	-10.3	2.26 H	238	39.4	24.3
7	11710.00	51.6 AV	54.0	-2.4	2.26 H	238	27.3	24.3

Antenna Polarity & Test Distance : Vertical at 3 m

No	Frequency (MHz)	Emission Level (dBuV/m)	Limit (dBuV/m)	Margin (dB)	Antenna Height (m)	Table Angle (Degree)	Raw Value (dBuV)	Correction Factor (dB/m)
1	#5582.77	59.4 PK	68.2	-8.8	3.42 V	241	46.0	13.4
2	*5855.00	114.6 PK			3.42 V	241	70.8	43.8
3	*5855.00	102.8 AV			3.42 V	241	59.0	43.8
4	#5922.87	81.2 PK	89.8	-8.6	3.42 V	241	67.1	14.1
5	#5932.85	80.4 PK	88.2	-7.8	3.42 V	241	66.3	14.1
6	11710.00	62.5 PK	74.0	-11.5	2.08 V	311	38.2	24.3
7	11710.00	50.8 AV	54.0	-3.2	2.08 V	311	26.5	24.3

Remarks:

1. Emission Level(dBuV/m) = Raw Value(dBuV) + Correction Factor(dB/m)
2. Correction Factor(dB/m) = Antenna Factor(dB/m) + Cable Factor(dB) – Pre-Amplifier Factor(dB)
3. Margin value = Emission Level – Limit value
4. The other emission levels were very low against the limit.
5. " * ": Fundamental frequency.
6. " # ": The radiated frequency is out of the restricted band.

RF Mode	TX 802.11ax (HE160)	Channel	CH 163 : 5815 MHz
Frequency Range	1GHz ~ 40GHz	Detector Function	Peak (PK) Average (AV)

Antenna Polarity & Test Distance : Horizontal at 3 m								
No	Frequency (MHz)	Emission Level (dBuV/m)	Limit (dBuV/m)	Margin (dB)	Antenna Height (m)	Table Angle (Degree)	Raw Value (dBuV)	Correction Factor (dB/m)
1	#5643.10	67.6 PK	68.2	-0.6	1.19 H	305	54.2	13.4
2	*5815.00	114.5 PK			1.19 H	305	70.7	43.8
3	*5815.00	104.2 AV			1.19 H	305	60.4	43.8
4	#5900.07	78.8 PK	106.5	-27.7	1.19 H	305	64.8	14.0
5	#5933.32	76.8 PK	88.2	-11.4	1.19 H	305	62.7	14.1
6	11630.00	64.3 PK	74.0	-9.7	2.28 H	239	39.5	24.8
7	11630.00	52.1 AV	54.0	-1.9	2.28 H	239	27.3	24.8

Antenna Polarity & Test Distance : Vertical at 3 m								
No	Frequency (MHz)	Emission Level (dBuV/m)	Limit (dBuV/m)	Margin (dB)	Antenna Height (m)	Table Angle (Degree)	Raw Value (dBuV)	Correction Factor (dB/m)
1	*5815.00	108.8 PK			3.38 V	241	65.0	43.8
2	*5815.00	98.4 AV			3.38 V	241	54.6	43.8
3	#5923.35	67.4 PK	89.4	-22.0	3.38 V	241	53.3	14.1
4	#5953.27	69.5 PK	88.2	-18.7	3.38 V	241	55.3	14.2
5	11630.00	62.9 PK	74.0	-11.1	2.12 V	307	38.1	24.8
6	11630.00	51.3 AV	54.0	-2.7	2.12 V	307	26.5	24.8

Remarks:

1. Emission Level(dBuV/m) = Raw Value(dBuV) + Correction Factor(dB/m)
2. Correction Factor(dB/m) = Antenna Factor(dB/m) + Cable Factor(dB) – Pre-Amplifier Factor(dB)
3. Margin value = Emission Level – Limit value
4. The other emission levels were very low against the limit.
5. " * ": Fundamental frequency.
6. " # ": The radiated frequency is out of the restricted band.

Below 1GHz Data:

RF Mode	TX 802.11ax (HE20)	Channel	CH 173 : 5865 MHz
Frequency Range	9kHz ~ 1GHz	Detector Function	Quasi-Peak (QP)
Test Mode	A		

ANTENNA POLARITY & TEST DISTANCE: HORIZONTAL AT 3 M								
NO.	FREQ. (MHz)	EMISSION LEVEL (dBuV/m)	LIMIT (dBuV/m)	MARGIN (dB)	ANTENNA HEIGHT (m)	TABLE ANGLE (Degree)	RAW VALUE (dBuV)	CORRECTION FACTOR (dB/m)
1	53.28	25.9 QP	40.0	-14.1	1.50 H	81	34.6	-8.7
2	84.32	28.8 QP	40.0	-11.2	1.50 H	287	42.8	-14.0
3	107.60	24.5 QP	43.5	-19.0	1.50 H	223	36.7	-12.2
4	202.66	30.2 QP	43.5	-13.3	1.50 H	257	41.9	-11.7
5	322.94	21.2 QP	46.0	-24.8	1.50 H	208	28.2	-7.0
6	544.10	34.5 QP	46.0	-11.5	1.50 H	70	38.0	-3.5

Remarks:

1. Emission Level(dBuV/m) = Raw Value(dBuV) + Correction Factor(dB/m).
2. Correction Factor(dB/m) = Antenna Factor(dB/m) + Cable Factor(dB) – Pre-Amplifier Factor(dB).
3. The other emission levels were very low against the limit of frequency range 30MHz ~ 1000MHz.
4. Margin value = Emission Level – Limit value.
5. The emission levels were very low against the limit of frequency range 9kHz ~ 30MHz: the amplitude of spurious emissions attenuated more than 20 dB below the permissible value to be report.

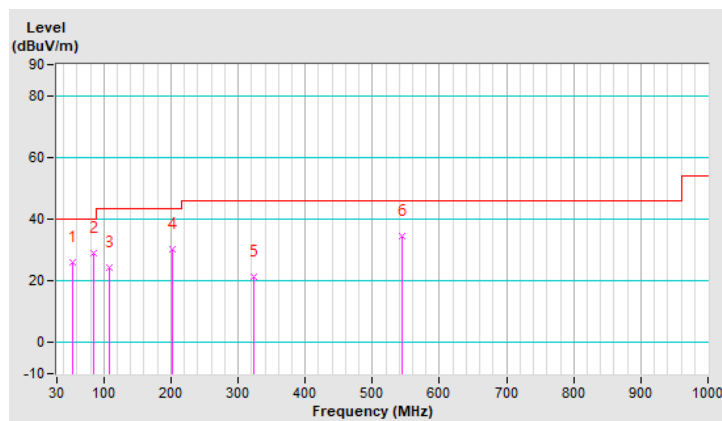

RF Mode	TX 802.11ax (HE20)	Channel	CH 173 : 5865 MHz
Frequency Range	9kHz ~ 1GHz	Detector Function	Quasi-Peak (QP)
Test Mode	A		

ANTENNA POLARITY & TEST DISTANCE: VERTICAL AT 3 M								
NO.	FREQ. (MHz)	EMISSION LEVEL (dBuV/m)	LIMIT (dBuV/m)	MARGIN (dB)	ANTENNA HEIGHT (m)	TABLE ANGLE (Degree)	RAW VALUE (dBuV)	CORRECTION FACTOR (dB/m)
1	125.06	32.5 QP	43.5	-11.0	2.00 V	247	43.2	-10.7
2	142.52	30.9 QP	43.5	-12.6	1.50 V	330	39.9	-9.0
3	165.80	34.0 QP	43.5	-9.5	1.50 V	314	42.9	-8.9
4	206.54	30.8 QP	43.5	-12.7	1.00 V	139	42.5	-11.7
5	249.22	28.9 QP	46.0	-17.1	1.50 V	145	38.3	-9.4
6	418.00	31.3 QP	46.0	-14.7	1.50 V	299	36.9	-5.6

Remarks:

1. Emission Level(dBuV/m) = Raw Value(dBuV) + Correction Factor(dB/m).
2. Correction Factor(dB/m) = Antenna Factor(dB/m) + Cable Factor(dB) – Pre-Amplifier Factor(dB).
3. The other emission levels were very low against the limit of frequency range 30MHz ~ 1000MHz.
4. Margin value = Emission Level – Limit value.
5. The emission levels were very low against the limit of frequency range 9kHz ~ 30MHz: the amplitude of spurious emissions attenuated more than 20 dB below the permissible value to be report.

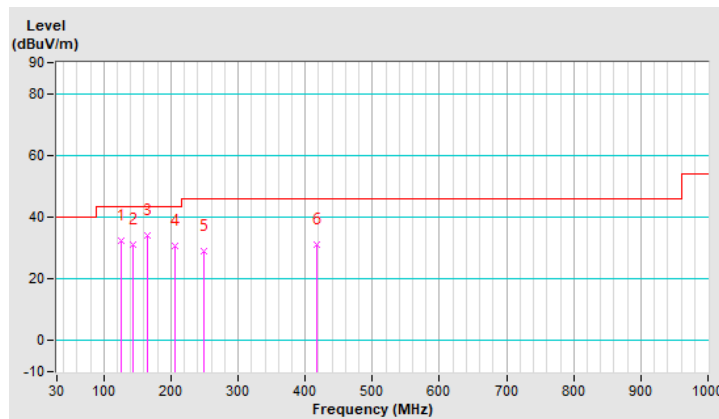

RF Mode	TX 802.11ax (HE20)	Channel	CH 173 : 5865 MHz
Frequency Range	9kHz ~ 1GHz	Detector Function	Quasi-Peak (QP)
Test Mode	B		

ANTENNA POLARITY & TEST DISTANCE: HORIZONTAL AT 3 M								
NO.	FREQ. (MHz)	EMISSION LEVEL (dBuV/m)	LIMIT (dBuV/m)	MARGIN (dB)	ANTENNA HEIGHT (m)	TABLE ANGLE (Degree)	RAW VALUE (dBuV)	CORRECTION FACTOR (dB/m)
1	74.62	28.9 QP	40.0	-11.1	1.00 H	77	40.4	-11.5
2	103.72	31.4 QP	43.5	-12.1	1.00 H	77	44.2	-12.8
3	128.94	29.7 QP	43.5	-13.8	1.49 H	302	40.0	-10.3
4	288.02	28.0 QP	46.0	-18.0	1.00 H	72	35.9	-7.9
5	324.88	28.3 QP	46.0	-17.7	1.49 H	330	35.2	-6.9
6	540.22	32.4 QP	46.0	-13.6	1.49 H	48	35.8	-3.4

Remarks:

1. Emission Level(dBuV/m) = Raw Value(dBuV) + Correction Factor(dB/m).
2. Correction Factor(dB/m) = Antenna Factor(dB/m) + Cable Factor(dB) – Pre-Amplifier Factor(dB).
3. The other emission levels were very low against the limit of frequency range 30MHz ~ 1000MHz.
4. Margin value = Emission Level – Limit value.
5. The emission levels were very low against the limit of frequency range 9kHz ~ 30MHz: the amplitude of spurious emissions attenuated more than 20 dB below the permissible value to be report.

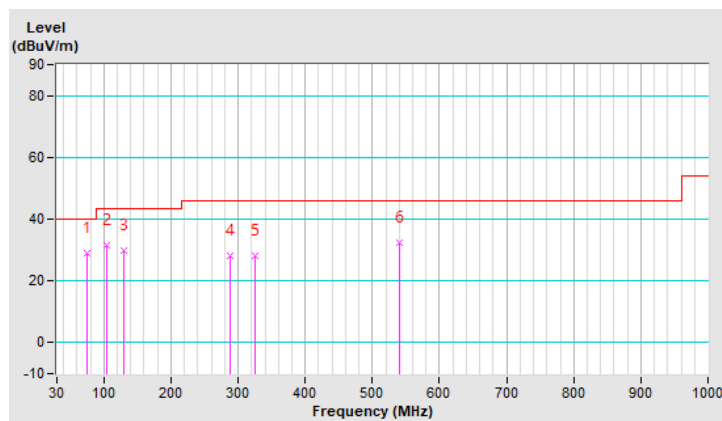

RF Mode	TX 802.11ax (HE20)	Channel	CH 173 : 5865 MHz
Frequency Range	9kHz ~ 1GHz	Detector Function	Quasi-Peak (QP)
Test Mode	B		

ANTENNA POLARITY & TEST DISTANCE: VERTICAL AT 3 M								
NO.	FREQ. (MHz)	EMISSION LEVEL (dBuV/m)	LIMIT (dBuV/m)	MARGIN (dB)	ANTENNA HEIGHT (m)	TABLE ANGLE (Degree)	RAW VALUE (dBuV)	CORRECTION FACTOR (dB/m)
1	51.34	33.3 QP	40.0	-6.7	1.00 V	78	41.8	-8.5
2	105.66	34.4 QP	43.5	-9.1	1.00 V	159	47.0	-12.6
3	136.70	35.9 QP	43.5	-7.6	1.50 V	242	45.3	-9.4
4	187.14	34.6 QP	43.5	-8.9	1.00 V	157	45.6	-11.0
5	274.44	37.1 QP	46.0	-8.9	1.50 V	169	45.3	-8.2
6	396.66	30.0 QP	46.0	-16.0	1.00 V	242	36.0	-6.0

Remarks:

1. Emission Level(dBuV/m) = Raw Value(dBuV) + Correction Factor(dB/m).
2. Correction Factor(dB/m) = Antenna Factor(dB/m) + Cable Factor(dB) – Pre-Amplifier Factor(dB).
3. The other emission levels were very low against the limit of frequency range 30MHz ~ 1000MHz.
4. Margin value = Emission Level – Limit value.
5. The emission levels were very low against the limit of frequency range 9kHz ~ 30MHz: the amplitude of spurious emissions attenuated more than 20 dB below the permissible value to be report.

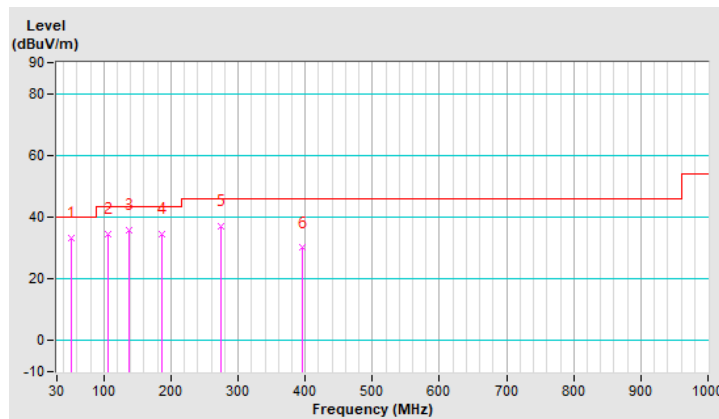

4.2 Conducted Emission Measurement

4.2.1 Limits of Conducted Emission Measurement

Frequency (MHz)	Conducted Limit (dBuV)	
	Quasi-peak	Average
0.15 - 0.5	66 - 56	56 - 46
0.50 - 5.0	56	46
5.0 - 30.0	60	50

- Note: 1. The lower limit shall apply at the transition frequencies.
 2. The limit decreases in line with the logarithm of the frequency in the range of 0.15 to 0.50MHz.

4.2.2 Test Instruments

Description & Manufacturer	Model No.	Serial No.	Cal. Date	Cal. Due
Test Receiver ROHDE & SCHWARZ	ESCI	100613	Dec. 03, 2021	Dec. 02, 2022
RF signal cable Woken	5D-FB	Cable-cond1-01	Jan. 16, 2021	Jan. 15, 2022
LISN ROHDE & SCHWARZ (EUT)	ENV216	101826	Feb. 25, 2021	Feb. 24, 2022
LISN ROHDE & SCHWARZ (Peripheral)	ESH3-Z5	100311	Sep. 07, 2021	Sep. 06, 2022
Software ADT	BV ADT_Cond_ V7.3.7.4	NA	NA	NA

- Note: 1. The calibration interval of the above test instruments is 12 months and the calibrations are traceable to NML/ROC and NIST/USA.
 2. The test was performed in HwaYa Shielded Room 1(Conduction 1).
 3. The VCCI Site Registration No. is C-12040.
 4. Tested date: Jan. 15, 2022

4.2.3 Test Procedure

- The EUT was placed 0.4 meters from the conducting wall of the shielded room with EUT being connected to the power mains through a line impedance stabilization network (LISN). Other support units were connected to the power mains through another LISN. The two LISNs provide 50 ohm/ 50uH of coupling impedance for the measuring instrument.
- Both lines of the power mains connected to the EUT were checked for maximum conducted interference.
- The frequency range from 150kHz to 30MHz was searched. Emission levels under (Limit - 20dB) was not recorded.

NOTE: All modes of operation were investigated and the worst-case emissions are reported.

4.2.4 Test Setup

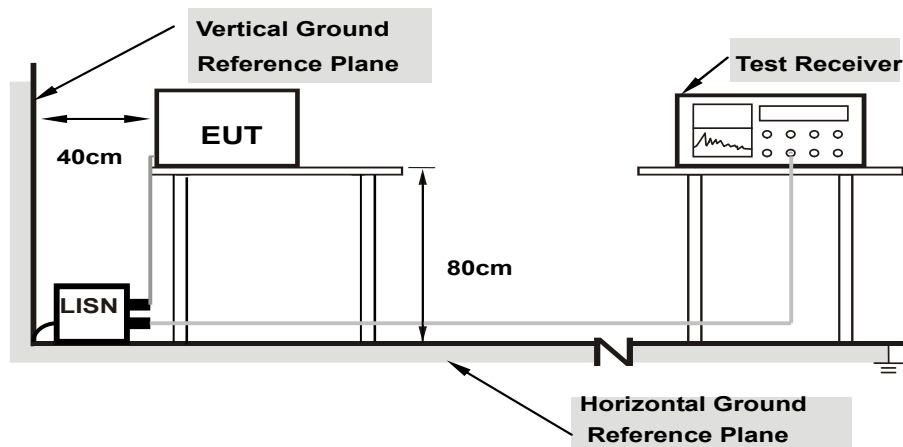

Note: 1.Support units were connected to second LISN.

For the actual test configuration, please refer to the attached file (Test Setup Photo).

4.2.5 EUT Operating Condition

Same as 4.1.6.

4.2.6 Test Results

802.11ax (HE20)

Phase	Line (L)	Detector Function	Quasi-Peak (QP) / Average (AV)
Test Mode	A		

No	Freq. [MHz]	Corr. Factor (dB)	Reading Value		Emission Level		Limit		Margin	
			[dB (uV)]		[dB (uV)]		[dB (uV)]		(dB)	
			Q.P.	AV.	Q.P.	AV.	Q.P.	AV.	Q.P.	AV.
1	0.15391	9.76	36.56	20.41	46.32	30.17	65.79	55.79	-19.47	-25.62
2	0.23993	9.78	24.69	16.96	34.47	26.74	62.10	52.10	-27.63	-25.36
3	0.31422	9.80	33.74	26.58	43.54	36.38	59.86	49.86	-16.32	-13.48
4	0.43543	9.83	14.72	8.76	24.55	18.59	57.15	47.15	-32.60	-28.56
5	1.47549	9.92	11.59	4.37	21.51	14.29	56.00	46.00	-34.49	-31.71
6	13.56130	10.06	6.55	1.76	16.61	11.82	60.00	50.00	-43.39	-38.18

Remarks:

1. Q.P. and AV. are abbreviations of quasi-peak and average individually.
2. The emission levels of other frequencies were very low against the limit.
3. Margin value = Emission level - Limit value
4. Correction factor = Insertion loss + Cable loss
5. Emission Level = Correction Factor + Reading Value.



Phase	Neutral (N)	Detector Function	Quasi-Peak (QP) / Average (AV)
Test Mode	A		

No	Freq. [MHz]	Corr. Factor (dB)	Reading Value [dB (uV)]		Emission Level [dB (uV)]		Limit [dB (uV)]		Margin (dB)	
			Q.P.	AV.	Q.P.	AV.	Q.P.	AV.	Q.P.	AV.
			1	0.16564	9.81	33.80	17.62	43.61	27.43	65.18
2	0.19301	9.83	28.42	16.13	38.25	25.96	63.91	53.91	-25.66	-27.95
3	0.23602	9.84	27.12	19.68	36.96	29.52	62.24	52.24	-25.28	-22.72
4	0.32187	9.87	35.79	25.51	45.66	35.38	59.66	49.66	-14.00	-14.28
5	1.48722	9.97	12.65	5.53	22.62	15.50	56.00	46.00	-33.38	-30.50
6	4.56439	10.05	9.00	2.59	19.05	12.64	56.00	46.00	-36.95	-33.36

Remarks:

1. Q.P. and AV. are abbreviations of quasi-peak and average individually.
2. The emission levels of other frequencies were very low against the limit.
3. Margin value = Emission level - Limit value
4. Correction factor = Insertion loss + Cable loss
5. Emission Level = Correction Factor + Reading Value.

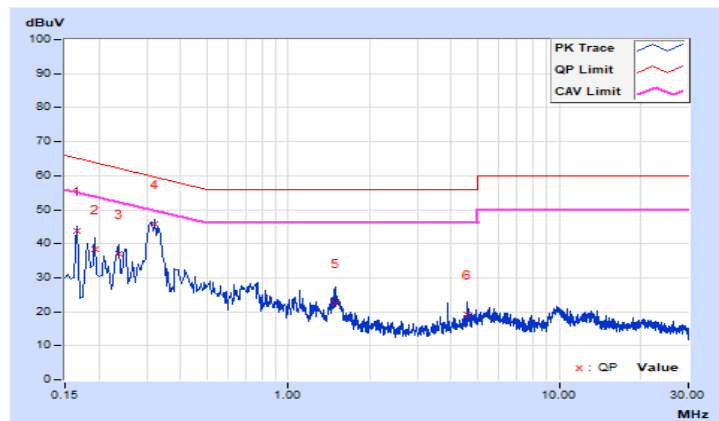

Phase	Line (L)	Detector Function	Quasi-Peak (QP) / Average (AV)
Test Mode	B		

No	Freq. [MHz]	Corr. Factor (dB)	Reading Value [dB (uV)]		Emission Level [dB (uV)]		Limit [dB (uV)]		Margin (dB)	
			Q.P.	AV.	Q.P.	AV.	Q.P.	AV.	Q.P.	AV.
			1	0.17737	9.71	40.87	35.13	50.58	44.84	64.61
2	0.23898	9.71	17.34	11.80	27.05	21.51	62.13	52.13	-35.08	-30.62
3	0.44716	9.73	32.45	25.46	42.18	35.19	56.93	46.93	-14.75	-11.74
4	0.54100	9.74	27.67	16.58	37.41	26.32	56.00	46.00	-18.59	-19.68
5	0.89290	9.75	31.91	24.82	41.66	34.57	56.00	46.00	-14.34	-11.43
6	18.93755	9.82	27.98	25.65	37.80	35.47	60.00	50.00	-22.20	-14.53

Remarks:

1. Q.P. and AV. are abbreviations of quasi-peak and average individually.
2. The emission levels of other frequencies were very low against the limit.
3. Margin value = Emission level - Limit value
4. Correction factor = Insertion loss + Cable loss
5. Emission Level = Correction Factor + Reading Value.

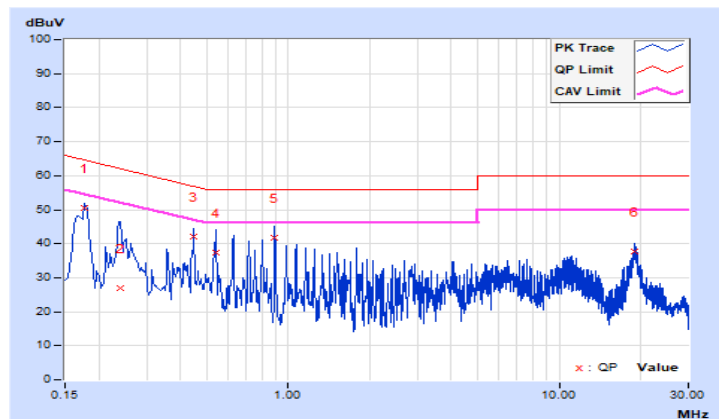

Phase	Neutral (N)	Detector Function	Quasi-Peak (QP) / Average (AV)
Test Mode	B		

No	Freq. [MHz]	Corr. Factor (dB)	Reading Value [dB (uV)]		Emission Level [dB (uV)]		Limit [dB (uV)]		Margin (dB)	
			Q.P.	AV.	Q.P.	AV.	Q.P.	AV.	Q.P.	AV.
			1	0.17737	9.77	40.58	34.43	50.35	44.20	64.61
2	0.26730	9.78	33.73	26.70	43.51	36.48	61.20	51.20	-17.69	-14.72
3	0.62311	9.80	30.63	24.36	40.43	34.16	56.00	46.00	-15.57	-11.84
4	0.80519	9.81	30.67	22.62	40.48	32.43	56.00	46.00	-15.52	-13.57
5	0.89290	9.81	30.96	24.19	40.77	34.00	56.00	46.00	-15.23	-12.00
6	19.18388	9.98	27.82	25.26	37.80	35.24	60.00	50.00	-22.20	-14.76

Remarks:

1. Q.P. and AV. are abbreviations of quasi-peak and average individually.
2. The emission levels of other frequencies were very low against the limit.
3. Margin value = Emission level - Limit value
4. Correction factor = Insertion loss + Cable loss
5. Emission Level = Correction Factor + Reading Value.

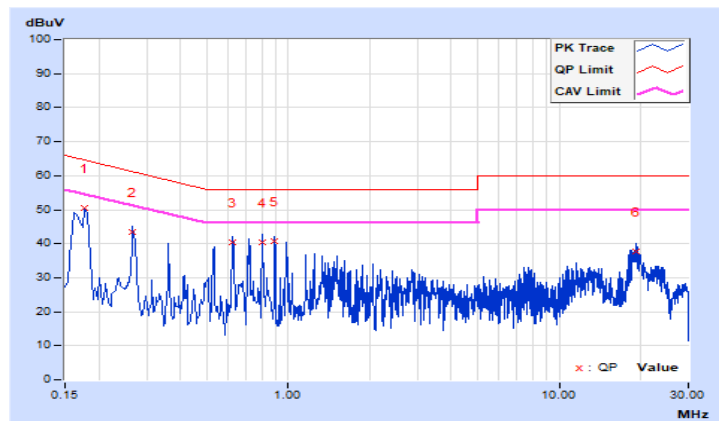

4.3 Transmit Power Measurement

4.3.1 Limits of Transmit Power Measurement

Device Category		Limit (Max Average Power)
<input checked="" type="checkbox"/>	Indoor access point	EIRP 36 dBm
<input type="checkbox"/>	Subordinate device	EIRP 36 dBm
<input type="checkbox"/>	Client device	EIRP 30 dBm

Per KDB 662911 Method of conducted output power measurement on IEEE 802.11 devices,

Array Gain = 0 dB (i.e., no array gain) for $N_{ANT} \leq 4$;

Array Gain = 0 dB (i.e., no array gain) for channel widths ≥ 40 MHz for any N_{ANT} ;

Array Gain = $5 \log(N_{ANT}/N_{SS})$ dB or 3 dB, whichever is less for 20-MHz channel widths with $N_{ANT} \geq 5$.

For power measurements on all other devices: Array Gain = $10 \log(N_{ANT}/N_{SS})$ dB.

4.3.2 Test Setup

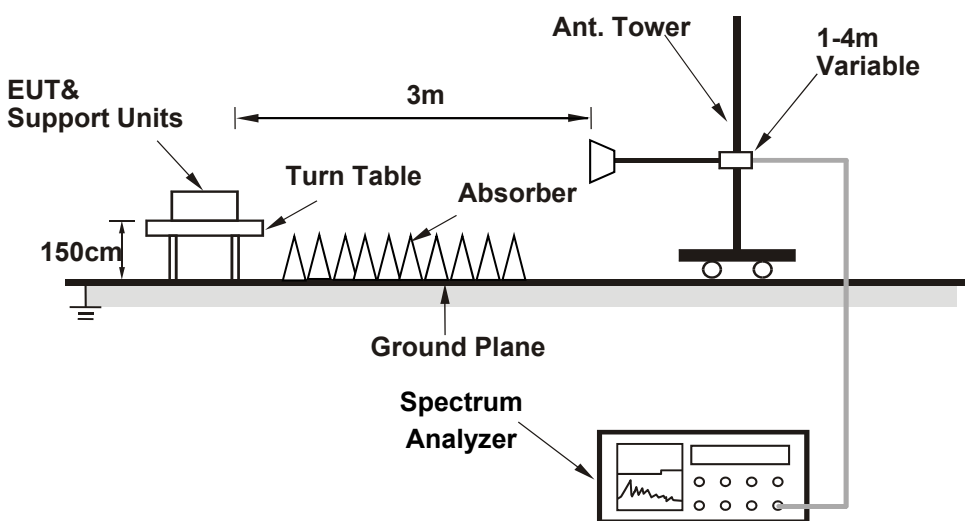

4.3.3 Test Instruments

Refer to section 4.1.2 to get information of above instrument.

4.3.4 Test Procedure

- a. The EUT was placed on the top of a rotating table 1.5 meters above the ground at 3 meter chamber room for test. The table was rotated 360 degrees to determine the position of the highest radiation.
- b. The EUT was set 3 meters away from the interference-receiving antenna, which was mounted on the top of a variable-height antenna tower.
- c. The height of antenna is varied from one meter to four meters above the ground to determine the maximum value of the field strength. Both horizontal and vertical polarizations of the antenna are set to make the measurement.
- d. Perform a field strength measurement and record the worse read value, is the field strength value via a spectrum reading obtained corrected for antenna factor, cable loss and pre-amplifier factor and then mathematically convert the measured field strength level to EIRP level.
- e. Follow ANSI 63.10 and KDB 412172 D01 v01r01, EIRP Value (dBm) = Field Strength Value (dB μ V/m) + Correction Factor @ 3m.
- f. Correction Factor (dB) @ 3m = $20\log(D) - 104.7$; where D is the measurement distance @3m = -95.23dB

Note: Spectrum analyzer setting as below:

Method SA-1

1. Set span to encompass the entire 99% occupied bandwidth of the signal.
2. Set RBW =1MHz.
3. Set the VBW $\geq 3 \times$ RBW.
4. Number of points in sweep ≥ 2 Span / RBW.
5. Sweep time = auto.
6. Set trigger to free run (duty cycle ≥ 98 percent) ; Set video trigger (duty cycle < 98 percent)
7. Detector = RMS.
8. Trace average at least 100 traces in power averaging mode
9. Compute power by integrating the spectrum across the 99% occupied bandwidth of the signal.

4.3.5 EUT Operating Condition

The software provided by client to enable the EUT under transmission condition continuously at lowest, middle and highest channel frequencies individually.

4.3.6 Test Result

Power Output:

CDD Mode

802.11a

Chan.	Chan. Freq. (MHz)	Field Strength (dBuV/m)	Correction Factor (dB)	EIRP (mW)	EIRP (dBm)	EIRP Limit (dBm)	Pass / Fail
169	5845	125.70	-95.23	1114.295	30.47	36	Pass
173	5865	125.60	-95.23	1088.930	30.37	36	Pass
177	5885	125.70	-95.23	1114.295	30.47	36	Pass

802.11ax (HE20)

Chan.	Chan. Freq. (MHz)	Field Strength (dBuV/m)	Correction Factor (dB)	EIRP (mW)	EIRP (dBm)	EIRP Limit (dBm)	Pass / Fail
169	5845	125.80	-95.23	1140.250	30.57	36	Pass
173	5865	125.70	-95.23	1114.295	30.47	36	Pass
177	5885	125.70	-95.23	1114.295	30.47	36	Pass

802.11ax (HE40)

Chan.	Chan. Freq. (MHz)	Field Strength (dBuV/m)	Correction Factor (dB)	EIRP (mW)	EIRP (dBm)	EIRP Limit (dBm)	Pass / Fail
167	5835	126.20	-95.23	1250.259	30.97	36	Pass
175	5875	126.40	-95.23	1309.182	31.17	36	Pass

802.11ax (HE80)

Chan.	Chan. Freq. (MHz)	Field Strength (dBuV/m)	Correction Factor (dB)	EIRP (mW)	EIRP (dBm)	EIRP Limit (dBm)	Pass / Fail
171	5855	125.00	-95.23	948.418	29.77	36	Pass

802.11ax (HE160)

Chan.	Chan. Freq. (MHz)	Field Strength (dBuV/m)	Correction Factor (dB)	EIRP (mW)	EIRP (dBm)	EIRP Limit (dBm)	Pass / Fail
163	5815	123.50	-95.23	671.429	28.27	36	Pass

Spectrum Plot of Worst Value

802.11a

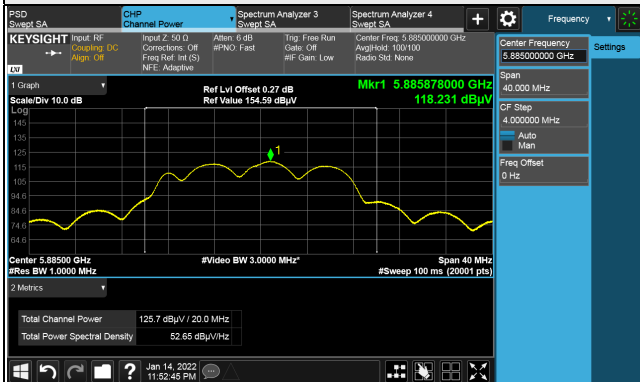

802.11ax (HE20)

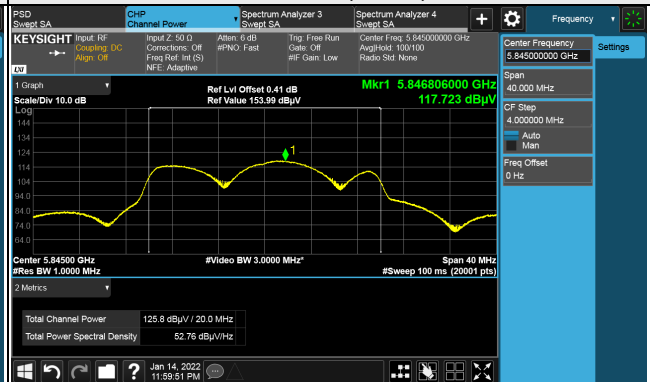

802.11ax (HE40)

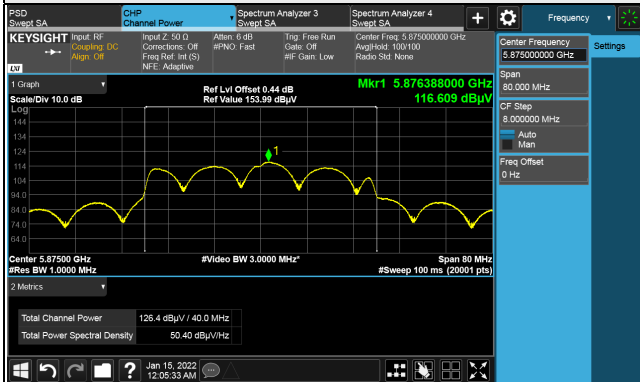

802.11ax (HE80)

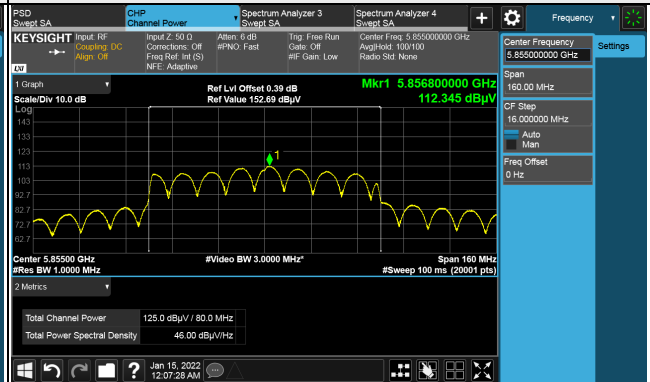

802.11ax (HE160)

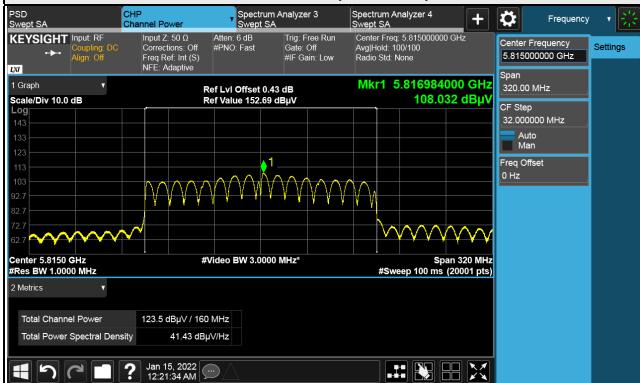

Beamforming Mode

802.11ax (HE20)

Chan.	Chan. Freq. (MHz)	Field Strength (dBuV/m)	Correction Factor (dB)	EIRP (mW)	EIRP (dBm)	EIRP Limit (dBm)	Pass / Fail
169	5845	127.60	-95.23	1725.838	32.37	36	Pass
173	5865	127.70	-95.23	1766.038	32.47	36	Pass
177	5885	127.50	-95.23	1686.553	32.27	36	Pass

802.11ax (HE40)

Chan.	Chan. Freq. (MHz)	Field Strength (dBuV/m)	Correction Factor (dB)	EIRP (mW)	EIRP (dBm)	EIRP Limit (dBm)	Pass / Fail
167	5835	127.80	-95.23	1807.174	32.57	36	Pass
175	5875	127.90	-95.23	1849.269	32.67	36	Pass

802.11ax (HE80)

Chan.	Chan. Freq. (MHz)	Field Strength (dBuV/m)	Correction Factor (dB)	EIRP (mW)	EIRP (dBm)	EIRP Limit (dBm)	Pass / Fail
171	5855	127.00	-95.23	1503.142	31.77	36	Pass

802.11ax (HE160)

Chan.	Chan. Freq. (MHz)	Field Strength (dBuV/m)	Correction Factor (dB)	EIRP (mW)	EIRP (dBm)	EIRP Limit (dBm)	Pass / Fail
163	5815	125.60	-95.23	1088.93	30.37	36	Pass

Spectrum Plot of Worst Value

802.11ax (HE20)

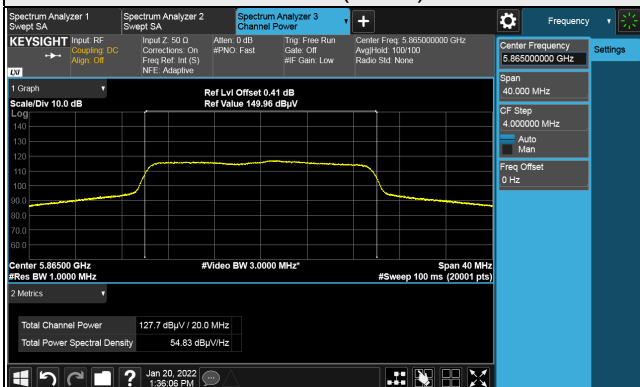

802.11ax (HE40)

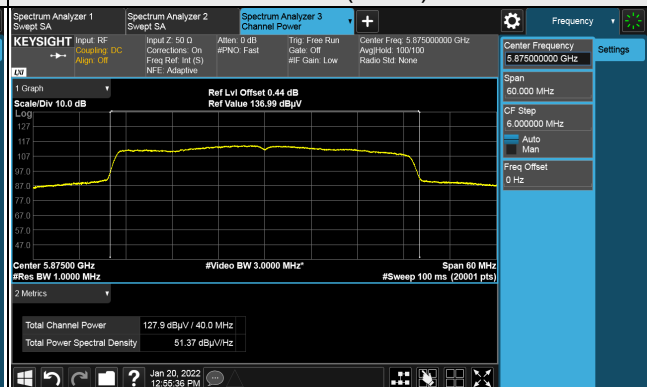

802.11ax (HE80)

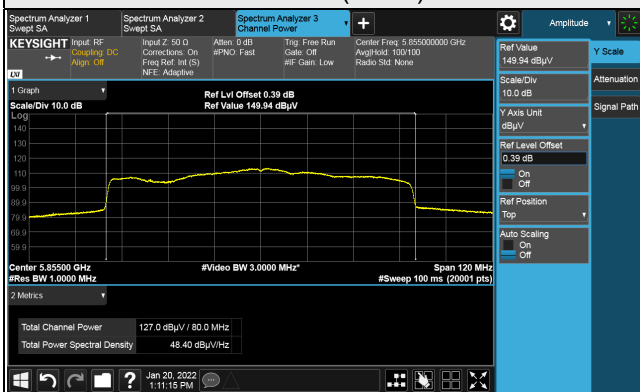

802.11ax (HE160)

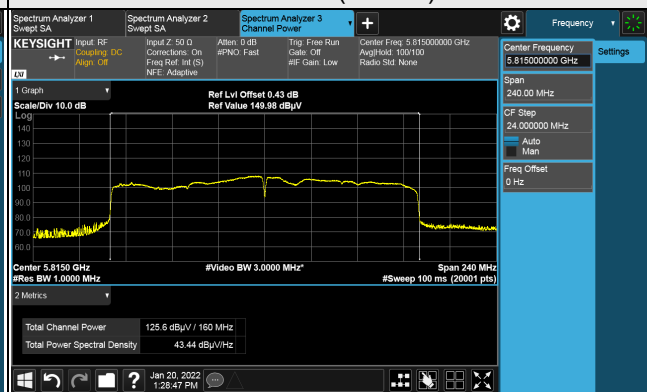

4.4 6dB Bandwidth Measurement

4.4.1 Limits of Emission Bandwidth Measurement

Within the 5.725-5.850GHz and 5.850-5.895 GHz bands, the minimum 6 dB bandwidth of U-NII devices shall be at least 500 kHz.

4.4.2 Test Setup

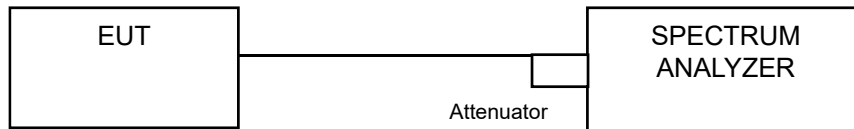

4.4.3 Test Instruments

Refer to section 4.1.2 to get information of above instrument.

4.4.4 Test Procedure

- a. Set resolution bandwidth (RBW) = 100kHz
- b. Set the video bandwidth (VBW) $\geq 3 \times$ RBW, Detector = Peak.
- c. Trace mode = max hold.
- d. Sweep = auto couple.
- e. Measure the maximum width of the emission that is constrained by the frequencies associated with the two amplitude points (upper and lower) that are attenuated by 6 dB relative to the maximum level measured in the fundamental emission

4.4.5 Test Results

802.11a

Channel	Frequency (MHz)	6dB Bandwidth (MHz)		Minimum Limit (MHz)	Pass / Fail
		Chain 0	Chain 1		
169	5845	15.15	15.13	0.5	Pass
173	5865	15.14	15.14	0.5	Pass
177	5885	15.15	15.14	0.5	Pass

802.11ax (HE20)

Channel	Frequency (MHz)	6dB Bandwidth (MHz)		Minimum Limit (MHz)	Pass / Fail
		Chain 0	Chain 1		
169	5845	15.56	15.85	0.5	Pass
173	5865	15.12	16.33	0.5	Pass
177	5885	15.44	15.13	0.5	Pass

802.11ax (HE40)

Channel	Frequency (MHz)	6dB Bandwidth (MHz)		Minimum Limit (MHz)	Pass / Fail
		Chain 0	Chain 1		
167	5835	35.99	36.22	0.5	Pass
175	5875	35.63	36.71	0.5	Pass

802.11ax (HE80)

Channel	Frequency (MHz)	6dB Bandwidth (MHz)		Minimum Limit (MHz)	Pass / Fail
		Chain 0	Chain 1		
171	5855	73.93	72.65	0.5	Pass

802.11ax (HE160)

Channel	Frequency (MHz)	6dB Bandwidth (MHz)		Minimum Limit (MHz)	Pass / Fail
		Chain 0	Chain 1		
163	5815	135.72	150.49	0.5	Pass

Spectrum Plot of Worst Value

802.11a

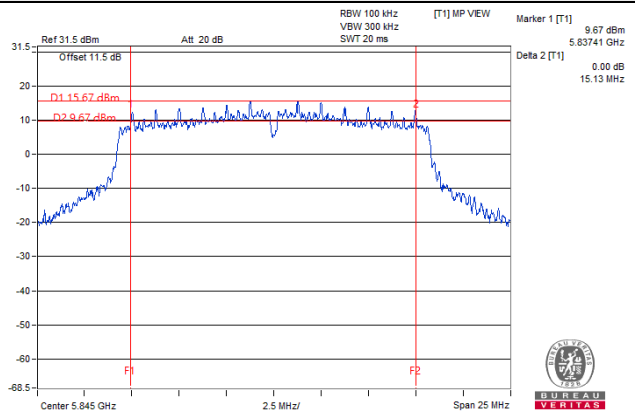

802.11ax (HE20)

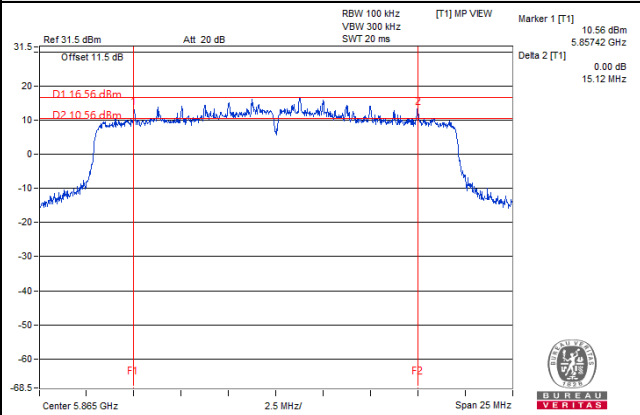

802.11ax (HE40)

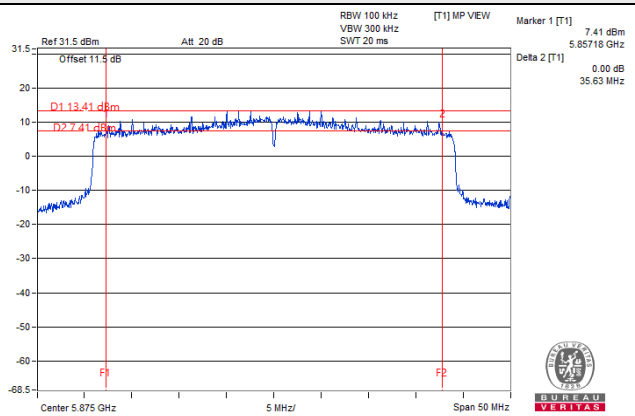

802.11ax (HE80)

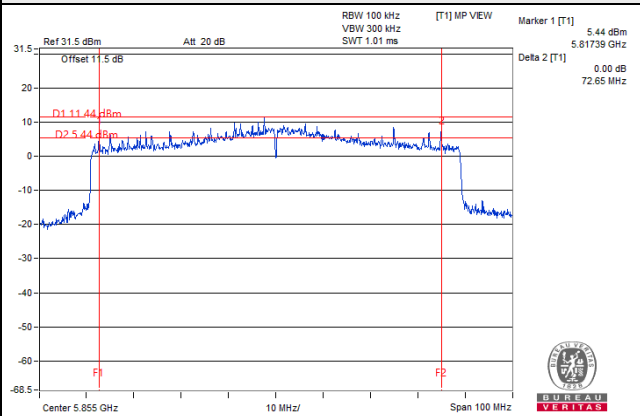

802.11ax (HE160)

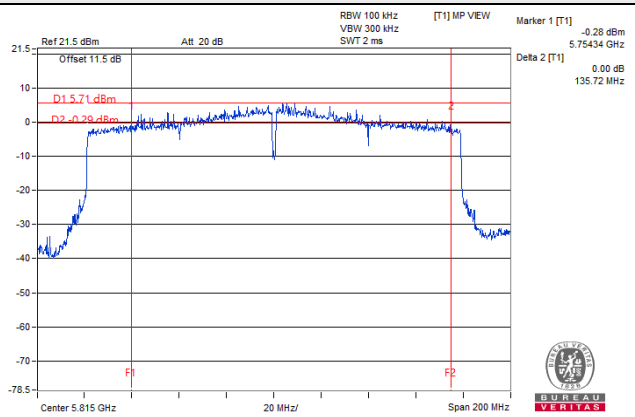

4.5 Peak Power Spectral Density Measurement

4.5.1 Limits of Peak Power Spectral Density Measurement

Device Category		Limit
<input checked="" type="checkbox"/>	Indoor access point	EIRP 20 dBm/MHz
<input type="checkbox"/>	Subordinate device	EIRP 20 dBm/MHz
<input type="checkbox"/>	Client device	EIRP 14 dBm/MHz

Note: For all U-NII-4 and U-NII-3 & -4 span channels shall met above EIRP values.

4.5.2 Test Setup

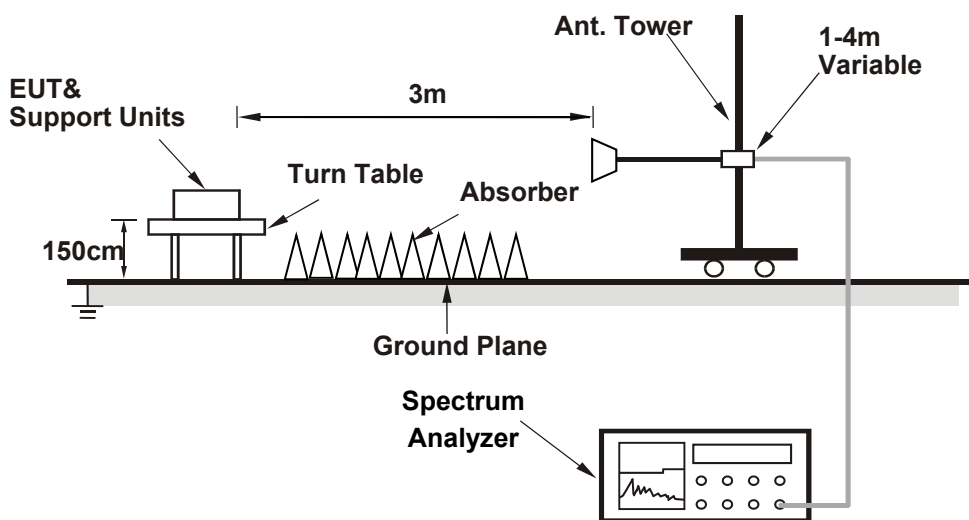

4.5.3 Test Instruments

Refer to section 4.1.2 to get information of above instrument.

4.5.4 Test Procedure

- a. The EUT was placed on the top of a rotating table 1.5 meters above the ground at 3 meter chamber room for test. The table was rotated 360 degrees to determine the position of the highest radiation.
- b. The EUT was set 3 meters away from the interference-receiving antenna, which was mounted on the top of a variable-height antenna tower.
- c. The height of antenna is varied from one meter to four meters above the ground to determine the maximum value of the field strength. Both horizontal and vertical polarizations of the antenna are set to make the measurement.
- d. Perform a field strength measurement and record the worse read value, is the field strength value via a spectrum reading obtained corrected for antenna factor, cable loss and pre-amplifier factor and then mathematically convert the measured field strength level to EIRP level.
- e. Follow ANSI 63.10 and KDB 412172 D01 v01r01, EIRP Value (dBm) = Field Strength Value (dB μ V/m) + Correction Factor @ 3m.
- f. Correction Factor (dB) @ 3m = $20\log(D) - 104.7$; where D is the measurement distance @3m = -95.23dB

Note: Spectrum analyzer setting as below:

Method SA-1

1. Set span to encompass the entire emission bandwidth (EBW) of the signal.
2. Set RBW = 1 MHz, Set VBW \geq 3 MHz, Detector = RMS
3. Sweep time = auto, trigger set to "free run" (duty cycle \geq 98 percent) ; Set video trigger (duty cycle < 98 percent).
4. Trace average at least 100 traces in power averaging mode.
5. Record the max value

4.5.5 EUT Operating Condition

Same as Item 4.3.6.

4.5.6 Test Results

CDD Mode

802.11a

Chan.	Chan. Freq. (MHz)	Field Strength (dBuV/m)	Correction Factor (dB)	EIRP PSD (dBm/MHz)	EIRP PSD Limit (dBm/MHz)	Pass / Fail
169	5845	115.04	-95.23	19.81	20.00	Pass
173	5865	115.06	-95.23	19.83	20.00	Pass
177	5885	115.05	-95.23	19.82	20.00	Pass

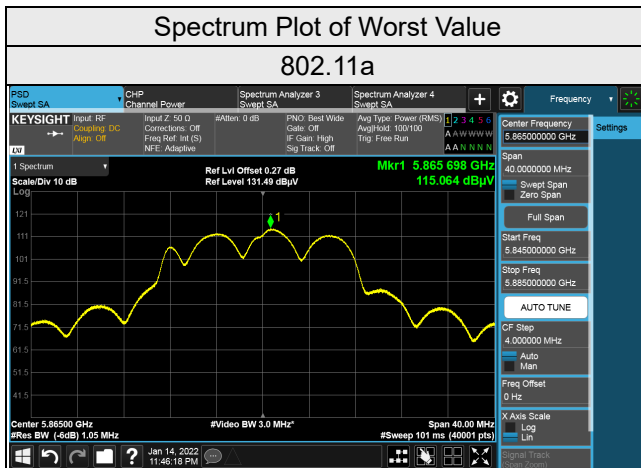

Beamforming Mode

802.11ax (HE20)

Chan.	Chan. Freq. (MHz)	Field Strength (dBuV/m)	Correction Factor (dB)	EIRP PSD (dBm/MHz)	EIRP PSD Limit (dBm/MHz)	Pass / Fail
169	5845	115.17	-95.23	19.94	20.00	Pass
173	5865	115.12	-95.23	19.89	20.00	Pass
177	5885	115.10	-95.23	19.87	20.00	Pass

802.11ax (HE40)

Chan.	Chan. Freq. (MHz)	Field Strength (dBuV/m)	Correction Factor (dB)	EIRP PSD (dBm/MHz)	EIRP PSD Limit (dBm/MHz)	Pass / Fail
167	5835	112.34	-95.23	17.11	20.00	Pass
175	5875	112.38	-95.23	17.15	20.00	Pass

802.11ax (HE80)

Chan.	Chan. Freq. (MHz)	Field Strength (dBuV/m)	Correction Factor (dB)	EIRP PSD (dBm/MHz)	EIRP PSD Limit (dBm/MHz)	Pass / Fail
171	5855	109.68	-95.23	14.45	20.00	Pass

802.11ax (HE160)

Chan.	Chan. Freq. (MHz)	Field Strength (dBuV/m)	Correction Factor (dB)	EIRP PSD (dBm/MHz)	EIRP PSD Limit (dBm/MHz)	Pass / Fail
163	5815	106.91	-95.23	11.68	20.00	Pass

Spectrum Plot of Worst Value

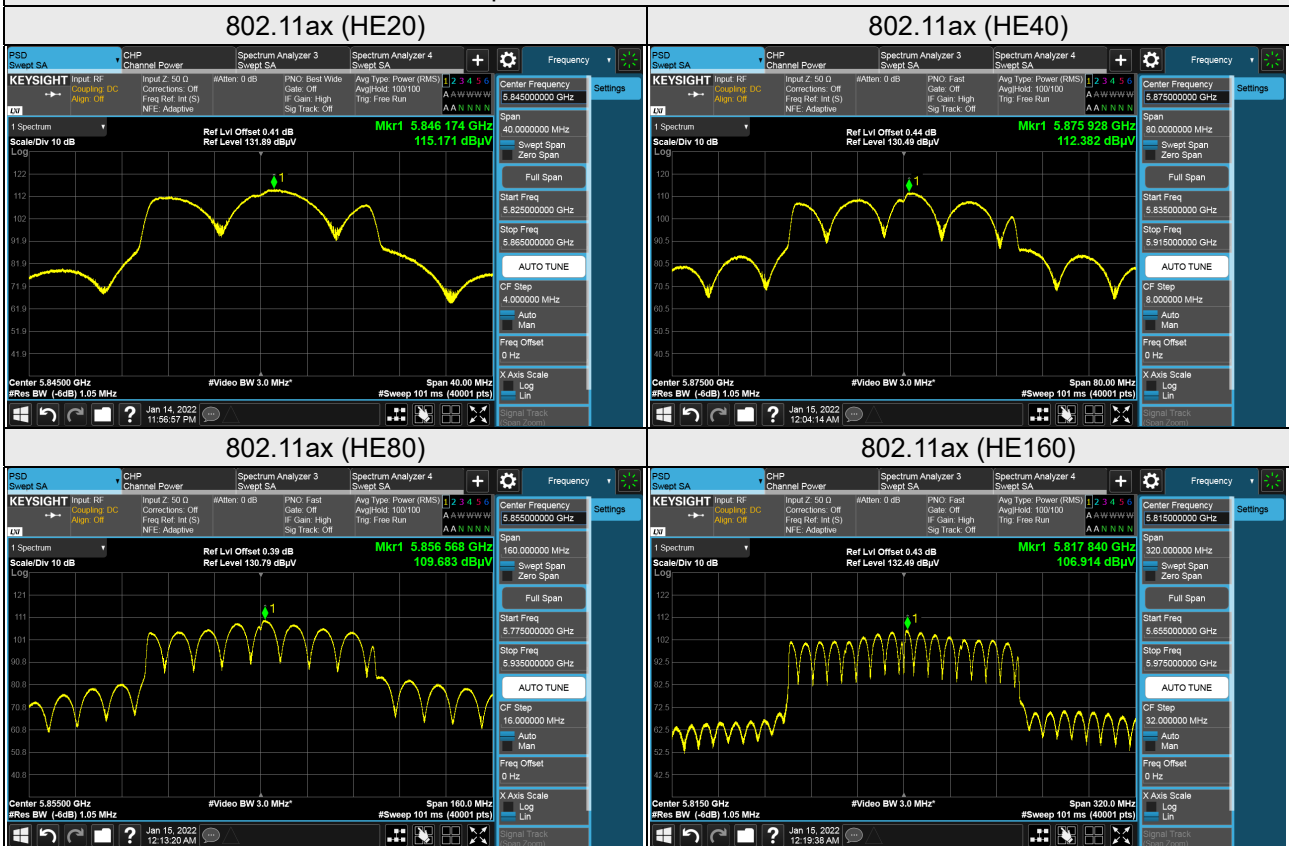

4.6 Frequency Stability Measurement

4.6.1 Limits of Frequency Stability Measurement

The frequency of the carrier signal shall be maintained within band of operation

4.6.2 Test Setup

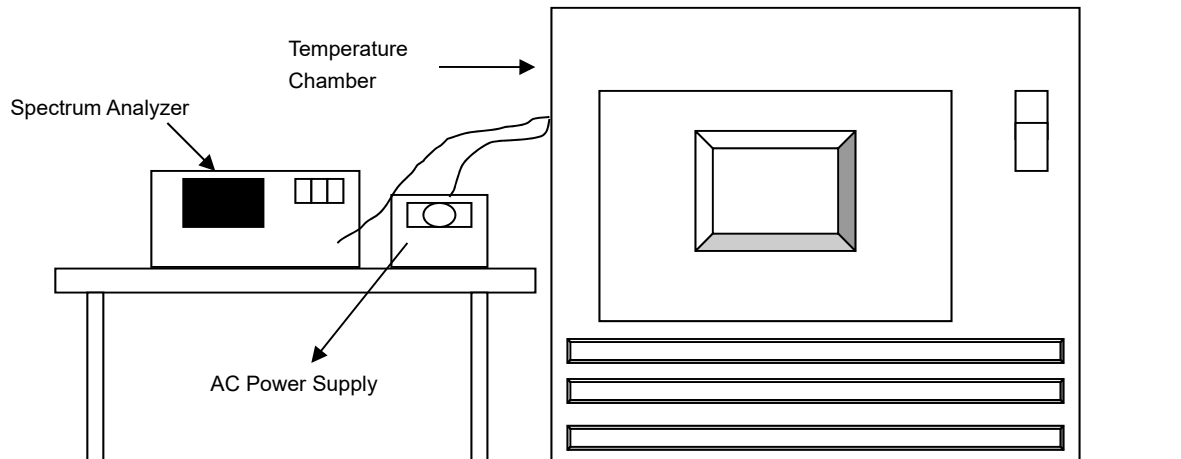

4.6.3 Test Instruments

Refer to section 4.1.2 to get information of above instrument.

4.6.4 Test Procedure

- The EUT was placed inside the environmental test chamber and powered by nominal AC voltage.
- Turn the EUT on and couple its output to a spectrum analyzer.
- Turn the EUT off and set the chamber to the highest temperature specified.
- Allow sufficient time (approximately 30 min) for the temperature of the chamber to stabilize, turn the EUT on and measure the operating frequency after 2, 5, and 10 Minutes.
- Repeat step (d) with the temperature chamber set to the next desired temperature until measurements down to the lowest specified temperature have been completed..
- The test chamber was allowed to stabilize at +20 degree C for a minimum of 30 Minutes. The supply voltage was then adjusted on the EUT from 85% to 115% and the frequency record.

4.6.5 EUT Operating Condition

Set the EUT transmit at un-modulation mode to test frequency stability.

4.6.6 Test Results

802.11a

Frequency Stability Versus Temp.									
Operating Frequency: 5885MHz									
TEMP. (°C)	Power Supply (Vac)	0 Minute		2 Minute		5 Minute		10 Minute	
		Measured Frequency (MHz)	Pass/Fail	Measured Frequency (MHz)	Pass/Fail	Measured Frequency (MHz)	Pass/Fail	Measured Frequency (MHz)	Pass/Fail
40	120	5885.0013	Pass	5885.0065	Pass	5885.0053	Pass	5885.0038	Pass
30	120	5884.9980	Pass	5884.9987	Pass	5884.9991	Pass	5884.9943	Pass
20	120	5884.9834	Pass	5884.9835	Pass	5884.9855	Pass	5884.9843	Pass
10	120	5884.9748	Pass	5884.9762	Pass	5884.9718	Pass	5884.9751	Pass
0	120	5885.0075	Pass	5885.0045	Pass	5885.0074	Pass	5885.0078	Pass

Frequency Stability Versus Voltage									
Operating Frequency: 5885MHz									
TEMP. (°C)	Power Supply (Vac)	0 Minute		2 Minute		5 Minute		10 Minute	
		Measured Frequency (MHz)	Pass/Fail	Measured Frequency (MHz)	Pass/Fail	Measured Frequency (MHz)	Pass/Fail	Measured Frequency (MHz)	Pass/Fail
20	138	5884.9849	Pass	5884.9888	Pass	5884.9864	Pass	5884.9874	Pass
	120	5884.9834	Pass	5884.9835	Pass	5884.9855	Pass	5884.9843	Pass
	102	5884.9939	Pass	5884.9961	Pass	5884.9925	Pass	5884.9939	Pass

4.7 Operational Restrictions for U-NII 4 Devices

4.7.1 Limits of Operational Restrictions for U-NII 4 Devices

(1) Indoor Access Point.

An access point that operates in the 5.850-5.895 GHz, is supplied power from a wired connection, has an integrated antenna, is not battery powered, and does not have a weatherized enclosure. Indoor access point devices must bear the following statement in a conspicuous location on the device and in the user's manual: FCC regulations restrict operation of this device to indoor use only.

(2) Subordinate Device.

A subordinate device that operates in the 5.850-5.895 GHz band under the control of an Indoor Access Point, is supplied power from a wired connection, has an integrated antenna, is not battery powered, does not have a weatherized enclosure, and does not have a direct connection to the internet. Subordinate devices must not be used to connect devices between separate buildings or structures. Subordinate devices must be authorized under certification procedures in part 2 of this chapter. Modules may not be certified as subordinate devices.

(3) Client Device.

A client device whose transmissions are generally under the control of an access point and is not capable of initiating a network

4.7.2 Test Setup

N/A

4.7.3 Test Instruments

N/A

4.7.4 Test Procedure

N/A.

4.7.5 Test Results

Device is an Indoor Access Point, all restrictions are meet the §15.403 requirements. Please refer to the Attestation letter exhibit supplied within this application.

5 Pictures of Test Arrangements

Please refer to the attached file (Test Setup Photo).

Annex A – Band Edge Measurement

802.11a

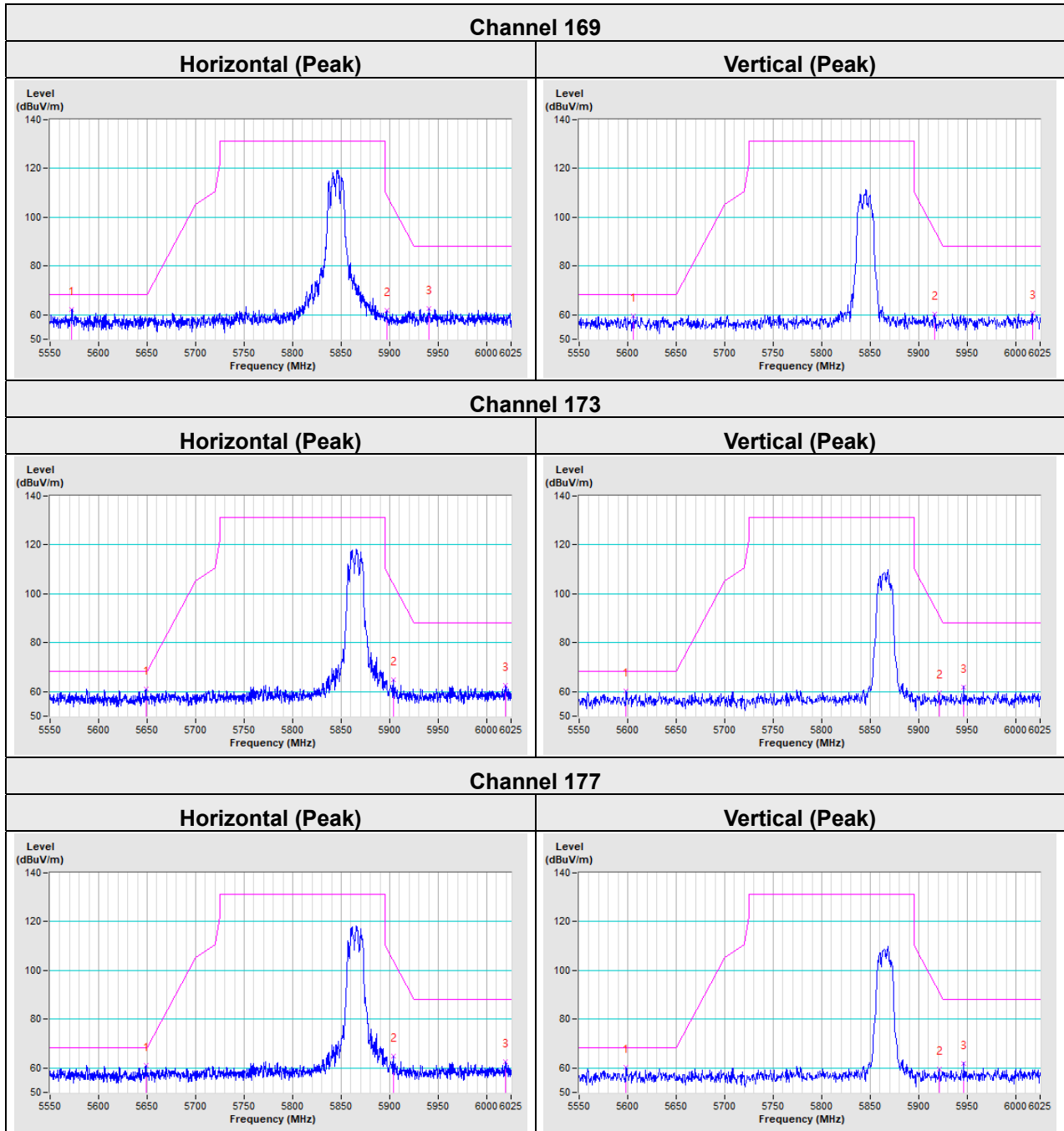

802.11ax (HE20)

Channel 169

Horizontal (Peak)

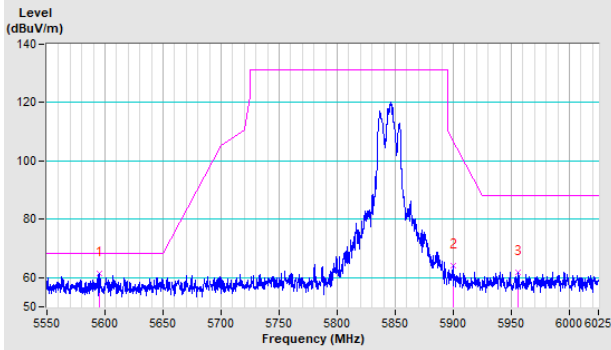

Vertical (Peak)

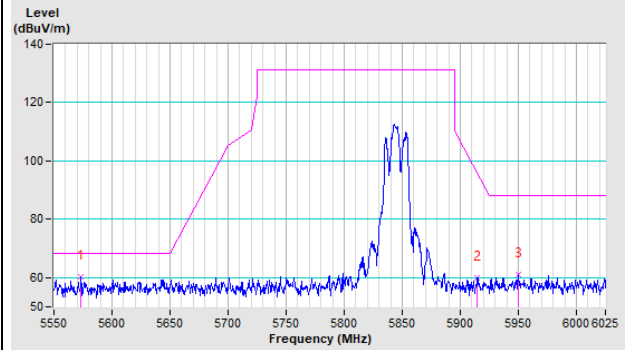

Channel 173

Horizontal (Peak)

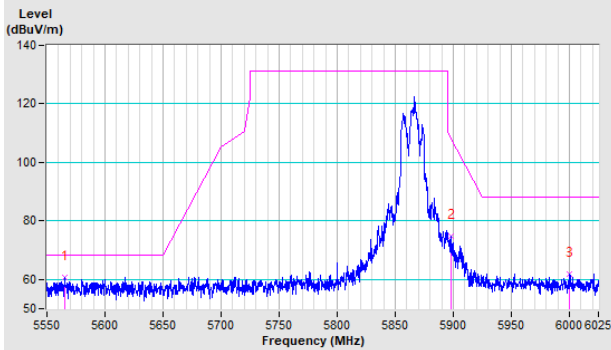

Vertical (Peak)

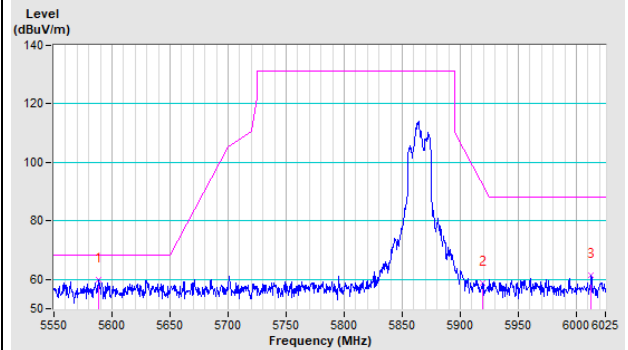

Channel 177

Horizontal (Peak)

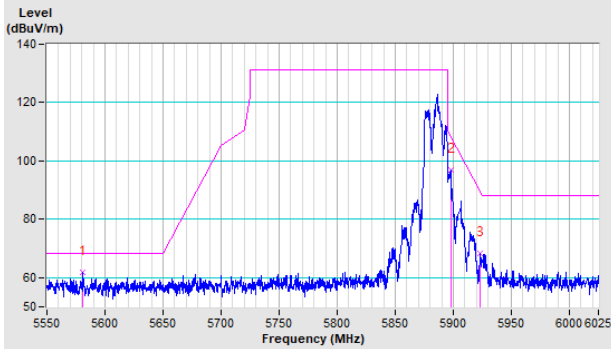

Vertical (Peak)

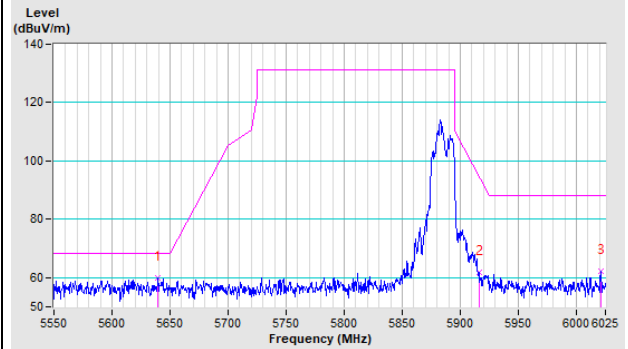

802.11ax (HE40)

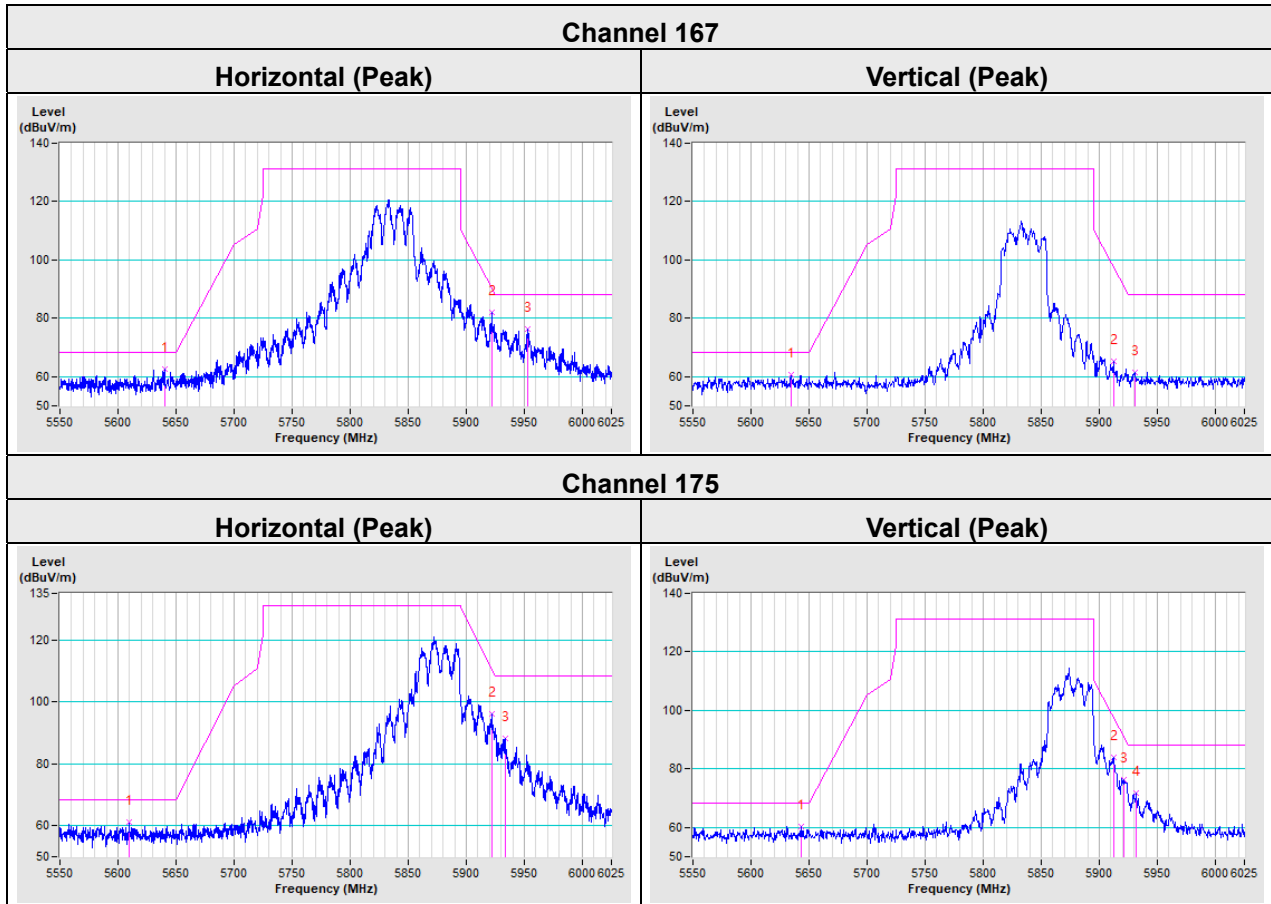

802.11ax (HE80)

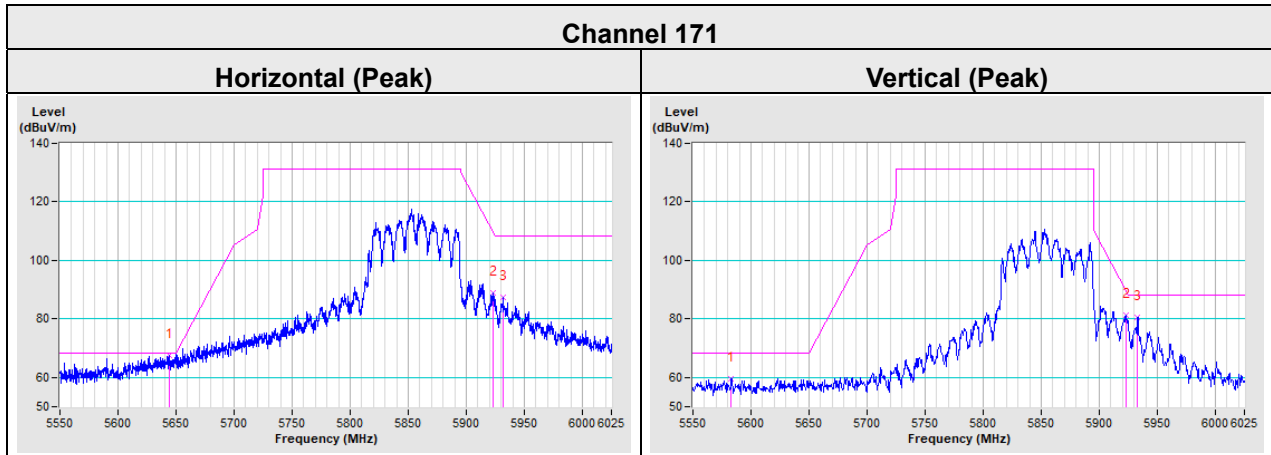

802.11ax (HE160)

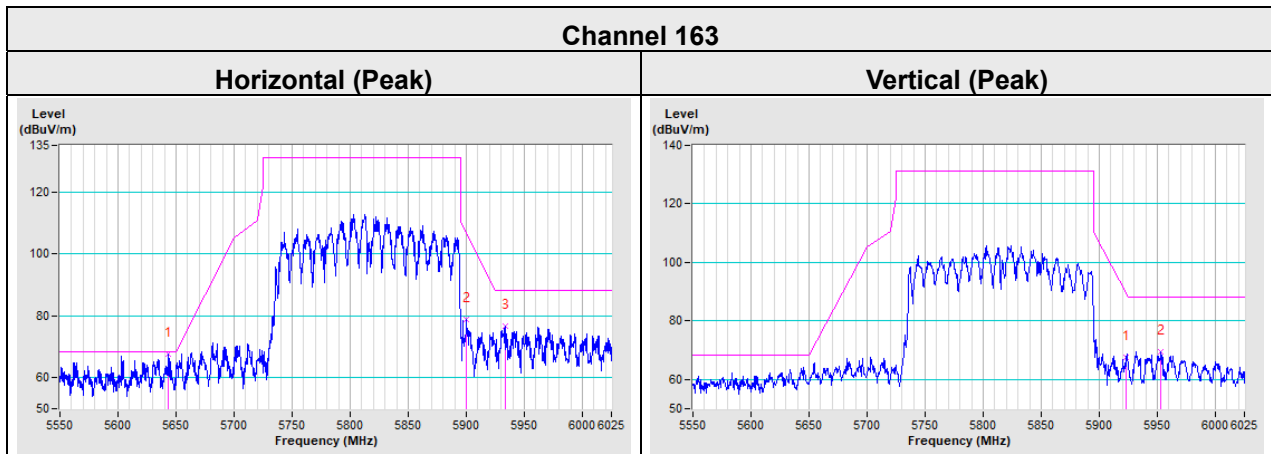

Appendix – Information of the Testing Laboratories

We, Bureau Veritas Consumer Products Services (H.K.) Ltd., Taoyuan Branch, were founded in 1988 to provide our best service in EMC, Radio, Telecom and Safety consultation. Our laboratories are FCC recognized accredited test firms and accredited according to ISO/IEC 17025.

If you have any comments, please feel free to contact us at the following:

Lin Kou EMC/RF Lab

Tel: 886-2-26052180

Fax: 886-2-26051924

Hsin Chu EMC/RF/Telecom Lab

Tel: 886-3-6668565

Fax: 886-3-6668323

Hwa Ya EMC/RF/Safety Lab

Tel: 886-3-3183232

Fax: 886-3-3270892

Email: service.adt@tw.bureauveritas.com

Web Site: www.bureauveritas-adt.com

The address and road map of all our labs can be found in our web site also.

--- END ---