



FCC RADIO TEST REPORT

FCC ID : PY321100529
Equipment : Netgear 5G MHS Travel Router
Brand Name : Netgear
Model Name : MR6500
Applicant : Netgear Inc
350 E. Plumeria Drive, San Jose, CA
95134, United States
Manufacturer : Netgear Inc
350 E. Plumeria Drive, San Jose, CA
95134, United States
Standard : FCC 47 CFR Part 2, 90(R)

The product was received on Oct. 19, 2021 and testing was performed from Oct. 29, 2021 and completed on Jan. 04, 2022. We, Sporton International Inc. EMC & Wireless Communications Laboratory, would like to declare that the tested sample has been evaluated in accordance with the test procedures given in ANSI / TIA-603-E and has been in compliance with the applicable technical standards.

The test results in this report apply exclusively to the tested model / sample. Without written approval of Sporton International Inc. EMC & Wireless Communications Laboratory, the test report shall not be reproduced except in full.

Louis Wu

Approved by: Louis Wu

Sporton International Inc. EMC & Wireless Communications Laboratory

No. 52, Huaya 1st Rd., Guishan Dist., Taoyuan City 333, Taiwan (R.O.C.)



Table of Contents

History of this test report.....3
Summary of Test Result.....4
1 General Description5
1.1 Product Feature of Equipment Under Test.....5
1.2 Modification of EUT5
1.3 Testing Site.....6
1.4 Applied Standards6
2 Test Configuration of Equipment Under Test7
2.1 Test Mode.....7
2.2 Connection Diagram of Test System.....8
2.3 Support Unit used in test configuration and system8
2.4 Measurement Results Explanation Example.....8
2.5 Frequency List of Low/Middle/High Channels9
3 Conducted Test Items.....10
3.1 Measuring Instruments10
3.2 Conducted Output Power Measurement and ERP.....11
3.3 Peak-to-Average Ratio12
3.4 Occupied Bandwidth.....13
3.5 Conducted Band Edge14
3.6 Emission Mask.....15
3.7 Conducted Spurious Emission16
3.8 Frequency Stability17
4 Radiated Test Items18
4.1 Measuring Instruments18
4.2 Radiated Spurious Emission20
5 List of Measuring Equipment.....21
6 Uncertainty of Evaluation.....23
Appendix A. Test Results of Conducted Test
Appendix B. Test Results of Radiated Test
Appendix C. Test Setup Photographs



History of this test report

| Report No. | Version | Description | Issued Date |
|------------|---------|--|---------------|
| FG190614E | 01 | Initial issue of report | Jan. 24, 2022 |
| FG190614E | 02 | Revise Product Feature of Equipment Under Test | Jan. 28, 2022 |
| FG190614E | 03 | Revised antenna information in section 1 and ERP | Mar. 23, 2022 |
| | | | |
| | | | |
| | | | |
| | | | |
| | | | |
| | | | |
| | | | |
| | | | |
| | | | |
| | | | |
| | | | |
| | | | |
| | | | |
| | | | |
| | | | |
| | | | |
| | | | |

**Summary of Test Result**

| Report Clause | Ref Std. Clause | Test Items | Result (PASS/FAIL) | Remark |
|---------------|--|--|--------------------|---|
| 3.2 | §2.1046 | Conducted Output Power | Reporting only | - |
| | §90.542 (a)(7) | Effective Radiated Power | Pass | - |
| 3.3 | - | Peak-to-Average Ratio | Reporting only | - |
| 3.4 | §2.1049 | Occupied Bandwidth | Reporting only | - |
| 3.5 | §2.1053 §90.543 (e)(2) | Conducted Band Edge Measurement | Pass | - |
| 3.6 | §2.1051 §90.210 (n) | Emission Mask | Pass | - |
| 3.7 | §2.1053 §90.543 (e)(3) | Conducted Spurious Emission | Pass | - |
| 3.8 | §2.1055 §90.539 (e) | Frequency Stability Temperature & Voltage | Pass | - |
| 4.2 | §2.1053 §90.543 (e)(3) §90.543 (f) | Radiated Spurious Emission | Pass | Under limit 7.05 dB at 1584.000 MHz |

Declaration of Conformity:

The test results with all measurement uncertainty excluded are presented in accordance with the regulation limits or requirements declared by manufacturers.

Comments and Explanations:

The declared of product specification for EUT presented in the report are provided by the manufacturer, and the manufacturer takes all the responsibilities for the accuracy of product specification.

Reviewed by: Avis Chuang**Report Producer: Lucy Wu**



1 General Description

1.1 Product Feature of Equipment Under Test

LTE/5G NR, Wi-Fi 2.4GHz 802.11b/g/n/ac/ax, Wi-Fi 5GHz 802.11a/n/ac/ax, Wi-Fi 6GHz 802.11a/n/ac/ax, and GNSS

| Product Feature | |
|-----------------|---|
| Antenna Type | WWAN: <Ant. 1>: Monopole Antenna <Ant. 2>: Monopole Antenna WLAN: <Ant. 3>: Monopole Antenna <Ant. 4>: Monopole Antenna GPS: PIFA Antenna |

Remark: The above EUT's information was declared by manufacturer. Please refer to Comments and Explanations in report summary.

| Antenna Information | |
|-----------------------|--------------------|
| Internal Antenna Gain | <Ant. 1>:-0.83 dBi |
| External Antenna Gain | <Ant. 1>:4 dBi |

Remark:

1. TS9 connector is for the external antennas, while the external antennas are connected, RF outputs are switched from internal antenna 1 to the external one.
2. The maximum antenna gain allowed for the external antenna is limited by the numbers in the table, and also illustrated in the user manual.

1.2 Modification of EUT

No modifications are made to the EUT during all test items.



1.3 Testing Site

| | |
|------------------------------|--|
| Test Site | Sporton International Inc. EMC & Wireless Communications Laboratory |
| Test Site Location | No.52, Huaya 1st Rd., Guishan Dist., Taoyuan City 333, Taiwan (R.O.C.) TEL: +886-3-327-3456 FAX: +886-3-328-4978 |
| Test Site No. | Sporton Site No. |
| | TH03-HY |
| Test Engineer | Bryant Liu |
| Temperature (°C) | 22.8~23.2 |
| Relative Humidity (%) | 52~56 |

| | |
|------------------------------|--|
| Test Site | Sporton International Inc. Wensan Laboratory |
| Test Site Location | No.58, Aly. 75, Ln. 564, Wenhua 3rd, Rd., Guishan Dist., Taoyuan City 333010, Taiwan (R.O.C.) TEL: +886-3-327-0868 FAX: +886-3-327-0855 |
| Test Site No. | Sporton Site No. |
| | 03CH16-HY (TAF Code: 3786) |
| Test Engineer | Karl Hou and Andy Yang |
| Temperature (°C) | 18~25 |
| Relative Humidity (%) | 50~65 |
| Remark | The Radiated Spurious Emission test item subcontracted to Sporton International Inc. Wensan Laboratory. |

Note: The test site complies with ANSI C63.4 2014 requirement.

FCC Designation No.: TW1190 and TW3786

1.4 Applied Standards

According to the specifications of the manufacturer, the EUT must comply with the requirements of the following standards:

- ♦ ANSI C63.26-2015
- ♦ FCC 47 CFR Part 2, Part 90(R)
- ♦ ANSI / TIA-603-E
- ♦ FCC KDB 971168 D01 Power Meas. License Digital Systems v03r01
- ♦ FCC KDB 412172 D01 Determining ERP and EIRP v01r01
- ♦ FCC KDB 414788 D01 Radiated Test Site v01r01

Remark:

1. All test items were verified and recorded according to the standards and without any deviation during the test.
2. This EUT has also been tested and complied with the requirements of FCC Part 15, Subpart B, recorded in a separate test report.
3. The TAF code is not including all the FCC KDB listed without accreditation.



2 Test Configuration of Equipment Under Test

2.1 Test Mode

Antenna port conducted and radiated test items listed below are performed according to KDB 971168 D01 Power Meas. License Digital Systems v03r01 with maximum output power.

For radiated measurement, the measured emission level of the EUT was maximized by rotating the EUT on a turntable, adjusting the orientation of the EUT and EUT antenna in three orthogonal axis (X: flat, Y: portrait, Z: landscape), and adjusting the measurement antenna orientation, following C63.26 exploratory test procedures and find X plane as worst plane.

| Conducted Test Cases | Band | Bandwidth (MHz) | | | | | | Modulation | | | | RB # | | | Test Channel | | |
|-----------------------------|---|-----------------|---|---|----|----|----|------------|-------|-------|--------|-----------|------|------|--------------|---|---|
| | | 1.4 | 3 | 5 | 10 | 15 | 20 | QPSK | 16QAM | 64QAM | 256QAM | 1 | Half | Full | L | M | H |
| Max. Output Power | 14 | - | - | V | V | - | - | V | V | V | V | V | V | V | V | V | V |
| Peak-to-Average Ratio | 14 | - | - | | V | - | - | V | V | V | V | | | V | | V | |
| 26dB and 99% Bandwidth | 14 | - | - | V | V | - | - | V | V | V | V | | | V | | V | |
| Conducted Band Edge | 14 | - | - | V | V | - | - | V | V | V | V | V | | V | V | | V |
| Emission Mask | 14 | - | - | V | V | - | - | V | V | V | V | V | | V | V | V | V |
| Conducted Spurious Emission | 14 | - | - | V | V | - | - | V | | | | V | | | V | V | V |
| Frequency Stability | 14 | - | - | | V | - | - | V | | | | | | V | | V | |
| E.R.P | 14 | - | - | V | V | - | - | V | V | V | V | Max Power | | | | | |
| Radiated Spurious Emission | 14 | Worst Case | | | | | | | | | | | | V | V | V | |
| Remark | <ol style="list-style-type: none"> The mark "v " means that this configuration is chosen for testing The mark "- " means that this bandwidth is not supported. The device is investigated from 30MHz to 10 times of fundamental signal for radiated spurious emission test under different RB size/offset and modulations in exploratory test. Subsequently, only the worst case emissions are reported. All the radiated test cases were performed with Adapter 1. | | | | | | | | | | | | | | | | |

2.2 Connection Diagram of Test System

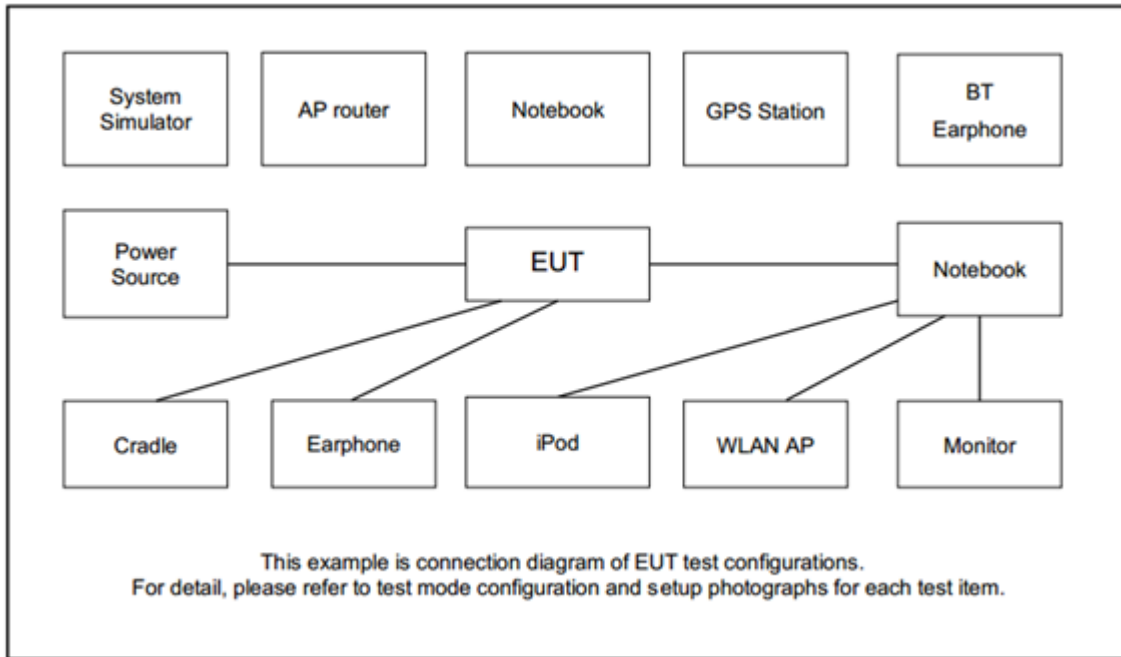

2.3 Support Unit used in test configuration and system

| Item | Equipment | Brand Name | Model No. | FCC ID | Data Cable | Power Cord |
|------|------------------|------------|-----------|--------|------------|-------------------|
| 1. | System Simulator | Anritsu | MT8821C | N/A | N/A | Unshielded, 1.8 m |

2.4 Measurement Results Explanation Example

For all conducted test items:

The offset level is set in the spectrum analyzer to compensate the RF cable loss and attenuator factor between EUT conducted output port and spectrum analyzer. With the offset compensation, the spectrum analyzer reading level is exactly the EUT RF output level.

The spectrum analyzer offset is derived from RF cable loss and attenuator factor.

Offset = RF cable loss + attenuator factor.

Following shows an offset computation example with cable loss 4.5 dB and 10dB attenuator.

Example :

Offset(dB) = RF cable loss(dB) + attenuator factor(dB).

$$= 4.5 + 10 = 14.5 \text{ (dB)}$$



2.5 Frequency List of Low/Middle/High Channels

| LTE Band 14 Channel and Frequency List | | | | |
|--|------------------------|--------|--------|---------|
| BW [MHz] | Channel/Frequency(MHz) | Lowest | Middle | Highest |
| 10 | Channel | - | 23330 | - |
| | Frequency | - | 793 | - |
| 5 | Channel | 23305 | 23330 | 23355 |
| | Frequency | 790.5 | 793 | 795.5 |

3 Conducted Test Items

3.1 Measuring Instruments

See list of measuring instruments of this test report.

3.1.1 Test Setup

3.1.2 Conducted Output Power

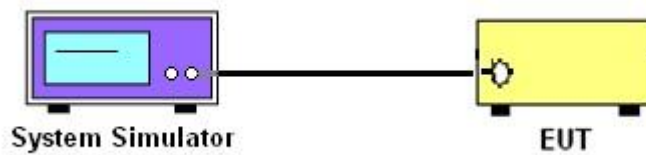

3.1.3 Peak-to-Average Ratio, Occupied Bandwidth, Conducted Band-Edge, Emission Mask, and Conducted Spurious Emission

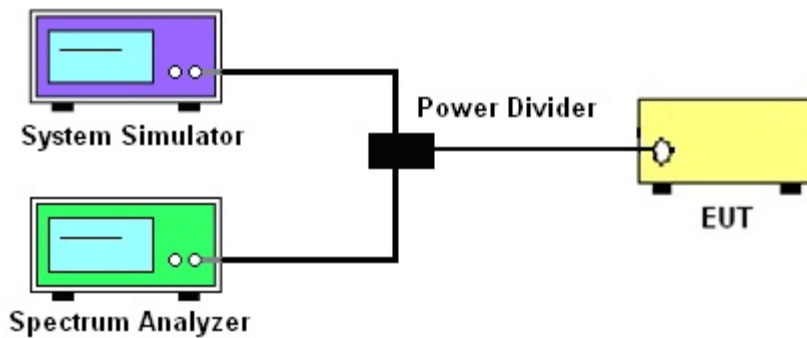

3.1.4 Frequency Stability

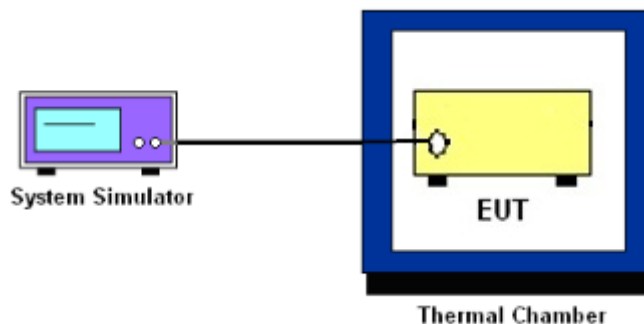

3.1.5 Test Result of Conducted Test

Please refer to Appendix A.



3.2 Conducted Output Power Measurement and ERP

3.2.1 Description of the Conducted Output Power Measurement and ERP Measurement

A base station simulator was used to establish communication with the EUT. Its parameters were set to transmit the maximum power on the EUT. The measured power in the radio frequency on the transmitter output terminals shall be reported.

The ERP of mobile transmitters must not exceed 3 Watts for LTE Band 14.

According to KDB 412172 D01 Power Approach,

$EIRP = P_T + G_T - L_C$, $ERP = EIRP - 2.15$, where

P_T = transmitter output power in dBm

G_T = gain of the transmitting antenna in dBi

L_C = signal attenuation in the connecting cable between the transmitter and antenna in dB

3.2.2 Test Procedures

1. The transmitter output port was connected to base station.
2. Set EUT at maximum power through base station.
3. Select lowest, middle, and highest channels for each band and different modulation.
4. Measure and record the power level from the system simulator.



3.3 Peak-to-Average Ratio

3.3.1 Description of the PAR Measurement

Power Complementary Cumulative Distribution Function (CCDF) curves provide a means for characterizing the power peaks of a digitally modulated signal on a statistical basis. A CCDF curve depicts the probability of the peak signal amplitude exceeding the average power level. Most contemporary measurement instrumentation include the capability to produce CCDF curves for an input signal provided that the instrument's resolution bandwidth can be set wide enough to accommodate the entire input signal bandwidth. In measuring transmissions in this band using an average power technique, the peak-to-average ratio (PAR) of the transmission may not exceed 13 dB.

3.3.2 Test Procedures

The testing follows ANSI C63.26-2015 Section 5.2.6

1. The EUT was connected to spectrum and system simulator via a power divider.
2. Set the CCDF (Complementary Cumulative Distribution Function) option in spectrum analyzer.
3. The highest RF powers were measured and recorded the maximum PAPR level associated with a probability of 0.1 %.
4. Record the deviation as Peak to Average Ratio.



3.4 Occupied Bandwidth

3.4.1 Description of Occupied Bandwidth Measurement

The occupied bandwidth is the width of a frequency band such that, below the lower and above the upper frequency limits, the mean powers emitted are each equal to a specified percentage 0.5% of the total mean transmitted power.

The 26 dB emission bandwidth is defined as the frequency range between two points, one above and one below the carrier frequency, at which the spectral density of the emission is attenuated 26 dB below the maximum in-band spectral density of the modulated signal. Spectral density (power per unit bandwidth) is to be measured with a detector of resolution bandwidth equal to approximately 1.0% of the emission bandwidth.

3.4.2 Test Procedures

The testing follows ANSI C63.26-2015 Section 5.4.3 (26dB) and Section 5.4.4 (99OB)

1. The EUT was connected to spectrum analyzer and system simulator via a power divider.
2. The spectrum analyzer center frequency is set to the nominal EUT channel center frequency. The span range for the spectrum analyzer shall be between two and five times the anticipated OBW.
3. The nominal resolution bandwidth (RBW) shall be in the range of 1 to 5 % of the anticipated OBW, and the VBW shall be at least 3 times the RBW.
4. Set the detection mode to peak, and the trace mode to max hold.
5. Determine the reference value: Set the EUT to transmit a modulated signal. Allow the trace to stabilize. Set the spectrum analyzer marker to the highest level of the displayed trace.
(this is the reference value)
6. Determine the “-26 dB down amplitude” as equal to (Reference Value – X).
7. Place two markers, one at the lowest and the other at the highest frequency of the envelope of the spectral display such that each marker is at or slightly below the “-X dB down amplitude” determined in step 6. If a marker is below this “-X dB down amplitude” value it shall be placed as close as possible to this value. The OBW is the positive frequency difference between the two markers.
8. Use the 99 % power bandwidth function of the spectrum analyzer and report the measured bandwidth.



3.5 Conducted Band Edge

3.5.1 Description of Conducted Band Edge Measurement

90.543(e)

- (1) On all frequencies between 769-775 MHz and 799-805 MHz, by a factor not less than $76 + 10 \log (P)$ dB in a 6.25 kHz band segment, for base and fixed stations.
- (2) On all frequencies between 769-775 MHz and 799-805 MHz, by a factor not less than $65 + 10 \log (P)$ dB in a 6.25 kHz band segment, for mobile and portable stations.
- (3) On any frequency between 775-788 MHz, above 805 MHz, and below 758 MHz, by at least $43 + 10 \log (P)$ dB.

3.5.2 Test Procedures

The testing follows FCC KDB 971168 D01 v03r01 Section 6.1.

1. The EUT was connected to spectrum analyzer and system simulator via a power divider.
2. The band edges of low and high channels for the highest RF powers were measured.
3. Set RBW $\geq 1\%$ EBW in the 100kHz band immediately outside and adjacent to the band edge.
4. Beyond the 100kHz band from the band edge, RBW=100kHz was used.
5. Set spectrum analyzer with RMS detector.
6. The RF fundamental frequency should be excluded against the limit line in the operating frequency band.
7. Checked that all the results comply with the emission limit line.

The limit line is derived from $43 + 10\log(P)$ dB below the transmitter power P(Watts)



3.6 Emission Mask

3.6.1 Description of Emissions Mask Measurement

Transmitters designed must meet the emission mask comply with the emission mask provisions of FCC Part 90.210(n).

3.6.2 Test Procedures

The testing follows FCC KDB 971168 D01 v03r01 Section 6.0.

1. The EUT was connected to spectrum analyzer and system simulator via a power divider.
2. The power of the modulated signal was measured on a spectrum analyzer using an RMS and 10 second sweep time in order to maximize the level.
3. The RF fundamental frequency should be excluded against the limit line in the operating frequency band.



3.7 Conducted Spurious Emission

3.7.1 Description of Conducted Spurious Emission Measurement

The power of any emission outside of the authorized operating frequency ranges must be lower than the transmitter power (P) by a factor of at least $43 + 10 \log (P)$ dB.

It is measured by means of a calibrated spectrum analyzer and scanned from 30MHz up to a frequency including its 10th harmonic.

3.7.2 Test Procedures

The testing follows FCC KDB 971168 D01 v03r01 Section 6.1.

1. The EUT was connected to spectrum analyzer and base station via power divider.
2. The RF output of EUT was connected to the spectrum analyzer by RF cable and attenuator. The path loss was compensated to the results for each measurement.
3. The middle channel for the highest RF power within the transmitting frequency was measured.
4. The conducted spurious emission for the whole frequency range was taken.
5. Make the measurement with the spectrum analyzer's RBW = 1MHz, VBW = 3MHz.
6. Set spectrum analyzer with RMS detector.
7. Taking the record of maximum spurious emission.
8. The RF fundamental frequency should be excluded against the limit line in the operating frequency band.
9. The limit line is derived from $43 + 10\log(P)$ dB below the transmitter power P(Watts)



3.8 Frequency Stability

3.8.1 Description of Frequency Stability Measurement

The frequency stability shall be sufficient to ensure that the fundamental emission stays within the authorized frequency block.

3.8.2 Test Procedures for Temperature Variation

The testing follows FCC KDB 971168 D01 v03r01 Section 9.0.

1. The EUT was set up in the thermal chamber and connected with the base station.
2. With power OFF, the temperature was decreased to -30°C and the EUT was stabilized before testing. Power was applied and the maximum change in frequency was recorded within one minute.
3. With power OFF, the temperature was raised in 10°C step up to 50°C. The EUT was stabilized at each step for at least half an hour. Power was applied and the maximum frequency change was recorded within one minute.

3.8.3 Test Procedures for Voltage Variation

The testing follows FCC KDB 971168 D01 v03r01 Section 9.0.

1. The EUT was placed in a temperature chamber at 20±5° C and connected with the base station.
2. The power supply voltage to the EUT was varied from 85% to 115% of the nominal value measured at the input to the EUT.
3. The variation in frequency was measured for the worst case.

4 Radiated Test Items

4.1 Measuring Instruments

See list of measuring instruments of this test report.

4.1.1 Test Setup

For radiated test below 30MHz

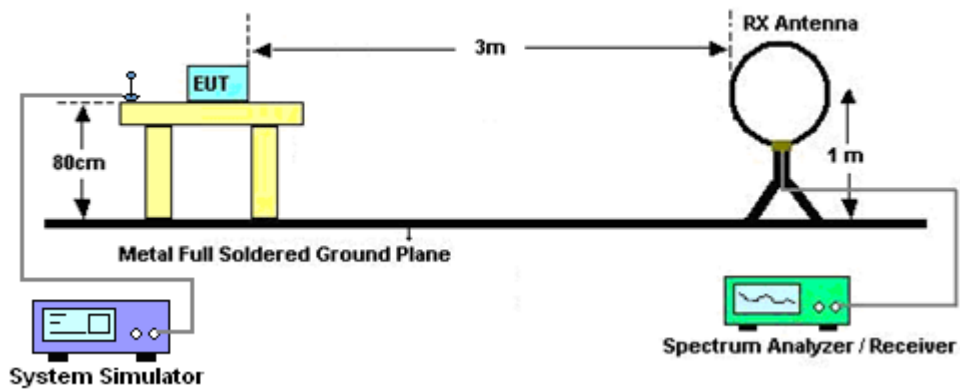

For radiated test from 30MHz to 1GHz

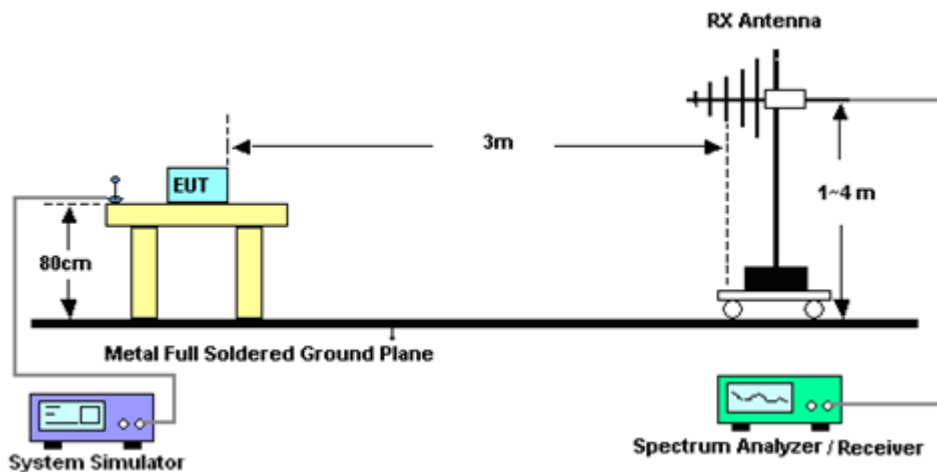

For radiated test above 1GHz

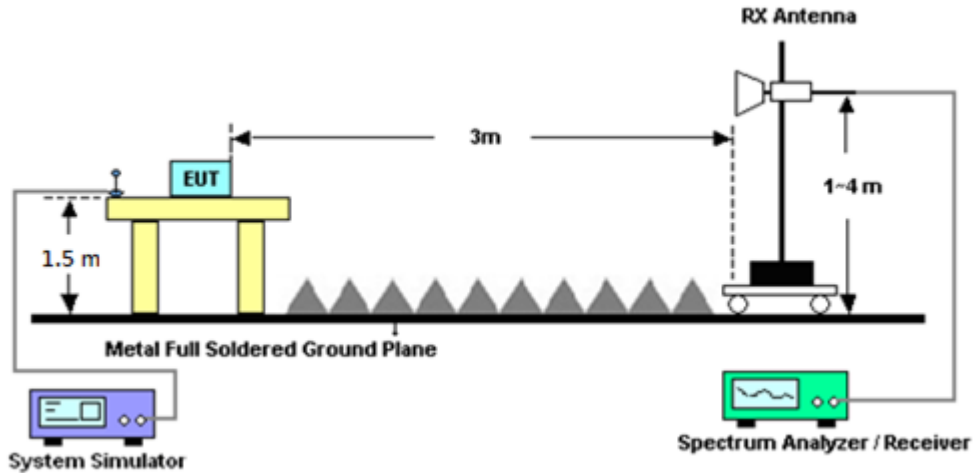

4.1.2 Test Result of Radiated Test

Please refer to Appendix B.

Note:

The low frequency, which started from 9 kHz to 30MHz, was pre-scanned and the result which was 20dB lower than the limit line was not reported.

There is adequate comparison measurement of both open-field test site and alternative test site - semi-Anechoic chamber according to 414788 D01 Radiated Test Site v01r01, and the result came out very similar.



4.2 Radiated Spurious Emission

4.2.1 Description of Radiated Spurious Emission

The radiated spurious emission was measured by substitution method according to ANSI / TIA-603-E. The power of any emission outside of the authorized operating frequency ranges must be attenuated below the transmitter power (P) by a factor of at least $43 + 10 \log (P)$ dB.

For operations in the 758-775 MHz and 788-805 MHz bands, all emissions including harmonics in the band 1559–1610 MHz shall be limited to -70 dBW/MHz equivalent isotropically radiated power (EIRP) for wideband signals, and -80 dBW EIRP for discrete emissions of less than 700 Hz bandwidth. For the purpose of equipment authorization, a transmitter shall be tested with an antenna that is representative of the type that will be used with the equipment in normal operation.

The spectrum is scanned from 30 MHz up to a frequency including its 10th harmonic.

4.2.2 Test Procedures

The testing follows FCC KDB 971168 D01 v03r01 Section 7 and ANSI / TIA-603-E Section 2.2.12.

1. The EUT was placed on a turntable with 0.8 meter for frequency below 1GHz and 1.5 meter for frequency above 1GHz respectively above ground.
2. The EUT was set 3 meters from the receiving antenna, which was mounted on the antenna tower.
3. The table was rotated 360 degrees to determine the position of the highest spurious emission.
4. The height of the receiving antenna is varied between one meter and four meters to search the maximum spurious emission for both horizontal and vertical polarizations.
5. Make the measurement with the spectrum analyzer's RBW = 1MHz, VBW = 3MHz, Sweep = 500ms, Taking the record of maximum spurious emission.
6. A horn antenna was substituted in place of the EUT and was driven by a signal generator.
7. Tune the output power of signal generator to the same emission level with EUT maximum spurious emission.
8. Taking the record of output power at antenna port.
9. Repeat step 7 to step 8 for another polarization.
10. The RF fundamental frequency should be excluded against the limit line in the operating frequency band.
11. The limit line is derived from $43 + 10\log(P)$ dB below the transmitter power P(Watts)



5 List of Measuring Equipment

| Instrument | Brand Name | Model No. | Serial No. | Characteristics | Calibration Date | Test Date | Due Date | Remark |
|-------------------|-------------------|-----------------------------------|----------------------|----------------------------------|------------------|---------------------------------|---------------|--------------------------|
| Loop Antenna | Rohde & Schwarz | HFH2-Z2 | 100488 | 9 kHz~30 MHz | Sep. 07, 2021 | Oct. 29, 2021~ Dec. 03, 2021 | Sep. 06, 2022 | Radiation (03CH16-HY) |
| Spectrum Analyzer | Keysight | N9010A | MY542004 86 | 10Hz~44GHz | Oct. 15, 2021 | Oct. 29, 2021~ Dec. 03, 2021 | Oct. 14, 2022 | Radiation (03CH16-HY) |
| Signal Generator | Agilent | MG3694C | 163401 | 0.1Hz~40GHz | Jan. 31, 2021 | Oct. 29, 2021~ Dec. 03, 2021 | Jan. 30, 2022 | Radiation (03CH16-HY) |
| Bilog Antenna | TESEQ | CBL 6111D & 00800N1D01 N-06 | 41912 & 05 | 30MHz to 1GHz | Feb. 08, 2021 | Oct. 29, 2021~ Dec. 03, 2021 | Feb. 07, 2022 | Radiation (03CH16-HY) |
| Bilog Antenna | TESEQ | CBL 6111D & 00802N1D01 N-06 | 47020 & 06 | 30MHz to 1GHz | Oct. 09, 2021 | Oct. 29, 2021~ Dec. 03, 2021 | Oct. 08, 2022 | Radiation (03CH16-HY) |
| Horn Antenna | SCHWARZBE CK | BBHA 9120 D | 9120D-152 2 | 1G~18GHz | Oct. 12, 2021 | Oct. 29, 2021~ Dec. 03, 2021 | Oct. 11, 2022 | Radiation (03CH16-HY) |
| Horn Antenna | SCHWARZBE CK | BBHA 9120 D | 9120D-121 2 | 1G~18GHz | May 18, 2021 | Oct. 29, 2021~ Dec. 03, 2021 | May 18, 2022 | Radiation (03CH16-HY) |
| Amplifier | SONOMA | 310N | 371607 | 9kHz~1G | Jul. 05, 2021 | Oct. 29, 2021~ Dec. 03, 2021 | Jul. 04, 2022 | Radiation (03CH16-HY) |
| Amplifier | Jet-Power | JPA0118-55-3 03 | 171000180 0054001 | 1-18GHz | Jun. 16, 2021 | Oct. 29, 2021~ Dec. 03, 2021 | Jun. 15, 2022 | Radiation (03CH16-HY) |
| Preamplifier | Keysight | 83017A | MY532702 64 | 1GHz~26.5GHz | Dec. 10, 2020 | Oct. 29, 2021~ Dec. 03, 2021 | Dec. 09, 2021 | Radiation (03CH16-HY) |
| EMI Test Receiver | Keysight | N9038A | MY572901 11 | 3Hz~26.5GHz | Dec. 11, 2020 | Oct. 29, 2021~ Dec. 03, 2021 | Dec. 10, 2021 | Radiation (03CH16-HY) |
| RF Cable | HUBER + SUHNER | SUCOFLEX 104 | MY11680/ 4PE | NA | Aug. 28, 2021 | Oct. 29, 2021~ Dec. 03, 2021 | Aug. 27, 2022 | Radiation (03CH16-HY) |
| RF Cable | HUBER + SUHNER | SUCOFLEX 104 | MY11688/ 4PE | NA | Aug. 28, 2021 | Oct. 29, 2021~ Dec. 03, 2021 | Aug. 27, 2022 | Radiation (03CH16-HY) |
| RF Cable | HUBER + SUHNER | SUCOFLEX 102 | EC-A5-300 -5757 | NA | Aug. 28, 2021 | Oct. 29, 2021~ Dec. 03, 2021 | Aug. 27, 2022 | Radiation (03CH16-HY) |
| Software | Audix | E3 6.2009-8-24 | RK-001136 | N/A | N/A | Oct. 29, 2021~ Dec. 03, 2021 | N/A | Radiation (03CH16-HY) |
| Controller | ChainTek | 3000-1 | N/A | Control Turn table & Ant Mast | N/A | Oct. 29, 2021~ Dec. 03, 2021 | N/A | Radiation (03CH16-HY) |
| Antenna Mast | ChainTek | MBS-520-1 | N/A | 1m~4m | N/A | Oct. 29, 2021~ Dec. 03, 2021 | N/A | Radiation (03CH16-HY) |
| Turn Table | ChainTek | T-200-S-1 | N/A | 0~360 Degree | N/A | Oct. 29, 2021~ Dec. 03, 2021 | N/A | Radiation (03CH16-HY) |



| Instrument | Brand Name | Model No. | Serial No. | Characteristics | Calibration Date | Test Date | Due Date | Remark |
|------------------------------|-----------------|----------------------------------|----------------|--|------------------|---------------------------------|---------------|---------------------|
| Radio Communication Analyzer | Anritsu | MT8821C | 620166475 5 | 2/3/4G/LTE FDD/TDD with44)/LTE-3C C DLCA/2CC ULCA, CatM1/NB1/NB2 | Jul. 21, 2021 | Nov. 03, 2021~ Jan. 04, 2022 | Jul. 20, 2022 | Conducted (TH03-HY) |
| Spectrum Analyzer | Rohde & Schwarz | FSV40 | 101909 | 10Hz~40GHz | Aug. 13, 2021 | Nov. 03, 2021~ Jan. 04, 2022 | Aug. 12, 2022 | Conducted (TH03-HY) |
| Thermal Chamber | ESPEC | SH-641 | 92013720 | -40℃ ~90℃ | Sep. 09, 2021 | Nov. 03, 2021~ Jan. 04, 2022 | Sep. 08, 2022 | Conducted (TH03-HY) |
| Programmable Power Supply | GW Instek | PSS-2005 | EL890001 | 1V~20V 0.5A~5A | Oct. 06, 2021 | Nov. 03, 2021~ Jan. 04, 2022 | Oct. 05, 2022 | Conducted (TH03-HY) |
| Coupler | Warison | 20dB 25W SMA Directional Coupler | #B | 1-18GHz | Jan. 09, 2021 | Nov. 03, 2021~ Jan. 04, 2022 | Jan. 08, 2022 | Conducted (TH03-HY) |



6 Uncertainty of Evaluation

Uncertainty of Radiated Emission Measurement (30 MHz ~ 1000 MHz)

| | |
|---|---------|
| Measuring Uncertainty for a Level of Confidence of 95% ($U = 2Uc(y)$) | 2.86 dB |
|---|---------|

Uncertainty of Radiated Emission Measurement (1 GHz ~ 18 GHz)

| | |
|---|---------|
| Measuring Uncertainty for a Level of Confidence of 95% ($U = 2Uc(y)$) | 3.68 dB |
|---|---------|



Appendix A. Test Results of Conducted Test

Conducted Output Power(Average power & ERP)

| LTE Band 14 Maximum Average Power [dBm] (GT - LC = 4 dB) | | | | | | | | |
|--|----------|-----------|---------|--------|--------|---------|-----------|---------|
| BW [MHz] | RB Size | RB Offset | Mod | Lowest | Middle | Highest | ERP (dBm) | ERP (W) |
| 10 | 1 | 0 | QPSK | | 23.09 | | 24.94 | 0.3119 |
| 10 | 1 | 25 | | | 23.03 | | | |
| 10 | 1 | 49 | | | 23.05 | | | |
| 10 | 25 | 0 | | | 22.08 | | | |
| 10 | 25 | 12 | | | 22.09 | | | |
| 10 | 25 | 25 | | | 22.13 | | | |
| 10 | 50 | 0 | | | 22.07 | | | |
| 10 | 1 | 0 | 16-QAM | | 22.37 | | 24.3 | 0.2692 |
| 10 | 1 | 25 | | | 22.45 | | | |
| 10 | 1 | 49 | | | 22.45 | | | |
| 10 | 25 | 0 | | | 21.09 | | | |
| 10 | 25 | 12 | | | 21.11 | | | |
| 10 | 25 | 25 | | | 21.16 | | | |
| 10 | 50 | 0 | | | 21.09 | | | |
| 10 | 1 | 0 | 64-QAM | | 21.24 | | 23.18 | 0.2080 |
| 10 | 1 | 25 | | | 21.32 | | | |
| 10 | 1 | 49 | | | 21.33 | | | |
| 10 | 25 | 0 | | | 20.06 | | | |
| 10 | 25 | 12 | | | 20.12 | | | |
| 10 | 25 | 25 | | | 20.13 | | | |
| 10 | 50 | 0 | | | 20.08 | | | |
| 10 | 1 | 0 | 256-QAM | | 18.27 | | 20.27 | 0.1064 |
| 10 | 1 | 25 | | | 18.32 | | | |
| 10 | 1 | 49 | | | 18.38 | | | |
| 10 | 25 | 0 | | | 18.30 | | | |
| 10 | 25 | 12 | | | 18.42 | | | |
| 10 | 25 | 25 | | | 18.41 | | | |
| 10 | 50 | 0 | | | 18.31 | | | |
| Limit | ERP < 3W | | | Result | | | Pass | |



| LTE Band 14 Maximum Average Power [dBm] (GT - LC = 4 dB) | | | | | | | | |
|--|----------|-----------|---------|--------|--------|---------|-----------|---------|
| BW [MHz] | RB Size | RB Offset | Mod | Lowest | Middle | Highest | ERP (dBm) | ERP (W) |
| 5 | 1 | 0 | QPSK | 22.95 | 22.88 | 23.01 | 24.86 | 0.3062 |
| 5 | 1 | 12 | | 22.89 | 22.78 | 22.86 | | |
| 5 | 1 | 24 | | 22.82 | 22.83 | 22.87 | | |
| 5 | 12 | 0 | | 21.90 | 21.87 | 22.00 | | |
| 5 | 12 | 7 | | 21.86 | 21.84 | 21.91 | | |
| 5 | 12 | 13 | | 21.96 | 21.83 | 22.04 | | |
| 5 | 25 | 0 | | 21.91 | 21.81 | 21.94 | | |
| 5 | 1 | 0 | 16-QAM | 22.16 | 22.09 | 22.26 | 24.17 | 0.2612 |
| 5 | 1 | 12 | | 22.31 | 22.21 | 22.32 | | |
| 5 | 1 | 24 | | 22.23 | 22.15 | 22.30 | | |
| 5 | 12 | 0 | | 20.91 | 20.79 | 20.91 | | |
| 5 | 12 | 7 | | 20.89 | 20.84 | 20.93 | | |
| 5 | 12 | 13 | | 20.97 | 20.91 | 20.98 | | |
| 5 | 25 | 0 | | 20.85 | 20.81 | 20.98 | | |
| 5 | 1 | 0 | 64-QAM | 21.03 | 20.97 | 21.12 | 23.05 | 0.2018 |
| 5 | 1 | 12 | | 21.14 | 21.10 | 21.20 | | |
| 5 | 1 | 24 | | 21.16 | 21.07 | 21.20 | | |
| 5 | 12 | 0 | | 19.87 | 19.81 | 19.95 | | |
| 5 | 12 | 7 | | 19.95 | 19.82 | 20.01 | | |
| 5 | 12 | 13 | | 19.90 | 19.87 | 20.00 | | |
| 5 | 25 | 0 | | 19.88 | 19.79 | 19.92 | | |
| 5 | 1 | 0 | 256-QAM | 18.12 | 17.98 | 18.16 | 20.18 | 0.1042 |
| 5 | 1 | 12 | | 18.10 | 18.06 | 18.16 | | |
| 5 | 1 | 24 | | 18.15 | 18.14 | 18.29 | | |
| 5 | 12 | 0 | | 18.10 | 18.02 | 18.21 | | |
| 5 | 12 | 7 | | 18.19 | 18.14 | 18.29 | | |
| 5 | 12 | 13 | | 18.18 | 18.17 | 18.33 | | |
| 5 | 25 | 0 | | 18.12 | 18.09 | 18.23 | | |
| Limit | ERP < 3W | | | Result | | | Pass | |



LTE Band 14

Peak-to-Average Ratio

| Mode | LTE Band 14 / 10MHz | | | | |
|-----------|---------------------|---------|---------|---------|-------------|
| Mod. | QPSK | 16QAM | 64QAM | 256QAM | Limit: 13dB |
| RB Size | Full RB | Full RB | Full RB | Full RB | Result |
| Middle CH | 4.55 | 5.65 | 6.32 | 6.41 | PASS |

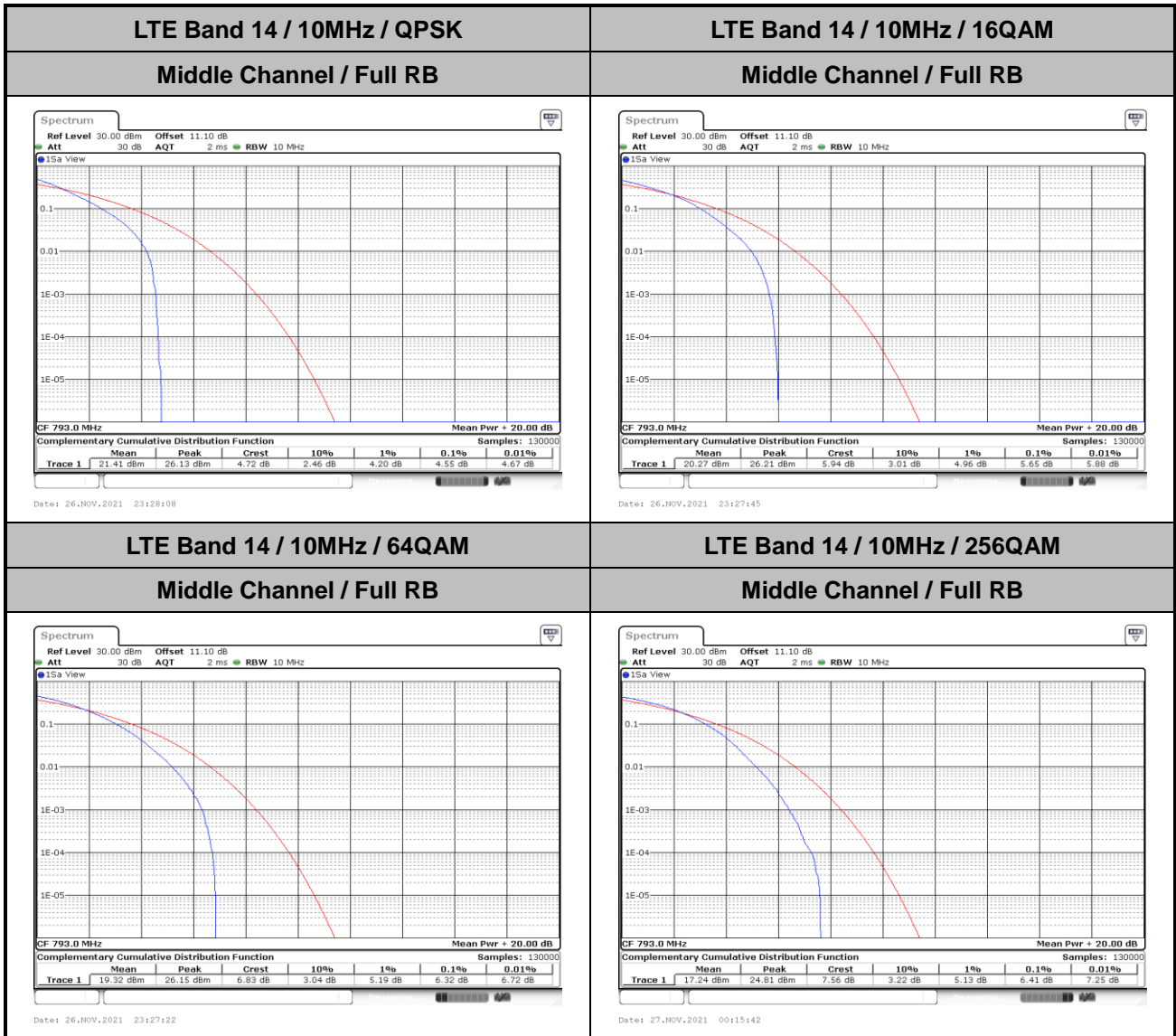



26dB Bandwidth

| Mode | LTE Band 14 : 26dB BW(MHz) | | | | | | | | | | | |
|-----------|----------------------------|---------|-------|---------|-------|---------|-------|---------|-------|---------|-------|---------|
| BW | 1.4MHz | | 3MHz | | 5MHz | | 10MHz | | 15MHz | | 20MHz | |
| Mod. | QPSK | 16QAM | QPSK | 16QAM | QPSK | 16QAM | QPSK | 16QAM | QPSK | 16QAM | QPSK | 16QAM |
| Middle CH | - | - | - | - | 5.15 | 5.05 | 9.89 | 9.81 | - | - | - | - |
| Mode | LTE Band 14 : 26dB BW(MHz) | | | | | | | | | | | |
| BW | 1.4MHz | | 3MHz | | 5MHz | | 10MHz | | 15MHz | | 20MHz | |
| Mod. | 64QAM | 256 QAM | 64QAM | 256 QAM | 64QAM | 256 QAM | 64QAM | 256 QAM | 64QAM | 256 QAM | 64QAM | 256 QAM |
| Middle CH | - | - | - | - | 5.00 | 5.20 | 9.69 | 10.07 | - | - | - | - |



LTE Band 14

Middle Channel / 5MHz / QPSK

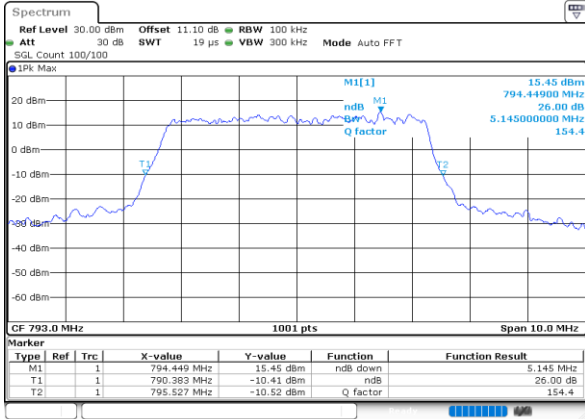

Date: 26.NOV.2021 22:09:20

Middle Channel / 5MHz / 16QAM

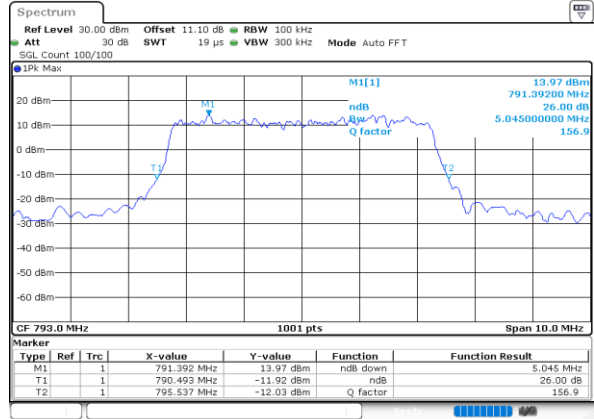

Date: 26.NOV.2021 22:10:41

Middle Channel / 10MHz / QPSK

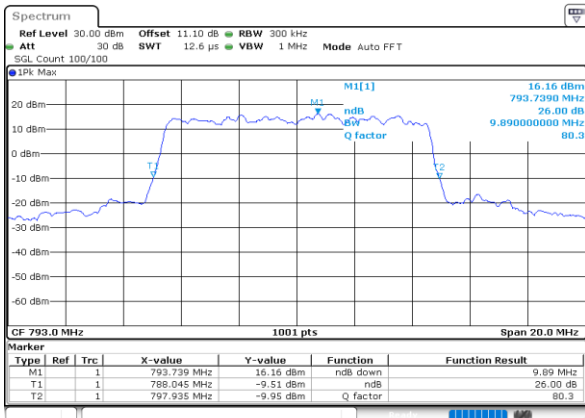

Date: 26.NOV.2021 22:19:37

Middle Channel / 10MHz / 16QAM

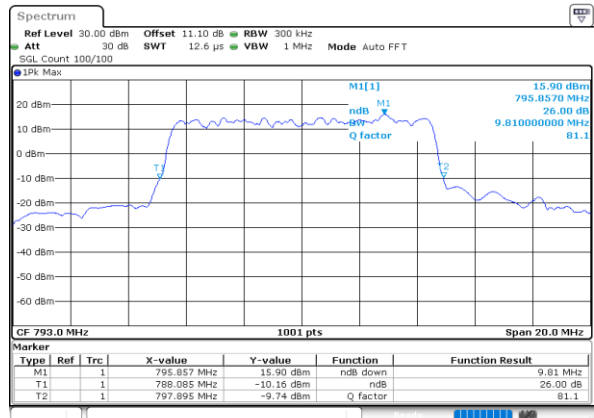

Date: 26.NOV.2021 22:19:16

Middle Channel / 5MHz / 64QAM

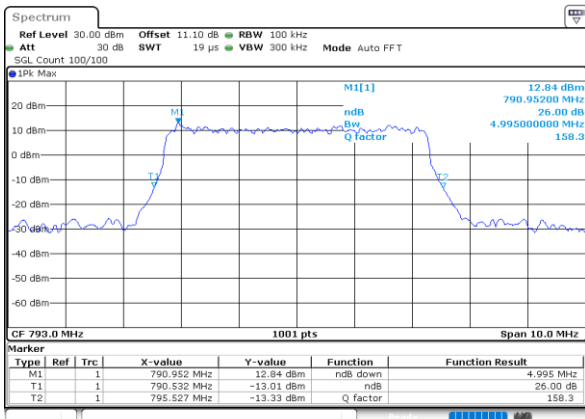

Date: 26.NOV.2021 22:16:19

Middle Channel / 10MHz / 64QAM

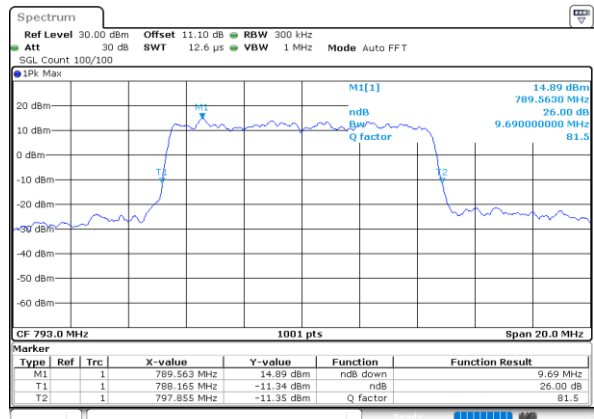

Date: 26.NOV.2021 22:25:49



LTE Band 14

Middle Channel / 5MHz / 256QAM

Middle Channel / 10MHz / 256QAM

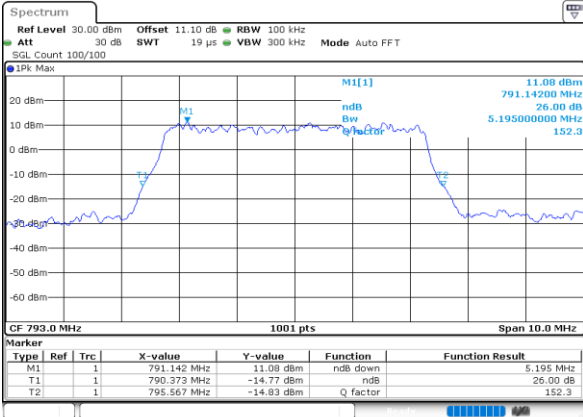

Date: 26.NOV.2021 23:40:49

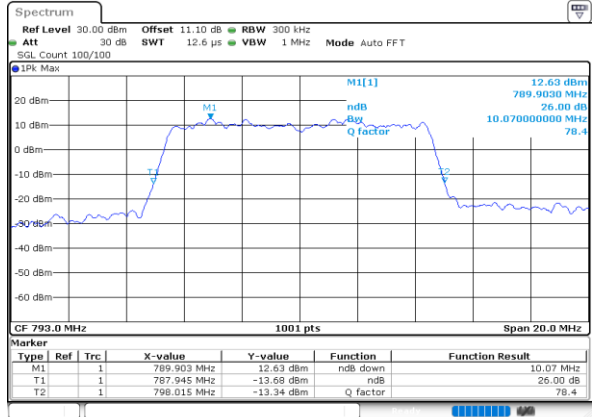

Date: 27.NOV.2021 00:15:21



Occupied Bandwidth

| Mode | LTE Band 14 : 99%OBW(MHz) | | | | | | | | | | | |
|-----------|---------------------------|---------|-------|---------|-------|---------|-------|---------|-------|---------|-------|---------|
| BW | 1.4MHz | | 3MHz | | 5MHz | | 10MHz | | 15MHz | | 20MHz | |
| Mod. | QPSK | 16QAM | QPSK | 16QAM | QPSK | 16QAM | QPSK | 16QAM | QPSK | 16QAM | QPSK | 16QAM |
| Middle CH | - | - | - | - | 4.51 | 4.51 | 9.05 | 9.03 | - | - | - | - |
| Mode | LTE Band 14 : 99%OBW(MHz) | | | | | | | | | | | |
| BW | 1.4MHz | | 3MHz | | 5MHz | | 10MHz | | 15MHz | | 20MHz | |
| Mod. | 64QAM | 256 QAM | 64QAM | 256 QAM | 64QAM | 256 QAM | 64QAM | 256 QAM | 64QAM | 256 QAM | 64QAM | 256 QAM |
| Middle CH | - | - | - | - | 4.50 | 4.50 | 9.11 | 9.03 | - | - | - | - |



LTE Band 14

Middle Channel / 5MHz / QPSK

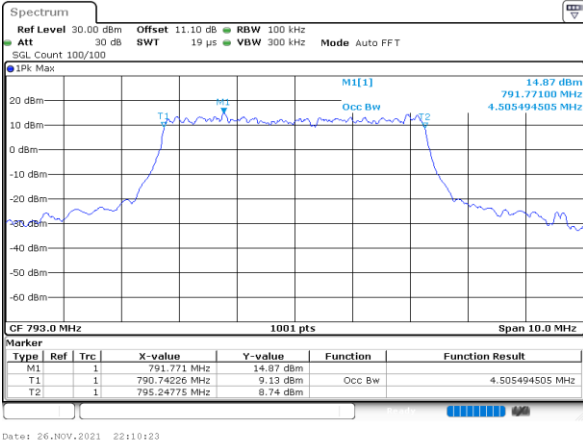

Date: 26.NOV.2021 22:10:23

Middle Channel / 5MHz / 16QAM

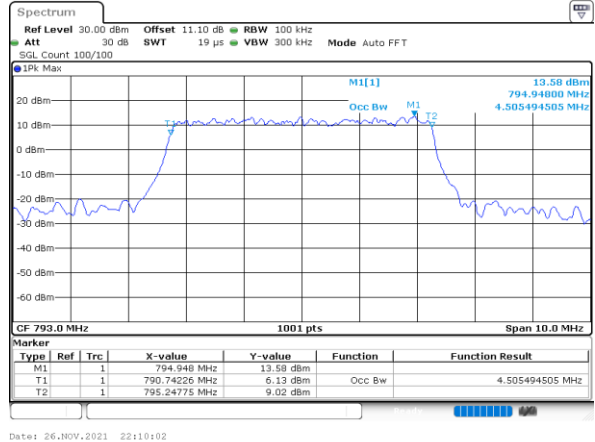

Date: 26.NOV.2021 22:10:02

Middle Channel / 10MHz / QPSK

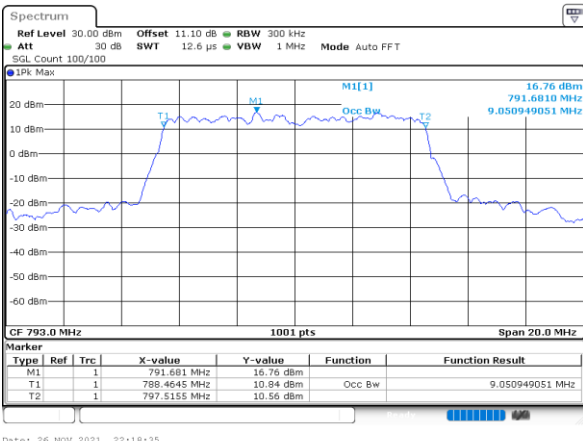

Date: 26.NOV.2021 22:18:35

Middle Channel / 10MHz / 16QAM

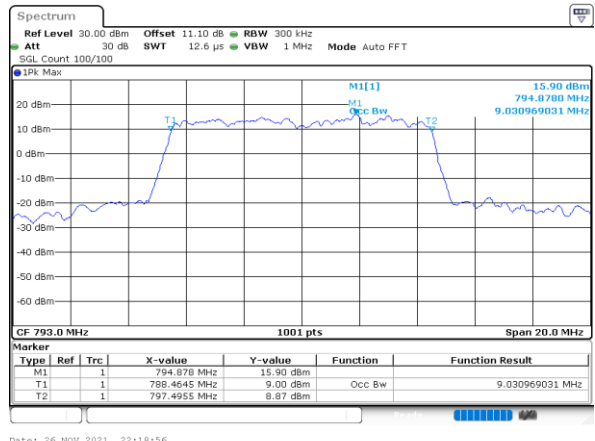

Date: 26.NOV.2021 22:18:56

Middle Channel / 5MHz / 64QAM

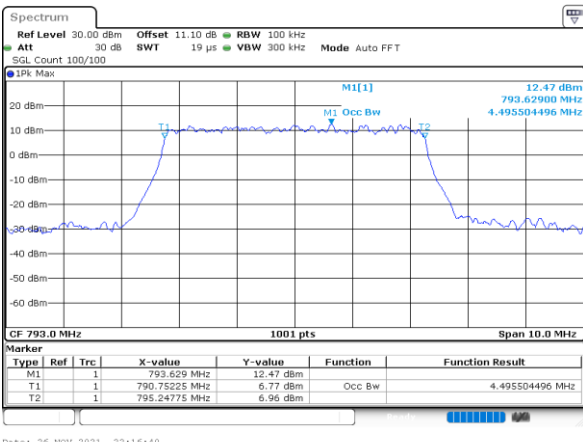

Date: 26.NOV.2021 22:16:40

Middle Channel / 10MHz / 64QAM

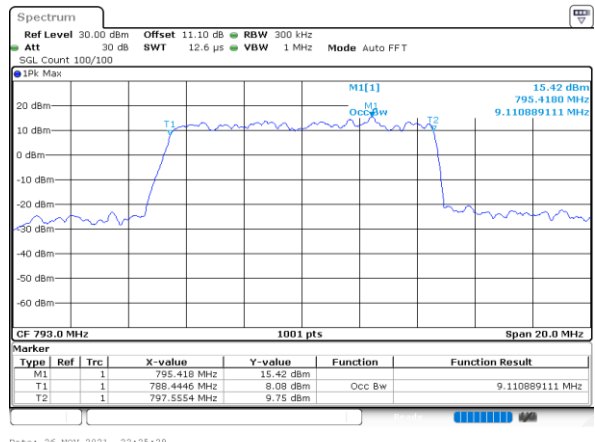

Date: 26.NOV.2021 22:25:29



LTE Band 14

Middle Channel / 5MHz / 256QAM

Middle Channel / 10MHz / 256QAM

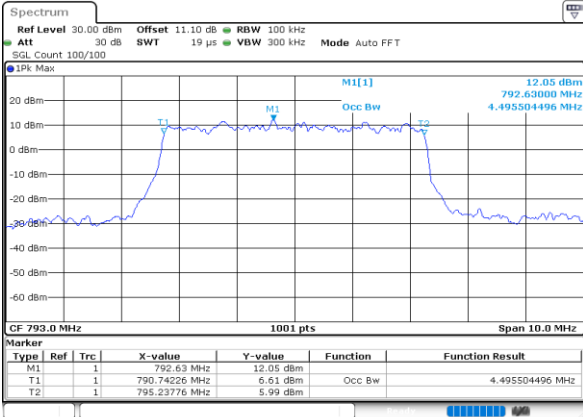

Date: 26.NOV.2021 23:40:29

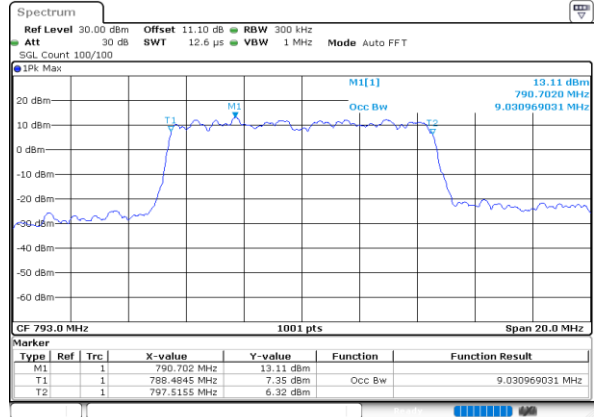

Date: 27.NOV.2021 00:14:58



Conducted Band Edge

LTE Band 14 / 5MHz / QPSK

Lowest Band Edge / 1 RB

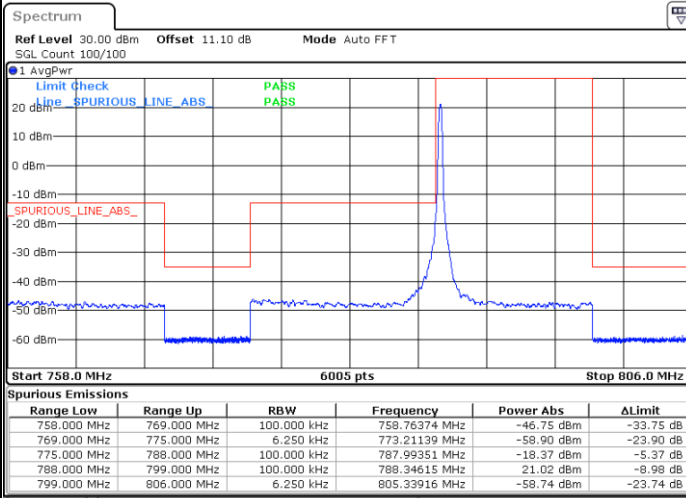

Date: 26.NOV.2021 22:07:08

Highest Band Edge / 1 RB

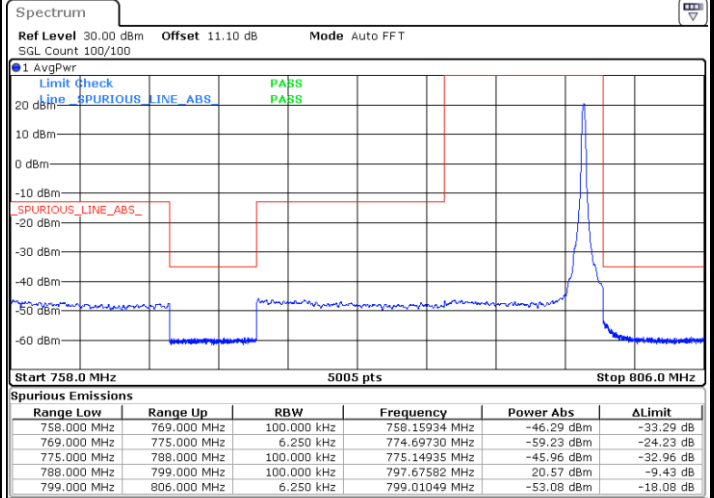

Date: 26.NOV.2021 22:13:28

Lowest Band Edge / Full RB

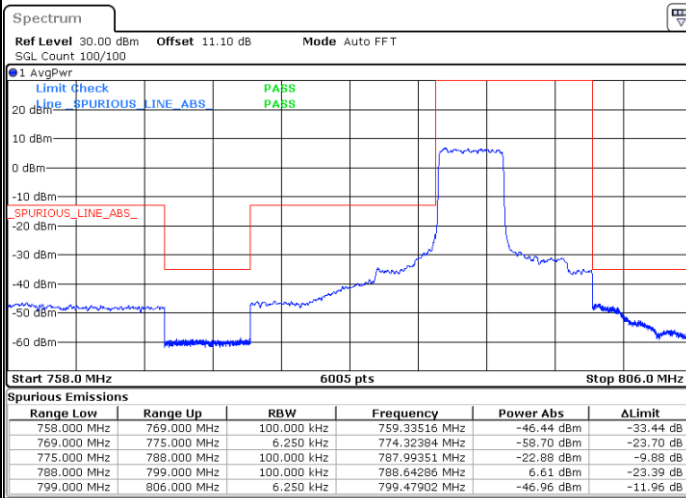

Date: 26.NOV.2021 22:04:47

Highest Band Edge / Full RB

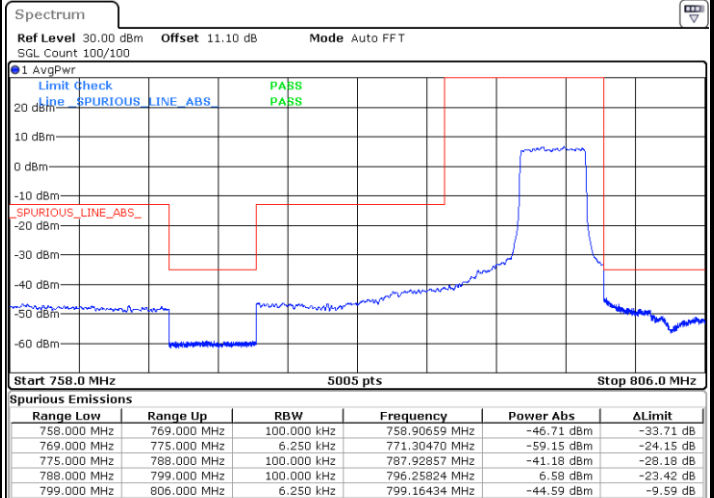

Date: 26.NOV.2021 22:11:08



LTE Band 14 / 5MHz / 16QAM

Lowest Band Edge / 1 RB

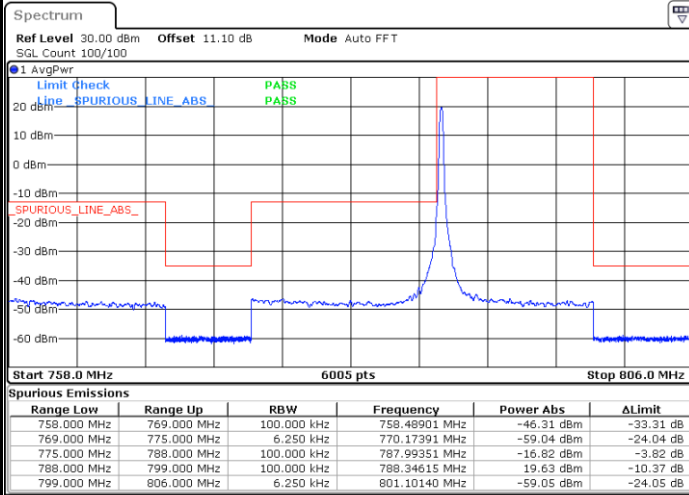

Date: 26.NOV.2021 22:06:21

Highest Band Edge / 1 RB

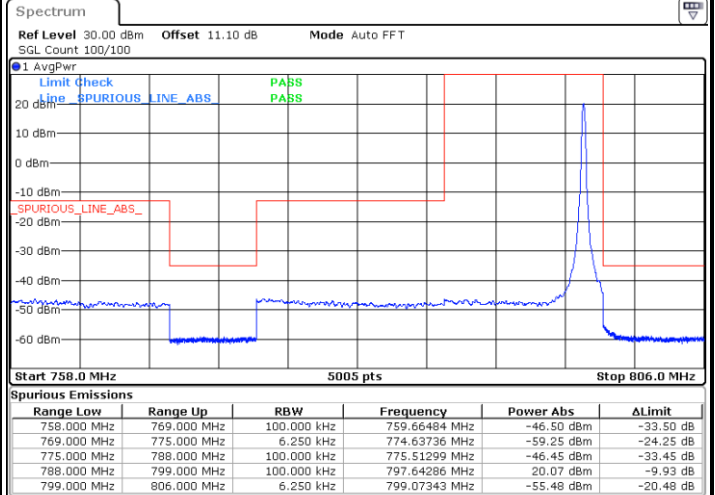

Date: 26.NOV.2021 22:12:41

Lowest Band Edge / Full RB

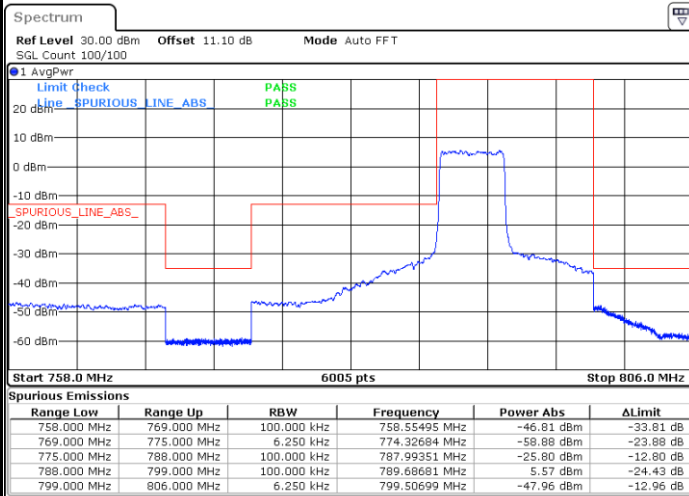

Date: 26.NOV.2021 22:05:34

Highest Band Edge / Full RB

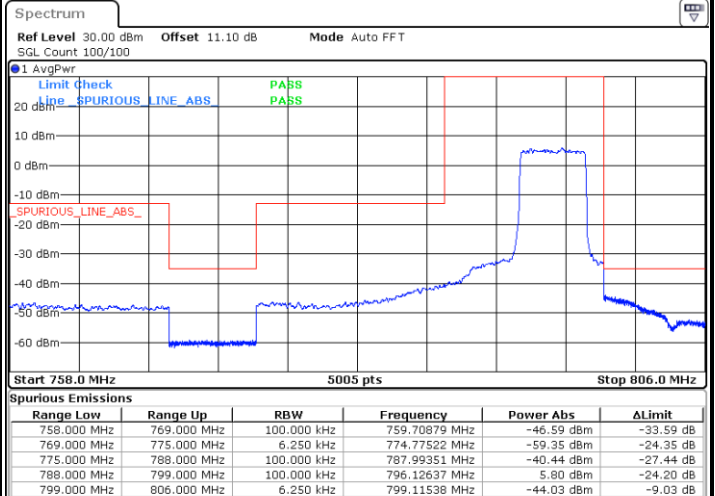

Date: 26.NOV.2021 22:11:54



LTE Band 14 / 5MHz / 64QAM

Lowest Band Edge / 1 RB

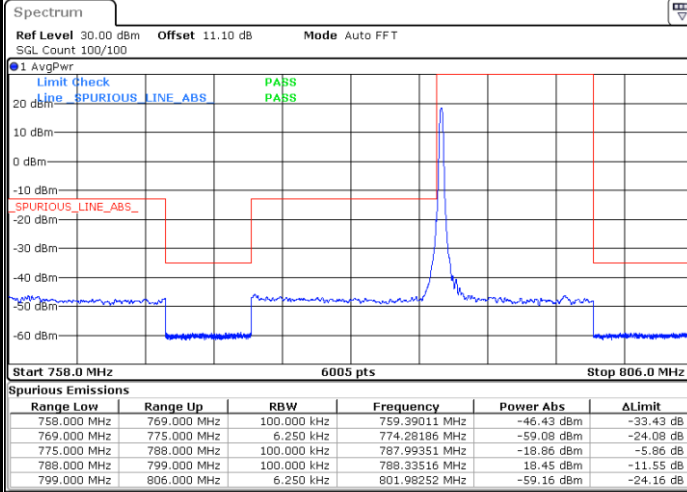

Date: 26.NOV.2021 22:15:56

Highest Band Edge / 1 RB

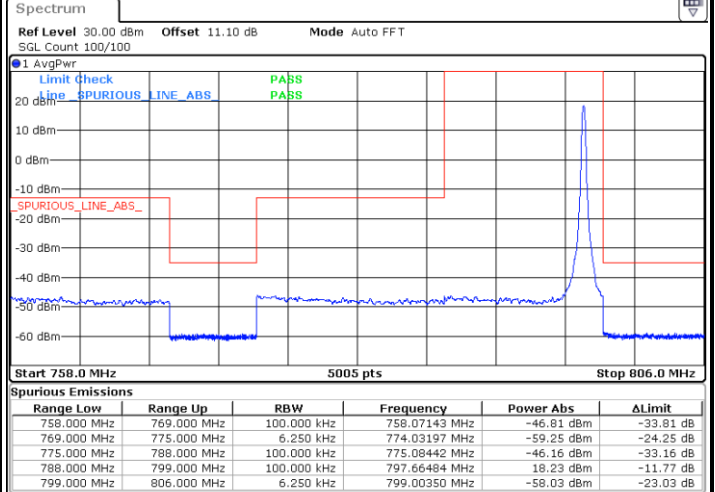

Date: 26.NOV.2021 22:18:11

Lowest Band Edge / Full RB

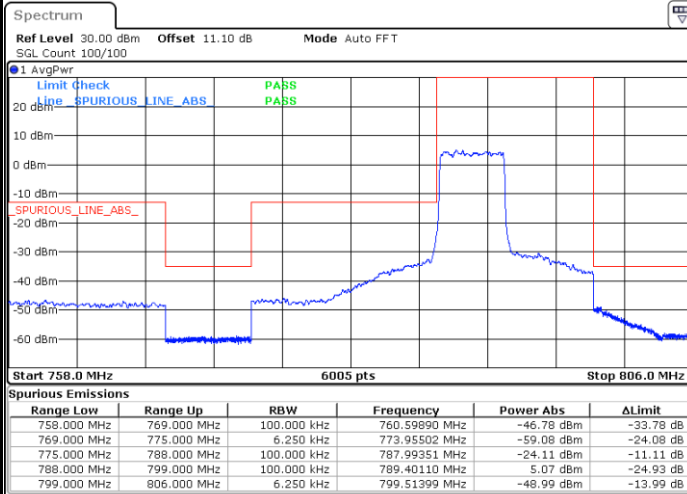

Date: 26.NOV.2021 22:15:09

Highest Band Edge / Full RB

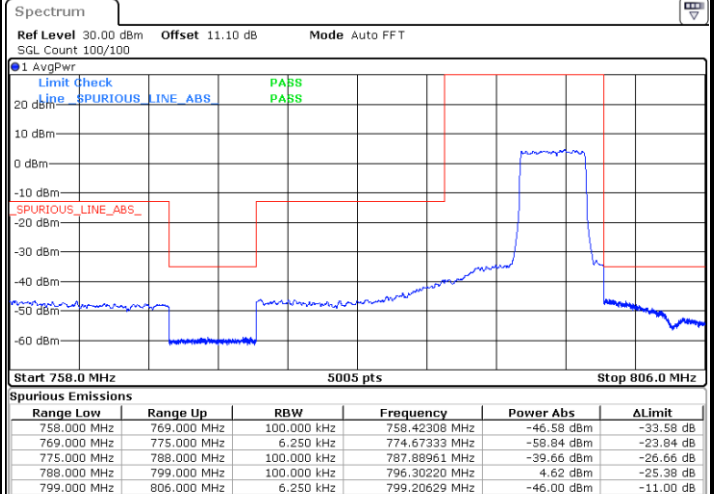

Date: 26.NOV.2021 22:17:24



LTE Band 14 / 5MHz / 256QAM

Lowest Band Edge / 1 RB

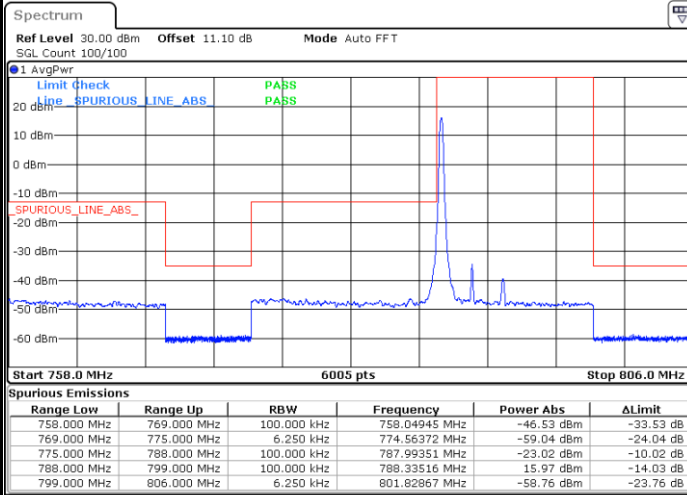

Date: 26.NOV.2021 23:32:37

Highest Band Edge / 1 RB

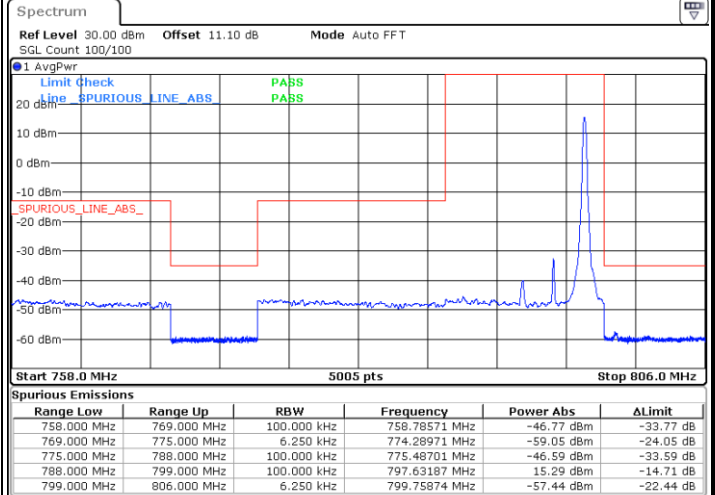

Date: 26.NOV.2021 23:52:47

Lowest Band Edge / Full RB

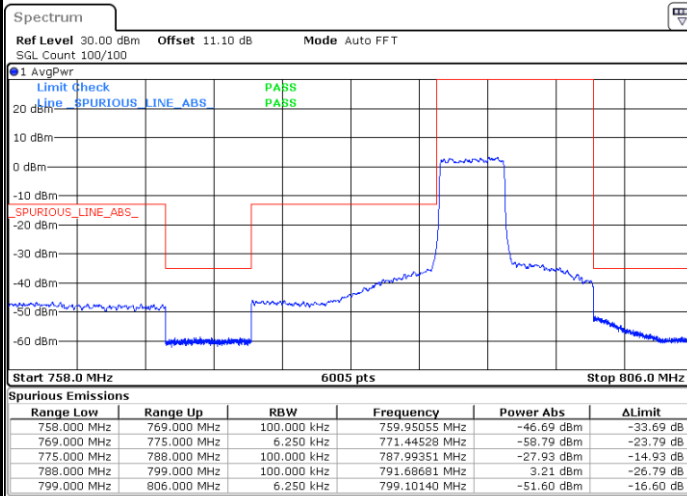

Date: 26.NOV.2021 23:34:51

Highest Band Edge / Full RB

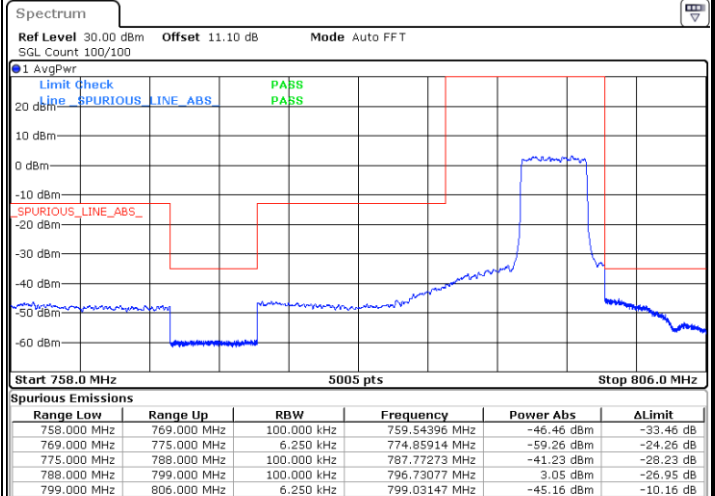

Date: 26.NOV.2021 23:56:59



LTE Band 14 / 10MHz / QPSK

Lowest Band Edge / 1 RB

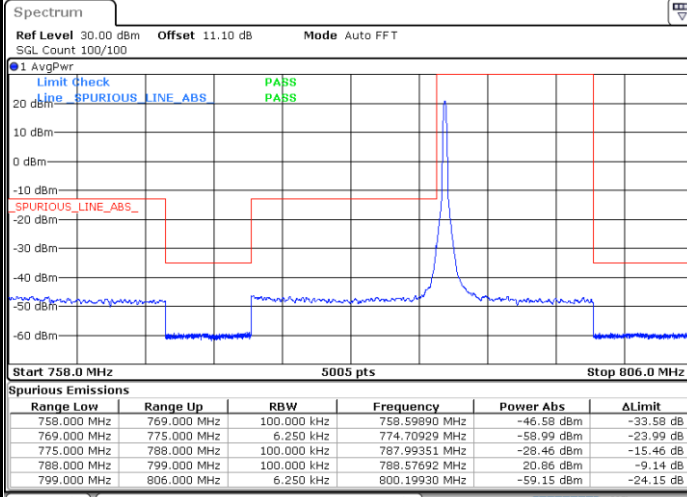

Date: 26.NOV.2021 22:22:40

Highest Band Edge / 1 RB

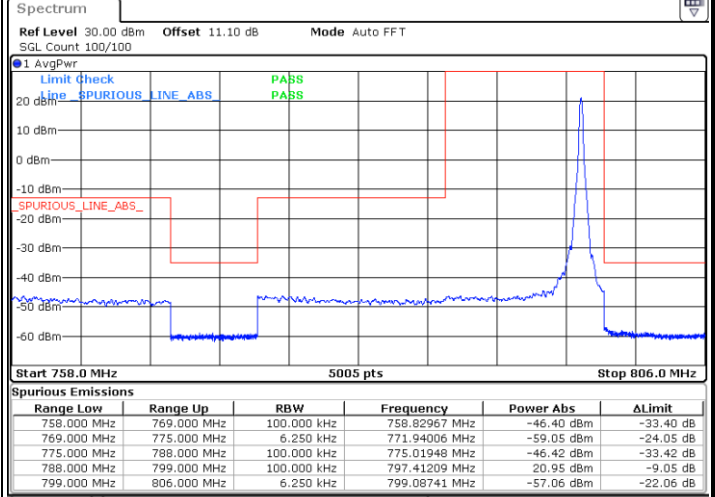

Date: 26.NOV.2021 22:23:25

Band Edge / Full RB

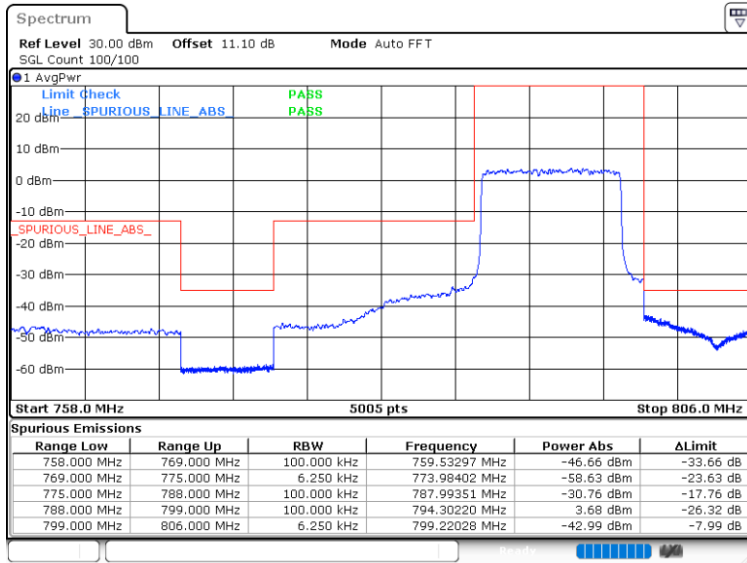

Date: 26.NOV.2021 22:20:22



LTE Band 14 / 10MHz / 16QAM

Lowest Band Edge / 1 RB

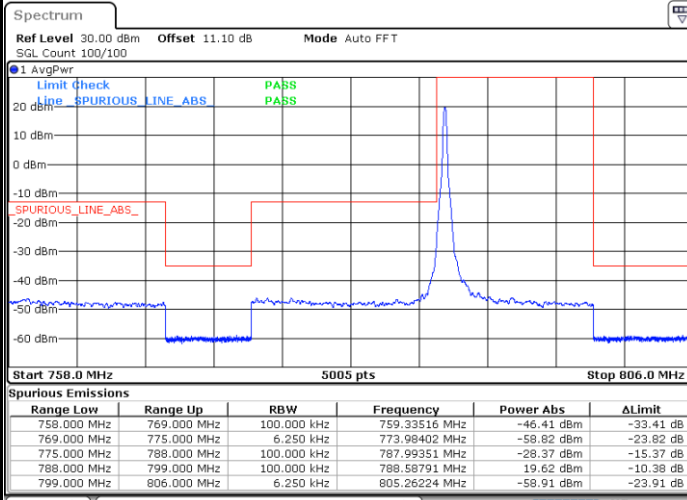

Date: 26.NOV.2021 22:21:54

Highest Band Edge / 1 RB

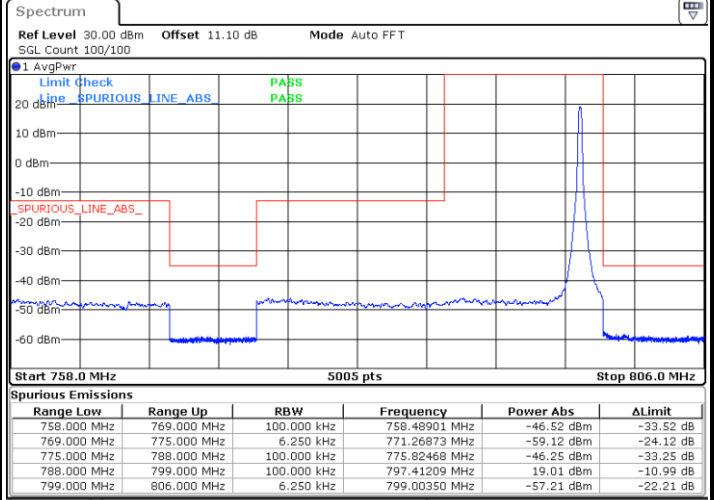

Date: 26.NOV.2021 22:24:11

Band Edge / Full RB

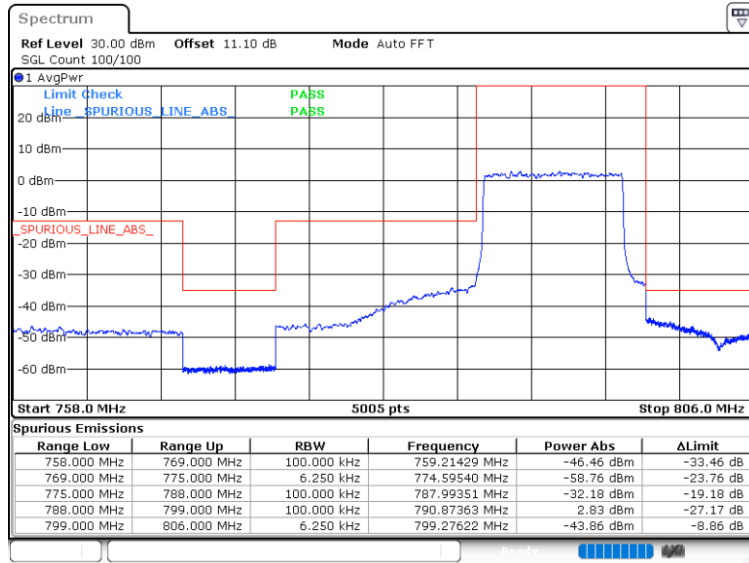

Date: 26.NOV.2021 22:21:08



LTE Band 14 / 10MHz / 64QAM

Lowest Band Edge / 1 RB

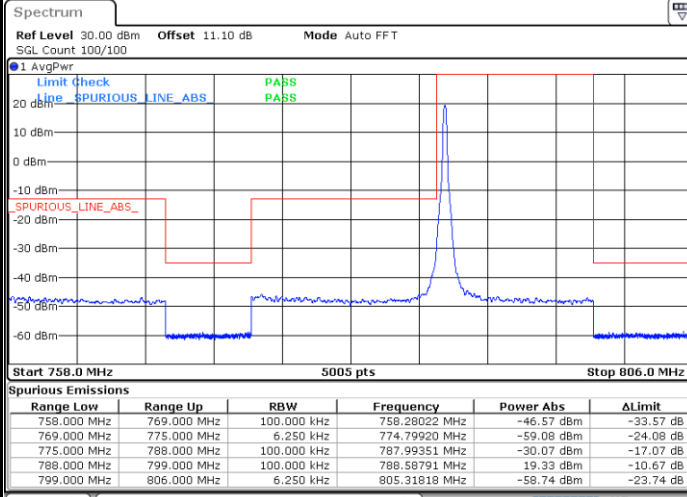

Date: 26.NOV.2021 22:27:20

Highest Band Edge / 1 RB

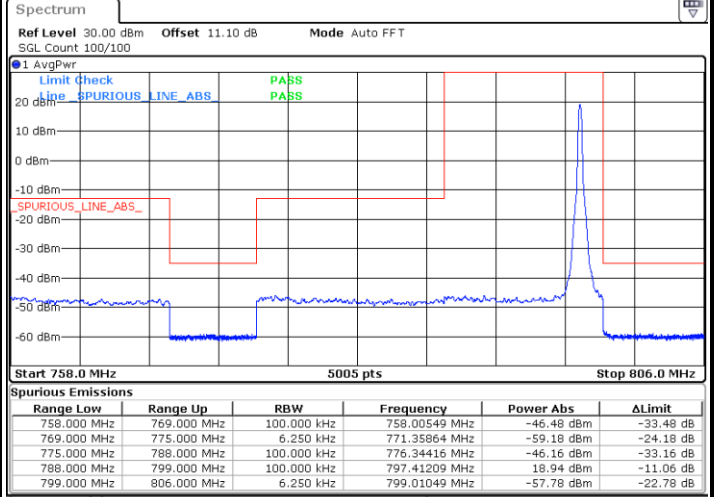

Date: 26.NOV.2021 22:28:07

Band Edge / Full RB

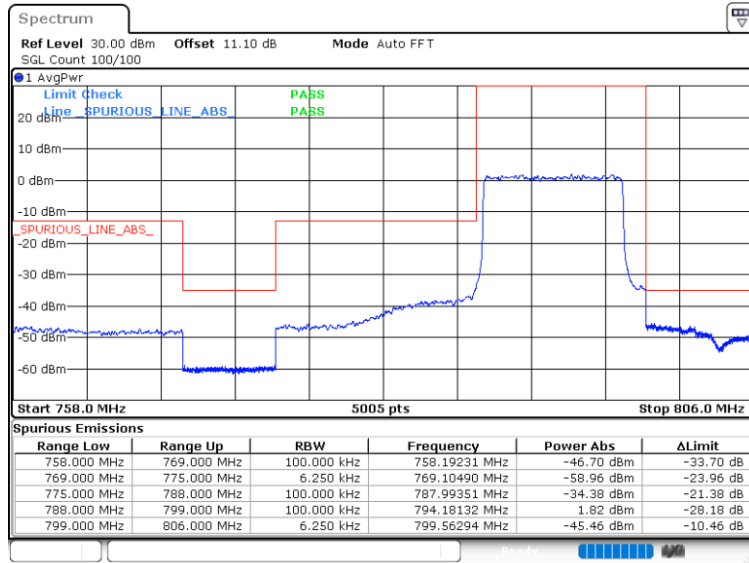

Date: 26.NOV.2021 22:26:34



LTE Band 14 / 10MHz / 256QAM

Lowest Band Edge / 1 RB

Highest Band Edge / 1 RB

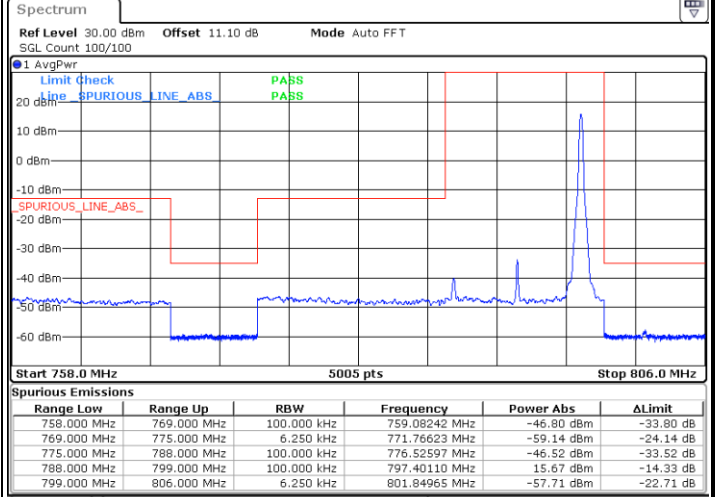
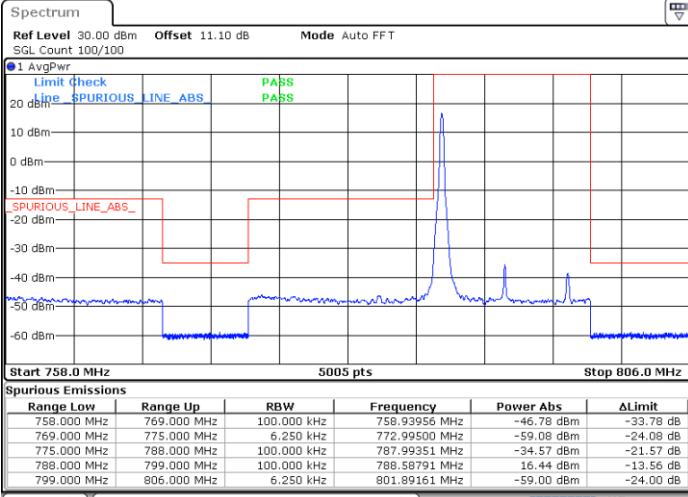

Date: 27.NOV.2021 00:09:45

Date: 27.NOV.2021 00:12:33

Band Edge / Full RB

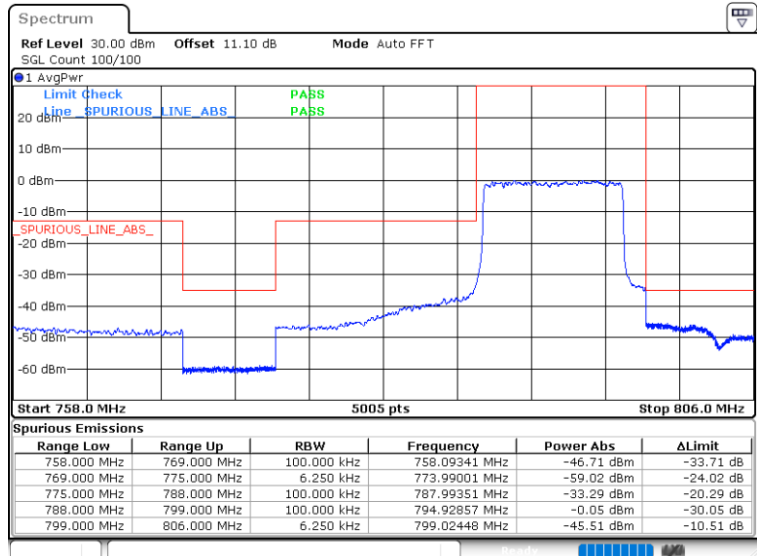

Date: 27.NOV.2021 00:16:06



Conducted Spurious Emission

LTE Band 14 / 5MHz

Lowest Channel / QPSK

Middle Channel / QPSK

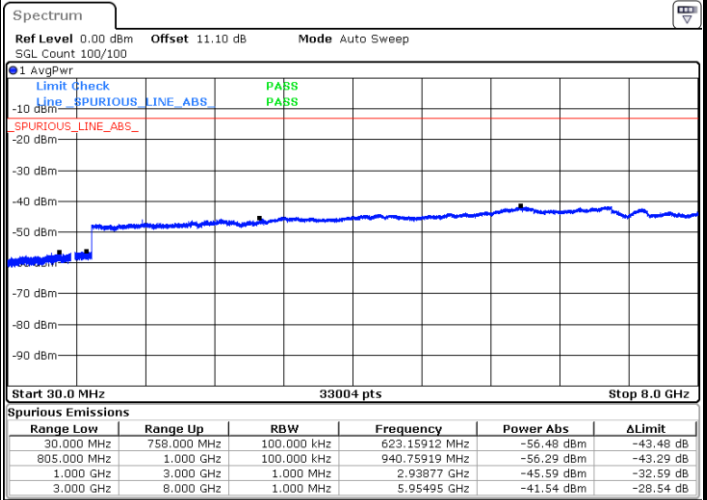
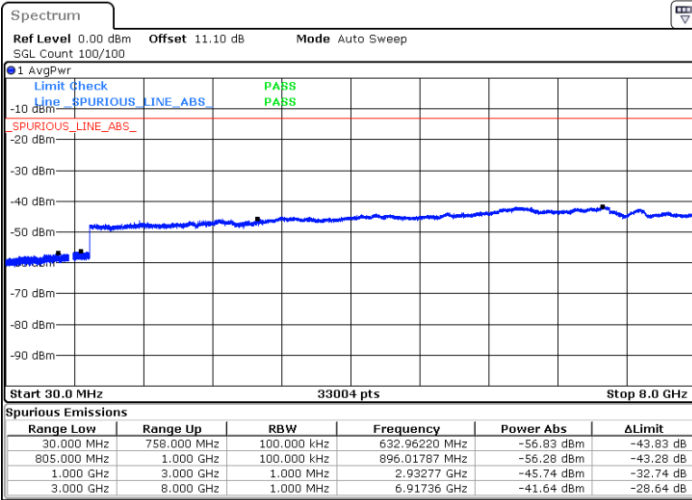

Date: 26.NOV.2021 22:08:03

Date: 26.NOV.2021 22:08:58

Highest Channel / QPSK

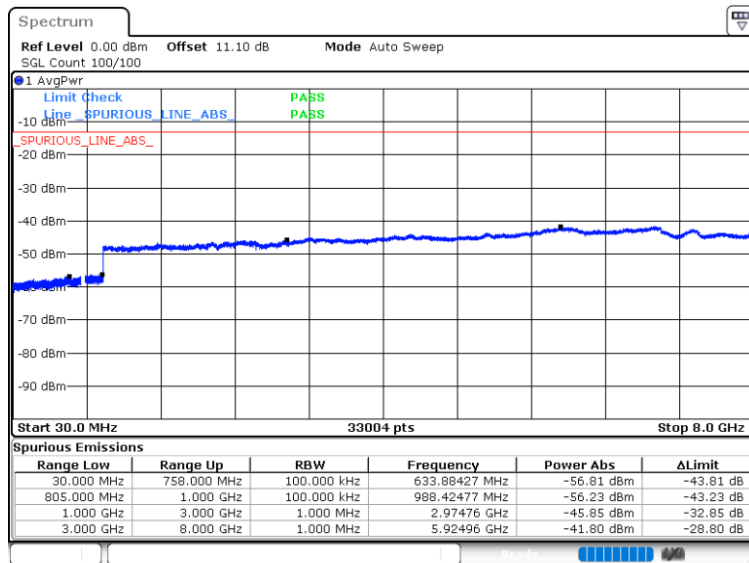

Date: 26.NOV.2021 22:14:24



LTE Band 14 / 10MHz

Middle Channel / QPSK

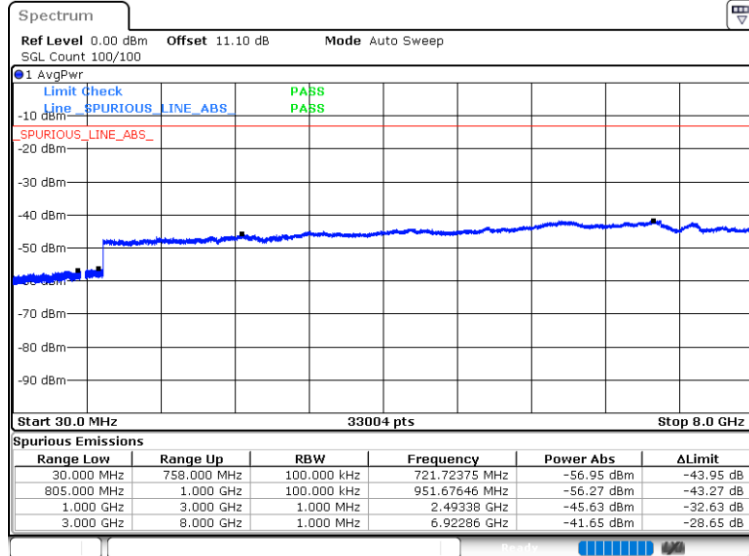

Date: 26.NOV.2021 22:25:07



Mask

LTE Band 14 / 5MHz / QPSK

Lowest Channel / 1RB

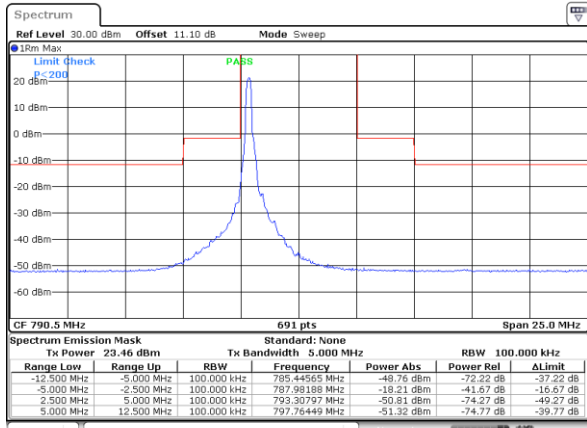

Date: 26.NOV.2021 22:138:00

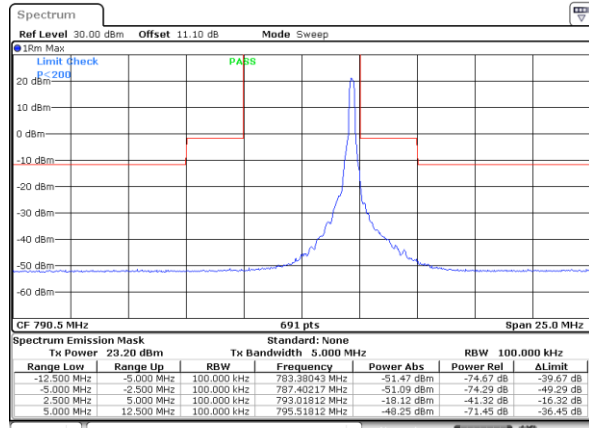

Date: 26.NOV.2021 22:139:38

Lowest Channel / Full RB

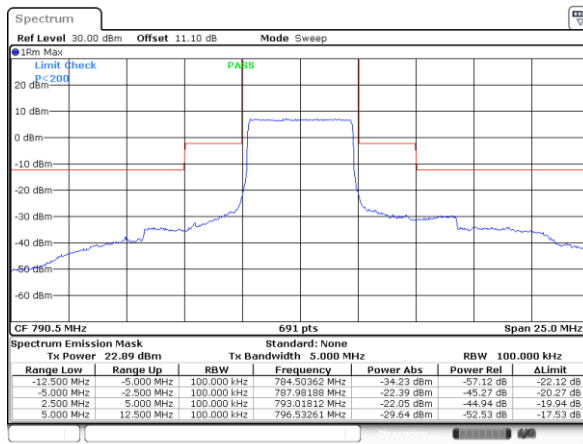

Date: 26.NOV.2021 22:29:48



LTE Band 14 / 5MHz / 16QAM

Lowest Channel / 1RB

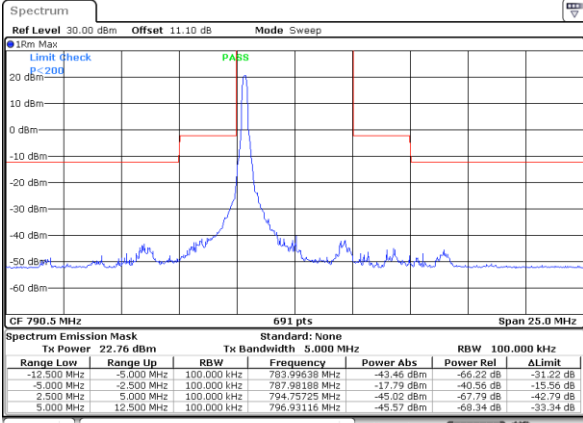

Date: 26.NOV.2021 22:36:21

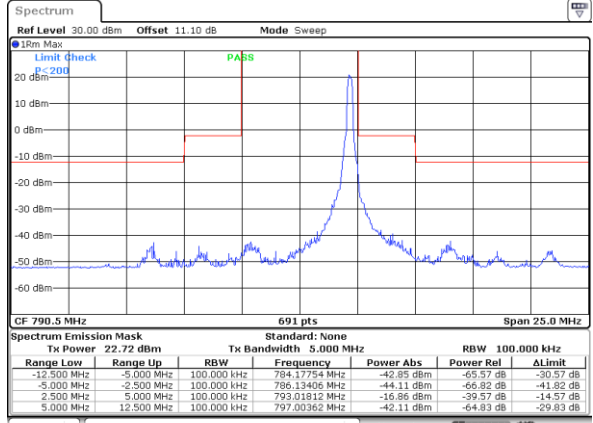

Date: 26.NOV.2021 22:41:17

Lowest Channel / Full RB

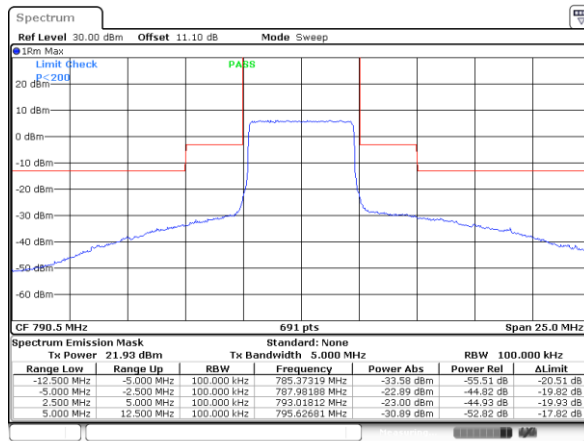

Date: 26.NOV.2021 22:31:26



LTE Band 14 / 5MHz / 64QAM

Lowest Channel / 1RB

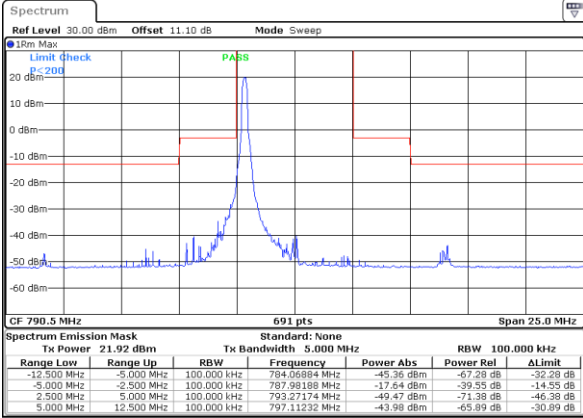

Date: 26.NOV.2021 22:34:43

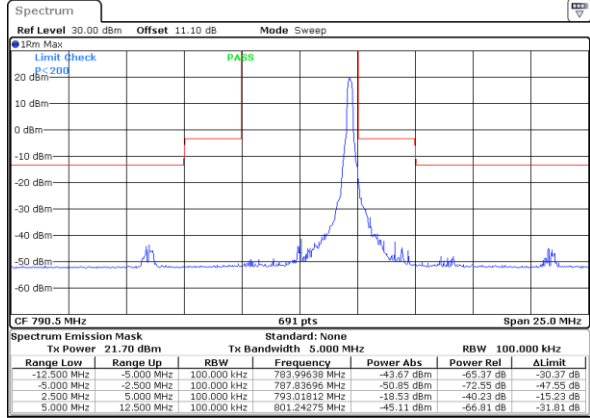

Date: 26.NOV.2021 22:42:55

Lowest Channel / Full RB

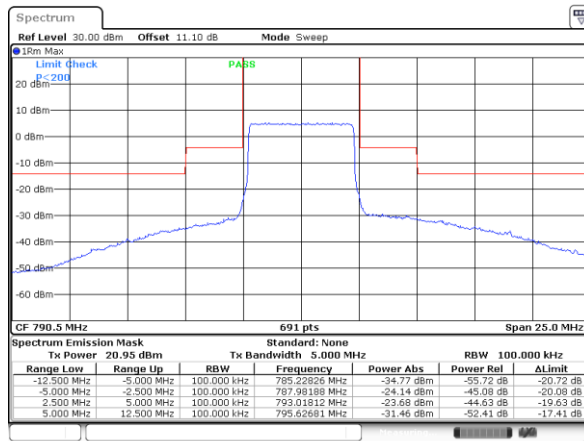

Date: 26.NOV.2021 22:33:05



LTE Band 14 / 5MHz / 256QAM

Lowest Channel / 1RB

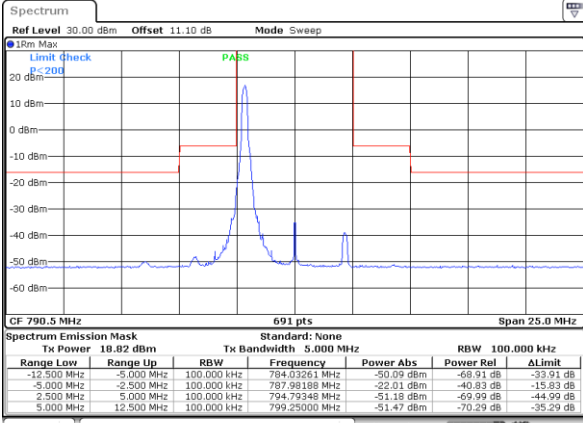

Date: 26.NOV.2021 23:39:07

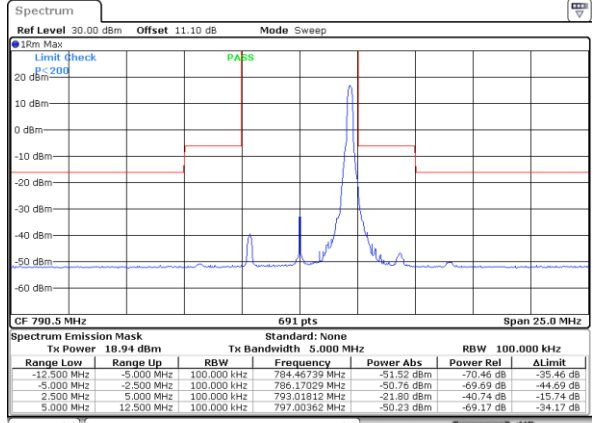

Date: 26.NOV.2021 23:50:58

Lowest Channel / Full RB

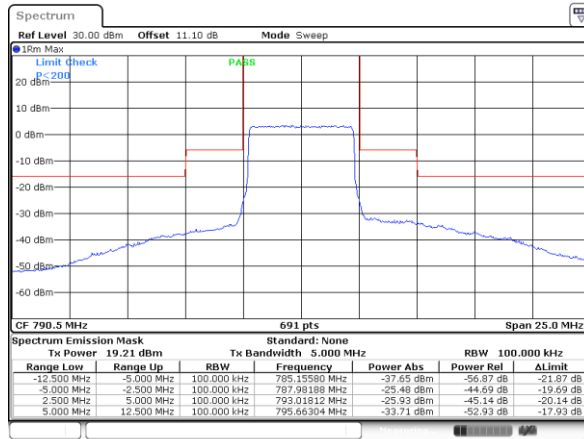

Date: 26.NOV.2021 23:36:47



LTE Band 14 / 5MHz / QPSK

Middle Channel / 1RB

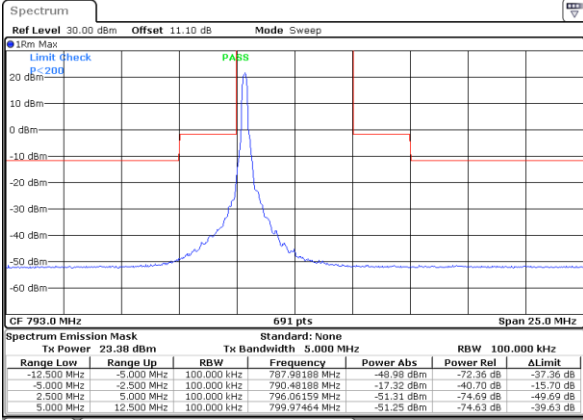

Date: 26.NOV.2021 22:49:26

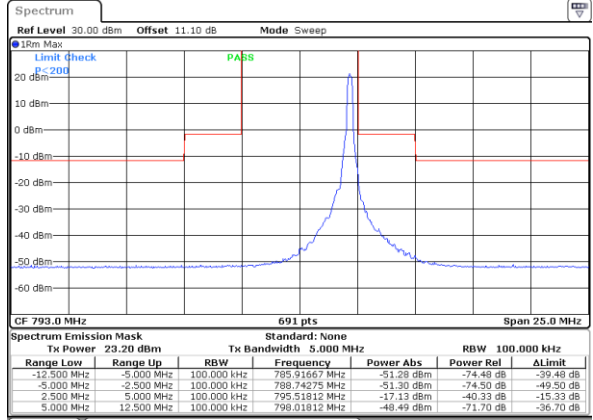

Date: 26.NOV.2021 22:47:148

Middle Channel / Full RB

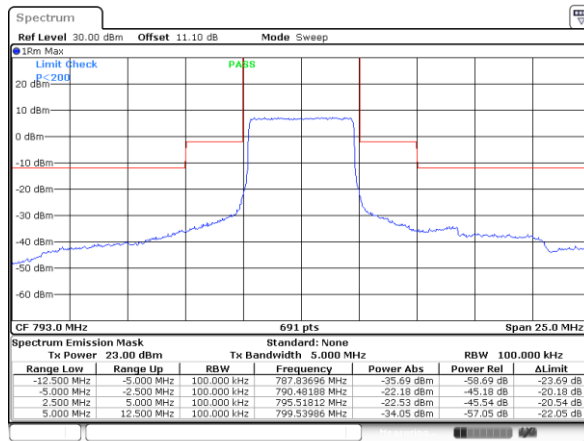

Date: 26.NOV.2021 22:57:34



LTE Band 14 / 5MHz / 16QAM

Middle Channel / 1RB

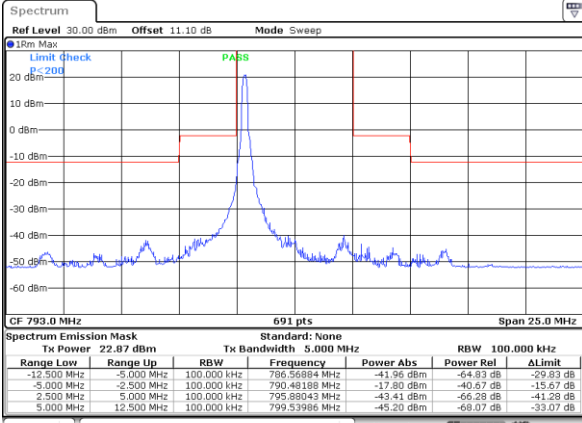

Date: 26.NOV.2021 22:51:04

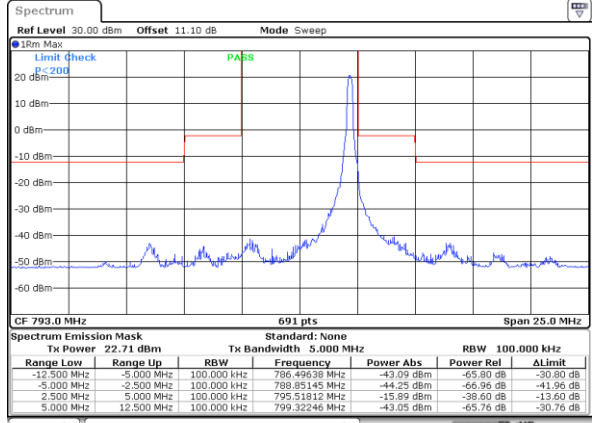

Date: 26.NOV.2021 22:46:11

Middle Channel / Full RB

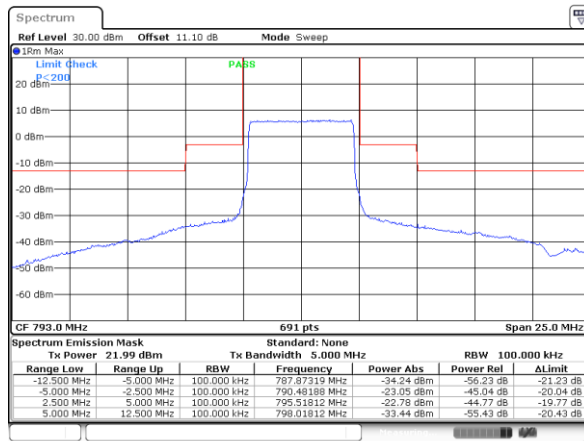

Date: 26.NOV.2021 22:55:57



LTE Band 14 / 5MHz / 64QAM

Middle Channel / 1RB

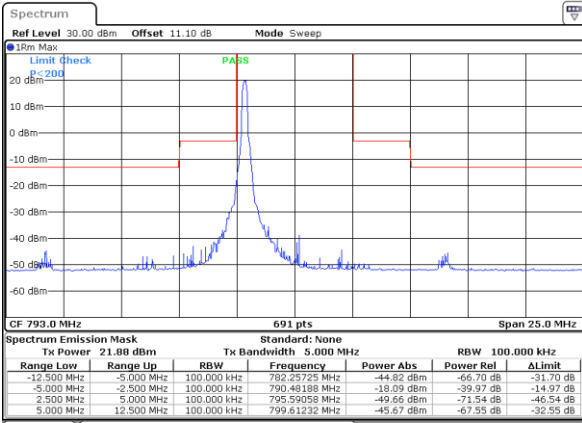

Date: 26.NOV.2021 22:52:41

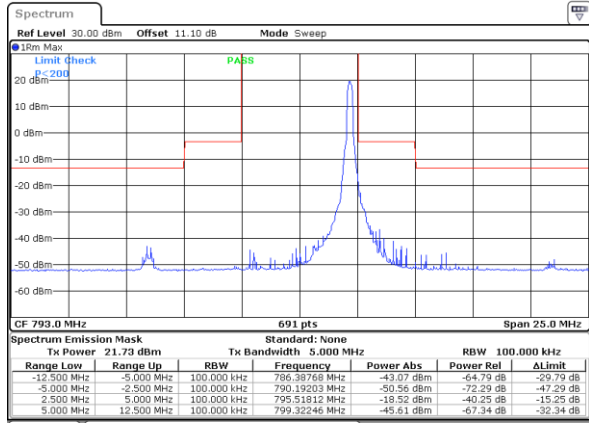

Date: 26.NOV.2021 22:44:33

Middle Channel / Full RB

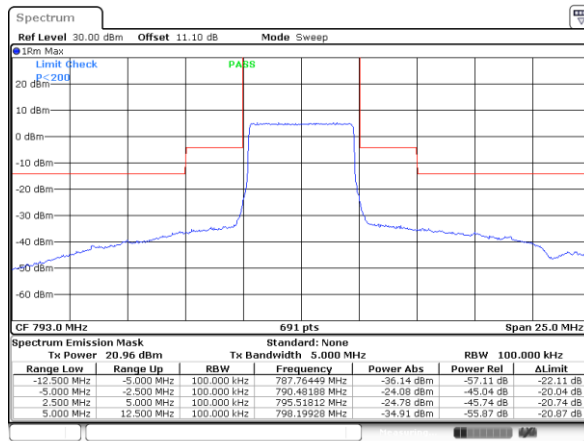

Date: 26.NOV.2021 22:54:19



LTE Band 14 / 5MHz / 256QAM

Middle Channel / 1RB

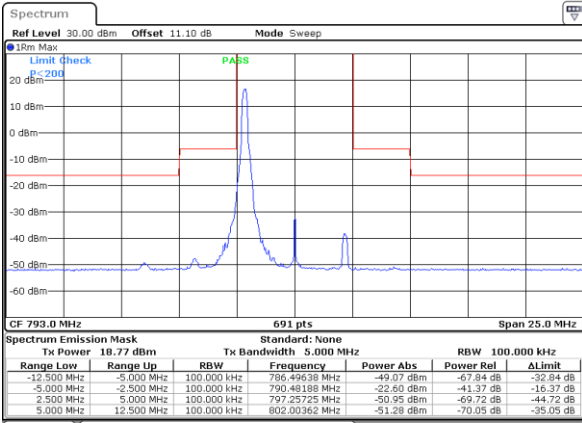

Date: 26.NOV.2021 23:46:23

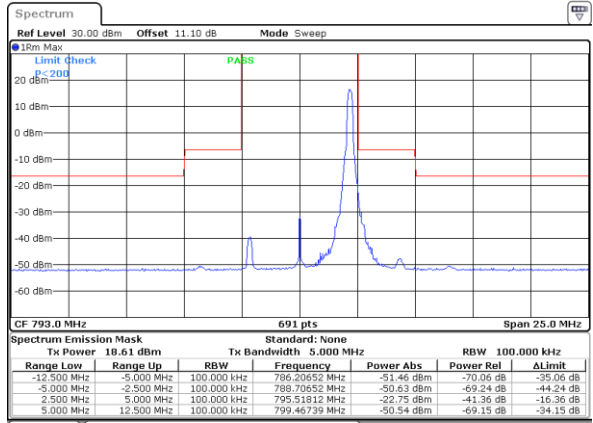

Date: 26.NOV.2021 23:48:22

Middle Channel / Full RB

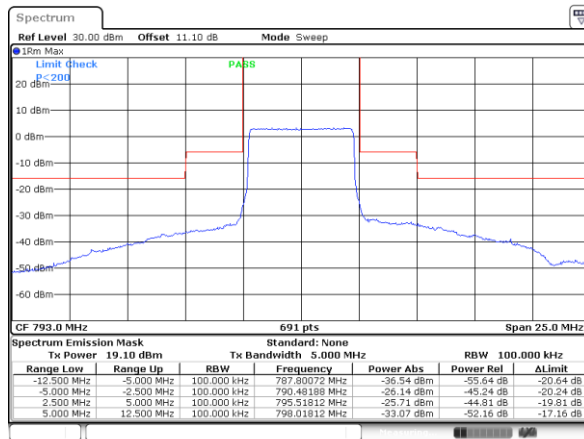

Date: 26.NOV.2021 23:43:12



LTE Band 14 / 5MHz / QPSK

Highest Channel / 1RB

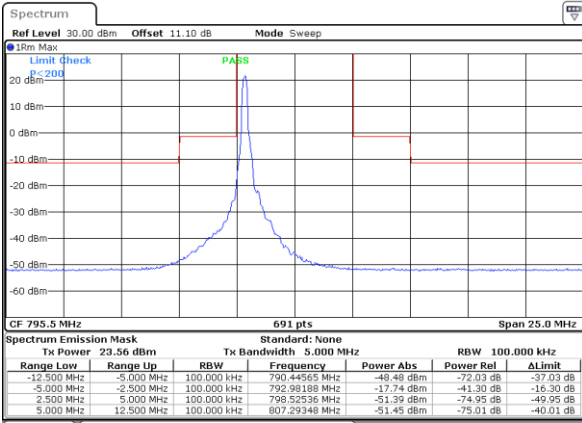

Date: 26.NOV.2021 23:07:25

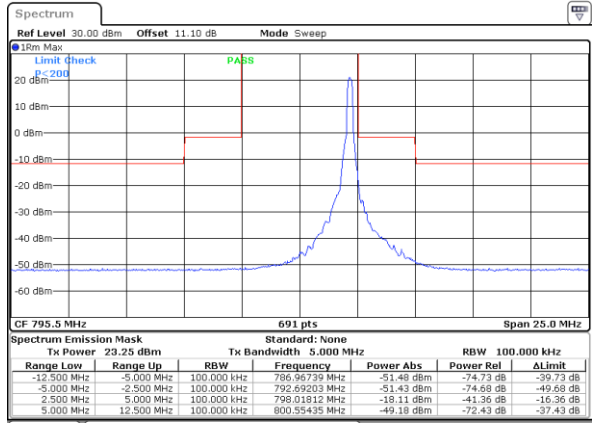

Date: 26.NOV.2021 23:09:03

Highest Channel / Full RB

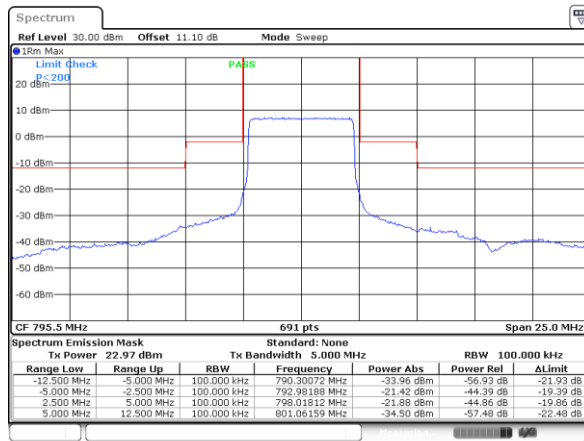

Date: 26.NOV.2021 22:59:13



LTE Band 14 / 5MHz / 16QAM

Highest Channel / 1RB

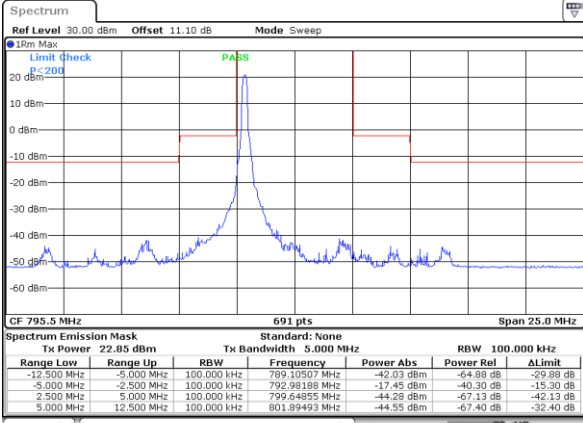

Date: 26.NOV.2021 23:05:46

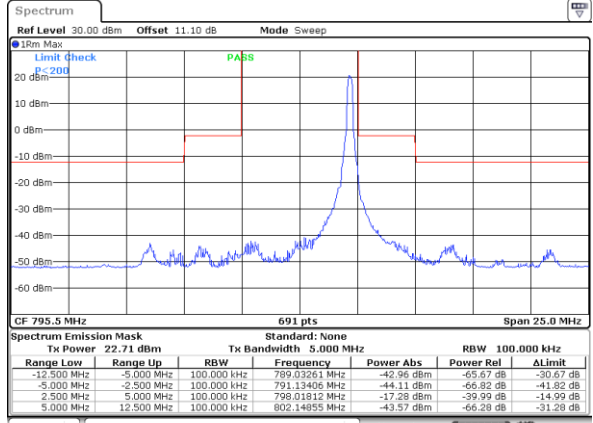

Date: 26.NOV.2021 23:10:41

Highest Channel / Full RB

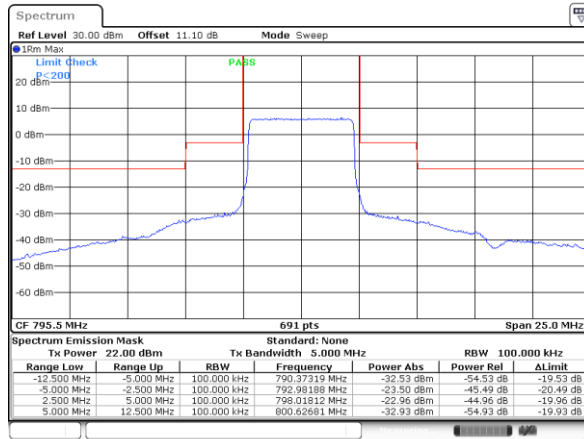

Date: 26.NOV.2021 23:00:51



LTE Band 14 / 5MHz / 64QAM

Highest Channel / 1RB

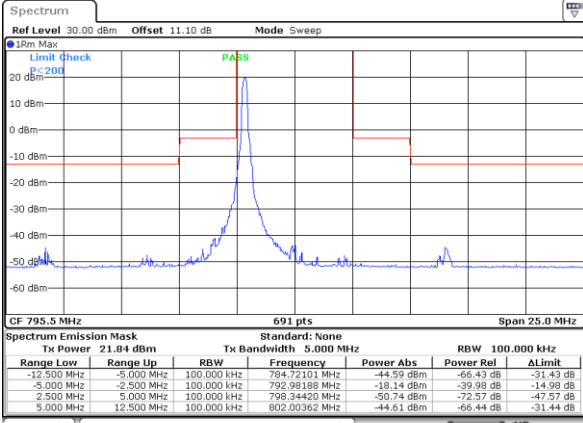

Date: 26.NOV.2021 23:04:08

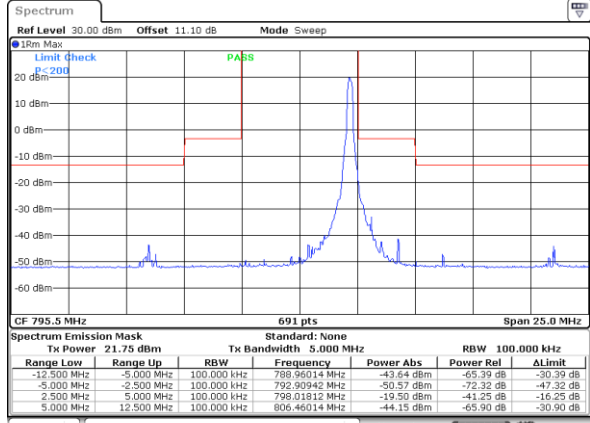

Date: 26.NOV.2021 23:12:20

Highest Channel / Full RB

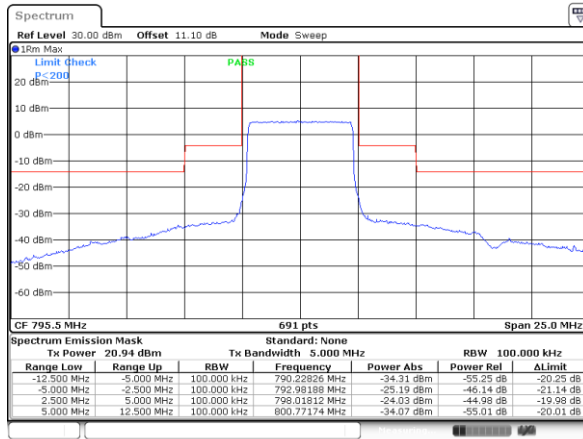

Date: 26.NOV.2021 23:02:29



LTE Band 14 / 5MHz / 256QAM

Highest Channel / 1RB

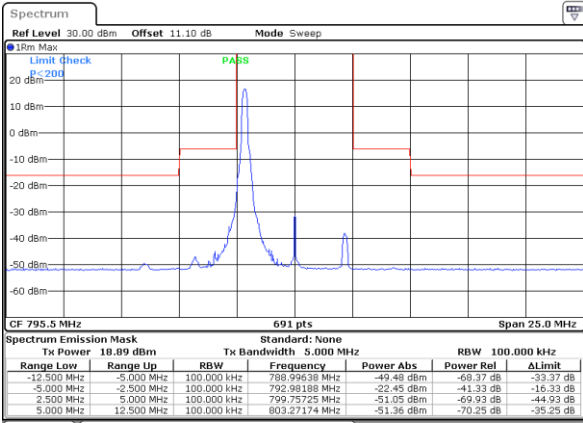

Date: 27.NOV.2021 00:08:31

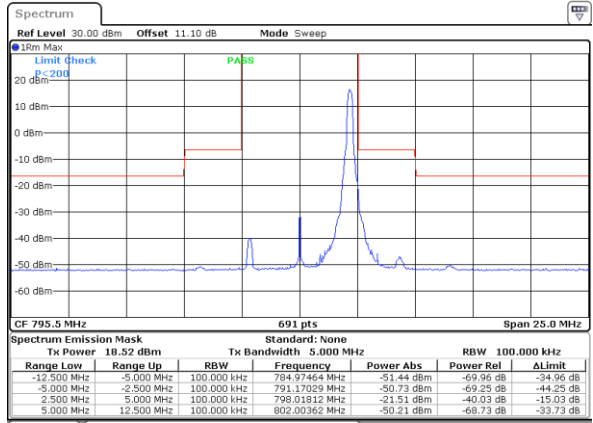

Date: 26.NOV.2021 23:55:127

Highest Channel / Full RB

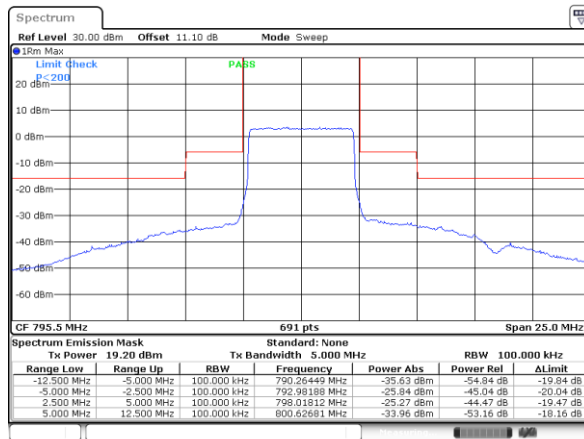

Date: 27.NOV.2021 00:02:47



LTE Band 14 / 10MHz / QPSK

Middle Channel / 1RB

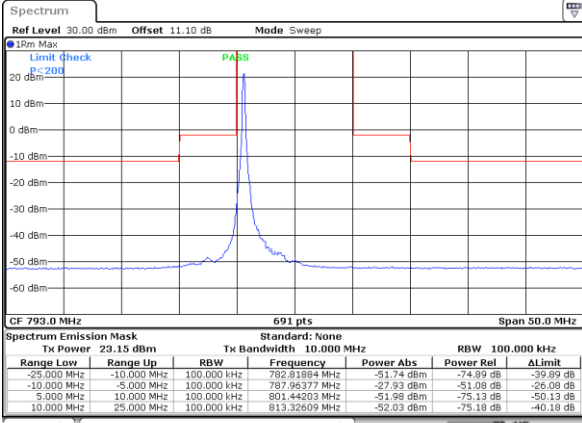

Date: 26.NOV.2021 23:18:52

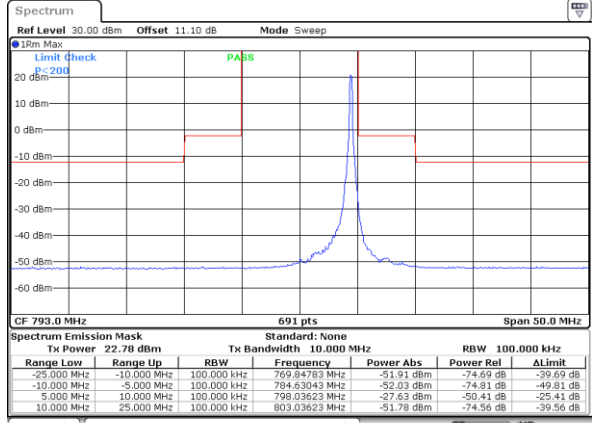

Date: 26.NOV.2021 23:17:14

Middle Channel / Full RB

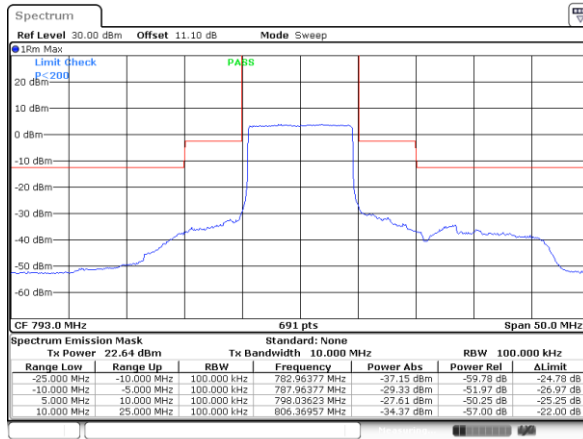

Date: 26.NOV.2021 23:27:00



LTE Band 14 / 10MHz / 16QAM

Middle Channel / 1RB

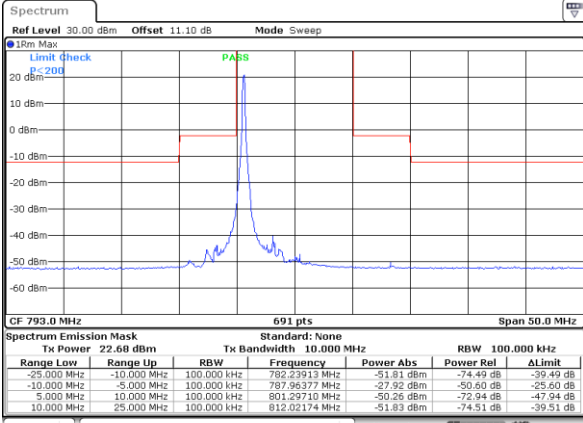

Date: 26.NOV.2021 23:20:30

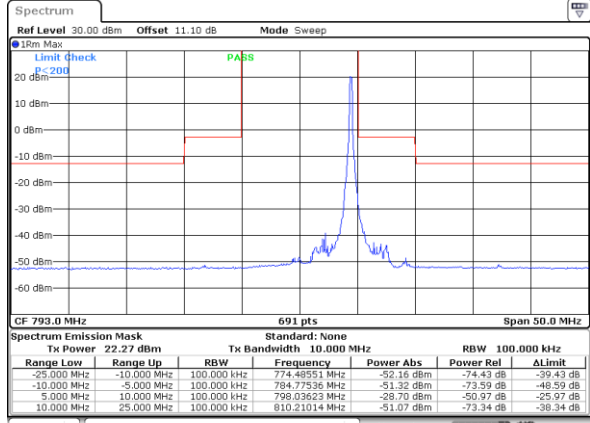

Date: 26.NOV.2021 23:15:36

Middle Channel / Full RB

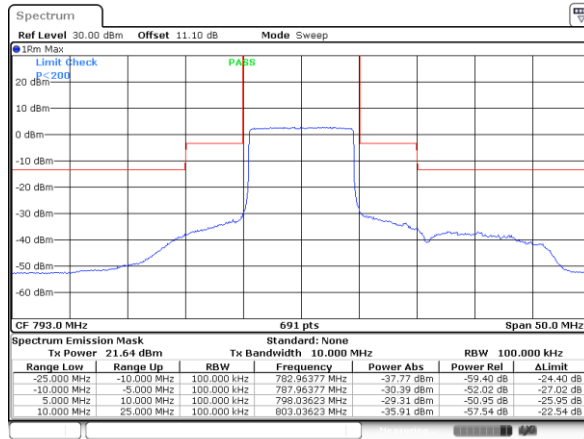

Date: 26.NOV.2021 23:25:23



LTE Band 14 / 10MHz / 64QAM

Middle Channel / 1RB

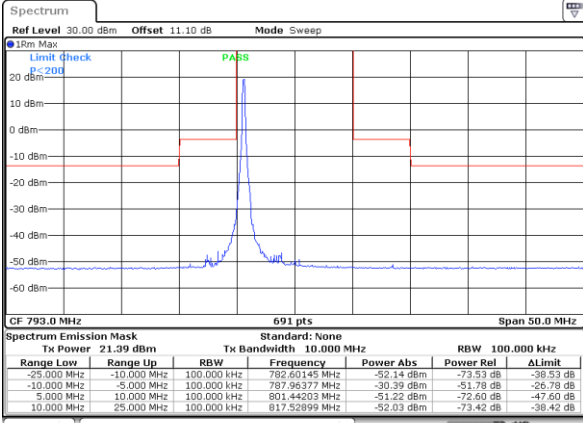

Date: 26.NOV.2021 23:22:07

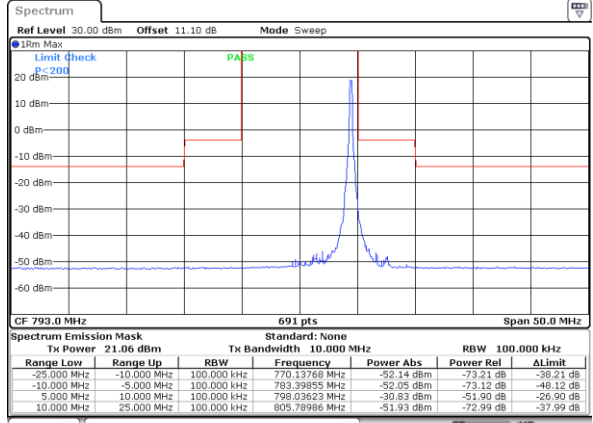

Date: 26.NOV.2021 23:13:58

Middle Channel / Full RB

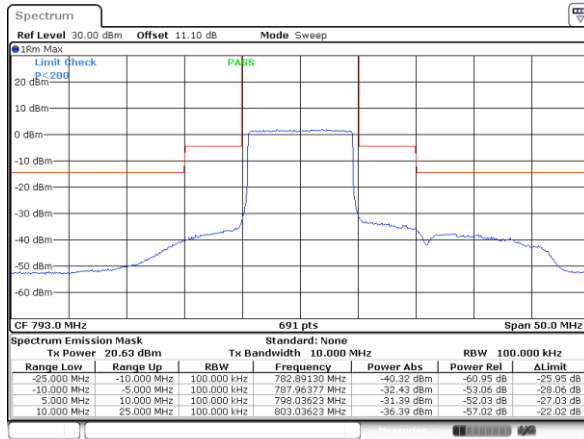

Date: 26.NOV.2021 23:23:45



LTE Band 14 / 10MHz / 256QAM

Middle Channel / 1RB

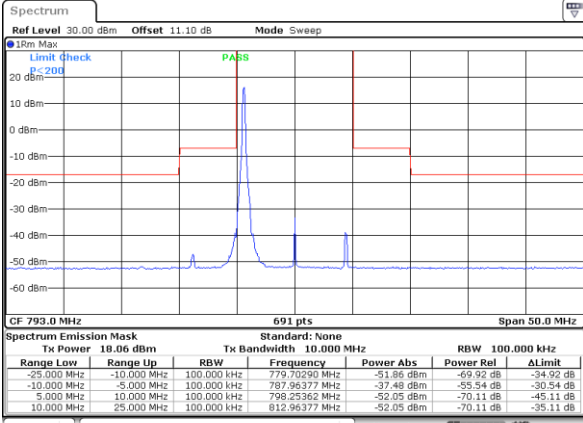

Date: 27.NOV.2021 00:11:30

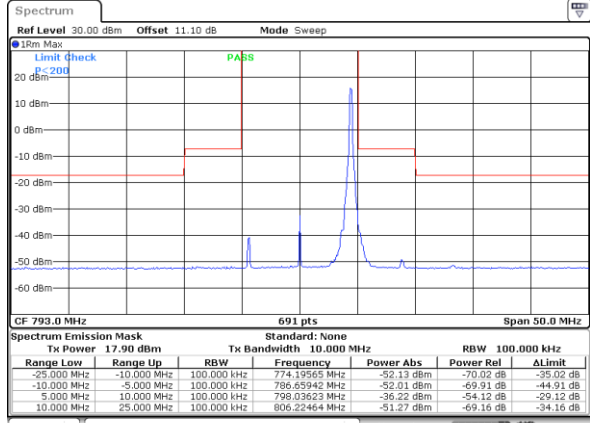

Date: 27.NOV.2021 00:11:31

Middle Channel / Full RB

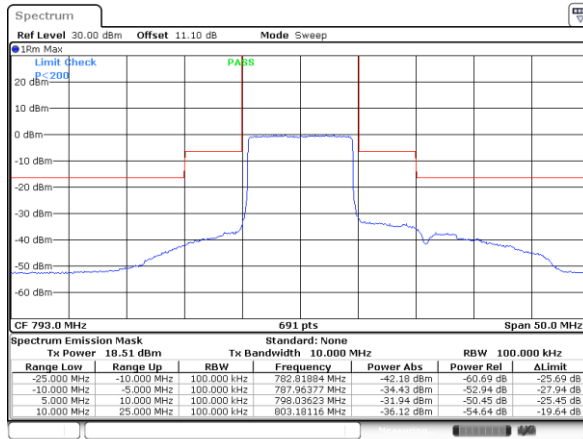

Date: 27.NOV.2021 00:17:56



Frequency Stability

| Test Conditions | | LTE Band 14 (QPSK) / Middle Channel | Limit |
|------------------|-------------------|-------------------------------------|---------|
| Temperature (°C) | Voltage (Volt) | BW 10MHz | Note 2. |
| | | Deviation (ppm) | Result |
| 50 | Normal Voltage | 0.0035 | PASS |
| 40 | Normal Voltage | 0.0103 | |
| 30 | Normal Voltage | 0.0006 | |
| 20(Ref.) | Normal Voltage | 0.0000 | |
| 10 | Normal Voltage | 0.0005 | |
| 0 | Normal Voltage | 0.0095 | |
| -10 | Normal Voltage | 0.0038 | |
| -20 | Normal Voltage | 0.0023 | |
| -30 | Normal Voltage | 0.0052 | |
| 20 | Maximum Voltage | 0.0003 | |
| 20 | Normal Voltage | 0.0000 | |
| 20 | Battery End Point | 0.0028 | |

Note:

1. Normal Voltage =3.85 V. ; Battery End Point (BEP) =3.4 V. ; Maximum Voltage =4.4 V.
2. The frequency fundamental emissions stay within the authorized frequency block.



Appendix B. Test Results of Radiated Test

<Internal Antenna 1>

LTE Band 14

| LTE Band 14 / 5MHz / QPSK | | | | | | | | | |
|---------------------------|-------------------|-------------|---------------|-------------------|-------------------|--------------------|----------------------|-----------------------|--------------------|
| Channel | Frequency (MHz) | ERP (dBm) | Limit (dBm) | Over Limit (dB) | SPA Reading (dBm) | S.G. Power (dBm) | TX Cable loss (dB) | TX Antenna Gain (dBi) | Polarization (H/V) |
| Lowest | 1576 | -51.92 | -42.15 | -9.77 | -67.18 | -54.98 | 3.80 | 9.01 | H |
| | 2368 | -52.69 | -13.00 | -39.69 | -72.11 | -55.80 | 4.69 | 9.94 | H |
| | 3153 | -53.37 | -13.00 | -40.37 | -75.33 | -57.11 | 5.42 | 11.31 | H |
| | | | | | | | | | H |
| | | | | | | | | | H |
| | | | | | | | | | H |
| | 1576 | -53.28 | -42.15 | -11.13 | -68.42 | -56.34 | 3.80 | 9.01 | V |
| | 2365 | -55.64 | -13.00 | -42.64 | -74.97 | -58.73 | 4.68 | 9.92 | V |
| | 3152 | -53.61 | -13.00 | -40.61 | -75.47 | -57.35 | 5.42 | 11.31 | V |
| | | | | | | | | | V |
| | | | | | | | | | V |
| | | | | | | | | | V |
| Middle | 1584 | -49.20 | -42.15 | -7.05 | -64.48 | -52.31 | 3.81 | 9.07 | H |
| | 2376 | -43.43 | -13.00 | -30.43 | -62.89 | -46.59 | 4.70 | 10.01 | H |
| | 3160 | -53.51 | -13.00 | -40.51 | -75.49 | -57.27 | 5.43 | 11.34 | H |
| | | | | | | | | | H |
| | | | | | | | | | H |
| | | | | | | | | | H |
| | 1584 | -53.47 | -42.15 | -11.32 | -68.61 | -56.58 | 3.81 | 9.07 | V |
| | 2376 | -42.53 | -13.00 | -29.53 | -61.85 | -45.69 | 4.70 | 10.01 | V |
| | 3160 | -53.66 | -13.00 | -40.66 | -75.54 | -57.42 | 5.43 | 11.34 | V |
| | | | | | | | | | V |
| | | | | | | | | | V |
| | | | | | | | | | V |



| | | | | | | | | | |
|---------|------|--------|--------|--------|--------|--------|------|-------|---|
| Highest | 1584 | -52.97 | -42.15 | -10.82 | -68.25 | -56.08 | 3.81 | 9.07 | H |
| | 2384 | -54.07 | -13.00 | -41.07 | -73.54 | -57.29 | 4.70 | 10.07 | H |
| | 3173 | -53.23 | -13.00 | -40.23 | -75.26 | -57.03 | 5.44 | 11.39 | H |
| | | | | | | | | | H |
| | | | | | | | | | H |
| | | | | | | | | | H |
| | 1584 | -53.89 | -42.15 | -11.74 | -69.03 | -57.00 | 3.81 | 9.07 | V |
| | 2380 | -56.07 | -13.00 | -43.07 | -75.37 | -59.26 | 4.70 | 10.04 | V |
| | 3173 | -53.20 | -13.00 | -40.20 | -75.12 | -57.00 | 5.44 | 11.39 | V |
| | | | | | | | | | V |
| | | | | | | | | | V |
| | | | | | | | | | V |



| LTE Band 14 / 10MHz / QPSK | | | | | | | | | |
|----------------------------|-------------------|-------------|---------------|-------------------|-------------------|--------------------|----------------------|-----------------------|--------------------|
| Channel | Frequency (MHz) | ERP (dBm) | Limit (dBm) | Over Limit (dB) | SPA Reading (dBm) | S.G. Power (dBm) | TX Cable loss (dB) | TX Antenna Gain (dBi) | Polarization (H/V) |
| Middle | 1576 | -52.11 | -42.15 | -9.96 | -67.37 | -55.17 | 3.80 | 9.01 | H |
| | 2365 | -55.75 | -13.00 | -42.75 | -75.17 | -58.84 | 4.68 | 9.92 | H |
| | 3154 | -53.24 | -13.00 | -40.24 | -75.20 | -56.98 | 5.42 | 11.32 | H |
| | | | | | | | | | H |
| | | | | | | | | | H |
| | | | | | | | | | H |
| | 1577 | -54.11 | -42.15 | -11.96 | -69.25 | -57.18 | 3.80 | 9.02 | V |
| | 2365 | -56.32 | -13.00 | -43.32 | -75.65 | -59.41 | 4.68 | 9.92 | V |
| | 3152 | -53.84 | -13.00 | -40.84 | -75.70 | -57.58 | 5.42 | 11.31 | V |
| | | | | | | | | | V |
| | | | | | | | | | V |
| | | | | | | | | | V |

Remark: Spurious emissions within 30-1000MHz were found more than 20dB below limit line.