

FCC Test Report (Co-Located)

Report No.: RFBBQZ-WTW-P21020623-2

FCC ID: PY321100520

Test Model: WAX630

Received Date: Mar. 05, 2021

Test Date: May 18, 2021

Issued Date: May 20, 2021

**Applicant and
Manufacturer:** NETGEAR, Inc.

Address: 350 East Plumeria Drive San Jose, CA 95134

Issued By: Bureau Veritas Consumer Products Services (H.K.) Ltd., Taoyuan Branch
Lin Kou Laboratories

Lab Address: No. 47-2, 14th Ling, Chia Pau Vil., Lin Kou Dist., New Taipei City, Taiwan

Test Location: No. 19, Hwa Ya 2nd Rd., Wen Hwa Vil., Kwei Shan Dist., Taoyuan City
33383, TAIWAN

**FCC Registration /
Designation Number:** 788550 / TW0003



This report is for your exclusive use. Any copying or replication of this report to or for any other person or entity, or use of our name or trademark, is permitted only with our prior written permission. This report sets forth our findings solely with respect to the test samples identified herein. The results set forth in this report are not indicative or representative of the quality or characteristics of the lot from which a test sample was taken or any similar or identical product unless specifically and expressly noted. Our report includes all of the tests requested by you and the results thereof based upon the information that you provided to us. You have 60 days from date of issuance of this report to notify us of any material error or omission caused by our negligence, provided, however, that such notice shall be in writing and shall specifically address the issue you wish to raise. A failure to raise such issue within the prescribed time shall constitute your unqualified acceptance of the completeness of this report, the tests conducted and the correctness of the report contents. Unless specific mention, the uncertainty of measurement has been explicitly taken into account to declare the compliance or non-compliance to the specification.

Table of Contents

Release Control Record	3
1 Certificate of Conformity	4
2 Summary of Test Results	5
2.1 Measurement Uncertainty	5
2.2 Modification Record	5
3 General Information	6
3.1 General Description of EUT	6
3.2 Description of Test Modes	8
3.2.1 Test Mode Applicability and Tested Channel Detail	10
3.3 Description of Support Units	11
3.3.1 Configuration of System under Test	11
3.4 General Description of Applied Standards	12
4 Test Types and Results	13
4.1 Radiated Emission and Bandedge Measurement	13
4.1.1 Limits of Radiated Emission and Bandedge Measurement	13
4.1.2 Test Instruments	14
4.1.3 Test Procedures	15
4.1.4 Deviation from Test Standard	16
4.1.5 Test Setup	16
4.1.6 EUT Operating Conditions	17
4.1.7 Test Results	18
5 Pictures of Test Arrangements	28
Appendix – Information of the Testing Laboratories	29

Release Control Record

Issue No.	Description	Date Issued
RFBBQZ-WTW-P21020623-2	Original Release	May 20, 2021

1 Certificate of Conformity

Product: NETGEAR® Insight Managed WiFi 6 AX6000 Tri-band Multi-Gig Access Point

Brand: NETGEAR

Test Model: WAX630

Sample Status: Engineering Sample

Applicant: NETGEAR, Inc.

Test Date: May 18, 2021

Standards: 47 CFR FCC Part 15, Subpart C (Section 15.247)

47 CFR FCC Part 15, Subpart E (Section 15.407)

ANSI C63.10:2013

The above equipment has been tested by **Bureau Veritas Consumer Products Services (H.K.) Ltd., Taoyuan Branch**, and found compliance with the requirement of the above standards. The test record, data evaluation & Equipment Under Test (EUT) configurations represented herein are true and accurate accounts of the measurements of the sample's RF characteristics under the conditions specified in this report.

Prepared by : , **Date:** May 20, 2021
Gina Liu / Specialist

Approved by : , **Date:** May 20, 2021
Dylan Chiou / Senior Project Engineer

2 Summary of Test Results

Applied Standard:	47 CFR FCC Part 15, Subpart C (Section 15.247) 47 CFR FCC Part 15, Subpart E (Section 15.407)		
FCC Clause	Test Item	Result	Remarks
15.205 / 15.209 / 15.247(d) 15.407(b) (1/2/3/4(i/ii)/6)	Radiated Emissions	Pass	Meet the requirement of limit. Minimum passing margin is -0.3dB at 2390.00 MHz.

Note: Determining compliance based on the results of the compliance measurement, not taking into account measurement instrumentation uncertainty.

2.1 Measurement Uncertainty

Where relevant, the following measurement uncertainty levels have been estimated for tests performed on the EUT as specified in CISPR 16-4-2:

Measurement	Frequency	Expanded Uncertainty (k=2) (\pm)
Radiated Emissions up to 1 GHz	9kHz ~ 30MHz	3.04 dB
	30MHz ~ 200MHz	3.63 dB
	200MHz ~ 1000MHz	3.64 dB
Radiated Emissions above 1 GHz	1GHz ~ 18GHz	2.29 dB
	18GHz ~ 40GHz	2.29 dB

2.2 Modification Record

There were no modifications required for compliance.

3 General Information

3.1 General Description of EUT

Product	NETGEAR® Insight Managed WiFi 6 AX6000 Tri-band Multi-Gig Access Point	
Brand	NETGEAR	
Test Model	WAX630	
Sample Status	Engineering sample	
Power Supply rating	12Vdc from adapter 55.5Vdc for POE	
Modulation Type	WLAN	CCK, DQPSK, DBPSK for DSSS 256QAM, 64QAM, 16QAM, QPSK, BPSK for OFDM 1024QAM, 256QAM, 64QAM, 16QAM, QPSK, BPSK for OFDMA
Transfer Rate	WLAN	802.11a: 54/48/36/24/18/12/9/6Mbps 802.11b: 11/5.5/2/1Mbps 802.11g: 54/48/36/24/18/12/9/6Mbps 802.11n: up to 800Mbps 802.11ac: up to 800Mbps 802.11ax: up to 4803.9Mbps
Operating Frequency	WLAN	2.4GHz: 2412 ~ 2462MHz 5.0GHz: 5180 ~ 5240 MHz, 5745 ~ 5825 MHz
Number of Channel	WLAN	2412 ~ 2462MHz: 11 for 802.11b, 802.11g, 802.11n (HT20), 802.11n (VHT20), 802.11ax (HE20) 7 for 802.11n (HT40), 802.11n (VHT40), 802.11ax (HE40) 5180 ~ 5240 MHz: 4 for 802.11a, 802.11n (HT20), 802.11ac (VHT20), 802.11ax (HE20) 2 for 802.11n (HT40), 802.11ac (VHT40), 802.11ax (HE40) 1 for 802.11ac (VHT80), 802.11ax (HE80) 5745 ~ 5825 MHz: 5 for 802.11a, 802.11n (HT20), 802.11ac (VHT20), 802.11ax (HE20) 2 for 802.11n (HT40), 802.11ac (VHT40), 802.11ax (HE40) 1 for 802.11ac (VHT80), 802.11ax (HE80)
Output Power	WLAN	CDD Mode: 2412 ~ 2462MHz: 962.436mW 5180 ~ 5240MHz: 813.943mW 5745 ~ 5825MHz: 838.706mW Beamforming Mode: 2412 ~ 2462MHz: 958.573mW 5180 ~ 5240MHz: 813.943mW 5745 ~ 5825MHz: 838.706mW
Antenna Type	Refer to note	
Antenna Connector	Refer to note	
Accessory Device	Adapter	
Cable Supplied	N/A	

Note:

1. The EUT consumes power from the following adapters.

Adapter 1	
Brand	NETGEAR
Model	AD2150F10
Input Power	100-120Vac, 50/60Hz, 1.0A
Output Power	+12Vdc, 3.5A
Power Line	1.8m cable without core attached on adapter

Adapter 2	
Brand	NETGEAR
Model	2ABN042F NA
Input Power	100-120Vac, 50/60Hz, 1.3A
Output Power	+12Vdc, 3.5A
Power Line	1.82m cable without core attached on adapter

* Adapter 1 was chosen for final test and presented in the test report.

POE injector (support unit only)	
Brand	BUFFALO
Model	BIJ-POE-1P/HG
Input Power	100-240Vac, 50-60Hz, 1.1A
Output Power	55.5Vdc, 0.63A

2. The following antennas were provided to the EUT.

Ant. Type	Dipole		
Connector Type	i-pex(MHF)		
Directional Gain (dBi)			
2400-2500	5180-5240	5745-5825	
5.85	5.91	5.86	

* For detailed antenna information, please refer to the Operational Description-Antenna Specification report.

3.2 Description of Test Modes

WLAN 2.4G:

11 channels are provided for 802.11b, 802.11g and 802.11n (HT20):

Channel	Frequency (MHz)	Channel	Frequency (MHz)
1	2412	7	2442
2	2417	8	2447
3	2422	9	2452
4	2427	10	2457
5	2432	11	2462
6	2437		

7 channels are provided for 802.11n (HT40):

Channel	Frequency (MHz)	Channel	Frequency (MHz)
3	2422	7	2442
4	2427	8	2447
5	2432	9	2452
6	2437		

For 5180 ~ 5240MHz:

4 channels are provided for 802.11a, 802.11n (HT20), 802.11ac (VHT20), 802.11ax (HE20):

Channel	Frequency	Channel	Frequency
36	5180 MHz	44	5220 MHz
40	5200 MHz	48	5240 MHz

2 channels are provided for 802.11n (HT40), 802.11ac (VHT40), 802.11ax (HE40):

Channel	Frequency	Channel	Frequency
38	5190 MHz	46	5230 MHz

1 channel is provided for 802.11ac (VHT80), 802.11ax (HE80):

Channel	Frequency
42	5210MHz

For 5745 ~ 5825MHz:

5 channels are provided for 802.11a, 802.11n (HT20), 802.11ac (VHT20), 802.11ax (HE20):

Channel	Frequency	Channel	Frequency
149	5745MHz	161	5805MHz
153	5765MHz	165	5825MHz
157	5785MHz		

2 channels are provided for 802.11n (HT40), 802.11ac (VHT40), 802.11ax (HE40):

Channel	Frequency	Channel	Frequency
151	5755MHz	159	5795MHz

1 channel is provided for 802.11ac (VHT80), 802.11ax (HE80):

Channel	Frequency
155	5775MHz

3.2.1 Test Mode Applicability and Tested Channel Detail

EUT Configure Mode	Applicable to		Description
	RE \geq 1G	RE<1G	
A	√	√	EUT with Adapter
B	√	√	EUT with POE

Where RE \geq 1G: Radiated Emission above 1GHz & Bandedge Measurement RE<1G: Radiated Emission below 1GHz

NOTE: For radiated emission (below 1GHz) and power line conducted emission test items, the worst radiated emission mode was selected.

NOTE: The EUT had been pre-tested on the positioned of each 3 axis. The worst case was found when positioned on **Y-plane**.

NOTE: "-" means no effect.

Radiated Emission Test (Above 1 GHz):

- Pre-Scan has been conducted to determine the worst-case mode from all possible combinations between available modulations, data rates and antenna ports (if EUT with antenna diversity architecture).
- Following channel(s) was (were) selected for the final test as listed below.

EUT Configure Mode	Mode	Freq. Range (MHz)	Available Channel	Tested Channel	Modulation Technology
A	802.11b + 802.11ax (HE20)	2412-2462	1 to 11	1 + 40	DSSS
		5180-5240	36 to 48		OFDMA
	802.11b + 802.11ax (HE40)	2412-2462	1 to 11	1 + 159	DSSS
		5745-5825	151 to 159		OFDMA

Radiated Emission Test (Below 1GHz):

- Pre-Scan has been conducted to determine the worst-case mode from all possible combinations between available modulations, data rates and antenna ports (if EUT with antenna diversity architecture).
- Following channel(s) was (were) selected for the final test as listed below.

EUT Configure Mode	Mode	Freq. Range (MHz)	Available Channel	Tested Channel	Modulation Technology
A, B	802.11b + 802.11ax (HE20)	2412-2462	1 to 11	1 + 40	DSSS
		5180-5240	36 to 48		OFDMA
	802.11b + 802.11ax (HE40)	2412-2462	1 to 11	1 + 159	DSSS
		5745-5825	151 to 159		OFDMA

Test Condition:

Applicable to	Environmental Conditions	Input Power (System)	Tested by
RE \geq 1G	23 deg. C, 66% RH	120 Vac, 60 Hz	Noah Chang
RE<1G	25 deg. C, 70% RH	120 Vac, 60 Hz	Noah Chang

3.3 Description of Support Units

The EUT has been tested as an independent unit together with other necessary accessories or support units. The following support units or accessories were used to form a representative test configuration during the tests.

ID	Product	Brand	Model No.	Serial No.	FCC ID	Remarks
A.	Notebook	DELL	E5410	1HC2XM1	N/A	-
B.	Load	N/A	N/A	N/A	N/A	-
C.	POE	BUFFALO	BIJ-POE-1P/HG	N/A	N/A	Provided by Client

Note:

1. All power cords of the above support units are non-shielded (1.8m).
2. Item A acted as a communication partner to transfer data.

ID	Descriptions	Qty.	Length (m)	Shielding (Yes/No)	Cores (Qty.)	Remarks
1.	LAN	1	10	N	0	RJ45, Cat5e
2.	LAN	1	2	N	0	RJ45, Cat5e
3.	LAN	1	10	N	0	RJ45, Cat5e

3.3.1 Configuration of System under Test

Mode A

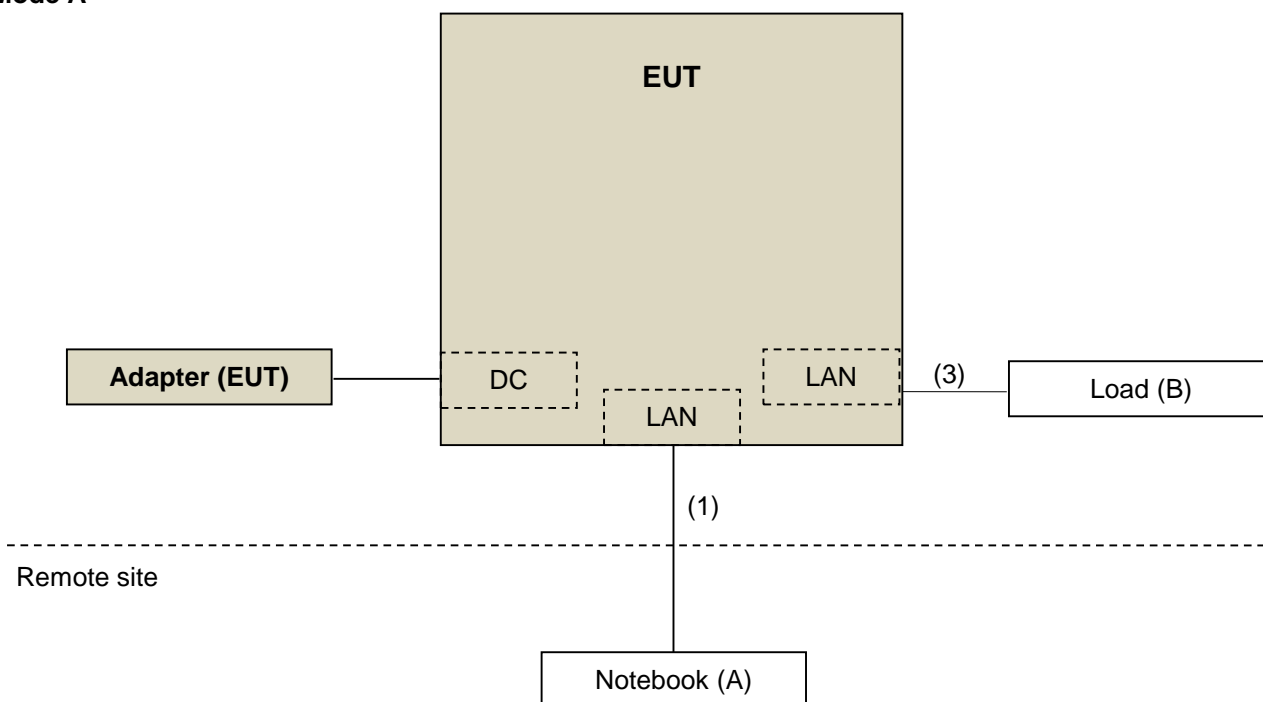

Mode B

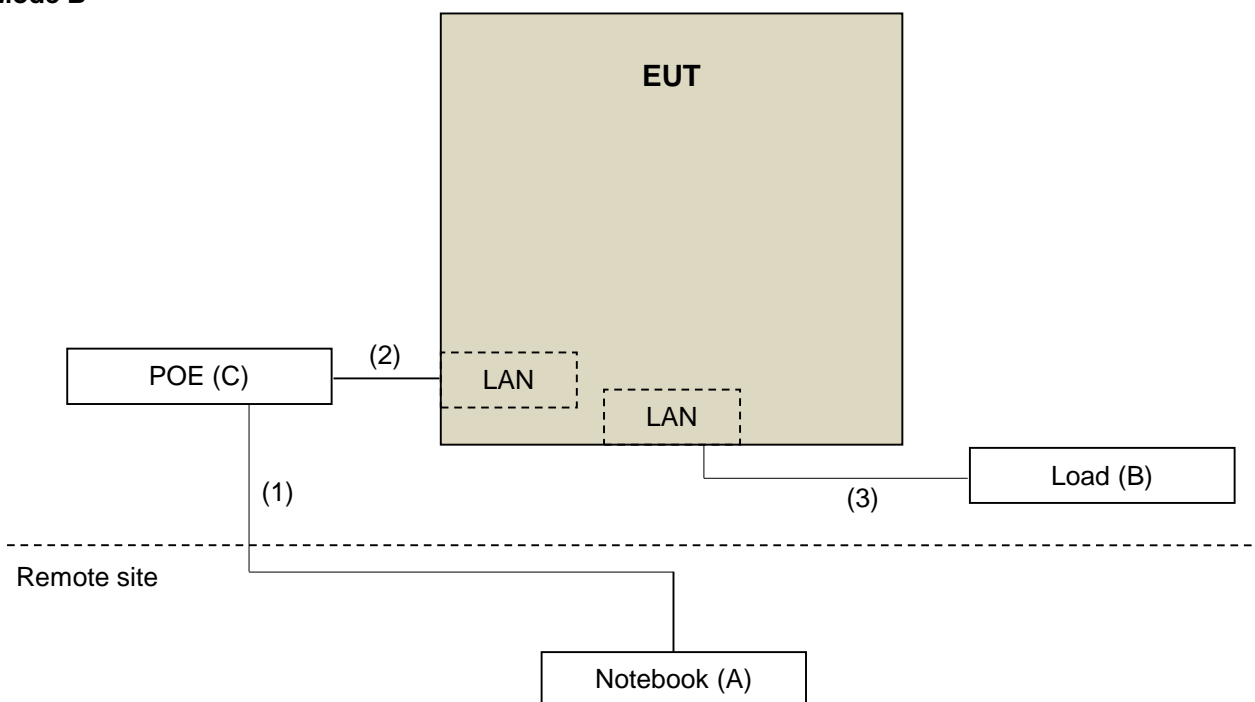

3.4 General Description of Applied Standards

The EUT is a RF Product. According to the specifications of the manufacturer, it must comply with the requirements of the following standards and references:

Test Standard:

FCC Part 15, Subpart C (15.247)

FCC Part 15, Subpart E (15.407)

ANSI C63.10-2013

All test items have been performed and recorded as per the above standards.

References Test Guidance:

KDB 558074 D01 Meas Guidance v05r02

KDB 662911 D01 Multiple Transmitter Output v02r01

KDB 789033 D02 General UNII Test Procedures New Rules v02r01

All test items have been performed as a reference to the above KDB test guidance.

4 Test Types and Results

4.1 Radiated Emission and Bandedge Measurement

4.1.1 Limits of Radiated Emission and Bandedge Measurement

Radiated emissions which fall in the restricted bands must comply with the radiated emission limits specified as below table.

Frequencies (MHz)	Field Strength (microvolts/meter)	Measurement Distance (meters)
0.009 ~ 0.490	2400/F(kHz)	300
0.490 ~ 1.705	24000/F(kHz)	30
1.705 ~ 30.0	30	30
30 ~ 88	100	3
88 ~ 216	150	3
216 ~ 960	200	3
Above 960	500	3

Note:

1. The lower limit shall apply at the transition frequencies.
2. Emission level (dBuV/m) = 20 log Emission level (uV/m).
3. For frequencies above 1000MHz, the field strength limits are based on average detector, however, the peak field strength of any emission shall not exceed the maximum permitted average limits, specified above by more than 20dB under any condition of modulation.

Limits of unwanted emission out of the restricted bands

Applicable To		Limit	
789033 D02 General UNII Test Procedure New Rules v02r01		Field Strength at 3m	
		PK: 74 (dBµV/m)	AV: 54 (dBµV/m)
Frequency Band	Applicable To	EIRP Limit	Equivalent Field Strength at 3m
5150~5250 MHz	15.407(b)(1)	PK: -27 (dBm/MHz)	PK: 68.2(dBµV/m)
5250~5350 MHz	15.407(b)(2)		
5470~5725 MHz	15.407(b)(3)		
5725~5850 MHz	<input checked="" type="checkbox"/> 15.407(b)(4)(i)	PK: -27 (dBm/MHz) ^{*1} PK: 10 (dBm/MHz) ^{*2} PK: 15.6 (dBm/MHz) ^{*3} PK: 27 (dBm/MHz) ^{*4}	PK: 68.2(dBµV/m) ^{*1} PK: 105.2 (dBµV/m) ^{*2} PK: 110.8(dBµV/m) ^{*3} PK: 122.2 (dBµV/m) ^{*4}
	<input type="checkbox"/> 15.407(b)(4)(ii)	Emission limits in section 15.247(d)	
*1 beyond 75 MHz or more above of the band edge.		*2 below the band edge increasing linearly to 10 dBm/MHz at 25 MHz above.	
*3 below the band edge increasing linearly to a level of 15.6 dBm/MHz at 5 MHz above.		*4 from 5 MHz above or below the band edge increasing linearly to a level of 27 dBm/MHz at the band edge.	

Note: The following formula is used to convert the equipment isotropic radiated power (eirp) to field strength:

$$E = \frac{1000000\sqrt{30P}}{3} \mu\text{V/m, where P is the eirp (Watts).}$$

4.1.2 Test Instruments

Description & Manufacturer	Model No.	Serial No.	Cal. Date	Cal. Due
Test Receiver ROHDE & SCHWARZ	ESCI	100424	Dec. 31, 2020	Dec. 30, 2021
Spectrum Analyzer ROHDE & SCHWARZ	FSP40	100040	Sep. 16, 2020	Sep. 15, 2021
BILOG Antenna SCHWARZBECK	VULB9168	9168-155	Nov. 03, 2020	Nov. 02, 2021
HORN Antenna SCHWARZBECK	BBHA 9120D	9120D-1170	Nov. 22, 2020	Nov. 21, 2021
HORN Antenna SCHWARZBECK	BBHA 9170	BBHA9170241	Nov. 22, 2020	Nov. 21, 2021
Loop Antenna TESEQ	HLA 6121	45745	Jul. 06, 2020	Jul. 05, 2021
Preamplifier Agilent (Below 1GHz)	8447D	2944A10631	Jun. 08, 2020	Jun. 07, 2021
Preamplifier KEYSIGHT (Above 1GHz)	83017A	MY53270295	Jun. 08, 2020	Jun. 07, 2021
RF Coaxial Cable WORKEN With 5dB PAD	8D-FB	Cable-CH4-01	Aug. 16, 2020	Aug. 15, 2021
RF Coaxial Cable EMCI	EMC102-KM-KM-3000	150929	Aug. 16, 2020	Aug. 15, 2021
RF Coaxial Cable EMCI	EMC102-KM-KM-600	150928	Aug. 16, 2020	Aug. 15, 2021
RF signal cable HUBER+SUHNER	SUCOFLEX 104	MY 13380+295012/04	Jun. 08, 2020	Jun. 07, 2021
RF signal cable HUBER+SUHNER	SUCOFLEX 104	Cable-CH4-03 (250724)	Jun. 08, 2020	Jun. 07, 2021
Software BV ADT	ADT_Radiated_V7.6.15.9.5	NA	NA	NA
Antenna Tower inn-co GmbH	MA 4000	010303	NA	NA
Antenna Tower Controller BV ADT	AT100	AT93021703	NA	NA
Turn Table BV ADT	TT100	TT93021703	NA	NA
Turn Table Controller BV ADT	SC100	SC93021703	NA	NA
Boresight Antenna Fixture	FBA-01	FBA-SIP01	NA	NA
Pre-amplifier (18GHz-40GHz) EMC	EMC184045B	980175	Sep. 04, 2020	Sep. 03, 2021
USB Wideband Power Sensor KEYSIGHT	U2021XA	MY55050005/MY55190004/MY55190007/MY55210005	Jul. 13, 2020	Jul. 12, 2021

Note: 1. The calibration interval of the above test instruments is 12 months and the calibrations are traceable to NML/ROC and NIST/USA.
2. The test was performed in HwaYa Chamber 4.

4.1.3 Test Procedures

For Radiated emission below 30MHz

- a. The EUT was placed on the top of a rotating table 0.8 meters above the ground at a 3 meter chamber room. The table was rotated 360 degrees to determine the position of the highest radiation.
- b. The EUT was set 3 meters away from the interference-receiving antenna, which was mounted on the top of a variable-height antenna tower.
- c. Parallel, perpendicular, and ground-parallel orientations of the antenna are set to make the measurement.
- d. For each suspected emission, the EUT was arranged to its worst case and the rotatable table was turned from 0 degrees to 360 degrees to find the maximum reading.
- e. The test-receiver system was set to Quasi-Peak Detect Function and Specified Bandwidth with Maximum Hold Mode.

Note:

1. The resolution bandwidth and video bandwidth of test receiver/spectrum analyzer is 9kHz at frequency below 30MHz.

For Radiated emission above 30MHz

- a. The EUT was placed on the top of a rotating table 0.8 meters (for 30MHz ~ 1GHz) / 1.5 meters (for above 1GHz) above the ground at 3 meter chamber room for test. The table was rotated 360 degrees to determine the position of the highest radiation.
- b. The EUT was set 3 meters away from the interference-receiving antenna, which was mounted on the top of a variable-height antenna tower.
- c. The height of antenna is varied from one meter to four meters above the ground to determine the maximum value of the field strength. Both horizontal and vertical polarizations of the antenna are set to make the measurement.
- d. For each suspected emission, the EUT was arranged to its worst case and then the antenna was tuned to heights from 1 meter to 4 meters and the rotatable table was turned from 0 degrees to 360 degrees to find the maximum reading.
- e. The test-receiver system was set to quasi-peak detect function and specified bandwidth with maximum hold mode when the test frequency is below 1 GHz.
- f. The test-receiver system was set to peak and average detect function and specified bandwidth with maximum hold mode when the test frequency is above 1 GHz. If the peak reading value also meets average limit, measurement with the average detector is unnecessary.

Note:

1. The resolution bandwidth and video bandwidth of test receiver/spectrum analyzer is 120kHz for Quasi-peak detection (QP) at frequency below 1GHz.
2. For WLAN device measurement, the resolution bandwidth of test receiver/spectrum analyzer is 1 MHz and the video bandwidth is 3 MHz for Peak detection (PK) at frequency above 1 GHz. The resolution bandwidth of test receiver/spectrum analyzer is 1MHz and the video bandwidth is $\geq 1/T$ (Duty cycle < 98%) or 10Hz (Duty cycle $\geq 98\%$) for Average detection (AV) at frequency above 1GHz.
3. All modes of operation were investigated and the worst-case emissions are reported.

4.1.4 Deviation from Test Standard

No deviation.

4.1.5 Test Setup

For Radiated emission below 30MHz

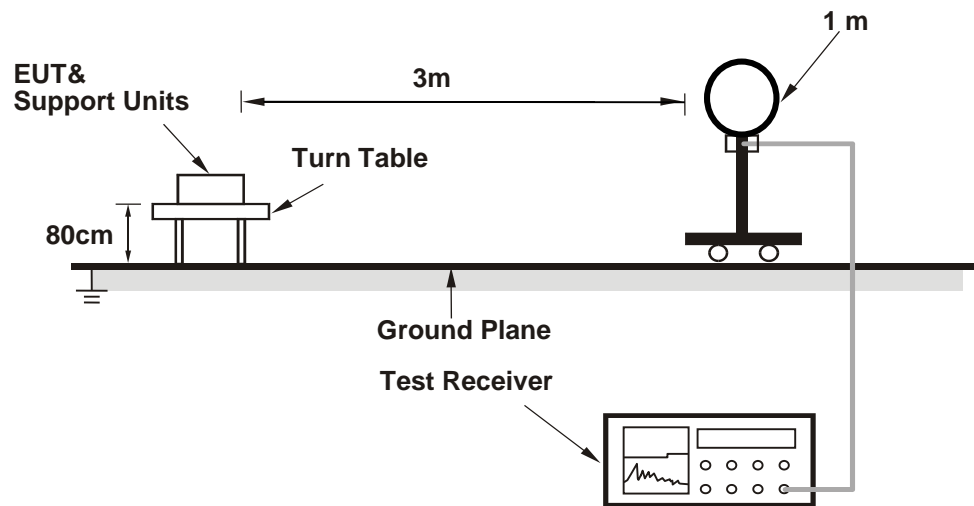

For Radiated emission 30MHz to 1GHz

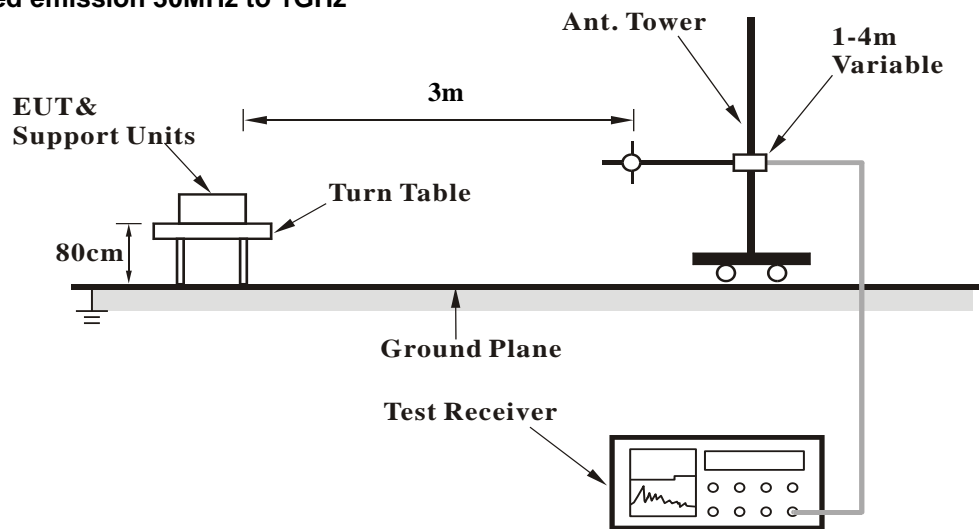

For Radiated emission above 1GHz

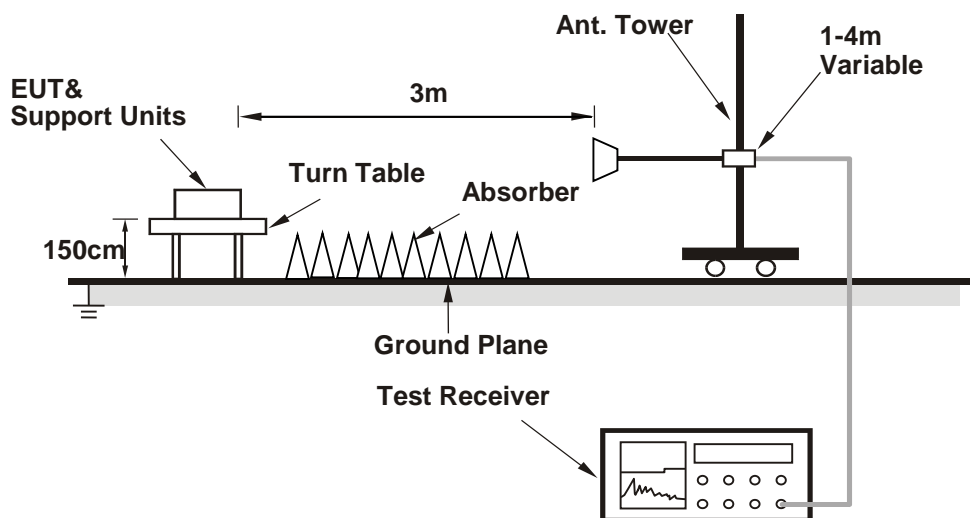

For the actual test configuration, please refer to the attached file (Test Setup Photo).

4.1.6 EUT Operating Conditions

- a. Placed the EUT on the testing table.
- b. Prepared a notebook to act as a communication partner and placed it outside of testing area.
- c. The communication partner connected with EUT via a RJ45 cable and ran a test program (provided by manufacturer) to enable EUT under transmission condition continuously at specific channel frequency.
- d. The communication partner sent data to EUT by command "PING".

4.1.7 Test Results

Above 1GHz Data:

Mode A:

802.11b + 802.11ax (HE20)

EUT Test Condition		Measurement Detail	
Channel	Channel 1 + Channel 40	Frequency Range	1 GHz ~ 40 GHz
Input Power	120 Vac, 60 Hz	Detector Function	Peak (PK) Average (AV)
Environmental Conditions	23 deg. C, 66 % RH	Tested By	Noah Chang

Antenna Polarity & Test Distance : Horizontal at 3 m								
No	Frequency (MHz)	Emission Level (dBuV/m)	Limit (dBuV/m)	Margin (dB)	Antenna Height (m)	Table Angle (Degree)	Raw Value (dBuV)	Correction Factor (dB/m)
1	2390.00	61.5 PK	74.0	-12.5	1.77 H	175	28.5	33.0
2	2390.00	52.0 AV	54.0	-2.0	1.77 H	175	19.0	33.0
3	*2412.00	118.8 PK			1.77 H	175	85.7	33.1
4	*2412.00	116.3 AV			1.77 H	175	83.2	33.1
5	4824.00	53.9 PK	74.0	-20.1	2.00 H	350	42.5	11.4
6	4824.00	50.4 AV	54.0	-3.6	2.00 H	350	39.0	11.4
7	5149.80	67.1 PK	74.0	-6.9	1.55 H	330	56.5	10.6
8	5149.80	49.3 AV	54.0	-4.7	1.55 H	330	38.7	10.6
9	*5200.00	119.9 PK			1.55 H	330	80.2	39.7
10	*5200.00	108.3 AV			1.55 H	330	68.6	39.7
11	#10400.00	59.7 PK	68.2	-8.5	1.56 H	125	38.0	21.7

Antenna Polarity & Test Distance : Vertical at 3 m								
No	Frequency (MHz)	Emission Level (dBuV/m)	Limit (dBuV/m)	Margin (dB)	Antenna Height (m)	Table Angle (Degree)	Raw Value (dBuV)	Correction Factor (dB/m)
1	2390.00	63.5 PK	74.0	-10.5	1.89 V	355	29.1	34.4
2	2390.00	53.7 AV	54.0	-0.3	1.89 V	355	19.3	34.4
3	*2412.00	120.6 PK			1.89 V	355	86.3	34.3
4	*2412.00	118.2 AV			1.89 V	355	83.9	34.3
5	4824.00	53.4 PK	74.0	-20.6	1.88 V	150	47.2	6.2
6	4824.00	48.8 AV	54.0	-5.2	1.88 V	150	42.6	6.2
7	5149.80	70.6 PK	74.0	-3.4	1.99 V	56	68.0	2.6
8	5149.80	53.6 AV	54.0	-0.4	1.99 V	56	51.0	2.6
9	*5200.00	119.1 PK			1.99 V	56	79.2	39.9
10	*5200.00	108.6 AV			1.99 V	56	68.7	39.9
11	#10400.00	58.5 PK	68.2	-9.7	2.00 V	150	48.0	10.5

Remarks:

1. Emission Level(dBuV/m) = Raw Value(dBuV) + Correction Factor(dB/m)
2. Correction Factor(dB/m) = Antenna Factor(dB/m) + Cable Factor(dB) – Pre-Amplifier Factor(dB)
3. Margin value = Emission Level – Limit value
4. The other emission levels were very low against the limit.
5. " * ": Fundamental frequency.
6. " # ": The radiated frequency is out of the restricted band.

802.11b + 802.11ax (HE40)

EUT Test Condition		Measurement Detail	
Channel	Channel 1 + Channel 159	Frequency Range	1 GHz ~ 40 GHz
Input Power	120 Vac, 60 Hz	Detector Function	Peak (PK) Average (AV)
Environmental Conditions	23 deg. C, 66 % RH	Tested By	Noah Chang

Antenna Polarity & Test Distance : Horizontal at 3 m

No	Frequency (MHz)	Emission Level (dBuV/m)	Limit (dBuV/m)	Margin (dB)	Antenna Height (m)	Table Angle (Degree)	Raw Value (dBuV)	Correction Factor (dB/m)
1	2390.00	61.6 PK	74.0	-12.4	1.70 H	171	28.6	33.0
2	2390.00	52.1 AV	54.0	-1.9	1.70 H	171	19.1	33.0
3	*2412.00	118.5 PK			1.70 H	171	85.4	33.1
4	*2412.00	116.2 AV			1.70 H	171	83.1	33.1
5	4824.00	53.7 PK	74.0	-20.3	1.89 H	355	42.3	11.4
6	4824.00	50.6 AV	54.0	-3.4	1.89 H	355	39.2	11.4
7	*5795.00	118.0 PK			1.35 H	315	77.0	41.0
8	*5795.00	107.7 AV			1.35 H	315	66.7	41.0
9	11590.00	63.2 PK	74.0	-10.8	1.89 H	50	40.0	23.2
10	11590.00	51.7 AV	54.0	-2.3	1.89 H	50	28.5	23.2

Antenna Polarity & Test Distance : Vertical at 3 m

No	Frequency (MHz)	Emission Level (dBuV/m)	Limit (dBuV/m)	Margin (dB)	Antenna Height (m)	Table Angle (Degree)	Raw Value (dBuV)	Correction Factor (dB/m)
1	2390.00	63.8 PK	74.0	-10.2	1.95 V	351	29.4	34.4
2	2390.00	53.4 AV	54.0	-0.6	1.95 V	351	19.0	34.4
3	*2412.00	120.5 PK			1.95 V	351	86.2	34.3
4	*2412.00	117.8 AV			1.95 V	351	83.5	34.3
5	4824.00	53.2 PK	74.0	-20.8	2.00 V	148	47.0	6.2
6	4824.00	48.6 AV	54.0	-5.4	2.00 V	148	42.4	6.2
7	*5795.00	123.1 PK			2.27 V	70	82.0	41.1
8	*5795.00	112.1 AV			2.27 V	70	71.0	41.1
9	11590.00	63.4 PK	74.0	-10.6	1.59 V	170	53.1	10.3
10	11590.00	52.5 AV	54.0	-1.5	1.59 V	170	42.2	10.3

Remarks:

1. Emission Level(dBuV/m) = Raw Value(dBuV) + Correction Factor(dB/m)
2. Correction Factor(dB/m) = Antenna Factor(dB/m) + Cable Factor(dB) – Pre-Amplifier Factor(dB)
3. Margin value = Emission Level – Limit value
4. The other emission levels were very low against the limit.
5. " * " : Fundamental frequency.
6. " # " : The radiated frequency is out of the restricted band.

Below 1GHz data

Mode A

802.11b + 802.11ax (HE20)

EUT Test Condition		Measurement Detail	
Channel	Channel 1 + Channel 40	Frequency Range	30 MHz ~ 1 GHz
Input Power	120 Vac, 60 Hz	Detector Function	Quasi-peak (QP)
Environmental Conditions	25 deg. C, 70 % RH	Tested By	Noah Chang

Antenna Polarity & Test Distance : Horizontal at 3 m								
No	Frequency (MHz)	Emission Level (dBuV/m)	Limit (dBuV/m)	Margin (dB)	Antenna Height (m)	Table Angle (Degree)	Raw Value (dBuV)	Correction Factor (dB/m)
1	37.66	29.9 QP	40.0	-10.1	1.01 H	10	39.7	-9.8
2	103.64	27.2 QP	43.5	-16.3	1.50 H	268	40.0	-12.8
3	133.71	28.4 QP	43.5	-15.1	1.50 H	94	38.3	-9.9
4	288.94	23.6 QP	46.0	-22.4	1.01 H	99	31.5	-7.9
5	492.69	30.6 QP	46.0	-15.4	1.50 H	267	34.8	-4.2
6	866.21	31.3 QP	46.0	-14.7	2.00 H	98	26.1	5.2

Remarks:

1. Emission Level(dBuV/m) = Raw Value(dBuV) + Correction Factor(dB/m)
2. Correction Factor(dB/m) = Antenna Factor(dB/m) + Cable Factor(dB) – Pre-Amplifier Factor(dB)
3. Margin value = Emission Level – Limit value
4. The other emission levels were very low against the limit of frequency range 30MHz~1000MHz.
5. The emission levels were very low against the limit of frequency range 9kHz~30MHz: the amplitude of spurious emissions attenuated more than 20 dB below the permissible value to be report.

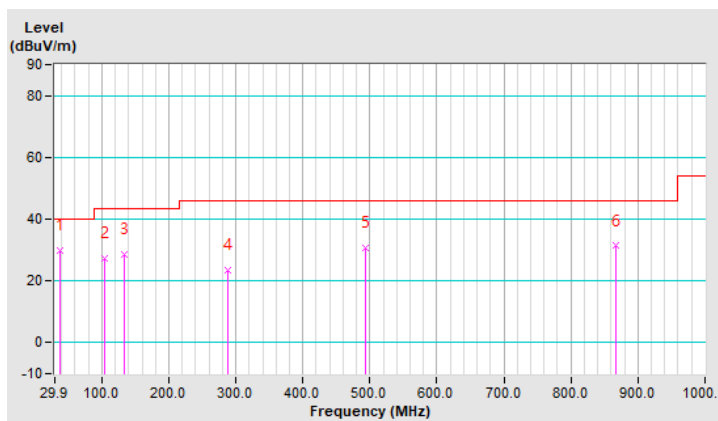

EUT Test Condition		Measurement Detail	
Channel	Channel 1 + Channel 40	Frequency Range	30 MHz ~ 1 GHz
Input Power	120 Vac, 60 Hz	Detector Function	Quasi-peak (QP)
Environmental Conditions	25 deg. C, 70 % RH	Tested By	Noah Chang

Antenna Polarity & Test Distance : Vertical at 3 m								
No	Frequency (MHz)	Emission Level (dBuV/m)	Limit (dBuV/m)	Margin (dB)	Antenna Height (m)	Table Angle (Degree)	Raw Value (dBuV)	Correction Factor (dB/m)
1	53.18	35.3 QP	40.0	-4.7	1.49 V	357	44.2	-8.9
2	230.73	21.6 QP	46.0	-24.4	1.00 V	222	32.9	-11.3
3	359.77	28.9 QP	46.0	-17.1	1.49 V	291	35.5	-6.6
4	682.84	30.3 QP	46.0	-15.7	1.99 V	181	29.7	0.6
5	873.97	31.8 QP	46.0	-14.2	1.00 V	4	26.3	5.5
6	977.79	33.0 QP	54.0	-21.0	1.00 V	352	25.6	7.4

Remarks:

1. Emission Level(dBuV/m) = Raw Value(dBuV) + Correction Factor(dB/m)
2. Correction Factor(dB/m) = Antenna Factor(dB/m) + Cable Factor(dB) – Pre-Amplifier Factor(dB)
3. Margin value = Emission Level – Limit value
4. The other emission levels were very low against the limit of frequency range 30MHz~1000MHz.
5. The emission levels were very low against the limit of frequency range 9kHz~30MHz: the amplitude of spurious emissions attenuated more than 20 dB below the permissible value to be report.

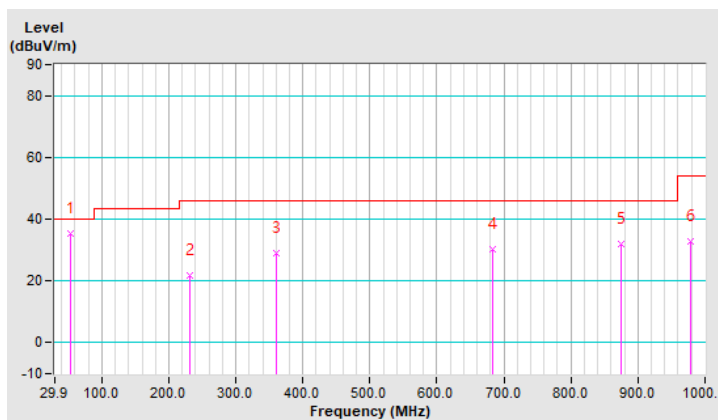

802.11b + 802.11ax (HE40)

EUT Test Condition		Measurement Detail	
Channel	Channel 1 + Channel 159	Frequency Range	30 MHz ~ 1 GHz
Input Power	120 Vac, 60 Hz	Detector Function	Quasi-peak (QP)
Environmental Conditions	25 deg. C, 70 % RH	Tested By	Noah Chang

Antenna Polarity & Test Distance : Horizontal at 3 m								
No	Frequency (MHz)	Emission Level (dBuV/m)	Limit (dBuV/m)	Margin (dB)	Antenna Height (m)	Table Angle (Degree)	Raw Value (dBuV)	Correction Factor (dB/m)
1	78.41	32.8 QP	40.0	-7.2	1.99 H	166	45.6	-12.8
2	145.35	34.5 QP	43.5	-9.0	1.00 H	134	43.5	-9.0
3	318.05	34.8 QP	46.0	-11.2	1.00 H	178	42.0	-7.2
4	502.39	29.9 QP	46.0	-16.1	1.50 H	88	33.8	-3.9
5	655.68	33.9 QP	46.0	-12.1	1.50 H	299	34.0	-0.1
6	875.91	37.4 QP	46.0	-8.6	1.50 H	152	31.9	5.5

Remarks:

1. Emission Level(dBuV/m) = Raw Value(dBuV) + Correction Factor(dB/m)
2. Correction Factor(dB/m) = Antenna Factor(dB/m) + Cable Factor(dB) – Pre-Amplifier Factor(dB)
3. Margin value = Emission Level – Limit value
4. The other emission levels were very low against the limit of frequency range 30MHz~1000MHz.
5. The emission levels were very low against the limit of frequency range 9kHz~30MHz: the amplitude of spurious emissions attenuated more than 20 dB below the permissible value to be report.

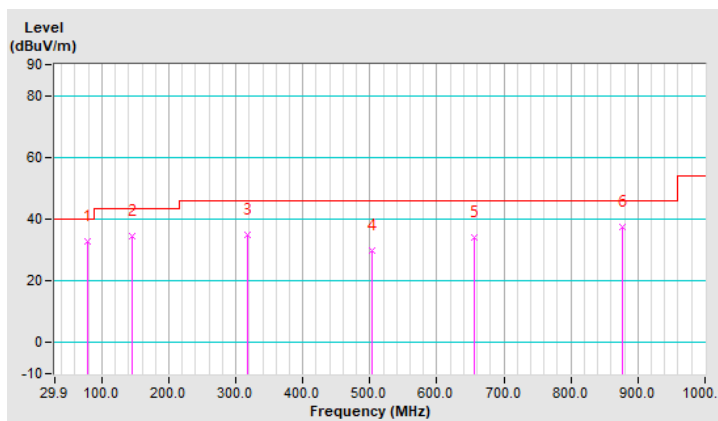

EUT Test Condition		Measurement Detail	
Channel	Channel 1 + Channel 159	Frequency Range	30 MHz ~ 1 GHz
Input Power	120 Vac, 60 Hz	Detector Function	Quasi-peak (QP)
Environmental Conditions	25 deg. C, 70 % RH	Tested By	Noah Chang

Antenna Polarity & Test Distance : Vertical at 3 m								
No	Frequency (MHz)	Emission Level (dBuV/m)	Limit (dBuV/m)	Margin (dB)	Antenna Height (m)	Table Angle (Degree)	Raw Value (dBuV)	Correction Factor (dB/m)
1	98.78	34.6 QP	43.5	-8.9	2.00 V	316	48.2	-13.6
2	163.79	33.5 QP	43.5	-10.0	2.00 V	290	42.3	-8.8
3	181.25	31.8 QP	43.5	-11.7	1.01 V	322	42.3	-10.5
4	287.97	35.7 QP	46.0	-10.3	2.00 V	312	43.6	-7.9
5	512.09	35.8 QP	46.0	-10.2	1.01 V	4	39.4	-3.6
6	962.26	34.7 QP	54.0	-19.3	1.50 V	300	27.3	7.4

Remarks:

1. Emission Level(dBuV/m) = Raw Value(dBuV) + Correction Factor(dB/m)
2. Correction Factor(dB/m) = Antenna Factor(dB/m) + Cable Factor(dB) – Pre-Amplifier Factor(dB)
3. Margin value = Emission Level – Limit value
4. The other emission levels were very low against the limit of frequency range 30MHz~1000MHz.
5. The emission levels were very low against the limit of frequency range 9kHz~30MHz: the amplitude of spurious emissions attenuated more than 20 dB below the permissible value to be report.

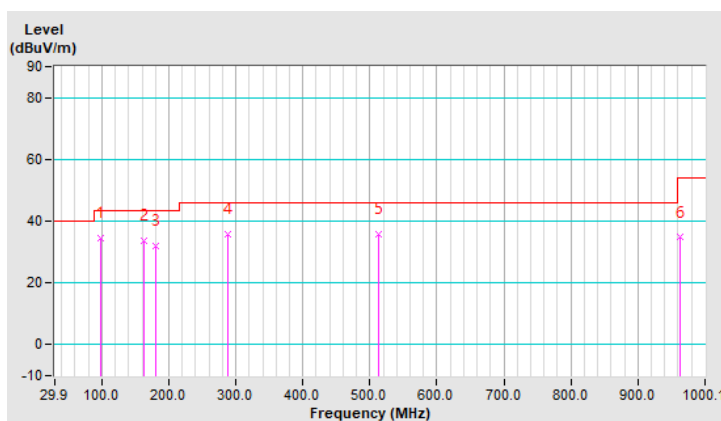

Mode B

802.11b + 802.11ax (HE20)

EUT Test Condition		Measurement Detail	
Channel	Channel 1 + Channel 40	Frequency Range	30 MHz ~ 1 GHz
Input Power	120 Vac, 60 Hz	Detector Function	Quasi-peak (QP)
Environmental Conditions	25 deg. C, 70 % RH	Tested By	Noah Chang

Antenna Polarity & Test Distance : Horizontal at 3 m								
No	Frequency (MHz)	Emission Level (dBuV/m)	Limit (dBuV/m)	Margin (dB)	Antenna Height (m)	Table Angle (Degree)	Raw Value (dBuV)	Correction Factor (dB/m)
1	56.62	30.4 QP	40.0	-9.6	1.00 H	179	39.7	-9.3
2	155.04	34.7 QP	43.5	-8.8	1.00 H	150	43.4	-8.7
3	207.07	31.7 QP	43.5	-11.8	1.00 H	282	43.5	-11.8
4	301.27	34.8 QP	46.0	-11.2	1.50 H	169	42.4	-7.6
5	730.13	33.8 QP	46.0	-12.2	1.00 H	14	31.8	2.0
6	907.30	33.8 QP	46.0	-12.2	1.50 H	169	27.5	6.3

Remarks:

1. Emission Level(dBuV/m) = Raw Value(dBuV) + Correction Factor(dB/m)
2. Correction Factor(dB/m) = Antenna Factor(dB/m) + Cable Factor(dB) – Pre-Amplifier Factor(dB)
3. Margin value = Emission Level – Limit value
4. The other emission levels were very low against the limit of frequency range 30MHz~1000MHz.
5. The emission levels were very low against the limit of frequency range 9kHz~30MHz: the amplitude of spurious emissions attenuated more than 20 dB below the permissible value to be report.

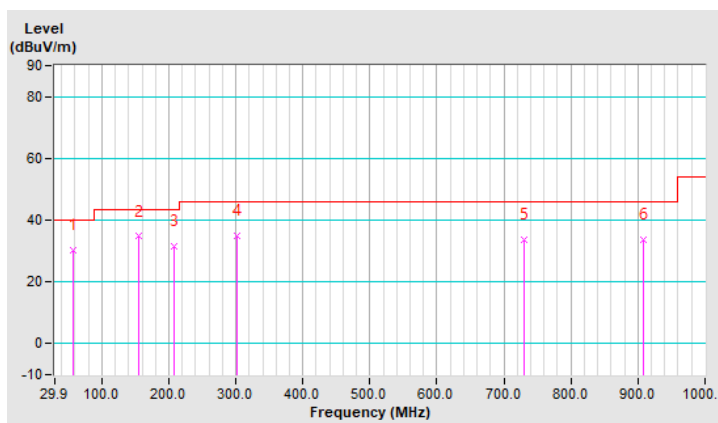

EUT Test Condition		Measurement Detail	
Channel	Channel 1 + Channel 40	Frequency Range	30 MHz ~ 1 GHz
Input Power	120 Vac, 60 Hz	Detector Function	Quasi-peak (QP)
Environmental Conditions	25 deg. C, 70 % RH	Tested By	Noah Chang

Antenna Polarity & Test Distance : Vertical at 3 m								
No	Frequency (MHz)	Emission Level (dBuV/m)	Limit (dBuV/m)	Margin (dB)	Antenna Height (m)	Table Angle (Degree)	Raw Value (dBuV)	Correction Factor (dB/m)
1	48.18	36.0 QP	40.0	-4.0	1.49 V	46	44.8	-8.8
2	155.04	31.0 QP	43.5	-12.5	1.00 V	90	39.7	-8.7
3	290.03	33.2 QP	46.0	-12.8	1.49 V	349	41.1	-7.9
4	394.08	31.8 QP	46.0	-14.2	1.00 V	200	37.7	-5.9
5	694.98	28.7 QP	46.0	-17.3	1.49 V	67	27.8	0.9
6	939.64	36.5 QP	46.0	-9.5	1.49 V	129	29.7	6.8

Remarks:

1. Emission Level(dBuV/m) = Raw Value(dBuV) + Correction Factor(dB/m)
2. Correction Factor(dB/m) = Antenna Factor(dB/m) + Cable Factor(dB) – Pre-Amplifier Factor(dB)
3. Margin value = Emission Level – Limit value
4. The other emission levels were very low against the limit of frequency range 30MHz~1000MHz.
5. The emission levels were very low against the limit of frequency range 9kHz~30MHz: the amplitude of spurious emissions attenuated more than 20 dB below the permissible value to be report.

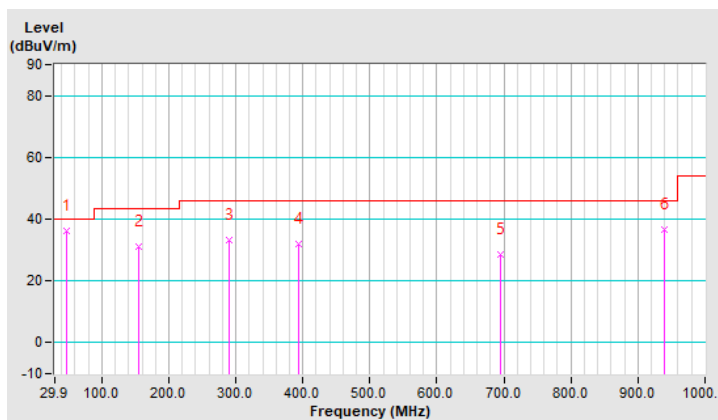

802.11b + 802.11ax (HE40)

EUT Test Condition		Measurement Detail	
Channel	Channel 1 + Channel 159	Frequency Range	30 MHz ~ 1 GHz
Input Power	120 Vac, 60 Hz	Detector Function	Quasi-peak (QP)
Environmental Conditions	25 deg. C, 70 % RH	Tested By	Noah Chang

Antenna Polarity & Test Distance : Horizontal at 3 m								
No	Frequency (MHz)	Emission Level (dBuV/m)	Limit (dBuV/m)	Margin (dB)	Antenna Height (m)	Table Angle (Degree)	Raw Value (dBuV)	Correction Factor (dB/m)
1	55.21	29.7 QP	40.0	-10.3	1.00 H	177	38.7	-9.0
2	105.83	29.9 QP	43.5	-13.6	1.00 H	290	42.4	-12.5
3	207.07	31.2 QP	43.5	-12.3	1.00 H	286	43.0	-11.8
4	360.33	31.4 QP	46.0	-14.6	1.00 H	201	37.9	-6.5
5	814.50	30.7 QP	46.0	-15.3	1.00 H	161	26.6	4.1
6	973.38	33.7 QP	54.0	-20.3	1.00 H	4	26.3	7.4

Remarks:

1. Emission Level(dBuV/m) = Raw Value(dBuV) + Correction Factor(dB/m)
2. Correction Factor(dB/m) = Antenna Factor(dB/m) + Cable Factor(dB) – Pre-Amplifier Factor(dB)
3. Margin value = Emission Level – Limit value
4. The other emission levels were very low against the limit of frequency range 30MHz~1000MHz.
5. The emission levels were very low against the limit of frequency range 9kHz~30MHz: the amplitude of spurious emissions attenuated more than 20 dB below the permissible value to be report.

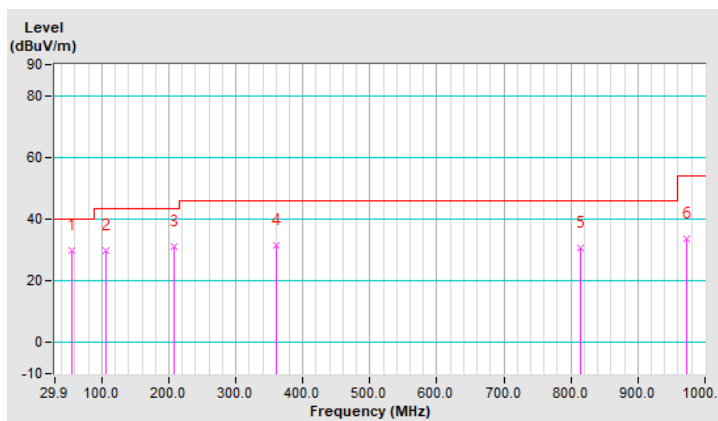

EUT Test Condition		Measurement Detail	
Channel	Channel 1 + Channel 159	Frequency Range	30 MHz ~ 1 GHz
Input Power	120 Vac, 60 Hz	Detector Function	Quasi-peak (QP)
Environmental Conditions	25 deg. C, 70 % RH	Tested By	Noah Chang

Antenna Polarity & Test Distance : Vertical at 3 m								
No	Frequency (MHz)	Emission Level (dBuV/m)	Limit (dBuV/m)	Margin (dB)	Antenna Height (m)	Table Angle (Degree)	Raw Value (dBuV)	Correction Factor (dB/m)
1	31.31	37.8 QP	40.0	-2.2	1.50 V	4	48.3	-10.5
2	79.11	36.1 QP	40.0	-3.9	2.00 V	35	49.1	-13.0
3	205.66	29.6 QP	43.5	-13.9	2.00 V	222	41.4	-11.8
4	349.08	33.7 QP	46.0	-12.3	1.50 V	4	40.6	-6.9
5	645.77	31.0 QP	46.0	-15.0	2.00 V	63	31.2	-0.2
6	834.18	36.7 QP	46.0	-9.3	2.00 V	336	32.1	4.6

Remarks:

1. Emission Level(dBuV/m) = Raw Value(dBuV) + Correction Factor(dB/m)
2. Correction Factor(dB/m) = Antenna Factor(dB/m) + Cable Factor(dB) – Pre-Amplifier Factor(dB)
3. Margin value = Emission Level – Limit value
4. The other emission levels were very low against the limit of frequency range 30MHz~1000MHz.
5. The emission levels were very low against the limit of frequency range 9kHz~30MHz: the amplitude of spurious emissions attenuated more than 20 dB below the permissible value to be report.

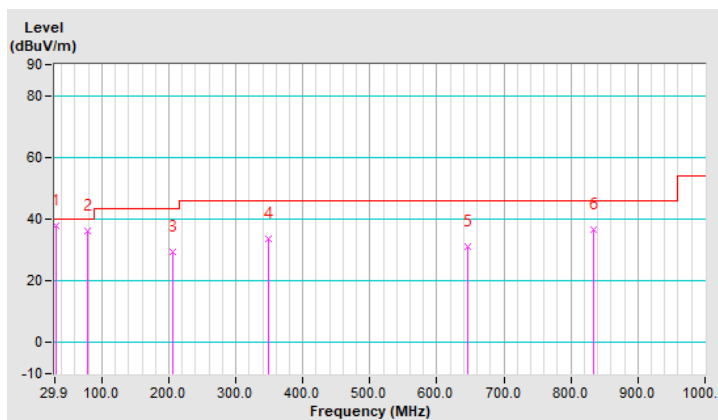

5 Pictures of Test Arrangements

Please refer to the attached file (Test Setup Photo).

Appendix – Information of the Testing Laboratories

We, Bureau Veritas Consumer Products Services (H.K.) Ltd., Taoyuan Branch, were founded in 1988 to provide our best service in EMC, Radio, Telecom and Safety consultation. Our laboratories are FCC recognized accredited test firms and accredited and approved according to ISO/IEC 17025.

If you have any comments, please feel free to contact us at the following:

Lin Kou EMC/RF Lab

Tel: 886-2-26052180

Fax: 886-2-26051924

Hsin Chu EMC/RF/Telecom Lab

Tel: 886-3-6668565

Fax: 886-3-6668323

Hwa Ya EMC/RF/Safety

Tel: 886-3-3183232

Fax: 886-3-3270892

Email: service.adt@tw.bureauveritas.com

Web Site: www.bureauveritas-adt.com

The address and road map of all our labs can be found in our web site also.

--- END ---