

## FCC Test Report

**Report No.:** RFBBQZ-WTW-P21020530-1

**FCC ID:** PY321100518

**Test Model:** WAX202

**Received Date:** Feb. 24, 2021

**Test Date:** Mar. 31 ~ May 04, 2021

**Issued Date:** May 11, 2021

**Applicant and Manufacturer:** NETGEAR INC.

**Address:** 350 East Plumeria Drive, San Jose, CA 95134, USA

**Issued By:** Bureau Veritas Consumer Products Services (H.K.) Ltd., Taoyuan Branch  
Lin Kou Laboratories

**Lab Address:** No. 47-2, 14th Ling, Chia Pau Vil., Lin Kou Dist., New Taipei City, Taiwan

**Test Location:** No. 19, Hwa Ya 2nd Rd., Wen Hwa Vil., Kwei Shan Dist., Taoyuan City  
33383, TAIWAN

**FCC Registration /** 788550 / TW0003  
**Designation Number:**



This report is for your exclusive use. Any copying or replication of this report to or for any other person or entity, or use of our name or trademark, is permitted only with our prior written permission. This report sets forth our findings solely with respect to the test samples identified herein. The results set forth in this report are not indicative or representative of the quality or characteristics of the lot from which a test sample was taken or any similar or identical product specifically and expressly noted. Our report includes all of the tests requested by you and the results thereof based upon the information that you provided to us. You have 60 days from date of issuance of this report to notify us of any material error or omission caused by our negligence, provided, however, that such notice shall be in writing and shall specifically address the issue you wish to raise. A failure to raise such issue within the prescribed time shall constitute your unqualified acceptance of the completeness of this report, the tests conducted and the correctness of the report contents. Unless specific mention, the uncertainty of measurement has been explicitly taken into account to declare the compliance or non-compliance to the specification.

## Table of Contents

<b>Release Control Record</b> .....	<b>4</b>
<b>1 Certificate of Conformity</b> .....	<b>5</b>
<b>2 Summary of Test Results</b> .....	<b>6</b>
2.1 Measurement Uncertainty.....	6
2.2 Modification Record.....	6
<b>3 General Information</b> .....	<b>7</b>
3.1 General Description of EUT.....	7
3.2 Description of Test Modes.....	9
3.2.1 Test Mode Applicability and Tested Channel Detail.....	10
3.3 Duty Cycle of Test Signal.....	12
3.4 Description of Support Units.....	13
3.4.1 Configuration of System under Test.....	13
3.5 General Description of Applied Standards and References.....	13
<b>4 Test Types and Results</b> .....	<b>14</b>
4.1 Radiated Emission and Bandedge Measurement.....	14
4.1.1 Limits of Radiated Emission and Bandedge Measurement.....	14
4.1.2 Test Instruments.....	15
4.1.3 Test Procedures.....	16
4.1.4 Deviation from Test Standard.....	16
4.1.5 Test Setup.....	17
4.1.6 EUT Operating Conditions.....	18
4.1.7 Test Results.....	19
4.2 Conducted Emission Measurement.....	39
4.2.1 Limits of Conducted Emission Measurement.....	39
4.2.2 Test Instruments.....	39
4.2.3 Test Procedures.....	40
4.2.4 Deviation from Test Standard.....	40
4.2.5 Test Setup.....	40
4.2.6 EUT Operating Conditions.....	40
4.2.7 Test Results.....	41
4.3 Transmit Power Measurement.....	43
4.3.1 Limits of Transmit Power Measurement.....	43
4.3.2 Test Setup.....	43
4.3.3 Test Instruments.....	43
4.3.4 Test Procedure.....	43
4.3.5 Deviation from Test Standard.....	43
4.3.6 EUT Operating Conditions.....	43
4.3.7 Test Result.....	44
4.4 Occupied Bandwidth Measurement.....	48
4.4.1 Test Setup.....	48
4.4.2 Test Instruments.....	48
4.4.3 Test Procedure.....	48
4.4.4 Test Result.....	49
4.5 Peak Power Spectral Density Measurement.....	53
4.5.1 Limits of Peak Power Spectral Density Measurement.....	53
4.5.2 Test Setup.....	53
4.5.3 Test Instruments.....	53
4.5.4 Test Procedures.....	53
4.5.5 Deviation from Test Standard.....	54
4.5.6 EUT Operating Conditions.....	54
4.5.7 Test Results.....	55
4.6 Frequency Stability.....	60
4.6.1 Limits of Frequency Stability Measurement.....	60

4.6.2	Test Setup.....	60
4.6.3	Test Instruments .....	60
4.6.4	Test Procedure .....	60
4.6.5	Deviation from Test Standard .....	61
4.6.6	EUT Operating Condition .....	61
4.6.7	Test Results .....	61
4.7	6dB Bandwidth Measurement.....	62
4.7.1	Limits of 6dB Bandwidth Measurement.....	62
4.7.2	Test Setup.....	62
4.7.3	Test Instruments .....	62
4.7.4	Test Procedure .....	62
4.7.5	Deviation from Test Standard .....	62
4.7.6	EUT Operating Condition .....	62
4.7.7	Test Results .....	63
<b>5</b>	<b>Pictures of Test Arrangements.....</b>	<b>65</b>
	<b>Annex A - Radiated Out of Band Emission (OOBE) Measurement (For U-NII-3 band) .....</b>	<b>66</b>
	<b>Annex B - Band Edge Measurement.....</b>	<b>69</b>
	<b>Appendix – Information of the Testing Laboratories .....</b>	<b>75</b>

### Release Control Record

Issue No.	Description	Date Issued
RFBBQZ-WTW-P21020530-1	Original release	May 11, 2021

## 1 Certificate of Conformity

**Product:** NETGEAR WiFi 6 AX1800 Access Point

**Brand:** Netgear

**Test Model:** WAX202

**Sample Status:** Engineering sample

**Applicant:** NETGEAR, INC.

**Test Date:** Mar. 31 ~ May 04, 2021

**Standards:** 47 CFR FCC Part 15, Subpart E (Section 15.407)  
ANSI C63.10:2013

The above equipment has been tested by **Bureau Veritas Consumer Products Services (H.K.) Ltd., Taoyuan Branch**, and found compliance with the requirement of the above standards. The test record, data evaluation & Equipment Under Test (EUT) configurations represented herein are true and accurate accounts of the measurements of the sample's RF characteristics under the conditions specified in this report.

**Prepared by :** Celine Chou , **Date:** May 11, 2021  
Celine Chou / Senior Specialist

**Approved by :** Bruce Chen , **Date:** May 11, 2021  
Bruce Chen / Senior Project Engineer

## 2 Summary of Test Results

47 CFR FCC Part 15, Subpart E (Section 15.407)			
FCC Clause	Test Item	Result	Remarks
15.407(b)(8)	AC Power Conducted Emissions	Pass	Meet the requirement of limit. Minimum passing margin is -14.19dB at 0.16600MHz.
15.407(b)(1/2/3/4(i/ii)/8)	Radiated Emissions & Band Edge Measurement	Pass	Meet the requirement of limit. Minimum passing margin is -0.1dB at 5150.00MHz.
15.407(a)(1/2/3)	Max Average Transmit Power	Pass	Meet the requirement of limit.
---	Occupied Bandwidth Measurement	-	Reference only.
15.407(a)(1/2/3)	Peak Power Spectral Density	Pass	Meet the requirement of limit.
15.407(e)	6dB bandwidth	Pass	Meet the requirement of limit. (U-NII-3 Band only)
15.407(g)	Frequency Stability	Pass	Meet the requirement of limit.
15.203	Antenna Requirement	Pass	Antenna connector is IPEX not a standard connector.

### Note:

1. For U-NII-3 band compliance with rule part 15.407(b)(4)(i), the OOB test plots were recorded in Annex A.
2. For U-NII-1 band compliance with rule 15.407(b) of the band-edge items, the test plots were recorded in Annex B. Test Procedures refer to report 4.1.3.
3. Determining compliance based on the results of the compliance measurement, not taking into account measurement instrumentation uncertainty.

### 2.1 Measurement Uncertainty

Where relevant, the following measurement uncertainty levels have been estimated for tests performed on the EUT as specified in CISPR 16-4-2:

Measurement	Frequency	Expanded Uncertainty (k=2) ( $\pm$ )
Conducted Emissions at mains ports	150kHz ~ 30MHz	2.79 dB
Radiated Emissions up to 1 GHz	9kHz ~ 30MHz	3.04 dB
	30MHz ~ 200MHz	3.63 dB
	200MHz ~ 1000MHz	3.64 dB
Radiated Emissions above 1 GHz	1GHz ~ 18GHz	2.29 dB
	18GHz ~ 40GHz	2.29 dB

### 2.2 Modification Record

There were no modifications required for compliance.

### 3 General Information

#### 3.1 General Description of EUT

Product	NETGEAR WiFi 6 AX1800 Access Point
Brand	Netgear
Test Model	WAX202
Sample Status	Engineering sample
Power Supply Rating	12Vdc from adapter
Modulation Type	256QAM, 64QAM, 16QAM, QPSK, BPSK for OFDM 1024QAM, 256QAM, 64QAM, 16QAM, QPSK, BPSK for OFDMA
Modulation Technology	OFDM, OFDMA
Transfer Rate	802.11a: 54/48/36/24/18/12/9/6Mbps 802.11n: up to 300Mbps 802.11ac: up to 866.7Mbps 802.11ax: up to 1200Mbps
Operating Frequency	5180 ~ 5240MHz, 5745 ~ 5825MHz
Number of Channel	5180 ~ 5240MHz: 802.11a, 802.11n (HT20), 802.11ac (VHT20), 802.11ax (HE20): 4 802.11n (HT40), 802.11ac (VHT40), 802.11ax (HE40): 2 802.11ac (VHT80), 802.11ax (HE80): 1 5745 ~ 5825MHz: 802.11a, 802.11n (HT20), 802.11ac (VHT20), 802.11ax (HE20): 5 802.11n (HT40), 802.11ac (VHT40), 802.11ax (HE40): 2 802.11ac (VHT80), 802.11ax (HE80): 1
Output Power	CDD Mode: 5180 ~ 5240MHz: 847.631mW 5745 ~ 5825MHz: 854.933mW Beamforming Mode: 5180 ~ 5240MHz: 838.753mW 5745 ~ 5825MHz: 844.791mW
Antenna Type	Refer to note
Antenna Connector	Refer to note
Accessory Device	Adapter
Cable Supplied	1.72m non-shielding LAN cable without core

**Note:**

- The EUT incorporates a MIMO function. Physically, the EUT provides 2 completed transmitters and 2 receivers.

Modulation Mode	Beamforming Mode	TX Function
802.11a	Not Support	2TX
802.11n (HT20)	Support	2TX
802.11n (HT40)	Support	2TX
802.11ac (VHT20)	Support	2TX
802.11ac (VHT40)	Support	2TX
802.11ac (VHT80)	Support	2TX
802.11ax (HE20)	Support	2TX
802.11ax (HE40)	Support	2TX
802.11ax (HE80)	Support	2TX

\* The bandwidth and modulation are similar for HT20/HT40 on 802.11n mode and VHT20/VHT40/VHT80 on 802.11ac mode and HE20/HE40/HE80 on 802.11ax mode. Therefore the investigated worst case is the representative mode in test report. (Final test mode refer section 3.2.1)

\* For 802.11n and 802.11ac, CDD mode and Beamforming mode are presented in power output test item. For other test items, CDD mode is the worst case for final tests after pretesting.

- The EUT consumes power from the following adapters.

Adapter 1	
Brand	PIE
Model	AD2076F10
P/N	332-10993-01
Input Power	100-120Vac, 50/60Hz, 0.56A
Output Power	+12Vdc, 1.5A
Power line	1.8m cable without core

Adapter 2	
Brand	CWT
Model	2AAJ018F 1
P/N	332-11572 -01
Input Power	100-120Vac, 50/60Hz, 0.6A
Output Power	+12Vdc, 1.5A
Power line	1.83m cable without core

\* Adapter 2 was chosen for final test and presented in the test report.

- The EUT with follow antennas gain is listed as table below.

No.	Type	Connector	Gain (dBi)				
			2400-2483.5 MHz	5150-5250 MHz	5250-5350 MHz	5470-5725 MHz	5725-5850 MHz
1	PIFA	IPEX	2.86	2.37	2.43	2.67	2.62
2	PIFA	IPEX	2.79	2.34	2.62	2.85	2.97

\* The above Antenna information is declared by manufacturer and for more detailed features description, please refer to the manufacturer's specifications, the laboratory shall not be held responsible.

- 2.4GHz & 5GHz technology can transmit at same time.
- Spurious emission of the simultaneous operation (2.4GHz & 5GHz) has been evaluated and no non-compliance was found.



### 3.2 Description of Test Modes

#### For 5180 ~ 5240MHz:

4 channels are provided for 802.11a, 802.11n (HT20), 802.11ac (VHT20), 802.11ax (HE20):

Channel	Frequency	Channel	Frequency
36	5180 MHz	44	5220 MHz
40	5200 MHz	48	5240 MHz

2 channels are provided for 802.11n (HT40), 802.11ac (VHT40), 802.11ax (HE40):

Channel	Frequency	Channel	Frequency
38	5190 MHz	46	5230 MHz

1 channel is provided for 802.11ac (VHT80), 802.11ax (HE80):

Channel	Frequency
42	5210MHz

#### For 5745 ~ 5825MHz:

5 channels are provided for 802.11a, 802.11n (HT20), 802.11ac (VHT20), 802.11ax (HE20):

Channel	Frequency	Channel	Frequency
149	5745MHz	161	5805MHz
153	5765MHz	165	5825MHz
157	5785MHz		

2 channels are provided for 802.11n (HT40), 802.11ac (VHT40), 802.11ax (HE40):

Channel	Frequency	Channel	Frequency
151	5755MHz	159	5795MHz

1 channel is provided for 802.11ac (VHT80), 802.11ax (HE80):

Channel	Frequency
155	5775MHz

### 3.2.1 Test Mode Applicability and Tested Channel Detail

EUT Configure Mode	Applicable to				Description
	RE≥1G	RE<1G	PLC	APCM	
-	√	√	√	√	-

Where RE≥1G: Radiated Emission above 1GHz & Bandedge Measurement  
 RE<1G: Radiated Emission below 1GHz  
 PLC: Power Line Conducted Emission  
 APCM: Antenna Port Conducted Measurement

Note:

- The EUT had been pre-tested on the positioned of each 3 axis. The worst case was found when positioned on **X-plane**.
- Radiated emission test (below 1GHz) and power line conducted emission test items chosen the worst maximum power.

#### **Radiated Emission Test (Above 1GHz):**

- Pre-Scan has been conducted to determine the worst-case mode from all possible combinations between available modulations, data rates and antenna ports (if EUT with antenna diversity architecture).
- Following channel(s) was (were) selected for the final test as listed below.

EUT Configure Mode	Mode	Frequency Band (MHz)	Available Channel	Tested Channel	Modulation Technology	Data Rate (Mbps)
-	802.11a	5180-5240	36 to 48	36, 40, 48	OFDM	6.0
	802.11ax (HE20)		36 to 48	36, 40, 48	OFDMA	MCS0
	802.11ax (HE40)		38 to 46	38, 46	OFDMA	MCS0
	802.11ax (HE80)		42	42	OFDMA	MCS0
-	802.11a	5745-5825	149 to 165	149, 157, 165	OFDM	6.0
	802.11ax (HE20)		149 to 165	149, 157, 165	OFDMA	MCS0
	802.11ax (HE40)		151 to 159	151, 159	OFDMA	MCS0
	802.11ax (HE80)		155	155	OFDMA	MCS0

#### **Radiated Emission Test (Below 1GHz):**

- Pre-Scan has been conducted to determine the worst-case mode from all possible combinations between available modulations, data rates and antenna ports (if EUT with antenna diversity architecture).
- Following channel(s) was (were) selected for the final test as listed below.

EUT Configure Mode	Mode	Frequency Band (MHz)	Available Channel	Tested Channel	Modulation Technology	Data Rate (Mbps)
-	802.11a	5180-5240	36 to 48	149	OFDM	6.0
-	802.11a	5745-5825	149 to 165		OFDM	6.0

#### **Power Line Conducted Emission Test:**

- Pre-Scan has been conducted to determine the worst-case mode from all possible combinations between available modulations, data rates and antenna ports (if EUT with antenna diversity architecture).
- Following channel(s) was (were) selected for the final test as listed below.

EUT Configure Mode	Mode	Frequency Band (MHz)	Available Channel	Tested Channel	Modulation Technology	Data Rate (Mbps)
-	802.11a	5180-5240	36 to 48	149	OFDM	6.0
-	802.11a	5745-5825	149 to 165		OFDM	6.0

**Bandwidth, Power Spectral Density and Frequency Stability Measurement:**

- This item includes all test value of each mode, but only includes spectrum plot of worst value of each mode.
- Pre-Scan has been conducted to determine the worst-case mode from all possible combinations between available modulations, data rates and antenna ports (if EUT with antenna diversity architecture).
- Following channel(s) was (were) selected for the final test as listed below.

EUT Configure Mode	Mode	Frequency Band (MHz)	Available Channel	Tested Channel	Modulation Technology	Data Rate (Mbps)
-	802.11a	5180-5240	36 to 48	36, 40, 48	OFDM	6.0
	802.11ax (HE20)		36 to 48	36, 40, 48	OFDMA	MCS0
	802.11ax (HE40)		38 to 46	38, 46	OFDMA	MCS0
	802.11ax (HE80)		42	42	OFDMA	MCS0
-	802.11a	5745-5825	149 to 165	149, 157, 165	OFDM	6.0
	802.11ax (HE20)		149 to 165	149, 157, 165	OFDMA	MCS0
	802.11ax (HE40)		151 to 159	151, 159	OFDMA	MCS0
	802.11ax (HE80)		155	155	OFDMA	MCS0

**Transmit Power Measurement:**

- This item includes all test value of each mode, but only includes spectrum plot of worst value of each mode.
- Pre-Scan has been conducted to determine the worst-case mode from all possible combinations between available modulations, data rates and antenna ports (if EUT with antenna diversity architecture).
- Following channel(s) was (were) selected for the final test as listed below.

EUT Configure Mode	Mode	Frequency Band (MHz)	Available Channel	Tested Channel	Modulation Technology	Data Rate (Mbps)
-	802.11a	5180-5240	36 to 48	36, 40, 48	OFDM	6.0
	802.11ac (VHT20)		36 to 48	36, 40, 48	OFDM	6.5
	802.11ac (VHT40)		38 to 46	38, 46	OFDM	13.5
	802.11ac (VHT80)		42	42	OFDM	29.3
	802.11ax (HE20)		36 to 48	36, 40, 48	OFDMA	MCS0
	802.11ax (HE40)		38 to 46	38, 46	OFDMA	MCS0
	802.11ax (HE80)		42	42	OFDMA	MCS0
-	802.11a	5745-5825	149 to 165	149, 157, 165	OFDM	6.0
	802.11ac (VHT20)		149 to 165	149, 157, 165	OFDM	6.5
	802.11ac (VHT40)		151 to 159	151, 159	OFDM	13.5
	802.11ac (VHT80)		155	155	OFDM	29.3
	802.11ax (HE20)		149 to 165	149, 157, 165	OFDMA	MCS0
	802.11ax (HE40)		151 to 159	151, 159	OFDMA	MCS0
	802.11ax (HE80)		155	155	OFDMA	MCS0

**Test Condition:**

Applicable to	Environmental Conditions	Input Power	Tested by
RE≥1G	25 deg. C, 70% RH	120Vac, 60Hz	Han Wu
RE<1G	25 deg. C, 70% RH	120Vac, 60Hz	Han Wu
PLC	25 deg. C, 70% RH	120Vac, 60Hz	Han Wu
APCM	25 deg. C, 60% RH	120Vac, 60Hz	Ivan Tseng

### 3.3 Duty Cycle of Test Signal

Duty cycle of test signal is < 98%, duty factor is required.

802.11a: Duty cycle =  $1.395/1.480 = 0.943$ , Duty factor =  $10 * \log(1/0.943) = 0.26$

802.11ax (HE20): Duty cycle =  $0.540/0.599 = 0.902$ , Duty factor =  $10 * \log(1/0.902) = 0.45$

802.11ax (HE40): Duty cycle =  $0.298/0.357 = 0.835$ , Duty factor =  $10 * \log(1/0.835) = 0.78$

802.11ax (HE80): Duty cycle =  $0.286/0.348 = 0.822$ , Duty factor =  $10 * \log(1/0.822) = 0.85$



### 3.4 Description of Support Units

The EUT has been tested as an independent unit together with other necessary accessories or support units. The following support units or accessories were used to form a representative test configuration during the tests.

ID	Product	Brand	Model No.	Serial No.	FCC ID	Remarks
A.	Notebook	DELL	E5410	1HC2XM1	FCC DoC Approved	-
B.	Load	NA	NA	NA	NA	-

Note:

1. All power cords of the above support units are non-shielded (1.8m).
2. Items A acted as communication partner to transfer data.

ID	Cable Descriptions	Qty.	Length (m)	Shielding (Yes/No)	Cores (Qty.)	Remarks
1.	LAN	1	7.0	N	0	RJ45, Cat5e
2.	LAN	3	1.5	N	0	RJ45, Cat5e

#### 3.4.1 Configuration of System under Test

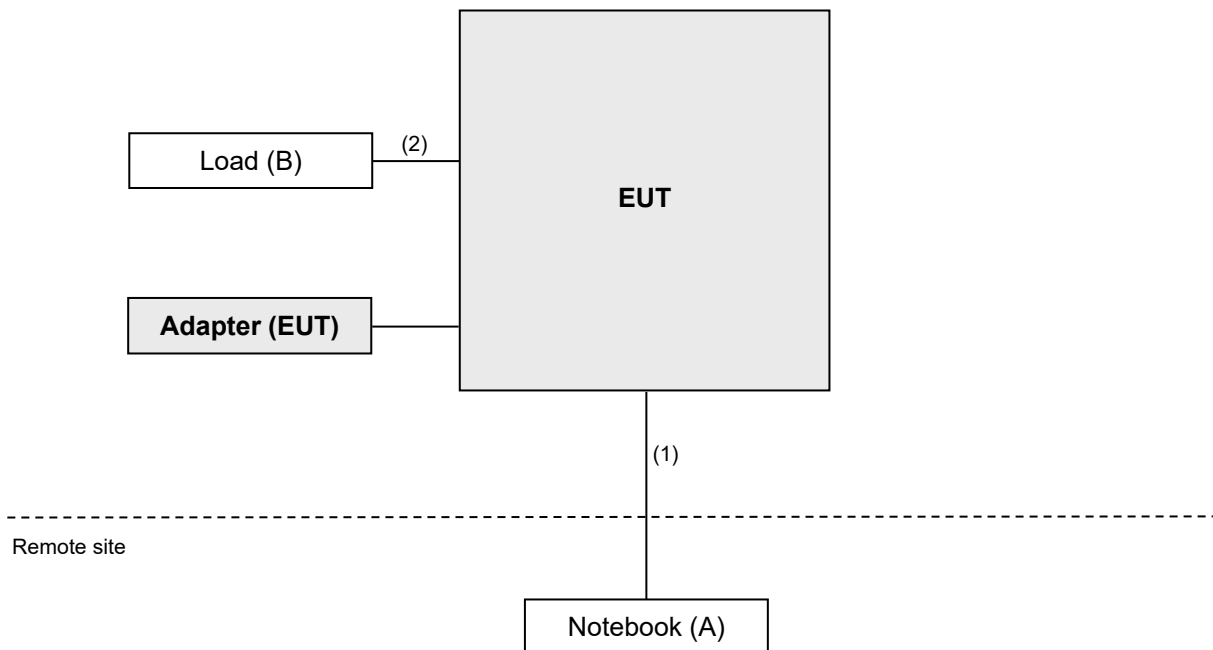

### 3.5 General Description of Applied Standards and References

The EUT is a RF Product. According to the specifications of the manufacturer, it must comply with the requirements of the following standards and references:

**Test standard:**

**FCC Part 15, Subpart E (15.407)**

ANSI C63.10:2013

All test items have been performed and recorded as per the above standards.

**References Test Guidance:**

**KDB 789033 D02 General UNII Test Procedure New Rules v02r01**

**KDB 662911 D01 Multiple Transmitter Output v02r01**

All test items have been performed as a reference to the above KDB test guidance.

## 4 Test Types and Results

### 4.1 Radiated Emission and Bandedge Measurement

#### 4.1.1 Limits of Radiated Emission and Bandedge Measurement

Radiated emissions which fall in the restricted bands must comply with the radiated emission limits specified as below table.

Frequencies (MHz)	Field Strength (microvolts/meter)	Measurement Distance (meters)
0.009 ~ 0.490	2400/F(kHz)	300
0.490 ~ 1.705	24000/F(kHz)	30
1.705 ~ 30.0	30	30
30 ~ 88	100	3
88 ~ 216	150	3
216 ~ 960	200	3
Above 960	500	3

Note:

1. The lower limit shall apply at the transition frequencies.
2. Emission level (dBuV/m) = 20 log Emission level (uV/m).
3. For frequencies above 1000MHz, the field strength limits are based on average detector, however, the peak field strength of any emission shall not exceed the maximum permitted average limits, specified above by more than 20dB under any condition of modulation.

Limits of unwanted emission out of the restricted bands

Applicable To		Limit	
789033 D02 General UNII Test Procedure New Rules v02r01		Field Strength at 3m	
		PK: 74 (dBuV/m)	AV: 54 (dBuV/m)
Frequency Band	Applicable To	EIRP Limit	Equivalent Field Strength at 3m
5150~5250 MHz	15.407(b)(1)	PK: -27 (dBm/MHz)	PK: 68.2(dBuV/m)
5250~5350 MHz	15.407(b)(2)		
5470~5725 MHz	15.407(b)(3)		
5725~5850 MHz	<input checked="" type="checkbox"/> 15.407(b)(4)(i)	PK: -27 (dBm/MHz) <sup>*1</sup> PK: 10 (dBm/MHz) <sup>*2</sup> PK: 15.6 (dBm/MHz) <sup>*3</sup> PK: 27 (dBm/MHz) <sup>*4</sup>	PK: 68.2(dBuV/m) <sup>*1</sup> PK: 105.2 (dBuV/m) <sup>*2</sup> PK: 110.8(dBuV/m) <sup>*3</sup> PK: 122.2 (dBuV/m) <sup>*4</sup>
	<input type="checkbox"/> 15.407(b)(4)(ii)	Emission limits in section 15.247(d)	
<sup>*1</sup> beyond 75 MHz or more above of the band edge. <sup>*3</sup> below the band edge increasing linearly to a level of 15.6 dBm/MHz at 5 MHz above.		<sup>*2</sup> below the band edge increasing linearly to 10 dBm/MHz at 25 MHz above. <sup>*4</sup> from 5 MHz above or below the band edge increasing linearly to a level of 27 dBm/MHz at the band edge.	

Note: The following formula is used to convert the equipment isotropic radiated power (eirp) to field strength:

$$E = \frac{1000000 \sqrt{30P}}{3} \mu\text{V/m, where P is the eirp (Watts).}$$

#### 4.1.2 Test Instruments

Description & Manufacturer	Model No.	Serial No.	Cal. Date	Cal. Due
Test Receiver ROHDE & SCHWARZ	ESCI	100424	Dec. 31, 2020	Dec. 30, 2021
Spectrum Analyzer ROHDE & SCHWARZ	FSP40	100040	Sep. 16, 2020	Sep. 15, 2021
BILOG Antenna SCHWARZBECK	VULB9168	9168-155	Nov. 03, 2020	Nov. 02, 2021
HORN Antenna SCHWARZBECK	BBHA 9120D	9120D-1170	Nov. 22, 2020	Nov. 21, 2021
HORN Antenna SCHWARZBECK	BBHA 9170	BBHA9170241	Nov. 22, 2020	Nov. 21, 2021
Loop Antenna TESEQ	HLA 6121	45745	Jul. 06, 2020	Jul. 05, 2021
Preamplifier Agilent (Below 1GHz)	8447D	2944A10631	Jun. 08, 2020	Jun. 07, 2021
Preamplifier KEYSIGHT (Above 1GHz)	83017A	MY53270295	Jun. 08, 2020	Jun. 07, 2021
RF Coaxial Cable WOKEN With 5dB PAD	8D-FB	Cable-CH4-01	Aug. 16, 2020	Aug. 15, 2021
RF Coaxial Cable EMCI	EMC102-KM-KM-3000	150929	Aug. 16, 2020	Aug. 15, 2021
RF Coaxial Cable EMCI	EMC102-KM-KM-600	150928	Aug. 16, 2020	Aug. 15, 2021
RF signal cable HUBER+SUHNER	SUCOFLEX 104	MY 13380+295012/04	Jun. 08, 2020	Jun. 07, 2021
RF signal cable HUBER+SUHNER	SUCOFLEX 104	Cable-CH4-03 (250724)	Jun. 08, 2020	Jun. 07, 2021
Software BV ADT	ADT_Radiated_V7.6.15.9.5	NA	NA	NA
Antenna Tower inn-co GmbH	MA 4000	010303	NA	NA
Antenna Tower Controller BV ADT	AT100	AT93021703	NA	NA
Turn Table BV ADT	TT100	TT93021703	NA	NA
Turn Table Controller BV ADT	SC100	SC93021703	NA	NA
Boresight Antenna Fixture	FBA-01	FBA-SIP01	NA	NA
Pre-amplifier (18GHz-40GHz) EMC	EMC184045B	980175	Sep. 04, 2020	Sep. 03, 2021
USB Wideband Power Sensor KEYSIGHT	U2021XA	MY55050005/MY55190004/MY55190007/MY55210005	Jul. 13, 2020	Jul. 12, 2021

Note: 1. The calibration interval of the above test instruments is 12 months and the calibrations are traceable to NML/ROC and NIST/USA.  
2. The test was performed in HwaYa Chamber 4.

### 4.1.3 Test Procedures

#### For Radiated emission below 30MHz

- a. The EUT was placed on the top of a rotating table 0.8 meters above the ground at a 3 meter chamber room. The table was rotated 360 degrees to determine the position of the highest radiation.
- b. The EUT was set 3 meters away from the interference-receiving antenna, which was mounted on the top of a variable-height antenna tower.
- c. Parallel, perpendicular, and ground-parallel orientations of the antenna are set to make the measurement.
- d. For each suspected emission, the EUT was arranged to its worst case and the rotatable table was turned from 0 degrees to 360 degrees to find the maximum reading.
- e. The test-receiver system was set to Quasi-Peak Detect Function and Specified Bandwidth with Maximum Hold Mode.

Note:

1. The resolution bandwidth and video bandwidth of test receiver/spectrum analyzer is 9kHz at frequency below 30MHz.

#### For Radiated emission above 30MHz

- a. The EUT was placed on the top of a rotating table 0.8 meters (for 30MHz ~ 1GHz) / 1.5 meters (for above 1GHz) above the ground at 3 meter chamber room for test. The table was rotated 360 degrees to determine the position of the highest radiation.
- b. The EUT was set 3 meters away from the interference-receiving antenna, which was mounted on the top of a variable-height antenna tower.
- c. The height of antenna is varied from one meter to four meters above the ground to determine the maximum value of the field strength. Both horizontal and vertical polarizations of the antenna are set to make the measurement.
- d. For each suspected emission, the EUT was arranged to its worst case and then the antenna was tuned to heights from 1 meter to 4 meters and the rotatable table was turned from 0 degrees to 360 degrees to find the maximum reading.
- e. The test-receiver system was set to quasi-peak detect function and specified bandwidth with maximum hold mode when the test frequency is below 1 GHz.
- f. The test-receiver system was set to peak and average detect function and specified bandwidth with maximum hold mode when the test frequency is above 1 GHz. If the peak reading value also meets average limit, measurement with the average detector is unnecessary.

Note:

1. The resolution bandwidth and video bandwidth of test receiver/spectrum analyzer is 120kHz for Quasi-peak detection (QP) at frequency below 1GHz.
2. The resolution bandwidth of test receiver/spectrum analyzer is 1 MHz and the video bandwidth is 3 MHz for Peak detection (PK) at frequency above 1GHz.
3. The resolution bandwidth of test receiver/spectrum analyzer is 1MHz and the video bandwidth is  $\geq 1/T$  (Duty cycle < 98%) or 10Hz (Duty cycle  $\geq 98\%$ ) for Average detection (AV) at frequency above 1GHz.  
(802.11a: RBW = 1MHz, VBW = 1kHz; 802.11ax (HE20): RBW = 1MHz, VBW = 3kHz;  
802.11ax (HE40): RBW = 1MHz, VBW = 10kHz; 802.11ax (HE80): RBW = 1MHz, VBW = 10kHz)
4. All modes of operation were investigated and the worst-case emissions are reported.

### 4.1.4 Deviation from Test Standard

No deviation.



#### 4.1.5 Test Setup

##### For Radiated emission below 30MHz

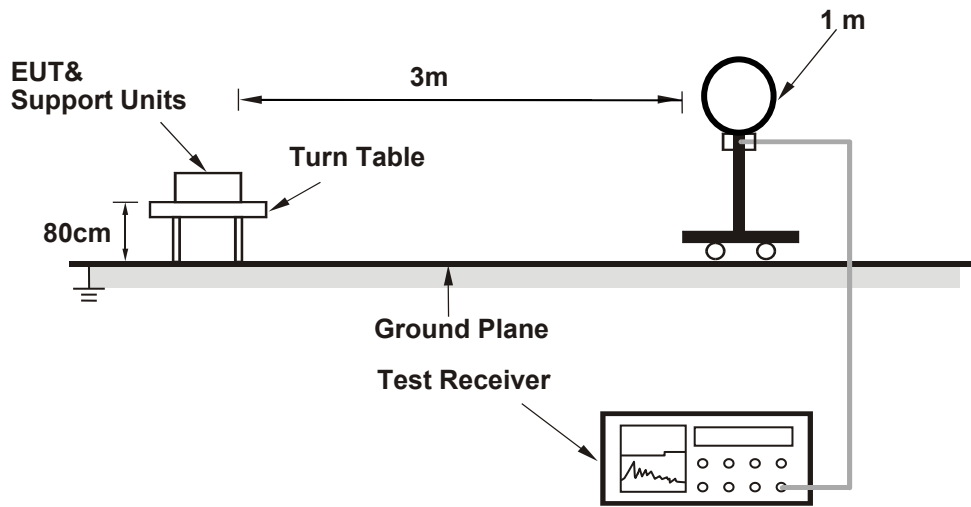

##### For Radiated emission 30MHz to 1GHz

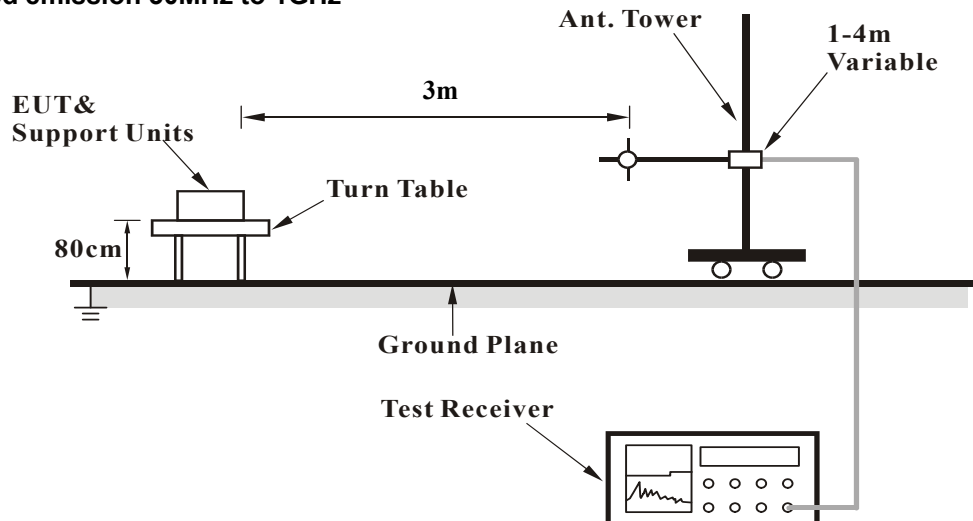

### For Radiated emission above 1GHz

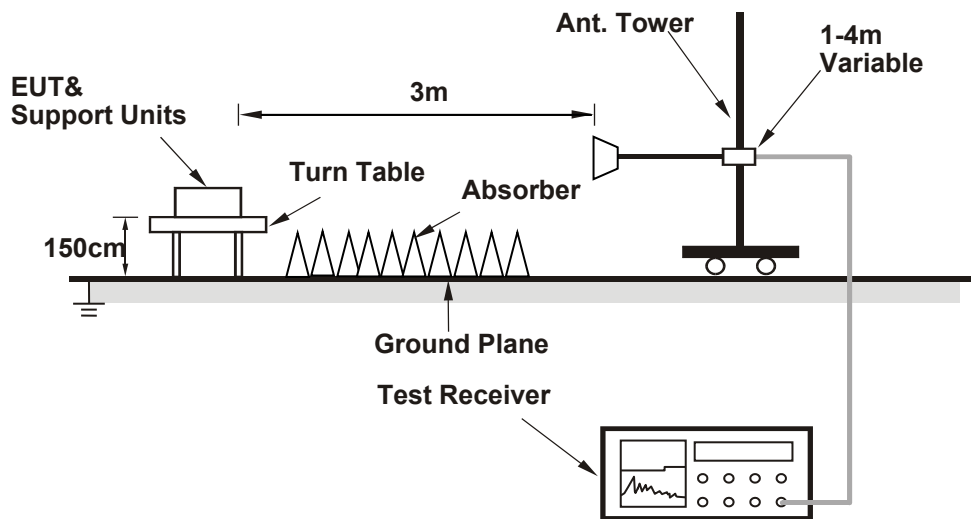

For the actual test configuration, please refer to the attached file (Test Setup Photo).

#### 4.1.6 EUT Operating Conditions

- a. Placed the EUT on the testing table.
- b. Prepared a notebook to act as a communication partner and placed it outside of testing area.
- c. The communication partner connected with EUT via a RJ45 cable and ran a test program (provided by manufacturer) to enable EUT under transmission condition continuously at specific channel frequency.
- d. The communication partner sent data to EUT by command.

#### 4.1.7 Test Results

Above 1GHz data:

RF Mode	TX 802.11a	Channel	CH 36 : 5180 MHz
Frequency Range	1GHz ~ 40GHz	Detector Function	Peak (PK) Average (AV)

Antenna Polarity & Test Distance : Horizontal at 3 m								
No	Frequency (MHz)	Emission Level (dBuV/m)	Limit (dBuV/m)	Margin (dB)	Antenna Height (m)	Table Angle (Degree)	Raw Value (dBuV)	Correction Factor (dB/m)
1	5150.00	56.4 PK	74.0	-17.6	1.50 H	223	45.8	10.6
2	5150.00	45.5 AV	54.0	-8.5	1.50 H	223	34.9	10.6
3	*5180.00	106.4 PK			1.50 H	223	66.7	39.7
4	*5180.00	97.7 AV			1.50 H	223	58.0	39.7
5	#10360.00	59.5 PK	68.2	-8.7	1.83 H	199	38.4	21.1

Antenna Polarity & Test Distance : Vertical at 3 m								
No	Frequency (MHz)	Emission Level (dBuV/m)	Limit (dBuV/m)	Margin (dB)	Antenna Height (m)	Table Angle (Degree)	Raw Value (dBuV)	Correction Factor (dB/m)
1	5150.00	66.3 PK	74.0	-7.7	1.50 V	101	55.7	10.6
2	5150.00	53.7 AV	54.0	-0.3	1.50 V	101	43.1	10.6
3	*5180.00	118.1 PK			1.51 V	100	78.4	39.7
4	*5180.00	110.2 AV			1.51 V	100	70.5	39.7
5	#10360.00	58.7 PK	68.2	-9.5	2.39 V	14	37.6	21.1

Remarks:

1. Emission Level(dBuV/m) = Raw Value(dBuV) + Correction Factor(dB/m).
2. Correction Factor(dB/m) = Antenna Factor(dB/m) + Cable Factor(dB) – Pre-Amplifier Factor(dB).
3. Margin value = Emission Level – Limit value.
4. The other emission levels were very low against the limit.
5. " \* " : Fundamental frequency.
6. " # " : The radiated frequency is out of the restricted band.

RF Mode	TX 802.11a	Channel	CH 40 : 5200 MHz
Frequency Range	1GHz ~ 40GHz	Detector Function	Peak (PK) Average (AV)

Antenna Polarity & Test Distance : Horizontal at 3 m								
No	Frequency (MHz)	Emission Level (dBuV/m)	Limit (dBuV/m)	Margin (dB)	Antenna Height (m)	Table Angle (Degree)	Raw Value (dBuV)	Correction Factor (dB/m)
1	5150.00	56.1 PK	74.0	-17.9	1.15 H	213	45.5	10.6
2	5150.00	45.9 AV	54.0	-8.1	1.15 H	213	35.3	10.6
3	*5200.00	110.7 PK			1.15 H	213	71.0	39.7
4	*5200.00	102.2 AV			1.15 H	213	62.5	39.7
5	#10400.00	59.3 PK	68.2	-8.9	1.43 H	355	37.6	21.7

Antenna Polarity & Test Distance : Vertical at 3 m								
No	Frequency (MHz)	Emission Level (dBuV/m)	Limit (dBuV/m)	Margin (dB)	Antenna Height (m)	Table Angle (Degree)	Raw Value (dBuV)	Correction Factor (dB/m)
1	5150.00	65.9 PK	74.0	-8.1	1.61 V	78	55.3	10.6
<b>2</b>	<b>5150.00</b>	<b>53.9 AV</b>	<b>54.0</b>	<b>-0.1</b>	<b>1.61 V</b>	<b>78</b>	<b>43.3</b>	<b>10.6</b>
3	*5200.00	122.4 PK			1.61 V	78	82.7	39.7
4	*5200.00	114.3 AV			1.61 V	78	74.6	39.7
5	#10400.00	59.6 PK	68.2	-8.6	1.63 V	21	37.9	21.7

Remarks:

1. Emission Level(dBuV/m) = Raw Value(dBuV) + Correction Factor(dB/m).
2. Correction Factor(dB/m) = Antenna Factor(dB/m) + Cable Factor(dB) – Pre-Amplifier Factor(dB).
3. Margin value = Emission Level – Limit value.
4. The other emission levels were very low against the limit.
5. " \* " : Fundamental frequency.
6. " # " : The radiated frequency is out of the restricted band.

RF Mode	TX 802.11a	Channel	CH 48 : 5240 MHz
Frequency Range	1GHz ~ 40GHz	Detector Function	Peak (PK) Average (AV)

Antenna Polarity & Test Distance : Horizontal at 3 m								
No	Frequency (MHz)	Emission Level (dBuV/m)	Limit (dBuV/m)	Margin (dB)	Antenna Height (m)	Table Angle (Degree)	Raw Value (dBuV)	Correction Factor (dB/m)
1	*5240.00	111.3 PK			1.49 H	221	71.7	39.6
2	*5240.00	104.0 AV			1.49 H	221	64.4	39.6
3	5350.00	55.9 PK	74.0	-18.1	1.49 H	221	45.7	10.2
4	5350.00	44.9 AV	54.0	-9.1	1.49 H	221	34.7	10.2
5	#10480.00	58.8 PK	68.2	-9.4	2.87 H	128	37.9	20.9

Antenna Polarity & Test Distance : Vertical at 3 m								
No	Frequency (MHz)	Emission Level (dBuV/m)	Limit (dBuV/m)	Margin (dB)	Antenna Height (m)	Table Angle (Degree)	Raw Value (dBuV)	Correction Factor (dB/m)
1	*5240.00	123.9 PK			1.62 V	77	84.3	39.6
2	*5240.00	114.6 AV			1.62 V	77	75.0	39.6
3	5350.00	57.4 PK	74.0	-16.6	1.62 V	77	47.2	10.2
4	5350.00	47.2 AV	54.0	-6.8	1.62 V	77	37.0	10.2
5	#10480.00	59.9 PK	68.2	-8.3	1.69 V	22	39.0	20.9

Remarks:

1. Emission Level(dBuV/m) = Raw Value(dBuV) + Correction Factor(dB/m).
2. Correction Factor(dB/m) = Antenna Factor(dB/m) + Cable Factor(dB) – Pre-Amplifier Factor(dB).
3. Margin value = Emission Level – Limit value.
4. The other emission levels were very low against the limit.
5. " \* " : Fundamental frequency.
6. " # " : The radiated frequency is out of the restricted band.

RF Mode	TX 802.11a	Channel	CH 149 : 5745 MHz
Frequency Range	1GHz ~ 40GHz	Detector Function	Peak (PK) Average (AV)

Antenna Polarity & Test Distance : Horizontal at 3 m								
No	Frequency (MHz)	Emission Level (dBuV/m)	Limit (dBuV/m)	Margin (dB)	Antenna Height (m)	Table Angle (Degree)	Raw Value (dBuV)	Correction Factor (dB/m)
1	#5604.40	60.7 PK	68.2	-7.5	1.20 H	323	50.0	10.7
2	*5745.00	111.7 PK			1.20 H	323	71.0	40.7
3	*5745.00	103.5 AV			1.20 H	323	62.8	40.7
4	#5948.40	59.8 PK	68.2	-8.4	1.20 H	323	48.3	11.5
5	11490.00	63.6 PK	74.0	-10.4	2.00 H	162	40.1	23.5
6	11490.00	52.9 AV	54.0	-1.1	2.00 H	162	29.4	23.5

Antenna Polarity & Test Distance : Vertical at 3 m								
No	Frequency (MHz)	Emission Level (dBuV/m)	Limit (dBuV/m)	Margin (dB)	Antenna Height (m)	Table Angle (Degree)	Raw Value (dBuV)	Correction Factor (dB/m)
1	#5646.80	61.1 PK	68.2	-7.1	1.50 V	71	50.4	10.7
2	*5745.00	124.8 PK			1.50 V	71	84.1	40.7
3	*5745.00	116.3 AV			1.50 V	71	75.6	40.7
4	#5948.00	61.6 PK	68.2	-6.6	1.50 V	71	50.1	11.5
5	11490.00	61.9 PK	74.0	-12.1	1.60 V	0	38.4	23.5
6	11490.00	51.8 AV	54.0	-2.2	1.60 V	0	28.3	23.5

Remarks:

1. Emission Level(dBuV/m) = Raw Value(dBuV) + Correction Factor(dB/m).
2. Correction Factor(dB/m) = Antenna Factor(dB/m) + Cable Factor(dB) – Pre-Amplifier Factor(dB).
3. Margin value = Emission Level – Limit value.
4. The other emission levels were very low against the limit.
5. " \* ": Fundamental frequency.
6. " # ": The radiated frequency is out of the restricted band.

RF Mode	TX 802.11a	Channel	CH 157 : 5785 MHz
Frequency Range	1GHz ~ 40GHz	Detector Function	Peak (PK) Average (AV)

Antenna Polarity & Test Distance : Horizontal at 3 m								
No	Frequency (MHz)	Emission Level (dBuV/m)	Limit (dBuV/m)	Margin (dB)	Antenna Height (m)	Table Angle (Degree)	Raw Value (dBuV)	Correction Factor (dB/m)
1	#5627.60	60.3 PK	68.2	-7.9	1.23 H	321	49.6	10.7
2	*5785.00	111.7 PK			1.23 H	321	70.8	40.9
3	*5785.00	102.3 AV			1.23 H	321	61.4	40.9
4	#5955.60	61.6 PK	68.2	-6.6	1.23 H	321	50.1	11.5
5	11570.00	63.1 PK	74.0	-10.9	1.97 H	158	39.8	23.3
6	11570.00	52.5 AV	54.0	-1.5	1.97 H	158	29.2	23.3

Antenna Polarity & Test Distance : Vertical at 3 m								
No	Frequency (MHz)	Emission Level (dBuV/m)	Limit (dBuV/m)	Margin (dB)	Antenna Height (m)	Table Angle (Degree)	Raw Value (dBuV)	Correction Factor (dB/m)
1	#5607.20	60.6 PK	68.2	-7.6	1.53 V	89	49.9	10.7
2	*5785.00	124.4 PK			1.53 V	89	83.5	40.9
3	*5785.00	116.3 AV			1.53 V	89	75.4	40.9
4	#5929.60	60.3 PK	68.2	-7.9	1.53 V	89	48.7	11.6
5	11570.00	61.6 PK	74.0	-12.4	1.73 V	4	38.3	23.3
6	11570.00	51.9 AV	54.0	-2.1	1.73 V	4	28.6	23.3

Remarks:

1. Emission Level(dBuV/m) = Raw Value(dBuV) + Correction Factor(dB/m).
2. Correction Factor(dB/m) = Antenna Factor(dB/m) + Cable Factor(dB) – Pre-Amplifier Factor(dB).
3. Margin value = Emission Level – Limit value.
4. The other emission levels were very low against the limit.
5. " \* ": Fundamental frequency.
6. " # ": The radiated frequency is out of the restricted band.

RF Mode	TX 802.11a	Channel	CH 165 : 5825 MHz
Frequency Range	1GHz ~ 40GHz	Detector Function	Peak (PK) Average (AV)

Antenna Polarity & Test Distance : Horizontal at 3 m								
No	Frequency (MHz)	Emission Level (dBuV/m)	Limit (dBuV/m)	Margin (dB)	Antenna Height (m)	Table Angle (Degree)	Raw Value (dBuV)	Correction Factor (dB/m)
1	#5611.60	59.5 PK	68.2	-8.7	1.23 H	315	48.8	10.7
2	*5825.00	111.0 PK			1.23 H	315	70.0	41.0
3	*5825.00	101.8 AV			1.23 H	315	60.8	41.0
4	#5961.20	59.3 PK	68.2	-8.9	1.23 H	315	47.8	11.5
5	11650.00	63.2 PK	74.0	-10.8	2.04 H	163	40.2	23.0
6	11650.00	52.5 AV	54.0	-1.5	2.04 H	163	29.5	23.0

Antenna Polarity & Test Distance : Vertical at 3 m								
No	Frequency (MHz)	Emission Level (dBuV/m)	Limit (dBuV/m)	Margin (dB)	Antenna Height (m)	Table Angle (Degree)	Raw Value (dBuV)	Correction Factor (dB/m)
1	#5632.00	59.6 PK	68.2	-8.6	1.30 V	87	48.9	10.7
2	*5825.00	124.0 PK			1.30 V	87	83.0	41.0
3	*5825.00	115.6 AV			1.30 V	87	74.6	41.0
4	#5925.60	62.8 PK	68.2	-5.4	1.30 V	87	51.2	11.6
5	11650.00	61.3 PK	74.0	-12.7	2.07 V	163	38.3	23.0
6	11650.00	51.0 AV	54.0	-3.0	2.07 V	163	28.0	23.0

Remarks:

1. Emission Level(dBuV/m) = Raw Value(dBuV) + Correction Factor(dB/m).
2. Correction Factor(dB/m) = Antenna Factor(dB/m) + Cable Factor(dB) – Pre-Amplifier Factor(dB).
3. Margin value = Emission Level – Limit value.
4. The other emission levels were very low against the limit.
5. " \* " : Fundamental frequency.
6. " # " : The radiated frequency is out of the restricted band.



RF Mode	TX 802.11ax (HE20)	Channel	CH 36 : 5180 MHz
Frequency Range	1GHz ~ 40GHz	Detector Function	Peak (PK) Average (AV)

Antenna Polarity & Test Distance : Horizontal at 3 m								
No	Frequency (MHz)	Emission Level (dBuV/m)	Limit (dBuV/m)	Margin (dB)	Antenna Height (m)	Table Angle (Degree)	Raw Value (dBuV)	Correction Factor (dB/m)
1	5150.00	56.1 PK	74.0	-17.9	1.50 H	224	45.5	10.6
2	5150.00	45.7 AV	54.0	-8.3	1.50 H	224	35.1	10.6
3	*5180.00	107.1 PK			1.50 H	224	67.4	39.7
4	*5180.00	96.3 AV			1.50 H	224	56.6	39.7
5	#10360.00	58.1 PK	68.2	-10.1	1.59 H	305	37.0	21.1

Antenna Polarity & Test Distance : Vertical at 3 m								
No	Frequency (MHz)	Emission Level (dBuV/m)	Limit (dBuV/m)	Margin (dB)	Antenna Height (m)	Table Angle (Degree)	Raw Value (dBuV)	Correction Factor (dB/m)
1	5150.00	69.6 PK	74.0	-4.4	1.56 V	102	59.0	10.6
<b>2</b>	<b>5150.00</b>	<b>53.9 AV</b>	<b>54.0</b>	<b>-0.1</b>	<b>1.56 V</b>	<b>102</b>	<b>43.3</b>	<b>10.6</b>
3	*5180.00	117.7 PK			1.56 V	102	78.0	39.7
4	*5180.00	107.7 AV			1.56 V	102	68.0	39.7
5	#10360.00	57.9 PK	68.2	-10.3	1.30 V	79	36.8	21.1

Remarks:

1. Emission Level(dBuV/m) = Raw Value(dBuV) + Correction Factor(dB/m).
2. Correction Factor(dB/m) = Antenna Factor(dB/m) + Cable Factor(dB) – Pre-Amplifier Factor(dB).
3. Margin value = Emission Level – Limit value.
4. The other emission levels were very low against the limit.
5. " \* " : Fundamental frequency.
6. " # " : The radiated frequency is out of the restricted band.

RF Mode	TX 802.11ax (HE20)	Channel	CH 40 : 5200 MHz
Frequency Range	1GHz ~ 40GHz	Detector Function	Peak (PK) Average (AV)

Antenna Polarity & Test Distance : Horizontal at 3 m								
No	Frequency (MHz)	Emission Level (dBuV/m)	Limit (dBuV/m)	Margin (dB)	Antenna Height (m)	Table Angle (Degree)	Raw Value (dBuV)	Correction Factor (dB/m)
1	5150.00	57.3 PK	74.0	-16.7	1.27 H	214	46.7	10.6
2	5150.00	45.7 AV	54.0	-8.3	1.27 H	214	35.1	10.6
3	*5200.00	108.3 PK			1.27 H	214	68.6	39.7
4	*5200.00	99.7 AV			1.27 H	214	60.0	39.7
5	#10400.00	59.1 PK	68.2	-9.1	1.63 H	76	37.4	21.7

Antenna Polarity & Test Distance : Vertical at 3 m								
No	Frequency (MHz)	Emission Level (dBuV/m)	Limit (dBuV/m)	Margin (dB)	Antenna Height (m)	Table Angle (Degree)	Raw Value (dBuV)	Correction Factor (dB/m)
1	5150.00	69.5 PK	74.0	-4.5	1.62 V	78	58.9	10.6
2	5150.00	53.7 AV	54.0	-0.3	1.62 V	78	43.1	10.6
3	*5200.00	122.7 PK			1.62 V	78	83.0	39.7
4	*5200.00	112.0 AV			1.62 V	78	72.3	39.7
5	#10400.00	59.7 PK	68.2	-8.5	1.00 V	193	38.0	21.7

Remarks:

1. Emission Level(dBuV/m) = Raw Value(dBuV) + Correction Factor(dB/m).
2. Correction Factor(dB/m) = Antenna Factor(dB/m) + Cable Factor(dB) – Pre-Amplifier Factor(dB).
3. Margin value = Emission Level – Limit value.
4. The other emission levels were very low against the limit.
5. " \* " : Fundamental frequency.
6. " # " : The radiated frequency is out of the restricted band.

RF Mode	TX 802.11ax (HE20)	Channel	CH 48 : 5240 MHz
Frequency Range	1GHz ~ 40GHz	Detector Function	Peak (PK) Average (AV)

Antenna Polarity & Test Distance : Horizontal at 3 m								
No	Frequency (MHz)	Emission Level (dBuV/m)	Limit (dBuV/m)	Margin (dB)	Antenna Height (m)	Table Angle (Degree)	Raw Value (dBuV)	Correction Factor (dB/m)
1	*5240.00	112.4 PK			1.48 H	220	72.8	39.6
2	*5240.00	102.5 AV			1.48 H	220	62.9	39.6
3	5350.00	56.8 PK	74.0	-17.2	1.48 H	220	46.6	10.2
4	5350.00	45.1 AV	54.0	-8.9	1.48 H	220	34.9	10.2
5	#10480.00	58.5 PK	68.2	-9.7	2.00 H	164	37.6	20.9

Antenna Polarity & Test Distance : Vertical at 3 m								
No	Frequency (MHz)	Emission Level (dBuV/m)	Limit (dBuV/m)	Margin (dB)	Antenna Height (m)	Table Angle (Degree)	Raw Value (dBuV)	Correction Factor (dB/m)
1	*5240.00	122.7 PK			1.53 V	84	83.1	39.6
2	*5240.00	114.0 AV			1.53 V	84	74.4	39.6
3	5350.00	58.0 PK	74.0	-16.0	1.53 V	84	47.8	10.2
4	5350.00	47.6 AV	54.0	-6.4	1.53 V	84	37.4	10.2
5	#10480.00	59.9 PK	68.2	-8.3	1.83 V	286	39.0	20.9

Remarks:

1. Emission Level(dBuV/m) = Raw Value(dBuV) + Correction Factor(dB/m).
2. Correction Factor(dB/m) = Antenna Factor(dB/m) + Cable Factor(dB) – Pre-Amplifier Factor(dB).
3. Margin value = Emission Level – Limit value.
4. The other emission levels were very low against the limit.
5. " \* " : Fundamental frequency.
6. " # " : The radiated frequency is out of the restricted band.

RF Mode	TX 802.11ax (HE20)	Channel	CH 149 : 5745 MHz
Frequency Range	1GHz ~ 40GHz	Detector Function	Peak (PK) Average (AV)

Antenna Polarity & Test Distance : Horizontal at 3 m								
No	Frequency (MHz)	Emission Level (dBuV/m)	Limit (dBuV/m)	Margin (dB)	Antenna Height (m)	Table Angle (Degree)	Raw Value (dBuV)	Correction Factor (dB/m)
1	#5611.20	62.1 PK	68.2	-6.1	1.22 H	323	51.4	10.7
2	*5745.00	112.5 PK			1.22 H	323	71.8	40.7
3	*5745.00	102.8 AV			1.22 H	323	62.1	40.7
4	#5986.00	60.6 PK	68.2	-7.6	1.22 H	323	49.2	11.4
5	11490.00	64.0 PK	74.0	-10.0	2.05 H	152	40.5	23.5
6	11490.00	52.9 AV	54.0	-1.1	2.05 H	152	29.4	23.5

Antenna Polarity & Test Distance : Vertical at 3 m								
No	Frequency (MHz)	Emission Level (dBuV/m)	Limit (dBuV/m)	Margin (dB)	Antenna Height (m)	Table Angle (Degree)	Raw Value (dBuV)	Correction Factor (dB/m)
1	#5638.00	63.5 PK	68.2	-4.7	1.42 V	72	52.8	10.7
2	*5745.00	124.3 PK			1.42 V	72	83.6	40.7
3	*5745.00	115.2 AV			1.42 V	72	74.5	40.7
4	#5937.60	60.2 PK	68.2	-8.0	1.42 V	72	48.7	11.5
5	11490.00	62.8 PK	74.0	-11.2	2.89 V	312	39.3	23.5
6	11490.00	52.2 AV	54.0	-1.8	2.89 V	312	28.7	23.5

Remarks:

1. Emission Level(dBuV/m) = Raw Value(dBuV) + Correction Factor(dB/m).
2. Correction Factor(dB/m) = Antenna Factor(dB/m) + Cable Factor(dB) – Pre-Amplifier Factor(dB).
3. Margin value = Emission Level – Limit value.
4. The other emission levels were very low against the limit.
5. " \* ": Fundamental frequency.
6. " # ": The radiated frequency is out of the restricted band.

RF Mode	TX 802.11ax (HE20)	Channel	CH 157 : 5785 MHz
Frequency Range	1GHz ~ 40GHz	Detector Function	Peak (PK) Average (AV)

Antenna Polarity & Test Distance : Horizontal at 3 m								
No	Frequency (MHz)	Emission Level (dBuV/m)	Limit (dBuV/m)	Margin (dB)	Antenna Height (m)	Table Angle (Degree)	Raw Value (dBuV)	Correction Factor (dB/m)
1	#5610.40	58.9 PK	68.2	-9.3	1.13 H	11	48.2	10.7
2	*5785.00	111.1 PK			1.13 H	11	70.2	40.9
3	*5785.00	102.0 AV			1.13 H	11	61.1	40.9
4	#5952.80	62.0 PK	68.2	-6.2	1.13 H	11	50.5	11.5
5	11570.00	63.6 PK	74.0	-10.4	2.11 H	154	40.3	23.3
6	11570.00	52.6 AV	54.0	-1.4	2.11 H	154	29.3	23.3

Antenna Polarity & Test Distance : Vertical at 3 m								
No	Frequency (MHz)	Emission Level (dBuV/m)	Limit (dBuV/m)	Margin (dB)	Antenna Height (m)	Table Angle (Degree)	Raw Value (dBuV)	Correction Factor (dB/m)
1	#5637.20	60.6 PK	68.2	-7.6	1.45 V	72	49.9	10.7
2	*5785.00	123.9 PK			1.45 V	72	83.0	40.9
3	*5785.00	114.7 AV			1.45 V	72	73.8	40.9
4	#5944.40	60.9 PK	68.2	-7.3	1.45 V	72	49.4	11.5
5	11570.00	61.4 PK	74.0	-12.6	2.47 V	119	38.1	23.3
6	11570.00	50.9 AV	54.0	-3.1	2.47 V	119	27.6	23.3

Remarks:

1. Emission Level(dBuV/m) = Raw Value(dBuV) + Correction Factor(dB/m).
2. Correction Factor(dB/m) = Antenna Factor(dB/m) + Cable Factor(dB) – Pre-Amplifier Factor(dB).
3. Margin value = Emission Level – Limit value.
4. The other emission levels were very low against the limit.
5. " \* ": Fundamental frequency.
6. " # ": The radiated frequency is out of the restricted band.

RF Mode	TX 802.11ax (HE20)	Channel	CH 165 : 5825 MHz
Frequency Range	1GHz ~ 40GHz	Detector Function	Peak (PK) Average (AV)

Antenna Polarity & Test Distance : Horizontal at 3 m								
No	Frequency (MHz)	Emission Level (dBuV/m)	Limit (dBuV/m)	Margin (dB)	Antenna Height (m)	Table Angle (Degree)	Raw Value (dBuV)	Correction Factor (dB/m)
1	#5644.80	58.6 PK	68.2	-9.6	1.16 H	4	47.9	10.7
2	*5825.00	110.7 PK			1.16 H	4	69.7	41.0
3	*5825.00	101.6 AV			1.16 H	4	60.6	41.0
4	#5934.00	60.7 PK	68.2	-7.5	1.16 H	4	49.2	11.5
5	11650.00	63.2 PK	74.0	-10.8	2.04 H	158	40.2	23.0
6	11650.00	52.2 AV	54.0	-1.8	2.04 H	158	29.2	23.0

Antenna Polarity & Test Distance : Vertical at 3 m								
No	Frequency (MHz)	Emission Level (dBuV/m)	Limit (dBuV/m)	Margin (dB)	Antenna Height (m)	Table Angle (Degree)	Raw Value (dBuV)	Correction Factor (dB/m)
1	#5643.20	60.0 PK	68.2	-8.2	1.67 V	86	49.3	10.7
2	*5825.00	123.0 PK			1.67 V	86	82.0	41.0
3	*5825.00	113.8 AV			1.67 V	86	72.8	41.0
4	#5928.80	65.0 PK	68.2	-3.2	1.67 V	86	53.4	11.6
5	11650.00	60.4 PK	74.0	-13.6	1.00 V	218	37.4	23.0
6	11650.00	50.6 AV	54.0	-3.4	1.00 V	218	27.6	23.0

Remarks:

1. Emission Level(dBuV/m) = Raw Value(dBuV) + Correction Factor(dB/m).
2. Correction Factor(dB/m) = Antenna Factor(dB/m) + Cable Factor(dB) – Pre-Amplifier Factor(dB).
3. Margin value = Emission Level – Limit value.
4. The other emission levels were very low against the limit.
5. " \* ": Fundamental frequency.
6. " # ": The radiated frequency is out of the restricted band.

RF Mode	TX 802.11ax (HE40)	Channel	CH 38 : 5190 MHz
Frequency Range	1GHz ~ 40GHz	Detector Function	Peak (PK) Average (AV)

Antenna Polarity & Test Distance : Horizontal at 3 m								
No	Frequency (MHz)	Emission Level (dBuV/m)	Limit (dBuV/m)	Margin (dB)	Antenna Height (m)	Table Angle (Degree)	Raw Value (dBuV)	Correction Factor (dB/m)
1	5150.00	57.1 PK	74.0	-16.9	1.49 H	227	46.5	10.6
2	5150.00	46.4 AV	54.0	-7.6	1.49 H	227	35.8	10.6
3	*5190.00	100.7 PK			1.49 H	227	61.0	39.7
4	*5190.00	91.1 AV			1.49 H	227	51.4	39.7
5	#10380.00	58.6 PK	68.2	-9.6	1.17 H	86	37.2	21.4

Antenna Polarity & Test Distance : Vertical at 3 m								
No	Frequency (MHz)	Emission Level (dBuV/m)	Limit (dBuV/m)	Margin (dB)	Antenna Height (m)	Table Angle (Degree)	Raw Value (dBuV)	Correction Factor (dB/m)
1	5150.00	68.8 PK	74.0	-5.2	1.65 V	92	58.2	10.6
2	5150.00	53.8 AV	54.0	-0.2	1.65 V	92	43.2	10.6
3	*5190.00	113.3 PK			1.65 V	92	73.6	39.7
4	*5190.00	102.7 AV			1.65 V	92	63.0	39.7
5	#10380.00	59.2 PK	68.2	-9.0	2.19 V	47	37.8	21.4

Remarks:

1. Emission Level(dBuV/m) = Raw Value(dBuV) + Correction Factor(dB/m).
2. Correction Factor(dB/m) = Antenna Factor(dB/m) + Cable Factor(dB) – Pre-Amplifier Factor(dB).
3. Margin value = Emission Level – Limit value.
4. The other emission levels were very low against the limit.
5. " \* " : Fundamental frequency.
6. " # " : The radiated frequency is out of the restricted band.

RF Mode	TX 802.11ax (HE40)	Channel	CH 46 : 5230 MHz
Frequency Range	1GHz ~ 40GHz	Detector Function	Peak (PK) Average (AV)

Antenna Polarity & Test Distance : Horizontal at 3 m								
No	Frequency (MHz)	Emission Level (dBuV/m)	Limit (dBuV/m)	Margin (dB)	Antenna Height (m)	Table Angle (Degree)	Raw Value (dBuV)	Correction Factor (dB/m)
1	5150.00	57.6 PK	74.0	-16.4	1.47 H	220	47.0	10.6
2	5150.00	46.1 AV	54.0	-7.9	1.47 H	220	35.5	10.6
3	*5230.00	106.9 PK			1.47 H	220	67.3	39.6
4	*5230.00	96.7 AV			1.47 H	220	57.1	39.6
5	5350.00	56.1 PK	74.0	-17.9	1.47 H	220	45.9	10.2
6	5350.00	45.5 AV	54.0	-8.5	1.47 H	220	35.3	10.2
7	#10460.00	58.9 PK	68.2	-9.3	1.84 H	173	37.8	21.1
Antenna Polarity & Test Distance : Vertical at 3 m								
No	Frequency (MHz)	Emission Level (dBuV/m)	Limit (dBuV/m)	Margin (dB)	Antenna Height (m)	Table Angle (Degree)	Raw Value (dBuV)	Correction Factor (dB/m)
1	5150.00	70.7 PK	74.0	-3.3	1.58 V	91	60.1	10.6
2	5150.00	53.7 AV	54.0	-0.3	1.58 V	91	43.1	10.6
3	*5230.00	118.2 PK			1.58 V	91	78.6	39.6
4	*5230.00	107.6 AV			1.58 V	91	68.0	39.6
5	5350.00	57.6 PK	74.0	-16.4	1.58 V	91	47.4	10.2
6	5350.00	46.5 AV	54.0	-7.5	1.58 V	91	36.3	10.2
7	#10460.00	59.4 PK	68.2	-8.8	1.18 V	223	38.3	21.1

Remarks:

1. Emission Level(dBuV/m) = Raw Value(dBuV) + Correction Factor(dB/m).
2. Correction Factor(dB/m) = Antenna Factor(dB/m) + Cable Factor(dB) – Pre-Amplifier Factor(dB).
3. Margin value = Emission Level – Limit value.
4. The other emission levels were very low against the limit.
5. " \* " : Fundamental frequency.
6. " # " : The radiated frequency is out of the restricted band.



RF Mode	TX 802.11ax (HE40)	Channel	CH 151 : 5755 MHz
Frequency Range	1GHz ~ 40GHz	Detector Function	Peak (PK) Average (AV)

Antenna Polarity & Test Distance : Horizontal at 3 m								
No	Frequency (MHz)	Emission Level (dBuV/m)	Limit (dBuV/m)	Margin (dB)	Antenna Height (m)	Table Angle (Degree)	Raw Value (dBuV)	Correction Factor (dB/m)
1	#5623.20	59.6 PK	68.2	-8.6	1.19 H	6	48.8	10.8
2	*5755.00	108.5 PK			1.19 H	6	67.7	40.8
3	*5755.00	97.9 AV			1.19 H	6	57.1	40.8
4	#5940.00	59.9 PK	68.2	-8.3	1.19 H	6	48.4	11.5
5	11510.00	61.8 PK	74.0	-12.2	1.68 H	242	38.4	23.4
6	11510.00	51.9 AV	54.0	-2.1	1.68 H	242	28.5	23.4
Antenna Polarity & Test Distance : Vertical at 3 m								
No	Frequency (MHz)	Emission Level (dBuV/m)	Limit (dBuV/m)	Margin (dB)	Antenna Height (m)	Table Angle (Degree)	Raw Value (dBuV)	Correction Factor (dB/m)
1	#5611.60	67.8 PK	68.2	-0.4	1.50 V	76	57.1	10.7
2	*5755.00	120.3 PK			1.50 V	76	79.5	40.8
3	*5755.00	110.7 AV			1.50 V	76	69.9	40.8
4	#5933.20	61.9 PK	68.2	-6.3	1.50 V	76	50.4	11.5
5	11510.00	60.8 PK	74.0	-13.2	1.68 V	263	37.4	23.4
6	11510.00	50.9 AV	54.0	-3.1	1.68 V	263	27.5	23.4

Remarks:

1. Emission Level(dBuV/m) = Raw Value(dBuV) + Correction Factor(dB/m).
2. Correction Factor(dB/m) = Antenna Factor(dB/m) + Cable Factor(dB) – Pre-Amplifier Factor(dB).
3. Margin value = Emission Level – Limit value.
4. The other emission levels were very low against the limit.
5. " \* ": Fundamental frequency.
6. " # ": The radiated frequency is out of the restricted band.

RF Mode	TX 802.11ax (HE40)	Channel	CH 159 : 5795 MHz
Frequency Range	1GHz ~ 40GHz	Detector Function	Peak (PK) Average (AV)

Antenna Polarity & Test Distance : Horizontal at 3 m								
No	Frequency (MHz)	Emission Level (dBuV/m)	Limit (dBuV/m)	Margin (dB)	Antenna Height (m)	Table Angle (Degree)	Raw Value (dBuV)	Correction Factor (dB/m)
1	#5612.40	58.7 PK	68.2	-9.5	1.18 H	356	48.0	10.7
2	*5795.00	108.6 PK			1.18 H	356	67.6	41.0
3	*5795.00	98.5 AV			1.18 H	356	57.5	41.0
4	#5978.40	59.6 PK	68.2	-8.6	1.18 H	356	48.2	11.4
5	11590.00	61.6 PK	74.0	-12.4	1.86 H	166	38.4	23.2
6	11590.00	51.4 AV	54.0	-2.6	1.86 H	166	28.2	23.2

Antenna Polarity & Test Distance : Vertical at 3 m								
No	Frequency (MHz)	Emission Level (dBuV/m)	Limit (dBuV/m)	Margin (dB)	Antenna Height (m)	Table Angle (Degree)	Raw Value (dBuV)	Correction Factor (dB/m)
1	#5648.00	63.0 PK	68.2	-5.2	1.50 V	68	52.3	10.7
2	*5795.00	120.2 PK			1.50 V	68	79.2	41.0
3	*5795.00	110.7 AV			1.50 V	68	69.7	41.0
4	#5927.20	67.9 PK	68.2	-0.3	1.50 V	68	56.3	11.6
5	11590.00	60.8 PK	74.0	-13.2	1.98 V	354	37.6	23.2
6	11590.00	51.2 AV	54.0	-2.8	1.98 V	354	28.0	23.2

Remarks:

1. Emission Level(dBuV/m) = Raw Value(dBuV) + Correction Factor(dB/m).
2. Correction Factor(dB/m) = Antenna Factor(dB/m) + Cable Factor(dB) – Pre-Amplifier Factor(dB).
3. Margin value = Emission Level – Limit value.
4. The other emission levels were very low against the limit.
5. " \* ": Fundamental frequency.
6. " # ": The radiated frequency is out of the restricted band.

RF Mode	TX 802.11ax (HE80)	Channel	CH 42 : 5210 MHz
Frequency Range	1GHz ~ 40GHz	Detector Function	Peak (PK) Average (AV)

Antenna Polarity & Test Distance : Horizontal at 3 m								
No	Frequency (MHz)	Emission Level (dBuV/m)	Limit (dBuV/m)	Margin (dB)	Antenna Height (m)	Table Angle (Degree)	Raw Value (dBuV)	Correction Factor (dB/m)
1	5150.00	56.2 PK	74.0	-17.8	1.45 H	226	45.6	10.6
2	5150.00	46.4 AV	54.0	-7.6	1.45 H	226	35.8	10.6
3	*5210.00	94.6 PK			1.45 H	226	54.9	39.7
4	*5210.00	85.4 AV			1.45 H	226	45.7	39.7
5	#10420.00	59.4 PK	68.2	-8.8	2.83 H	64	37.9	21.5

Antenna Polarity & Test Distance : Vertical at 3 m								
No	Frequency (MHz)	Emission Level (dBuV/m)	Limit (dBuV/m)	Margin (dB)	Antenna Height (m)	Table Angle (Degree)	Raw Value (dBuV)	Correction Factor (dB/m)
1	5150.00	63.8 PK	74.0	-10.2	1.65 V	102	53.2	10.6
2	5150.00	53.5 AV	54.0	-0.5	1.65 V	102	42.9	10.6
3	*5210.00	106.7 PK			1.65 V	102	67.0	39.7
4	*5210.00	98.1 AV			1.65 V	102	58.4	39.7
5	#10420.00	59.8 PK	68.2	-8.4	2.68 V	271	38.3	21.5

Remarks:

1. Emission Level(dBuV/m) = Raw Value(dBuV) + Correction Factor(dB/m).
2. Correction Factor(dB/m) = Antenna Factor(dB/m) + Cable Factor(dB) – Pre-Amplifier Factor(dB).
3. Margin value = Emission Level – Limit value.
4. The other emission levels were very low against the limit.
5. " \* " : Fundamental frequency.
6. " # " : The radiated frequency is out of the restricted band.

RF Mode	TX 802.11ax (HE80)	Channel	CH 155 : 5775 MHz
Frequency Range	1GHz ~ 40GHz	Detector Function	Peak (PK) Average (AV)

Antenna Polarity & Test Distance : Horizontal at 3 m								
No	Frequency (MHz)	Emission Level (dBuV/m)	Limit (dBuV/m)	Margin (dB)	Antenna Height (m)	Table Angle (Degree)	Raw Value (dBuV)	Correction Factor (dB/m)
1	#5647.60	61.5 PK	68.2	-6.7	1.00 H	4	50.8	10.7
2	*5775.00	99.4 PK			1.00 H	4	58.6	40.8
3	*5775.00	91.0 AV			1.00 H	4	50.2	40.8
4	#5954.00	61.6 PK	68.2	-6.6	1.00 H	4	50.1	11.5
5	11550.00	61.5 PK	74.0	-12.5	1.31 H	316	38.2	23.3
6	11550.00	49.5 AV	54.0	-4.5	1.31 H	316	26.2	23.3

Antenna Polarity & Test Distance : Vertical at 3 m								
No	Frequency (MHz)	Emission Level (dBuV/m)	Limit (dBuV/m)	Margin (dB)	Antenna Height (m)	Table Angle (Degree)	Raw Value (dBuV)	Correction Factor (dB/m)
1	#5648.80	67.6 PK	68.2	-0.6	1.55 V	76	56.9	10.7
2	*5775.00	115.6 PK			1.55 V	76	74.8	40.8
3	*5775.00	105.2 AV			1.55 V	76	64.4	40.8
4	#5939.60	65.4 PK	68.2	-2.8	1.55 V	76	53.9	11.5
5	11550.00	60.2 PK	74.0	-13.8	1.31 V	306	36.9	23.3
6	11550.00	49.8 AV	54.0	-4.2	1.31 V	306	26.5	23.3

Remarks:

1. Emission Level(dBuV/m) = Raw Value(dBuV) + Correction Factor(dB/m).
2. Correction Factor(dB/m) = Antenna Factor(dB/m) + Cable Factor(dB) – Pre-Amplifier Factor(dB).
3. Margin value = Emission Level – Limit value.
4. The other emission levels were very low against the limit.
5. " \* ": Fundamental frequency.
6. " # ": The radiated frequency is out of the restricted band.

Below 1GHz Worst-Case Data:

RF Mode	TX 802.11a	Channel	CH 149 : 5745 MHz
Frequency Range	30MHz ~ 1GHz	Detector Function	Quasi-Peak (QP)

Antenna Polarity & Test Distance : Horizontal at 3 m								
NO.	FREQ. (MHz)	EMISSION LEVEL (dBuV/m)	LIMIT (dBuV/m)	MARGIN (dB)	ANTENNA HEIGHT (m)	TABLE ANGLE (Degree)	RAW VALUE (dBuV)	CORRECTION FACTOR (dB/m)
1	117.22	38.5 QP	43.5	-5.0	1.49 H	262	49.8	-11.3
2	141.47	40.5 QP	43.5	-3.0	1.99 H	270	49.7	-9.2
3	161.85	37.2 QP	43.5	-6.3	1.49 H	260	46.0	-8.8
4	208.42	32.3 QP	43.5	-11.2	1.00 H	86	44.0	-11.7
5	294.76	34.4 QP	46.0	-11.6	1.00 H	83	42.2	-7.8
6	936.07	43.2 QP	46.0	-2.8	1.00 H	325	36.4	6.8

Remarks:

1. Emission Level(dBuV/m) = Raw Value(dBuV) + Correction Factor(dB/m).
2. Correction Factor(dB/m) = Antenna Factor(dB/m) + Cable Factor(dB) – Pre-Amplifier Factor(dB).
3. The other emission levels were very low against the limit of frequency range 30MHz ~ 1000MHz.
4. Margin value = Emission Level – Limit value.
5. The emission levels were very low against the limit of frequency range 9kHz ~ 30MHz: the amplitude of spurious emissions attenuated more than 20 dB below the permissible value to be report.

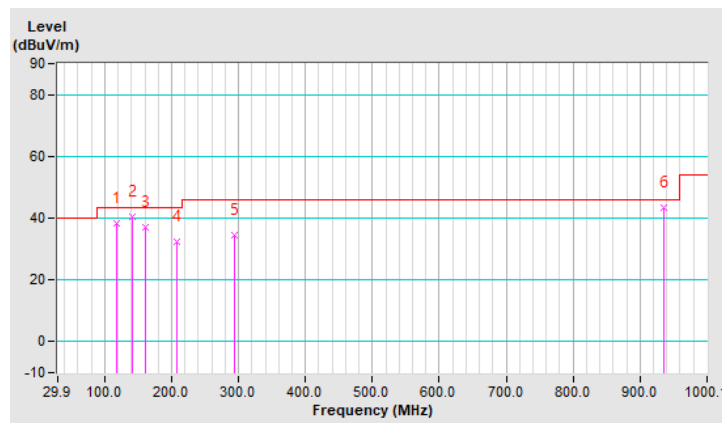

RF Mode	TX 802.11a	Channel	CH 149 : 5745 MHz
Frequency Range	30MHz ~ 1GHz	Detector Function	Quasi-Peak (QP)

Antenna Polarity & Test Distance : Vertical at 3 m								
NO.	FREQ. (MHz)	EMISSION LEVEL (dBuV/m)	LIMIT (dBuV/m)	MARGIN (dB)	ANTENNA HEIGHT (m)	TABLE ANGLE (Degree)	RAW VALUE (dBuV)	CORRECTION FACTOR (dB/m)
1	186.10	39.7 QP	43.5	-3.8	1.49 V	61	50.7	-11.0
2	330.66	41.1 QP	46.0	-4.9	1.99 V	43	48.1	-7.0
3	350.07	39.1 QP	46.0	-6.9	1.99 V	45	45.8	-6.7
4	412.16	42.5 QP	46.0	-3.5	1.49 V	50	48.1	-5.6
5	482.98	41.8 QP	46.0	-4.2	1.49 V	61	46.1	-4.3
6	937.04	44.2 QP	46.0	-1.8	1.49 V	116	37.4	6.8

Remarks:

1. Emission Level(dBuV/m) = Raw Value(dBuV) + Correction Factor(dB/m).
2. Correction Factor(dB/m) = Antenna Factor(dB/m) + Cable Factor(dB) – Pre-Amplifier Factor(dB).
3. The other emission levels were very low against the limit of frequency range 30MHz ~ 1000MHz.
4. Margin value = Emission Level – Limit value.
5. The emission levels were very low against the limit of frequency range 9kHz ~ 30MHz: the amplitude of spurious emissions attenuated more than 20 dB below the permissible value to be report.

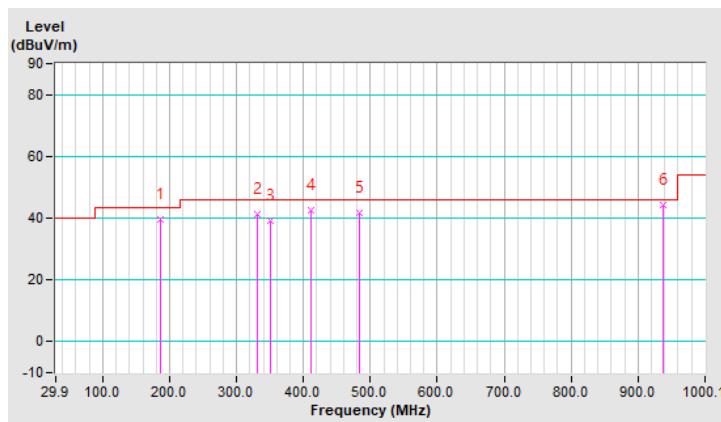

## 4.2 Conducted Emission Measurement

### 4.2.1 Limits of Conducted Emission Measurement

Frequency (MHz)	Conducted Limit (dBuV)	
	Quasi-peak	Average
0.15 - 0.5	66 - 56	56 - 46
0.50 - 5.0	56	46
5.0 - 30.0	60	50

Note: 1. The lower limit shall apply at the transition frequencies.

2. The limit decreases in line with the logarithm of the frequency in the range of 0.15 to 0.50MHz.

### 4.2.2 Test Instruments

Description & Manufacturer	Model No.	Serial No.	Cal. Date	Cal. Due
Test Receiver ROHDE & SCHWARZ	ESCI	100613	Dec. 04, 2020	Dec. 03, 2021
RF signal cable Woken	5D-FB	Cable-cond1-01	Jan. 16, 2021	Jan. 15, 2022
LISN ROHDE & SCHWARZ (EUT)	ENV216	101826	Feb. 25, 2021	Feb. 24, 2022
LISN ROHDE & SCHWARZ (Peripheral)	ESH3-Z5	100311	Aug. 28, 2020	Aug. 27, 2021
Software ADT	BV ADT_Cond_ V7.3.7.4	NA	NA	NA

Note: 1. The calibration interval of the above test instruments is 12 months and the calibrations are traceable to NML/ROC and NIST/USA.

2. The test was performed in HwaYa Shielded Room 1 (Conduction 1).

3. The VCCI Site Registration No. is C-12040.

#### 4.2.3 Test Procedures

- The EUT was placed 0.4 meters from the conducting wall of the shielded room with EUT being connected to the power mains through a line impedance stabilization network (LISN). Other support units were connected to the power mains through another LISN. The two LISNs provide 50 ohm/ 50uH of coupling impedance for the measuring instrument.
- Both lines of the power mains connected to the EUT were checked for maximum conducted interference.
- The frequency range from 150kHz to 30MHz was searched. Emission levels under (Limit - 20dB) was not recorded.

Note: The resolution bandwidth and video bandwidth of test receiver is 9kHz for quasi-peak detection (QP) and average detection (AV) at frequency 0.15MHz-30MHz.

#### 4.2.4 Deviation from Test Standard

No deviation.

#### 4.2.5 Test Setup

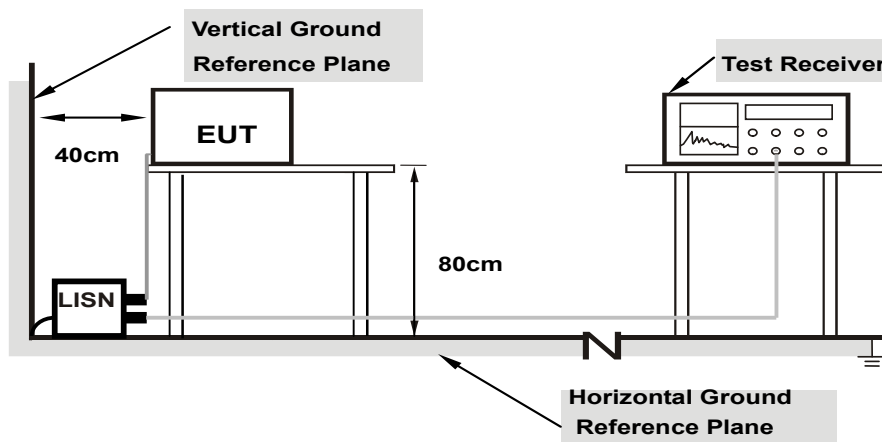

**Note: 1.Support units were connected to second LISN.**

For the actual test configuration, please refer to the attached file (Test Setup Photo).

#### 4.2.6 EUT Operating Conditions

Same as 4.1.6.



#### 4.2.7 Test Results

Worst-case data:

802.11a

Phase	Line (L)	Detector Function	Quasi-Peak (QP) / Average (AV)
-------	----------	-------------------	--------------------------------

No	Freq. [MHz]	Corr. Factor (dB)	Reading Value [dB (uV)]		Emission Level [dB (uV)]		Limit [dB (uV)]		Margin (dB)	
			Q.P.	AV.	Q.P.	AV.	Q.P.	AV.	Q.P.	AV.
			1	0.15000	9.71	38.92	24.36	48.63	34.07	66.00
<b>2</b>	<b>0.16600</b>	<b>9.71</b>	<b>41.26</b>	<b>24.74</b>	<b>50.97</b>	<b>34.45</b>	<b>65.16</b>	<b>55.16</b>	<b>-14.19</b>	<b>-20.71</b>
3	0.19800	9.71	34.82	19.67	44.53	29.38	63.69	53.69	-19.16	-24.31
4	0.21800	9.71	32.78	19.10	42.49	28.81	62.89	52.89	-20.40	-24.08
5	0.23800	9.71	31.03	17.87	40.74	27.58	62.17	52.17	-21.43	-24.59
6	0.30600	9.72	24.22	9.02	33.94	18.74	60.08	50.08	-26.14	-31.34

Remarks:

1. Q.P. and AV. are abbreviations of quasi-peak and average individually.
2. The emission levels of other frequencies were very low against the limit.
3. Margin value = Emission level - Limit value
4. Correction factor = Insertion loss + Cable loss
5. Emission Level = Correction Factor + Reading Value.

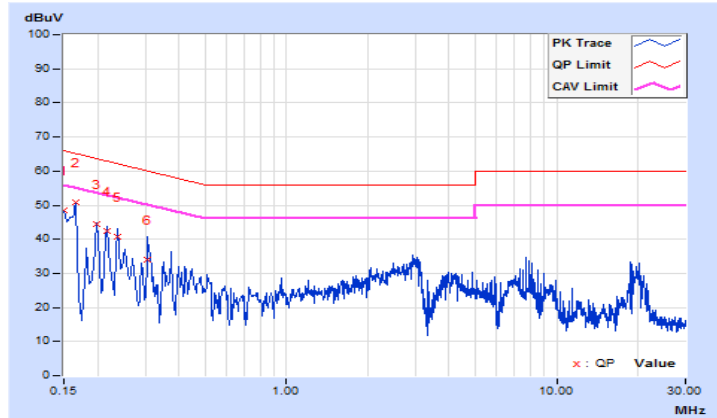

Phase	Neutral (N)	Detector Function	Quasi-Peak (QP) / Average (AV)
-------	-------------	-------------------	--------------------------------

No	Freq. [MHz]	Corr. Factor (dB)	Reading Value [dB (uV)]		Emission Level [dB (uV)]		Limit [dB (uV)]		Margin (dB)	
			Q.P.	AV.	Q.P.	AV.	Q.P.	AV.	Q.P.	AV.
			1	0.15800	9.77	38.98	18.33	48.75	28.10	65.57
2	0.17400	9.77	39.88	22.65	49.65	32.42	64.77	54.77	-15.12	-22.35
3	0.20600	9.77	32.45	17.08	42.22	26.85	63.37	53.37	-21.15	-26.52
4	0.26200	9.78	29.93	16.84	39.71	26.62	61.37	51.37	-21.66	-24.75
5	0.39000	9.79	31.92	22.61	41.71	32.40	58.06	48.06	-16.35	-15.66
6	18.79400	9.98	15.78	2.28	25.76	12.26	60.00	50.00	-34.24	-37.74

Remarks:

1. Q.P. and AV. are abbreviations of quasi-peak and average individually.
2. The emission levels of other frequencies were very low against the limit.
3. Margin value = Emission level - Limit value
4. Correction factor = Insertion loss + Cable loss
5. Emission Level = Correction Factor + Reading Value.

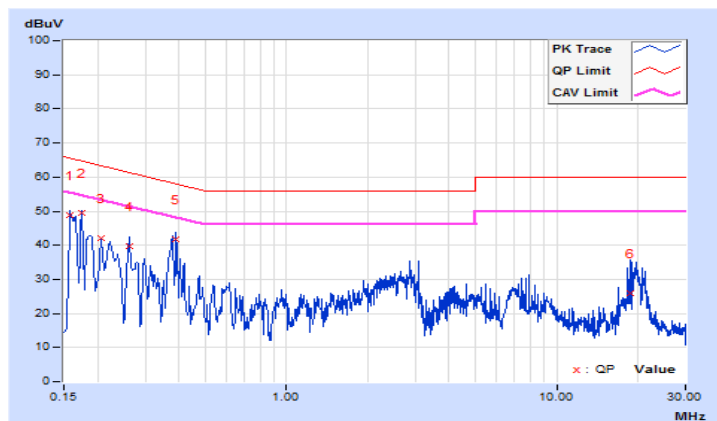

### 4.3 Transmit Power Measurement

#### 4.3.1 Limits of Transmit Power Measurement

Operation Band	EUT Category		Limit
U-NII-1		Outdoor Access Point	1 Watt (30 dBm) (Max. e.i.r.p $\leq$ 125mW(21 dBm) at any elevation angle above 30 degrees as measured from the horizon)
		Fixed point-to-point Access Point	1 Watt (30 dBm)
	√	Indoor Access Point	1 Watt (30 dBm)
		Mobile and Portable client device	250mW (24 dBm)
U-NII-2A			250mW (24 dBm) or 11 dBm+10 log B*
U-NII-2C			250mW (24 dBm) or 11 dBm+10 log B*
U-NII-3	√		1 Watt (30 dBm)

\*B is the 26 dB emission bandwidth in megahertz

Per KDB 662911 Method of conducted output power measurement on IEEE 802.11 devices,

Array Gain = 0 dB (i.e., no array gain) for  $N_{ANT} \leq 4$ ;

Array Gain = 0 dB (i.e., no array gain) for channel widths  $\geq 40$  MHz for any  $N_{ANT}$ ;

Array Gain =  $5 \log(N_{ANT}/N_{SS})$  dB or 3 dB, whichever is less for 20-MHz channel widths with  $N_{ANT} \geq 5$ .

For power measurements on all other devices: Array Gain =  $10 \log(N_{ANT}/N_{SS})$  dB.

#### 4.3.2 Test Setup

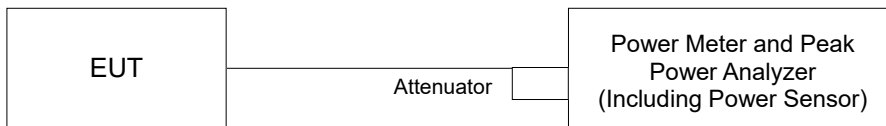

#### 4.3.3 Test Instruments

Refer to section 4.1.2 to get information of above instrument.

#### 4.3.4 Test Procedure

Method PM is used to perform output power measurement, trigger and gating function of wide band power meter is enabled to measure max output power of TX on burst and set the detector to average. Duty factor is not added to measured value.

#### 4.3.5 Deviation from Test Standard

No deviation.

#### 4.3.6 EUT Operating Conditions

The software provided by client to enable the EUT under transmission condition continuously at lowest, middle and highest channel frequencies individually.

#### 4.3.7 Test Result

Power Output:

CDD Mode

802.11a

Chan.	Freq. (MHz)	Average Power (dBm)		Total Power (mW)	Total Power (dBm)	Power Limit (dBm)	Pass / Fail
		Chain 0	Chain 1				
36	5180	20.98	21.74	274.594	24.39	30.00	Pass
40	5200	25.92	26.12	800.102	29.03	30.00	Pass
48	5240	26.22	26.32	<b>847.631</b>	29.28	30.00	Pass
149	5745	26.58	26.02	<b>854.933</b>	29.32	30.00	Pass
157	5785	26.56	25.83	835.722	29.22	30.00	Pass
165	5825	26.45	26.03	842.437	29.26	30.00	Pass

802.11ac (VHT20)

Chan.	Freq. (MHz)	Average Power (dBm)		Total Power (mW)	Total Power (dBm)	Power Limit (dBm)	Pass / Fail
		Chain 0	Chain 1				
36	5180	20.62	21.61	260.223	24.15	30.00	Pass
40	5200	26.02	26.04	801.736	29.04	30.00	Pass
48	5240	26.07	26.27	828.219	29.18	30.00	Pass
149	5745	26.49	25.73	819.767	29.14	30.00	Pass
157	5785	26.45	25.92	832.411	29.20	30.00	Pass
165	5825	26.44	25.90	829.600	29.19	30.00	Pass

802.11ac (VHT40)

Chan.	Freq. (MHz)	Average Power (dBm)		Total Power (mW)	Total Power (dBm)	Power Limit (dBm)	Pass / Fail
		Chain 0	Chain 1				
38	5190	18.96	19.93	177.106	22.48	30.00	Pass
46	5230	25.45	24.82	654.141	28.16	30.00	Pass
151	5755	26.53	25.84	833.487	29.21	30.00	Pass
159	5795	26.27	25.76	800.347	29.03	30.00	Pass

802.11ac (VHT80)

Chan.	Freq. (MHz)	Average Power (dBm)		Total Power (mW)	Total Power (dBm)	Power Limit (dBm)	Pass / Fail
		Chain 0	Chain 1				
42	5210	18.25	17.95	129.208	21.11	30.00	Pass
155	5775	24.55	24.51	567.590	27.54	30.00	Pass

802.11ax (HE20)

Chan.	Freq. (MHz)	Average Power (dBm)		Total Power (mW)	Total Power (dBm)	Power Limit (dBm)	Pass / Fail
		Chain 0	Chain 1				
36	5180	20.75	21.67	265.743	24.24	30.00	Pass
40	5200	25.96	26.13	804.661	29.06	30.00	Pass
48	5240	26.13	26.32	838.753	29.24	30.00	Pass
149	5745	26.50	25.77	824.256	29.16	30.00	Pass
157	5785	26.50	26.00	844.791	29.27	30.00	Pass
165	5825	26.54	25.94	843.462	29.26	30.00	Pass

802.11ax (HE40)

Chan.	Freq. (MHz)	Average Power (dBm)		Total Power (mW)	Total Power (dBm)	Power Limit (dBm)	Pass / Fail
		Chain 0	Chain 1				
38	5190	19.02	20.01	180.030	22.55	30.00	Pass
46	5230	24.97	24.23	578.901	27.63	30.00	Pass
151	5755	26.57	25.92	844.783	29.27	30.00	Pass
159	5795	26.37	25.78	811.953	29.10	30.00	Pass

802.11ax (HE80)

Chan.	Freq. (MHz)	Average Power (dBm)		Total Power (mW)	Total Power (dBm)	Power Limit (dBm)	Pass / Fail
		Chain 0	Chain 1				
42	5210	18.30	17.86	128.703	21.10	30.00	Pass
155	5775	24.58	24.63	577.480	27.62	30.00	Pass

### Beamforming Mode

#### 802.11ac (VHT20)

Chan.	Freq. (MHz)	Average Power (dBm)		Total Power (mW)	Total Power (dBm)	Power Limit (dBm)	Pass / Fail
		Chain 0	Chain 1				
36	5180	20.62	21.61	260.223	24.15	30.00	Pass
40	5200	26.02	26.04	801.736	29.04	30.00	Pass
48	5240	26.07	26.27	828.219	29.18	30.00	Pass
149	5745	26.49	25.73	819.767	29.14	30.00	Pass
157	5785	26.45	25.92	832.411	29.20	30.00	Pass
165	5825	26.44	25.90	829.600	29.19	30.00	Pass

Note:

1. 5180-5240MHz: Directional gain =  $10 \log[(10^{G1/20} + 10^{G2/20} + \dots + 10^{GN/20})^2/2] = 5.37\text{dBi} < 6\text{dBi}$ , so the power limit not need to reduce.
2. 5745-5825MHz: Directional gain =  $10 \log[(10^{G1/20} + 10^{G2/20} + \dots + 10^{GN/20})^2/2] = 5.81\text{dBi} < 6\text{dBi}$ , so the power limit not need to reduce.

#### 802.11ac (VHT40)

Chan.	Freq. (MHz)	Average Power (dBm)		Total Power (mW)	Total Power (dBm)	Power Limit (dBm)	Pass / Fail
		Chain 0	Chain 1				
38	5190	18.96	19.93	177.106	22.48	30.00	Pass
46	5230	25.45	24.82	654.141	28.16	30.00	Pass
151	5755	26.53	25.84	833.487	29.21	30.00	Pass
159	5795	26.27	25.76	800.347	29.03	30.00	Pass

Note:

1. 5180-5240MHz: Directional gain =  $10 \log[(10^{G1/20} + 10^{G2/20} + \dots + 10^{GN/20})^2/2] = 5.37\text{dBi} < 6\text{dBi}$ , so the power limit not need to reduce.
2. 5745-5825MHz: Directional gain =  $10 \log[(10^{G1/20} + 10^{G2/20} + \dots + 10^{GN/20})^2/2] = 5.81\text{dBi} < 6\text{dBi}$ , so the power limit not need to reduce.

#### 802.11ac (VHT80)

Chan.	Freq. (MHz)	Average Power (dBm)		Total Power (mW)	Total Power (dBm)	Power Limit (dBm)	Pass / Fail
		Chain 0	Chain 1				
42	5210	18.25	17.95	129.208	21.11	30.00	Pass
155	5775	24.55	24.51	567.590	27.54	30.00	Pass

Note:

1. 5180-5240MHz: Directional gain =  $10 \log[(10^{G1/20} + 10^{G2/20} + \dots + 10^{GN/20})^2/2] = 5.37\text{dBi} < 6\text{dBi}$ , so the power limit not need to reduce.
2. 5745-5825MHz: Directional gain =  $10 \log[(10^{G1/20} + 10^{G2/20} + \dots + 10^{GN/20})^2/2] = 5.81\text{dBi} < 6\text{dBi}$ , so the power limit not need to reduce.

### 802.11ax (HE20)

Chan.	Freq. (MHz)	Average Power (dBm)		Total Power (mW)	Total Power (dBm)	Power Limit (dBm)	Pass / Fail
		Chain 0	Chain 1				
36	5180	20.75	21.67	265.743	24.24	30.00	Pass
40	5200	25.96	26.13	804.661	29.06	30.00	Pass
48	5240	26.13	26.32	<b>838.753</b>	29.24	30.00	Pass
149	5745	26.50	25.77	824.256	29.16	30.00	Pass
157	5785	26.50	26.00	<b>844.791</b>	29.27	30.00	Pass
165	5825	26.54	25.94	843.462	29.26	30.00	Pass

Note:

- 5180-5240MHz: Directional gain =  $10 \log[(10^{G1/20} + 10^{G2/20} + \dots + 10^{GN/20})^2/2]$  = 5.37dBi < 6dBi, so the power limit not need to reduce.
- 5745-5825MHz: Directional gain =  $10 \log[(10^{G1/20} + 10^{G2/20} + \dots + 10^{GN/20})^2/2]$  = 5.81dBi < 6dBi, so the power limit not need to reduce.

### 802.11ax (HE40)

Chan.	Freq. (MHz)	Average Power (dBm)		Total Power (mW)	Total Power (dBm)	Power Limit (dBm)	Pass / Fail
		Chain 0	Chain 1				
38	5190	19.02	20.01	180.030	22.55	30.00	Pass
46	5230	24.97	24.23	578.901	27.63	30.00	Pass
151	5755	26.57	25.92	844.783	29.27	30.00	Pass
159	5795	26.37	25.78	811.953	29.10	30.00	Pass

Note:

- 5180-5240MHz: Directional gain =  $10 \log[(10^{G1/20} + 10^{G2/20} + \dots + 10^{GN/20})^2/2]$  = 5.37dBi < 6dBi, so the power limit not need to reduce.
- 5745-5825MHz: Directional gain =  $10 \log[(10^{G1/20} + 10^{G2/20} + \dots + 10^{GN/20})^2/2]$  = 5.81dBi < 6dBi, so the power limit not need to reduce.

### 802.11ax (HE80)

Chan.	Freq. (MHz)	Average Power (dBm)		Total Power (mW)	Total Power (dBm)	Power Limit (dBm)	Pass / Fail
		Chain 0	Chain 1				
42	5210	18.30	17.86	128.703	21.10	30.00	Pass
155	5775	24.58	24.63	577.480	27.62	30.00	Pass

Note:

- 5180-5240MHz: Directional gain =  $10 \log[(10^{G1/20} + 10^{G2/20} + \dots + 10^{GN/20})^2/2]$  = 5.37dBi < 6dBi, so the power limit not need to reduce.
- 5745-5825MHz: Directional gain =  $10 \log[(10^{G1/20} + 10^{G2/20} + \dots + 10^{GN/20})^2/2]$  = 5.81dBi < 6dBi, so the power limit not need to reduce.

## 4.4 Occupied Bandwidth Measurement

### 4.4.1 Test Setup

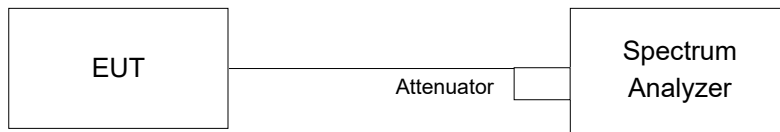

### 4.4.2 Test Instruments

Refer to section 4.1.2 to get information of above instrument.

### 4.4.3 Test Procedure

The transmitter output was connected to the spectrum analyzer through an attenuator. The bandwidth of the fundamental frequency was measured by spectrum analyzer with resolution bandwidth in the range of 1% to 5% of the anticipated emission bandwidth, and a video bandwidth at least 3x the resolution bandwidth and set the detector to sampling. The width of a frequency band such that, below the lower and above the upper frequency limits, the mean powers emitted are each equal to a specified percentage 0.5 %of the total mean power of a given emission.



#### 4.4.4 Test Result

##### 802.11a

Chan.	Freq. (MHz)	Occupied Bandwidth (MHz)	
		Chain 0	Chain 1
36	5180	16.92	16.68
40	5200	17.64	18.12
48	5240	19.92	19.92
149	5745	26.64	27.66
157	5785	28.98	28.80
165	5825	28.68	27.84

##### 802.11ax (HE20)

Chan.	Freq. (MHz)	Occupied Bandwidth (MHz)	
		Chain 0	Chain 1
36	5180	19.32	19.32
40	5200	19.56	19.56
48	5240	19.76	19.76
149	5745	35.16	35.76
157	5785	34.32	34.92
165	5825	33.24	33.36

##### 802.11ax (HE40)

Chan.	Freq. (MHz)	Occupied Bandwidth (MHz)	
		Chain 0	Chain 1
38	5190	38.04	38.28
46	5230	38.40	38.52
151	5755	45.00	45.96
159	5795	44.88	45.84

##### 802.11ax (HE80)

Chan.	Freq. (MHz)	Occupied Bandwidth (MHz)	
		Chain 0	Chain 1
42	5210	77.28	77.52
155	5775	78.24	78.00

### Spectrum Plot of Worst Value

#### 802.11a

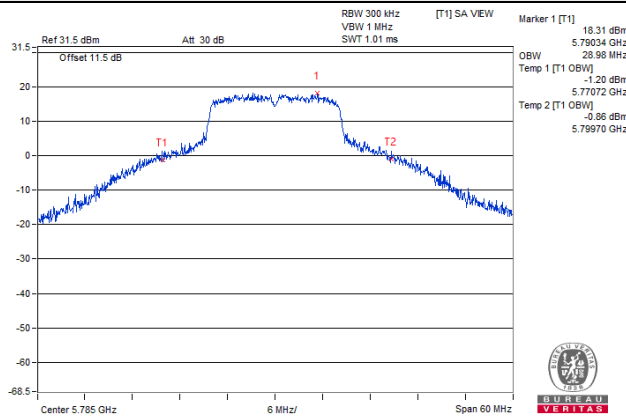

#### 802.11ax (HE20)

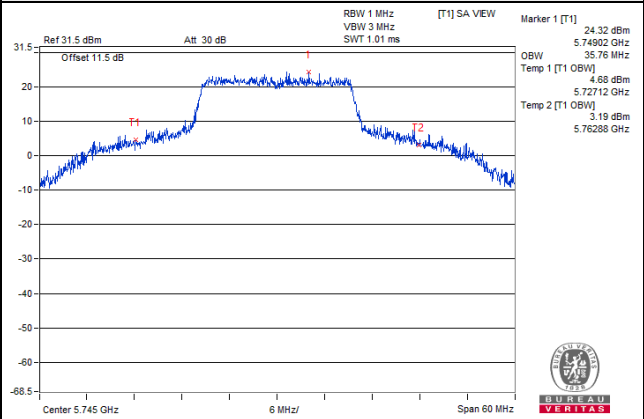

#### 802.11ax (HE40)

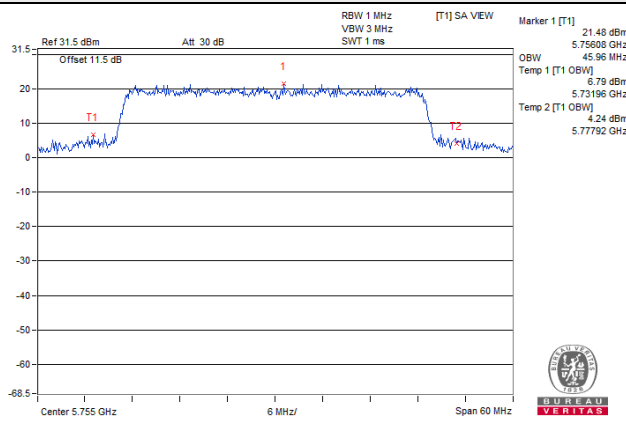

#### 802.11ax (HE80)

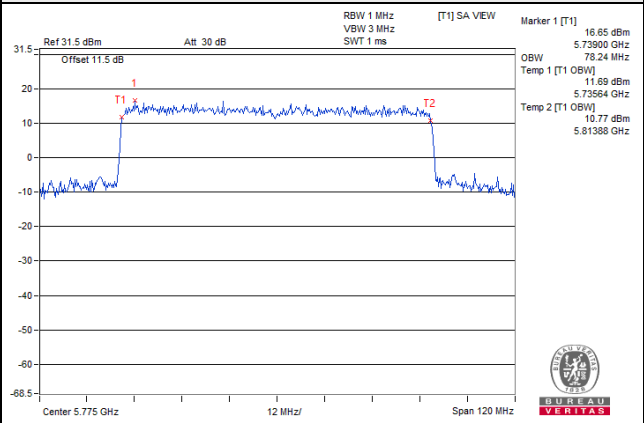

**Spectrum Plot for near By DFS Band**

**802.11a / Chain 0 / CH 48**

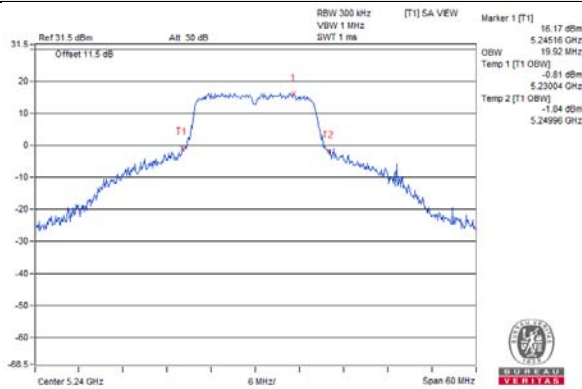

**802.11a / Chain 1 / CH 48**

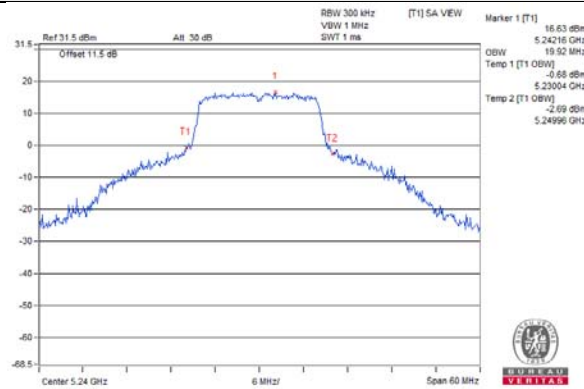

**802.11ax (HE20) / Chain 0 / CH 48**

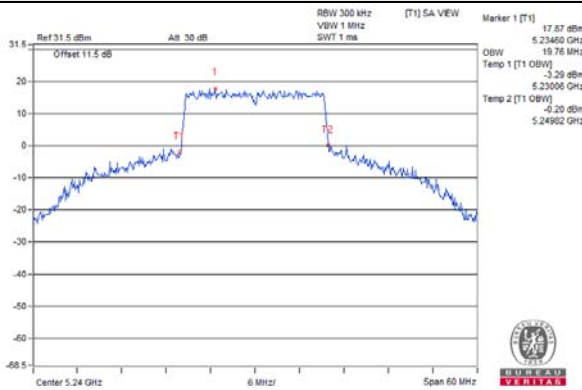

**802.11ax (HE20) / Chain 1 / CH 48**

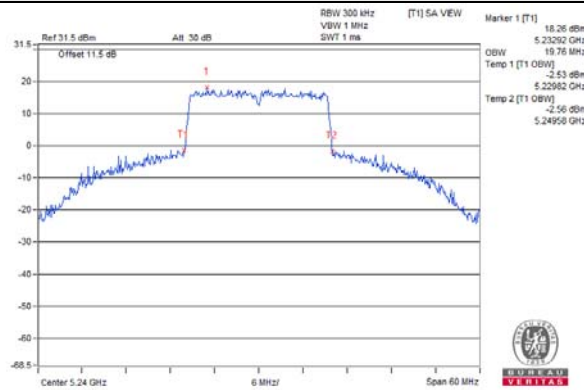

**802.11ax (HE40) / Chain 0 / CH 46**

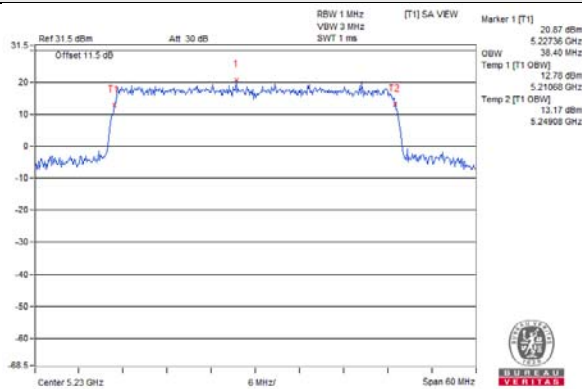

**802.11ax (HE40) / Chain 1 / CH 46**

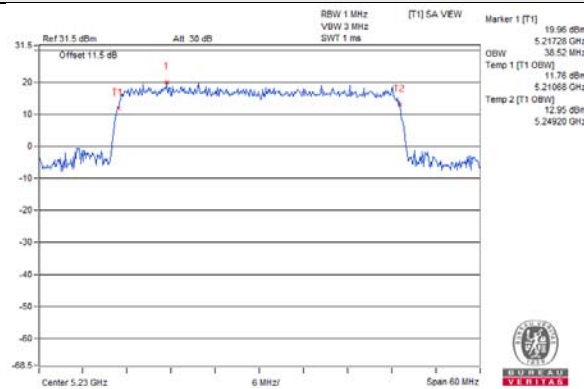

**802.11ax (HE80) / Chain 0 / CH 42**

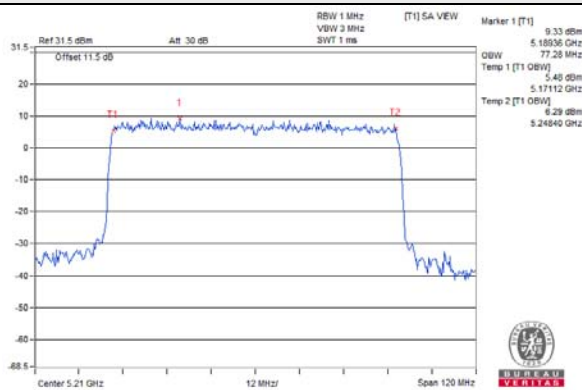

**802.11ax (HE80) / Chain 1 / CH 42**

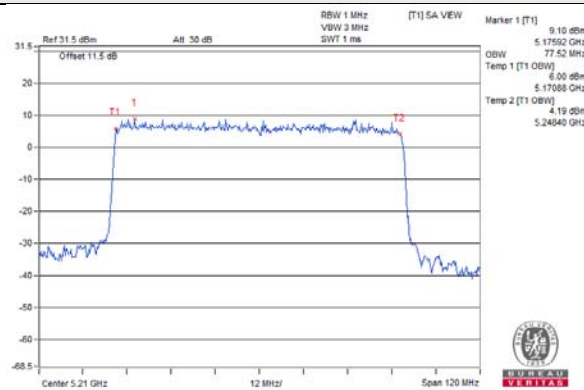

Spectrum Plot for near By DFS Band

802.11a / Chain 0 / CH 149

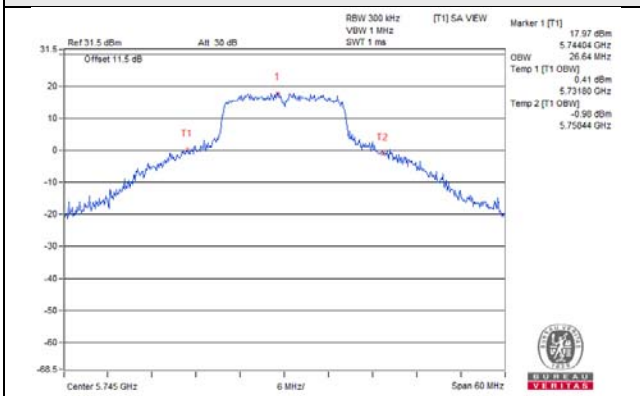

802.11a / Chain 1 / CH 149

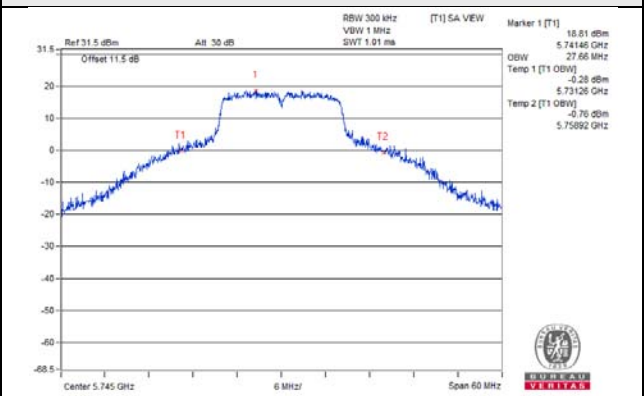

802.11ax (HE20) / Chain 0 / CH 149

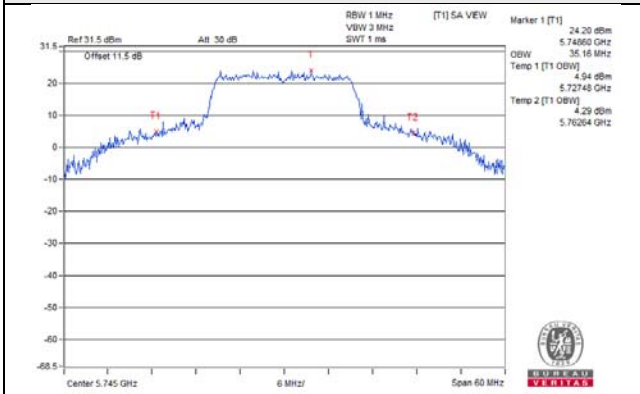

802.11ax (HE20) / Chain 1 / CH 149

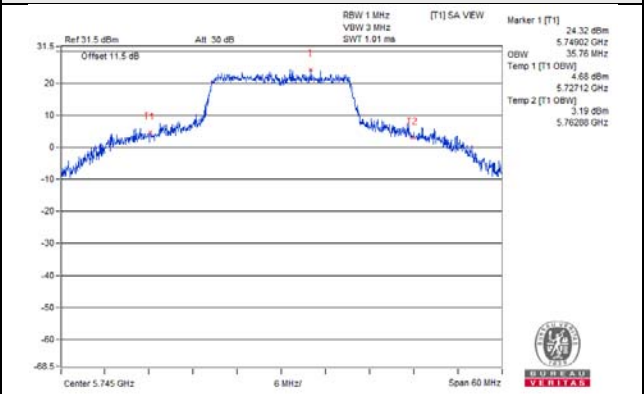

802.11ax (HE40) / Chain 0 / CH 151

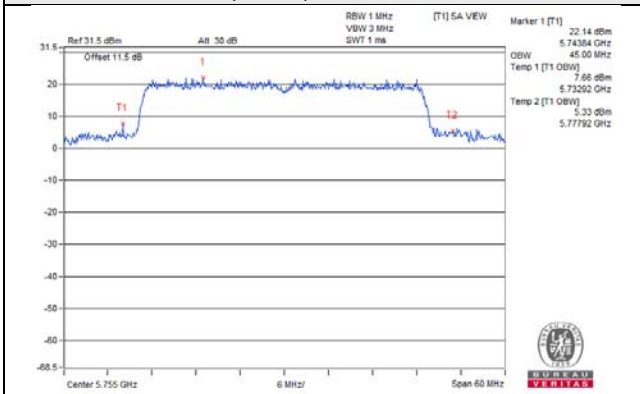

802.11ax (HE40) / Chain 1 / CH 151

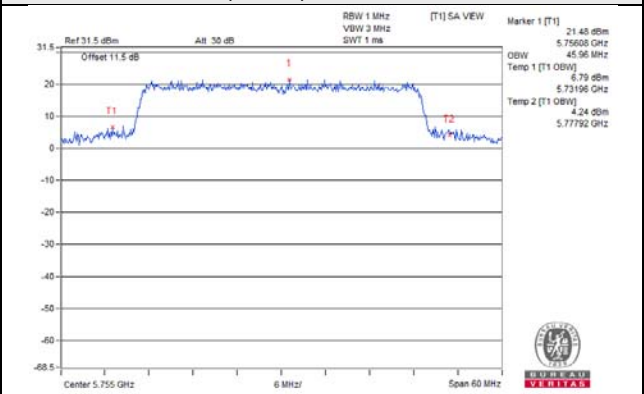

802.11ax (HE80) / Chain 0 / CH 155

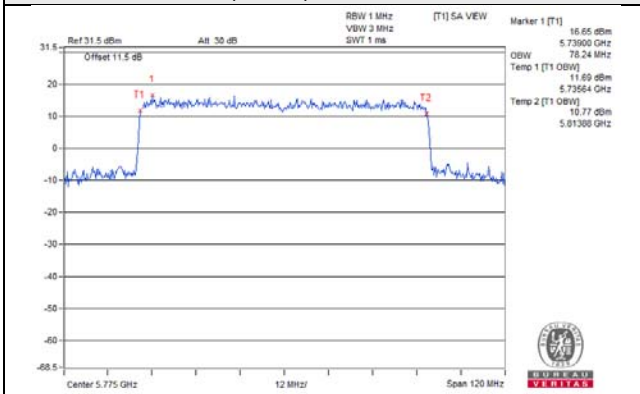

802.11ax (HE80) / Chain 1 / CH 155

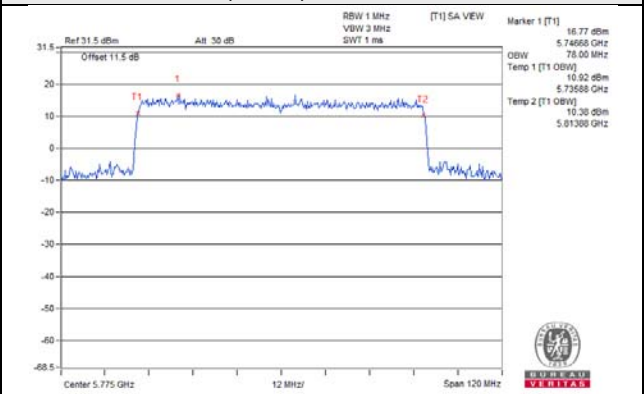

## 4.5 Peak Power Spectral Density Measurement

### 4.5.1 Limits of Peak Power Spectral Density Measurement

Operation Band	EUT Category		Limit
U-NII-1		Outdoor Access Point	17dBm/ MHz
		Fixed point-to-point Access Point	
	√	Indoor Access Point	
		Mobile and Portable client device	11dBm/ MHz
U-NII-2A			11dBm/ MHz
U-NII-2C			11dBm/ MHz
U-NII-3	√		30dBm/ 500kHz

### 4.5.2 Test Setup

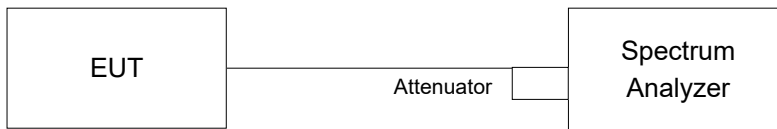

### 4.5.3 Test Instruments

Refer to section 4.1.2 to get information of above instrument.

### 4.5.4 Test Procedures

For U-NII-1 band:

Using method SA-2

- Set span to encompass the entire emission bandwidth (EBW) of the signal.
- Set RBW = 1MHz, Set VBW  $\geq$  3 MHz, Detector = RMS
- Set Channel power measure = 1MHz
- Sweep time = auto, trigger set to "free run".
- Trace average at least 100 traces in power averaging mode.
- Record the max value and add 10 log (1/duty cycle)

For U-NII-3 band:

Duty cycle of test signal is < 98%

- Set span to encompass the entire emission bandwidth (EBW) of the signal.
- Set RBW = 300 kHz, Set VBW  $\geq$  1 MHz, Detector = RMS
- Use the peak marker function to determine the maximum power level in any 300 kHz band segment within the fundamental EBW.
- Scale the observed power level to an equivalent value in 500 kHz by adjusting (increasing) the measured power by a bandwidth correction factor (BWCF) where  $BWCF = 10\log(500 \text{ kHz} / 300 \text{ kHz})$
- Sweep time = auto, trigger set to "free run".
- Trace average at least 100 traces in power averaging mode.
- Record the max value and add 10 log (1/duty cycle)

#### **4.5.5 Deviation from Test Standard**

No deviation.

#### **4.5.6 EUT Operating Conditions**

Same as 4.3.6.

#### 4.5.7 Test Results

For U-NII-1 band:

##### 802.11a

Chan.	Freq. (MHz)	PSD w/o Duty Factor (dBm/MHz)		Duty Factor (dB)	Total PSD with Duty Factor (dBm/MHz)	Max. Limit (dBm/MHz)	Pass / Fail
		Chain 0	Chain 1				
36	5180	7.87	8.57	0.26	11.50	17.00	Pass
40	5200	12.66	13.37	0.26	16.30	17.00	Pass
48	5240	13.57	13.71	0.26	16.91	17.00	Pass

Note:

- Method E) 2) a) of power density measurement of KDB 662911 is using for calculating total power density. Total power density is summing entire spectra across corresponding frequency bins on the various outputs by computer.
- Directional gain =  $10 \log[(10^{G1/20} + 10^{G2/20} + \dots + 10^{GN/20})^2/2] = 5.37\text{dBi} < 6\text{dBi}$ , so the power density limit not need to reduce.
- Refer to section 3.3 for duty cycle spectrum plot.

##### 802.11ax (HE20)

Chan.	Freq. (MHz)	PSD w/o Duty Factor (dBm/MHz)		Duty Factor (dB)	Total PSD with Duty Factor (dBm/MHz)	Max. Limit (dBm/MHz)	Pass / Fail
		Chain 0	Chain 1				
36	5180	7.33	8.10	0.45	11.19	17.00	Pass
40	5200	11.70	12.02	0.45	15.32	17.00	Pass
48	5240	12.87	13.08	0.45	16.44	17.00	Pass

Note:

- Method E) 2) a) of power density measurement of KDB 662911 is using for calculating total power density. Total power density is summing entire spectra across corresponding frequency bins on the various outputs by computer.
- Directional gain =  $10 \log[(10^{G1/20} + 10^{G2/20} + \dots + 10^{GN/20})^2/2] = 5.37\text{dBi} < 6\text{dBi}$ , so the power density limit not need to reduce.
- Refer to section 3.3 for duty cycle spectrum plot.

##### 802.11ax (HE40)

Chan.	Freq. (MHz)	PSD w/o Duty Factor (dBm/MHz)		Duty Factor (dB)	Total PSD with Duty Factor (dBm/MHz)	Max. Limit (dBm/MHz)	Pass / Fail
		Chain 0	Chain 1				
38	5190	2.97	4.02	0.78	7.32	17.00	Pass
46	5230	8.87	8.70	0.78	12.58	17.00	Pass

Note:

- Method E) 2) a) of power density measurement of KDB 662911 is using for calculating total power density. Total power density is summing entire spectra across corresponding frequency bins on the various outputs by computer.
- Directional gain =  $10 \log[(10^{G1/20} + 10^{G2/20} + \dots + 10^{GN/20})^2/2] = 5.37\text{dBi} < 6\text{dBi}$ , so the power density limit not need to reduce.
- Refer to section 3.3 for duty cycle spectrum plot.

802.11ax (HE80)

Chan.	Freq. (MHz)	PSD w/o Duty Factor (dBm/MHz)		Duty Factor (dB)	Total PSD with Duty Factor (dBm/MHz)	Max. Limit (dBm/MHz)	Pass / Fail
		Chain 0	Chain 1				
42	5210	-2.27	-2.37	0.85	1.54	17.00	Pass

Note:

- Method E) 2) a) of power density measurement of KDB 662911 is using for calculating total power density. Total power density is summing entire spectra across corresponding frequency bins on the various outputs by computer.
- Directional gain =  $10 \log[(10^{G1/20} + 10^{G2/20} + \dots + 10^{GN/20})^2/2] = 5.37\text{dBi} < 6\text{dBi}$ , so the power density limit not need to reduce.
- Refer to section 3.3 for duty cycle spectrum plot.

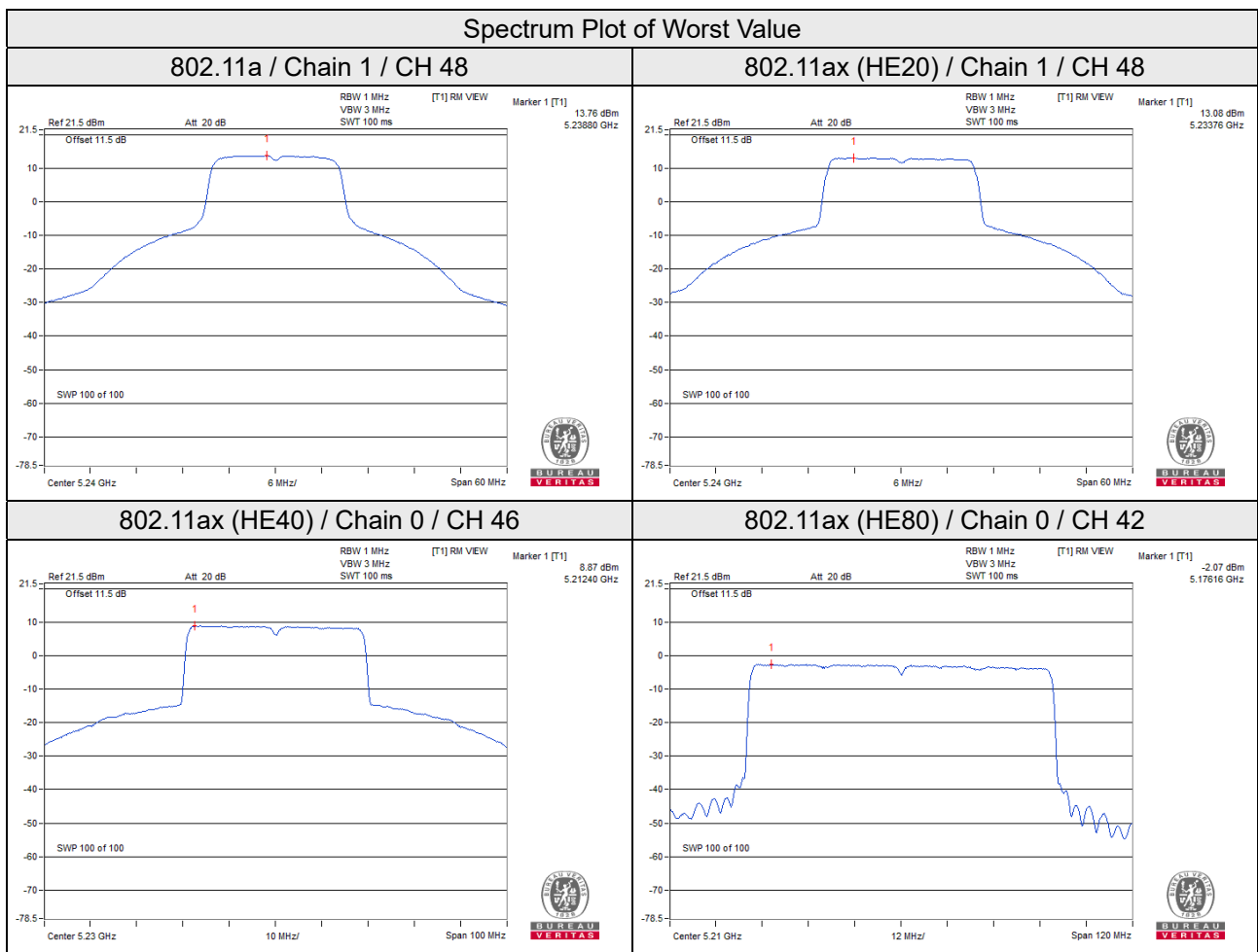



For U-NII-3 band:

802.11a

TX chain	Chan.	Freq. (MHz)	PSD W/O Duty Factor		10 log (N=2) dB	Duty Factor (dB)	Total PSD With Duty Factor (dBm/500kHz)	Limit (dBm/500kHz)	Pass / Fail
			(dBm/300kHz)	(dBm/500kHz)					
0	149	5745	9.76	11.98	3.01	0.26	15.25	30.00	Pass
	157	5785	9.83	12.05	3.01	0.26	15.32	30.00	Pass
	165	5825	9.83	12.05	3.01	0.26	15.32	30.00	Pass
1	149	5745	9.28	11.50	3.01	0.26	14.77	30.00	Pass
	157	5785	9.22	11.44	3.01	0.26	14.71	30.00	Pass
	165	5825	9.29	11.51	3.01	0.26	14.78	30.00	Pass

Note:

- Method E) 2) c) of power density measurement of KDB 662911 is using for calculating total power density, Measure and add 10 log (N<sub>ANT</sub>) dB.
- Directional gain =  $10 \log[(10^{G1/20} + 10^{G2/20} + \dots + 10^{GN/20})^2/2] = 5.81\text{dBi} < 6\text{dBi}$ , so the power density limit not need to reduce.
- Refer to section 3.3 for duty cycle spectrum plot.

802.11ax (HE20)

TX chain	Chan.	Freq. (MHz)	PSD W/O Duty Factor		10 log (N=2) dB	Duty Factor (dB)	Total PSD With Duty Factor (dBm/500kHz)	Limit (dBm/500kHz)	Pass / Fail
			(dBm/300kHz)	(dBm/500kHz)					
0	149	5745	9.19	11.41	3.01	0.45	14.87	30.00	Pass
	157	5785	8.95	11.17	3.01	0.45	14.63	30.00	Pass
	165	5825	8.75	10.97	3.01	0.45	14.43	30.00	Pass
1	149	5745	8.63	10.85	3.01	0.45	14.31	30.00	Pass
	157	5785	8.32	10.54	3.01	0.45	14.00	30.00	Pass
	165	5825	8.37	10.59	3.01	0.45	14.05	30.00	Pass

Note:

- Method E) 2) c) of power density measurement of KDB 662911 is using for calculating total power density, Measure and add 10 log (N<sub>ANT</sub>) dB.
- Directional gain =  $10 \log[(10^{G1/20} + 10^{G2/20} + \dots + 10^{GN/20})^2/2] = 5.81\text{dBi} < 6\text{dBi}$ , so the power density limit not need to reduce.
- Refer to section 3.3 for duty cycle spectrum plot.

802.11ax (HE40)

TX chain	Chan.	Freq. (MHz)	PSD W/O Duty Factor		10 log (N=2) dB	Duty Factor (dB)	Total PSD With Duty Factor (dBm/500kHz)	Limit (dBm/500kHz)	Pass / Fail
			(dBm/300kHz)	(dBm/500kHz)					
0	151	5755	6.09	8.31	3.01	0.78	12.10	30.00	Pass
	159	5795	5.88	8.10	3.01	0.78	11.89	30.00	Pass
1	151	5755	5.75	7.97	3.01	0.78	11.76	30.00	Pass
	159	5795	5.49	7.71	3.01	0.78	11.50	30.00	Pass

Note:

1. Method E) 2) c) of power density measurement of KDB 662911 is using for calculating total power density, Measure and add 10 log (N<sub>ANT</sub>) dB.
2. Directional gain =  $10 \log[(10^{G^1/20} + 10^{G^2/20} + \dots + 10^{G^N/20})^2/2] = 5.81\text{dBi} < 6\text{dBi}$ , so the power density limit not need to reduce.
3. Refer to section 3.3 for duty cycle spectrum plot.

802.11ax (HE80)

TX chain	Chan.	Freq. (MHz)	PSD W/O Duty Factor		10 log (N=2) dB	Duty Factor (dB)	Total PSD With Duty Factor (dBm/500kHz)	Limit (dBm/500kHz)	Pass / Fail
			(dBm/300kHz)	(dBm/500kHz)					
0	155	5775	0.31	2.53	3.01	0.85	6.39	30.00	Pass
1	155	5775	0.53	2.75	3.01	0.85	6.61	30.00	Pass

Note:

1. Method E) 2) c) of power density measurement of KDB 662911 is using for calculating total power density, Measure and add 10 log (N<sub>ANT</sub>) dB.
2. Directional gain =  $10 \log[(10^{G^1/20} + 10^{G^2/20} + \dots + 10^{G^N/20})^2/2] = 5.81\text{dBi} < 6\text{dBi}$ , so the power density limit not need to reduce.
3. Refer to section 3.3 for duty cycle spectrum plot.

### Spectrum Plot of Worst Value

#### 802.11a

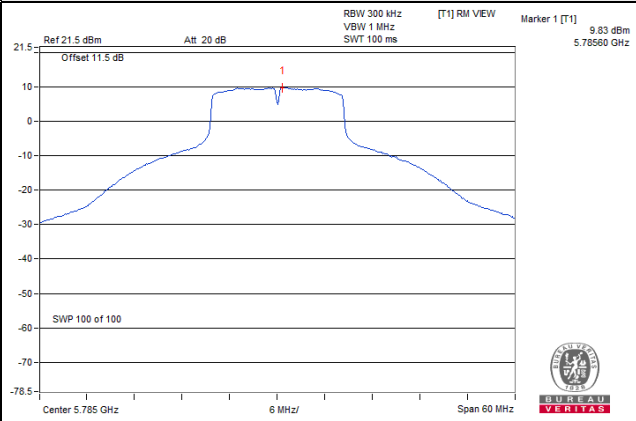

#### 802.11ax (HE20)

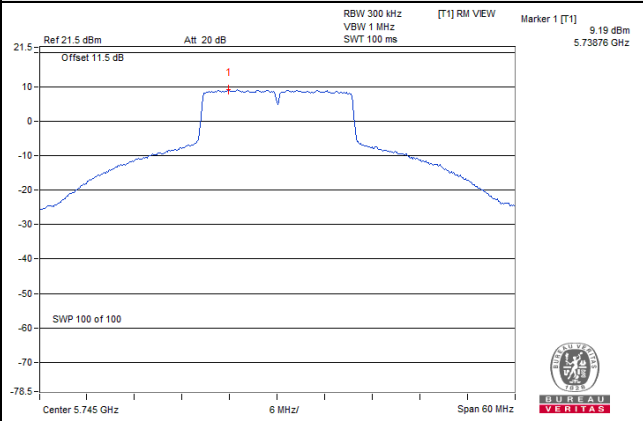

#### 802.11ax (HE40)

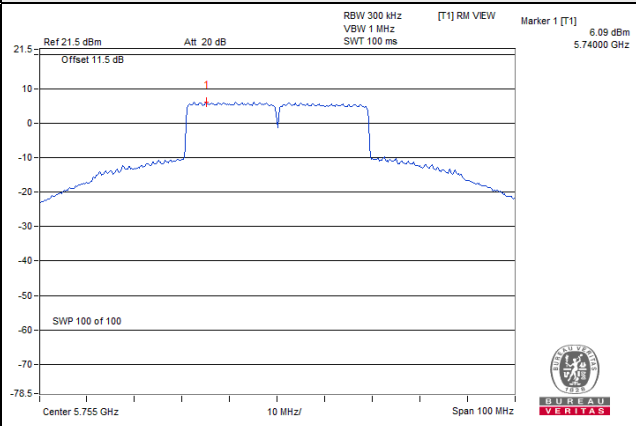

#### 802.11ax (HE80)

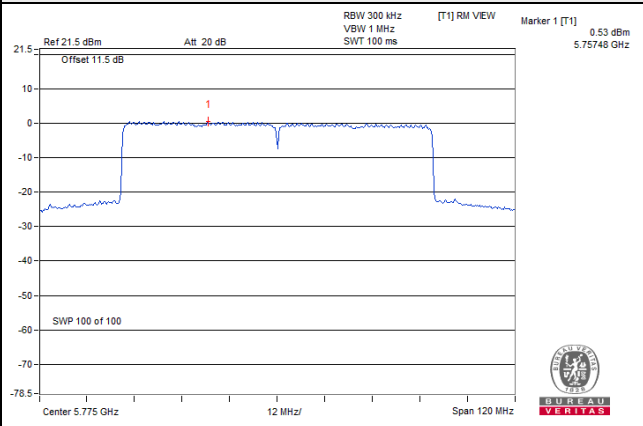

## 4.6 Frequency Stability

### 4.6.1 Limits of Frequency Stability Measurement

The frequency of the carrier signal shall be maintained within band of operation

### 4.6.2 Test Setup

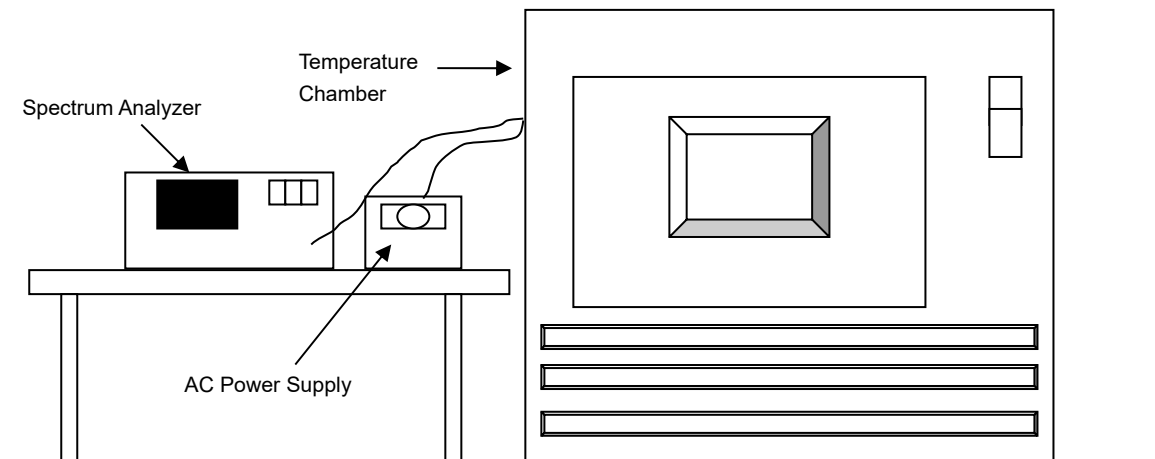

### 4.6.3 Test Instruments

Description & Manufacturer	Model No.	Serial No.	Cal. Date	Cal. Due
Spectrum Analyzer ROHDE & SCHWARZ	FSP40	100040	Sep. 16, 2020	Sep. 15, 2021
WIT Standard Temperature And Humidity Chamber	TH-4S-C	W981030	Jun. 01, 2020	May 31, 2021
Digital Multimeter Fluke	87-III	70360742	Jun. 23, 2020	Jun. 22, 2021
AC Power Supply Extech	CFW-105	E000603	NA	NA

Note: 1. The calibration interval of the above test instruments is 12 months and the calibrations are traceable to NML/ROC and NIST/USA.

### 4.6.4 Test Procedure

- The EUT was placed inside the environmental test chamber and powered by nominal AC voltage.
- Turn the EUT on and couple its output to a spectrum analyzer.
- Turn the EUT off and set the chamber to the highest temperature specified.
- Allow sufficient time (approximately 30 min) for the temperature of the chamber to stabilize, turn the EUT on and measure the operating frequency after 2, 5, and 10 minutes.
- Repeat step d with every 10 degrees reduction until the lowest temperature achieved.
- The test chamber was allowed to stabilize at +20 degree C for a minimum of 30 minutes. The supply voltage was then adjusted on the EUT from 85% to 115% and the frequency record.

#### 4.6.5 Deviation from Test Standard

No deviation.

#### 4.6.6 EUT Operating Condition

Set the EUT transmit at un-modulation mode to test frequency stability.

#### 4.6.7 Test Results

Frequency Stability Versus Temp.									
Operating Frequency: 5180MHz									
Temp. (°C)	Power Supply (Vac)	0 Minute		2 Minute		5 Minute		10 Minute	
		Measured Frequency (MHz)	Result	Measured Frequency (MHz)	Result	Measured Frequency (MHz)	Result	Measured Frequency (MHz)	Result
40	120	5179.9931	Pass	5179.9899	Pass	5179.9938	Pass	5179.9921	Pass
30	120	5180.0101	Pass	5180.011	Pass	5180.0088	Pass	5180.0082	Pass
20	120	5180.0153	Pass	5180.0185	Pass	5180.0184	Pass	5180.0169	Pass
10	120	5180.0076	Pass	5180.0091	Pass	5180.0086	Pass	5180.0057	Pass
0	120	5180.0217	Pass	5180.0195	Pass	5180.0234	Pass	5180.0237	Pass

Frequency Stability Versus Voltage									
Operating Frequency: 5180MHz									
Temp. (°C)	Power Supply (Vac)	0 Minute		2 Minute		5 Minute		10 Minute	
		Measured Frequency (MHz)	Result	Measured Frequency (MHz)	Result	Measured Frequency (MHz)	Result	Measured Frequency (MHz)	Result
20	138	5180.0158	Pass	5180.0191	Pass	5180.0178	Pass	5180.0176	Pass
	120	5180.0153	Pass	5180.0185	Pass	5180.0184	Pass	5180.0169	Pass
	102	5180.0148	Pass	5180.019	Pass	5180.0189	Pass	5180.0162	Pass

## 4.7 6dB Bandwidth Measurement

### 4.7.1 Limits of 6dB Bandwidth Measurement

The minimum of 6dB Bandwidth Measurement is 0.5MHz.

### 4.7.2 Test Setup

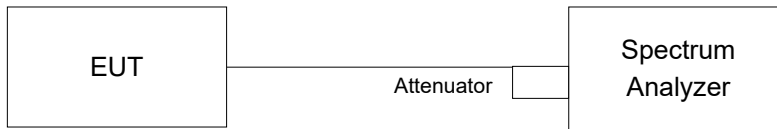

### 4.7.3 Test Instruments

Refer to section 4.1.2 to get information of above instrument.

### 4.7.4 Test Procedure

- Set resolution bandwidth (RBW) = 100kHz
- Set the video bandwidth (VBW)  $\geq 3 \times$  RBW, Detector = Peak.
- Trace mode = max hold.
- Sweep = auto couple.
- Measure the maximum width of the emission that is constrained by the frequencies associated with the two amplitude points (upper and lower) that are attenuated by 6 dB relative to the maximum level measured in the fundamental emission

### 4.7.5 Deviation from Test Standard

No deviation.

### 4.7.6 EUT Operating Condition

The software provided by client to enable the EUT under transmission condition continuously at lowest, middle and highest channel frequencies individually.

#### 4.7.7 Test Results

##### 802.11a

Channel	Frequency (MHz)	6dB Bandwidth (MHz)		Minimum Limit (MHz)	Pass / Fail
		Chain 0	Chain 1		
149	5745	16.37	16.36	0.50	Pass
157	5785	15.95	16.38	0.50	Pass
165	5825	16.35	16.37	0.50	Pass

##### 802.11ax (HE20)

Channel	Frequency (MHz)	6dB Bandwidth (MHz)		Minimum Limit (MHz)	Pass / Fail
		Chain 0	Chain 1		
149	5745	18.93	19.01	0.50	Pass
157	5785	18.94	18.98	0.50	Pass
165	5825	18.93	19.03	0.50	Pass

##### 802.11ax (HE40)

Channel	Frequency (MHz)	6dB Bandwidth (MHz)		Minimum Limit (MHz)	Pass / Fail
		Chain 0	Chain 1		
151	5755	38.24	38.26	0.50	Pass
159	5795	38.27	38.22	0.50	Pass

##### 802.11ax (HE80)

Channel	Frequency (MHz)	6dB Bandwidth (MHz)		Minimum Limit (MHz)	Pass / Fail
		Chain 0	Chain 1		
155	5775	78.18	78.04	0.50	Pass

### Spectrum Plot of Worst Value

#### 802.11a

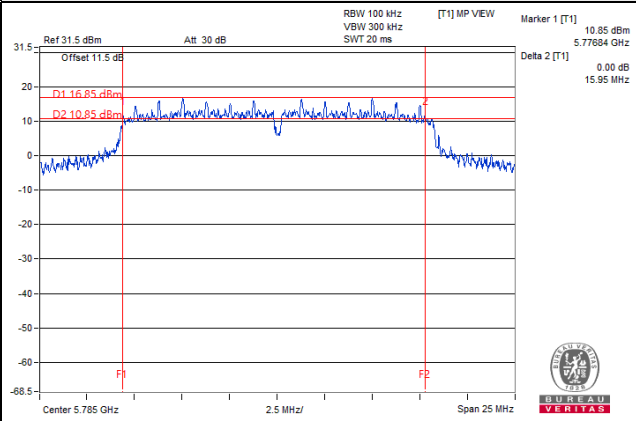

#### 802.11ax (HE20)

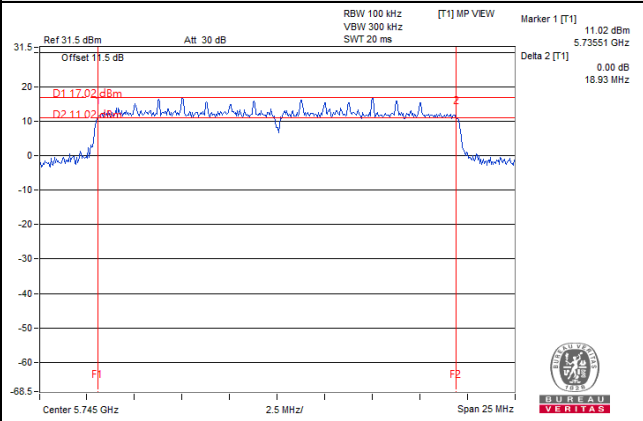

#### 802.11ax (HE40)

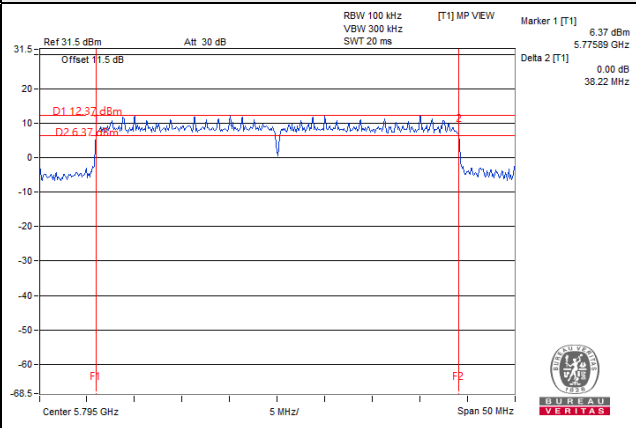

#### 802.11ax (HE80)

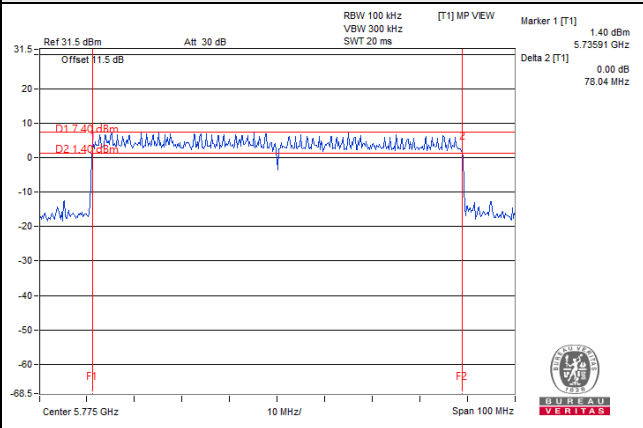



## 5 Pictures of Test Arrangements

Please refer to the attached file (Test Setup Photo).

### Annex A - Radiated Out of Band Emission (OOBE) Measurement (For U-NII-3 band)

802.11a CH 149 : 5745 MHz

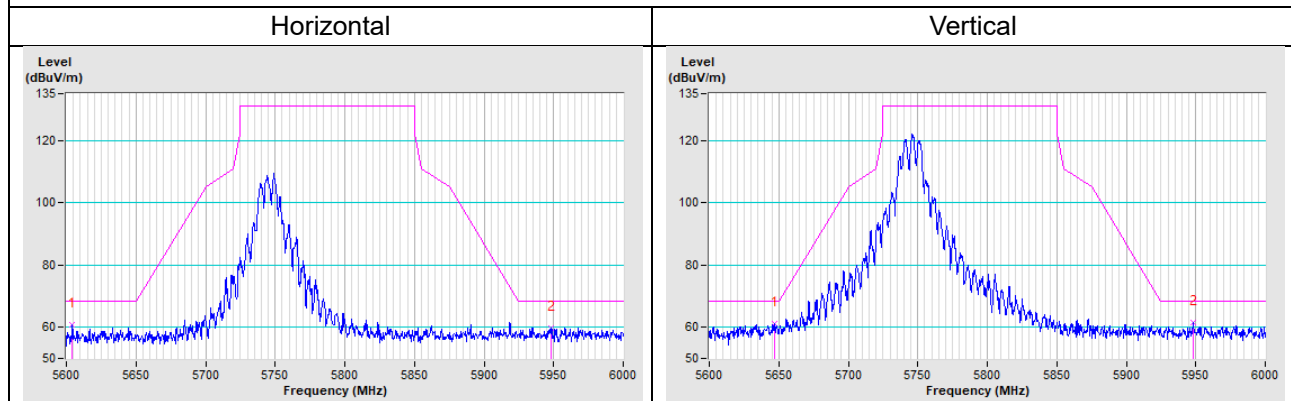

802.11a CH 157 : 5785 MHz

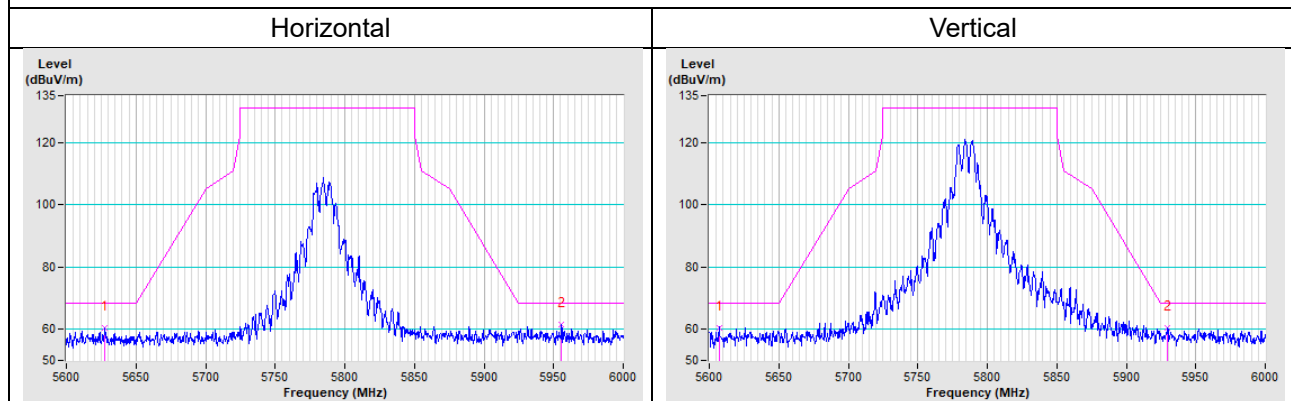

802.11a CH 165 : 5825 MHz

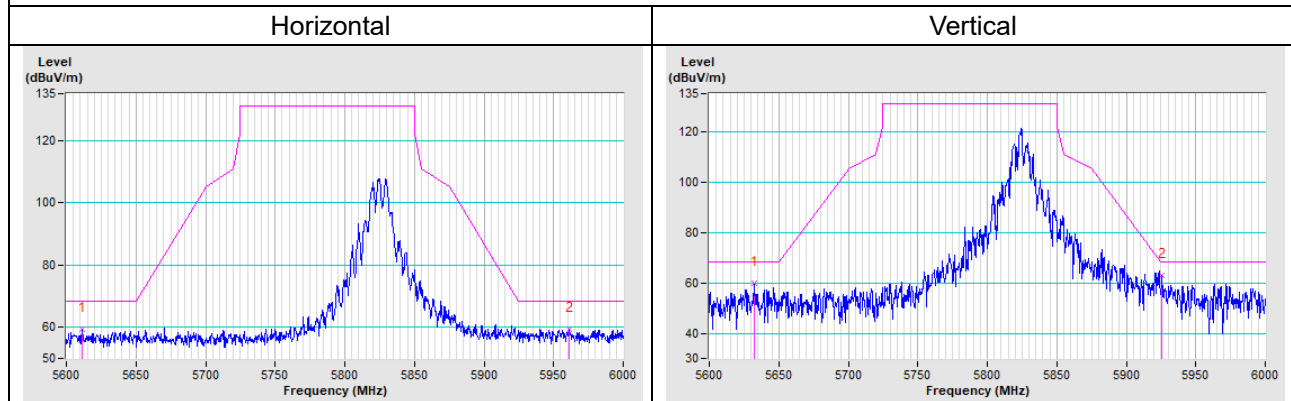

802.11ax (HE20) CH 149 : 5745 MHz

Horizontal

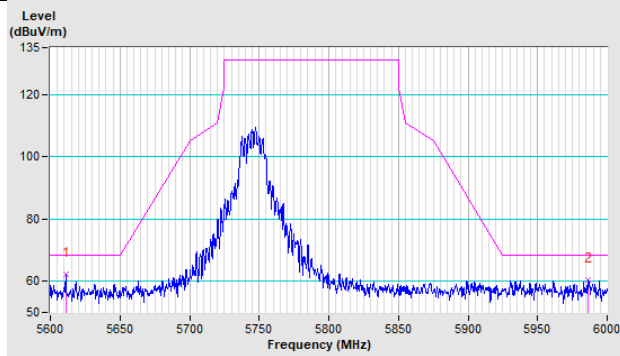

Vertical

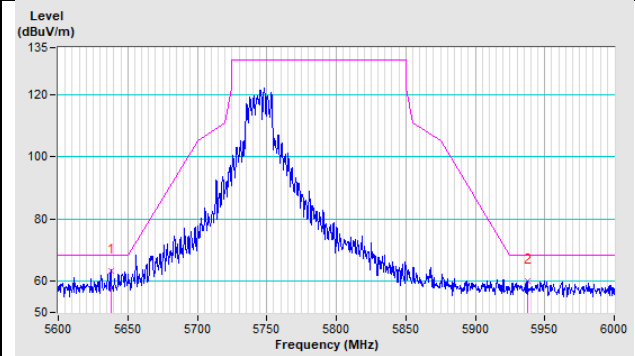

802.11ax (HE20) CH 157 : 5785 MHz

Horizontal

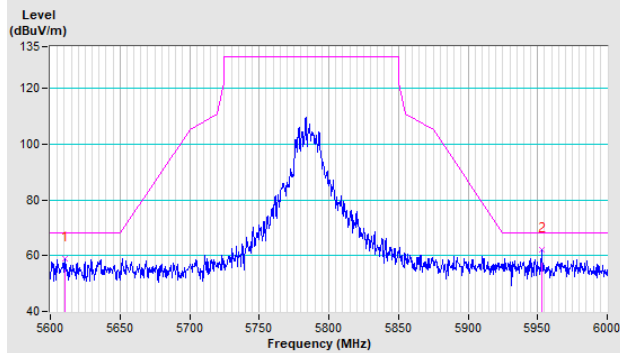

Vertical

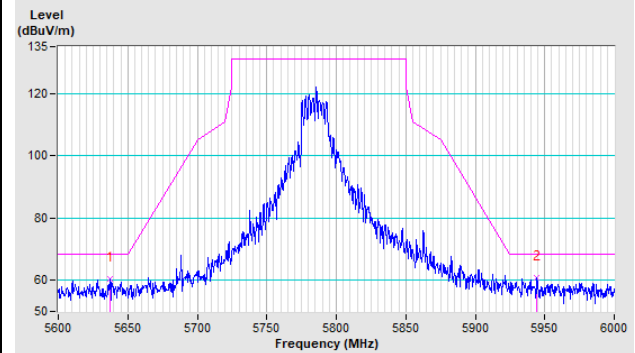

802.11ax (HE20) CH 165 : 5825 MHz

Horizontal

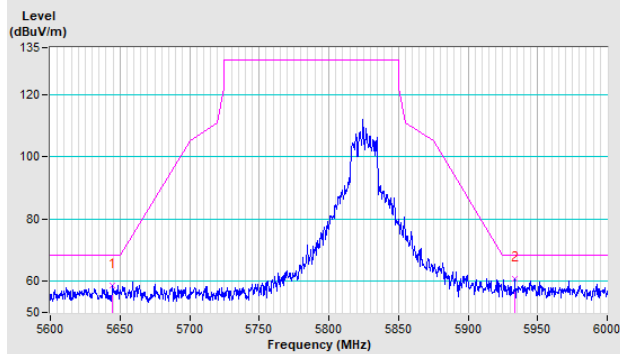

Vertical

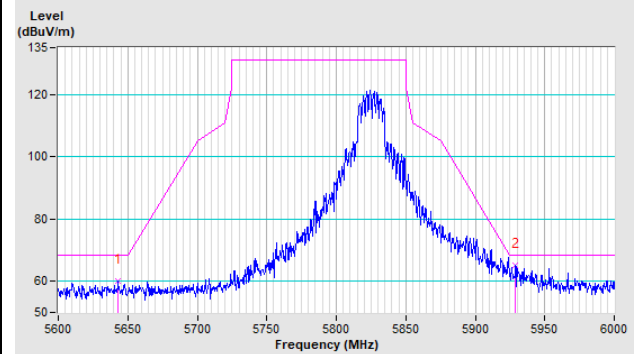

802.11ax (HE40) CH 151 : 5755 MHz

Horizontal

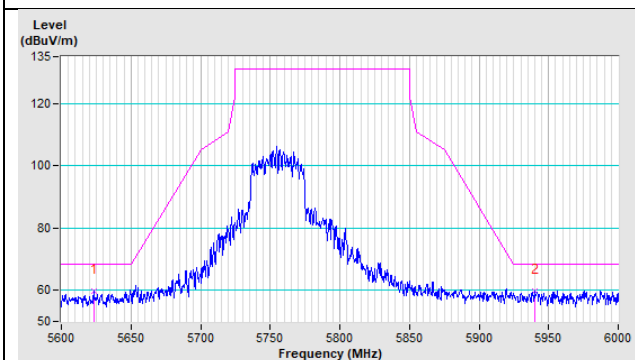

Vertical

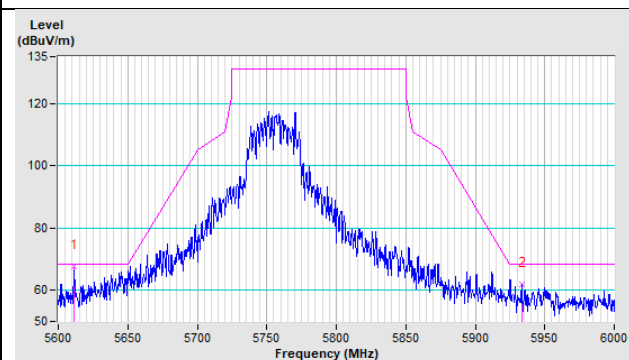

802.11ax (HE40) CH 159 : 5795 MHz

Horizontal

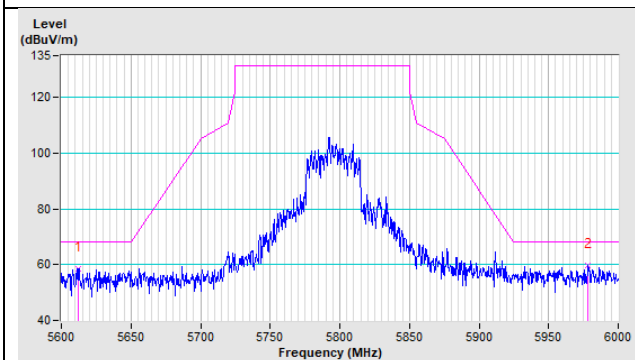

Vertical

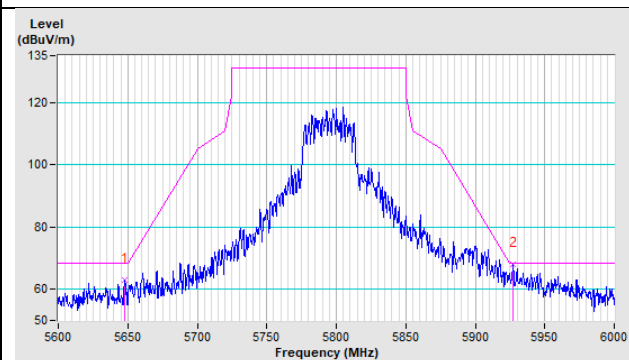

802.11ax (HE80) CH 155 : 5775 MHz

Horizontal

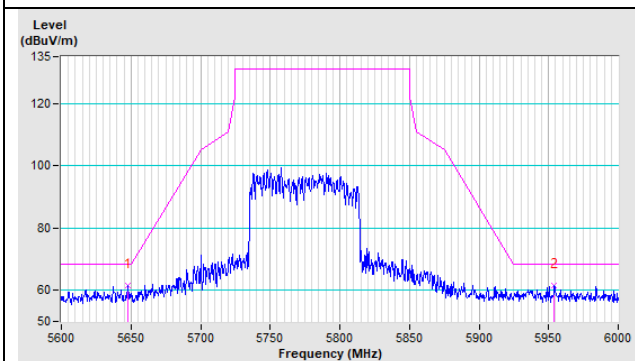

Vertical

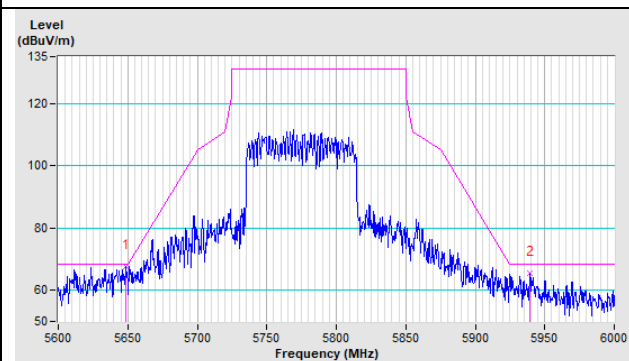

## Annex B - Band Edge Measurement

802.11a Channel 36

Horizontal (Peak)

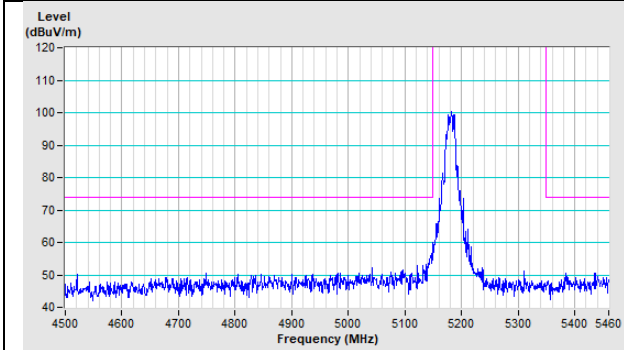

Horizontal (Average)

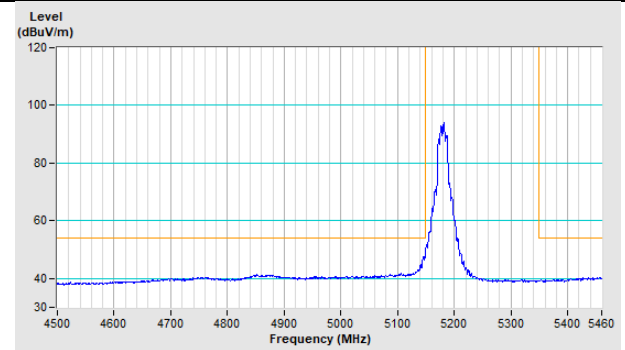

Vertical (Peak)

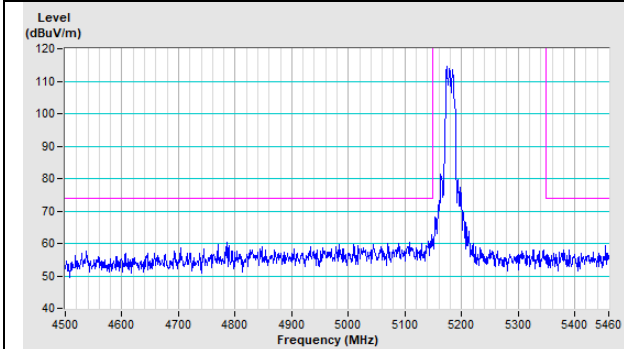

Vertical (Average)

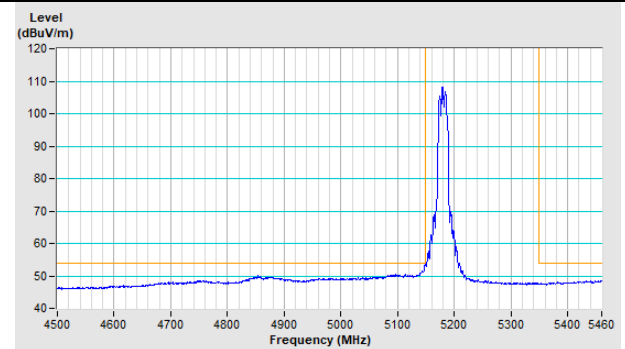

802.11a Channel 40

Horizontal (Peak)

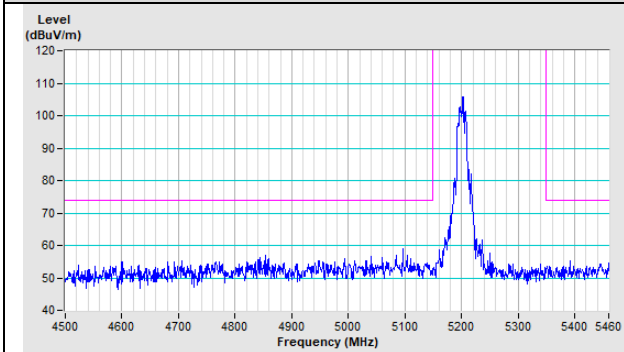

Horizontal (Average)

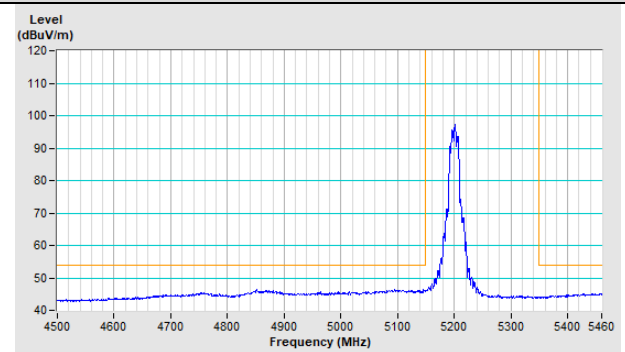

Vertical (Peak)

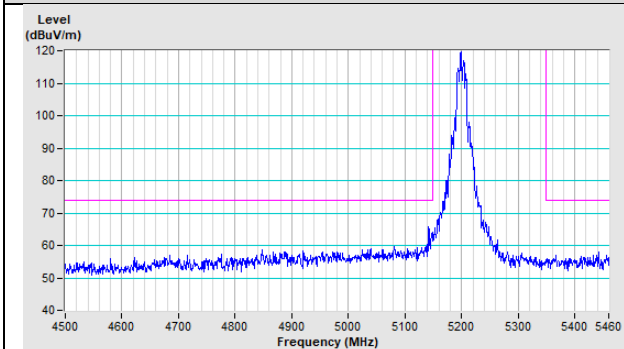

Vertical (Average)

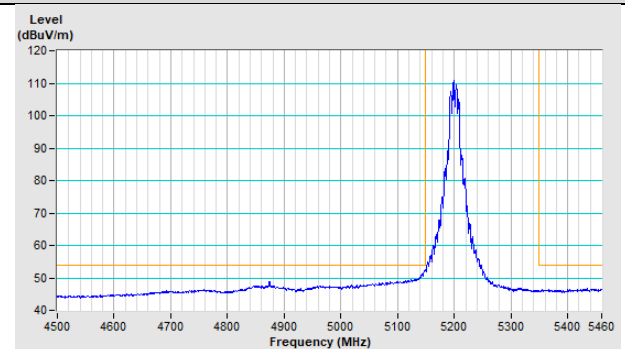

### 802.11a Channel 48

Horizontal (Peak)

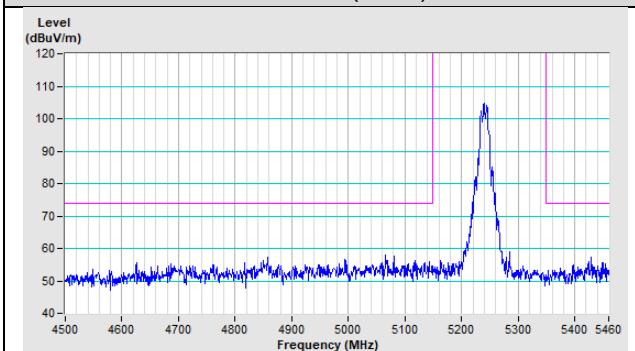

Horizontal (Average)

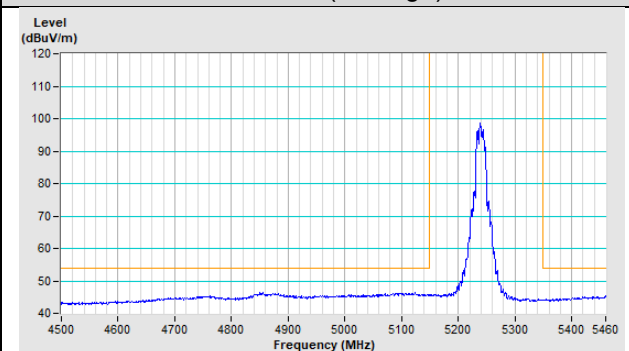

Vertical (Peak)

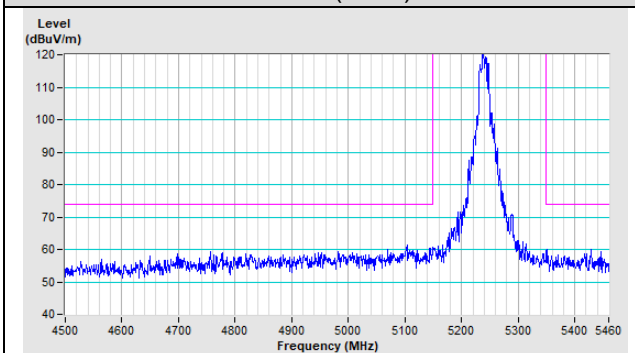

Vertical (Average)

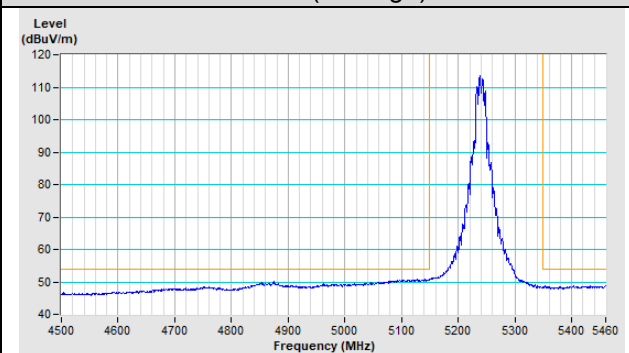

802.11ax (HE20) Channel 36

Horizontal (Peak)

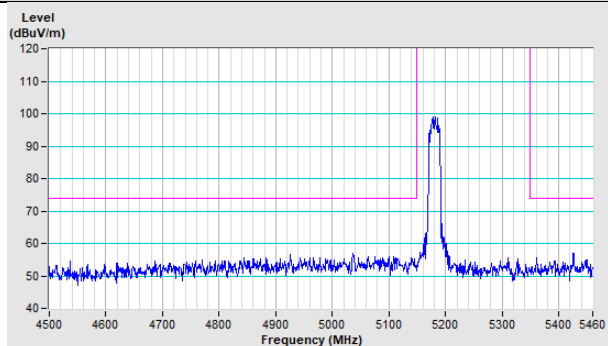

Horizontal (Average)

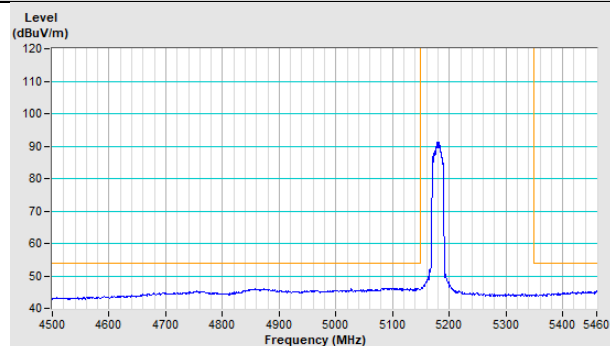

Vertical (Peak)

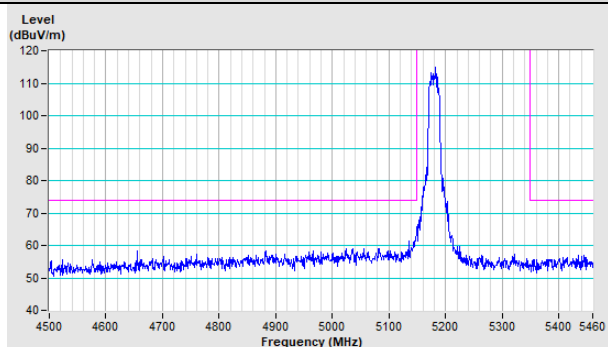

Vertical (Average)

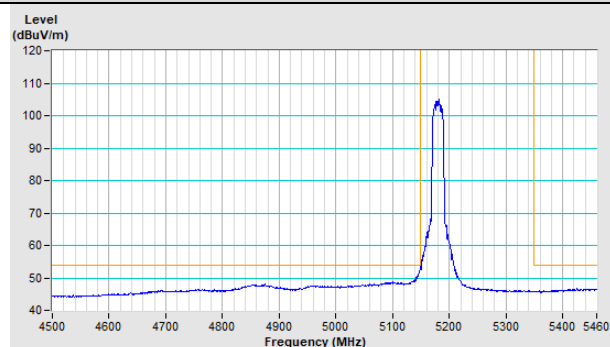

802.11ax (HE20) Channel 40

Horizontal (Peak)

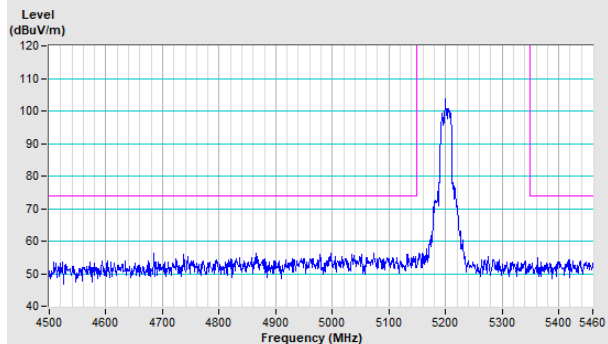

Horizontal (Average)

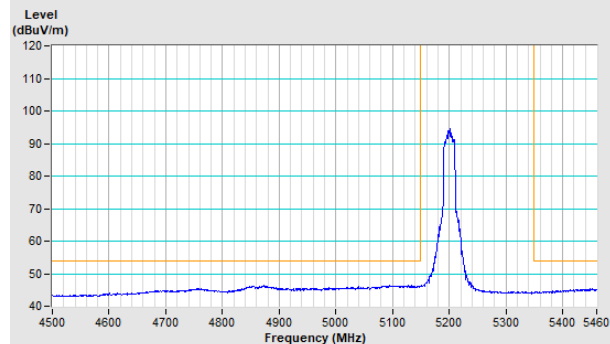

Vertical (Peak)

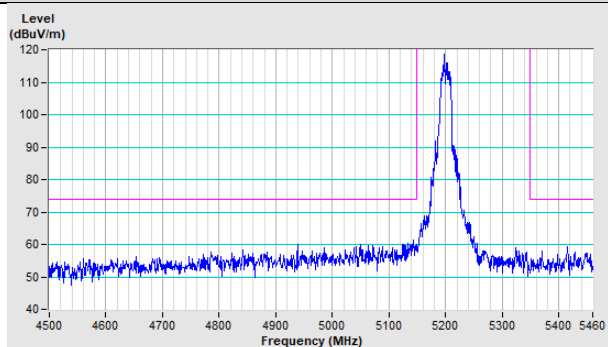

Vertical (Average)

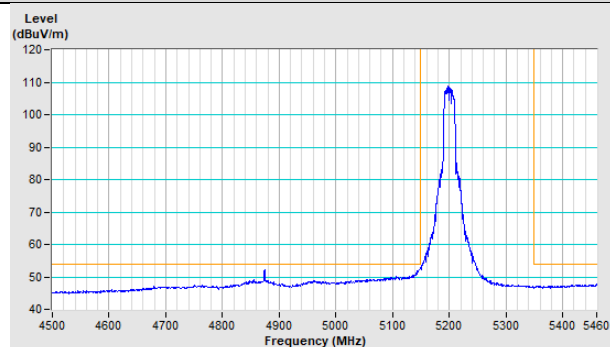

802.11ax (HE20) Channel 48

Horizontal (Peak)

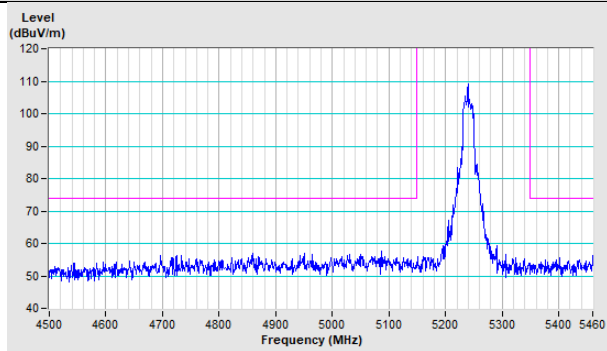

Horizontal (Average)

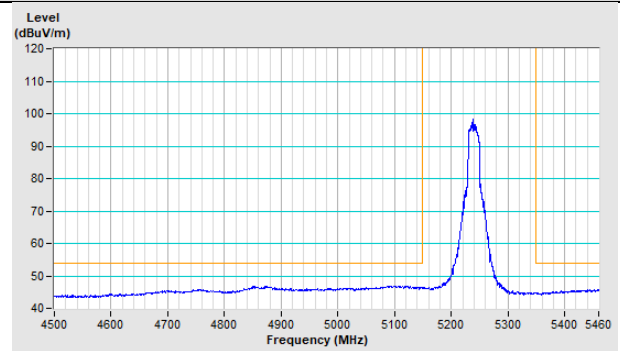

Vertical (Peak)

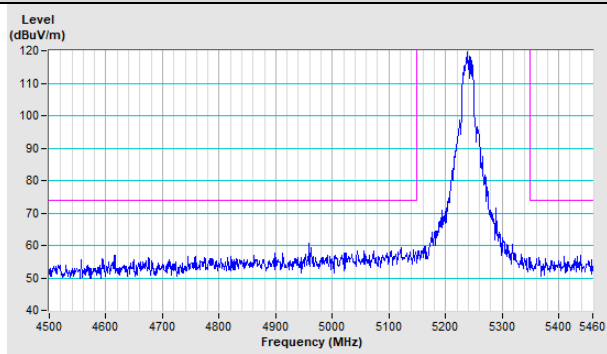

Vertical (Average)

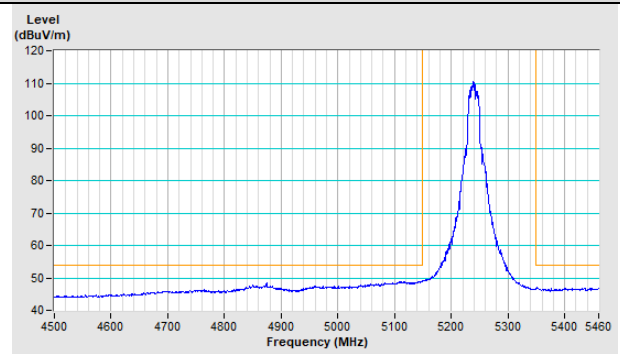



802.11ax (HE40) Channel 38

Horizontal (Peak)

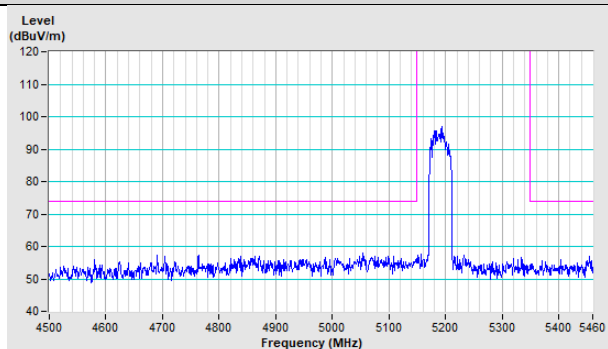

Horizontal (Average)

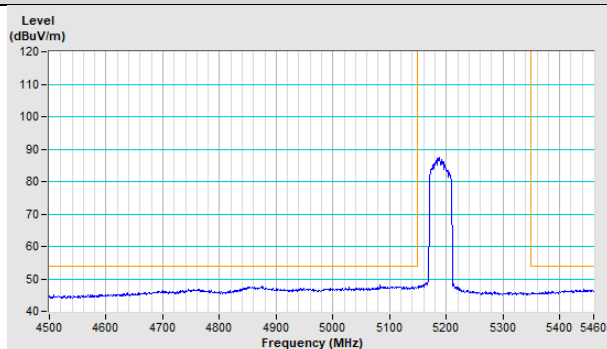

Vertical (Peak)

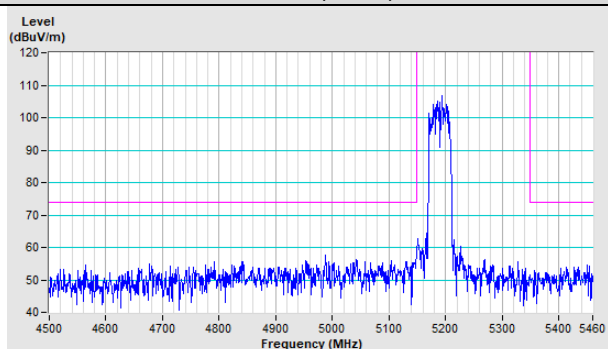

Vertical (Average)

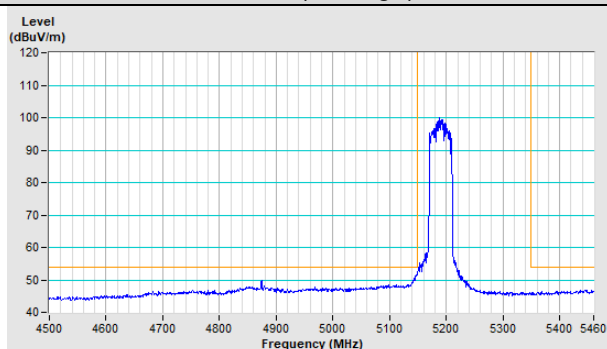

802.11ax (HE40) Channel 46

Horizontal (Peak)

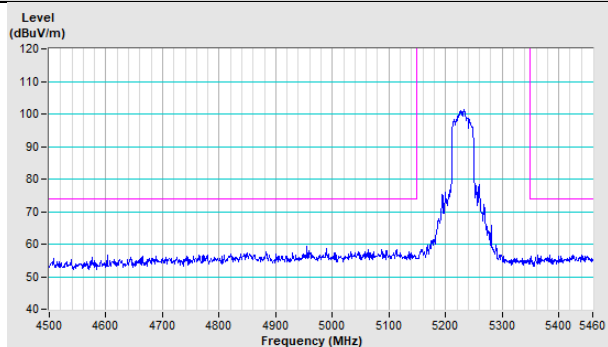

Horizontal (Average)

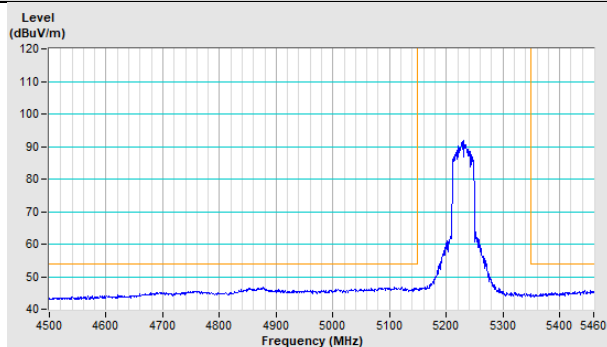

Vertical (Peak)

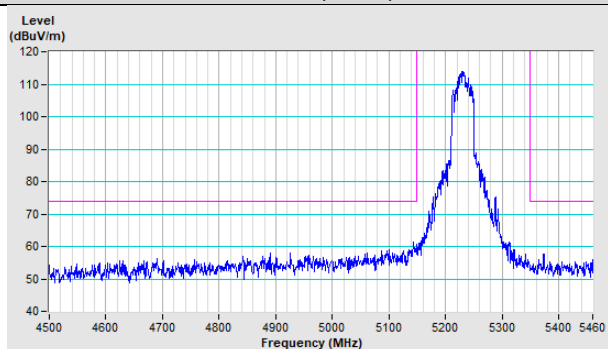

Vertical (Average)

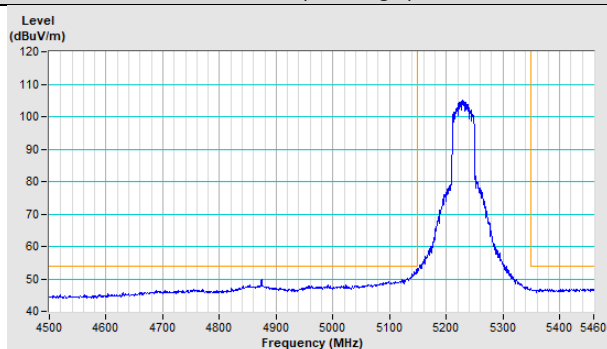

802.11ax (HE80) Channel 42

Horizontal (Peak)

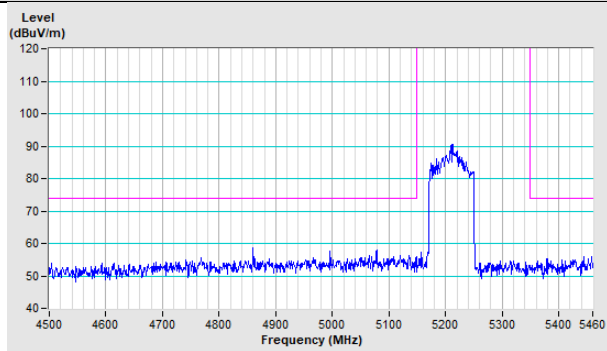

Horizontal (Average)

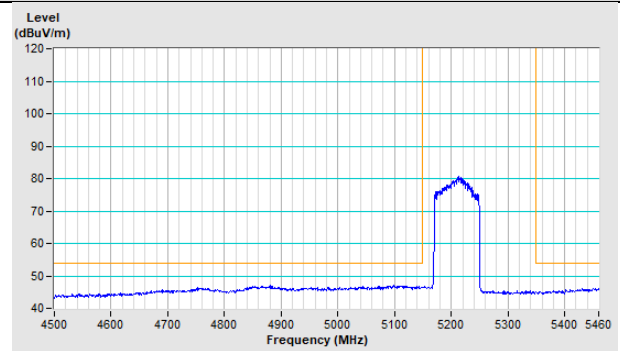

Vertical (Peak)

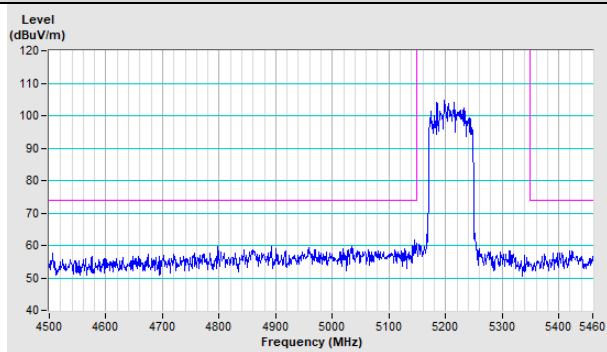

Vertical (Average)

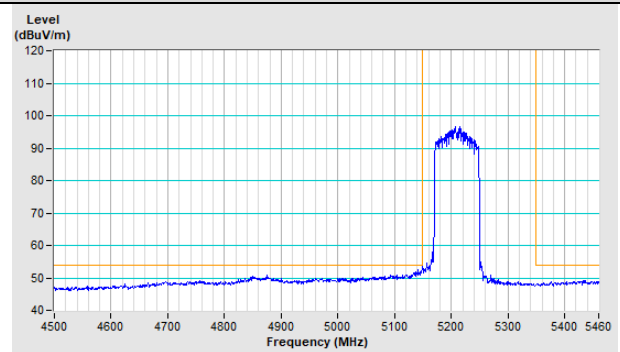

## Appendix – Information of the Testing Laboratories

We, Bureau Veritas Consumer Products Services (H.K.) Ltd., Taoyuan Branch, were founded in 1988 to provide our best service in EMC, Radio, Telecom and Safety consultation. Our laboratories are FCC recognized accredited test firms and accredited and approved according to ISO/IEC 17025.

If you have any comments, please feel free to contact us at the following:

### Lin Kou EMC/RF Lab

Tel: 886-2-26052180

Fax: 886-2-26051924

### Hsin Chu EMC/RF/Telecom Lab

Tel: 886-3-6668565

Fax: 886-3-6668323

### Hwa Ya EMC/RF/Safety

Tel: 886-3-3183232

Fax: 886-3-3270892

**Email:** [service.adt@tw.bureauveritas.com](mailto:service.adt@tw.bureauveritas.com)

**Web Site:** [www.bureauveritas-adt.com](http://www.bureauveritas-adt.com)

The address and road map of all our labs can be found in our web site also.

--- END ---