

FCC Test Report

Report No.: RF200603E10-1 R1

FCC ID: PY320200501

Test Model: MR80

Serialized Model: MS80

Received Date: June 03, 2020

Test Date: Aug. 12 to 27, 2020

Issued Date: Nov. 11, 2020

Applicant: NETGEAR, Inc.

Address: 350 East Plumeria Drive San Jose, CA 95134

Issued By: Bureau Veritas Consumer Products Services (H.K.) Ltd., Taoyuan Branch
Hsin Chu Laboratory

Lab Address: E-2, No.1, Li Hsin 1st Road, Hsinchu Science Park, Hsinchu City 300,
Taiwa.

Test Location: E-2, No.1, Li Hsin 1st Road, Hsinchu Science Park, Hsinchu City 300,
Taiwan.

**FCC Registration /
Designation Number:** 723255 / TW2022



This report is for your exclusive use. Any copying or replication of this report to or for any other person or entity, or use of our name or trademark, is permitted only with our prior written permission. This report sets forth our findings solely with respect to the test samples identified herein. The results set forth in this report are not indicative or representative of the quality or characteristics of the lot from which a test sample was taken or any similar or identical product unless specifically and expressly noted. Our report includes all of the tests requested by you and the results thereof based upon the information that you provided to us. You have 60 days from date of issuance of this report to notify us of any material error or omission caused by our negligence, provided, however, that such notice shall be in writing and shall specifically address the issue you wish to raise. A failure to raise such issue within the prescribed time shall constitute your unqualified acceptance of the completeness of this report, the tests conducted and the correctness of the report contents. Unless specific mention, the uncertainty of measurement has been explicitly taken into account to declare the compliance or non-compliance to the specification.

Table of Contents

Release Control Record	4
1 Certificate of Conformity	5
2 Summary of Test Results	6
2.1 Measurement Uncertainty	6
2.2 Modification Record	6
3 General Information	7
3.1 General Description of EUT	7
3.2 Description of Test Modes	10
3.2.1 Test Mode Applicability and Tested Channel Detail	11
3.3 Duty Cycle of Test Signal	14
3.4 Description of Support Units	16
3.4.1 Configuration of System under Test	17
3.5 General Description of Applied Standard and references	18
4 Test Types and Results	19
4.1 Radiated Emission and Bandedge Measurement	19
4.1.1 Limits of Radiated Emission and Bandedge Measurement	19
4.1.2 Test Instruments	20
4.1.3 Test Procedure	22
4.1.4 Deviation from Test Standard	23
4.1.5 Test Setup	23
4.1.6 EUT Operating Condition	24
4.1.7 Test Results	25
4.2 Conducted Emission Measurement	47
4.2.1 Limits of Conducted Emission Measurement	47
4.2.2 Test Instruments	47
4.2.3 Test Procedure	48
4.2.4 Deviation from Test Standard	48
4.2.5 Test Setup	48
4.2.6 EUT Operating Condition	48
4.2.7 Test Results	49
4.3 Transmit Power Measurement	53
4.3.1 Limits of Transmit Power Measurement	53
4.3.2 Test Setup	53
4.3.3 Test Instruments	53
4.3.4 Test Procedure	53
4.3.5 Deviation from Test Standard	53
4.3.6 EUT Operating Condition	53
4.3.7 Test Results	54
4.4 Occupied Bandwidth Measurement	62
4.4.1 Test Setup	62
4.4.2 Test Instruments	62
4.4.3 Test Procedure	62
4.4.4 Test Results	63
4.5 Peak Power Spectral Density Measurement	70
4.5.1 Limits of Peak Power Spectral Density Measurement	70
4.5.2 Test Setup	70
4.5.3 Test Instruments	70
4.5.4 Test Procedure	70
4.5.5 Deviation from Test Standard	70
4.5.6 EUT Operating Condition	70
4.5.7 Test Results	71
4.6 Frequency Stability Measurement	75
4.6.1 Limits of Frequency Stability Measurement	75

4.6.2	Test Setup.....	75
4.6.3	Test Instruments	75
4.6.4	Test Procedure	75
4.6.5	Deviation from Test Standard	75
4.6.6	EUT Operating Condition	75
4.6.7	Test Results	76
4.7	6dB Bandwidth Measurement	77
4.7.1	Limits of 6dB Bandwidth Measurement.....	77
4.7.2	Test Setup.....	77
4.7.3	Test Instruments	77
4.7.4	Test Procedure	77
4.7.5	Deviation from Test Standard	77
4.7.6	EUT Operating Condition	77
4.7.7	Test Results	78
5	Pictures of Test Arrangements.....	80
	Annex A- Radiated Out of Band Emission (OOBE) Measurement (For U-NII-3 band)	81
	Annex B- Band-edge measurement (For U-NII-1 band)	84
	Appendix – Information of the Testing Laboratories	88

Release Control Record

Issue No.	Description	Date Issued
RF200603E10-1	Original release.	Sep. 07, 2020
RF200603E10-1 R1	Modified Simultaneously transmission condition.	Nov. 11, 2020

1 Certificate of Conformity

Product: Orion
Brand: NETGEAR
Test Model: MR80
Series Model: MS80
Sample Status: ENGINEERING SAMPLE
Applicant: NETGEAR, Inc
Test Date: Aug. 12 to 27, 2020
Standard: 47 CFR FCC Part 15, Subpart E (Section 15.407)
ANSI C63.10: 2013

The above equipment has been tested by **Bureau Veritas Consumer Products Services (H.K.) Ltd., Taoyuan Branch**, and found compliance with the requirement of the above standards. The test record, data evaluation & Equipment Under Test (EUT) configurations represented herein are true and accurate accounts of the measurements of the sample's EMC characteristics under the conditions specified in this report.

Prepared by : Vivian Huang , **Date:** Nov. 11, 2020
Vivian Hunag / Specialist

Approved by : Clark Lin , **Date:** Nov. 11, 2020
Clark Lin / Technical Manager

2 Summary of Test Results

47 CFR FCC Part 15, Subpart E (Section 15.407)			
FCC Clause	Test Item	Result	Remarks
15.407(b)(6)	AC Power Conducted Emissions	Pass	Meet the requirement of limit. Minimum passing margin is -10.15dB at 0.30625MHz.
15.407(b) (1/2/3/4(i/ii)/6)	Radiated Emissions & Band Edge Measurement*	Pass	Meet the requirement of limit. Minimum passing margin is -0.2dB at 5150.00MHz.
15.407(a)(1/2/3)	Max Average Transmit Power	Pass	Meet the requirement of limit.
---	Occupied Bandwidth Measurement	-	Reference only.
15.407(a)(1/2/3)	Peak Power Spectral Density	Pass	Meet the requirement of limit.
15.407(e)	6dB bandwidth	Pass	Meet the requirement of limit. (U-NII-3 Band only)
15.407(g)	Frequency Stability	Pass	Meet the requirement of limit.
15.203	Antenna Requirement	Pass	Antenna connector is i-pex(MHF) not a standard connector.

Note:

1. For U-NII-3 band compliance with rule part 15.407(b)(4)(i), the OOB test plots were recorded in Annex A.
2. For U-NII-1 band compliance with rule 15.407(b) of the band-edge items, the test plots were recorded in Annex B. Test Procedures refer to report 4.1.3.
3. Determining compliance based on the results of the compliance measurement, not taking into account measurement instrumentation uncertainty.

2.1 Measurement Uncertainty

Where relevant, the following measurement uncertainty levels have been estimated for tests performed on the EUT as specified in CISPR 16-4-2:

Measurement	Frequency	Expanded Uncertainty (k=2) (\pm)
Conducted Emissions at mains ports	150kHz ~ 30MHz	1.9 dB
Radiated Emissions up to 1 GHz	9kHz ~ 30MHz	3.1 dB
	30MHz ~ 1GHz	5.5 dB
Radiated Emissions above 1 GHz	1GHz ~ 18GHz	5.1 dB
	18GHz ~ 40GHz	5.3 dB

2.2 Modification Record

There were no modifications required for compliance.

3 General Information

3.1 General Description of EUT

Product	Orion
Brand	NETGEAR
Test Model	MR80
Series Model	MS80
Status of EUT	ENGINEERING SAMPLE
Power Supply Rating	12Vdc from power adapter
Modulation Type	CCK, DQPSK, DBPSK for DSSS 64QAM, 16QAM, QPSK, BPSK for OFDM 256QAM for OFDM in 11ac mode and VHT20/40 in 2.4GHz 1024QAM for OFDMA in 11ax HE mode
Modulation Technology	DSSS, OFDM, OFDMA
Transfer Rate	802.11b: up to 11 Mbps 802.11a/g: up to 54 Mbps 802.11n: up to 450 Mbps 802.11ac: up to 300 Mbps 802.11ax: up to 1801.5 Mbps
Operating Frequency	2.4GHz: 2.412GHz ~ 2.462GHz 5GHz: 5.18 ~ 5.24GHz, 5.745 ~ 5.825GHz
Number of Channel	2.4GHz: 802.11b, 802.11g, 802.11n (HT20), VHT20, 802.11ax (HE20): 11 802.11n (HT40), VHT40, 802.11ax (HE40): 7 5GHz: 802.11a, 802.11n (HT20), 802.11ac (VHT20), 802.11ax (HE20): 9 802.11n (HT40), 802.11ac (VHT40), 802.11ax (HE40): 4 802.11ac (VHT80), 802.11ax (HE80): 2
Output Power	CDD Mode: 2.412 ~ 2.462 GHz: 915.235 mW 5.18 ~ 5.24 GHz: 925.902 mW 5.745 ~ 5.825 GHz: 927.847 mW Beamforming Mode: 2.412 ~ 2.462 GHz: 915.235 mW 5.18 ~ 5.24 GHz: 925.902 mW 5.745 ~ 5.825 GHz: 927.847 mW
Antenna Type	Refer to Note
Antenna Connector	Refer to Note
Accessory Device	Adapter x1
Data Cable Supplied	RJ45 cable x1 (Unshielded, 1.8m)

Note:

- The EUT has below product names and model names which are identical to each other in all aspects except for the followings:

Product Name	Model Name	Description
Orion	MR80	Function: Master More for WAN port and single GPHY
Orion	MS80	Function: Client

Note: From the above models, model: MR80 was selected as representative model for the test and its data was recorded in this report.

2. The EUT has two radios as following table:

Radio 1	Radio 2
WLAN 2.4GHz + WLAN 5GHz (U-NII-1 Band)	WLAN 5GHz (U-NII-3 Band)

3. Simultaneously transmission condition.

Condition	Technology
1	WLAN 2.4GHz + WLAN 5GHz (U-NII-1 Band) + WLAN 5GHz (U-NII-3 Band)

Note: The emission of the simultaneous operation has been evaluated and no non-compliance was found.

4. The EUT must be supplied with a power adapter as following table:

No.	Brand	Model No.	P/N	Spec.
1	NETGEAR	ADS-40FPA-12 12030EPCU-L ADS-40FPA-12 12030EPC-L	332-11525-01	Input: 100-120Vac, 1.0A, 50/60Hz Output: 12V, 2.5A DC Output cable: Unshielded, 1.8m
2	NETGEAR	2ABL030F 1 NA	332-10758-01	Input: 100-120Vac, 1.0A, 50/60Hz Output: 12V, 2.5A DC Output cable: Unshielded, 1.8m

Note:

1. From the above adapters, the AC Power Conducted Emissions and Radiated Emissions worse case was found in **Adapter 2**. Therefore only the test data of the mode was recorded in this report.

5. The directional antenna gain, please refer to the following table:

Frequency Range (GHz)	Directional Antenna Gain (dBi)	Antenna Type	Connector Type
2.4~2.4835	4.31	PIFA	i-pex(MHF)
5.15 ~ 5.25	4.72		
5.725 ~ 5.85	6.02		

Note: More detailed information, please refer to antenna specification.

6. The EUT incorporates a MIMO function:

2.4GHz Band		
MODULATION MODE	TX & RX CONFIGURATION	
802.11b	2TX	2RX
802.11g	2TX	2RX
802.11n (HT20)	2TX	2RX
802.11n (HT40)	2TX	2RX
VHT20	2TX	2RX
VHT40	2TX	2RX
802.11ax (HE20)	2TX	2RX
802.11ax (HE40)	2TX	2RX
5GHz Band (For U-NII-1 Band)		
MODULATION MODE	TX & RX CONFIGURATION	
802.11a	2TX	2RX
802.11n (HT20)	2TX	2RX
802.11n (HT40)	2TX	2RX
802.11ac (VHT20)	2TX	2RX
802.11ac (VHT40)	2TX	2RX
802.11ac (VHT80)	2TX	2RX
802.11ax (HE20)	2TX	2RX
802.11ax (HE40)	2TX	2RX
802.11ax (HE80)	2TX	2RX
5GHz Band (For U-NII-3 Band)		
MODULATION MODE	TX & RX CONFIGURATION	
802.11a	3TX	3RX
802.11n (HT20)	3TX	3RX
802.11n (HT40)	3TX	3RX
802.11ac (VHT20)	3TX	3RX
802.11ac (VHT40)	3TX	3RX
802.11ac (VHT80)	3TX	3RX
802.11ax (HE20)	3TX	3RX
802.11ax (HE40)	3TX	3RX
802.11ax (HE80)	3TX	3RX

Note:

1. All of modulation mode support beamforming function except 802.11a/b/g modulation mode.
2. The EUT support Beamforming and CDD mode, therefore both mode were investigated and the worst case scenario was identified. The worst case data were presented in test report.
3. The modulation and bandwidth are similar for 802.11n mode for 20MHz (40MHz), 802.11ac mode for 20MHz (40MHz, 80MHz) and 802.11ax mode for 20MHz (40MHz, 80MHz), therefore the manufacturer will control the power for 802.11ac mode is the same as the 802.11ax mode or more lower than it and investigated worst case to representative mode in test report. (Final test mode refer to section 3.2.1)

7. The above EUT information is declared by manufacturer and for more detailed features description, please refers to the manufacturer's specifications or user's manual.
8. The above Antenna information is declared by manufacturer and for more detailed features description, please refer to the manufacturer's specifications, the laboratory shall not be held responsible.

3.2 Description of Test Modes

FOR 5180 ~ 5240MHz

4 channels are provided for 802.11a, 802.11n (HT20), 802.11ac (VHT20), 802.11ax (HE20):

Channel	Frequency	Channel	Frequency
36	5180 MHz	44	5220 MHz
40	5200 MHz	48	5240 MHz

2 channels are provided for 802.11n (HT40), 802.11ac (VHT40), 802.11ax (HE40):

Channel	Frequency	Channel	Frequency
38	5190 MHz	46	5230 MHz

1 channel is provided for 802.11ac (VHT80), 802.11ax (HE80):

Channel	Frequency
42	5210 MHz

FOR 5745 ~ 5825MHz:

5 channels are provided for 802.11a, 802.11n (HT20), 802.11ac (VHT20), 802.11ax (HE20):

Channel	Frequency	Channel	Frequency
149	5745 MHz	161	5805 MHz
153	5765 MHz	165	5825 MHz
157	5785 MHz		

2 channels are provided for 802.11n (HT40), 802.11ac (VHT40), 802.11ax (HE40):

Channel	Frequency	Channel	Frequency
151	5755 MHz	159	5795 MHz

1 channel is provided for 802.11ac (VHT80), 802.11ax (HE80):

Channel	Frequency
155	5775 MHz

3.2.1 Test Mode Applicability and Tested Channel Detail

EUT Configure Mode	Applicable To				Description
	RE \geq 1G	RE<1G	PLC	APCM	
-	√	√	√	√	-

Where **RE \geq 1G**: Radiated Emission above 1GHz
RE<1G: Radiated Emission below 1GHz
PLC: Power Line Conducted Emission
APCM: Antenna Port Conducted Measurement

Radiated Emission Test (Above 1GHz):

- Pre-Scan has been conducted to determine the worst-case mode from all possible combinations between available modulations, data rates and antenna ports (if EUT with antenna diversity architecture).
- Following channel(s) was (were) selected for the final test as listed below.

CDD Mode						
Mode	FREQ. Band (MHz)	Available Channel	Tested Channel	Modulation Technology	Modulation Type	Data Rate Parameter
802.11a	5180-5240	36 to 48	36, 40, 48	OFDM	BPSK	6Mb/s
802.11ax (HE20)		36 to 48	36, 40, 48	OFDMA	BPSK	MCS0
802.11ax (HE40)		38 to 46	38, 46	OFDMA	BPSK	MCS0
802.11ax (HE80)		42	42	OFDMA	BPSK	MCS0
802.11a	5745-5825	149 to 165	149, 157, 165	OFDM	BPSK	6Mb/s
802.11ax (HE20)		149 to 165	149, 157, 165	OFDMA	BPSK	MCS0
802.11ax (HE40)		151 to 159	151, 159	OFDMA	BPSK	MCS0
802.11ax (HE80)		155	155	OFDMA	BPSK	MCS0

Radiated Emission Test (Below 1GHz):

- Pre-Scan has been conducted to determine the worst-case mode from all possible combinations between available modulations, data rates and antenna ports (if EUT with antenna diversity architecture).
- Following channel(s) was (were) selected for the final test as listed below.

CDD Mode						
Mode	FREQ. Band (MHz)	Available Channel	Tested Channel	Modulation Technology	Modulation Type	Data Rate Parameter
802.11ax (HE20)	5180-5240	36 to 48	40	OFDMA	BPSK	MCS0
802.11ax (HE20)	5745-5825	149 to 165	157	OFDMA	BPSK	MCS0

Power Line Conducted Emission Test:

- Pre-Scan has been conducted to determine the worst-case mode from all possible combinations between available modulations, data rates and antenna ports (if EUT with antenna diversity architecture).
- Following channel(s) was (were) selected for the final test as listed below.

CDD Mode						
Mode	FREQ. Band (MHz)	Available Channel	Tested Channel	Modulation Technology	Modulation Type	Data Rate Parameter
802.11ax (HE20)	5180-5240	36 to 48	40	OFDMA	BPSK	MCS0
802.11ax (HE20)	5745-5825	149 to 165	157	OFDMA	BPSK	MCS0

Antenna Port Conducted Measurement:

- This item includes all test value of each mode, but only includes spectrum plot of worst value of each mode.
- Pre-Scan has been conducted to determine the worst-case mode from all possible combinations between available modulations, data rates and antenna ports (if EUT with antenna diversity architecture).
- Following channel(s) was (were) selected for the final test as listed below.

CDD Mode						
Mode	FREQ. Band (MHz)	Available Channel	Tested Channel	Modulation Technology	Modulation Type	Data Rate Parameter
802.11a	5180-5240	36 to 48	36, 40, 48	OFDM	BPSK	6Mb/s
802.11ac (VHT20) (for output power)		36 to 48	36, 40, 48	OFDM	BPSK	MCS0
802.11ac (VHT40) (for output power)		38 to 46	38, 46	OFDM	BPSK	MCS0
802.11ac (VHT80) (for output power)		42	42	OFDM	BPSK	MCS0
802.11ax (HE20)		36 to 48	36, 40, 48	OFDMA	BPSK	MCS0
802.11ax (HE40)		38 to 46	38, 46	OFDMA	BPSK	MCS0
802.11ax (HE80)		42	42	OFDMA	BPSK	MCS0
802.11a	5745-5825	149 to 165	149, 157, 165	OFDM	BPSK	6Mb/s
802.11ac (VHT20) (for output power)		149 to 165	149, 157, 165	OFDM	BPSK	MCS0
802.11ac (VHT40) (for output power)		151 to 159	151, 159	OFDM	BPSK	MCS0
802.11ac (VHT80) (for output power)		155	155	OFDM	BPSK	MCS0
802.11ax (HE20)		149 to 165	149, 157, 165	OFDMA	BPSK	MCS0
802.11ax (HE40)		151 to 159	151, 159	OFDMA	BPSK	MCS0
802.11ax (HE80)		155	155	OFDMA	BPSK	MCS0

Beamforming Mode (output power only)						
Mode	FREQ. Band (MHz)	Available Channel	Tested Channel	Modulation Technology	Modulation Type	Data Rate Parameter
802.11ac (VHT20)	5180-5240	36 to 48	36, 40, 48	OFDM	BPSK	MCS0
802.11ac (VHT40)		38 to 46	38, 46	OFDM	BPSK	MCS0
802.11ac (VHT80)		42	42	OFDM	BPSK	MCS0
802.11ax (HE20)		36 to 48	36, 40, 48	OFDMA	BPSK	MCS0
802.11ax (HE40)		38 to 46	38, 46	OFDMA	BPSK	MCS0
802.11ax (HE80)		42	42	OFDMA	BPSK	MCS0
802.11ac (VHT20)	5745-5825	149 to 165	149, 157, 165	OFDM	BPSK	MCS0
802.11ac (VHT40)		151 to 159	151, 159	OFDM	BPSK	MCS0
802.11ac (VHT80)		155	155	OFDM	BPSK	MCS0
802.11ax (HE20)		149 to 165	149, 157, 165	OFDMA	BPSK	MCS0
802.11ax (HE40)		151 to 159	151, 159	OFDMA	BPSK	MCS0
802.11ax (HE80)		155	155	OFDMA	BPSK	MCS0

Test Condition:

Applicable To	Environmental Conditions	Input Power	Tested By
RE \geq 1G	25deg. C, 75%RH	120Vac, 60Hz	Ryan Du
RE $<$ 1G	22deg. C, 70%RH	120Vac, 60Hz	Ryan Du
PLC	25deg. C, 75%RH	120Vac, 60Hz	Sampson Chen
APCM	25deg. C, 60%RH	120Vac, 60Hz	Jyunchun Lin

3.3 Duty Cycle of Test Signal

If duty cycle of test signal is $\geq 98\%$, duty factor is not required.

For U-NII-1:

802.11a: Duty cycle = 2.964 ms / 3.004 ms = 0.987

802.11ax (HE20): Duty cycle = 2.276 ms / 2.311 ms = 0.985

802.11ax (HE40): Duty cycle = 2.363 ms / 2.396 ms = 0.986

802.11ax (HE80): Duty cycle = 2.439 ms / 2.473 ms = 0.986

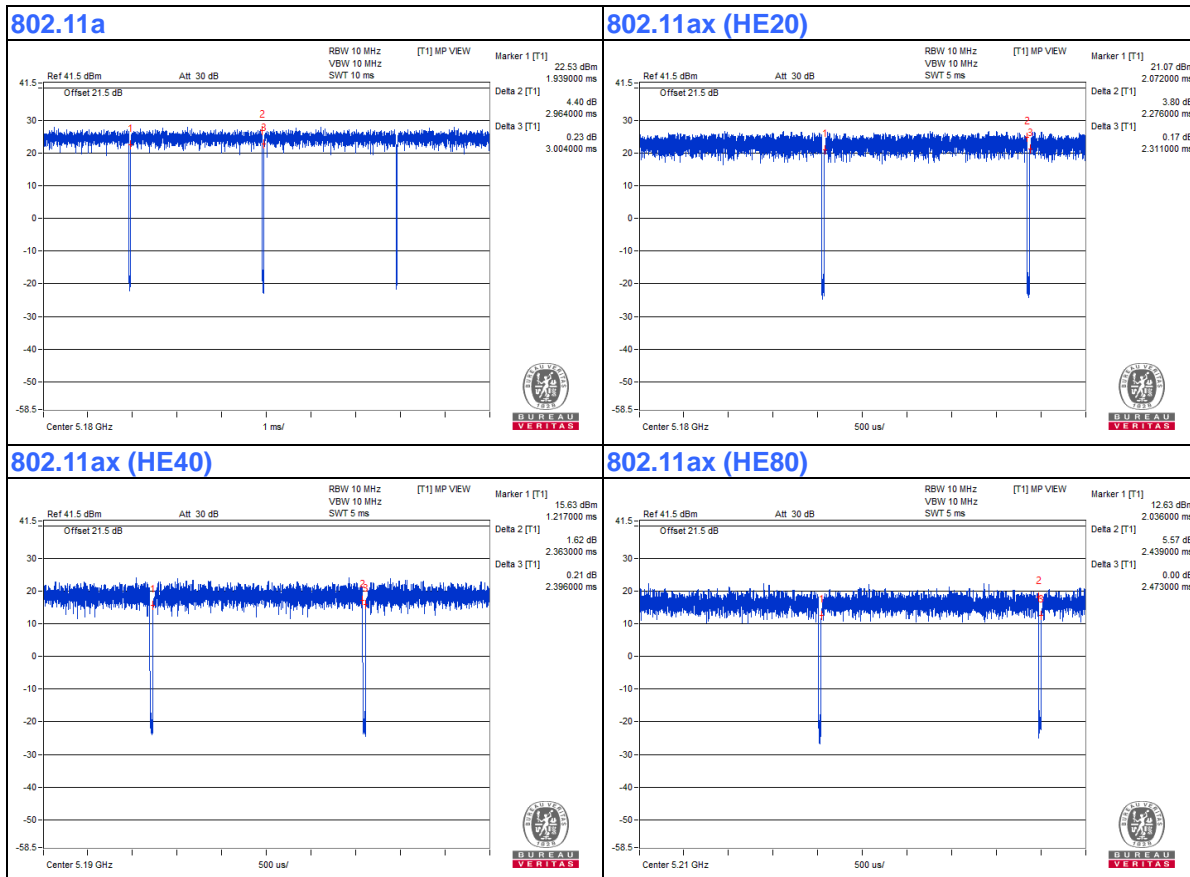

For U-NII-3:

802.11a: Duty cycle = 2.97 ms /3.004 ms=0.989

802.11ax (HE20): Duty cycle = 2.277 ms /2.311 ms=0.985

802.11ax (HE40): Duty cycle = 2.363 ms /2.394 ms=0.987

802.11ax (HE80): Duty cycle = 2.44 ms /2.474 ms=0.986

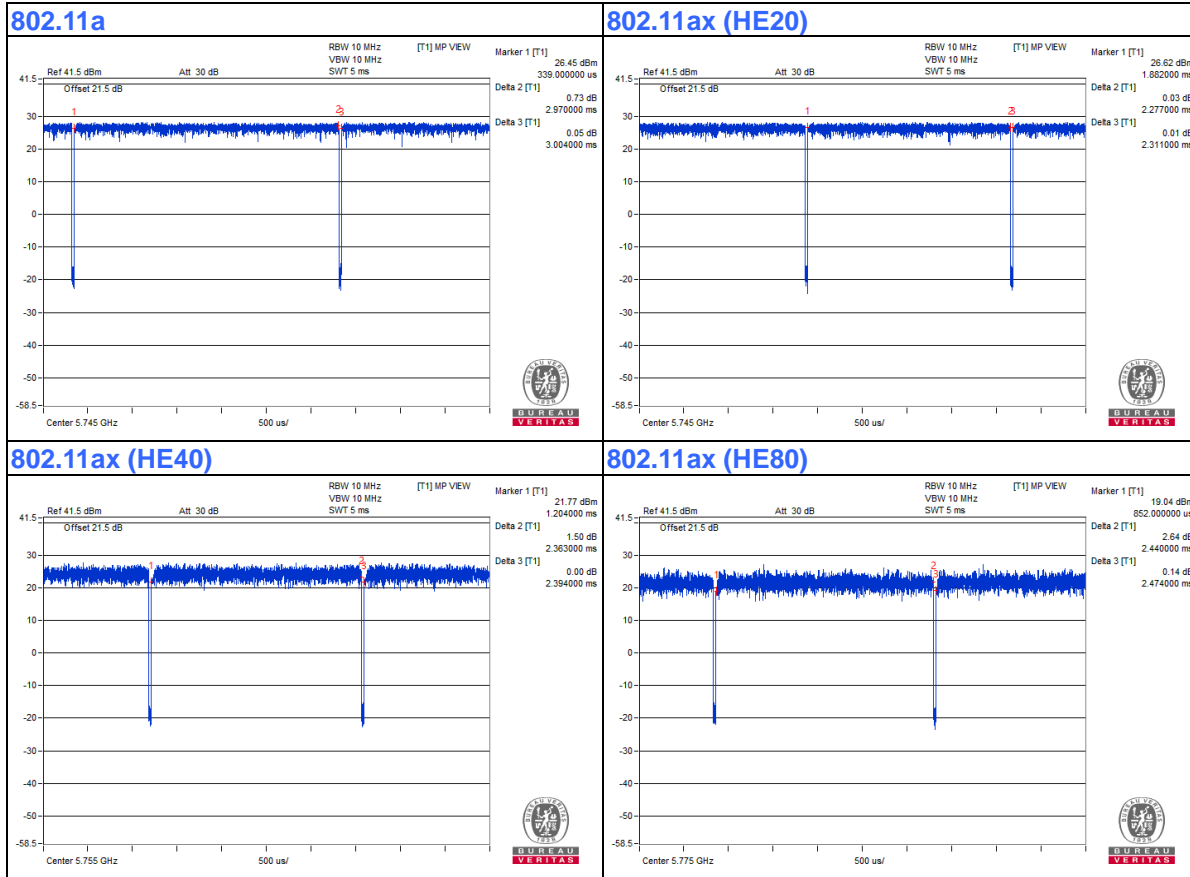

3.4 Description of Support Units

The EUT has been tested as an independent unit together with other necessary accessories or support units. The following support units or accessories were used to form a representative test configuration during the tests.

ID	Product	Brand	Model No.	Serial No.	FCC ID	Remarks
A.	Laptop	DELL	E5430	HYV4VY1	FCC DoC	Provided by Lab
B.	Laptop	DELL	E6420	B92T3R1	FCC DoC	Provided by Lab
C.	HUB	ZyXEL	GS1100-16	S150H44000046	FCC DoC	Provided by Lab

Note:

- All power cords of the above support units are non-shielded (1.8m).

ID	Descriptions	Qty.	Length (m)	Shielding (Yes/No)	Cores (Qty.)	Remarks
1.	DC Cable	1	1.8	No	0	Supplied by client
2.	RJ-45 Cable	1	10	No	0	Provided by Lab
3.	RJ-45 Cable	1	10	No	0	Provided by Lab
4.	RJ-45 Cable	2	10	No	0	Provided by Lab

3.4.1 Configuration of System under Test

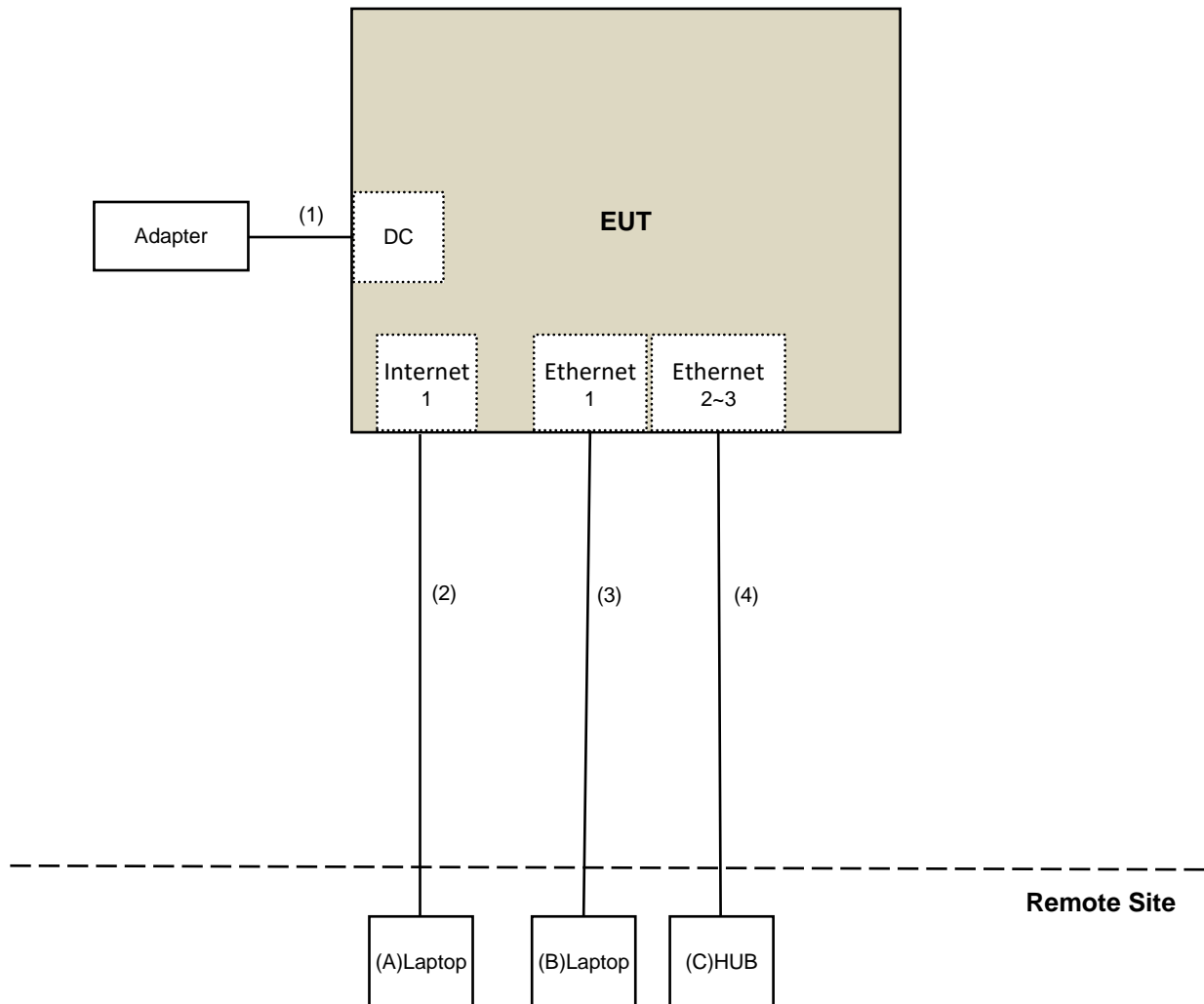

3.5 General Description of Applied Standard and references

The EUT is a RF Product. According to the specifications of the manufacturer, it must comply with the requirements of the following standards and references:

Test Standard:

FCC Part 15, Subpart E (15.407)
ANSI C63.10-2013

All test items have been performed and recorded as per the above standards.

References Test Guidance:

KDB 789033 D02 General UNII Test Procedure New Rules v02r01
KDB 662911 D01 Multiple Transmitter Output v02r01

All test items have been performed as a reference to the above KDB test guidance.

4 Test Types and Results

4.1 Radiated Emission and Bandedge Measurement

4.1.1 Limits of Radiated Emission and Bandedge Measurement

Radiated emissions which fall in the restricted bands must comply with the radiated emission limits specified as below table.

Frequencies (MHz)	Field Strength (microvolts/meter)	Measurement Distance (meters)
0.009 ~ 0.490	2400/F(kHz)	300
0.490 ~ 1.705	24000/F(kHz)	30
1.705 ~ 30.0	30	30
30 ~ 88	100	3
88 ~ 216	150	3
216 ~ 960	200	3
Above 960	500	3

NOTE:

1. The lower limit shall apply at the transition frequencies.
2. Emission level (dBuV/m) = 20 log Emission level (uV/m).
3. For frequencies above 1000MHz, the field strength limits are based on average detector, however, the peak field strength of any emission shall not exceed the maximum permitted average limits, specified above by more than 20dB under any condition of modulation.

Limits of unwanted emission out of the restricted bands

Applicable To		Limit	
789033 D02 General UNII Test Procedure New Rules v02r01		Field Strength at 3m	
		PK:74 (dBuV/m)	AV:54 (dBuV/m)
Frequency Band	Applicable To	EIRP Limit	Equivalent Field Strength at 3m
5150~5250 MHz	15.407(b)(1)	PK:-27 (dBm/MHz)	PK:68.2(dBuV/m)
5250~5350 MHz	15.407(b)(2)		
5470~5725 MHz	15.407(b)(3)		
5725~5850 MHz	15.407(b)(4)(i)	PK:-27 (dBm/MHz) ^{*1} PK:10 (dBm/MHz) ^{*2} PK:15.6 (dBm/MHz) ^{*3} PK:27 (dBm/MHz) ^{*4}	PK: 68.2(dBuV/m) ^{*1} PK:105.2 (dBuV/m) ^{*2} PK: 110.8(dBuV/m) ^{*3} PK:122.2 (dBuV/m) ^{*4}
^{*1} beyond 75 MHz or more above of the band edge.		^{*2} below the band edge increasing linearly to 10 dBm/MHz at 25 MHz above.	
^{*3} below the band edge increasing linearly to a level of 15.6 dBm/MHz at 5 MHz above.		^{*4} from 5 MHz above or below the band edge increasing linearly to a level of 27 dBm/MHz at the band edge.	

Note:

The following formula is used to convert the equipment isotropic radiated power (eirp) to field strength:

$$E = \frac{1000000\sqrt{30P}}{3} \mu\text{V/m, where P is the eirp (Watts).}$$

4.1.2 Test Instruments

For Radiated emission & OOB & Bandedge test:

DESCRIPTION & MANUFACTURER	MODEL NO.	SERIAL NO.	CALIBRATED DATE	CALIBRATED UNTIL
Test Receiver Agilent	N9038A	MY51210202	Dec. 13, 2019	Dec. 12, 2020
Pre-Amplifier EMCI	EMC001340	980142	May 25, 2020	May 24, 2021
Loop Antenna Electro-Metrics	EM-6879	264	Feb. 18, 2020	Feb. 17, 2021
RF Cable	NA	LOOPCAB-001	Jan. 08, 2020	Jan. 07, 2021
RF Cable	NA	LOOPCAB-002	Jan. 08, 2020	Jan. 07, 2021
Pre-Amplifier Mini-Circuits	ZFL-1000VH2B	AMP-ZFL-01	Oct. 23, 2019	Oct. 22, 2020
Trilog Broadband Antenna SCHWARZBECK	VULB 9168	9168-406	Nov. 11, 2019	Nov. 10, 2020
RF Cable	8D	966-4-1	Mar. 18, 2020	Mar. 17, 2021
RF Cable	8D	966-4-2	Mar. 18, 2020	Mar. 17, 2021
RF Cable	8D	966-4-3	Mar. 18, 2020	Mar. 17, 2021
Fixed attenuator Mini-Circuits	UNAT-5+	PAD-3m-4-01	Sep. 26, 2019	Sep. 25, 2020
Horn_Antenna SCHWARZBECK	BBHA 9120D	9120D-783	Nov. 24, 2019	Nov. 23, 2020
Pre-Amplifier EMCI	EMC 12630 SE	980638	Apr. 08, 2020	Apr. 07, 2021
RF Cable	EMC104-SM-SM-1200	160923	Jan. 15, 2020	Jan. 14, 2021
RF Cable	EMC104-SM-SM-2000	180502	Apr. 29, 2020	Apr. 28, 2021
RF Cable	EMC104-SM-SM-6000	180418	Apr. 29, 2020	Apr. 28, 2021
Pre-Amplifier EMCI	EMC184045SE	980387	Jan. 15, 2020	Jan. 14, 2021
Horn_Antenna SCHWARZBECK	BBHA 9170	BBHA9170519	Nov. 24, 2019	Nov. 23, 2020
RF Cable	EMC102-KM-KM-1200	160924	Jan. 15, 2020	Jan. 14, 2021
RF Cable	EMC-KM-KM-4000	200214	Mar. 11, 2020	Mar. 10, 2021
Software	ADT_Radiated_V8.7.08	NA	NA	NA
Boresight Antenna Tower & Turn Table Max-Full	MF-7802BS	MF780208530	NA	NA

Note:

1. The calibration interval of the above test instruments is 12 months and the calibrations are traceable to NML/ROC and NIST/USA.
2. The test was performed in 966 Chamber No. 4.
3. Tested Date: Aug. 12 to 19, 2020

For other test

DESCRIPTION & MANUFACTURER	MODEL NO.	SERIAL NO.	CALIBRATED DATE	CALIBRATED UNTIL
Spectrum Analyzer R&S	FSV40	100964	May 29, 2020	May 28, 2021
Power meter Anritsu	ML2495A	1529002	July 22, 2020	July 21, 2021
Power sensor Anritsu	MA2411B	1339443	July 22, 2020	July 21, 2021
Fixed Attenuator Mini-Circuits	MDCS18N-10	MDCS18N-10-01	Apr. 14, 2020	Apr. 13, 2021
AC Power Source Extech Electronics	6205	1440452	NA	NA
Temperature & Humidity Chamber Giant Force	GTH-150-40-SP-AR	MAA0812-008	Jan. 16, 2020	Jan. 15, 2021
True RMS Clamp Meter FLUKE	325	31130711WS	June 06, 2020	June 05, 2021
Software	ADT_RF Test Software V6.6.5.4	NA	NA	NA

Note:

1. The test was performed in Oven room 2.
2. The calibration interval of the above test instruments is 12 months and the calibrations are traceable to NML/ROC and NIST/USA.
3. Tested Date: Aug. 27, 2020

4.1.3 Test Procedure

For Radiated emission below 30MHz

- a. The EUT was placed on the top of a rotating table 0.8 meters above the ground at a 3 meter chamber room. The table was rotated 360 degrees to determine the position of the highest radiation.
- b. The EUT was set 3 meters away from the interference-receiving antenna, which was mounted on the top of a variable-height antenna tower.
- c. Parallel, perpendicular, and ground-parallel orientations of the antenna are set to make the measurement.
- d. For each suspected emission, the EUT was arranged to its worst case and the rotatable table was turned from 0 degrees to 360 degrees to find the maximum reading.
- e. The test-receiver system was set to Quasi-Peak Detect Function and Specified Bandwidth with Maximum Hold Mode.

Note:

1. The resolution bandwidth and video bandwidth of test receiver/spectrum analyzer is 9kHz at frequency below 30MHz.

For Radiated emission above 30MHz

- a. The EUT was placed on the top of a rotating table 0.8 meters (for 30MHz ~ 1GHz) / 1.5 meters (for above 1GHz) above the ground at 3 meter chamber room for test. The table was rotated 360 degrees to determine the position of the highest radiation.
- b. The EUT was set 3 meters away from the interference-receiving antenna, which was mounted on the top of a variable-height antenna tower.
- c. The height of antenna is varied from one meter to four meters above the ground to determine the maximum value of the field strength. Both horizontal and vertical polarizations of the antenna are set to make the measurement.
- d. For each suspected emission, the EUT was arranged to its worst case and then the antenna was tuned to heights from 1 meter to 4 meters and the rotatable table was turned from 0 degrees to 360 degrees to find the maximum reading.
- e. The test-receiver system was set to quasi-peak detect function and specified bandwidth with maximum hold mode when the test frequency is below 1 GHz.
- f. The test-receiver system was set to peak and average detects function and specified bandwidth with maximum hold mode when the test frequency is above 1 GHz. If the peak reading value also meets average limit, measurement with the average detector is unnecessary.

Note:

1. The resolution bandwidth and video bandwidth of test receiver/spectrum analyzer is 120kHz for Quasi-peak detection (QP) at frequency below 1GHz.
2. The resolution bandwidth of test receiver/spectrum analyzer is 1 MHz and the video bandwidth is 3 MHz for Peak detection (PK) at frequency above 1GHz.
3. The resolution bandwidth of test receiver/spectrum analyzer is 1MHz and the video bandwidth is $\geq 1/T$ (Duty cycle < 98%) or 10Hz (Duty cycle $\geq 98\%$) for Average detection (AV) at frequency above 1GHz.
4. All modes of operation were investigated and the worst-case emissions are reported.

4.1.4 Deviation from Test Standard

No deviation.

4.1.5 Test Setup

For Radiated emission below 30MHz

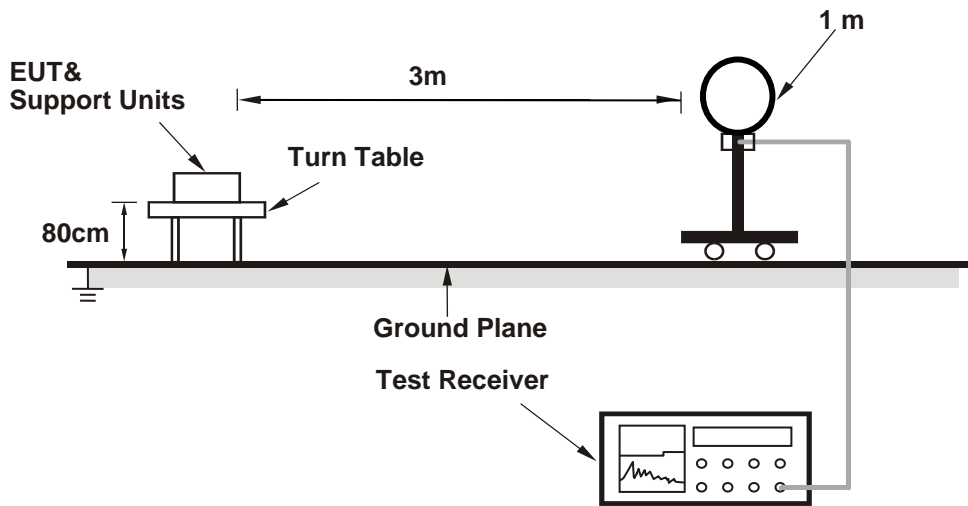

For Radiated emission 30MHz to 1GHz

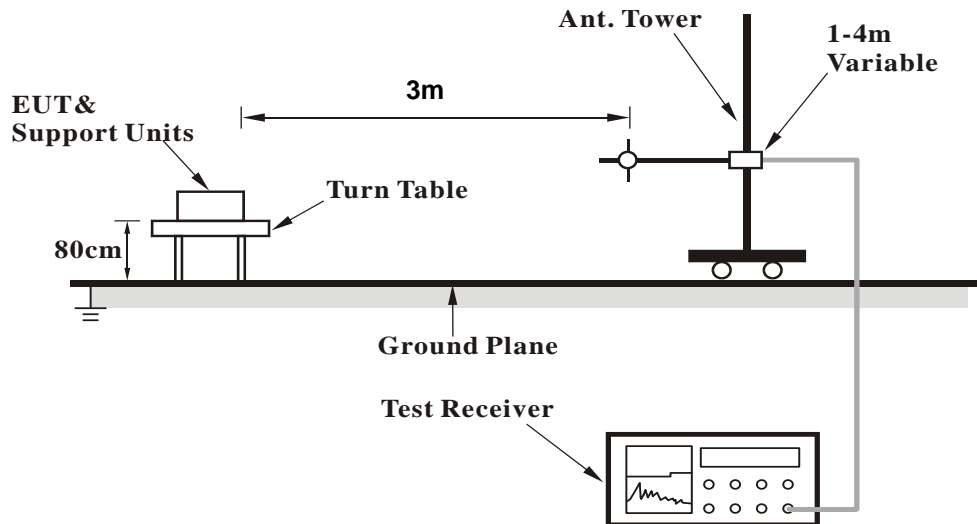

For Radiated emission above 1GHz

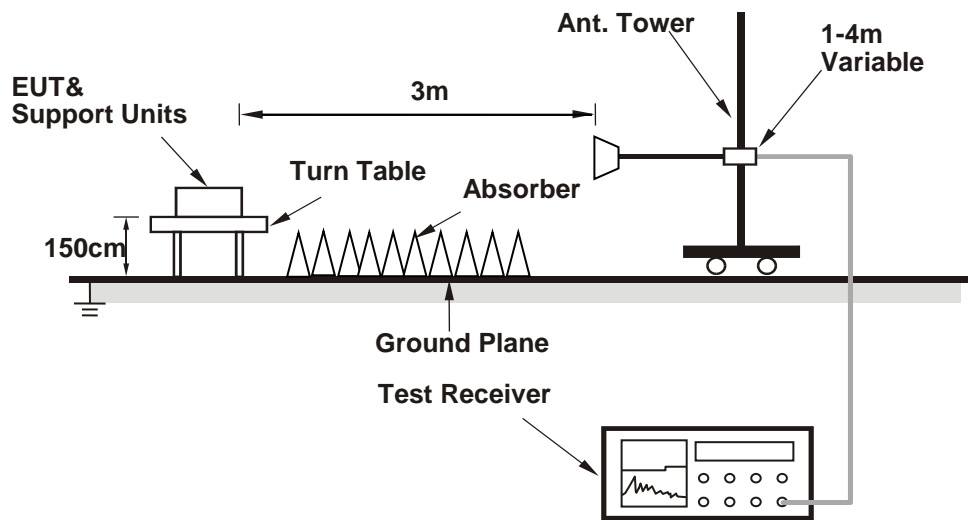

For the actual test configuration, please refer to the attached file (Test Setup Photo).

4.1.6 EUT Operating Condition

- a. Connected the EUT with the Laptop Computer which is placed on remote site.
- b. Controlling software (Mtool [3.1.0.1]) has been activated to set the EUT under transmission condition continuously at specific channel frequency.

4.1.7 Test Results

Above 1GHz Data:

802.11a

Channel	TX Channel 36	Detector Function	Peak (PK)
Frequency Range	1GHz ~ 40GHz		Average (AV)

Antenna Polarity & Test Distance : Horizontal at 3 m

No	Frequency (MHz)	Emission Level (dBuV/m)	Limit (dBuV/m)	Margin (dB)	Antenna Height (m)	Table Angle (Degree)	Raw Value (dBuV)	Correction Factor (dB/m)
1	5150.00	61.3 PK	74.0	-12.7	3.51 H	324	60.6	0.7
2	5150.00	44.5 AV	54.0	-9.5	3.51 H	324	43.8	0.7
3	*5180.00	107.7 PK			3.51 H	324	107.0	0.7
4	*5180.00	98.9 AV			3.51 H	324	98.2	0.7
5	#10360.00	48.5 PK	68.2	-19.7	1.18 H	50	38.0	10.5
6	15540.00	53.3 PK	74.0	-20.7	3.74 H	328	41.3	12.0
7	15540.00	41.4 AV	54.0	-12.6	3.74 H	328	29.4	12.0

Antenna Polarity & Test Distance : Vertical at 3 m

No	Frequency (MHz)	Emission Level (dBuV/m)	Limit (dBuV/m)	Margin (dB)	Antenna Height (m)	Table Angle (Degree)	Raw Value (dBuV)	Correction Factor (dB/m)
1	5150.00	71.1 PK	74.0	-2.9	1.34 V	194	70.4	0.7
2	5150.00	53.8 AV	54.0	-0.2	1.34 V	194	53.1	0.7
3	*5180.00	116.5 PK			1.34 V	194	115.8	0.7
4	*5180.00	107.5 AV			1.34 V	194	106.8	0.7
5	#10360.00	48.9 PK	68.2	-19.3	2.31 V	104	38.4	10.5
6	15540.00	58.9 PK	74.0	-15.1	1.98 V	137	46.9	12.0
7	15540.00	46.2 AV	54.0	-7.8	1.98 V	137	34.2	12.0

Remarks:

1. Emission Level(dBuV/m) = Raw Value(dBuV) + Correction Factor(dB/m)
2. Correction Factor(dB/m) = Antenna Factor(dB/m) + Cable Factor(dB) – Pre-Amplifier Factor(dB)
3. Margin value = Emission Level – Limit value
4. The other emission levels were very low against the limit.
5. " * ": Fundamental frequency.
6. " # ": The radiated frequency is out of the restricted band.

Channel	TX Channel 40	Detector Function	Peak (PK)
Frequency Range	1GHz ~ 40GHz		Average (AV)

Antenna Polarity & Test Distance : Horizontal at 3 m

No	Frequency (MHz)	Emission Level (dBuV/m)	Limit (dBuV/m)	Margin (dB)	Antenna Height (m)	Table Angle (Degree)	Raw Value (dBuV)	Correction Factor (dB/m)
1	*5200.00	108.6 PK			3.47 H	322	108.0	0.6
2	*5200.00	101.2 AV			3.47 H	322	100.6	0.6
3	#10400.00	48.3 PK	68.2	-19.9	1.19 H	52	37.7	10.6
4	15600.00	53.6 PK	74.0	-20.4	3.72 H	331	41.3	12.3
5	15600.00	41.6 AV	54.0	-12.4	3.72 H	331	29.3	12.3

Antenna Polarity & Test Distance : Vertical at 3 m

No	Frequency (MHz)	Emission Level (dBuV/m)	Limit (dBuV/m)	Margin (dB)	Antenna Height (m)	Table Angle (Degree)	Raw Value (dBuV)	Correction Factor (dB/m)
1	*5200.00	117.8 PK			1.90 V	32	117.2	0.6
2	*5200.00	110.0 AV			1.90 V	32	109.4	0.6
3	#10400.00	48.9 PK	68.2	-19.3	2.34 V	102	38.3	10.6
4	15600.00	59.1 PK	74.0	-14.9	2.03 V	151	46.8	12.3
5	15600.00	46.3 AV	54.0	-7.7	2.03 V	151	34.0	12.3

Remarks:

1. Emission Level(dBuV/m) = Raw Value(dBuV) + Correction Factor(dB/m)
2. Correction Factor(dB/m) = Antenna Factor(dB/m) + Cable Factor(dB) – Pre-Amplifier Factor(dB)
3. Margin value = Emission Level – Limit value
4. The other emission levels were very low against the limit.
5. " * ": Fundamental frequency.
6. " # ": The radiated frequency is out of the restricted band.

Channel	TX Channel 48	Detector Function	Peak (PK)
Frequency Range	1GHz ~ 40GHz		Average (AV)

Antenna Polarity & Test Distance : Horizontal at 3 m

No	Frequency (MHz)	Emission Level (dBuV/m)	Limit (dBuV/m)	Margin (dB)	Antenna Height (m)	Table Angle (Degree)	Raw Value (dBuV)	Correction Factor (dB/m)
1	*5240.00	109.5 PK			3.49 H	313	108.9	0.6
2	*5240.00	101.8 AV			3.49 H	313	101.2	0.6
3	5350.00	45.2 PK	74.0	-28.8	3.49 H	313	44.6	0.6
4	5350.00	36.1 AV	54.0	-17.9	3.49 H	313	35.5	0.6
5	#10480.00	48.3 PK	68.2	-19.9	1.22 H	51	37.8	10.5
6	15720.00	53.9 PK	74.0	-20.1	3.68 H	329	42.6	11.3
7	15720.00	41.7 AV	54.0	-12.3	3.68 H	329	30.4	11.3

Antenna Polarity & Test Distance : Vertical at 3 m

No	Frequency (MHz)	Emission Level (dBuV/m)	Limit (dBuV/m)	Margin (dB)	Antenna Height (m)	Table Angle (Degree)	Raw Value (dBuV)	Correction Factor (dB/m)
1	*5240.00	118.3 PK			1.94 V	17	117.7	0.6
2	*5240.00	110.4 AV			1.94 V	17	109.8	0.6
3	5350.00	53.9 PK	74.0	-20.1	1.94 V	17	53.3	0.6
4	5350.00	42.2 AV	54.0	-11.8	1.94 V	17	41.6	0.6
5	#10480.00	49.1 PK	68.2	-19.1	2.35 V	104	38.6	10.5
6	15720.00	59.2 PK	74.0	-14.8	2.02 V	149	47.9	11.3
7	15720.00	46.6 AV	54.0	-7.4	2.02 V	149	35.3	11.3

Remarks:

1. Emission Level(dBuV/m) = Raw Value(dBuV) + Correction Factor(dB/m)
2. Correction Factor(dB/m) = Antenna Factor(dB/m) + Cable Factor(dB) – Pre-Amplifier Factor(dB)
3. Margin value = Emission Level – Limit value
4. The other emission levels were very low against the limit.
5. " * ": Fundamental frequency.
6. " # ": The radiated frequency is out of the restricted band.

Channel	TX Channel 149	Detector Function	Peak (PK)
Frequency Range	1GHz ~ 40GHz		Average (AV)

Antenna Polarity & Test Distance : Horizontal at 3 m

No	Frequency (MHz)	Emission Level (dBuV/m)	Limit (dBuV/m)	Margin (dB)	Antenna Height (m)	Table Angle (Degree)	Raw Value (dBuV)	Correction Factor (dB/m)
1	*5745.00	112.6 PK			3.57 H	321	111.2	1.4
2	*5745.00	104.9 AV			3.57 H	321	103.5	1.4
3	11490.00	47.3 PK	74.0	-26.7	1.13 H	70	35.5	11.8
4	11490.00	34.8 AV	54.0	-19.2	1.13 H	70	23.0	11.8
5	#17235.00	55.9 PK	68.2	-12.3	1.02 H	302	40.5	15.4

Antenna Polarity & Test Distance : Vertical at 3 m

No	Frequency (MHz)	Emission Level (dBuV/m)	Limit (dBuV/m)	Margin (dB)	Antenna Height (m)	Table Angle (Degree)	Raw Value (dBuV)	Correction Factor (dB/m)
1	*5745.00	117.8 PK			1.71 V	14	116.4	1.4
2	*5745.00	109.7 AV			1.71 V	14	108.3	1.4
3	11490.00	49.5 PK	74.0	-24.5	1.28 V	186	37.7	11.8
4	11490.00	37.1 AV	54.0	-16.9	1.28 V	186	25.3	11.8
5	#17235.00	55.5 PK	68.2	-12.7	1.37 V	143	40.1	15.4

Remarks:

1. Emission Level(dBuV/m) = Raw Value(dBuV) + Correction Factor(dB/m)
2. Correction Factor(dB/m) = Antenna Factor(dB/m) + Cable Factor(dB) – Pre-Amplifier Factor(dB)
3. Margin value = Emission Level – Limit value
4. The other emission levels were very low against the limit.
5. " * ": Fundamental frequency.
6. " # ": The radiated frequency is out of the restricted band.

Channel	TX Channel 157	Detector Function	Peak (PK)
Frequency Range	1GHz ~ 40GHz		Average (AV)

Antenna Polarity & Test Distance : Horizontal at 3 m

No	Frequency (MHz)	Emission Level (dBuV/m)	Limit (dBuV/m)	Margin (dB)	Antenna Height (m)	Table Angle (Degree)	Raw Value (dBuV)	Correction Factor (dB/m)
1	*5785.00	113.1 PK			3.57 H	313	111.6	1.5
2	*5785.00	105.3 AV			3.57 H	313	103.8	1.5
3	11570.00	47.4 PK	74.0	-26.6	1.09 H	85	35.9	11.5
4	11570.00	35.1 AV	54.0	-18.9	1.09 H	85	23.6	11.5
5	#17355.00	55.3 PK	68.2	-12.9	1.01 H	302	39.0	16.3

Antenna Polarity & Test Distance : Vertical at 3 m

No	Frequency (MHz)	Emission Level (dBuV/m)	Limit (dBuV/m)	Margin (dB)	Antenna Height (m)	Table Angle (Degree)	Raw Value (dBuV)	Correction Factor (dB/m)
1	*5785.00	117.5 PK			1.76 V	22	116.0	1.5
2	*5785.00	109.5 AV			1.76 V	22	108.0	1.5
3	11570.00	49.2 PK	74.0	-24.8	1.26 V	191	37.7	11.5
4	11570.00	37.1 AV	54.0	-16.9	1.26 V	191	25.6	11.5
5	#17355.00	55.3 PK	68.2	-12.9	1.43 V	145	39.0	16.3

Remarks:

1. Emission Level(dBuV/m) = Raw Value(dBuV) + Correction Factor(dB/m)
2. Correction Factor(dB/m) = Antenna Factor(dB/m) + Cable Factor(dB) – Pre-Amplifier Factor(dB)
3. Margin value = Emission Level – Limit value
4. The other emission levels were very low against the limit.
5. " * ": Fundamental frequency.
6. " # ": The radiated frequency is out of the restricted band.

Channel	TX Channel 165	Detector Function	Peak (PK)
Frequency Range	1GHz ~ 40GHz		Average (AV)

Antenna Polarity & Test Distance : Horizontal at 3 m

No	Frequency (MHz)	Emission Level (dBuV/m)	Limit (dBuV/m)	Margin (dB)	Antenna Height (m)	Table Angle (Degree)	Raw Value (dBuV)	Correction Factor (dB/m)
1	*5825.00	112.9 PK			3.63 H	307	111.2	1.7
2	*5825.00	105.4 AV			3.63 H	307	103.7	1.7
3	11650.00	47.8 PK	74.0	-26.2	1.16 H	72	36.5	11.3
4	11650.00	35.2 AV	54.0	-18.8	1.16 H	72	23.9	11.3
5	#17475.00	55.6 PK	68.2	-12.6	1.07 H	315	37.1	18.5

Antenna Polarity & Test Distance : Vertical at 3 m

No	Frequency (MHz)	Emission Level (dBuV/m)	Limit (dBuV/m)	Margin (dB)	Antenna Height (m)	Table Angle (Degree)	Raw Value (dBuV)	Correction Factor (dB/m)
1	*5825.00	118.4 PK			1.74 V	14	116.7	1.7
2	*5825.00	110.1 AV			1.74 V	14	108.4	1.7
3	11650.00	48.8 PK	74.0	-25.2	1.20 V	183	37.5	11.3
4	11650.00	36.7 AV	54.0	-17.3	1.20 V	183	25.4	11.3
5	#17475.00	55.3 PK	68.2	-12.9	1.44 V	150	36.8	18.5

Remarks:

1. Emission Level(dBuV/m) = Raw Value(dBuV) + Correction Factor(dB/m)
2. Correction Factor(dB/m) = Antenna Factor(dB/m) + Cable Factor(dB) – Pre-Amplifier Factor(dB)
3. Margin value = Emission Level – Limit value
4. The other emission levels were very low against the limit.
5. " * ": Fundamental frequency.
6. " # ": The radiated frequency is out of the restricted band.

802.11ax (HE20)

Channel	TX Channel 36	Detector Function	Peak (PK)
Frequency Range	1GHz ~ 40GHz		Average (AV)

Antenna Polarity & Test Distance : Horizontal at 3 m								
No	Frequency (MHz)	Emission Level (dBuV/m)	Limit (dBuV/m)	Margin (dB)	Antenna Height (m)	Table Angle (Degree)	Raw Value (dBuV)	Correction Factor (dB/m)
1	5150.00	54.6 PK	74.0	-19.4	3.47 H	333	53.9	0.7
2	5150.00	43.6 AV	54.0	-10.4	3.47 H	333	42.9	0.7
3	*5180.00	108.1 PK			3.47 H	333	107.4	0.7
4	*5180.00	98.6 AV			3.47 H	333	97.9	0.7
5	#10360.00	48.3 PK	68.2	-19.9	1.25 H	38	37.8	10.5
6	#10360.00	35.6 AV	54.0	-18.4	1.25 H	38	25.1	10.5
7	15540.00	54.0 PK	74.0	-20.0	3.75 H	332	42.0	12.0
8	15540.00	41.8 AV	54.0	-12.2	3.75 H	332	29.8	12.0
Antenna Polarity & Test Distance : Vertical at 3 m								
No	Frequency (MHz)	Emission Level (dBuV/m)	Limit (dBuV/m)	Margin (dB)	Antenna Height (m)	Table Angle (Degree)	Raw Value (dBuV)	Correction Factor (dB/m)
1	5150.00	72.8 PK	74.0	-1.2	1.37 V	197	72.1	0.7
2	5150.00	53.6 AV	54.0	-0.4	1.37 V	197	52.9	0.7
3	*5180.00	117.9 PK			1.37 V	197	117.2	0.7
4	*5180.00	106.3 AV			1.37 V	197	105.6	0.7
5	#10360.00	49.3 PK	68.2	-18.9	2.36 V	91	38.8	10.5
6	#10360.00	37.1 AV	54.0	-16.9	2.36 V	91	26.6	10.5
7	15540.00	58.7 PK	74.0	-15.3	2.03 V	147	46.7	12.0
8	15540.00	46.2 AV	54.0	-7.8	2.03 V	147	34.2	12.0

Remarks:

1. Emission Level(dBuV/m) = Raw Value(dBuV) + Correction Factor(dB/m)
2. Correction Factor(dB/m) = Antenna Factor(dB/m) + Cable Factor(dB) – Pre-Amplifier Factor(dB)
3. Margin value = Emission Level – Limit value
4. The other emission levels were very low against the limit.
5. " * ": Fundamental frequency.
6. " # ": The radiated frequency is out of the restricted band.

Channel	TX Channel 40	Detector Function	Peak (PK)
Frequency Range	1GHz ~ 40GHz		Average (AV)

Antenna Polarity & Test Distance : Horizontal at 3 m

No	Frequency (MHz)	Emission Level (dBuV/m)	Limit (dBuV/m)	Margin (dB)	Antenna Height (m)	Table Angle (Degree)	Raw Value (dBuV)	Correction Factor (dB/m)
1	*5200.00	110.2 PK			3.51 H	332	109.6	0.6
2	*5200.00	99.4 AV			3.51 H	332	98.8	0.6
3	#10400.00	48.8 PK	68.2	-19.4	1.24 H	65	38.2	10.6
4	#10400.00	36.1 AV	54.0	-17.9	1.24 H	65	25.5	10.6
5	15600.00	53.4 PK	74.0	-20.6	3.69 H	344	41.1	12.3
6	15600.00	41.2 AV	54.0	-12.8	3.69 H	344	28.9	12.3

Antenna Polarity & Test Distance : Vertical at 3 m

No	Frequency (MHz)	Emission Level (dBuV/m)	Limit (dBuV/m)	Margin (dB)	Antenna Height (m)	Table Angle (Degree)	Raw Value (dBuV)	Correction Factor (dB/m)
1	*5200.00	119.5 PK			1.53 V	7	118.9	0.6
2	*5200.00	108.9 AV			1.53 V	7	108.3	0.6
3	#10400.00	48.7 PK	68.2	-19.5	2.30 V	101	38.1	10.6
4	#10400.00	36.8 AV	54.0	-17.2	2.30 V	101	26.2	10.6
5	15600.00	59.5 PK	74.0	-14.5	1.97 V	162	47.2	12.3
6	15600.00	46.8 AV	54.0	-7.2	1.97 V	162	34.5	12.3

Remarks:

1. Emission Level(dBuV/m) = Raw Value(dBuV) + Correction Factor(dB/m)
2. Correction Factor(dB/m) = Antenna Factor(dB/m) + Cable Factor(dB) – Pre-Amplifier Factor(dB)
3. Margin value = Emission Level – Limit value
4. The other emission levels were very low against the limit.
5. " * " : Fundamental frequency.
6. " # " : The radiated frequency is out of the restricted band.

Channel	TX Channel 48	Detector Function	Peak (PK)
Frequency Range	1GHz ~ 40GHz		Average (AV)

Antenna Polarity & Test Distance : Horizontal at 3 m

No	Frequency (MHz)	Emission Level (dBuV/m)	Limit (dBuV/m)	Margin (dB)	Antenna Height (m)	Table Angle (Degree)	Raw Value (dBuV)	Correction Factor (dB/m)
1	*5240.00	110.7 PK			3.48 H	321	110.1	0.6
2	*5240.00	100.5 AV			3.48 H	321	99.9	0.6
3	5350.00	45.4 PK	74.0	-28.6	3.48 H	321	44.8	0.6
4	5350.00	36.9 AV	54.0	-17.1	3.48 H	321	36.3	0.6
5	#10480.00	47.9 PK	68.2	-20.3	1.18 H	54	37.4	10.5
6	#10480.00	35.4 AV	54.0	-18.6	1.18 H	54	24.9	10.5
7	15720.00	53.8 PK	74.0	-20.2	3.77 H	340	42.5	11.3
8	15720.00	41.9 AV	54.0	-12.1	3.77 H	340	30.6	11.3

Antenna Polarity & Test Distance : Vertical at 3 m

No	Frequency (MHz)	Emission Level (dBuV/m)	Limit (dBuV/m)	Margin (dB)	Antenna Height (m)	Table Angle (Degree)	Raw Value (dBuV)	Correction Factor (dB/m)
1	*5240.00	119.6 PK			1.50 V	17	119.0	0.6
2	*5240.00	109.2 AV			1.50 V	17	108.6	0.6
3	5350.00	53.9 PK	74.0	-20.1	1.50 V	17	53.3	0.6
4	5350.00	42.5 AV	54.0	-11.5	1.50 V	17	41.9	0.6
5	#10480.00	48.4 PK	68.2	-19.8	2.31 V	111	37.9	10.5
6	#10480.00	36.7 AV	54.0	-17.3	2.31 V	111	26.2	10.5
7	15720.00	59.1 PK	74.0	-14.9	2.04 V	135	47.8	11.3
8	15720.00	46.2 AV	54.0	-7.8	2.04 V	135	34.9	11.3

Remarks:

1. Emission Level(dBuV/m) = Raw Value(dBuV) + Correction Factor(dB/m)
2. Correction Factor(dB/m) = Antenna Factor(dB/m) + Cable Factor(dB) – Pre-Amplifier Factor(dB)
3. Margin value = Emission Level – Limit value
4. The other emission levels were very low against the limit.
5. " * ": Fundamental frequency.
6. " # ": The radiated frequency is out of the restricted band.

Channel	TX Channel 149	Detector Function	Peak (PK)
Frequency Range	1GHz ~ 40GHz		Average (AV)

Antenna Polarity & Test Distance : Horizontal at 3 m

No	Frequency (MHz)	Emission Level (dBUV/m)	Limit (dBUV/m)	Margin (dB)	Antenna Height (m)	Table Angle (Degree)	Raw Value (dBUV)	Correction Factor (dB/m)
1	*5745.00	112.0 PK			3.54 H	322	110.6	1.4
2	*5745.00	104.5 AV			3.54 H	322	103.1	1.4
3	11490.00	47.4 PK	74.0	-26.6	1.09 H	76	35.6	11.8
4	11490.00	35.2 AV	54.0	-18.8	1.09 H	76	23.4	11.8
5	#17235.00	56.1 PK	68.2	-12.1	1.00 H	313	40.7	15.4
6	#17235.00	44.8 AV	54.0	-9.2	1.00 H	313	29.4	15.4

Antenna Polarity & Test Distance : Vertical at 3 m

No	Frequency (MHz)	Emission Level (dBUV/m)	Limit (dBUV/m)	Margin (dB)	Antenna Height (m)	Table Angle (Degree)	Raw Value (dBUV)	Correction Factor (dB/m)
1	*5745.00	117.9 PK			1.92 V	14	116.5	1.4
2	*5745.00	108.2 AV			1.92 V	14	106.8	1.4
3	11490.00	48.5 PK	74.0	-25.5	1.28 V	207	36.7	11.8
4	11490.00	36.6 AV	54.0	-17.4	1.28 V	207	24.8	11.8
5	#17235.00	55.8 PK	68.2	-12.4	1.43 V	134	40.4	15.4
6	#17235.00	43.7 AV	54.0	-10.3	1.43 V	134	28.3	15.4

Remarks:

1. Emission Level(dBUV/m) = Raw Value(dBUV) + Correction Factor(dB/m)
2. Correction Factor(dB/m) = Antenna Factor(dB/m) + Cable Factor(dB) – Pre-Amplifier Factor(dB)
3. Margin value = Emission Level – Limit value
4. The other emission levels were very low against the limit.
5. " * ": Fundamental frequency.
6. " # ": The radiated frequency is out of the restricted band.

Channel	TX Channel 157	Detector Function	Peak (PK)
Frequency Range	1GHz ~ 40GHz		Average (AV)

Antenna Polarity & Test Distance : Horizontal at 3 m

No	Frequency (MHz)	Emission Level (dBuV/m)	Limit (dBuV/m)	Margin (dB)	Antenna Height (m)	Table Angle (Degree)	Raw Value (dBuV)	Correction Factor (dB/m)
1	*5785.00	112.6 PK			3.60 H	321	111.1	1.5
2	*5785.00	104.8 AV			3.60 H	321	103.3	1.5
3	11570.00	47.2 PK	74.0	-26.8	1.10 H	73	35.7	11.5
4	11570.00	34.9 AV	54.0	-19.1	1.10 H	73	23.4	11.5
5	#17355.00	56.0 PK	68.2	-12.2	1.07 H	301	39.7	16.3
6	#17355.00	44.5 AV	54.0	-9.5	1.07 H	301	28.2	16.3

Antenna Polarity & Test Distance : Vertical at 3 m

No	Frequency (MHz)	Emission Level (dBuV/m)	Limit (dBuV/m)	Margin (dB)	Antenna Height (m)	Table Angle (Degree)	Raw Value (dBuV)	Correction Factor (dB/m)
1	*5785.00	118.0 PK			1.96 V	19	116.5	1.5
2	*5785.00	108.3 AV			1.96 V	19	106.8	1.5
3	11570.00	49.0 PK	74.0	-25.0	1.21 V	204	37.5	11.5
4	11570.00	36.9 AV	54.0	-17.1	1.21 V	204	25.4	11.5
5	#17355.00	54.8 PK	68.2	-13.4	1.41 V	160	38.5	16.3
6	#17355.00	43.0 AV	54.0	-11.0	1.41 V	160	26.7	16.3

Remarks:

1. Emission Level(dBuV/m) = Raw Value(dBuV) + Correction Factor(dB/m)
2. Correction Factor(dB/m) = Antenna Factor(dB/m) + Cable Factor(dB) – Pre-Amplifier Factor(dB)
3. Margin value = Emission Level – Limit value
4. The other emission levels were very low against the limit.
5. " * ": Fundamental frequency.
6. " # ": The radiated frequency is out of the restricted band.

Channel	TX Channel 165	Detector Function	Peak (PK)
Frequency Range	1GHz ~ 40GHz		Average (AV)

Antenna Polarity & Test Distance : Horizontal at 3 m

No	Frequency (MHz)	Emission Level (dBuV/m)	Limit (dBuV/m)	Margin (dB)	Antenna Height (m)	Table Angle (Degree)	Raw Value (dBuV)	Correction Factor (dB/m)
1	*5825.00	112.5 PK			3.58 H	327	110.8	1.7
2	*5825.00	105.0 AV			3.58 H	327	103.3	1.7
3	11650.00	47.5 PK	74.0	-26.5	1.08 H	80	36.2	11.3
4	11650.00	34.8 AV	54.0	-19.2	1.08 H	80	23.5	11.3
5	#17475.00	55.8 PK	68.2	-12.4	1.06 H	290	37.3	18.5
6	#17475.00	44.6 AV	54.0	-9.4	1.06 H	290	26.1	18.5

Antenna Polarity & Test Distance : Vertical at 3 m

No	Frequency (MHz)	Emission Level (dBuV/m)	Limit (dBuV/m)	Margin (dB)	Antenna Height (m)	Table Angle (Degree)	Raw Value (dBuV)	Correction Factor (dB/m)
1	*5825.00	117.8 PK			1.89 V	8	116.1	1.7
2	*5825.00	108.3 AV			1.89 V	8	106.6	1.7
3	11650.00	49.5 PK	74.0	-24.5	1.20 V	194	38.2	11.3
4	11650.00	37.5 AV	54.0	-16.5	1.20 V	194	26.2	11.3
5	#17475.00	55.0 PK	68.2	-13.2	1.39 V	140	36.5	18.5
6	#17475.00	43.1 AV	54.0	-10.9	1.39 V	140	24.6	18.5

Remarks:

1. Emission Level(dBuV/m) = Raw Value(dBuV) + Correction Factor(dB/m)
2. Correction Factor(dB/m) = Antenna Factor(dB/m) + Cable Factor(dB) – Pre-Amplifier Factor(dB)
3. Margin value = Emission Level – Limit value
4. The other emission levels were very low against the limit.
5. " * ": Fundamental frequency.
6. " # ": The radiated frequency is out of the restricted band.

802.11ax (HE40)

Channel	TX Channel 38	Detector Function	Peak (PK)
Frequency Range	1GHz ~ 40GHz		Average (AV)

Antenna Polarity & Test Distance : Horizontal at 3 m								
No	Frequency (MHz)	Emission Level (dBuV/m)	Limit (dBuV/m)	Margin (dB)	Antenna Height (m)	Table Angle (Degree)	Raw Value (dBuV)	Correction Factor (dB/m)
1	5150.00	53.4 PK	74.0	-20.6	3.47 H	323	52.7	0.7
2	5150.00	43.7 AV	54.0	-10.3	3.47 H	323	43.0	0.7
3	*5190.00	103.3 PK			3.47 H	323	102.6	0.7
4	*5190.00	93.6 AV			3.47 H	323	92.9	0.7
5	#10380.00	48.4 PK	68.2	-19.8	1.24 H	45	37.9	10.5
6	#10380.00	36.0 AV	54.0	-18.0	1.24 H	45	25.5	10.5
7	15570.00	53.3 PK	74.0	-20.7	3.75 H	346	41.0	12.3
8	15570.00	41.5 AV	54.0	-12.5	3.75 H	346	29.2	12.3

Antenna Polarity & Test Distance : Vertical at 3 m								
No	Frequency (MHz)	Emission Level (dBuV/m)	Limit (dBuV/m)	Margin (dB)	Antenna Height (m)	Table Angle (Degree)	Raw Value (dBuV)	Correction Factor (dB/m)
1	5150.00	70.1 PK	74.0	-3.9	1.30 V	196	69.4	0.7
2	5150.00	53.7 AV	54.0	-0.3	1.30 V	196	53.0	0.7
3	*5190.00	112.9 PK			1.30 V	196	112.2	0.7
4	*5190.00	102.5 AV			1.30 V	196	101.8	0.7
5	#10380.00	48.4 PK	68.2	-19.8	2.40 V	101	37.9	10.5
6	#10380.00	36.6 AV	54.0	-17.4	2.40 V	101	26.1	10.5
7	15570.00	59.8 PK	74.0	-14.2	2.09 V	141	47.5	12.3
8	15570.00	46.7 AV	54.0	-7.3	2.09 V	141	34.4	12.3

Remarks:

1. Emission Level(dBuV/m) = Raw Value(dBuV) + Correction Factor(dB/m)
2. Correction Factor(dB/m) = Antenna Factor(dB/m) + Cable Factor(dB) – Pre-Amplifier Factor(dB)
3. Margin value = Emission Level – Limit value
4. The other emission levels were very low against the limit.
5. " * ": Fundamental frequency.
6. " # ": The radiated frequency is out of the restricted band.

Channel	TX Channel 46	Detector Function	Peak (PK)
Frequency Range	1GHz ~ 40GHz		Average (AV)

Antenna Polarity & Test Distance : Horizontal at 3 m

No	Frequency (MHz)	Emission Level (dBuV/m)	Limit (dBuV/m)	Margin (dB)	Antenna Height (m)	Table Angle (Degree)	Raw Value (dBuV)	Correction Factor (dB/m)
1	5150.00	53.5 PK	74.0	-20.5	3.47 H	336	52.8	0.7
2	5150.00	42.8 AV	54.0	-11.2	3.47 H	336	42.1	0.7
3	*5230.00	110.0 PK			3.47 H	336	109.4	0.6
4	*5230.00	98.1 AV			3.47 H	336	97.5	0.6
5	5350.00	48.0 PK	74.0	-26.0	3.47 H	336	47.4	0.6
6	5350.00	36.7 AV	54.0	-17.3	3.47 H	336	36.1	0.6
7	#10460.00	47.7 PK	68.2	-20.5	1.25 H	47	37.0	10.7
8	#10460.00	35.5 AV	54.0	-18.5	1.25 H	47	24.8	10.7
9	15690.00	53.3 PK	74.0	-20.7	3.76 H	346	41.9	11.4
10	15690.00	41.5 AV	54.0	-12.5	3.76 H	346	30.1	11.4

Antenna Polarity & Test Distance : Vertical at 3 m

No	Frequency (MHz)	Emission Level (dBuV/m)	Limit (dBuV/m)	Margin (dB)	Antenna Height (m)	Table Angle (Degree)	Raw Value (dBuV)	Correction Factor (dB/m)
1	5150.00	67.1 PK	74.0	-6.9	1.50 V	197	66.4	0.7
2	5150.00	53.6 AV	54.0	-0.4	1.50 V	197	52.9	0.7
3	*5230.00	119.3 PK			1.50 V	197	118.7	0.6
4	*5230.00	107.0 AV			1.50 V	197	106.4	0.6
5	5350.00	57.5 PK	74.0	-16.5	1.50 V	197	56.9	0.6
6	5350.00	45.9 AV	54.0	-8.1	1.50 V	197	45.3	0.6
7	#10460.00	48.3 PK	68.2	-19.9	2.38 V	99	37.6	10.7
8	#10460.00	36.5 AV	54.0	-17.5	2.38 V	99	25.8	10.7
9	15690.00	59.2 PK	74.0	-14.8	2.02 V	162	47.8	11.4
10	15690.00	46.5 AV	54.0	-7.5	2.02 V	162	35.1	11.4

Remarks:

1. Emission Level(dBuV/m) = Raw Value(dBuV) + Correction Factor(dB/m)
2. Correction Factor(dB/m) = Antenna Factor(dB/m) + Cable Factor(dB) – Pre-Amplifier Factor(dB)
3. Margin value = Emission Level – Limit value
4. The other emission levels were very low against the limit.
5. " * ": Fundamental frequency.
6. " # ": The radiated frequency is out of the restricted band.

Channel	TX Channel 151	Detector Function	Peak (PK)
Frequency Range	1GHz ~ 40GHz		Average (AV)

Antenna Polarity & Test Distance : Horizontal at 3 m

No	Frequency (MHz)	Emission Level (dBuV/m)	Limit (dBuV/m)	Margin (dB)	Antenna Height (m)	Table Angle (Degree)	Raw Value (dBuV)	Correction Factor (dB/m)
1	*5755.00	110.6 PK			3.61 H	342	109.2	1.4
2	*5755.00	98.7 AV			3.61 H	342	97.3	1.4
3	11510.00	47.2 PK	74.0	-26.8	1.09 H	57	35.6	11.6
4	11510.00	34.4 AV	54.0	-19.6	1.09 H	57	22.8	11.6
5	#17265.00	55.8 PK	68.2	-12.4	1.03 H	306	40.3	15.5
6	#17265.00	44.3 AV	54.0	-9.7	1.03 H	306	28.8	15.5

Antenna Polarity & Test Distance : Vertical at 3 m

No	Frequency (MHz)	Emission Level (dBuV/m)	Limit (dBuV/m)	Margin (dB)	Antenna Height (m)	Table Angle (Degree)	Raw Value (dBuV)	Correction Factor (dB/m)
1	*5755.00	114.9 PK			2.98 V	180	113.5	1.4
2	*5755.00	102.9 AV			2.98 V	180	101.5	1.4
3	11510.00	49.1 PK	74.0	-24.9	1.24 V	189	37.5	11.6
4	11510.00	36.8 AV	54.0	-17.2	1.24 V	189	25.2	11.6
5	#17265.00	55.5 PK	68.2	-12.7	1.48 V	131	40.0	15.5
6	#17265.00	43.7 AV	54.0	-10.3	1.48 V	131	28.2	15.5

Remarks:

1. Emission Level(dBuV/m) = Raw Value(dBuV) + Correction Factor(dB/m)
2. Correction Factor(dB/m) = Antenna Factor(dB/m) + Cable Factor(dB) – Pre-Amplifier Factor(dB)
3. Margin value = Emission Level – Limit value
4. The other emission levels were very low against the limit.
5. " * ": Fundamental frequency.
6. " # ": The radiated frequency is out of the restricted band.

Channel	TX Channel 159	Detector Function	Peak (PK)
Frequency Range	1GHz ~ 40GHz		Average (AV)

Antenna Polarity & Test Distance : Horizontal at 3 m

No	Frequency (MHz)	Emission Level (dBuV/m)	Limit (dBuV/m)	Margin (dB)	Antenna Height (m)	Table Angle (Degree)	Raw Value (dBuV)	Correction Factor (dB/m)
1	*5795.00	111.4 PK			3.56 H	313	109.9	1.5
2	*5795.00	99.6 AV			3.56 H	313	98.1	1.5
3	11590.00	48.0 PK	74.0	-26.0	1.17 H	73	36.5	11.5
4	11590.00	35.2 AV	54.0	-18.8	1.17 H	73	23.7	11.5
5	#17385.00	55.9 PK	68.2	-12.3	1.00 H	300	38.9	17.0
6	#17385.00	44.9 AV	54.0	-9.1	1.00 H	300	27.9	17.0

Antenna Polarity & Test Distance : Vertical at 3 m

No	Frequency (MHz)	Emission Level (dBuV/m)	Limit (dBuV/m)	Margin (dB)	Antenna Height (m)	Table Angle (Degree)	Raw Value (dBuV)	Correction Factor (dB/m)
1	*5795.00	115.6 PK			3.02 V	164	114.1	1.5
2	*5795.00	103.3 AV			3.02 V	164	101.8	1.5
3	11590.00	50.0 PK	74.0	-24.0	1.27 V	200	38.5	11.5
4	11590.00	37.6 AV	54.0	-16.4	1.27 V	200	26.1	11.5
5	#17385.00	54.7 PK	68.2	-13.5	1.37 V	130	37.7	17.0
6	#17385.00	43.1 AV	54.0	-10.9	1.37 V	130	26.1	17.0

Remarks:

1. Emission Level(dBuV/m) = Raw Value(dBuV) + Correction Factor(dB/m)
2. Correction Factor(dB/m) = Antenna Factor(dB/m) + Cable Factor(dB) – Pre-Amplifier Factor(dB)
3. Margin value = Emission Level – Limit value
4. The other emission levels were very low against the limit.
5. " * ": Fundamental frequency.
6. " # ": The radiated frequency is out of the restricted band.

802.11ax (HE80)

Channel	TX Channel 42	Detector Function	Peak (PK)
Frequency Range	1GHz ~ 40GHz		Average (AV)

Antenna Polarity & Test Distance : Horizontal at 3 m

No	Frequency (MHz)	Emission Level (dBuV/m)	Limit (dBuV/m)	Margin (dB)	Antenna Height (m)	Table Angle (Degree)	Raw Value (dBuV)	Correction Factor (dB/m)
1	5150.00	58.4 PK	74.0	-15.6	3.50 H	332	57.7	0.7
2	5150.00	45.9 AV	54.0	-8.1	3.50 H	332	45.2	0.7
3	*5210.00	99.6 PK			3.50 H	332	98.9	0.7
4	*5210.00	90.5 AV			3.50 H	332	89.8	0.7
5	5350.00	45.8 PK	74.0	-28.2	3.50 H	332	45.2	0.6
6	5350.00	36.8 AV	54.0	-17.2	3.50 H	332	36.2	0.6
7	#10420.00	48.6 PK	68.2	-19.6	1.17 H	68	38.0	10.6
8	#10420.00	36.2 AV	54.0	-17.8	1.17 H	68	25.6	10.6
9	15630.00	54.1 PK	74.0	-19.9	3.78 H	333	42.1	12.0
10	15630.00	41.8 AV	54.0	-12.2	3.78 H	333	29.8	12.0

Antenna Polarity & Test Distance : Vertical at 3 m

No	Frequency (MHz)	Emission Level (dBuV/m)	Limit (dBuV/m)	Margin (dB)	Antenna Height (m)	Table Angle (Degree)	Raw Value (dBuV)	Correction Factor (dB/m)
1	5150.00	66.9 PK	74.0	-7.1	1.50 V	17	66.2	0.7
2	5150.00	53.5 AV	54.0	-0.5	1.50 V	17	52.8	0.7
3	*5210.00	108.9 PK			1.50 V	17	108.2	0.7
4	*5210.00	97.7 AV			1.50 V	17	97.0	0.7
5	5350.00	56.1 PK	74.0	-17.9	1.50 V	17	55.5	0.6
6	5350.00	44.1 AV	54.0	-9.9	1.50 V	17	43.5	0.6
7	#10420.00	48.5 PK	68.2	-19.7	2.38 V	117	37.9	10.6
8	#10420.00	36.7 AV	54.0	-17.3	2.38 V	117	26.1	10.6
9	15630.00	59.4 PK	74.0	-14.6	2.06 V	136	47.4	12.0
10	15630.00	46.4 AV	54.0	-7.6	2.06 V	136	34.4	12.0

Remarks:

1. Emission Level(dBuV/m) = Raw Value(dBuV) + Correction Factor(dB/m)
2. Correction Factor(dB/m) = Antenna Factor(dB/m) + Cable Factor(dB) – Pre-Amplifier Factor(dB)
3. Margin value = Emission Level – Limit value
4. The other emission levels were very low against the limit.
5. " * ": Fundamental frequency.
6. " # ": The radiated frequency is out of the restricted band.

Channel	TX Channel 155	Detector Function	Peak (PK)
Frequency Range	1GHz ~ 40GHz		Average (AV)

Antenna Polarity & Test Distance : Horizontal at 3 m

No	Frequency (MHz)	Emission Level (dBuV/m)	Limit (dBuV/m)	Margin (dB)	Antenna Height (m)	Table Angle (Degree)	Raw Value (dBuV)	Correction Factor (dB/m)
1	*5775.00	106.3 PK			3.54 H	339	104.8	1.5
2	*5775.00	94.8 AV			3.54 H	339	93.3	1.5
3	11550.00	47.1 PK	74.0	-26.9	1.08 H	78	35.5	11.6
4	11550.00	34.6 AV	54.0	-19.4	1.08 H	78	23.0	11.6
5	#17325.00	56.0 PK	68.2	-12.2	1.05 H	309	40.2	15.8
6	#17325.00	44.8 AV	54.0	-9.2	1.05 H	309	29.0	15.8

Antenna Polarity & Test Distance : Vertical at 3 m

No	Frequency (MHz)	Emission Level (dBuV/m)	Limit (dBuV/m)	Margin (dB)	Antenna Height (m)	Table Angle (Degree)	Raw Value (dBuV)	Correction Factor (dB/m)
1	*5775.00	110.1 PK			3.09 V	181	108.6	1.5
2	*5775.00	98.2 AV			3.09 V	181	96.7	1.5
3	11550.00	49.2 PK	74.0	-24.8	1.22 V	191	37.6	11.6
4	11550.00	37.1 AV	54.0	-16.9	1.22 V	191	25.5	11.6
5	#17325.00	54.9 PK	68.2	-13.3	1.41 V	132	39.1	15.8
6	#17325.00	43.1 AV	54.0	-10.9	1.41 V	132	27.3	15.8

Remarks:

1. Emission Level(dBuV/m) = Raw Value(dBuV) + Correction Factor(dB/m)
2. Correction Factor(dB/m) = Antenna Factor(dB/m) + Cable Factor(dB) – Pre-Amplifier Factor(dB)
3. Margin value = Emission Level – Limit value
4. The other emission levels were very low against the limit.
5. " * ": Fundamental frequency.
6. " # ": The radiated frequency is out of the restricted band.

Below 1GHz Data:
For U-NII-1:
802.11ax (HE20)

CHANNEL	TX Channel 40	DETECTOR FUNCTION	Quasi-Peak (QP)
FREQUENCY RANGE	9kHz ~ 1GHz		

ANTENNA POLARITY & TEST DISTANCE: HORIZONTAL AT 3 M

NO.	FREQ. (MHz)	EMISSION LEVEL (dBuV/m)	LIMIT (dBuV/m)	MARGIN (dB)	ANTENNA HEIGHT (m)	TABLE ANGLE (Degree)	RAW VALUE (dBuV)	CORRECTION FACTOR (dB/m)
1	31.22	30.2 QP	40.0	-9.8	1.50 H	214	39.6	-9.4
2	44.09	33.2 QP	40.0	-6.8	1.00 H	135	41.3	-8.1
3	125.00	28.2 QP	43.5	-15.3	1.00 H	93	37.4	-9.2
4	143.74	28.2 QP	43.5	-15.3	1.50 H	145	35.8	-7.6
5	243.46	26.8 QP	46.0	-19.2	1.50 H	84	35.5	-8.7
6	337.60	35.8 QP	46.0	-10.2	1.00 H	147	41.3	-5.5

REMARKS:

1. Emission Level(dBuV/m) = Raw Value(dBuV) + Correction Factor(dB/m)
2. Correction Factor(dB/m) = Antenna Factor(dB/m) + Cable Factor(dB) – Pre-Amplifier Factor(dB)
3. Margin value = Emission Level – Limit value
4. The other emission levels were very low against the limit of frequency range 30MHz~1000MHz.
5. The emission levels were very low against the limit of frequency range 9kHz~30MHz: the amplitude of spurious emissions attenuated more than 20 dB below the permissible value to be report.

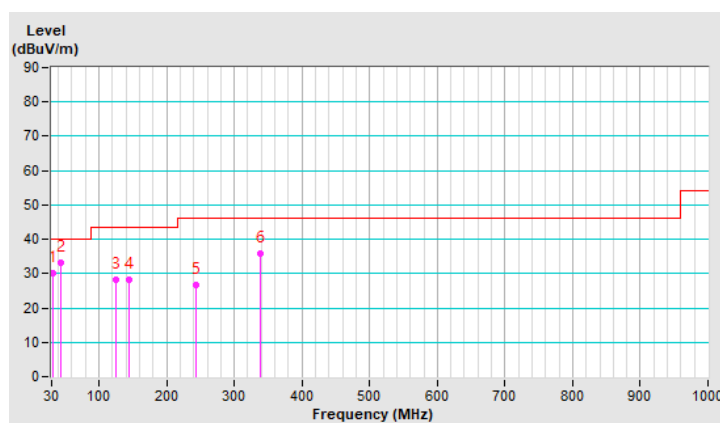

CHANNEL	TX Channel 40	DETECTOR FUNCTION	Quasi-Peak (QP)
FREQUENCY RANGE	9kHz ~ 1GHz		

ANTENNA POLARITY & TEST DISTANCE: VERTICAL AT 3 M

NO.	FREQ. (MHz)	EMISSION LEVEL (dBuV/m)	LIMIT (dBuV/m)	MARGIN (dB)	ANTENNA HEIGHT (m)	TABLE ANGLE (Degree)	RAW VALUE (dBuV)	CORRECTION FACTOR (dB/m)
1	36.42	36.4 QP	40.0	-3.6	1.00 V	196	45.3	-8.9
2	101.87	30.2 QP	43.5	-13.3	1.50 V	245	41.9	-11.7
3	125.01	34.5 QP	43.5	-9.0	1.00 V	277	43.7	-9.2
4	146.10	32.6 QP	43.5	-10.9	1.50 V	175	40.1	-7.5
5	332.29	25.5 QP	46.0	-20.5	1.00 V	293	31.1	-5.6
6	427.04	27.4 QP	46.0	-18.6	1.00 V	117	30.4	-3.0

REMARKS:

1. Emission Level(dBuV/m) = Raw Value(dBuV) + Correction Factor(dB/m)
2. Correction Factor(dB/m) = Antenna Factor(dB/m) + Cable Factor(dB) – Pre-Amplifier Factor(dB)
3. Margin value = Emission Level – Limit value
4. The other emission levels were very low against the limit of frequency range 30MHz~1000MHz.
5. The emission levels were very low against the limit of frequency range 9kHz~30MHz: the amplitude of spurious emissions attenuated more than 20 dB below the permissible value to be report.

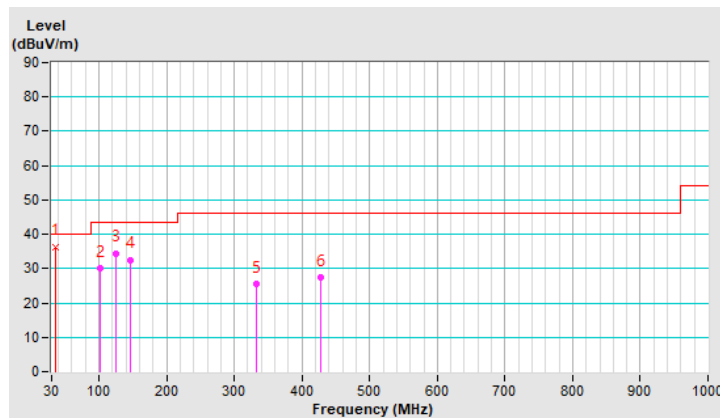

For U-NII-3:

802.11ax (HE20)

CHANNEL	TX Channel 157	DETECTOR FUNCTION	Quasi-Peak (QP)
FREQUENCY RANGE	9kHz ~ 1GHz		

ANTENNA POLARITY & TEST DISTANCE: HORIZONTAL AT 3 M

NO.	FREQ. (MHz)	EMISSION LEVEL (dBuV/m)	LIMIT (dBuV/m)	MARGIN (dB)	ANTENNA HEIGHT (m)	TABLE ANGLE (Degree)	RAW VALUE (dBuV)	CORRECTION FACTOR (dB/m)
1	31.29	30.4 QP	40.0	-9.6	1.50 H	199	39.8	-9.4
2	44.06	33.4 QP	40.0	-6.6	1.00 H	167	41.5	-8.1
3	125.01	28.3 QP	43.5	-15.2	1.00 H	105	37.5	-9.2
4	143.82	28.5 QP	43.5	-15.0	1.50 H	167	36.1	-7.6
5	243.53	26.9 QP	46.0	-19.1	1.50 H	73	35.6	-8.7
6	337.68	35.9 QP	46.0	-10.1	1.00 H	163	41.4	-5.5

REMARKS:

1. Emission Level(dBuV/m) = Raw Value(dBuV) + Correction Factor(dB/m)
2. Correction Factor(dB/m) = Antenna Factor(dB/m) + Cable Factor(dB) – Pre-Amplifier Factor(dB)
3. Margin value = Emission Level – Limit value
4. The other emission levels were very low against the limit of frequency range 30MHz~1000MHz.
5. The emission levels were very low against the limit of frequency range 9kHz~30MHz: the amplitude of spurious emissions attenuated more than 20 dB below the permissible value to be report.

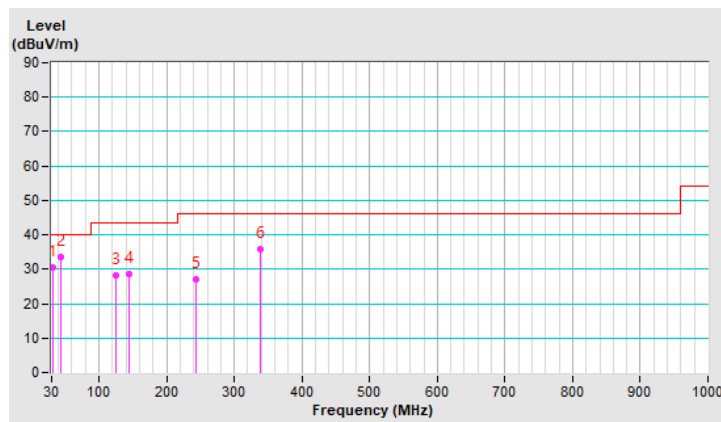

CHANNEL	TX Channel 157	DETECTOR FUNCTION	Quasi-Peak (QP)
FREQUENCY RANGE	9kHz ~ 1GHz		

ANTENNA POLARITY & TEST DISTANCE: VERTICAL AT 3 M

NO.	FREQ. (MHz)	EMISSION LEVEL (dBuV/m)	LIMIT (dBuV/m)	MARGIN (dB)	ANTENNA HEIGHT (m)	TABLE ANGLE (Degree)	RAW VALUE (dBuV)	CORRECTION FACTOR (dB/m)
1	36.39	36.5 QP	40.0	-3.5	1.00 V	175	45.4	-8.9
2	101.85	30.1 QP	43.5	-13.4	1.50 V	236	41.8	-11.7
3	125.01	34.6 QP	43.5	-8.9	1.00 V	297	43.8	-9.2
4	146.07	32.5 QP	43.5	-11.0	1.50 V	148	40.0	-7.5
5	332.31	25.3 QP	46.0	-20.7	1.00 V	249	30.9	-5.6
6	426.99	27.5 QP	46.0	-18.5	1.00 V	164	30.5	-3.0

REMARKS:

1. Emission Level(dBuV/m) = Raw Value(dBuV) + Correction Factor(dB/m)
2. Correction Factor(dB/m) = Antenna Factor(dB/m) + Cable Factor(dB) – Pre-Amplifier Factor(dB)
3. Margin value = Emission Level – Limit value
4. The other emission levels were very low against the limit of frequency range 30MHz~1000MHz.
5. The emission levels were very low against the limit of frequency range 9kHz~30MHz: the amplitude of spurious emissions attenuated more than 20 dB below the permissible value to be report.

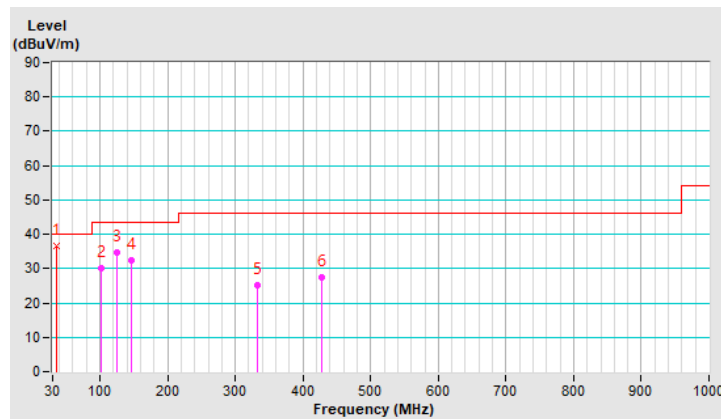

4.2 Conducted Emission Measurement

4.2.1 Limits of Conducted Emission Measurement

Frequency (MHz)	Conducted Limit (dBuV)	
	Quasi-peak	Average
0.15 - 0.5	66 - 56	56 - 46
0.50 - 5.0	56	46
5.0 - 30.0	60	50

Note: 1. The lower limit shall apply at the transition frequencies.

2. The limit decreases in line with the logarithm of the frequency in the range of 0.15 to 0.50MHz.

4.2.2 Test Instruments

DESCRIPTION & MANUFACTURER	MODEL NO.	SERIAL NO.	CALIBRATED DATE	CALIBRATED UNTIL
Test Receiver R&S	ESCS 30	847124/029	Oct. 23, 2019	Oct. 22, 2020
Line-Impedance Stabilization Network (for EUT) R&S	ESH3-Z5	848773/004	Oct. 23, 2019	Oct. 22, 2020
Line-Impedance Stabilization Network (for Peripheral) R&S	ESH3-Z5	835239/001	Mar. 19, 2020	Mar. 18, 2021
50 ohms Terminator	50	3	Oct. 23, 2019	Oct. 22, 2020
RF Cable	5D-FB	COCCAB-001	Sep. 27, 2019	Sep. 26, 2020
Fixed attenuator EMCI	STI02-2200-10	005	Aug. 30, 2019	Aug. 29, 2020
Software BVADT	BVADT_Cond_V7.3.7.4	NA	NA	NA

Note:

1. The calibration interval of the above test instruments are 12 months and the calibrations are traceable to NML/ROC and NIST/USA.
2. The test was performed in Conduction 1.
- 3 Tested Date: Aug. 19, 2020

4.2.3 Test Procedure

- The EUT was placed 0.4 meters from the conducting wall of the shielded room with EUT being connected to the power mains through a line impedance stabilization network (LISN). Other support units were connected to the power mains through another LISN. The two LISNs provide 50 ohm/ 50uH of coupling impedance for the measuring instrument.
- Both lines of the power mains connected to the EUT were checked for maximum conducted interference.
- The frequency range from 150kHz to 30MHz was searched. Emission levels under (Limit - 20dB) was not recorded.

NOTE: All modes of operation were investigated and the worst-case emissions are reported.

4.2.4 Deviation from Test Standard

No deviation.

4.2.5 Test Setup

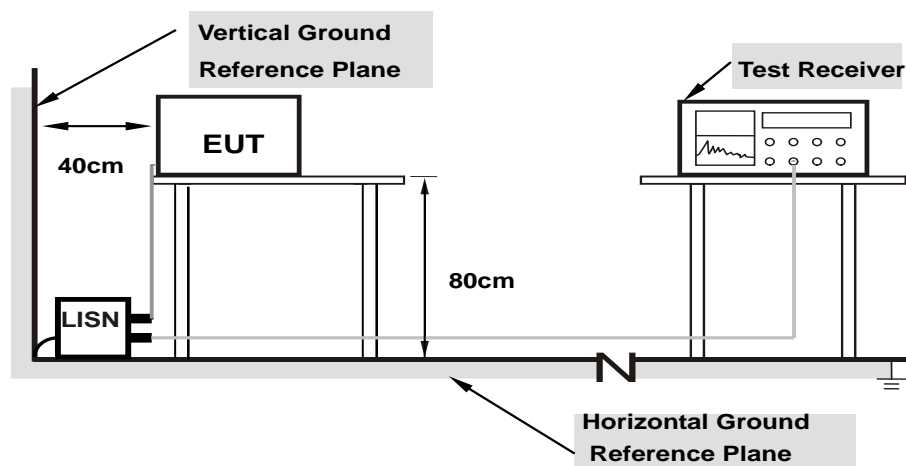

Note: 1.Support units were connected to second LISN.

For the actual test configuration, please refer to the attached file (Test Setup Photo).

4.2.6 EUT Operating Condition

Same as 4.1.6.

4.2.7 Test Results

For U-NII-1:

Phase	Line (L)	Detector Function	Quasi-Peak (QP) / Average (AV)
-------	----------	-------------------	--------------------------------

No	Freq. [MHz]	Corr.	Reading Value		Emission Level		Limit		Margin	
		Factor	[dB (uV)]		[dB (uV)]		[dB (uV)]		(dB)	
	(dB)	Q.P.	AV.	Q.P.	AV.	Q.P.	AV.	Q.P.	AV.	
1	0.15391	9.98	34.33	25.00	44.31	34.98	65.79	55.79	-21.48	-20.81
2	0.17734	9.99	31.15	21.20	41.14	31.19	64.61	54.61	-23.47	-23.42
3	0.19297	9.99	30.61	21.73	40.60	31.72	63.91	53.91	-23.31	-22.19
4	0.22812	9.99	29.30	20.67	39.29	30.66	62.52	52.52	-23.23	-21.86
5	0.30234	10.00	31.63	26.11	41.63	36.11	60.18	50.18	-18.55	-14.07
6	0.37656	10.01	19.42	10.61	29.43	20.62	58.35	48.35	-28.92	-27.73

Remarks:

1. Q.P. and AV. are abbreviations of quasi-peak and average individually.
2. The emission levels of other frequencies were very low against the limit.
3. Margin value = Emission level – Limit value
4. Correction factor = Insertion loss + Cable loss
5. Emission Level = Correction Factor + Reading Value

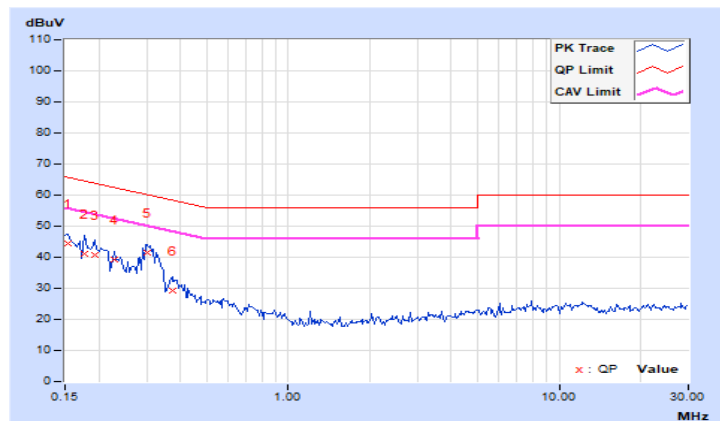

Phase	Neutral (N)	Detector Function	Quasi-Peak (QP) / Average (AV)
-------	-------------	-------------------	--------------------------------

No	Freq. [MHz]	Corr.	Reading Value		Emission Level		Limit		Margin	
		Factor	[dB (uV)]		[dB (uV)]		[dB (uV)]		(dB)	
	(dB)	Q.P.	AV.	Q.P.	AV.	Q.P.	AV.	Q.P.	AV.	
1	0.15391	9.99	36.76	26.76	46.75	36.75	65.79	55.79	-19.04	-19.04
2	0.19297	10.00	33.42	24.13	43.42	34.13	63.91	53.91	-20.49	-19.78
3	0.31016	10.02	34.79	27.87	44.81	37.89	59.97	49.97	-15.16	-12.08
4	0.38438	10.03	23.88	16.32	33.91	26.35	58.18	48.18	-24.27	-21.83
5	0.56406	10.05	16.24	9.69	26.29	19.74	56.00	46.00	-29.71	-26.26
6	9.10547	10.55	10.25	5.05	20.80	15.60	60.00	50.00	-39.20	-34.40

Remarks:

1. Q.P. and AV. are abbreviations of quasi-peak and average individually.
2. The emission levels of other frequencies were very low against the limit.
3. Margin value = Emission level – Limit value
4. Correction factor = Insertion loss + Cable loss
5. Emission Level = Correction Factor + Reading Value

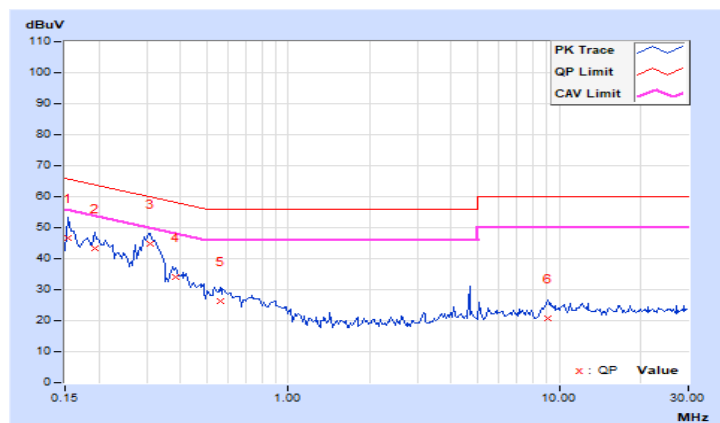

For U-NII-3:

Phase	Line (L)	Detector Function	Quasi-Peak (QP) / Average (AV)
-------	----------	-------------------	--------------------------------

No	Freq. [MHz]	Corr.	Reading Value		Emission Level		Limit		Margin	
		Factor (dB)	[dB (uV)]		[dB (uV)]		[dB (uV)]		(dB)	
			Q.P.	AV.	Q.P.	AV.	Q.P.	AV.	Q.P.	AV.
1	0.15391	9.98	33.98	25.08	43.96	35.06	65.79	55.79	-21.83	-20.73
2	0.19297	9.99	30.65	21.93	40.64	31.92	63.91	53.91	-23.27	-21.99
3	0.24766	9.99	28.48	20.04	38.47	30.03	61.84	51.84	-23.37	-21.81
4	0.30234	10.00	32.51	26.56	42.51	36.56	60.18	50.18	-17.67	-13.62
5	0.40000	10.01	18.62	9.17	28.63	19.18	57.85	47.85	-29.22	-28.67
6	12.01563	10.82	8.49	3.57	19.31	14.39	60.00	50.00	-40.69	-35.61

Remarks:

1. Q.P. and AV. are abbreviations of quasi-peak and average individually.
2. The emission levels of other frequencies were very low against the limit.
3. Margin value = Emission level – Limit value
4. Correction factor = Insertion loss + Cable loss
5. Emission Level = Correction Factor + Reading Value

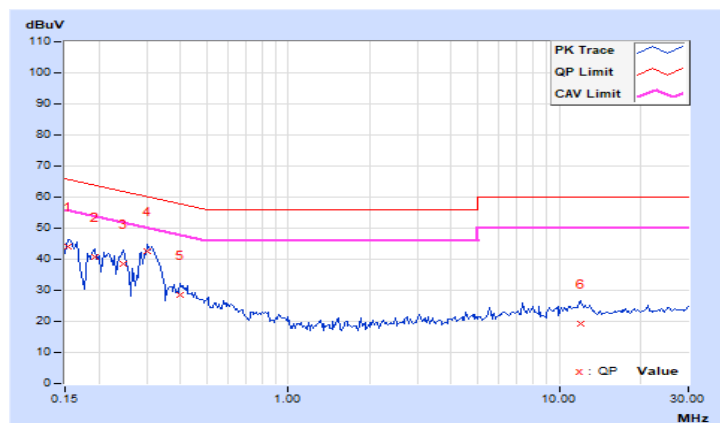

Phase	Neutral (N)	Detector Function	Quasi-Peak (QP) / Average (AV)
-------	-------------	-------------------	--------------------------------

No	Freq. [MHz]	Corr. Factor	Reading Value [dB (uV)]		Emission Level [dB (uV)]		Limit [dB (uV)]		Margin (dB)	
		(dB)	Q.P.	AV.	Q.P.	AV.	Q.P.	AV.	Q.P.	AV.
	1	0.15391	9.99	36.75	27.40	46.74	37.39	65.79	55.79	-19.05
2	0.19687	10.00	34.02	23.05	44.02	33.05	63.74	53.74	-19.72	-20.69
3	0.25156	10.01	27.45	17.01	37.46	27.02	61.71	51.71	-24.25	-24.69
4	0.30625	10.02	36.00	29.90	46.02	39.92	60.07	50.07	-14.05	-10.15
5	0.38047	10.03	25.38	17.79	35.41	27.82	58.27	48.27	-22.86	-20.45
6	9.27734	10.56	10.76	5.36	21.32	15.92	60.00	50.00	-38.68	-34.08

Remarks:

1. Q.P. and AV. are abbreviations of quasi-peak and average individually.
2. The emission levels of other frequencies were very low against the limit.
3. Margin value = Emission level – Limit value
4. Correction factor = Insertion loss + Cable loss
5. Emission Level = Correction Factor + Reading Value

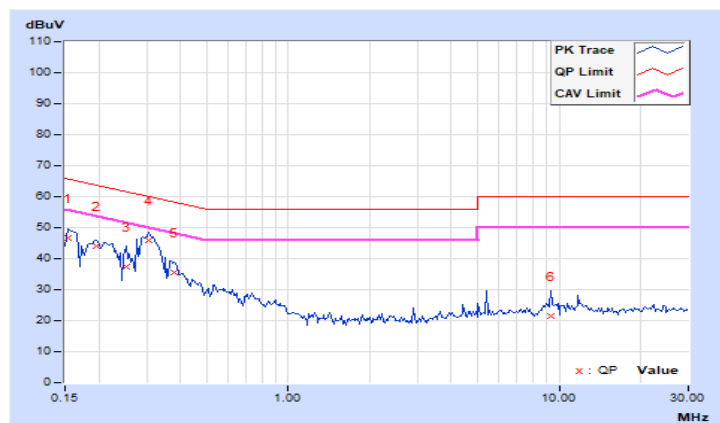

4.3 Transmit Power Measurement

4.3.1 Limits of Transmit Power Measurement

Operation Band	EUT Category		Limit
U-NII-1		Outdoor Access Point	1 Watt (30 dBm) (Max. e.i.r.p \leq 125mW(21 dBm) at any elevation angle above 30 degrees as measured from the horizon)
		Fixed point-to-point Access Point	1 Watt (30 dBm)
	√	Indoor Access Point	1 Watt (30 dBm)
		Client device	250mW (24 dBm)
U-NII-2A			250mW (24 dBm) or 11 dBm+10 log B*
U-NII-2C			250mW (24 dBm) or 11 dBm+10 log B*
U-NII-3	√		1 Watt (30 dBm)

*B is the 26 dB emission bandwidth in megahertz

Per KDB 662911 Method of conducted output power measurement on IEEE 802.11 devices,

Array Gain = 0 dB (i.e., no array gain) for $N_{ANT} \leq 4$;

Array Gain = 0 dB (i.e., no array gain) for channel widths ≥ 40 MHz for any N_{ANT} ;

Array Gain = $5 \log(N_{ANT}/N_{SS})$ dB or 3 dB, whichever is less for 20-MHz channel widths with $N_{ANT} \geq 5$.

For power measurements on all other devices: Array Gain = $10 \log(N_{ANT}/N_{SS})$ dB.

4.3.2 Test Setup

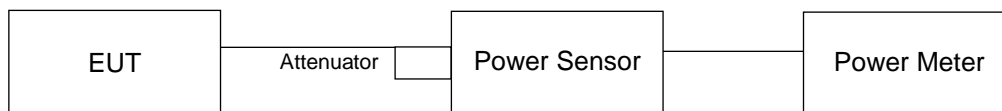

4.3.3 Test Instruments

Refer to section 4.1.2 to get information of above instrument.

4.3.4 Test Procedure

Method PM is used to perform output power measurement, trigger and gating function of wide band power meter is enabled to measure max output power of TX on burst. Duty factor is not added to measured value.

4.3.5 Deviation from Test Standard

No deviation.

4.3.6 EUT Operating Condition

The software provided by client to enable the EUT under transmission condition continuously at lowest, middle and highest channel frequencies individually.

4.3.7 Test Results

For U-NII-1:

CDD Mode

802.11a

Chan.	Chan. Freq. (MHz)	Maximum Conducted Power (dBm)		Total Power (mW)	Total Power (dBm)	Limit (dBm)	Pass / Fail
		Chain 0	Chain 1				
36	5180	21.80	21.68	298.587	24.75	30.00	Pass
40	5200	26.59	26.65	918.418	29.63	30.00	Pass
48	5240	26.46	26.08	848.097	29.28	30.00	Pass

802.11ac (VHT20)

Chan.	Chan. Freq. (MHz)	Maximum Conducted Power (dBm)		Total Power (mW)	Total Power (dBm)	Limit (dBm)	Pass / Fail
		Chain 0	Chain 1				
36	5180	20.84	20.62	236.684	23.74	30.00	Pass
40	5200	26.50	26.61	904.825	29.57	30.00	Pass
48	5240	26.34	26.12	839.787	29.24	30.00	Pass

802.11ac (VHT40)

Chan.	Chan. Freq. (MHz)	Maximum Conducted Power (dBm)		Total Power (mW)	Total Power (dBm)	Limit (dBm)	Pass / Fail
		Chain 0	Chain 1				
38	5190	19.41	19.47	175.809	22.45	30.00	Pass
46	5230	26.26	26.46	865.257	29.37	30.00	Pass

802.11ac (VHT80)

Chan.	Chan. Freq. (MHz)	Maximum Conducted Power (dBm)		Total Power (mW)	Total Power (dBm)	Limit (dBm)	Pass / Fail
		Chain 0	Chain 1				
42	5210	20.53	19.95	211.835	23.26	30.00	Pass

802.11ax (HE20)

Chan.	Chan. Freq. (MHz)	Maximum Conducted Power (dBm)		Total Power (mW)	Total Power (dBm)	Limit (dBm)	Pass / Fail
		Chain 0	Chain 1				
36	5180	20.99	20.78	245.277	23.90	30.00	Pass
40	5200	26.60	26.71	925.902	29.67	30.00	Pass
48	5240	26.42	26.22	857.324	29.33	30.00	Pass

802.11ax (HE40)

Chan.	Chan. Freq. (MHz)	Maximum Conducted Power (dBm)		Total Power (mW)	Total Power (dBm)	Limit (dBm)	Pass / Fail
		Chain 0	Chain 1				
38	5190	19.57	19.58	181.355	22.59	30.00	Pass
46	5230	26.43	26.36	872.055	29.41	30.00	Pass

802.11ax (HE80)

Chan.	Chan. Freq. (MHz)	Maximum Conducted Power (dBm)		Total Power (mW)	Total Power (dBm)	Limit (dBm)	Pass / Fail
		Chain 0	Chain 1				
42	5210	20.69	19.98	216.76	23.36	30.00	Pass

Beamforming Mode

802.11ac (VHT20)

Chan.	Chan. Freq. (MHz)	Maximum Conducted Power (dBm)		Total Power (mW)	Total Power (dBm)	Limit (dBm)	Pass / Fail
		Chain 0	Chain 1				
36	5180	20.84	20.62	236.684	23.74	30.00	Pass
40	5200	26.50	26.61	904.825	29.57	30.00	Pass
48	5240	26.34	26.12	839.787	29.24	30.00	Pass

Note: 1. For U-NII-1: The directional gain = 4.72 dBi < 6dBi, so the power limit shall not be reduced.

802.11ac (VHT40)

Chan.	Chan. Freq. (MHz)	Maximum Conducted Power (dBm)		Total Power (mW)	Total Power (dBm)	Limit (dBm)	Pass / Fail
		Chain 0	Chain 1				
38	5190	19.41	19.47	175.809	22.45	30.00	Pass
46	5230	26.26	26.46	865.257	29.37	30.00	Pass

Note: 1. For U-NII-1: The directional gain = 4.72 dBi < 6dBi, so the power limit shall not be reduced.

802.11ac (VHT80)

Chan.	Chan. Freq. (MHz)	Maximum Conducted Power (dBm)		Total Power (mW)	Total Power (dBm)	Limit (dBm)	Pass / Fail
		Chain 0	Chain 1				
42	5210	20.53	19.95	211.835	23.26	30.00	Pass

Note: 1. For U-NII-1: The directional gain = 4.72 dBi < 6dBi, so the power limit shall not be reduced.

802.11ax (HE20)

Chan.	Chan. Freq. (MHz)	Maximum Conducted Power (dBm)		Total Power (mW)	Total Power (dBm)	Limit (dBm)	Pass / Fail
		Chain 0	Chain 1				
36	5180	20.99	20.78	245.277	23.90	30.00	Pass
40	5200	26.60	26.71	925.902	29.67	30.00	Pass
48	5240	26.42	26.22	857.324	29.33	30.00	Pass

Note: 1. For U-NII-1: The directional gain = 4.72 dBi < 6dBi, so the power limit shall not be reduced.

802.11ax (HE40)

Chan.	Chan. Freq. (MHz)	Maximum Conducted Power (dBm)		Total Power (mW)	Total Power (dBm)	Limit (dBm)	Pass / Fail
		Chain 0	Chain 1				
38	5190	19.57	19.58	181.355	22.59	30.00	Pass
46	5230	26.43	26.36	872.055	29.41	30.00	Pass

Note: 1. For U-NII-1: The directional gain = 4.72 dBi < 6dBi, so the power limit shall not be reduced.

802.11ax (HE80)

Chan.	Chan. Freq. (MHz)	Maximum Conducted Power (dBm)		Total Power (mW)	Total Power (dBm)	Limit (dBm)	Pass / Fail
		Chain 0	Chain 1				
42	5210	20.69	19.98	216.76	23.36	30.00	Pass

Note: 1. For U-NII-1: The directional gain = 4.72 dBi < 6dBi, so the power limit shall not be reduced.

For U-NII-3:

CDD Mode

802.11a

Chan.	Chan. Freq. (MHz)	Maximum Conducted Power (dBm)			Total Power (mW)	Total Power (dBm)	Limit (dBm)	Pass / Fail
		Chain 0	Chain 1	Chain 2				
149	5745	24.52	24.80	25.03	903.554	29.56	30.00	Pass
157	5785	24.69	24.82	25.06	918.458	29.63	30.00	Pass
165	5825	24.56	24.72	24.95	894.85	29.52	30.00	Pass

802.11ac (VHT20)

Chan.	Chan. Freq. (MHz)	Maximum Conducted Power (dBm)			Total Power (mW)	Total Power (dBm)	Limit (dBm)	Pass / Fail
		Chain 0	Chain 1	Chain 2				
149	5745	24.50	24.75	24.89	888.695	29.49	30.00	Pass
157	5785	24.58	24.84	24.97	905.918	29.57	30.00	Pass
165	5825	24.47	24.65	24.84	876.43	29.43	30.00	Pass

802.11ac (VHT40)

Chan.	Chan. Freq. (MHz)	Maximum Conducted Power (dBm)			Total Power (mW)	Total Power (dBm)	Limit (dBm)	Pass / Fail
		Chain 0	Chain 1	Chain 2				
151	5755	24.41	24.52	24.92	869.653	29.39	30.00	Pass
159	5795	24.44	24.58	24.70	860.17	29.35	30.00	Pass

802.11ac (VHT80)

Chan.	Chan. Freq. (MHz)	Maximum Conducted Power (dBm)			Total Power (mW)	Total Power (dBm)	Limit (dBm)	Pass / Fail
		Chain 0	Chain 1	Chain 2				
155	5775	23.52	23.58	23.77	691.172	28.40	30.00	Pass

802.11ax (HE20)

Chan.	Chan. Freq. (MHz)	Maximum Conducted Power (dBm)			Total Power (mW)	Total Power (dBm)	Limit (dBm)	Pass / Fail
		Chain 0	Chain 1	Chain 2				
149	5745	24.59	24.82	25.06	911.756	29.60	30.00	Pass
157	5785	24.68	24.91	25.11	927.847	29.67	30.00	Pass
165	5825	24.55	24.80	25.00	903.325	29.56	30.00	Pass

802.11ax (HE40)

Chan.	Chan. Freq. (MHz)	Maximum Conducted Power (dBm)			Total Power (mW)	Total Power (dBm)	Limit (dBm)	Pass / Fail
		Chain 0	Chain 1	Chain 2				
151	5755	24.57	24.70	25.03	899.958	29.54	30.00	Pass
159	5795	24.58	24.73	24.82	887.634	29.48	30.00	Pass

802.11ax (HE80)

Chan.	Chan. Freq. (MHz)	Maximum Conducted Power (dBm)			Total Power (mW)	Total Power (dBm)	Limit (dBm)	Pass / Fail
		Chain 0	Chain 1	Chain 2				
155	5775	23.62	23.72	23.87	709.43	28.51	30.00	Pass

Beamforming Mode

802.11ac (VHT20)

Chan.	Chan. Freq. (MHz)	Maximum Conducted Power (dBm)			Total Power (mW)	Total Power (dBm)	Limit (dBm)	Pass / Fail
		Chain 0	Chain 1	Chain 2				
149	5745	24.50	24.75	24.89	888.695	29.49	29.98	Pass
157	5785	24.58	24.84	24.97	905.918	29.57	29.98	Pass
165	5825	24.47	24.65	24.84	876.43	29.43	29.98	Pass

Note: 1. For U-NII-3: The directional gain = 6.02 dBi > 6dBi, so the so the power limit shall be reduced to $30-(6.02-6) = 29.98$ dBm.

802.11ac (VHT40)

Chan.	Chan. Freq. (MHz)	Maximum Conducted Power (dBm)			Total Power (mW)	Total Power (dBm)	Limit (dBm)	Pass / Fail
		Chain 0	Chain 1	Chain 2				
151	5755	24.41	24.52	24.92	869.653	29.39	29.98	Pass
159	5795	24.44	24.58	24.70	860.17	29.35	29.98	Pass

Note: 1. For U-NII-3: The directional gain = 6.02 dBi > 6dBi, so the so the power limit shall be reduced to $30-(6.02-6) = 29.98$ dBm.

802.11ac (VHT80)

Chan.	Chan. Freq. (MHz)	Maximum Conducted Power (dBm)			Total Power (mW)	Total Power (dBm)	Limit (dBm)	Pass / Fail
		Chain 0	Chain 1	Chain 2				
155	5775	23.52	23.58	23.77	691.172	28.40	29.98	Pass

Note: 1. For U-NII-3: The directional gain = 6.02 dBi > 6dBi, so the so the power limit shall be reduced to $30-(6.02-6) = 29.98$ dBm.

802.11ax (HE20)

Chan.	Chan. Freq. (MHz)	Maximum Conducted Power (dBm)			Total Power (mW)	Total Power (dBm)	Limit (dBm)	Pass / Fail
		Chain 0	Chain 1	Chain 2				
149	5745	24.59	24.82	25.06	911.756	29.60	29.98	Pass
157	5785	24.68	24.91	25.11	927.847	29.67	29.98	Pass
165	5825	24.55	24.80	25.00	903.325	29.56	29.98	Pass

Note: 1. For U-NII-3: The directional gain = 6.02 dBi > 6dBi, so the so the power limit shall be reduced to $30-(6.02-6) = 29.98$ dBm.

802.11ax (HE40)

Chan.	Chan. Freq. (MHz)	Maximum Conducted Power (dBm)			Total Power (mW)	Total Power (dBm)	Limit (dBm)	Pass / Fail
		Chain 0	Chain 1	Chain 2				
151	5755	24.57	24.70	25.03	899.958	29.54	29.98	Pass
159	5795	24.58	24.73	24.82	887.634	29.48	29.98	Pass

Note: 1. For U-NII-3: The directional gain = 6.02 dBi > 6dBi, so the so the power limit shall be reduced to $30-(6.02-6) = 29.98$ dBm.

802.11ax (HE80)

Chan.	Chan. Freq. (MHz)	Maximum Conducted Power (dBm)			Total Power (mW)	Total Power (dBm)	Limit (dBm)	Pass / Fail
		Chain 0	Chain 1	Chain 2				
155	5775	23.62	23.72	23.87	709.43	28.51	29.98	Pass

Note: 1. For U-NII-3: The directional gain = 6.02 dBi > 6dBi, so the so the power limit shall be reduced to $30-(6.02-6) = 29.98$ dBm.

4.4 Occupied Bandwidth Measurement

4.4.1 Test Setup

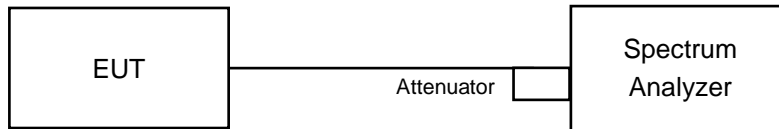

4.4.2 Test Instruments

Refer to section 4.1.2 to get information of above instrument.

4.4.3 Test Procedure

The transmitter output was connected to the spectrum analyzer through an attenuator. The bandwidth of the fundamental frequency was measured by spectrum analyzer with resolution bandwidth in the range of 1% to 5% of the anticipated emission bandwidth, and a video bandwidth at least 3x the resolution bandwidth and set the detector to SAMPLE. The width of a frequency band such that, below the lower and above the upper frequency limits, the mean powers emitted are each equal to a specified percentage 0.5% of the total mean power of a given emission.

4.4.4 Test Results

For U-NII-1:

802.11a

Channel	Channel Frequency (MHz)	Occupied Bandwidth (MHz)	
		Chain 0	Chain 1
36	5180	17.16	17.16
40	5200	24.6	23.04
48	5240	19.2	18.96

802.11ax (HE20)

Channel	Channel Frequency (MHz)	Occupied Bandwidth (MHz)	
		Chain 0	Chain 1
36	5180	19.2	19.08
40	5200	28.2	26.88
48	5240	19.68	19.68

802.11ax (HE40)

Channel	Channel Frequency (MHz)	Occupied Bandwidth (MHz)	
		Chain 0	Chain 1
38	5190	37.92	37.92
46	5230	39.6	39.6

802.11ax (HE80)

Channel	Channel Frequency (MHz)	Occupied Bandwidth (MHz)	
		Chain 0	Chain 1
42	5210	76.8	77.28

Spectrum Plot of Max. Value

802.11a_Chain 0 / CH40

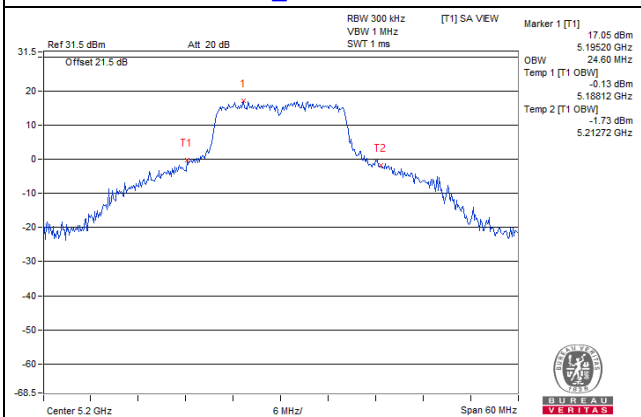

802.11ax (HE20)_Chain 0 / CH40

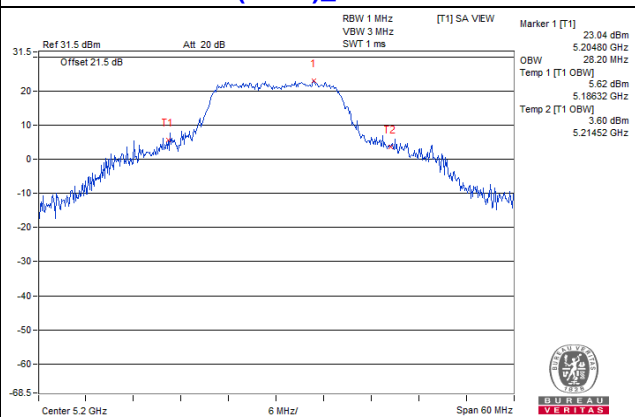

802.11ax (HE40)_Chain 0 / CH46

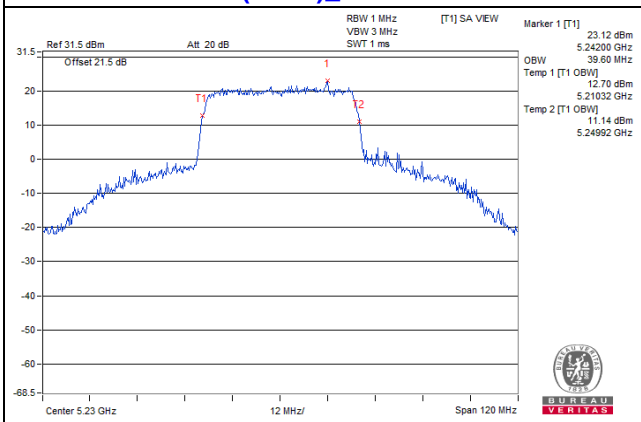

802.11ax (HE80)_Chain 1 / CH42

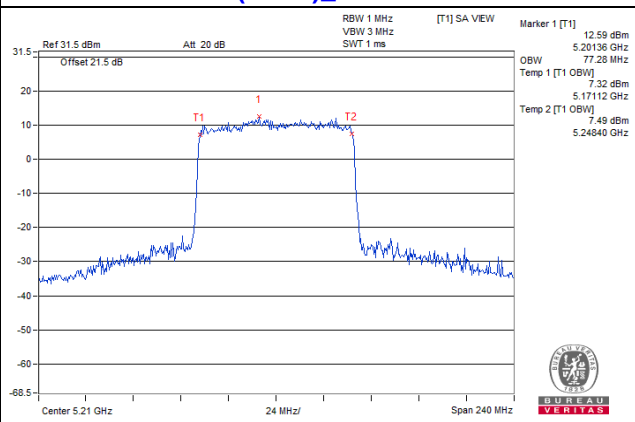

For U-NII-3:

802.11a

Channel	Channel Frequency (MHz)	Occupied Bandwidth (MHz)		
		Chain 0	Chain 1	Chain 2
149	5745	22.69	25.48	26.26
157	5785	25.8	24.78	26.64
165	5825	39.56	39.71	40.58

802.11ax (HE20)

Channel	Channel Frequency (MHz)	Occupied Bandwidth (MHz)		
		Chain 0	Chain 1	Chain 2
149	5745	23.28	23.83	25.4
157	5785	23.83	26.04	28.09
165	5825	41.6	45.36	49.91

802.11ax (HE40)

Channel	Channel Frequency (MHz)	Occupied Bandwidth (MHz)		
		Chain 0	Chain 1	Chain 2
151	5755	39.36	42.44	44.88
159	5795	59.28	55.2	57.84

802.11ax (HE80)

Channel	Channel Frequency (MHz)	Occupied Bandwidth (MHz)		
		Chain 0	Chain 1	Chain 2
155	5775	78.24	78.24	78.72

Spectrum Plot of Max. Value

802.11a_Chain 2 / CH165

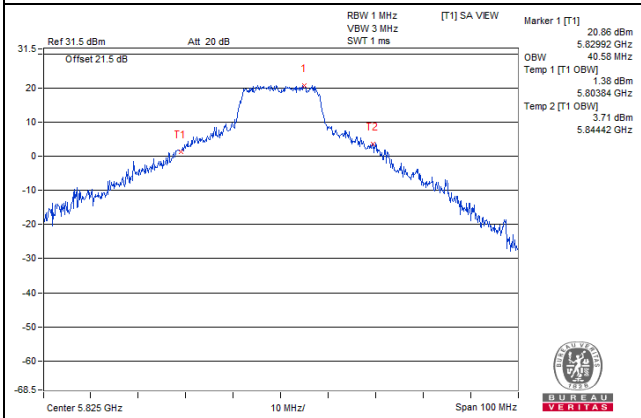

802.11ax (HE20)_Chain 2 / CH165

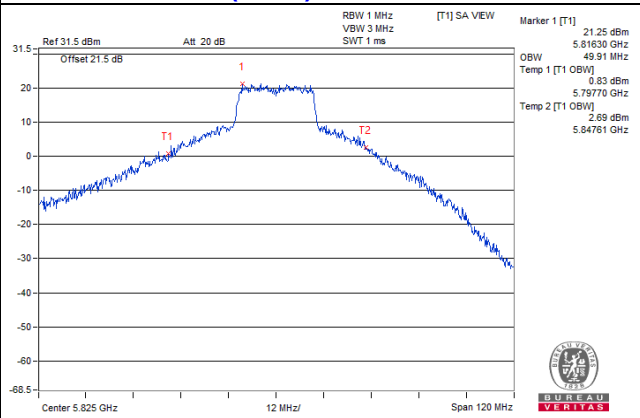

802.11ax (HE40)_Chain 0 / CH159

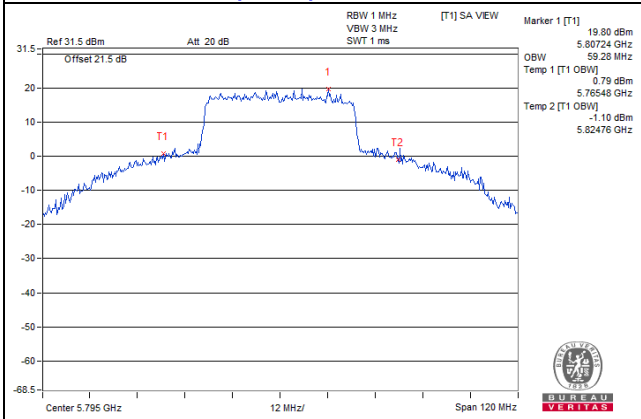

802.11ax (HE80)_Chain 2 / CH155

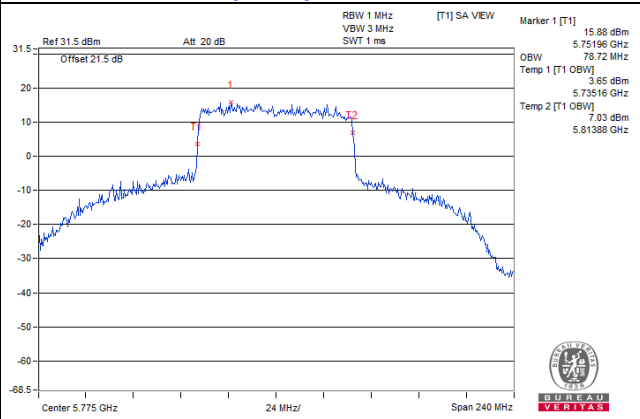

Spectrum Plot for near by DFS band
(DFS is required, if 99% OCP straddle into U-NII-2A band)

802.11a_Chain 0 / CH48

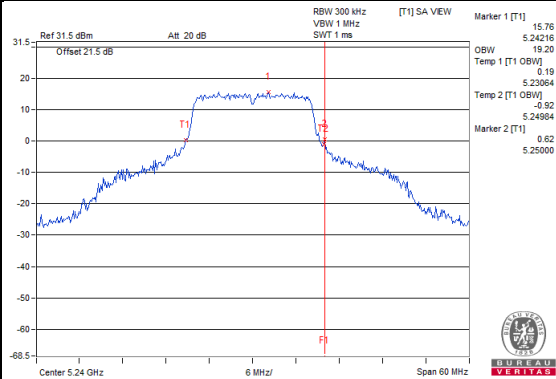

802.11a_Chain 1 / CH48

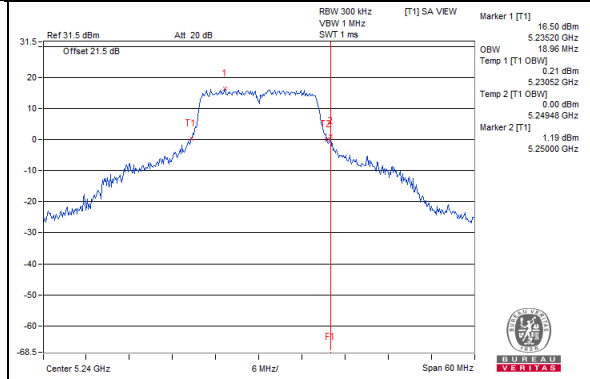

802.11ax (HE20)_Chain 0 / CH48

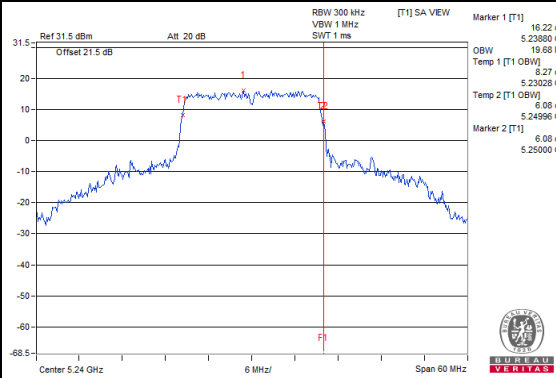

802.11ax (HE20)_Chain 1 / CH48

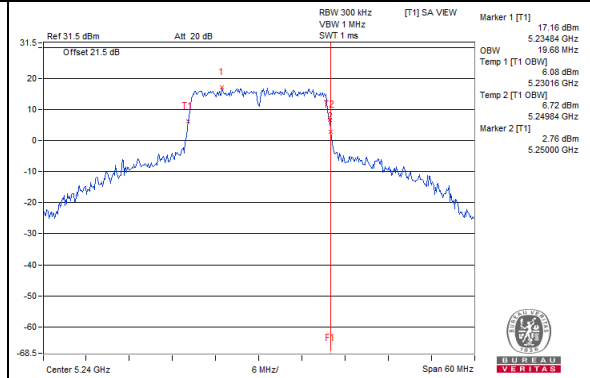

802.11ax (HE40)_Chain 0 / CH46

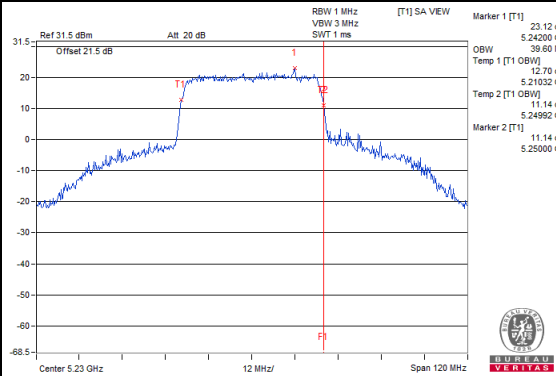

802.11ax (HE40)_Chain 1 / CH46

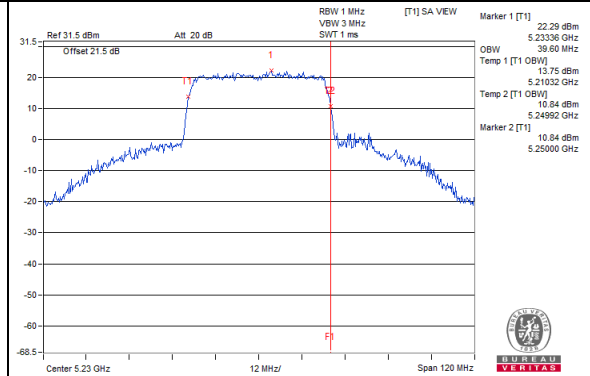

802.11ax (HE80)_Chain 0 / CH42

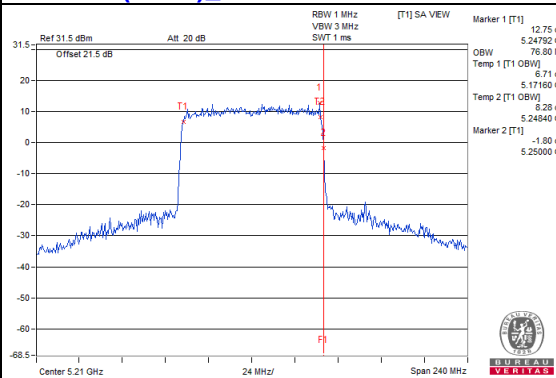

802.11ax (HE80)_Chain 1 / CH42

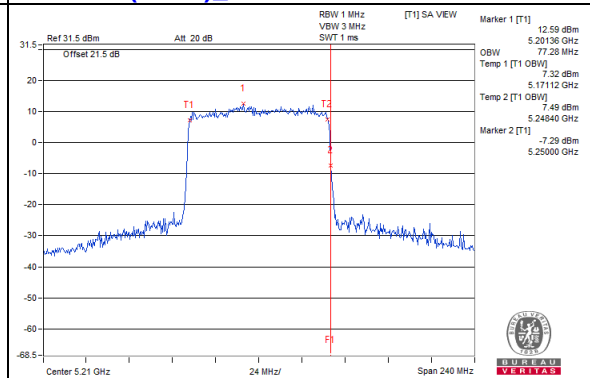

**Spectrum Plot for near by DFS band
(DFS is required, if 99% OCP straddle into U-NII-2C band)**

802.11a_Chain 0 / CH149

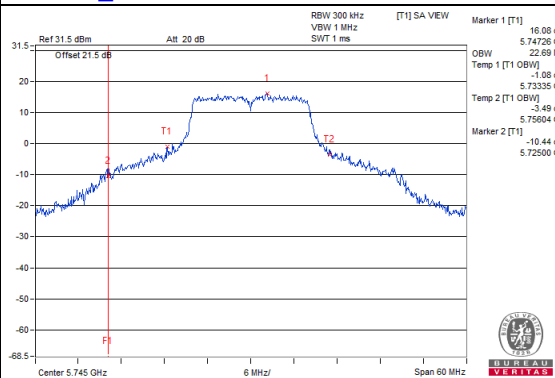

802.11a_Chain 1 / CH149

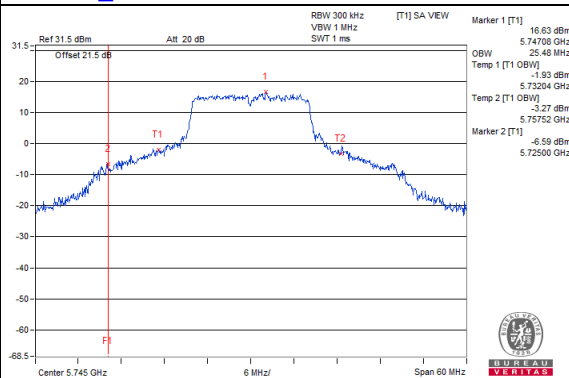

802.11a_Chain 2 / CH149

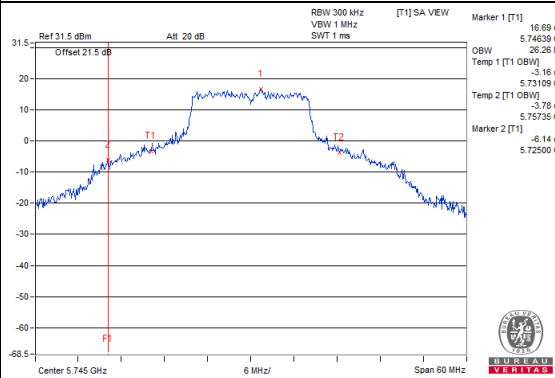

802.11ax (HE20)_Chain 0 / CH149

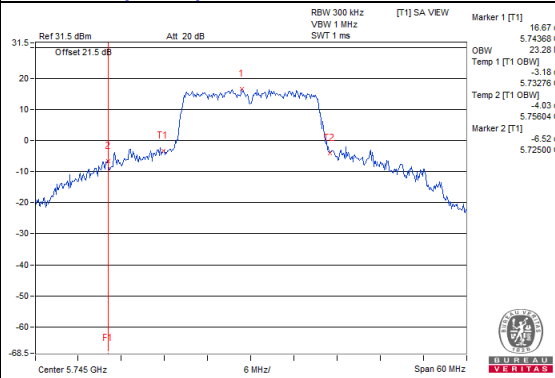

802.11ax (HE20)_Chain 1 / CH149

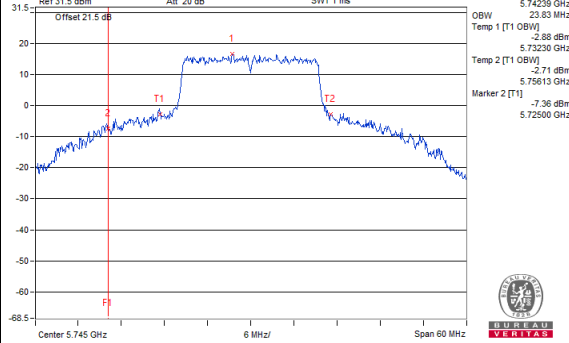

802.11ax (HE20)_Chain 2 / CH149

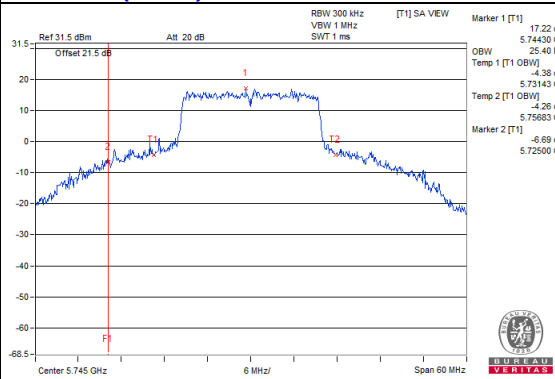

**Spectrum Plot for near by DFS band
(DFS is required, if 99% OCP straddle into U-NII-2C band)**

802.11ax (HE40)_Chain 0 / CH151

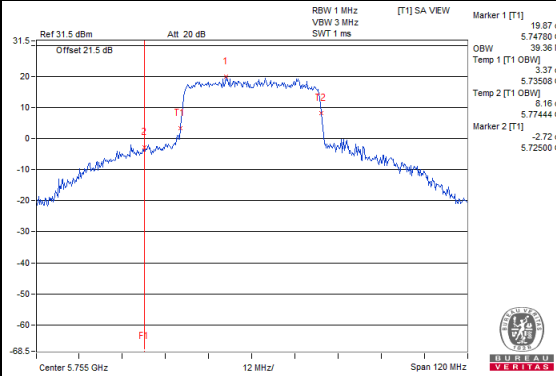

802.11ax (HE40)_Chain 1 / CH151

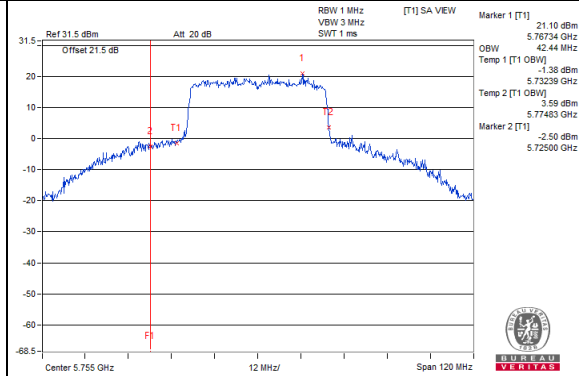

802.11ax (HE40)_Chain 2 / CH151

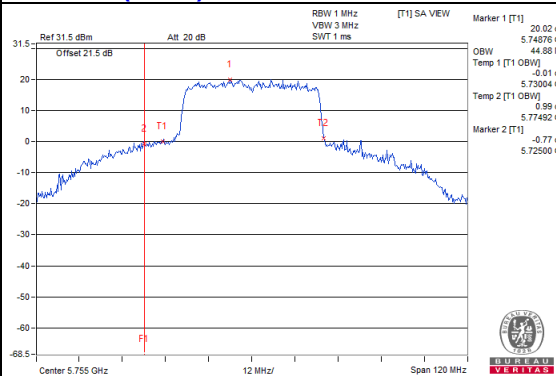

802.11ax (HE80)_Chain 0 / CH155

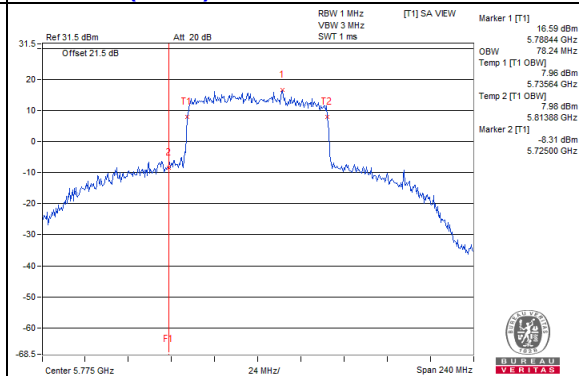
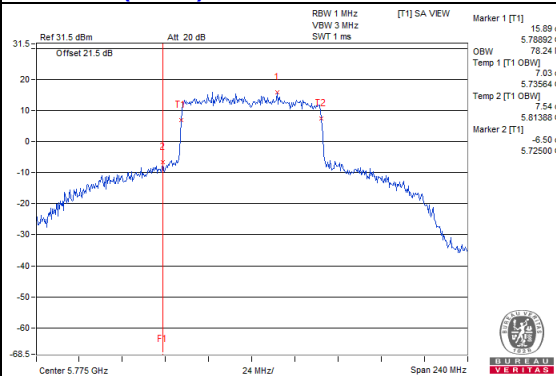

802.11ax (HE80)_Chain 2 / CH155

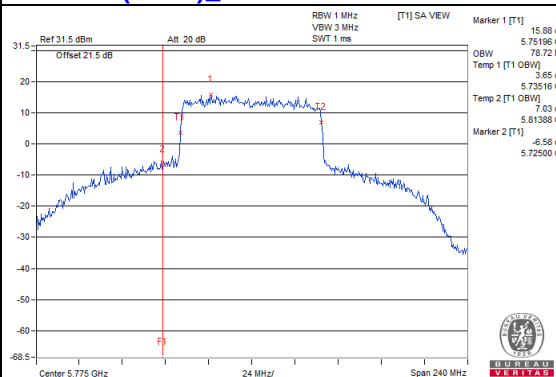

4.5 Peak Power Spectral Density Measurement

4.5.1 Limits of Peak Power Spectral Density Measurement

Operation Band	EUT Category		Limit
U-NII-1		Outdoor Access Point	17dBm/ MHz
		Fixed point-to-point Access Point	
	√	Indoor Access Point	
		Client device	11dBm/ MHz
U-NII-2A			11dBm/ MHz
U-NII-2C			11dBm/ MHz
U-NII-3		√	30dBm/ 500kHz

4.5.2 Test Setup

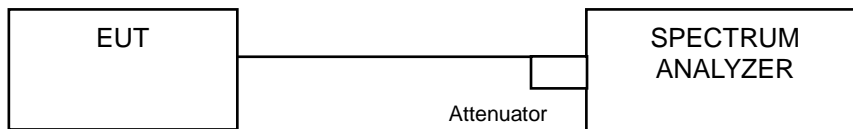

4.5.3 Test Instruments

Refer to section 4.1.2 to get information of above instrument.

4.5.4 Test Procedure

For U-NII-1, U-NII-2A, U-NII-2C band:

1. Set span to encompass the entire emission bandwidth (EBW) of the signal.
2. Set RBW = 1 MHz, Set VBW ≥ 3 MHz, Detector = RMS
3. Sweep time = auto, trigger set to "free run".
4. Trace average at least 100 traces in power averaging mode.
5. Record the max value

※For U-NII-3:

1. Set span to encompass the entire emission bandwidth (EBW) of the signal.
2. Set RBW = 300 kHz, Set VBW ≥ 1 MHz, Detector = RMS
3. Use the peak marker function to determine the maximum power level in any 300 kHz band segment within the fundamental EBW.
4. Scale the observed power level to an equivalent value in 500 kHz by adjusting (increasing) the measured power by a bandwidth correction factor (BWCF) where $BWCF = 10\log(500\text{ kHz}/300\text{ kHz})$
5. Sweep time = auto, trigger set to "free run".
6. Trace average at least 100 traces in power averaging mode.
7. Record the max value

4.5.5 Deviation from Test Standard

No deviation.

4.5.6 EUT Operating Condition

Same as Item 4.3.6.

4.5.7 Test Results

CDD Mode

For U-NII-1:

802.11a

Chan.	Chan. Freq. (MHz)	PSD w/o Duty Factor (dBm/MHz)		Total PSD (dBm/MHz)	Max. PSD Limit (dBm/MHz)	Pass / Fail
		Chain0	Chain1			
36	5180	8.59	8.31	11.46	17.00	PASS
40	5200	13.00	12.78	15.90	17.00	PASS
48	5240	11.47	12.10	14.81	17.00	PASS

- Note: 1. Method a) of power density measurement of KDB 662911 is using for calculating total power density. Total power density is summing entire spectra across corresponding frequency bins on the various outputs by computer.
 2. The directional gain = 4.72 dBi < 6dBi, so the power density limit shall not be reduced.

802.11ax (HE20)

Chan.	Chan. Freq. (MHz)	PSD w/o Duty Factor (dBm/MHz)		Total PSD (dBm/MHz)	Max. PSD Limit (dBm/MHz)	Pass / Fail
		Chain0	Chain1			
36	5180	7.09	7.02	10.07	17.00	PASS
40	5200	12.65	12.66	15.67	17.00	PASS
48	5240	10.52	11.51	14.05	17.00	PASS

- Note: 1. Method a) of power density measurement of KDB 662911 is using for calculating total power density. Total power density is summing entire spectra across corresponding frequency bins on the various outputs by computer.
 2. The directional gain = 4.72 dBi < 6dBi, so the power density limit shall not be reduced.

802.11ax (HE40)

Chan.	Chan. Freq. (MHz)	PSD w/o Duty Factor (dBm/MHz)		Total PSD (dBm/MHz)	Max. PSD Limit (dBm/MHz)	Pass / Fail
		Chain0	Chain1			
38	5190	3.13	2.89	6.02	17.00	PASS
46	5230	7.77	8.06	10.93	17.00	PASS

- Note: 1. Method a) of power density measurement of KDB 662911 is using for calculating total power density. Total power density is summing entire spectra across corresponding frequency bins on the various outputs by computer.
 2. The directional gain = 4.72 dBi < 6dBi, so the power density limit shall not be reduced.

802.11ax (HE80)

Chan.	Chan. Freq. (MHz)	PSD w/o Duty Factor (dBm/MHz)		Total PSD (dBm/MHz)	Max. PSD Limit (dBm/MHz)	Pass / Fail
		Chain0	Chain1			
42	5210	0.92	0.62	3.78	17.00	PASS

- Note: 1. Method a) of power density measurement of KDB 662911 is using for calculating total power density. Total power density is summing entire spectra across corresponding frequency bins on the various outputs by computer.
2. The directional gain = 4.72 dBi < 6dBi, so the power density limit shall not be reduced.

Spectrum Plot of Worst Value

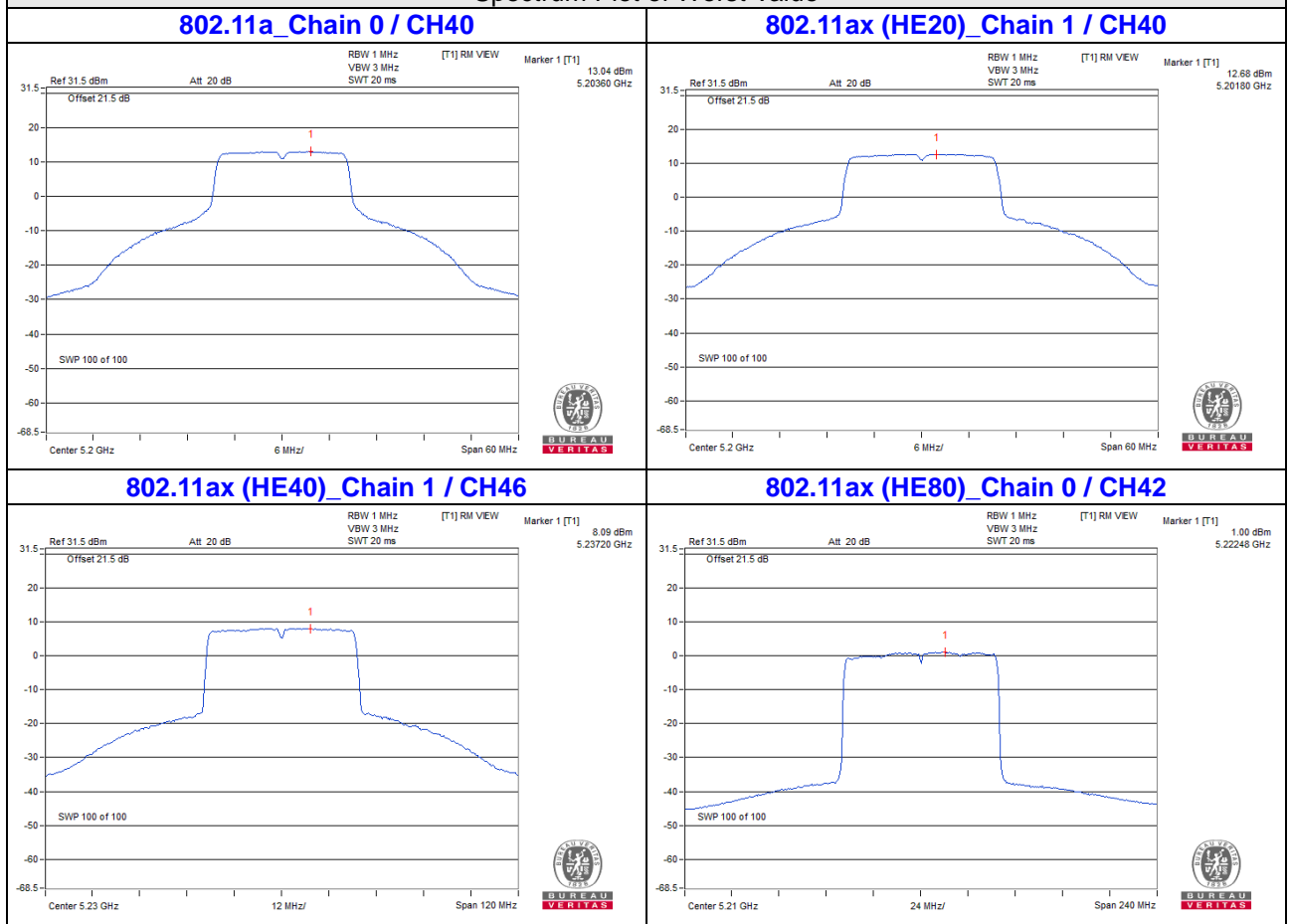

For U-NII-3:
802.11a

Chan.	Chan. Freq. (MHz)	PSD w/o Duty Factor (dBm/300kHz)			Total PSD (mW/300kHz)	Total PSD (dBm/300kHz)	Total PSD (dBm/500kHz)	PSD Limit (dBm/500kHz)	Pass / Fail
		Chain0	Chain1	Chain2					
149	5745	2.80	3.25	3.06	6.039	7.81	10.03	29.98	PASS
157	5785	2.78	2.73	2.50	5.546	7.44	9.66	29.98	PASS
165	5825	2.45	1.97	1.93	4.887	6.89	9.11	29.98	PASS

- Note: 1. Method b) Measure and sum spectral maxima across the outputs of KDB 662911 is using for calculating total power density.
 2. The directional gain = 6.02 dBi > 6dBi, so the power density limit shall be reduced to $30-(6.02-6) = 29.98$ dBm.

802.11ax (HE20)

Chan.	Chan. Freq. (MHz)	PSD w/o Duty Factor (dBm/300kHz)			Total PSD (mW/300kHz)	Total PSD (dBm/300kHz)	Total PSD (dBm/500kHz)	PSD Limit (dBm/500kHz)	Pass / Fail
		Chain0	Chain1	Chain2					
149	5745	1.89	1.76	1.59	4.487	6.52	8.74	29.98	PASS
157	5785	1.39	1.77	2.00	4.467	6.50	8.72	29.98	PASS
165	5825	0.88	1.07	0.98	3.758	5.75	7.97	29.98	PASS

- Note: 1. Method b) Measure and sum spectral maxima across the outputs of KDB 662911 is using for calculating total power density.
 2. The directional gain = 6.02 dBi > 6dBi, so the power density limit shall be reduced to $30-(6.02-6) = 29.98$ dBm.

802.11ax (HE40)

Chan.	Chan. Freq. (MHz)	PSD w/o Duty Factor (dBm/300kHz)			Total PSD (mW/300kHz)	Total PSD (dBm/300kHz)	Total PSD (dBm/500kHz)	PSD Limit (dBm/500kHz)	Pass / Fail
		Chain0	Chain1	Chain2					
151	5755	-1.29	-0.99	-0.73	2.3823	3.77	5.99	29.98	PASS
159	5795	-1.62	-1.69	-1.62	2.0559	3.13	5.35	29.98	PASS

- Note: 1. Method b) Measure and sum spectral maxima across the outputs of KDB 662911 is using for calculating total power density.
 2. The directional gain = 6.02 dBi > 6dBi, so the power density limit shall be reduced to $30-(6.02-6) = 29.98$ dBm.

802.11ax (HE80)

Chan.	Chan. Freq. (MHz)	PSD w/o Duty Factor (dBm/300kHz)			Total PSD (mW/300kHz)	Total PSD (dBm/300kHz)	Total PSD (dBm/500kHz)	PSD Limit (dBm/500kHz)	Pass / Fail
		Chain0	Chain1	Chain2					
155	5775	-5.20	-4.93	-4.78	0.955	-0.20	2.02	29.98	PASS

- Note: 1. Method b) Measure and sum spectral maxima across the outputs of KDB 662911 is using for calculating total power density.
 2. The directional gain = 6.02 dBi > 6dBi, so the power density limit shall be reduced to $30 - (6.02 - 6) = 29.98$ dBm.

Spectrum Plot of Worst Value

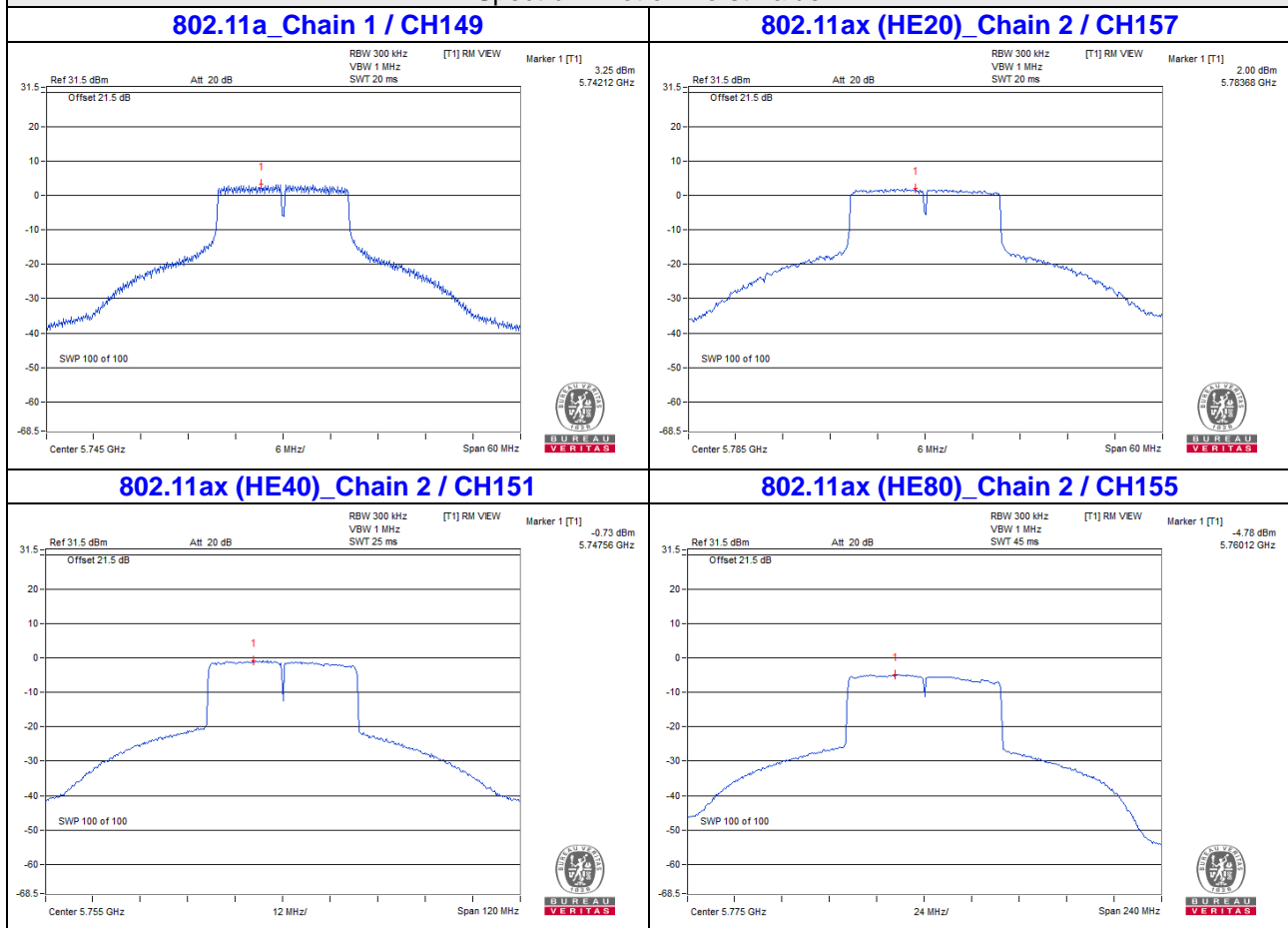

4.6 Frequency Stability Measurement

4.6.1 Limits of Frequency Stability Measurement

The frequency of the carrier signal shall be maintained within band of operation

4.6.2 Test Setup

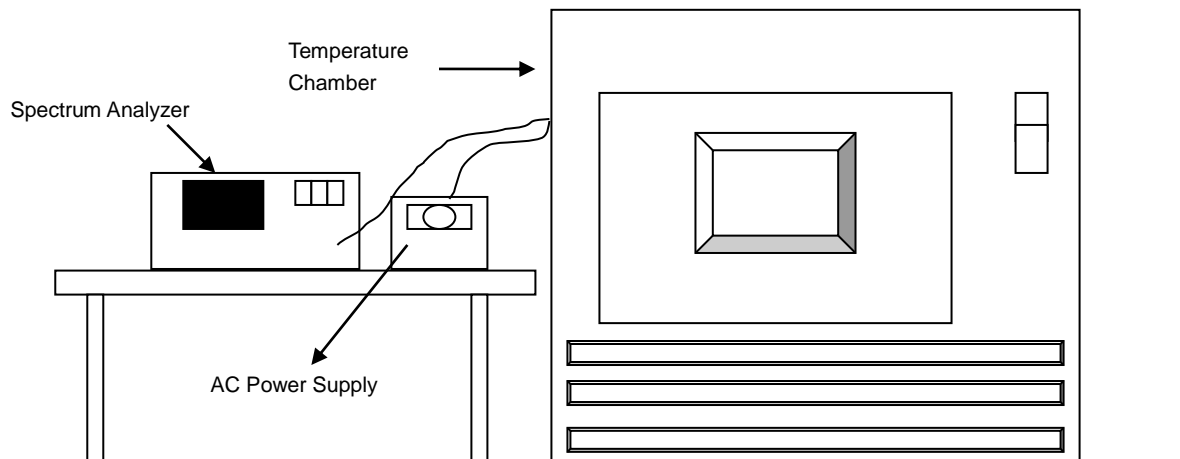

4.6.3 Test Instruments

Refer to section 4.1.2 to get information of above instrument.

4.6.4 Test Procedure

- The EUT was placed inside the environmental test chamber and powered by nominal AC voltage.
- Turn the EUT on and couple its output to a spectrum analyzer.
- Turn the EUT off and set the chamber to the highest temperature specified.
- Allow sufficient time (approximately 30 min) for the temperature of the chamber to stabilize, turn the EUT on and measure the operating frequency after 2, 5, and 10 Minutes.
- Repeat step (d) with the temperature chamber set to the next desired temperature until measurements down to the lowest specified temperature have been completed.
- The test chamber was allowed to stabilize at +20 degree C for a minimum of 30 Minutes. The supply voltage was then adjusted on the EUT from 85% to 115% and the frequency record.

4.6.5 Deviation from Test Standard

No deviation.

4.6.6 EUT Operating Condition

Set the EUT transmit at un-modulation mode to test frequency stability.

4.6.7 Test Results

Frequency Stability Versus Temp.									
Operating Frequency: 5180 MHz									
TEMP. (°C)	Power Supply (Vac)	0 Minute		2 Minutes		5 Minutes		10 Minutes	
		Measured Frequency (MHz)	Pass/Fail	Measured Frequency (MHz)	Pass/Fail	Measured Frequency (MHz)	Pass/Fail	Measured Frequency (MHz)	Pass/Fail
40	120	5179.9847	Pass	5179.9874	Pass	5179.9848	Pass	5179.9853	Pass
30	120	5179.983	Pass	5179.9868	Pass	5179.9844	Pass	5179.9852	Pass
20	120	5179.9774	Pass	5179.9818	Pass	5179.9787	Pass	5179.9792	Pass
10	120	5180.009	Pass	5180.0088	Pass	5180.0112	Pass	5180.0108	Pass
0	120	5180.0103	Pass	5180.0066	Pass	5180.0102	Pass	5180.0094	Pass

Frequency Stability Versus Voltage									
Operating Frequency: 5180 MHz									
TEMP. (°C)	Power Supply (Vac)	0 Minute		2 Minutes		5 Minutes		10 Minutes	
		Measured Frequency (MHz)	Pass/Fail	Measured Frequency (MHz)	Pass/Fail	Measured Frequency (MHz)	Pass/Fail	Measured Frequency (MHz)	Pass/Fail
20	138	5180.0094	Pass	5180.0086	Pass	5180.0104	Pass	5180.0111	Pass
	120	5180.009	Pass	5180.0088	Pass	5180.0112	Pass	5180.0108	Pass
	102	5180.0085	Pass	5180.0078	Pass	5180.0109	Pass	5180.0105	Pass

4.7 6dB Bandwidth Measurement

4.7.1 Limits of 6dB Bandwidth Measurement

The minimum of 6dB Bandwidth Measurement is 0.5MHz.

4.7.2 Test Setup

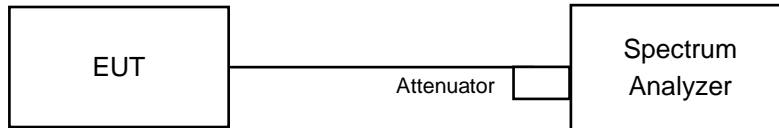

4.7.3 Test Instruments

Refer to section 4.1.2 to get information of above instrument.

4.7.4 Test Procedure

MEASUREMENT PROCEDURE REF

- Set resolution bandwidth (RBW) = 100kHz
- Set the video bandwidth (VBW) $\geq 3 \times$ RBW, Detector = Peak.
- Trace mode = max hold.
- Sweep = auto couple.
- Measure the maximum width of the emission that is constrained by the frequencies associated with the two amplitude points (upper and lower) that are attenuated by 6 dB relative to the maximum level measured in the fundamental emission.

4.7.5 Deviation from Test Standard

No deviation.

4.7.6 EUT Operating Condition

The software provided by client to enable the EUT under transmission condition continuously at lowest, middle and highest channel frequencies individually.

4.7.7 Test Results

802.11a

Channel	Frequency (MHz)	6dB Bandwidth (MHz)			Minimum Limit (MHz)	Pass / Fail
		Chain 0	Chain 1	Chain 2		
149	5745	16.39	16.39	16.41	0.5	Pass
157	5785	16.41	16.39	16.44	0.5	Pass
165	5825	16.4	16.4	16.39	0.5	Pass

802.11ax (HE20)

Channel	Frequency (MHz)	6dB Bandwidth (MHz)			Minimum Limit (MHz)	Pass / Fail
		Chain 0	Chain 1	Chain 2		
149	5745	18.94	18.96	18.86	0.5	Pass
157	5785	18.93	18.98	18.97	0.5	Pass
165	5825	18.72	18.24	18.38	0.5	Pass

802.11ax (HE40)

Channel	Frequency (MHz)	6dB Bandwidth (MHz)			Minimum Limit (MHz)	Pass / Fail
		Chain 0	Chain 1	Chain 2		
151	5755	37.78	37.69	37.5	0.5	Pass
159	5795	37.44	37.83	37.5	0.5	Pass

802.11ax (HE80)

Channel	Frequency (MHz)	6dB Bandwidth (MHz)			Minimum Limit (MHz)	Pass / Fail
		Chain 0	Chain 1	Chain 2		
155	5775	77.9	77.09	77.72	0.5	Pass

Spectrum Plot of Worst Value

802.11a_Chain 0 / CH149

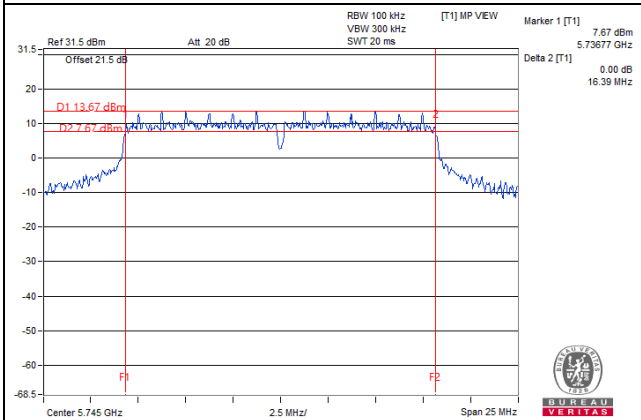

802.11ax (HE20)_Chain 1 / CH165

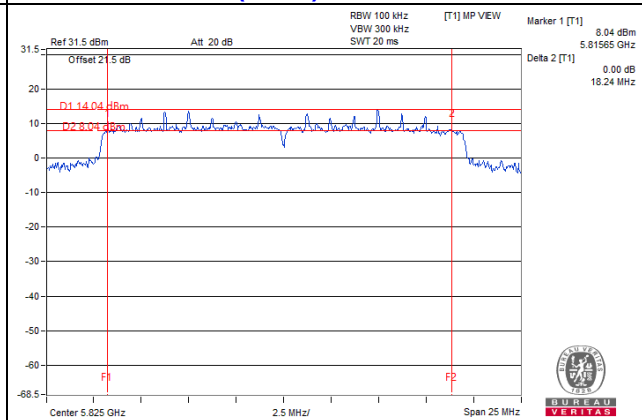

802.11ax (HE40)_Chain 0 / CH159

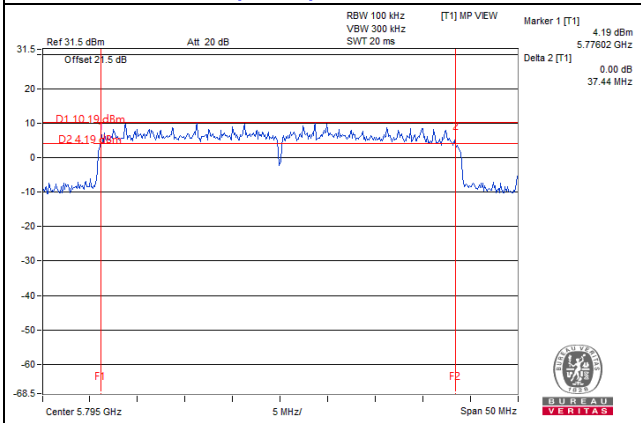

802.11ax (HE80)_Chain 1 / CH155

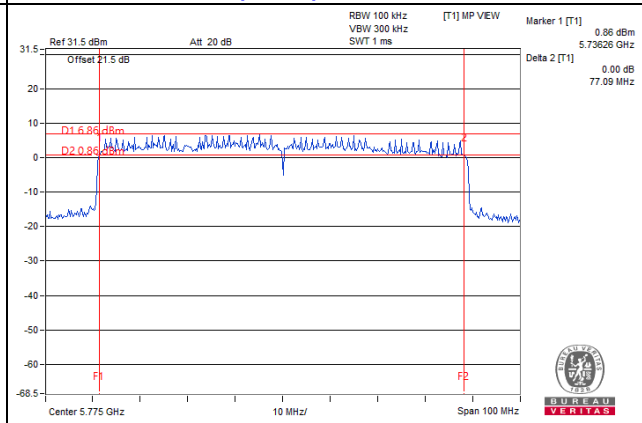

5 Pictures of Test Arrangements

Please refer to the attached file (Test Setup Photo).

Annex A- Radiated Out of Band Emission (OOBE) Measurement (For U-NII-3 band)

802.11a

CH 149 5745 MHz

Horizontal

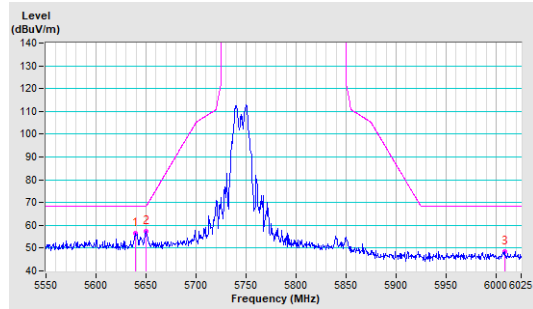

Vertical

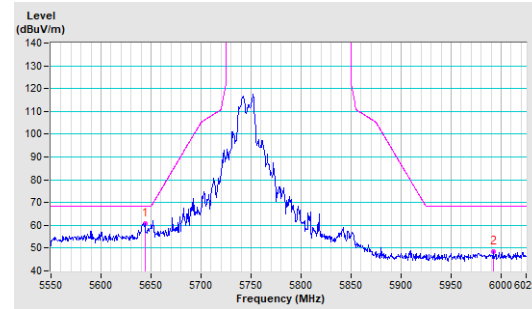

CH 157 5785 MHz

Horizontal

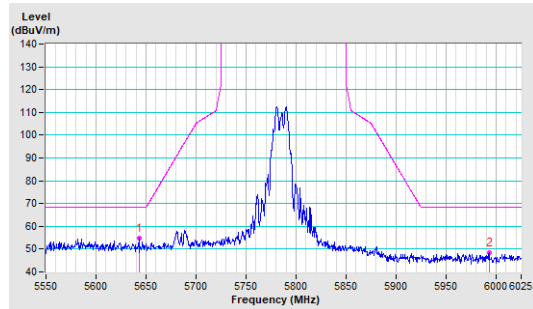

Vertical

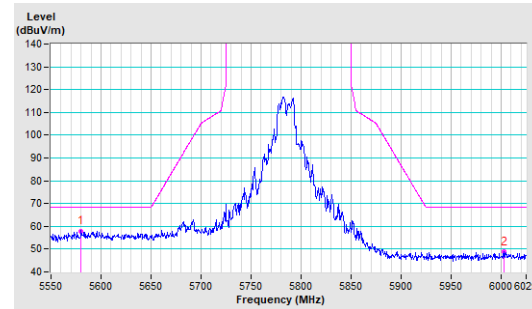

CH 165 5825 MHz

Horizontal

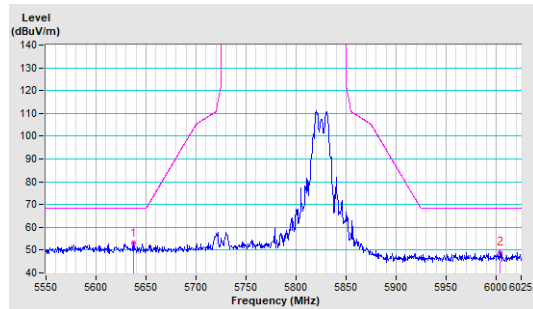

Vertical

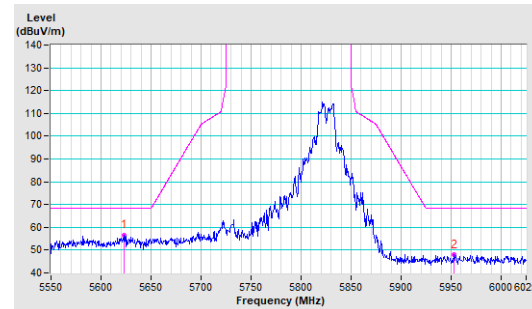

802.11ax (HE20)

CH 149 5745 MHz

Horizontal

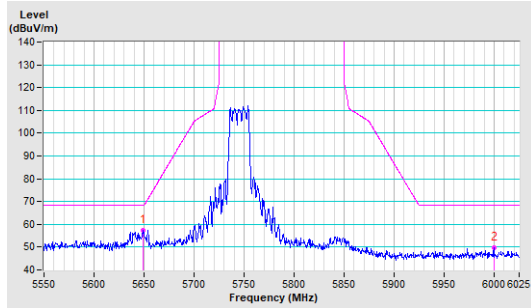

Vertical

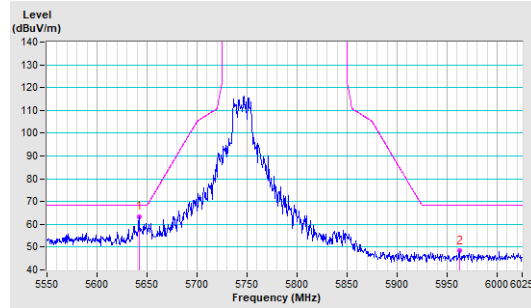

CH 157 5785 MHz

Horizontal

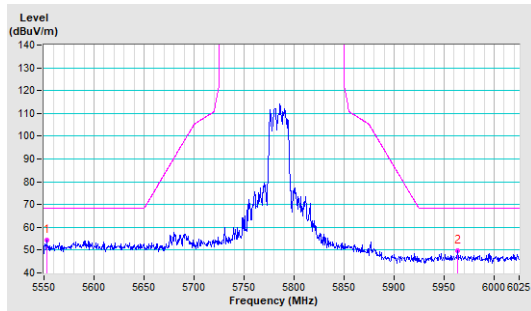

Vertical

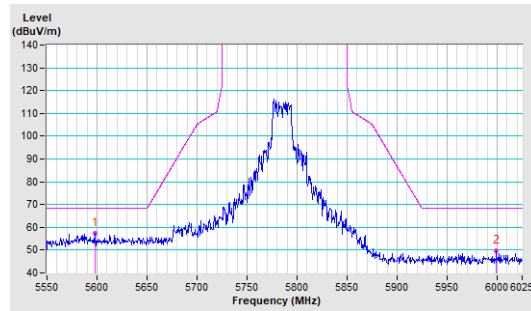

CH 165 5825 MHz

Horizontal

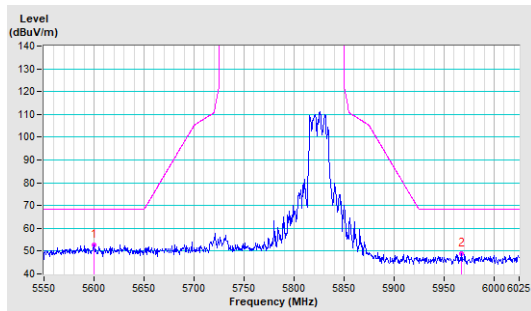

Vertical

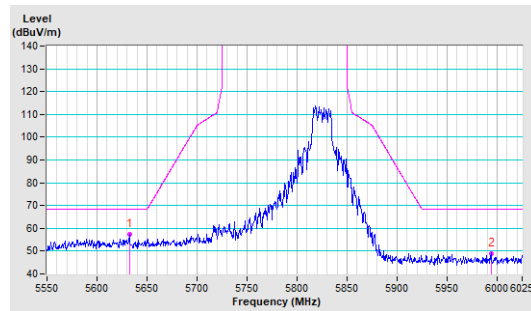

802.11ax (HE40)

CH 151 5755 MHz

Horizontal

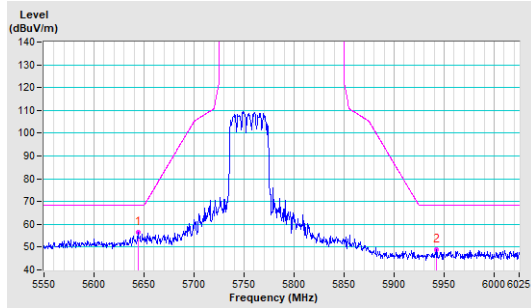

Vertical

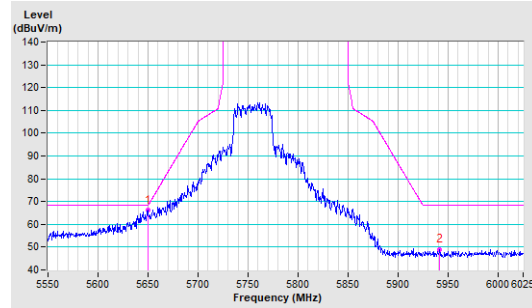

CH 159 5795 MHz

Horizontal

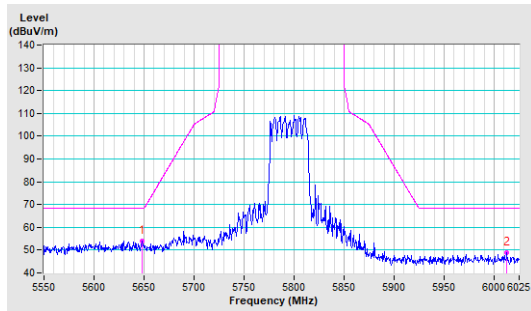

Vertical

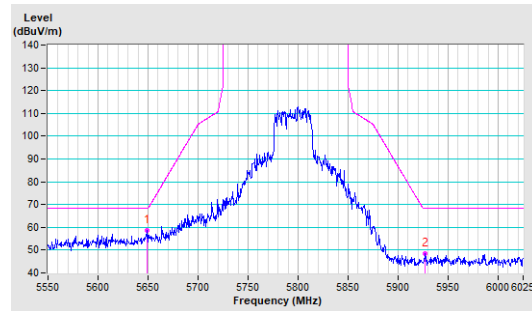

802.11ax (HE80)

CH 155 5775 MHz

Horizontal

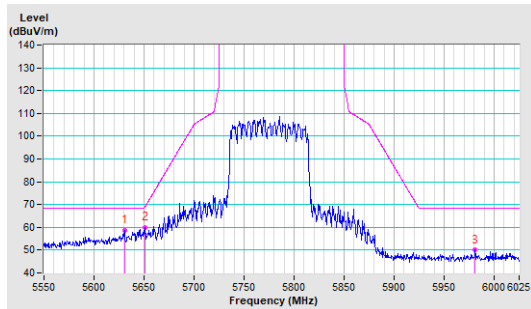

Vertical

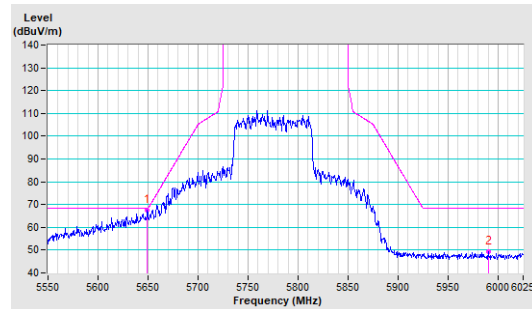

Annex B- Band-edge measurement (For U-NII-1 band)

802.11a

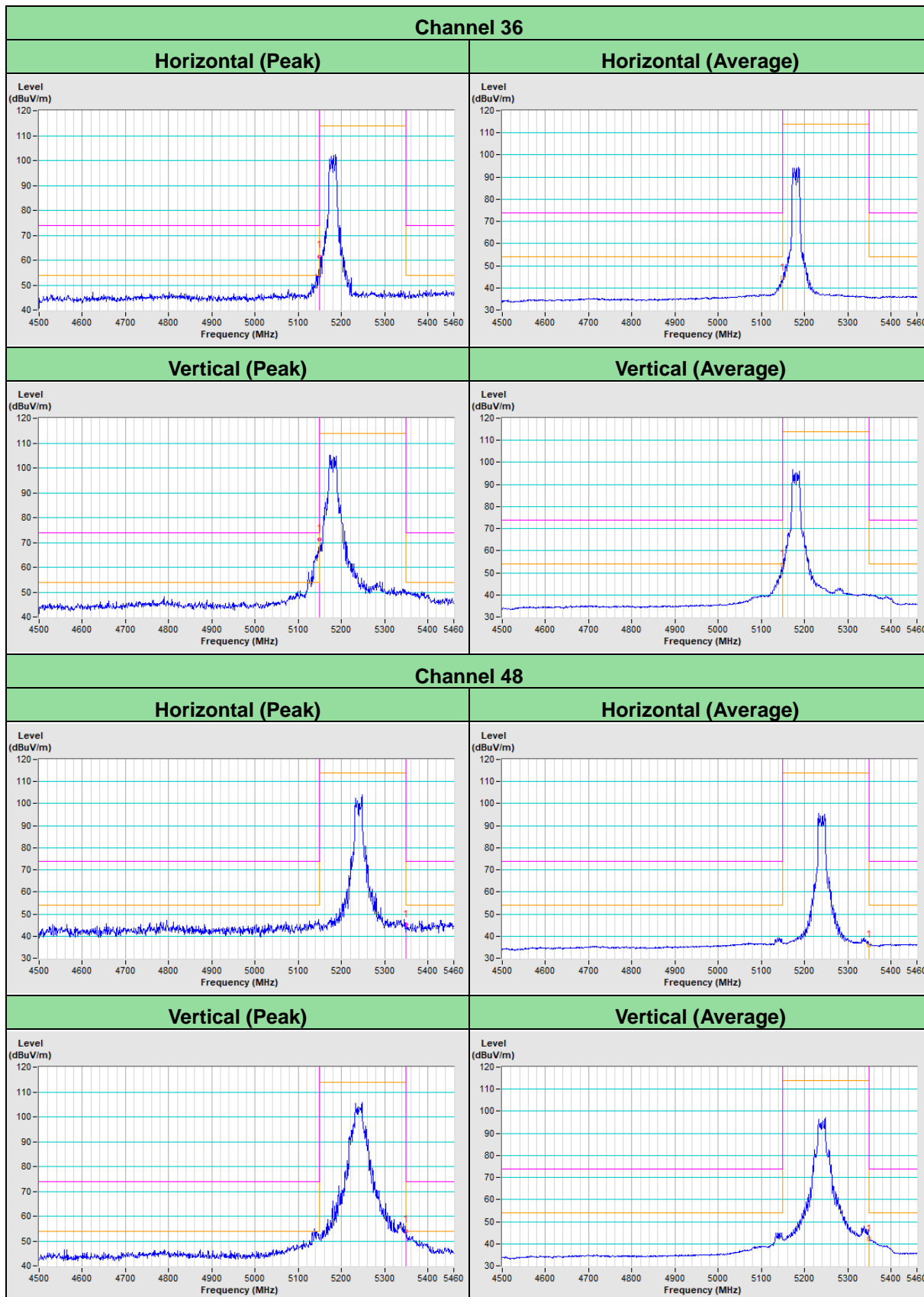

802.11ax (HE20)

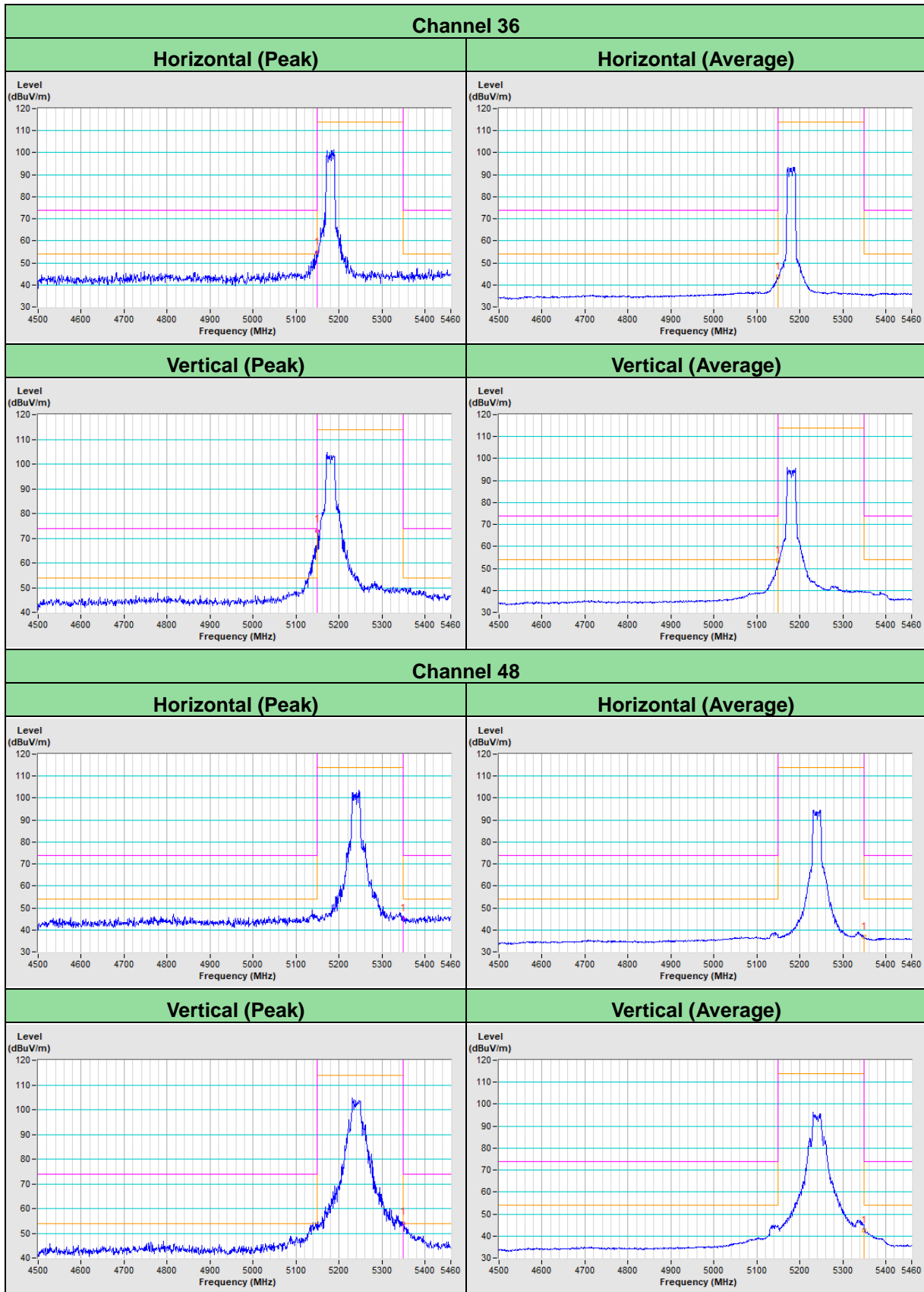

802.11ax (HE40)

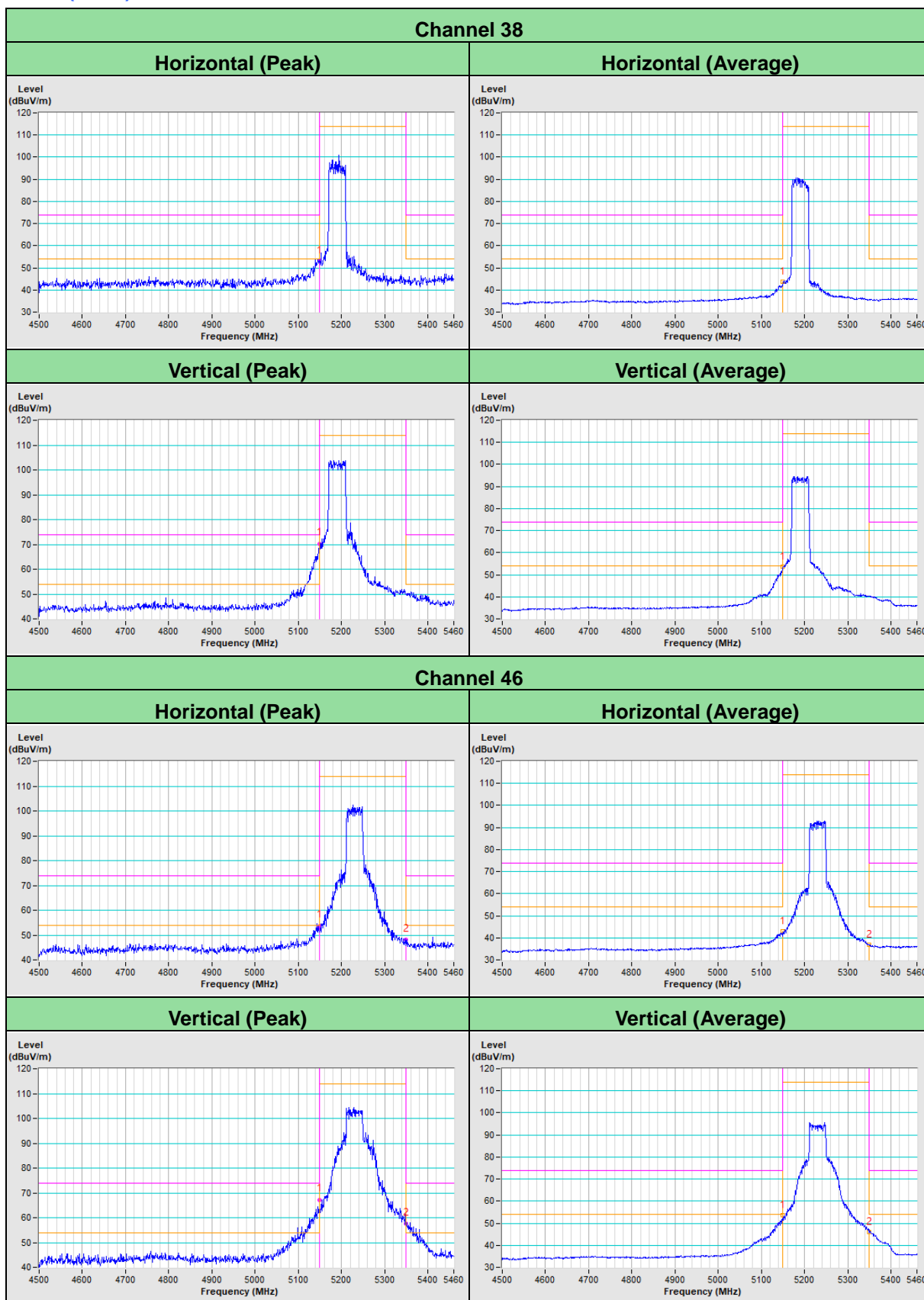

802.11ax (HE80)

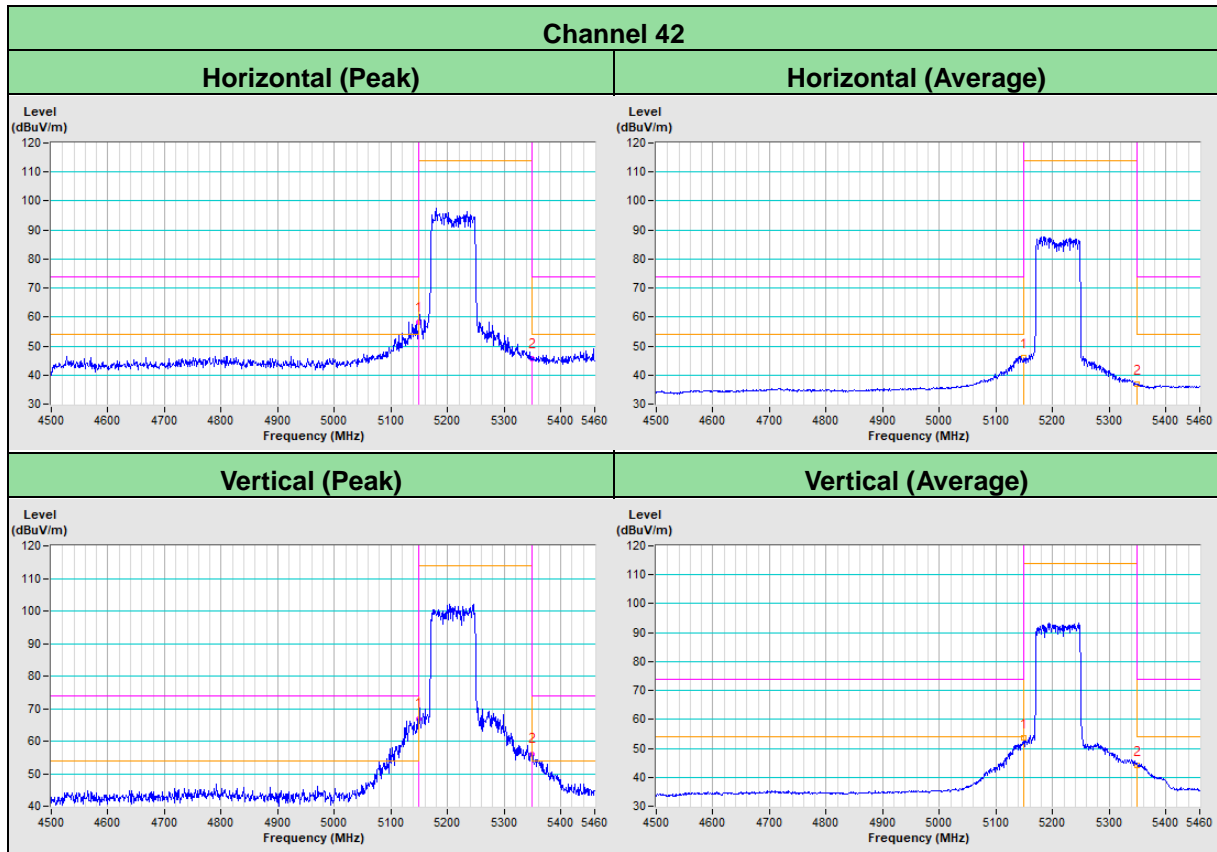

Appendix – Information of the Testing Laboratories

We, Bureau Veritas Consumer Products Services (H.K.) Ltd., Taoyuan Branch, were founded in 1988 to provide our best service in EMC, Radio, Telecom and Safety consultation. Our laboratories are FCC recognized accredited test firms and accredited according to ISO/IEC 17025.

If you have any comments, please feel free to contact us at the following:

Lin Kou EMC/RF Lab

Tel: 886-2-26052180

Fax: 886-2-26051924

Hsin Chu EMC/RF/Telecom Lab

Tel: 886-3-6668565

Fax: 886-3-6668323

Hwa Ya EMC/RF/Safety Lab

Tel: 886-3-3183232

Fax: 886-3-3270892

Email: service.adt@tw.bureauveritas.com

Web Site: www.bureauveritas-adt.com

The address and road map of all our labs can be found in our web site also.

--- END ---