

## FCC Test Report

**Report No.:** RF190430E06B

**FCC ID:** PY320200500

**Test Model:** MC315

**Received Date:** Apr. 22, 2020

**Test Date:** May 04 to June 01, 2020

**Issued Date:** June 05, 2020

**Applicant:** NETGEAR, Inc.

**Address:** 350 East Plumeria Drive San Jose, CA 95134

**Issued By:** Bureau Veritas Consumer Products Services (H.K.) Ltd., Taoyuan Branch  
Hsin Chu Laboratory

**Lab Address:** E-2, No.1, Li Hsin 1st Road, Hsinchu Science Park, Hsinchu City 300,  
Taiwan

**Test Location:** E-2, No.1, Li Hsin 1st Road, Hsinchu Science Park, Hsinchu City 300,  
Taiwan

**FCC Registration /  
Designation Number:** 723255 / TW2022



This report is for your exclusive use. Any copying or replication of this report to or for any other person or entity, or use of our name or trademark, is permitted only with our prior written permission. This report sets forth our findings solely with respect to the test samples identified herein. The results set forth in this report are not indicative or representative of the quality or characteristics of the lot from which a test sample was taken or any similar or identical product unless specifically and expressly noted. Our report includes all of the tests requested by you and the results thereof based upon the information that you provided to us. You have 60 days from date of issuance of this report to notify us of any material error or omission caused by our negligence, provided, however, that such notice shall be in writing and shall specifically address the issue you wish to raise. A failure to raise such issue within the prescribed time shall constitute your unqualified acceptance of the completeness of this report, the tests conducted and the correctness of the report contents. Unless specific mention, the uncertainty of measurement has been explicitly taken into account to declare the compliance or non-compliance to the specification. This report should not be used by the client to claim product certification, approval, or endorsement by TAF or any government agencies.

## Table of Contents

|   |           |
|---|-----------|
| <b>Release Control Record</b> .....                               | <b>4</b>  |
| <b>1 Certificate of Conformity</b> .....                          | <b>5</b>  |
| <b>2 Summary of Test Results</b> .....                            | <b>6</b>  |
| 2.1 Measurement Uncertainty .....                                 | 6         |
| 2.2 Modification Record .....                                     | 6         |
| <b>3 General Information</b> .....                                | <b>7</b>  |
| 3.1 General Description of EUT .....                              | 7         |
| 3.2 Description of Test Modes .....                               | 9         |
| 3.2.1 Test Mode Applicability and Tested Channel Detail .....     | 10        |
| 3.3 Duty Cycle of Test Signal .....                               | 12        |
| 3.4 Description of Support Units .....                            | 13        |
| 3.4.1 Configuration of System under Test .....                    | 13        |
| 3.5 General Description of Applied Standards and References ..... | 14        |
| <b>4 Test Types and Results</b> .....                             | <b>15</b> |
| 4.1 Radiated Emission and Bandedge Measurement .....              | 15        |
| 4.1.1 Limits of Radiated Emission and Bandedge Measurement .....  | 15        |
| 4.1.2 Test Instruments .....                                      | 16        |
| 4.1.3 Test Procedures .....                                       | 18        |
| 4.1.4 Deviation from Test Standard .....                          | 19        |
| 4.1.5 Test Setup .....  | 19        |
| 4.1.6 EUT Operating Conditions .....                              | 20        |
| 4.1.7 Test Results .....  | 21        |
| 4.2 Conducted Emission Measurement .....                          | 35        |
| 4.2.1 Limits of Conducted Emission Measurement .....              | 35        |
| 4.2.2 Test Instruments .....                                      | 35        |
| 4.2.3 Test Procedures .....                                       | 36        |
| 4.2.4 Deviation from Test Standard .....                          | 36        |
| 4.2.5 Test Setup .....  | 36        |
| 4.2.6 EUT Operating Conditions .....                              | 36        |
| 4.2.7 Test Results .....  | 37        |
| 4.3 6dB Bandwidth Measurement .....                               | 39        |
| 4.3.1 Limits of 6dB Bandwidth Measurement .....                   | 39        |
| 4.3.2 Test Setup .....  | 39        |
| 4.3.3 Test Instruments .....                                      | 39        |
| 4.3.4 Test Procedure .....  | 39        |
| 4.3.5 Deviation from Test Standard .....                          | 39        |
| 4.3.6 EUT Operating Conditions .....                              | 39        |
| 4.3.7 Test Result .....   | 40        |
| 4.4 Conducted Output Power Measurement .....                      | 42        |
| 4.4.1 Limits of Conducted Output Power Measurement .....          | 42        |
| 4.4.2 Test Setup .....  | 42        |
| 4.4.3 Test Instruments .....                                      | 42        |
| 4.4.4 Test Procedures .....                                       | 42        |
| 4.4.5 Deviation from Test Standard .....                          | 42        |
| 4.4.6 EUT Operating Conditions .....                              | 42        |
| 4.4.7 Test Results .....  | 43        |
| 4.5 Power Spectral Density Measurement .....                      | 44        |
| 4.5.1 Limits of Power Spectral Density Measurement .....          | 44        |
| 4.5.2 Test Setup .....  | 44        |
| 4.5.3 Test Instruments .....                                      | 44        |
| 4.5.4 Test Procedure .....  | 44        |
| 4.5.5 Deviation from Test Standard .....                          | 44        |
| 4.5.6 EUT Operating Condition .....                               | 44        |

|   |           |
|---|-----------|
| 4.5.7 Test Results .....  | 45        |
| 4.6 Conducted Out of Band Emission Measurement .....            | 47        |
| 4.6.1 Limits of Conducted Out of Band Emission Measurement..... | 47        |
| 4.6.2 Test Setup.....   | 47        |
| 4.6.3 Test Instruments .....                                    | 47        |
| 4.6.4 Test Procedure .....                                      | 47        |
| 4.6.5 Deviation from Test Standard .....                        | 47        |
| 4.6.6 EUT Operating Condition .....                             | 47        |
| 4.6.7 Test Results .....  | 47        |
| <b>5 Pictures of Test Arrangements.....</b>                     | <b>52</b> |
| <b>Annex A - Band-Edge Measurement.....</b>                     | <b>53</b> |
| <b>Appendix – Information of the Testing Laboratories .....</b> | <b>57</b> |

### Release Control Record

| Issue No.    | Description       | Date Issued   |
|--------------|-------------------|---------------|
| RF190430E06B | Original release. | June 05, 2020 |

## 1 Certificate of Conformity

**Product:** Meural Canvas

**Brand:** NETGEAR

**Test Model:** MC315

**Sample Status:** ENGINEERING SAMPLE

**Applicant:** NETGEAR, Inc.

**Test Date:** May 04 to June 01, 2020

**Standards:** 47 CFR FCC Part 15, Subpart C (Section 15.247)  
ANSI C63.10: 2013

The above equipment has been tested by **Bureau Veritas Consumer Products Services (H.K.) Ltd., Taoyuan Branch**, and found compliance with the requirement of the above standards. The test record, data evaluation & Equipment Under Test (EUT) configurations represented herein are true and accurate accounts of the measurements of the sample's EMC characteristics under the conditions specified in this report.

**Prepared by :** Joyce Kuo, **Date:** June 05, 2020  
Joyce Kuo / Specialist

**Approved by :** Clark Lin, **Date:** June 05, 2020  
Clark Lin / Technical Manager

## 2 Summary of Test Results

| 47 CFR FCC Part 15, Subpart C (Section 15.247) |  |        |   |
|--|--|--------|---|
| FCC Clause                                     | Test Item                                    | Result | Remarks   |
| 15.207   | AC Power Conducted Emission                  | PASS   | Meet the requirement of limit.<br>Minimum passing margin is -15.28 dB at 0.15000 MHz. |
| 15.205 /<br>15.209 /<br>15.247(d)              | Radiated Emissions and Band Edge Measurement | PASS   | Meet the requirement of limit.<br>Minimum passing margin is -1.5 dB at 2387.23 MHz.   |
| 15.247(d)                                      | Antenna Port Emission                        | PASS   | Meet the requirement of limit.  |
| 15.247(a)(2)                                   | 6dB bandwidth                                | PASS   | Meet the requirement of limit.  |
| 15.247(b)                                      | Conducted power                              | PASS   | Meet the requirement of limit.  |
| 15.247(e)                                      | Power Spectral Density                       | PASS   | Meet the requirement of limit.  |
| 15.203   | Antenna Requirement                          | PASS   | Antenna connector is I-PEX not a standard connector.                                  |

**Note:**

- For 2.4GHz band compliance with rule 15.247(d) of the band-edge items, the test plots were recorded in Annex A. Test Procedures refer to report 4.1.3.
- Determining compliance based on the results of the compliance measurement, not taking into account measurement instrumentation uncertainty.

### 2.1 Measurement Uncertainty

Where relevant, the following measurement uncertainty levels have been estimated for tests performed on the EUT as specified in CISPR 16-4-2:

| Measurement                        | Frequency      | Expanded Uncertainty (k=2) (±) |
|------------------------------------|----------------|--------------------------------|
| Conducted Emissions at mains ports | 150kHz ~ 30MHz | 1.9 dB                         |
| Conducted emissions                | -              | 2.5 dB                         |
| Radiated Emissions up to 1 GHz     | 9kHz ~ 30MHz   | 3.1 dB                         |
|                                    | 30MHz ~ 1GHz   | 5.5 dB                         |
| Radiated Emissions above 1 GHz     | 1GHz ~ 18GHz   | 5.1 dB                         |
|                                    | 18GHz ~ 40GHz  | 5.3 dB                         |

### 2.2 Modification Record

There were no modifications required for compliance.

### 3 General Information General Description of EUT

|                       |   |
|-----------------------|---|
| Product               | Meural Canvas   |
| Brand                 | NETGEAR   |
| Test Model            | MC315   |
| Status of EUT         | ENGINEERING SAMPLE  |
| Power Supply Rating   | DC 12V from power adapter   |
| Modulation Type       | CCK, DQPSK, DBPSK for DSSS<br>64QAM, 16QAM, QPSK, BPSK for OFDM<br>256QAM for OFDM in 11ac mode only  |
| Modulation Technology | DSSS, OFDM  |
| Transfer Rate         | 802.11b: up to 11 Mbps<br>802.11a/g: up to 54 Mbps<br>802.11n: up to 150 Mbps<br>802.11ac: up to 433.3 Mbps   |
| Operating Frequency   | <b>2.4GHz:</b> 2.412GHz ~ 2.462GHz<br><b>5GHz:</b> 5.18 ~ 5.24GHz, 5.745 ~ 5.825GHz   |
| Number of Channel     | <b>2.4GHz:</b><br>802.11b, 802.11g, 802.11n (HT20): 11<br>802.11n (HT40): 7<br><b>5GHz:</b><br>802.11a, 802.11n (HT20), 802.11ac (VHT20): 9<br>802.11n (HT40), 802.11ac (VHT40): 4<br>802.11ac (VHT80): 2 |
| Output Power          | <b>2.412 ~ 2.462GHz:</b> 243.781 mW<br><b>5.18 ~ 5.24GHz:</b> 229.615mW<br><b>5.745 ~ 5.825GHz:</b> 224.388 mW  |
| Antenna Type          | Refer to Note   |
| Antenna Connector     | Refer to Note   |
| Accessory Device      | Adapter x 1   |
| Data Cable Supplied   | NA  |

Note:

1. The device of WLAN 2.4GHz and 5GHz technology cannot transmit simultaneously.
2. The ETU must be supplied power adapter as following table:

| Brand   | Model No. | P/N          | Spec.  |
|---------|-----------|--------------|--|
| NETGEAR | AD2076F10 | 332-11554-01 | Input: 100-120Vac, 0.56A, 50/60Hz<br>Output: 12Vdc, 1.5A<br>DC output cable: 1.8 m, unshielded |

3. The antenna provided to the EUT, please refer to the following table:

| Ant. No. | Antenna Net Gain (dBi) | Frequency Range (GHz) | Antenna Type | Connector Type |
|----------|------------------------|-----------------------|--------------|----------------|
| 1        | 2.7                    | 2.4~2.4835            | Dipole       | I-PEX          |
|          | 3.77                   | 5.15~5.25             |              |                |
|          | 3.81                   | 5.725~5.85            |              |                |

4. The EUT incorporates a SISO function.

| 2.4GHz Band      |                       |     |
|------------------|-----------------------|-----|
| MODULATION MODE  | TX & RX CONFIGURATION |     |
| 802.11b          | 1TX                   | 1RX |
| 802.11g          | 1TX                   | 1RX |
| 802.11n (HT20)   | 1TX                   | 1RX |
| 802.11n (HT40)   | 1TX                   | 1RX |
| 5GHz Band        |                       |     |
| MODULATION MODE  | TX & RX CONFIGURATION |     |
| 802.11a          | 1TX                   | 1RX |
| 802.11n (HT20)   | 1TX                   | 1RX |
| 802.11n (HT40)   | 1TX                   | 1RX |
| 802.11ac (VHT20) | 1TX                   | 1RX |
| 802.11ac (VHT40) | 1TX                   | 1RX |
| 802.11ac (VHT80) | 1TX                   | 1RX |

5. The above EUT information is declared by manufacturer and for more detailed features description, please refers to the manufacturer's specifications or user's manual.



### 3.1 Description of Test Modes

11 channels are provided for 802.11b, 802.11g, 802.11n (HT20):

| Channel | Frequency | Channel | Frequency |
|---------|-----------|---------|-----------|
| 1       | 2412MHz   | 7       | 2442MHz   |
| 2       | 2417MHz   | 8       | 2447MHz   |
| 3       | 2422MHz   | 9       | 2452MHz   |
| 4       | 2427MHz   | 10      | 2457MHz   |
| 5       | 2432MHz   | 11      | 2462MHz   |
| 6       | 2437MHz   |         |           |

7 channels are provided for 802.11n (HT40):

| Channel | Frequency | Channel | Frequency |
|---------|-----------|---------|-----------|
| 3       | 2422MHz   | 7       | 2442MHz   |
| 4       | 2427MHz   | 8       | 2447MHz   |
| 5       | 2432MHz   | 9       | 2452MHz   |
| 6       | 2437MHz   |         |           |

### 3.1.1 Test Mode Applicability and Tested Channel Detail

| EUT CONFIGURE MODE | APPLICABLE TO |           |     |      | DESCRIPTION |
|--------------------|---------------|-----------|-----|------|-------------|
|                    | RE $\geq$ 1G  | RE $<$ 1G | PLC | APCM |             |
| -                  | √             | √         | √   | √    | -           |

Where **RE $\geq$ 1G**: Radiated Emission above 1GHz & Bandedge Measurement  
**RE $<$ 1G**: Radiated Emission below 1GHz  
**PLC**: Power Line Conducted Emission  
**APCM**: Antenna Port Conducted Measurement

#### Radiated Emission Test (Above 1GHz):

- Pre-Scan has been conducted to determine the worst-case mode from all possible combinations between available modulations, data rates and antenna ports (if EUT with antenna diversity architecture).
- Following channel(s) was (were) selected for the final test as listed below.

| MODE           | AVAILABLE CHANNEL | TESTED CHANNEL | MODULATION TECHNOLOGY | MODULATION TYPE | DATA RATE (Mbps) |
|----------------|-------------------|----------------|-----------------------|-----------------|------------------|
| 802.11b        | 1 to 11           | 1, 6, 11       | DSSS                  | DBPSK           | 1                |
| 802.11g        | 1 to 11           | 1, 6, 11       | OFDM                  | BPSK            | 6                |
| 802.11n (HT20) | 1 to 11           | 1, 6, 11       | OFDM                  | BPSK            | 6.5              |
| 802.11n (HT40) | 3 to 9            | 3, 6, 9        | OFDM                  | BPSK            | 13.5             |

#### Radiated Emission Test (Below 1GHz):

- Pre-Scan has been conducted to determine the worst-case mode from all possible combinations between available modulations, data rates and antenna ports (if EUT with antenna diversity architecture).
- Following channel(s) was (were) selected for the final test as listed below.

| MODE    | AVAILABLE CHANNEL | TESTED CHANNEL | MODULATION TECHNOLOGY | MODULATION TYPE | DATA RATE (Mbps) |
|---------|-------------------|----------------|-----------------------|-----------------|------------------|
| 802.11b | 1 to 11           | 6              | DSSS                  | DBPSK           | 1                |

#### Power Line Conducted Emission Test:

- Pre-Scan has been conducted to determine the worst-case mode from all possible combinations between available modulations, data rates and antenna ports (if EUT with antenna diversity architecture).
- Following channel(s) was (were) selected for the final test as listed below.

| MODE    | AVAILABLE CHANNEL | TESTED CHANNEL | MODULATION TECHNOLOGY | MODULATION TYPE | DATA RATE (Mbps) |
|---------|-------------------|----------------|-----------------------|-----------------|------------------|
| 802.11b | 1 to 11           | 6              | DSSS                  | DBPSK           | 1                |

**Antenna Port Conducted Measurement:**

- This item includes all test value of each mode, but only includes spectrum plot of worst value of each mode.
- Pre-Scan has been conducted to determine the worst-case mode from all possible combinations between available modulations, data rates and antenna ports (if EUT with antenna diversity architecture).
- Following channel(s) was (were) selected for the final test as listed below.

| MODE           | AVAILABLE CHANNEL | TESTED CHANNEL | MODULATION TECHNOLOGY | MODULATION TYPE | DATA RATE (Mbps) |
|----------------|-------------------|----------------|-----------------------|-----------------|------------------|
| 802.11b        | 1 to 11           | 1, 6, 11       | DSSS                  | DBPSK           | 1                |
| 802.11g        | 1 to 11           | 1, 6, 11       | OFDM                  | BPSK            | 6                |
| 802.11n (HT20) | 1 to 11           | 1, 6, 11       | OFDM                  | BPSK            | 6.5              |
| 802.11n (HT40) | 3 to 9            | 3, 6, 9        | OFDM                  | BPSK            | 13.5             |

**Test Condition:**

| APPLICABLE TO | ENVIRONMENTAL CONDITIONS | INPUT POWER  | TESTED BY    |
|---------------|--------------------------|--------------|--------------|
| RE $\geq$ 1G  | 25deg. C, 75%RH          | 120Vac, 60Hz | Ryan Du      |
| RE<1G         | 22deg. C, 68%RH          | 120Vac, 60Hz | Ryan Du      |
| PLC           | 25deg. C, 70%RH          | 120Vac, 60Hz | Duncan Wang  |
| APCM          | 25deg. C, 60%RH          | 120Vac, 60Hz | Jyunchun Lin |

### 3.2 Duty Cycle of Test Signal

The duty cycle of test signal is  $\geq 98\%$ , duty factor is not required.

802.11b: Duty cycle =  $128.188 \text{ ms} / 128.563 \text{ ms} = 0.997$

802.11g: Duty cycle =  $21.337 \text{ ms} / 21.562 \text{ ms} = 0.99$

802.11n (HT20): Duty cycle =  $19.744 \text{ ms} / 19.925 \text{ ms} = 0.991$

802.11n (HT40): Duty cycle =  $9.531 \text{ ms} / 9.726 \text{ ms} = 0.98$

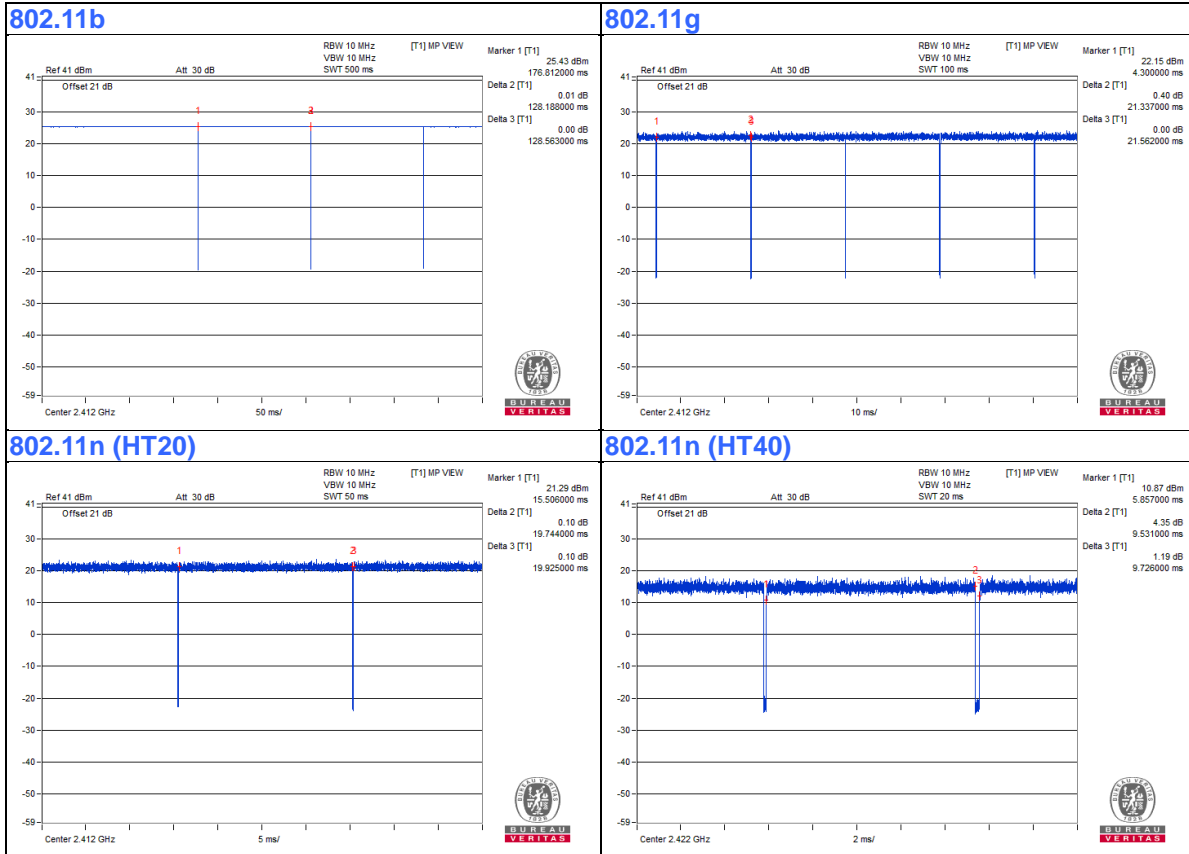

### 3.3 Description of Support Units

The EUT has been tested as an independent unit together with other necessary accessories or support units. The following support units or accessories were used to form a representative test configuration during the tests.

| ID | Descriptions    | Qty. | Length (m) | Shielding (Yes/No) | Cores (Qty.) | Remarks                           |
|----|-----------------|------|------------|--------------------|--------------|-----------------------------------|
| 1. | DC Cable        | 1    | 1.8        | No                 | 0            | Supplied by client                |
| 2. | Micro USB Cable | 1    | 1          | No                 | 0            | Provided by Lab (For console use) |

#### 3.3.1 Configuration of System under Test

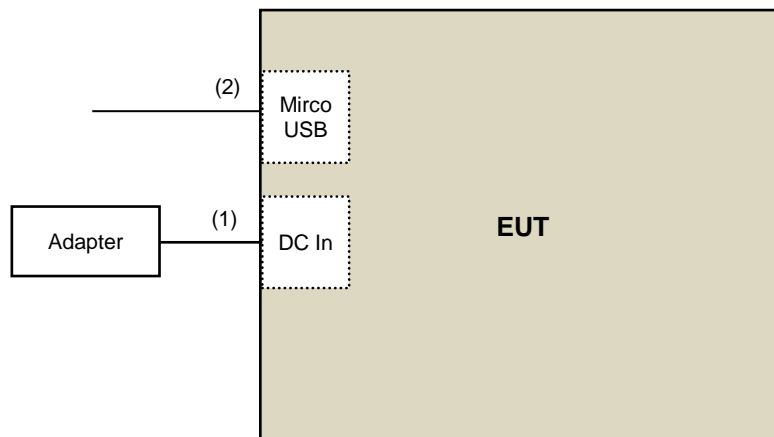

### 3.4 General Description of Applied Standards and References

The EUT is a RF Product. According to the specifications of the manufacturer, it must comply with the requirements of the following standards and references:

**Test Standard:**

**FCC Part 15, Subpart C (15.247)**

**ANSI C63.10-2013**

All test items have been performed and recorded as per the above standards.

**References Test Guidance:**

**KDB 558074 D01 15.247 Meas Guidance v05r02**

All test items have been performed as a reference to the above KDB test guidance.

## 4 Test Types and Results

### 4.1 Radiated Emission and Bandedge Measurement

#### 4.1.1 Limits of Radiated Emission and Bandedge Measurement

Radiated emissions which fall in the restricted bands must comply with the radiated emission limits specified as below table. Other emissions shall be at least 30dB below the highest level of the desired power:

| Frequencies (MHz) | Field Strength (microvolts/meter) | Measurement Distance (meters) |
|-------------------|-----------------------------------|-------------------------------|
| 0.009 ~ 0.490     | 2400/F(kHz)                       | 300                           |
| 0.490 ~ 1.705     | 24000/F(kHz)                      | 30                            |
| 1.705 ~ 30.0      | 30                                | 30                            |
| 30 ~ 88           | 100                               | 3                             |
| 88 ~ 216          | 150                               | 3                             |
| 216 ~ 960         | 200                               | 3                             |
| Above 960         | 500                               | 3                             |

#### NOTE:

1. The lower limit shall apply at the transition frequencies.
2. Emission level (dBuV/m) = 20 log Emission level (uV/m).
3. For frequencies above 1000MHz, the field strength limits are based on average detector, however, the peak field strength of any emission shall not exceed the maximum permitted average limits, specified above by more than 20dB under any condition of modulation.

## 4.1.2 Test Instruments

**For Radiated Emission test: (802.11b)**

| DESCRIPTION & MANUFACTURER                          | MODEL NO.            | SERIAL NO.  | CALIBRATED DATE | CALIBRATED UNTIL |
|---|----------------------|-------------|-----------------|------------------|
| Test Receiver<br>Agilent                            | N9038A               | MY51210202  | Dec. 13, 2019   | Dec. 12, 2020    |
| Pre-Amplifier<br>EMCI                               | EMC001340            | 980142      | May 30, 2019    | May 29, 2020     |
| Loop Antenna<br>Electro-Metrics                     | EM-6879              | 264         | Feb. 18, 2020   | Feb. 17, 2021    |
| RF Cable  | NA                   | LOOPCAB-001 | Jan. 08, 2020   | Jan. 07, 2021    |
| RF Cable  | NA                   | LOOPCAB-002 | Jan. 08, 2020   | Jan. 07, 2021    |
| Pre-Amplifier<br>Mini-Circuits                      | ZFL-1000VH2B         | AMP-ZFL-01  | Oct. 23, 2019   | Oct. 22, 2020    |
| Trilog Broadband Antenna<br>SCHWARZBECK             | VULB 9168            | 9168-406    | Nov. 11, 2019   | Nov. 10, 2020    |
| RF Cable  | 8D                   | 966-4-1     | Mar. 18, 2020   | Mar. 17, 2021    |
| RF Cable  | 8D                   | 966-4-2     | Mar. 18, 2020   | Mar. 17, 2021    |
| RF Cable  | 8D                   | 966-4-3     | Mar. 18, 2020   | Mar. 17, 2021    |
| Fixed attenuator<br>Mini-Circuits                   | UNAT-5+              | PAD-3m-4-01 | Sep. 26, 2019   | Sep. 25, 2020    |
| Horn_Antenna<br>SCHWARZBECK                         | BBHA 9120D           | 9120D-783   | Nov. 24, 2019   | Nov. 23, 2020    |
| Pre-Amplifier<br>EMCI                               | EMC12630SE           | 980385      | Aug. 15, 2019   | Aug. 14, 2020    |
| RF Cable  | EMC104-SM-SM-1200    | 160923      | Jan. 15, 2020   | Jan. 14, 2021    |
| RF Cable  | EMC104-SM-SM-2000    | 180502      | Apr. 29, 2020   | Apr. 28, 2021    |
| RF Cable  | EMC104-SM-SM-6000    | 180418      | Apr. 29, 2020   | Apr. 28, 2021    |
| Pre-Amplifier<br>EMCI                               | EMC184045SE          | 980387      | Jan. 15, 2020   | Jan. 14, 2021    |
| Horn_Antenna<br>SCHWARZBECK                         | BBHA 9170            | BBHA9170519 | Nov. 24, 2019   | Nov. 23, 2020    |
| RF Cable  | EMC102-KM-KM-1200    | 160924      | Jan. 15, 2020   | Jan. 14, 2021    |
| RF Cable  | EMC-KM-KM-4000       | 200214      | Mar. 11, 2020   | Mar. 10, 2021    |
| Software  | ADT_Radiated_V8.7.08 | NA          | NA              | NA               |
| Boresight Antenna Tower &<br>Turn Table<br>Max-Full | MF-7802BS            | MF780208530 | NA              | NA               |

**Note:**

1. The calibration interval of the above test instruments is 12 months and the calibrations are traceable to NML/ROC and NIST/USA.
2. The test was performed in 966 Chamber No. 4.
3. Tested Date: May 04 to 07, 2020



**For Radiated Emission test: (other modulation mode)**

| DESCRIPTION & MANUFACTURER                          | MODEL NO.            | SERIAL NO.  | CALIBRATED DATE | CALIBRATED UNTIL |
|---|----------------------|-------------|-----------------|------------------|
| Test Receiver<br>Agilent                            | N9038A               | MY51210202  | Dec. 13, 2019   | Dec. 12, 2020    |
| Horn_Antenna<br>SCHWARZBECK                         | BBHA 9120D           | 9120D-783   | Nov. 24, 2019   | Nov. 23, 2020    |
| Pre-Amplifier<br>EMCI                               | EMC12630SE           | 980385      | Aug. 15, 2019   | Aug. 14, 2020    |
| RF Cable  | EMC104-SM-SM-1200    | 160923      | Jan. 15, 2020   | Jan. 14, 2021    |
| RF Cable  | EMC104-SM-SM-2000    | 180502      | Apr. 29, 2020   | Apr. 28, 2021    |
| RF Cable  | EMC104-SM-SM-6000    | 180418      | Apr. 29, 2020   | Apr. 28, 2021    |
| Pre-Amplifier<br>EMCI                               | EMC184045SE          | 980387      | Jan. 15, 2020   | Jan. 14, 2021    |
| Horn_Antenna<br>SCHWARZBECK                         | BBHA 9170            | BBHA9170519 | Nov. 24, 2019   | Nov. 23, 2020    |
| RF Cable  | EMC102-KM-KM-1200    | 160924      | Jan. 15, 2020   | Jan. 14, 2021    |
| RF Cable  | EMC-KM-KM-4000       | 200214      | Mar. 11, 2020   | Mar. 10, 2021    |
| Software  | ADT_Radiated_V8.7.08 | NA          | NA              | NA               |
| Boresight Antenna Tower &<br>Turn Table<br>Max-Full | MF-7802BS            | MF780208530 | NA              | NA               |

**Note:**

1. The calibration interval of the above test instruments is 12 months and the calibrations are traceable to NML/ROC and NIST/USA.
2. The test was performed in 966 Chamber No. 4.
3. Tested Date: May 30 to June 01, 2020

**For other test items:**

| DESCRIPTION & MANUFACTURER        | MODEL NO.                        | SERIAL NO.    | CALIBRATED DATE | CALIBRATED UNTIL |
|-----------------------------------|----------------------------------|---------------|-----------------|------------------|
| Spectrum Analyzer<br>R&S          | FSV40                            | 100964        | June 04, 2019   | June 03, 2020    |
| Power meter<br>Anritsu            | ML2495A                          | 1529002       | July 26, 2019   | July 25, 2020    |
| Power sensor<br>Anritsu           | MA2411B                          | 1339443       | July 26, 2019   | July 25, 2020    |
| Fixed Attenuator<br>Mini-Circuits | MDCS18N-10                       | MDCS18N-10-01 | Apr. 14, 2020   | Apr. 13, 2021    |
| Software                          | ADT_RF Test<br>Software V6.6.5.4 | NA            | NA              | NA               |

- NOTE:**
1. The test was performed in Oven room 2.
  2. The calibration interval of the above test instruments is 12 months and the calibrations are traceable to NML/ROC and NIST/USA.
  3. Tested Date: May 29, 2020

#### 4.1.3 Test Procedures

##### **For Radiated emission below 30MHz**

- a. The EUT was placed on the top of a rotating table 0.8 meters above the ground at a 3 meter chamber room. The table was rotated 360 degrees to determine the position of the highest radiation.
- b. The EUT was set 3 meters away from the interference-receiving antenna, which was mounted on the top of a variable-height antenna tower.
- c. Parallel, perpendicular, and ground-parallel orientations of the antenna are set to make the measurement.
- d. For each suspected emission, the EUT was arranged to its worst case and the rotatable table was turned from 0 degrees to 360 degrees to find the maximum reading.
- e. The test-receiver system was set to Quasi-Peak Detect Function and Specified Bandwidth with Maximum Hold Mode.

##### **NOTE:**

1. The resolution bandwidth and video bandwidth of test receiver/spectrum analyzer is 9kHz at frequency below 30MHz.

##### **For Radiated emission above 30MHz**

- a. The EUT was placed on the top of a rotating table 0.8 meters (for 30MHz ~ 1GHz) / 1.5 meters (for above 1GHz) above the ground at 3 meter chamber room for test. The table was rotated 360 degrees to determine the position of the highest radiation.
- b. The EUT was set 3 meters away from the interference-receiving antenna, which was mounted on the top of a variable-height antenna tower.
- c. The height of antenna is varied from one meter to four meters above the ground to determine the maximum value of the field strength. Both horizontal and vertical polarizations of the antenna are set to make the measurement.
- d. For each suspected emission, the EUT was arranged to its worst case and then the antenna was tuned to heights from 1 meter to 4 meters and the rotatable table was turned from 0 degrees to 360 degrees to find the maximum reading.
- e. The test-receiver system was set to quasi-peak detect function and specified bandwidth with maximum hold mode when the test frequency is below 1 GHz.
- f. The test-receiver system was set to peak and average detects function and specified bandwidth with maximum hold mode when the test frequency is above 1 GHz. If the peak reading value also meets average limit, measurement with the average detector is unnecessary.

##### **Note:**

1. The resolution bandwidth and video bandwidth of test receiver/spectrum analyzer is 120kHz for Quasi-peak detection (QP) at frequency below 1GHz.
2. The resolution bandwidth of test receiver/spectrum analyzer is 1 MHz and the video bandwidth is 3 MHz for Peak detection (PK) at frequency above 1GHz.
3. The resolution bandwidth of test receiver/spectrum analyzer is 1MHz and the video bandwidth is  $\geq 1/T$  (Duty cycle < 98%) or 10Hz (Duty cycle  $\geq 98\%$ ) for Average detection (AV) at frequency above 1GHz.
4. All modes of operation were investigated and the worst-case emissions are reported.

4.1.4 Deviation from Test Standard

No deviation.

4.1.5 Test Setup

**For Radiated emission below 30MHz**

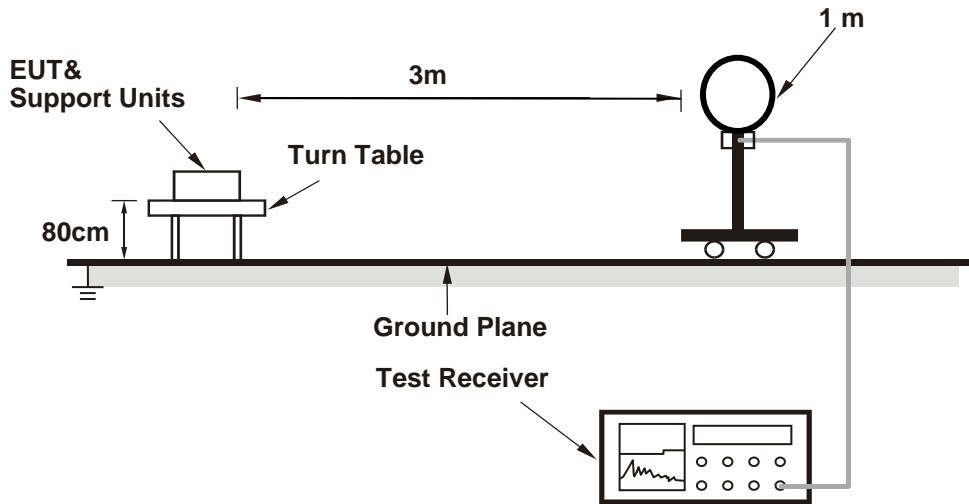

**For Radiated emission 30MHz to 1GHz**

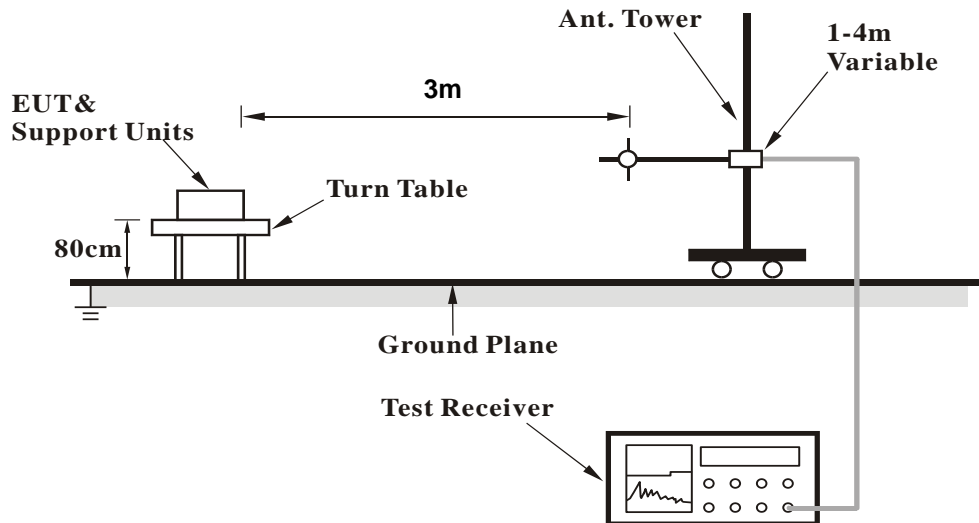

### For Radiated emission above 1GHz

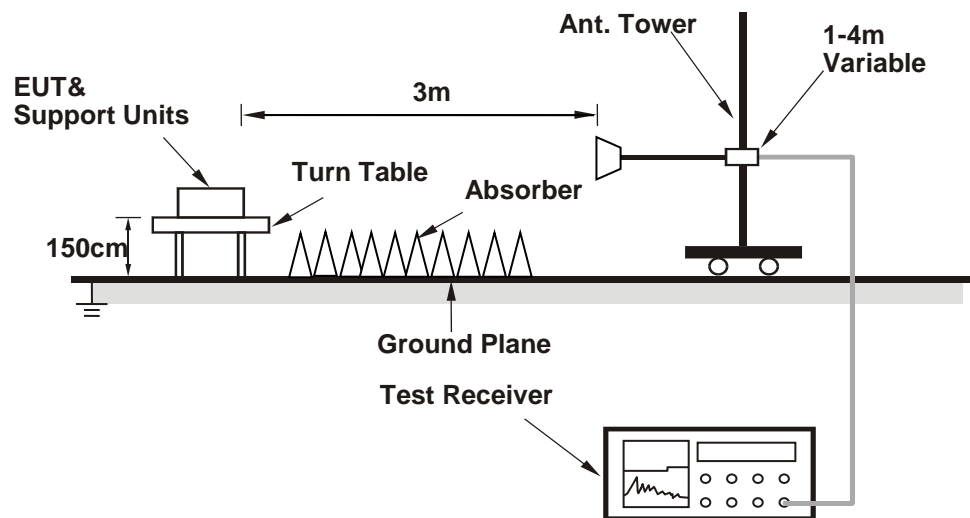

For the actual test configuration, please refer to the attached file (Test Setup Photo).

#### 4.1.6 EUT Operating Conditions

- Connected the EUT with the Laptop which is placed on remote site.
- Controlling software (qdart\_conn.win.1.0\_installer\_00056.1) has been activated to set the EUT under transmission condition continuously at specific channel frequency.

## 4.1.7 Test Results

## Above 1GHz Data :

## 802.11b

|                        |              |                          |              |
|------------------------|--------------|--------------------------|--------------|
| <b>Channel</b>         | TX Channel 1 | <b>Detector Function</b> | Peak (PK)    |
| <b>Frequency Range</b> | 1GHz ~ 25GHz |                          | Average (AV) |

| Antenna Polarity & Test Distance : Horizontal at 3 m |                 |                         |                |             |                    |                      |                  |                          |
|--|-----------------|-------------------------|----------------|-------------|--------------------|----------------------|------------------|--------------------------|
| No   | Frequency (MHz) | Emission Level (dBuV/m) | Limit (dBuV/m) | Margin (dB) | Antenna Height (m) | Table Angle (Degree) | Raw Value (dBuV) | Correction Factor (dB/m) |
| 1  | 2387.23         | 60.4 PK                 | 74.0           | -13.6       | 3.47 H             | 4                    | 62.2             | -1.8                     |
| 2  | <b>2387.23</b>  | <b>52.5 AV</b>          | <b>54.0</b>    | <b>-1.5</b> | <b>3.47 H</b>      | <b>4</b>             | <b>54.3</b>      | <b>-1.8</b>              |
| 3  | *2412.00        | 114.4 PK                |                |             | 3.47 H             | 4                    | 116.2            | -1.8                     |
| 4  | *2412.00        | 112.1 AV                |                |             | 3.47 H             | 4                    | 113.9            | -1.8                     |
| 5  | 4824.00         | 48.8 PK                 | 74.0           | -25.2       | 1.05 H             | 259                  | 46.6             | 2.2                      |
| 6  | 4824.00         | 46.7 AV                 | 54.0           | -7.3        | 1.05 H             | 259                  | 44.5             | 2.2                      |
| Antenna Polarity & Test Distance : Vertical at 3 m   |                 |                         |                |             |                    |                      |                  |                          |
| No   | Frequency (MHz) | Emission Level (dBuV/m) | Limit (dBuV/m) | Margin (dB) | Antenna Height (m) | Table Angle (Degree) | Raw Value (dBuV) | Correction Factor (dB/m) |
| 1  | 2385.36         | 55.8 PK                 | 74.0           | -18.2       | 3.82 V             | 234                  | 57.6             | -1.8                     |
| 2  | 2385.36         | 45.3 AV                 | 54.0           | -8.7        | 3.82 V             | 234                  | 47.1             | -1.8                     |
| 3  | *2412.00        | 104.7 PK                |                |             | 3.82 V             | 234                  | 106.5            | -1.8                     |
| 4  | *2412.00        | 102.4 AV                |                |             | 3.82 V             | 234                  | 104.2            | -1.8                     |
| 5  | 4824.00         | 48.8 PK                 | 74.0           | -25.2       | 1.62 V             | 168                  | 46.6             | 2.2                      |
| 6  | 4824.00         | 47.3 AV                 | 54.0           | -6.7        | 1.62 V             | 168                  | 45.1             | 2.2                      |

## Remarks:

1. Emission Level(dBuV/m) = Raw Value(dBuV) + Correction Factor(dB/m)
2. Correction Factor(dB/m) = Antenna Factor(dB/m) + Cable Factor(dB) – Pre-Amplifier Factor(dB)
3. Margin value = Emission Level – Limit value
4. The other emission levels were very low against the limit.
5. " \* ": Fundamental frequency.

|                        |              |                          |              |
|------------------------|--------------|--------------------------|--------------|
| <b>Channel</b>         | TX Channel 6 | <b>Detector Function</b> | Peak (PK)    |
| <b>Frequency Range</b> | 1GHz ~ 25GHz |                          | Average (AV) |

**Antenna Polarity & Test Distance : Horizontal at 3 m**

| No | Frequency (MHz) | Emission Level (dBuV/m) | Limit (dBuV/m) | Margin (dB) | Antenna Height (m) | Table Angle (Degree) | Raw Value (dBuV) | Correction Factor (dB/m) |
|----|-----------------|-------------------------|----------------|-------------|--------------------|----------------------|------------------|--------------------------|
| 1  | 2390.00         | 58.9 PK                 | 74.0           | -15.1       | 3.25 H             | 12                   | 60.7             | -1.8                     |
| 2  | 2390.00         | 47.8 AV                 | 54.0           | -6.2        | 3.25 H             | 12                   | 49.6             | -1.8                     |
| 3  | *2437.00        | 115.5 PK                |                |             | 3.25 H             | 12                   | 117.3            | -1.8                     |
| 4  | *2437.00        | 113.0 AV                |                |             | 3.25 H             | 12                   | 114.8            | -1.8                     |
| 5  | 2483.50         | 56.8 PK                 | 74.0           | -17.2       | 3.25 H             | 12                   | 58.7             | -1.9                     |
| 6  | 2483.50         | 45.5 AV                 | 54.0           | -8.5        | 3.25 H             | 12                   | 47.4             | -1.9                     |
| 7  | 4874.00         | 49.2 PK                 | 74.0           | -24.8       | 1.00 H             | 245                  | 47.1             | 2.1                      |
| 8  | 4874.00         | 47.3 AV                 | 54.0           | -6.7        | 1.00 H             | 245                  | 45.2             | 2.1                      |
| 9  | 7311.00         | 49.6 PK                 | 74.0           | -24.4       | 1.72 H             | 327                  | 40.5             | 9.1                      |
| 10 | 7311.00         | 43.8 AV                 | 54.0           | -10.2       | 1.72 H             | 327                  | 34.7             | 9.1                      |

**Antenna Polarity & Test Distance : Vertical at 3 m**

| No | Frequency (MHz) | Emission Level (dBuV/m) | Limit (dBuV/m) | Margin (dB) | Antenna Height (m) | Table Angle (Degree) | Raw Value (dBuV) | Correction Factor (dB/m) |
|----|-----------------|-------------------------|----------------|-------------|--------------------|----------------------|------------------|--------------------------|
| 1  | 2390.00         | 54.6 PK                 | 74.0           | -19.4       | 3.34 V             | 66                   | 56.4             | -1.8                     |
| 2  | 2390.00         | 42.2 AV                 | 54.0           | -11.8       | 3.34 V             | 66                   | 44.0             | -1.8                     |
| 3  | *2437.00        | 105.9 PK                |                |             | 3.34 V             | 66                   | 107.7            | -1.8                     |
| 4  | *2437.00        | 103.2 AV                |                |             | 3.34 V             | 66                   | 105.0            | -1.8                     |
| 5  | 2483.50         | 54.2 PK                 | 74.0           | -19.8       | 3.34 V             | 66                   | 56.1             | -1.9                     |
| 6  | 2483.50         | 42.1 AV                 | 54.0           | -11.9       | 3.34 V             | 66                   | 44.0             | -1.9                     |
| 7  | 4874.00         | 49.3 PK                 | 74.0           | -24.7       | 1.66 V             | 178                  | 47.2             | 2.1                      |
| 8  | 4874.00         | 48.0 AV                 | 54.0           | -6.0        | 1.66 V             | 178                  | 45.9             | 2.1                      |
| 9  | 7311.00         | 45.8 PK                 | 74.0           | -28.2       | 3.72 V             | 70                   | 36.7             | 9.1                      |
| 10 | 7311.00         | 38.1 AV                 | 54.0           | -15.9       | 3.72 V             | 70                   | 29.0             | 9.1                      |

**Remarks:**

1. Emission Level(dBuV/m) = Raw Value(dBuV) + Correction Factor(dB/m)
2. Correction Factor(dB/m) = Antenna Factor(dB/m) + Cable Factor(dB) – Pre-Amplifier Factor(dB)
3. Margin value = Emission Level – Limit value
4. The other emission levels were very low against the limit.
5. " \* ": Fundamental frequency.

|                        |               |                          |              |
|------------------------|---------------|--------------------------|--------------|
| <b>Channel</b>         | TX Channel 11 | <b>Detector Function</b> | Peak (PK)    |
| <b>Frequency Range</b> | 1GHz ~ 25GHz  |                          | Average (AV) |

**Antenna Polarity & Test Distance : Horizontal at 3 m**

| No | Frequency (MHz) | Emission Level (dBuV/m) | Limit (dBuV/m) | Margin (dB) | Antenna Height (m) | Table Angle (Degree) | Raw Value (dBuV) | Correction Factor (dB/m) |
|----|-----------------|-------------------------|----------------|-------------|--------------------|----------------------|------------------|--------------------------|
| 1  | *2462.00        | 113.6 PK                |                |             | 3.38 H             | 5                    | 115.4            | -1.8                     |
| 2  | *2462.00        | 111.4 AV                |                |             | 3.38 H             | 5                    | 113.2            | -1.8                     |
| 3  | 2488.80         | 59.5 PK                 | 74.0           | -14.5       | 3.38 H             | 5                    | 61.4             | -1.9                     |
| 4  | 2488.80         | 49.0 AV                 | 54.0           | -5.0        | 3.38 H             | 5                    | 50.9             | -1.9                     |
| 5  | 4924.00         | 48.2 PK                 | 74.0           | -25.8       | 1.02 H             | 249                  | 45.9             | 2.3                      |
| 6  | 4924.00         | 46.1 AV                 | 54.0           | -7.9        | 1.02 H             | 249                  | 43.8             | 2.3                      |
| 7  | 7386.00         | 48.4 PK                 | 74.0           | -25.6       | 1.78 H             | 314                  | 39.0             | 9.4                      |
| 8  | 7386.00         | 42.5 AV                 | 54.0           | -11.5       | 1.78 H             | 314                  | 33.1             | 9.4                      |

**Antenna Polarity & Test Distance : Vertical at 3 m**

| No | Frequency (MHz) | Emission Level (dBuV/m) | Limit (dBuV/m) | Margin (dB) | Antenna Height (m) | Table Angle (Degree) | Raw Value (dBuV) | Correction Factor (dB/m) |
|----|-----------------|-------------------------|----------------|-------------|--------------------|----------------------|------------------|--------------------------|
| 1  | *2462.00        | 104.3 PK                |                |             | 3.14 V             | 88                   | 106.1            | -1.8                     |
| 2  | *2462.00        | 101.9 AV                |                |             | 3.14 V             | 88                   | 103.7            | -1.8                     |
| 3  | 2488.80         | 55.1 PK                 | 74.0           | -18.9       | 3.14 V             | 88                   | 57.0             | -1.9                     |
| 4  | 2488.80         | 43.6 AV                 | 54.0           | -10.4       | 3.14 V             | 88                   | 45.5             | -1.9                     |
| 5  | 4924.00         | 48.6 PK                 | 74.0           | -25.4       | 1.68 V             | 165                  | 46.3             | 2.3                      |
| 6  | 4924.00         | 47.0 AV                 | 54.0           | -7.0        | 1.68 V             | 165                  | 44.7             | 2.3                      |
| 7  | 7386.00         | 44.2 PK                 | 74.0           | -29.8       | 3.69 V             | 60                   | 34.8             | 9.4                      |
| 8  | 7386.00         | 36.7 AV                 | 54.0           | -17.3       | 3.69 V             | 60                   | 27.3             | 9.4                      |

**Remarks:**

1. Emission Level(dBuV/m) = Raw Value(dBuV) + Correction Factor(dB/m)
2. Correction Factor(dB/m) = Antenna Factor(dB/m) + Cable Factor(dB) – Pre-Amplifier Factor(dB)
3. Margin value = Emission Level – Limit value
4. The other emission levels were very low against the limit.
5. " \* ": Fundamental frequency.

## 802.11g

|                        |              |                          |              |
|------------------------|--------------|--------------------------|--------------|
| <b>Channel</b>         | TX Channel 1 | <b>Detector Function</b> | Peak (PK)    |
| <b>Frequency Range</b> | 1GHz ~ 25GHz |                          | Average (AV) |

| Antenna Polarity & Test Distance : Horizontal at 3 m |                 |                         |                |             |                    |                      |                  |                          |
|--|-----------------|-------------------------|----------------|-------------|--------------------|----------------------|------------------|--------------------------|
| No   | Frequency (MHz) | Emission Level (dBuV/m) | Limit (dBuV/m) | Margin (dB) | Antenna Height (m) | Table Angle (Degree) | Raw Value (dBuV) | Correction Factor (dB/m) |
| 1  | 2390.00         | 59.9 PK                 | 74.0           | -14.1       | 3.44 H             | 3                    | 61.7             | -1.8                     |
| 2  | 2390.00         | 48.9 AV                 | 54.0           | -5.1        | 3.44 H             | 3                    | 50.7             | -1.8                     |
| 3  | *2412.00        | 110.6 PK                |                |             | 3.44 H             | 3                    | 112.4            | -1.8                     |
| 4  | *2412.00        | 100.1 AV                |                |             | 3.44 H             | 3                    | 101.9            | -1.8                     |
| 5  | 4824.00         | 46.0 PK                 | 74.0           | -28.0       | 1.00 H             | 235                  | 43.8             | 2.2                      |
| 6  | 4824.00         | 43.5 AV                 | 54.0           | -10.5       | 1.00 H             | 235                  | 41.3             | 2.2                      |

| Antenna Polarity & Test Distance : Vertical at 3 m |                 |                         |                |             |                    |                      |                  |                          |
|--|-----------------|-------------------------|----------------|-------------|--------------------|----------------------|------------------|--------------------------|
| No   | Frequency (MHz) | Emission Level (dBuV/m) | Limit (dBuV/m) | Margin (dB) | Antenna Height (m) | Table Angle (Degree) | Raw Value (dBuV) | Correction Factor (dB/m) |
| 1  | 2390.00         | 55.7 PK                 | 74.0           | -18.3       | 3.86 V             | 64                   | 57.5             | -1.8                     |
| 2  | 2390.00         | 44.7 AV                 | 54.0           | -9.3        | 3.86 V             | 64                   | 46.5             | -1.8                     |
| 3  | *2412.00        | 102.5 PK                |                |             | 3.86 V             | 64                   | 104.3            | -1.8                     |
| 4  | *2412.00        | 93.3 AV                 |                |             | 3.86 V             | 64                   | 95.1             | -1.8                     |
| 5  | 4824.00         | 44.7 PK                 | 74.0           | -29.3       | 1.62 V             | 162                  | 42.5             | 2.2                      |
| 6  | 4824.00         | 42.6 AV                 | 54.0           | -11.4       | 1.62 V             | 162                  | 40.4             | 2.2                      |

**Remarks:**

1. Emission Level(dBuV/m) = Raw Value(dBuV) + Correction Factor(dB/m)
2. Correction Factor(dB/m) = Antenna Factor(dB/m) + Cable Factor(dB) – Pre-Amplifier Factor(dB)
3. Margin value = Emission Level – Limit value
4. The other emission levels were very low against the limit.
5. " \* ": Fundamental frequency.



|                        |              |                          |              |
|------------------------|--------------|--------------------------|--------------|
| <b>Channel</b>         | TX Channel 6 | <b>Detector Function</b> | Peak (PK)    |
| <b>Frequency Range</b> | 1GHz ~ 25GHz |                          | Average (AV) |

**Antenna Polarity & Test Distance : Horizontal at 3 m**

| No | Frequency (MHz) | Emission Level (dBuV/m) | Limit (dBuV/m) | Margin (dB) | Antenna Height (m) | Table Angle (Degree) | Raw Value (dBuV) | Correction Factor (dB/m) |
|----|-----------------|-------------------------|----------------|-------------|--------------------|----------------------|------------------|--------------------------|
| 1  | 2390.00         | 55.6 PK                 | 74.0           | -18.4       | 3.13 H             | 7                    | 57.4             | -1.8                     |
| 2  | 2390.00         | 44.2 AV                 | 54.0           | -9.8        | 3.13 H             | 7                    | 46.0             | -1.8                     |
| 3  | *2437.00        | 115.1 PK                |                |             | 3.13 H             | 7                    | 116.9            | -1.8                     |
| 4  | *2437.00        | 105.6 AV                |                |             | 3.13 H             | 7                    | 107.4            | -1.8                     |
| 5  | 2483.50         | 55.3 PK                 | 74.0           | -18.7       | 3.13 H             | 7                    | 57.2             | -1.9                     |
| 6  | 2483.50         | 43.9 AV                 | 54.0           | -10.1       | 3.13 H             | 7                    | 45.8             | -1.9                     |
| 7  | 4874.00         | 47.5 PK                 | 74.0           | -26.5       | 1.00 H             | 240                  | 45.4             | 2.1                      |
| 8  | 4874.00         | 45.4 AV                 | 54.0           | -8.6        | 1.00 H             | 240                  | 43.3             | 2.1                      |
| 9  | 7311.00         | 47.1 PK                 | 74.0           | -26.9       | 1.76 H             | 319                  | 38.0             | 9.1                      |
| 10 | 7311.00         | 41.8 AV                 | 54.0           | -12.2       | 1.76 H             | 319                  | 32.7             | 9.1                      |

**Antenna Polarity & Test Distance : Vertical at 3 m**

| No | Frequency (MHz) | Emission Level (dBuV/m) | Limit (dBuV/m) | Margin (dB) | Antenna Height (m) | Table Angle (Degree) | Raw Value (dBuV) | Correction Factor (dB/m) |
|----|-----------------|-------------------------|----------------|-------------|--------------------|----------------------|------------------|--------------------------|
| 1  | 2390.00         | 55.1 PK                 | 74.0           | -18.9       | 3.93 V             | 86                   | 56.9             | -1.8                     |
| 2  | 2390.00         | 44.0 AV                 | 54.0           | -10.0       | 3.93 V             | 86                   | 45.8             | -1.8                     |
| 3  | *2437.00        | 109.2 PK                |                |             | 3.93 V             | 86                   | 111.0            | -1.8                     |
| 4  | *2437.00        | 98.9 AV                 |                |             | 3.93 V             | 86                   | 100.7            | -1.8                     |
| 5  | 2483.50         | 55.2 PK                 | 74.0           | -18.8       | 3.93 V             | 86                   | 57.1             | -1.9                     |
| 6  | 2483.50         | 44.1 AV                 | 54.0           | -9.9        | 3.93 V             | 86                   | 46.0             | -1.9                     |
| 7  | 4874.00         | 47.4 PK                 | 74.0           | -26.6       | 1.70 V             | 164                  | 45.3             | 2.1                      |
| 8  | 4874.00         | 45.2 AV                 | 54.0           | -8.8        | 1.70 V             | 164                  | 43.1             | 2.1                      |
| 9  | 7311.00         | 45.1 PK                 | 74.0           | -28.9       | 3.78 V             | 79                   | 36.0             | 9.1                      |
| 10 | 7311.00         | 36.5 AV                 | 54.0           | -17.5       | 3.78 V             | 79                   | 27.4             | 9.1                      |

**Remarks:**

1. Emission Level(dBuV/m) = Raw Value(dBuV) + Correction Factor(dB/m)
2. Correction Factor(dB/m) = Antenna Factor(dB/m) + Cable Factor(dB) – Pre-Amplifier Factor(dB)
3. Margin value = Emission Level – Limit value
4. The other emission levels were very low against the limit.
5. " \* ": Fundamental frequency.

|                        |               |                          |              |
|------------------------|---------------|--------------------------|--------------|
| <b>Channel</b>         | TX Channel 11 | <b>Detector Function</b> | Peak (PK)    |
| <b>Frequency Range</b> | 1GHz ~ 25GHz  |                          | Average (AV) |

**Antenna Polarity & Test Distance : Horizontal at 3 m**

| No | Frequency (MHz) | Emission Level (dBuV/m) | Limit (dBuV/m) | Margin (dB) | Antenna Height (m) | Table Angle (Degree) | Raw Value (dBuV) | Correction Factor (dB/m) |
|----|-----------------|-------------------------|----------------|-------------|--------------------|----------------------|------------------|--------------------------|
| 1  | *2462.00        | 111.0 PK                |                |             | 2.76 H             | 11                   | 112.8            | -1.8                     |
| 2  | *2462.00        | 100.9 AV                |                |             | 2.76 H             | 11                   | 102.7            | -1.8                     |
| 3  | 2483.50         | 57.8 PK                 | 74.0           | -16.2       | 2.76 H             | 11                   | 59.7             | -1.9                     |
| 4  | 2483.50         | 47.2 AV                 | 54.0           | -6.8        | 2.76 H             | 11                   | 49.1             | -1.9                     |
| 5  | 4924.00         | 45.3 PK                 | 74.0           | -28.7       | 1.00 H             | 235                  | 43.0             | 2.3                      |
| 6  | 4924.00         | 43.0 AV                 | 54.0           | -11.0       | 1.00 H             | 235                  | 40.7             | 2.3                      |
| 7  | 7386.00         | 44.3 PK                 | 74.0           | -29.7       | 1.79 H             | 312                  | 34.9             | 9.4                      |
| 8  | 7386.00         | 39.6 AV                 | 54.0           | -14.4       | 1.79 H             | 312                  | 30.2             | 9.4                      |

**Antenna Polarity & Test Distance : Vertical at 3 m**

| No | Frequency (MHz) | Emission Level (dBuV/m) | Limit (dBuV/m) | Margin (dB) | Antenna Height (m) | Table Angle (Degree) | Raw Value (dBuV) | Correction Factor (dB/m) |
|----|-----------------|-------------------------|----------------|-------------|--------------------|----------------------|------------------|--------------------------|
| 1  | *2462.00        | 103.3 PK                |                |             | 4.00 V             | 91                   | 105.1            | -1.8                     |
| 2  | *2462.00        | 93.9 AV                 |                |             | 4.00 V             | 91                   | 95.7             | -1.8                     |
| 3  | 2483.50         | 55.2 PK                 | 74.0           | -18.8       | 4.00 V             | 91                   | 57.1             | -1.9                     |
| 4  | 2483.50         | 44.2 AV                 | 54.0           | -9.8        | 4.00 V             | 91                   | 46.1             | -1.9                     |
| 5  | 4924.00         | 44.8 PK                 | 74.0           | -29.2       | 1.68 V             | 166                  | 42.5             | 2.3                      |
| 6  | 4924.00         | 42.5 AV                 | 54.0           | -11.5       | 1.68 V             | 166                  | 40.2             | 2.3                      |
| 7  | 7386.00         | 42.3 PK                 | 74.0           | -31.7       | 3.77 V             | 74                   | 32.9             | 9.4                      |
| 8  | 7386.00         | 36.3 AV                 | 54.0           | -17.7       | 3.77 V             | 74                   | 26.9             | 9.4                      |

**Remarks:**

1. Emission Level(dBuV/m) = Raw Value(dBuV) + Correction Factor(dB/m)
2. Correction Factor(dB/m) = Antenna Factor(dB/m) + Cable Factor(dB) – Pre-Amplifier Factor(dB)
3. Margin value = Emission Level – Limit value
4. The other emission levels were very low against the limit.
5. " \* ": Fundamental frequency.

**802.11n (HT20)**

|                        |              |                          |              |
|------------------------|--------------|--------------------------|--------------|
| <b>Channel</b>         | TX Channel 1 | <b>Detector Function</b> | Peak (PK)    |
| <b>Frequency Range</b> | 1GHz ~ 25GHz |                          | Average (AV) |

| Antenna Polarity & Test Distance : Horizontal at 3 m |                 |                         |                |             |                    |                      |                  |                          |
|--|-----------------|-------------------------|----------------|-------------|--------------------|----------------------|------------------|--------------------------|
| No   | Frequency (MHz) | Emission Level (dBuV/m) | Limit (dBuV/m) | Margin (dB) | Antenna Height (m) | Table Angle (Degree) | Raw Value (dBuV) | Correction Factor (dB/m) |
| 1  | 2390.00         | 63.0 PK                 | 74.0           | -11.0       | 2.70 H             | 9                    | 64.8             | -1.8                     |
| 2  | 2390.00         | 50.6 AV                 | 54.0           | -3.4        | 2.70 H             | 9                    | 52.4             | -1.8                     |
| 3  | *2412.00        | 111.3 PK                |                |             | 2.70 H             | 9                    | 113.1            | -1.8                     |
| 4  | *2412.00        | 100.9 AV                |                |             | 2.70 H             | 9                    | 102.7            | -1.8                     |
| 5  | 4824.00         | 45.0 PK                 | 74.0           | -29.0       | 1.00 H             | 223                  | 42.8             | 2.2                      |
| 6  | 4824.00         | 42.6 AV                 | 54.0           | -11.4       | 1.00 H             | 223                  | 40.4             | 2.2                      |

| Antenna Polarity & Test Distance : Vertical at 3 m |                 |                         |                |             |                    |                      |                  |                          |
|--|-----------------|-------------------------|----------------|-------------|--------------------|----------------------|------------------|--------------------------|
| No   | Frequency (MHz) | Emission Level (dBuV/m) | Limit (dBuV/m) | Margin (dB) | Antenna Height (m) | Table Angle (Degree) | Raw Value (dBuV) | Correction Factor (dB/m) |
| 1  | 2390.00         | 55.6 PK                 | 74.0           | -18.4       | 3.88 V             | 63                   | 57.4             | -1.8                     |
| 2  | 2390.00         | 45.1 AV                 | 54.0           | -8.9        | 3.88 V             | 63                   | 46.9             | -1.8                     |
| 3  | *2412.00        | 102.7 PK                |                |             | 3.88 V             | 63                   | 104.5            | -1.8                     |
| 4  | *2412.00        | 93.2 AV                 |                |             | 3.88 V             | 63                   | 95.0             | -1.8                     |
| 5  | 4824.00         | 44.4 PK                 | 74.0           | -29.6       | 1.67 V             | 159                  | 42.2             | 2.2                      |
| 6  | 4824.00         | 42.1 AV                 | 54.0           | -11.9       | 1.67 V             | 159                  | 39.9             | 2.2                      |

**Remarks:**

1. Emission Level(dBuV/m) = Raw Value(dBuV) + Correction Factor(dB/m)
2. Correction Factor(dB/m) = Antenna Factor(dB/m) + Cable Factor(dB) – Pre-Amplifier Factor(dB)
3. Margin value = Emission Level – Limit value
4. The other emission levels were very low against the limit.
5. " \* ": Fundamental frequency.

|                        |              |                          |              |
|------------------------|--------------|--------------------------|--------------|
| <b>Channel</b>         | TX Channel 6 | <b>Detector Function</b> | Peak (PK)    |
| <b>Frequency Range</b> | 1GHz ~ 25GHz |                          | Average (AV) |

**Antenna Polarity & Test Distance : Horizontal at 3 m**

| No | Frequency (MHz) | Emission Level (dBuV/m) | Limit (dBuV/m) | Margin (dB) | Antenna Height (m) | Table Angle (Degree) | Raw Value (dBuV) | Correction Factor (dB/m) |
|----|-----------------|-------------------------|----------------|-------------|--------------------|----------------------|------------------|--------------------------|
| 1  | 2390.00         | 55.8 PK                 | 74.0           | -18.2       | 2.83 H             | 9                    | 57.6             | -1.8                     |
| 2  | 2390.00         | 44.3 AV                 | 54.0           | -9.7        | 2.83 H             | 9                    | 46.1             | -1.8                     |
| 3  | *2437.00        | 115.8 PK                |                |             | 2.83 H             | 9                    | 117.6            | -1.8                     |
| 4  | *2437.00        | 106.2 AV                |                |             | 2.83 H             | 9                    | 108.0            | -1.8                     |
| 5  | 2483.50         | 55.4 PK                 | 74.0           | -18.6       | 2.83 H             | 9                    | 57.3             | -1.9                     |
| 6  | 2483.50         | 44.0 AV                 | 54.0           | -10.0       | 2.83 H             | 9                    | 45.9             | -1.9                     |
| 7  | 4874.00         | 48.2 PK                 | 74.0           | -25.8       | 1.00 H             | 248                  | 46.1             | 2.1                      |
| 8  | 4874.00         | 45.9 AV                 | 54.0           | -8.1        | 1.00 H             | 248                  | 43.8             | 2.1                      |
| 9  | 7311.00         | 46.4 PK                 | 74.0           | -27.6       | 1.81 H             | 312                  | 37.3             | 9.1                      |
| 10 | 7311.00         | 41.3 AV                 | 54.0           | -12.7       | 1.81 H             | 312                  | 32.2             | 9.1                      |

**Antenna Polarity & Test Distance : Vertical at 3 m**

| No | Frequency (MHz) | Emission Level (dBuV/m) | Limit (dBuV/m) | Margin (dB) | Antenna Height (m) | Table Angle (Degree) | Raw Value (dBuV) | Correction Factor (dB/m) |
|----|-----------------|-------------------------|----------------|-------------|--------------------|----------------------|------------------|--------------------------|
| 1  | 2390.00         | 54.9 PK                 | 74.0           | -19.1       | 3.91 V             | 93                   | 56.7             | -1.8                     |
| 2  | 2390.00         | 43.0 AV                 | 54.0           | -11.0       | 3.91 V             | 93                   | 44.8             | -1.8                     |
| 3  | *2437.00        | 109.3 PK                |                |             | 3.91 V             | 93                   | 111.1            | -1.8                     |
| 4  | *2437.00        | 99.3 AV                 |                |             | 3.91 V             | 93                   | 101.1            | -1.8                     |
| 5  | 2483.50         | 55.2 PK                 | 74.0           | -18.8       | 3.91 V             | 93                   | 57.1             | -1.9                     |
| 6  | 2483.50         | 43.6 AV                 | 54.0           | -10.4       | 3.91 V             | 93                   | 45.5             | -1.9                     |
| 7  | 4874.00         | 47.4 PK                 | 74.0           | -26.6       | 1.67 V             | 155                  | 45.3             | 2.1                      |
| 8  | 4874.00         | 45.3 AV                 | 54.0           | -8.7        | 1.67 V             | 155                  | 43.2             | 2.1                      |
| 9  | 7311.00         | 45.1 PK                 | 74.0           | -28.9       | 3.77 V             | 94                   | 36.0             | 9.1                      |
| 10 | 7311.00         | 36.5 AV                 | 54.0           | -17.5       | 3.77 V             | 94                   | 27.4             | 9.1                      |

**Remarks:**

1. Emission Level(dBuV/m) = Raw Value(dBuV) + Correction Factor(dB/m)
2. Correction Factor(dB/m) = Antenna Factor(dB/m) + Cable Factor(dB) – Pre-Amplifier Factor(dB)
3. Margin value = Emission Level – Limit value
4. The other emission levels were very low against the limit.
5. " \* ": Fundamental frequency.

|                        |               |                          |              |
|------------------------|---------------|--------------------------|--------------|
| <b>Channel</b>         | TX Channel 11 | <b>Detector Function</b> | Peak (PK)    |
| <b>Frequency Range</b> | 1GHz ~ 25GHz  |                          | Average (AV) |

**Antenna Polarity & Test Distance : Horizontal at 3 m**

| No | Frequency (MHz) | Emission Level (dBuV/m) | Limit (dBuV/m) | Margin (dB) | Antenna Height (m) | Table Angle (Degree) | Raw Value (dBuV) | Correction Factor (dB/m) |
|----|-----------------|-------------------------|----------------|-------------|--------------------|----------------------|------------------|--------------------------|
| 1  | *2462.00        | 110.3 PK                |                |             | 2.78 H             | 9                    | 112.1            | -1.8                     |
| 2  | *2462.00        | 100.8 AV                |                |             | 2.78 H             | 9                    | 102.6            | -1.8                     |
| 3  | 2483.50         | 57.6 PK                 | 74.0           | -16.4       | 2.78 H             | 9                    | 59.5             | -1.9                     |
| 4  | 2483.50         | 47.2 AV                 | 54.0           | -6.8        | 2.78 H             | 9                    | 49.1             | -1.9                     |
| 5  | 4924.00         | 45.5 PK                 | 74.0           | -28.5       | 1.00 H             | 245                  | 43.2             | 2.3                      |
| 6  | 4924.00         | 43.4 AV                 | 54.0           | -10.6       | 1.00 H             | 245                  | 41.1             | 2.3                      |
| 7  | 7386.00         | 44.5 PK                 | 74.0           | -29.5       | 1.84 H             | 314                  | 35.1             | 9.4                      |
| 8  | 7386.00         | 40.1 AV                 | 54.0           | -13.9       | 1.84 H             | 314                  | 30.7             | 9.4                      |

**Antenna Polarity & Test Distance : Vertical at 3 m**

| No | Frequency (MHz) | Emission Level (dBuV/m) | Limit (dBuV/m) | Margin (dB) | Antenna Height (m) | Table Angle (Degree) | Raw Value (dBuV) | Correction Factor (dB/m) |
|----|-----------------|-------------------------|----------------|-------------|--------------------|----------------------|------------------|--------------------------|
| 1  | *2462.00        | 103.5 PK                |                |             | 4.00 V             | 88                   | 105.3            | -1.8                     |
| 2  | *2462.00        | 93.9 AV                 |                |             | 4.00 V             | 88                   | 95.7             | -1.8                     |
| 3  | 2483.50         | 55.1 PK                 | 74.0           | -18.9       | 4.00 V             | 88                   | 57.0             | -1.9                     |
| 4  | 2483.50         | 44.7 AV                 | 54.0           | -9.3        | 4.00 V             | 88                   | 46.6             | -1.9                     |
| 5  | 4924.00         | 44.7 PK                 | 74.0           | -29.3       | 1.63 V             | 178                  | 42.4             | 2.3                      |
| 6  | 4924.00         | 42.5 AV                 | 54.0           | -11.5       | 1.63 V             | 178                  | 40.2             | 2.3                      |
| 7  | 7386.00         | 42.5 PK                 | 74.0           | -31.5       | 3.79 V             | 59                   | 33.1             | 9.4                      |
| 8  | 7386.00         | 36.3 AV                 | 54.0           | -17.7       | 3.79 V             | 59                   | 26.9             | 9.4                      |

**Remarks:**

1. Emission Level(dBuV/m) = Raw Value(dBuV) + Correction Factor(dB/m)
2. Correction Factor(dB/m) = Antenna Factor(dB/m) + Cable Factor(dB) – Pre-Amplifier Factor(dB)
3. Margin value = Emission Level – Limit value
4. The other emission levels were very low against the limit.
5. " \* ": Fundamental frequency.

**802.11n (HT40)**

|                        |              |                          |              |
|------------------------|--------------|--------------------------|--------------|
| <b>Channel</b>         | TX Channel 3 | <b>Detector Function</b> | Peak (PK)    |
| <b>Frequency Range</b> | 1GHz ~ 25GHz |                          | Average (AV) |

| Antenna Polarity & Test Distance : Horizontal at 3 m |                 |                         |                |             |                    |                      |                  |                          |
|--|-----------------|-------------------------|----------------|-------------|--------------------|----------------------|------------------|--------------------------|
| No   | Frequency (MHz) | Emission Level (dBuV/m) | Limit (dBuV/m) | Margin (dB) | Antenna Height (m) | Table Angle (Degree) | Raw Value (dBuV) | Correction Factor (dB/m) |
| 1  | 2390.00         | 66.2 PK                 | 74.0           | -7.8        | 2.88 H             | 5                    | 68.0             | -1.8                     |
| 2  | 2390.00         | 49.1 AV                 | 54.0           | -4.9        | 2.88 H             | 5                    | 50.9             | -1.8                     |
| 3  | *2422.00        | 102.1 PK                |                |             | 2.88 H             | 5                    | 103.9            | -1.8                     |
| 4  | *2422.00        | 93.8 AV                 |                |             | 2.88 H             | 5                    | 95.6             | -1.8                     |
| 5  | 4844.00         | 44.8 PK                 | 74.0           | -29.2       | 1.00 H             | 237                  | 42.6             | 2.2                      |
| 6  | 4844.00         | 42.8 AV                 | 54.0           | -11.2       | 1.00 H             | 237                  | 40.6             | 2.2                      |
| 7  | 7266.00         | 44.5 PK                 | 74.0           | -29.5       | 1.76 H             | 304                  | 35.5             | 9.0                      |
| 8  | 7266.00         | 39.8 AV                 | 54.0           | -14.2       | 1.76 H             | 304                  | 30.8             | 9.0                      |
| Antenna Polarity & Test Distance : Vertical at 3 m   |                 |                         |                |             |                    |                      |                  |                          |
| No   | Frequency (MHz) | Emission Level (dBuV/m) | Limit (dBuV/m) | Margin (dB) | Antenna Height (m) | Table Angle (Degree) | Raw Value (dBuV) | Correction Factor (dB/m) |
| 1  | 2390.00         | 55.6 PK                 | 74.0           | -18.4       | 3.88 V             | 79                   | 57.4             | -1.8                     |
| 2  | 2390.00         | 44.7 AV                 | 54.0           | -9.3        | 3.88 V             | 79                   | 46.5             | -1.8                     |
| 3  | *2422.00        | 95.2 PK                 |                |             | 3.88 V             | 79                   | 97.0             | -1.8                     |
| 4  | *2422.00        | 86.3 AV                 |                |             | 3.88 V             | 79                   | 88.1             | -1.8                     |
| 5  | 4844.00         | 45.3 PK                 | 74.0           | -28.7       | 1.74 V             | 160                  | 43.1             | 2.2                      |
| 6  | 4844.00         | 43.0 AV                 | 54.0           | -11.0       | 1.74 V             | 160                  | 40.8             | 2.2                      |
| 7  | 7266.00         | 42.6 PK                 | 74.0           | -31.4       | 3.72 V             | 77                   | 33.6             | 9.0                      |
| 8  | 7266.00         | 36.6 AV                 | 54.0           | -17.4       | 3.72 V             | 77                   | 27.6             | 9.0                      |

**Remarks:**

1. Emission Level(dBuV/m) = Raw Value(dBuV) + Correction Factor(dB/m)
2. Correction Factor(dB/m) = Antenna Factor(dB/m) + Cable Factor(dB) – Pre-Amplifier Factor(dB)
3. Margin value = Emission Level – Limit value
4. The other emission levels were very low against the limit.
5. " \* " : Fundamental frequency.

|                        |              |                          |              |
|------------------------|--------------|--------------------------|--------------|
| <b>Channel</b>         | TX Channel 6 | <b>Detector Function</b> | Peak (PK)    |
| <b>Frequency Range</b> | 1GHz ~ 25GHz |                          | Average (AV) |

**Antenna Polarity & Test Distance : Horizontal at 3 m**

| No | Frequency (MHz) | Emission Level (dBuV/m) | Limit (dBuV/m) | Margin (dB) | Antenna Height (m) | Table Angle (Degree) | Raw Value (dBuV) | Correction Factor (dB/m) |
|----|-----------------|-------------------------|----------------|-------------|--------------------|----------------------|------------------|--------------------------|
| 1  | 2390.00         | 56.3 PK                 | 74.0           | -17.7       | 2.67 H             | 12                   | 58.1             | -1.8                     |
| 2  | 2390.00         | 45.3 AV                 | 54.0           | -8.7        | 2.67 H             | 12                   | 47.1             | -1.8                     |
| 3  | *2437.00        | 108.6 PK                |                |             | 2.67 H             | 12                   | 110.4            | -1.8                     |
| 4  | *2437.00        | 99.1 AV                 |                |             | 2.67 H             | 12                   | 100.9            | -1.8                     |
| 5  | 2483.50         | 55.9 PK                 | 74.0           | -18.1       | 2.67 H             | 12                   | 57.8             | -1.9                     |
| 6  | 2483.50         | 45.0 AV                 | 54.0           | -9.0        | 2.67 H             | 12                   | 46.9             | -1.9                     |
| 7  | 4874.00         | 45.4 PK                 | 74.0           | -28.6       | 1.00 H             | 219                  | 43.3             | 2.1                      |
| 8  | 4874.00         | 42.9 AV                 | 54.0           | -11.1       | 1.00 H             | 219                  | 40.8             | 2.1                      |
| 9  | 7311.00         | 44.8 PK                 | 74.0           | -29.2       | 1.78 H             | 322                  | 35.7             | 9.1                      |
| 10 | 7311.00         | 39.9 AV                 | 54.0           | -14.1       | 1.78 H             | 322                  | 30.8             | 9.1                      |

**Antenna Polarity & Test Distance : Vertical at 3 m**

| No | Frequency (MHz) | Emission Level (dBuV/m) | Limit (dBuV/m) | Margin (dB) | Antenna Height (m) | Table Angle (Degree) | Raw Value (dBuV) | Correction Factor (dB/m) |
|----|-----------------|-------------------------|----------------|-------------|--------------------|----------------------|------------------|--------------------------|
| 1  | 2390.00         | 55.6 PK                 | 74.0           | -18.4       | 3.76 V             | 76                   | 57.4             | -1.8                     |
| 2  | 2390.00         | 44.4 AV                 | 54.0           | -9.6        | 3.76 V             | 76                   | 46.2             | -1.8                     |
| 3  | *2437.00        | 101.4 PK                |                |             | 3.76 V             | 76                   | 103.2            | -1.8                     |
| 4  | *2437.00        | 92.3 AV                 |                |             | 3.76 V             | 76                   | 94.1             | -1.8                     |
| 5  | 2483.50         | 55.8 PK                 | 74.0           | -18.2       | 3.76 V             | 76                   | 57.7             | -1.9                     |
| 6  | 2483.50         | 44.5 AV                 | 54.0           | -9.5        | 3.76 V             | 76                   | 46.4             | -1.9                     |
| 7  | 4874.00         | 44.9 PK                 | 74.0           | -29.1       | 1.67 V             | 178                  | 42.8             | 2.1                      |
| 8  | 4874.00         | 42.4 AV                 | 54.0           | -11.6       | 1.67 V             | 178                  | 40.3             | 2.1                      |
| 9  | 7311.00         | 42.7 PK                 | 74.0           | -31.3       | 3.79 V             | 71                   | 33.6             | 9.1                      |
| 10 | 7311.00         | 36.7 AV                 | 54.0           | -17.3       | 3.79 V             | 71                   | 27.6             | 9.1                      |

**Remarks:**

1. Emission Level(dBuV/m) = Raw Value(dBuV) + Correction Factor(dB/m)
2. Correction Factor(dB/m) = Antenna Factor(dB/m) + Cable Factor(dB) – Pre-Amplifier Factor(dB)
3. Margin value = Emission Level – Limit value
4. The other emission levels were very low against the limit.
5. " \* ": Fundamental frequency.

|                        |              |                          |              |
|------------------------|--------------|--------------------------|--------------|
| <b>Channel</b>         | TX Channel 9 | <b>Detector Function</b> | Peak (PK)    |
| <b>Frequency Range</b> | 1GHz ~ 25GHz |                          | Average (AV) |

**Antenna Polarity & Test Distance : Horizontal at 3 m**

| No | Frequency (MHz) | Emission Level (dBuV/m) | Limit (dBuV/m) | Margin (dB) | Antenna Height (m) | Table Angle (Degree) | Raw Value (dBuV) | Correction Factor (dB/m) |
|----|-----------------|-------------------------|----------------|-------------|--------------------|----------------------|------------------|--------------------------|
| 1  | *2452.00        | 105.9 PK                |                |             | 2.57 H             | 8                    | 107.7            | -1.8                     |
| 2  | *2452.00        | 96.7 AV                 |                |             | 2.57 H             | 8                    | 98.5             | -1.8                     |
| 3  | 2483.50         | 65.5 PK                 | 74.0           | -8.5        | 2.57 H             | 8                    | 67.4             | -1.9                     |
| 4  | 2483.50         | 47.2 AV                 | 54.0           | -6.8        | 2.57 H             | 8                    | 49.1             | -1.9                     |
| 5  | 4904.00         | 45.2 PK                 | 74.0           | -28.8       | 1.00 H             | 242                  | 43.1             | 2.1                      |
| 6  | 4904.00         | 42.9 AV                 | 54.0           | -11.1       | 1.00 H             | 242                  | 40.8             | 2.1                      |
| 7  | 7356.00         | 44.0 PK                 | 74.0           | -30.0       | 1.84 H             | 313                  | 34.8             | 9.2                      |
| 8  | 7356.00         | 39.5 AV                 | 54.0           | -14.5       | 1.84 H             | 313                  | 30.3             | 9.2                      |

**Antenna Polarity & Test Distance : Vertical at 3 m**

| No | Frequency (MHz) | Emission Level (dBuV/m) | Limit (dBuV/m) | Margin (dB) | Antenna Height (m) | Table Angle (Degree) | Raw Value (dBuV) | Correction Factor (dB/m) |
|----|-----------------|-------------------------|----------------|-------------|--------------------|----------------------|------------------|--------------------------|
| 1  | *2452.00        | 98.8 PK                 |                |             | 3.98 V             | 87                   | 100.6            | -1.8                     |
| 2  | *2452.00        | 89.7 AV                 |                |             | 3.98 V             | 87                   | 91.5             | -1.8                     |
| 3  | 2483.50         | 57.2 PK                 | 74.0           | -16.8       | 3.98 V             | 87                   | 59.1             | -1.9                     |
| 4  | 2483.50         | 44.7 AV                 | 54.0           | -9.3        | 3.98 V             | 87                   | 46.6             | -1.9                     |
| 5  | 4904.00         | 45.0 PK                 | 74.0           | -29.0       | 1.66 V             | 168                  | 42.9             | 2.1                      |
| 6  | 4904.00         | 42.7 AV                 | 54.0           | -11.3       | 1.66 V             | 168                  | 40.6             | 2.1                      |
| 7  | 7356.00         | 42.5 PK                 | 74.0           | -31.5       | 3.76 V             | 76                   | 33.3             | 9.2                      |
| 8  | 7356.00         | 36.3 AV                 | 54.0           | -17.7       | 3.76 V             | 76                   | 27.1             | 9.2                      |

**Remarks:**

1. Emission Level(dBuV/m) = Raw Value(dBuV) + Correction Factor(dB/m)
2. Correction Factor(dB/m) = Antenna Factor(dB/m) + Cable Factor(dB) – Pre-Amplifier Factor(dB)
3. Margin value = Emission Level – Limit value
4. The other emission levels were very low against the limit.
5. " \* ": Fundamental frequency.



Below 1GHz Data:

802.11b

|                 |              |                   |                 |
|-----------------|--------------|-------------------|-----------------|
| Channel         | TX Channel 6 | Detector Function | Quasi-Peak (QP) |
| Frequency Range | 9kHz ~ 1GHz  |                   |                 |

| Antenna Polarity & Test Distance : Horizontal at 3 m |                 |                         |                |             |                    |                      |                  |                          |
|--|-----------------|-------------------------|----------------|-------------|--------------------|----------------------|------------------|--------------------------|
| No   | Frequency (MHz) | Emission Level (dBuV/m) | Limit (dBuV/m) | Margin (dB) | Antenna Height (m) | Table Angle (Degree) | Raw Value (dBuV) | Correction Factor (dB/m) |
| 1  | 30.53           | 25.4 QP                 | 40.0           | -14.6       | 1.00 H             | 114                  | 34.6             | -9.2                     |
| 2  | 88.93           | 26.8 QP                 | 43.5           | -16.7       | 2.00 H             | 266                  | 40.5             | -13.7                    |
| 3  | 128.58          | 33.4 QP                 | 43.5           | -10.1       | 2.00 H             | 226                  | 42.3             | -8.9                     |
| 4  | 246.77          | 23.7 QP                 | 46.0           | -22.3       | 1.50 H             | 231                  | 32.3             | -8.6                     |
| 5  | 343.67          | 28.7 QP                 | 46.0           | -17.3       | 1.00 H             | 210                  | 34.2             | -5.5                     |
| 6  | 512.87          | 28.5 QP                 | 46.0           | -17.5       | 1.50 H             | 318                  | 29.5             | -1.0                     |

REMARKS:

1. Emission Level(dBuV/m) = Raw Value(dBuV) + Correction Factor(dB/m)
2. Correction Factor(dB/m) = Antenna Factor(dB/m) + Cable Factor(dB) – Pre-Amplifier Factor(dB)
3. Margin value = Emission Level – Limit value
4. The other emission levels were very low against the limit of frequency range 30MHz~1000MHz.
5. The emission levels were very low against the limit of frequency range 9kHz~30MHz: the amplitude of spurious emissions attenuated more than 20 dB below the permissible value to be report.

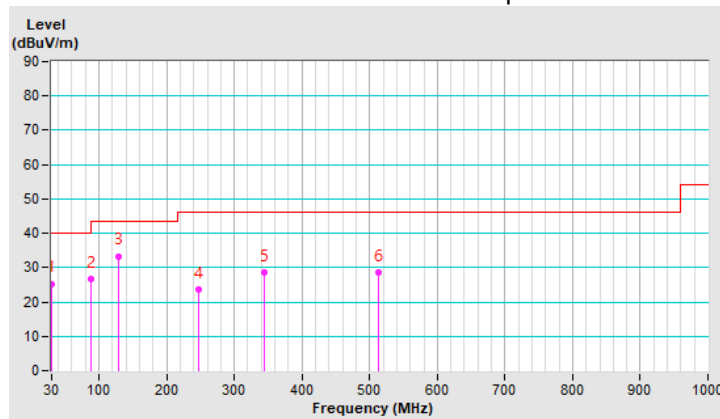

|                        |              |                          |                 |
|------------------------|--------------|--------------------------|-----------------|
| <b>Channel</b>         | TX Channel 6 | <b>Detector Function</b> | Quasi-Peak (QP) |
| <b>Frequency Range</b> | 9kHz ~ 1GHz  |                          |                 |

| Antenna Polarity & Test Distance : Vertical at 3 m |                 |                         |                |             |                    |                      |                  |                          |
|--|-----------------|-------------------------|----------------|-------------|--------------------|----------------------|------------------|--------------------------|
| No   | Frequency (MHz) | Emission Level (dBuV/m) | Limit (dBuV/m) | Margin (dB) | Antenna Height (m) | Table Angle (Degree) | Raw Value (dBuV) | Correction Factor (dB/m) |
| 1  | 48.87           | 30.7 QP                 | 40.0           | -9.3        | 1.00 V             | 315                  | 38.6             | -7.9                     |
| 2  | 84.03           | 25.3 QP                 | 40.0           | -14.7       | 1.50 V             | 247                  | 38.7             | -13.4                    |
| 3  | 128.16          | 27.5 QP                 | 43.5           | -16.0       | 1.50 V             | 53                   | 36.4             | -8.9                     |
| 4  | 162.87          | 25.0 QP                 | 43.5           | -18.5       | 1.00 V             | 286                  | 32.5             | -7.5                     |
| 5  | 329.41          | 24.6 QP                 | 46.0           | -21.4       | 1.00 V             | 34                   | 30.2             | -5.6                     |
| 6  | 472.05          | 26.9 QP                 | 46.0           | -19.1       | 1.50 V             | 144                  | 28.6             | -1.7                     |

**REMARKS:**

1. Emission Level(dBuV/m) = Raw Value(dBuV) + Correction Factor(dB/m)
2. Correction Factor(dB/m) = Antenna Factor(dB/m) + Cable Factor(dB) – Pre-Amplifier Factor(dB)
3. Margin value = Emission Level – Limit value
4. The other emission levels were very low against the limit of frequency range 30MHz~1000MHz.
5. The emission levels were very low against the limit of frequency range 9kHz~30MHz: the amplitude of spurious emissions attenuated more than 20 dB below the permissible value to be report.

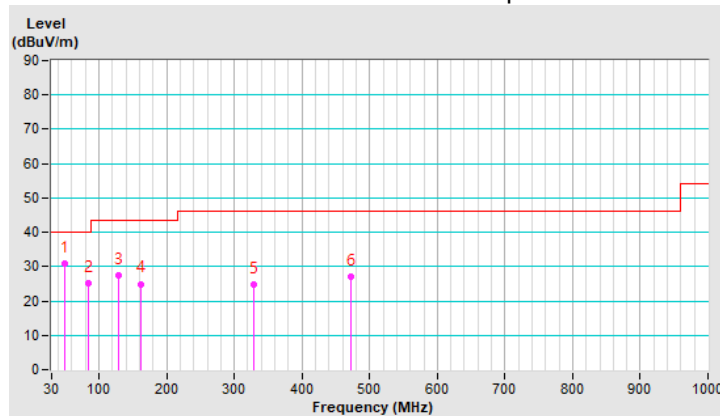

## 4.2 Conducted Emission Measurement

### 4.2.1 Limits of Conducted Emission Measurement

| Frequency (MHz) | Conducted Limit (dBuV) |         |
|-----------------|------------------------|---------|
|                 | Quasi-peak             | Average |
| 0.15 - 0.5      | 66 - 56                | 56 - 46 |
| 0.50 - 5.0      | 56                     | 46      |
| 5.0 - 30.0      | 60                     | 50      |

Note: 1. The lower limit shall apply at the transition frequencies.

2. The limit decreases in line with the logarithm of the frequency in the range of 0.15 to 0.50MHz.

### 4.2.2 Test Instruments

| DESCRIPTION & MANUFACTURER   | MODEL NO.               | SERIAL NO. | CALIBRATED DATE | CALIBRATED UNTIL |
|--|-------------------------|------------|-----------------|------------------|
| Test Receiver<br>R&S   | ESCS 30                 | 847124/029 | Oct. 23, 2019   | Oct. 22, 2020    |
| Line-Impedance<br>Stabilization Network (for<br>EUT)<br>R&S        | ESH3-Z5                 | 848773/004 | Oct. 23, 2019   | Oct. 22, 2020    |
| Line-Impedance<br>Stabilization Network<br>(for Peripheral)<br>R&S | ESH3-Z5                 | 835239/001 | Mar. 19, 2020   | Mar. 18, 2021    |
| 50 ohms Terminator   | 50                      | 3          | Oct. 23, 2019   | Oct. 22, 2020    |
| RF Cable   | 5D-FB                   | COCCAB-001 | Sep. 27, 2019   | Sep. 26, 2020    |
| Fixed attenuator<br>EMCI   | STI02-2200-10           | 005        | Aug. 30, 2019   | Aug. 29, 2020    |
| Software<br>BVADT  | BVADT_Cond_<br>V7.3.7.4 | NA         | NA              | NA               |

**Note:**

1. The calibration interval of the above test instruments are 12 months and the calibrations are traceable to NML/ROC and NIST/USA.
2. The test was performed in Conduction 1.
3. Tested Date: May 12, 2020

#### 4.2.3 Test Procedures

- The EUT was placed 0.4 meters from the conducting wall of the shielded room with EUT being connected to the power mains through a line impedance stabilization network (LISN). Other support units were connected to the power mains through another LISN. The two LISNs provide 50 ohm/ 50uH of coupling impedance for the measuring instrument.
- Both lines of the power mains connected to the EUT were checked for maximum conducted interference.
- The frequency range from 150kHz to 30MHz was searched. Emission levels under (Limit - 20dB) was not recorded.

**NOTE:** The resolution bandwidth and video bandwidth of test receiver is 9kHz for quasi-peak detection (QP) and average detection (AV) at frequency 0.15MHz-30MHz.

#### 4.2.4 Deviation from Test Standard

No deviation.

#### 4.2.5 Test Setup

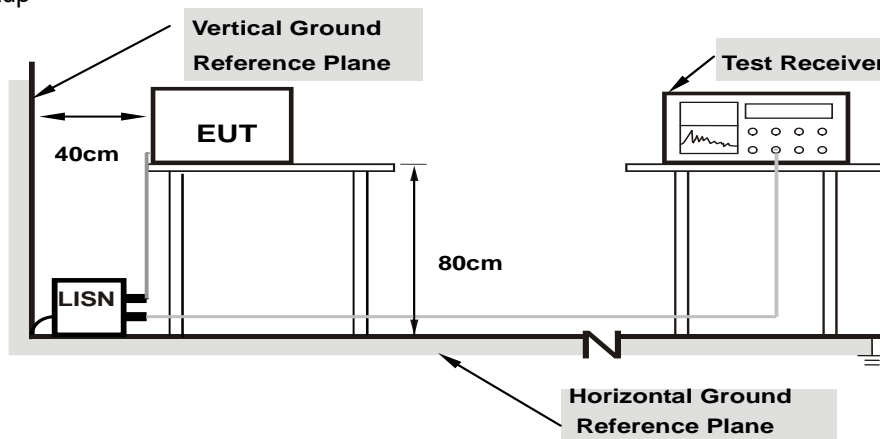

**Note:** 1.Support units were connected to second LISN.

For the actual test configuration, please refer to the attached file (Test Setup Photo).

#### 4.2.6 EUT Operating Conditions

Same as 4.1.6.

#### 4.2.7 Test Results

| Phase | Line (L) | Detector Function | Quasi-Peak (QP) / Average (AV) |
|-------|----------|-------------------|--------------------------------|
|-------|----------|-------------------|--------------------------------|

| No | Freq.<br>[MHz] | Corr.  | Reading Value |       | Emission Level |       | Limit     |       | Margin |        |
|----|----------------|--------|---------------|-------|----------------|-------|-----------|-------|--------|--------|
|    |                | Factor | [dB (uV)]     |       | [dB (uV)]      |       | [dB (uV)] |       | (dB)   |        |
|    | (dB)           | Q.P.   | AV.           | Q.P.  | AV.            | Q.P.  | AV.       | Q.P.  | AV.    |        |
| 1  | 0.15000        | 10.02  | 40.70         | 24.87 | 50.72          | 34.89 | 66.00     | 56.00 | -15.28 | -21.11 |
| 2  | 0.16953        | 10.02  | 38.33         | 25.63 | 48.35          | 35.65 | 64.98     | 54.98 | -16.63 | -19.33 |
| 3  | 0.20078        | 10.02  | 33.24         | 21.48 | 43.26          | 31.50 | 63.58     | 53.58 | -20.32 | -22.08 |
| 4  | 0.27109        | 10.03  | 26.61         | 14.87 | 36.64          | 24.90 | 61.08     | 51.08 | -24.44 | -26.18 |
| 5  | 0.70469        | 10.06  | 14.31         | 9.64  | 24.37          | 19.70 | 56.00     | 46.00 | -31.63 | -26.30 |
| 6  | 3.26172        | 10.27  | 21.78         | 15.46 | 32.05          | 25.73 | 56.00     | 46.00 | -23.95 | -20.27 |

#### Remarks:

1. Q.P. and AV. are abbreviations of quasi-peak and average individually.
2. The emission levels of other frequencies were very low against the limit.
3. Margin value = Emission level – Limit value
4. Correction factor = Insertion loss + Cable loss
5. Emission Level = Correction Factor + Reading Value

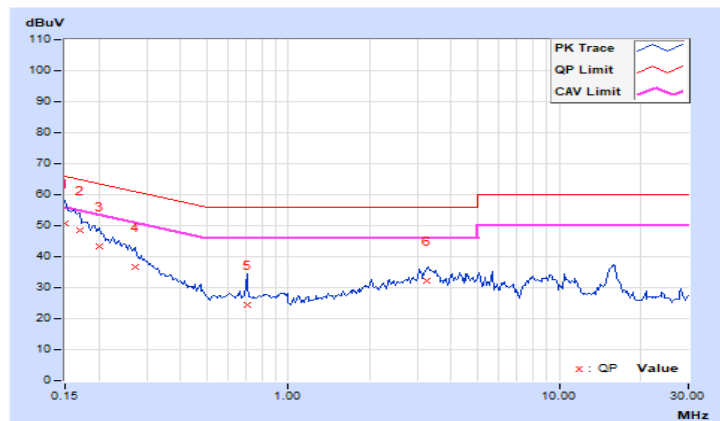

|       |             |                   |                                |
|-------|-------------|-------------------|--------------------------------|
| Phase | Neutral (N) | Detector Function | Quasi-Peak (QP) / Average (AV) |
|-------|-------------|-------------------|--------------------------------|

| No | Freq.<br>[MHz] | Corr.  | Reading Value |       | Emission Level |       | Limit     |       | Margin |        |
|----|----------------|--------|---------------|-------|----------------|-------|-----------|-------|--------|--------|
|    |                | Factor | [dB (uV)]     |       | [dB (uV)]      |       | [dB (uV)] |       | (dB)   |        |
|    |                | (dB)   | Q.P.          | AV.   | Q.P.           | AV.   | Q.P.      | AV.   | Q.P.   | AV.    |
| 1  | 0.15000        | 10.10  | 39.53         | 22.24 | 49.63          | 32.34 | 66.00     | 56.00 | -16.37 | -23.66 |
| 2  | 0.16562        | 10.09  | 37.09         | 23.24 | 47.18          | 33.33 | 65.18     | 55.18 | -18.00 | -21.85 |
| 3  | 0.20078        | 10.08  | 30.83         | 19.53 | 40.91          | 29.61 | 63.58     | 53.58 | -22.67 | -23.97 |
| 4  | 0.23984        | 10.09  | 26.62         | 14.66 | 36.71          | 24.75 | 62.10     | 52.10 | -25.39 | -27.35 |
| 5  | 0.40000        | 10.12  | 24.73         | 19.32 | 34.85          | 29.44 | 57.85     | 47.85 | -23.00 | -18.41 |
| 6  | 3.23438        | 10.29  | 19.52         | 14.62 | 29.81          | 24.91 | 56.00     | 46.00 | -26.19 | -21.09 |

**Remarks:**

1. Q.P. and AV. are abbreviations of quasi-peak and average individually.
2. The emission levels of other frequencies were very low against the limit.
3. Margin value = Emission level – Limit value
4. Correction factor = Insertion loss + Cable loss
5. Emission Level = Correction Factor + Reading Value

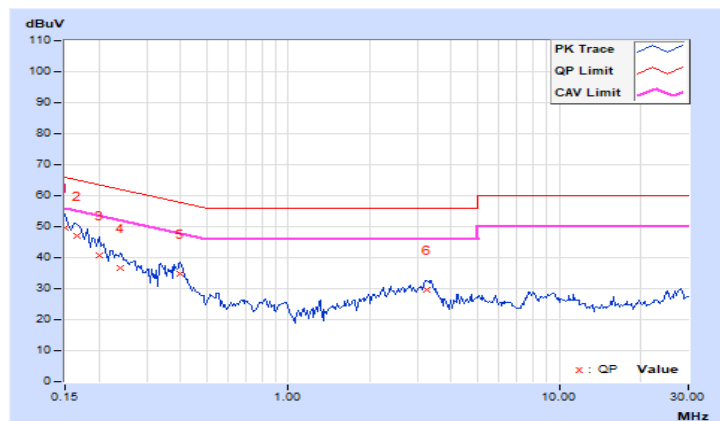

### 4.3 6dB Bandwidth Measurement

#### 4.3.1 Limits of 6dB Bandwidth Measurement

The minimum of 6dB Bandwidth Measurement is 0.5 MHz.

#### 4.3.2 Test Setup

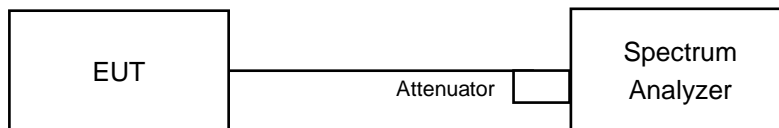

#### 4.3.3 Test Instruments

Refer to section 4.1.2 to get information of above instrument.

#### 4.3.4 Test Procedure

- a. Set resolution bandwidth (RBW) = 100kHz
- b. Set the video bandwidth (VBW)  $\geq 3 \times$  RBW, Detector = Peak.
- c. Trace mode = max hold.
- d. Sweep = auto couple.
- e. Measure the maximum width of the emission that is constrained by the frequencies associated with the two amplitude points (upper and lower) that are attenuated by 6 dB relative to the maximum level measured in the fundamental emission

#### 4.3.5 Deviation from Test Standard

No deviation.

#### 4.3.6 EUT Operating Conditions

The software provided by client to enable the EUT under transmission condition continuously at lowest, middle and highest channel frequencies individually.

#### 4.3.7 Test Result

##### 802.11b

| Channel | Frequency (MHz) | 6dB Bandwidth (MHz) | Minimum Limit (MHz) | Pass / Fail |
|---------|-----------------|---------------------|---------------------|-------------|
| 1       | 2412            | 8.05                | 0.5                 | Pass        |
| 6       | 2437            | 8.09                | 0.5                 | Pass        |
| 11      | 2462            | 8.1                 | 0.5                 | Pass        |

##### 802.11g

| Channel | Frequency (MHz) | 6dB Bandwidth (MHz) | Minimum Limit (MHz) | Pass / Fail |
|---------|-----------------|---------------------|---------------------|-------------|
| 1       | 2412            | 15.14               | 0.5                 | Pass        |
| 6       | 2437            | 15.16               | 0.5                 | Pass        |
| 11      | 2462            | 15.11               | 0.5                 | Pass        |

##### 802.11n (HT20)

| Channel | Frequency (MHz) | 6dB Bandwidth (MHz) | Minimum Limit (MHz) | Pass / Fail |
|---------|-----------------|---------------------|---------------------|-------------|
| 1       | 2412            | 15.37               | 0.5                 | Pass        |
| 6       | 2437            | 14.51               | 0.5                 | Pass        |
| 11      | 2462            | 15.18               | 0.5                 | Pass        |

##### 802.11n (HT40)

| Channel | Frequency (MHz) | 6dB Bandwidth (MHz) | Minimum Limit (MHz) | Pass / Fail |
|---------|-----------------|---------------------|---------------------|-------------|
| 3       | 2422            | 34.04               | 0.5                 | Pass        |
| 6       | 2437            | 34.27               | 0.5                 | Pass        |
| 9       | 2452            | 35.13               | 0.5                 | Pass        |



### Spectrum Plot of Worst Value

#### 802.11b / CH1

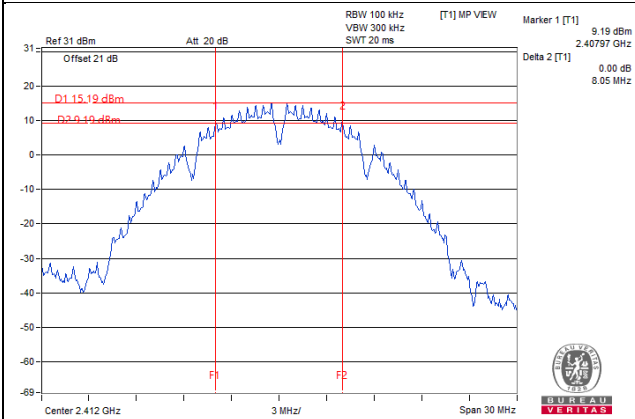

#### 802.11g / CH11

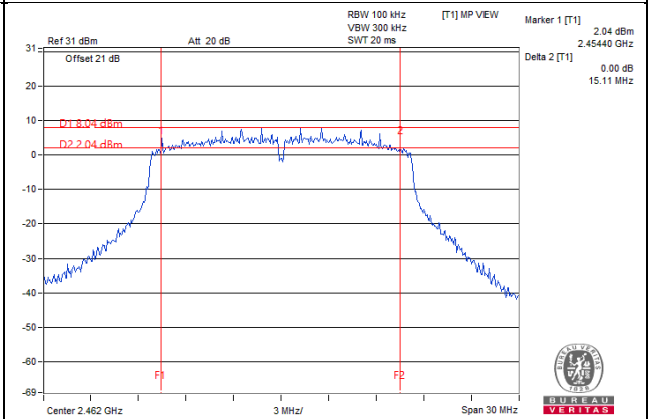

#### 802.11n (HT20) / CH6

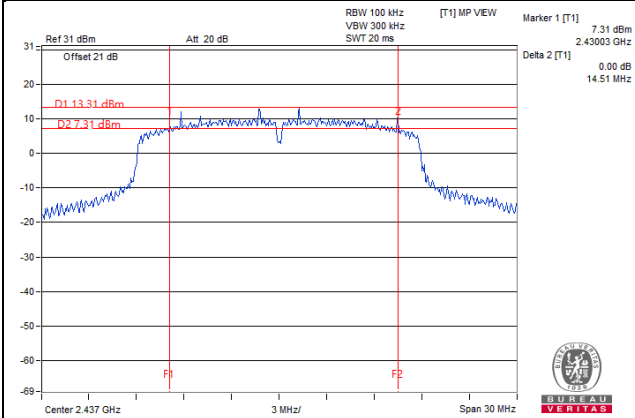

#### 802.11n (HT40) / CH3

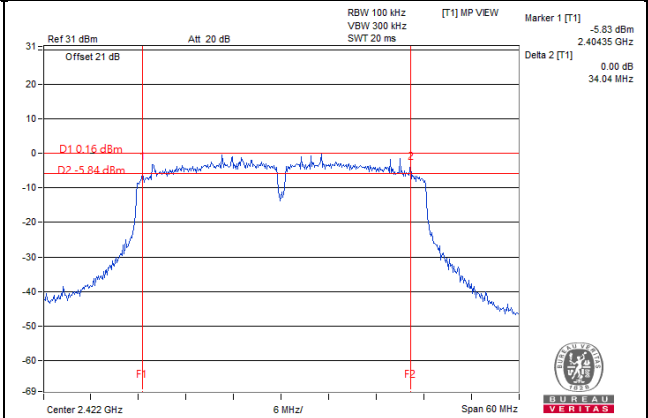

## 4.4 Conducted Output Power Measurement

### 4.4.1 Limits of Conducted Output Power Measurement

For systems using digital modulation in the 2400–2483.5 MHz bands: 1 Watt (30dBm)

### 4.4.2 Test Setup

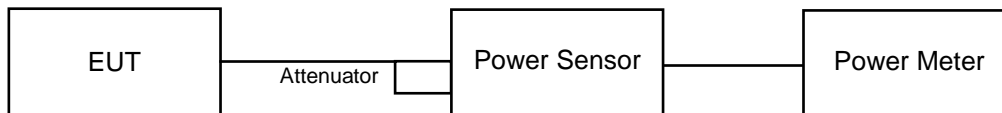

### 4.4.3 Test Instruments

Refer to section 4.1.2 to get information of above instrument.

### 4.4.4 Test Procedures

Average power sensor was used to perform output power measurement, trigger and gating function of wide band power meter is enabled to measure max output power of TX on burst. Duty factor is not added to measured value.

### 4.4.5 Deviation from Test Standard

No deviation.

### 4.4.6 EUT Operating Conditions

Same as Item 4.3.6.

#### 4.4.7 Test Results

##### 802.11b

| Chan. | Chan. Freq. (MHz) | Average Power (mW) | Average Power (dBm) | Limit (dBm) | Pass / Fail |
|-------|-------------------|--------------------|---------------------|-------------|-------------|
| 1     | 2412              | 192.752            | 22.85               | 30.00       | Pass        |
| 6     | 2437              | 243.781            | 23.87               | 30.00       | Pass        |
| 11    | 2462              | 164.437            | 22.16               | 30.00       | Pass        |

##### 802.11g

| Chan. | Chan. Freq. (MHz) | Average Power (mW) | Average Power (dBm) | Limit (dBm) | Pass / Fail |
|-------|-------------------|--------------------|---------------------|-------------|-------------|
| 1     | 2412              | 64.714             | 18.11               | 30.00       | Pass        |
| 6     | 2437              | 208.449            | 23.19               | 30.00       | Pass        |
| 11    | 2462              | 69.343             | 18.41               | 30.00       | Pass        |

##### 802.11n (HT20)

| Chan. | Chan. Freq. (MHz) | Average Power (mW) | Average Power (dBm) | Limit (dBm) | Pass / Fail |
|-------|-------------------|--------------------|---------------------|-------------|-------------|
| 1     | 2412              | 51.88              | 17.15               | 30.00       | Pass        |
| 6     | 2437              | 204.644            | 23.11               | 30.00       | Pass        |
| 11    | 2462              | 65.766             | 18.18               | 30.00       | Pass        |

##### 802.11n (HT40)

| Chan. | Chan. Freq. (MHz) | Average Power (mW) | Average Power (dBm) | Limit (dBm) | Pass / Fail |
|-------|-------------------|--------------------|---------------------|-------------|-------------|
| 3     | 2422              | 23.442             | 13.70               | 30.00       | Pass        |
| 6     | 2437              | 81.47              | 19.11               | 30.00       | Pass        |
| 9     | 2452              | 39.628             | 15.98               | 30.00       | Pass        |

## 4.5 Power Spectral Density Measurement

### 4.5.1 Limits of Power Spectral Density Measurement

The Maximum of Power Spectral Density Measurement is 8dBm in any 3 kHz.

### 4.5.2 Test Setup

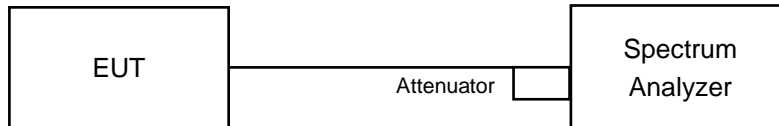

### 4.5.3 Test Instruments

Refer to section 4.1.2 to get information of above instrument.

### 4.5.4 Test Procedure

- a. Set instrument center frequency to DTS channel center frequency.
- b. Set span to at least 1.5 times the OBW.
- c. Set RBW to:  $3 \text{ kHz} \leq \text{RBW} \leq 100 \text{ kHz}$ .
- d. Set VBW  $\geq 3 \times \text{RBW}$ .
- e. Detector = power averaging (RMS) or sample detector (when RMS not available).
- f. Ensure that the number of measurement points in the sweep  $\geq 2 \times \text{span}/\text{RBW}$ .
- g. Sweep time = auto couple.
- h. Employ trace averaging (RMS) mode over a minimum of 100 traces.
- i. Use the peak marker function to determine the maximum amplitude level.

### 4.5.5 Deviation from Test Standard

No deviation.

### 4.5.6 EUT Operating Condition

Same as Item 4.3.6

#### 4.5.7 Test Results

##### 802.11b

| Chan. | Chan. Freq. (MHz) | PSD (dBm/3kHz) | PSD Limit (dBm/3kHz) | Pass / Fail |
|-------|-------------------|----------------|----------------------|-------------|
| 1     | 2412              | -9.64          | 8.00                 | Pass        |
| 6     | 2437              | -8.63          | 8.00                 | Pass        |
| 11    | 2462              | -9.77          | 8.00                 | Pass        |

##### 802.11g

| Chan. | Chan. Freq. (MHz) | PSD (dBm/3kHz) | PSD Limit (dBm/3kHz) | Pass / Fail |
|-------|-------------------|----------------|----------------------|-------------|
| 1     | 2412              | -16.73         | 8.00                 | Pass        |
| 6     | 2437              | -11.32         | 8.00                 | Pass        |
| 11    | 2462              | -16.03         | 8.00                 | Pass        |

##### 802.11n (HT20)

| Chan. | Chan. Freq. (MHz) | PSD (dBm/3kHz) | PSD Limit (dBm/3kHz) | Pass / Fail |
|-------|-------------------|----------------|----------------------|-------------|
| 1     | 2412              | -17.69         | 8.00                 | Pass        |
| 6     | 2437              | -11.65         | 8.00                 | Pass        |
| 11    | 2462              | -16.75         | 8.00                 | Pass        |

##### 802.11n (HT40)

| Chan. | Chan. Freq. (MHz) | PSD (dBm/3kHz) | PSD Limit (dBm/3kHz) | Pass / Fail |
|-------|-------------------|----------------|----------------------|-------------|
| 3     | 2422              | -23.70         | 8.00                 | Pass        |
| 6     | 2437              | -18.29         | 8.00                 | Pass        |
| 9     | 2452              | -21.16         | 8.00                 | Pass        |

Spectrum Plot of Worst Value

802.11b / CH6

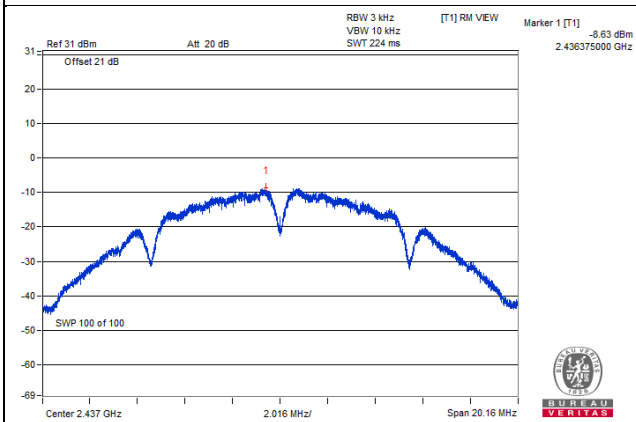

802.11g / CH6

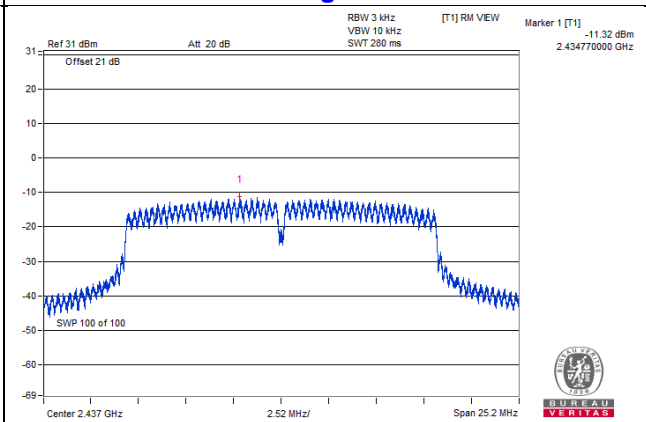

802.11n (HT20) / CH6

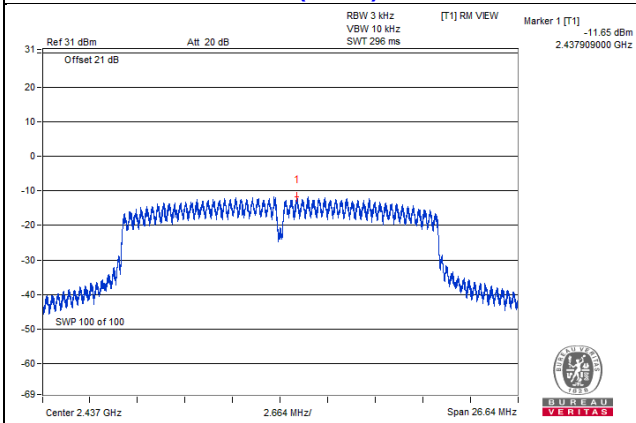

802.11n (HT40) / CH6

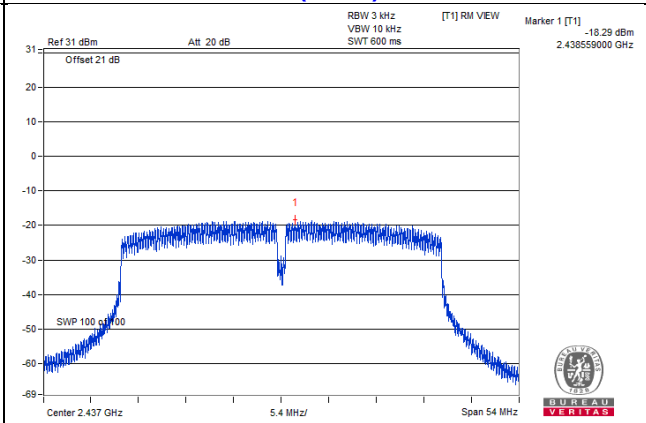

## 4.6 Conducted Out of Band Emission Measurement

### 4.6.1 Limits of Conducted Out of Band Emission Measurement

Below -30dB of the highest emission level of operating band (in 100kHz Resolution Bandwidth).

### 4.6.2 Test Setup

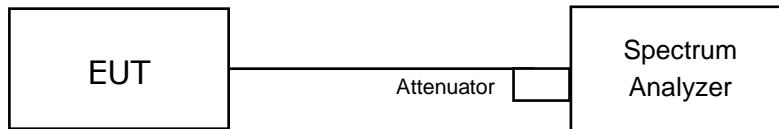

### 4.6.3 Test Instruments

Refer to section 4.1.2 to get information of above instrument.

### 4.6.4 Test Procedure

#### MEASUREMENT PROCEDURE REF

1. Set the RBW = 100 kHz.
2. Set the VBW  $\geq$  300 kHz.
3. Detector = peak.
4. Sweep time = auto couple.
5. Trace mode = max hold.
6. Allow trace to fully stabilize.
7. Use the peak marker function to determine the maximum power level in any 100 kHz band segment within the fundamental EBW.

#### MEASUREMENT PROCEDURE OOBE

1. Set RBW = 100 kHz.
2. Set VBW  $\geq$  300 kHz.
3. Detector = peak.
4. Sweep = auto couple.
5. Trace Mode = max hold.
6. Allow trace to fully stabilize.
7. Use the peak marker function to determine the maximum amplitude level.

### 4.6.5 Deviation from Test Standard

No deviation.

### 4.6.6 EUT Operating Condition

Same as Item 4.3.6

### 4.6.7 Test Results

The spectrum plots are attached on the following pages. D1 line indicates the highest level, and D2 line indicates the 30dB offset below D1. It shows compliance with the requirement.

802.11b

CH 1

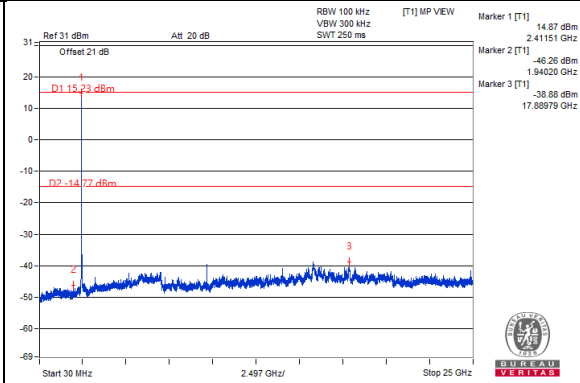
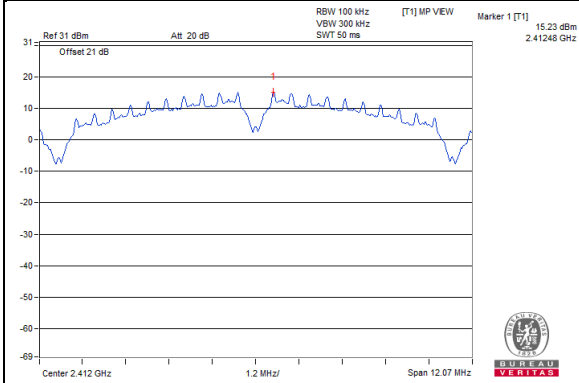

CH 6

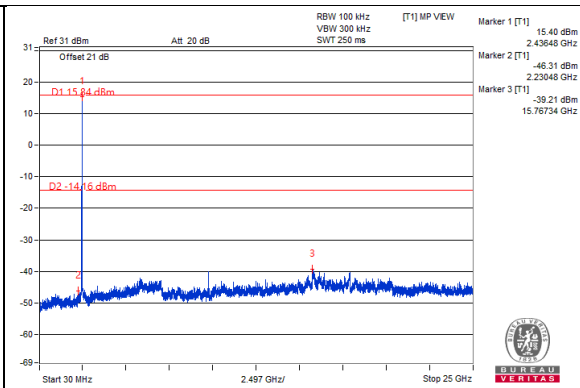
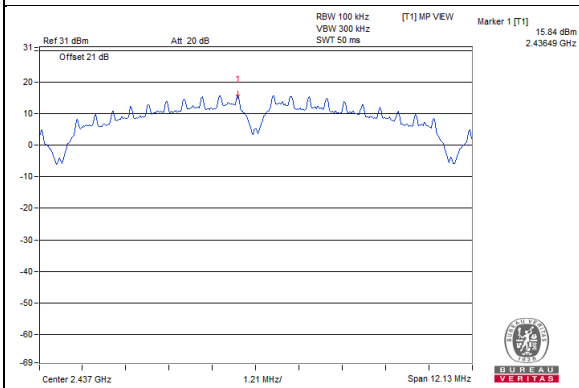

CH 11

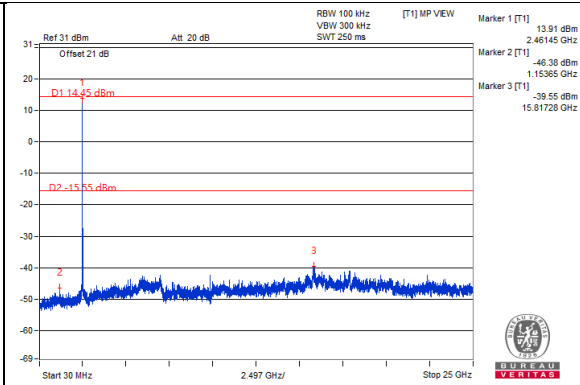
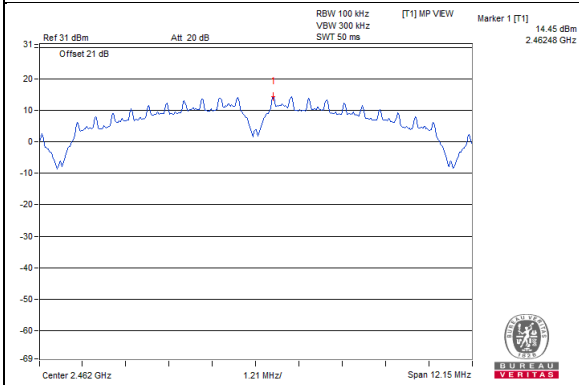

CH 1 Band edge

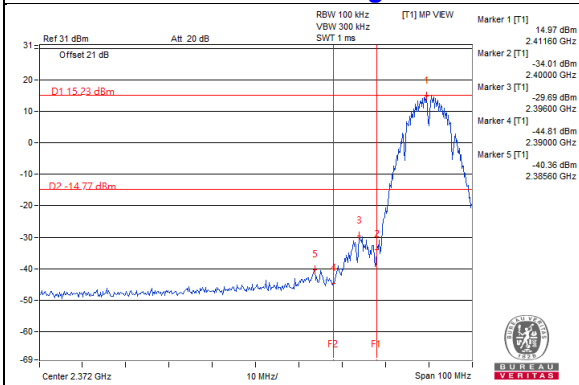

CH 11 Band edge

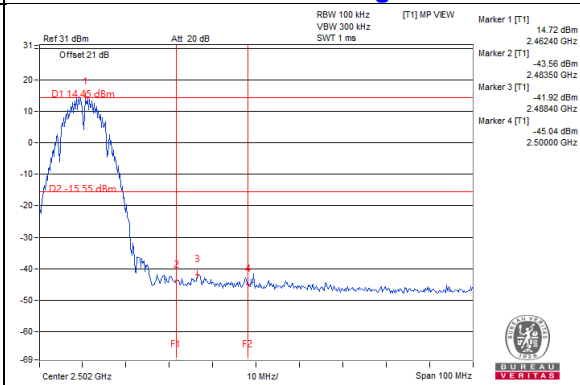



802.11g

CH 1

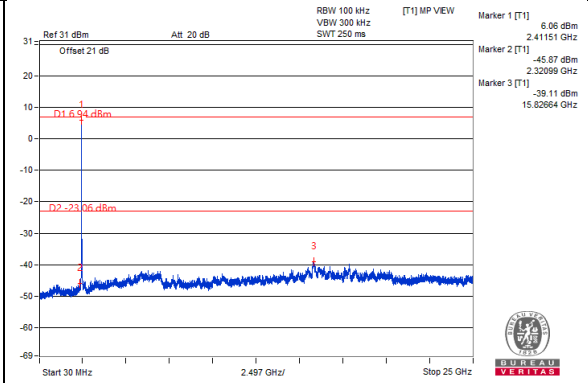
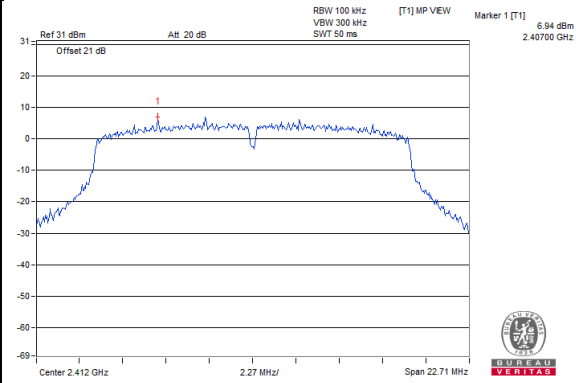

CH 6

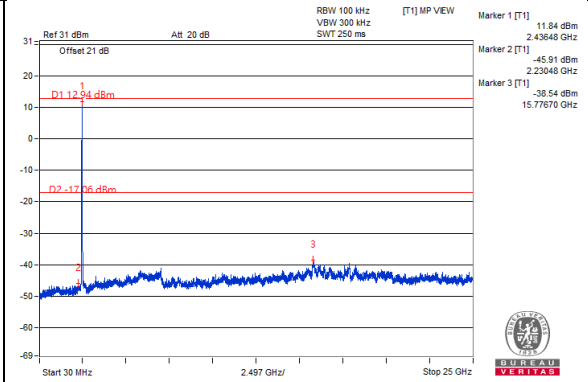
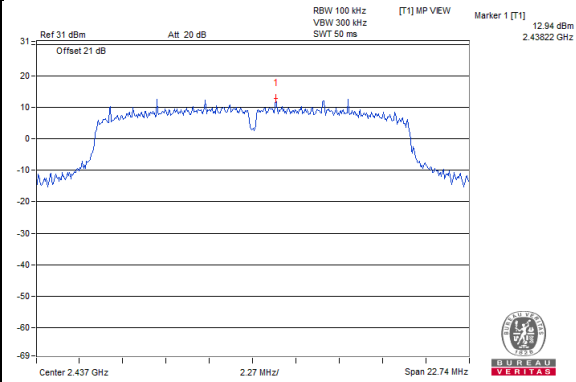

CH 11

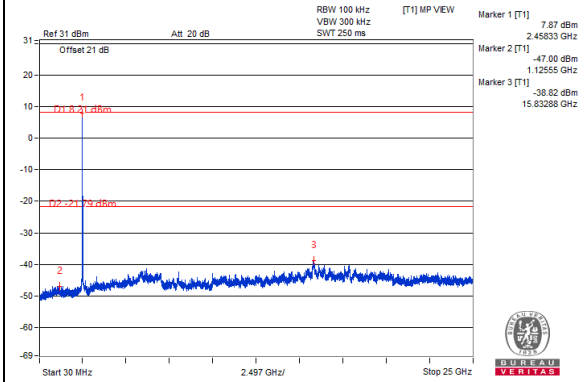
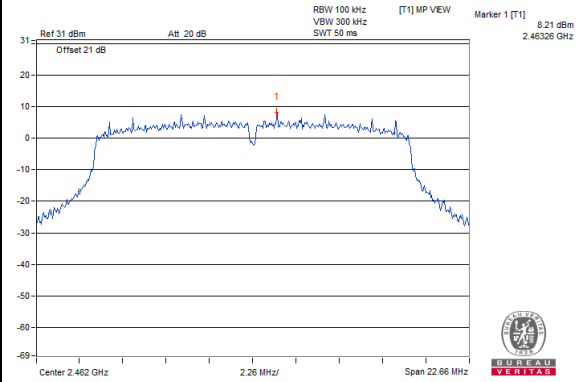

CH 1 Band edge

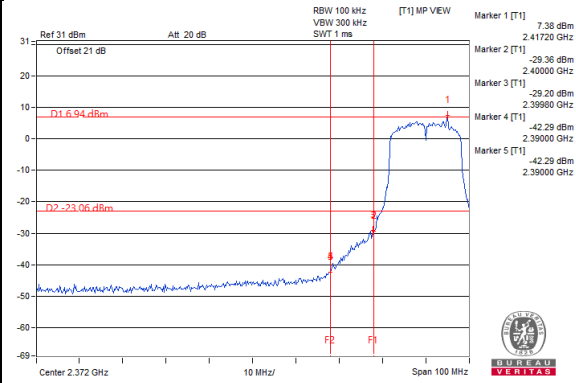

CH 11 Band edge

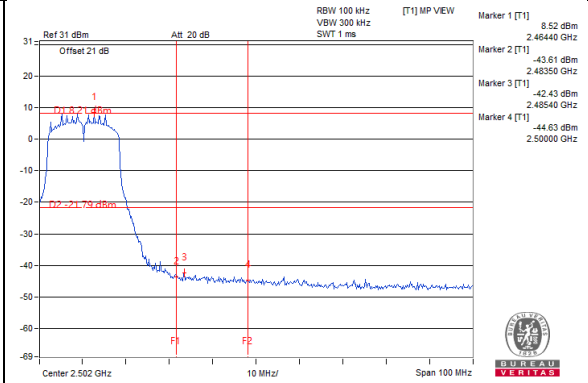

# 802.11n (HT20)

## CH 1

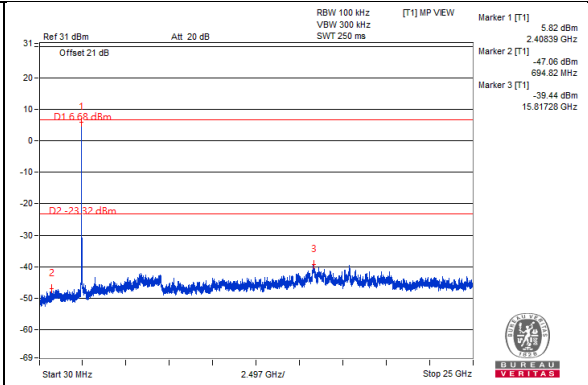
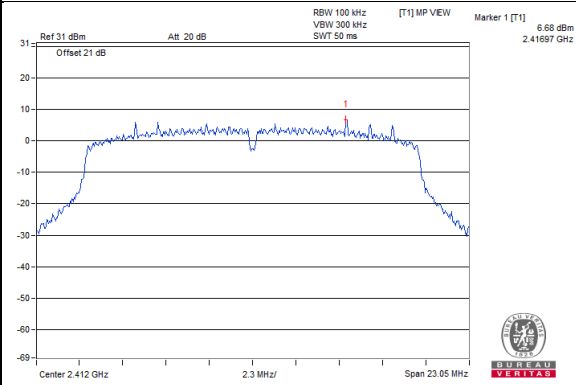

## CH 6

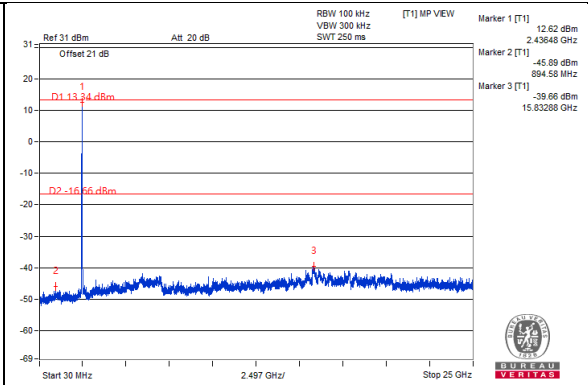
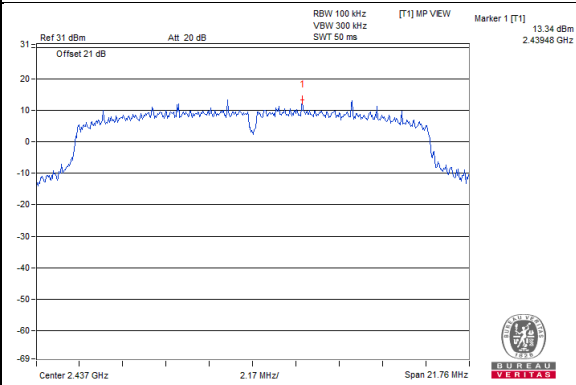

## CH 11

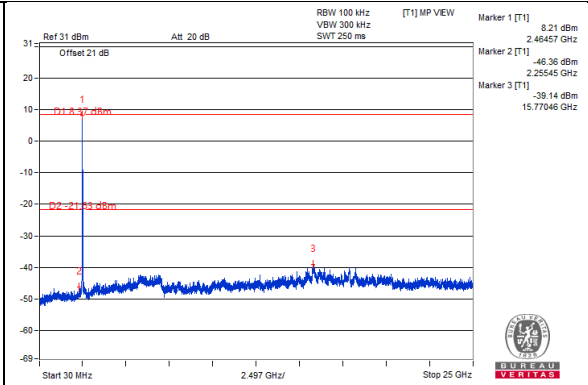
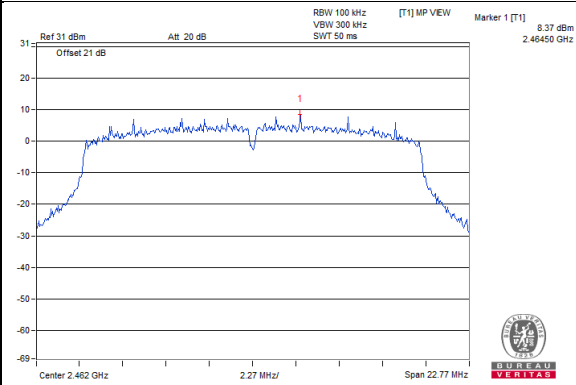

## CH 1 Band edge

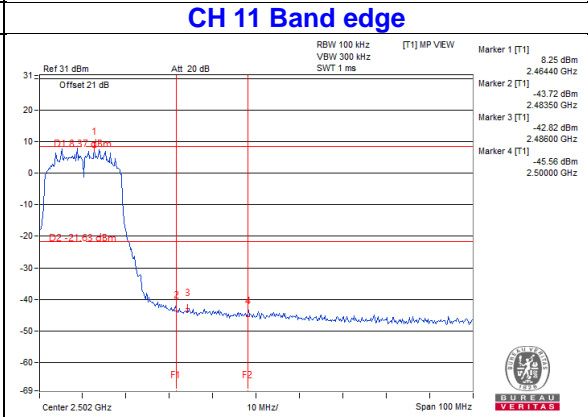
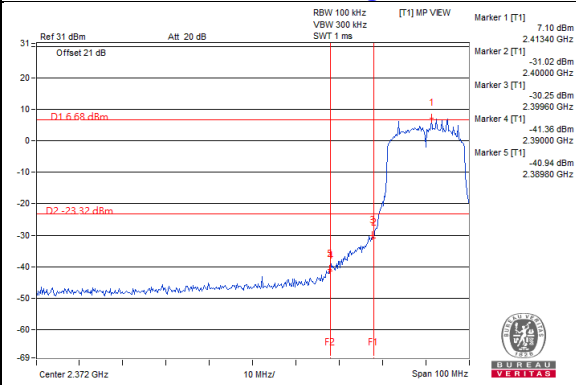

802.11n (HT40)

CH 3

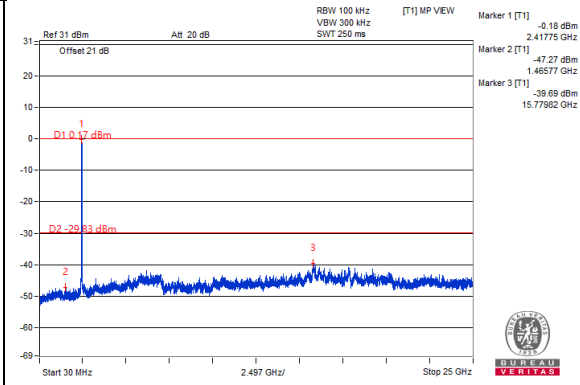
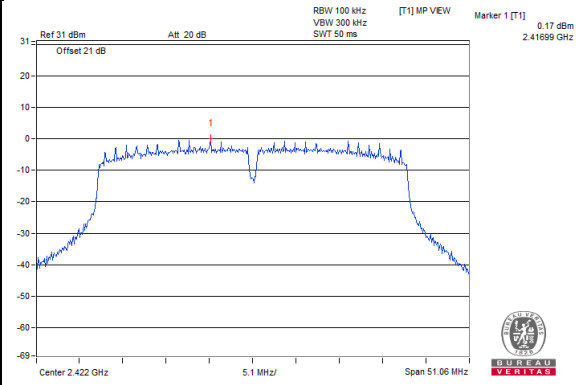

CH 6

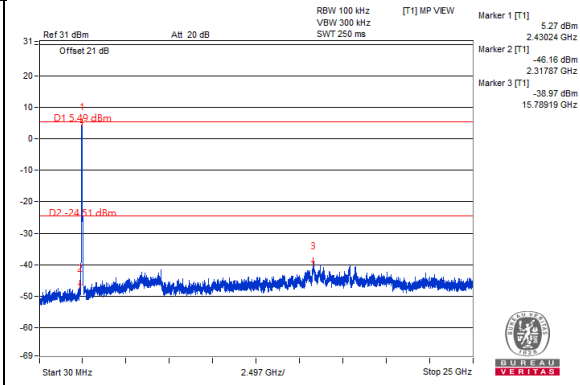
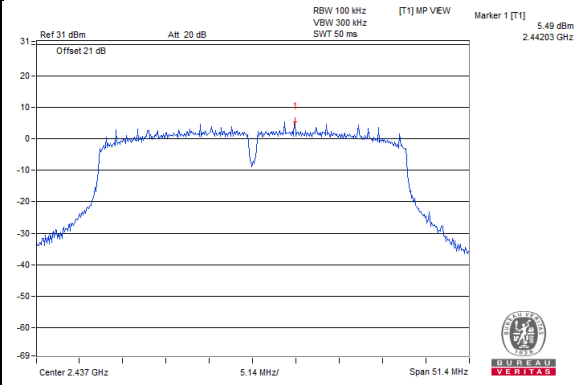

CH 9

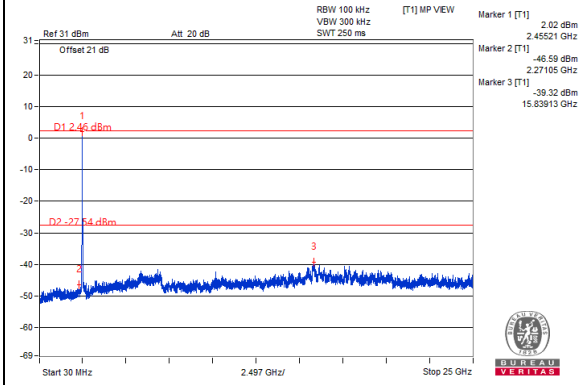
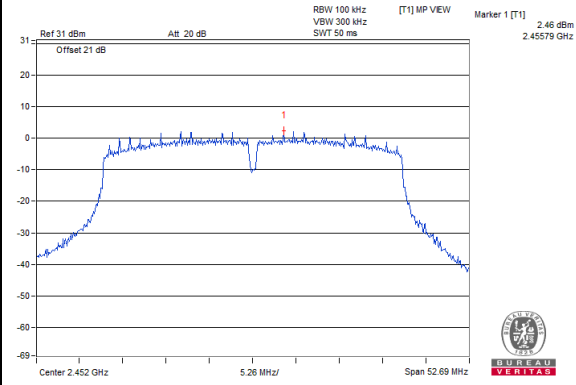

CH 3 Band edge

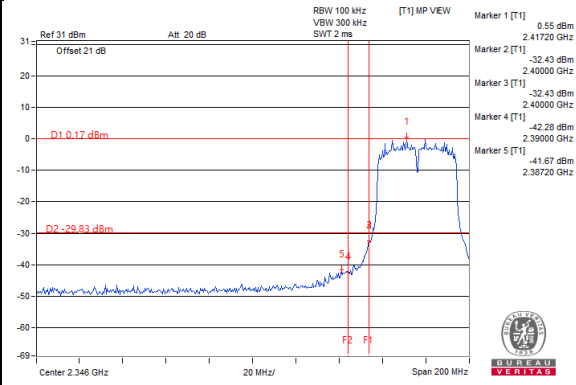

CH 9 Band edge

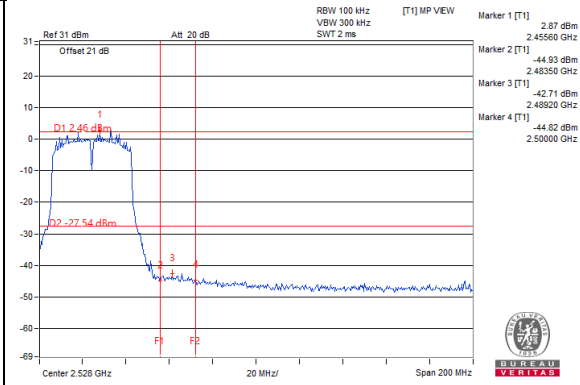

## 5 Pictures of Test Arrangements

Please refer to the attached file (Test Setup Photo).

# Annex A - Band-Edge Measurement

## 802.11b

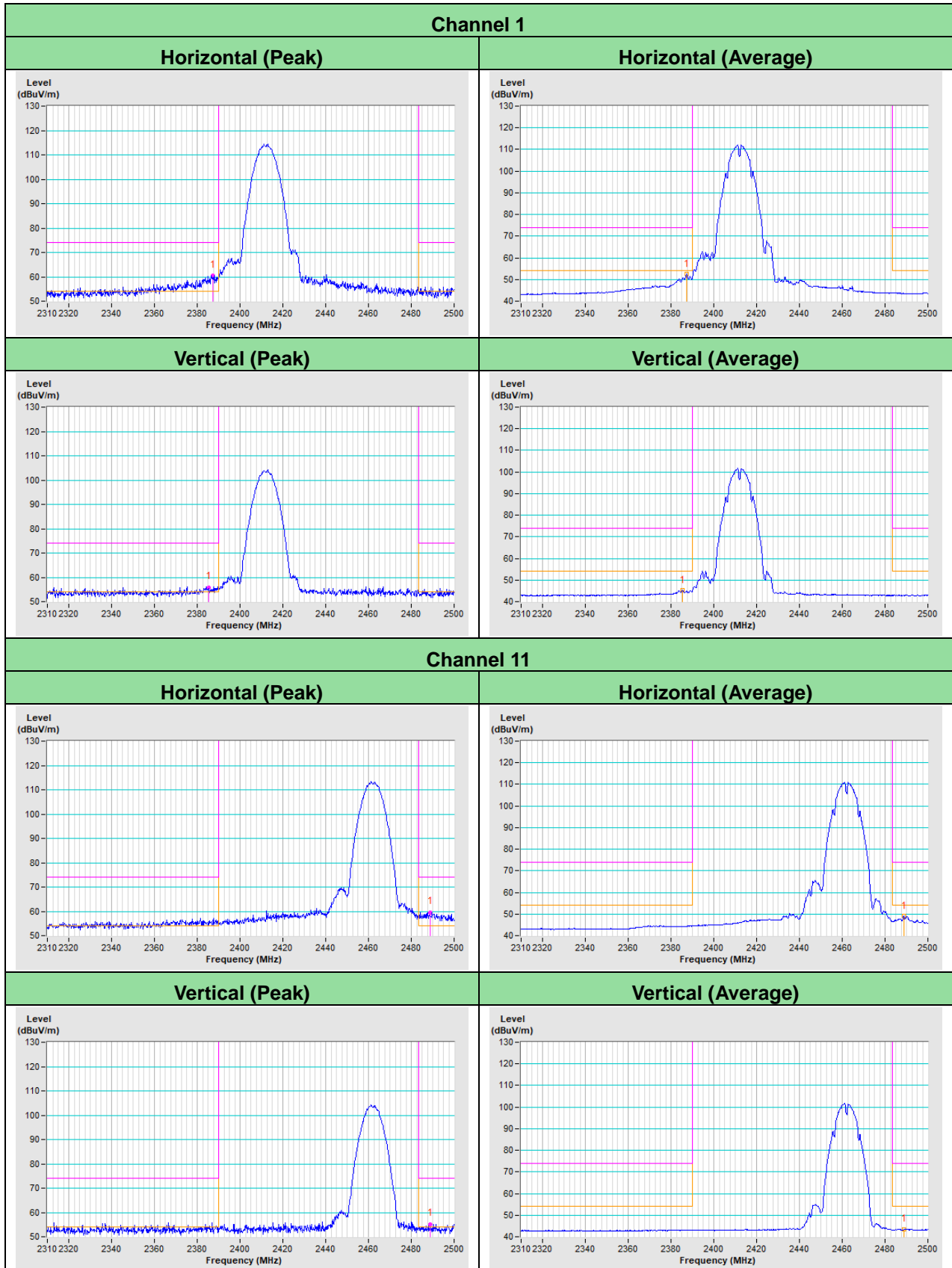

802.11g

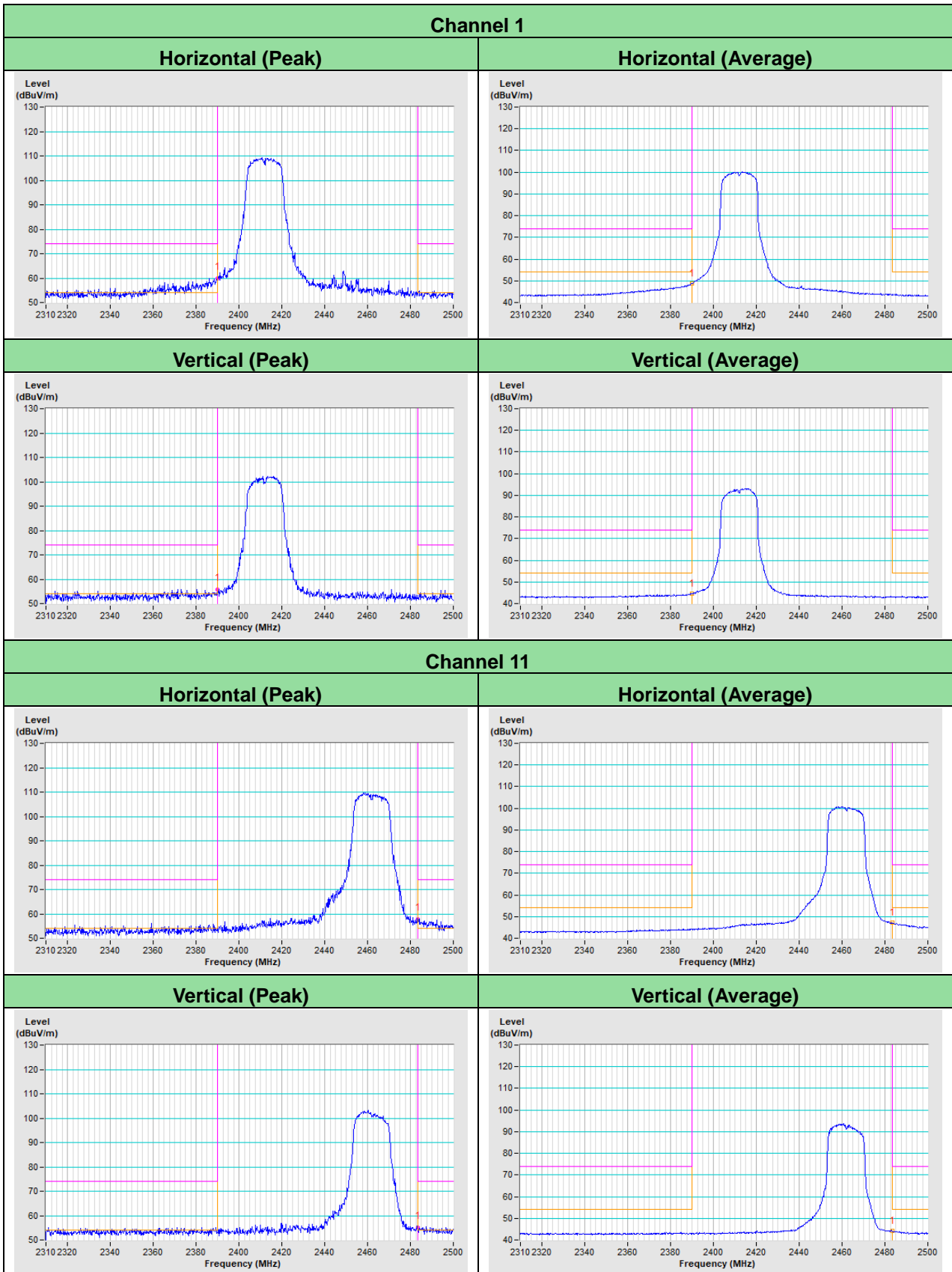

802.11n (HT20)

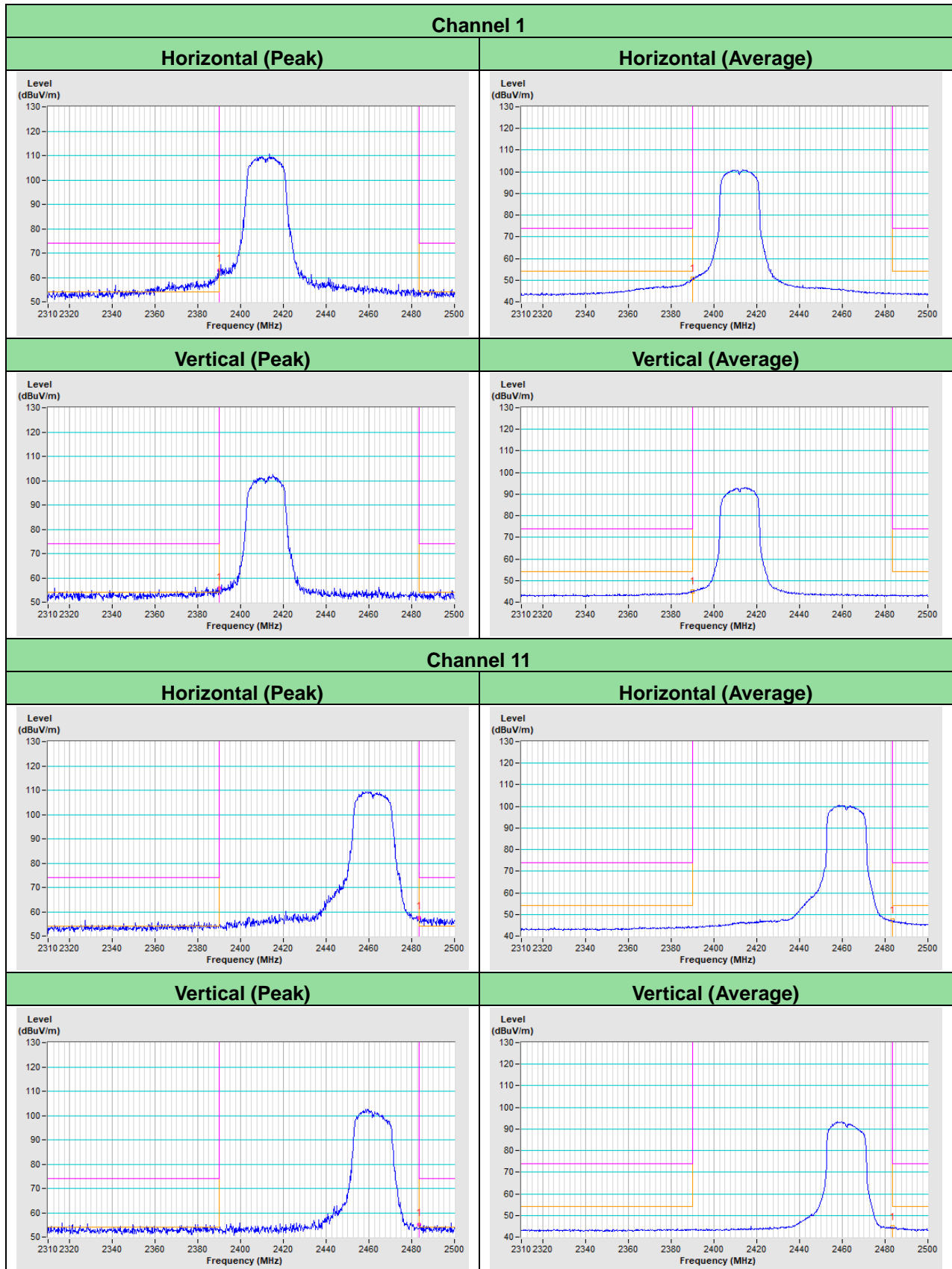

802.11n (HT40)

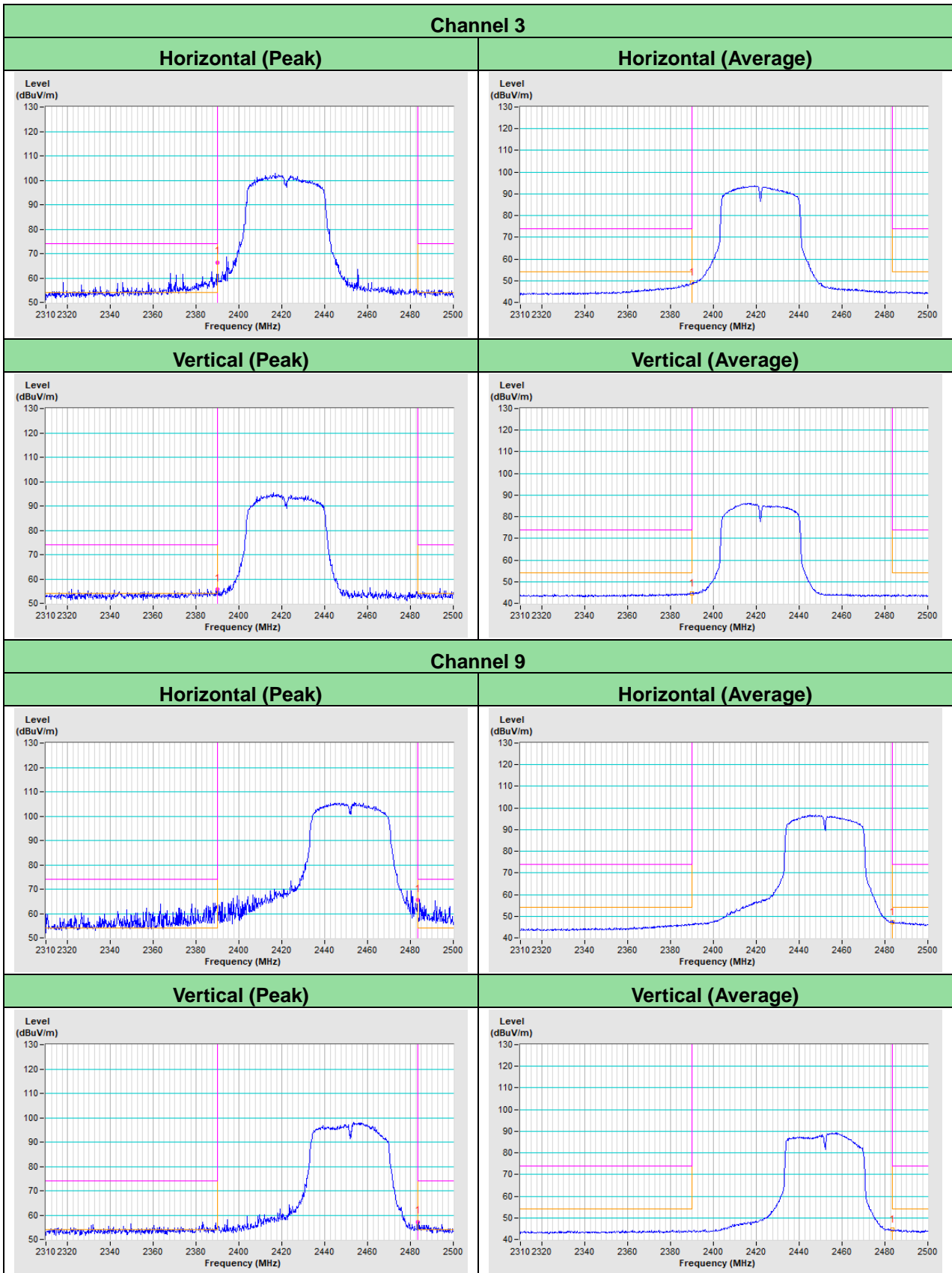



## Appendix – Information of the Testing Laboratories

We, Bureau Veritas Consumer Products Services (H.K.) Ltd., Taoyuan Branch, were founded in 1988 to provide our best service in EMC, Radio, Telecom and Safety consultation. Our laboratories are accredited and approved according to ISO/IEC 17025.

If you have any comments, please feel free to contact us at the following:

**Lin Kou EMC/RF Lab**

Tel: 886-2-26052180

Fax: 886-2-26051924

**Hsin Chu EMC/RF/Telecom Lab**

Tel: 886-3-6668565

Fax: 886-3-6668323

**Hwa Ya EMC/RF/Safety Lab**

Tel: 886-3-3183232

Fax: 886-3-3270892

**Email:** [service.adt@tw.bureauveritas.com](mailto:service.adt@tw.bureauveritas.com)

**Web Site:** [www.bureauveritas-adt.com](http://www.bureauveritas-adt.com)

The address and road map of all our labs can be found in our web site also.

--- END ---