

FCC Test Report

Report No.: RF200522E10-1

FCC ID: PY320100482

Contains FCC ID: XMR201807EG06A

Test Model: LAX20

Received Date: May 22, 2020

Test Date: June 19 to July 27, 2020

Issued Date: Aug. 03, 2020

Applicant: NETGEAR, Inc.

Address: 350 East Plumeria Drive San Jose, CA 95134

Issued By: Bureau Veritas Consumer Products Services (H.K.) Ltd., Taoyuan Branch
Hsin Chu Laboratory

Lab Address: E-2, No.1, Li Hsin 1st Road, Hsinchu Science Park, Hsinchu City 300,
Taiwa.

Test Location: E-2, No.1, Li Hsin 1st Road, Hsinchu Science Park, Hsinchu City 300,
Taiwan.

**FCC Registration /
Designation Number:** 723255 / TW2022



This report is for your exclusive use. Any copying or replication of this report to or for any other person or entity, or use of our name or trademark, is permitted only with our prior written permission. This report sets forth our findings solely with respect to the test samples identified herein. The results set forth in this report are not indicative or representative of the quality or characteristics of the lot from which a test sample was taken or any similar or identical product unless specifically and expressly noted. Our report includes all of the tests requested by you and the results thereof based upon the information that you provided to us. You have 60 days from date of issuance of this report to notify us of any material error or omission caused by our negligence, provided, however, that such notice shall be in writing and shall specifically address the issue you wish to raise. A failure to raise such issue within the prescribed time shall constitute your unqualified acceptance of the completeness of this report, the tests conducted and the correctness of the report contents. Unless specific mention, the uncertainty of measurement has been explicitly taken into account to declare the compliance or non-compliance to the specification.

Table of Contents

Release Control Record	4
1 Certificate of Conformity	5
2 Summary of Test Results	6
2.1 Measurement Uncertainty	6
2.2 Modification Record	6
3 General Information	7
3.1 General Description of EUT	7
3.2 Description of Test Modes	10
3.2.1 Test Mode Applicability and Tested Channel Detail	11
3.3 Duty Cycle of Test Signal	14
3.4 Description of Support Units	15
3.4.1 Configuration of System under Test	16
3.5 General Description of Applied Standard and references	17
4 Test Types and Results	18
4.1 Radiated Emission and Bandedge Measurement	18
4.1.1 Limits of Radiated Emission and Bandedge Measurement	18
4.1.2 Test Instruments	19
4.1.3 Test Procedure	22
4.1.4 Deviation from Test Standard	23
4.1.5 Test Setup	23
4.1.6 EUT Operating Condition	24
4.1.7 Test Results	25
4.2 Conducted Emission Measurement	45
4.2.1 Limits of Conducted Emission Measurement	45
4.2.2 Test Instruments	45
4.2.3 Test Procedure	46
4.2.4 Deviation from Test Standard	46
4.2.5 Test Setup	46
4.2.6 EUT Operating Condition	46
4.2.7 Test Results	47
4.3 Transmit Power Measurement	49
4.3.1 Limits of Transmit Power Measurement	49
4.3.2 Test Setup	49
4.3.3 Test Instruments	49
4.3.4 Test Procedure	49
4.3.5 Deviation from Test Standard	49
4.3.6 EUT Operating Condition	49
4.3.7 Test Results	50
4.4 Occupied Bandwidth Measurement	54
4.4.1 Test Setup	54
4.4.2 Test Instruments	54
4.4.3 Test Procedure	54
4.4.4 Test Results	55
4.5 Peak Power Spectral Density Measurement	59
4.5.1 Limits of Peak Power Spectral Density Measurement	59
4.5.2 Test Setup	59
4.5.3 Test Instruments	59
4.5.4 Test Procedure	59
4.5.5 Deviation from Test Standard	60
4.5.6 EUT Operating Condition	60
4.5.7 Test Results	61
4.6 Frequency Stability Measurement	65
4.6.1 Limits of Frequency Stability Measurement	65

4.6.2	Test Setup.....	65
4.6.3	Test Instruments	65
4.6.4	Test Procedure	65
4.6.5	Deviation from Test Standard	65
4.6.6	EUT Operating Condition	65
4.6.7	Test Results	66
4.7	6dB Bandwidth Measurement	67
4.7.1	Limits of 6dB Bandwidth Measurement.....	67
4.7.2	Test Setup.....	67
4.7.3	Test Instruments	67
4.7.4	Test Procedure	67
4.7.5	Deviation from Test Standard	67
4.7.6	EUT Operating Condition	67
4.7.7	Test Results	68
5	Pictures of Test Arrangements.....	70
	Annex A- Radiated Out of Band Emission (OOBE) Measurement (For U-NII-3 band)	71
	Annex B- Band-edge measurement (For U-NII-1 band)	74
	Appendix – Information of the Testing Laboratories	78

Release Control Record

Issue No.	Description	Date Issued
RF200522E10-1	Original release.	Aug. 03, 2020

1 Certificate of Conformity

Product: Nighthawk AX6 AX1800 LTE WiFi Router

Brand: NETGEAR

Test Model: LAX20

Sample Status: ENGINEERING SAMPLE

Applicant: NETGEAR, Inc.

Test Date: June 19 to July 27, 2020

Standard: 47 CFR FCC Part 15, Subpart E (Section 15.407)
ANSI C63.10: 2013

The above equipment has been tested by **Bureau Veritas Consumer Products Services (H.K.) Ltd., Taoyuan Branch**, and found compliance with the requirement of the above standards. The test record, data evaluation & Equipment Under Test (EUT) configurations represented herein are true and accurate accounts of the measurements of the sample's EMC characteristics under the conditions specified in this report.

Prepared by :



Joyce Kuo / Specialist

Date:

Aug. 03, 2020

Approved by :



Clark Lin / Technical Manager

Date:

Aug. 03, 2020

2 Summary of Test Results

47 CFR FCC Part 15, Subpart E (Section 15.407)			
FCC Clause	Test Item	Result	Remarks
15.407(b)(6)	AC Power Conducted Emissions	Pass	Meet the requirement of limit. Minimum passing margin is -15.65dB at 0.29453MHz.
15.407(b) (1/2/3/4(i/ii)/6)	Radiated Emissions & Band Edge Measurement*	Pass	Meet the requirement of limit. Minimum passing margin is -0.1dB at 5150.00MHz.
15.407(a)(1/2/3)	Max Average Transmit Power	Pass	Meet the requirement of limit.
---	Occupied Bandwidth Measurement	-	Reference only.
15.407(a)(1/2/3)	Peak Power Spectral Density	Pass	Meet the requirement of limit.
15.407(e)	6dB bandwidth	Pass	Meet the requirement of limit. (U-NII-3 Band only)
15.407(g)	Frequency Stability	Pass	Meet the requirement of limit.
15.203	Antenna Requirement	Pass	Antenna connector is R-SMA not a standard connector.

Note:

1. For U-NII-3 band compliance with rule part 15.407(b)(4)(i), the OOB test plots were recorded in Annex A.
2. For U-NII-1 band compliance with rule 15.407(b) of the band-edge items, the test plots were recorded in Annex B. Test Procedures refer to report 4.1.3.
3. Determining compliance based on the results of the compliance measurement, not taking into account measurement instrumentation uncertainty.

2.1 Measurement Uncertainty

Where relevant, the following measurement uncertainty levels have been estimated for tests performed on the EUT as specified in CISPR 16-4-2:

Measurement	Frequency	Expanded Uncertainty (k=2) (\pm)
Conducted Emissions at mains ports	150kHz ~ 30MHz	1.9 dB
Radiated Emissions up to 1 GHz	9kHz ~ 30MHz	3.1 dB
	30MHz ~ 1GHz	5.5 dB
Radiated Emissions above 1 GHz	1GHz ~ 18GHz	5.1 dB
	18GHz ~ 40GHz	5.3 dB

2.2 Modification Record

There were no modifications required for compliance.

3 General Information

3.1 General Description of EUT

Product	NIGHTHAWK AX6 AX1800 LTE WiFi Router
Brand	NETGEAR
Test Model	LAX20
Status of EUT	ENGINEERING SAMPLE
Power Supply Rating	12Vdc from power adapter
Modulation Type	CCK, DQPSK, DBPSK for DSSS 64QAM, 16QAM, QPSK, BPSK for OFDM 256QAM for OFDM in 11ac mode and VHT (20/40) mode in 2.4GHz 1024QAM for OFDMA in 11ax HE mode
Modulation Technology	DSSS, OFDM, OFDMA
Transfer Rate	802.11b: up to 11 Mbps 802.11a/g: up to 54 Mbps 802.11n: up to 300 Mbps 802.11ac: up to 866.7 Mbps 802.11ax: up to 1201.0 Mbps
Operating Frequency	2.4GHz: 2.412GHz ~ 2.462GHz 5GHz: 5.18 ~ 5.24GHz, 5.745 ~ 5.825GHz
Number of Channel	2.4GHz: 802.11b, 802.11g, 802.11n (HT20), VHT20, 80211ax (HE20): 11 802.11n (HT40), VHT40, 80211ax (HE40): 7 5GHz: 802.11a, 802.11n (HT20), 802.11ac (VHT20), 80211ax (HE20): 9 802.11n (HT40), 802.11ac (VHT40), 80211ax (HE40): 4 802.11ac (VHT80), 80211ax (HE80): 2
Output Power	CDD Mode: 2.412 ~ 2.462 GHz: 867.292 mW 5.18 ~ 5.24 GHz: 843.395 mW 5.745 ~ 5.825 GHz: 887.09 mW Beamforming Mode: 2.412 ~ 2.462 GHz: 867.292 mW 5.18 ~ 5.24 GHz: 843.395 mW 5.745 ~ 5.825 GHz: 877.563 mW
Antenna Type	Refer to Note
Antenna Connector	Refer to Note
Accessory Device	Adapter x1
Data Cable Supplied	NA

Note:

- The EUT contains certified WWAN module which FCC ID: XMR201807EG06A.
- There are WLAN and WWAN technology used for the EUT. The EUT has two radios as following table:

Radio 1	Radio 2
WLAN (2.4GHz+5GHz)	WWAN (WCDMA/LTE)

- Simultaneously transmission condition.

Condition	Technology		
1	WWAN	WLAN (2.4GHz)	WLAN (5GHz)

Note: The emission of the simultaneous operation has been evaluated and no non-compliance was found.

4. The EUT must be supplied one power adapter and following different models could be chosen as following table:

No.	Brand	Model No.	P/N	Spec.
1	NETGEAR	ADS-40FPA-12 12030EPCU-L ADS-40FPA-12 12030EPC-L	332-11525-01	Input: 100-120Vac, 1.0A, 50/60Hz Output: 12V, 2.5A DC Output cable: Unshielded, 1.8m
2	NETGEAR	AD2067F10	332-10797-01	Input: 100-120Vac, 1.0A, 50/60Hz Output: 12V, 2.5A DC Output cable: Unshielded, 1.8m

Note: From the above models, the worst emissions test was found in **Adapter 1**. Therefore only the test data of the modes were recorded in this report.

5. The antennas provided to the EUT, please refer to the following table:

Antenna Set 1	Antenna Ste 2
Dual_Ant 5	Dual_Ant 4
Dual_Ant 6	Dual_Ant 3

From the above antenna conditions, the worst case was found in Antenna Set 1. Therefore only the test data of the mode was recorded in this report.

6. The directional antenna gain, please refer to the following table:

Frequency Range (GHz)	Directional Antenna Gain (dBi)	Antenna Type	Antenna Connector
2.4~2.4835	4.55	Dipole	R-SMA
5.15 ~ 5.25	5.24		
5.725 ~ 5.85	6.01		

Note: More detailed information, please refer to antenna specification.

7. The EUT incorporates a MIMO function:

2.4GHz Band		
MODULATION MODE	TX & RX CONFIGURATION	
802.11b	2TX	2RX
802.11g	2TX	2RX
802.11n (HT20)	2TX	2RX
802.11n (HT40)	2TX	2RX
VHT20	2TX	2RX
VHT40	2TX	2RX
802.11ax (HE20)	2TX	2RX
802.11ax (HE40)	2TX	2RX
5GHz Band		
MODULATION MODE	TX & RX CONFIGURATION	
802.11a	2TX	2RX
802.11n (HT20)	2TX	2RX
802.11n (HT40)	2TX	2RX
802.11ac (VHT20)	2TX	2RX
802.11ac (VHT40)	2TX	2RX
802.11ac (VHT80)	2TX	2RX
802.11ax (HE20)	2TX	2RX
802.11ax (HE40)	2TX	2RX
802.11ax (HE80)	2TX	2RX

Note:

1. All of modulation mode support beamforming function except 802.11a/b/g modulation mode.
 2. The EUT support Beamforming and CDD mode, therefore both mode were investigated and the worst case scenario was identified. The worst case data were presented in test report.
 3. The modulation and bandwidth are similar for 802.11n mode for 20MHz (40MHz), 802.11ac mode for 20MHz (40MHz, 80MHz) and 802.11ax mode for 20MHz (40MHz, 80MHz), therefore the manufacturer will control the power for 802.11n/ac mode is the same as the 802.11ax or more lower than it and investigated worst case to representative mode in test report. (Final test mode refer to section 3.2.1)
8. The above EUT information is declared by manufacturer and for more detailed features description, please refers to the manufacturer's specifications or user's manual.
9. The above Antenna information is declared by manufacturer and for more detailed features description, please refer to the manufacturer's specifications, the laboratory shall not be held responsible.

3.2 Description of Test Modes

FOR 5180 ~ 5240MHz

4 channels are provided for 802.11a, 802.11n (HT20), 802.11ac (VHT20), 802.11ax (HE20):

Channel	Frequency	Channel	Frequency
36	5180 MHz	44	5220 MHz
40	5200 MHz	48	5240 MHz

2 channels are provided for 802.11n (HT40), 802.11ac (VHT40), 802.11ax (HE40):

Channel	Frequency	Channel	Frequency
38	5190 MHz	46	5230 MHz

1 channel is provided for 802.11ac (VHT80), 802.11ax (HE80):

Channel	Frequency
42	5210 MHz

FOR 5745 ~ 5825MHz:

5 channels are provided for 802.11a, 802.11n (HT20), 802.11ac (VHT20), 802.11ax (HE20):

Channel	Frequency	Channel	Frequency
149	5745 MHz	161	5805 MHz
153	5765 MHz	165	5825 MHz
157	5785 MHz		

2 channels are provided for 802.11n (HT40), 802.11ac (VHT40), 802.11ax (HE40):

Channel	Frequency	Channel	Frequency
151	5755 MHz	159	5795 MHz

1 channel is provided for 802.11ac (VHT80), 802.11ax (HE80):

Channel	Frequency
155	5775 MHz

3.2.1 Test Mode Applicability and Tested Channel Detail

EUT Configure Mode	Applicable To				Description
	RE≥1G	RE<1G	PLC	APCM	
-	√	√	√	√	-

Where **RE≥1G**: Radiated Emission above 1GHz

RE<1G: Radiated Emission below 1GHz

PLC: Power Line Conducted Emission

APCM: Antenna Port Conducted Measurement

Note: The EUT had been pre-tested on the positioned of laying-flat and wall-mount. The worst case was found when positioned of on laying-flat.

Radiated Emission Test (Above 1GHz):

- Pre-Scan has been conducted to determine the worst-case mode from all possible combinations between available modulations, data rates and antenna ports (if EUT with antenna diversity architecture).
- Following channel(s) was (were) selected for the final test as listed below.

CDD Mode						
Mode	FREQ. Band (MHz)	Available Channel	Tested Channel	Modulation Technology	Modulation Type	Data Rate Parameter
802.11a	5180-5240	36 to 48	36, 40, 48	OFDM	BPSK	6Mb/s
802.11ax (HE20)		36 to 48	36, 40, 48	OFDMA	BPSK	MCS0
802.11ax (HE40)		38 to 46	38, 46	OFDMA	BPSK	MCS0
802.11ax (HE80)		42	42	OFDMA	BPSK	MCS0
11a	5745-5825	149 to 165	149, 157, 165	OFDM	BPSK	6Mb/s
802.11ax (HE20)		149 to 165	149, 157, 165	OFDMA	BPSK	MCS0
802.11ax (HE40)		151 to 159	151, 159	OFDMA	BPSK	MCS0
802.11ax (HE80)		155	155	OFDMA	BPSK	MCS0

Radiated Emission Test (Below 1GHz):

- Pre-Scan has been conducted to determine the worst-case mode from all possible combinations between available modulations, data rates and antenna ports (if EUT with antenna diversity architecture).
- Following channel(s) was (were) selected for the final test as listed below.

CDD Mode						
Mode	FREQ. Band (MHz)	Available Channel	Tested Channel	Modulation Technology	Modulation Type	Data Rate Parameter
802.11a	5180-5240 5745-5825	36 to 48 149 to 165	149	OFDM	BPSK	6Mb/s

Power Line Conducted Emission Test:

- Pre-Scan has been conducted to determine the worst-case mode from all possible combinations between available modulations, data rates and antenna ports (if EUT with antenna diversity architecture).
- Following channel(s) was (were) selected for the final test as listed below.

CDD Mode						
Mode	FREQ. Band (MHz)	Available Channel	Tested Channel	Modulation Technology	Modulation Type	Data Rate Parameter
802.11a	5180-5240 5745-5825	36 to 48 149 to 165	149	OFDM	BPSK	6Mb/s

Antenna Port Conducted Measurement:

- This item includes all test value of each mode, but only includes spectrum plot of worst value of each mode.
- Pre-Scan has been conducted to determine the worst-case mode from all possible combinations between available modulations, data rates and antenna ports (if EUT with antenna diversity architecture).
- Following channel(s) was (were) selected for the final test as listed below.

CDD Mode						
Mode	FREQ. Band (MHz)	Available Channel	Tested Channel	Modulation Technology	Modulation Type	Data Rate Parameter
802.11a	5180-5240	36 to 48	36, 40, 48	OFDM	BPSK	6Mb/s
802.11ac (VHT20) (output power only)		36 to 48	36, 40, 48	OFDM	BPSK	MCS0
802.11ac (VHT40) (output power only)		38 to 46	38, 46	OFDM	BPSK	MCS0
802.11ac (VHT80) (output power only)		42	42	OFDM	BPSK	MCS0
802.11ax (HE20)		36 to 48	36, 40, 48	OFDMA	BPSK	MCS0
802.11ax (HE40)		38 to 46	38, 46	OFDMA	BPSK	MCS0
802.11ax (HE80)		42	42	OFDMA	BPSK	MCS0
802.11a		5745-5825	149 to 165	149, 157, 165	OFDM	BPSK
802.11ac (VHT20) (output power only)	149 to 165		149, 157, 165	OFDM	BPSK	MCS0
802.11ac (VHT40) (output power only)	151 to 159		151, 159	OFDM	BPSK	MCS0
802.11ac (VHT80) (output power only)	155		155	OFDM	BPSK	MCS0
802.11ax (HE20)	149 to 165		149, 157, 165	OFDMA	BPSK	MCS0
802.11ax (HE40)	151 to 159		151, 159	OFDMA	BPSK	MCS0
802.11ax (HE80)	155		155	OFDMA	BPSK	MCS0

Beamforming Mode (output power only)

MODE	AVAILABLE CHANNEL	TESTED CHANNEL	MODULATION TECHNOLOGY	MODULATION TYPE	Data Rate Parameter	
802.11ac (VHT20)	5180-5240	36 to 48	36, 40, 48	OFDM	BPSK	MCS0
802.11ac (VHT40)		38 to 46	38, 46	OFDM	BPSK	MCS0
802.11ac (VHT80)		42	42	OFDM	BPSK	MCS0
802.11ax (HE20)		36 to 48	36, 40, 48	OFDMA	BPSK	MCS0
802.11ax (HE40)		38 to 46	38, 46	OFDMA	BPSK	MCS0
802.11ax (HE80)		42	42	OFDMA	BPSK	MCS0
802.11ac (VHT20)	5745-5825	149 to 165	149, 157, 165	OFDM	BPSK	MCS0
802.11ac (VHT40)		151 to 159	151, 159	OFDM	BPSK	MCS0
802.11ac (VHT80)		155	155	OFDM	BPSK	MCS0
802.11ax (HE20)		149 to 165	149, 157, 165	OFDMA	BPSK	MCS0
802.11ax (HE40)		151 to 159	151, 159	OFDMA	BPSK	MCS0
802.11ax (HE80)		155	155	OFDMA	BPSK	MCS0

Test Condition:

Applicable To	Environmental Conditions	Input Power	Tested By
RE \geq 1G	23deg. C, 68%RH	120Vac, 60Hz	Ryan Du
RE $<$ 1G	24deg. C, 68%RH	120Vac, 60Hz	Ryan Du
PLC	23deg. C, 66%RH	120Vac, 60Hz	Kevin Ko
APCM	25deg. C, 60%RH	120Vac, 60Hz	Jyunchun Lin

3.3 Duty Cycle of Test Signal

If duty cycle of test signal is $\geq 98\%$, duty factor is not required.

802.11a: Duty cycle = $2.964 \text{ ms} / 3.001 \text{ ms} = 0.988$

802.11ax (HE20): Duty cycle = $2.276 \text{ ms} / 2.312 \text{ ms} = 0.984$

802.11ax (HE40): Duty cycle = $2.356 \text{ ms} / 2.395 \text{ ms} = 0.984$

802.11ax (HE80): Duty cycle = $2.438 \text{ ms} / 2.474 \text{ ms} = 0.985$

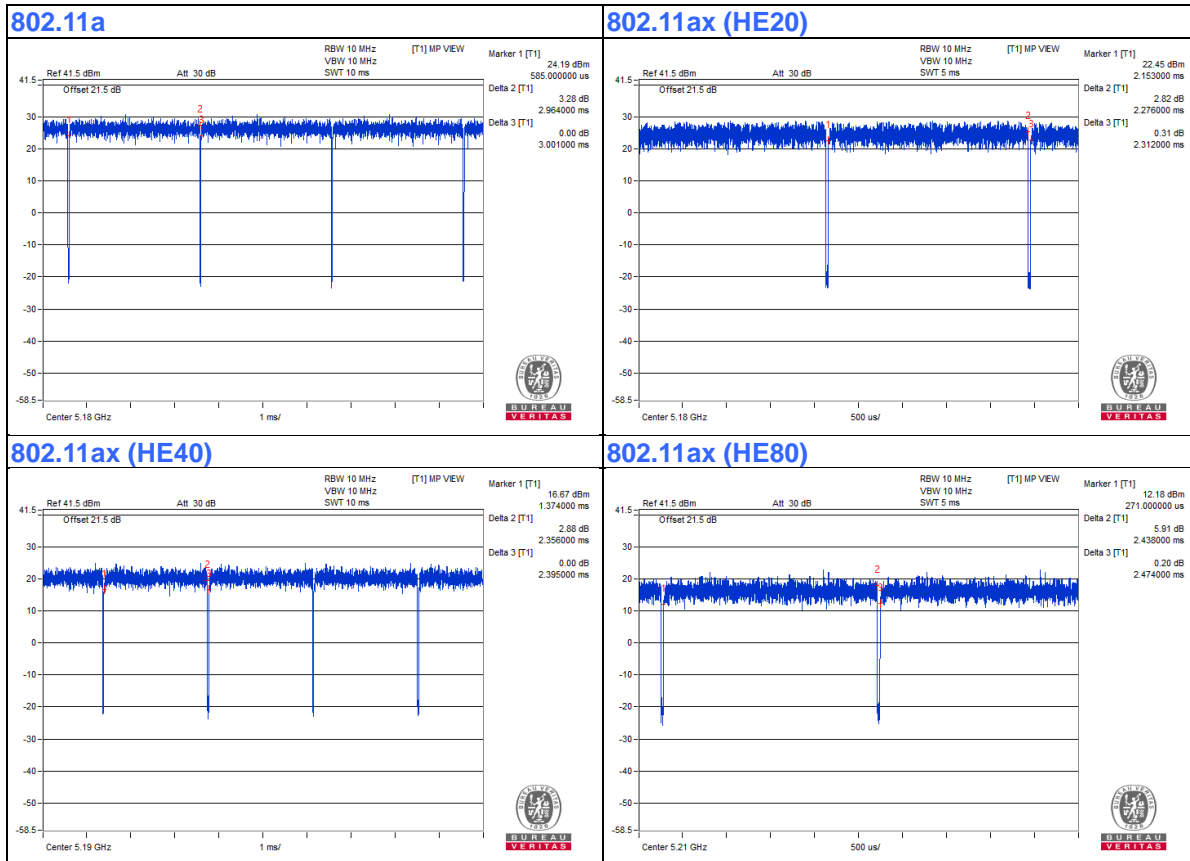

3.4 Description of Support Units

The EUT has been tested as an independent unit together with other necessary accessories or support units. The following support units or accessories were used to form a representative test configuration during the tests.

ID	Product	Brand	Model No.	Serial No.	FCC ID	Remarks
A.	SIM Card	R&S	CRT-Z3	NA	NA	Provided by Lab
B.	iPod	Apple	MC749TA/A	CC4DM9M8DFDM	NA	Provided by Lab
C.	HUB	ZyXEL	GS1100-16	S150H44000046	FCC DoC	Provided by Lab
D.	Laptop	Lenovo	81A4	YD02YN76	PD93165NGU	Provided by Lab

Note:

- All power cords of the above support units are non-shielded (1.8m).

ID	Descriptions	Qty.	Length (m)	Shielding (Yes/No)	Cores (Qty.)	Remarks
1.	DC Cable	1	1.8	No	0	Supplied by client
2.	RJ-45 Cable	1	2	No	0	Supplied by client
3.	RJ-45 Cable	3	10	No	0	Provided by Lab
4.	RJ-45 Cable	1	10	No	0	Provided by Lab
5.	USB Cable	1	0.1	Yes	0	Provided by Lab
6.	RJ-45 Cable	1	10	Yes	0	Provided by Lab

3.4.1 Configuration of System under Test

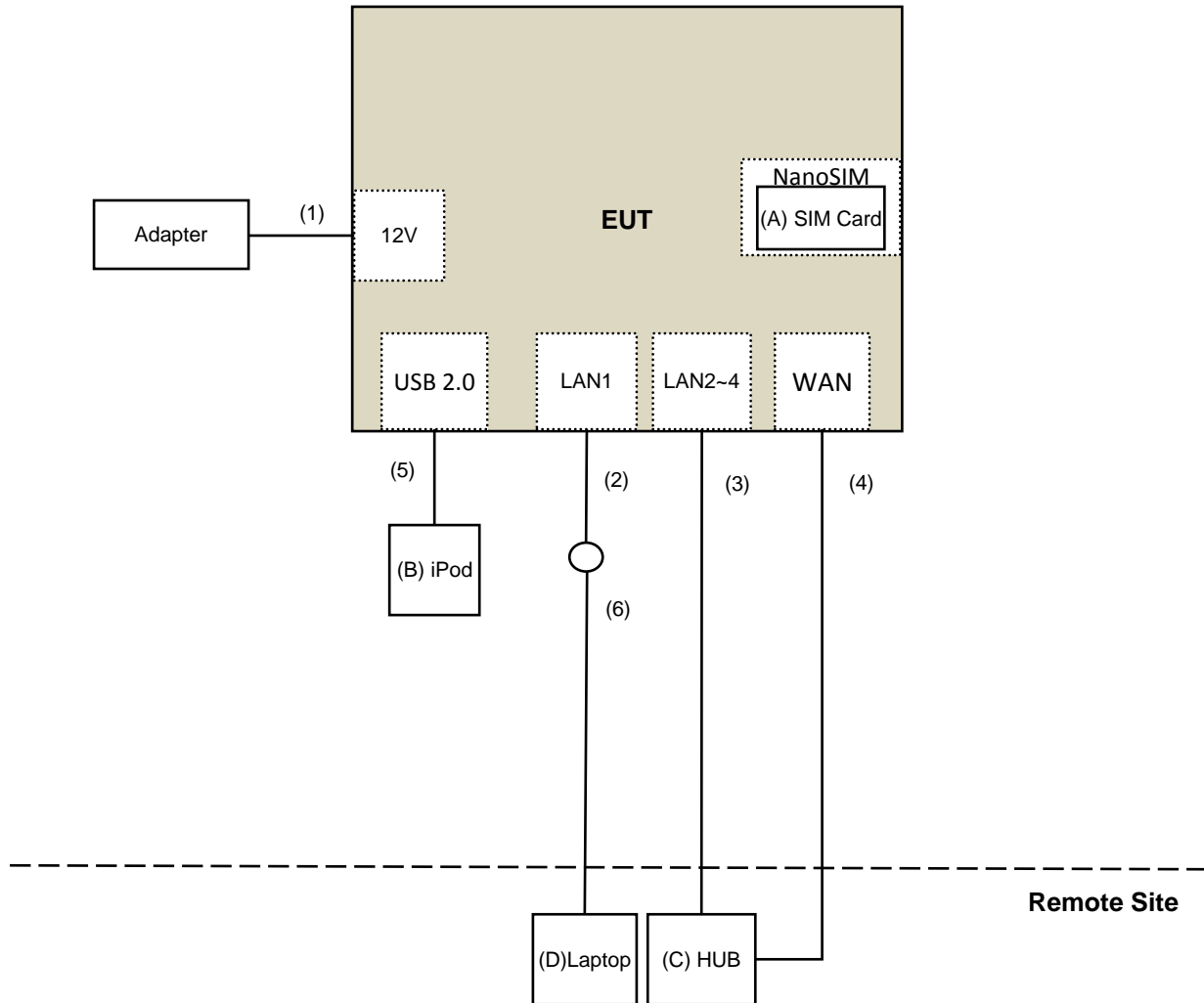

3.5 General Description of Applied Standard and references

The EUT is a RF Product. According to the specifications of the manufacturer, it must comply with the requirements of the following standards and references:

Test Standard:

FCC Part 15, Subpart E (15.407)
ANSI C63.10-2013

All test items have been performed and recorded as per the above standards.

References Test Guidance:

KDB 789033 D02 General UNII Test Procedure New Rules v02r01
KDB 662911 D01 Multiple Transmitter Output v02r01

All test items have been performed as a reference to the above KDB test guidance.

4 Test Types and Results

4.1 Radiated Emission and Bandedge Measurement

4.1.1 Limits of Radiated Emission and Bandedge Measurement

Radiated emissions which fall in the restricted bands must comply with the radiated emission limits specified as below table.

Frequencies (MHz)	Field Strength (microvolts/meter)	Measurement Distance (meters)
0.009 ~ 0.490	2400/F(kHz)	300
0.490 ~ 1.705	24000/F(kHz)	30
1.705 ~ 30.0	30	30
30 ~ 88	100	3
88 ~ 216	150	3
216 ~ 960	200	3
Above 960	500	3

NOTE:

1. The lower limit shall apply at the transition frequencies.
2. Emission level (dBuV/m) = 20 log Emission level (uV/m).
3. For frequencies above 1000MHz, the field strength limits are based on average detector, however, the peak field strength of any emission shall not exceed the maximum permitted average limits, specified above by more than 20dB under any condition of modulation.

Limits of unwanted emission out of the restricted bands

Applicable To		Limit	
789033 D02 General UNII Test Procedure New Rules v02r01		Field Strength at 3m	
		PK:74 (dBuV/m)	AV:54 (dBuV/m)
Frequency Band	Applicable To	EIRP Limit	Equivalent Field Strength at 3m
5150~5250 MHz	15.407(b)(1)	PK:-27 (dBm/MHz)	PK:68.2(dBuV/m)
5250~5350 MHz	15.407(b)(2)		
5470~5725 MHz	15.407(b)(3)		
5725~5850 MHz	15.407(b)(4)(i)	PK:-27 (dBm/MHz) ^{*1} PK:10 (dBm/MHz) ^{*2} PK:15.6 (dBm/MHz) ^{*3} PK:27 (dBm/MHz) ^{*4}	PK: 68.2(dBuV/m) ^{*1} PK:105.2 (dBuV/m) ^{*2} PK: 110.8(dBuV/m) ^{*3} PK:122.2 (dBuV/m) ^{*4}
*1 beyond 75 MHz or more above of the band edge.		*2 below the band edge increasing linearly to 10 dBm/MHz at 25 MHz above.	
*3 below the band edge increasing linearly to a level of 15.6 dBm/MHz at 5 MHz above.		*4 from 5 MHz above or below the band edge increasing linearly to a level of 27 dBm/MHz at the band edge.	

Note:

The following formula is used to convert the equipment isotropic radiated power (eirp) to field strength:

$$E = \frac{1000000\sqrt{30P}}{3} \mu\text{V/m, where P is the eirp (Watts).}$$

4.1.2 Test Instruments

For Radiated emission (Below 1GHz) & Bandedge test

DESCRIPTION & MANUFACTURER	MODEL NO.	SERIAL NO.	CALIBRATED DATE	CALIBRATED UNTIL
Test Receiver Agilent	N9038A	MY51210202	Dec. 13, 2019	Dec. 12, 2020
Pre-Amplifier EMCI	EMC001340	980142	May 25, 2020	May 24, 2021
Loop Antenna Electro-Metrics	EM-6879	264	Feb. 18, 2020	Feb. 17, 2021
RF Cable	NA	LOOPCAB-001	Jan. 08, 2020	Jan. 07, 2021
RF Cable	NA	LOOPCAB-002	Jan. 08, 2020	Jan. 07, 2021
Pre-Amplifier Mini-Circuits	ZFL-1000VH2B	AMP-ZFL-01	Oct. 23, 2019	Oct. 22, 2020
Trilog Broadband Antenna SCHWARZBECK	VULB 9168	9168-406	Nov. 11, 2019	Nov. 10, 2020
RF Cable	8D	966-4-1	Mar. 18, 2020	Mar. 17, 2021
RF Cable	8D	966-4-2	Mar. 18, 2020	Mar. 17, 2021
RF Cable	8D	966-4-3	Mar. 18, 2020	Mar. 17, 2021
Fixed attenuator Mini-Circuits	UNAT-5+	PAD-3m-4-01	Sep. 26, 2019	Sep. 25, 2020
Horn_Antenna SCHWARZBECK	BBHA 9120D	9120D-783	Nov. 24, 2019	Nov. 23, 2020
Pre-Amplifier EMCI	EMC12630SE	980385	Aug. 15, 2019	Aug. 14, 2020
RF Cable	EMC104-SM-SM-1200	160923	Jan. 15, 2020	Jan. 14, 2021
RF Cable	EMC104-SM-SM-2000	180502	Apr. 29, 2020	Apr. 28, 2021
RF Cable	EMC104-SM-SM-6000	180418	Apr. 29, 2020	Apr. 28, 2021
Pre-Amplifier EMCI	EMC184045SE	980387	Jan. 15, 2020	Jan. 14, 2021
Horn_Antenna SCHWARZBECK	BBHA 9170	BBHA9170519	Nov. 24, 2019	Nov. 23, 2020
RF Cable	EMC102-KM-KM-1200	160924	Jan. 15, 2020	Jan. 14, 2021
RF Cable	EMC-KM-KM-4000	200214	Mar. 11, 2020	Mar. 10, 2021
Software	ADT_Radiated_V8.7.08	NA	NA	NA
Boresight Antenna Tower & Turn Table Max-Full	MF-7802BS	MF780208530	NA	NA

Note:

1. The calibration interval of the above test instruments is 12 months and the calibrations are traceable to NML/ROC and NIST/USA.
2. The test was performed in 966 Chamber No. 4.
3. Tested Date: June 19 to July 01, 2020

For Radiated emission (Above 1GHz) test

DESCRIPTION & MANUFACTURER	MODEL NO.	SERIAL NO.	CALIBRATED DATE	CALIBRATED UNTIL
Test Receiver Agilent	N9038A	MY51210202	Dec. 13, 2019	Dec. 12, 2020
Horn_Antenna SCHWARZBECK	BBHA 9120D	9120D-783	Nov. 24, 2019	Nov. 23, 2020
Pre-Amplifier EMCI	EMC12630SE	980385	Aug. 15, 2019	Aug. 14, 2020
RF Cable	EMC104-SM-SM-1200	160923	Jan. 15, 2020	Jan. 14, 2021
RF Cable	EMC104-SM-SM-2000	180502	Apr. 29, 2020	Apr. 28, 2021
RF Cable	EMC104-SM-SM-6000	180418	Apr. 29, 2020	Apr. 28, 2021
Pre-Amplifier EMCI	EMC184045SE	980387	Jan. 15, 2020	Jan. 14, 2021
Horn_Antenna SCHWARZBECK	BBHA 9170	BBHA9170519	Nov. 24, 2019	Nov. 23, 2020
RF Cable	EMC102-KM-KM-1200	160924	Jan. 15, 2020	Jan. 14, 2021
RF Cable	EMC-KM-KM-4000	200214	Mar. 11, 2020	Mar. 10, 2021
Software	ADT_Radiated_V8.7.08	NA	NA	NA
Boresight Antenna Tower & Turn Table Max-Full	MF-7802BS	MF780208530	NA	NA

Note:

1. The calibration interval of the above test instruments is 12 months and the calibrations are traceable to NML/ROC and NIST/USA.
2. The test was performed in 966 Chamber No. 4.
3. Tested Date: July 25, 2020

For other test:

DESCRIPTION & MANUFACTURER	MODEL NO.	SERIAL NO.	CALIBRATED DATE	CALIBRATED UNTIL
Spectrum Analyzer R&S	FSV40	100964	May 29, 2020	May 28, 2021
Power meter Anritsu	ML2495A	1529002	July 22, 2020	July 21, 2021
Power sensor Anritsu	MA2411B	1339443	July 22, 2020	July 21, 2021
Fixed Attenuator Mini-Circuits	MDCS18N-10	MDCS18N-10-01	Apr. 14, 2020	Apr. 13, 2021
AC Power Source Extech Electronics	6205	1440452	NA	NA
DC Power Supply Topward	6603D	795558	NA	NA
Temperature & Humidity Chamber Giant Force	GTH-150-40-SP-AR	MAA0812-008	Jan. 16, 2020	Jan. 15, 2021
True RMS Clamp Meter FLUKE	325	31130711WS	June 06, 2020	June 05, 2021
Voltage Meter FLUKE	179	89610322	Sep. 25, 2019	Sep. 24, 2020
Software	ADT_RF Test Software V6.6.5.4	NA	NA	NA

- NOTE:**
1. The test was performed in Oven room 2.
 2. The calibration interval of the above test instruments is 12 months and the calibrations are traceable to NML/ROC and NIST/USA.
 3. Tested Date: July 27, 2020

4.1.3 Test Procedure

For Radiated emission below 30MHz

- a. The EUT was placed on the top of a rotating table 0.8 meters above the ground at a 3 meter chamber room. The table was rotated 360 degrees to determine the position of the highest radiation.
- b. The EUT was set 3 meters away from the interference-receiving antenna, which was mounted on the top of a variable-height antenna tower.
- c. Parallel, perpendicular, and ground-parallel orientations of the antenna are set to make the measurement.
- d. For each suspected emission, the EUT was arranged to its worst case and the rotatable table was turned from 0 degrees to 360 degrees to find the maximum reading.
- e. The test-receiver system was set to Quasi-Peak Detect Function and Specified Bandwidth with Maximum Hold Mode.

Note:

1. The resolution bandwidth and video bandwidth of test receiver/spectrum analyzer is 9kHz at frequency below 30MHz.

For Radiated emission above 30MHz

- a. The EUT was placed on the top of a rotating table 0.8 meters (for 30MHz ~ 1GHz) / 1.5 meters (for above 1GHz) above the ground at 3 meter chamber room for test. The table was rotated 360 degrees to determine the position of the highest radiation.
- b. The EUT was set 3 meters away from the interference-receiving antenna, which was mounted on the top of a variable-height antenna tower.
- c. The height of antenna is varied from one meter to four meters above the ground to determine the maximum value of the field strength. Both horizontal and vertical polarizations of the antenna are set to make the measurement.
- d. For each suspected emission, the EUT was arranged to its worst case and then the antenna was tuned to heights from 1 meter to 4 meters and the rotatable table was turned from 0 degrees to 360 degrees to find the maximum reading.
- e. The test-receiver system was set to quasi-peak detect function and specified bandwidth with maximum hold mode when the test frequency is below 1 GHz.
- f. The test-receiver system was set to peak and average detects function and specified bandwidth with maximum hold mode when the test frequency is above 1 GHz. If the peak reading value also meets average limit, measurement with the average detector is unnecessary.

Note:

1. The resolution bandwidth and video bandwidth of test receiver/spectrum analyzer is 120kHz for Quasi-peak detection (QP) at frequency below 1GHz.
2. The resolution bandwidth of test receiver/spectrum analyzer is 1 MHz and the video bandwidth is 3 MHz for Peak detection (PK) at frequency above 1GHz.
3. The resolution bandwidth of test receiver/spectrum analyzer is 1MHz and the video bandwidth is $\geq 1/T$ (Duty cycle < 98%) or 10Hz (Duty cycle $\geq 98\%$) for Average detection (AV) at frequency above 1GHz.
4. All modes of operation were investigated and the worst-case emissions are reported.

4.1.4 Deviation from Test Standard

No deviation.

4.1.5 Test Setup

For Radiated emission below 30MHz

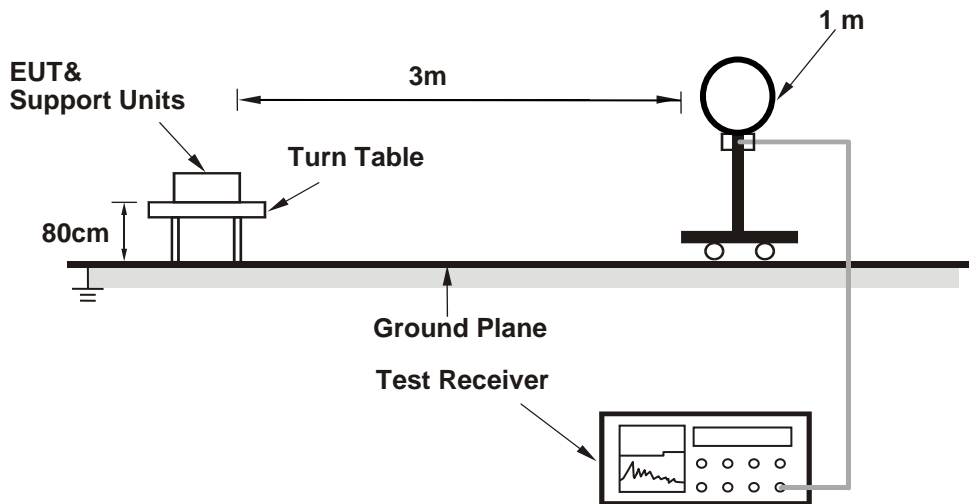

For Radiated emission 30MHz to 1GHz

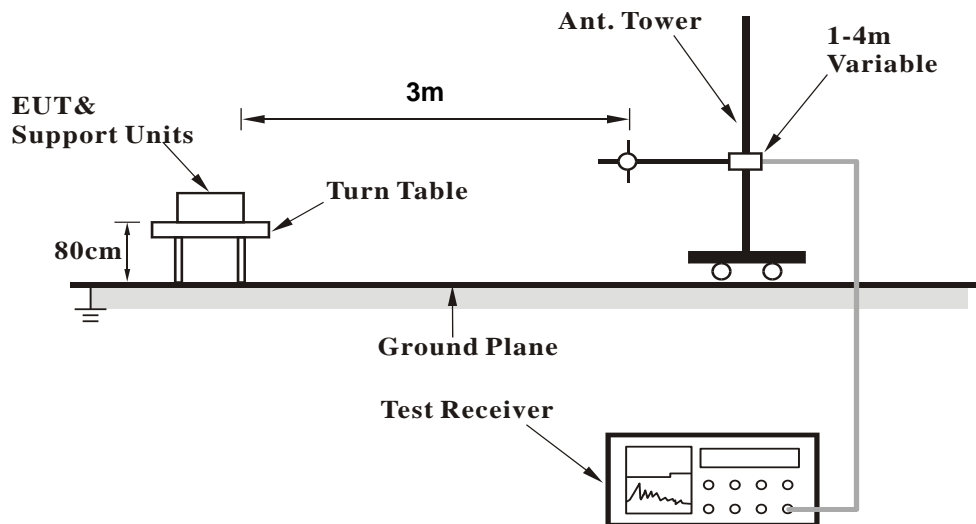

For Radiated emission above 1GHz

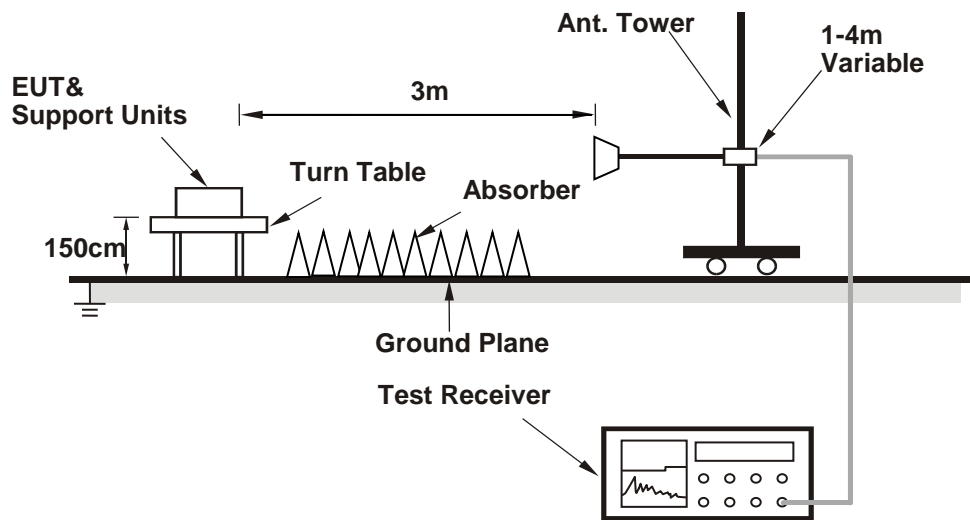

For the actual test configuration, please refer to the attached file (Test Setup Photo).

4.1.6 EUT Operating Condition

- a. Connected the EUT with the Laptop Computer which is placed on remote site.
- b. Controlling software (accessMtool_3_1_0_1) has been activated to set the EUT under transmission condition continuously at specific channel frequency.

4.1.7 Test Results

Above 1GHz Data:

802.11a

Channel	TX Channel 36	Detector Function	Peak (PK)
Frequency Range	1GHz ~ 40GHz		Average (AV)

Antenna Polarity & Test Distance : Horizontal at 3 m

No	Frequency (MHz)	Emission Level (dBuV/m)	Limit (dBuV/m)	Margin (dB)	Antenna Height (m)	Table Angle (Degree)	Raw Value (dBuV)	Correction Factor (dB/m)
1	5150.00	50.0 PK	74.0	-24.0	1.59 H	356	47.0	3.0
2	5150.00	43.4 AV	54.0	-10.6	1.59 H	356	40.4	3.0
3	*5180.00	107.2 PK			1.59 H	356	104.2	3.0
4	*5180.00	98.7 AV			1.59 H	356	95.7	3.0
5	#10360.00	47.1 PK	68.2	-21.1	2.71 H	221	33.9	13.2
6	15540.00	46.7 PK	74.0	-27.3	3.70 H	219	33.1	13.6
7	15540.00	33.9 AV	54.0	-20.1	3.70 H	219	20.3	13.6

Antenna Polarity & Test Distance : Vertical at 3 m

No	Frequency (MHz)	Emission Level (dBuV/m)	Limit (dBuV/m)	Margin (dB)	Antenna Height (m)	Table Angle (Degree)	Raw Value (dBuV)	Correction Factor (dB/m)
1	5150.00	67.9 PK	74.0	-6.1	3.10 V	256	64.9	3.0
2	5150.00	53.7 AV	54.0	-0.3	3.10 V	256	50.7	3.0
3	*5180.00	115.1 PK			3.10 V	256	112.1	3.0
4	*5180.00	106.6 AV			3.10 V	256	103.6	3.0
5	#10360.00	47.9 PK	68.2	-20.3	2.73 V	341	34.7	13.2
6	15540.00	43.6 PK	74.0	-30.4	2.26 V	148	30.0	13.6
7	15540.00	37.1 AV	54.0	-16.9	2.26 V	148	23.5	13.6

Remarks:

1. Emission Level(dBuV/m) = Raw Value(dBuV) + Correction Factor(dB/m)
2. Correction Factor(dB/m) = Antenna Factor(dB/m) + Cable Factor(dB) – Pre-Amplifier Factor(dB)
3. Margin value = Emission Level – Limit value
4. The other emission levels were very low against the limit.
5. " * ": Fundamental frequency.
6. " # ": The radiated frequency is out of the restricted band.

Channel	TX Channel 40	Detector Function	Peak (PK)
Frequency Range	1GHz ~ 40GHz		Average (AV)

Antenna Polarity & Test Distance : Horizontal at 3 m

No	Frequency (MHz)	Emission Level (dBuV/m)	Limit (dBuV/m)	Margin (dB)	Antenna Height (m)	Table Angle (Degree)	Raw Value (dBuV)	Correction Factor (dB/m)
1	5150.00	59.4 PK	74.0	-14.6	1.00 H	150	56.4	3.0
2	5150.00	43.5 AV	54.0	-10.5	1.00 H	150	40.5	3.0
3	*5200.00	111.5 PK			1.00 H	150	108.6	2.9
4	*5200.00	103.2 AV			1.00 H	150	100.3	2.9
5	#10400.00	47.2 PK	68.2	-21.0	2.78 H	223	33.9	13.3
6	15600.00	46.6 PK	74.0	-27.4	3.72 H	210	32.7	13.9
7	15600.00	33.9 AV	54.0	-20.1	3.72 H	210	20.0	13.9

Antenna Polarity & Test Distance : Vertical at 3 m

No	Frequency (MHz)	Emission Level (dBuV/m)	Limit (dBuV/m)	Margin (dB)	Antenna Height (m)	Table Angle (Degree)	Raw Value (dBuV)	Correction Factor (dB/m)
1	5150.00	69.6 PK	74.0	-4.4	3.16 V	279	66.6	3.0
2	5150.00	53.4 AV	54.0	-0.6	3.16 V	279	50.4	3.0
3	*5200.00	120.6 PK			3.16 V	279	117.7	2.9
4	*5200.00	111.6 AV			3.16 V	279	108.7	2.9
5	#10400.00	47.4 PK	68.2	-20.8	2.77 V	348	34.1	13.3
6	15600.00	43.9 PK	74.0	-30.1	2.28 V	162	30.0	13.9
7	15600.00	37.2 AV	54.0	-16.8	2.28 V	162	23.3	13.9

Remarks:

1. Emission Level(dBuV/m) = Raw Value(dBuV) + Correction Factor(dB/m)
2. Correction Factor(dB/m) = Antenna Factor(dB/m) + Cable Factor(dB) – Pre-Amplifier Factor(dB)
3. Margin value = Emission Level – Limit value
4. The other emission levels were very low against the limit.
5. " * ": Fundamental frequency.
6. " # ": The radiated frequency is out of the restricted band.

Channel	TX Channel 48	Detector Function	Peak (PK)
Frequency Range	1GHz ~ 40GHz		Average (AV)

Antenna Polarity & Test Distance : Horizontal at 3 m

No	Frequency (MHz)	Emission Level (dBuV/m)	Limit (dBuV/m)	Margin (dB)	Antenna Height (m)	Table Angle (Degree)	Raw Value (dBuV)	Correction Factor (dB/m)
1	5146.30	49.5 PK	74.0	-24.5	1.02 H	131	46.5	3.0
2	5146.30	39.7 AV	54.0	-14.3	1.02 H	131	36.7	3.0
3	*5240.00	113.2 PK			1.02 H	131	110.3	2.9
4	*5240.00	104.3 AV			1.02 H	131	101.4	2.9
5	#10480.00	47.4 PK	68.2	-20.8	2.76 H	209	33.9	13.5
6	15720.00	46.9 PK	74.0	-27.1	3.69 H	208	33.5	13.4
7	15720.00	34.3 AV	54.0	-19.7	3.69 H	208	20.9	13.4

Antenna Polarity & Test Distance : Vertical at 3 m

No	Frequency (MHz)	Emission Level (dBuV/m)	Limit (dBuV/m)	Margin (dB)	Antenna Height (m)	Table Angle (Degree)	Raw Value (dBuV)	Correction Factor (dB/m)
1	5146.30	55.5 PK	74.0	-18.5	2.76 V	275	52.5	3.0
2	5146.30	45.8 AV	54.0	-8.2	2.76 V	275	42.8	3.0
3	*5240.00	120.8 PK			2.76 V	275	117.9	2.9
4	*5240.00	111.8 AV			2.76 V	275	108.9	2.9
5	#10480.00	47.3 PK	68.2	-20.9	2.72 V	343	33.8	13.5
6	15720.00	43.5 PK	74.0	-30.5	2.26 V	153	30.1	13.4
7	15720.00	36.7 AV	54.0	-17.3	2.26 V	153	23.3	13.4

Remarks:

1. Emission Level(dBuV/m) = Raw Value(dBuV) + Correction Factor(dB/m)
2. Correction Factor(dB/m) = Antenna Factor(dB/m) + Cable Factor(dB) – Pre-Amplifier Factor(dB)
3. Margin value = Emission Level – Limit value
4. The other emission levels were very low against the limit.
5. " * ": Fundamental frequency.
6. " # ": The radiated frequency is out of the restricted band.

Channel	TX Channel 149	Detector Function	Peak (PK)
Frequency Range	1GHz ~ 40GHz		Average (AV)

Antenna Polarity & Test Distance : Horizontal at 3 m

No	Frequency (MHz)	Emission Level (dBuV/m)	Limit (dBuV/m)	Margin (dB)	Antenna Height (m)	Table Angle (Degree)	Raw Value (dBuV)	Correction Factor (dB/m)
1	#5649.42	53.3 PK	68.2	-14.9	1.00 H	131	49.8	3.5
2	*5745.00	114.9 PK			1.00 H	131	111.1	3.8
3	*5745.00	105.7 AV			1.00 H	131	101.9	3.8
4	#5925.65	52.0 PK	68.2	-16.2	1.00 H	131	48.1	3.9
5	11490.00	52.9 PK	74.0	-21.1	1.26 H	109	38.9	14.0
6	11490.00	39.8 AV	54.0	-14.2	1.26 H	109	25.8	14.0
7	#17235.00	51.2 PK	68.2	-17.0	1.77 H	360	34.7	16.5

Antenna Polarity & Test Distance : Vertical at 3 m

No	Frequency (MHz)	Emission Level (dBuV/m)	Limit (dBuV/m)	Margin (dB)	Antenna Height (m)	Table Angle (Degree)	Raw Value (dBuV)	Correction Factor (dB/m)
1	#5642.67	60.6 PK	68.2	-7.6	1.47 V	260	57.1	3.5
2	*5745.00	120.4 PK			1.46 V	260	116.6	3.8
3	*5745.00	111.2 AV			1.46 V	260	107.4	3.8
4	#5942.60	54.3 PK	68.2	-13.9	1.47 V	260	50.3	4.0
5	11490.00	57.1 PK	74.0	-16.9	1.32 V	228	43.1	14.0
6	11490.00	44.3 AV	54.0	-9.7	1.32 V	228	30.3	14.0
7	#17235.00	50.3 PK	68.2	-17.9	2.83 V	248	33.8	16.5

Remarks:

1. Emission Level(dBuV/m) = Raw Value(dBuV) + Correction Factor(dB/m)
2. Correction Factor(dB/m) = Antenna Factor(dB/m) + Cable Factor(dB) – Pre-Amplifier Factor(dB)
3. Margin value = Emission Level – Limit value
4. The other emission levels were very low against the limit.
5. " * ": Fundamental frequency.
6. " # ": The radiated frequency is out of the restricted band.

Channel	TX Channel 157	Detector Function	Peak (PK)
Frequency Range	1GHz ~ 40GHz		Average (AV)

Antenna Polarity & Test Distance : Horizontal at 3 m

No	Frequency (MHz)	Emission Level (dBuV/m)	Limit (dBuV/m)	Margin (dB)	Antenna Height (m)	Table Angle (Degree)	Raw Value (dBuV)	Correction Factor (dB/m)
1	#5650.19	51.2 PK	68.3	-17.1	1.07 H	133	47.7	3.5
2	*5785.00	115.5 PK			1.07 H	133	111.6	3.9
3	*5785.00	105.7 AV			1.07 H	133	101.8	3.9
4	#5926.38	48.6 PK	68.2	-19.6	1.07 H	133	44.7	3.9
5	11570.00	52.8 PK	74.0	-21.2	1.20 H	94	39.2	13.6
6	11570.00	39.9 AV	54.0	-14.1	1.20 H	94	26.3	13.6
7	#17355.00	51.3 PK	68.2	-16.9	1.74 H	355	34.3	17.0

Antenna Polarity & Test Distance : Vertical at 3 m

No	Frequency (MHz)	Emission Level (dBuV/m)	Limit (dBuV/m)	Margin (dB)	Antenna Height (m)	Table Angle (Degree)	Raw Value (dBuV)	Correction Factor (dB/m)
1	#5640.83	56.9 PK	68.2	-11.3	1.44 V	261	53.5	3.4
2	*5785.00	120.3 PK			1.44 V	261	116.4	3.9
3	*5785.00	110.9 AV			1.44 V	261	107.0	3.9
4	#5953.81	54.4 PK	68.2	-13.8	1.44 V	261	50.3	4.1
5	11570.00	56.9 PK	74.0	-17.1	1.37 V	236	43.3	13.6
6	11570.00	44.1 AV	54.0	-9.9	1.37 V	236	30.5	13.6
7	#17355.00	50.8 PK	68.2	-17.4	2.79 V	259	33.8	17.0

Remarks:

1. Emission Level(dBuV/m) = Raw Value(dBuV) + Correction Factor(dB/m)
2. Correction Factor(dB/m) = Antenna Factor(dB/m) + Cable Factor(dB) – Pre-Amplifier Factor(dB)
3. Margin value = Emission Level – Limit value
4. The other emission levels were very low against the limit.
5. " * ": Fundamental frequency.
6. " # ": The radiated frequency is out of the restricted band.

Channel	TX Channel 165	Detector Function	Peak (PK)
Frequency Range	1GHz ~ 40GHz		Average (AV)

Antenna Polarity & Test Distance : Horizontal at 3 m

No	Frequency (MHz)	Emission Level (dBuV/m)	Limit (dBuV/m)	Margin (dB)	Antenna Height (m)	Table Angle (Degree)	Raw Value (dBuV)	Correction Factor (dB/m)
1	#5646.84	50.7 PK	68.2	-17.5	1.26 H	132	47.2	3.5
2	*5825.00	115.8 PK			1.26 H	132	111.7	4.1
3	*5825.00	106.3 AV			1.26 H	132	102.2	4.1
4	#5925.52	51.1 PK	68.2	-17.1	1.26 H	132	47.2	3.9
5	11650.00	52.5 PK	74.0	-21.5	1.16 H	94	39.0	13.5
6	11650.00	39.6 AV	54.0	-14.4	1.16 H	94	26.1	13.5
7	#17475.00	51.4 PK	68.2	-16.8	1.79 H	360	32.8	18.6

Antenna Polarity & Test Distance : Vertical at 3 m

No	Frequency (MHz)	Emission Level (dBuV/m)	Limit (dBuV/m)	Margin (dB)	Antenna Height (m)	Table Angle (Degree)	Raw Value (dBuV)	Correction Factor (dB/m)
1	#5614.18	56.8 PK	68.2	-11.4	1.35 V	262	53.4	3.4
2	*5825.00	121.1 PK			1.35 V	262	117.0	4.1
3	*5825.00	111.2 AV			1.35 V	262	107.1	4.1
4	#5928.80	58.0 PK	68.2	-10.2	1.35 V	262	54.0	4.0
5	11650.00	56.3 PK	74.0	-17.7	1.39 V	231	42.8	13.5
6	11650.00	43.7 AV	54.0	-10.3	1.39 V	231	30.2	13.5
7	#17475.00	50.8 PK	68.2	-17.4	2.84 V	272	32.2	18.6

Remarks:

1. Emission Level(dBuV/m) = Raw Value(dBuV) + Correction Factor(dB/m)
2. Correction Factor(dB/m) = Antenna Factor(dB/m) + Cable Factor(dB) – Pre-Amplifier Factor(dB)
3. Margin value = Emission Level – Limit value
4. The other emission levels were very low against the limit.
5. " * ": Fundamental frequency.
6. " # ": The radiated frequency is out of the restricted band.

802.11ax (HE20)

Channel	TX Channel 36	Detector Function	Peak (PK)
Frequency Range	1GHz ~ 40GHz		Average (AV)

Antenna Polarity & Test Distance : Horizontal at 3 m								
No	Frequency (MHz)	Emission Level (dBuV/m)	Limit (dBuV/m)	Margin (dB)	Antenna Height (m)	Table Angle (Degree)	Raw Value (dBuV)	Correction Factor (dB/m)
1	5150.00	56.2 PK	74.0	-17.8	1.48 H	355	53.2	3.0
2	5150.00	45.4 AV	54.0	-8.6	1.48 H	355	42.4	3.0
3	*5180.00	108.7 PK			1.48 H	355	105.7	3.0
4	*5180.00	97.7 AV			1.48 H	355	94.7	3.0
5	#10360.00	46.9 PK	68.2	-21.3	2.73 H	200	33.7	13.2
6	15540.00	46.6 PK	74.0	-27.4	3.75 H	213	33.0	13.6
7	15540.00	34.2 AV	54.0	-19.8	3.75 H	213	20.6	13.6

Antenna Polarity & Test Distance : Vertical at 3 m								
No	Frequency (MHz)	Emission Level (dBuV/m)	Limit (dBuV/m)	Margin (dB)	Antenna Height (m)	Table Angle (Degree)	Raw Value (dBuV)	Correction Factor (dB/m)
1	5150.00	67.6 PK	74.0	-6.4	3.15 V	280	64.6	3.0
2	5150.00	53.6 AV	54.0	-0.4	3.15 V	280	50.6	3.0
3	*5180.00	117.9 PK			3.15 V	280	114.9	3.0
4	*5180.00	106.6 AV			3.15 V	280	103.6	3.0
5	#10360.00	46.7 PK	68.2	-21.5	2.81 V	276	33.5	13.2
6	15540.00	46.4 PK	74.0	-27.6	2.42 V	213	32.8	13.6
7	15540.00	34.6 AV	54.0	-19.4	2.42 V	213	21.0	13.6

Remarks:

1. Emission Level(dBuV/m) = Raw Value(dBuV) + Correction Factor(dB/m)
2. Correction Factor(dB/m) = Antenna Factor(dB/m) + Cable Factor(dB) – Pre-Amplifier Factor(dB)
3. Margin value = Emission Level – Limit value
4. The other emission levels were very low against the limit.
5. " * ": Fundamental frequency.
6. " # ": The radiated frequency is out of the restricted band.

Channel	TX Channel 40	Detector Function	Peak (PK)
Frequency Range	1GHz ~ 40GHz		Average (AV)

Antenna Polarity & Test Distance : Horizontal at 3 m

No	Frequency (MHz)	Emission Level (dBuV/m)	Limit (dBuV/m)	Margin (dB)	Antenna Height (m)	Table Angle (Degree)	Raw Value (dBuV)	Correction Factor (dB/m)
1	5150.00	61.9 PK	74.0	-12.1	1.00 H	150	58.9	3.0
2	5150.00	44.9 AV	54.0	-9.1	1.00 H	150	41.9	3.0
3	*5200.00	113.5 PK			1.00 H	150	110.6	2.9
4	*5200.00	101.9 AV			1.00 H	150	99.0	2.9
5	#10400.00	47.6 PK	68.2	-20.6	2.71 H	205	34.3	13.3
6	15600.00	46.8 PK	74.0	-27.2	3.68 H	207	32.9	13.9
7	15600.00	34.4 AV	54.0	-19.6	3.68 H	207	20.5	13.9

Antenna Polarity & Test Distance : Vertical at 3 m

No	Frequency (MHz)	Emission Level (dBuV/m)	Limit (dBuV/m)	Margin (dB)	Antenna Height (m)	Table Angle (Degree)	Raw Value (dBuV)	Correction Factor (dB/m)
1	5150.00	70.5 PK	74.0	-3.5	3.13 V	278	67.5	3.0
2	5150.00	53.7 AV	54.0	-0.3	3.13 V	278	50.7	3.0
3	*5200.00	121.7 PK			3.13 V	278	118.8	2.9
4	*5200.00	110.1 AV			3.13 V	278	107.2	2.9
5	#10400.00	47.1 PK	68.2	-21.1	2.80 V	276	33.8	13.3
6	15600.00	46.3 PK	74.0	-27.7	2.44 V	214	32.4	13.9
7	15600.00	34.1 AV	54.0	-19.9	2.44 V	214	20.2	13.9

Remarks:

1. Emission Level(dBuV/m) = Raw Value(dBuV) + Correction Factor(dB/m)
2. Correction Factor(dB/m) = Antenna Factor(dB/m) + Cable Factor(dB) – Pre-Amplifier Factor(dB)
3. Margin value = Emission Level – Limit value
4. The other emission levels were very low against the limit.
5. " * ": Fundamental frequency.
6. " # ": The radiated frequency is out of the restricted band.

Channel	TX Channel 48	Detector Function	Peak (PK)
Frequency Range	1GHz ~ 40GHz		Average (AV)

Antenna Polarity & Test Distance : Horizontal at 3 m

No	Frequency (MHz)	Emission Level (dBuV/m)	Limit (dBuV/m)	Margin (dB)	Antenna Height (m)	Table Angle (Degree)	Raw Value (dBuV)	Correction Factor (dB/m)
1	5143.50	52.5 PK	74.0	-21.5	1.03 H	131	49.5	3.0
2	5143.50	39.6 AV	54.0	-14.4	1.03 H	131	36.6	3.0
3	*5240.00	114.3 PK			1.03 H	131	111.4	2.9
4	*5240.00	102.6 AV			1.03 H	131	99.7	2.9
5	#10480.00	47.5 PK	68.2	-20.7	1.53 H	186	34.0	13.5
6	15720.00	46.8 PK	74.0	-27.2	1.00 H	113	33.4	13.4
7	15720.00	33.9 AV	54.0	-20.1	1.00 H	113	20.5	13.4

Antenna Polarity & Test Distance : Vertical at 3 m

No	Frequency (MHz)	Emission Level (dBuV/m)	Limit (dBuV/m)	Margin (dB)	Antenna Height (m)	Table Angle (Degree)	Raw Value (dBuV)	Correction Factor (dB/m)
1	5148.20	55.8 PK	74.0	-18.2	2.75 V	275	52.8	3.0
2	5148.20	46.3 AV	54.0	-7.7	2.75 V	275	43.3	3.0
3	*5240.00	120.6 PK			2.75 V	275	117.7	2.9
4	*5240.00	109.4 AV			2.75 V	275	106.5	2.9
5	#10480.00	46.9 PK	68.2	-21.3	2.82 V	276	33.4	13.5
6	15720.00	46.4 PK	74.0	-27.6	2.44 V	220	33.0	13.4
7	15720.00	34.4 AV	54.0	-19.6	2.44 V	220	21.0	13.4

Remarks:

1. Emission Level(dBuV/m) = Raw Value(dBuV) + Correction Factor(dB/m)
2. Correction Factor(dB/m) = Antenna Factor(dB/m) + Cable Factor(dB) – Pre-Amplifier Factor(dB)
3. Margin value = Emission Level – Limit value
4. The other emission levels were very low against the limit.
5. " * ": Fundamental frequency.
6. " # ": The radiated frequency is out of the restricted band.

Channel	TX Channel 149	Detector Function	Peak (PK)
Frequency Range	1GHz ~ 40GHz		Average (AV)

Antenna Polarity & Test Distance : Horizontal at 3 m

No	Frequency (MHz)	Emission Level (dBuV/m)	Limit (dBuV/m)	Margin (dB)	Antenna Height (m)	Table Angle (Degree)	Raw Value (dBuV)	Correction Factor (dB/m)
1	#5647.42	54.2 PK	68.2	-14.0	1.07 H	131	50.7	3.5
2	*5745.00	117.3 PK			1.07 H	131	113.5	3.8
3	*5745.00	105.2 AV			1.07 H	131	101.4	3.8
4	#5927.71	49.6 PK	68.2	-18.6	1.07 H	131	45.7	3.9
5	11490.00	57.3 PK	74.0	-16.7	3.83 H	170	43.3	14.0
6	11490.00	44.8 AV	54.0	-9.2	3.83 H	170	30.8	14.0
7	#17235.00	50.6 PK	68.2	-17.6	2.27 H	171	34.1	16.5

Antenna Polarity & Test Distance : Vertical at 3 m

No	Frequency (MHz)	Emission Level (dBuV/m)	Limit (dBuV/m)	Margin (dB)	Antenna Height (m)	Table Angle (Degree)	Raw Value (dBuV)	Correction Factor (dB/m)
1	#5646.37	61.1 PK	68.2	-7.1	1.47 V	260	57.6	3.5
2	*5745.00	121.5 PK			1.46 V	260	117.7	3.8
3	*5745.00	110.4 AV			1.46 V	260	106.6	3.8
4	#5971.97	55.1 PK	68.2	-13.1	1.47 V	260	51.0	4.1
5	11490.00	55.5 PK	74.0	-18.5	1.39 V	237	41.5	14.0
6	11490.00	43.2 AV	54.0	-10.8	1.39 V	237	29.2	14.0
7	#17235.00	52.0 PK	68.2	-16.2	3.10 V	247	35.5	16.5

Remarks:

1. Emission Level(dBuV/m) = Raw Value(dBuV) + Correction Factor(dB/m)
2. Correction Factor(dB/m) = Antenna Factor(dB/m) + Cable Factor(dB) – Pre-Amplifier Factor(dB)
3. Margin value = Emission Level – Limit value
4. The other emission levels were very low against the limit.
5. " * ": Fundamental frequency.
6. " # ": The radiated frequency is out of the restricted band.

Channel	TX Channel 157	Detector Function	Peak (PK)
Frequency Range	1GHz ~ 40GHz		Average (AV)

Antenna Polarity & Test Distance : Horizontal at 3 m

No	Frequency (MHz)	Emission Level (dBuV/m)	Limit (dBuV/m)	Margin (dB)	Antenna Height (m)	Table Angle (Degree)	Raw Value (dBuV)	Correction Factor (dB/m)
1	#5643.63	52.7 PK	68.2	-15.5	1.21 H	132	49.2	3.5
2	*5785.00	117.2 PK			1.21 H	132	113.3	3.9
3	*5785.00	104.9 AV			1.21 H	132	101.0	3.9
4	#5924.83	49.4 PK	68.3	-18.9	1.21 H	132	45.5	3.9
5	11570.00	57.2 PK	74.0	-16.8	3.86 H	168	43.6	13.6
6	11570.00	44.5 AV	54.0	-9.5	3.86 H	168	30.9	13.6
7	#17355.00	50.8 PK	68.2	-17.4	2.25 H	181	33.8	17.0

Antenna Polarity & Test Distance : Vertical at 3 m

No	Frequency (MHz)	Emission Level (dBuV/m)	Limit (dBuV/m)	Margin (dB)	Antenna Height (m)	Table Angle (Degree)	Raw Value (dBuV)	Correction Factor (dB/m)
1	#5629.55	58.9 PK	68.2	-9.3	1.43 V	260	55.5	3.4
2	*5785.00	122.5 PK			1.43 V	260	118.6	3.9
3	*5785.00	110.2 AV			1.43 V	260	106.3	3.9
4	#5994.83	56.1 PK	68.2	-12.1	1.43 V	260	52.0	4.1
5	11570.00	56.2 PK	74.0	-17.8	1.38 V	236	42.6	13.6
6	11570.00	43.6 AV	54.0	-10.4	1.38 V	236	30.0	13.6
7	#17355.00	51.5 PK	68.2	-16.7	3.11 V	238	34.5	17.0

Remarks:

1. Emission Level(dBuV/m) = Raw Value(dBuV) + Correction Factor(dB/m)
2. Correction Factor(dB/m) = Antenna Factor(dB/m) + Cable Factor(dB) – Pre-Amplifier Factor(dB)
3. Margin value = Emission Level – Limit value
4. The other emission levels were very low against the limit.
5. " * ": Fundamental frequency.
6. " # ": The radiated frequency is out of the restricted band.

Channel	TX Channel 165	Detector Function	Peak (PK)
Frequency Range	1GHz ~ 40GHz		Average (AV)

Antenna Polarity & Test Distance : Horizontal at 3 m

No	Frequency (MHz)	Emission Level (dBuV/m)	Limit (dBuV/m)	Margin (dB)	Antenna Height (m)	Table Angle (Degree)	Raw Value (dBuV)	Correction Factor (dB/m)
1	#5645.30	51.9 PK	68.2	-16.3	1.08 H	132	48.4	3.5
2	*5825.00	117.6 PK			1.08 H	132	113.5	4.1
3	*5825.00	104.9 AV			1.08 H	132	100.8	4.1
4	#5929.16	52.9 PK	68.2	-15.3	1.08 H	132	48.9	4.0
5	11650.00	57.7 PK	74.0	-16.3	3.87 H	180	44.2	13.5
6	11650.00	44.9 AV	54.0	-9.1	3.87 H	180	31.4	13.5
7	#17475.00	50.3 PK	68.2	-17.9	2.22 H	174	31.7	18.6

Antenna Polarity & Test Distance : Vertical at 3 m

No	Frequency (MHz)	Emission Level (dBuV/m)	Limit (dBuV/m)	Margin (dB)	Antenna Height (m)	Table Angle (Degree)	Raw Value (dBuV)	Correction Factor (dB/m)
1	#5626.63	54.4 PK	68.2	-13.8	2.81 V	262	51.0	3.4
2	*5825.00	123.4 PK			2.80 V	262	119.3	4.1
3	*5825.00	110.9 AV			2.80 V	262	106.8	4.1
4	#5933.38	58.7 PK	68.2	-9.5	2.81 V	262	54.7	4.0
5	11650.00	55.9 PK	74.0	-18.1	1.33 V	242	42.4	13.5
6	11650.00	43.5 AV	54.0	-10.5	1.33 V	242	30.0	13.5
7	#17475.00	50.9 PK	68.2	-17.3	3.12 V	234	32.3	18.6

Remarks:

1. Emission Level(dBuV/m) = Raw Value(dBuV) + Correction Factor(dB/m)
2. Correction Factor(dB/m) = Antenna Factor(dB/m) + Cable Factor(dB) – Pre-Amplifier Factor(dB)
3. Margin value = Emission Level – Limit value
4. The other emission levels were very low against the limit.
5. " * ": Fundamental frequency.
6. " # ": The radiated frequency is out of the restricted band.

802.11ax (HE40)

Channel	TX Channel 38	Detector Function	Peak (PK)
Frequency Range	1GHz ~ 40GHz		Average (AV)

Antenna Polarity & Test Distance : Horizontal at 3 m								
No	Frequency (MHz)	Emission Level (dBuV/m)	Limit (dBuV/m)	Margin (dB)	Antenna Height (m)	Table Angle (Degree)	Raw Value (dBuV)	Correction Factor (dB/m)
1	5150.00	58.7 PK	74.0	-15.3	1.47 H	356	55.7	3.0
2	5150.00	44.8 AV	54.0	-9.2	1.47 H	356	41.8	3.0
3	*5190.00	105.8 PK			1.47 H	356	102.8	3.0
4	*5190.00	93.8 AV			1.47 H	356	90.8	3.0
5	#10380.00	47.3 PK	68.2	-20.9	1.52 H	182	34.1	13.2
6	15570.00	46.4 PK	74.0	-27.6	1.01 H	105	32.6	13.8
7	15570.00	33.8 AV	54.0	-20.2	1.01 H	105	20.0	13.8

Antenna Polarity & Test Distance : Vertical at 3 m								
No	Frequency (MHz)	Emission Level (dBuV/m)	Limit (dBuV/m)	Margin (dB)	Antenna Height (m)	Table Angle (Degree)	Raw Value (dBuV)	Correction Factor (dB/m)
1	5150.00	66.6 PK	74.0	-7.4	3.03 V	255	63.6	3.0
2	5150.00	53.9 AV	54.0	-0.1	3.03 V	255	50.9	3.0
3	*5190.00	113.3 PK			3.03 V	255	110.3	3.0
4	*5190.00	101.6 AV			3.03 V	255	98.6	3.0
5	#10380.00	47.4 PK	68.2	-20.8	2.76 V	291	34.2	13.2
6	15570.00	46.3 PK	74.0	-27.7	2.39 V	204	32.5	13.8
7	15570.00	34.1 AV	54.0	-19.9	2.39 V	204	20.3	13.8

Remarks:

1. Emission Level(dBuV/m) = Raw Value(dBuV) + Correction Factor(dB/m)
2. Correction Factor(dB/m) = Antenna Factor(dB/m) + Cable Factor(dB) – Pre-Amplifier Factor(dB)
3. Margin value = Emission Level – Limit value
4. The other emission levels were very low against the limit.
5. " * ": Fundamental frequency.
6. " # ": The radiated frequency is out of the restricted band.

Channel	TX Channel 46	Detector Function	Peak (PK)
Frequency Range	1GHz ~ 40GHz		Average (AV)

Antenna Polarity & Test Distance : Horizontal at 3 m

No	Frequency (MHz)	Emission Level (dBuV/m)	Limit (dBuV/m)	Margin (dB)	Antenna Height (m)	Table Angle (Degree)	Raw Value (dBuV)	Correction Factor (dB/m)
1	5150.00	56.8 PK	74.0	-17.2	1.16 H	149	53.8	3.0
2	5150.00	45.8 AV	54.0	-8.2	1.16 H	149	42.8	3.0
3	*5230.00	110.4 PK			1.16 H	149	107.5	2.9
4	*5230.00	98.7 AV			1.16 H	149	95.8	2.9
5	#10460.00	47.1 PK	68.2	-21.1	1.56 H	189	33.6	13.5
6	15690.00	46.9 PK	74.0	-27.1	1.00 H	126	33.4	13.5
7	15690.00	34.3 AV	54.0	-19.7	1.00 H	126	20.8	13.5

Antenna Polarity & Test Distance : Vertical at 3 m

No	Frequency (MHz)	Emission Level (dBuV/m)	Limit (dBuV/m)	Margin (dB)	Antenna Height (m)	Table Angle (Degree)	Raw Value (dBuV)	Correction Factor (dB/m)
1	5150.00	65.6 PK	74.0	-8.4	2.74 V	275	62.6	3.0
2	5150.00	53.7 AV	54.0	-0.3	2.74 V	275	50.7	3.0
3	*5230.00	117.8 PK			2.74 V	275	114.9	2.9
4	*5230.00	106.5 AV			2.74 V	275	103.6	2.9
5	#10460.00	47.7 PK	68.2	-20.5	2.82 V	286	34.2	13.5
6	15690.00	46.3 PK	74.0	-27.7	2.47 V	202	32.8	13.5
7	15690.00	34.0 AV	54.0	-20.0	2.47 V	202	20.5	13.5

Remarks:

1. Emission Level(dBuV/m) = Raw Value(dBuV) + Correction Factor(dB/m)
2. Correction Factor(dB/m) = Antenna Factor(dB/m) + Cable Factor(dB) – Pre-Amplifier Factor(dB)
3. Margin value = Emission Level – Limit value
4. The other emission levels were very low against the limit.
5. " * ": Fundamental frequency.
6. " # ": The radiated frequency is out of the restricted band.

Channel	TX Channel 151	Detector Function	Peak (PK)
Frequency Range	1GHz ~ 40GHz		Average (AV)

Antenna Polarity & Test Distance : Horizontal at 3 m

No	Frequency (MHz)	Emission Level (dBuV/m)	Limit (dBuV/m)	Margin (dB)	Antenna Height (m)	Table Angle (Degree)	Raw Value (dBuV)	Correction Factor (dB/m)
1	#5647.89	63.0 PK	68.2	-5.2	1.00 H	132	59.5	3.5
2	*5755.00	113.1 PK			1.00 H	132	109.3	3.8
3	*5755.00	101.1 AV			1.00 H	132	97.3	3.8
4	#5929.75	50.1 PK	68.2	-18.1	1.00 H	132	46.1	4.0
5	11510.00	47.5 PK	74.0	-26.5	1.49 H	174	33.7	13.8
6	11510.00	34.9 AV	54.0	-19.1	1.49 H	174	21.1	13.8
7	#17265.00	47.0 PK	68.2	-21.2	1.05 H	103	30.4	16.6

Antenna Polarity & Test Distance : Vertical at 3 m

No	Frequency (MHz)	Emission Level (dBuV/m)	Limit (dBuV/m)	Margin (dB)	Antenna Height (m)	Table Angle (Degree)	Raw Value (dBuV)	Correction Factor (dB/m)
1	#5645.88	67.7 PK	68.2	-0.5	1.47 V	259	64.2	3.5
2	*5755.00	119.5 PK			1.47 V	259	115.7	3.8
3	*5755.00	107.5 AV			1.47 V	259	103.7	3.8
4	#5927.10	55.7 PK	68.2	-12.5	1.47 V	259	51.8	3.9
5	11510.00	47.0 PK	74.0	-27.0	2.81 V	262	33.2	13.8
6	11510.00	35.0 AV	54.0	-19.0	2.81 V	262	21.2	13.8
7	#17265.00	46.7 PK	68.2	-21.5	2.45 V	224	30.1	16.6

Remarks:

1. Emission Level(dBuV/m) = Raw Value(dBuV) + Correction Factor(dB/m)
2. Correction Factor(dB/m) = Antenna Factor(dB/m) + Cable Factor(dB) – Pre-Amplifier Factor(dB)
3. Margin value = Emission Level – Limit value
4. The other emission levels were very low against the limit.
5. " * ": Fundamental frequency.
6. " # ": The radiated frequency is out of the restricted band.

Channel	TX Channel 159	Detector Function	Peak (PK)
Frequency Range	1GHz ~ 40GHz		Average (AV)

Antenna Polarity & Test Distance : Horizontal at 3 m

No	Frequency (MHz)	Emission Level (dBuV/m)	Limit (dBuV/m)	Margin (dB)	Antenna Height (m)	Table Angle (Degree)	Raw Value (dBuV)	Correction Factor (dB/m)
1	#5648.61	54.4 PK	68.2	-13.8	1.19 H	132	50.9	3.5
2	*5795.00	114.8 PK			1.19 H	132	110.9	3.9
3	*5795.00	102.5 AV			1.19 H	132	98.6	3.9
4	#5926.07	58.0 PK	68.2	-10.2	1.19 H	132	54.1	3.9
5	11590.00	47.8 PK	74.0	-26.2	1.59 H	193	34.2	13.6
6	11590.00	34.9 AV	54.0	-19.1	1.59 H	193	21.3	13.6
7	#17385.00	46.9 PK	68.2	-21.3	1.00 H	101	29.5	17.4

Antenna Polarity & Test Distance : Vertical at 3 m

No	Frequency (MHz)	Emission Level (dBuV/m)	Limit (dBuV/m)	Margin (dB)	Antenna Height (m)	Table Angle (Degree)	Raw Value (dBuV)	Correction Factor (dB/m)
1	#5643.68	61.4 PK	68.2	-6.8	1.42 V	260	57.9	3.5
2	*5795.00	119.3 PK			1.42 V	260	115.4	3.9
3	*5795.00	107.8 AV			1.42 V	260	103.9	3.9
4	#5930.19	65.3 PK	68.2	-2.9	1.42 V	260	61.3	4.0
5	11590.00	46.9 PK	74.0	-27.1	2.79 V	277	33.3	13.6
6	11590.00	34.8 AV	54.0	-19.2	2.79 V	277	21.2	13.6
7	#17385.00	46.0 PK	68.2	-22.2	2.41 V	205	28.6	17.4

Remarks:

1. Emission Level(dBuV/m) = Raw Value(dBuV) + Correction Factor(dB/m)
2. Correction Factor(dB/m) = Antenna Factor(dB/m) + Cable Factor(dB) – Pre-Amplifier Factor(dB)
3. Margin value = Emission Level – Limit value
4. The other emission levels were very low against the limit.
5. " * ": Fundamental frequency.
6. " # ": The radiated frequency is out of the restricted band.

802.11ax (HE80)

Channel	TX Channel 42	Detector Function	Peak (PK)
Frequency Range	1GHz ~ 40GHz		Average (AV)

Antenna Polarity & Test Distance : Horizontal at 3 m								
No	Frequency (MHz)	Emission Level (dBuV/m)	Limit (dBuV/m)	Margin (dB)	Antenna Height (m)	Table Angle (Degree)	Raw Value (dBuV)	Correction Factor (dB/m)
1	5150.00	58.1 PK	74.0	-15.9	2.70 H	215	55.1	3.0
2	5150.00	45.4 AV	54.0	-8.6	2.70 H	215	42.4	3.0
3	*5210.00	110.7 PK			2.70 H	215	107.7	3.0
4	*5210.00	98.3 AV			2.70 H	215	95.3	3.0
5	5350.00	50.1 PK	74.0	-23.9	2.70 H	215	47.1	3.0
6	5350.00	40.1 AV	54.0	-13.9	2.70 H	215	37.1	3.0
7	#10420.00	46.9 PK	68.2	-21.3	1.59 H	196	33.6	13.3
8	15630.00	47.3 PK	74.0	-26.7	1.00 H	115	33.6	13.7
9	15630.00	34.2 AV	54.0	-19.8	1.00 H	115	20.5	13.7

Antenna Polarity & Test Distance : Vertical at 3 m								
No	Frequency (MHz)	Emission Level (dBuV/m)	Limit (dBuV/m)	Margin (dB)	Antenna Height (m)	Table Angle (Degree)	Raw Value (dBuV)	Correction Factor (dB/m)
1	5150.00	68.3 PK	74.0	-5.7	2.96 V	255	65.3	3.0
2	5150.00	53.8 AV	54.0	-0.2	2.96 V	255	50.8	3.0
3	*5210.00	112.2 PK			2.96 V	255	109.2	3.0
4	*5210.00	99.2 AV			2.96 V	255	96.2	3.0
5	5350.00	55.3 PK	74.0	-18.7	2.96 V	255	52.3	3.0
6	5350.00	44.4 AV	54.0	-9.6	2.96 V	255	41.4	3.0
7	#10420.00	47.2 PK	68.2	-21.0	2.82 V	284	33.9	13.3
8	15630.00	46.1 PK	74.0	-27.9	2.50 V	208	32.4	13.7
9	15630.00	34.1 AV	54.0	-19.9	2.50 V	208	20.4	13.7

Remarks:

1. Emission Level(dBuV/m) = Raw Value(dBuV) + Correction Factor(dB/m)
2. Correction Factor(dB/m) = Antenna Factor(dB/m) + Cable Factor(dB) – Pre-Amplifier Factor(dB)
3. Margin value = Emission Level – Limit value
4. The other emission levels were very low against the limit.
5. " * ": Fundamental frequency.
6. " # ": The radiated frequency is out of the restricted band.

Channel	TX Channel 155	Detector Function	Peak (PK)
Frequency Range	1GHz ~ 40GHz		Average (AV)

Antenna Polarity & Test Distance : Horizontal at 3 m

No	Frequency (MHz)	Emission Level (dBuV/m)	Limit (dBuV/m)	Margin (dB)	Antenna Height (m)	Table Angle (Degree)	Raw Value (dBuV)	Correction Factor (dB/m)
1	#5646.81	60.9 PK	68.2	-7.3	1.00 H	135	57.4	3.5
2	*5775.00	108.1 PK			1.00 H	135	104.2	3.9
3	*5775.00	95.3 AV			1.00 H	135	91.4	3.9
4	#5927.52	57.6 PK	68.2	-10.6	1.00 H	135	53.7	3.9
5	11550.00	48.1 PK	74.0	-25.9	1.57 H	190	34.4	13.7
6	11550.00	35.0 AV	54.0	-19.0	1.57 H	190	21.3	13.7
7	#17325.00	47.3 PK	68.2	-20.9	1.00 H	123	30.5	16.8

Antenna Polarity & Test Distance : Vertical at 3 m

No	Frequency (MHz)	Emission Level (dBuV/m)	Limit (dBuV/m)	Margin (dB)	Antenna Height (m)	Table Angle (Degree)	Raw Value (dBuV)	Correction Factor (dB/m)
1	#5646.77	67.5 PK	68.2	-0.7	3.07 V	261	64.0	3.5
2	*5775.00	114.9 PK			3.06 V	261	111.0	3.9
3	*5775.00	103.2 AV			3.06 V	261	99.3	3.9
4	#5936.12	64.1 PK	68.2	-4.1	3.07 V	261	60.1	4.0
5	11550.00	47.7 PK	74.0	-26.3	2.76 V	291	34.0	13.7
6	11550.00	35.3 AV	54.0	-18.7	2.76 V	291	21.6	13.7
7	#17325.00	46.5 PK	68.2	-21.7	2.38 V	219	29.7	16.8

Remarks:

1. Emission Level(dBuV/m) = Raw Value(dBuV) + Correction Factor(dB/m)
2. Correction Factor(dB/m) = Antenna Factor(dB/m) + Cable Factor(dB) – Pre-Amplifier Factor(dB)
3. Margin value = Emission Level – Limit value
4. The other emission levels were very low against the limit.
5. " * ": Fundamental frequency.
6. " # ": The radiated frequency is out of the restricted band.

Below 1GHz Data:

802.11a

Channel	TX Channel 149	Detector Function	Quasi-Peak (QP)
Frequency Range	9kHz ~ 1GHz		

Antenna Polarity & Test Distance : Horizontal at 3 m								
No	Frequency (MHz)	Emission Level (dBuV/m)	Limit (dBuV/m)	Margin (dB)	Antenna Height (m)	Table Angle (Degree)	Raw Value (dBuV)	Correction Factor (dB/m)
1	30.21	28.9 QP	40.0	-11.1	1.00 H	324	37.9	-9.0
2	109.35	22.8 QP	43.5	-20.7	1.50 H	114	33.3	-10.5
3	149.17	23.2 QP	43.5	-20.3	1.50 H	301	30.7	-7.5
4	196.75	26.5 QP	43.5	-17.0	2.00 H	254	37.1	-10.6
5	310.36	23.2 QP	46.0	-22.8	1.50 H	321	29.4	-6.2
6	484.49	27.5 QP	46.0	-18.5	2.00 H	45	29.1	-1.6

Remarks:

1. Emission Level(dBuV/m) = Raw Value(dBuV) + Correction Factor(dB/m)
2. Correction Factor(dB/m) = Antenna Factor(dB/m) + Cable Factor(dB) – Pre-Amplifier Factor(dB)
3. Margin value = Emission Level – Limit value
4. The other emission levels were very low against the limit of frequency range 30MHz~1000MHz.
5. The emission levels were very low against the limit of frequency range 9kHz~30MHz: the amplitude of spurious emissions attenuated more than 20 dB below the permissible value to be report.

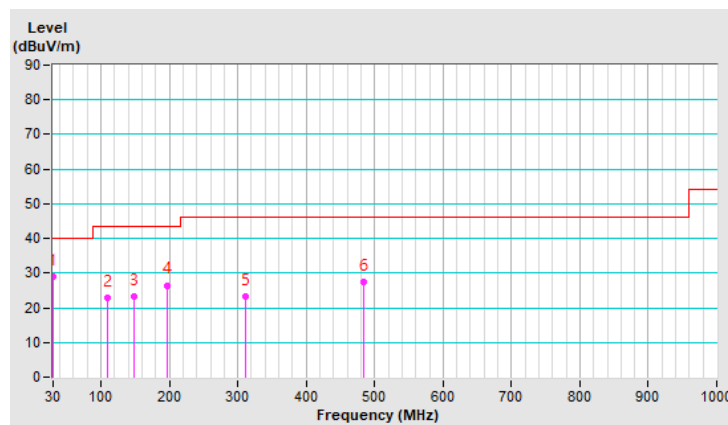

Channel	TX Channel 149	Detector Function	Quasi-Peak (QP)
Frequency Range	30MHz ~ 1GHz		

Antenna Polarity & Test Distance : Vertical at 3 m								
No	Frequency (MHz)	Emission Level (dBuV/m)	Limit (dBuV/m)	Margin (dB)	Antenna Height (m)	Table Angle (Degree)	Raw Value (dBuV)	Correction Factor (dB/m)
1	30.11	31.7 QP	40.0	-8.3	1.00 V	287	40.7	-9.0
2	48.79	29.3 QP	40.0	-10.7	1.00 V	301	37.1	-7.8
3	105.22	24.4 QP	43.5	-19.1	1.50 V	199	35.5	-11.1
4	159.96	25.4 QP	43.5	-18.1	1.00 V	183	32.7	-7.3
5	196.77	22.3 QP	43.5	-21.2	1.50 V	178	32.9	-10.6
6	379.76	25.5 QP	46.0	-20.5	1.00 V	347	29.9	-4.4

Remarks:

1. Emission Level(dBuV/m) = Raw Value(dBuV) + Correction Factor(dB/m)
2. Correction Factor(dB/m) = Antenna Factor(dB/m) + Cable Factor(dB) – Pre-Amplifier Factor(dB)
3. Margin value = Emission Level – Limit value
4. The other emission levels were very low against the limit of frequency range 30MHz~1000MHz.
5. The emission levels were very low against the limit of frequency range 9kHz~30MHz: the amplitude of spurious emissions attenuated more than 20 dB below the permissible value to be report.

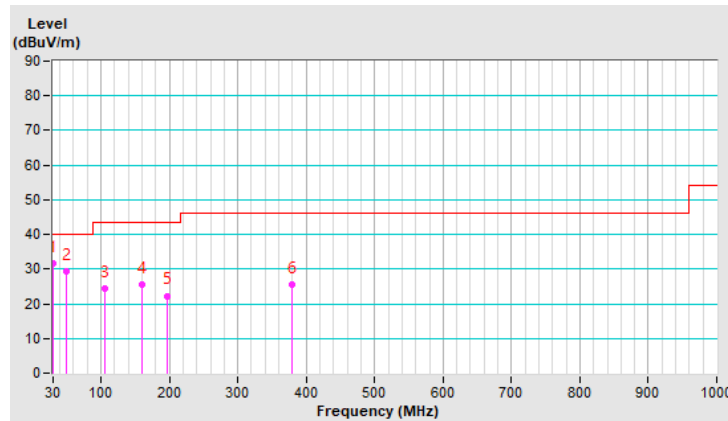

4.2 Conducted Emission Measurement

4.2.1 Limits of Conducted Emission Measurement

Frequency (MHz)	Conducted Limit (dBuV)	
	Quasi-peak	Average
0.15 - 0.5	66 - 56	56 - 46
0.50 - 5.0	56	46
5.0 - 30.0	60	50

Note: 1. The lower limit shall apply at the transition frequencies.

2. The limit decreases in line with the logarithm of the frequency in the range of 0.15 to 0.50MHz.

4.2.2 Test Instruments

DESCRIPTION & MANUFACTURER	MODEL NO.	SERIAL NO.	CALIBRATED DATE	CALIBRATED UNTIL
Test Receiver R&S	ESCS 30	847124/029	Oct. 23, 2019	Oct. 22, 2020
Line-Impedance Stabilization Network (for EUT) R&S	ESH3-Z5	848773/004	Oct. 23, 2019	Oct. 22, 2020
Line-Impedance Stabilization Network (for Peripheral) R&S	ESH3-Z5	835239/001	Mar. 19, 2020	Mar. 18, 2021
50 ohms Terminator	50	3	Oct. 23, 2019	Oct. 22, 2020
RF Cable	5D-FB	COCCAB-001	Sep. 27, 2019	Sep. 26, 2020
Fixed attenuator EMCI	STI02-2200-10	005	Aug. 30, 2019	Aug. 29, 2020
Software BVADT	BVADT_Cond_ V7.3.7.4	NA	NA	NA

Note:

1. The calibration interval of the above test instruments are 12 months and the calibrations are traceable to NML/ROC and NIST/USA.
2. The test was performed in Conduction 1.
- 3 Tested Date: July 27, 2020

4.2.3 Test Procedure

- The EUT was placed 0.4 meters from the conducting wall of the shielded room with EUT being connected to the power mains through a line impedance stabilization network (LISN). Other support units were connected to the power mains through another LISN. The two LISNs provide 50 ohm/ 50uH of coupling impedance for the measuring instrument.
- Both lines of the power mains connected to the EUT were checked for maximum conducted interference.
- The frequency range from 150kHz to 30MHz was searched. Emission levels under (Limit - 20dB) was not recorded.

NOTE: All modes of operation were investigated and the worst-case emissions are reported.

4.2.4 Deviation from Test Standard

No deviation.

4.2.5 Test Setup

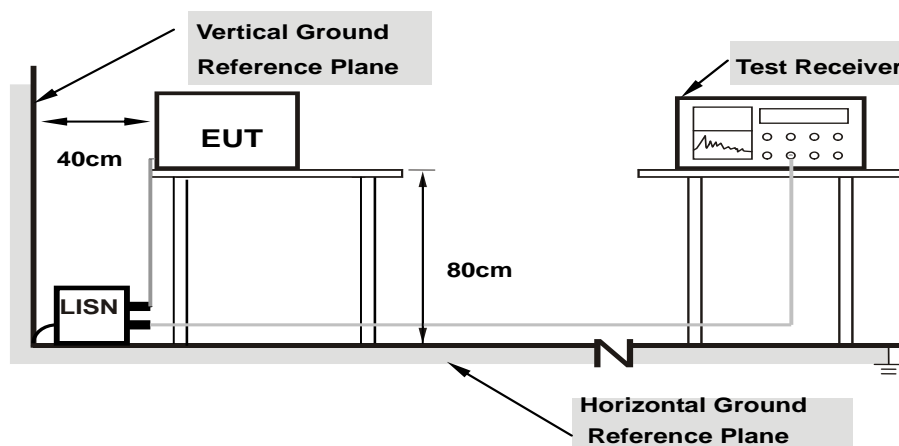

Note: 1.Support units were connected to second LISN.

For the actual test configuration, please refer to the attached file (Test Setup Photo).

4.2.6 EUT Operating Condition

Same as 4.1.6.

4.2.7 Test Results

Phase	Line (L)	Detector Function	Quasi-Peak (QP) / Average (AV)
-------	----------	-------------------	--------------------------------

No	Freq. [MHz]	Corr. Factor	Reading Value [dB (uV)]		Emission Level [dB (uV)]		Limit [dB (uV)]		Margin (dB)	
		(dB)	Q.P.	AV.	Q.P.	AV.	Q.P.	AV.	Q.P.	AV.
	1	0.15000	9.98	36.14	21.02	46.12	31.00	66.00	56.00	-19.88
2	0.23984	9.99	26.13	6.99	36.12	16.98	62.10	52.10	-25.98	-35.12
3	0.26328	10.00	17.39	7.87	27.39	17.87	61.33	51.33	-33.94	-33.46
4	0.30234	10.00	26.29	14.75	36.29	24.75	60.18	50.18	-23.89	-25.43
5	0.86484	10.04	9.17	2.57	19.21	12.61	56.00	46.00	-36.79	-33.39
6	15.07813	11.04	12.02	5.13	23.06	16.17	60.00	50.00	-36.94	-33.83

Remarks:

1. Q.P. and AV. are abbreviations of quasi-peak and average individually.
2. The emission levels of other frequencies were very low against the limit.
3. Margin value = Emission level – Limit value
4. Correction factor = Insertion loss + Cable loss
5. Emission Level = Correction Factor + Reading Value

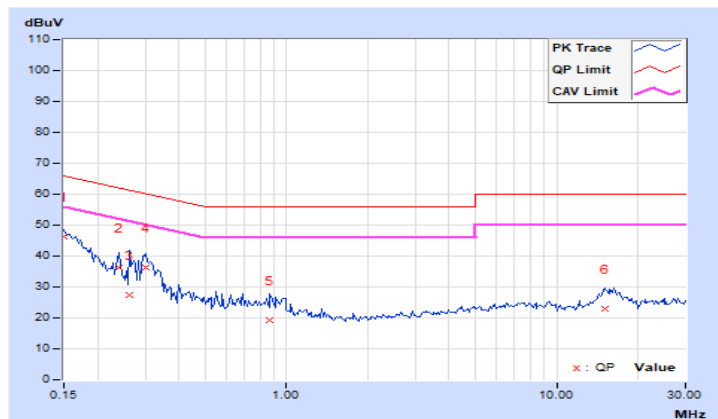

Phase	Neutral (N)	Detector Function	Quasi-Peak (QP) / Average (AV)
-------	-------------	-------------------	--------------------------------

No	Freq. [MHz]	Corr. Factor	Reading Value [dB (uV)]		Emission Level [dB (uV)]		Limit [dB (uV)]		Margin (dB)	
		(dB)	Q.P.	AV.	Q.P.	AV.	Q.P.	AV.	Q.P.	AV.
	1	0.15000	9.99	37.10	21.75	47.09	31.74	66.00	56.00	-18.91
2	0.17344	9.99	32.46	16.87	42.45	26.86	64.79	54.79	-22.34	-27.93
3	0.24375	10.01	23.53	12.28	33.54	22.29	61.97	51.97	-28.43	-29.68
4	0.29453	10.01	28.92	24.74	38.93	34.75	60.40	50.40	-21.47	-15.65
5	0.29844	10.01	29.72	23.78	39.73	33.79	60.29	50.29	-20.56	-16.50
6	15.37891	10.89	15.01	8.43	25.90	19.32	60.00	50.00	-34.10	-30.68

Remarks:

1. Q.P. and AV. are abbreviations of quasi-peak and average individually.
2. The emission levels of other frequencies were very low against the limit.
3. Margin value = Emission level – Limit value
4. Correction factor = Insertion loss + Cable loss
5. Emission Level = Correction Factor + Reading Value

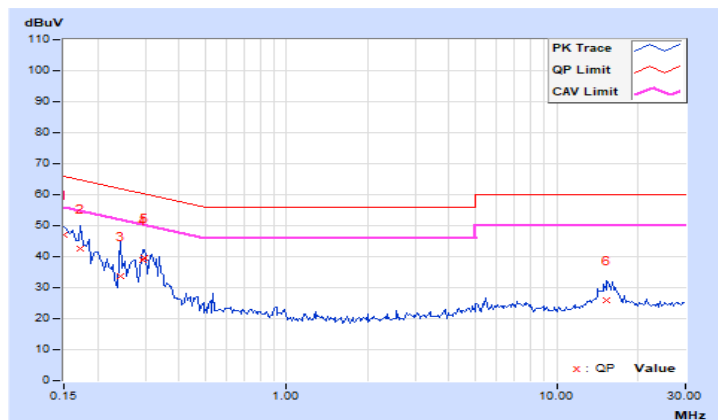

4.3 Transmit Power Measurement

4.3.1 Limits of Transmit Power Measurement

Operation Band	EUT Category		Limit
U-NII-1		Outdoor Access Point	1 Watt (30 dBm) (Max. e.i.r.p \leq 125mW(21 dBm) at any elevation angle above 30 degrees as measured from the horizon)
		Fixed point-to-point Access Point	1 Watt (30 dBm)
	√	Indoor Access Point	1 Watt (30 dBm)
		Client device	250mW (24 dBm)
U-NII-2A			250mW (24 dBm) or 11 dBm+10 log B*
U-NII-2C			250mW (24 dBm) or 11 dBm+10 log B*
U-NII-3	√		1 Watt (30 dBm)

*B is the 26 dB emission bandwidth in megahertz

Per KDB 662911 Method of conducted output power measurement on IEEE 802.11 devices,

Array Gain = 0 dB (i.e., no array gain) for $N_{ANT} \leq 4$;

Array Gain = 0 dB (i.e., no array gain) for channel widths ≥ 40 MHz for any N_{ANT} ;

Array Gain = $5 \log(N_{ANT}/N_{SS})$ dB or 3 dB, whichever is less for 20-MHz channel widths with $N_{ANT} \geq 5$.

For power measurements on all other devices: Array Gain = $10 \log(N_{ANT}/N_{SS})$ dB.

4.3.2 Test Setup

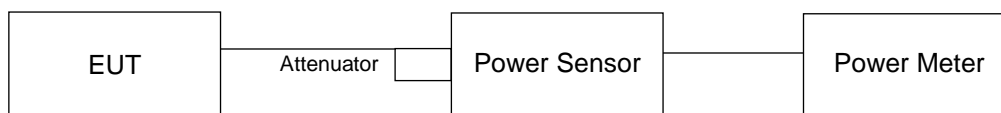

4.3.3 Test Instruments

Refer to section 4.1.2 to get information of above instrument.

4.3.4 Test Procedure

Method PM is used to perform output power measurement, trigger and gating function of wide band power meter is enabled to measure max output power of TX on burst. Duty factor is not added to measured value.

4.3.5 Deviation from Test Standard

No deviation.

4.3.6 EUT Operating Condition

The software provided by client to enable the EUT under transmission condition continuously at lowest, middle and highest channel frequencies individually.

4.3.7 Test Results

CDD Mode

802.11a

Chan.	Chan. Freq. (MHz)	Maximum Conducted Power (dBm)		Total Power (mW)	Total Power (dBm)	Limit (dBm)	Pass / Fail
		Chain 0	Chain 1				
36	5180	23.46	23.09	425.524	26.29	30.00	Pass
40	5200	26.13	25.89	798.354	29.02	30.00	Pass
48	5240	26.23	25.84	803.466	29.05	30.00	Pass
149	5745	26.27	26.66	887.09	29.48	30.00	Pass
157	5785	26.48	26.39	880.143	29.45	30.00	Pass
165	5825	26.49	26.38	880.166	29.45	30.00	Pass

802.11ac (VHT20)

Chan.	Chan. Freq. (MHz)	Maximum Conducted Power (dBm)		Total Power (mW)	Total Power (dBm)	Limit (dBm)	Pass / Fail
		Chain 0	Chain 1				
36	5180	22.57	22.45	356.51	25.52	30.00	Pass
40	5200	26.07	26.09	811.019	29.09	30.00	Pass
48	5240	26.12	26.04	811.051	29.09	30.00	Pass
149	5745	26.09	26.26	829.112	29.19	30.00	Pass
157	5785	26.25	26.23	841.455	29.25	30.00	Pass
165	5825	26.35	26.23	851.278	29.30	30.00	Pass

802.11ac (VHT40)

Chan.	Chan. Freq. (MHz)	Maximum Conducted Power (dBm)		Total Power (mW)	Total Power (dBm)	Limit (dBm)	Pass / Fail
		Chain 0	Chain 1				
38	5190	20.44	20.15	214.177	23.31	30.00	Pass
46	5230	25.60	25.81	744.144	28.72	30.00	Pass
151	5755	26.12	26.51	856.974	29.33	30.00	Pass
159	5795	26.05	26.42	841.248	29.25	30.00	Pass

802.11ac (VHT80)

Chan.	Chan. Freq. (MHz)	Maximum Conducted Power (dBm)		Total Power (mW)	Total Power (dBm)	Limit (dBm)	Pass / Fail
		Chain 0	Chain 1				
42	5210	20.14	20.14	206.552	23.15	30.00	Pass
155	5775	24.47	24.59	567.638	27.54	30.00	Pass

802.11ax (HE20)

Chan.	Chan. Freq. (MHz)	Maximum Conducted Power (dBm)		Total Power (mW)	Total Power (dBm)	Limit (dBm)	Pass / Fail
		Chain 0	Chain 1				
36	5180	22.75	22.59	369.916	25.68	30.00	Pass
40	5200	26.26	26.20	839.538	29.24	30.00	Pass
48	5240	26.26	26.24	843.395	29.26	30.00	Pass
149	5745	26.21	26.45	859.401	29.34	30.00	Pass
157	5785	26.36	26.42	871.045	29.40	30.00	Pass
165	5825	26.41	26.34	868.049	29.39	30.00	Pass

802.11ax (HE40)

Chan.	Chan. Freq. (MHz)	Maximum Conducted Power (dBm)		Total Power (mW)	Total Power (dBm)	Limit (dBm)	Pass / Fail
		Chain 0	Chain 1				
38	5190	20.53	20.16	216.732	23.36	30.00	Pass
46	5230	25.65	25.94	759.927	28.81	30.00	Pass
151	5755	26.16	26.67	877.563	29.43	30.00	Pass
159	5795	26.17	26.62	873.198	29.41	30.00	Pass

802.11ax (HE80)

Chan.	Chan. Freq. (MHz)	Maximum Conducted Power (dBm)		Total Power (mW)	Total Power (dBm)	Limit (dBm)	Pass / Fail
		Chain 0	Chain 1				
42	5210	20.25	20.21	210.88	23.24	30.00	Pass
155	5775	24.66	24.75	590.953	27.72	30.00	Pass

Beamforming Mode

802.11ac (VHT20)

Chan.	Chan. Freq. (MHz)	Maximum Conducted Power (dBm)		Total Power (mW)	Total Power (dBm)	Limit (dBm)	Pass / Fail
		Chain 0	Chain 1				
36	5180	22.57	22.45	356.51	25.52	30.00	Pass
40	5200	26.07	26.09	811.019	29.09	30.00	Pass
48	5240	26.12	26.04	811.051	29.09	30.00	Pass
149	5745	26.09	26.26	829.112	29.19	29.99	Pass
157	5785	26.25	26.23	841.455	29.25	29.99	Pass
165	5825	26.35	26.23	851.278	29.30	29.99	Pass

Note: 1. For U-NII-1: The directional gain = 5.24 dBi < 6 dBi, so the power limit shall not be reduced.
 2. For U-NII-3: The directional gain = 6.01 dBi > 6 dBi, so the power limit shall be reduced to $30-(6.01-6) = 29.99\text{dBm}$.

802.11ac (VHT40)

Chan.	Chan. Freq. (MHz)	Maximum Conducted Power (dBm)		Total Power (mW)	Total Power (dBm)	Limit (dBm)	Pass / Fail
		Chain 0	Chain 1				
38	5190	20.44	20.15	214.177	23.31	30.00	Pass
46	5230	25.60	25.81	744.144	28.72	30.00	Pass
151	5755	26.12	26.51	856.974	29.33	29.99	Pass
159	5795	26.05	26.42	841.248	29.25	29.99	Pass

Note: 1. For U-NII-1: The directional gain = 5.24 dBi < 6 dBi, so the power limit shall not be reduced.
 2. For U-NII-3: The directional gain = 6.01 dBi > 6 dBi, so the power limit shall be reduced to $30-(6.01-6) = 29.99\text{dBm}$.

802.11ac (VHT80)

Chan.	Chan. Freq. (MHz)	Maximum Conducted Power (dBm)		Total Power (mW)	Total Power (dBm)	Limit (dBm)	Pass / Fail
		Chain 0	Chain 1				
42	5210	20.14	20.14	206.552	23.15	30.00	Pass
155	5775	24.47	24.59	567.638	27.54	29.99	Pass

Note: 1. For U-NII-1: The directional gain = 5.24 dBi < 6 dBi, so the power limit shall not be reduced.
 2. For U-NII-3: The directional gain = 6.01 dBi > 6 dBi, so the power limit shall be reduced to $30-(6.01-6) = 29.99\text{dBm}$.

802.11ax (HE20)

Chan.	Chan. Freq. (MHz)	Maximum Conducted Power (dBm)		Total Power (mW)	Total Power (dBm)	Limit (dBm)	Pass / Fail
		Chain 0	Chain 1				
36	5180	22.75	22.59	369.916	25.68	30.00	Pass
40	5200	26.26	26.20	839.538	29.24	30.00	Pass
48	5240	26.26	26.24	843.395	29.26	30.00	Pass
149	5745	26.21	26.45	859.401	29.34	29.99	Pass
157	5785	26.36	26.42	871.045	29.40	29.99	Pass
165	5825	26.41	26.34	868.049	29.39	29.99	Pass

Note:

1. For U-NII-1: The directional gain = 5.24 dBi < 6 dBi, so the power limit shall not be reduced.
2. For U-NII-3: The directional gain = 6.01 dBi > 6 dBi, so the power limit shall be reduced to $30-(6.01-6) = 29.99\text{dBm}$.

802.11ax (HE40)

Chan.	Chan. Freq. (MHz)	Maximum Conducted Power (dBm)		Total Power (mW)	Total Power (dBm)	Limit (dBm)	Pass / Fail
		Chain 0	Chain 1				
38	5190	20.53	20.16	216.732	23.36	30.00	Pass
46	5230	25.65	25.94	759.927	28.81	30.00	Pass
151	5755	26.16	26.67	877.563	29.43	29.99	Pass
159	5795	26.17	26.62	873.198	29.41	29.99	Pass

Note:

1. For U-NII-1: The directional gain = 5.24 dBi < 6 dBi, so the power limit shall not be reduced.
2. For U-NII-3: The directional gain = 6.01 dBi > 6 dBi, so the power limit shall be reduced to $30-(6.01-6) = 29.99\text{dBm}$.

802.11ax (HE80)

Chan.	Chan. Freq. (MHz)	Maximum Conducted Power (dBm)		Total Power (mW)	Total Power (dBm)	Limit (dBm)	Pass / Fail
		Chain 0	Chain 1				
42	5210	20.25	20.21	210.88	23.24	30.00	Pass
155	5775	24.66	24.75	590.953	27.72	29.99	Pass

Note:

1. For U-NII-1: The directional gain = 5.24 dBi < 6 dBi, so the power limit shall not be reduced.
2. For U-NII-3: The directional gain = 6.01 dBi > 6 dBi, so the power limit shall be reduced to $30-(6.01-6) = 29.99\text{dBm}$.

4.4 Occupied Bandwidth Measurement

4.4.1 Test Setup

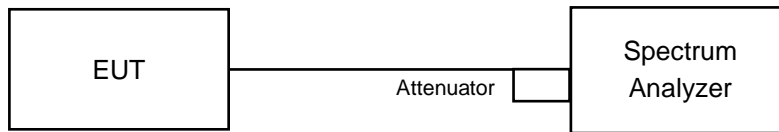

4.4.2 Test Instruments

Refer to section 4.1.2 to get information of above instrument.

4.4.3 Test Procedure

The transmitter output was connected to the spectrum analyzer through an attenuator. The bandwidth of the fundamental frequency was measured by spectrum analyzer with resolution bandwidth in the range of 1% to 5% of the anticipated emission bandwidth, and a video bandwidth at least 3x the resolution bandwidth and set the detector to SAMPLE. The width of a frequency band such that, below the lower and above the upper frequency limits, the mean powers emitted are each equal to a specified percentage 0.5% of the total mean power of a given emission.

4.4.4 Test Results

CDD Mode

802.11a

Channel	Channel Frequency (MHz)	Occupied Bandwidth (MHz)	
		Chain 0	Chain 1
36	5180	17.04	17.16
40	5200	17.64	17.28
48	5240	17.76	17.28
149	5745	17.88	19.08
157	5785	17.76	18.72
165	5825	17.88	18.36

802.11ax (HE20)

Channel	Channel Frequency (MHz)	Occupied Bandwidth (MHz)	
		Chain 0	Chain 1
36	5180	19.08	19.2
40	5200	19.44	19.2
48	5240	19.56	19.32
149	5745	19.44	19.8
157	5785	19.44	19.8
165	5825	19.44	19.8

802.11ax (HE40)

Channel	Channel Frequency (MHz)	Occupied Bandwidth (MHz)	
		Chain 0	Chain 1
38	5190	37.68	37.92
46	5230	38.4	38.16
151	5755	38.16	40.32
159	5795	38.4	40.32

802.11ax (HE80)

Channel	Channel Frequency (MHz)	Occupied Bandwidth (MHz)	
		Chain 0	Chain 1
42	5210	76.8	77.28
155	5775	77.28	77.76

Spectrum Plot of Max. Value

802.11a_Chain 1 / CH149

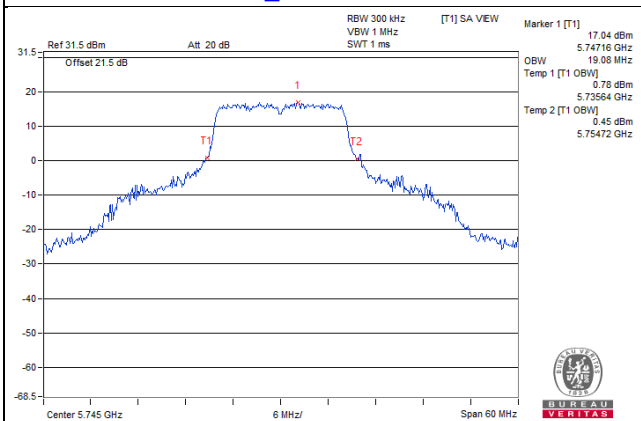

802.11ax (HE20)_Chain 1 / CH149

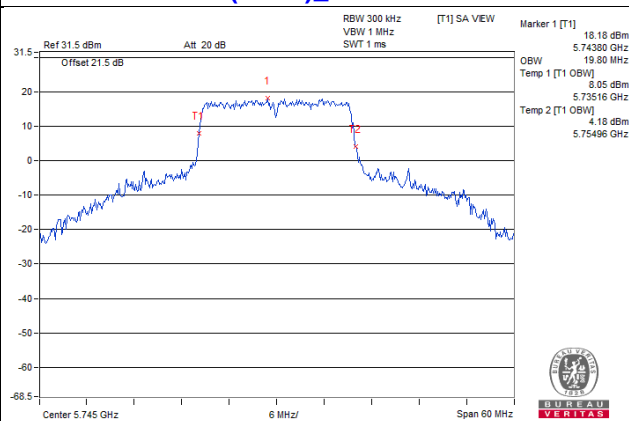

802.11ax (HE40)_Chain 1 / CH151

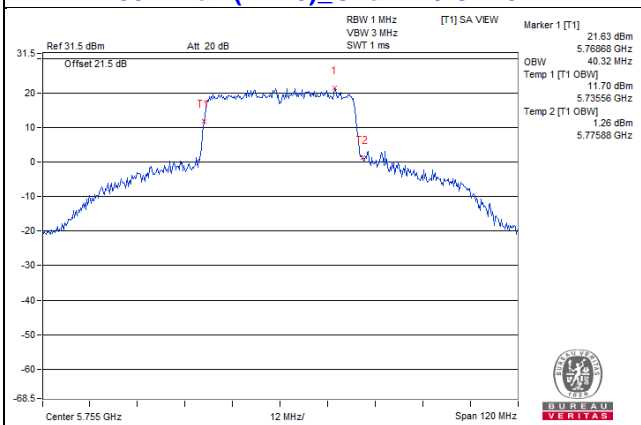

802.11ax (HE80)_Chain 1 / CH155

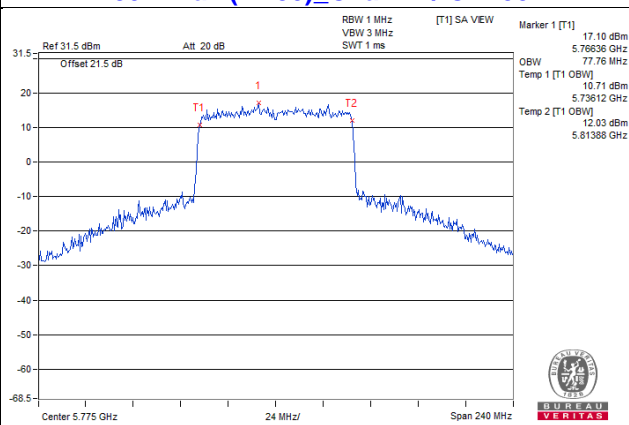

**Spectrum Plot for near by DFS band
(DFS is required, if 99% OCP straddle into U-NII-2A band)**

802.11a_Chain 0 / CH48

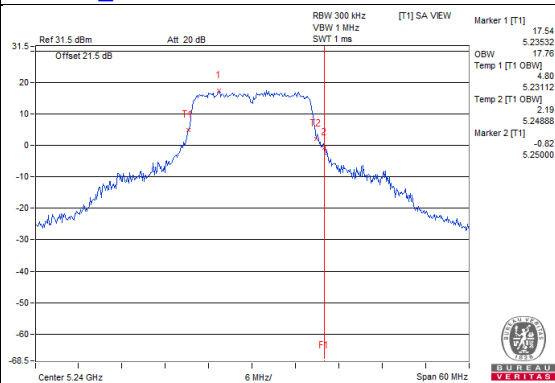

802.11a_Chain 1 / CH48

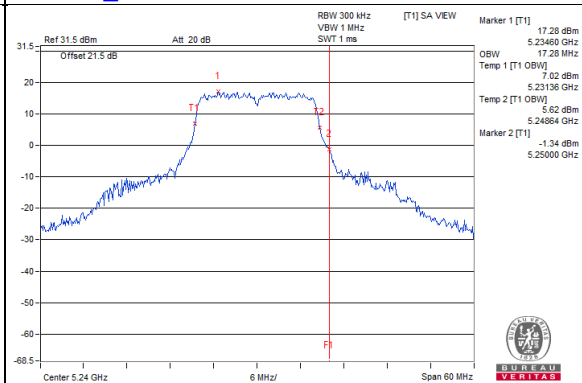

802.11ax (HE20)_Chain 0 / CH48

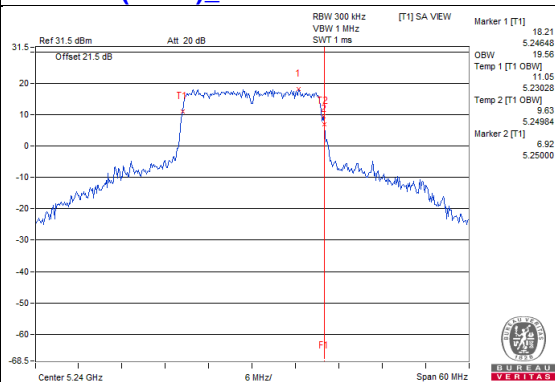

802.11ax (HE20)_Chain 1 / CH48

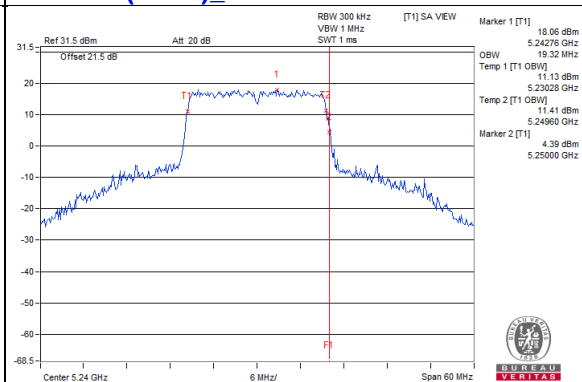

802.11ax (HE40)_Chain 0 / CH46

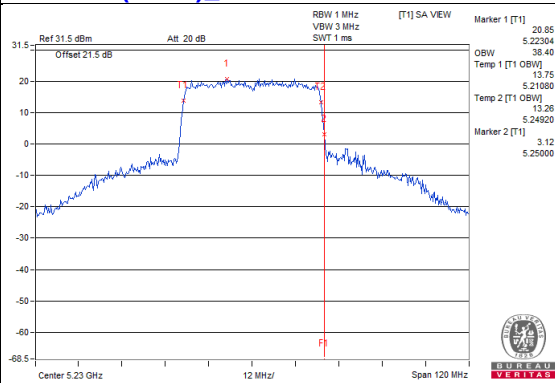

802.11ax (HE40)_Chain 1 / CH46

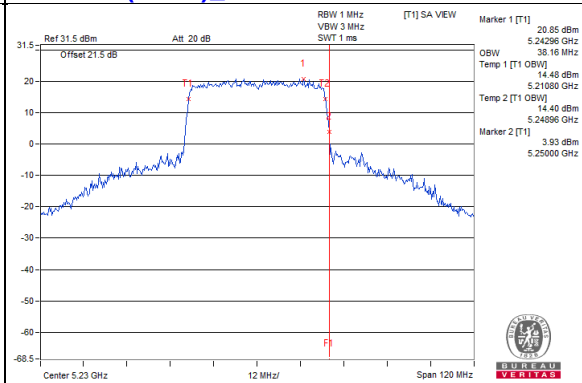

802.11ax (HE80)_Chain 0 / CH42

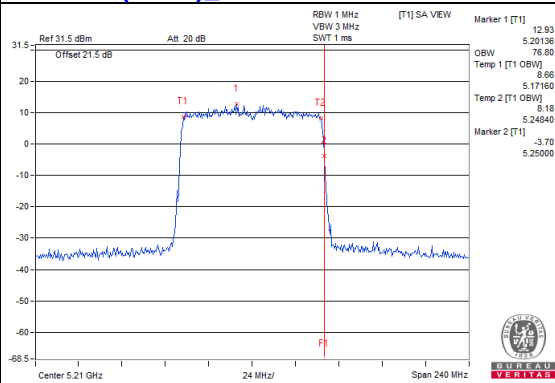

802.11ax (HE80)_Chain 1 / CH42

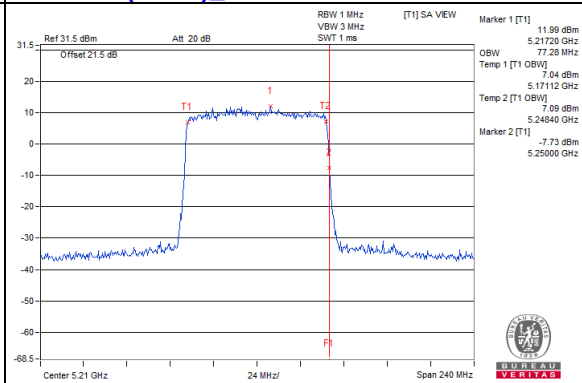

Spectrum Plot for near by DFS band
(DFS is required, if 99% OCP straddle into U-NII-2C band)

802.11a_Chain 0 / CH149

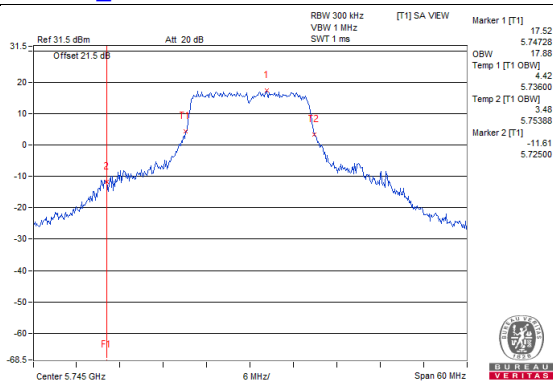

802.11a_Chain 1 / CH149

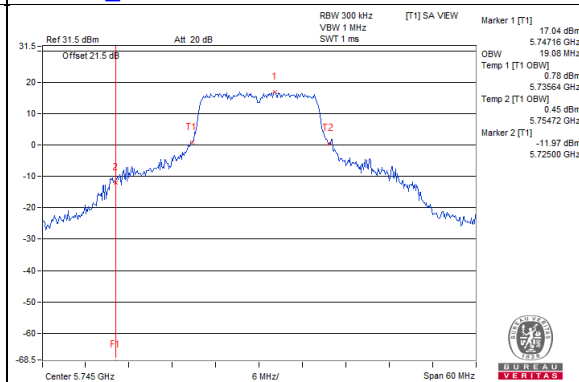

802.11ax (HE20)_Chain 0 / CH149

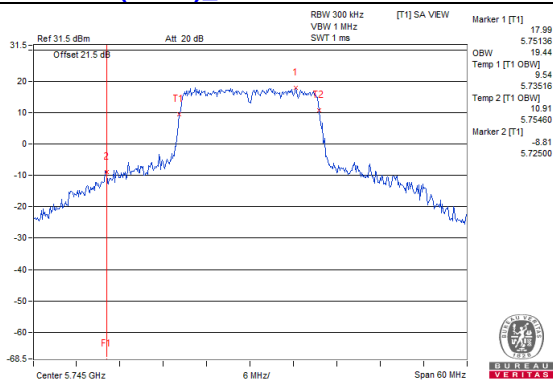

802.11ax (HE20)_Chain 1 / CH149

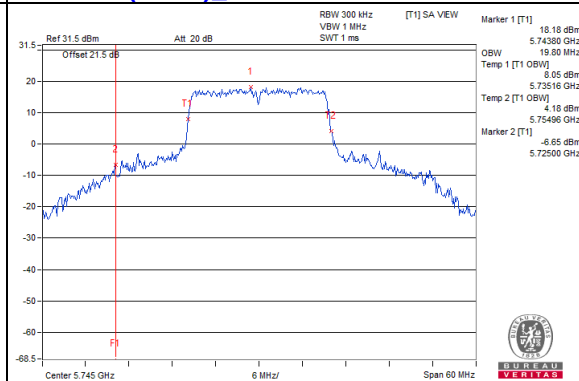

802.11ax (HE40)_Chain 0 / CH151

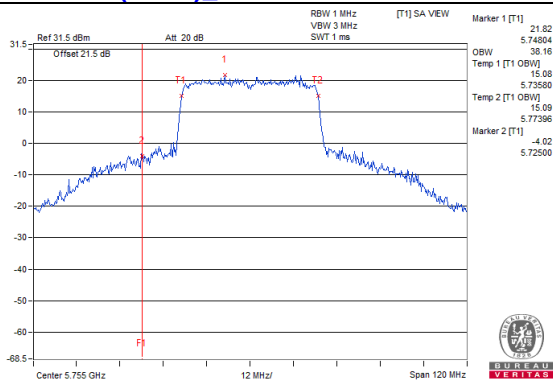

802.11ax (HE40)_Chain 1 / CH151

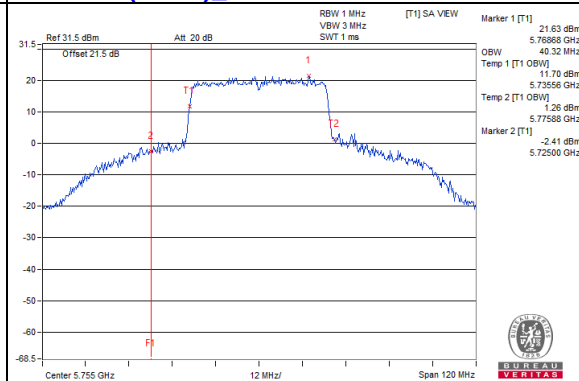

802.11ax (HE80)_Chain 0 / CH155

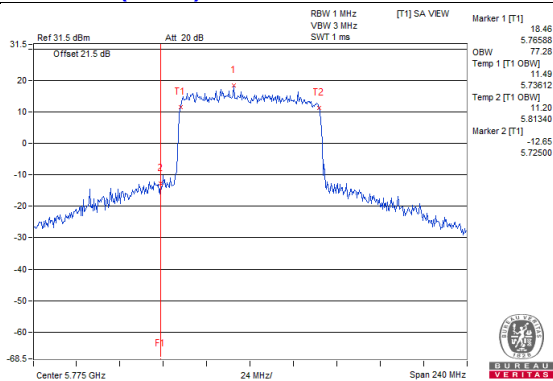

802.11ax (HE80)_Chain 1 / CH155

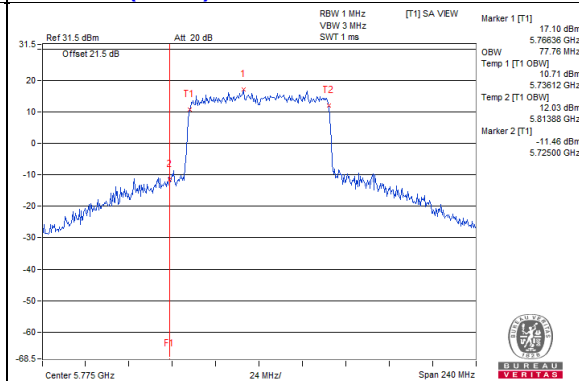

4.5 Peak Power Spectral Density Measurement

4.5.1 Limits of Peak Power Spectral Density Measurement

Operation Band	EUT Category		Limit
U-NII-1		Outdoor Access Point	17dBm/ MHz
		Fixed point-to-point Access Point	
	√	Indoor Access Point	
		Client device	
U-NII-2A			11dBm/ MHz
U-NII-2C			11dBm/ MHz
U-NII-3	√		30dBm/ 500kHz

4.5.2 Test Setup

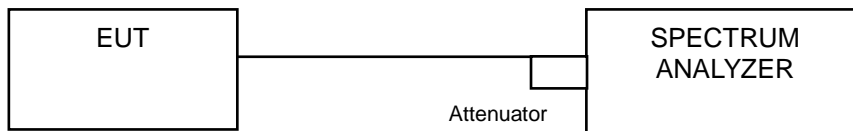

4.5.3 Test Instruments

Refer to section 4.1.2 to get information of above instrument.

4.5.4 Test Procedure

For U-NII-1 band:

Using method SA-1

1. Set span to encompass the entire emission bandwidth (EBW) of the signal.
2. Set RBW = 1 MHz, Set VBW ≥ 3 MHz, Detector = RMS
3. Sweep time = auto, trigger set to "free run".
4. Trace average at least 100 traces in power averaging mode.
5. Record the max value

For U-NII-3:

1. Set span to encompass the entire emission bandwidth (EBW) of the signal.
2. Set RBW = 300 kHz, Set VBW ≥ 1 MHz, Detector = RMS
3. Use the peak marker function to determine the maximum power level in any 300 kHz band segment within the fundamental EBW.
4. Scale the observed power level to an equivalent value in 500 kHz by adjusting (reducing) the measured power by a bandwidth correction factor (BWCF) where $BWCF = 10\log(500\text{ kHz}/300\text{ kHz})$
5. Sweep time = auto, trigger set to "free run".
6. Trace average at least 100 traces in power averaging mode.
7. Record the max value

4.5.5 Deviation from Test Standard

No deviation.

4.5.6 EUT Operating Condition

Same as Item 4.3.6.

4.5.7 Test Results

For U-NII-1:

CDD Mode

802.11a

Chan.	Chan. Freq. (MHz)	PSD w/o Duty Factor (dBm/MHz)		Total PSD (dBm/MHz)	Max. PSD Limit (dBm/MHz)	Pass / Fail
		Chain 0	Chain 1			
36	5180	10.16	9.93	13.06	17.00	PASS
40	5200	13.61	13.70	16.67	17.00	PASS
48	5240	13.56	13.50	16.54	17.00	PASS

- Note: 1. Method a) of power density measurement of KDB 662911 is using for calculating total power density. Total power density is summing entire spectra across corresponding frequency bins on the various outputs by computer.
 2. The directional gain =5.24dBi < 6 dBi, so the power density limit shall not be reduced.

802.11ax (HE20)

Chan.	Chan. Freq. (MHz)	PSD w/o Duty Factor (dBm/MHz)		Total PSD (dBm/MHz)	Max. PSD Limit (dBm/MHz)	Pass / Fail
		Chain 0	Chain 1			
36	5180	8.90	8.99	11.96	17.00	PASS
40	5200	12.69	12.64	15.68	17.00	PASS
48	5240	12.65	12.59	15.63	17.00	PASS

- Note: 1. Method a) of power density measurement of KDB 662911 is using for calculating total power density. Total power density is summing entire spectra across corresponding frequency bins on the various outputs by computer.
 2. The directional gain =5.24dBi < 6 dBi, so the power density limit shall not be reduced.

802.11ax (HE40)

Chan.	Chan. Freq. (MHz)	PSD w/o Duty Factor (dBm/MHz)		Total PSD (dBm/MHz)	Max. PSD Limit (dBm/MHz)	Pass / Fail
		Chain 0	Chain 1			
38	5190	3.83	3.78	6.82	17.00	PASS
46	5230	9.09	9.35	12.23	17.00	PASS

- Note: 1. Method a) of power density measurement of KDB 662911 is using for calculating total power density. Total power density is summing entire spectra across corresponding frequency bins on the various outputs by computer.
 2. The directional gain =5.24dBi < 6 dBi, so the power density limit shall not be reduced.

802.11ax (HE80)

Chan.	Chan. Freq. (MHz)	PSD w/o Duty Factor (dBm/MHz)		Total PSD (dBm/MHz)	Max. PSD Limit (dBm/MHz)	Pass / Fail
		Chain 0	Chain 1			
42	5210	0.84	0.75	3.81	17.00	PASS

- Note: 1. Method a) of power density measurement of KDB 662911 is using for calculating total power density. Total power density is summing entire spectra across corresponding frequency bins on the various outputs by computer.
 2. The directional gain =5.24dBi < 6 dBi, so the power density limit shall not be reduced.

Spectrum Plot of Worst Value

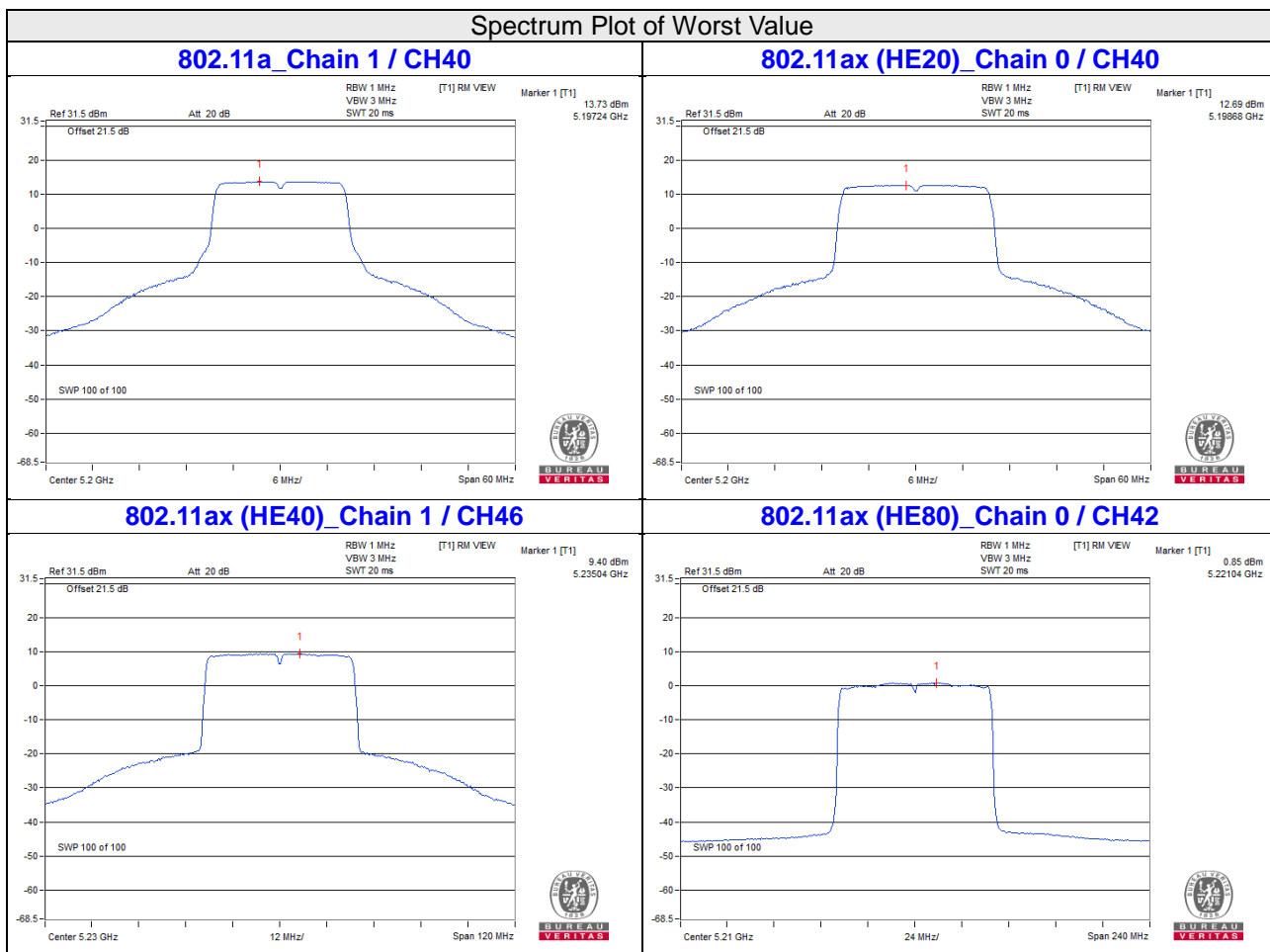

For U-NII-3:

CDD Mode

802.11a

Chan.	Chan. Freq. (MHz)	PSD (dBm/300kHz)		Total PSD (mW/300kHz)	Total PSD (dBm/300kHz)	Total PSD (dBm/500kHz)	PSD Limit (dBm/500kHz)	Pass / Fail
		Chain 0	Chain 1					
149	5745	4.68	4.51	5.768	7.61	9.83	29.99	PASS
157	5785	4.57	4.56	5.728	7.58	9.80	29.99	PASS
165	5825	4.81	4.35	5.754	7.60	9.82	29.99	PASS

- Note: 1. Method b) Measure and sum spectral maxima across the outputs of KDB 662911 is using for calculating total power density.
 2. The directional gain = 6.01 dBi > 6 dBi , so the power density limit shall be reduced to $30-(6.01-6) = 29.99\text{dBm}$.

802.11ax (HE20)

Chan.	Chan. Freq. (MHz)	PSD (dBm/300kHz)		Total PSD (mW/300kHz)	Total PSD (dBm/300kHz)	Total PSD (dBm/500kHz)	PSD Limit (dBm/500kHz)	Pass / Fail
		Chain 0	Chain 1					
149	5745	3.28	3.28	4.256	6.29	8.51	29.99	PASS
157	5785	3.26	3.44	4.325	6.36	8.58	29.99	PASS
165	5825	3.37	3.37	4.345	6.38	8.60	29.99	PASS

- Note: 1. Method b) Measure and sum spectral maxima across the outputs of KDB 662911 is using for calculating total power density.
 2. The directional gain = 6.01 dBi > 6 dBi , so the power density limit shall be reduced to $30-(6.01-6) = 29.99\text{dBm}$.

802.11ax (HE40)

Chan.	Chan. Freq. (MHz)	PSD (dBm/300kHz)		Total PSD (mW/300kHz)	Total PSD (dBm/300kHz)	Total PSD (dBm/500kHz)	PSD Limit (dBm/500kHz)	Pass / Fail
		Chain 0	Chain 1					
151	5755	0.33	0.71	2.254	3.53	5.75	29.99	PASS
159	5795	0.55	0.70	2.312	3.64	5.86	29.99	PASS

- Note: 1. Method b) Measure and sum spectral maxima across the outputs of KDB 662911 is using for calculating total power density.
 2. The directional gain = 6.01 dBi > 6 dBi , so the power density limit shall be reduced to $30-(6.01-6) = 29.99\text{dBm}$.

802.11ax (HE80)

Chan.	Chan. Freq. (MHz)	PSD (dBm/300kHz)		Total PSD (mW/300kHz)	Total PSD (dBm/300kHz)	Total PSD (dBm/500kHz)	PSD Limit (dBm/500kHz)	Pass / Fail
		Chain 0	Chain 1					
155	5775	-3.82	-3.85	0.8279	-0.82	1.40	29.99	PASS

- Note: 1. Method b) Measure and sum spectral maxima across the outputs of KDB 662911 is using for calculating total power density.
 2. The directional gain = 6.01 dBi > 6 dBi , so the power density limit shall be reduced to 30-(6.01-6) = 29.99dBm.

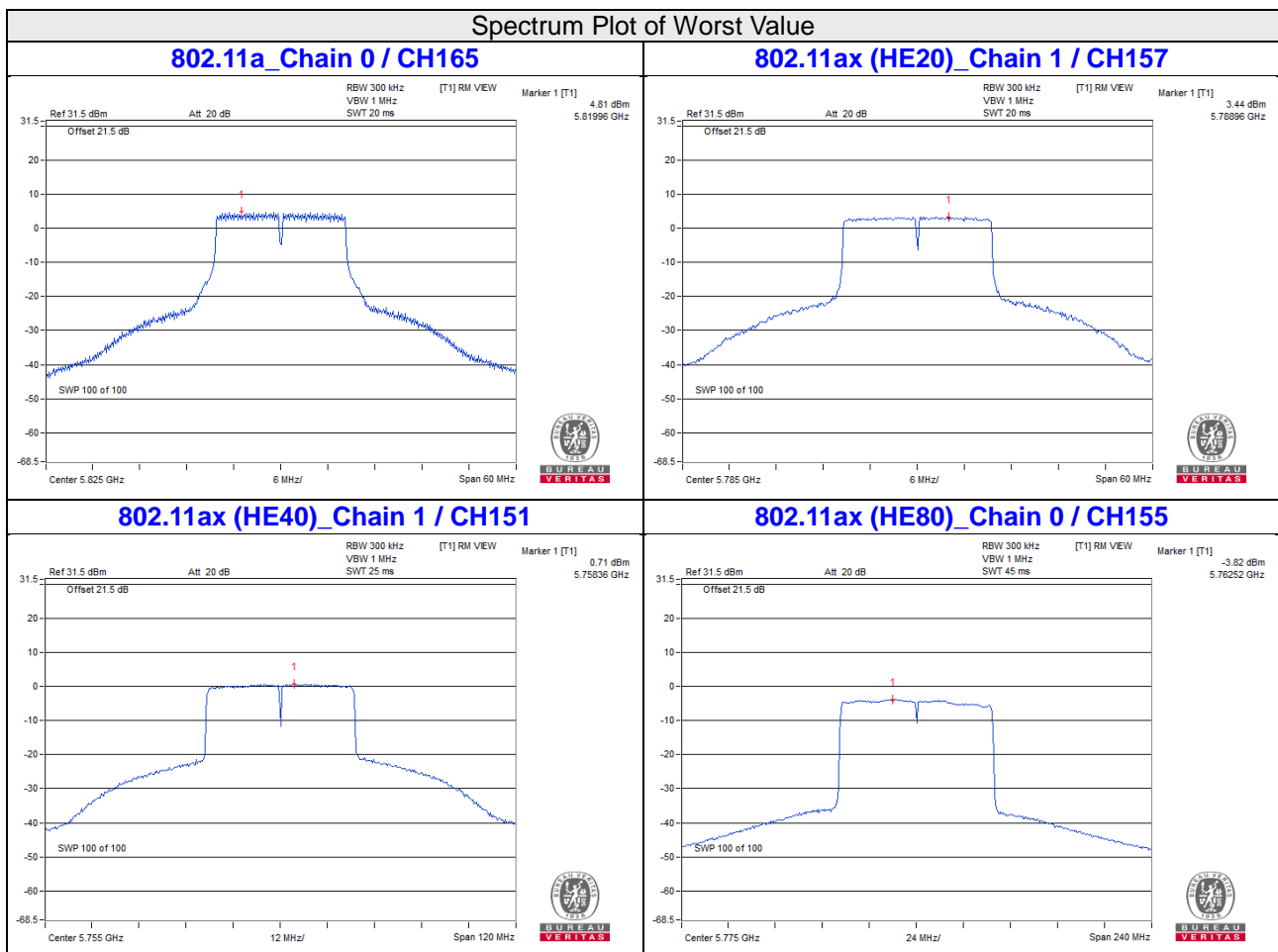

4.6 Frequency Stability Measurement

4.6.1 Limits of Frequency Stability Measurement

The frequency of the carrier signal shall be maintained within band of operation

4.6.2 Test Setup

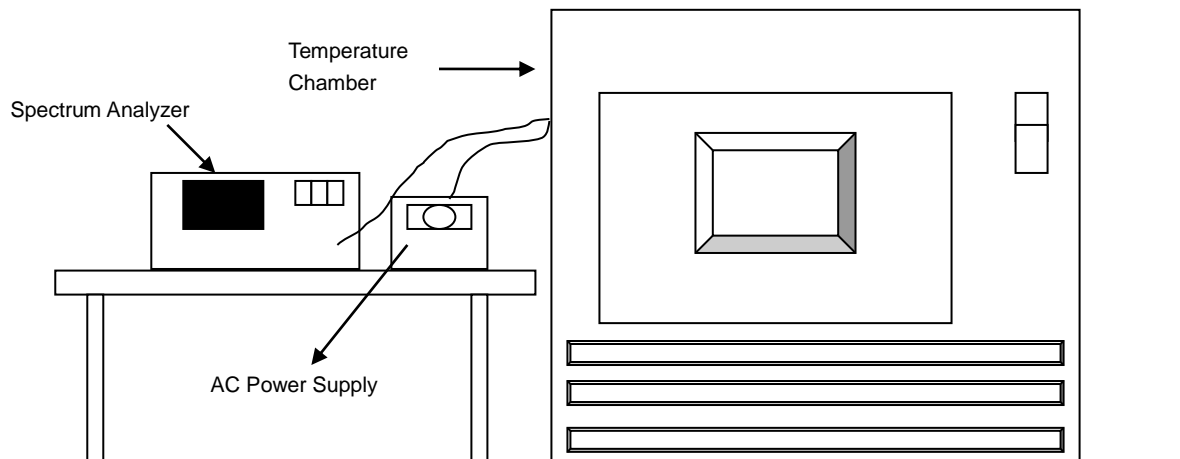

4.6.3 Test Instruments

Refer to section 4.1.2 to get information of above instrument.

4.6.4 Test Procedure

- The EUT was placed inside the environmental test chamber and powered by nominal AC voltage.
- Turn the EUT on and couple its output to a spectrum analyzer.
- Turn the EUT off and set the chamber to the highest temperature specified.
- Allow sufficient time (approximately 30 min) for the temperature of the chamber to stabilize, turn the EUT on and measure the operating frequency after 2, 5, and 10 Minutes.
- Repeat step (d) with the temperature chamber set to the next desired temperature until measurements down to the lowest specified temperature have been completed.
- The test chamber was allowed to stabilize at +20 degree C for a minimum of 30 Minutes. The supply voltage was then adjusted on the EUT from 85% to 115% and the frequency record.

4.6.5 Deviation from Test Standard

No deviation.

4.6.6 EUT Operating Condition

Set the EUT transmit at un-modulation mode to test frequency stability.

4.6.7 Test Results

Frequency Stability Versus Temp.									
Operating Frequency: 5180 MHz									
TEMP. (°C)	Power Supply (Vac)	0 Minute		2 Minutes		5 Minutes		10 Minutes	
		Measured Frequency (MHz)	Pass/Fail	Measured Frequency (MHz)	Pass/Fail	Measured Frequency (MHz)	Pass/Fail	Measured Frequency (MHz)	Pass/Fail
40	120	5180.0098	PASS	5180.0083	PASS	5180.0069	PASS	5180.0067	PASS
30	120	5180.0074	PASS	5180.0091	PASS	5180.0055	PASS	5180.0062	PASS
20	120	5180.0122	PASS	5180.0123	PASS	5180.0135	PASS	5180.0118	PASS
10	120	5179.9985	PASS	5180.0013	PASS	5180.0003	PASS	5179.9986	PASS
0	120	5180.0079	PASS	5180.0079	PASS	5180.0098	PASS	5180.0066	PASS

Frequency Stability Versus Voltage									
Operating Frequency: 5180 MHz									
TEMP. (°C)	Power Supply (Vac)	0 Minute		2 Minutes		5 Minutes		10 Minutes	
		Measured Frequency (MHz)	Pass/Fail	Measured Frequency (MHz)	Pass/Fail	Measured Frequency (MHz)	Pass/Fail	Measured Frequency (MHz)	Pass/Fail
20	138	5180.012	PASS	5180.0127	PASS	5180.0139	PASS	5180.0119	PASS
	120	5180.0122	PASS	5180.0123	PASS	5180.0135	PASS	5180.0118	PASS
	102	5180.0117	PASS	5180.0115	PASS	5180.0137	PASS	5180.0117	PASS

4.7 6dB Bandwidth Measurement

4.7.1 Limits of 6dB Bandwidth Measurement

The minimum of 6dB Bandwidth Measurement is 0.5MHz.

4.7.2 Test Setup

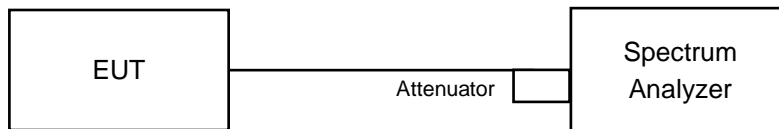

4.7.3 Test Instruments

Refer to section 4.1.2 to get information of above instrument.

4.7.4 Test Procedure

MEASUREMENT PROCEDURE REF

- Set resolution bandwidth (RBW) = 100kHz
- Set the video bandwidth (VBW) $\geq 3 \times$ RBW, Detector = Peak.
- Trace mode = max hold.
- Sweep = auto couple.
- Measure the maximum width of the emission that is constrained by the frequencies associated with the two amplitude points (upper and lower) that are attenuated by 6 dB relative to the maximum level measured in the fundamental emission.

4.7.5 Deviation from Test Standard

No deviation.

4.7.6 EUT Operating Condition

The software provided by client to enable the EUT under transmission condition continuously at lowest, middle and highest channel frequencies individually.

4.7.7 Test Results

CDD Mode

802.11a

Channel	Frequency (MHz)	6dB Bandwidth (MHz)		Minimum Limit (MHz)	Pass / Fail
		Chain 0	Chain 1		
149	5745	16.43	16.42	0.5	Pass
157	5785	16.43	16.42	0.5	Pass
165	5825	16.42	16.42	0.5	Pass

802.11ax (HE20)

Channel	Frequency (MHz)	6dB Bandwidth (MHz)		Minimum Limit (MHz)	Pass / Fail
		Chain 0	Chain 1		
149	5745	19.04	19.02	0.5	Pass
157	5785	19.07	19.02	0.5	Pass
165	5825	19.04	19.05	0.5	Pass

802.11ax (HE40)

Channel	Frequency (MHz)	6dB Bandwidth (MHz)		Minimum Limit (MHz)	Pass / Fail
		Chain 0	Chain 1		
151	5755	37.86	37.86	0.5	Pass
159	5795	37.83	37.85	0.5	Pass

802.11ax (HE80)

Channel	Frequency (MHz)	6dB Bandwidth (MHz)		Minimum Limit (MHz)	Pass / Fail
		Chain 0	Chain 1		
155	5775	77.95	77.97	0.5	Pass

Spectrum Plot of Worst Value

802.11a_Chain 0 / CH165

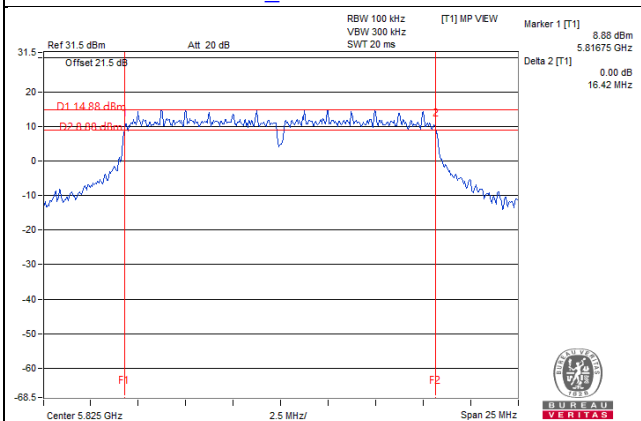

802.11ax (HE20)_Chain 1 / CH149

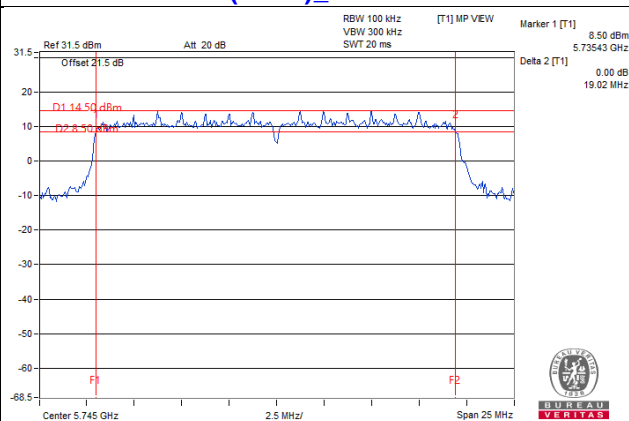

802.11ax (HE40)_Chain 0 / CH159

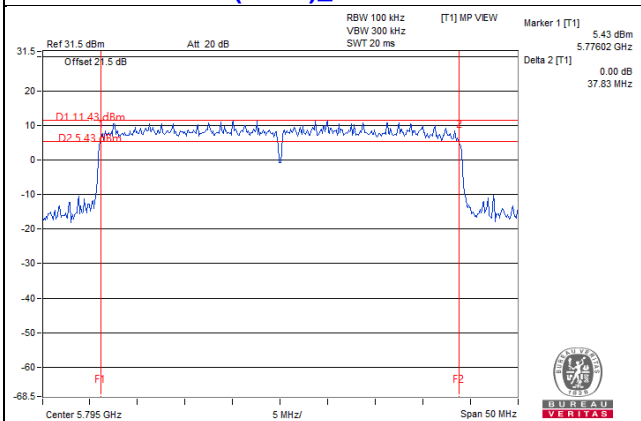

802.11ax (HE80)_Chain 0 / CH155

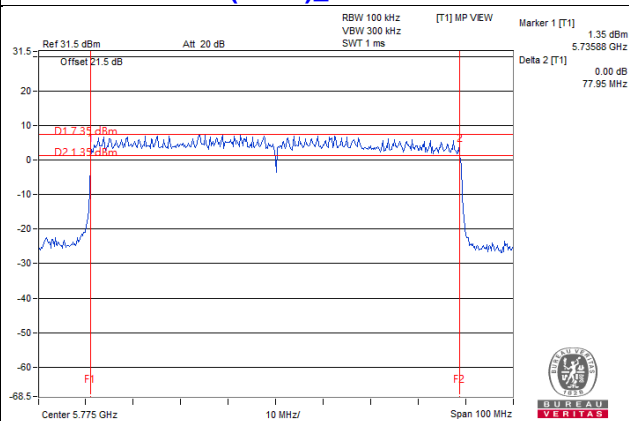

5 Pictures of Test Arrangements

Please refer to the attached file (Test Setup Photo).

Annex A- Radiated Out of Band Emission (OOBE) Measurement (For U-NII-3 band)

802.11a

CH 149 5745 MHz

Horizontal

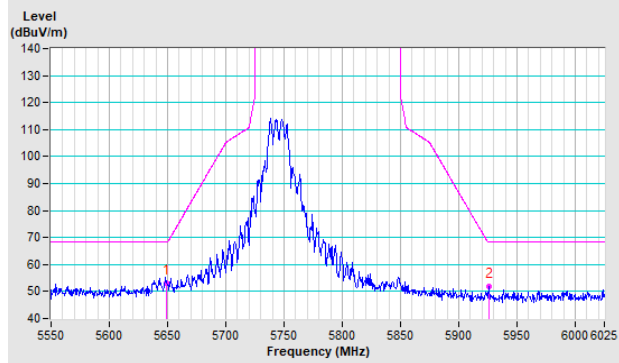

Vertical

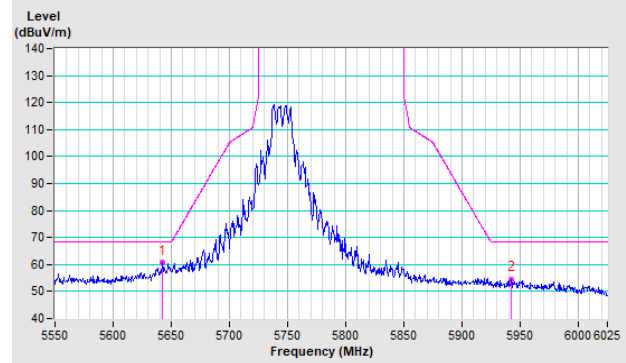

CH 157 5785 MHz

Horizontal

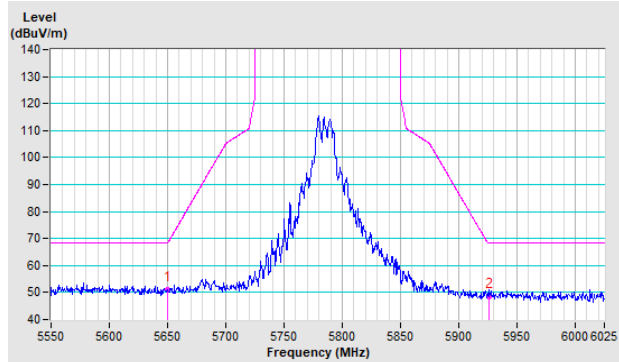

Vertical

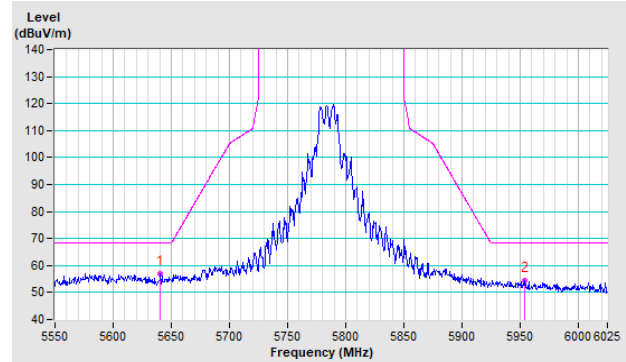

CH 165 5825 MHz

Horizontal

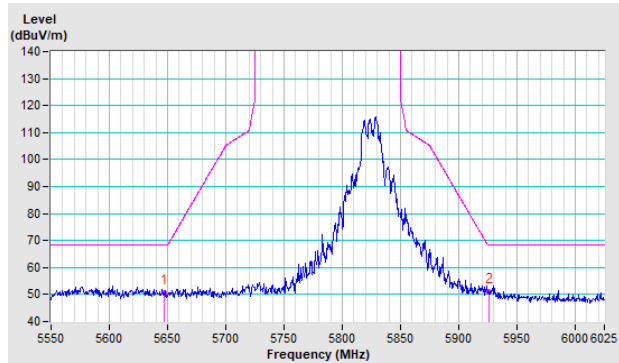

Vertical

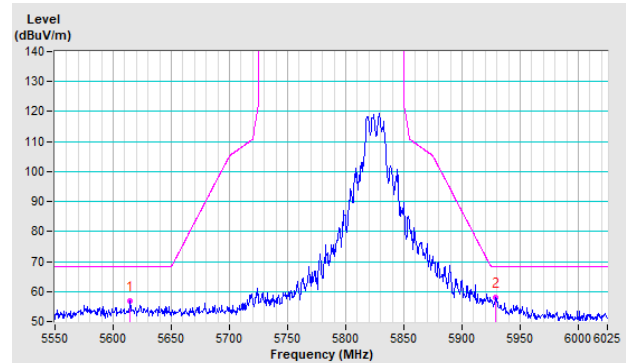

802.11ax (HE20)

CH 149 5745 MHz

Horizontal

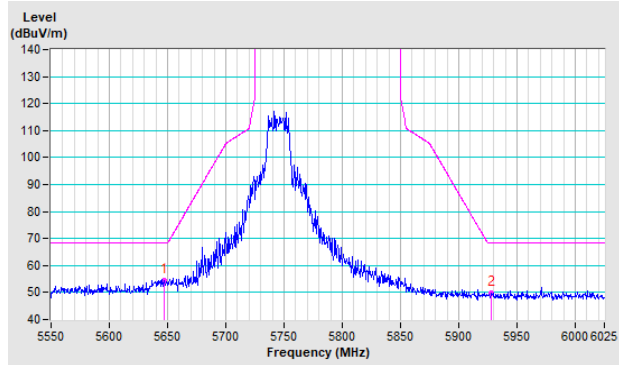

Vertical

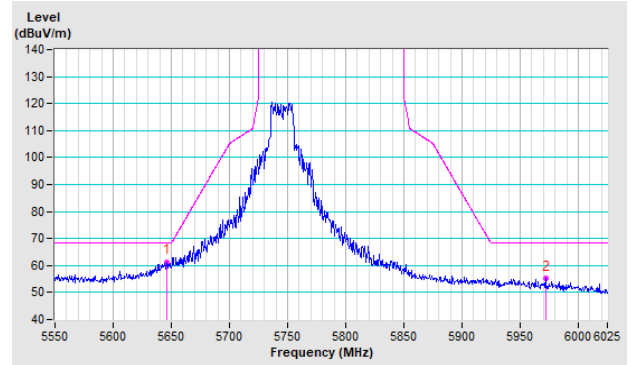

CH 157 5785 MHz

Horizontal

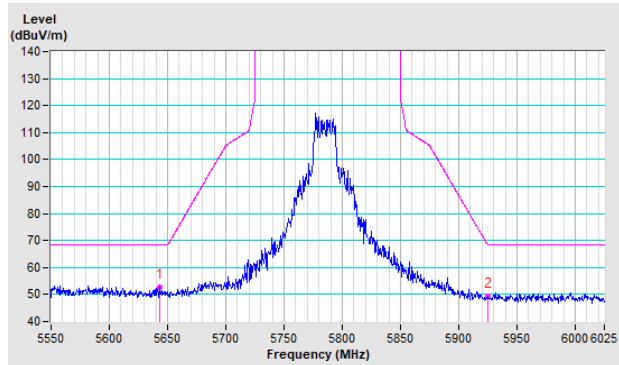

Vertical

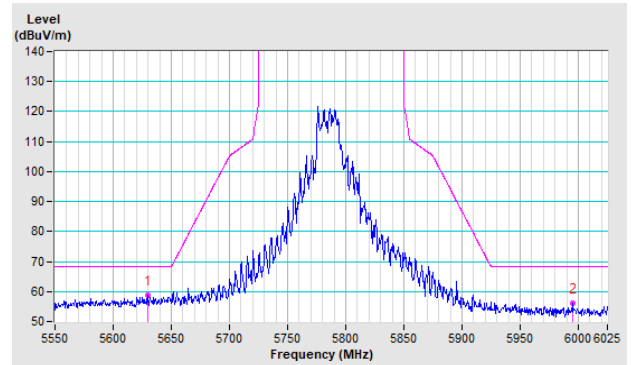

CH 165 5825 MHz

Horizontal

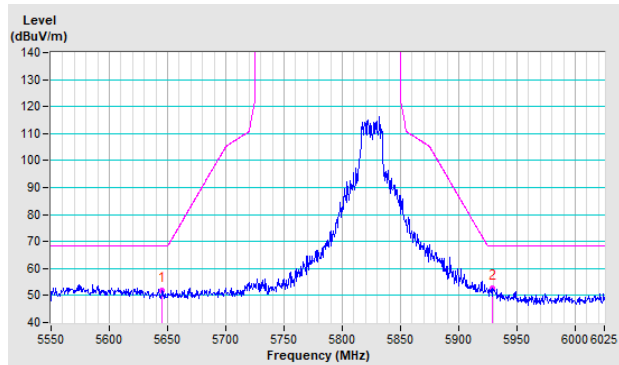

Vertical

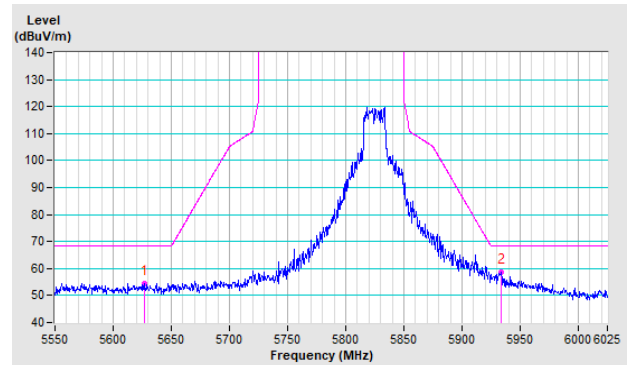

802.11ax (HE40)

CH 151 5755 MHz

Horizontal

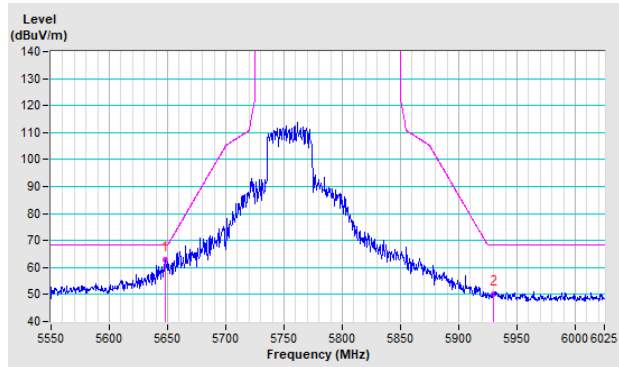

Vertical

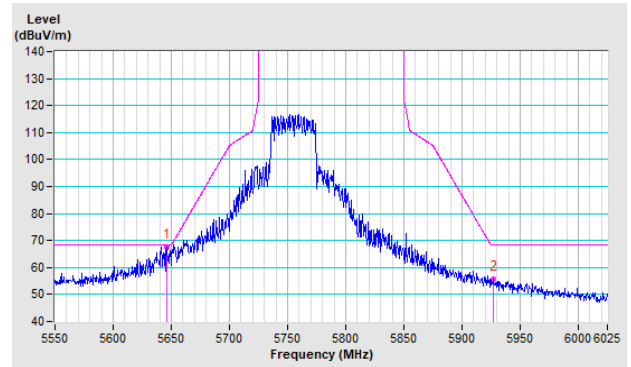

CH 159 5795 MHz

Horizontal

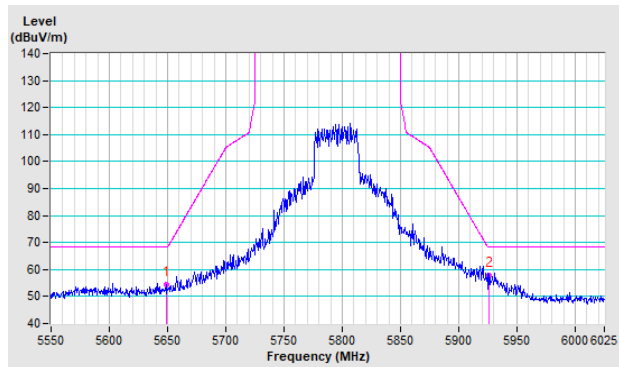

Vertical

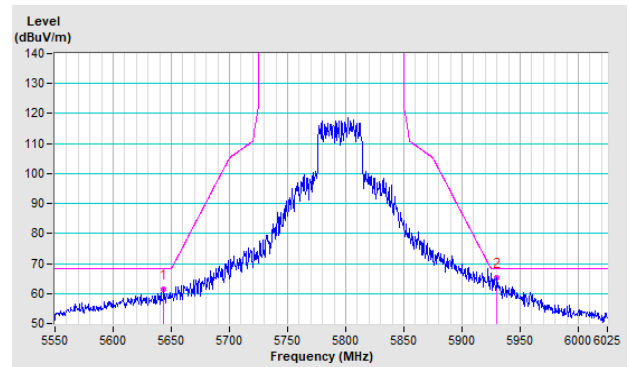

802.11ax (HE80)

CH 155 5775 MHz

Horizontal

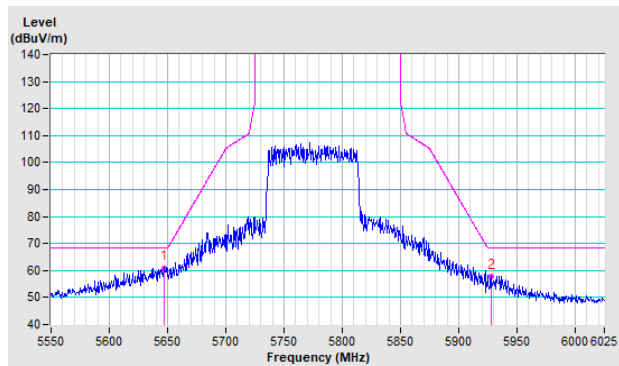

Vertical

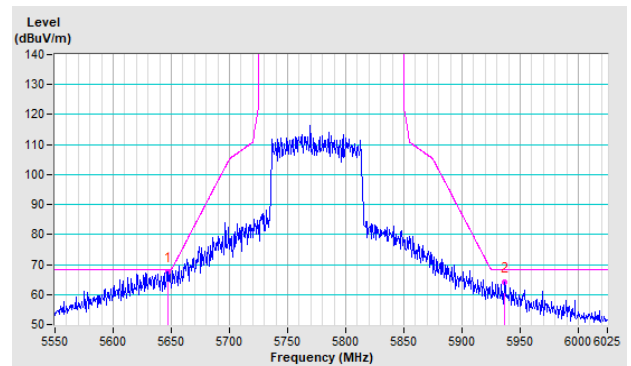

Annex B- Band-edge measurement (For U-NII-1 band)

802.11a

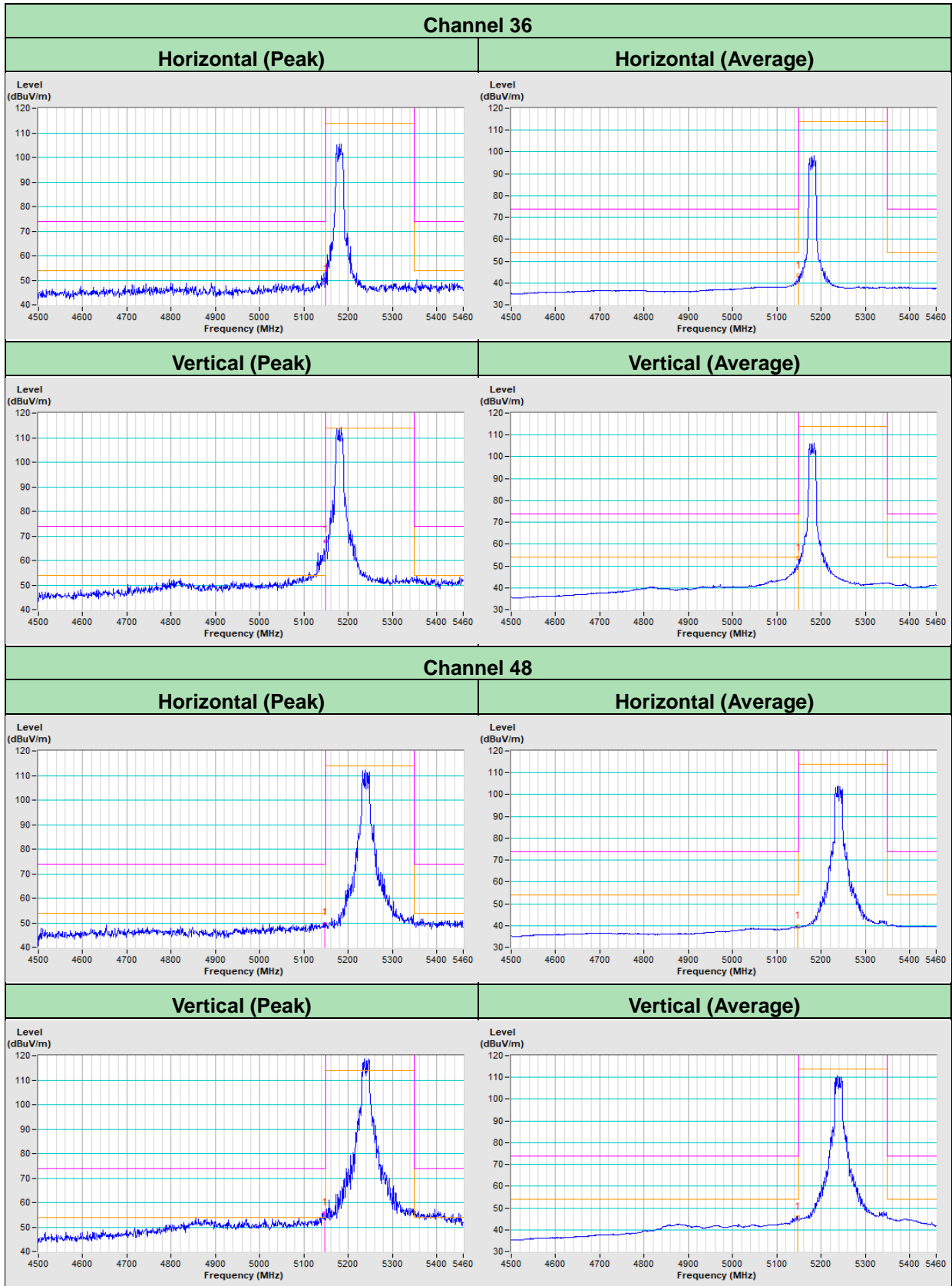

802.11ax (HE20)

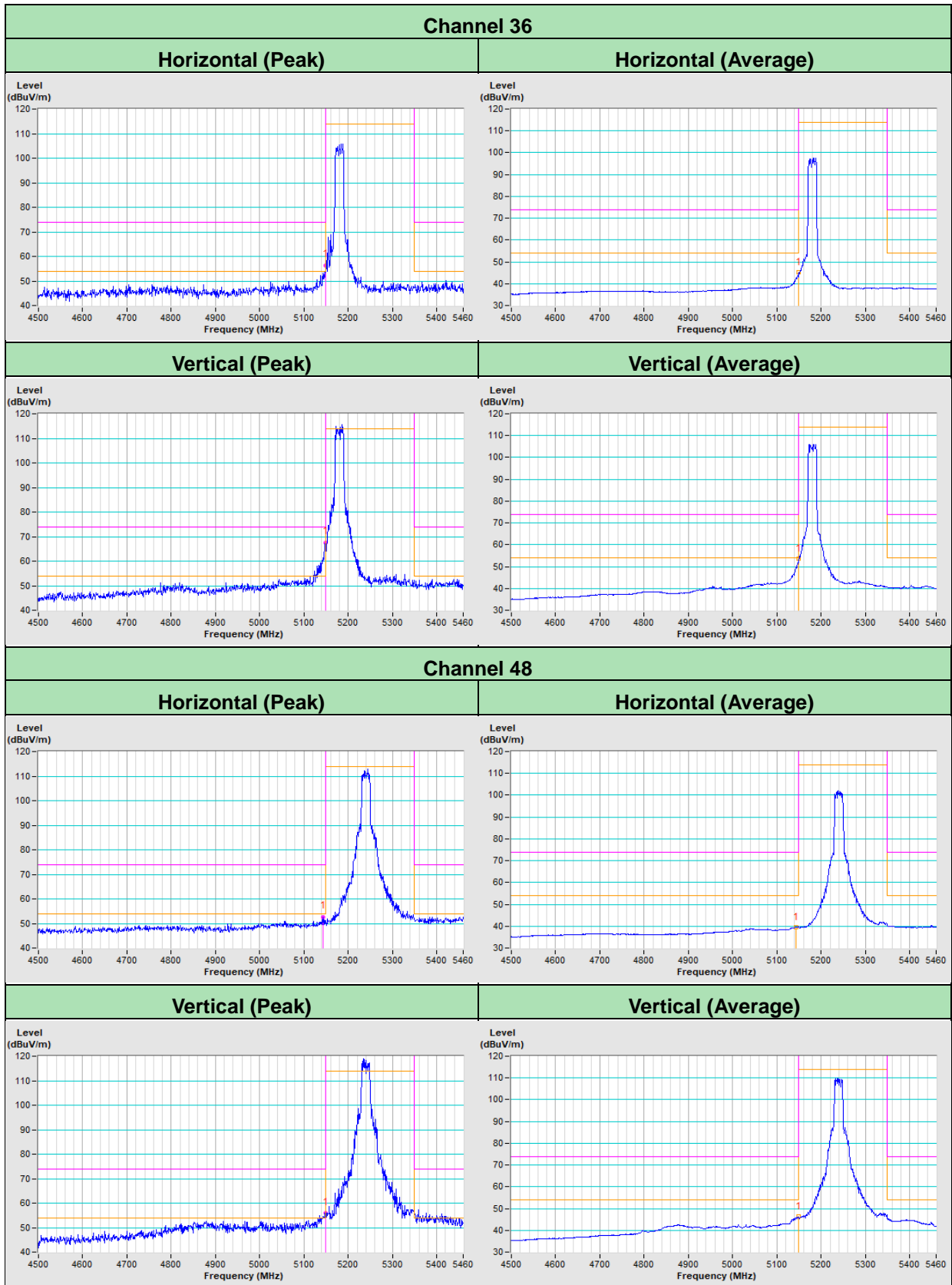

802.11ax (HE40)

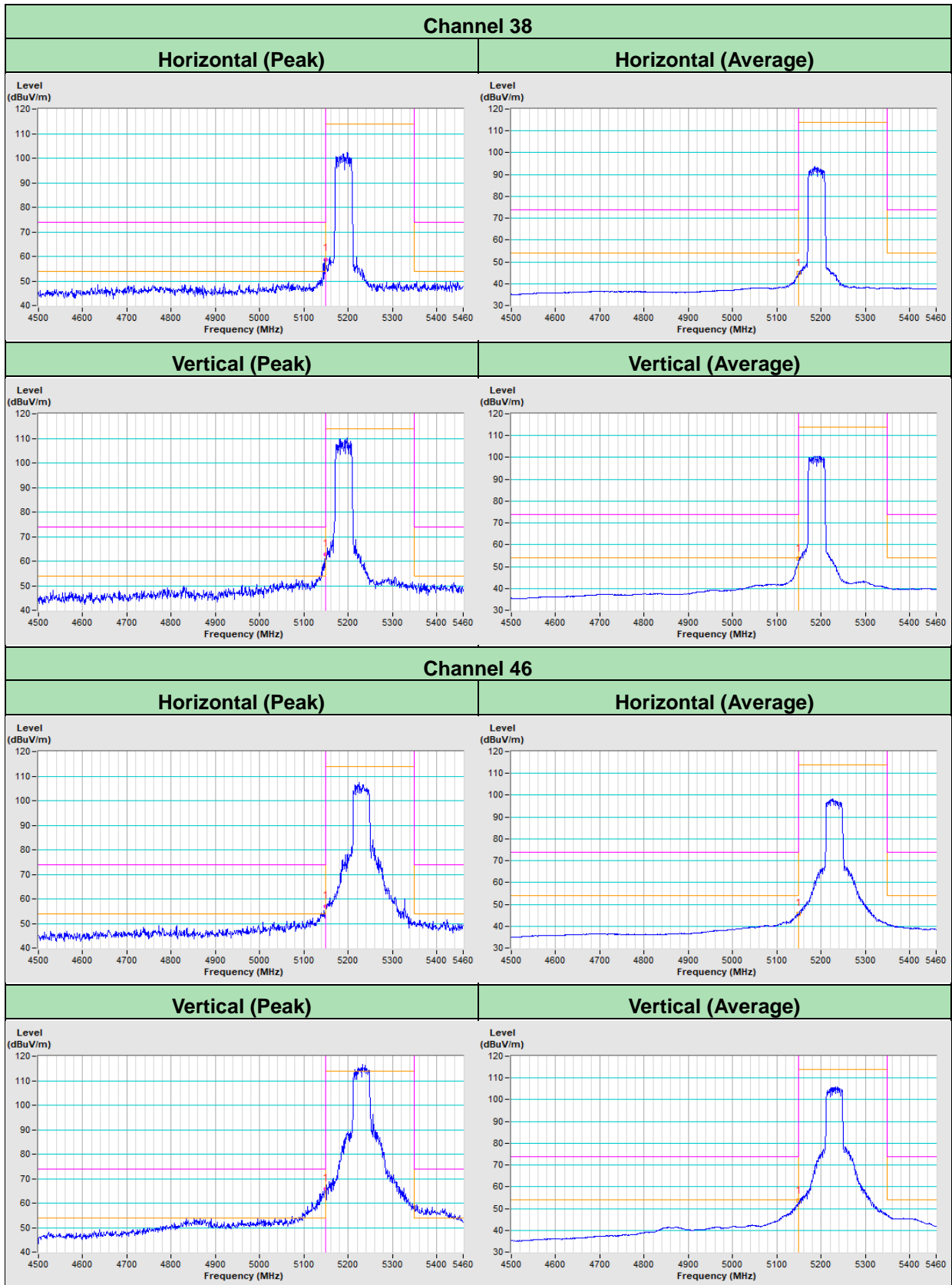

802.11ax (HE80)

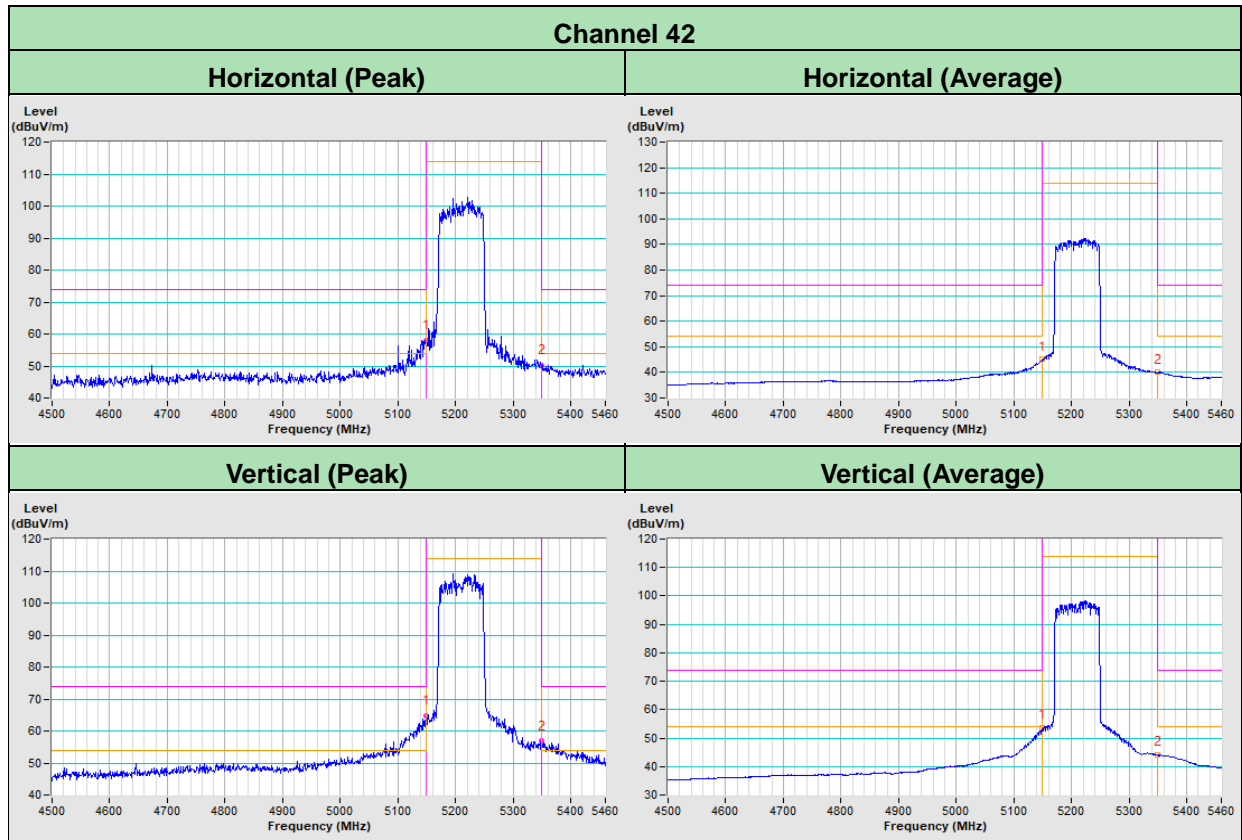

Appendix – Information of the Testing Laboratories

We, Bureau Veritas Consumer Products Services (H.K.) Ltd., Taoyuan Branch, were founded in 1988 to provide our best service in EMC, Radio, Telecom and Safety consultation. Our laboratories are FCC recognized accredited test firms and accredited according to ISO/IEC 17025.

If you have any comments, please feel free to contact us at the following:

Lin Kou EMC/RF Lab

Tel: 886-2-26052180

Fax: 886-2-26051924

Hsin Chu EMC/RF/Telecom Lab

Tel: 886-3-6668565

Fax: 886-3-6668323

Hwa Ya EMC/RF/Safety Lab

Tel: 886-3-3183232

Fax: 886-3-3270892

Email: service.adt@tw.bureauveritas.com

Web Site: www.bureauveritas-adt.com

The address and road map of all our labs can be found in our web site also.

--- END ---