

FCC Test Report

Report No.: RF161017C17C-1 R1

FCC ID: PY320100476

Test Model: C6230

Received Date: Oct. 30, 2019

Test Date: Nov. 08, 2019 ~ Feb. 12, 2020

Issued Date: Feb. 14, 2020

Applicant: NETGEAR, INC.

Address: 350 East Plumeria Drive San Jose, CA 95134

Issued By: Bureau Veritas Consumer Products Services (H.K.) Ltd., Taoyuan Branch
Lin Kou Laboratories

Lab Address: No. 47-2, 14th Ling, Chia Pau Vil., Lin Kou Dist., New Taipei City, Taiwan

Test Location: No. 19, Hwa Ya 2nd Rd., Wen Hwa Vil., Kwei Shan Dist., Taoyuan City
33383, TAIWAN

**FCC Registration /
Designation Number:** 788550 / TW0003



This report is for your exclusive use. Any copying or replication of this report to or for any other person or entity, or use of our name or trademark, is permitted only with our prior written permission. This report sets forth our findings solely with respect to the test samples identified herein. The results set forth in this report are not indicative or representative of the quality or characteristics of the lot from which a test sample was taken or any similar or identical product specifically and expressly noted. Our report includes all of the tests requested by you and the results thereof based upon the information that you provided to us. You have 60 days from date of issuance of this report to notify us of any material error or omission caused by our negligence, provided, however, that such notice shall be in writing and shall specifically address the issue you wish to raise. A failure to raise such issue within the prescribed time shall constitute your unqualified acceptance of the completeness of this report, the tests conducted and the correctness of the report contents. Unless specific mention, the uncertainty of measurement has been explicitly taken into account to declare the compliance or non-compliance to the specification. The report must not be used by the client to claim product certification, approval, or endorsement by TAF or any government agencies.

Table of Contents

Release Control Record	4
1 Certificate of Conformity	5
2 Summary of Test Results	6
2.1 Measurement Uncertainty.....	6
2.2 Modification Record.....	6
3 General Information	7
3.1 General Description of EUT.....	7
3.2 Description of Test Modes.....	9
3.2.1 Test Mode Applicability and Tested Channel Detail.....	10
3.3 Duty Cycle of Test Signal.....	12
3.4 Description of Support Units.....	13
3.4.1 Configuration of System under Test.....	13
3.5 General Description of Applied Standards and References.....	13
4 Test Types and Results	14
4.1 Radiated Emission and Bandedge Measurement.....	14
4.1.1 Limits of Radiated Emission and Bandedge Measurement.....	14
4.1.2 Test Instruments.....	15
4.1.3 Test Procedures.....	16
4.1.4 Deviation from Test Standard.....	16
4.1.5 Test Setup.....	17
4.1.6 EUT Operating Conditions.....	18
4.1.7 Test Results.....	19
4.2 Conducted Emission Measurement.....	41
4.2.1 Limits of Conducted Emission Measurement.....	41
4.2.2 Test Instruments.....	41
4.2.3 Test Procedures.....	42
4.2.4 Deviation from Test Standard.....	42
4.2.5 Test Setup.....	42
4.2.6 EUT Operating Conditions.....	42
4.2.7 Test Results.....	43
4.3 Transmit Power Measurement.....	47
4.3.1 Limits of Transmit Power Measurement.....	47
4.3.2 Test Setup.....	47
4.3.3 Test Instruments.....	47
4.3.4 Test Procedure.....	47
4.3.5 Deviation from Test Standard.....	47
4.3.6 EUT Operating Conditions.....	47
4.3.7 Test Result.....	48
4.4 Occupied Bandwidth Measurement.....	50
4.4.1 Test Setup.....	50
4.4.2 Test Instruments.....	50
4.4.3 Test Procedure.....	50
4.4.4 Test Result.....	51
4.5 Peak Power Spectral Density Measurement.....	55
4.5.1 Limits of Peak Power Spectral Density Measurement.....	55
4.5.2 Test Setup.....	55
4.5.3 Test Instruments.....	55
4.5.4 Test Procedures.....	55
4.5.5 Deviation from Test Standard.....	56
4.5.6 EUT Operating Conditions.....	56
4.5.7 Test Results.....	57
4.6 Frequency Stability.....	62
4.6.1 Limits of Frequency Stability Measurement.....	62

4.6.2	Test Setup.....	62
4.6.3	Test Instruments	62
4.6.4	Test Procedure	62
4.6.5	Deviation from Test Standard	63
4.6.6	EUT Operating Condition	63
4.6.7	Test Results	63
4.7	6dB Bandwidth Measurement.....	64
4.7.1	Limits of 6dB Bandwidth Measurement.....	64
4.7.2	Test Setup.....	64
4.7.3	Test Instruments	64
4.7.4	Test Procedure	64
4.7.5	Deviation from Test Standard	64
4.7.6	EUT Operating Condition	64
4.7.7	Test Results	65
5	Pictures of Test Arrangements.....	67
	Annex A- Radiated Out of Band Emission (OOBE) Measurement (For U-NII-3 band).....	68
	Annex B- Band Edge Measurement.....	71
	Appendix – Information of the Testing Laboratories	79

Release Control Record

Issue No.	Description	Date Issued
RF161017C17C-1	Original release	Jan. 07, 2020
RF161017C17C-1 R1	Removed series model and revised FCC ID Re-tested antenna port conducted measurement	Feb. 14, 2020

1 Certificate of Conformity

Product: Cable Gateway

Brand: Netgear

Test Model: C6230

Sample Status: Engineering sample

Applicant: NETGEAR, INC.

Test Date: Nov. 08, 2019 ~ Feb. 12, 2020

Standards: 47 CFR FCC Part 15, Subpart E (Section 15.407)
ANSI C63.10:2013

The above equipment has been tested by **Bureau Veritas Consumer Products Services (H.K.) Ltd., Taoyuan Branch**, and found compliance with the requirement of the above standards. The test record, data evaluation & Equipment Under Test (EUT) configurations represented herein are true and accurate accounts of the measurements of the sample's RF characteristics under the conditions specified in this report.

Prepared by : Celine Chou , **Date:** Feb. 14, 2020
Celine Chou / Senior Specialist

Approved by : Bruce Chen , **Date:** Feb. 14, 2020
Bruce Chen / Senior Project Engineer

2 Summary of Test Results

47 CFR FCC Part 15, Subpart E (Section 15.407)			
FCC Clause	Test Item	Result	Remarks
15.407(b)(6)	AC Power Conducted Emissions	Pass	Meet the requirement of limit. Minimum passing margin is -14.31dB at 0.15000MHz.
15.407(b)(1/2/3/4(i/ii)/6)	Radiated Emissions & Band Edge Measurement	Pass	Meet the requirement of limit. Minimum passing margin is -0.1dB at 5150.00MHz.
15.407(a)(1/2/3)	Max Average Transmit Power	Pass	Meet the requirement of limit.
---	Occupied Bandwidth Measurement	-	Reference only.
15.407(a)(1/2/3)	Peak Power Spectral Density	Pass	Meet the requirement of limit.
15.407(e)	6dB bandwidth	Pass	Meet the requirement of limit. (U-NII-3 Band only)
15.407(g)	Frequency Stability	Pass	Meet the requirement of limit.
15.203	Antenna Requirement	Pass	Antenna connector is i-pex(MHF) not a standard connector.

Note:

- Determining compliance based on the results of the compliance measurement, not taking into account measurement instrumentation uncertainty.
- For U-NII-3 band compliance with rule part 15.407(b)(4)(i), the OOB test plots were recorded in Annex A.
- For U-NII-1 band compliance with rule 15.407(b) of the band-edge items, the test plots were recorded in Annex B. Test Procedures refer to report 4.1.3.

2.1 Measurement Uncertainty

Where relevant, the following measurement uncertainty levels have been estimated for tests performed on the EUT as specified in CISPR 16-4-2:

Measurement	Frequency	Expanded Uncertainty (k=2) (\pm)
Conducted Emissions at mains ports	150kHz ~ 30MHz	2.79 dB
Radiated Emissions up to 1 GHz	9kHz ~ 30MHz	3.04 dB
	30MHz ~ 200MHz	3.63 dB
	200MHz ~ 1000MHz	3.64 dB
Radiated Emissions above 1 GHz	1GHz ~ 18GHz	2.29 dB
	18GHz ~ 40GHz	2.29 dB

2.2 Modification Record

There were no modifications required for compliance.

3 General Information

3.1 General Description of EUT

Product	Cable Gateway
Brand	Netgear
Test Model	C6230
Sample Status	Engineering sample
Power Supply Rating	12Vdc from adapter
Modulation Type	256QAM, 64QAM, 16QAM, QPSK, BPSK
Modulation Technology	OFDM
Transfer Rate	802.11a: 54/48/36/24/18/12/9/6Mbps 802.11n: up to 300Mbps 802.11ac: up to 866Mbps
Operating Frequency	5180 ~ 5240MHz, 5745 ~ 5825MHz
Number of Channel	5180 ~ 5240MHz: 802.11a, 802.11n (HT20), 802.11ac (VHT20): 4 802.11n (HT40), 802.11ac (VHT40): 2 802.11ac (VHT80): 1 5745 ~ 5825MHz: 802.11a, 802.11n (HT20), 802.11ac (VHT20): 5 802.11n (HT40), 802.11ac (VHT40): 2 802.11ac (VHT80): 1
Output Power	CDD Mode: 5180 ~ 5240MHz: 442.880mW 5745 ~ 5825MHz: 547.702mW Beamforming Mode: 5180 ~ 5240MHz: 427.435mW 5745 ~ 5825MHz: 547.702W
Antenna Type	Refer to note
Antenna Connector	Refer to note
Accessory Device	Adapter
Cable Supplied	1.45m non-shielded RJ45 cable without core

Note:

1. The EUT incorporates a MIMO function.

Modulation Mode	Data Rate (MCS)	Tx & Rx configuration	
802.11a	6 ~ 54Mbps	2TX	2RX
802.11n (VHT20)	MCS 0~7	2TX	2RX
	MCS 8~15	2TX	2RX
802.11n (HT40)	MCS 0~7	2TX	2RX
	MCS 8~15	2TX	2RX
802.11ac (VHT20)	MCS0~8 Nss=1	2TX	2RX
	MCS0~8 Nss=2	2TX	2RX
802.11ac (VHT40)	MCS0~9 Nss=1	2TX	2RX
	MCS0~9 Nss=2	2TX	2RX
802.11ac (VHT80)	MCS0~9 Nss=1	2TX	2RX
	MCS0~9 Nss=2	2TX	2RX

Note:

- All of modulation mode support beamforming function except 802.11a modulation mode.
- For 802.11n and 802.11ac, CDD mode and Beamforming mode are presented in power output test item. For other test items, CDD mode is the worst case for final tests after pretesting.
- The bandwidth and modulation are similar for HT20/HT40 on 802.11n mode and VHT20/VHT40 on 802.11ac mode. Therefore the investigated worst case is the representative mode in test report. (Final test mode refer section 3.2.1)

2. The EUT must be supplied with a power adapter following table: (The new adapter is adapter 2)

No	Brand Name	Model No.	PN	Spec.
1	NETGEAR	AD2067F10	332-10797-01	Input: 100-120Vac, 50/60Hz, 1.0A Output: 12Vdc, 2.5A DC cable 1.85m
2	NETGEAR	ADS-40FPA-12 12030EPCU-L / ADS-40FPA-12 12030EPC-L (For Model: C6230 used only)	332-11525-01	Input: 100-120Vac, 50/60Hz, 1.0A Output: 12.0Vdc, 2.5A DC cable 1.85m

3. The antennas provided to the EUT, please refer to the following table:

Antenna No.	Brand	Model	Antenna Gain (dBi)	Frequency range	Antenna connector	Antenna Type
ant_1	NA	NA	2.38	2.4~2.4835GHz	i-pex(MHF)	PCB
			4.74	5.15~5.25GHz		
			4.64	5.725~5.85GHz		
ant_2	NA	NA	2.04	2.4~2.4835GHz	i-pex(MHF)	PCB
			4.11	5.15~5.25GHz		
			4.76	5.725~5.85GHz		

4. Simultaneously transmission condition.

Condition	Technology	
1	WLAN (2.4GHz)	WLAN (5GHz)

Note: The emission of the simultaneous operation has been evaluated and no non-compliance was found.

3.2 Description of Test Modes

For 5180 ~ 5240MHz:

4 channels are provided for 802.11a, 802.11n (HT20), 802.11ac (VHT20):

Channel	Frequency	Channel	Frequency
36	5180 MHz	44	5220 MHz
40	5200 MHz	48	5240 MHz

2 channels are provided for 802.11n (HT40), 802.11ac (VHT40):

Channel	Frequency	Channel	Frequency
38	5190 MHz	46	5230 MHz

1 channel is provided for 802.11ac (VHT80):

Channel	Frequency
42	5210MHz

For 5745 ~ 5825MHz:

5 channels are provided for 802.11a, 802.11n (HT20), 802.11ac (VHT20):

Channel	Frequency	Channel	Frequency
149	5745MHz	161	5805MHz
153	5765MHz	165	5825MHz
157	5785MHz		

2 channels are provided for 802.11n (HT40), 802.11ac (VHT40):

Channel	Frequency	Channel	Frequency
151	5755MHz	159	5795MHz

1 channel is provided for 802.11ac (VHT80):

Channel	Frequency
155	5775MHz

3.2.1 Test Mode Applicability and Tested Channel Detail

EUT Configure Mode	Applicable to				Description
	RE \geq 1G	RE<1G	PLC	APCM	
A	√	√	√	√	Powered by adapter 1
B	-	√	√	-	Powered by adapter 2

Where RE \geq 1G: Radiated Emission above 1GHz & Bandedge Measurement
 RE<1G: Radiated Emission below 1GHz
 PLC: Power Line Conducted Emission
 APCM: Antenna Port Conducted Measurement

Note:

1. The EUT had been pre-tested on the positioned of each 3 axis. The worst case was found when positioned on **Z-plane**.
2. Radiated emission test (below 1GHz) and power line conducted emission test items chosen the worst maximum power.
3. "-" means no effect.

Radiated Emission Test (Above 1GHz):

- Pre-Scan has been conducted to determine the worst-case mode from all possible combinations between available modulations, data rates and antenna ports (if EUT with antenna diversity architecture).
- Following channel(s) was (were) selected for the final test as listed below.

EUT Configure Mode	Mode	Frequency Band (MHz)	Available Channel	Tested Channel	Modulation Technology	Data Rate (Mbps)
A	802.11a	5180-5240	36 to 48	36, 40, 48	OFDM	6.0
	802.11ac (VHT20)		36 to 48	36, 40, 48	OFDM	6.5
	802.11ac (VHT40)		38 to 46	38, 46	OFDM	13.5
	802.11ac (VHT80)		42	42	OFDM	29.3
A	802.11a	5745-5825	149 to 165	149, 157, 165	OFDM	6.0
	802.11ac (VHT20)		149 to 165	149, 157, 165	OFDM	6.5
	802.11ac (VHT40)		151 to 159	151, 159	OFDM	13.5
	802.11ac (VHT80)		155	155	OFDM	29.3

Radiated Emission Test (Below 1GHz):

- Pre-Scan has been conducted to determine the worst-case mode from all possible combinations between available modulations, data rates and antenna ports (if EUT with antenna diversity architecture).
- Following channel(s) was (were) selected for the final test as listed below.

EUT Configure Mode	Mode	Frequency Band (MHz)	Available Channel	Tested Channel	Modulation Technology	Data Rate (Mbps)
A, B	802.11ac (VHT20)	5180-5240	36 to 48	149	OFDM	6.5
	802.11ac (VHT20)	5745-5825	149 to 165		OFDM	6.5

Power Line Conducted Emission Test:

- Pre-Scan has been conducted to determine the worst-case mode from all possible combinations between available modulations, data rates and antenna ports (if EUT with antenna diversity architecture).
- Following channel(s) was (were) selected for the final test as listed below.

EUT Configure Mode	Mode	Frequency Band (MHz)	Available Channel	Tested Channel	Modulation Technology	Data Rate (Mbps)
A, B	802.11ac (VHT20)	5180-5240	36 to 48	149	OFDM	6.5
	802.11ac (VHT20)	5745-5825	149 to 165		OFDM	6.5

Antenna Port Conducted Measurement:

- This item includes all test value of each mode, but only includes spectrum plot of worst value of each mode.
- Pre-Scan has been conducted to determine the worst-case mode from all possible combinations between available modulations, data rates and antenna ports (if EUT with antenna diversity architecture).
- Following channel(s) was (were) selected for the final test as listed below.

EUT Configure Mode	Mode	Frequency Band (MHz)	Available Channel	Tested Channel	Modulation Technology	Data Rate (Mbps)
A	802.11a	5180-5240	36 to 48	36, 40, 48	OFDM	6.0
	802.11ac (VHT20)		36 to 48	36, 40, 48	OFDM	6.5
	802.11ac (VHT40)		38 to 46	38, 46	OFDM	13.5
	802.11ac (VHT80)		42	42	OFDM	29.3
A	802.11a	5745-5825	149 to 165	149, 157, 165	OFDM	6.0
	802.11ac (VHT20)		149 to 165	149, 157, 165	OFDM	6.5
	802.11ac (VHT40)		151 to 159	151, 159	OFDM	13.5
	802.11ac (VHT80)		155	155	OFDM	29.3

Test Condition:

Applicable to	Environmental Conditions	Input Power	Tested by
RE _≥ 1G	25 deg. C, 70% RH	120Vac, 60Hz	Noah Chang
RE _{<} 1G	25 deg. C, 70% RH	120Vac, 60Hz	Noah Chang Luis Lee
PLC	23 deg. C, 67% RH 25 deg. C, 75% RH	120Vac, 60Hz	Noah Chang Luis Lee
APCM	25 deg. C, 60% RH	120Vac, 60Hz	Chris Lin

3.3 Duty Cycle of Test Signal

802.11a, 802.11ac (VHT20): Duty cycle of test signal $\geq 98\%$, duty factor is not required.

802.11ac (VHT40), 802.11ac (VHT80): Duty cycle of test signal is $< 98\%$, duty factor is required.

802.11a: Duty cycle = $1.918/1.950 = 0.984$

802.11ac (VHT20): Duty cycle = $1.919/1.950 = 0.984$

802.11ac (VHT40): Duty cycle = $0.943/0.982 = 0.960$, Duty factor = $10 * \log (1/0.960) = 0.18$

802.11ac (VHT80): Duty cycle = $0.458/0.489 = 0.937$, Duty factor = $10 * \log (1/0.937) = 0.28$

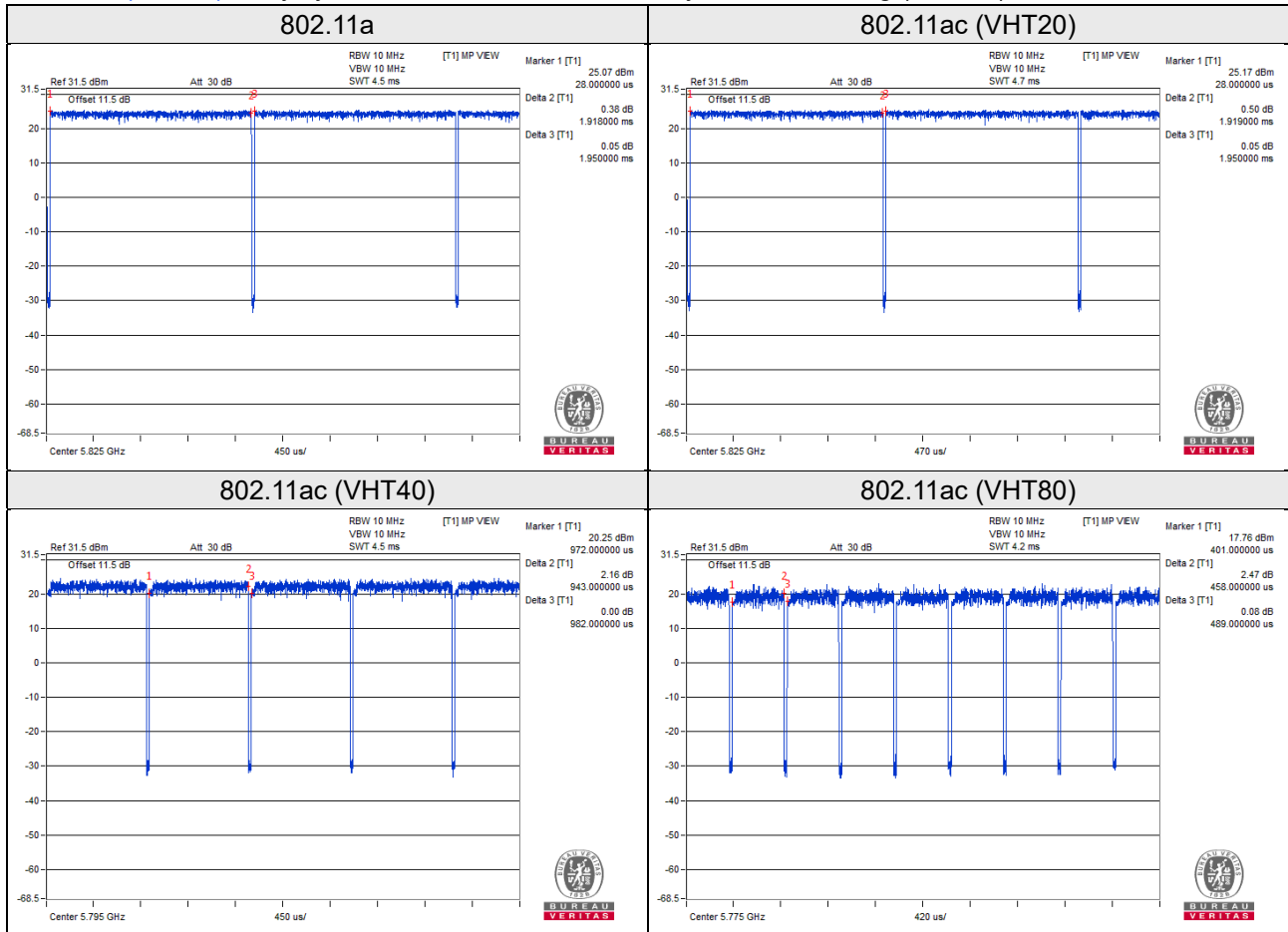

3.4 Description of Support Units

The EUT has been tested as an independent unit together with other necessary accessories or support units. The following support units or accessories were used to form a representative test configuration during the tests.

ID	Product	Brand	Model No.	Serial No.	FCC ID	Remarks
A.	Notebook	Lenovo	81A4	YD02TWF5	PPD-QCNFA435	-

Note:

1. All power cords of the above support units are non-shielded (1.8m).
2. Item A acted as a communication partner to transfer data.

ID	Descriptions	Qty.	Length (m)	Shielding (Yes/No)	Cores (Qty.)	Remarks
1.	LAN	1	8	N	0	RJ45, Cat5e

3.4.1 Configuration of System under Test

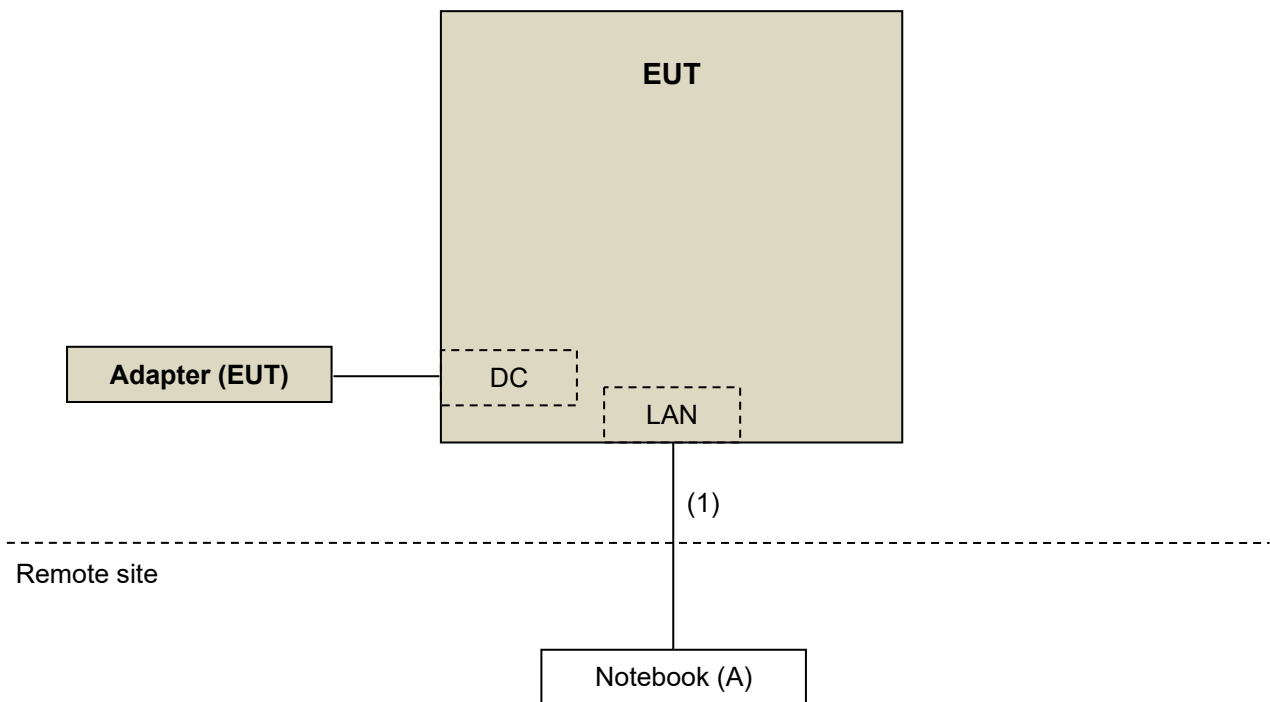

3.5 General Description of Applied Standards and References

The EUT is a RF Product. According to the specifications of the manufacturer, it must comply with the requirements of the following standards:

Test standard:

FCC Part 15, Subpart E (15.407)

ANSI C63.10:2013

All test items have been performed and recorded as per the above standards.

References Test Guidance:

KDB 789033 D02 General UNII Test Procedure New Rules v02r01

KDB 662911 D01 Multiple Transmitter Output v02r01

All test items have been performed as a reference to the above KDB test guidance.

4 Test Types and Results

4.1 Radiated Emission and Bandedge Measurement

4.1.1 Limits of Radiated Emission and Bandedge Measurement

Radiated emissions which fall in the restricted bands must comply with the radiated emission limits specified as below table.

Frequencies (MHz)	Field Strength (microvolts/meter)	Measurement Distance (meters)
0.009 ~ 0.490	2400/F(kHz)	300
0.490 ~ 1.705	24000/F(kHz)	30
1.705 ~ 30.0	30	30
30 ~ 88	100	3
88 ~ 216	150	3
216 ~ 960	200	3
Above 960	500	3

Note:

- The lower limit shall apply at the transition frequencies.
- Emission level (dBuV/m) = 20 log Emission level (uV/m).
- For frequencies above 1000MHz, the field strength limits are based on average detector, however, the peak field strength of any emission shall not exceed the maximum permitted average limits, specified above by more than 20dB under any condition of modulation.

Limits of unwanted emission out of the restricted bands

Applicable To		Limit	
789033 D02 General UNII Test Procedure New Rules v02r01		Field Strength at 3m	
		PK: 74 (dBµV/m)	AV: 54 (dBµV/m)
Frequency Band	Applicable To	EIRP Limit	Equivalent Field Strength at 3m
5150~5250 MHz	15.407(b)(1)	PK: -27 (dBm/MHz)	PK: 68.2(dBµV/m)
5250~5350 MHz	15.407(b)(2)		
5470~5725 MHz	15.407(b)(3)		
5725~5850 MHz	<input checked="" type="checkbox"/> 15.407(b)(4)(i)	PK: -27 (dBm/MHz) ^{*1} PK: 10 (dBm/MHz) ^{*2} PK: 15.6 (dBm/MHz) ^{*3} PK: 27 (dBm/MHz) ^{*4}	PK: 68.2(dBµV/m) ^{*1} PK: 105.2 (dBµV/m) ^{*2} PK: 110.8(dBµV/m) ^{*3} PK: 122.2 (dBµV/m) ^{*4}
	<input type="checkbox"/> 15.407(b)(4)(ii)	Emission limits in section 15.247(d)	
^{*1} beyond 75 MHz or more above of the band edge.		^{*2} below the band edge increasing linearly to 10 dBm/MHz at 25 MHz above.	
^{*3} below the band edge increasing linearly to a level of 15.6 dBm/MHz at 5 MHz above.		^{*4} from 5 MHz above or below the band edge increasing linearly to a level of 27 dBm/MHz at the band edge.	

Note: The following formula is used to convert the equipment isotropic radiated power (eirp) to field strength:

$$E = \frac{1000000 \sqrt{30P}}{3} \mu\text{V/m, where P is the eirp (Watts).}$$

4.1.2 Test Instruments

Description & Manufacturer	Model No.	Serial No.	Cal. Date	Cal. Due
Test Receiver ROHDE & SCHWARZ	ESCI	100424	Jan. 03, 2019	Jan. 02, 2020
			Dec. 31, 2019	Dec. 30, 2020
Spectrum Analyzer ROHDE & SCHWARZ	FSP40	100040	Sep. 23, 2019	Sep. 22, 2020
BILOG Antenna SCHWARZBECK	VULB9168	9168-155	Nov. 21, 2018	Nov. 20, 2019
			Nov. 11, 2019	Nov. 10, 2020
HORN Antenna SCHWARZBECK	BBHA 9120D	9120D-1170	Nov. 25, 2018	Nov. 24, 2019
			Nov. 24, 2019	Nov. 23, 2020
HORN Antenna SCHWARZBECK	BBHA 9170	BBHA9170241	Nov. 25, 2018	Nov. 24, 2019
			Nov. 24, 2019	Nov. 23, 2020
Loop Antenna TESEQ	HLA 6121	45745	Jul. 01, 2019	Jun. 30, 2020
Preamplifier Agilent (Below 1GHz)	8447D	2944A10631	Jul. 11, 2019	Jul. 10, 2020
Preamplifier KEYSIGHT (Above 1GHz)	83017A	MY53270295	Jun. 11, 2019	Jun. 10, 2020
RF Coaxial Cable WORKEN With 5dB PAD	8D-FB	Cable-CH4-01	Aug. 20, 2019	Aug. 19, 2020
RF Coaxial Cable EMCI	EMC102-KM-KM-3000	150929	Aug. 20, 2019	Aug. 19, 2020
RF Coaxial Cable EMCI	EMC102-KM-KM-600	150928	Aug. 20, 2019	Aug. 19, 2020
RF signal cable HUBER+SUHNER	SUCOFLEX 104	MY 13380+295012/04	Jul. 11, 2019	Jul. 10, 2020
RF signal cable HUBER+SUHNER	SUCOFLEX 104	Cable-CH4-03 (250724)	Jul. 11, 2019	Jul. 10, 2020
Software BV ADT	ADT_Radiated_V7.6.15.9.5	NA	NA	NA
Antenna Tower inn-co GmbH	MA 4000	010303	NA	NA
Antenna Tower Controller BV ADT	AT100	AT93021703	NA	NA
Turn Table BV ADT	TT100	TT93021703	NA	NA
Turn Table Controller BV ADT	SC100	SC93021703	NA	NA
Boresight Antenna Fixture	FBA-01	FBA-SIP01	NA	NA
Pre-amplifier (18GHz-40GHz) EMC	EMC184045B	980175	Sep. 05, 2019	Sep. 04, 2020
USB Wideband Power Sensor KEYSIGHT	U2021XA	MY55050005/MY55190004/MY55190007/MY55210005	Jul. 15, 2019	Jul. 14, 2020

Note: 1. The calibration interval of the above test instruments is 12 months and the calibrations are traceable to NML/ROC and NIST/USA.
2. The test was performed in HwaYa Chamber 4.

4.1.3 Test Procedures

For Radiated emission below 30MHz

- a. The EUT was placed on the top of a rotating table 0.8 meters above the ground at a 3 meter chamber room. The table was rotated 360 degrees to determine the position of the highest radiation.
- b. The EUT was set 3 meters away from the interference-receiving antenna, which was mounted on the top of a variable-height antenna tower.
- c. Parallel, perpendicular, and ground-parallel orientations of the antenna are set to make the measurement.
- d. For each suspected emission, the EUT was arranged to its worst case and the rotatable table was turned from 0 degrees to 360 degrees to find the maximum reading.
- e. The test-receiver system was set to Quasi-Peak Detect Function and Specified Bandwidth with Maximum Hold Mode.

Note:

1. The resolution bandwidth and video bandwidth of test receiver/spectrum analyzer is 9kHz at frequency below 30MHz.

For Radiated emission above 30MHz

- a. The EUT was placed on the top of a rotating table 0.8 meters (for 30MHz ~ 1GHz) / 1.5 meters (for above 1GHz) above the ground at 3 meter chamber room for test. The table was rotated 360 degrees to determine the position of the highest radiation.
- b. The EUT was set 3 meters away from the interference-receiving antenna, which was mounted on the top of a variable-height antenna tower.
- c. The height of antenna is varied from one meter to four meters above the ground to determine the maximum value of the field strength. Both horizontal and vertical polarizations of the antenna are set to make the measurement.
- d. For each suspected emission, the EUT was arranged to its worst case and then the antenna was tuned to heights from 1 meter to 4 meters and the rotatable table was turned from 0 degrees to 360 degrees to find the maximum reading.
- e. The test-receiver system was set to quasi-peak detect function and specified bandwidth with maximum hold mode when the test frequency is below 1 GHz.
- f. The test-receiver system was set to peak and average detect function and specified bandwidth with maximum hold mode when the test frequency is above 1 GHz. If the peak reading value also meets average limit, measurement with the average detector is unnecessary.

Note:

1. The resolution bandwidth and video bandwidth of test receiver/spectrum analyzer is 120kHz for Quasi-peak detection (QP) at frequency below 1GHz.
2. The resolution bandwidth of test receiver/spectrum analyzer is 1 MHz and the video bandwidth is 3 MHz for Peak detection (PK) at frequency above 1GHz.
3. The resolution bandwidth of test receiver/spectrum analyzer is 1MHz and the video bandwidth is $\geq 1/T$ (Duty cycle < 98%) or 10Hz (Duty cycle $\geq 98\%$) for Average detection (AV) at frequency above 1GHz. (802.11a: RBW = 1MHz, VBW = 10Hz; 802.11ac (VHT20): RBW = 1MHz, VBW = 10Hz; 802.11ac (VHT40): RBW = 1MHz, VBW = 3kHz; 802.11ac (VHT80): RBW = 1MHz, VBW = 3kHz)
4. All modes of operation were investigated and the worst-case emissions are reported.

4.1.4 Deviation from Test Standard

No deviation.

4.1.5 Test Setup

For Radiated emission below 30MHz

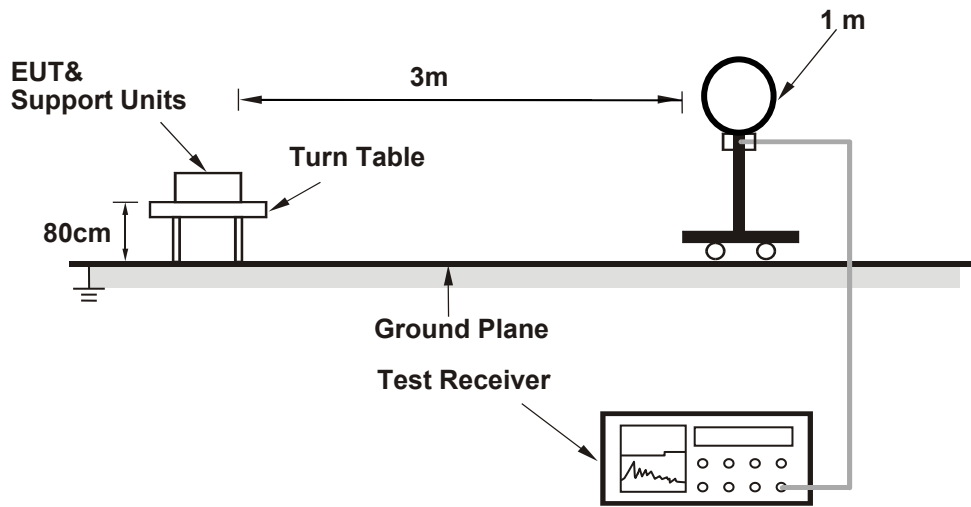

For Radiated emission 30MHz to 1GHz

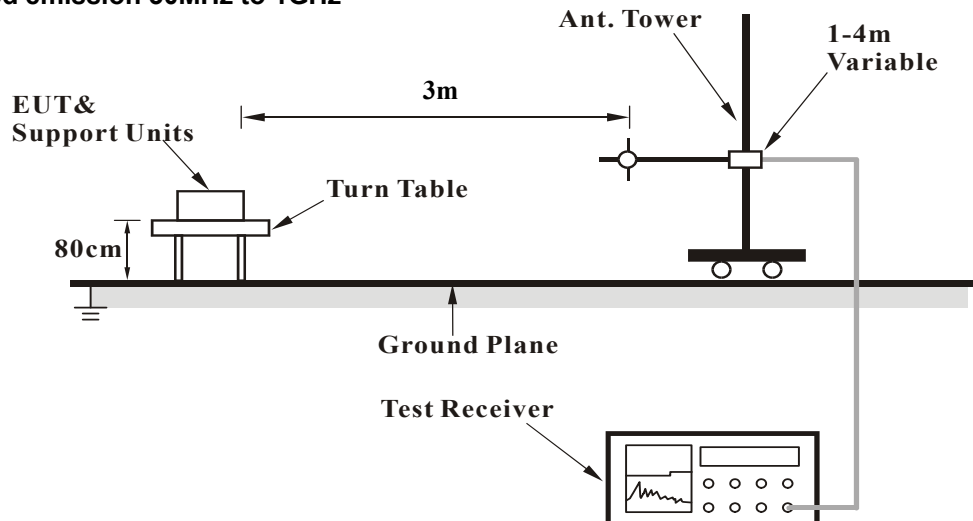

For Radiated emission above 1GHz

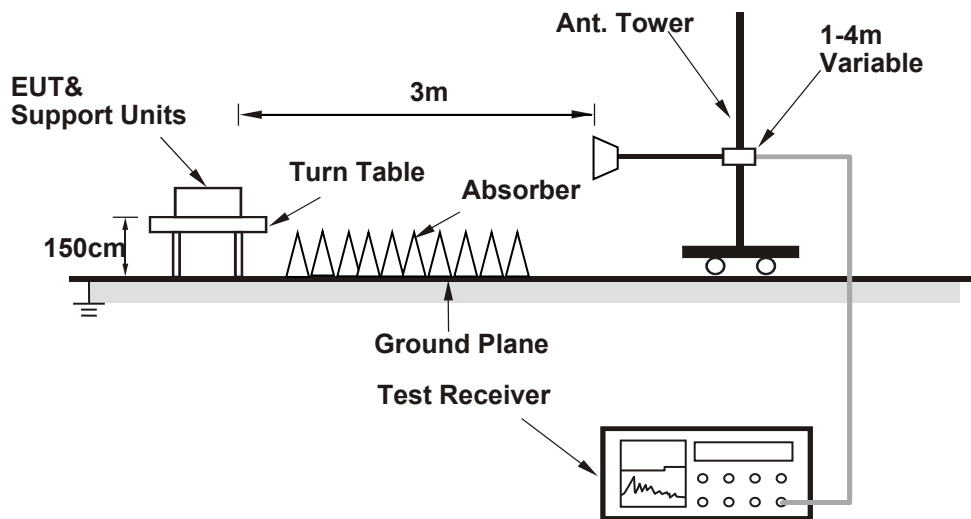

For the actual test configuration, please refer to the attached file (Test Setup Photo).

4.1.6 EUT Operating Conditions

- a. Placed the EUT on the testing table.
- b. Prepared a notebook to act as a communication partner and placed it outside of testing area.
- c. The communication partner connected with EUT via a RJ45 cable and ran a test program (provided by manufacturer) to enable EUT under transmission condition continuously at specific channel frequency.
- d. The communication partner sent data to EUT by command "PING".

4.1.7 Test Results

Above 1GHz data:

802.11a

CHANNEL	TX Channel 36	DETECTOR FUNCTION	Peak (PK) Average (AV)
FREQUENCY RANGE	1GHz ~ 40GHz		

ANTENNA POLARITY & TEST DISTANCE: HORIZONTAL AT 3 M								
NO.	FREQ. (MHz)	EMISSION LEVEL (dBuV/m)	LIMIT (dBuV/m)	MARGIN (dB)	ANTENNA HEIGHT (m)	TABLE ANGLE (Degree)	RAW VALUE (dBuV)	CORRECTION FACTOR (dB/m)
1	5150.00	71.0 PK	74.0	-3.0	2.93 H	286	64.6	6.4
2	5150.00	53.5 AV	54.0	-0.5	2.93 H	286	47.1	6.4
3	*5180.00	114.4 PK			2.93 H	286	76.7	37.7
4	*5180.00	104.9 AV			2.93 H	286	67.2	37.7
5	#10360.00	57.2 PK	68.2	-11.0	1.74 H	230	40.5	16.7
ANTENNA POLARITY & TEST DISTANCE: VERTICAL AT 3 M								
NO.	FREQ. (MHz)	EMISSION LEVEL (dBuV/m)	LIMIT (dBuV/m)	MARGIN (dB)	ANTENNA HEIGHT (m)	TABLE ANGLE (Degree)	RAW VALUE (dBuV)	CORRECTION FACTOR (dB/m)
1	5150.00	68.3 PK	74.0	-5.7	2.86 V	238	59.3	9.0
2	5150.00	51.3 AV	54.0	-2.7	2.86 V	238	42.3	9.0
3	*5180.00	113.2 PK			2.86 V	238	72.9	40.3
4	*5180.00	104.1 AV			2.86 V	238	63.8	40.3
5	#10360.00	57.0 PK	68.2	-11.2	2.65 V	156	37.1	19.9

Remarks:

1. Emission Level(dBuV/m) = Raw Value(dBuV) + Correction Factor(dB/m).
2. Correction Factor(dB/m) = Antenna Factor(dB/m) + Cable Factor(dB) – Pre-Amplifier Factor(dB).
3. Margin value = Emission Level – Limit value.
4. The other emission levels were very low against the limit.
5. " * ": Fundamental frequency.
6. " # ": The radiated frequency is out of the restricted band.

CHANNEL	TX Channel 40	DETECTOR FUNCTION	Peak (PK) Average (AV)
FREQUENCY RANGE	1GHz ~ 40GHz		

ANTENNA POLARITY & TEST DISTANCE: HORIZONTAL AT 3 M								
NO.	FREQ. (MHz)	EMISSION LEVEL (dBuV/m)	LIMIT (dBuV/m)	MARGIN (dB)	ANTENNA HEIGHT (m)	TABLE ANGLE (Degree)	RAW VALUE (dBuV)	CORRECTION FACTOR (dB/m)
1	5119.00	64.5 PK	74.0	-9.5	2.89 H	284	58.1	6.4
2	5119.00	53.8 AV	54.0	-0.2	2.89 H	284	47.4	6.4
3	*5200.00	116.8 PK			2.89 H	284	79.1	37.7
4	*5200.00	106.6 AV			2.89 H	284	68.9	37.7
5	#10400.00	57.8 PK	68.2	-10.4	1.95 H	211	40.8	17.0

ANTENNA POLARITY & TEST DISTANCE: VERTICAL AT 3 M								
NO.	FREQ. (MHz)	EMISSION LEVEL (dBuV/m)	LIMIT (dBuV/m)	MARGIN (dB)	ANTENNA HEIGHT (m)	TABLE ANGLE (Degree)	RAW VALUE (dBuV)	CORRECTION FACTOR (dB/m)
1	5119.00	62.1 PK	74.0	-11.9	2.88 V	233	53.1	9.0
2	5119.00	51.8 AV	54.0	-2.2	2.88 V	233	42.8	9.0
3	*5200.00	115.7 PK			2.88 V	233	75.5	40.2
4	*5200.00	105.5 AV			2.88 V	233	65.3	40.2
5	#10400.00	57.2 PK	68.2	-11.0	2.16 V	105	37.1	20.1

Remarks:

1. Emission Level(dBuV/m) = Raw Value(dBuV) + Correction Factor(dB/m).
2. Correction Factor(dB/m) = Antenna Factor(dB/m) + Cable Factor(dB) – Pre-Amplifier Factor(dB).
3. Margin value = Emission Level – Limit value.
4. The other emission levels were very low against the limit.
5. " * ": Fundamental frequency.
6. " # ": The radiated frequency is out of the restricted band.

CHANNEL	TX Channel 48	DETECTOR FUNCTION	Peak (PK) Average (AV)
FREQUENCY RANGE	1GHz ~ 40GHz		

ANTENNA POLARITY & TEST DISTANCE: HORIZONTAL AT 3 M

NO.	FREQ. (MHz)	EMISSION LEVEL (dBuV/m)	LIMIT (dBuV/m)	MARGIN (dB)	ANTENNA HEIGHT (m)	TABLE ANGLE (Degree)	RAW VALUE (dBuV)	CORRECTION FACTOR (dB/m)
1	*5240.00	117.0 PK			2.88 H	287	79.5	37.5
2	*5240.00	106.7 AV			2.88 H	287	69.2	37.5
3	5400.00	60.8 PK	74.0	-13.2	2.88 H	287	54.4	6.4
4	5400.00	49.7 AV	54.0	-4.3	2.88 H	287	43.3	6.4
5	#10480.00	57.8 PK	68.2	-10.4	1.43 H	265	40.9	16.9

ANTENNA POLARITY & TEST DISTANCE: VERTICAL AT 3 M

NO.	FREQ. (MHz)	EMISSION LEVEL (dBuV/m)	LIMIT (dBuV/m)	MARGIN (dB)	ANTENNA HEIGHT (m)	TABLE ANGLE (Degree)	RAW VALUE (dBuV)	CORRECTION FACTOR (dB/m)
1	*5240.00	116.0 PK			2.86 V	238	76.2	39.8
2	*5240.00	105.7 AV			2.86 V	238	65.9	39.8
3	5400.00	58.8 PK	74.0	-15.2	2.86 V	238	49.9	8.9
4	5400.00	47.7 AV	54.0	-6.3	2.86 V	238	38.8	8.9
5	#10480.00	56.9 PK	68.2	-11.3	1.05 V	133	36.7	20.2

Remarks:

1. Emission Level(dBuV/m) = Raw Value(dBuV) + Correction Factor(dB/m).
2. Correction Factor(dB/m) = Antenna Factor(dB/m) + Cable Factor(dB) – Pre-Amplifier Factor(dB).
3. Margin value = Emission Level – Limit value.
4. The other emission levels were very low against the limit.
5. " * " : Fundamental frequency.
6. " # " : The radiated frequency is out of the restricted band.

CHANNEL	TX Channel 149	DETECTOR FUNCTION	Peak (PK) Average (AV)
FREQUENCY RANGE	1GHz ~ 40GHz		

ANTENNA POLARITY & TEST DISTANCE: HORIZONTAL AT 3 M

NO.	FREQ. (MHz)	EMISSION LEVEL (dBuV/m)	LIMIT (dBuV/m)	MARGIN (dB)	ANTENNA HEIGHT (m)	TABLE ANGLE (Degree)	RAW VALUE (dBuV)	CORRECTION FACTOR (dB/m)
1	#5620.80	58.3 PK	68.2	-9.9	2.89 H	281	51.6	6.7
2	*5745.00	117.4 PK			2.89 H	281	79.0	38.4
3	*5745.00	107.0 AV			2.89 H	281	68.6	38.4
4	#5988.80	58.8 PK	68.2	-9.4	2.89 H	281	51.3	7.5
5	11490.00	59.6 PK	74.0	-14.4	1.36 H	187	40.8	18.8
6	11490.00	45.4 AV	54.0	-8.6	1.36 H	187	26.6	18.8

ANTENNA POLARITY & TEST DISTANCE: VERTICAL AT 3 M

NO.	FREQ. (MHz)	EMISSION LEVEL (dBuV/m)	LIMIT (dBuV/m)	MARGIN (dB)	ANTENNA HEIGHT (m)	TABLE ANGLE (Degree)	RAW VALUE (dBuV)	CORRECTION FACTOR (dB/m)
1	#5621.60	59.2 PK	68.2	-9.0	2.86 V	238	49.8	9.4
2	*5745.00	116.2 PK			2.86 V	238	75.2	41.0
3	*5745.00	105.8 AV			2.86 V	238	64.8	41.0
4	#5991.20	60.5 PK	68.2	-7.7	2.86 V	238	50.2	10.3
5	11490.00	58.9 PK	74.0	-15.1	3.01 V	105	36.8	22.1
6	11490.00	48.6 AV	54.0	-5.4	3.01 V	105	26.5	22.1

Remarks:

1. Emission Level(dBuV/m) = Raw Value(dBuV) + Correction Factor(dB/m).
2. Correction Factor(dB/m) = Antenna Factor(dB/m) + Cable Factor(dB) – Pre-Amplifier Factor(dB).
3. Margin value = Emission Level – Limit value.
4. The other emission levels were very low against the limit.
5. " * " : Fundamental frequency.
6. " # " : The radiated frequency is out of the restricted band.

CHANNEL	TX Channel 157	DETECTOR FUNCTION	Peak (PK) Average (AV)
FREQUENCY RANGE	1GHz ~ 40GHz		

ANTENNA POLARITY & TEST DISTANCE: HORIZONTAL AT 3 M

NO.	FREQ. (MHz)	EMISSION LEVEL (dBuV/m)	LIMIT (dBuV/m)	MARGIN (dB)	ANTENNA HEIGHT (m)	TABLE ANGLE (Degree)	RAW VALUE (dBuV)	CORRECTION FACTOR (dB/m)
1	#5624.00	59.8 PK	68.2	-8.4	2.69 H	271	53.1	6.7
2	*5785.00	118.6 PK			2.69 H	271	80.2	38.4
3	*5785.00	107.5 AV			2.69 H	271	69.1	38.4
4	#5949.60	60.7 PK	68.2	-7.5	2.69 H	271	53.3	7.4
5	11570.00	59.7 PK	74.0	-14.3	2.50 H	136	40.8	18.9
6	11570.00	45.8 AV	54.0	-8.2	2.50 H	136	26.9	18.9

ANTENNA POLARITY & TEST DISTANCE: VERTICAL AT 3 M

NO.	FREQ. (MHz)	EMISSION LEVEL (dBuV/m)	LIMIT (dBuV/m)	MARGIN (dB)	ANTENNA HEIGHT (m)	TABLE ANGLE (Degree)	RAW VALUE (dBuV)	CORRECTION FACTOR (dB/m)
1	#5620.00	59.7 PK	68.2	-8.5	2.88 V	233	50.3	9.4
2	*5785.00	116.9 PK			2.88 V	233	75.7	41.2
3	*5785.00	106.0 AV			2.88 V	233	64.8	41.2
4	#5953.20	61.5 PK	68.2	-6.7	2.88 V	233	51.2	10.3
5	11570.00	59.1 PK	74.0	-14.9	1.96 V	210	36.9	22.2
6	11570.00	48.7 AV	54.0	-5.3	1.96 V	210	26.5	22.2

Remarks:

1. Emission Level(dBuV/m) = Raw Value(dBuV) + Correction Factor(dB/m).
2. Correction Factor(dB/m) = Antenna Factor(dB/m) + Cable Factor(dB) – Pre-Amplifier Factor(dB).
3. Margin value = Emission Level – Limit value.
4. The other emission levels were very low against the limit.
5. " * " : Fundamental frequency.
6. " # " : The radiated frequency is out of the restricted band.

CHANNEL	TX Channel 165	DETECTOR FUNCTION	Peak (PK) Average (AV)
FREQUENCY RANGE	1GHz ~ 40GHz		

ANTENNA POLARITY & TEST DISTANCE: HORIZONTAL AT 3 M

NO.	FREQ. (MHz)	EMISSION LEVEL (dBuV/m)	LIMIT (dBuV/m)	MARGIN (dB)	ANTENNA HEIGHT (m)	TABLE ANGLE (Degree)	RAW VALUE (dBuV)	CORRECTION FACTOR (dB/m)
1	#5608.80	58.1 PK	68.2	-10.1	2.65 H	270	51.4	6.7
2	*5825.00	118.0 PK			2.65 H	270	79.6	38.4
3	*5825.00	107.0 AV			2.65 H	270	68.6	38.4
4	#5983.20	60.9 PK	68.2	-7.3	2.65 H	270	53.4	7.5
5	11650.00	59.2 PK	74.0	-14.8	2.50 H	142	40.8	18.4
6	11650.00	45.1 AV	54.0	-8.9	2.50 H	142	26.7	18.4

ANTENNA POLARITY & TEST DISTANCE: VERTICAL AT 3 M

NO.	FREQ. (MHz)	EMISSION LEVEL (dBuV/m)	LIMIT (dBuV/m)	MARGIN (dB)	ANTENNA HEIGHT (m)	TABLE ANGLE (Degree)	RAW VALUE (dBuV)	CORRECTION FACTOR (dB/m)
1	#5648.40	60.1 PK	68.2	-8.1	2.86 V	234	50.6	9.5
2	*5825.00	117.0 PK			2.86 V	234	75.6	41.4
3	*5825.00	106.0 AV			2.86 V	234	64.6	41.4
4	#5978.40	62.0 PK	68.2	-6.2	2.86 V	234	51.7	10.3
5	11650.00	58.7 PK	74.0	-15.3	2.10 V	155	36.8	21.9
6	11650.00	48.6 AV	54.0	-5.4	2.10 V	155	26.7	21.9

Remarks:

1. Emission Level(dBuV/m) = Raw Value(dBuV) + Correction Factor(dB/m).
2. Correction Factor(dB/m) = Antenna Factor(dB/m) + Cable Factor(dB) – Pre-Amplifier Factor(dB).
3. Margin value = Emission Level – Limit value.
4. The other emission levels were very low against the limit.
5. " * " : Fundamental frequency.
6. " # " : The radiated frequency is out of the restricted band.

802.11ac (VHT20)

CHANNEL	TX Channel 36	DETECTOR FUNCTION	Peak (PK) Average (AV)
FREQUENCY RANGE	1GHz ~ 40GHz		

ANTENNA POLARITY & TEST DISTANCE: HORIZONTAL AT 3 M								
NO.	FREQ. (MHz)	EMISSION LEVEL (dBuV/m)	LIMIT (dBuV/m)	MARGIN (dB)	ANTENNA HEIGHT (m)	TABLE ANGLE (Degree)	RAW VALUE (dBuV)	CORRECTION FACTOR (dB/m)
1	5150.00	70.0 PK	74.0	-4.0	2.80 H	289	63.6	6.4
2	5150.00	53.9 AV	54.0	-0.1	2.80 H	289	47.5	6.4
3	*5180.00	114.2 PK			2.80 H	289	76.5	37.7
4	*5180.00	103.5 AV			2.80 H	289	65.8	37.7
5	#10360.00	57.5 PK	68.2	-10.7	1.63 H	250	40.8	16.7

ANTENNA POLARITY & TEST DISTANCE: VERTICAL AT 3 M								
NO.	FREQ. (MHz)	EMISSION LEVEL (dBuV/m)	LIMIT (dBuV/m)	MARGIN (dB)	ANTENNA HEIGHT (m)	TABLE ANGLE (Degree)	RAW VALUE (dBuV)	CORRECTION FACTOR (dB/m)
1	5150.00	68.1 PK	74.0	-5.9	2.89 V	226	59.1	9.0
2	5150.00	51.7 AV	54.0	-2.3	2.89 V	226	42.7	9.0
3	*5180.00	112.3 PK			2.89 V	226	72.0	40.3
4	*5180.00	101.7 AV			2.89 V	226	61.4	40.3
5	#10360.00	56.9 PK	68.2	-11.3	1.99 V	165	37.0	19.9

Remarks:

1. Emission Level(dBuV/m) = Raw Value(dBuV) + Correction Factor(dB/m).
2. Correction Factor(dB/m) = Antenna Factor(dB/m) + Cable Factor(dB) – Pre-Amplifier Factor(dB).
3. Margin value = Emission Level – Limit value.
4. The other emission levels were very low against the limit.
5. " * ": Fundamental frequency.
6. " # ": The radiated frequency is out of the restricted band.

CHANNEL	TX Channel 40	DETECTOR FUNCTION	Peak (PK) Average (AV)
FREQUENCY RANGE	1GHz ~ 40GHz		

ANTENNA POLARITY & TEST DISTANCE: HORIZONTAL AT 3 M

NO.	FREQ. (MHz)	EMISSION LEVEL (dBuV/m)	LIMIT (dBuV/m)	MARGIN (dB)	ANTENNA HEIGHT (m)	TABLE ANGLE (Degree)	RAW VALUE (dBuV)	CORRECTION FACTOR (dB/m)
1	*5200.00	116.3 PK			2.79 H	292	78.6	37.7
2	*5200.00	105.6 AV			2.79 H	292	67.9	37.7
3	#10400.00	57.8 PK	68.2	-10.4	2.40 H	188	40.8	17.0

ANTENNA POLARITY & TEST DISTANCE: VERTICAL AT 3 M

NO.	FREQ. (MHz)	EMISSION LEVEL (dBuV/m)	LIMIT (dBuV/m)	MARGIN (dB)	ANTENNA HEIGHT (m)	TABLE ANGLE (Degree)	RAW VALUE (dBuV)	CORRECTION FACTOR (dB/m)
1	*5200.00	115.4 PK			2.89 V	215	75.2	40.2
2	*5200.00	104.5 AV			2.89 V	215	64.3	40.2
3	#10400.00	56.7 PK	68.2	-11.5	2.99 V	210	36.6	20.1

Remarks:

1. Emission Level(dBuV/m) = Raw Value(dBuV) + Correction Factor(dB/m).
2. Correction Factor(dB/m) = Antenna Factor(dB/m) + Cable Factor(dB) – Pre-Amplifier Factor(dB).
3. Margin value = Emission Level – Limit value.
4. The other emission levels were very low against the limit.
5. " * ": Fundamental frequency.
6. " # ": The radiated frequency is out of the restricted band.

CHANNEL	TX Channel 48	DETECTOR FUNCTION	Peak (PK) Average (AV)
FREQUENCY RANGE	1GHz ~ 40GHz		

ANTENNA POLARITY & TEST DISTANCE: HORIZONTAL AT 3 M								
NO.	FREQ. (MHz)	EMISSION LEVEL (dBuV/m)	LIMIT (dBuV/m)	MARGIN (dB)	ANTENNA HEIGHT (m)	TABLE ANGLE (Degree)	RAW VALUE (dBuV)	CORRECTION FACTOR (dB/m)
1	*5240.00	116.8 PK			2.86 H	286	79.3	37.5
2	*5240.00	105.8 AV			2.86 H	286	68.3	37.5
3	5397.00	59.3 PK	74.0	-14.7	2.86 H	286	52.9	6.4
4	5397.00	48.5 AV	54.0	-5.5	2.86 H	286	42.1	6.4
5	#10480.00	57.8 PK	68.2	-10.4	2.14 H	102	40.9	16.9

ANTENNA POLARITY & TEST DISTANCE: VERTICAL AT 3 M								
NO.	FREQ. (MHz)	EMISSION LEVEL (dBuV/m)	LIMIT (dBuV/m)	MARGIN (dB)	ANTENNA HEIGHT (m)	TABLE ANGLE (Degree)	RAW VALUE (dBuV)	CORRECTION FACTOR (dB/m)
1	*5240.00	115.7 PK			2.89 V	238	75.9	39.8
2	*5240.00	104.7 AV			2.89 V	238	64.9	39.8
3	5397.00	57.3 PK	74.0	-16.7	2.89 V	238	48.4	8.9
4	5397.00	46.5 AV	54.0	-7.5	2.89 V	238	37.6	8.9
5	#10480.00	57.2 PK	68.2	-11.0	1.05 V	136	37.0	20.2

Remarks:

1. Emission Level(dBuV/m) = Raw Value(dBuV) + Correction Factor(dB/m).
2. Correction Factor(dB/m) = Antenna Factor(dB/m) + Cable Factor(dB) – Pre-Amplifier Factor(dB).
3. Margin value = Emission Level – Limit value.
4. The other emission levels were very low against the limit.
5. " * " : Fundamental frequency.
6. " # " : The radiated frequency is out of the restricted band.

CHANNEL	TX Channel 149	DETECTOR FUNCTION	Peak (PK) Average (AV)
FREQUENCY RANGE	1GHz ~ 40GHz		

ANTENNA POLARITY & TEST DISTANCE: HORIZONTAL AT 3 M

NO.	FREQ. (MHz)	EMISSION LEVEL (dBuV/m)	LIMIT (dBuV/m)	MARGIN (dB)	ANTENNA HEIGHT (m)	TABLE ANGLE (Degree)	RAW VALUE (dBuV)	CORRECTION FACTOR (dB/m)
1	#5632.80	57.5 PK	68.2	-10.7	2.78 H	268	50.8	6.7
2	*5745.00	116.8 PK			2.78 H	268	78.4	38.4
3	*5745.00	106.5 AV			2.78 H	268	68.1	38.4
4	#5984.80	59.4 PK	68.2	-8.8	2.78 H	268	51.9	7.5
5	11490.00	59.4 PK	74.0	-14.6	2.41 H	135	40.6	18.8
6	11490.00	45.6 AV	54.0	-8.4	2.41 H	135	26.8	18.8

ANTENNA POLARITY & TEST DISTANCE: VERTICAL AT 3 M

NO.	FREQ. (MHz)	EMISSION LEVEL (dBuV/m)	LIMIT (dBuV/m)	MARGIN (dB)	ANTENNA HEIGHT (m)	TABLE ANGLE (Degree)	RAW VALUE (dBuV)	CORRECTION FACTOR (dB/m)
1	#5645.60	59.9 PK	68.2	-8.3	2.85 V	230	50.4	9.5
2	*5745.00	115.7 PK			2.85 V	230	74.7	41.0
3	*5745.00	105.4 AV			2.85 V	230	64.4	41.0
4	#5984.40	60.1 PK	68.2	-8.1	2.85 V	230	49.8	10.3
5	11490.00	59.0 PK	74.0	-15.0	2.18 V	230	36.9	22.1
6	11490.00	48.9 AV	54.0	-5.1	2.18 V	230	26.8	22.1

Remarks:

1. Emission Level(dBuV/m) = Raw Value(dBuV) + Correction Factor(dB/m).
2. Correction Factor(dB/m) = Antenna Factor(dB/m) + Cable Factor(dB) – Pre-Amplifier Factor(dB).
3. Margin value = Emission Level – Limit value.
4. The other emission levels were very low against the limit.
5. " * " : Fundamental frequency.
6. " # " : The radiated frequency is out of the restricted band.

CHANNEL	TX Channel 157	DETECTOR FUNCTION	Peak (PK) Average (AV)
FREQUENCY RANGE	1GHz ~ 40GHz		

ANTENNA POLARITY & TEST DISTANCE: HORIZONTAL AT 3 M								
NO.	FREQ. (MHz)	EMISSION LEVEL (dBuV/m)	LIMIT (dBuV/m)	MARGIN (dB)	ANTENNA HEIGHT (m)	TABLE ANGLE (Degree)	RAW VALUE (dBuV)	CORRECTION FACTOR (dB/m)
1	#5626.40	59.7 PK	68.2	-8.5	2.77 H	267	53.0	6.7
2	*5785.00	116.7 PK			2.77 H	267	78.3	38.4
3	*5785.00	106.4 AV			2.77 H	267	68.0	38.4
4	#5946.40	60.8 PK	68.2	-7.4	2.77 H	267	53.4	7.4
5	11570.00	59.6 PK	74.0	-14.4	2.10 H	154	40.7	18.9
6	11570.00	45.7 AV	54.0	-8.3	2.10 H	154	26.8	18.9

ANTENNA POLARITY & TEST DISTANCE: VERTICAL AT 3 M								
NO.	FREQ. (MHz)	EMISSION LEVEL (dBuV/m)	LIMIT (dBuV/m)	MARGIN (dB)	ANTENNA HEIGHT (m)	TABLE ANGLE (Degree)	RAW VALUE (dBuV)	CORRECTION FACTOR (dB/m)
1	#5620.40	60.8 PK	68.2	-7.4	2.81 V	231	51.4	9.4
2	*5785.00	115.6 PK			2.81 V	231	74.4	41.2
3	*5785.00	105.2 AV			2.81 V	231	64.0	41.2
4	#5950.00	61.4 PK	68.2	-6.8	2.81 V	231	51.2	10.2
5	11570.00	58.9 PK	74.0	-15.1	1.69 V	125	36.7	22.2
6	11570.00	48.8 AV	54.0	-5.2	1.69 V	125	26.6	22.2

Remarks:

1. Emission Level(dBuV/m) = Raw Value(dBuV) + Correction Factor(dB/m).
2. Correction Factor(dB/m) = Antenna Factor(dB/m) + Cable Factor(dB) – Pre-Amplifier Factor(dB).
3. Margin value = Emission Level – Limit value.
4. The other emission levels were very low against the limit.
5. " * " : Fundamental frequency.
6. " # " : The radiated frequency is out of the restricted band.

CHANNEL	TX Channel 165	DETECTOR FUNCTION	Peak (PK) Average (AV)
FREQUENCY RANGE	1GHz ~ 40GHz		

ANTENNA POLARITY & TEST DISTANCE: HORIZONTAL AT 3 M

NO.	FREQ. (MHz)	EMISSION LEVEL (dBuV/m)	LIMIT (dBuV/m)	MARGIN (dB)	ANTENNA HEIGHT (m)	TABLE ANGLE (Degree)	RAW VALUE (dBuV)	CORRECTION FACTOR (dB/m)
1	#5608.00	56.7 PK	68.2	-11.5	2.65 H	270	50.0	6.7
2	*5825.00	117.0 PK			2.65 H	270	78.6	38.4
3	*5825.00	106.4 AV			2.65 H	270	68.0	38.4
4	#5979.20	60.0 PK	68.2	-8.2	2.65 H	270	52.5	7.5
5	11650.00	59.1 PK	74.0	-14.9	2.03 H	184	40.7	18.4
6	11650.00	45.2 AV	54.0	-8.8	2.03 H	184	26.8	18.4

ANTENNA POLARITY & TEST DISTANCE: VERTICAL AT 3 M

NO.	FREQ. (MHz)	EMISSION LEVEL (dBuV/m)	LIMIT (dBuV/m)	MARGIN (dB)	ANTENNA HEIGHT (m)	TABLE ANGLE (Degree)	RAW VALUE (dBuV)	CORRECTION FACTOR (dB/m)
1	#5648.80	59.8 PK	68.2	-8.4	2.69 V	230	50.3	9.5
2	*5825.00	115.1 PK			2.69 V	230	73.7	41.4
3	*5825.00	104.6 AV			2.69 V	230	63.2	41.4
4	#5990.00	61.0 PK	68.2	-7.2	2.69 V	230	50.7	10.3
5	11650.00	58.6 PK	74.0	-15.4	2.01 V	105	36.7	21.9
6	11650.00	48.6 AV	54.0	-5.4	2.01 V	105	26.7	21.9

Remarks:

1. Emission Level(dBuV/m) = Raw Value(dBuV) + Correction Factor(dB/m).
2. Correction Factor(dB/m) = Antenna Factor(dB/m) + Cable Factor(dB) – Pre-Amplifier Factor(dB).
3. Margin value = Emission Level – Limit value.
4. The other emission levels were very low against the limit.
5. " * " : Fundamental frequency.
6. " # " : The radiated frequency is out of the restricted band.

802.11ac (VHT40)

CHANNEL	TX Channel 38	DETECTOR FUNCTION	Peak (PK) Average (AV)
FREQUENCY RANGE	1GHz ~ 40GHz		

ANTENNA POLARITY & TEST DISTANCE: HORIZONTAL AT 3 M								
NO.	FREQ. (MHz)	EMISSION LEVEL (dBuV/m)	LIMIT (dBuV/m)	MARGIN (dB)	ANTENNA HEIGHT (m)	TABLE ANGLE (Degree)	RAW VALUE (dBuV)	CORRECTION FACTOR (dB/m)
1	5150.00	72.7 PK	74.0	-1.3	2.86 H	290	66.3	6.4
2	5150.00	53.9 AV	54.0	-0.1	2.86 H	290	47.5	6.4
3	*5190.00	108.1 PK			2.86 H	290	70.4	37.7
4	*5190.00	97.4 AV			2.86 H	290	59.7	37.7
5	#10380.00	57.7 PK	68.2	-10.5	2.01 H	186	40.9	16.8

ANTENNA POLARITY & TEST DISTANCE: VERTICAL AT 3 M								
NO.	FREQ. (MHz)	EMISSION LEVEL (dBuV/m)	LIMIT (dBuV/m)	MARGIN (dB)	ANTENNA HEIGHT (m)	TABLE ANGLE (Degree)	RAW VALUE (dBuV)	CORRECTION FACTOR (dB/m)
1	5150.00	70.7 PK	74.0	-3.3	2.86 V	286	61.7	9.0
2	5150.00	51.7 AV	54.0	-2.3	2.86 V	286	42.7	9.0
3	*5190.00	107.0 PK			2.86 V	286	66.7	40.3
4	*5190.00	96.3 AV			2.86 V	286	56.0	40.3
5	#10380.00	56.8 PK	68.2	-11.4	1.56 V	165	36.8	20.0

Remarks:

1. Emission Level(dBuV/m) = Raw Value(dBuV) + Correction Factor(dB/m).
2. Correction Factor(dB/m) = Antenna Factor(dB/m) + Cable Factor(dB) – Pre-Amplifier Factor(dB).
3. Margin value = Emission Level – Limit value.
4. The other emission levels were very low against the limit.
5. " * ": Fundamental frequency.
6. " # ": The radiated frequency is out of the restricted band.

CHANNEL	TX Channel 46	DETECTOR FUNCTION	Peak (PK) Average (AV)
FREQUENCY RANGE	1GHz ~ 40GHz		

ANTENNA POLARITY & TEST DISTANCE: HORIZONTAL AT 3 M

NO.	FREQ. (MHz)	EMISSION LEVEL (dBuV/m)	LIMIT (dBuV/m)	MARGIN (dB)	ANTENNA HEIGHT (m)	TABLE ANGLE (Degree)	RAW VALUE (dBuV)	CORRECTION FACTOR (dB/m)
1	5144.00	67.0 PK	74.0	-7.0	2.86 H	285	60.6	6.4
2	5144.00	53.5 AV	54.0	-0.5	2.86 H	285	47.1	6.4
3	*5230.00	113.6 PK			2.86 H	285	76.0	37.6
4	*5230.00	103.4 AV			2.86 H	285	65.8	37.6
5	5394.00	58.2 PK	74.0	-15.8	2.86 H	285	51.8	6.4
6	5394.00	47.1 AV	54.0	-6.9	2.86 H	285	40.7	6.4
7	#10460.00	57.8 PK	68.2	-10.4	2.10 H	140	40.8	17.0

ANTENNA POLARITY & TEST DISTANCE: VERTICAL AT 3 M

NO.	FREQ. (MHz)	EMISSION LEVEL (dBuV/m)	LIMIT (dBuV/m)	MARGIN (dB)	ANTENNA HEIGHT (m)	TABLE ANGLE (Degree)	RAW VALUE (dBuV)	CORRECTION FACTOR (dB/m)
1	5144.00	65.0 PK	74.0	-9.0	2.85 V	233	56.0	9.0
2	5144.00	51.2 AV	54.0	-2.8	2.85 V	233	42.2	9.0
3	*5230.00	112.6 PK			2.85 V	233	72.7	39.9
4	*5230.00	102.4 AV			2.85 V	233	62.5	39.9
5	5394.00	55.1 PK	74.0	-18.9	2.85 V	233	46.2	8.9
6	5394.00	45.7 AV	54.0	-8.3	2.85 V	233	36.8	8.9
7	#10460.00	57.0 PK	68.2	-11.2	1.05 V	133	36.8	20.2

Remarks:

1. Emission Level(dBuV/m) = Raw Value(dBuV) + Correction Factor(dB/m).
2. Correction Factor(dB/m) = Antenna Factor(dB/m) + Cable Factor(dB) – Pre-Amplifier Factor(dB).
3. Margin value = Emission Level – Limit value.
4. The other emission levels were very low against the limit.
5. " * ": Fundamental frequency.
6. " # ": The radiated frequency is out of the restricted band.

CHANNEL	TX Channel 151	DETECTOR FUNCTION	Peak (PK) Average (AV)
FREQUENCY RANGE	1GHz ~ 40GHz		

ANTENNA POLARITY & TEST DISTANCE: HORIZONTAL AT 3 M

NO.	FREQ. (MHz)	EMISSION LEVEL (dBuV/m)	LIMIT (dBuV/m)	MARGIN (dB)	ANTENNA HEIGHT (m)	TABLE ANGLE (Degree)	RAW VALUE (dBuV)	CORRECTION FACTOR (dB/m)
1	#5644.80	60.9 PK	68.2	-7.3	2.71 H	274	54.2	6.7
2	*5755.00	114.3 PK			2.71 H	274	75.9	38.4
3	*5755.00	103.7 AV			2.71 H	274	65.3	38.4
4	#5947.20	58.3 PK	68.2	-9.9	2.71 H	274	50.9	7.4
5	11510.00	59.4 PK	74.0	-14.6	2.41 H	188	40.7	18.7
6	11510.00	45.6 AV	54.0	-8.4	2.41 H	188	26.9	18.7

ANTENNA POLARITY & TEST DISTANCE: VERTICAL AT 3 M

NO.	FREQ. (MHz)	EMISSION LEVEL (dBuV/m)	LIMIT (dBuV/m)	MARGIN (dB)	ANTENNA HEIGHT (m)	TABLE ANGLE (Degree)	RAW VALUE (dBuV)	CORRECTION FACTOR (dB/m)
1	#5641.60	63.0 PK	68.2	-5.2	2.88 V	233	53.5	9.5
2	*5755.00	113.1 PK			2.88 V	233	72.1	41.0
3	*5755.00	102.5 AV			2.88 V	233	61.5	41.0
4	#5933.20	60.2 PK	68.2	-8.0	2.88 V	233	50.0	10.2
5	11510.00	58.8 PK	74.0	-15.2	2.11 V	155	36.8	22.0
6	11510.00	49.0 AV	54.0	-5.0	2.11 V	155	27.0	22.0

Remarks:

1. Emission Level(dBuV/m) = Raw Value(dBuV) + Correction Factor(dB/m).
2. Correction Factor(dB/m) = Antenna Factor(dB/m) + Cable Factor(dB) – Pre-Amplifier Factor(dB).
3. Margin value = Emission Level – Limit value.
4. The other emission levels were very low against the limit.
5. " * " : Fundamental frequency.
6. " # " : The radiated frequency is out of the restricted band.

CHANNEL	TX Channel 159	DETECTOR FUNCTION	Peak (PK) Average (AV)
FREQUENCY RANGE	1GHz ~ 40GHz		

ANTENNA POLARITY & TEST DISTANCE: HORIZONTAL AT 3 M

NO.	FREQ. (MHz)	EMISSION LEVEL (dBuV/m)	LIMIT (dBuV/m)	MARGIN (dB)	ANTENNA HEIGHT (m)	TABLE ANGLE (Degree)	RAW VALUE (dBuV)	CORRECTION FACTOR (dB/m)
1	#5648.80	59.5 PK	68.2	-8.7	2.68 H	273	52.8	6.7
2	*5795.00	114.1 PK			2.68 H	273	75.7	38.4
3	*5795.00	103.6 AV			2.68 H	273	65.2	38.4
4	#5943.20	60.8 PK	68.2	-7.4	2.68 H	273	53.4	7.4
5	11590.00	59.7 PK	74.0	-14.3	1.89 H	231	40.8	18.9
6	11590.00	45.7 AV	54.0	-8.3	1.89 H	231	26.8	18.9

ANTENNA POLARITY & TEST DISTANCE: VERTICAL AT 3 M

NO.	FREQ. (MHz)	EMISSION LEVEL (dBuV/m)	LIMIT (dBuV/m)	MARGIN (dB)	ANTENNA HEIGHT (m)	TABLE ANGLE (Degree)	RAW VALUE (dBuV)	CORRECTION FACTOR (dB/m)
1	#5642.40	60.5 PK	68.2	-7.7	2.65 V	230	51.0	9.5
2	*5795.00	112.9 PK			2.65 V	230	71.6	41.3
3	*5795.00	102.4 AV			2.65 V	230	61.1	41.3
4	#5940.00	61.4 PK	68.2	-6.8	2.65 V	230	51.2	10.2
5	11590.00	58.9 PK	74.0	-15.1	2.18 V	105	36.8	22.1
6	11590.00	48.6 AV	54.0	-5.4	2.18 V	105	26.5	22.1

Remarks:

1. Emission Level(dBuV/m) = Raw Value(dBuV) + Correction Factor(dB/m).
2. Correction Factor(dB/m) = Antenna Factor(dB/m) + Cable Factor(dB) – Pre-Amplifier Factor(dB).
3. Margin value = Emission Level – Limit value.
4. The other emission levels were very low against the limit.
5. " * " : Fundamental frequency.
6. " # " : The radiated frequency is out of the restricted band.

802.11ac (VHT80)

CHANNEL	TX Channel 42	DETECTOR FUNCTION	Peak (PK) Average (AV)
FREQUENCY RANGE	1GHz ~ 40GHz		

ANTENNA POLARITY & TEST DISTANCE: HORIZONTAL AT 3 M

NO.	FREQ. (MHz)	EMISSION LEVEL (dBuV/m)	LIMIT (dBuV/m)	MARGIN (dB)	ANTENNA HEIGHT (m)	TABLE ANGLE (Degree)	RAW VALUE (dBuV)	CORRECTION FACTOR (dB/m)
1	5147.00	70.4 PK	74.0	-3.6	2.85 H	283	64.0	6.4
2	5147.00	53.5 AV	54.0	-0.5	2.85 H	283	47.1	6.4
3	*5210.00	103.8 PK			2.85 H	283	66.2	37.6
4	*5210.00	93.3 AV			2.85 H	283	55.7	37.6
5	5350.00	55.7 PK	74.0	-18.3	2.85 H	283	49.4	6.3
6	5350.00	42.5 AV	54.0	-11.5	2.85 H	283	36.2	6.3
7	#10420.00	57.4 PK	68.2	-10.8	1.53 H	210	40.5	16.9

ANTENNA POLARITY & TEST DISTANCE: VERTICAL AT 3 M

NO.	FREQ. (MHz)	EMISSION LEVEL (dBuV/m)	LIMIT (dBuV/m)	MARGIN (dB)	ANTENNA HEIGHT (m)	TABLE ANGLE (Degree)	RAW VALUE (dBuV)	CORRECTION FACTOR (dB/m)
1	5147.00	68.4 PK	74.0	-5.6	2.89 V	263	59.4	9.0
2	5147.00	51.5 AV	54.0	-2.5	2.89 V	263	42.5	9.0
3	*5210.00	102.6 PK			2.89 V	263	62.5	40.1
4	*5210.00	92.1 AV			2.89 V	263	52.0	40.1
5	5350.00	57.0 PK	74.0	-17.0	2.89 V	263	48.2	8.8
6	5350.00	44.8 AV	54.0	-9.2	2.89 V	263	36.0	8.8
7	#10420.00	57.0 PK	68.2	-11.2	3.16 V	200	36.9	20.1

Remarks:

1. Emission Level(dBuV/m) = Raw Value(dBuV) + Correction Factor(dB/m).
2. Correction Factor(dB/m) = Antenna Factor(dB/m) + Cable Factor(dB) – Pre-Amplifier Factor(dB).
3. Margin value = Emission Level – Limit value.
4. The other emission levels were very low against the limit.
5. " * ": Fundamental frequency.
6. " # ": The radiated frequency is out of the restricted band.

CHANNEL	TX Channel 155	DETECTOR FUNCTION	Peak (PK) Average (AV)
FREQUENCY RANGE	1GHz ~ 40GHz		

ANTENNA POLARITY & TEST DISTANCE: HORIZONTAL AT 3 M

NO.	FREQ. (MHz)	EMISSION LEVEL (dBuV/m)	LIMIT (dBuV/m)	MARGIN (dB)	ANTENNA HEIGHT (m)	TABLE ANGLE (Degree)	RAW VALUE (dBuV)	CORRECTION FACTOR (dB/m)
1	#5640.00	67.8 PK	68.2	-0.4	2.35 H	272	58.3	9.5
2	*5775.00	110.1 PK			2.35 H	272	69.0	41.1
3	*5775.00	99.8 AV			2.35 H	272	58.7	41.1
4	#5926.40	64.6 PK	68.2	-3.6	2.35 H	272	54.4	10.2
5	11550.00	59.1 PK	74.0	-14.9	2.15 H	233	36.9	22.2
6	11550.00	49.0 AV	54.0	-5.0	2.15 H	233	26.8	22.2

ANTENNA POLARITY & TEST DISTANCE: VERTICAL AT 3 M

NO.	FREQ. (MHz)	EMISSION LEVEL (dBuV/m)	LIMIT (dBuV/m)	MARGIN (dB)	ANTENNA HEIGHT (m)	TABLE ANGLE (Degree)	RAW VALUE (dBuV)	CORRECTION FACTOR (dB/m)
1	#5638.40	63.9 PK	68.2	-4.3	2.86 V	238	54.4	9.5
2	*5775.00	109.1 PK			2.86 V	238	68.0	41.1
3	*5775.00	98.8 AV			2.86 V	238	57.7	41.1
4	#5928.80	62.0 PK	68.2	-6.2	2.86 V	238	51.8	10.2
5	11550.00	60.8 PK	74.0	-13.2	1.66 V	133	38.6	22.2
6	11550.00	48.9 AV	54.0	-5.1	1.66 V	133	26.7	22.2

Remarks:

1. Emission Level(dBuV/m) = Raw Value(dBuV) + Correction Factor(dB/m).
2. Correction Factor(dB/m) = Antenna Factor(dB/m) + Cable Factor(dB) – Pre-Amplifier Factor(dB).
3. Margin value = Emission Level – Limit value.
4. The other emission levels were very low against the limit.
5. " * " : Fundamental frequency.
6. " # " : The radiated frequency is out of the restricted band.

Below 1GHz Worst-Case Data:

802.11ac (VHT20)

CHANNEL	TX Channel 149	DETECTOR FUNCTION	Quasi-Peak (QP)
FREQUENCY RANGE	9kHz ~ 1GHz		
TEST MDOE	A		

ANTENNA POLARITY & TEST DISTANCE: HORIZONTAL AT 3 M

NO.	FREQ. (MHz)	EMISSION LEVEL (dBuV/m)	LIMIT (dBuV/m)	MARGIN (dB)	ANTENNA HEIGHT (m)	TABLE ANGLE (Degree)	RAW VALUE (dBuV)	CORRECTION FACTOR (dB/m)
1	132.74	36.3 QP	43.5	-7.2	2.00 H	121	46.1	-9.8
2	173.49	37.3 QP	43.5	-6.2	1.00 H	300	46.7	-9.4
3	317.08	40.4 QP	46.0	-5.6	1.00 H	308	47.2	-6.8
4	586.79	35.1 QP	46.0	-10.9	1.00 H	308	35.5	-0.4
5	707.10	35.3 QP	46.0	-10.7	1.00 H	308	33.0	2.3
6	875.91	39.9 QP	46.0	-6.1	1.49 H	223	33.6	6.3

Remarks:

1. Emission Level(dBuV/m) = Raw Value(dBuV) + Correction Factor(dB/m).
2. Correction Factor(dB/m) = Antenna Factor(dB/m) + Cable Factor(dB) – Pre-Amplifier Factor(dB).
3. The other emission levels were very low against the limit of frequency range 30MHz ~ 1000MHz.
4. Margin value = Emission Level – Limit value.
5. The emission levels were very low against the limit of frequency range 9kHz ~ 30MHz: the amplitude of spurious emissions attenuated more than 20 dB below the permissible value to be report.

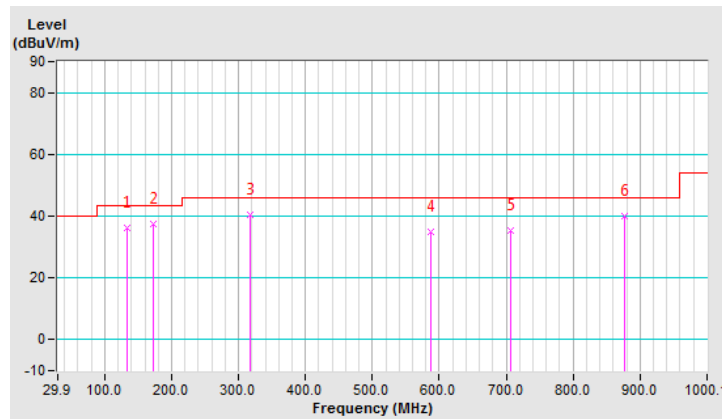

CHANNEL	TX Channel 149	DETECTOR FUNCTION	Quasi-Peak (QP)
FREQUENCY RANGE	9kHz ~ 1GHz		
TEST MDOE	A		

ANTENNA POLARITY & TEST DISTANCE: VERTICAL AT 3 M								
NO.	FREQ. (MHz)	EMISSION LEVEL (dBuV/m)	LIMIT (dBuV/m)	MARGIN (dB)	ANTENNA HEIGHT (m)	TABLE ANGLE (Degree)	RAW VALUE (dBuV)	CORRECTION FACTOR (dB/m)
1	154.09	35.4 QP	43.5	-8.1	1.50 V	332	43.9	-8.5
2	375.29	34.8 QP	46.0	-11.2	1.50 V	334	40.2	-5.4
3	540.23	38.2 QP	46.0	-7.8	1.01 V	95	40.2	-2.0
4	563.51	37.4 QP	46.0	-8.6	1.01 V	4	38.7	-1.3
5	662.47	35.8 QP	46.0	-10.2	1.01 V	4	34.4	1.4
6	875.91	41.9 QP	46.0	-4.1	1.01 V	128	35.6	6.3

Remarks:

1. Emission Level(dBuV/m) = Raw Value(dBuV) + Correction Factor(dB/m).
2. Correction Factor(dB/m) = Antenna Factor(dB/m) + Cable Factor(dB) – Pre-Amplifier Factor(dB).
3. The other emission levels were very low against the limit of frequency range 30MHz ~ 1000MHz.
4. Margin value = Emission Level – Limit value.
5. The emission levels were very low against the limit of frequency range 9kHz ~ 30MHz: the amplitude of spurious emissions attenuated more than 20 dB below the permissible value to be report.

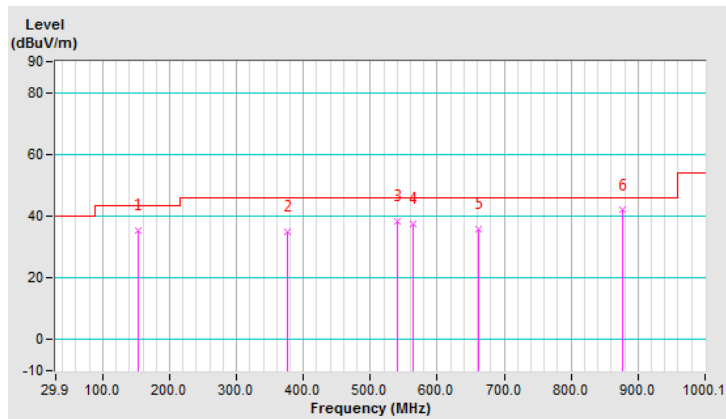

CHANNEL	TX Channel 149	DETECTOR FUNCTION	Quasi-Peak (QP)
FREQUENCY RANGE	9kHz ~ 1GHz		
TEST MDOE	B		

ANTENNA POLARITY & TEST DISTANCE: HORIZONTAL AT 3 M

NO.	FREQ. (MHz)	EMISSION LEVEL (dBuV/m)	LIMIT (dBuV/m)	MARGIN (dB)	ANTENNA HEIGHT (m)	TABLE ANGLE (Degree)	RAW VALUE (dBuV)	CORRECTION FACTOR (dB/m)
1	53.18	33.6 QP	40.0	-6.4	1.00 H	358	42.0	-8.4
2	88.11	31.4 QP	43.5	-12.1	1.00 H	280	45.4	-14.0
3	144.38	35.4 QP	43.5	-8.1	1.00 H	121	44.3	-8.9
4	190.95	28.6 QP	43.5	-14.9	1.00 H	300	39.9	-11.3
5	355.89	33.0 QP	46.0	-13.0	1.00 H	356	39.1	-6.1
6	625.60	32.1 QP	46.0	-13.9	1.00 H	142	31.4	0.7

Remarks:

1. Emission Level(dBuV/m) = Raw Value(dBuV) + Correction Factor(dB/m).
2. Correction Factor(dB/m) = Antenna Factor(dB/m) + Cable Factor(dB) – Pre-Amplifier Factor(dB).
3. The other emission levels were very low against the limit of frequency range 30MHz ~ 1000MHz.
4. Margin value = Emission Level – Limit value.
5. The emission levels were very low against the limit of frequency range 9kHz ~ 30MHz: the amplitude of spurious emissions attenuated more than 20 dB below the permissible value to be report.

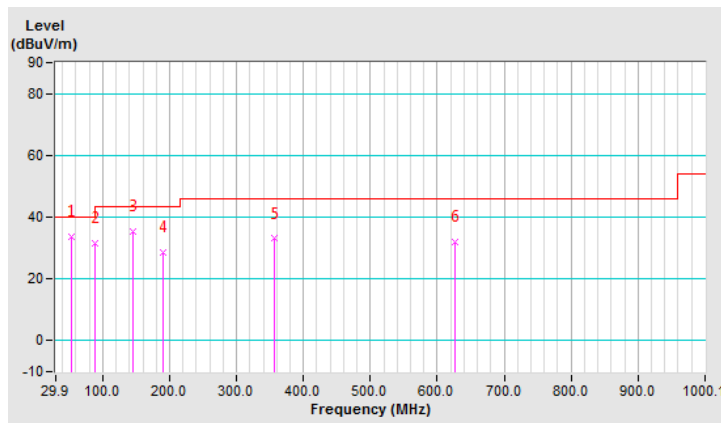

CHANNEL	TX Channel 149	DETECTOR FUNCTION	Quasi-Peak (QP)
FREQUENCY RANGE	9kHz ~ 1GHz		
TEST MDOE	B		

ANTENNA POLARITY & TEST DISTANCE: VERTICAL AT 3 M								
NO.	FREQ. (MHz)	EMISSION LEVEL (dBuV/m)	LIMIT (dBuV/m)	MARGIN (dB)	ANTENNA HEIGHT (m)	TABLE ANGLE (Degree)	RAW VALUE (dBuV)	CORRECTION FACTOR (dB/m)
1	101.69	33.0 QP	43.5	-10.5	1.50 V	162	46.0	-13.0
2	177.37	27.9 QP	43.5	-15.6	1.50 V	123	37.6	-9.7
3	361.71	31.5 QP	46.0	-14.5	1.01 V	4	37.3	-5.8
4	427.68	30.7 QP	46.0	-15.3	1.50 V	120	34.8	-4.1
5	450.97	31.7 QP	46.0	-14.3	1.50 V	332	35.2	-3.5
6	646.95	32.3 QP	46.0	-13.7	1.50 V	339	31.3	1.0

Remarks:

1. Emission Level(dBuV/m) = Raw Value(dBuV) + Correction Factor(dB/m).
2. Correction Factor(dB/m) = Antenna Factor(dB/m) + Cable Factor(dB) – Pre-Amplifier Factor(dB).
3. The other emission levels were very low against the limit of frequency range 30MHz ~ 1000MHz.
4. Margin value = Emission Level – Limit value.
5. The emission levels were very low against the limit of frequency range 9kHz ~ 30MHz: the amplitude of spurious emissions attenuated more than 20 dB below the permissible value to be report.

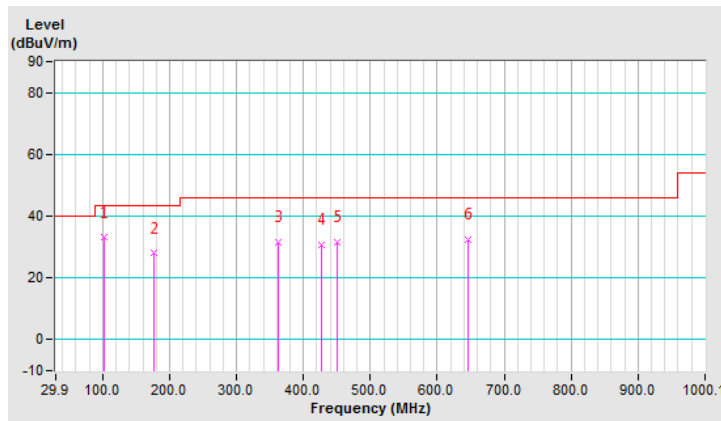

4.2 Conducted Emission Measurement

4.2.1 Limits of Conducted Emission Measurement

Frequency (MHz)	Conducted Limit (dBuV)	
	Quasi-peak	Average
0.15 - 0.5	66 - 56	56 - 46
0.50 - 5.0	56	46
5.0 - 30.0	60	50

Note: 1. The lower limit shall apply at the transition frequencies.
 2. The limit decreases in line with the logarithm of the frequency in the range of 0.15 to 0.50MHz.

4.2.2 Test Instruments

Description & Manufacturer	Model No.	Serial No.	Cal. Date	Cal. Due
Test Receiver ROHDE & SCHWARZ	ESCI	100613	Dec. 11, 2019	Dec. 10, 2020
RF signal cable Woken	5D-FB	Cable-cond1-01	Sep. 05, 2019	Sep. 04, 2020
LISN ROHDE & SCHWARZ (EUT)	ENV216	101826	Feb. 21, 2019	Feb. 20, 2020
LISN ROHDE & SCHWARZ (Peripheral)	ESH3-Z5	100311	Aug. 22, 2019	Aug. 21, 2020
Software ADT	BV ADT_Cond_ V7.3.7.4	NA	NA	NA

Note: 1. The calibration interval of the above test instruments is 12 months and the calibrations are traceable to NML/ROC and NIST/USA.
 2. The test was performed in HwaYa Shielded Room 1.
 3. The VCCI Site Registration No. is C-12040.

4.2.3 Test Procedures

- The EUT was placed 0.4 meters from the conducting wall of the shielded room with EUT being connected to the power mains through a line impedance stabilization network (LISN). Other support units were connected to the power mains through another LISN. The two LISNs provide 50 ohm/ 50uH of coupling impedance for the measuring instrument.
- Both lines of the power mains connected to the EUT were checked for maximum conducted interference.
- The frequency range from 150kHz to 30MHz was searched. Emission levels under (Limit - 20dB) was not recorded.

Note: The resolution bandwidth and video bandwidth of test receiver is 9kHz for quasi-peak detection (QP) and average detection (AV) at frequency 0.15MHz-30MHz.

4.2.4 Deviation from Test Standard

No deviation.

4.2.5 Test Setup

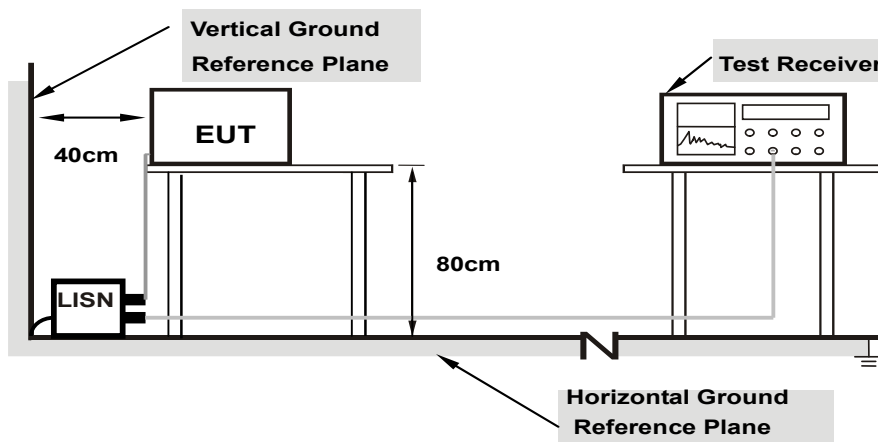

Note: 1.Support units were connected to second LISN.

For the actual test configuration, please refer to the attached file (Test Setup Photo).

4.2.6 EUT Operating Conditions

Same as 4.1.6.

4.2.7 Test Results

Worst-case data:

802.11ac (VHT20)

Phase	Line (L)	Detector Function	Quasi-Peak (QP) / Average (AV)
Test Mode	A		

No	Freq. [MHz]	Corr. Factor (dB)	Reading Value [dB (uV)]		Emission Level [dB (uV)]		Limit [dB (uV)]		Margin (dB)	
			Q.P.	AV.	Q.P.	AV.	Q.P.	AV.	Q.P.	AV.
			1	0.15000	9.67	42.02	29.96	51.69	39.63	66.00
2	0.18519	9.66	35.59	25.74	45.25	35.40	64.25	54.25	-19.00	-18.85
3	0.22038	9.66	29.37	21.67	39.03	31.33	62.80	52.80	-23.77	-21.47
4	0.47039	9.69	24.11	18.53	33.80	28.22	56.51	46.51	-22.71	-18.29
5	7.87616	9.90	28.12	22.94	38.02	32.84	60.00	50.00	-21.98	-17.16
6	13.53002	9.95	23.25	17.81	33.20	27.76	60.00	50.00	-26.80	-22.24

Remarks:

1. Q.P. and AV. are abbreviations of quasi-peak and average individually.
2. The emission levels of other frequencies were very low against the limit.
3. Margin value = Emission level - Limit value
4. Correction factor = Insertion loss + Cable loss
5. Emission Level = Correction Factor + Reading Value.

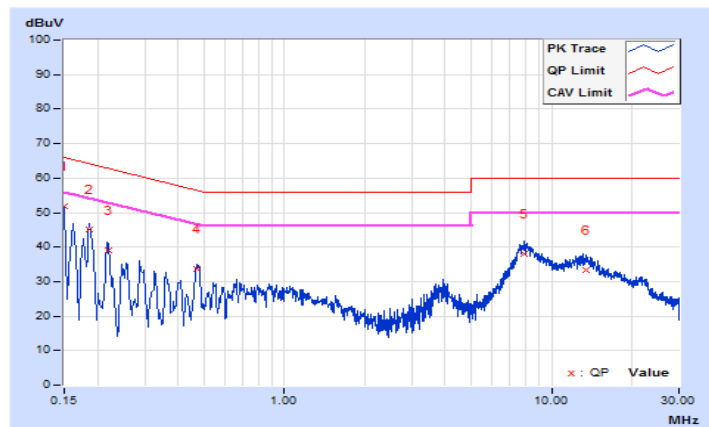

Phase	Neutral (N)	Detector Function	Quasi-Peak (QP) / Average (AV)
Test Mode	A		

No	Freq. [MHz]	Corr. Factor (dB)	Reading Value [dB (uV)]		Emission Level [dB (uV)]		Limit [dB (uV)]		Margin (dB)	
			Q.P.	AV.	Q.P.	AV.	Q.P.	AV.	Q.P.	AV.
			1	0.18122	9.64	36.86	25.86	46.50	35.50	64.43
2	0.21647	9.64	30.36	19.60	40.00	29.24	62.95	52.95	-22.95	-23.71
3	0.46915	9.66	24.42	18.58	34.08	28.24	56.53	46.53	-22.45	-18.29
4	3.72374	9.80	16.83	7.60	26.63	17.40	56.00	46.00	-29.37	-28.60
5	7.98564	9.88	28.64	23.52	38.52	33.40	60.00	50.00	-21.48	-16.60
6	21.78794	10.06	19.09	13.80	29.15	23.86	60.00	50.00	-30.85	-26.14

Remarks:

1. Q.P. and AV. are abbreviations of quasi-peak and average individually.
2. The emission levels of other frequencies were very low against the limit.
3. Margin value = Emission level - Limit value
4. Correction factor = Insertion loss + Cable loss
5. Emission Level = Correction Factor + Reading Value.

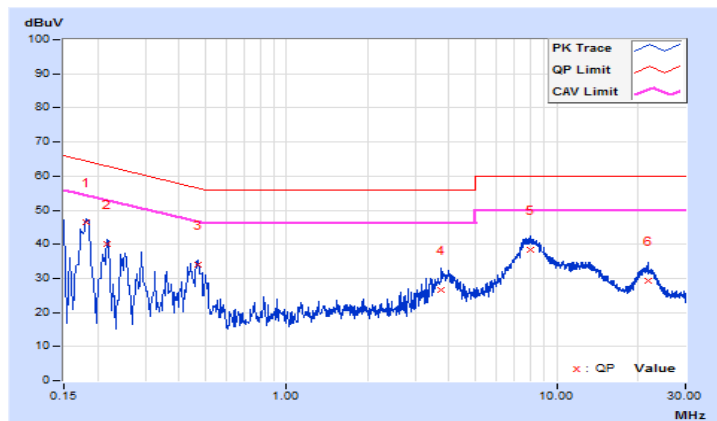

Phase	Line (L)	Detector Function	Quasi-Peak (QP) / Average (AV)
Test Mode	B		

No	Freq. [MHz]	Corr. Factor (dB)	Reading Value [dB (uV)]		Emission Level [dB (uV)]		Limit [dB (uV)]		Margin (dB)	
			Q.P.	AV.	Q.P.	AV.	Q.P.	AV.	Q.P.	AV.
			1	0.15391	9.71	41.61	27.53	51.32	37.24	65.79
2	0.16564	9.73	38.69	23.96	48.42	33.69	65.18	55.18	-16.76	-21.49
3	0.18128	9.75	31.88	16.84	41.63	26.59	64.43	54.43	-22.80	-27.84
4	0.19301	9.77	34.01	21.52	43.78	31.29	63.91	53.91	-20.13	-22.62
5	0.20838	9.79	30.98	17.00	40.77	26.79	63.27	53.27	-22.50	-26.48
6	0.23602	9.80	33.50	19.12	43.30	28.92	62.24	52.24	-18.94	-23.32

Remarks:

1. Q.P. and AV. are abbreviations of quasi-peak and average individually.
2. The emission levels of other frequencies were very low against the limit.
3. Margin value = Emission level - Limit value
4. Correction factor = Insertion loss + Cable loss
5. Emission Level = Correction Factor + Reading Value.

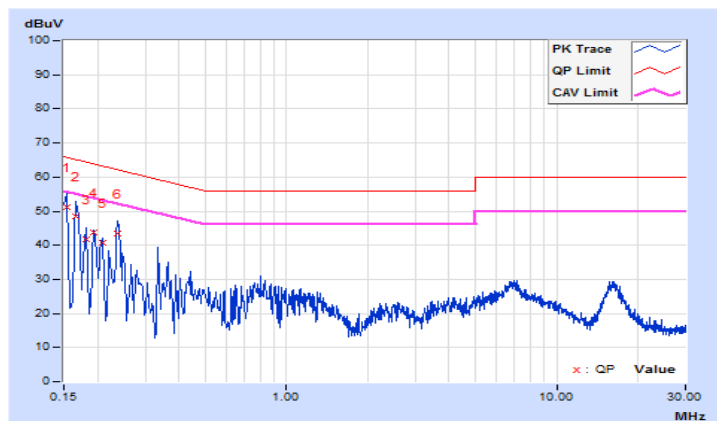

Phase	Neutral (N)	Detector Function	Quasi-Peak (QP) / Average (AV)
Test Mode	B		

No	Freq. [MHz]	Corr. Factor (dB)	Reading Value [dB (uV)]		Emission Level [dB (uV)]		Limit [dB (uV)]		Margin (dB)	
			Q.P.	AV.	Q.P.	AV.	Q.P.	AV.	Q.P.	AV.
			1	0.16181	9.71	37.27	27.91	46.98	37.62	65.37
2	0.17737	9.75	33.58	18.47	43.33	28.22	64.61	54.61	-21.28	-26.39
3	0.19153	9.78	34.73	20.54	44.51	30.32	63.97	53.97	-19.46	-23.65
4	0.20474	9.80	35.31	22.52	45.11	32.32	63.42	53.42	-18.31	-21.10
5	0.29076	9.83	28.70	13.36	38.53	23.19	60.50	50.50	-21.97	-27.31
6	0.31813	9.84	28.62	16.36	38.46	26.20	59.76	49.76	-21.30	-23.56

Remarks:

1. Q.P. and AV. are abbreviations of quasi-peak and average individually.
2. The emission levels of other frequencies were very low against the limit.
3. Margin value = Emission level - Limit value
4. Correction factor = Insertion loss + Cable loss
5. Emission Level = Correction Factor + Reading Value.

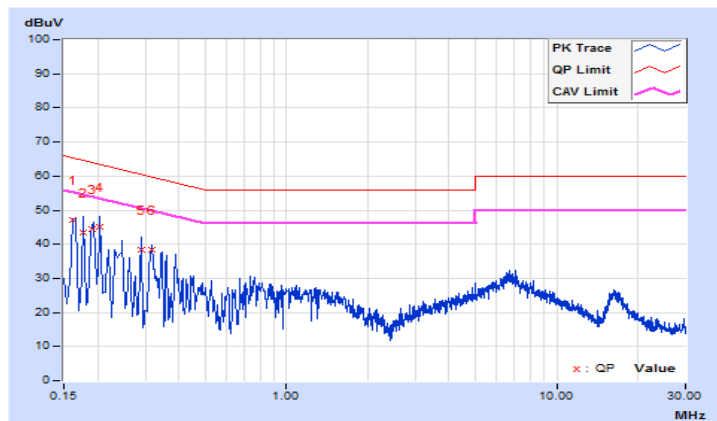

4.3 Transmit Power Measurement

4.3.1 Limits of Transmit Power Measurement

Operation Band	EUT Category		Limit
U-NII-1		Outdoor Access Point	1 Watt (30 dBm) (Max. e.i.r.p \leq 125mW(21 dBm) at any elevation angle above 30 degrees as measured from the horizon)
		Fixed point-to-point Access Point	1 Watt (30 dBm)
	√	Indoor Access Point	1 Watt (30 dBm)
		Mobile and Portable client device	250mW (24 dBm)
U-NII-2A			250mW (24 dBm) or 11 dBm+10 log B*
U-NII-2C			250mW (24 dBm) or 11 dBm+10 log B*
U-NII-3	√		1 Watt (30 dBm)

*B is the 26 dB emission bandwidth in megahertz

Per KDB 662911 Method of conducted output power measurement on IEEE 802.11 devices,

Array Gain = 0 dB (i.e., no array gain) for $N_{ANT} \leq 4$;

Array Gain = 0 dB (i.e., no array gain) for channel widths ≥ 40 MHz for any N_{ANT} ;

Array Gain = $5 \log(N_{ANT}/N_{SS})$ dB or 3 dB, whichever is less for 20-MHz channel widths with $N_{ANT} \geq 5$.

For power measurements on all other devices: Array Gain = $10 \log(N_{ANT}/N_{SS})$ dB.

4.3.2 Test Setup

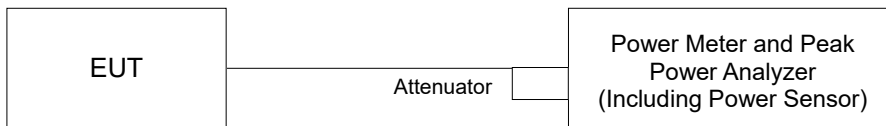

4.3.3 Test Instruments

Refer to section 4.1.2 to get information of above instrument.

4.3.4 Test Procedure

Method PM is used to perform output power measurement, trigger and gating function of wide band power meter is enabled to measure max output power of TX on burst and set the detector to average. Duty factor is not added to measured value.

4.3.5 Deviation from Test Standard

No deviation.

4.3.6 EUT Operating Conditions

The software provided by client to enable the EUT under transmission condition continuously at lowest, middle and highest channel frequencies individually.

4.3.7 Test Result

Power Output:

CDD Mode

802.11a

Chan.	Freq. (MHz)	Maximum Conducted Power (dBm)		Total Power (mW)	Total Power (dBm)	Power Limit (dBm)	Pass / Fail
		Chain 0	Chain 1				
36	5180	20.61	21.22	247.514	23.94	30.00	Pass
40	5200	22.49	24.24	442.880	26.46	30.00	Pass
48	5240	22.69	23.78	424.562	26.28	30.00	Pass
149	5745	24.23	24.10	521.890	27.18	30.00	Pass
157	5785	24.33	23.82	512.010	27.09	30.00	Pass
165	5825	24.46	23.95	527.568	27.22	30.00	Pass

802.11ac (VHT20)

Chan.	Freq. (MHz)	Maximum Conducted Power (dBm)		Total Power (mW)	Total Power (dBm)	Power Limit (dBm)	Pass / Fail
		Chain 0	Chain 1				
36	5180	21.20	20.78	251.500	24.01	30.00	Pass
40	5200	22.64	23.87	427.435	26.31	30.00	Pass
48	5240	22.15	23.64	395.265	25.97	30.00	Pass
149	5745	24.34	24.41	547.702	27.39	30.00	Pass
157	5785	24.34	24.21	535.277	27.29	30.00	Pass
165	5825	24.25	24.03	519.002	27.15	30.00	Pass

802.11ac (VHT40)

Chan.	Freq. (MHz)	Maximum Conducted Power (dBm)		Total Power (mW)	Total Power (dBm)	Power Limit (dBm)	Pass / Fail
		Chain 0	Chain 1				
38	5190	17.62	17.81	118.204	20.73	30.00	Pass
46	5230	22.35	22.82	363.216	25.60	30.00	Pass
151	5755	24.23	24.25	530.923	27.25	30.00	Pass
159	5795	24.29	24.27	535.835	27.29	30.00	Pass

802.11ac (VHT80)

Chan.	Freq. (MHz)	Maximum Conducted Power (dBm)		Total Power (mW)	Total Power (dBm)	Power Limit (dBm)	Pass / Fail
		Chain 0	Chain 1				
42	5210	16.59	16.82	93.688	19.72	30.00	Pass
155	5775	22.00	22.16	322.926	25.09	30.00	Pass

Beamforming Mode

802.11ac (VHT20)

Chan.	Freq. (MHz)	Maximum Conducted Power (dBm)		Total Power (mW)	Total Power (dBm)	Power Limit (dBm)	Pass / Fail
		Chain 0	Chain 1				
36	5180	21.20	20.78	251.500	24.01	28.56	Pass
40	5200	22.64	23.87	427.435	26.31	28.56	Pass
48	5240	22.15	23.64	395.265	25.97	28.56	Pass
149	5745	24.34	24.41	547.702	27.39	28.29	Pass
157	5785	24.34	24.21	535.277	27.29	28.29	Pass
165	5825	24.25	24.03	519.002	27.15	28.29	Pass

Note:

- 5180-5240MHz: Directional gain = $10 \log[(10^{G1/20} + 10^{G2/20} + \dots + 10^{GN/20})^2/2]$ = 7.44dBi > 6dBi, so the power limit shall be reduced to 30 - (7.44 - 6) = 28.56dBm.
- 5745-5825MHz: Directional gain = $10 \log[(10^{G1/20} + 10^{G2/20} + \dots + 10^{GN/20})^2/2]$ = 7.71dBi > 6dBi, so the power limit shall be reduced to 30 - (7.71 - 6) = 28.29dBm.

802.11ac (VHT40)

Chan.	Freq. (MHz)	Maximum Conducted Power (dBm)		Total Power (mW)	Total Power (dBm)	Power Limit (dBm)	Pass / Fail
		Chain 0	Chain 1				
38	5190	17.62	17.81	118.204	20.73	28.56	Pass
46	5230	22.35	22.82	363.216	25.60	28.56	Pass
151	5755	24.23	24.25	530.923	27.25	28.29	Pass
159	5795	24.29	24.27	535.835	27.29	28.29	Pass

Note:

- 5180-5240MHz: Directional gain = $10 \log[(10^{G1/20} + 10^{G2/20} + \dots + 10^{GN/20})^2/2]$ = 7.44dBi > 6dBi, so the power limit shall be reduced to 30 - (7.44 - 6) = 28.56dBm.
- 5745-5825MHz: Directional gain = $10 \log[(10^{G1/20} + 10^{G2/20} + \dots + 10^{GN/20})^2/2]$ = 7.71dBi > 6dBi, so the power limit shall be reduced to 30 - (7.71 - 6) = 28.29dBm.

802.11ac (VHT80)

Chan.	Freq. (MHz)	Maximum Conducted Power (dBm)		Total Power (mW)	Total Power (dBm)	Power Limit (dBm)	Pass / Fail
		Chain 0	Chain 1				
42	5210	16.59	16.82	93.688	19.72	28.56	Pass
155	5775	22.00	22.16	322.926	25.09	28.29	Pass

Note:

- 5180-5240MHz: Directional gain = $10 \log[(10^{G1/20} + 10^{G2/20} + \dots + 10^{GN/20})^2/2]$ = 7.44dBi > 6dBi, so the power limit shall be reduced to 30 - (7.44 - 6) = 28.56dBm.
- 5745-5825MHz: Directional gain = $10 \log[(10^{G1/20} + 10^{G2/20} + \dots + 10^{GN/20})^2/2]$ = 7.71dBi > 6dBi, so the power limit shall be reduced to 30 - (7.71 - 6) = 28.29dBm.

4.4 Occupied Bandwidth Measurement

4.4.1 Test Setup

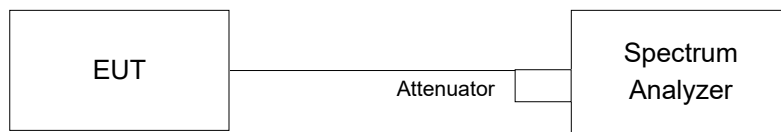

4.4.2 Test Instruments

Refer to section 4.1.2 to get information of above instrument.

4.4.3 Test Procedure

The transmitter output was connected to the spectrum analyzer through an attenuator. The bandwidth of the fundamental frequency was measured by spectrum analyzer with resolution bandwidth in the range of 1% to 5% of the anticipated emission bandwidth, and a video bandwidth at least 3x the resolution bandwidth and set the detector to sampling. The width of a frequency band such that, below the lower and above the upper frequency limits, the mean powers emitted are each equal to a specified percentage 0.5 %of the total mean power of a given emission.

4.4.4 Test Result

802.11a

Chan.	Freq. (MHz)	Occupied Bandwidth (MHz)	
		Chain 0	Chain 1
36	5180	18.12	24.60
40	5200	28.08	29.28
48	5240	18.60	20.04
149	5745	32.08	30.60
157	5785	31.44	31.08
165	5825	30.60	30.24

802.11ac (VHT20)

Chan.	Freq. (MHz)	Occupied Bandwidth (MHz)	
		Chain 0	Chain 1
36	5180	18.60	26.04
40	5200	29.04	32.40
48	5240	20.17	20.28
149	5745	31.32	33.60
157	5785	31.32	33.60
165	5825	31.08	33.00

802.11ac (VHT40)

Chan.	Freq. (MHz)	Occupied Bandwidth (MHz)	
		Chain 0	Chain 1
38	5190	36.60	36.96
46	5230	38.76	38.64
151	5755	46.08	48.60
159	5795	45.00	48.48

802.11ac (VHT80)

Chan.	Freq. (MHz)	Occupied Bandwidth (MHz)	
		Chain 0	Chain 1
42	5210	75.60	75.84
155	5775	85.44	93.84

Spectrum Plot of Worst Value

802.11a

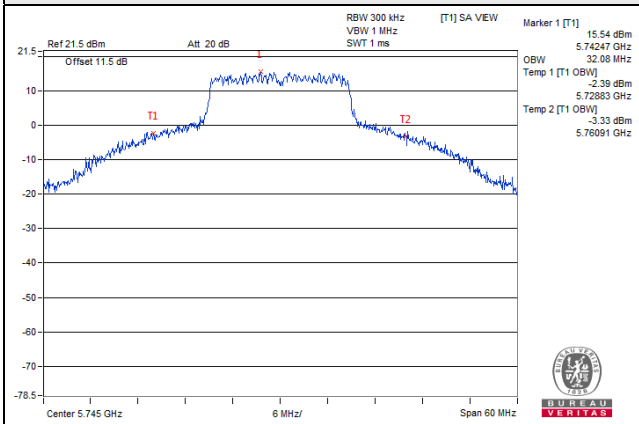

802.11ac (VHT20)

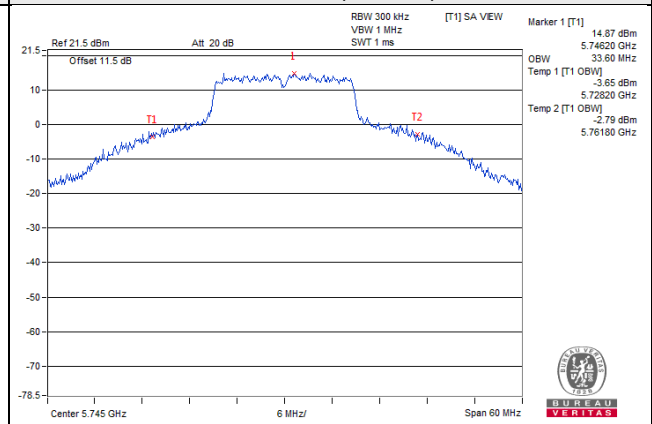

802.11ac (VHT40)

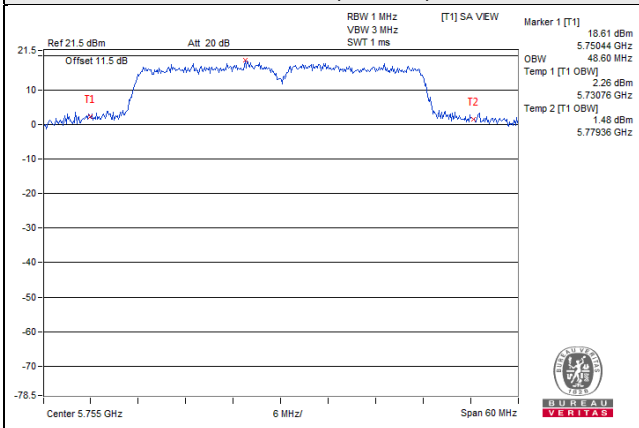

802.11ac (VHT80)

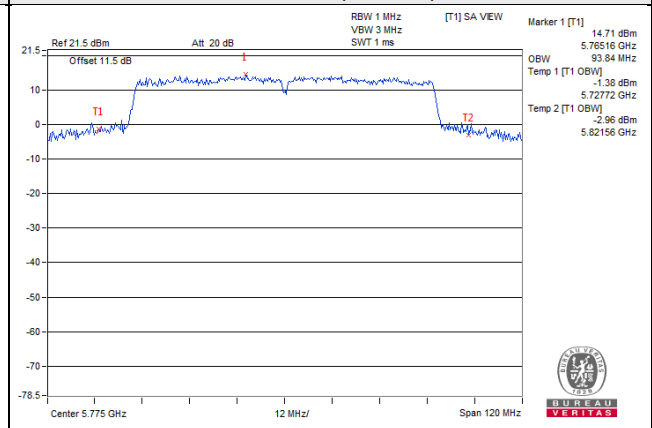

Spectrum Plot for near By DFS Band

802.11a / Chain 0 / CH 48

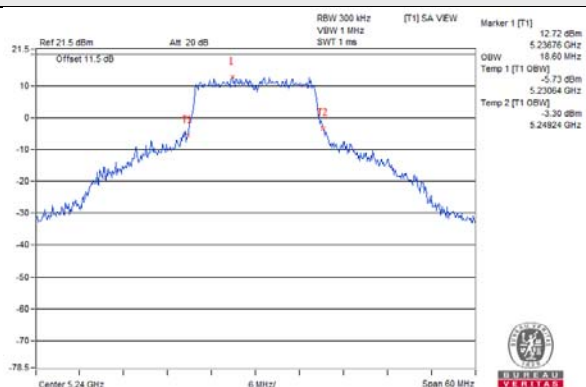

802.11a / Chain 1 / CH 48

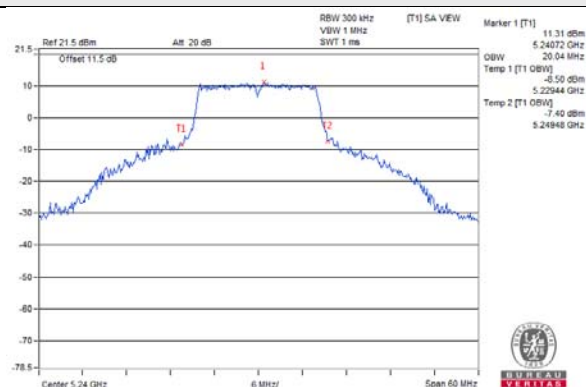

802.11ac (VHT20) / Chain 0 / CH 48

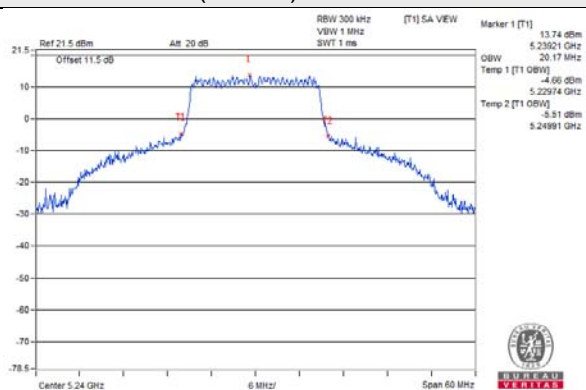

802.11ac (VHT20) / Chain 1 / CH 48

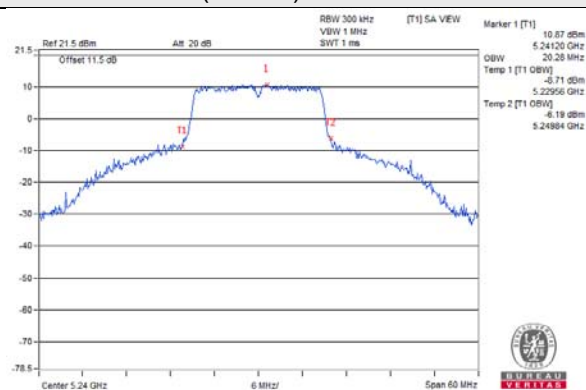

802.11ac (VHT40) / Chain 0 / CH 46

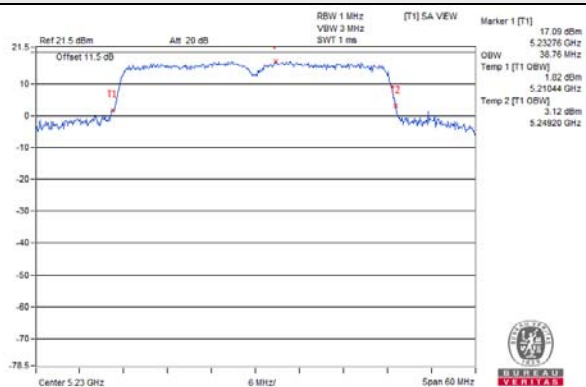

802.11ac (VHT40) / Chain 1 / CH 46

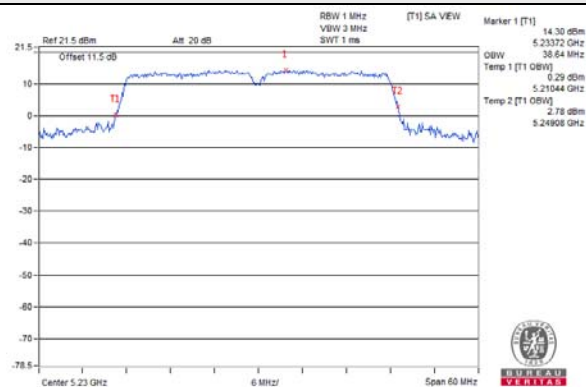

802.11ac (VHT80) / Chain 0 / CH 42

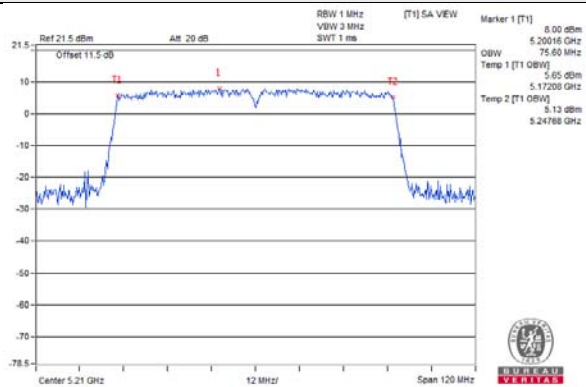

802.11ac (VHT80) / Chain 1 / CH 42

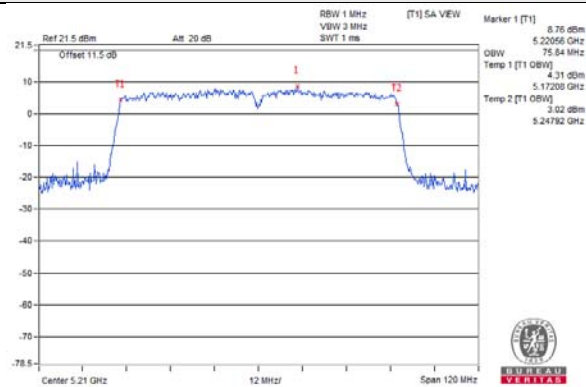

Spectrum Plot for near By DFS Band

802.11a / Chain 0 / CH 149

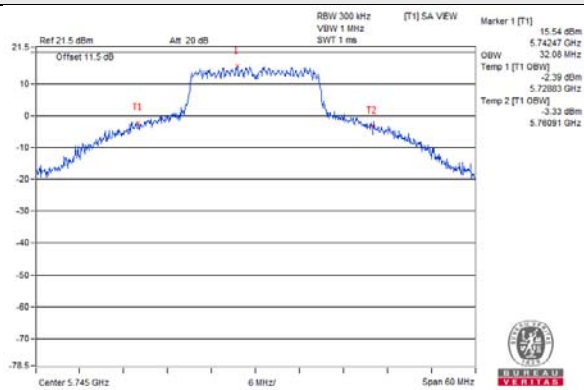

802.11a / Chain 1 / CH 149

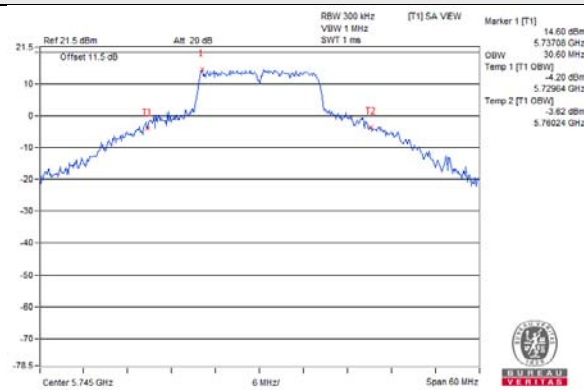

802.11ac (VHT20) / Chain 0 / CH 149

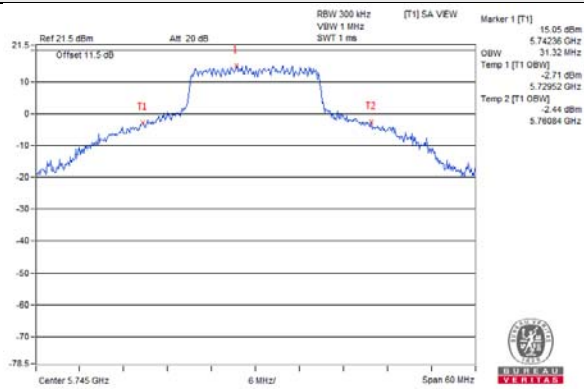

802.11ac (VHT20) / Chain 1 / CH 149

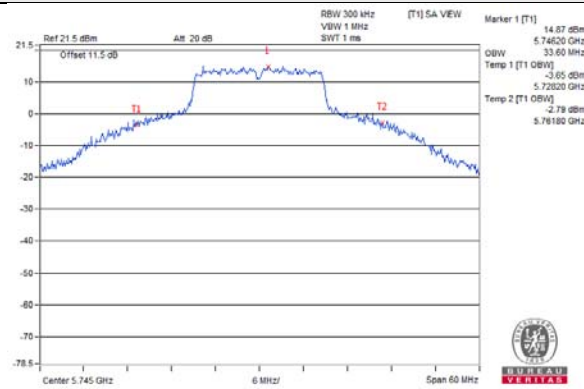

802.11ac (VHT40) / Chain 0 / CH 151

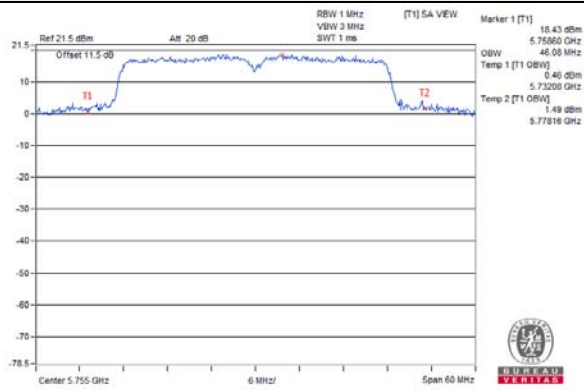

802.11ac (VHT40) / Chain 1 / CH 151

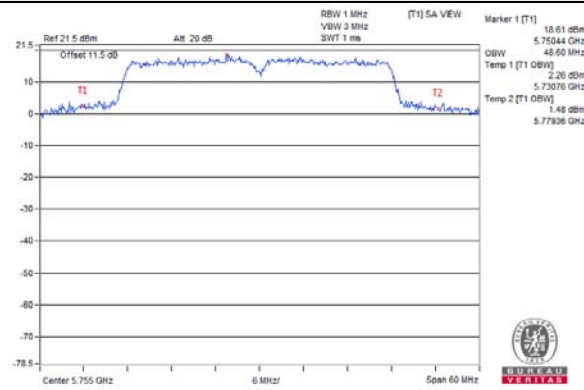

802.11ac (VHT80) / Chain 0 / CH 155

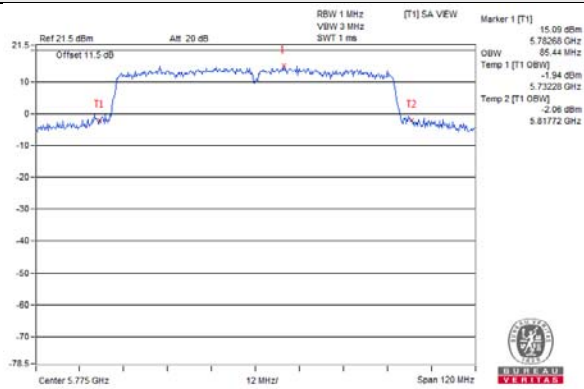

802.11ac (VHT80) / Chain 1 / CH 155

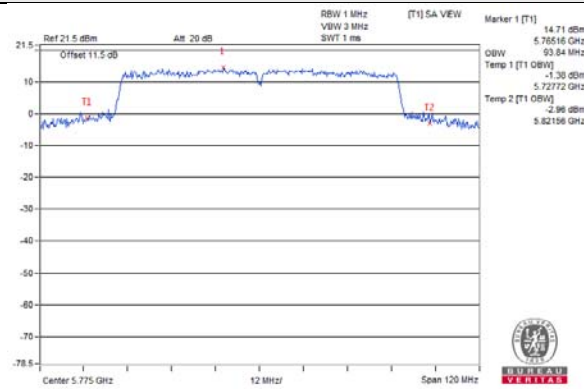

4.5 Peak Power Spectral Density Measurement

4.5.1 Limits of Peak Power Spectral Density Measurement

Operation Band	EUT Category		Limit
U-NII-1		Outdoor Access Point	17dBm/ MHz
		Fixed point-to-point Access Point	
	√	Indoor Access Point	
		Mobile and Portable client device	11dBm/ MHz
U-NII-2A			11dBm/ MHz
U-NII-2C			11dBm/ MHz
U-NII-3	√		30dBm/ 500kHz

4.5.2 Test Setup

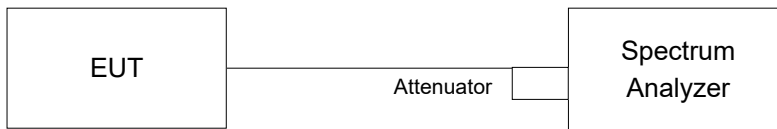

4.5.3 Test Instruments

Refer to section 4.1.2 to get information of above instrument.

4.5.4 Test Procedures

For U-NII-1 band:

Using method SA-2

- Set span to encompass the entire emission bandwidth (EBW) of the signal.
- Set RBW = 1MHz, Set VBW \geq 3 MHz, Detector = RMS
- Set Channel power measure = 1MHz
- Sweep time = auto, trigger set to "free run".
- Trace average at least 100 traces in power averaging mode.
- Record the max value and add $10 \log (1/\text{duty cycle})$

For U-NII-3 band:

- Set span to encompass the entire emission bandwidth (EBW) of the signal.
- Set RBW = 300 kHz, Set VBW \geq 1 MHz, Detector = RMS
- Use the peak marker function to determine the maximum power level in any 300 kHz band segment within the fundamental EBW.
- Scale the observed power level to an equivalent value in 500 kHz by adjusting (reducing) the measured power by a bandwidth correction factor (BWCF) where $\text{BWCF} = 10\log(500 \text{ kHz} / 300 \text{ kHz})$
- Sweep time = auto, trigger set to "free run".
- Trace average at least 100 traces in power averaging mode.
- Record the max value and add $10 \log (1/\text{duty cycle})$

4.5.5 Deviation from Test Standard

No deviation.

4.5.6 EUT Operating Conditions

Same as 4.3.6.

4.5.7 Test Results

For U-NII-1 band:

802.11a

Chan.	Freq. (MHz)	PSD (dBm/MHz)		Total PSD (dBm/MHz)	Max. Limit (dBm/MHz)	Pass / Fail
		Chain 0	Chain 1			
36	5180	8.38	7.60	11.02	15.56	Pass
40	5200	10.54	8.49	12.65	15.56	Pass
48	5240	10.28	8.84	12.63	15.56	Pass

Note:

- Method E) 2) a) of power density measurement of KDB 662911 is using for calculating total power density. Total power density is summing entire spectra across corresponding frequency bins on the various outputs by computer.
- Directional gain = $10 \log[(10^{G1/20} + 10^{G2/20} + \dots + 10^{GN/20})^2/2] = 7.44\text{dBi} > 6\text{dBi}$, so the power density limit shall be reduced to $17 - (7.44 - 6) = 15.56\text{dBm}$.

802.11ac (VHT20)

Chan.	Freq. (MHz)	PSD (dBm/MHz)		Total PSD (dBm/MHz)	Max. Limit (dBm/MHz)	Pass / Fail
		Chain 0	Chain 1			
36	5180	8.03	7.45	10.76	15.56	Pass
40	5200	10.03	8.61	12.39	15.56	Pass
48	5240	10.30	8.71	12.59	15.56	Pass

Note:

- Method E) 2) a) of power density measurement of KDB 662911 is using for calculating total power density. Total power density is summing entire spectra across corresponding frequency bins on the various outputs by computer.
- Directional gain = $10 \log[(10^{G1/20} + 10^{G2/20} + \dots + 10^{GN/20})^2/2] = 7.44\text{dBi} > 6\text{dBi}$, so the power density limit shall be reduced to $17 - (7.44 - 6) = 15.56\text{dBm}$.

802.11ac (VHT40)

Chan.	Freq. (MHz)	PSD w/o Duty Factor (dBm/MHz)		Duty Factor (dB)	Total PSD with Duty Factor (dBm/MHz)	Max. Limit (dBm/MHz)	Pass / Fail
		Chain 0	Chain 1				
38	5190	1.68	1.30	0.18	4.50	15.56	Pass
46	5230	6.83	5.36	0.18	9.17	15.56	Pass

Note:

- Method E) 2) a) of power density measurement of KDB 662911 is using for calculating total power density. Total power density is summing entire spectra across corresponding frequency bins on the various outputs by computer.
- Directional gain = $10 \log[(10^{G1/20} + 10^{G2/20} + \dots + 10^{GN/20})^2/2] = 7.44\text{dBi} > 6\text{dBi}$, so the power density limit shall be reduced to $17 - (7.44 - 6) = 15.56\text{dBm}$.
- Refer to section 3.3 for duty cycle spectrum plot.

802.11ac (VHT80)

Chan.	Freq. (MHz)	PSD w/o Duty Factor (dBm/MHz)		Duty Factor (dB)	Total PSD with Duty Factor (dBm/MHz)	Max. Limit (dBm/MHz)	Pass / Fail
		Chain 0	Chain 1				
42	5210	-1.93	-2.00	0.28	1.05	15.56	Pass

Note:

- Method E) 2) a) of power density measurement of KDB 662911 is using for calculating total power density. Total power density is summing entire spectra across corresponding frequency bins on the various outputs by computer.
- Directional gain = $10 \log[(10^{G1/20} + 10^{G2/20} + \dots + 10^{GN/20})^2/2] = 7.44\text{dBi} > 6\text{dBi}$, so the power density limit shall be reduced to $17 - (7.44 - 6) = 15.56\text{dBm}$.
- Refer to section 3.3 for duty cycle spectrum plot.

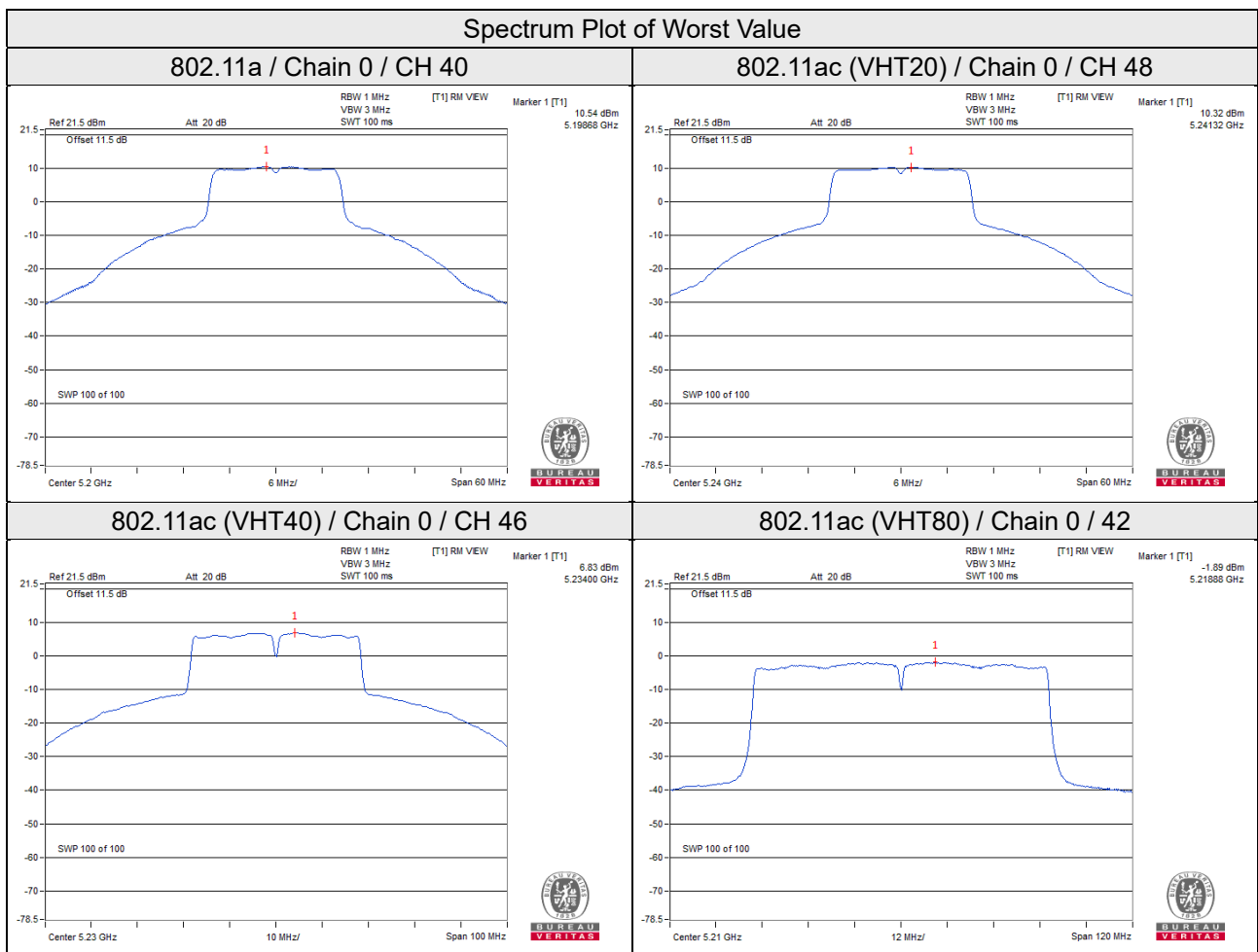

For U-NII-3 band:

802.11a

TX chain	Chan.	Freq. (MHz)	PSD (dBm/300 kHz)	PSD (dBm/500 kHz)	10 log (N=2) dB	Total PSD (dBm/500 kHz)	Limit (dBm/500 kHz)	Pass / Fail
0	149	5745	2.15	4.37	3.01	7.38	28.29	Pass
	157	5785	2.18	4.40	3.01	7.41	28.29	Pass
	165	5825	1.82	4.04	3.01	7.05	28.29	Pass
1	149	5745	2.12	4.34	3.01	7.35	28.29	Pass
	157	5785	2.18	4.40	3.01	7.41	28.29	Pass
	165	5825	2.00	4.22	3.01	7.23	28.29	Pass

Note:

- Method E) 2) c) of power density measurement of KDB 662911 is using for calculating total power density, Measure and add 10 log (N_{ANT}) dB.
- Directional gain = $10 \log[(10^{G1/20} + 10^{G2/20} + \dots + 10^{GN/20})^2/2] = 7.71\text{dBi} > 6\text{dBi}$, so the power density limit shall be reduced to $30 - (7.71 - 6) = 28.29\text{dBm}$.

802.11ac (VHT20)

TX chain	Chan.	Freq. (MHz)	PSD (dBm/300 kHz)	PSD (dBm/500 kHz)	10 log (N=2) dB	Total PSD (dBm/500 kHz)	Limit (dBm/500 kHz)	Pass / Fail
0	149	5745	2.06	4.28	3.01	7.29	28.29	Pass
	157	5785	2.06	4.28	3.01	7.29	28.29	Pass
	165	5825	2.05	4.27	3.01	7.28	28.29	Pass
1	149	5745	1.83	4.05	3.01	7.06	28.29	Pass
	157	5785	1.88	4.1	3.01	7.11	28.29	Pass
	165	5825	1.97	4.19	3.01	7.2	28.29	Pass

Note:

- Method E) 2) c) of power density measurement of KDB 662911 is using for calculating total power density, Measure and add 10 log (N_{ANT}) dB.
- Directional gain = $10 \log[(10^{G1/20} + 10^{G2/20} + \dots + 10^{GN/20})^2/2] = 7.71\text{dBi} > 6\text{dBi}$, so the power density limit shall be reduced to $30 - (7.71 - 6) = 28.29\text{dBm}$.

802.11ac (VHT40)

TX chain	Chan.	Freq. (MHz)	PSD W/O Duty Factor		10 log (N=2) dB	Duty Factor (dB)	Total PSD With Duty Factor (dBm/500kHz)	Limit (dBm/500kHz)	Pass / Fail
			(dBm/300kHz)	(dBm/500kHz)					
0	151	5755	-1.46	0.76	3.01	0.18	3.95	28.29	Pass
	159	5795	-1.63	0.59	3.01	0.18	3.78	28.29	Pass
1	151	5755	-1.64	0.58	3.01	0.18	3.77	28.29	Pass
	159	5795	-1.62	0.6	3.01	0.18	3.79	28.29	Pass

Note:

- Method E) 2) c) of power density measurement of KDB 662911 is using for calculating total power density, Measure and add $10 \log (N_{ANT})$ dB.
- Directional gain = $10 \log[(10^{G1/20} + 10^{G2/20} + \dots + 10^{GN/20})^2/2] = 7.71 \text{dBi} > 6 \text{dBi}$, so the power density limit shall be reduced to $30 - (7.71 - 6) = 28.29 \text{dBm}$.
- Refer to section 3.3 for duty cycle spectrum plot.

802.11ac (VHT80)

TX chain	Chan.	Freq. (MHz)	PSD W/O Duty Factor		10 log (N=2) dB	Duty Factor (dB)	Total PSD With Duty Factor (dBm/500kHz)	Limit (dBm/500kHz)	Pass / Fail
			(dBm/300kHz)	(dBm/500kHz)					
0	155	5775	-4.86	-2.64	3.01	0.28	0.65	28.29	Pass
1	155	5775	-4.67	-2.45	3.01	0.28	0.84	28.29	Pass

Note:

- Method E) 2) c) of power density measurement of KDB 662911 is using for calculating total power density, Measure and add $10 \log (N_{ANT})$ dB.
- Directional gain = $10 \log[(10^{G1/20} + 10^{G2/20} + \dots + 10^{GN/20})^2/2] = 7.71 \text{dBi} > 6 \text{dBi}$, so the power density limit shall be reduced to $30 - (7.71 - 6) = 28.29 \text{dBm}$.
- Refer to section 3.3 for duty cycle spectrum plot.

Spectrum Plot of Worst Value

802.11a

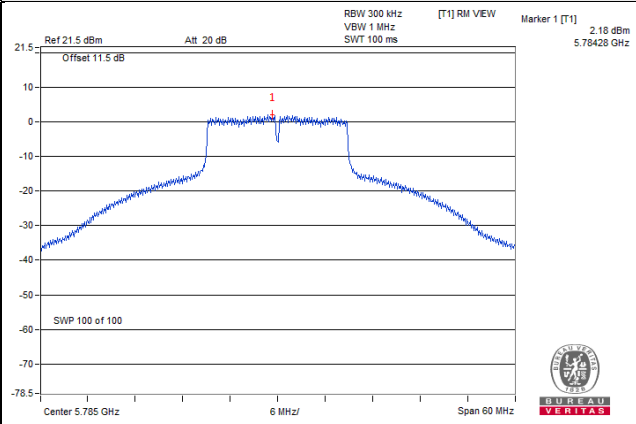

802.11ac (VHT20)

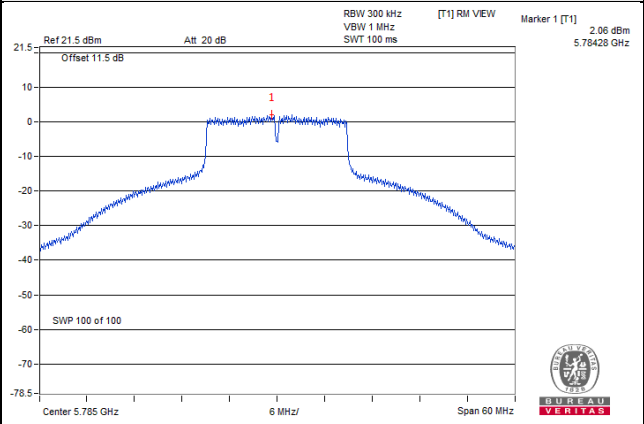

802.11ac (VHT40)

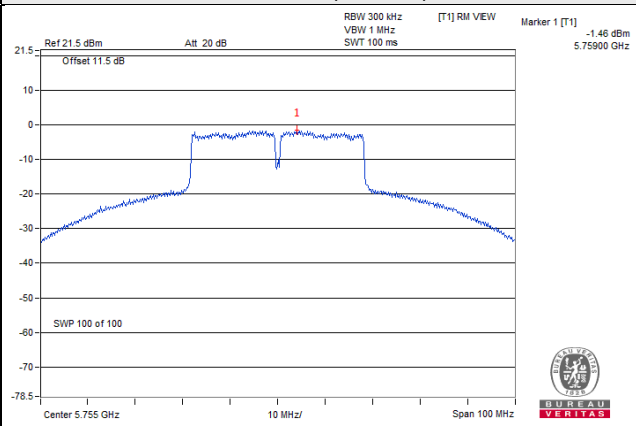

802.11ac (VHT80)

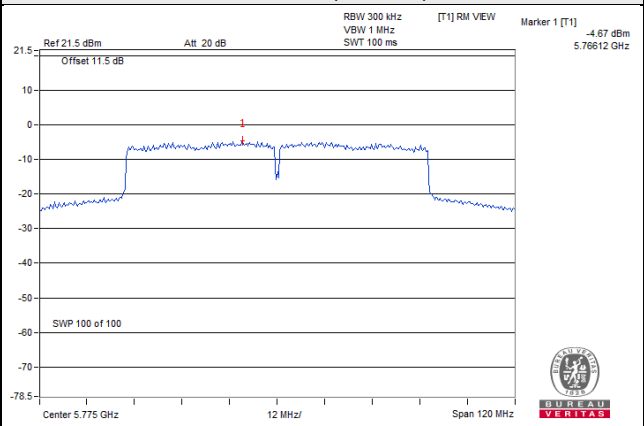

4.6 Frequency Stability

4.6.1 Limits of Frequency Stability Measurement

The frequency of the carrier signal shall be maintained within band of operation

4.6.2 Test Setup

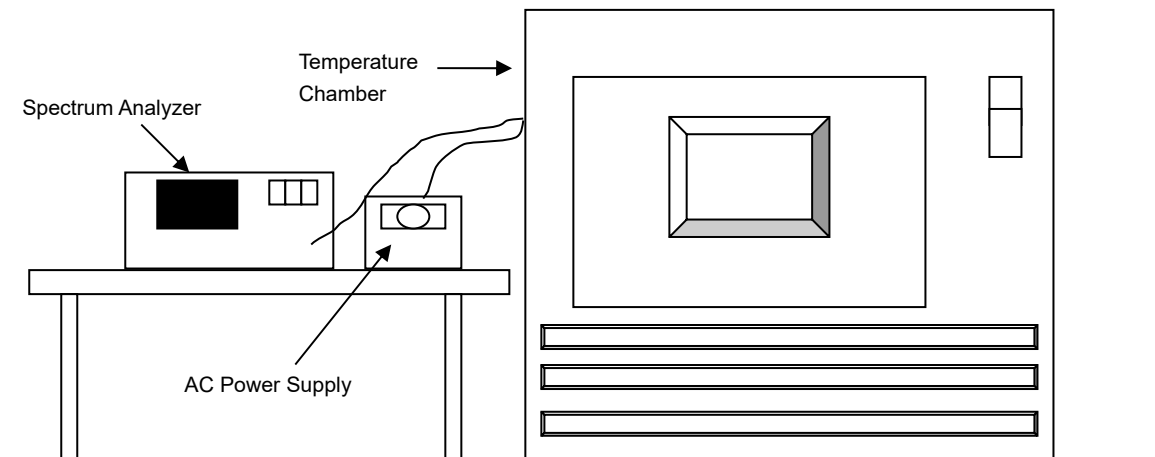

4.6.3 Test Instruments

Description & Manufacturer	Model No.	Serial No.	Cal. Date	Cal. Due
Spectrum Analyzer ROHDE & SCHWARZ	FSP40	100040	Sep. 23, 2019	Sep. 22, 2020
WIT Standard Temperature And Humidity Chamber	TH-4S-C	W981030	Jun. 03, 2019	Jun. 02, 2020
Digital Multimeter Fluke	87-III	70360742	Jun. 28, 2019	Jun. 27, 2020
AC Power Supply Extech	CFW-105	E000603	NA	NA
True RMS Clamp Meter Fluke	325	31130711WS	May 21, 2019	May 20, 2020

Note: 1. The calibration interval of the above test instruments is 12 months and the calibrations are traceable to NML/ROC and NIST/USA.

4.6.4 Test Procedure

- The EUT was placed inside the environmental test chamber and powered by nominal AC voltage.
- Turn the EUT on and couple its output to a spectrum analyzer.
- Turn the EUT off and set the chamber to the highest temperature specified.
- Allow sufficient time (approximately 30 min) for the temperature of the chamber to stabilize, turn the EUT on and measure the operating frequency after 2, 5, and 10 minutes.
- Repeat step d with every 10 degrees reduction until the lowest temperature achieved.
- The test chamber was allowed to stabilize at +20 degree C for a minimum of 30 minutes. The supply voltage was then adjusted on the EUT from 85% to 115% and the frequency record.

4.6.5 Deviation from Test Standard

No deviation.

4.6.6 EUT Operating Condition

Set the EUT transmit at un-modulation mode to test frequency stability.

4.6.7 Test Results

Frequency Stability Versus Temp.									
Operating Frequency: 5180MHz									
Temp. (°C)	Power Supply (Vac)	0 Minute		2 Minute		5 Minute		10 Minute	
		Measured Frequency (MHz)	Result	Measured Frequency (MHz)	Result	Measured Frequency (MHz)	Result	Measured Frequency (MHz)	Result
50	120	5180.0091	Pass	5180.012	Pass	5180.012	Pass	5180.0111	Pass
40	120	5180.0217	Pass	5180.0222	Pass	5180.024	Pass	5180.0204	Pass
30	120	5180.0048	Pass	5180.006	Pass	5180.0064	Pass	5180.0059	Pass
20	120	5180.0217	Pass	5180.0229	Pass	5180.022	Pass	5180.0202	Pass
10	120	5180.0086	Pass	5180.0065	Pass	5180.0083	Pass	5180.0052	Pass
0	120	5180.0185	Pass	5180.015	Pass	5180.0196	Pass	5180.0196	Pass
-10	120	5179.9939	Pass	5179.9928	Pass	5179.996	Pass	5179.9938	Pass
-20	120	5179.9826	Pass	5179.9856	Pass	5179.9859	Pass	5179.9864	Pass
-30	120	5180.0092	Pass	5180.0078	Pass	5180.0074	Pass	5180.0067	Pass

Frequency Stability Versus Voltage									
Operating Frequency: 5180MHz									
Temp. (°C)	Power Supply (Vac)	0 Minute		2 Minute		5 Minute		10 Minute	
		Measured Frequency (MHz)	Result	Measured Frequency (MHz)	Result	Measured Frequency (MHz)	Result	Measured Frequency (MHz)	Result
20	138	5180.0223	Pass	5180.022	Pass	5180.022	Pass	5180.02	Pass
	120	5180.0217	Pass	5180.0229	Pass	5180.022	Pass	5180.0202	Pass
	102	5180.0225	Pass	5180.0237	Pass	5180.0225	Pass	5180.0201	Pass

4.7 6dB Bandwidth Measurement

4.7.1 Limits of 6dB Bandwidth Measurement

The minimum of 6dB Bandwidth Measurement is 0.5MHz.

4.7.2 Test Setup

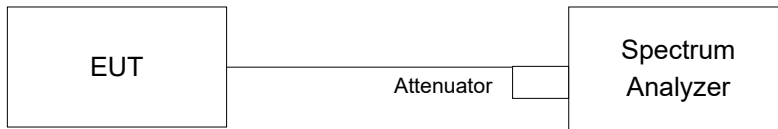

4.7.3 Test Instruments

Refer to section 4.1.2 to get information of above instrument.

4.7.4 Test Procedure

- Set resolution bandwidth (RBW) = 100kHz
- Set the video bandwidth (VBW) $\geq 3 \times$ RBW, Detector = Peak.
- Trace mode = max hold.
- Sweep = auto couple.
- Measure the maximum width of the emission that is constrained by the frequencies associated with the two amplitude points (upper and lower) that are attenuated by 6 dB relative to the maximum level measured in the fundamental emission

4.7.5 Deviation from Test Standard

No deviation.

4.7.6 EUT Operating Condition

The software provided by client to enable the EUT under transmission condition continuously at lowest, middle and highest channel frequencies individually.

4.7.7 Test Results

802.11a

Channel	Frequency (MHz)	6dB Bandwidth (MHz)		Minimum Limit (MHz)	Pass / Fail
		Chain 0	Chain 1		
149	5745	17.62	16.41	0.5	Pass
157	5785	17.65	16.40	0.5	Pass
165	5825	17.63	16.39	0.5	Pass

802.11ac (VHT20)

Channel	Frequency (MHz)	6dB Bandwidth (MHz)		Minimum Limit (MHz)	Pass / Fail
		Chain 0	Chain 1		
149	5745	17.62	17.64	0.5	Pass
157	5785	17.63	17.62	0.5	Pass
165	5825	17.64	17.62	0.5	Pass

802.11ac (VHT40)

Channel	Frequency (MHz)	6dB Bandwidth (MHz)		Minimum Limit (MHz)	Pass / Fail
		Chain 0	Chain 1		
151	5755	36.41	36.42	0.5	Pass
159	5795	36.44	36.42	0.5	Pass

802.11ac (VHT80)

Channel	Frequency (MHz)	6dB Bandwidth (MHz)		Minimum Limit (MHz)	Pass / Fail
		Chain 0	Chain 1		
155	5775	75.46	75.55	0.5	Pass

Spectrum Plot of Worst Value

802.11a

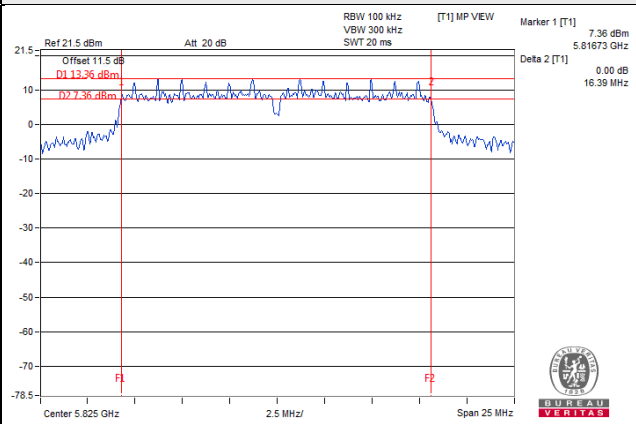

802.11ac (VHT20)

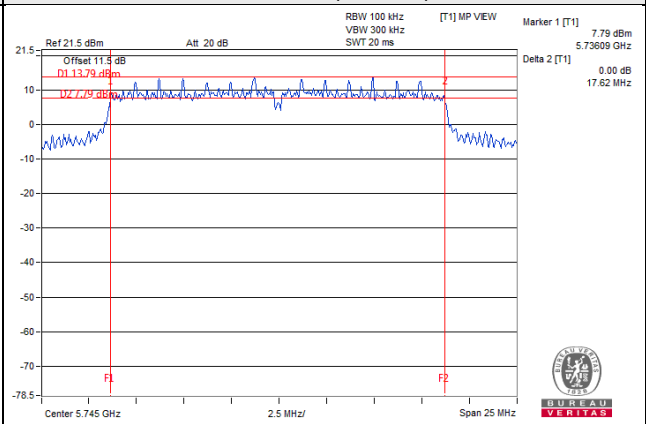

802.11ac (VHT40)

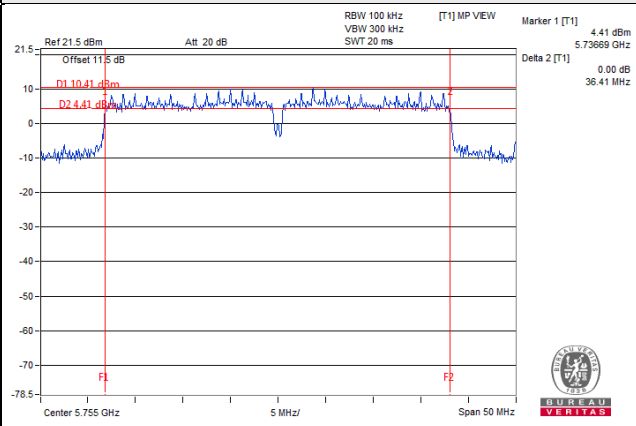

802.11ac (VHT80)

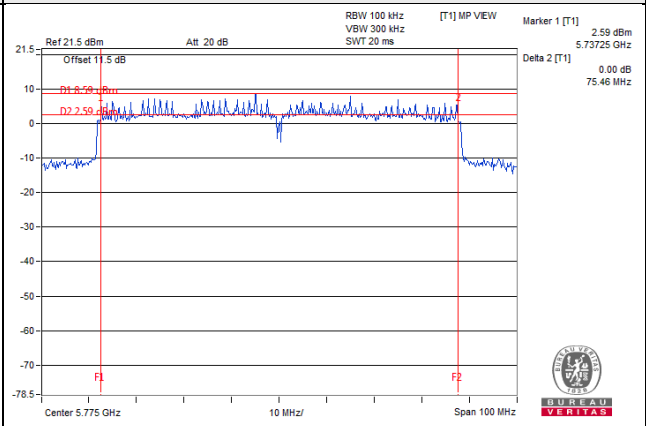

5 Pictures of Test Arrangements

Please refer to the attached file (Test Setup Photo).

Annex A- Radiated Out of Band Emission (OOBE) Measurement (For U-NII-3 band)

802.11a

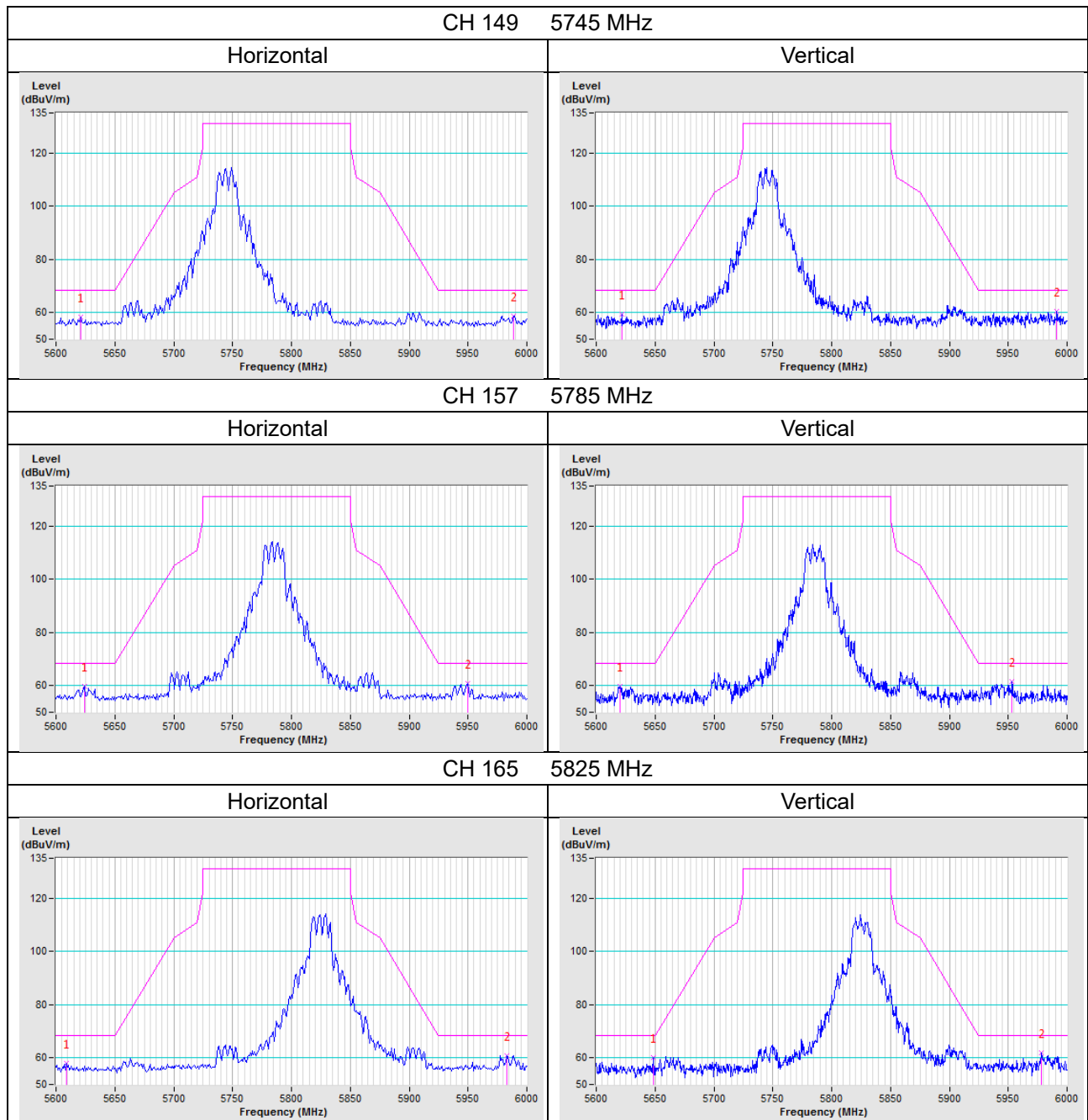

802.11ac (VHT20)

CH 149 5745 MHz

Horizontal

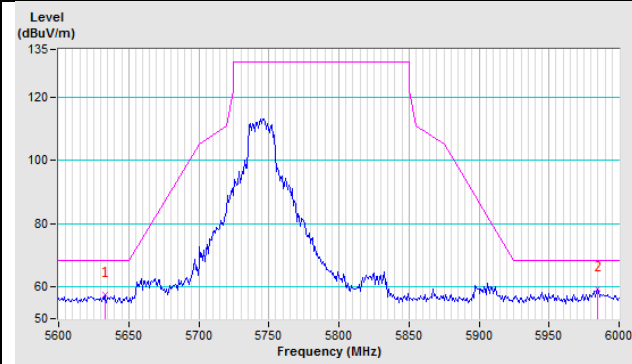

Vertical

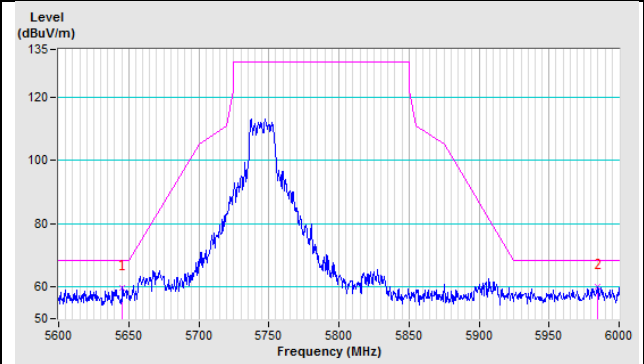

CH 157 5785 MHz

Horizontal

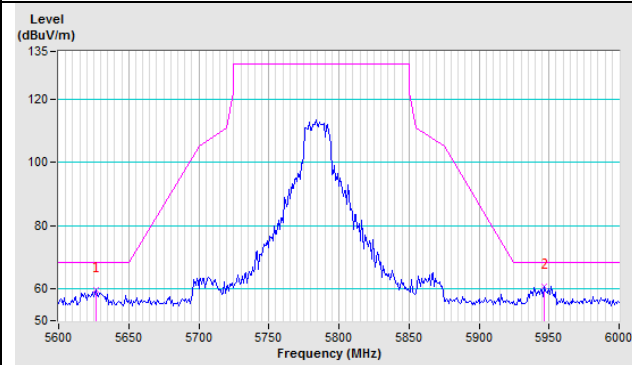

Vertical

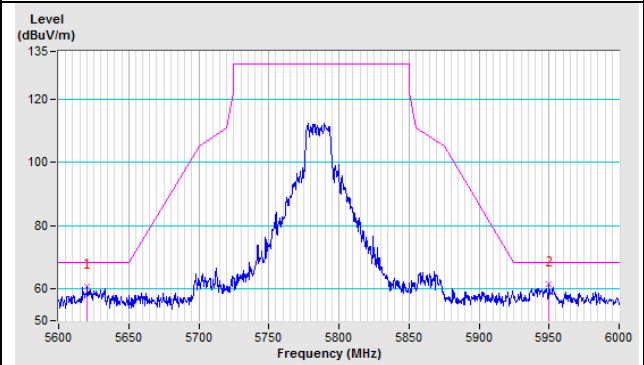

CH 165 5825 MHz

Horizontal

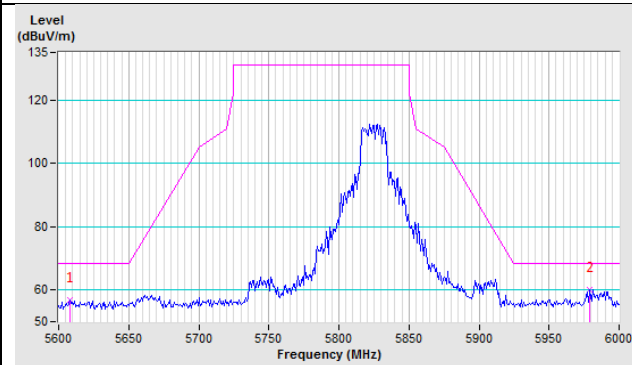

Vertical

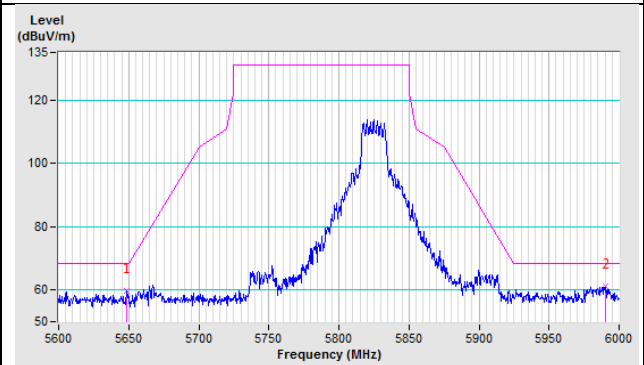

802.11ac (VHT40)

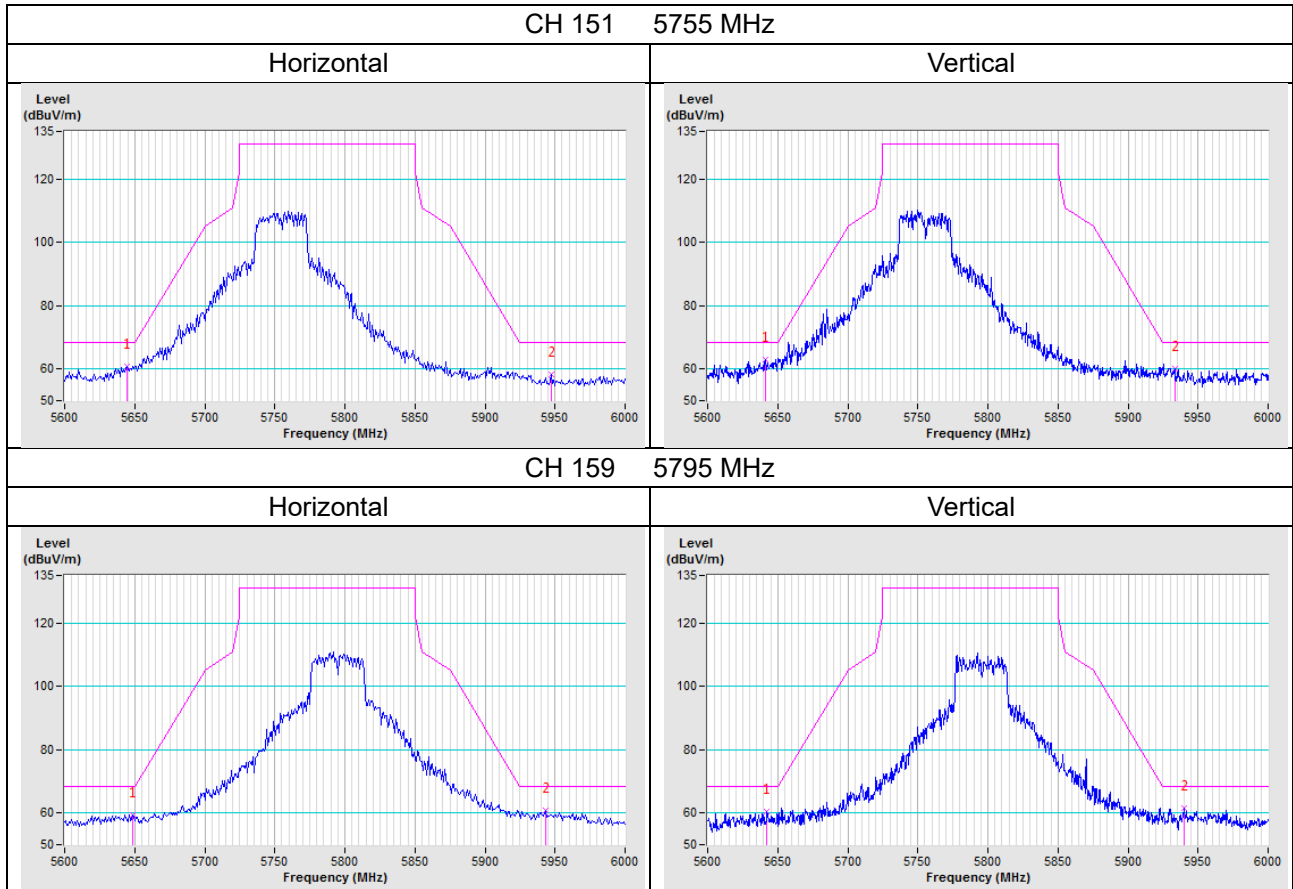

802.11ac (VHT80)

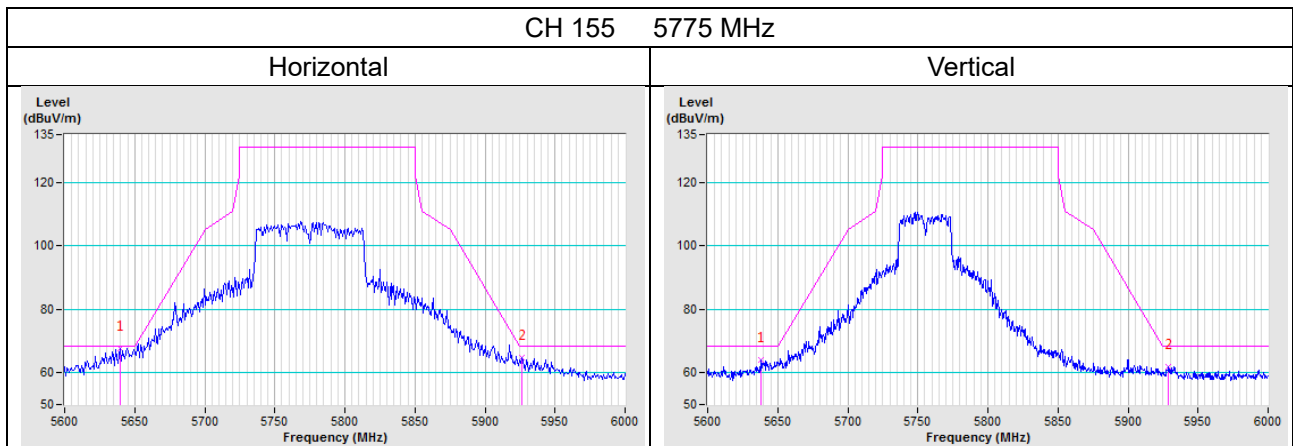

Annex B- Band Edge Measurement

802.11a

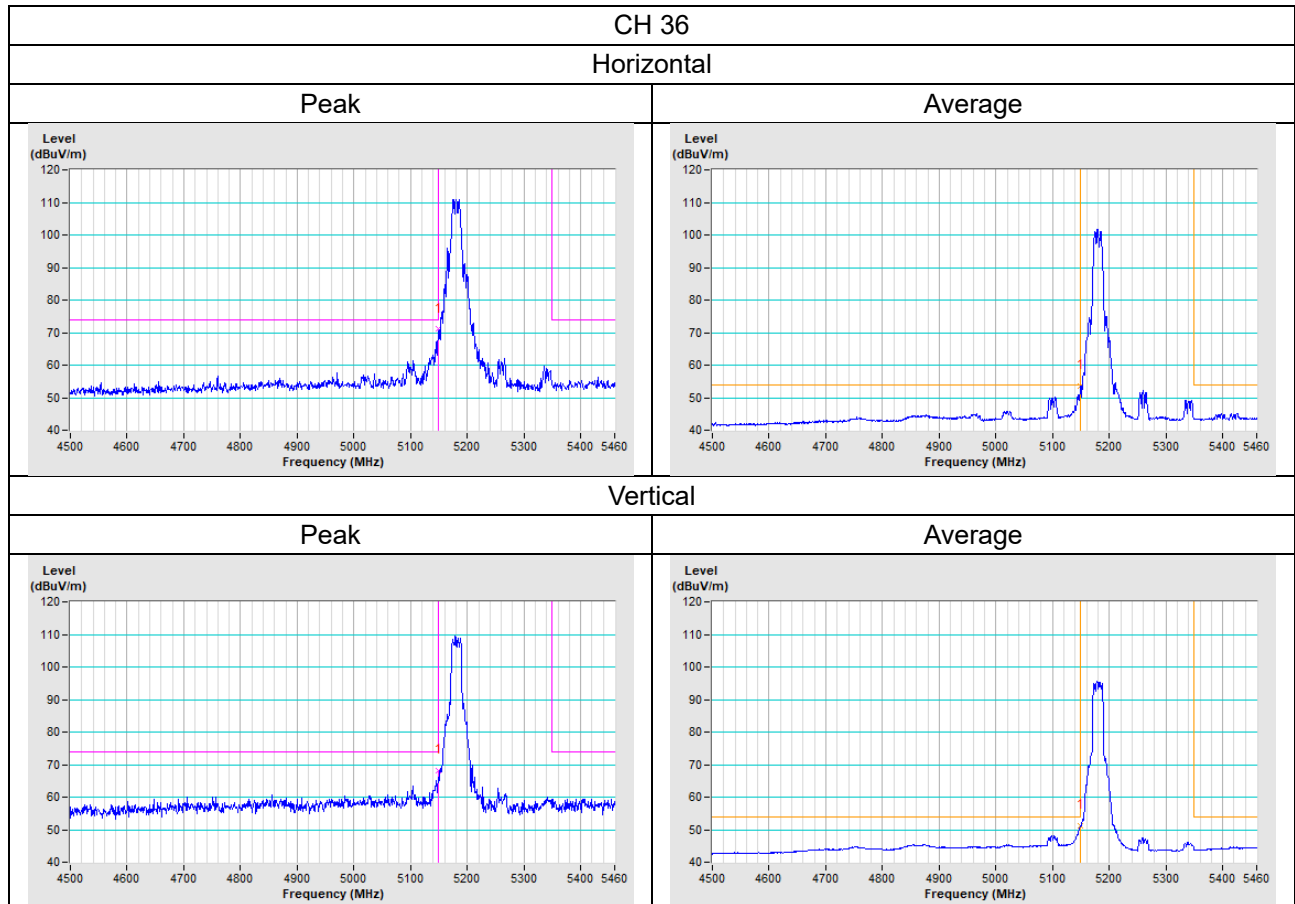

CH 40

Horizontal

Peak

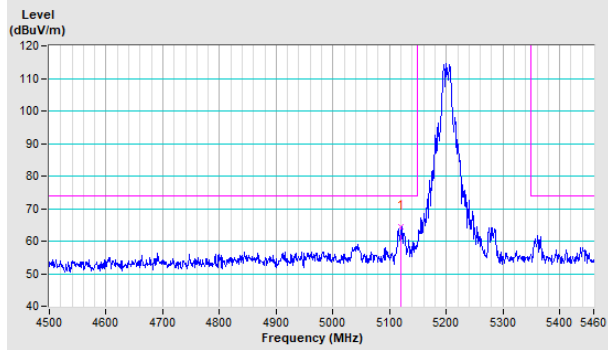

Average

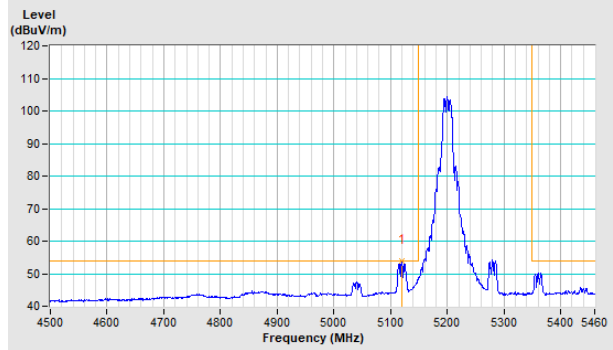

Vertical

Peak

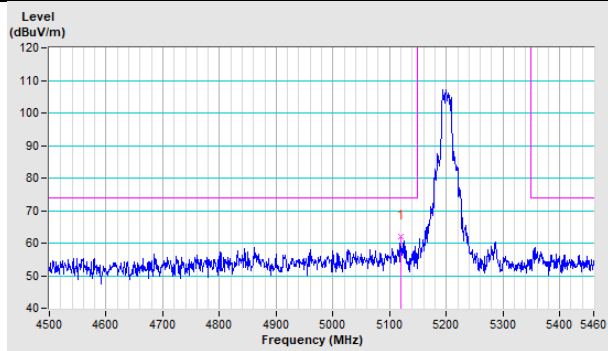

Average

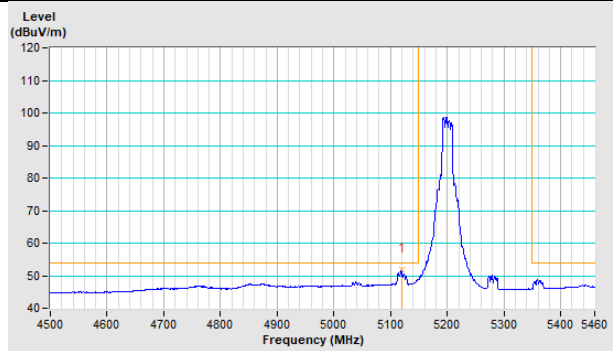

CH 48

Horizontal

Peak

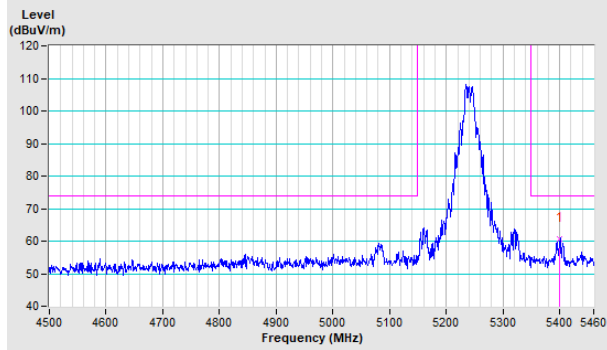

Average

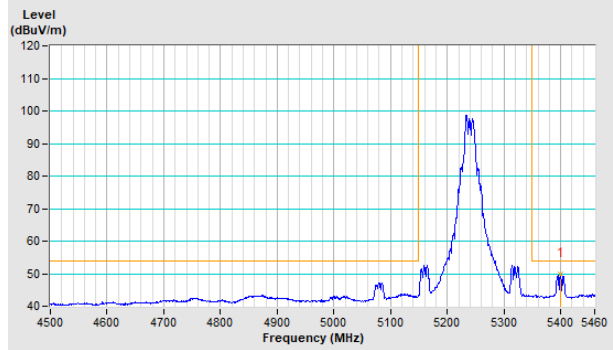

Vertical

Peak

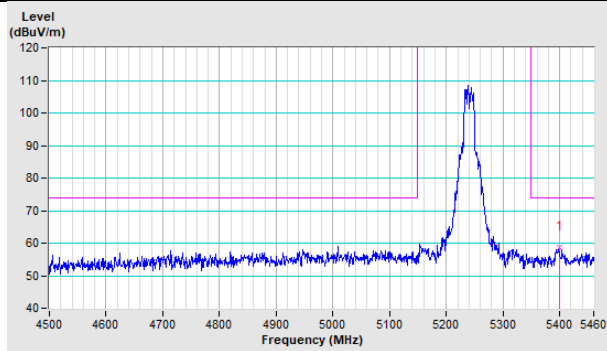

Average

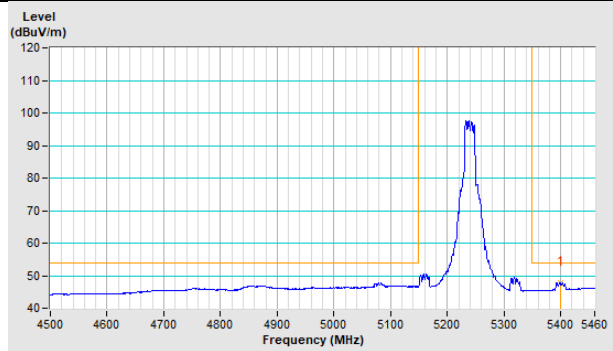

802.11ac (VHT20)

CH 36

Horizontal

Peak

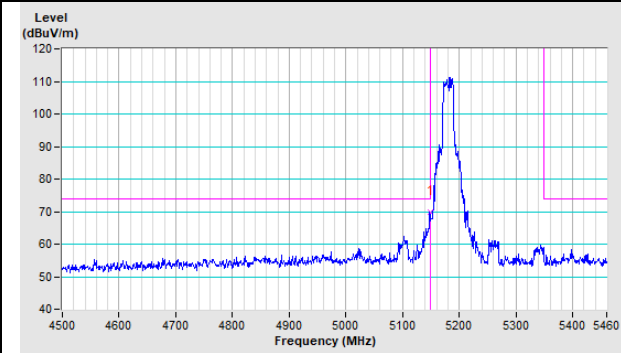

Average

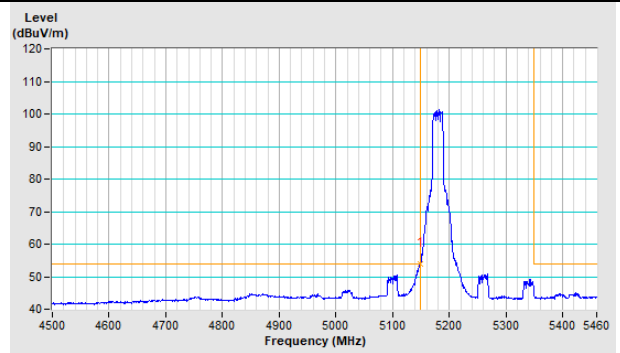

Vertical

Peak

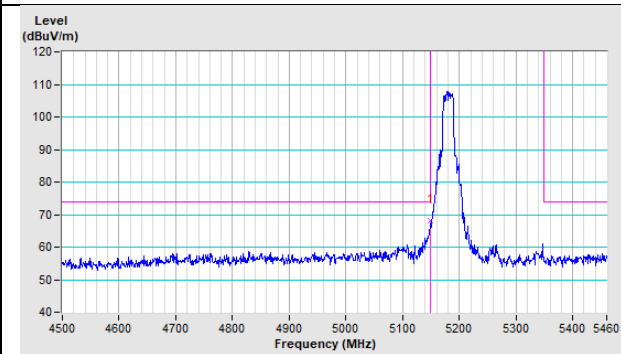

Average

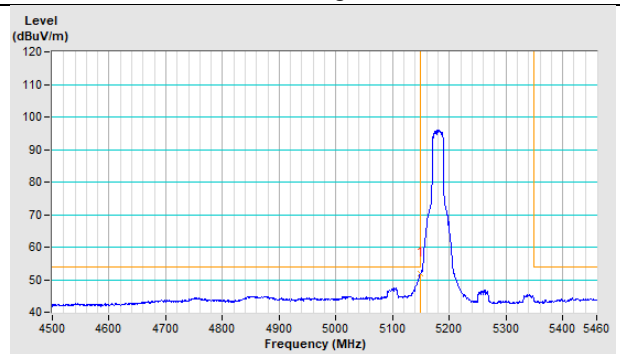

CH 48

Horizontal

Peak

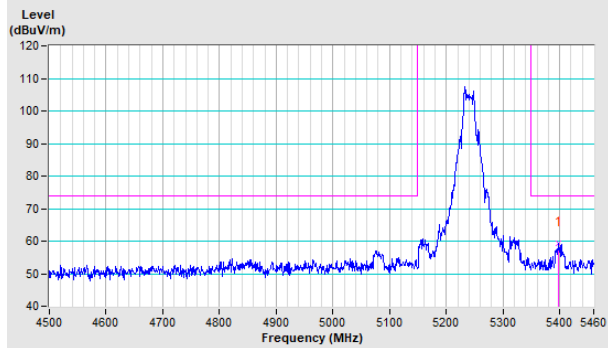

Average

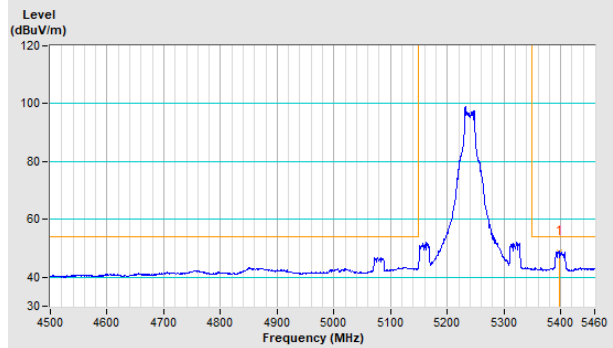

Vertical

Peak

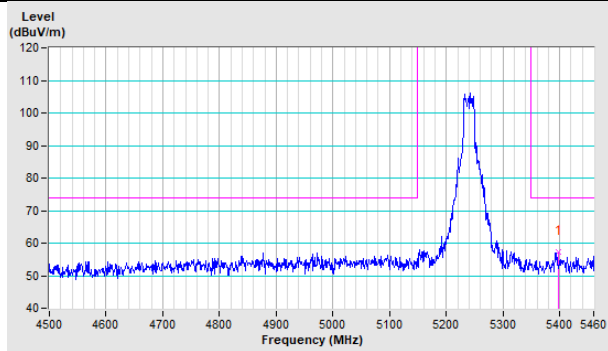

Average

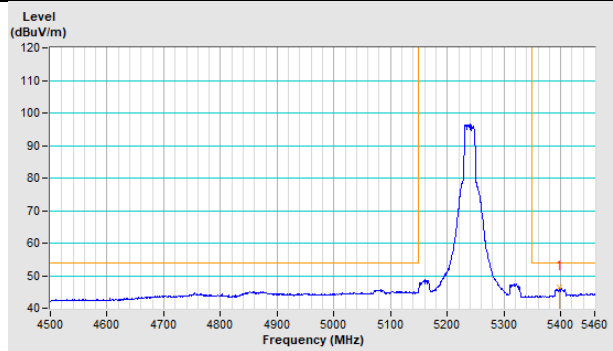

802.11ac (VHT40)

CH 38

Horizontal

Peak

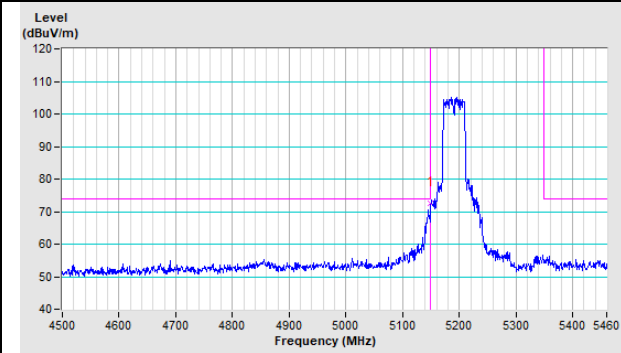

Average

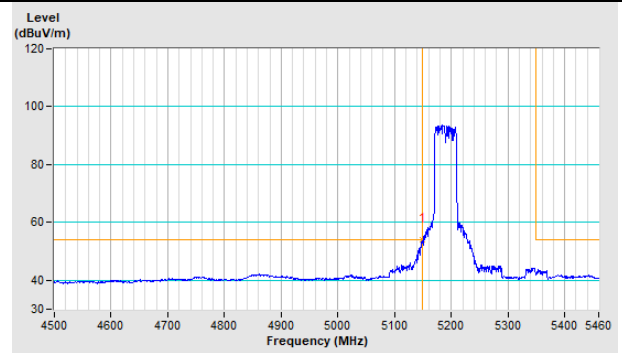

Vertical

Peak

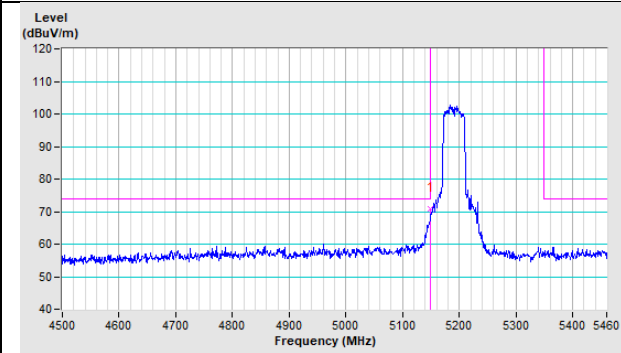

Average

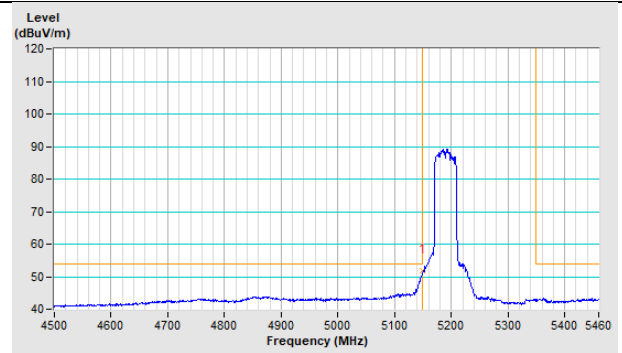

CH 46

Horizontal

Peak

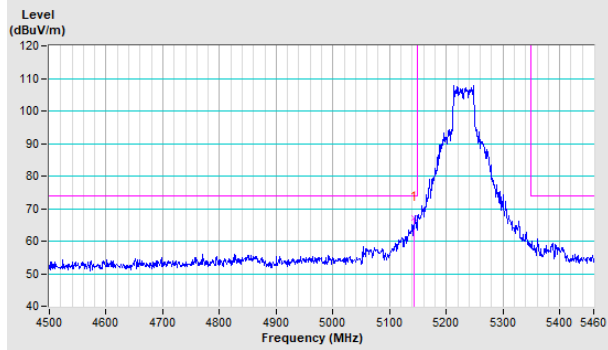

Average

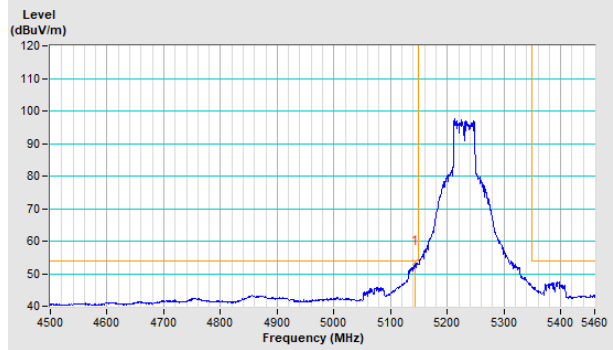

Vertical

Peak

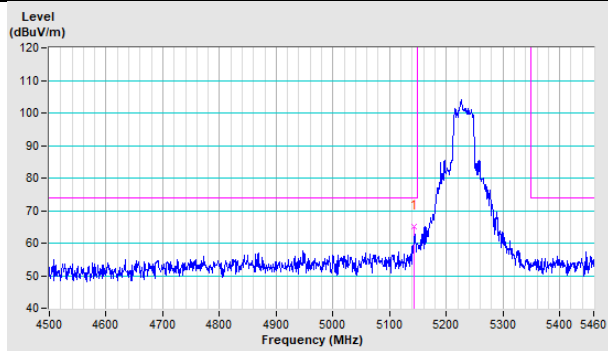

Average

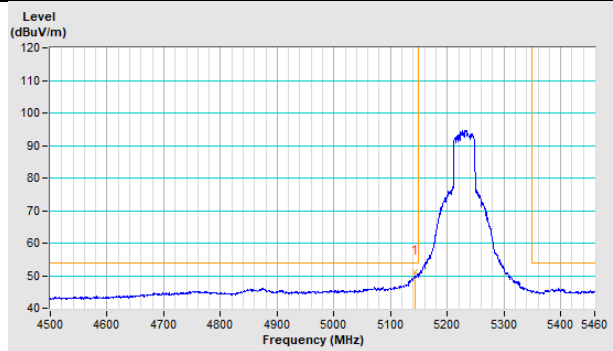

802.11ac (VHT80)

CH 42

Horizontal

Peak

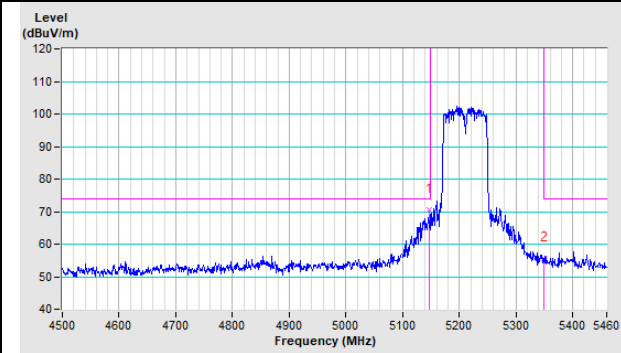

Average

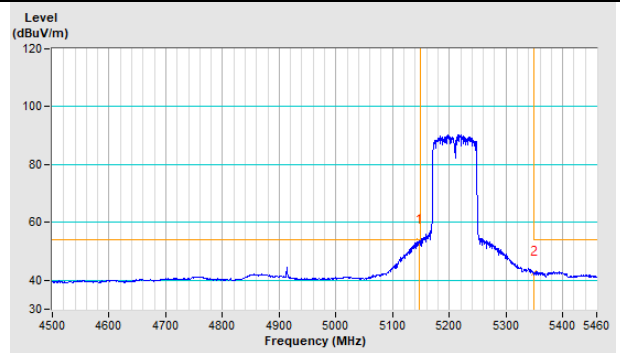

Vertical

Peak

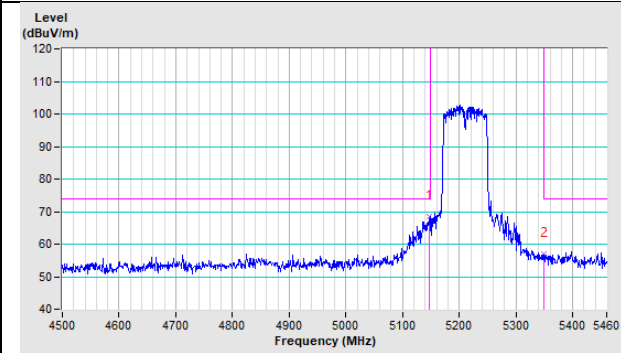

Average

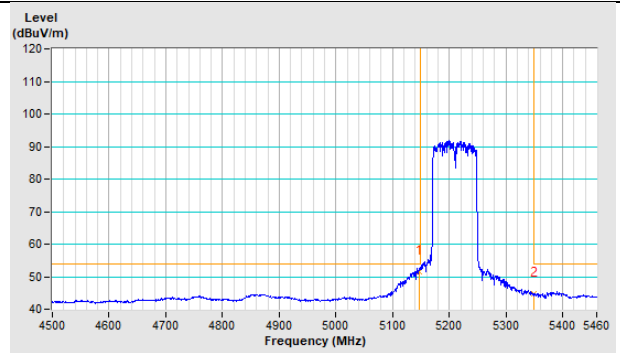

Appendix – Information of the Testing Laboratories

We, Bureau Veritas Consumer Products Services (H.K.) Ltd., Taoyuan Branch, were founded in 1988 to provide our best service in EMC, Radio, Telecom and Safety consultation. Our laboratories are FCC recognized accredited test firms and accredited and approved according to ISO/IEC 17025.

If you have any comments, please feel free to contact us at the following:

Lin Kou EMC/RF Lab

Tel: 886-2-26052180

Fax: 886-2-26051924

Hsin Chu EMC/RF/Telecom Lab

Tel: 886-3-6668565

Fax: 886-3-6668323

Hwa Ya EMC/RF/Safety

Tel: 886-3-3183232

Fax: 886-3-3270892

Email: service.adt@tw.bureauveritas.com

Web Site: www.bureauveritas-adt.com

The address and road map of all our labs can be found in our web site also.

--- END ---