

FCC Test Report (WLAN)

Report No.: RF191118E09C-1

FCC ID: PY319400466

Test Model: RAX43

Series Model: RAX50

Received Date: May 28, 2020

Test Date: June 17 to Aug. 03, 2020

Issued Date: Aug. 11, 2020

Applicant: NETGEAR, Inc.

Address: 350 East Plumeria Drive San Jose, CA 95134

Issued By: Bureau Veritas Consumer Products Services (H.K.) Ltd., Taoyuan Branch
Hsin Chu Laboratory

Lab Address: E-2, No.1, Li Hsin 1st Road, Hsinchu Science Park, Hsinchu City 300,
Taiwan

Test Location: E-2, No.1, Li Hsin 1st Road, Hsinchu Science Park, Hsinchu City 300,
Taiwan

**FCC Registration /
Designation Number:** 723255 / TW2022



This report is for your exclusive use. Any copying or replication of this report to or for any other person or entity, or use of our name or trademark, is permitted only with our prior written permission. This report sets forth our findings solely with respect to the test samples identified herein. The results set forth in this report are not indicative or representative of the quality or characteristics of the lot from which a test sample was taken or any similar or identical product unless specifically and expressly noted. Our report includes all of the tests requested by you and the results thereof based upon the information that you provided to us. You have 60 days from date of issuance of this report to notify us of any material error or omission caused by our negligence, provided, however, that such notice shall be in writing and shall specifically address the issue you wish to raise. A failure to raise such issue within the prescribed time shall constitute your unqualified acceptance of the completeness of this report, the tests conducted and the correctness of the report contents. Unless specific mention, the uncertainty of measurement has been explicitly taken into account to declare the compliance or non-compliance to the specification.

Table of Contents

Release Control Record	4
1 Certificate of Conformity	5
2 Summary of Test Results	6
2.1 Measurement Uncertainty	6
2.2 Modification Record	6
3 General Information	7
3.1 General Description of EUT	7
3.2 Description of Test Modes	10
3.2.1 Test Mode Applicability and Tested Channel Detail	12
3.3 Duty Cycle of Test Signal	16
3.4 Description of Support Units	17
3.4.1 Configuration of System under Test	18
3.5 General Description of Applied Standard and References	19
4 Test Types and Results	20
4.1 Radiated Emission and Bandedge Measurement	20
4.1.1 Limits of Radiated Emission and Bandedge Measurement	20
4.1.2 Test Instruments	21
4.1.3 Test Procedure	23
4.1.4 Deviation from Test Standard	24
4.1.5 Test Setup	24
4.1.6 EUT Operating Condition	25
4.1.7 Test Results	26
4.2 Conducted Emission Measurement	72
4.2.1 Limits of Conducted Emission Measurement	72
4.2.2 Test Instruments	72
4.2.3 Test Procedure	73
4.2.4 Deviation from Test Standard	73
4.2.5 Test Setup	73
4.2.6 EUT Operating Condition	73
4.2.7 Test Results	74
4.3 Transmit Power Measurement	76
4.3.1 Limits of Transmit Power Measurement	76
4.3.2 Test Setup	76
4.3.3 Test Instruments	77
4.3.4 Test Procedure	77
4.3.5 Deviation from Test Standard	77
4.3.6 EUT Operating Condition	77
4.3.7 Test Results	78
4.4 Occupied Bandwidth Measurement	115
4.4.1 Test Setup	115
4.4.2 Test Instruments	115
4.4.3 Test Procedure	115
4.4.4 Test Results	116
4.5 Peak Power Spectral Density Measurement	123
4.5.1 Limits of Peak Power Spectral Density Measurement	123
4.5.2 Test Setup	123
4.5.3 Test Instruments	123
4.5.4 Test Procedure	123
4.5.5 Deviation from Test Standard	124
4.5.6 EUT Operating Condition	124
4.5.7 Test Results	125

4.6	Frequency Stability Measurement.....	131
4.6.1	Limits of Frequency Stability Measurement	131
4.6.2	Test Setup.....	131
4.6.3	Test Instruments	131
4.6.4	Test Procedure	131
4.6.5	Deviation from Test Standard	131
4.6.6	EUT Operating Condition	131
4.6.7	Test Results	132
4.7	6dB Bandwidth Measurement.....	133
4.7.1	Limits of 6dB Bandwidth Measurement.....	133
4.7.2	Test Setup.....	133
4.7.3	Test Instruments	133
4.7.4	Test Procedure	133
4.7.5	Deviation from Test Standard	133
4.7.6	EUT Operating Condition	133
4.7.7	Test Results	134
5	Pictures of Test Arrangements.....	136
	Annex A - Radiated Out of Band Emission (OOBE) Measurement (For U-NII-3 band)	137
	Annex B - Band-Edge Measurement (For U-NII-1, U-NII-2A, U-NII-2C band)	140
	Appendix – Information of the Testing Laboratories	149

Release Control Record

Issue No.	Description	Date Issued
RF191118E09C-1	Original release.	Aug. 11, 2020

1 Certificate of Conformity

Product: NIGHTHAWK AX6 AX5400 6-Stream WiFi Router,
NIGHTHAWK AX6 AX4300 6-Stream WiFi Router

Brand: NETGEAR

Test Model: RAX43

Series Model: RAX50

Sample Status: ENGINEERING SAMPLE

Applicant: NETGEAR, Inc.

Test Date: June 17 to Aug. 03, 2020

Standard: 47 CFR FCC Part 15, Subpart E (Section 15.407)
ANSI C63.10: 2013

The above equipment has been tested by **Bureau Veritas Consumer Products Services (H.K.) Ltd., Taoyuan Branch**, and found compliance with the requirement of the above standards. The test record, data evaluation & Equipment Under Test (EUT) configurations represented herein are true and accurate accounts of the measurements of the sample's EMC characteristics under the conditions specified in this report.

Prepared by : Vivian Huang , **Date:** Aug. 11, 2020
Vivian Huang / Specialist

Approved by : Clark Lin , **Date:** Aug. 11, 2020
Clark Lin / Technical Manager

2 Summary of Test Results

47 CFR FCC Part 15, Subpart E (Section 15.407)			
FCC Clause	Test Item	Result	Remarks
15.407(b)(6)	AC Power Conducted Emissions	Pass	Meet the requirement of limit. Minimum passing margin is -8.93dB at 0.30625 MHz.
15.407(b) (1/2/3/4(i/ii)/6)	Radiated Emissions & Band Edge Measurement*	Pass	Meet the requirement of limit. Minimum passing margin is -0.2 dB at 5350.00 MHz and 5150.00 MHz.
15.407(a)(1/2/3)	Max Average Transmit Power	Pass	Meet the requirement of limit.
---	Occupied Bandwidth Measurement	-	Reference only.
15.407(a)(1/2/3)	Peak Power Spectral Density	Pass	Meet the requirement of limit.
15.407(e)	6dB bandwidth	Pass	Meet the requirement of limit. (U-NII-3 Band only)
15.407(g)	Frequency Stability	Pass	Meet the requirement of limit.
15.203	Antenna Requirement	Pass	Antenna connector is R-SMA not a standard connector.

Note:

- For U-NII-3 band compliance with rule part 15.407(b)(4)(i), the OBE test plots were recorded in Annex A.
- For U-NII-1, U-NII-2A, U-NII-2C band compliance with rule 15.407(b) of the band-edge items, the test plots were recorded in Annex B. Test Procedures refer to report 4.1.3.
- Determining compliance based on the results of the compliance measurement, not taking into account measurement instrumentation uncertainty.

2.1 Measurement Uncertainty

Where relevant, the following measurement uncertainty levels have been estimated for tests performed on the EUT as specified in CISPR 16-4-2:

Measurement	Frequency	Expanded Uncertainty (k=2) (\pm)
Conducted Emissions at mains ports	150kHz ~ 30MHz	1.9 dB
Radiated Emissions up to 1 GHz	9kHz ~ 30MHz	3.1 dB
	30MHz ~ 1GHz	5.5 dB
Radiated Emissions above 1 GHz	1GHz ~ 18GHz	5.1 dB
	18GHz ~ 40GHz	5.3 dB

2.2 Modification Record

There were no modifications required for compliance.

3 General Information

3.1 General Description of EUT

Product	NIGHTHAWK AX6 AX5400 6-Stream WiFi Router, NIGHTHAWK AX6 AX4300 6-Stream WiFi Router
Brand	NETGEAR
Test Model	RAX43
Series Model	RAX50
Status of EUT	ENGINEERING SAMPLE
Power Supply Rating	12Vdc from power adapter
Modulation Type	CCK, DQPSK, DBPSK for DSSS 64QAM, 16QAM, QPSK, BPSK for OFDM 256QAM for OFDM in 11ac mode and VHT20/40 in 2.4GHz 1024QAM for OFDMA in 11ax HE mode
Modulation Technology	DSSS, OFDM, OFDMA
Transfer Rate	802.11b: up to 11 Mbps 802.11a/g: up to 54 Mbps 802.11n: up to 600 Mbps 802.11ac: up to 3466.7 Mbps 802.11ax: up to 4803.9 Mbps
Operating Frequency	2.4GHz: 2.412 ~ 2.462GHz 5GHz: 5.18~5.32GHz, 5.50~5.72GHz, 5.745 ~ 5.825GHz
Number of Channel	2.4GHz: 802.11b, 802.11g, 802.11n (HT20), VHT20, 802.11ax (HE20): 11 802.11n (HT40), VHT40, 802.11ax (HE40): 7 5GHz: 802.11a, 802.11n (HT20), 802.11ac (VHT20), 802.11ax (HE20): 25 802.11n (HT40), 802.11ac (VHT40), 802.11ax (HE40): 12 802.11ac (VHT80), 802.11ax (HE80): 6 802.11ac (VHT160), 802.11ax (HE160): 2
Output Power	CDD Mode: 2.412 ~ 2.462 GHz: 917.02 mW 5.18 ~ 5.25 GHz: 675.929 mW 5.25 ~ 5.32GHz: 162.354 mW 5.5 ~ 5.72GHz: 171.97 mW 5.745 ~ 5.825 GHz: 732.981 mW Beamforming Mode: 2.412 ~ 2.462 GHz: 874.052 mW 5.18 ~ 5.25 GHz: 624.315 mW 5.25 ~ 5.32GHz: 157.265 mW 5.5 ~ 5.72GHz: 154.545 mW 5.745 ~ 5.825 GHz: 573.792 mW
Antenna Type	Refer to Note
Antenna Connector	Refer to Note
Accessory Device	Adapter x 1
Data Cable Supplied	RJ-45 Cable x 1 (Unshielded, 1.8 m)

Note:

1. This report is prepared for FCC Class II permissive change. The difference compared with the Report No.: RF191118E09-1 R2, RF191118E09B-1 R2 design is as the following information:

◆ Added new model. (Model name: RAX43)

2. According to above condition, all test items need to be performed. And all data was verified to meet the requirements.

3. All models are listed as below.

Product Name	Model Name	Description
NIGHTHAWK AX6 AX5400 6-Stream WiFi Router	RAX50	The hardware are the same, just only the Link Rate is different. - Link Rate RAX50: 2.4GHz 600 Mbps, 5GHz 4800 Mbps RAX43: 5GHz 3X3
NIGHTHAWK AX6 AX4300 6-Stream WiFi Router	RAX43	

Note: From the above models, model: RAX43 was selected as representative model for the test and its data was recorded in this report.

4. Simultaneously transmission condition.

Condition	Technology	
1	WLAN (2.4GHz)	WLAN (5GHz)

Note: The emission of the simultaneous operation has been evaluated and no non-compliance was found.

5. The EUT must be supplied one power adapter and following different models could be chosen as following table:

No.	Brand	Model No.	P/N	Spec.
1	NETGEAR	2ABL030F 1 NA	332-10758-01	Input: 100-120Vac, 1.0A, 50/60Hz Output: 12V, 2.5A DC Output cable: Unshielded, 1.8m
2	NETGEAR	AD2067F10	332-10797-01	Input: 100-120Vac, 1.0A, 50/60Hz Output: 12V, 2.5A DC Output cable: Unshielded, 1.8m

Note: From the above models, the worst AC Power Conducted Emissions and Radiated Emissions test was found in **Adapter 1**. Therefore only the test data of the modes were recorded in this report.

6. The antennas provided to the EUT, please refer to the following table:

Antenna Operation 1	Antenna Operation 2
Dual_Ant0	Dual_Ant0
Dual_Ant1	Dual_Ant1
Single_Ant2	Dual_Ant2
Single_Ant3	Dual_Ant3

Note: From the above antenna conditions, the worst case was found in Antenna Operation 1. Therefore only the test data of the mode was recorded in this report.

7. The directional antenna gain, please refer to the following table:

Frequency Range (GHz)	4TX Directional Antenna Gain (dBi)	3TX Directional Antenna Gain (dBi)	Antenna Type	Antenna Connector
2.4~2.4835	3.73	3.73	Dipole	R-SMA
5.15 ~ 5.25	6.61	6.14		
5.25 ~ 5.35	6.53	6.26		
5.47 ~ 5.725	6.64	6.33		
5.725 ~ 5.85	6.66	6.29		

Note: More detailed information, please refer to antenna specification.

8. The EUT incorporates a MIMO function:

2.4GHz Band		
MODULATION MODE	TX & RX CONFIGURATION	
802.11b	2TX	2RX
802.11g	2TX	2RX
802.11n (HT20)	2TX	2RX
802.11n (HT40)	2TX	2RX
VHT20	2TX	2RX
VHT40	2TX	2RX
802.11ax (HE20)	2TX	2RX
802.11ax (HE40)	2TX	2RX
5GHz Band (for Model: RAX50)		
MODULATION MODE	TX & RX CONFIGURATION	
802.11a	4TX	4RX
802.11n (HT20)	4TX	4RX
802.11n (HT40)	4TX	4RX
802.11ac (VHT20)	4TX	4RX
802.11ac (VHT40)	4TX	4RX
802.11ac (VHT80)	4TX	4RX
802.11ac (VHT160)	4TX	4RX
802.11ax (HE20)	4TX	4RX
802.11ax (HE40)	4TX	4RX
802.11ax (HE80)	4TX	4RX
802.11ax (HE160)	4TX	4RX
5GHz Band (for Model: RAX43)		
MODULATION MODE	TX & RX CONFIGURATION	
802.11a	3TX	3RX
802.11n (HT20)	3TX	3RX
802.11n (HT40)	3TX	3RX
802.11ac (VHT20)	3TX	3RX
802.11ac (VHT40)	3TX	3RX
802.11ac (VHT80)	3TX	3RX
802.11ac (VHT160)	3TX	3RX
802.11ax (HE20)	3TX	3RX
802.11ax (HE40)	3TX	3RX
802.11ax (HE80)	3TX	3RX
802.11ax (HE160)	3TX	3RX

Note:

1. All of modulation mode support beamforming function except 802.11a/b/g modulation mode.
2. The EUT support Beamforming and Non-Beamforming mode, therefore both mode were investigated and the worst case scenario was identified. The worst case data were presented in test report.
3. The modulation and bandwidth are similar for 802.11n mode for 20MHz (40MHz), VHT mode for 20MHz (40MHz, 80MHz, 160MHz) and 802.11ax mode for 20MHz (40MHz, 80MHz, 160MHz), therefore the manufacturer will control the power for 802.11n/ac mode is the same as the 802.11ax or more lower than it and investigated worst case to representative mode in test report.

9. The above EUT information is declared by manufacturer and for more detailed features description, please refers to the manufacturer's specifications or user's manual.

10. The above Antenna information is declared by manufacturer and for more detailed features description, please refer to the manufacturer's specifications, the laboratory shall not be held responsible.

3.2 Description of Test Modes

FOR 5180 ~ 5320MHz

8 channels are provided for 802.11a, 802.11n (HT20), 802.11ac (VHT20), 802.11ax (HE20):

Channel	Frequency	Channel	Frequency
36	5180 MHz	52	5260 MHz
40	5200 MHz	56	5280 MHz
44	5220 MHz	60	5300 MHz
48	5240 MHz	64	5320 MHz

4 channels are provided for 802.11n (HT40), 802.11ac (VHT40), 802.11ax (HE40):

Channel	Frequency	Channel	Frequency
38	5190 MHz	54	5270 MHz
46	5230 MHz	62	5310 MHz

2 channel is provided for 802.11ac (VHT80), 802.11ax (HE80):

Channel	Frequency	Channel	Frequency
42	5210 MHz	58	5290 MHz

1 straddle channel is provided for 802.11ac (VHT160), 802.11ax (HE160):

Channel	Frequency
50	5250 MHz

FOR 5500 ~ 5720MHz

12 channels are provided for 802.11a, 802.11n (HT20), 802.11ac (VHT20), 802.11ax (HE20):

Channel	Frequency	Channel	Frequency
100	5500 MHz	124	5620 MHz
104	5520 MHz	128	5640 MHz
108	5540 MHz	132	5660 MHz
112	5560 MHz	136	5680 MHz
116	5580 MHz	140	5700 MHz
120	5600 MHz	144	5720 MHz

6 channels are provided for 802.11n (HT40), 802.11ac (VHT40), 802.11ax (HE40):

Channel	Frequency	Channel	Frequency
102	5510 MHz	126	5630 MHz
110	5550 MHz	134	5670 MHz
118	5590 MHz	142	5710 MHz

3 channels are provided for 802.11ac (VHT80), 802.11ax (HE80):

Channel	Frequency	Channel	Frequency
106	5530 MHz	138	5690 MHz
122	5610 MHz		

1 straddle channel is provided for 802.11ac (VHT160), 802.11ax (HE160):

Channel	Frequency
114	5570 MHz

FOR 5745 ~ 5825MHz:

5 channels are provided for 802.11a, 802.11n (HT20), 802.11ac (VHT20), 802.11ax (HE20):

Channel	Frequency	Channel	Frequency
149	5745 MHz	161	5805 MHz
153	5765 MHz	165	5825 MHz
157	5785 MHz		

2 channels are provided for 802.11n (HT40), 802.11ac (VHT40), 802.11ax (HE40):

Channel	Frequency	Channel	Frequency
151	5755 MHz	159	5795 MHz

1 channel is provided for 802.11ac (VHT80), 802.11ax (HE80):

Channel	Frequency
155	5775 MHz

3.2.1 Test Mode Applicability and Tested Channel Detail

EUT Configure Mode	Applicable To				Description
	RE \geq 1G	RE<1G	PLC	APCM	
-	√	√	√	√	-

Where **RE \geq 1G**: Radiated Emission above 1GHz

RE<1G: Radiated Emission below 1GHz

PLC: Power Line Conducted Emission

APCM: Antenna Port Conducted Measurement

Note: In the original report, the EUT had been pre-tested on the positioned of each 2 axis. The worst case was found when positioned on X-plane.

Radiated Emission Test (Above 1GHz):

- Pre-Scan has been conducted to determine the worst-case mode from all possible combinations between available modulations, data rates and antenna ports (if EUT with antenna diversity architecture).
- Following channel(s) was (were) selected for the final test as listed below.

CDD Mode						
Mode	FREQ. Band (MHz)	Available Channel	Tested Channel	Modulation Technology	Modulation Type	Data Rate Parameter
802.11a	5180-5320	36 to 64	36, 40, 48, 52, 60, 64	OFDM	BPSK	6Mb/s
802.11ax (HE20)		36 to 64	36, 40, 48, 52, 60, 64	OFDMA	BPSK	MCS0
802.11ax (HE40)		38 to 62	38, 46, 54, 62	OFDMA	BPSK	MCS0
802.11ax (HE80)		42, 58	42, 58	OFDMA	BPSK	MCS0
802.11ax (HE160)		50	50	OFDMA	BPSK	MCS0
802.11a	5500-5720	100 to 144	100, 116, 140, 144	OFDM	BPSK	6Mb/s
802.11ax (HE20)		100 to 144	100, 116, 140, 144	OFDMA	BPSK	MCS0
802.11ax (HE40)		102 to 142	102, 110, 134, 142	OFDMA	BPSK	MCS0
802.11ax (HE80)		106 to 138	106, 122, 138	OFDMA	BPSK	MCS0
802.11ax (HE160)		114	114	OFDMA	BPSK	MCS0
802.11a	5745-5825	149 to 165	149, 157, 165	OFDM	BPSK	6Mb/s
802.11ax (HE20)		149 to 165	149, 157, 165	OFDMA	BPSK	MCS0
802.11ax (HE40)		151 to 159	151, 159	OFDMA	BPSK	MCS0
802.11ax (HE80)		155	155	OFDMA	BPSK	MCS0

Radiated Emission Test (Below 1GHz):

- Pre-Scan has been conducted to determine the worst-case mode from all possible combinations between available modulations, data rates and antenna ports (if EUT with antenna diversity architecture).
- Following channel(s) was (were) selected for the final test as listed below.

CDD Mode						
Mode	FREQ. Band (MHz)	Available Channel	Tested Channel	Modulation Technology	Modulation Type	Data Rate Parameter
802.11ax (HE40)	5180-5320	36 to 62	151	OFDMA	BPSK	MCS0
	5500-5720	102 to 142				
	5745-5825	151 to 159				

Power Line Conducted Emission Test:

- Pre-Scan has been conducted to determine the worst-case mode from all possible combinations between available modulations, data rates and antenna ports (if EUT with antenna diversity architecture).
- Following channel(s) was (were) selected for the final test as listed below.

CDD Mode						
Mode	FREQ. Band (MHz)	Available Channel	Tested Channel	Modulation Technology	Modulation Type	Data Rate Parameter
802.11ax (HE40)	5180-5320	36 to 62	151	OFDMA	BPSK	MCS0
	5500-5720	102 to 142				
	5745-5825	151 to 159				

Antenna Port Conducted Measurement:

- This item includes all test value of each mode, but only includes spectrum plot of worst value of each mode.
- Pre-Scan has been conducted to determine the worst-case mode from all possible combinations between available modulations, data rates and antenna ports (if EUT with antenna diversity architecture).
- Following channel(s) was (were) selected for the final test as listed below.

CDD Mode						
Mode	FREQ. Band (MHz)	Available Channel	Tested Channel	Modulation Technology	Modulation Type	Data Rate Parameter
802.11a	5180-5320	36 to 64	36, 40, 48, 52, 60, 64	OFDM	BPSK	6Mb/s
802.11ac (VHT20) (Output power only)		36 to 64	36, 40, 48, 52, 60, 64	OFDM	BPSK	MCS0
802.11ac (VHT40) (Output power only)		38 to 62	38, 46, 54, 62	OFDM	BPSK	MCS0
802.11ac (VHT80) (Output power only)		42, 58	42, 58	OFDM	BPSK	MCS0
802.11ac (VHT160) (Output power only)		50	50	OFDM	BPSK	MCS0
802.11ax (HE20)		36 to 64	36, 40, 48, 52, 60, 64	OFDMA	BPSK	MCS0
802.11ax (HE40)		38 to 62	38, 46, 54, 62	OFDMA	BPSK	MCS0
802.11ax (HE80)		42, 58	42, 58	OFDMA	BPSK	MCS0
802.11ax (HE160)		50	50	OFDMA	BPSK	MCS0
802.11a		5500-5720	100 to 144	100, 116, 140, 144	OFDM	BPSK
802.11ac (VHT20) (Output power only)	100 to 144		100, 116, 140, 144	OFDM	BPSK	MCS0
802.11ac (VHT40) (Output power only)	102 to 142		102, 110, 134, 142	OFDM	BPSK	MCS0
802.11ac (VHT80) (Output power only)	106 to 138		106, 122, 138	OFDM	BPSK	MCS0
802.11ac (VHT160) (Output power only)	114		114	OFDM	BPSK	MCS0
802.11ax (HE20)	100 to 144		100, 116, 140, 144	OFDMA	BPSK	MCS0
802.11ax (HE40)	102 to 142		102, 110, 134, 142	OFDMA	BPSK	MCS0
802.11ax (HE80)	106 to 138		106, 122, 138	OFDMA	BPSK	MCS0
802.11ax (HE160)	114		114	OFDMA	BPSK	MCS0
802.11a	5745-5825		149 to 165	149, 157, 165	OFDM	BPSK
802.11ac (VHT20) (Output power only)		149 to 165	149, 157, 165	OFDM	BPSK	MCS0
802.11ac (VHT40) (Output power only)		151 to 159	151, 159	OFDM	BPSK	MCS0
802.11ac (VHT80) (Output power only)		155	155	OFDM	BPSK	MCS0
802.11ax (HE20)		149 to 165	149, 157, 165	OFDMA	BPSK	MCS0
802.11ax (HE40)		151 to 159	151, 159	OFDMA	BPSK	MCS0
802.11ax (HE80)		155	155	OFDMA	BPSK	MCS0

Beamforming Mode (output power only)						
Mode	FREQ. Band (MHz)	Available Channel	Tested Channel	Modulation Technology	Modulation Type	Data Rate Parameter
802.11ac (VHT20)	5180-5320	36 to 48	36, 40, 48	OFDM	BPSK	MCS0
802.11ac (VHT40)		38 to 46	38, 46	OFDM	BPSK	MCS0
802.11ac (VHT80)		42	42	OFDM	BPSK	MCS0
802.11ac (VHT160)		50	50	OFDM	BPSK	MCS0
802.11ax (HE20)		36 to 48	36, 40, 48	OFDMA	BPSK	MCS0
802.11ax (HE40)		38 to 46	38, 46	OFDMA	BPSK	MCS0
802.11ax (HE80)		42	42	OFDMA	BPSK	MCS0
802.11ax (HE160)		50	50	OFDMA	BPSK	MCS0
802.11ac (VHT20)	5500-5720	100 to 144	100, 116, 140, 144	OFDM	BPSK	MCS0
802.11ac (VHT40)		102 to 142	102, 110, 134, 142	OFDM	BPSK	MCS0
802.11ac (VHT80)		106 to 138	106, 122, 138	OFDM	BPSK	MCS0
802.11ac (VHT160)		114	114	OFDM	BPSK	MCS0
802.11ax (HE20)		100 to 144	100, 116, 140, 144	OFDMA	BPSK	MCS0
802.11ax (HE40)		102 to 142	102, 110, 134, 142	OFDMA	BPSK	MCS0
802.11ax (HE80)		106 to 138	106, 122, 138	OFDMA	BPSK	MCS0
802.11ax (HE160)		114	114	OFDMA	BPSK	MCS0
802.11ac (VHT20)	5745-5825	149 to 165	149, 157, 165	OFDM	BPSK	MCS0
802.11ac (VHT40)		151 to 159	151, 159	OFDM	BPSK	MCS0
802.11ac (VHT80)		155	155	OFDM	BPSK	MCS0
802.11ax (HE20)		149 to 165	149, 157, 165	OFDMA	BPSK	MCS0
802.11ax (HE40)		151 to 159	151, 159	OFDMA	BPSK	MCS0
802.11ax (HE80)		155	155	OFDMA	BPSK	MCS0

Test Condition:

Applicable To	Environmental Conditions	Input Power (System)	Tested By
RE \geq 1G	25deg. C, 75%RH	120Vac, 60Hz	Tom Yang
RE $<$ 1G	27deg. C, 72%RH	120Vac, 60Hz	Kevien Ko
PLC	25deg. C, 75%RH	120Vac, 60Hz	Kevien Ko
APCM	25deg. C, 60%RH	120Vac, 60Hz	Jyunchun Lin

3.3 Duty Cycle of Test Signal

If duty cycle of test signal is $\geq 98\%$, duty factor is not required.
 If duty cycle of test signal is $< 98\%$, duty factor shall be considered.

802.11b: Duty cycle = $5.057 \text{ ms} / 5.111 \text{ ms} = 0.989$

802.11ax (HE20): Duty cycle = $2.277 \text{ ms} / 2.31 \text{ ms} = 0.986$

802.11ax (HE40): Duty cycle = $2.359 \text{ ms} / 2.396 \text{ ms} = 0.985$

802.11ax (HE80): Duty cycle = $2.439 \text{ ms} / 2.477 \text{ ms} = 0.985$

802.11ax (HE160): Duty cycle = $0.232 \text{ ms} / 0.263 \text{ ms} = 0.882$, Duty factor = $10 * \log (1/\text{Duty cycle}) = 0.54 \text{ dB}$

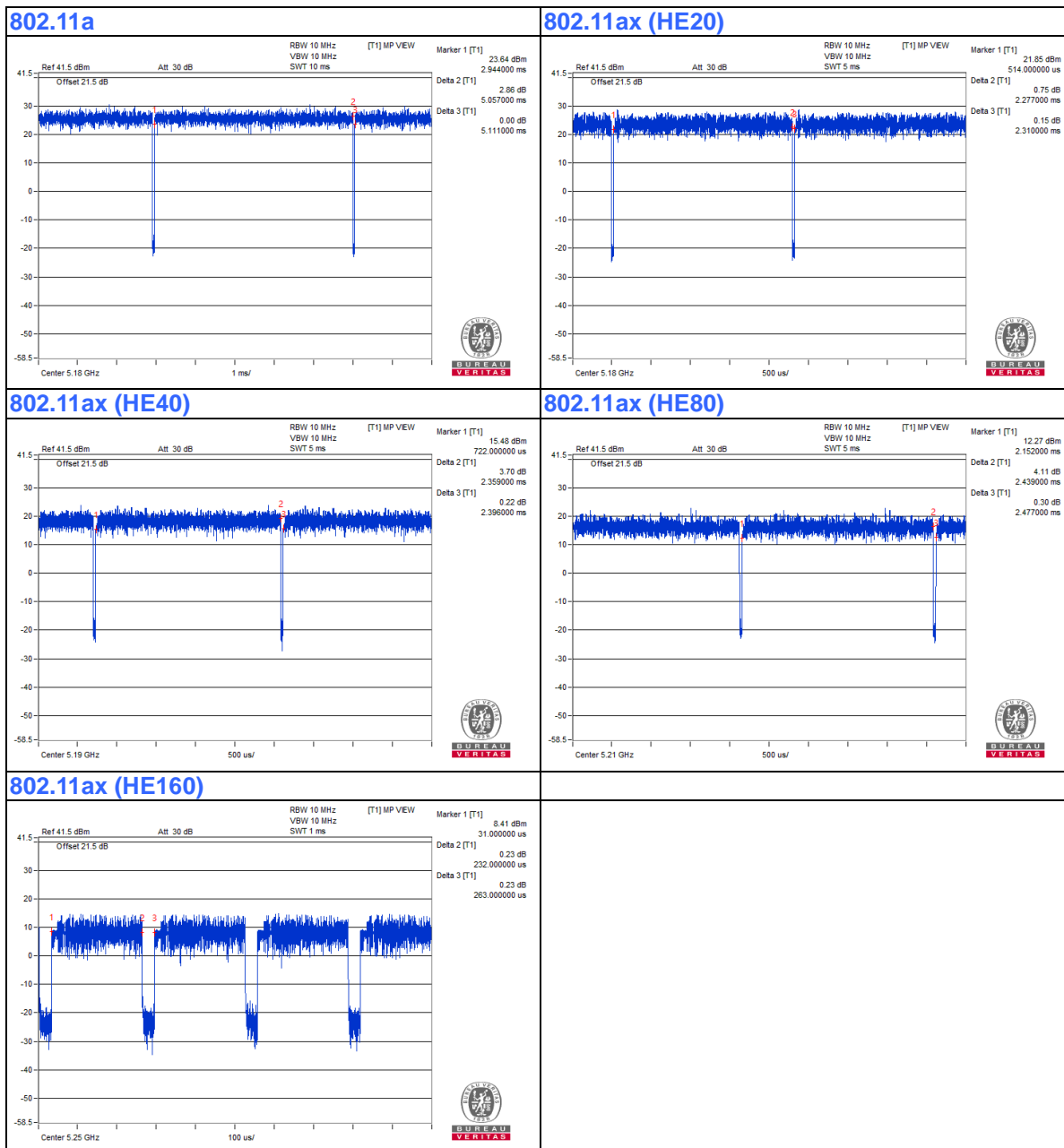

3.4 Description of Support Units

The EUT has been tested as an independent unit together with other necessary accessories or support units. The following support units or accessories were used to form a representative test configuration during the tests.

ID	Product	Brand	Model No.	Serial No.	FCC ID	Remarks
A.	Laptop	DELL	E6420	B92T3R1	FCC DoC	Provided by Lab
B.	Laptop	DELL	E5430	HYV4VY1	FCC DoC	Provided by Lab
C.	USB 3.0 Disk	SanDisk	BM181225896Z	NA	NA	Provided by Lab
D.	HUB	ZyXEL	GS1100-16	S150H44000046	FCC DoC	Provided by Lab

Note:

1. All power cords of the above support units are non-shielded (1.8m).

ID	Descriptions	Qty.	Length (m)	Shielding (Yes/No)	Cores (Qty.)	Remarks
1.	RJ-45 Cable	1	10	No	0	Provided by Lab
2.	RJ-45 Cable	1	10	No	0	Provided by Lab
3.	DC Cable	1	1.8	No	0	Supplied by client
4.	RJ-45 Cable	1	1.8	No	0	Supplied by client
5.	RJ-45 Cable	3	10	No	0	Provided by Lab

3.4.1 Configuration of System under Test

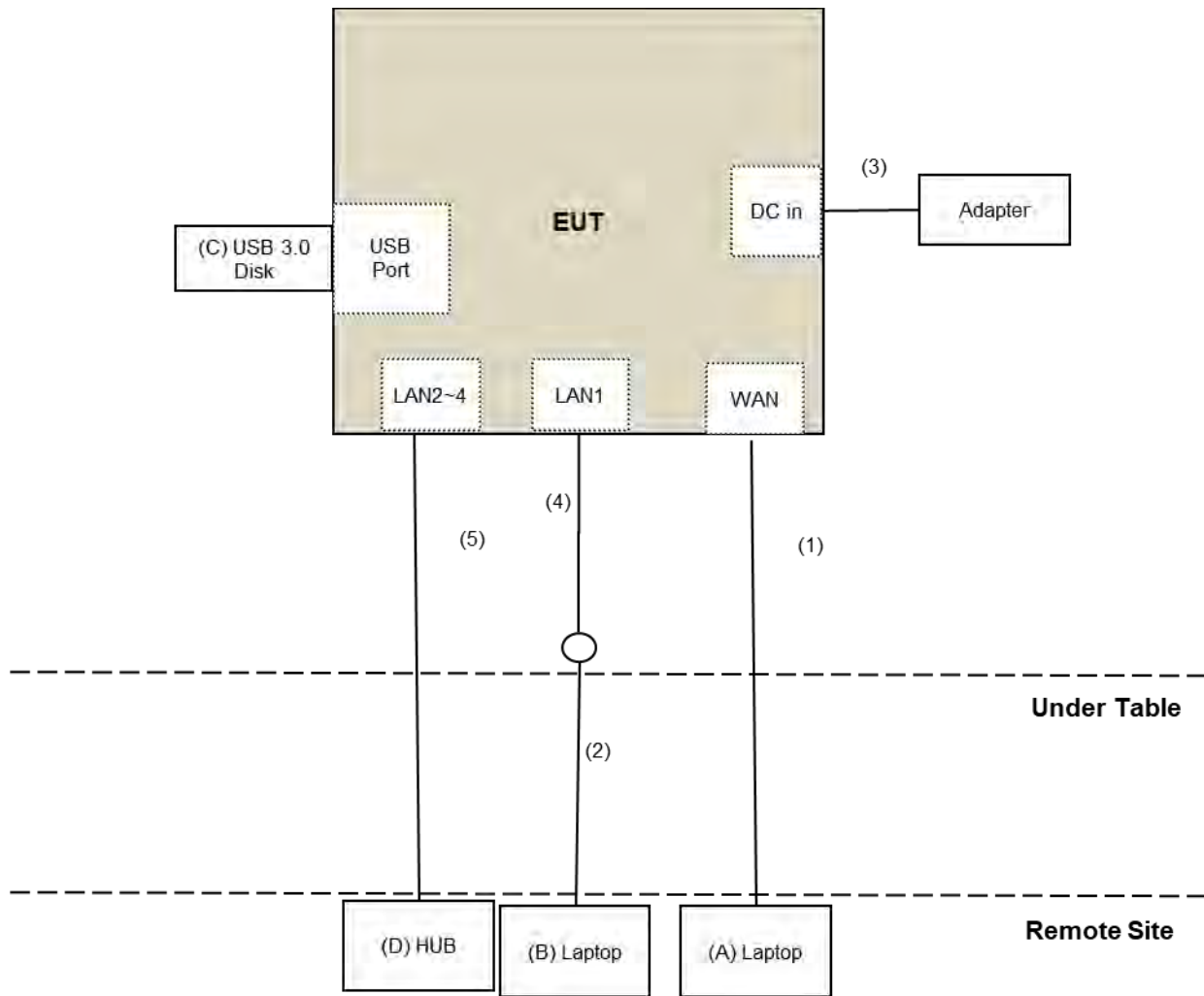

3.5 General Description of Applied Standard and References

The EUT is a RF Product. According to the specifications of the manufacturer, it must comply with the requirements of the following standards and references:

Test Standard:

FCC Part 15, Subpart E (15.407)

ANSI C63.10-2013

All test items have been performed and recorded as per the above standards.

References Test Guidance:

KDB 789033 D02 General UNII Test Procedure New Rules v02r01

KDB 662911 D01 Multiple Transmitter Output v02r01

All test items have been performed as a reference to the above KDB test guidance.

4 Test Types and Results

4.1 Radiated Emission and Bandedge Measurement

4.1.1 Limits of Radiated Emission and Bandedge Measurement

Radiated emissions which fall in the restricted bands must comply with the radiated emission limits specified as below table.

Frequencies (MHz)	Field Strength (microvolts/meter)	Measurement Distance (meters)
0.009 ~ 0.490	2400/F(kHz)	300
0.490 ~ 1.705	24000/F(kHz)	30
1.705 ~ 30.0	30	30
30 ~ 88	100	3
88 ~ 216	150	3
216 ~ 960	200	3
Above 960	500	3

NOTE:

1. The lower limit shall apply at the transition frequencies.
2. Emission level (dBuV/m) = 20 log Emission level (uV/m).
3. For frequencies above 1000MHz, the field strength limits are based on average detector, however, the peak field strength of any emission shall not exceed the maximum permitted average limits, specified above by more than 20dB under any condition of modulation.

Limits of unwanted emission out of the restricted bands

Applicable To		Limit	
789033 D02 General UNII Test Procedure New Rules v02r01		Field Strength at 3m	
		PK:74 (dBuV/m)	AV:54 (dBuV/m)
Frequency Band	Applicable To	EIRP Limit	Equivalent Field Strength at 3m
5150~5250 MHz	15.407(b)(1)	PK:-27 (dBm/MHz)	PK:68.2(dBuV/m)
5250~5350 MHz	15.407(b)(2)		
5470~5725 MHz	15.407(b)(3)		
5725~5850 MHz	15.407(b)(4)(i)	PK:-27 (dBm/MHz) ^{*1} PK:10 (dBm/MHz) ^{*2} PK:15.6 (dBm/MHz) ^{*3} PK:27 (dBm/MHz) ^{*4}	PK: 68.2(dBuV/m) ^{*1} PK:105.2 (dBuV/m) ^{*2} PK: 110.8(dBuV/m) ^{*3} PK:122.2 (dBuV/m) ^{*4}
^{*1} beyond 75 MHz or more above of the band edge.		^{*2} below the band edge increasing linearly to 10 dBm/MHz at 25 MHz above.	
^{*3} below the band edge increasing linearly to a level of 15.6 dBm/MHz at 5 MHz above.		^{*4} from 5 MHz above or below the band edge increasing linearly to a level of 27 dBm/MHz at the band edge.	

Note:

The following formula is used to convert the equipment isotropic radiated power (eirp) to field strength:

$$E = \frac{1000000\sqrt{30P}}{3} \mu\text{V/m, where P is the eirp (Watts).}$$

4.1.2 Test Instruments

For Radiated emission & Bandedge & OOBE test:

DESCRIPTION & MANUFACTURER	MODEL NO.	SERIAL NO.	CALIBRATED DATE	CALIBRATED UNTIL
Test Receiver Agilent	N9038A	MY51210202	Dec. 13, 2019	Dec. 12, 2020
Pre-Amplifier EMCI	EMC001340	980142	May 25, 2020	May 24, 2021
Loop Antenna Electro-Metrics	EM-6879	264	Feb. 18, 2020	Feb. 17, 2021
RF Cable	NA	LOOPCAB-001	Jan. 08, 2020	Jan. 07, 2021
RF Cable	NA	LOOPCAB-002	Jan. 08, 2020	Jan. 07, 2021
Pre-Amplifier Mini-Circuits	ZFL-1000VH2B	AMP-ZFL-01	Oct. 23, 2019	Oct. 22, 2020
Trilog Broadband Antenna SCHWARZBECK	VULB 9168	9168-406	Nov. 11, 2019	Nov. 10, 2020
RF Cable	8D	966-4-1	Mar. 18, 2020	Mar. 17, 2021
RF Cable	8D	966-4-2	Mar. 18, 2020	Mar. 17, 2021
RF Cable	8D	966-4-3	Mar. 18, 2020	Mar. 17, 2021
Fixed attenuator Mini-Circuits	UNAT-5+	PAD-3m-4-01	Sep. 26, 2019	Sep. 25, 2020
Horn_Antenna SCHWARZBECK	BBHA 9120D	9120D-783	Nov. 24, 2019	Nov. 23, 2020
Pre-Amplifier EMCI	EMC12630SE	980385	Aug. 15, 2019	Aug. 14, 2020
RF Cable	EMC104-SM-SM-1200	160923	Jan. 15, 2020	Jan. 14, 2021
RF Cable	EMC104-SM-SM-2000	180502	Apr. 29, 2020	Apr. 28, 2021
RF Cable	EMC104-SM-SM-6000	180418	Apr. 29, 2020	Apr. 28, 2021
Pre-Amplifier EMCI	EMC184045SE	980387	Jan. 15, 2020	Jan. 14, 2021
Horn_Antenna SCHWARZBECK	BBHA 9170	BBHA9170519	Nov. 24, 2019	Nov. 23, 2020
RF Cable	EMC102-KM-KM-1200	160924	Jan. 15, 2020	Jan. 14, 2021
RF Cable	EMC-KM-KM-4000	200214	Mar. 11, 2020	Mar. 10, 2021
Software	ADT_Radiated_V8.7.08	NA	NA	NA
Boresight Antenna Tower & Turn Table Max-Full	MF-7802BS	MF780208530	NA	NA

Note:

1. The calibration interval of the above test instruments is 12 months and the calibrations are traceable to NML/ROC and NIST/USA.
2. The test was performed in 966 Chamber No. 4.
3. Tested Date: June 17 to Aug. 1, 2020

For other test items:

DESCRIPTION & MANUFACTURER	MODEL NO.	SERIAL NO.	CALIBRATED DATE	CALIBRATED UNTIL
Spectrum Analyzer R&S	FSV40	100964	May 29, 2020	May 28, 2021
Power meter Anritsu	ML2495A	1529002	July 22, 2020	July 21, 2021
Power sensor Anritsu	MA2411B	1339443	July 22, 2020	July 21, 2021
Fixed Attenuator Mini-Circuits	MDCS18N-10	MDCS18N-10-01	Apr. 14, 2020	Apr. 13, 2021
AC Power Source Extech Electronics	6205	1440452	NA	NA
Temperature & Humidity Chamber Giant Force	GTH-150-40-SP-AR	MAA0812-008	Jan. 16, 2020	Jan. 15, 2021
Voltage Meter FLUKE	179	89610322	Sep. 25, 2019	Sep. 24, 2020
Software	ADT_RF Test Software V6.6.5.4	NA	NA	NA

- NOTE:**
1. The test was performed in Oven room 2.
 2. The calibration interval of the above test instruments is 12 months and the calibrations are traceable to NML/ROC and NIST/USA.
 3. Tested Date: Aug. 03, 2020

4.1.3 Test Procedure

For Radiated emission below 30MHz

- a. The EUT was placed on the top of a rotating table 0.8 meters above the ground at a 3 meter chamber room. The table was rotated 360 degrees to determine the position of the highest radiation.
- b. The EUT was set 3 meters away from the interference-receiving antenna, which was mounted on the top of a variable-height antenna tower.
- c. Parallel, perpendicular, and ground-parallel orientations of the antenna are set to make the measurement.
- d. For each suspected emission, the EUT was arranged to its worst case and the rotatable table was turned from 0 degrees to 360 degrees to find the maximum reading.
- e. The test-receiver system was set to Quasi-Peak Detect Function and Specified Bandwidth with Maximum Hold Mode.

Note:

1. The resolution bandwidth and video bandwidth of test receiver/spectrum analyzer is 9kHz at frequency below 30MHz.

For Radiated emission above 30MHz

- a. The EUT was placed on the top of a rotating table 0.8 meters (for 30MHz ~ 1GHz) / 1.5 meters (for above 1GHz) above the ground at 3 meter chamber room for test. The table was rotated 360 degrees to determine the position of the highest radiation.
- b. The EUT was set 3 meters away from the interference-receiving antenna, which was mounted on the top of a variable-height antenna tower.
- c. The height of antenna is varied from one meter to four meters above the ground to determine the maximum value of the field strength. Both horizontal and vertical polarizations of the antenna are set to make the measurement.
- d. For each suspected emission, the EUT was arranged to its worst case and then the antenna was tuned to heights from 1 meter to 4 meters and the rotatable table was turned from 0 degrees to 360 degrees to find the maximum reading.
- e. The test-receiver system was set to quasi-peak detect function and specified bandwidth with maximum hold mode when the test frequency is below 1 GHz.
- f. The test-receiver system was set to peak and average detects function and specified bandwidth with maximum hold mode when the test frequency is above 1 GHz. If the peak reading value also meets average limit, measurement with the average detector is unnecessary.

Note:

1. The resolution bandwidth and video bandwidth of test receiver/spectrum analyzer is 120kHz for Quasi-peak detection (QP) at frequency below 1GHz.
2. The resolution bandwidth of test receiver/spectrum analyzer is 1 MHz and the video bandwidth is 3 MHz for Peak detection (PK) at frequency above 1GHz.
3. The resolution bandwidth of test receiver/spectrum analyzer is 1MHz and the video bandwidth is $\geq 1/T$ (Duty cycle < 98%) or 10Hz (Duty cycle $\geq 98\%$) for Average detection (AV) at frequency above 1GHz.
4. All modes of operation were investigated and the worst-case emissions are reported.

4.1.4 Deviation from Test Standard

No deviation.

4.1.5 Test Setup

For Radiated emission below 30MHz

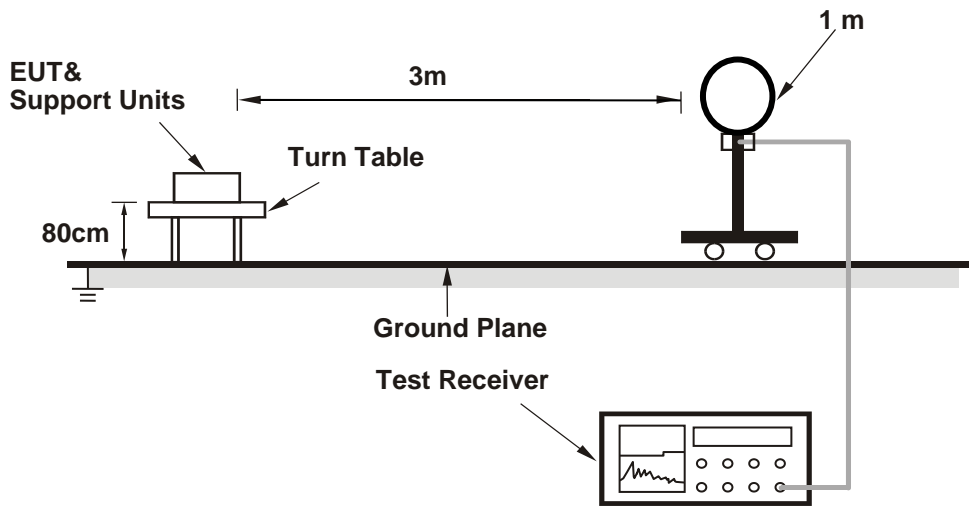

For Radiated emission 30MHz to 1GHz

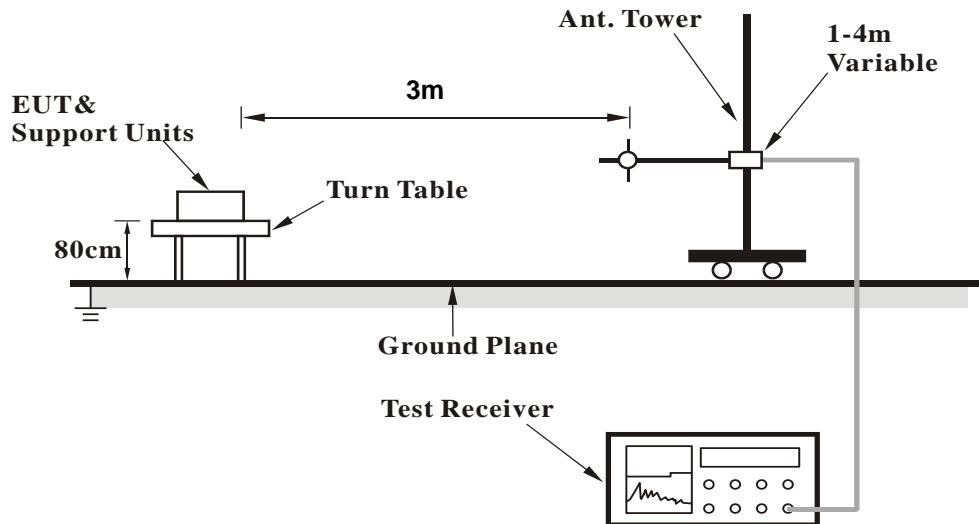

For Radiated emission above 1GHz

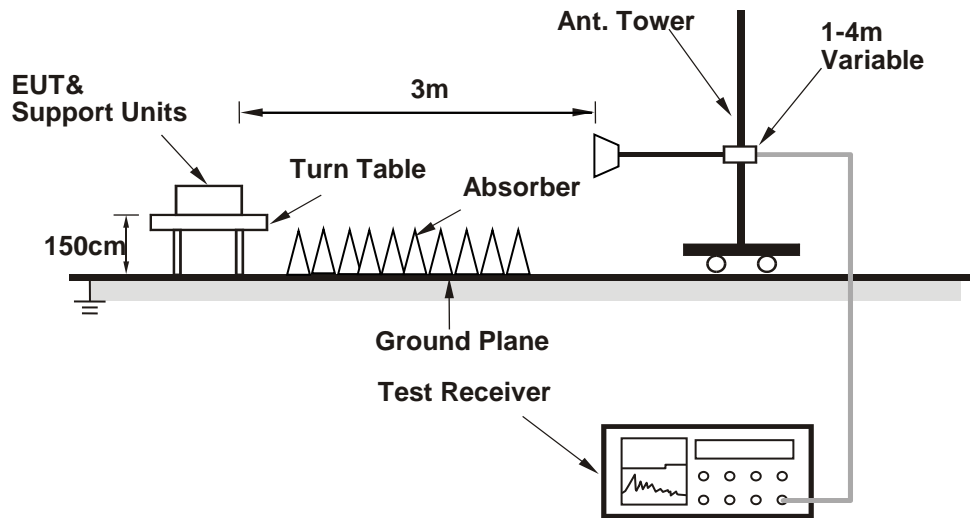

For the actual test configuration, please refer to the attached file (Test Setup Photo).

4.1.6 EUT Operating Condition

- a. Connected the EUT with the Laptop which is placed on the testing table.
- b. Controlling software (Mtool 3.1.0.1) has been activated to set the EUT under transmission condition continuously.

4.1.7 Test Results

Above 1GHz Data:

802.11a

Channel	TX Channel 36	Detector Function	Peak (PK)
Frequency Range	1GHz ~ 40GHz		Average (AV)

Antenna Polarity & Test Distance : Horizontal at 3 m

No	Frequency (MHz)	Emission Level (dBuV/m)	Limit (dBuV/m)	Margin (dB)	Antenna Height (m)	Table Angle (Degree)	Raw Value (dBuV)	Correction Factor (dB/m)
1	5150.00	65.4 PK	74.0	-8.6	2.89 H	209	62.4	3.0
2	5150.00	46.9 AV	54.0	-7.1	2.89 H	209	43.9	3.0
3	*5180.00	112.1 PK			2.89 H	209	109.1	3.0
4	*5180.00	100.8 AV			2.89 H	209	97.8	3.0
5	#10360.00	47.7 PK	68.2	-20.5	1.49 H	220	34.5	13.2
6	15540.00	45.7 PK	74.0	-28.3	1.46 H	154	32.1	13.6
7	15540.00	36.1 AV	54.0	-17.9	1.46 H	154	22.5	13.6

Antenna Polarity & Test Distance : Vertical at 3 m

No	Frequency (MHz)	Emission Level (dBuV/m)	Limit (dBuV/m)	Margin (dB)	Antenna Height (m)	Table Angle (Degree)	Raw Value (dBuV)	Correction Factor (dB/m)
1	5150.00	71.7 PK	74.0	-2.3	1.89 V	358	68.7	3.0
2	5150.00	53.5 AV	54.0	-0.5	1.89 V	358	50.5	3.0
3	*5180.00	119.7 PK			1.89 V	358	116.7	3.0
4	*5180.00	110.3 AV			1.89 V	358	107.3	3.0
5	#10360.00	47.9 PK	68.2	-20.3	1.53 V	231	34.7	13.2
6	15540.00	46.1 PK	74.0	-27.9	1.48 V	146	32.5	13.6
7	15540.00	35.9 AV	54.0	-18.1	1.48 V	146	22.3	13.6

Remarks:

1. Emission Level(dBuV/m) = Raw Value(dBuV) + Correction Factor(dB/m)
2. Correction Factor(dB/m) = Antenna Factor(dB/m) + Cable Factor(dB) – Pre-Amplifier Factor(dB)
3. Margin value = Emission Level – Limit value
4. The other emission levels were very low against the limit.
5. " * ": Fundamental frequency.
6. " # ": The radiated frequency is out of the restricted band.

Channel	TX Channel 40	Detector Function	Peak (PK)
Frequency Range	1GHz ~ 40GHz		Average (AV)

Antenna Polarity & Test Distance : Horizontal at 3 m

No	Frequency (MHz)	Emission Level (dBuV/m)	Limit (dBuV/m)	Margin (dB)	Antenna Height (m)	Table Angle (Degree)	Raw Value (dBuV)	Correction Factor (dB/m)
1	5150.00	64.2 PK	74.0	-9.8	2.43 H	210	61.2	3.0
2	5150.00	47.3 AV	54.0	-6.7	2.43 H	210	44.3	3.0
3	*5200.00	115.8 PK			2.43 H	210	112.9	2.9
4	*5200.00	106.7 AV			2.43 H	210	103.8	2.9
5	#10400.00	47.1 PK	68.2	-21.1	1.56 H	217	33.8	13.3
6	15600.00	45.7 PK	74.0	-28.3	1.55 H	141	31.8	13.9
7	15600.00	36.1 AV	54.0	-17.9	1.55 H	141	22.2	13.9

Antenna Polarity & Test Distance : Vertical at 3 m

No	Frequency (MHz)	Emission Level (dBuV/m)	Limit (dBuV/m)	Margin (dB)	Antenna Height (m)	Table Angle (Degree)	Raw Value (dBuV)	Correction Factor (dB/m)
1	5150.00	67.0 PK	74.0	-7.0	1.74 V	20	64.0	3.0
2	5150.00	53.6 AV	54.0	-0.4	1.74 V	20	50.6	3.0
3	*5200.00	123.6 PK			1.74 V	20	120.7	2.9
4	*5200.00	114.8 AV			1.74 V	20	111.9	2.9
5	#10400.00	47.6 PK	68.2	-20.6	1.50 V	227	34.3	13.3
6	15600.00	45.8 PK	74.0	-28.2	1.50 V	143	31.9	13.9
7	15600.00	35.9 AV	54.0	-18.1	1.50 V	143	22.0	13.9

Remarks:

1. Emission Level(dBuV/m) = Raw Value(dBuV) + Correction Factor(dB/m)
2. Correction Factor(dB/m) = Antenna Factor(dB/m) + Cable Factor(dB) – Pre-Amplifier Factor(dB)
3. Margin value = Emission Level – Limit value
4. The other emission levels were very low against the limit.
5. " * ": Fundamental frequency.
6. " # ": The radiated frequency is out of the restricted band.

Channel	TX Channel 48	Detector Function	Peak (PK)
Frequency Range	1GHz ~ 40GHz		Average (AV)

Antenna Polarity & Test Distance : Horizontal at 3 m

No	Frequency (MHz)	Emission Level (dBuV/m)	Limit (dBuV/m)	Margin (dB)	Antenna Height (m)	Table Angle (Degree)	Raw Value (dBuV)	Correction Factor (dB/m)
1	*5240.00	116.3 PK			2.42 H	213	113.4	2.9
2	*5240.00	105.3 AV			2.42 H	213	102.4	2.9
3	5350.00	54.1 PK	74.0	-19.9	2.42 H	213	51.1	3.0
4	5350.00	42.2 AV	54.0	-11.8	2.42 H	213	39.2	3.0
5	5362.92	54.7 PK	74.0	-19.3	2.42 H	213	51.6	3.1
6	5362.92	43.2 AV	54.0	-10.8	2.42 H	213	40.1	3.1
7	#10480.00	47.6 PK	68.2	-20.6	1.54 H	238	34.1	13.5
8	15720.00	46.4 PK	74.0	-27.6	1.48 H	157	33.0	13.4
9	15720.00	36.4 AV	54.0	-17.6	1.48 H	157	23.0	13.4

Antenna Polarity & Test Distance : Vertical at 3 m

No	Frequency (MHz)	Emission Level (dBuV/m)	Limit (dBuV/m)	Margin (dB)	Antenna Height (m)	Table Angle (Degree)	Raw Value (dBuV)	Correction Factor (dB/m)
1	5150.00	57.9 PK	74.0	-16.1	1.74 V	23	54.9	3.0
2	5150.00	47.8 AV	54.0	-6.2	1.74 V	23	44.8	3.0
3	*5240.00	123.1 PK			1.74 V	23	120.2	2.9
4	*5240.00	113.2 AV			1.74 V	23	110.3	2.9
5	5350.00	57.5 PK	74.0	-16.5	1.74 V	23	54.5	3.0
6	5350.00	47.0 AV	54.0	-7.0	1.74 V	23	44.0	3.0
7	#10480.00	47.2 PK	68.2	-21.0	1.46 V	234	33.7	13.5
8	15720.00	46.4 PK	74.0	-27.6	1.49 V	136	33.0	13.4
9	15720.00	36.4 AV	54.0	-17.6	1.49 V	136	23.0	13.4

Remarks:

1. Emission Level(dBuV/m) = Raw Value(dBuV) + Correction Factor(dB/m)
2. Correction Factor(dB/m) = Antenna Factor(dB/m) + Cable Factor(dB) – Pre-Amplifier Factor(dB)
3. Margin value = Emission Level – Limit value
4. The other emission levels were very low against the limit.
5. " * ": Fundamental frequency.
6. " # ": The radiated frequency is out of the restricted band.

Channel	TX Channel 52	Detector Function	Peak (PK)
Frequency Range	1GHz ~ 40GHz		Average (AV)

Antenna Polarity & Test Distance : Horizontal at 3 m

No	Frequency (MHz)	Emission Level (dBuV/m)	Limit (dBuV/m)	Margin (dB)	Antenna Height (m)	Table Angle (Degree)	Raw Value (dBuV)	Correction Factor (dB/m)
1	5150.00	54.4 PK	74.0	-19.6	2.29 H	215	51.4	3.0
2	5150.00	43.0 AV	54.0	-11.0	2.29 H	215	40.0	3.0
3	*5260.00	114.0 PK			2.29 H	215	111.2	2.8
4	*5260.00	104.9 AV			2.29 H	215	102.1	2.8
5	5350.00	54.3 PK	74.0	-19.7	2.29 H	215	51.3	3.0
6	5350.00	42.4 AV	54.0	-11.6	2.29 H	215	39.4	3.0
7	#10520.00	47.5 PK	68.2	-20.7	1.46 H	229	33.9	13.6
8	15780.00	45.6 PK	74.0	-28.4	1.47 H	151	32.5	13.1
9	15780.00	35.4 AV	54.0	-18.6	1.47 H	151	22.3	13.1

Antenna Polarity & Test Distance : Vertical at 3 m

No	Frequency (MHz)	Emission Level (dBuV/m)	Limit (dBuV/m)	Margin (dB)	Antenna Height (m)	Table Angle (Degree)	Raw Value (dBuV)	Correction Factor (dB/m)
1	5150.00	59.3 PK	74.0	-14.7	1.73 V	360	56.3	3.0
2	5150.00	48.0 AV	54.0	-6.0	1.73 V	360	45.0	3.0
3	*5260.00	121.6 PK			1.73 V	360	118.8	2.8
4	*5260.00	112.7 AV			1.73 V	360	109.9	2.8
5	5350.00	60.2 PK	74.0	-13.8	1.73 V	360	57.2	3.0
6	5350.00	47.9 AV	54.0	-6.1	1.73 V	360	44.9	3.0
7	#10520.00	47.6 PK	68.2	-20.6	1.52 V	213	34.0	13.6
8	15780.00	45.3 PK	74.0	-28.7	1.46 V	157	32.2	13.1
9	15780.00	35.5 AV	54.0	-18.5	1.46 V	157	22.4	13.1

Remarks:

1. Emission Level(dBuV/m) = Raw Value(dBuV) + Correction Factor(dB/m)
2. Correction Factor(dB/m) = Antenna Factor(dB/m) + Cable Factor(dB) – Pre-Amplifier Factor(dB)
3. Margin value = Emission Level – Limit value
4. The other emission levels were very low against the limit.
5. " * ": Fundamental frequency.
6. " # ": The radiated frequency is out of the restricted band.

Channel	TX Channel 60	Detector Function	Peak (PK)
Frequency Range	1GHz ~ 40GHz		Average (AV)

Antenna Polarity & Test Distance : Horizontal at 3 m

No	Frequency (MHz)	Emission Level (dBuV/m)	Limit (dBuV/m)	Margin (dB)	Antenna Height (m)	Table Angle (Degree)	Raw Value (dBuV)	Correction Factor (dB/m)
1	*5300.00	113.6 PK			2.30 H	225	110.7	2.9
2	*5300.00	104.4 AV			2.30 H	225	101.5	2.9
3	5350.00	62.6 PK	74.0	-11.4	2.30 H	225	59.6	3.0
4	5350.00	46.9 AV	54.0	-7.1	2.30 H	225	43.9	3.0
5	10600.00	47.8 PK	74.0	-26.2	1.48 H	223	34.6	13.2
6	10600.00	37.9 AV	54.0	-16.1	1.48 H	223	24.7	13.2
7	15900.00	45.8 PK	74.0	-28.2	1.51 H	132	32.7	13.1
8	15900.00	35.9 AV	54.0	-18.1	1.51 H	132	22.8	13.1

Antenna Polarity & Test Distance : Vertical at 3 m

No	Frequency (MHz)	Emission Level (dBuV/m)	Limit (dBuV/m)	Margin (dB)	Antenna Height (m)	Table Angle (Degree)	Raw Value (dBuV)	Correction Factor (dB/m)
1	*5300.00	121.6 PK			1.79 V	345	118.7	2.9
2	*5300.00	112.8 AV			1.79 V	345	109.9	2.9
3	5350.00	70.9 PK	74.0	-3.1	1.79 V	345	67.9	3.0
4	5350.00	52.9 AV	54.0	-1.1	1.79 V	345	49.9	3.0
5	10600.00	47.6 PK	74.0	-26.4	1.44 V	216	34.4	13.2
6	10600.00	37.7 AV	54.0	-16.3	1.44 V	216	24.5	13.2
7	15900.00	46.2 PK	74.0	-27.8	1.50 V	150	33.1	13.1
8	15900.00	36.3 AV	54.0	-17.7	1.50 V	150	23.2	13.1

Remarks:

1. Emission Level(dBuV/m) = Raw Value(dBuV) + Correction Factor(dB/m)
2. Correction Factor(dB/m) = Antenna Factor(dB/m) + Cable Factor(dB) – Pre-Amplifier Factor(dB)
3. Margin value = Emission Level – Limit value
4. The other emission levels were very low against the limit.
5. " * ": Fundamental frequency.

Channel	TX Channel 64	Detector Function	Peak (PK)
Frequency Range	1GHz ~ 40GHz		Average (AV)

Antenna Polarity & Test Distance : Horizontal at 3 m

No	Frequency (MHz)	Emission Level (dBuV/m)	Limit (dBuV/m)	Margin (dB)	Antenna Height (m)	Table Angle (Degree)	Raw Value (dBuV)	Correction Factor (dB/m)
1	*5320.00	114.8 PK			2.27 H	221	111.9	2.9
2	*5320.00	104.6 AV			2.27 H	221	101.7	2.9
3	5352.14	64.5 PK	74.0	-9.5	2.27 H	221	61.5	3.0
4	5352.14	47.6 AV	54.0	-6.4	2.27 H	221	44.6	3.0
5	10640.00	48.2 PK	74.0	-25.8	1.49 H	235	34.9	13.3
6	10640.00	37.8 AV	54.0	-16.2	1.49 H	235	24.5	13.3
7	15960.00	45.2 PK	74.0	-28.8	1.45 H	148	31.8	13.4
8	15960.00	35.5 AV	54.0	-18.5	1.45 H	148	22.1	13.4

Antenna Polarity & Test Distance : Vertical at 3 m

No	Frequency (MHz)	Emission Level (dBuV/m)	Limit (dBuV/m)	Margin (dB)	Antenna Height (m)	Table Angle (Degree)	Raw Value (dBuV)	Correction Factor (dB/m)
1	*5320.00	121.4 PK			1.62 V	22	118.5	2.9
2	*5320.00	111.8 AV			1.62 V	22	108.9	2.9
3	5352.14	72.4 PK	74.0	-1.6	1.62 V	22	69.4	3.0
4	5352.14	53.6 AV	54.0	-0.4	1.62 V	22	50.6	3.0
5	10640.00	48.0 PK	74.0	-26.0	1.49 V	223	34.7	13.3
6	10640.00	37.8 AV	54.0	-16.2	1.49 V	223	24.5	13.3
7	15960.00	46.1 PK	74.0	-27.9	1.45 V	148	32.7	13.4
8	15960.00	36.0 AV	54.0	-18.0	1.45 V	148	22.6	13.4

Remarks:

1. Emission Level(dBuV/m) = Raw Value(dBuV) + Correction Factor(dB/m)
2. Correction Factor(dB/m) = Antenna Factor(dB/m) + Cable Factor(dB) – Pre-Amplifier Factor(dB)
3. Margin value = Emission Level – Limit value
4. The other emission levels were very low against the limit.
5. " * ": Fundamental frequency.

Channel	TX Channel 100	Detector Function	Peak (PK)
Frequency Range	1GHz ~ 40GHz		Average (AV)

Antenna Polarity & Test Distance : Horizontal at 3 m

No	Frequency (MHz)	Emission Level (dBuV/m)	Limit (dBuV/m)	Margin (dB)	Antenna Height (m)	Table Angle (Degree)	Raw Value (dBuV)	Correction Factor (dB/m)
1	5460.00	54.2 PK	74.0	-19.8	2.44 H	329	51.0	3.2
2	5460.00	41.5 AV	54.0	-12.5	2.44 H	329	38.3	3.2
3	#5470.00	60.1 PK	68.2	-8.1	2.44 H	329	56.9	3.2
4	*5500.00	110.8 PK			2.44 H	329	107.5	3.3
5	*5500.00	100.6 AV			2.44 H	329	97.3	3.3
6	11000.00	47.8 PK	74.0	-26.2	1.51 H	242	33.8	14.0
7	11000.00	37.7 AV	54.0	-16.3	1.51 H	242	23.7	14.0
8	#16500.00	46.2 PK	68.2	-22.0	1.46 H	158	30.7	15.5

Antenna Polarity & Test Distance : Vertical at 3 m

No	Frequency (MHz)	Emission Level (dBuV/m)	Limit (dBuV/m)	Margin (dB)	Antenna Height (m)	Table Angle (Degree)	Raw Value (dBuV)	Correction Factor (dB/m)
1	5460.00	62.2 PK	74.0	-11.8	1.80 V	340	59.0	3.2
2	5460.00	48.0 AV	54.0	-6.0	1.80 V	340	44.8	3.2
3	#5470.00	67.7 PK	68.2	-0.5	1.80 V	340	64.5	3.2
4	*5500.00	118.9 PK			1.80 V	340	115.6	3.3
5	*5500.00	108.9 AV			1.80 V	340	105.6	3.3
6	11000.00	47.3 PK	74.0	-26.7	1.54 V	239	33.3	14.0
7	11000.00	37.1 AV	54.0	-16.9	1.54 V	239	23.1	14.0
8	#16500.00	46.4 PK	68.2	-21.8	1.49 V	134	30.9	15.5

Remarks:

1. Emission Level(dBuV/m) = Raw Value(dBuV) + Correction Factor(dB/m)
2. Correction Factor(dB/m) = Antenna Factor(dB/m) + Cable Factor(dB) – Pre-Amplifier Factor(dB)
3. Margin value = Emission Level – Limit value
4. The other emission levels were very low against the limit.
5. " * ": Fundamental frequency.
6. " # ": The radiated frequency is out of the restricted band.

Channel	TX Channel 116	Detector Function	Peak (PK)
Frequency Range	1GHz ~ 40GHz		Average (AV)

Antenna Polarity & Test Distance : Horizontal at 3 m

No	Frequency (MHz)	Emission Level (dBuV/m)	Limit (dBuV/m)	Margin (dB)	Antenna Height (m)	Table Angle (Degree)	Raw Value (dBuV)	Correction Factor (dB/m)
1	*5580.00	113.7 PK			2.27 H	223	110.4	3.3
2	*5580.00	104.3 AV			2.27 H	223	101.0	3.3
3	11160.00	47.4 PK	74.0	-26.6	1.45 H	216	34.0	13.4
4	11160.00	37.2 AV	54.0	-16.8	1.45 H	216	23.8	13.4
5	#16740.00	45.8 PK	68.2	-22.4	1.47 H	142	29.2	16.6

Antenna Polarity & Test Distance : Vertical at 3 m

No	Frequency (MHz)	Emission Level (dBuV/m)	Limit (dBuV/m)	Margin (dB)	Antenna Height (m)	Table Angle (Degree)	Raw Value (dBuV)	Correction Factor (dB/m)
1	*5580.00	121.7 PK			1.78 V	359	118.4	3.3
2	*5580.00	112.7 AV			1.78 V	359	109.4	3.3
3	11160.00	47.9 PK	74.0	-26.1	1.50 V	232	34.5	13.4
4	11160.00	37.6 AV	54.0	-16.4	1.50 V	232	24.2	13.4
5	#16740.00	45.4 PK	68.2	-22.8	1.52 V	146	28.8	16.6

Remarks:

1. Emission Level(dBuV/m) = Raw Value(dBuV) + Correction Factor(dB/m)
2. Correction Factor(dB/m) = Antenna Factor(dB/m) + Cable Factor(dB) – Pre-Amplifier Factor(dB)
3. Margin value = Emission Level – Limit value
4. The other emission levels were very low against the limit.
5. " * ": Fundamental frequency.
6. " # ": The radiated frequency is out of the restricted band.

Channel	TX Channel 140	Detector Function	Peak (PK)
Frequency Range	1GHz ~ 40GHz		Average (AV)

Antenna Polarity & Test Distance : Horizontal at 3 m

No	Frequency (MHz)	Emission Level (dBuV/m)	Limit (dBuV/m)	Margin (dB)	Antenna Height (m)	Table Angle (Degree)	Raw Value (dBuV)	Correction Factor (dB/m)
1	*5700.00	110.6 PK			2.41 H	330	106.8	3.8
2	*5700.00	100.4 AV			2.41 H	330	96.6	3.8
3	#5725.77	59.2 PK	68.2	-9.0	2.41 H	330	55.4	3.8
4	11400.00	47.6 PK	74.0	-26.4	1.55 H	214	33.4	14.2
5	11400.00	37.7 AV	54.0	-16.3	1.55 H	214	23.5	14.2
6	#17100.00	46.0 PK	68.2	-22.2	1.49 H	138	28.5	17.5

Antenna Polarity & Test Distance : Vertical at 3 m

No	Frequency (MHz)	Emission Level (dBuV/m)	Limit (dBuV/m)	Margin (dB)	Antenna Height (m)	Table Angle (Degree)	Raw Value (dBuV)	Correction Factor (dB/m)
1	*5700.00	117.8 PK			1.50 V	350	114.0	3.8
2	*5700.00	108.1 AV			1.50 V	350	104.3	3.8
3	#5725.77	66.6 PK	68.2	-1.6	1.50 V	350	62.8	3.8
4	11400.00	47.3 PK	74.0	-26.7	1.45 V	233	33.1	14.2
5	11400.00	37.3 AV	54.0	-16.7	1.45 V	233	23.1	14.2
6	#17100.00	46.1 PK	68.2	-22.1	1.52 V	159	28.6	17.5

Remarks:

1. Emission Level(dBuV/m) = Raw Value(dBuV) + Correction Factor(dB/m)
2. Correction Factor(dB/m) = Antenna Factor(dB/m) + Cable Factor(dB) – Pre-Amplifier Factor(dB)
3. Margin value = Emission Level – Limit value
4. The other emission levels were very low against the limit.
5. " * ": Fundamental frequency.
6. " # ": The radiated frequency is out of the restricted band.

Channel	TX Channel 144	Detector Function	Peak (PK)
Frequency Range	1GHz ~ 40GHz		Average (AV)

Antenna Polarity & Test Distance : Horizontal at 3 m

No	Frequency (MHz)	Emission Level (dBuV/m)	Limit (dBuV/m)	Margin (dB)	Antenna Height (m)	Table Angle (Degree)	Raw Value (dBuV)	Correction Factor (dB/m)
1	5460.00	53.7 PK	74.0	-20.3	2.25 H	216	50.5	3.2
2	5460.00	41.3 AV	54.0	-12.7	2.25 H	216	38.1	3.2
3	#5470.00	56.1 PK	68.2	-12.1	2.25 H	216	52.9	3.2
4	*5720.00	114.0 PK			2.25 H	216	110.2	3.8
5	*5720.00	104.4 AV			2.25 H	216	100.6	3.8
6	#5850.00	57.0 PK	68.2	-11.2	2.25 H	216	52.8	4.2
7	11440.00	47.9 PK	74.0	-26.1	1.56 H	211	33.8	14.1
8	11440.00	37.5 AV	54.0	-16.5	1.56 H	211	23.4	14.1
9	#17160.00	45.7 PK	68.2	-22.5	1.53 H	134	28.7	17.0

Antenna Polarity & Test Distance : Vertical at 3 m

No	Frequency (MHz)	Emission Level (dBuV/m)	Limit (dBuV/m)	Margin (dB)	Antenna Height (m)	Table Angle (Degree)	Raw Value (dBuV)	Correction Factor (dB/m)
1	5460.00	56.8 PK	74.0	-17.2	1.50 V	324	53.6	3.2
2	5460.00	44.5 AV	54.0	-9.5	1.50 V	324	41.3	3.2
3	#5470.00	58.2 PK	68.2	-10.0	1.50 V	324	55.0	3.2
4	*5720.00	122.3 PK			1.50 V	324	118.5	3.8
5	*5720.00	112.5 AV			1.50 V	324	108.7	3.8
6	#5850.00	59.0 PK	68.2	-9.2	1.50 V	324	54.8	4.2
7	11440.00	47.9 PK	74.0	-26.1	1.45 V	227	33.8	14.1
8	11440.00	37.6 AV	54.0	-16.4	1.45 V	227	23.5	14.1
9	#17160.00	46.0 PK	68.2	-22.2	1.53 V	135	29.0	17.0

Remarks:

1. Emission Level(dBuV/m) = Raw Value(dBuV) + Correction Factor(dB/m)
2. Correction Factor(dB/m) = Antenna Factor(dB/m) + Cable Factor(dB) – Pre-Amplifier Factor(dB)
3. Margin value = Emission Level – Limit value
4. The other emission levels were very low against the limit.
5. " * ": Fundamental frequency.
6. " # ": The radiated frequency is out of the restricted band.

Channel	TX Channel 149	Detector Function	Peak (PK)
Frequency Range	1GHz ~ 40GHz		Average (AV)

Antenna Polarity & Test Distance : Horizontal at 3 m

No	Frequency (MHz)	Emission Level (dBuV/m)	Limit (dBuV/m)	Margin (dB)	Antenna Height (m)	Table Angle (Degree)	Raw Value (dBuV)	Correction Factor (dB/m)
1	*5745.00	118.3 PK			1.10 H	43	114.5	3.8
2	*5745.00	108.8 AV			1.10 H	43	105.0	3.8
3	11490.00	47.7 PK	74.0	-26.3	1.46 H	212	33.7	14.0
4	11490.00	37.4 AV	54.0	-16.6	1.46 H	212	23.4	14.0
5	#17235.00	45.6 PK	68.2	-22.6	1.52 H	131	29.1	16.5

Antenna Polarity & Test Distance : Vertical at 3 m

No	Frequency (MHz)	Emission Level (dBuV/m)	Limit (dBuV/m)	Margin (dB)	Antenna Height (m)	Table Angle (Degree)	Raw Value (dBuV)	Correction Factor (dB/m)
1	*5745.00	125.1 PK			1.50 V	349	121.3	3.8
2	*5745.00	115.3 AV			1.50 V	349	111.5	3.8
3	11490.00	47.4 PK	74.0	-26.6	1.54 V	222	33.4	14.0
4	11490.00	37.5 AV	54.0	-16.5	1.54 V	222	23.5	14.0
5	#17235.00	45.0 PK	68.2	-23.2	1.55 V	138	28.5	16.5

Remarks:

1. Emission Level(dBuV/m) = Raw Value(dBuV) + Correction Factor(dB/m)
2. Correction Factor(dB/m) = Antenna Factor(dB/m) + Cable Factor(dB) – Pre-Amplifier Factor(dB)
3. Margin value = Emission Level – Limit value
4. The other emission levels were very low against the limit.
5. " * ": Fundamental frequency.
6. " # ": The radiated frequency is out of the restricted band.

Channel	TX Channel 157	Detector Function	Peak (PK)
Frequency Range	1GHz ~ 40GHz		Average (AV)

Antenna Polarity & Test Distance : Horizontal at 3 m

No	Frequency (MHz)	Emission Level (dBuV/m)	Limit (dBuV/m)	Margin (dB)	Antenna Height (m)	Table Angle (Degree)	Raw Value (dBuV)	Correction Factor (dB/m)
1	*5785.00	118.2 PK			1.09 H	45	114.3	3.9
2	*5785.00	108.6 AV			1.09 H	45	104.7	3.9
3	11570.00	47.4 PK	74.0	-26.6	1.48 H	216	33.8	13.6
4	11570.00	37.2 AV	54.0	-16.8	1.48 H	216	23.6	13.6
5	#17355.00	45.5 PK	68.2	-22.7	1.47 H	146	28.5	17.0

Antenna Polarity & Test Distance : Vertical at 3 m

No	Frequency (MHz)	Emission Level (dBuV/m)	Limit (dBuV/m)	Margin (dB)	Antenna Height (m)	Table Angle (Degree)	Raw Value (dBuV)	Correction Factor (dB/m)
1	*5785.00	125.4 PK			1.51 V	351	121.5	3.9
2	*5785.00	115.6 AV			1.51 V	351	111.7	3.9
3	11570.00	47.1 PK	74.0	-26.9	1.50 V	239	33.5	13.6
4	11570.00	37.0 AV	54.0	-17.0	1.50 V	239	23.4	13.6
5	#17355.00	45.9 PK	68.2	-22.3	1.51 V	138	28.9	17.0

Remarks:

1. Emission Level(dBuV/m) = Raw Value(dBuV) + Correction Factor(dB/m)
2. Correction Factor(dB/m) = Antenna Factor(dB/m) + Cable Factor(dB) – Pre-Amplifier Factor(dB)
3. Margin value = Emission Level – Limit value
4. The other emission levels were very low against the limit.
5. " * ": Fundamental frequency.
6. " # ": The radiated frequency is out of the restricted band.

Channel	TX Channel 165	Detector Function	Peak (PK)
Frequency Range	1GHz ~ 40GHz		Average (AV)

Antenna Polarity & Test Distance : Horizontal at 3 m

No	Frequency (MHz)	Emission Level (dBuV/m)	Limit (dBuV/m)	Margin (dB)	Antenna Height (m)	Table Angle (Degree)	Raw Value (dBuV)	Correction Factor (dB/m)
1	*5825.00	118.0 PK			1.08 H	44	113.9	4.1
2	*5825.00	108.5 AV			1.08 H	44	104.4	4.1
3	11650.00	47.6 PK	74.0	-26.4	1.56 H	230	34.1	13.5
4	11650.00	37.3 AV	54.0	-16.7	1.56 H	230	23.8	13.5
5	#17475.00	45.4 PK	68.2	-22.8	1.48 H	131	26.8	18.6

Antenna Polarity & Test Distance : Vertical at 3 m

No	Frequency (MHz)	Emission Level (dBuV/m)	Limit (dBuV/m)	Margin (dB)	Antenna Height (m)	Table Angle (Degree)	Raw Value (dBuV)	Correction Factor (dB/m)
1	*5825.00	125.2 PK			1.52 V	358	121.1	4.1
2	*5825.00	115.4 AV			1.52 V	358	111.3	4.1
3	11650.00	47.6 PK	74.0	-26.4	1.50 V	217	34.1	13.5
4	11650.00	37.6 AV	54.0	-16.4	1.50 V	217	24.1	13.5
5	#17475.00	45.9 PK	68.2	-22.3	1.51 V	141	27.3	18.6

Remarks:

1. Emission Level(dBuV/m) = Raw Value(dBuV) + Correction Factor(dB/m)
2. Correction Factor(dB/m) = Antenna Factor(dB/m) + Cable Factor(dB) – Pre-Amplifier Factor(dB)
3. Margin value = Emission Level – Limit value
4. The other emission levels were very low against the limit.
5. " * ": Fundamental frequency.
6. " # ": The radiated frequency is out of the restricted band.

802.11ax (HE20)

Channel	TX Channel 36	Detector Function	Peak (PK)
Frequency Range	1GHz ~ 40GHz		Average (AV)

Antenna Polarity & Test Distance : Horizontal at 3 m

No	Frequency (MHz)	Emission Level (dBuV/m)	Limit (dBuV/m)	Margin (dB)	Antenna Height (m)	Table Angle (Degree)	Raw Value (dBuV)	Correction Factor (dB/m)
1	5150.00	64.3 PK	74.0	-9.7	2.90 H	209	61.3	3.0
2	5150.00	46.6 AV	54.0	-7.4	2.90 H	209	43.6	3.0
3	*5180.00	112.2 PK			2.90 H	209	109.2	3.0
4	*5180.00	101.3 AV			2.90 H	209	98.3	3.0
5	#10360.00	47.7 PK	68.2	-20.5	1.46 H	216	34.5	13.2
6	15540.00	45.8 PK	74.0	-28.2	1.56 H	147	32.2	13.6
7	15540.00	36.2 AV	54.0	-17.8	1.56 H	147	22.6	13.6

Antenna Polarity & Test Distance : Vertical at 3 m

No	Frequency (MHz)	Emission Level (dBuV/m)	Limit (dBuV/m)	Margin (dB)	Antenna Height (m)	Table Angle (Degree)	Raw Value (dBuV)	Correction Factor (dB/m)
1	5150.00	66.8 PK	74.0	-7.2	1.80 V	357	63.8	3.0
2	5150.00	53.7 AV	54.0	-0.3	1.80 V	357	50.7	3.0
3	*5180.00	120.7 PK			1.80 V	357	117.7	3.0
4	*5180.00	109.4 AV			1.80 V	357	106.4	3.0
5	#10360.00	47.4 PK	68.2	-20.8	1.52 V	206	34.2	13.2
6	15540.00	45.4 PK	74.0	-28.6	1.47 V	127	31.8	13.6
7	15540.00	35.7 AV	54.0	-18.3	1.47 V	127	22.1	13.6

Remarks:

1. Emission Level(dBuV/m) = Raw Value(dBuV) + Correction Factor(dB/m)
2. Correction Factor(dB/m) = Antenna Factor(dB/m) + Cable Factor(dB) – Pre-Amplifier Factor(dB)
3. Margin value = Emission Level – Limit value
4. The other emission levels were very low against the limit.
5. " * ": Fundamental frequency.
6. " # ": The radiated frequency is out of the restricted band.

Channel	TX Channel 40	Detector Function	Peak (PK)
Frequency Range	1GHz ~ 40GHz		Average (AV)

Antenna Polarity & Test Distance : Horizontal at 3 m

No	Frequency (MHz)	Emission Level (dBuV/m)	Limit (dBuV/m)	Margin (dB)	Antenna Height (m)	Table Angle (Degree)	Raw Value (dBuV)	Correction Factor (dB/m)
1	5150.00	64.7 PK	74.0	-9.3	2.79 H	210	61.7	3.0
2	5150.00	48.5 AV	54.0	-5.5	2.79 H	210	45.5	3.0
3	*5200.00	118.0 PK			2.79 H	210	115.1	2.9
4	*5200.00	108.7 AV			2.79 H	210	105.8	2.9
5	#10400.00	47.8 PK	68.2	-20.4	1.47 H	207	34.5	13.3
6	15600.00	46.4 PK	74.0	-27.6	1.51 H	134	32.5	13.9
7	15600.00	36.4 AV	54.0	-17.6	1.51 H	134	22.5	13.9

Antenna Polarity & Test Distance : Vertical at 3 m

No	Frequency (MHz)	Emission Level (dBuV/m)	Limit (dBuV/m)	Margin (dB)	Antenna Height (m)	Table Angle (Degree)	Raw Value (dBuV)	Correction Factor (dB/m)
1	5150.00	69.5 PK	74.0	-4.5	1.82 V	3	66.5	3.0
2	5150.00	53.3 AV	54.0	-0.7	1.82 V	3	50.3	3.0
3	*5200.00	123.8 PK			1.82 V	3	120.9	2.9
4	*5200.00	113.6 AV			1.82 V	3	110.7	2.9
5	#10400.00	47.5 PK	68.2	-20.7	1.49 V	214	34.2	13.3
6	15600.00	45.5 PK	74.0	-28.5	1.51 V	142	31.6	13.9
7	15600.00	35.8 AV	54.0	-18.2	1.51 V	142	21.9	13.9

Remarks:

1. Emission Level(dBuV/m) = Raw Value(dBuV) + Correction Factor(dB/m)
2. Correction Factor(dB/m) = Antenna Factor(dB/m) + Cable Factor(dB) – Pre-Amplifier Factor(dB)
3. Margin value = Emission Level – Limit value
4. The other emission levels were very low against the limit.
5. " * ": Fundamental frequency.
6. " # ": The radiated frequency is out of the restricted band.

Channel	TX Channel 48	Detector Function	Peak (PK)
Frequency Range	1GHz ~ 40GHz		Average (AV)

Antenna Polarity & Test Distance : Horizontal at 3 m

No	Frequency (MHz)	Emission Level (dBuV/m)	Limit (dBuV/m)	Margin (dB)	Antenna Height (m)	Table Angle (Degree)	Raw Value (dBuV)	Correction Factor (dB/m)
1	5150.00	52.6 PK	74.0	-21.4	2.56 H	209	49.6	3.0
2	5150.00	41.6 AV	54.0	-12.4	2.56 H	209	38.6	3.0
3	*5240.00	114.0 PK			2.56 H	209	111.1	2.9
4	*5240.00	104.1 AV			2.56 H	209	101.2	2.9
5	5350.00	52.0 PK	74.0	-22.0	2.56 H	209	49.0	3.0
6	5350.00	40.2 AV	54.0	-13.8	2.56 H	209	37.2	3.0
7	#10480.00	47.6 PK	68.2	-20.6	1.47 H	221	34.1	13.5
8	15720.00	45.2 PK	74.0	-28.8	1.47 H	138	31.8	13.4
9	15720.00	35.7 AV	54.0	-18.3	1.47 H	138	22.3	13.4

Antenna Polarity & Test Distance : Vertical at 3 m

No	Frequency (MHz)	Emission Level (dBuV/m)	Limit (dBuV/m)	Margin (dB)	Antenna Height (m)	Table Angle (Degree)	Raw Value (dBuV)	Correction Factor (dB/m)
1	5150.00	57.8 PK	74.0	-16.2	1.81 V	15	54.8	3.0
2	5150.00	46.2 AV	54.0	-7.8	1.81 V	15	43.2	3.0
3	*5240.00	122.3 PK			1.81 V	15	119.4	2.9
4	*5240.00	110.8 AV			1.81 V	15	107.9	2.9
5	5350.00	56.9 PK	74.0	-17.1	1.81 V	15	53.9	3.0
6	5350.00	45.9 AV	54.0	-8.1	1.81 V	15	42.9	3.0
7	#10480.00	47.8 PK	68.2	-20.4	1.47 V	229	34.3	13.5
8	15720.00	46.2 PK	74.0	-27.8	1.54 V	142	32.8	13.4
9	15720.00	36.3 AV	54.0	-17.7	1.54 V	142	22.9	13.4

Remarks:

1. Emission Level(dBuV/m) = Raw Value(dBuV) + Correction Factor(dB/m)
2. Correction Factor(dB/m) = Antenna Factor(dB/m) + Cable Factor(dB) – Pre-Amplifier Factor(dB)
3. Margin value = Emission Level – Limit value
4. The other emission levels were very low against the limit.
5. " * ": Fundamental frequency.
6. " # ": The radiated frequency is out of the restricted band.

Channel	TX Channel 52	Detector Function	Peak (PK)
Frequency Range	1GHz ~ 40GHz		Average (AV)

Antenna Polarity & Test Distance : Horizontal at 3 m

No	Frequency (MHz)	Emission Level (dBuV/m)	Limit (dBuV/m)	Margin (dB)	Antenna Height (m)	Table Angle (Degree)	Raw Value (dBuV)	Correction Factor (dB/m)
1	5150.00	54.8 PK	74.0	-19.2	2.56 H	201	51.8	3.0
2	5150.00	43.2 AV	54.0	-10.8	2.56 H	201	40.2	3.0
3	*5260.00	113.8 PK			2.56 H	201	111.0	2.8
4	*5260.00	104.4 AV			2.56 H	201	101.6	2.8
5	5350.00	54.5 PK	74.0	-19.5	2.56 H	201	51.5	3.0
6	5350.00	42.9 AV	54.0	-11.1	2.56 H	201	39.9	3.0
7	#10520.00	47.8 PK	68.2	-20.4	1.52 H	220	34.2	13.6
8	15780.00	46.2 PK	74.0	-27.8	1.49 H	149	33.1	13.1
9	15780.00	36.6 AV	54.0	-17.4	1.49 H	149	23.5	13.1

Antenna Polarity & Test Distance : Vertical at 3 m

No	Frequency (MHz)	Emission Level (dBuV/m)	Limit (dBuV/m)	Margin (dB)	Antenna Height (m)	Table Angle (Degree)	Raw Value (dBuV)	Correction Factor (dB/m)
1	5150.00	59.0 PK	74.0	-15.0	1.66 V	23	56.0	3.0
2	5150.00	47.6 AV	54.0	-6.4	1.66 V	23	44.6	3.0
3	*5260.00	124.6 PK			1.66 V	23	121.8	2.8
4	*5260.00	113.8 AV			1.66 V	23	111.0	2.8
5	5350.00	59.7 PK	74.0	-14.3	1.66 V	23	56.7	3.0
6	5350.00	47.7 AV	54.0	-6.3	1.66 V	23	44.7	3.0
7	#10520.00	47.0 PK	68.2	-21.2	1.56 V	203	33.4	13.6
8	15780.00	45.6 PK	74.0	-28.4	1.49 V	127	32.5	13.1
9	15780.00	36.1 AV	54.0	-17.9	1.49 V	127	23.0	13.1

Remarks:

1. Emission Level(dBuV/m) = Raw Value(dBuV) + Correction Factor(dB/m)
2. Correction Factor(dB/m) = Antenna Factor(dB/m) + Cable Factor(dB) – Pre-Amplifier Factor(dB)
3. Margin value = Emission Level – Limit value
4. The other emission levels were very low against the limit.
5. " * ": Fundamental frequency.
6. " # ": The radiated frequency is out of the restricted band.

Channel	TX Channel 60	Detector Function	Peak (PK)
Frequency Range	1GHz ~ 40GHz		Average (AV)

Antenna Polarity & Test Distance : Horizontal at 3 m

No	Frequency (MHz)	Emission Level (dBuV/m)	Limit (dBuV/m)	Margin (dB)	Antenna Height (m)	Table Angle (Degree)	Raw Value (dBuV)	Correction Factor (dB/m)
1	*5300.00	113.5 PK			2.61 H	201	110.6	2.9
2	*5300.00	104.1 AV			2.61 H	201	101.2	2.9
3	5350.00	66.5 PK	74.0	-7.5	2.61 H	201	63.5	3.0
4	5350.00	47.5 AV	54.0	-6.5	2.61 H	201	44.5	3.0
5	10600.00	47.8 PK	74.0	-26.2	1.49 H	232	34.6	13.2
6	10600.00	37.8 AV	54.0	-16.2	1.49 H	232	24.6	13.2
7	15900.00	46.3 PK	74.0	-27.7	1.48 H	150	33.2	13.1
8	15900.00	36.4 AV	54.0	-17.6	1.48 H	150	23.3	13.1

Antenna Polarity & Test Distance : Vertical at 3 m

No	Frequency (MHz)	Emission Level (dBuV/m)	Limit (dBuV/m)	Margin (dB)	Antenna Height (m)	Table Angle (Degree)	Raw Value (dBuV)	Correction Factor (dB/m)
1	*5300.00	124.1 PK			1.79 V	16	121.2	2.9
2	*5300.00	113.5 AV			1.79 V	16	110.6	2.9
3	5350.00	67.9 PK	74.0	-6.1	1.79 V	16	64.9	3.0
4	5350.00	53.8 AV	54.0	-0.2	1.79 V	16	50.8	3.0
5	10600.00	47.4 PK	74.0	-26.6	1.52 V	219	34.2	13.2
6	10600.00	37.3 AV	54.0	-16.7	1.52 V	219	24.1	13.2
7	15900.00	46.0 PK	74.0	-28.0	1.52 V	130	32.9	13.1
8	15900.00	36.6 AV	54.0	-17.4	1.52 V	130	23.5	13.1

Remarks:

1. Emission Level(dBuV/m) = Raw Value(dBuV) + Correction Factor(dB/m)
2. Correction Factor(dB/m) = Antenna Factor(dB/m) + Cable Factor(dB) – Pre-Amplifier Factor(dB)
3. Margin value = Emission Level – Limit value
4. The other emission levels were very low against the limit.
5. " * ": Fundamental frequency.

Channel	TX Channel 64	Detector Function	Peak (PK)
Frequency Range	1GHz ~ 40GHz		Average (AV)

Antenna Polarity & Test Distance : Horizontal at 3 m

No	Frequency (MHz)	Emission Level (dBuV/m)	Limit (dBuV/m)	Margin (dB)	Antenna Height (m)	Table Angle (Degree)	Raw Value (dBuV)	Correction Factor (dB/m)
1	*5320.00	113.7 PK			2.24 H	220	110.8	2.9
2	*5320.00	103.6 AV			2.24 H	220	100.7	2.9
3	5350.00	66.8 PK	74.0	-7.2	2.24 H	220	63.8	3.0
4	5350.00	47.4 AV	54.0	-6.6	2.24 H	220	44.4	3.0
5	10640.00	46.9 PK	74.0	-27.1	1.44 H	223	33.6	13.3
6	10640.00	37.2 AV	54.0	-16.8	1.44 H	223	23.9	13.3
7	15960.00	46.4 PK	74.0	-27.6	1.55 H	146	33.0	13.4
8	15960.00	36.5 AV	54.0	-17.5	1.55 H	146	23.1	13.4

Antenna Polarity & Test Distance : Vertical at 3 m

No	Frequency (MHz)	Emission Level (dBuV/m)	Limit (dBuV/m)	Margin (dB)	Antenna Height (m)	Table Angle (Degree)	Raw Value (dBuV)	Correction Factor (dB/m)
1	*5320.00	122.0 PK			1.68 V	20	119.1	2.9
2	*5320.00	110.3 AV			1.68 V	20	107.4	2.9
3	5350.00	68.4 PK	74.0	-5.6	1.68 V	20	65.4	3.0
4	5350.00	53.7 AV	54.0	-0.3	1.68 V	20	50.7	3.0
5	10640.00	47.4 PK	74.0	-26.6	1.51 V	210	34.1	13.3
6	10640.00	37.4 AV	54.0	-16.6	1.51 V	210	24.1	13.3
7	15960.00	45.8 PK	74.0	-28.2	1.56 V	140	32.4	13.4
8	15960.00	36.4 AV	54.0	-17.6	1.56 V	140	23.0	13.4

Remarks:

1. Emission Level(dBuV/m) = Raw Value(dBuV) + Correction Factor(dB/m)
2. Correction Factor(dB/m) = Antenna Factor(dB/m) + Cable Factor(dB) – Pre-Amplifier Factor(dB)
3. Margin value = Emission Level – Limit value
4. The other emission levels were very low against the limit.
5. " * ": Fundamental frequency.

Channel	TX Channel 100	Detector Function	Peak (PK)
Frequency Range	1GHz ~ 40GHz		Average (AV)

Antenna Polarity & Test Distance : Horizontal at 3 m

No	Frequency (MHz)	Emission Level (dBuV/m)	Limit (dBuV/m)	Margin (dB)	Antenna Height (m)	Table Angle (Degree)	Raw Value (dBuV)	Correction Factor (dB/m)
1	5460.00	55.3 PK	74.0	-18.7	2.44 H	330	52.1	3.2
2	5460.00	41.0 AV	54.0	-13.0	2.44 H	330	37.8	3.2
3	#5470.00	58.0 PK	68.2	-10.2	2.44 H	330	54.8	3.2
4	*5500.00	108.7 PK			2.44 H	330	105.4	3.3
5	*5500.00	98.6 AV			2.44 H	330	95.3	3.3
6	11000.00	48.0 PK	74.0	-26.0	1.55 H	214	34.0	14.0
7	11000.00	37.8 AV	54.0	-16.2	1.55 H	214	23.8	14.0
8	#16500.00	46.5 PK	68.2	-21.7	1.47 H	141	31.0	15.5

Antenna Polarity & Test Distance : Vertical at 3 m

No	Frequency (MHz)	Emission Level (dBuV/m)	Limit (dBuV/m)	Margin (dB)	Antenna Height (m)	Table Angle (Degree)	Raw Value (dBuV)	Correction Factor (dB/m)
1	5460.00	63.7 PK	74.0	-10.3	1.68 V	7	60.5	3.2
2	5460.00	46.3 AV	54.0	-7.7	1.68 V	7	43.1	3.2
3	#5470.00	67.0 PK	68.2	-1.2	1.68 V	7	63.8	3.2
4	*5500.00	117.6 PK			1.68 V	7	114.3	3.3
5	*5500.00	106.4 AV			1.68 V	7	103.1	3.3
6	11000.00	47.3 PK	74.0	-26.7	1.46 V	221	33.3	14.0
7	11000.00	37.4 AV	54.0	-16.6	1.46 V	221	23.4	14.0
8	#16500.00	45.8 PK	68.2	-22.4	1.57 V	156	30.3	15.5

Remarks:

1. Emission Level(dBuV/m) = Raw Value(dBuV) + Correction Factor(dB/m)
2. Correction Factor(dB/m) = Antenna Factor(dB/m) + Cable Factor(dB) – Pre-Amplifier Factor(dB)
3. Margin value = Emission Level – Limit value
4. The other emission levels were very low against the limit.
5. " * ": Fundamental frequency.
6. " # ": The radiated frequency is out of the restricted band.

Channel	TX Channel 116	Detector Function	Peak (PK)
Frequency Range	1GHz ~ 40GHz		Average (AV)

Antenna Polarity & Test Distance : Horizontal at 3 m

No	Frequency (MHz)	Emission Level (dBuV/m)	Limit (dBuV/m)	Margin (dB)	Antenna Height (m)	Table Angle (Degree)	Raw Value (dBuV)	Correction Factor (dB/m)
1	*5580.00	114.1 PK			2.32 H	230	110.8	3.3
2	*5580.00	104.5 AV			2.32 H	230	101.2	3.3
3	11160.00	47.2 PK	74.0	-26.8	1.53 H	226	33.8	13.4
4	11160.00	37.1 AV	54.0	-16.9	1.53 H	226	23.7	13.4
5	#16740.00	45.6 PK	68.2	-22.6	1.51 H	138	29.0	16.6

Antenna Polarity & Test Distance : Vertical at 3 m

No	Frequency (MHz)	Emission Level (dBuV/m)	Limit (dBuV/m)	Margin (dB)	Antenna Height (m)	Table Angle (Degree)	Raw Value (dBuV)	Correction Factor (dB/m)
1	*5580.00	124.2 PK			1.63 V	24	120.9	3.3
2	*5580.00	113.5 AV			1.63 V	24	110.2	3.3
3	11160.00	47.6 PK	74.0	-26.4	1.55 V	202	34.2	13.4
4	11160.00	37.6 AV	54.0	-16.4	1.55 V	202	24.2	13.4
5	#16740.00	45.7 PK	68.2	-22.5	1.50 V	128	29.1	16.6

Remarks:

1. Emission Level(dBuV/m) = Raw Value(dBuV) + Correction Factor(dB/m)
2. Correction Factor(dB/m) = Antenna Factor(dB/m) + Cable Factor(dB) – Pre-Amplifier Factor(dB)
3. Margin value = Emission Level – Limit value
4. The other emission levels were very low against the limit.
5. " * ": Fundamental frequency.
6. " # ": The radiated frequency is out of the restricted band.

Channel	TX Channel 140	Detector Function	Peak (PK)
Frequency Range	1GHz ~ 40GHz		Average (AV)

Antenna Polarity & Test Distance : Horizontal at 3 m

No	Frequency (MHz)	Emission Level (dBuV/m)	Limit (dBuV/m)	Margin (dB)	Antenna Height (m)	Table Angle (Degree)	Raw Value (dBuV)	Correction Factor (dB/m)
1	*5700.00	110.7 PK			2.38 H	339	106.9	3.8
2	*5700.00	100.3 AV			2.38 H	339	96.5	3.8
3	#5725.00	58.9 PK	68.2	-9.3	2.38 H	339	55.1	3.8
4	11400.00	47.6 PK	74.0	-26.4	1.52 H	210	33.4	14.2
5	11400.00	37.8 AV	54.0	-16.2	1.52 H	210	23.6	14.2
6	#17100.00	45.4 PK	68.2	-22.8	1.45 H	144	27.9	17.5

Antenna Polarity & Test Distance : Vertical at 3 m

No	Frequency (MHz)	Emission Level (dBuV/m)	Limit (dBuV/m)	Margin (dB)	Antenna Height (m)	Table Angle (Degree)	Raw Value (dBuV)	Correction Factor (dB/m)
1	*5700.00	119.6 PK			1.50 V	360	115.8	3.8
2	*5700.00	107.1 AV			1.50 V	360	103.3	3.8
3	#5725.00	67.7 PK	68.2	-0.5	1.50 V	360	63.9	3.8
4	11400.00	47.2 PK	74.0	-26.8	1.52 V	228	33.0	14.2
5	11400.00	37.2 AV	54.0	-16.8	1.52 V	228	23.0	14.2
6	#17100.00	45.7 PK	68.2	-22.5	1.56 V	144	28.2	17.5

Remarks:

1. Emission Level(dBuV/m) = Raw Value(dBuV) + Correction Factor(dB/m)
2. Correction Factor(dB/m) = Antenna Factor(dB/m) + Cable Factor(dB) – Pre-Amplifier Factor(dB)
3. Margin value = Emission Level – Limit value
4. The other emission levels were very low against the limit.
5. " * ": Fundamental frequency.
6. " # ": The radiated frequency is out of the restricted band.

Channel	TX Channel 144	Detector Function	Peak (PK)
Frequency Range	1GHz ~ 40GHz		Average (AV)

Antenna Polarity & Test Distance : Horizontal at 3 m

No	Frequency (MHz)	Emission Level (dBuV/m)	Limit (dBuV/m)	Margin (dB)	Antenna Height (m)	Table Angle (Degree)	Raw Value (dBuV)	Correction Factor (dB/m)
1	5460.00	53.3 PK	74.0	-20.7	2.42 H	344	50.1	3.2
2	5460.00	40.9 AV	54.0	-13.1	2.42 H	344	37.7	3.2
3	#5470.00	56.3 PK	68.2	-11.9	2.42 H	344	53.1	3.2
4	*5720.00	113.9 PK			2.42 H	344	110.1	3.8
5	*5720.00	104.5 AV			2.42 H	344	100.7	3.8
6	#5850.00	56.5 PK	68.2	-11.7	2.42 H	344	52.3	4.2
7	11440.00	47.7 PK	74.0	-26.3	1.46 H	215	33.6	14.1
8	11440.00	37.7 AV	54.0	-16.3	1.46 H	215	23.6	14.1
9	#17160.00	46.6 PK	68.2	-21.6	1.53 H	151	29.6	17.0

Antenna Polarity & Test Distance : Vertical at 3 m

No	Frequency (MHz)	Emission Level (dBuV/m)	Limit (dBuV/m)	Margin (dB)	Antenna Height (m)	Table Angle (Degree)	Raw Value (dBuV)	Correction Factor (dB/m)
1	5460.00	57.3 PK	74.0	-16.7	1.50 V	360	54.1	3.2
2	5460.00	44.7 AV	54.0	-9.3	1.50 V	360	41.5	3.2
3	#5470.00	58.4 PK	68.2	-9.8	1.50 V	360	55.2	3.2
4	*5720.00	124.5 PK			1.50 V	360	120.7	3.8
5	*5720.00	113.2 AV			1.50 V	360	109.4	3.8
6	#5850.00	59.1 PK	68.2	-9.1	1.50 V	360	54.9	4.2
7	11440.00	47.8 PK	74.0	-26.2	1.49 V	218	33.7	14.1
8	11440.00	37.9 AV	54.0	-16.1	1.49 V	218	23.8	14.1
9	#17160.00	45.8 PK	68.2	-22.4	1.52 V	130	28.8	17.0

Remarks:

1. Emission Level(dBuV/m) = Raw Value(dBuV) + Correction Factor(dB/m)
2. Correction Factor(dB/m) = Antenna Factor(dB/m) + Cable Factor(dB) – Pre-Amplifier Factor(dB)
3. Margin value = Emission Level – Limit value
4. The other emission levels were very low against the limit.
5. " * ": Fundamental frequency.
6. " # ": The radiated frequency is out of the restricted band.

Channel	TX Channel 149	Detector Function	Peak (PK)
Frequency Range	1GHz ~ 40GHz		Average (AV)

Antenna Polarity & Test Distance : Horizontal at 3 m

No	Frequency (MHz)	Emission Level (dBuV/m)	Limit (dBuV/m)	Margin (dB)	Antenna Height (m)	Table Angle (Degree)	Raw Value (dBuV)	Correction Factor (dB/m)
1	*5745.00	117.7 PK			1.19 H	44	113.9	3.8
2	*5745.00	108.3 AV			1.19 H	44	104.5	3.8
3	11490.00	47.1 PK	74.0	-26.9	1.49 H	209	33.1	14.0
4	11490.00	37.2 AV	54.0	-16.8	1.49 H	209	23.2	14.0
5	#17235.00	45.9 PK	68.2	-22.3	1.50 H	142	29.4	16.5

Antenna Polarity & Test Distance : Vertical at 3 m

No	Frequency (MHz)	Emission Level (dBuV/m)	Limit (dBuV/m)	Margin (dB)	Antenna Height (m)	Table Angle (Degree)	Raw Value (dBuV)	Correction Factor (dB/m)
1	*5745.00	125.4 PK			1.49 V	329	121.6	3.8
2	*5745.00	115.4 AV			1.49 V	329	111.6	3.8
3	11490.00	48.0 PK	74.0	-26.0	1.55 V	221	34.0	14.0
4	11490.00	38.0 AV	54.0	-16.0	1.55 V	221	24.0	14.0
5	#17235.00	46.3 PK	68.2	-21.9	1.46 V	128	29.8	16.5

Remarks:

1. Emission Level(dBuV/m) = Raw Value(dBuV) + Correction Factor(dB/m)
2. Correction Factor(dB/m) = Antenna Factor(dB/m) + Cable Factor(dB) – Pre-Amplifier Factor(dB)
3. Margin value = Emission Level – Limit value
4. The other emission levels were very low against the limit.
5. " * ": Fundamental frequency.
6. " # ": The radiated frequency is out of the restricted band.

Channel	TX Channel 157	Detector Function	Peak (PK)
Frequency Range	1GHz ~ 40GHz		Average (AV)

Antenna Polarity & Test Distance : Horizontal at 3 m

No	Frequency (MHz)	Emission Level (dBuV/m)	Limit (dBuV/m)	Margin (dB)	Antenna Height (m)	Table Angle (Degree)	Raw Value (dBuV)	Correction Factor (dB/m)
1	*5785.00	118.1 PK			1.03 H	62	114.2	3.9
2	*5785.00	108.9 AV			1.03 H	62	105.0	3.9
3	11570.00	47.8 PK	74.0	-26.2	1.51 H	217	34.2	13.6
4	11570.00	38.0 AV	54.0	-16.0	1.51 H	217	24.4	13.6
5	#17355.00	45.6 PK	68.2	-22.6	1.54 H	145	28.6	17.0

Antenna Polarity & Test Distance : Vertical at 3 m

No	Frequency (MHz)	Emission Level (dBuV/m)	Limit (dBuV/m)	Margin (dB)	Antenna Height (m)	Table Angle (Degree)	Raw Value (dBuV)	Correction Factor (dB/m)
1	*5785.00	125.5 PK			1.52 V	328	121.6	3.9
2	*5785.00	115.6 AV			1.52 V	328	111.7	3.9
3	11570.00	47.8 PK	74.0	-26.2	1.54 V	204	34.2	13.6
4	11570.00	37.9 AV	54.0	-16.1	1.54 V	204	24.3	13.6
5	#17355.00	45.4 PK	68.2	-22.8	1.53 V	135	28.4	17.0

Remarks:

1. Emission Level(dBuV/m) = Raw Value(dBuV) + Correction Factor(dB/m)
2. Correction Factor(dB/m) = Antenna Factor(dB/m) + Cable Factor(dB) – Pre-Amplifier Factor(dB)
3. Margin value = Emission Level – Limit value
4. The other emission levels were very low against the limit.
5. " * ": Fundamental frequency.
6. " # ": The radiated frequency is out of the restricted band.

Channel	TX Channel 165	Detector Function	Peak (PK)
Frequency Range	1GHz ~ 40GHz		Average (AV)

Antenna Polarity & Test Distance : Horizontal at 3 m

No	Frequency (MHz)	Emission Level (dBuV/m)	Limit (dBuV/m)	Margin (dB)	Antenna Height (m)	Table Angle (Degree)	Raw Value (dBuV)	Correction Factor (dB/m)
1	*5825.00	118.6 PK			1.28 H	43	114.5	4.1
2	*5825.00	108.9 AV			1.28 H	43	104.8	4.1
3	11650.00	47.4 PK	74.0	-26.6	1.45 H	216	33.9	13.5
4	11650.00	37.6 AV	54.0	-16.4	1.45 H	216	24.1	13.5
5	#17475.00	45.3 PK	68.2	-22.9	1.52 H	149	26.7	18.6

Antenna Polarity & Test Distance : Vertical at 3 m

No	Frequency (MHz)	Emission Level (dBuV/m)	Limit (dBuV/m)	Margin (dB)	Antenna Height (m)	Table Angle (Degree)	Raw Value (dBuV)	Correction Factor (dB/m)
1	*5825.00	125.7 PK			1.50 V	360	121.6	4.1
2	*5825.00	115.8 AV			1.50 V	360	111.7	4.1
3	11650.00	47.3 PK	74.0	-26.7	1.45 V	221	33.8	13.5
4	11650.00	37.1 AV	54.0	-16.9	1.45 V	221	23.6	13.5
5	#17475.00	46.4 PK	68.2	-21.8	1.47 V	134	27.8	18.6

Remarks:

1. Emission Level(dBuV/m) = Raw Value(dBuV) + Correction Factor(dB/m)
2. Correction Factor(dB/m) = Antenna Factor(dB/m) + Cable Factor(dB) – Pre-Amplifier Factor(dB)
3. Margin value = Emission Level – Limit value
4. The other emission levels were very low against the limit.
5. " * ": Fundamental frequency.
6. " # ": The radiated frequency is out of the restricted band.

802.11ax (HE40)

Channel	TX Channel 38	Detector Function	Peak (PK)
Frequency Range	1GHz ~ 40GHz		Average (AV)

Antenna Polarity & Test Distance : Horizontal at 3 m

No	Frequency (MHz)	Emission Level (dBuV/m)	Limit (dBuV/m)	Margin (dB)	Antenna Height (m)	Table Angle (Degree)	Raw Value (dBuV)	Correction Factor (dB/m)
1	5150.00	57.9 PK	74.0	-16.1	2.92 H	212	54.9	3.0
2	5150.00	47.2 AV	54.0	-6.8	2.92 H	212	44.2	3.0
3	*5190.00	105.3 PK			2.92 H	212	102.3	3.0
4	*5190.00	94.5 AV			2.92 H	212	91.5	3.0
5	#10380.00	47.7 PK	68.2	-20.5	1.45 H	208	34.5	13.2
6	15570.00	45.3 PK	74.0	-28.7	1.55 H	143	31.5	13.8
7	15570.00	35.8 AV	54.0	-18.2	1.55 H	143	22.0	13.8

Antenna Polarity & Test Distance : Vertical at 3 m

No	Frequency (MHz)	Emission Level (dBuV/m)	Limit (dBuV/m)	Margin (dB)	Antenna Height (m)	Table Angle (Degree)	Raw Value (dBuV)	Correction Factor (dB/m)
1	5150.00	64.9 PK	74.0	-9.1	2.69 V	297	61.9	3.0
2	5150.00	53.5 AV	54.0	-0.5	2.69 V	297	50.5	3.0
3	*5190.00	113.7 PK			2.69 V	297	110.7	3.0
4	*5190.00	103.1 AV			2.69 V	297	100.1	3.0
5	#10380.00	47.5 PK	68.2	-20.7	1.45 V	212	34.3	13.2
6	15570.00	46.4 PK	74.0	-27.6	1.47 V	151	32.6	13.8
7	15570.00	36.7 AV	54.0	-17.3	1.47 V	151	22.9	13.8

Remarks:

1. Emission Level(dBuV/m) = Raw Value(dBuV) + Correction Factor(dB/m)
2. Correction Factor(dB/m) = Antenna Factor(dB/m) + Cable Factor(dB) – Pre-Amplifier Factor(dB)
3. Margin value = Emission Level – Limit value
4. The other emission levels were very low against the limit.
5. " * ": Fundamental frequency.
6. " # ": The radiated frequency is out of the restricted band.

Channel	TX Channel 46	Detector Function	Peak (PK)
Frequency Range	1GHz ~ 40GHz		Average (AV)

Antenna Polarity & Test Distance : Horizontal at 3 m

No	Frequency (MHz)	Emission Level (dBuV/m)	Limit (dBuV/m)	Margin (dB)	Antenna Height (m)	Table Angle (Degree)	Raw Value (dBuV)	Correction Factor (dB/m)
1	*5230.00	114.0 PK			2.96 H	196	111.1	2.9
2	*5230.00	103.9 AV			2.96 H	196	101.0	2.9
3	5350.00	53.1 PK	74.0	-20.9	2.96 H	196	50.1	3.0
4	5350.00	42.5 AV	54.0	-11.5	2.96 H	196	39.5	3.0
5	#10460.00	47.6 PK	68.2	-20.6	1.51 H	228	34.1	13.5
6	15690.00	46.0 PK	74.0	-28.0	1.56 H	136	32.5	13.5
7	15690.00	36.2 AV	54.0	-17.8	1.56 H	136	22.7	13.5

Antenna Polarity & Test Distance : Vertical at 3 m

No	Frequency (MHz)	Emission Level (dBuV/m)	Limit (dBuV/m)	Margin (dB)	Antenna Height (m)	Table Angle (Degree)	Raw Value (dBuV)	Correction Factor (dB/m)
1	*5230.00	121.8 PK			1.79 V	14	118.9	2.9
2	*5230.00	111.3 AV			1.79 V	14	108.4	2.9
3	5350.00	60.1 PK	74.0	-13.9	1.79 V	14	57.1	3.0
4	5350.00	48.4 AV	54.0	-5.6	1.79 V	14	45.4	3.0
5	#10460.00	48.1 PK	68.2	-20.1	1.45 V	217	34.6	13.5
6	15690.00	46.3 PK	74.0	-27.7	1.54 V	126	32.8	13.5
7	15690.00	36.5 AV	54.0	-17.5	1.54 V	126	23.0	13.5

Remarks:

1. Emission Level(dBuV/m) = Raw Value(dBuV) + Correction Factor(dB/m)
2. Correction Factor(dB/m) = Antenna Factor(dB/m) + Cable Factor(dB) – Pre-Amplifier Factor(dB)
3. Margin value = Emission Level – Limit value
4. The other emission levels were very low against the limit.
5. " * ": Fundamental frequency.
6. " # ": The radiated frequency is out of the restricted band.

Channel	TX Channel 54	Detector Function	Peak (PK)
Frequency Range	1GHz ~ 40GHz		Average (AV)

Antenna Polarity & Test Distance : Horizontal at 3 m

No	Frequency (MHz)	Emission Level (dBuV/m)	Limit (dBuV/m)	Margin (dB)	Antenna Height (m)	Table Angle (Degree)	Raw Value (dBuV)	Correction Factor (dB/m)
1	*5270.00	113.8 PK			2.93 H	184	111.0	2.8
2	*5270.00	103.6 AV			2.93 H	184	100.8	2.8
3	5354.00	60.8 PK	74.0	-13.2	2.93 H	184	57.8	3.0
4	5354.00	47.7 AV	54.0	-6.3	2.93 H	184	44.7	3.0
5	#10540.00	47.9 PK	68.2	-20.3	1.51 H	216	34.5	13.4
6	15810.00	45.9 PK	74.0	-28.1	1.48 H	129	33.0	12.9
7	15810.00	36.3 AV	54.0	-17.7	1.48 H	129	23.4	12.9

Antenna Polarity & Test Distance : Vertical at 3 m

No	Frequency (MHz)	Emission Level (dBuV/m)	Limit (dBuV/m)	Margin (dB)	Antenna Height (m)	Table Angle (Degree)	Raw Value (dBuV)	Correction Factor (dB/m)
1	*5270.00	121.2 PK			1.80 V	16	118.4	2.8
2	*5270.00	111.0 AV			1.80 V	16	108.2	2.8
3	5354.00	66.9 PK	74.0	-7.1	1.80 V	16	63.9	3.0
4	5354.00	53.7 AV	54.0	-0.3	1.80 V	16	50.7	3.0
5	#10540.00	47.1 PK	68.2	-21.1	1.44 V	216	33.7	13.4
6	15810.00	45.2 PK	74.0	-28.8	1.46 V	125	32.3	12.9
7	15810.00	35.7 AV	54.0	-18.3	1.46 V	125	22.8	12.9

Remarks:

1. Emission Level(dBuV/m) = Raw Value(dBuV) + Correction Factor(dB/m)
2. Correction Factor(dB/m) = Antenna Factor(dB/m) + Cable Factor(dB) – Pre-Amplifier Factor(dB)
3. Margin value = Emission Level – Limit value
4. The other emission levels were very low against the limit.
5. " * ": Fundamental frequency.
6. " # ": The radiated frequency is out of the restricted band.

Channel	TX Channel 62	Detector Function	Peak (PK)
Frequency Range	1GHz ~ 40GHz		Average (AV)

Antenna Polarity & Test Distance : Horizontal at 3 m

No	Frequency (MHz)	Emission Level (dBuV/m)	Limit (dBuV/m)	Margin (dB)	Antenna Height (m)	Table Angle (Degree)	Raw Value (dBuV)	Correction Factor (dB/m)
1	*5310.00	107.3 PK			2.52 H	212	104.4	2.9
2	*5310.00	97.0 AV			2.52 H	212	94.1	2.9
3	5350.00	57.7 PK	74.0	-16.3	2.52 H	212	54.7	3.0
4	5350.00	43.7 AV	54.0	-10.3	2.52 H	212	40.7	3.0
5	10620.00	47.5 PK	74.0	-26.5	1.46 H	208	34.2	13.3
6	10620.00	37.2 AV	54.0	-16.8	1.46 H	208	23.9	13.3
7	15930.00	46.3 PK	74.0	-27.7	1.50 H	137	33.0	13.3
8	15930.00	36.6 AV	54.0	-17.4	1.50 H	137	23.3	13.3

Antenna Polarity & Test Distance : Vertical at 3 m

No	Frequency (MHz)	Emission Level (dBuV/m)	Limit (dBuV/m)	Margin (dB)	Antenna Height (m)	Table Angle (Degree)	Raw Value (dBuV)	Correction Factor (dB/m)
1	*5310.00	115.4 PK			1.78 V	14	112.5	2.9
2	*5310.00	104.4 AV			1.78 V	14	101.5	2.9
3	5350.00	70.3 PK	74.0	-3.7	1.78 V	14	67.3	3.0
4	5350.00	53.8 AV	54.0	-0.2	1.78 V	14	50.8	3.0
5	10620.00	47.4 PK	74.0	-26.6	1.46 V	212	34.1	13.3
6	10620.00	37.5 AV	54.0	-16.5	1.46 V	212	24.2	13.3
7	15930.00	45.9 PK	74.0	-28.1	1.54 V	152	32.6	13.3
8	15930.00	36.2 AV	54.0	-17.8	1.54 V	152	22.9	13.3

Remarks:

1. Emission Level(dBuV/m) = Raw Value(dBuV) + Correction Factor(dB/m)
2. Correction Factor(dB/m) = Antenna Factor(dB/m) + Cable Factor(dB) – Pre-Amplifier Factor(dB)
3. Margin value = Emission Level – Limit value
4. The other emission levels were very low against the limit.
5. " * ": Fundamental frequency.

Channel	TX Channel 102	Detector Function	Peak (PK)
Frequency Range	1GHz ~ 40GHz		Average (AV)

Antenna Polarity & Test Distance : Horizontal at 3 m

No	Frequency (MHz)	Emission Level (dBuV/m)	Limit (dBuV/m)	Margin (dB)	Antenna Height (m)	Table Angle (Degree)	Raw Value (dBuV)	Correction Factor (dB/m)
1	5458.05	54.0 PK	74.0	-20.0	1.20 H	355	50.8	3.2
2	5458.05	43.0 AV	54.0	-11.0	1.20 H	355	39.8	3.2
3	#5467.00	58.0 PK	68.2	-10.2	1.20 H	355	54.8	3.2
4	*5510.00	105.9 PK			1.20 H	355	102.7	3.2
5	*5510.00	94.6 AV			1.20 H	355	91.4	3.2
6	11020.00	48.1 PK	74.0	-25.9	1.46 H	217	34.3	13.8
7	11020.00	38.0 AV	54.0	-16.0	1.46 H	217	24.2	13.8
8	#16530.00	46.3 PK	68.2	-21.9	1.49 H	143	30.6	15.7

Antenna Polarity & Test Distance : Vertical at 3 m

No	Frequency (MHz)	Emission Level (dBuV/m)	Limit (dBuV/m)	Margin (dB)	Antenna Height (m)	Table Angle (Degree)	Raw Value (dBuV)	Correction Factor (dB/m)
1	5457.79	62.1 PK	74.0	-11.9	1.68 V	356	58.9	3.2
2	5457.79	49.6 AV	54.0	-4.4	1.68 V	356	46.4	3.2
3	#5467.41	66.5 PK	68.2	-1.7	1.68 V	356	63.3	3.2
4	*5510.00	111.8 PK			1.68 V	356	108.6	3.2
5	*5510.00	101.7 AV			1.68 V	356	98.5	3.2
6	11020.00	46.9 PK	74.0	-27.1	1.45 V	212	33.1	13.8
7	11020.00	37.2 AV	54.0	-16.8	1.45 V	212	23.4	13.8
8	#16530.00	46.0 PK	68.2	-22.2	1.57 V	145	30.3	15.7

Remarks:

1. Emission Level(dBuV/m) = Raw Value(dBuV) + Correction Factor(dB/m)
2. Correction Factor(dB/m) = Antenna Factor(dB/m) + Cable Factor(dB) – Pre-Amplifier Factor(dB)
3. Margin value = Emission Level – Limit value
4. The other emission levels were very low against the limit.
5. " * ": Fundamental frequency.
6. " # ": The radiated frequency is out of the restricted band.

Channel	TX Channel 110	Detector Function	Peak (PK)
Frequency Range	1GHz ~ 40GHz		Average (AV)

Antenna Polarity & Test Distance : Horizontal at 3 m

No	Frequency (MHz)	Emission Level (dBuV/m)	Limit (dBuV/m)	Margin (dB)	Antenna Height (m)	Table Angle (Degree)	Raw Value (dBuV)	Correction Factor (dB/m)
1	*5550.00	112.0 PK			1.28 H	302	108.7	3.3
2	*5550.00	102.2 AV			1.28 H	302	98.9	3.3
3	11100.00	48.0 PK	74.0	-26.0	1.49 H	232	34.7	13.3
4	11100.00	37.9 AV	54.0	-16.1	1.49 H	232	24.6	13.3
5	#16650.00	46.2 PK	68.2	-22.0	1.54 H	155	29.6	16.6

Antenna Polarity & Test Distance : Vertical at 3 m

No	Frequency (MHz)	Emission Level (dBuV/m)	Limit (dBuV/m)	Margin (dB)	Antenna Height (m)	Table Angle (Degree)	Raw Value (dBuV)	Correction Factor (dB/m)
1	*5550.00	120.6 PK			1.67 V	355	117.3	3.3
2	*5550.00	109.9 AV			1.67 V	355	106.6	3.3
3	11100.00	48.2 PK	74.0	-25.8	1.49 V	229	34.9	13.3
4	11100.00	38.0 AV	54.0	-16.0	1.49 V	229	24.7	13.3
5	#16650.00	45.7 PK	68.2	-22.5	1.48 V	131	29.1	16.6

Remarks:

1. Emission Level(dBuV/m) = Raw Value(dBuV) + Correction Factor(dB/m)
2. Correction Factor(dB/m) = Antenna Factor(dB/m) + Cable Factor(dB) – Pre-Amplifier Factor(dB)
3. Margin value = Emission Level – Limit value
4. The other emission levels were very low against the limit.
5. " * ": Fundamental frequency.
6. " # ": The radiated frequency is out of the restricted band.

Channel	TX Channel 134	Detector Function	Peak (PK)
Frequency Range	1GHz ~ 40GHz		Average (AV)

Antenna Polarity & Test Distance : Horizontal at 3 m

No	Frequency (MHz)	Emission Level (dBuV/m)	Limit (dBuV/m)	Margin (dB)	Antenna Height (m)	Table Angle (Degree)	Raw Value (dBuV)	Correction Factor (dB/m)
1	*5670.00	120.2 PK			1.63 H	344	116.6	3.6
2	*5670.00	109.7 AV			1.63 H	344	106.1	3.6
3	#5725.00	66.7 PK	68.2	-1.5	1.63 H	344	62.9	3.8
4	11340.00	47.8 PK	74.0	-26.2	1.53 H	222	33.7	14.1
5	11340.00	37.7 AV	54.0	-16.3	1.53 H	222	23.6	14.1
6	#17010.00	46.0 PK	68.2	-22.2	1.56 H	148	28.2	17.8

Antenna Polarity & Test Distance : Vertical at 3 m

No	Frequency (MHz)	Emission Level (dBuV/m)	Limit (dBuV/m)	Margin (dB)	Antenna Height (m)	Table Angle (Degree)	Raw Value (dBuV)	Correction Factor (dB/m)
1	*5670.00	120.2 PK			1.63 V	344	116.6	3.6
2	*5670.00	109.7 AV			1.63 V	344	106.1	3.6
3	#5725.00	66.7 PK	68.2	-1.5	1.63 V	344	62.9	3.8
4	11340.00	47.8 PK	74.0	-26.2	1.53 V	222	33.7	14.1
5	11340.00	37.7 AV	54.0	-16.3	1.53 V	222	23.6	14.1
6	#17010.00	46.0 PK	68.2	-22.2	1.56 V	148	28.2	17.8

Remarks:

1. Emission Level(dBuV/m) = Raw Value(dBuV) + Correction Factor(dB/m)
2. Correction Factor(dB/m) = Antenna Factor(dB/m) + Cable Factor(dB) – Pre-Amplifier Factor(dB)
3. Margin value = Emission Level – Limit value
4. The other emission levels were very low against the limit.
5. " * ": Fundamental frequency.
6. " # ": The radiated frequency is out of the restricted band.

Channel	TX Channel 142	Detector Function	Peak (PK)
Frequency Range	1GHz ~ 40GHz		Average (AV)

Antenna Polarity & Test Distance : Horizontal at 3 m

No	Frequency (MHz)	Emission Level (dBuV/m)	Limit (dBuV/m)	Margin (dB)	Antenna Height (m)	Table Angle (Degree)	Raw Value (dBuV)	Correction Factor (dB/m)
1	5460.00	53.6 PK	74.0	-20.4	1.28 H	328	50.4	3.2
2	5460.00	41.3 AV	54.0	-12.7	1.28 H	328	38.1	3.2
3	#5470.00	56.4 PK	68.2	-11.8	1.28 H	328	53.2	3.2
4	*5710.00	112.6 PK			1.28 H	328	108.8	3.8
5	*5710.00	102.9 AV			1.28 H	328	99.1	3.8
6	#5850.00	57.0 PK	68.2	-11.2	1.28 H	328	52.8	4.2
7	11420.00	48.1 PK	74.0	-25.9	1.49 H	201	34.0	14.1
8	11420.00	38.0 AV	54.0	-16.0	1.49 H	201	23.9	14.1
9	#17130.00	46.2 PK	68.2	-22.0	1.56 H	136	29.0	17.2

Antenna Polarity & Test Distance : Vertical at 3 m

No	Frequency (MHz)	Emission Level (dBuV/m)	Limit (dBuV/m)	Margin (dB)	Antenna Height (m)	Table Angle (Degree)	Raw Value (dBuV)	Correction Factor (dB/m)
1	5460.00	58.0 PK	74.0	-16.0	1.63 V	359	54.8	3.2
2	5460.00	45.2 AV	54.0	-8.8	1.63 V	359	42.0	3.2
3	#5470.00	58.1 PK	68.2	-10.1	1.63 V	359	54.9	3.2
4	*5710.00	120.9 PK			1.63 V	359	117.1	3.8
5	*5710.00	110.1 AV			1.63 V	359	106.3	3.8
6	#5850.00	58.9 PK	68.2	-9.3	1.63 V	359	54.7	4.2
7	11420.00	47.5 PK	74.0	-26.5	1.50 V	215	33.4	14.1
8	11420.00	37.3 AV	54.0	-16.7	1.50 V	215	23.2	14.1
9	#17130.00	45.8 PK	68.2	-22.4	1.56 V	139	28.6	17.2

Remarks:

1. Emission Level(dBuV/m) = Raw Value(dBuV) + Correction Factor(dB/m)
2. Correction Factor(dB/m) = Antenna Factor(dB/m) + Cable Factor(dB) – Pre-Amplifier Factor(dB)
3. Margin value = Emission Level – Limit value
4. The other emission levels were very low against the limit.
5. " * ": Fundamental frequency.
6. " # ": The radiated frequency is out of the restricted band.

Channel	TX Channel 151	Detector Function	Peak (PK)
Frequency Range	1GHz ~ 40GHz		Average (AV)

Antenna Polarity & Test Distance : Horizontal at 3 m

No	Frequency (MHz)	Emission Level (dBuV/m)	Limit (dBuV/m)	Margin (dB)	Antenna Height (m)	Table Angle (Degree)	Raw Value (dBuV)	Correction Factor (dB/m)
1	*5755.00	112.6 PK			1.23 H	316	108.8	3.8
2	*5755.00	102.7 AV			1.23 H	316	98.9	3.8
3	11510.00	47.6 PK	74.0	-26.4	1.45 H	217	33.8	13.8
4	11510.00	37.3 AV	54.0	-16.7	1.45 H	217	23.5	13.8
5	#17265.00	45.3 PK	68.2	-22.9	1.49 H	143	28.7	16.6

Antenna Polarity & Test Distance : Vertical at 3 m

No	Frequency (MHz)	Emission Level (dBuV/m)	Limit (dBuV/m)	Margin (dB)	Antenna Height (m)	Table Angle (Degree)	Raw Value (dBuV)	Correction Factor (dB/m)
1	*5755.00	120.8 PK			1.59 V	334	117.0	3.8
2	*5755.00	109.7 AV			1.59 V	334	105.9	3.8
3	11510.00	47.9 PK	74.0	-26.1	1.49 V	210	34.1	13.8
4	11510.00	38.0 AV	54.0	-16.0	1.49 V	210	24.2	13.8
5	#17265.00	46.3 PK	68.2	-21.9	1.50 V	128	29.7	16.6

Remarks:

1. Emission Level(dBuV/m) = Raw Value(dBuV) + Correction Factor(dB/m)
2. Correction Factor(dB/m) = Antenna Factor(dB/m) + Cable Factor(dB) – Pre-Amplifier Factor(dB)
3. Margin value = Emission Level – Limit value
4. The other emission levels were very low against the limit.
5. " * ": Fundamental frequency.
6. " # ": The radiated frequency is out of the restricted band.

Channel	TX Channel 159	Detector Function	Peak (PK)
Frequency Range	1GHz ~ 40GHz		Average (AV)

Antenna Polarity & Test Distance : Horizontal at 3 m

No	Frequency (MHz)	Emission Level (dBuV/m)	Limit (dBuV/m)	Margin (dB)	Antenna Height (m)	Table Angle (Degree)	Raw Value (dBuV)	Correction Factor (dB/m)
1	*5795.00	113.8 PK			1.24 H	317	109.9	3.9
2	*5795.00	103.2 AV			1.24 H	317	99.3	3.9
3	11590.00	47.8 PK	74.0	-26.2	1.48 H	220	34.2	13.6
4	11590.00	37.6 AV	54.0	-16.4	1.48 H	220	24.0	13.6
5	#17385.00	46.0 PK	68.2	-22.2	1.48 H	149	28.6	17.4

Antenna Polarity & Test Distance : Vertical at 3 m

No	Frequency (MHz)	Emission Level (dBuV/m)	Limit (dBuV/m)	Margin (dB)	Antenna Height (m)	Table Angle (Degree)	Raw Value (dBuV)	Correction Factor (dB/m)
1	*5795.00	120.5 PK			1.59 V	360	116.6	3.9
2	*5795.00	109.4 AV			1.59 V	360	105.5	3.9
3	11590.00	47.1 PK	74.0	-26.9	1.51 V	215	33.5	13.6
4	11590.00	37.1 AV	54.0	-16.9	1.51 V	215	23.5	13.6
5	#17385.00	45.9 PK	68.2	-22.3	1.49 V	132	28.5	17.4

Remarks:

1. Emission Level(dBuV/m) = Raw Value(dBuV) + Correction Factor(dB/m)
2. Correction Factor(dB/m) = Antenna Factor(dB/m) + Cable Factor(dB) – Pre-Amplifier Factor(dB)
3. Margin value = Emission Level – Limit value
4. The other emission levels were very low against the limit.
5. " * ": Fundamental frequency.
6. " # ": The radiated frequency is out of the restricted band.

802.11ax (HE80)

Channel	TX Channel 42	Detector Function	Peak (PK)
Frequency Range	1GHz ~ 40GHz		Average (AV)

Antenna Polarity & Test Distance : Horizontal at 3 m								
No	Frequency (MHz)	Emission Level (dBuV/m)	Limit (dBuV/m)	Margin (dB)	Antenna Height (m)	Table Angle (Degree)	Raw Value (dBuV)	Correction Factor (dB/m)
1	5150.00	51.9 PK	74.0	-22.1	1.15 H	356	48.9	3.0
2	5150.00	41.3 AV	54.0	-12.7	1.15 H	356	38.3	3.0
3	*5210.00	100.8 PK			1.15 H	356	97.8	3.0
4	*5210.00	90.1 AV			1.15 H	356	87.1	3.0
5	5350.00	49.9 PK	74.0	-24.1	1.15 H	356	46.9	3.0
6	5350.00	37.9 AV	54.0	-16.1	1.15 H	356	34.9	3.0
7	#10420.00	47.2 PK	68.2	-21.0	1.48 H	202	33.9	13.3
8	15630.00	45.4 PK	74.0	-28.6	1.47 H	132	31.7	13.7
9	15630.00	35.7 AV	54.0	-18.3	1.47 H	132	22.0	13.7

Antenna Polarity & Test Distance : Vertical at 3 m								
No	Frequency (MHz)	Emission Level (dBuV/m)	Limit (dBuV/m)	Margin (dB)	Antenna Height (m)	Table Angle (Degree)	Raw Value (dBuV)	Correction Factor (dB/m)
1	5150.00	64.4 PK	74.0	-9.6	1.80 V	17	61.4	3.0
2	5150.00	53.7 AV	54.0	-0.3	1.80 V	17	50.7	3.0
3	*5210.00	111.3 PK			1.80 V	17	108.3	3.0
4	*5210.00	100.2 AV			1.80 V	17	97.2	3.0
5	5350.00	54.4 PK	74.0	-19.6	1.80 V	17	51.4	3.0
6	5350.00	43.1 AV	54.0	-10.9	1.80 V	17	40.1	3.0
7	#10420.00	48.4 PK	68.2	-19.8	1.54 V	215	35.1	13.3
8	15630.00	45.4 PK	74.0	-28.6	1.45 V	142	31.7	13.7
9	15630.00	35.9 AV	54.0	-18.1	1.45 V	142	22.2	13.7

Remarks:

1. Emission Level(dBuV/m) = Raw Value(dBuV) + Correction Factor(dB/m)
2. Correction Factor(dB/m) = Antenna Factor(dB/m) + Cable Factor(dB) – Pre-Amplifier Factor(dB)
3. Margin value = Emission Level – Limit value
4. The other emission levels were very low against the limit.
5. " * ": Fundamental frequency.
6. " # ": The radiated frequency is out of the restricted band.

Channel	TX Channel 58	Detector Function	Peak (PK)
Frequency Range	1GHz ~ 40GHz		Average (AV)

Antenna Polarity & Test Distance : Horizontal at 3 m

No	Frequency (MHz)	Emission Level (dBuV/m)	Limit (dBuV/m)	Margin (dB)	Antenna Height (m)	Table Angle (Degree)	Raw Value (dBuV)	Correction Factor (dB/m)
1	5150.00	50.4 PK	74.0	-23.6	1.31 H	353	47.4	3.0
2	5150.00	38.9 AV	54.0	-15.1	1.31 H	353	35.9	3.0
3	*5290.00	103.5 PK			1.31 H	353	100.6	2.9
4	*5290.00	91.9 AV			1.31 H	353	89.0	2.9
5	5350.00	52.4 PK	74.0	-21.6	1.31 H	353	49.4	3.0
6	5350.00	41.7 AV	54.0	-12.3	1.31 H	353	38.7	3.0
7	#10580.00	48.0 PK	68.2	-20.2	1.55 H	224	34.7	13.3
8	15870.00	45.8 PK	74.0	-28.2	1.48 H	145	32.7	13.1
9	15870.00	36.0 AV	54.0	-18.0	1.48 H	145	22.9	13.1

Antenna Polarity & Test Distance : Vertical at 3 m

No	Frequency (MHz)	Emission Level (dBuV/m)	Limit (dBuV/m)	Margin (dB)	Antenna Height (m)	Table Angle (Degree)	Raw Value (dBuV)	Correction Factor (dB/m)
1	5150.00	56.2 PK	74.0	-17.8	1.79 V	18	53.2	3.0
2	5150.00	45.0 AV	54.0	-9.0	1.79 V	18	42.0	3.0
3	*5290.00	112.3 PK			1.79 V	18	109.4	2.9
4	*5290.00	101.0 AV			1.79 V	18	98.1	2.9
5	5350.00	65.3 PK	74.0	-8.7	1.79 V	18	62.3	3.0
6	5350.00	53.6 AV	54.0	-0.4	1.79 V	18	50.6	3.0
7	#10580.00	46.9 PK	68.2	-21.3	1.50 V	216	33.6	13.3
8	15870.00	45.7 PK	74.0	-28.3	1.54 V	128	32.6	13.1
9	15870.00	35.9 AV	54.0	-18.1	1.54 V	128	22.8	13.1

Remarks:

1. Emission Level(dBuV/m) = Raw Value(dBuV) + Correction Factor(dB/m)
2. Correction Factor(dB/m) = Antenna Factor(dB/m) + Cable Factor(dB) – Pre-Amplifier Factor(dB)
3. Margin value = Emission Level – Limit value
4. The other emission levels were very low against the limit.
5. " * ": Fundamental frequency.
6. " # ": The radiated frequency is out of the restricted band.

Channel	TX Channel 106	Detector Function	Peak (PK)
Frequency Range	1GHz ~ 40GHz		Average (AV)

Antenna Polarity & Test Distance : Horizontal at 3 m

No	Frequency (MHz)	Emission Level (dBuV/m)	Limit (dBuV/m)	Margin (dB)	Antenna Height (m)	Table Angle (Degree)	Raw Value (dBuV)	Correction Factor (dB/m)
1	5457.46	57.3 PK	74.0	-16.7	1.00 H	354	54.1	3.2
2	5457.46	44.6 AV	54.0	-9.4	1.00 H	354	41.4	3.2
3	#5466.94	58.6 PK	68.2	-9.6	1.00 H	354	55.4	3.2
4	*5530.00	104.1 PK			1.00 H	354	100.8	3.3
5	*5530.00	93.0 AV			1.00 H	354	89.7	3.3
6	#5747.94	51.4 PK	68.2	-16.8	1.00 H	354	47.6	3.8
7	11060.00	47.2 PK	74.0	-26.8	1.53 H	206	33.6	13.6
8	11060.00	37.5 AV	54.0	-16.5	1.53 H	206	23.9	13.6
9	#16590.00	45.9 PK	68.2	-22.3	1.55 H	146	29.6	16.3

Antenna Polarity & Test Distance : Vertical at 3 m

No	Frequency (MHz)	Emission Level (dBuV/m)	Limit (dBuV/m)	Margin (dB)	Antenna Height (m)	Table Angle (Degree)	Raw Value (dBuV)	Correction Factor (dB/m)
1	5457.61	65.6 PK	74.0	-8.4	1.50 V	355	62.4	3.2
2	5457.61	52.6 AV	54.0	-1.4	1.50 V	355	49.4	3.2
3	#5463.23	67.2 PK	68.2	-1.0	1.50 V	355	64.0	3.2
4	*5530.00	111.9 PK			1.50 V	355	108.6	3.3
5	*5530.00	100.1 AV			1.50 V	355	96.8	3.3
6	#5725.00	54.8 PK	68.2	-13.4	1.50 V	355	51.0	3.8
7	11060.00	47.1 PK	74.0	-26.9	1.50 V	218	33.5	13.6
8	11060.00	37.2 AV	54.0	-16.8	1.50 V	218	23.6	13.6
9	#16590.00	46.1 PK	68.2	-22.1	1.52 V	148	29.8	16.3

Remarks:

1. Emission Level(dBuV/m) = Raw Value(dBuV) + Correction Factor(dB/m)
2. Correction Factor(dB/m) = Antenna Factor(dB/m) + Cable Factor(dB) – Pre-Amplifier Factor(dB)
3. Margin value = Emission Level – Limit value
4. The other emission levels were very low against the limit.
5. " * ": Fundamental frequency.
6. " # ": The radiated frequency is out of the restricted band.

Channel	TX Channel 122	Detector Function	Peak (PK)
Frequency Range	1GHz ~ 40GHz		Average (AV)

Antenna Polarity & Test Distance : Horizontal at 3 m

No	Frequency (MHz)	Emission Level (dBuV/m)	Limit (dBuV/m)	Margin (dB)	Antenna Height (m)	Table Angle (Degree)	Raw Value (dBuV)	Correction Factor (dB/m)
1	*5610.00	110.6 PK			1.32 H	356	107.2	3.4
2	*5610.00	100.3 AV			1.32 H	356	96.9	3.4
3	#5725.00	58.9 PK	68.2	-9.3	1.32 H	356	55.1	3.8
4	11220.00	46.8 PK	74.0	-27.2	1.56 H	220	33.4	13.4
5	11220.00	37.1 AV	54.0	-16.9	1.56 H	220	23.7	13.4
6	#16830.00	46.2 PK	68.2	-22.0	1.55 H	148	29.5	16.7

Antenna Polarity & Test Distance : Vertical at 3 m

No	Frequency (MHz)	Emission Level (dBuV/m)	Limit (dBuV/m)	Margin (dB)	Antenna Height (m)	Table Angle (Degree)	Raw Value (dBuV)	Correction Factor (dB/m)
1	*5610.00	117.8 PK			1.51 V	351	114.4	3.4
2	*5610.00	107.6 AV			1.51 V	351	104.2	3.4
3	#5725.00	65.8 PK	68.2	-2.4	1.51 V	351	62.0	3.8
4	11220.00	47.6 PK	74.0	-26.4	1.45 V	216	34.2	13.4
5	11220.00	37.9 AV	54.0	-16.1	1.45 V	216	24.5	13.4
6	#16830.00	45.4 PK	68.2	-22.8	1.47 V	142	28.7	16.7

Remarks:

1. Emission Level(dBuV/m) = Raw Value(dBuV) + Correction Factor(dB/m)
2. Correction Factor(dB/m) = Antenna Factor(dB/m) + Cable Factor(dB) – Pre-Amplifier Factor(dB)
3. Margin value = Emission Level – Limit value
4. The other emission levels were very low against the limit.
5. " * ": Fundamental frequency.
6. " # ": The radiated frequency is out of the restricted band.

Channel	TX Channel 138	Detector Function	Peak (PK)
Frequency Range	1GHz ~ 40GHz		Average (AV)

Antenna Polarity & Test Distance : Horizontal at 3 m

No	Frequency (MHz)	Emission Level (dBuV/m)	Limit (dBuV/m)	Margin (dB)	Antenna Height (m)	Table Angle (Degree)	Raw Value (dBuV)	Correction Factor (dB/m)
1	5460.00	53.6 PK	74.0	-20.4	1.34 H	356	50.4	3.2
2	5460.00	41.2 AV	54.0	-12.8	1.34 H	356	38.0	3.2
3	#5470.00	56.7 PK	68.2	-11.5	1.34 H	356	53.5	3.2
4	*5690.00	110.5 PK			1.34 H	356	106.7	3.8
5	*5690.00	100.1 AV			1.34 H	356	96.3	3.8
6	#5850.00	56.6 PK	68.2	-11.6	1.34 H	356	52.4	4.2
7	11380.00	47.6 PK	74.0	-26.4	1.51 H	209	33.5	14.1
8	11380.00	37.6 AV	54.0	-16.4	1.51 H	209	23.5	14.1
9	#17070.00	46.0 PK	68.2	-22.2	1.49 H	135	28.4	17.6

Antenna Polarity & Test Distance : Vertical at 3 m

No	Frequency (MHz)	Emission Level (dBuV/m)	Limit (dBuV/m)	Margin (dB)	Antenna Height (m)	Table Angle (Degree)	Raw Value (dBuV)	Correction Factor (dB/m)
1	5460.00	57.8 PK	74.0	-16.2	1.49 V	358	54.6	3.2
2	5460.00	45.2 AV	54.0	-8.8	1.49 V	358	42.0	3.2
3	#5470.00	58.3 PK	68.2	-9.9	1.49 V	358	55.1	3.2
4	*5690.00	117.9 PK			1.49 V	358	114.1	3.8
5	*5690.00	107.9 AV			1.49 V	358	104.1	3.8
6	#5850.00	57.2 PK	68.2	-11.0	1.49 V	358	53.0	4.2
7	11380.00	48.1 PK	74.0	-25.9	1.45 V	207	34.0	14.1
8	11380.00	37.9 AV	54.0	-16.1	1.45 V	207	23.8	14.1
9	#17070.00	46.3 PK	68.2	-21.9	1.48 V	146	28.7	17.6

Remarks:

1. Emission Level(dBuV/m) = Raw Value(dBuV) + Correction Factor(dB/m)
2. Correction Factor(dB/m) = Antenna Factor(dB/m) + Cable Factor(dB) – Pre-Amplifier Factor(dB)
3. Margin value = Emission Level – Limit value
4. The other emission levels were very low against the limit.
5. " * ": Fundamental frequency.
6. " # ": The radiated frequency is out of the restricted band.

Channel	TX Channel 155	Detector Function	Peak (PK)
Frequency Range	1GHz ~ 40GHz		Average (AV)

Antenna Polarity & Test Distance : Horizontal at 3 m

No	Frequency (MHz)	Emission Level (dBuV/m)	Limit (dBuV/m)	Margin (dB)	Antenna Height (m)	Table Angle (Degree)	Raw Value (dBuV)	Correction Factor (dB/m)
1	*5775.00	107.8 PK			1.32 H	315	103.9	3.9
2	*5775.00	97.1 AV			1.32 H	315	93.2	3.9
3	11550.00	48.0 PK	74.0	-26.0	1.53 H	226	34.3	13.7
4	11550.00	37.9 AV	54.0	-16.1	1.53 H	226	24.2	13.7
5	#17325.00	45.4 PK	68.2	-22.8	1.49 H	143	28.6	16.8

Antenna Polarity & Test Distance : Vertical at 3 m

No	Frequency (MHz)	Emission Level (dBuV/m)	Limit (dBuV/m)	Margin (dB)	Antenna Height (m)	Table Angle (Degree)	Raw Value (dBuV)	Correction Factor (dB/m)
1	*5775.00	116.5 PK			3.08 V	356	112.6	3.9
2	*5775.00	105.4 AV			3.08 V	356	101.5	3.9
3	11550.00	47.9 PK	74.0	-26.1	1.53 V	217	34.2	13.7
4	11550.00	37.7 AV	54.0	-16.3	1.53 V	217	24.0	13.7
5	#17325.00	45.3 PK	68.2	-22.9	1.47 V	135	28.5	16.8

Remarks:

1. Emission Level(dBuV/m) = Raw Value(dBuV) + Correction Factor(dB/m)
2. Correction Factor(dB/m) = Antenna Factor(dB/m) + Cable Factor(dB) – Pre-Amplifier Factor(dB)
3. Margin value = Emission Level – Limit value
4. The other emission levels were very low against the limit.
5. " * ": Fundamental frequency.
6. " # ": The radiated frequency is out of the restricted band.

802.11ax (HE160)

Channel	TX Channel 50	Detector Function	Peak (PK)
Frequency Range	1GHz ~ 40GHz		Average (AV)

Antenna Polarity & Test Distance : Horizontal at 3 m								
No	Frequency (MHz)	Emission Level (dBuV/m)	Limit (dBuV/m)	Margin (dB)	Antenna Height (m)	Table Angle (Degree)	Raw Value (dBuV)	Correction Factor (dB/m)
1	5136.58	54.4 PK	74.0	-19.6	1.20 H	50	51.4	3.0
2	5136.58	42.2 AV	54.0	-11.8	1.20 H	50	39.2	3.0
3	*5250.00	99.8 PK			1.20 H	50	97.0	2.8
4	*5250.00	89.3 AV			1.20 H	50	86.5	2.8
5	5406.14	55.6 PK	74.0	-18.4	1.20 H	50	52.5	3.1
6	5406.14	43.2 AV	54.0	-10.8	1.20 H	50	40.1	3.1
7	#10500.00	47.8 PK	68.2	-20.4	1.47 H	209	34.2	13.6
8	15750.00	45.9 PK	74.0	-28.1	1.56 H	136	32.7	13.2
9	15750.00	36.0 AV	54.0	-18.0	1.56 H	136	22.8	13.2

Antenna Polarity & Test Distance : Vertical at 3 m								
No	Frequency (MHz)	Emission Level (dBuV/m)	Limit (dBuV/m)	Margin (dB)	Antenna Height (m)	Table Angle (Degree)	Raw Value (dBuV)	Correction Factor (dB/m)
1	5150.00	64.9 PK	74.0	-9.1	1.80 V	15	61.9	3.0
2	5150.00	53.8 AV	54.0	-0.2	1.80 V	15	50.8	3.0
3	*5250.00	110.2 PK			1.80 V	15	107.4	2.8
4	*5250.00	99.8 AV			1.80 V	15	97.0	2.8
5	5350.00	66.1 PK	74.0	-7.9	1.80 V	15	63.1	3.0
6	5350.00	53.3 AV	54.0	-0.7	1.80 V	15	50.3	3.0
7	#10500.00	48.0 PK	68.2	-20.2	1.51 V	232	34.4	13.6
8	15750.00	46.1 PK	74.0	-27.9	1.56 V	141	32.9	13.2
9	15750.00	36.1 AV	54.0	-17.9	1.56 V	141	22.9	13.2

Remarks:

1. Emission Level(dBuV/m) = Raw Value(dBuV) + Correction Factor(dB/m)
2. Correction Factor(dB/m) = Antenna Factor(dB/m) + Cable Factor(dB) – Pre-Amplifier Factor(dB)
3. Margin value = Emission Level – Limit value
4. The other emission levels were very low against the limit.
5. " * ": Fundamental frequency.
6. " # ": The radiated frequency is out of the restricted band.

Channel	TX Channel 114	Detector Function	Peak (PK)
Frequency Range	1GHz ~ 40GHz		Average (AV)

Antenna Polarity & Test Distance : Horizontal at 3 m

No	Frequency (MHz)	Emission Level (dBuV/m)	Limit (dBuV/m)	Margin (dB)	Antenna Height (m)	Table Angle (Degree)	Raw Value (dBuV)	Correction Factor (dB/m)
1	5431.86	55.5 PK	74.0	-18.5	1.08 H	46	52.3	3.2
2	5431.86	42.6 AV	54.0	-11.4	1.08 H	46	39.4	3.2
3	#5466.35	57.4 PK	68.2	-10.8	1.08 H	46	54.2	3.2
4	*5570.00	98.4 PK			1.08 H	46	95.1	3.3
5	*5570.00	88.5 AV			1.08 H	46	85.2	3.3
6	#5734.31	56.4 PK	68.2	-11.8	1.08 H	46	52.6	3.8
7	11140.00	47.7 PK	74.0	-26.3	1.47 H	210	34.4	13.3
8	11140.00	37.8 AV	54.0	-16.2	1.47 H	210	24.5	13.3
9	#16710.00	45.8 PK	68.2	-22.4	1.56 H	129	29.2	16.6

Antenna Polarity & Test Distance : Vertical at 3 m

No	Frequency (MHz)	Emission Level (dBuV/m)	Limit (dBuV/m)	Margin (dB)	Antenna Height (m)	Table Angle (Degree)	Raw Value (dBuV)	Correction Factor (dB/m)
1	5456.69	66.8 PK	74.0	-7.2	1.69 V	7	63.6	3.2
2	5456.69	53.1 AV	54.0	-0.9	1.69 V	7	49.9	3.2
3	#5462.16	67.2 PK	68.2	-1.0	1.69 V	7	64.0	3.2
4	*5570.00	109.5 PK			1.69 V	7	106.2	3.3
5	*5570.00	98.6 AV			1.69 V	7	95.3	3.3
6	#5739.05	62.4 PK	68.2	-5.8	1.69 V	7	58.6	3.8
7	11140.00	47.2 PK	74.0	-26.8	1.45 V	207	33.9	13.3
8	11140.00	37.3 AV	54.0	-16.7	1.45 V	207	24.0	13.3
9	#16710.00	45.9 PK	68.2	-22.3	1.52 V	135	29.3	16.6

Remarks:

1. Emission Level(dBuV/m) = Raw Value(dBuV) + Correction Factor(dB/m)
2. Correction Factor(dB/m) = Antenna Factor(dB/m) + Cable Factor(dB) – Pre-Amplifier Factor(dB)
3. Margin value = Emission Level – Limit value
4. The other emission levels were very low against the limit.
5. " * ": Fundamental frequency.
6. " # ": The radiated frequency is out of the restricted band.

Below 1GHz Data:

802.11ax (HE40)

CHANNEL	TX Channel 151	DETECTOR FUNCTION	Quasi-Peak (QP)
FREQUENCY RANGE	9kHz ~ 1GHz		

ANTENNA POLARITY & TEST DISTANCE: HORIZONTAL AT 3 M

NO.	FREQ. (MHz)	EMISSION LEVEL (dBuV/m)	LIMIT (dBuV/m)	MARGIN (dB)	ANTENNA HEIGHT (m)	TABLE ANGLE (Degree)	RAW VALUE (dBuV)	CORRECTION FACTOR (dB/m)
1	125.01	32.9 QP	43.5	-10.6	1.00 H	234	42.1	-9.2
2	156.59	38.1 QP	43.5	-5.4	1.00 H	116	45.5	-7.4
3	185.69	31.9 QP	43.5	-11.6	1.00 H	352	41.8	-9.9
4	500.01	34.5 QP	46.0	-11.5	1.50 H	1	35.8	-1.3
5	625.00	33.1 QP	46.0	-12.9	1.00 H	118	31.0	2.1
6	777.92	34.2 QP	46.0	-11.8	1.50 H	139	29.2	5.0

REMARKS:

1. Emission Level(dBuV/m) = Raw Value(dBuV) + Correction Factor(dB/m)
2. Correction Factor(dB/m) = Antenna Factor(dB/m) + Cable Factor(dB) – Pre-Amplifier Factor(dB)
3. Margin value = Emission Level – Limit value
4. The other emission levels were very low against the limit of frequency range 30MHz~1000MHz.
5. The emission levels were very low against the limit of frequency range 9kHz~30MHz: the amplitude of spurious emissions attenuated more than 20 dB below the permissible value to be report.

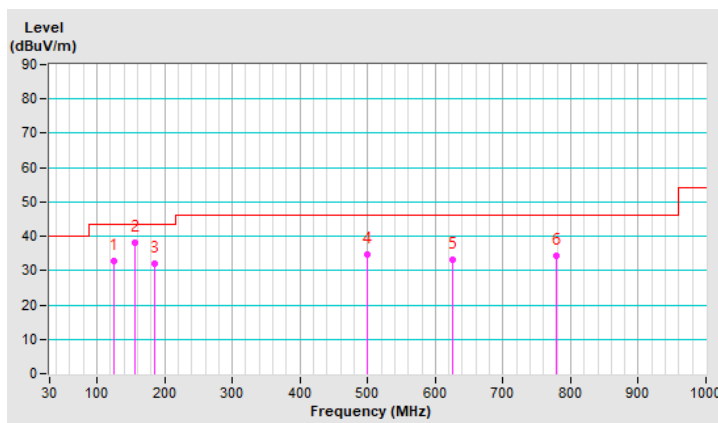

CHANNEL	TX Channel 151	DETECTOR FUNCTION	Quasi-Peak (QP)
FREQUENCY RANGE	9kHz ~ 1GHz		

ANTENNA POLARITY & TEST DISTANCE: VERTICAL AT 3 M

NO.	FREQ. (MHz)	EMISSION LEVEL (dBuV/m)	LIMIT (dBuV/m)	MARGIN (dB)	ANTENNA HEIGHT (m)	TABLE ANGLE (Degree)	RAW VALUE (dBuV)	CORRECTION FACTOR (dB/m)
1	91.64	35.1 QP	43.5	-8.4	2.00 V	343	48.5	-13.4
2	125.01	39.1 QP	43.5	-4.4	2.00 V	72	48.3	-9.2
3	182.34	33.0 QP	43.5	-10.5	1.00 V	297	42.4	-9.4
4	260.33	27.0 QP	46.0	-19.0	1.00 V	184	35.1	-8.1
5	499.99	30.7 QP	46.0	-15.3	1.50 V	360	32.0	-1.3
6	781.51	34.4 QP	46.0	-11.6	1.00 V	40	29.3	5.1

REMARKS:

1. Emission Level(dBuV/m) = Raw Value(dBuV) + Correction Factor(dB/m)
2. Correction Factor(dB/m) = Antenna Factor(dB/m) + Cable Factor(dB) – Pre-Amplifier Factor(dB)
3. Margin value = Emission Level – Limit value
4. The other emission levels were very low against the limit of frequency range 30MHz~1000MHz.
5. The emission levels were very low against the limit of frequency range 9kHz~30MHz: the amplitude of spurious emissions attenuated more than 20 dB below the permissible value to be report.

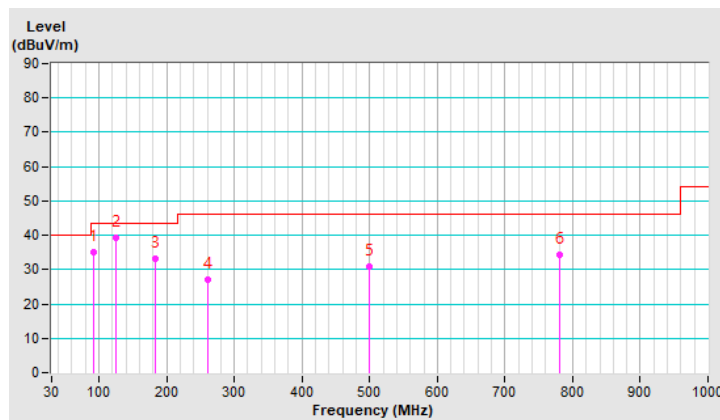

4.2 Conducted Emission Measurement

4.2.1 Limits of Conducted Emission Measurement

Frequency (MHz)	Conducted Limit (dBuV)	
	Quasi-peak	Average
0.15 - 0.5	66 - 56	56 - 46
0.50 - 5.0	56	46
5.0 - 30.0	60	50

Note: 1. The lower limit shall apply at the transition frequencies.

2. The limit decreases in line with the logarithm of the frequency in the range of 0.15 to 0.50MHz.

4.2.2 Test Instruments

DESCRIPTION & MANUFACTURER	MODEL NO.	SERIAL NO.	CALIBRATED DATE	CALIBRATED UNTIL
Test Receiver R&S	ESCS 30	847124/029	Oct. 23, 2019	Oct. 22, 2020
Line-Impedance Stabilization Network (for EUT) R&S	ESH3-Z5	848773/004	Oct. 23, 2019	Oct. 22, 2020
Line-Impedance Stabilization Network (for Peripheral) R&S	ESH3-Z5	835239/001	Mar. 19, 2020	Mar. 18, 2021
50 ohms Terminator	50	3	Oct. 23, 2019	Oct. 22, 2020
RF Cable	5D-FB	COCCAB-001	Sep. 27, 2019	Sep. 26, 2020
Fixed attenuator EMCI	STI02-2200-10	005	Aug. 30, 2019	Aug. 29, 2020
Software BVADT	BVADT_Cond_V7.3.7.4	NA	NA	NA

Note:

1. The calibration interval of the above test instruments are 12 months and the calibrations are traceable to NML/ROC and NIST/USA.
2. The test was performed in Conduction 1.
- 3 Tested Date: July 31, 2020

4.2.3 Test Procedure

- The EUT was placed 0.4 meters from the conducting wall of the shielded room with EUT being connected to the power mains through a line impedance stabilization network (LISN). Other support units were connected to the power mains through another LISN. The two LISNs provide 50 ohm/ 50uH of coupling impedance for the measuring instrument.
- Both lines of the power mains connected to the EUT were checked for maximum conducted interference.
- The frequency range from 150kHz to 30MHz was searched. Emission levels under (Limit - 20dB) was not recorded.

Note: All modes of operation were investigated and the worst-case emissions are reported.

4.2.4 Deviation from Test Standard

No deviation.

4.2.5 Test Setup

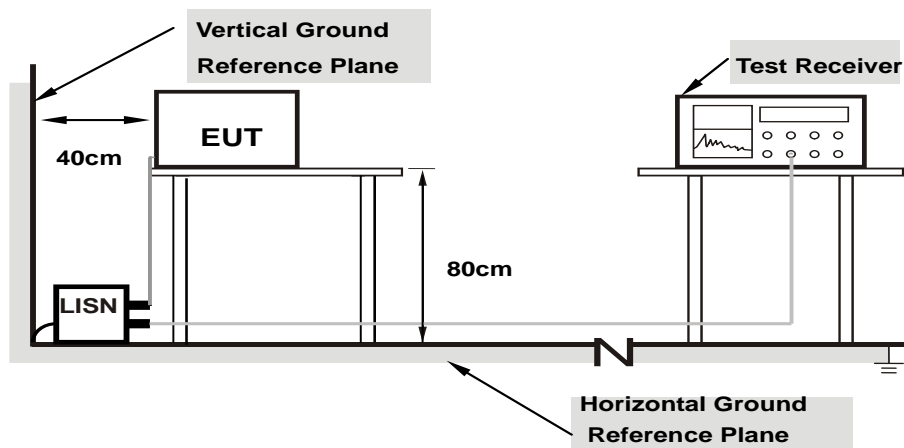

Note: 1.Support units were connected to second LISN.

For the actual test configuration, please refer to the attached file (Test Setup Photo).

4.2.6 EUT Operating Condition

Same as 4.1.6.

4.2.7 Test Results

Phase	Line (L)	Detector Function	Quasi-Peak (QP) / Average (AV)
-------	----------	-------------------	--------------------------------

Phase Of Power : Line (L)										
No	Frequency (MHz)	Correction Factor (dB)	Reading Value (dBuV)		Emission Level (dBuV)		Limit (dBuV)		Margin (dB)	
			Q.P.	AV.	Q.P.	AV.	Q.P.	AV.	Q.P.	AV.
1	0.16172	9.98	34.31	25.83	44.29	35.81	65.38	55.38	-21.09	-19.57
2	0.18125	9.99	31.55	23.06	41.54	33.05	64.43	54.43	-22.89	-21.38
3	0.30234	10.00	32.43	24.53	42.43	34.53	60.18	50.18	-17.75	-15.65
4	17.79297	11.23	21.41	14.64	32.64	25.87	60.00	50.00	-27.36	-24.13
5	25.25000	11.58	24.16	20.06	35.74	31.64	60.00	50.00	-24.26	-18.36
6	29.96875	11.75	22.99	13.89	34.74	25.64	60.00	50.00	-25.26	-24.36

Remarks:

1. Q.P. and AV. are abbreviations of quasi-peak and average individually.
2. The emission levels of other frequencies were very low against the limit.
3. Margin value = Emission level – Limit value
4. Correction factor = Insertion loss + Cable loss
5. Emission Level = Correction Factor + Reading Value

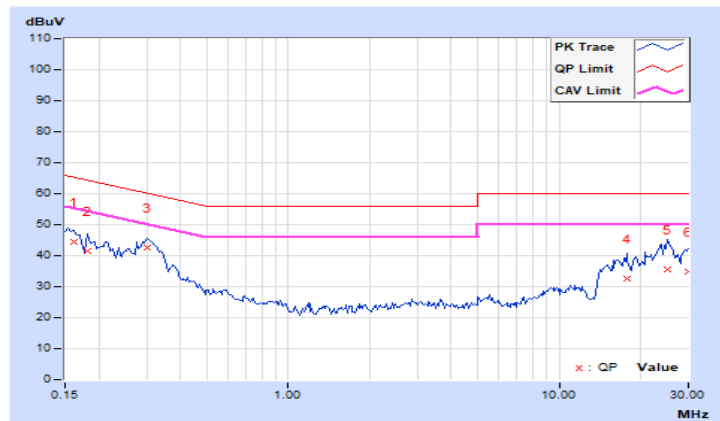

Phase	Neutral (N)	Detector Function	Quasi-Peak (QP) / Average (AV)
-------	-------------	-------------------	--------------------------------

Phase Of Power : Neutral (N)										
No	Frequency (MHz)	Correction Factor (dB)	Reading Value (dBuV)		Emission Level (dBuV)		Limit (dBuV)		Margin (dB)	
			Q.P.	AV.	Q.P.	AV.	Q.P.	AV.	Q.P.	AV.
1	0.17734	10.00	34.11	21.54	44.11	31.54	64.61	54.61	-20.50	-23.07
2	0.30625	10.02	36.65	31.12	46.67	41.14	60.07	50.07	-13.40	-8.93
3	0.32969	10.02	33.77	26.51	43.79	36.53	59.46	49.46	-15.67	-12.93
4	19.45703	11.10	24.96	13.60	36.06	24.70	60.00	50.00	-23.94	-25.30
5	25.30859	11.26	26.86	23.65	38.12	34.91	60.00	50.00	-21.88	-15.09
6	29.35938	11.36	24.58	14.78	35.94	26.14	60.00	50.00	-24.06	-23.86

Remarks:

1. Q.P. and AV. are abbreviations of quasi-peak and average individually.
2. The emission levels of other frequencies were very low against the limit.
3. Margin value = Emission level – Limit value
4. Correction factor = Insertion loss + Cable loss
5. Emission Level = Correction Factor + Reading Value

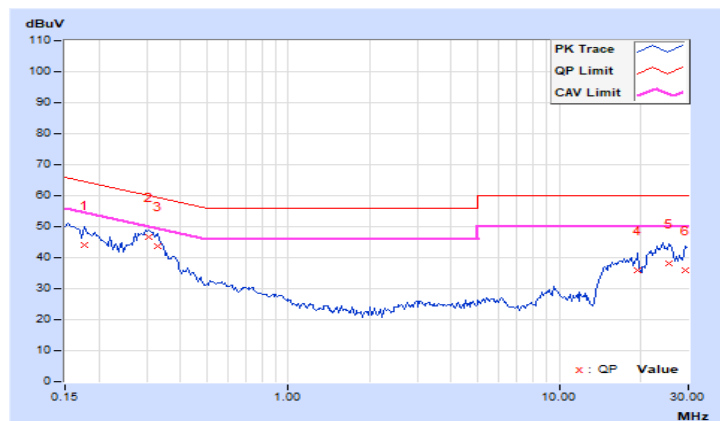

4.3 Transmit Power Measurement

4.3.1 Limits of Transmit Power Measurement

Operation Band	EUT Category		Limit
U-NII-1		Outdoor Access Point	1 Watt (30 dBm) (Max. e.i.r.p \leq 125mW(21 dBm) at any elevation angle above 30 degrees as measured from the horizon)
		Fixed point-to-point Access Point	1 Watt (30 dBm)
	√	Indoor Access Point	1 Watt (30 dBm)
		Client device	250mW (24 dBm)
U-NII-2A	√		250mW (24 dBm) or 11 dBm+10 log B*
U-NII-2C	√		250mW (24 dBm) or 11 dBm+10 log B*
U-NII-3	√		1 Watt (30 dBm)

*B is the 26 dB emission bandwidth in megahertz

Per KDB 662911 Method of conducted output power measurement on IEEE 802.11 devices,

Array Gain = 0 dB (i.e., no array gain) for $N_{ANT} \leq 4$;

Array Gain = 0 dB (i.e., no array gain) for channel widths ≥ 40 MHz for any N_{ANT} ;

Array Gain = $5 \log(N_{ANT}/N_{SS})$ dB or 3 dB, whichever is less for 20-MHz channel widths with $N_{ANT} \geq 5$.

For power measurements on all other devices: Array Gain = $10 \log(N_{ANT}/N_{SS})$ dB.

4.3.2 Test Setup

FOR POWER OUTPUT MEASUREMENT

For channel straddling 5250MHz & channel straddling 5725MHz:

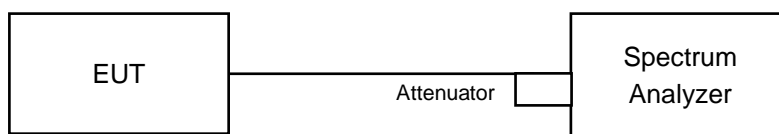

For other channels:

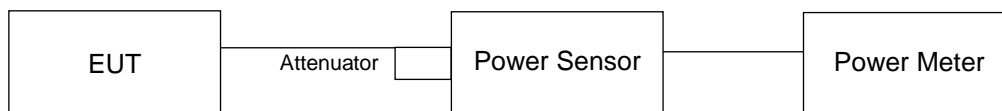

FOR 26dB OCCUPIED BANDWIDTH

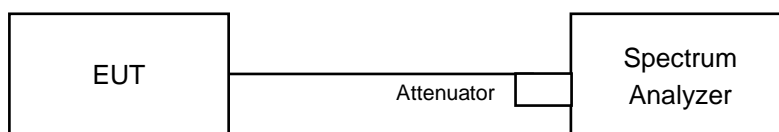

4.3.3 Test Instruments

Refer to section 4.1.2 to get information of above instrument.

4.3.4 Test Procedure

FOR POWER OUTPUT MEASUREMENT

For channel straddling 5725MHz:

Follow FCC KDB 789033 UNII test procedure:

Method SA-1

1. Set span to encompass the entire emission bandwidth (EBW) of the signal.
2. Set RBW =1MHz.
3. Set the VBW $\geq 3 \times$ RBW.
4. Number of points in sweep ≥ 2 Span / RBW.
5. Sweep time = auto.
6. Set trigger to free run (duty cycle ≥ 98 percent)
7. Detector = RMS.
8. Trace average at least 100 traces in power averaging mode
9. Compute power by integrating the spectrum across the 26 dB EBW of the signal.

For channel straddling 5250MHz

Follow FCC KDB 789033 UNII test procedure:

Method SA-2

1. Set span to encompass the emission bandwidth (EBW) of the signal.
2. Set RBW =1MHz.
3. Set the VBW $\geq 3 \times$ RBW.
4. Number of points in sweep ≥ 2 Span / RBW.
5. Sweep time = auto.
6. Detector = RMS.
7. Trace average at least 100 traces in power averaging mode
8. Compute power by integrating the spectrum across the 26 dB EBW of the signal.
9. Duty factor need added to measured value (duty cycle < 98 percent).

For other channels:

Method PM is used to perform output power measurement, trigger and gating function of wide band power meter is enabled to measure max output power of TX on burst. Duty factor is not added to measured value.

FOR 26dB OCCUPIED BANDWIDTH

1. Set RBW = approximately 1% of the emission bandwidth.
2. Set the VBW $>$ RBW.
3. Detector = Peak.
4. Trace mode = max hold.
5. Measure the maximum width of the emission that is 26 dB down from the peak of the emission. Compare this with the RBW setting of the analyzer. Readjust RBW and repeat measurement as needed until the RBW/EBW ratio is approximately 1%.

4.3.5 Deviation from Test Standard

No deviation.

4.3.6 EUT Operating Condition

The software provided by client to enable the EUT under transmission condition continuously at lowest, middle and highest channel frequencies individually.

4.3.7 Test Results

POWER OUTPUT

CDD Mode

802.11a

Chan.	Chan. Freq. (MHz)	Average Power (dBm)			Total Power (mW)	Total Power (dBm)	Limit (dBm)	Pass / Fail
		Chain 0	Chain 1	Chain 2				
36	5180	22.89	22.92	22.93	586.757	27.68	30.00	Pass
40	5200	22.77	23.05	23.43	611.364	27.86	30.00	Pass
48	5240	22.76	22.99	23.73	623.914	27.95	30.00	Pass
52	5260	17.32	17.82	15.99	154.204	21.88	24.00	Pass
60	5300	17.28	17.71	16.31	155.233	21.91	24.00	Pass
64	5320	17.23	17.66	15.95	150.544	21.78	24.00	Pass
100	5500	16.65	17.68	16.25	147.022	21.67	24.00	Pass
116	5580	16.47	16.79	16.55	137.299	21.38	24.00	Pass
140	5700	16.13	17.15	16.82	140.984	21.49	24.00	Pass
*144 (U-NII-2C Band)	5720	14.70	15.42	15.22	97.612	19.90	23.01	Pass
*144 (U-NII-3 Band)	5720	8.48	9.19	8.29	22.091	13.44	30.00	Pass
149	5745	23.28	23.74	24.35	721.676	28.58	30.00	Pass
157	5785	22.99	22.90	24.24	659.512	28.19	30.00	Pass
165	5825	22.97	23.02	24.17	659.816	28.19	30.00	Pass

Note: * Test was performed in accordance with Measurement follow FCC KDB 789033 UNII test procedure Method SA-1 and use spectrum analyzer test.

The Total Power for the straddle channel and power meter value for reference only:

Chan.	Chan. Freq. (MHz)	Total Power (mW)	Total Power (dBm)	Average Power (dBm)			Total Average Power (mW)	Total Average Power (dBm)
				Chain 0	Chain 1	Chain 2		
144	5720	119.703	20.78	16.64	16.97	16.70	142.679	21.54

Note: For U-NII-2A, U-NII-2C Band output power limitation is determined based on 26dBc bandwidth

Power Limit = 11dBm + 10logB < U-NII-2A, U-NII-2C >			
Channel Number	Freq.(MHz)	Min. B(MHz)	Determined Conducted Limit (dBm)
52	5260	21.66	24.35 > 24
60	5300	21.69	24.36 > 24
64	5320	21.66	24.35 > 24
100	5500	21.66	24.35 > 24
116	5580	21.69	24.36 > 24
140	5700	21.71	24.36 > 24
144 (U-NII-2C Band)	5720	15.92	23.01 < 24

802.11ac (VHT20)

Chan.	Chan. Freq. (MHz)	Average Power (dBm)			Total Power (mW)	Total Power (dBm)	Limit (dBm)	Pass / Fail
		Chain 0	Chain 1	Chain 2				
36	5180	21.39	21.64	22.42	458.185	26.61	30.00	Pass
40	5200	22.96	23.26	23.87	653.314	28.15	30.00	Pass
48	5240	22.98	23.19	23.84	649.161	28.12	30.00	Pass
52	5260	17.08	17.33	15.87	143.763	21.58	24.00	Pass
60	5300	17.04	17.35	15.62	141.383	21.50	24.00	Pass
64	5320	16.92	17.46	15.81	143.029	21.55	24.00	Pass
100	5500	16.29	16.48	16.50	131.691	21.20	24.00	Pass
116	5580	16.74	17.54	16.46	148.22	21.71	24.00	Pass
140	5700	16.76	17.73	16.21	148.5	21.72	24.00	Pass
*144 (U-NII-2C Band)	5720	14.59	15.14	13.87	85.811	19.34	23.00	Pass
*144 (U-NII-3 Band)	5720	8.35	9.87	8.75	24.043	13.81	30.00	Pass
149	5745	23.11	23.51	24.17	690.249	28.39	30.00	Pass
157	5785	23.35	23.22	24.03	679.096	28.32	30.00	Pass
165	5825	22.78	22.94	24.21	650.092	28.13	30.00	Pass

Note: * Test was performed in accordance with Measurement follow FCC KDB 789033 UNII test procedure Method SA-1 and use spectrum analyzer test.

The Total Power for the straddle channel and power meter value for reference only:

Chan.	Chan. Freq. (MHz)	Total Power (mW)	Total Power (dBm)	Average Power (dBm)			Total Average Power (mW)	Total Average Power (dBm)
				Chain 0	Chain 1	Chain 2		
144	5720	109.854	20.41	16.93	17.50	16.10	146.29	21.65

Note: For U-NII-2A, U-NII-2C Band output power limitation is determined based on 26dBc bandwidth

Power Limit = 11dBm + 10logB < U-NII-2A, U-NII-2C >			
Channel Number	Freq.(MHz)	Min. B(MHz)	Determined Conducted Limit (dBm)
52	5260	21.83	24.39 > 24
60	5300	21.8	24.38 > 24
64	5320	21.8	24.38 > 24
100	5500	21.81	24.38 > 24
116	5580	21.74	24.37 > 24
140	5700	21.84	24.39 > 24
144 (U-NII-2C Band)	5720	15.85	23 < 24

802.11ac (VHT40)

Chan.	Chan. Freq. (MHz)	Average Power (dBm)			Total Power (mW)	Total Power (dBm)	Limit (dBm)	Pass / Fail
		Chain 0	Chain 1	Chain 2				
38	5190	19.28	19.86	20.48	293.237	24.67	30.00	Pass
46	5230	22.85	22.74	23.64	611.891	27.87	30.00	Pass
54	5270	17.48	17.30	16.36	152.93	21.84	24.00	Pass
62	5310	17.57	17.52	16.32	156.496	21.95	24.00	Pass
102	5510	17.16	17.76	16.94	161.134	22.07	24.00	Pass
110	5550	17.05	18.29	16.75	165.467	22.19	24.00	Pass
134	5670	16.23	17.86	16.94	152.501	21.83	24.00	Pass
*142 (U-NII-2C Band)	5710	14.61	16.74	15.39	110.707	20.44	24.00	Pass
*142 (U-NII-3 Band)	5710	4.62	6.51	5.10	10.61	10.26	30.00	Pass
151	5755	24.30	22.87	23.99	713.407	28.53	30.00	Pass
159	5795	24.14	22.90	23.65	686.142	28.36	30.00	Pass

Note: * Test was performed in accordance with Measurement follow FCC KDB 789033 UNII test procedure Method SA-1 and use spectrum analyzer test.

The Total Power for the straddle channel and power meter value for reference only:

Chan.	Chan. Freq. (MHz)	Total Power (mW)	Total Power (dBm)	Average Power (dBm)			Total Average Power (mW)	Total Average Power (dBm)
				Chain 0	Chain 1	Chain 2		
142	5710	121.317	20.84	16.21	17.94	17.04	154.596	21.89

Note: For U-NII-2A, U-NII-2C Band output power limitation is determined based on 26dBc bandwidth

Power Limit = 11dBm + 10logB < U-NII-2A, U-NII-2C >			
Channel Number	Freq.(MHz)	Min. B(MHz)	Determined Conducted Limit (dBm)
54	5270	41.15	27.14 > 24
62	5310	41.35	27.16 > 24
102	5510	41.27	27.15 > 24
110	5550	41.17	27.14 > 24
134	5670	41.39	27.16 > 24
142 (U-NII-2C Band)	5710	35.51	26.5 > 24

802.11ac (VHT80)

Chan.	Chan. Freq. (MHz)	Average Power (dBm)			Total Power (mW)	Total Power (dBm)	Limit (dBm)	Pass / Fail
		Chain 0	Chain 1	Chain 2				
42	5210	20.07	20.07	20.16	307.003	24.87	30.00	Pass
58	5290	17.29	17.33	15.84	146.026	21.64	24.00	Pass
106	5530	16.28	17.83	16.61	148.95	21.73	24.00	Pass
122	5610	16.65	17.90	16.95	157.443	21.97	24.00	Pass
*138 (U-NII-2C Band)	5690	15.23	17.25	15.50	121.912	20.86	24.00	Pass
*138 (U-NII-3 Band)	5690	1.08	3.72	1.54	5.063	7.04	30.00	Pass
155	5775	23.83	23.07	24.02	696.662	28.43	30.00	Pass

Note: * Test was performed in accordance with Measurement follow FCC KDB 789033 UNII test procedure Method SA-1 and use spectrum analyzer test.

The Total Power for the straddle channel and power meter value for reference only:

Chan.	Chan. Freq. (MHz)	Total Power (mW)	Total Power (dBm)	Average Power (dBm)			Total Average Power (mW)	Total Average Power (dBm)
				Chain 0	Chain 1	Chain 2		
138	5690	126.975	21.04	16.52	18.18	16.66	156.985	21.96

Note: For U-NII-2A, U-NII-2C Band output power limitation is determined based on 26dBc bandwidth

Power Limit = 11dBm + 10logB < U-NII-2A, U-NII-2C >			
Channel Number	Freq.(MHz)	Min. B(MHz)	Determined Conducted Limit (dBm)
58	5290	82.45	30.16 > 24
106	5530	82.67	30.17 > 24
122	5610	82.59	30.16 > 24
138 (U-NII-2C Band)	5690	76.2	29.81 > 24

802.11ac (VHT160)

Chan.	Chan. Freq. (MHz)	Average Power (dBm)			Total Power (mW)	Total Power (dBm)	Limit (dBm)	Pass / Fail
		Chain 0	Chain 1	Chain 2				
*50 (U-NII-1 Band)	5250	9.83	9.56	9.09	30.338	14.82	30.00	Pass
*50 (U-NII-2A Band)	5250	10.07	9.85	9.10	31.686	15.01	24.00	Pass
114	5570	16.93	17.79	16.26	151.702	21.81	24.00	Pass

Note: * Test was performed in accordance with Measurement follow FCC KDB 789033 UNII test procedure Method SA-2 and use spectrum analyzer test.

The Total Power for the straddle channel and power meter value for reference only:

Chan.	Chan. Freq. (MHz)	Total Power (mW)	Total Power (dBm)	Average Power (dBm)			Total Average Power (mW)	Total Average Power (dBm)
				Chain 0	Chain 1	Chain 2		
50	5250	62.024	17.93	17.69	17.93	16.22	162.715	22.11

Note: For U-NII-2A, U-NII-2C Band output power limitation is determined based on 26dBc bandwidth

Power Limit = 11dBm + 10logB < U-NII-2A, U-NII-2C >			
Channel Number	Freq.(MHz)	Min. B(MHz)	Determined Conducted Limit (dBm)
50 (U-NII-2A Band)	5250	81.64	30.11 > 24
114	5570	163.14	33.12 > 24

802.11ax (HE20)

Chan.	Chan. Freq. (MHz)	Average Power (dBm)			Total Power (mW)	Total Power (dBm)	Limit (dBm)	Pass / Fail
		Chain 0	Chain 1	Chain 2				
36	5180	21.42	21.78	22.49	466.755	26.69	30.00	Pass
40	5200	23.03	23.31	23.94	662.941	28.21	30.00	Pass
48	5240	23.18	23.36	24.00	675.929	28.30	30.00	Pass
52	5260	17.31	17.49	15.90	148.836	21.73	24.00	Pass
60	5300	17.19	17.52	15.83	147.136	21.68	24.00	Pass
64	5320	17.07	17.54	15.99	147.407	21.69	24.00	Pass
100	5500	16.48	16.76	16.70	138.661	21.42	24.00	Pass
116	5580	16.92	17.61	16.62	152.8	21.84	24.00	Pass
140	5700	16.96	17.86	16.39	154.305	21.88	24.00	Pass
*144 (U-NII-2C Band)	5720	14.71	15.38	14.00	89.213	19.50	23.00	Pass
*144 (U-NII-3 Band)	5720	8.59	10.02	9.00	25.217	14.02	30.00	Pass
149	5745	23.30	23.71	24.21	712.393	28.53	30.00	Pass
157	5785	23.56	23.37	24.22	708.497	28.50	30.00	Pass
165	5825	22.97	23.06	24.23	665.305	28.23	30.00	Pass

Note: * Test was performed in accordance with Measurement follow FCC KDB 789033 UNII test procedure Method SA-1 and use spectrum analyzer test.

The Total Power for the straddle channel and power meter value for reference only:

Chan.	Chan. Freq. (MHz)	Total Power (mW)	Total Power (dBm)	Average Power (dBm)			Total Average Power (mW)	Total Average Power (dBm)
				Chain 0	Chain 1	Chain 2		
144	5720	114.43	20.59	17.06	17.60	16.24	150.433	21.77

Note: For U-NII-2A, U-NII-2C Band output power limitation is determined based on 26dBc bandwidth

Power Limit = 11dBm + 10logB < U-NII-2A, U-NII-2C >			
Channel Number	Freq.(MHz)	Min. B(MHz)	Determined Conducted Limit (dBm)
52	5260	21.83	24.39 > 24
60	5300	21.8	24.38 > 24
64	5320	21.8	24.38 > 24
100	5500	21.81	24.38 > 24
116	5580	21.74	24.37 > 24
140	5700	21.84	24.39 > 24
144 (U-NII-2C Band)	5720	15.85	23 < 24

802.11ax (HE40)

Chan.	Chan. Freq. (MHz)	Average Power (dBm)			Total Power (mW)	Total Power (dBm)	Limit (dBm)	Pass / Fail
		Chain 0	Chain 1	Chain 2				
38	5190	19.38	20.00	20.60	301.512	24.79	30.00	Pass
46	5230	22.97	22.78	23.75	624.961	27.96	30.00	Pass
54	5270	17.56	17.40	16.54	157.052	21.96	24.00	Pass
62	5310	17.75	17.62	16.53	162.354	22.10	24.00	Pass
102	5510	17.27	18.02	17.14	168.481	22.27	24.00	Pass
110	5550	17.31	18.42	16.87	171.97	22.35	24.00	Pass
134	5670	16.46	18.13	17.12	160.795	22.06	24.00	Pass
*142 (U-NII-2C Band)	5710	14.76	16.90	15.57	114.958	20.61	24.00	Pass
*142 (U-NII-3 Band)	5710	4.76	6.80	5.25	11.128	10.46	30.00	Pass
151	5755	24.43	22.98	24.10	732.981	28.65	30.00	Pass
159	5795	24.37	23.07	23.82	717.286	28.56	30.00	Pass

Note: * Test was performed in accordance with Measurement follow FCC KDB 789033 UNII test procedure Method SA-1 and use spectrum analyzer test.

The Total Power for the straddle channel and power meter value for reference only:

Chan.	Chan. Freq. (MHz)	Total Power (mW)	Total Power (dBm)	Average Power (dBm)			Total Average Power (mW)	Total Average Power (dBm)
				Chain 0	Chain 1	Chain 2		
142	5710	126.086	21.01	16.42	18.05	17.18	159.919	22.04

Note: For U-NII-2A, U-NII-2C Band output power limitation is determined based on 26dBc bandwidth

Power Limit = 11dBm + 10logB < U-NII-2A, U-NII-2C >			
Channel Number	Freq.(MHz)	Min. B(MHz)	Determined Conducted Limit (dBm)
54	5270	41.15	27.14 > 24
62	5310	41.35	27.16 > 24
102	5510	41.27	27.15 > 24
110	5550	41.17	27.14 > 24
134	5670	41.39	27.16 > 24
142 (U-NII-2C Band)	5710	35.51	26.5 > 24

802.11ax (HE80)

Chan.	Chan. Freq. (MHz)	Average Power (dBm)			Total Power (mW)	Total Power (dBm)	Limit (dBm)	Pass / Fail
		Chain 0	Chain 1	Chain 2				
42	5210	20.19	20.33	20.35	320.759	25.06	30.00	Pass
58	5290	17.39	17.47	16.14	151.79	21.81	24.00	Pass
106	5530	16.48	17.94	16.81	154.667	21.89	24.00	Pass
122	5610	16.89	18.13	17.21	166.48	22.21	24.00	Pass
*138 (U-NII-2C Band)	5690	15.35	17.35	15.84	126.973	21.04	24.00	Pass
*138 (U-NII-3 Band)	5690	1.35	4.06	1.84	5.439	7.36	30.00	Pass
155	5775	23.92	23.10	24.07	706.048	28.49	30.00	Pass

Note: * Test was performed in accordance with Measurement follow FCC KDB 789033 UNII test procedure Method SA-1 and use spectrum analyzer test.

The Total Power for the straddle channel and power meter value for reference only:

Chan.	Chan. Freq. (MHz)	Total Power (mW)	Total Power (dBm)	Average Power (dBm)			Total Average Power (mW)	Total Average Power (dBm)
				Chain 0	Chain 1	Chain 2		
138	5690	132.412	21.22	16.70	18.43	16.94	165.867	22.20

Note: For U-NII-2A, U-NII-2C Band output power limitation is determined based on 26dBc bandwidth

Power Limit = 11dBm + 10logB < U-NII-2A, U-NII-2C >			
Channel Number	Freq.(MHz)	Min. B(MHz)	Determined Conducted Limit (dBm)
58	5290	82.45	30.16 > 24
106	5530	82.67	30.17 > 24
122	5610	82.59	30.16 > 24
138 (U-NII-2C Band)	5690	76.2	29.81 > 24

802.11ax (HE160)

Chan.	Chan. Freq. (MHz)	Average Power (dBm)			Total Power (mW)	Total Power (dBm)	Limit (dBm)	Pass / Fail
		Chain 0	Chain 1	Chain 2				
*50 (U-NII-1 Band)	5250	10.02	9.89	9.21	31.892	15.04	30.00	Pass
*50 (U-NII-2A Band)	5250	10.39	10.05	9.44	33.834	15.29	24.00	Pass
114	5570	17.06	17.94	16.48	157.509	21.97	24.00	Pass

Note: * Test was performed in accordance with Measurement follow FCC KDB 789033 UNII test procedure Method SA-2 and use spectrum analyzer test.

The Total Power for the straddle channel and power meter value for reference only:

Chan.	Chan. Freq. (MHz)	Total Power (mW)	Total Power (dBm)	Average Power (dBm)			Total Average Power (mW)	Total Average Power (dBm)
				Chain 0	Chain 1	Chain 2		
50	5250	65.726	18.18	17.87	17.95	16.35	166.76	22.22

Note: For U-NII-2A, U-NII-2C Band output power limitation is determined based on 26dBc bandwidth

Power Limit = 11dBm + 10logB < U-NII-2A, U-NII-2C >			
Channel Number	Freq.(MHz)	Min. B(MHz)	Determined Conducted Limit (dBm)
50 (U-NII-2A Band)	5250	81.64	30.11 > 24
114	5570	163.14	33.12 > 24

Beamforming Mode

802.11ac (VHT20)

Chan.	Chan. Freq. (MHz)	Average Power (dBm)			Total Power (mW)	Total Power (dBm)	Limit (dBm)	Pass / Fail
		Chain 0	Chain 1	Chain 2				
36	5180	21.18	21.49	22.41	446.33	26.50	29.86	Pass
40	5200	22.57	22.67	23.42	585.43	27.67	29.86	Pass
48	5240	22.60	22.73	23.43	589.762	27.71	29.86	Pass
52	5260	17.06	17.19	15.87	141.813	21.52	23.74	Pass
60	5300	16.91	17.34	15.62	139.766	21.45	23.74	Pass
64	5320	16.81	17.46	15.86	142.24	21.53	23.74	Pass
100	5500	16.25	16.57	16.65	133.802	21.26	23.67	Pass
116	5580	16.51	17.34	16.13	139.992	21.46	23.67	Pass
140	5700	16.64	17.49	15.98	141.864	21.52	23.67	Pass
*144 (U-NII-2C Band)	5720	14.18	14.88	13.49	79.279	18.99	22.67	Pass
*144 (U-NII-3 Band)	5720	7.92	9.47	8.40	21.964	13.42	29.71	Pass
149	5745	22.02	22.47	23.04	537.197	27.30	29.71	Pass
157	5785	22.24	22.26	23.00	535.288	27.29	29.71	Pass
165	5825	21.89	21.81	23.08	509.466	27.07	29.71	Pass

Note: * Test was performed in accordance with Measurement follow FCC KDB 789033 UNII test procedure Method SA-1 and use spectrum analyzer test.

1. For UNII-1: Directional gain = 6.14dBi > 6dBi , so the power limit shall be reduced to $30-(6.14-6) = 29.86\text{dBm}$.
2. For UNII-2A: Directional gain = 6.26 dBi > 6 dBi, therefore the limit needs to reduce, so the power limit shall be reduced to "Determined Conducted Limit-(6.26-6)". 24-0.
3. For UNII-2C: Directional gain = 6.33 dBi > 6 dBi, therefore the limit needs to reduce, so the power limit shall be reduced to "Determined Conducted Limit-(6.33-6)". 24-0.33
4. For UNII-3: Directional gain = 6.29dBi > 6dBi , so the power limit shall be reduced to $30-(6.29-6) = 29.71\text{dBm}$.

The Total Power for the straddle channel and power meter value for reference only:

Chan.	Chan. Freq. (MHz)	Total Power (mW)	Total Power (dBm)	Average Power (dBm)			Total Average Power (mW)	Total Average Power (dBm)
				Chain 0	Chain 1	Chain 2		
144	5720	101.243	20.05	16.53	17.33	15.97	138.59	21.42

Note: For U-NII-2A, U-NII-2C Band output power limitation is determined based on 26dBc bandwidth

Power Limit = 11dBm + 10logB < U-NII-2A, U-NII-2C >			
Channel Number	Freq.(MHz)	Min. B(MHz)	Determined Conducted Limit (dBm)
52	5260	21.83	24.39 > 24
60	5300	21.8	24.38 > 24
64	5320	21.8	24.38 > 24
100	5500	21.81	24.38 > 24
116	5580	21.74	24.37 > 24
140	5700	21.84	24.39 > 24
144 (U-NII-2C Band)	5720	15.85	23 < 24

802.11ac (VHT40)

Chan.	Chan. Freq. (MHz)	Average Power (dBm)			Total Power (mW)	Total Power (dBm)	Limit (dBm)	Pass / Fail
		Chain 0	Chain 1	Chain 2				
38	5190	19.38	19.66	20.49	291.11	24.64	29.86	Pass
46	5230	22.77	22.34	23.49	583.987	27.66	29.86	Pass
54	5270	17.41	17.07	16.23	147.99	21.70	23.74	Pass
62	5310	17.31	17.00	15.78	141.79	21.52	23.74	Pass
102	5510	16.75	17.47	16.49	147.728	21.69	23.67	Pass
110	5550	16.64	17.73	16.15	146.634	21.66	23.67	Pass
134	5670	15.69	17.24	16.42	133.887	21.27	23.67	Pass
*142 (U-NII-2C Band)	5710	14.21	16.49	14.97	102.334	20.10	23.67	Pass
*142 (U-NII-3 Band)	5710	4.27	6.06	4.57	9.574	9.81	29.71	Pass
151	5755	23.18	21.66	22.75	542.889	27.35	29.71	Pass
159	5795	23.04	21.70	22.77	538.518	27.31	29.71	Pass

Note: * Test was performed in accordance with Measurement follow FCC KDB 789033 UNII test procedure Method SA-1 and use spectrum analyzer test.

1. For UNII-1: Directional gain = 6.14dBi > 6dBi , so the power limit shall be reduced to 30-(6.14-6) = 29.86dBm.
2. For UNII-2A: Directional gain = 6.26 dBi > 6 dBi, therefore the limit needs to reduce, so the power limit shall be reduced to "Determined Conducted Limit-(6.26-6)".
3. For UNII-2C: Directional gain = 6.33 dBi > 6 dBi, therefore the limit needs to reduce, so the power limit shall be reduced to "Determined Conducted Limit-(6.33-6)".
4. For UNII-3: Directional gain = 6.29dBi > 6dBi , so the power limit shall be reduced to 30-(6.29-6) = 29.71dBm.

The Total Power for the straddle channel and power meter value for reference only:

Chan.	Chan. Freq. (MHz)	Total Power (mW)	Total Power (dBm)	Average Power (dBm)			Total Average Power (mW)	Total Average Power (dBm)
				Chain 0	Chain 1	Chain 2		
142	5710	111.908	20.49	15.85	17.32	16.55	137.596	21.39

Note: For U-NII-2A, U-NII-2C Band output power limitation is determined based on 26dBc bandwidth

Power Limit = 11dBm + 10logB < U-NII-2A, U-NII-2C >			
Channel Number	Freq.(MHz)	Min. B(MHz)	Determined Conducted Limit (dBm)
54	5270	41.15	27.14 > 24
62	5310	41.35	27.16 > 24
102	5510	41.27	27.15 > 24
110	5550	41.17	27.14 > 24
134	5670	41.39	27.16 > 24
142 (U-NII-2C Band)	5710	35.51	26.5 > 24

802.11ac (VHT80)

Chan.	Chan. Freq. (MHz)	Average Power (dBm)			Total Power (mW)	Total Power (dBm)	Limit (dBm)	Pass / Fail
		Chain 0	Chain 1	Chain 2				
42	5210	20.08	19.96	20.03	301.636	24.79	29.86	Pass
58	5290	17.28	17.21	15.80	144.077	21.59	23.74	Pass
106	5530	16.17	17.57	16.52	143.422	21.57	23.67	Pass
122	5610	16.26	17.33	16.39	139.893	21.46	23.67	Pass
*138 (U-NII-2C Band)	5690	15.00	16.89	15.34	114.686	20.60	23.67	Pass
*138 (U-NII-3 Band)	5690	0.80	3.29	1.34	4.697	6.72	29.71	Pass
155	5775	23.23	21.77	22.61	543.082	27.35	29.71	Pass

Note: * Test was performed in accordance with Measurement follow FCC KDB 789033 UNII test procedure Method SA-1 and use spectrum analyzer test.

1. For UNII-1: Directional gain = 6.14dBi > 6dBi , so the power limit shall be reduced to 30-(6.14-6) = 29.86dBm.
2. For UNII-2A: Directional gain = 6.26 dBi > 6 dBi, therefore the limit needs to reduce, so the power limit shall be reduced to "Determined Conducted Limit-(6.26-6)".
3. For UNII-2C: Directional gain = 6.33 dBi > 6 dBi, therefore the limit needs to reduce, so the power limit shall be reduced to "Determined Conducted Limit-(6.33-6)".
4. For UNII-3: Directional gain = 6.29dBi > 6dBi , so the power limit shall be reduced to 30-(6.29-6) = 29.71dBm.

The Total Power for the straddle channel and power meter value for reference only:

Chan.	Chan. Freq. (MHz)	Total Power (mW)	Total Power (dBm)	Average Power (dBm)			Total Average Power (mW)	Total Average Power (dBm)
				Chain 0	Chain 1	Chain 2		
138	5690	119.383	20.77	16.01	17.55	16.06	137.152	21.37

Note: For U-NII-2A, U-NII-2C Band output power limitation is determined based on 26dBc bandwidth

Power Limit = 11dBm + 10logB < U-NII-2A, U-NII-2C >			
Channel Number	Freq.(MHz)	Min. B(MHz)	Determined Conducted Limit (dBm)
58	5290	82.45	30.16 > 24
106	5530	82.67	30.17 > 24
122	5610	82.59	30.16 > 24
138 (U-NII-2C Band)	5690	76.2	29.81 > 24

802.11ac (VHT160)

Chan.	Chan. Freq. (MHz)	Average Power (dBm)			Total Power (mW)	Total Power (dBm)	Limit (dBm)	Pass / Fail
		Chain 0	Chain 1	Chain 2				
*50 (U-NII-1 Band)	5250	9.39	9.22	8.77	27.863	14.45	29.86	Pass
*50 (U-NII-2A Band)	5250	9.79	9.44	8.62	29.016	14.63	23.74	Pass
114	5570	16.55	17.56	16.16	143.507	21.57	23.67	Pass

Note: * Test was performed in accordance with Measurement follow FCC KDB 789033 UNII test procedure Method SA-2 and use spectrum analyzer test.

1. For UNII-1: Directional gain = 6.14dBi > 6dBi , so the power limit shall be reduced to $30-(6.14-6) = 29.86\text{dBm}$.
2. For UNII-2A: Directional gain = 6.26 dBi > 6 dBi, therefore the limit needs to reduce, so the power limit shall be reduced to "Determined Conducted Limit-(6.26-6)".
3. For UNII-2C: Directional gain = 6.33 dBi > 6 dBi, therefore the limit needs to reduce, so the power limit shall be reduced to "Determined Conducted Limit-(6.33-6)".

The Total Power for the straddle channel and power meter value for reference only:

Chan.	Chan. Freq. (MHz)	Total Power (mW)	Total Power (dBm)	Average Power (dBm)			Total Average Power (mW)	Total Average Power (dBm)
				Chain 0	Chain 1	Chain 2		
50	5250	56.879	17.55	17.38	17.55	15.89	150.402	21.77

Note: For U-NII-2A, U-NII-2C Band output power limitation is determined based on 26dBc bandwidth

Power Limit = $11\text{dBm} + 10\log B < \text{U-NII-2A, U-NII-2C} >$			
Channel Number	Freq.(MHz)	Min. B(MHz)	Determined Conducted Limit (dBm)
50 (U-NII-2A Band)	5250	81.64	30.11 > 24
114	5570	163.1	33.12 > 24

802.11ax (HE20)

Chan.	Chan. Freq. (MHz)	Average Power (dBm)			Total Power (mW)	Total Power (dBm)	Limit (dBm)	Pass / Fail
		Chain 0	Chain 1	Chain 2				
36	5180	21.52	21.74	22.41	465.366	26.68	29.86	Pass
40	5200	22.73	23.00	23.46	608.845	27.85	29.86	Pass
48	5240	22.87	22.94	23.69	624.315	27.95	29.86	Pass
52	5260	17.21	17.59	16.03	150.1	21.76	23.74	Pass
60	5300	17.24	17.52	15.91	148.454	21.72	23.74	Pass
64	5320	17.00	17.67	15.88	147.323	21.68	23.74	Pass
100	5500	16.47	16.55	16.78	137.19	21.37	23.67	Pass
116	5580	16.75	17.44	16.33	145.731	21.64	23.67	Pass
140	5700	16.72	17.73	16.26	148.549	21.72	23.67	Pass
*144 (U-NII-2C Band)	5720	14.29	14.99	13.73	82.008	19.14	22.67	Pass
*144 (U-NII-3 Band)	5720	8.67	9.50	8.77	23.808	13.77	29.71	Pass
149	5745	22.26	22.75	23.21	566.044	27.53	29.71	Pass
157	5785	22.46	22.23	23.16	550.321	27.41	29.71	Pass
165	5825	22.07	22.04	23.22	530.914	27.25	29.71	Pass

Note: * Test was performed in accordance with Measurement follow FCC KDB 789033 UNII test procedure Method SA-1 and use spectrum analyzer test.

1. For UNII-1: Directional gain = 6.14dBi > 6dBi , so the power limit shall be reduced to 30-(6.14-6) = 29.86dBm.
2. For UNII-2A: Directional gain = 6.26 dBi > 6 dBi, therefore the limit needs to reduce, so the power limit shall be reduced to "Determined Conducted Limit-(6.26-6)".
3. For UNII-2C: Directional gain = 6.33 dBi > 6 dBi, therefore the limit needs to reduce, so the power limit shall be reduced to "Determined Conducted Limit-(6.33-6)".
4. For UNII-3: Directional gain = 6.29dBi > 6dBi , so the power limit shall be reduced to 30-(6.29-6) = 29.71dBm.

The Total Power for the straddle channel and power meter value for reference only:

Chan.	Chan. Freq. (MHz)	Total Power (mW)	Total Power (dBm)	Average Power (dBm)			Total Average Power (mW)	Total Average Power (dBm)
				Chain 0	Chain 1	Chain 2		
144	5720	105.816	20.25	16.73	17.47	16.03	143.031	21.55

Note: For U-NII-2A, U-NII-2C Band output power limitation is determined based on 26dBc bandwidth

Power Limit = 11dBm + 10logB < U-NII-2A, U-NII-2C >			
Channel Number	Freq.(MHz)	Min. B(MHz)	Determined Conducted Limit (dBm)
52	5260	21.83	24.39 > 24
60	5300	21.8	24.38 > 24
64	5320	21.8	24.38 > 24
100	5500	21.81	24.38 > 24
116	5580	21.74	24.37 > 24
140	5700	21.84	24.39 > 24
144 (U-NII-2C Band)	5720	15.85	23 < 24

802.11ax (HE40)

Chan.	Chan. Freq. (MHz)	Average Power (dBm)			Total Power (mW)	Total Power (dBm)	Limit (dBm)	Pass / Fail
		Chain 0	Chain 1	Chain 2				
38	5190	19.40	19.81	20.62	298.161	24.74	29.86	Pass
46	5230	22.77	22.60	23.60	600.291	27.78	29.86	Pass
54	5270	17.61	17.28	16.64	157.265	21.97	23.74	Pass
62	5310	17.46	17.35	16.01	149.946	21.76	23.74	Pass
102	5510	16.95	17.51	16.71	152.79	21.84	23.67	Pass
110	5550	16.79	18.01	16.39	154.545	21.89	23.67	Pass
134	5670	16.01	17.35	16.69	140.893	21.49	23.67	Pass
*142 (U-NII-2C Band)	5710	14.48	16.69	15.29	108.527	20.36	23.67	Pass
*142 (U-NII-3 Band)	5710	4.51	6.54	4.94	10.452	10.19	29.71	Pass
151	5755	23.41	21.89	23.01	573.792	27.59	29.71	Pass
159	5795	23.34	22.03	22.77	564.597	27.52	29.71	Pass

Note: * Test was performed in accordance with Measurement follow FCC KDB 789033 UNII test procedure Method SA-1 and use spectrum analyzer test.

1. For UNII-1: Directional gain = 6.14dBi > 6dBi , so the power limit shall be reduced to 30-(6.14-6) = 29.86dBm.
2. For UNII-2A: Directional gain = 6.26 dBi > 6 dBi, therefore the limit needs to reduce, so the power limit shall be reduced to “Determined Conducted Limit-(6.26-6)”.
3. For UNII-2C: Directional gain =6.33 dBi > 6 dBi, therefore the limit needs to reduce, so the power limit shall be reduced to “Determined Conducted Limit-(6.33-6)”.
4. For UNII-3: Directional gain = 6.29dBi > 6dBi , so the power limit shall be reduced to 30-(6.29-6) = 29.71dBm.

The Total Power for the straddle channel and power meter value for reference only:

Chan.	Chan. Freq. (MHz)	Total Power (mW)	Total Power (dBm)	Average Power (dBm)			Total Average Power (mW)	Total Average Power (dBm)
				Chain 0	Chain 1	Chain 2		
142	5710	118.979	20.75	16.02	17.60	16.75	144.854	21.61

Note: For U-NII-2A, U-NII-2C Band output power limitation is determined based on 26dBc bandwidth

Power Limit = 11dBm + 10logB < U-NII-2A, U-NII-2C >			
Channel Number	Freq.(MHz)	Min. B(MHz)	Determined Conducted Limit (dBm)
54	5270	41.15	27.14 > 24
62	5310	41.35	27.16 > 24
102	5510	41.27	27.15 > 24
110	5550	41.17	27.14 > 24
134	5670	41.39	27.16 > 24
142 (U-NII-2C Band)	5710	35.51	26.5 > 24

802.11ax (HE80)

Chan.	Chan. Freq. (MHz)	Average Power (dBm)			Total Power (mW)	Total Power (dBm)	Limit (dBm)	Pass / Fail
		Chain 0	Chain 1	Chain 2				
42	5210	20.22	20.33	20.36	321.733	25.07	29.86	Pass
58	5290	17.44	17.44	16.06	151.29	21.80	23.74	Pass
106	5530	16.28	17.57	16.58	145.109	21.62	23.67	Pass
122	5610	16.22	17.43	16.56	142.504	21.54	23.67	Pass
*138 (U-NII-2C Band)	5690	14.93	17.01	15.54	117.161	20.69	23.67	Pass
*138 (U-NII-3 Band)	5690	1.23	3.62	1.36	4.997	6.99	29.71	Pass
155	5775	23.34	21.95	22.85	565.202	27.52	29.71	Pass

Note: * Test was performed in accordance with Measurement follow FCC KDB 789033 UNII test procedure Method SA-1 and use spectrum analyzer test.

1. For UNII-1: Directional gain = 6.14dBi > 6dBi , so the power limit shall be reduced to 30-(6.14-6) = 29.86dBm.
2. For UNII-2A: Directional gain = 6.26 dBi > 6 dBi, therefore the limit needs to reduce, so the power limit shall be reduced to "Determined Conducted Limit-(6.26-6)".
3. For UNII-2C: Directional gain = 6.33 dBi > 6 dBi, therefore the limit needs to reduce, so the power limit shall be reduced to "Determined Conducted Limit-(6.33-6)".
4. For UNII-3: Directional gain = 6.29dBi > 6dBi , so the power limit shall be reduced to 30-(6.29-6) = 29.71dBm.

The Total Power for the straddle channel and power meter value for reference only:

Chan.	Chan. Freq. (MHz)	Total Power (mW)	Total Power (dBm)	Average Power (dBm)			Total Average Power (mW)	Total Average Power (dBm)
				Chain 0	Chain 1	Chain 2		
138	5690	122.158	20.87	16.15	17.69	16.46	144.218	21.59

Note: For U-NII-2A, U-NII-2C Band output power limitation is determined based on 26dBc bandwidth

Power Limit = 11dBm + 10logB < U-NII-2A, U-NII-2C >			
Channel Number	Freq.(MHz)	Min. B(MHz)	Determined Conducted Limit (dBm)
58	5290	82.45	30.16 > 24
106	5530	82.67	30.17 > 24
122	5610	82.59	30.16 > 24
138 (U-NII-2C Band)	5690	76.2	29.81 > 24

802.11ax (HE160)

Chan.	Chan. Freq. (MHz)	Average Power (dBm)			Total Power (mW)	Total Power (dBm)	Limit (dBm)	Pass / Fail
		Chain 0	Chain 1	Chain 2				
*50 (U-NII-1 Band)	5250	9.62	9.52	8.93	29.397	14.68	29.86	Pass
*50 (U-NII-2A Band)	5250	10.12	9.68	9.18	31.57	14.99	23.74	Pass
114	5570	16.80	17.66	16.11	147.039	21.67	23.67	Pass

Note: * Test was performed in accordance with Measurement follow FCC KDB 789033 UNII test procedure Method SA-2 and use spectrum analyzer test.

1. For UNII-1: Directional gain = 6.14dBi > 6dBi , so the power limit shall be reduced to $30-(6.14-6) = 29.86\text{dBm}$.
2. For UNII-2A: Directional gain = 6.26 dBi > 6 dBi, therefore the limit needs to reduce, so the power limit shall be reduced to "Determined Conducted Limit-(6.26-6)".
3. For UNII-2C: Directional gain = 6.33 dBi > 6 dBi, therefore the limit needs to reduce, so the power limit shall be reduced to "Determined Conducted Limit-(6.33-6)".

The Total Power for the straddle channel and power meter value for reference only:

Chan.	Chan. Freq. (MHz)	Total Power (mW)	Total Power (dBm)	Average Power (dBm)			Total Average Power (mW)	Total Average Power (dBm)
				Chain 0	Chain 1	Chain 2		
50	5250	60.967	17.85	17.46	17.51	15.91	151.077	21.79

Note: For U-NII-2A, U-NII-2C Band output power limitation is determined based on 26dBc bandwidth

Power Limit = $11\text{dBm} + 10\log B < \text{U-NII-2A, U-NII-2C} >$			
Channel Number	Freq.(MHz)	Min. B(MHz)	Determined Conducted Limit (dBm)
50 (U-NII-2A Band)	5250	81.64	30.11 > 24
114	5570	163.14	33.12 > 24

For channel straddling 5725MHz of Power
CDD Mode / Beamforming Mode

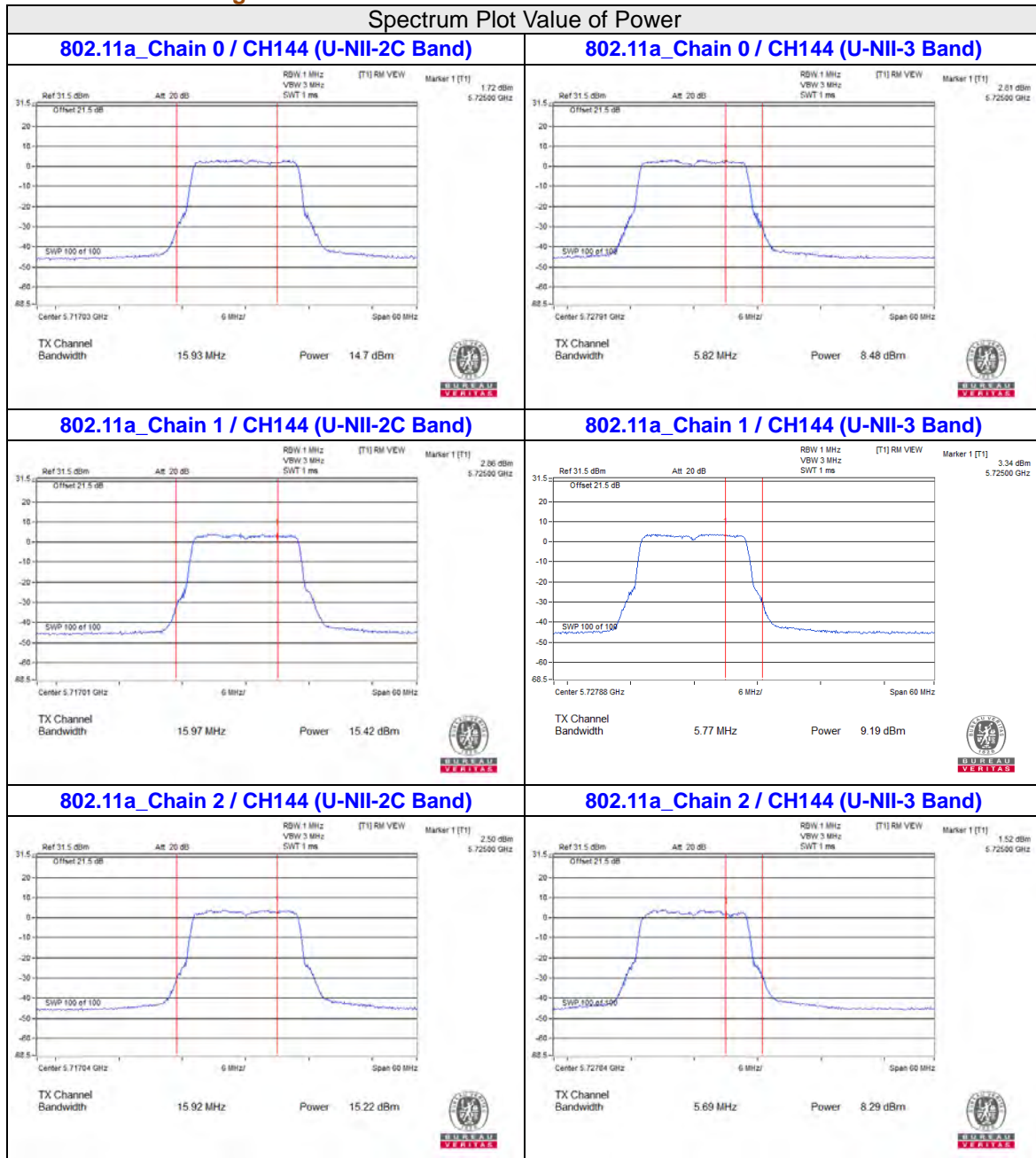

Spectrum Plot Value of Power

802.11ac (VHT20)_Chain 0 / CH144 (U-NII-2C Band) 802.11ac (VHT20)_Chain 0 / CH144 (U-NII-3 Band)

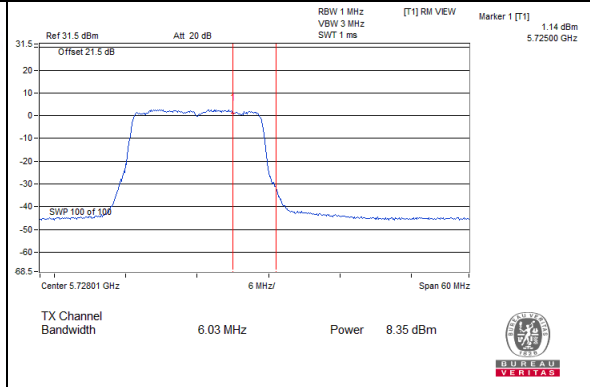
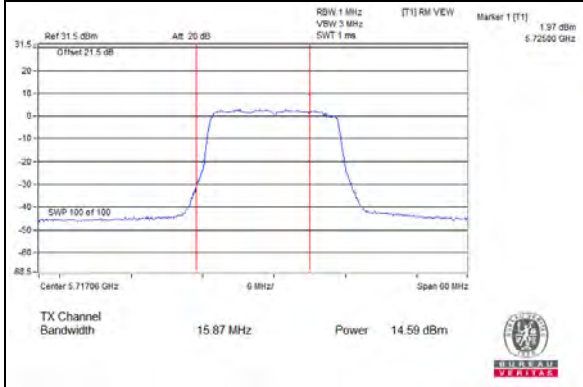

802.11ac (VHT20)_Chain 1 / CH144 (U-NII-2C Band) 802.11ac (VHT20)_Chain 1 / CH144 (U-NII-3 Band)

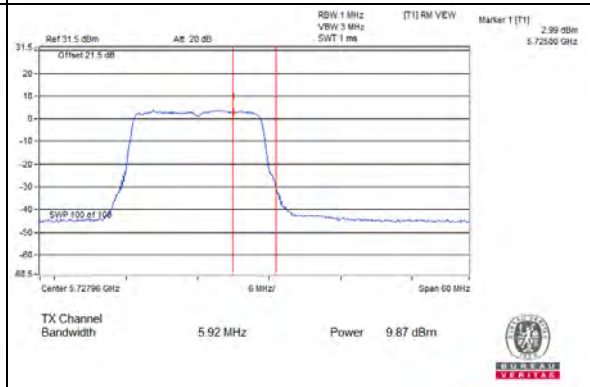
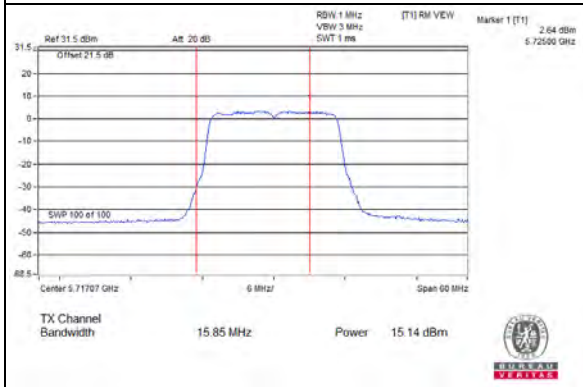

802.11ac (VHT20)_Chain 2 / CH144 (U-NII-2C Band) 802.11ac (VHT20)_Chain 2 / CH144 (U-NII-3 Band)

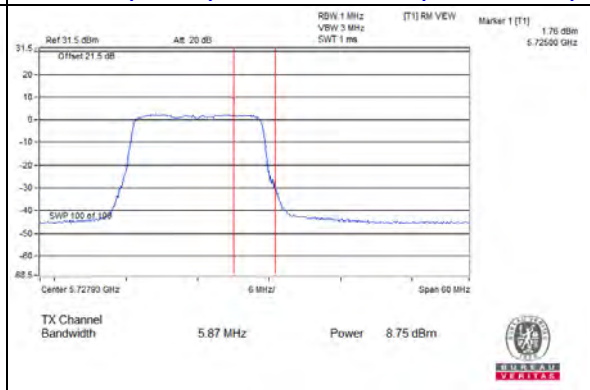
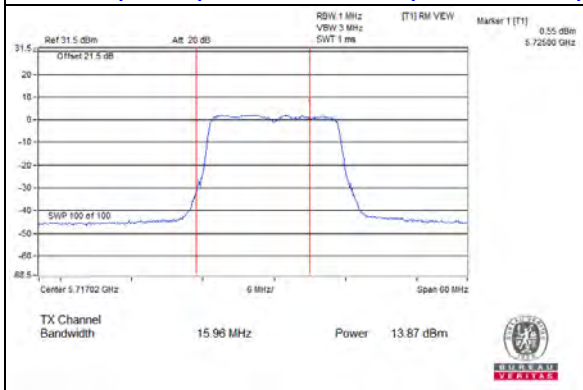

Spectrum Plot Value of Power

802.11ac (VHT40)_Chain 0 / CH142 (U-NII-2C Band) 802.11ac (VHT40)_Chain 0 / CH142 (U-NII-3 Band)

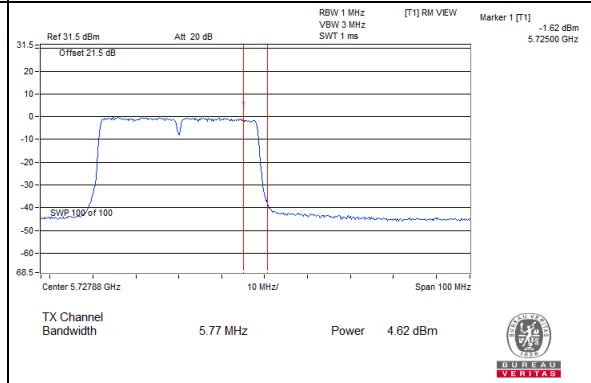
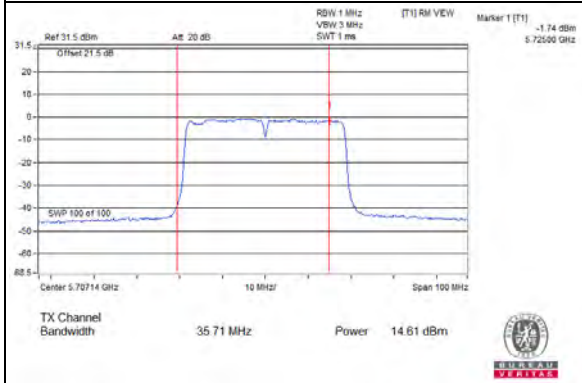

802.11ac (VHT40)_Chain 1 / CH142 (U-NII-2C Band) 802.11ac (VHT40)_Chain 1 / CH142 (U-NII-3 Band)

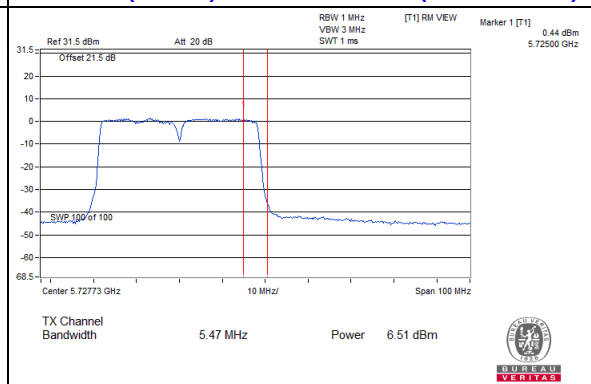
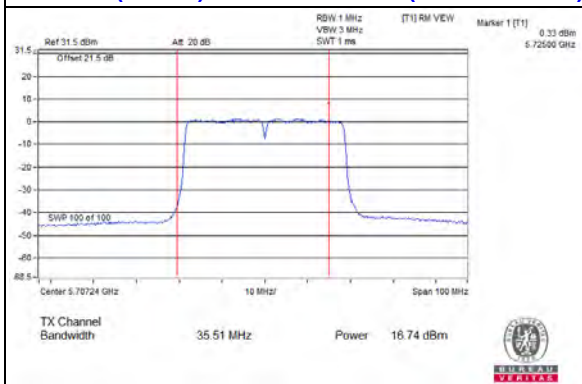

802.11ac (VHT40)_Chain 2 / CH142 (U-NII-2C Band) 802.11ac (VHT40)_Chain 2 / CH142 (U-NII-3 Band)

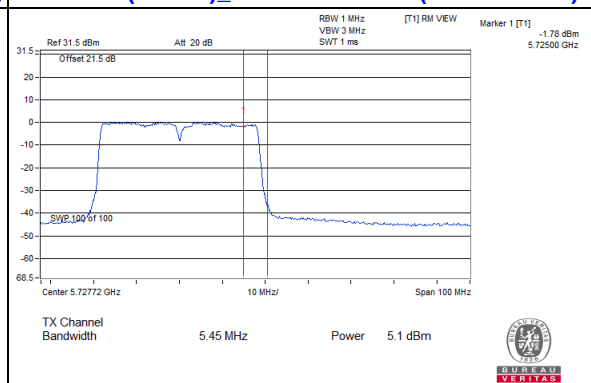
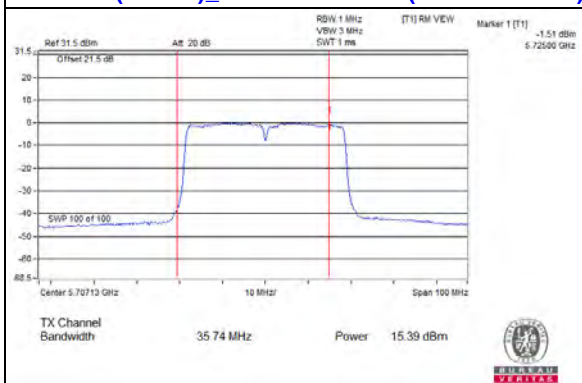

Spectrum Plot Value of Power

802.11ac (VHT80)_Chain 0 / CH138 (U-NII-2C Band) 802.11ac (VHT80)_Chain 0 / CH138 (U-NII-3 Band)

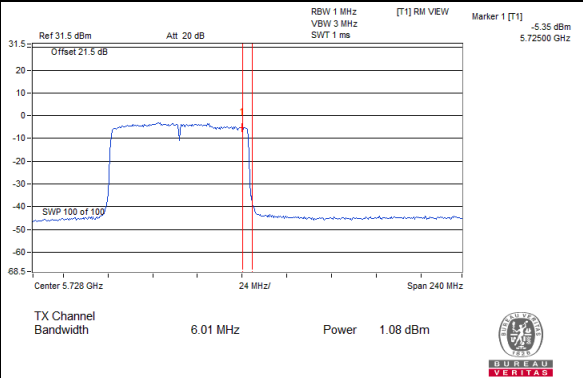
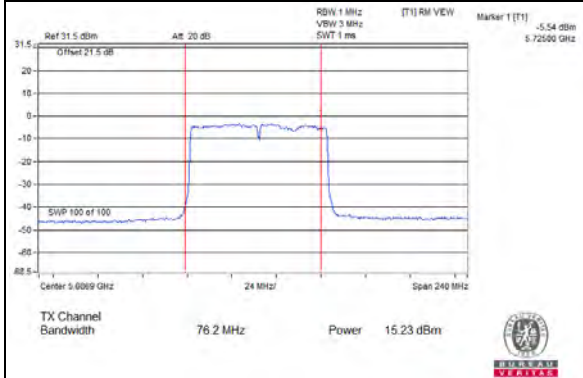

802.11ac (VHT80)_Chain 1 / CH138 (U-NII-2C Band) 802.11ac (VHT80)_Chain 1 / CH138 (U-NII-3 Band)

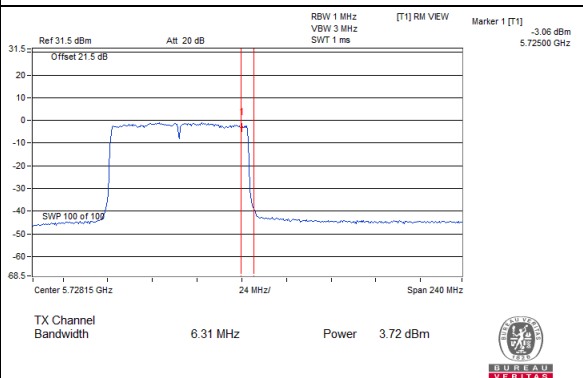
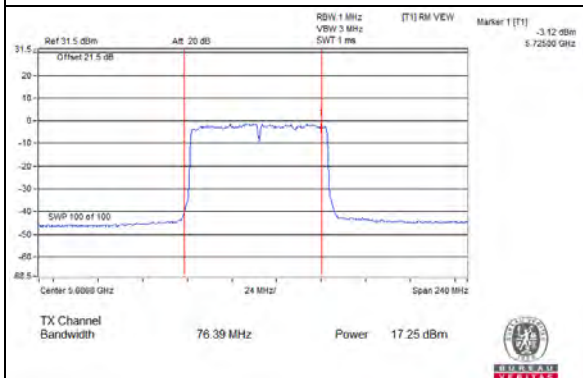

802.11ac (VHT80)_Chain 2 / CH138 (U-NII-2C Band) 802.11ac (VHT80)_Chain 2 / CH138 (U-NII-3 Band)

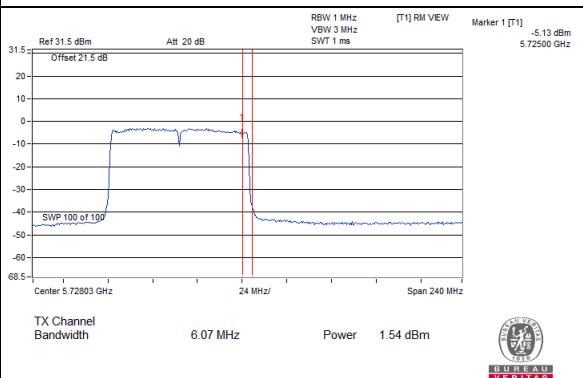
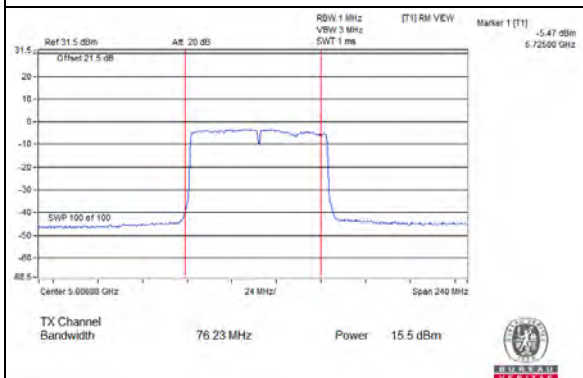



Spectrum Plot Value of Power

802.11ax (HE20)_Chain 0 / CH144 (U-NII-2C Band)

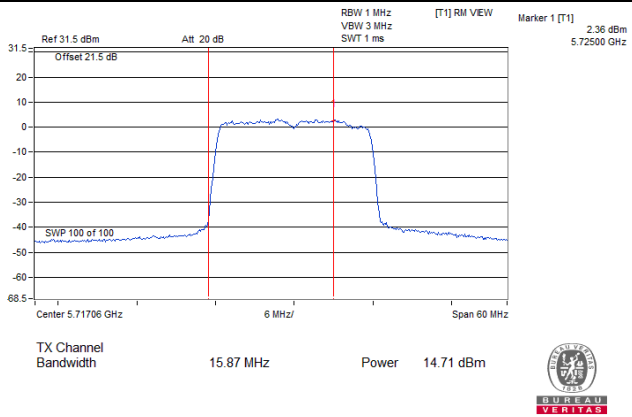

802.11ax (HE20)_Chain 0 / CH144 (U-NII-3 Band)

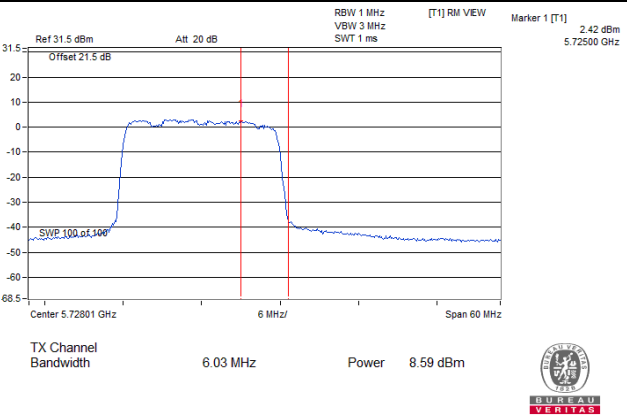

802.11ax (HE20)_Chain 1 / CH144 (U-NII-2C Band)

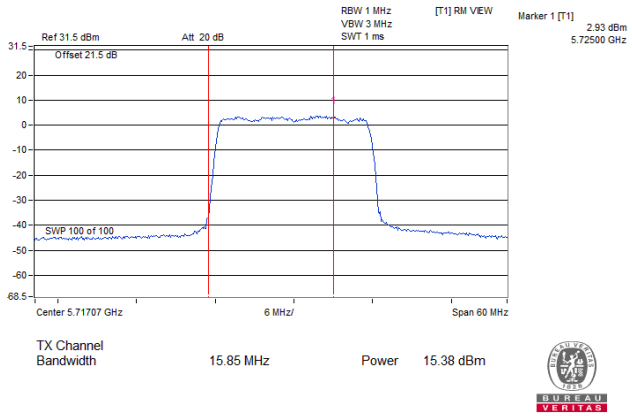

802.11ax (HE20)_Chain 1 / CH144 (U-NII-3 Band)

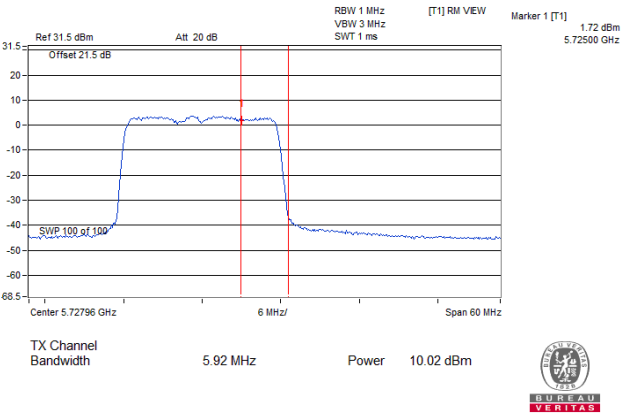

802.11ax (HE20)_Chain 2 / CH144 (U-NII-2C Band)

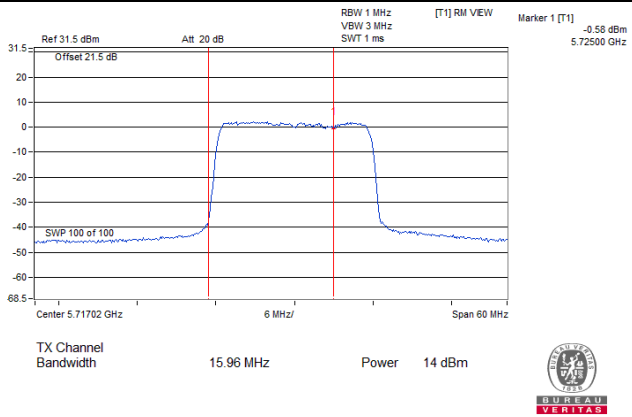

802.11ax (HE20)_Chain 2 / CH144 (U-NII-3 Band)

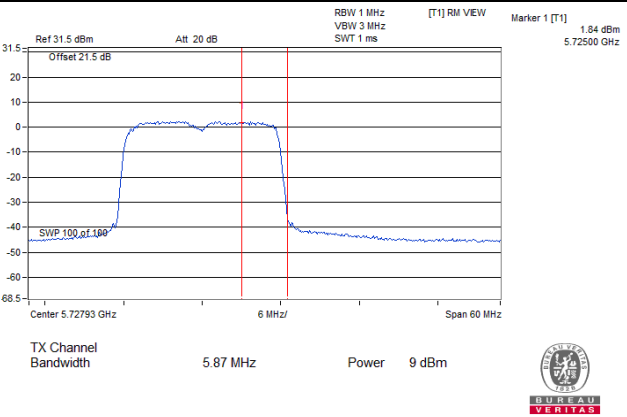

Spectrum Plot Value of Power

802.11ax (HE40)_Chain 0 / CH142 (U-NII-2C Band)

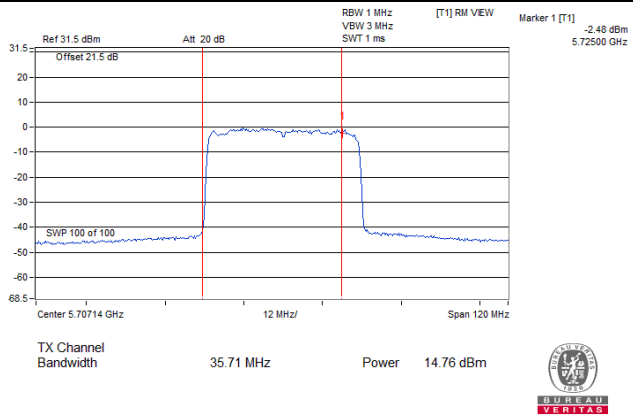

802.11ax (HE40)_Chain 0 / CH142 (U-NII-3 Band)

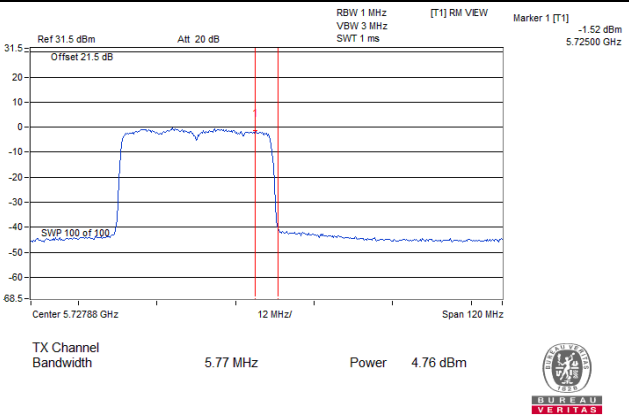

802.11ax (HE40)_Chain 1 / CH142 (U-NII-2C Band)

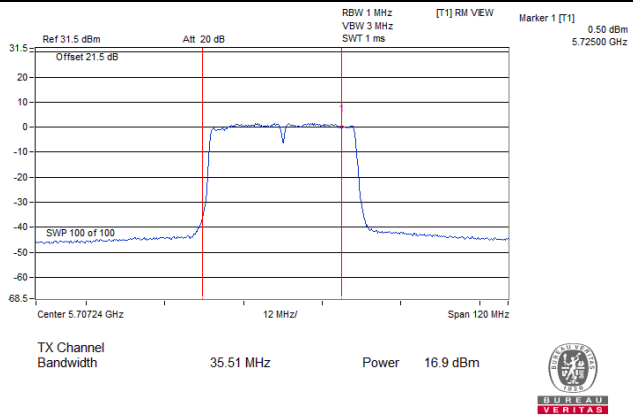

802.11ax (HE40)_Chain 1 / CH142 (U-NII-3 Band)

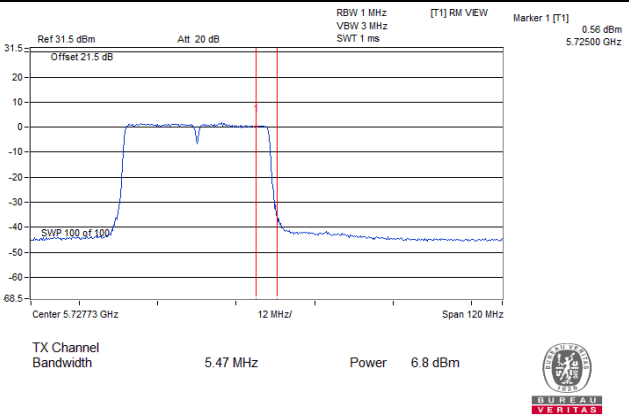

802.11ax (HE40)_Chain 2 / CH142 (U-NII-2C Band)

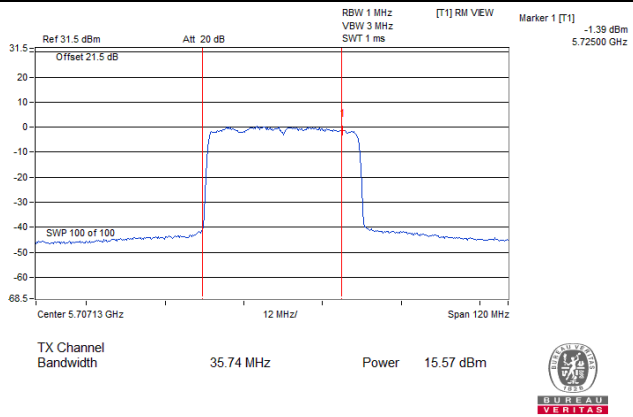

802.11ax (HE40)_Chain 2 / CH142 (U-NII-3 Band)

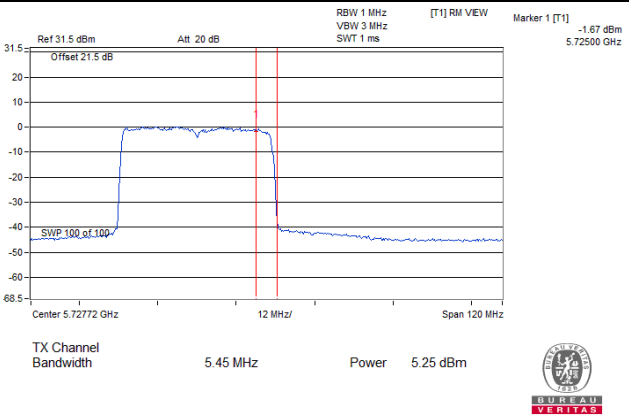

Spectrum Plot Value of Power

802.11ax (HE80)_Chain 0 / CH138 (U-NII-2C Band)

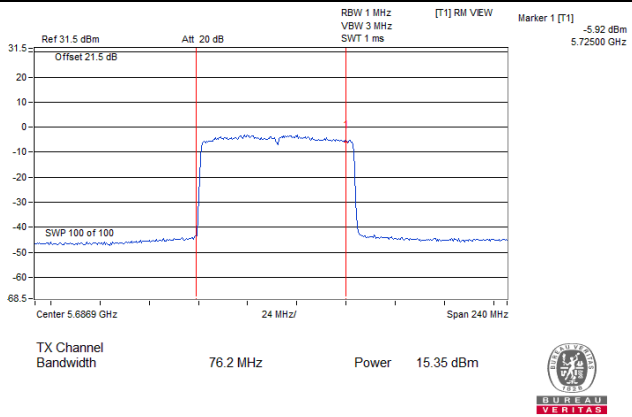

802.11ax (HE80)_Chain 0 / CH138 (U-NII-3 Band)

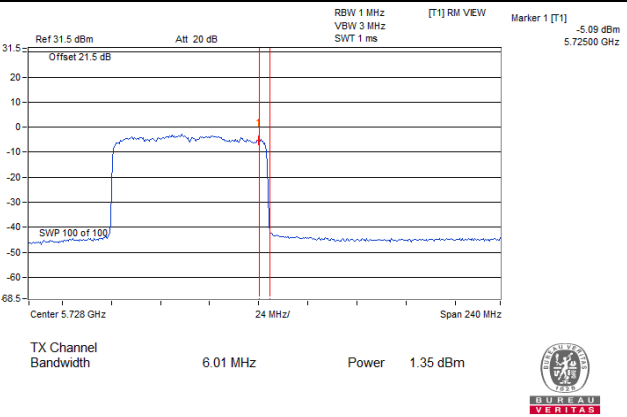

802.11ax (HE80)_Chain 1 / CH138 (U-NII-2C Band)

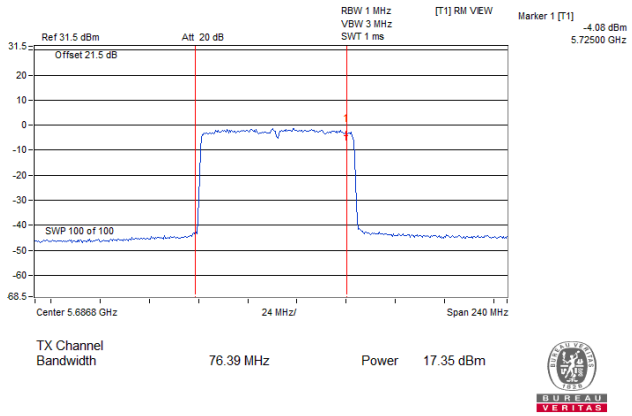

802.11ax (HE80)_Chain 1 / CH138 (U-NII-3 Band)

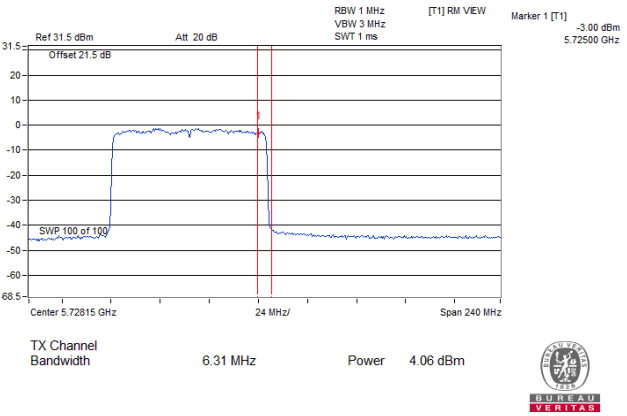

802.11ax (HE80)_Chain 2 / CH138 (U-NII-2C Band)

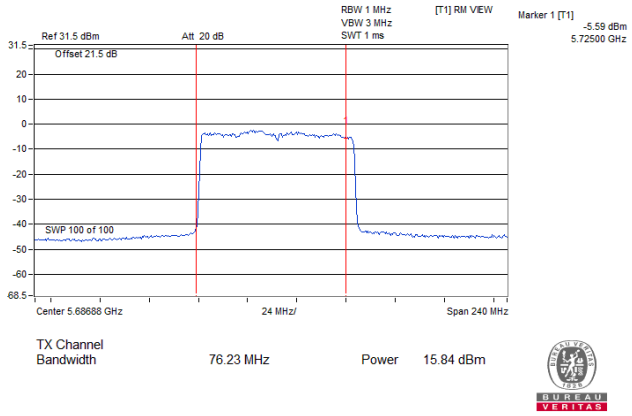

802.11ax (HE80)_Chain 2 / CH138 (U-NII-3 Band)

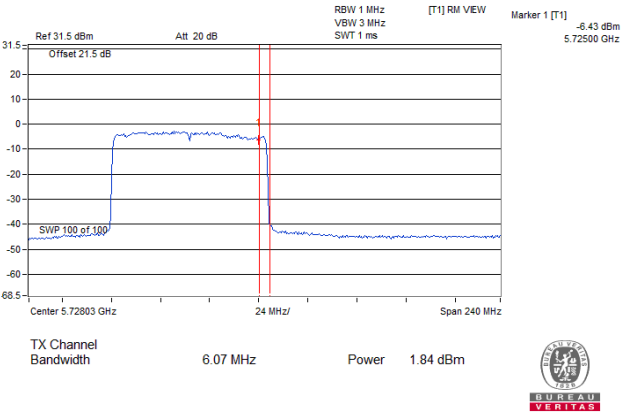

Spectrum Plot Value of Power

802.11ax (HE160)_Chain 0 / CH50 (U-NII-1 Band)

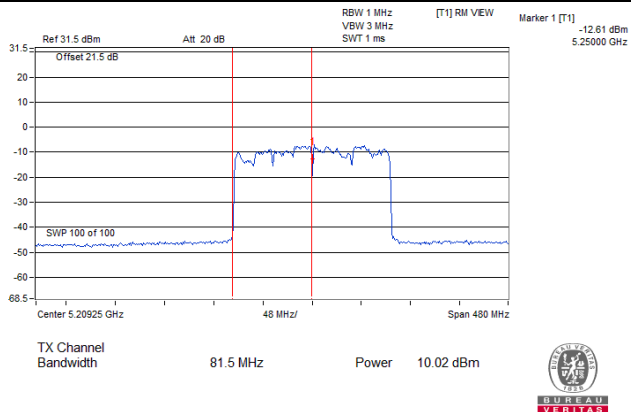

802.11ax (HE160)_Chain 0 / CH50 (U-NII-1 Band)

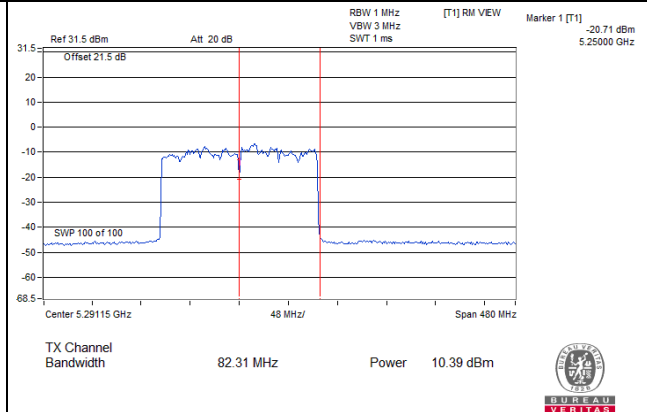

802.11ax (HE160)_Chain 1 / CH50 (U-NII-1 Band)

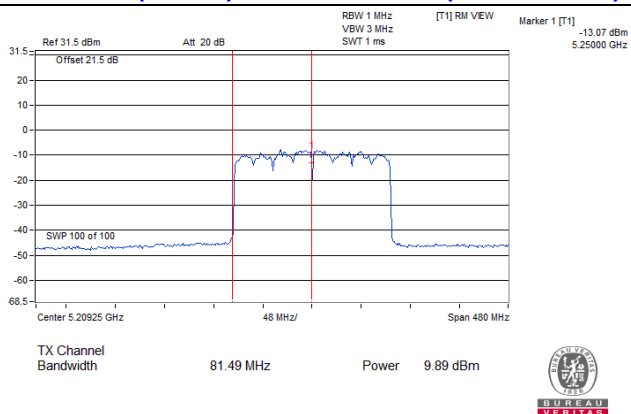

802.11ax (HE160)_Chain 1 / CH50 (U-NII-1 Band)

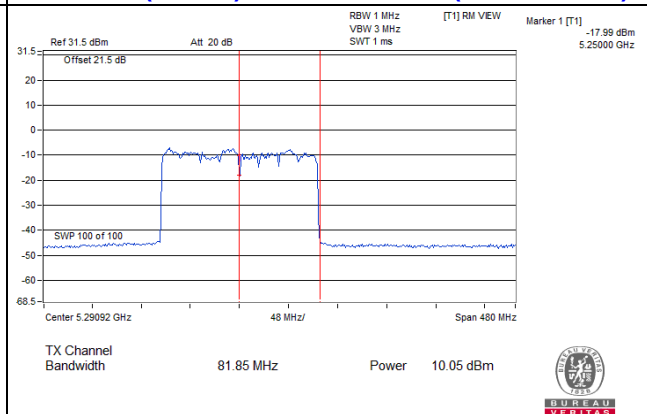

802.11ax (HE160)_Chain 2 / CH50 (U-NII-1 Band)

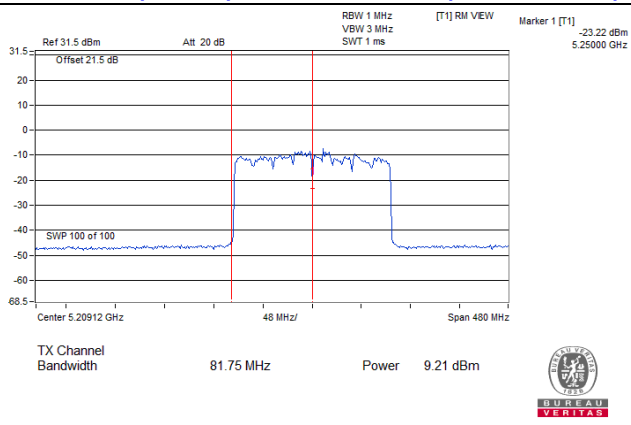

802.11ax (HE160)_Chain 2 / CH50 (U-NII-1 Band)

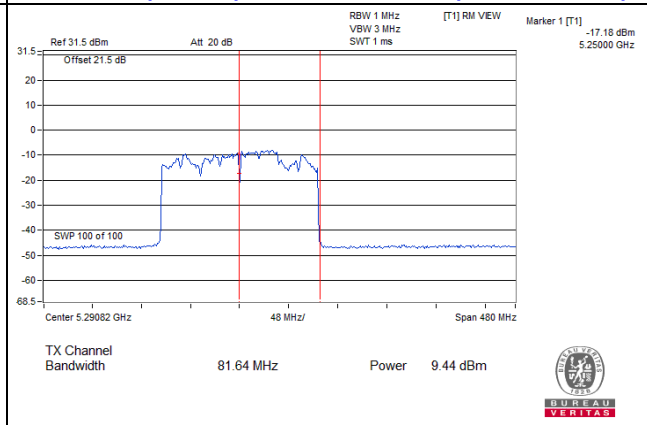

26dB OCCUPIED BANDWIDTH

802.11a

Channel	Frequency (MHz)	26dB Bandwidth (MHz)		
		Chain0	Chain1	Chain2
36	5180	21.94	22	22.05
40	5200	21.91	22.1	22.02
48	5240	21.96	21.92	22.17
52	5260	21.83	21.86	21.66
60	5300	21.9	21.84	21.69
64	5320	21.89	21.8	21.66
100	5500	21.89	21.8	21.66
116	5580	21.94	21.86	21.69
140	5700	21.8	21.85	21.71
144 (U-NII-2C Band)	5720	15.93	15.97	15.92
144 (U-NII-3 Band)	5720	5.82	5.77	5.69
149	5745	21.89	23.85	24.81
157	5785	21.93	22.25	27.91
165	5825	21.95	22.07	28.82

802.11ax (HE20)

Channel	Frequency (MHz)	26dB Bandwidth (MHz)		
		Chain0	Chain1	Chain2
36	5180	21.96	21.83	21.91
40	5200	21.84	22.46	22.08
48	5240	21.78	21.85	21.93
52	5260	21.98	21.83	21.83
60	5300	21.92	21.8	21.82
64	5320	21.9	21.86	21.8
100	5500	22.02	21.85	21.81
116	5580	21.78	21.79	21.74
140	5700	21.96	21.84	21.85
144 (U-NII-2C Band)	5720	15.87	15.85	15.96
144 (U-NII-3 Band)	5720	6.03	5.92	5.87
149	5745	22.19	22.68	23.09
157	5785	22.21	22.54	22.46
165	5825	21.85	22.59	24.58

802.11ax (HE40)

Channel	Frequency (MHz)	26dB Bandwidth (MHz)		
		Chain0	Chain1	Chain2
38	5190	41.52	41.35	41.33
46	5230	41.57	41.25	41.29
54	5270	41.51	41.15	41.4
62	5310	41.55	41.36	41.35
102	5510	41.49	41.27	41.32
110	5550	41.49	41.17	41.43
134	5670	41.56	41.39	41.46
142 (U-NII-2C Band)	5710	35.71	35.51	35.74
142 (U-NII-3 Band)	5710	5.77	5.47	5.45
151	5755	49.8	41.35	50.14
159	5795	49.91	42.52	50.68

802.11ax (HE80)

Channel	Frequency (MHz)	26dB Bandwidth (MHz)		
		Chain0	Chain1	Chain2
42	5210	82.98	82.68	82.75
58	5290	82.74	82.5	82.45
106	5530	82.95	82.67	82.75
122	5610	82.92	82.59	82.71
138 (U-NII-2C Band)	5690	76.2	76.39	76.23
138 (U-NII-3 Band)	5690	6.01	6.31	6.07
155	5775	82.85	82.49	82.98

802.11ax (HE160)

Channel	Frequency (MHz)	26dB Bandwidth (MHz)		
		Chain0	Chain1	Chain2
50 (U-NII-1 Band)	5250	81.5	81.49	81.75
50 (U-NII-2A Band)	5250	82.31	81.85	81.64
114	5570	163.2	163.29	163.14

Spectrum Plot of Worst Value

802.11a_Chain 2 / CH144 (U-NII-3 Band)

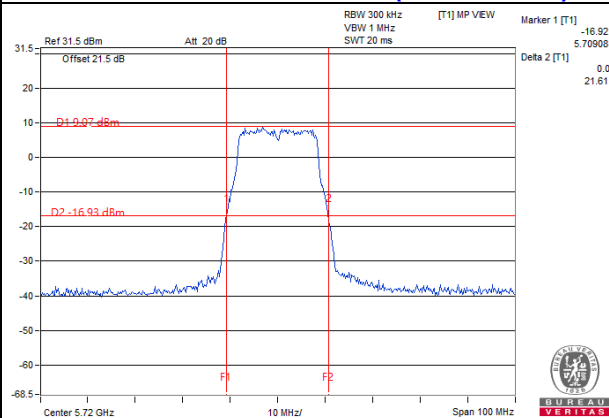

802.11ax (HE20)_Chain 2 / CH144 (U-NII-3 Band)

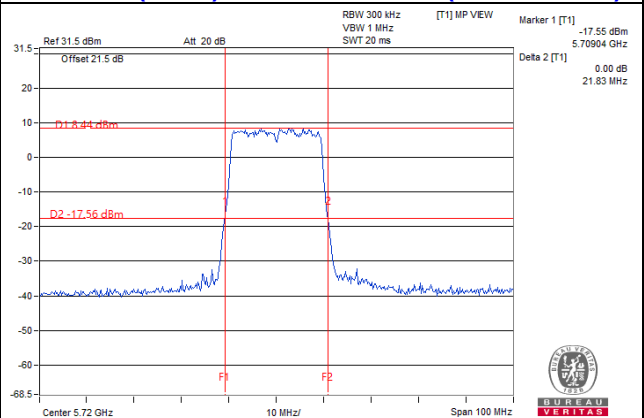

802.11ax (HE40)_Chain 2 / CH142 (U-NII-3 Band)

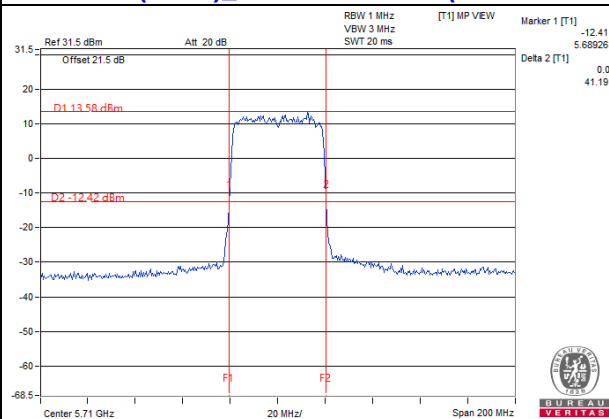

802.11ax (HE80)_Chain 0 / CH138 (U-NII-3 Band)

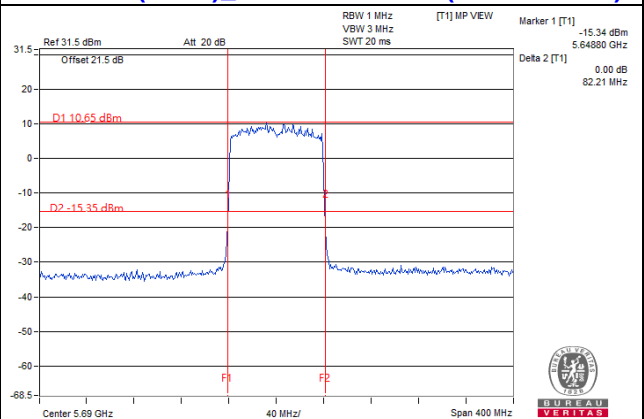

802.11ax (HE160)_Chain 1 / CH50 (U-NII-1 Band)

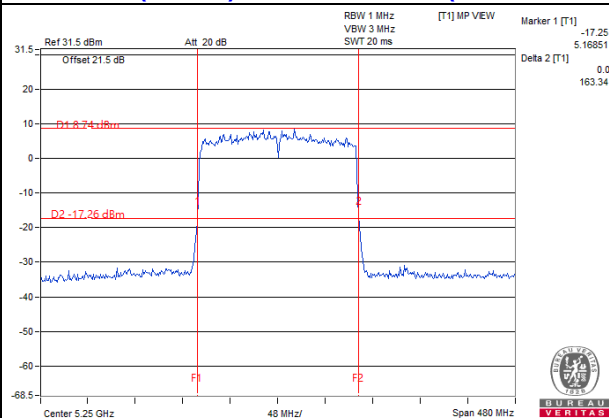

Note:

- For CH144 (U-NII-3) = Delta 2 - (5725MHz - Marker 1)
- For CH142 (U-NII-3) = Delta 2 - (5725MHz - Marker 1)
- For CH138 (U-NII-3) = Delta 2 - (5725MHz - Marker 1)
- For CH50 (U-NII-1) = 5250MHz - Marker 1

For channel straddling 5725MHz of 26dB BW

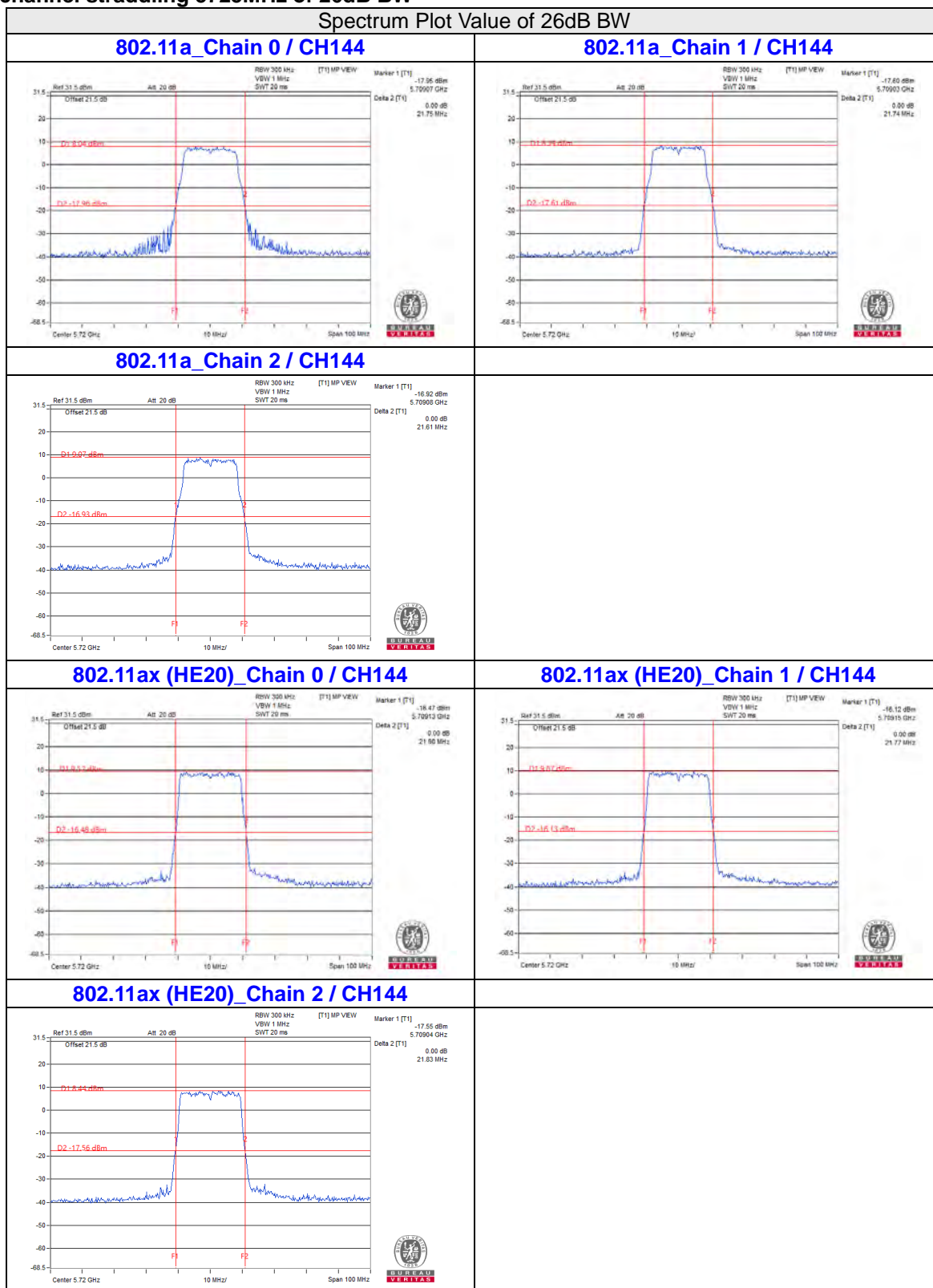

Spectrum Plot Value of 26dB BW

802.11ax (HE40)_Chain 0 / CH142

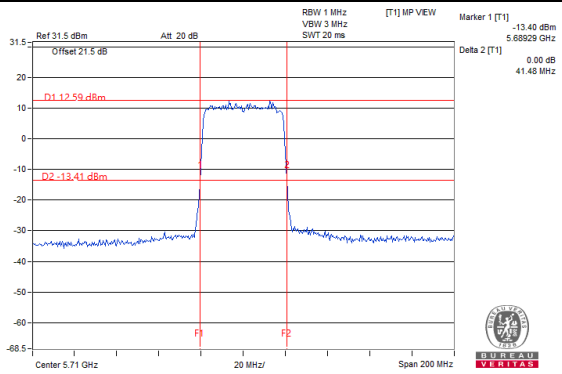

802.11ax (HE40)_Chain 1 / CH142

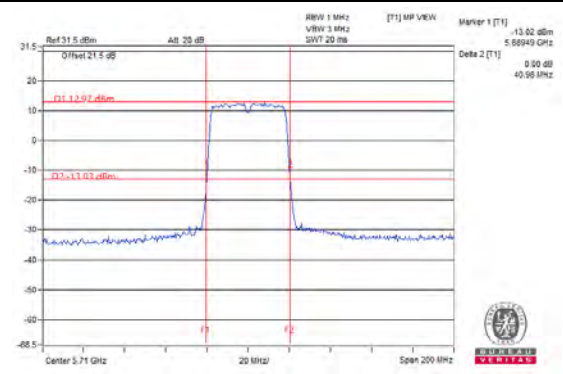

802.11ax (HE40)_Chain 2 / CH142

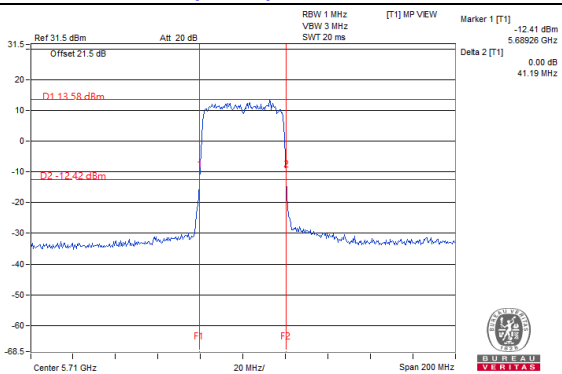

802.11ax (HE80)_Chain 0 / CH138

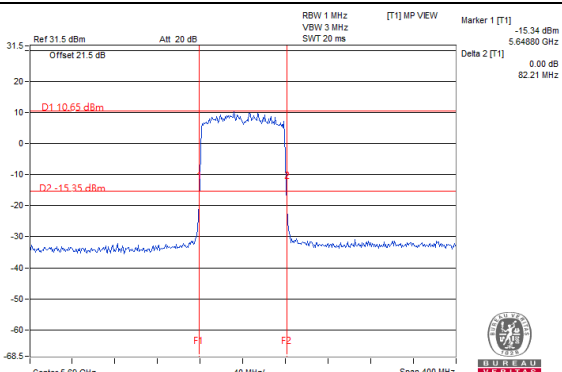

802.11ax (HE80)_Chain 1 / CH138

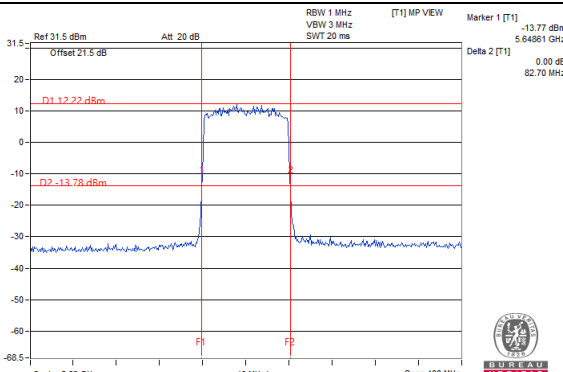

802.11ax (HE80)_Chain 2 / CH138

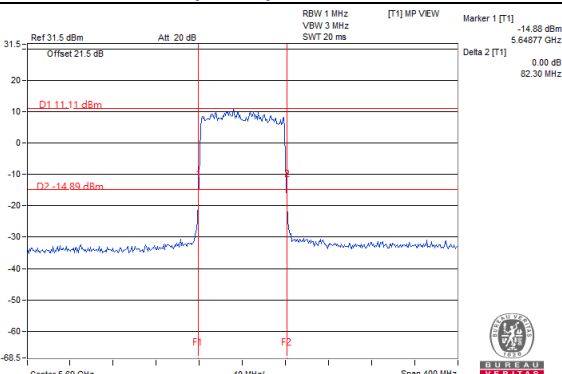

Note:

- For CH144 (U-NII-2C) = 5725MHz - Marker 1
- For CH142 (U-NII-2C) = 5725MHz - Marker 1
- For CH138 (U-NII-2C) = 5725MHz - Marker 1

For channel straddling 5250MHz of 26dB BW

Spectrum Plot Value of 26dB BW

802.11ax (HE160)_Chain 0 / CH50

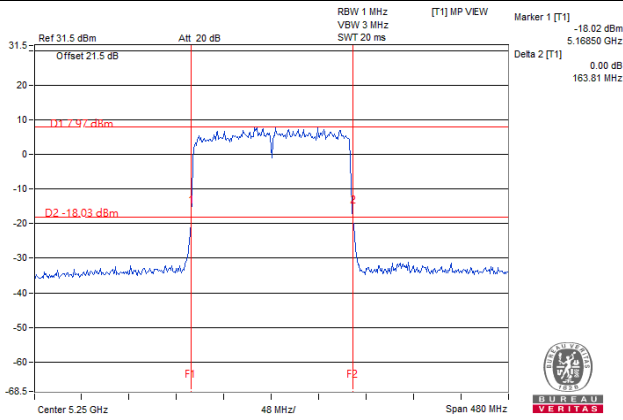

802.11ax (HE160)_Chain 1 / CH50

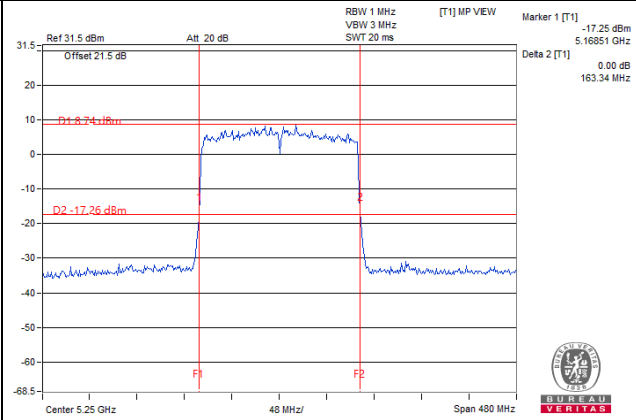

802.11ax (HE160)_Chain 2 / CH50

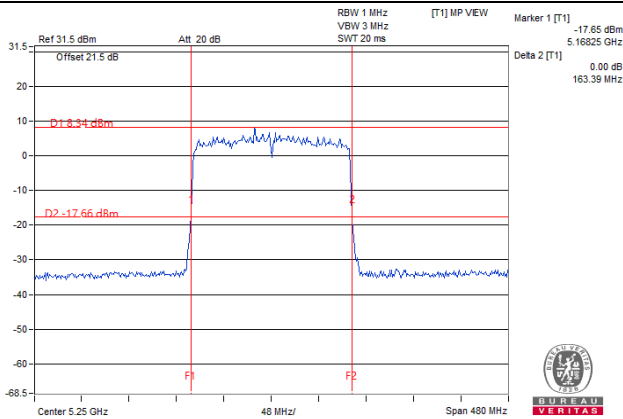

Note: For CH50 (U-NII-2A) = Delta 2 – (5250MHz - Marker 1)

4.4 Occupied Bandwidth Measurement

4.4.1 Test Setup

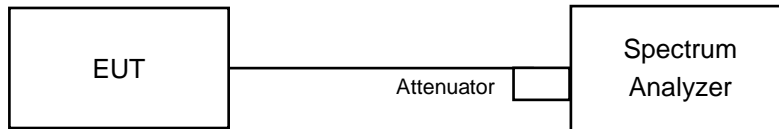

4.4.2 Test Instruments

Refer to section 4.1.2 to get information of above instrument.

4.4.3 Test Procedure

The transmitter output was connected to the spectrum analyzer through an attenuator. The bandwidth of the fundamental frequency was measured by spectrum analyzer with resolution bandwidth in the range of 1% to 5% of the anticipated emission bandwidth, and a video bandwidth at least 3x the resolution bandwidth and set the detector to SAMPLE. The width of a frequency band such that, below the lower and above the upper frequency limits, the mean powers emitted are each equal to a specified percentage 0.5% of the total mean power of a given emission.

4.4.4 Test Results

CDD Mode

802.11a

Channel	Frequency (MHz)	Occupied Bandwidth (MHz)		
		Chain 0	Chain 1	Chain 2
36	5180	17.16	17.04	16.92
40	5200	17.04	16.92	16.92
48	5240	17.28	17.04	16.92
52	5260	17.16	16.92	16.92
60	5300	17.16	16.92	16.92
64	5320	17.04	16.92	16.92
100	5500	17.16	16.92	16.92
116	5580	17.16	17.04	16.92
140	5700	17.16	16.92	16.92
144 (U-NII-2C Band)	5720	13.64	13.52	13.52
144 (U-NII-3 Band)	5720	3.52	3.4	3.4
149	5745	17.28	17.16	17.16
157	5785	17.16	17.16	17.28
165	5825	17.16	17.04	17.4

802.11ax (HE20)

Channel	Frequency (MHz)	Occupied Bandwidth (MHz)		
		Chain 0	Chain 1	Chain 2
36	5180	19.08	17.88	19.08
40	5200	19.08	18.12	19.08
48	5240	19.2	19.2	19.08
52	5260	19.2	19.08	19.08
60	5300	19.2	19.08	19.08
64	5320	19.2	19.08	19.08
100	5500	19.2	19.08	19.08
116	5580	19.2	17.88	19.2
140	5700	19.08	19.08	19.08
144 (U-NII-2C Band)	5720	14.72	14.6	14.6
144 (U-NII-3 Band)	5720	4.6	4.48	4.48
149	5745	19.08	18.12	19.08
157	5785	19.32	18.12	19.2
165	5825	19.32	18	19.2

802.11ax (HE40)

Channel	Frequency (MHz)	Occupied Bandwidth (MHz)		
		Chain 0	Chain 1	Chain 2
38	5190	37.68	37.68	37.68
46	5230	37.92	37.92	37.92
54	5270	37.92	36.48	37.68
62	5310	37.92	37.68	37.68
102	5510	37.92	36.48	37.92
110	5550	37.92	37.92	37.92
134	5670	37.68	37.92	37.68
142 (U-NII-2C Band)	5710	33.96	33.48	33.96
142 (U-NII-3 Band)	5710	3.96	3.24	3.72
151	5755	38.16	37.92	38.16
159	5795	37.92	36.72	38.16

802.11ax (HE80)

Channel	Frequency (MHz)	Occupied Bandwidth (MHz)		
		Chain 0	Chain 1	Chain 2
42	5210	77.28	77.28	77.28
58	5290	76.8	77.28	77.28
106	5530	77.28	77.28	77.28
122	5610	77.28	76.8	77.28
138 (U-NII-2C Band)	5690	73.88	73.88	73.88
138 (U-NII-3 Band)	5690	3.4	3.4	3.4
155	5775	77.28	77.28	77.28

802.11ax (HE160)

Channel	Frequency (MHz)	Occupied Bandwidth (MHz)		
		Chain 0	Chain 1	Chain 2
50 (U-NII-1 Band)	5250	77.76	77.76	77.76
50 (U-NII-2A Band)	5250	77.76	77.76	77.76
114	5570	155.52	155.52	155.52

Spectrum Plot of Max. Value

802.11a_Chain 2 / CH165

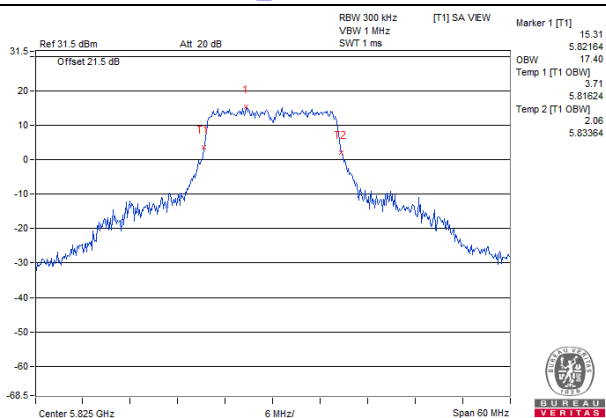

802.11ax (HE20)_Chain 0 / CH157

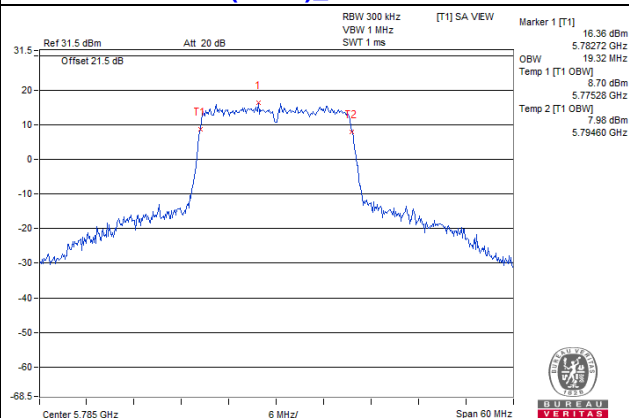

802.11ax (HE40)_Chain 2 / CH151

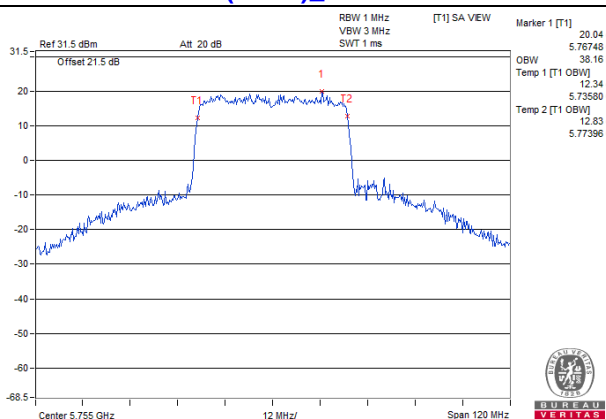

802.11ax (HE80)_Chain 0 / CH42

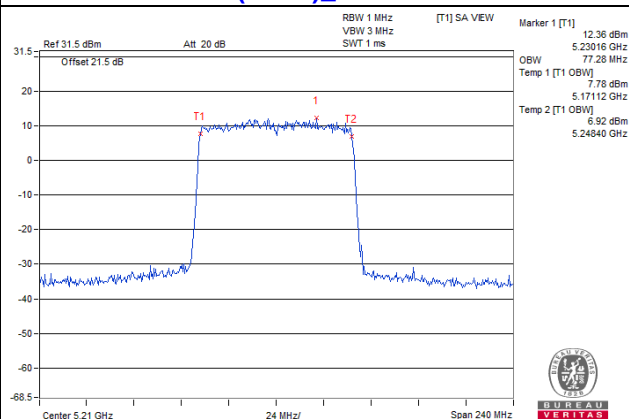

802.11ax (HE160)_Chain 0 / CH114

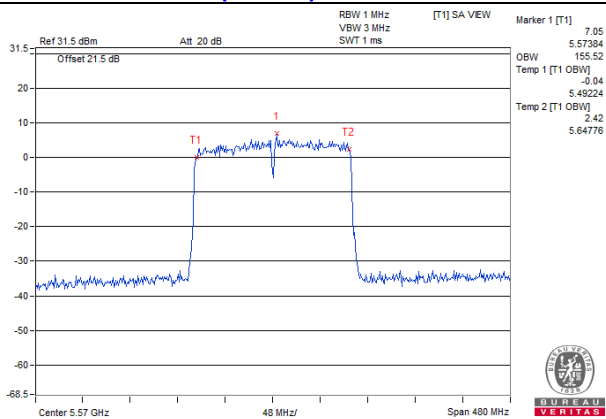

**Spectrum Plot for near by DFS band
(DFS is required, if 99% OCP straddle into U-NII-2A band)**

802.11a_Chain 0 / CH48

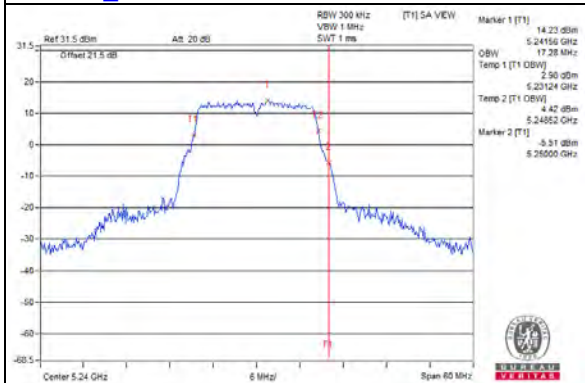

802.11a_Chain 1 / CH48

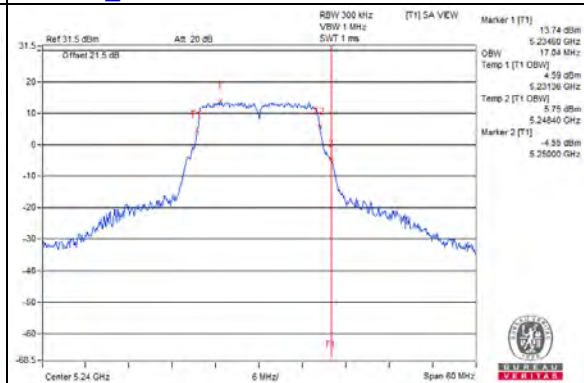

802.11a_Chain 2 / CH48

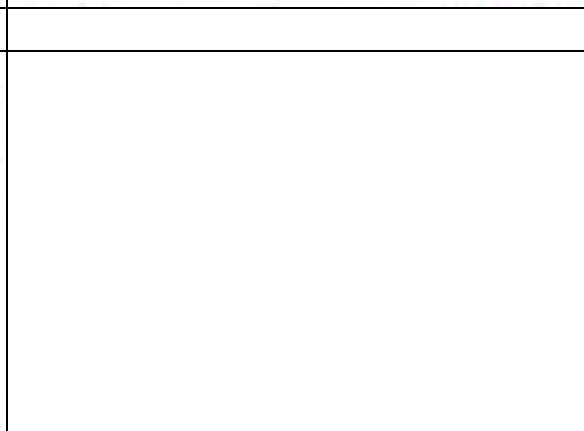
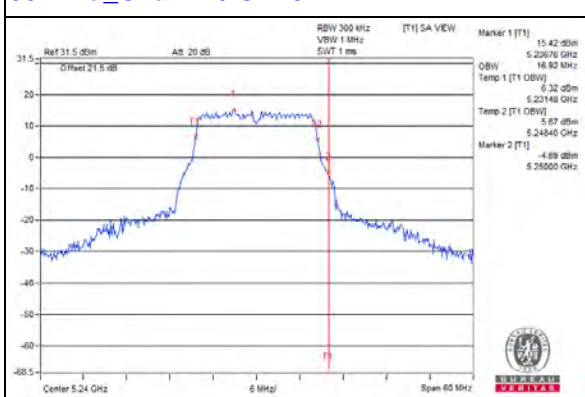

802.11ax (HE20)_Chain 0 / CH48

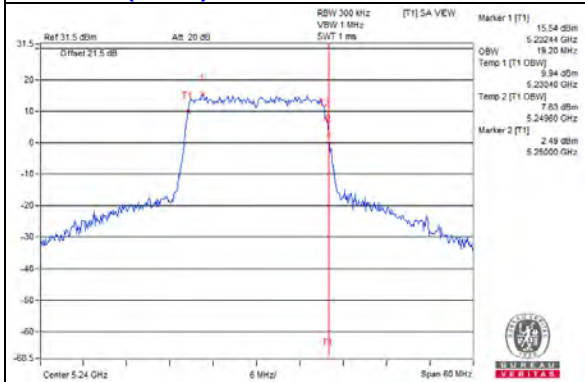

802.11ax (HE20)_Chain 1 / CH48

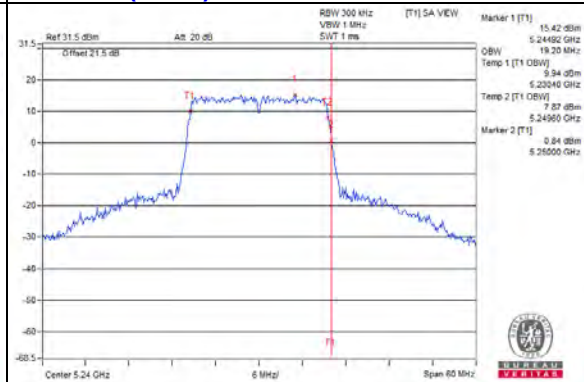

802.11ax (HE20)_Chain 2 / CH48

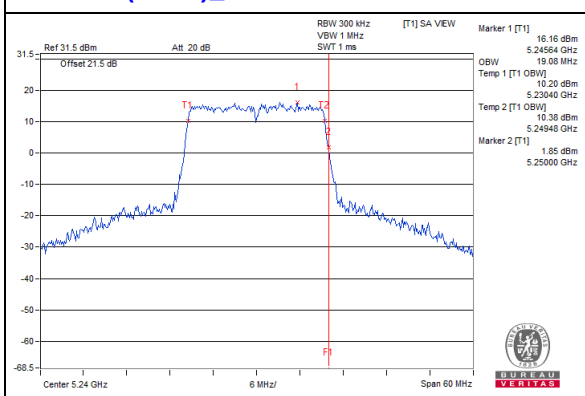

Spectrum Plot for near by DFS band
(DFS is required, if 99% OCP straddle into U-NII-2A band)

802.11ax (HE40)_Chain 0 / CH46

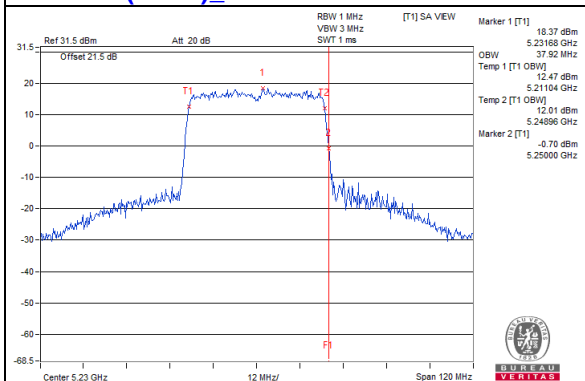

802.11ax (HE40)_Chain 1 / CH46

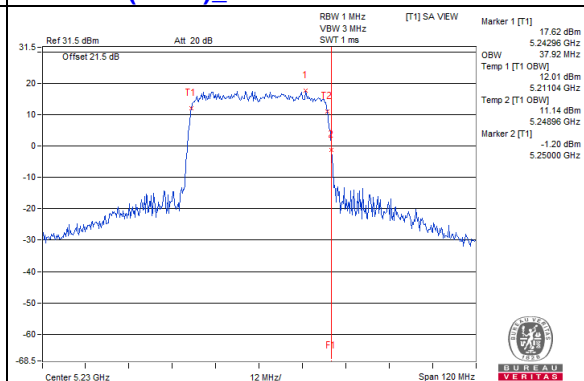

802.11ax (HE40)_Chain 2 / CH46

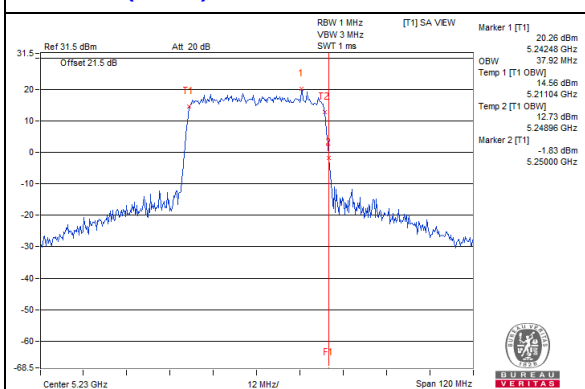

802.11ax (HE80)_Chain 0 / CH42

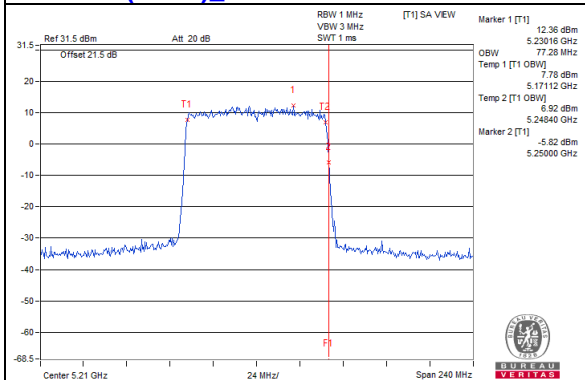

802.11ax (HE80)_Chain 1 / CH42

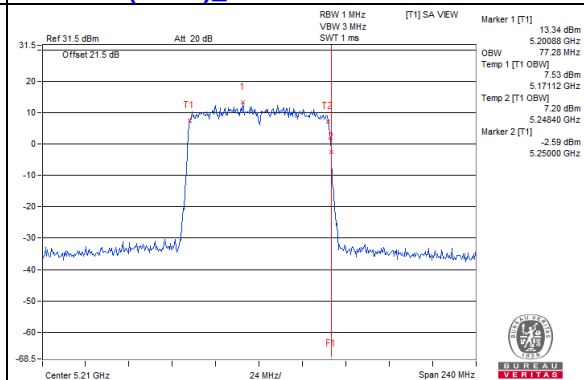

802.11ax (HE80)_Chain 2 / CH42

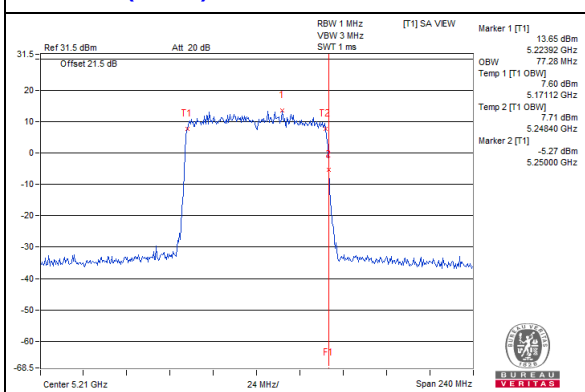

**Spectrum Plot for near by DFS band
(DFS is required, if 99% OCP straddle into U-NII-2C band)**

802.11a_Chain 0 / CH149

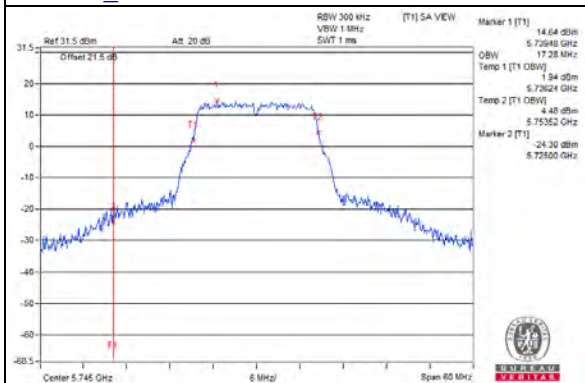

802.11a_Chain 1 / CH149

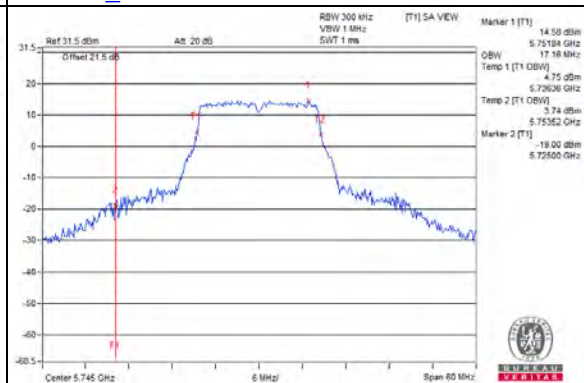

802.11a_Chain 2 / CH149

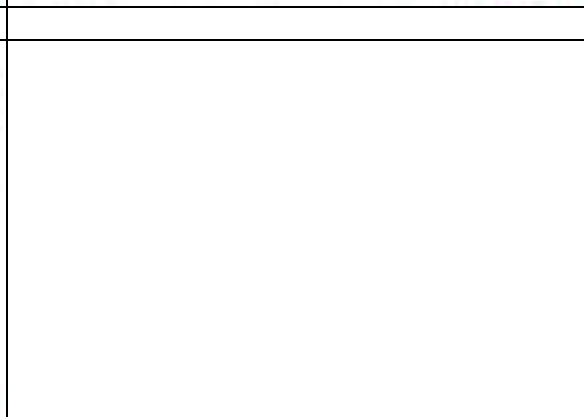
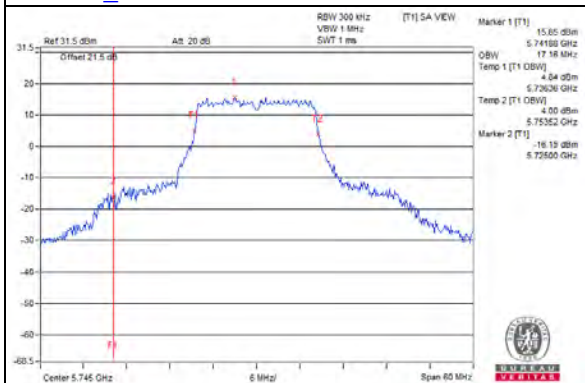

802.11ax (HE20)_Chain 0 / CH149

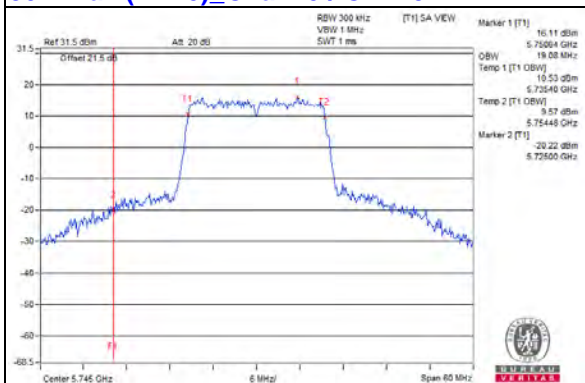

802.11ax (HE20)_Chain 1 / CH149

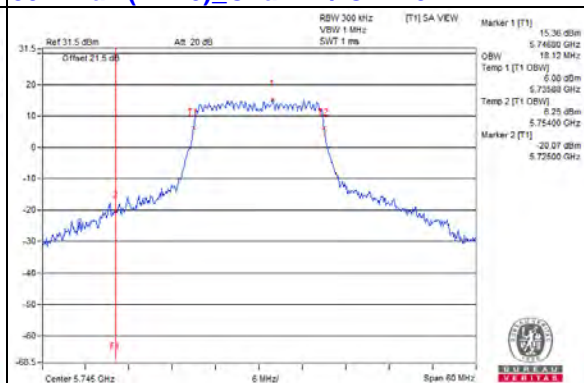

802.11ax (HE20)_Chain 2 / CH149

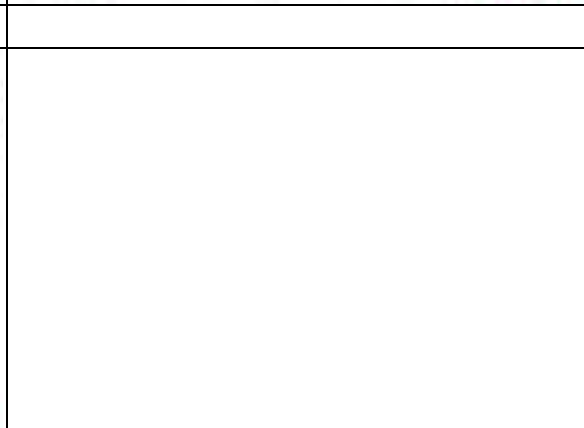
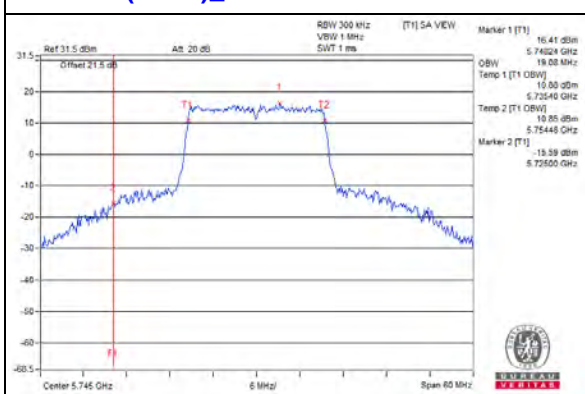

**Spectrum Plot for near by DFS band
(DFS is required, if 99% OCP straddle into U-NII-2C band)**

802.11ax (HE40)_Chain 0 / CH151

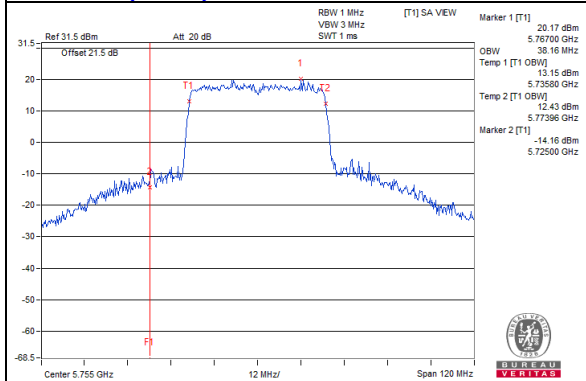

802.11ax (HE40)_Chain 1 / CH151

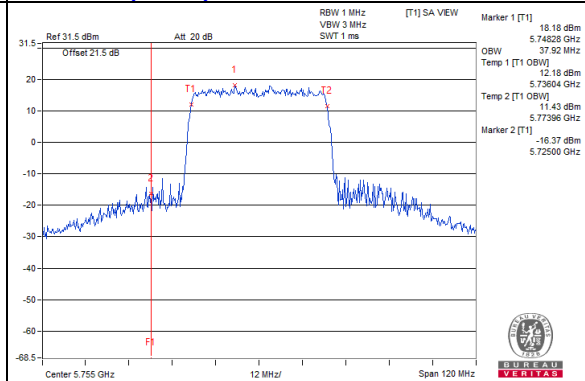

802.11ax (HE40)_Chain 2 / CH151

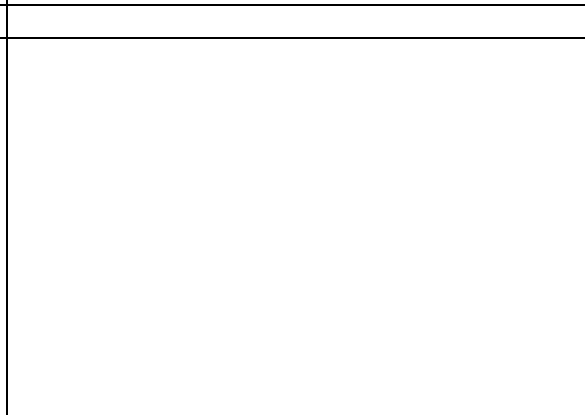
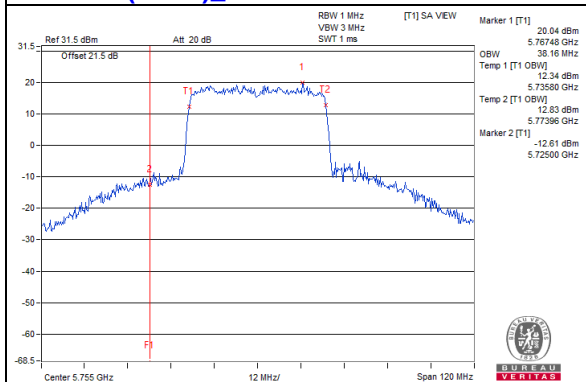

802.11ax (HE80)_Chain 0 / CH155

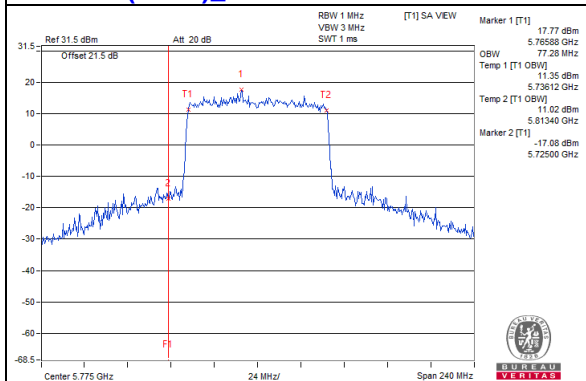

802.11ax (HE80)_Chain 1 / CH155

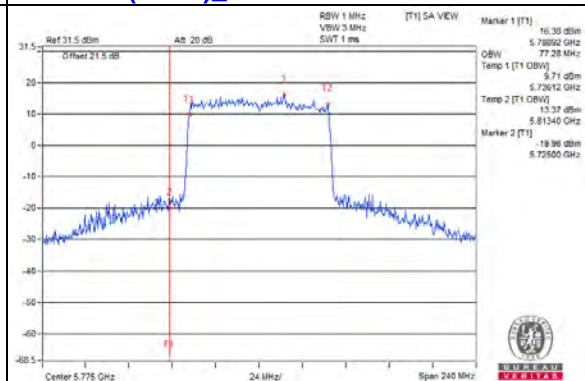

802.11ax (HE80)_Chain 2 / CH155

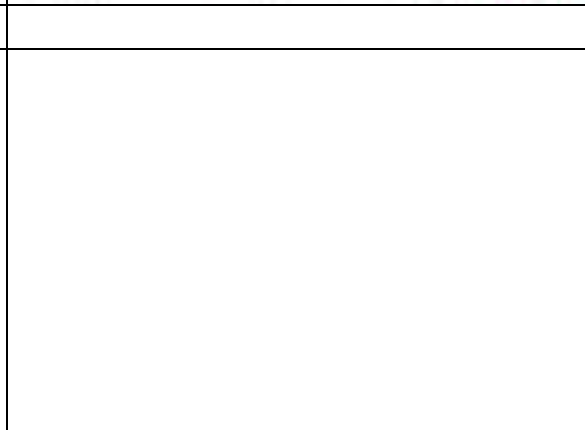
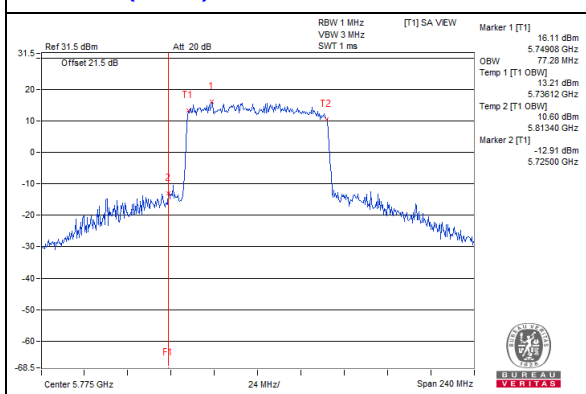

4.5 Peak Power Spectral Density Measurement

4.5.1 Limits of Peak Power Spectral Density Measurement

Operation Band	EUT Category		Limit
U-NII-1		Outdoor Access Point	17dBm/ MHz
		Fixed point-to-point Access Point	
	√	Indoor Access Point	
		Client device	11dBm/ MHz
U-NII-2A		√	11dBm/ MHz
U-NII-2C		√	11dBm/ MHz
U-NII-3		√	30dBm/ 500kHz

4.5.2 Test Setup

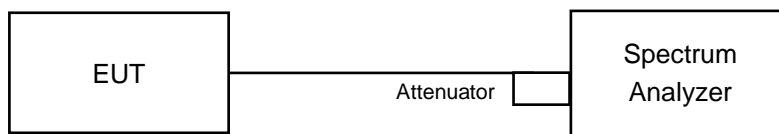

4.5.3 Test Instruments

Refer to section 4.1.2 to get information of above instrument.

4.5.4 Test Procedure

For 802.11b, 802.11ax (HE20), 802.11ax (HE40), 802.11ax (HE80)

For U-NII-1, U-NII-2A, U-NII-2C band:

Using method SA-1

1. Set span to encompass the entire emission bandwidth (EBW) of the signal.
2. Set RBW = 1 MHz, Set VBW ≥ 3 MHz, Detector = RMS
3. Sweep time = auto, trigger set to “free run”.
4. Trace average at least 100 traces in power averaging mode.
5. Record the max value

For U-NII-3 band:

1. Set span to encompass the entire emission bandwidth (EBW) of the signal.
2. Set RBW = 300 kHz, Set VBW ≥ 1 MHz, Detector = RMS
3. Use the peak marker function to determine the maximum power level in any 300 kHz band segment within the fundamental EBW.
4. Scale the observed power level to an equivalent value in 500 kHz by adjusting (reducing) the measured power by a bandwidth correction factor (BWCF) where $BWCF = 10\log(500\text{kHz}/300\text{kHz})$
5. Sweep time = auto, trigger set to “free run”.
6. Trace average at least 100 traces in power averaging mode.
7. Record the max value

For 802.11ax (HE160)

For U-NII-1, U-NII-2A, U-NII-2C band:

Using method SA-2

1. Set span to encompass the entire emission bandwidth (EBW) of the signal.
2. Set RBW = 1 MHz, Set VBW \geq 3 MHz, Detector = RMS
3. Sweep time = auto, trigger set to "free run".
4. Trace average at least 100 traces in power averaging mode.
5. Record the max value and add $10 \log (1/\text{duty cycle})$

4.5.5 Deviation from Test Standard

No deviation.

4.5.6 EUT Operating Condition

Same as Item 4.3.6.

4.5.7 Test Results

For U-NII-1, U-NII-2A, U-NII-2C band:

CDD Mode

802.11a

Chan.	Chan. Freq. (MHz)	PSD w/o Duty Factor (dBm/MHz)			Total PSD (dBm/MHz)	Max. PSD Limit (dBm/MHz)	Pass / Fail
		Chain 0	Chain 1	Chain 2			
36	5180	9.48	9.80	9.74	14.45	16.86	Pass
40	5200	9.93	9.77	9.78	14.60	16.86	Pass
48	5240	9.99	9.68	10.61	14.88	16.86	Pass
52	5260	4.60	4.71	3.06	8.96	10.74	Pass
60	5300	4.37	4.59	2.91	8.79	10.74	Pass
64	5320	4.31	4.54	2.87	8.74	10.74	Pass
100	5500	3.62	4.34	3.26	8.53	10.67	Pass
116	5580	3.55	3.40	3.21	8.16	10.67	Pass
140	5700	3.26	4.22	3.45	8.43	10.67	Pass
144 (U-NII-2C Band)	5720	3.28	3.93	3.81	8.45	10.67	Pass

- Note: 1. Method a) of power density measurement of KDB 662911 is using for calculating total power density. Total power density is summing entire spectra across corresponding frequency bins on the various outputs by computer.
2. For UNII-1: Directional gain = 6.14dBi > 6dBi , so the power density limit shall be reduced to $17-(6.14-6) = 16.86\text{dBm}$.
3. For UNII-2A: Directional gain = 6.26dBi > 6dBi , so the power density limit shall be reduced to $11-(6.26-6) = 10.74\text{dBm}$.
4. For UNII-2C: Directional gain = 6.33dBi > 6dBi , so the power density limit shall be reduced to $11-(6.33-6) = 10.67\text{dBm}$.

802.11ax (HE20)

Chan.	Chan. Freq. (MHz)	PSD w/o Duty Factor (dBm/MHz)			Total PSD (dBm/MHz)	Max. PSD Limit (dBm/MHz)	Pass / Fail
		Chain 0	Chain 1	Chain 2			
36	5180	7.95	8.36	9.05	13.25	16.86	Pass
40	5200	9.68	10.04	10.35	14.80	16.86	Pass
48	5240	9.70	9.84	10.39	14.76	16.86	Pass
52	5260	4.01	3.98	2.56	8.34	10.74	Pass
60	5300	3.64	4.05	2.39	8.19	10.74	Pass
64	5320	3.57	3.94	2.37	8.11	10.74	Pass
100	5500	2.86	3.12	2.95	7.75	10.67	Pass
116	5580	3.17	4.55	2.85	8.36	10.67	Pass
140	5700	3.26	4.20	2.53	8.16	10.67	Pass
144 (U-NII-2C Band)	5720	3.24	3.99	2.51	8.06	10.67	Pass

- Note: 1. Method a) of power density measurement of KDB 662911 is using for calculating total power density. Total power density is summing entire spectra across corresponding frequency bins on the various outputs by computer.
2. For UNII-1: Directional gain = 6.14dBi > 6dBi , so the power density limit shall be reduced to 17-(6.14-6) = 16.86dBm.
3. For UNII-2A: Directional gain = 6.26dBi > 6dBi , so the power density limit shall be reduced to 11-(6.26-6) = 10.74dBm.
4. For UNII-2C: Directional gain = 6.33dBi > 6dBi , so the power density limit shall be reduced to 11-(6.33-6) = 10.67dBm.

802.11ax (HE40)

Chan.	Chan. Freq. (MHz)	PSD w/o Duty Factor (dBm/MHz)			Total PSD (dBm/MHz)	Max. PSD Limit (dBm/MHz)	Pass / Fail
		Chain 0	Chain 1	Chain 2			
38	5190	2.62	3.30	4.23	8.21	16.86	Pass
46	5230	6.66	5.91	7.31	11.44	16.86	Pass
54	5270	1.12	0.72	-0.10	5.38	10.74	Pass
62	5310	1.40	0.77	-0.35	5.44	10.74	Pass
102	5510	0.64	1.71	0.72	5.82	10.67	Pass
110	5550	0.83	2.04	0.10	5.84	10.67	Pass
134	5670	-0.07	1.74	0.29	5.50	10.67	Pass
142 (U-NII-2C Band)	5710	-0.22	1.85	0.35	5.52	10.67	Pass

- Note: 1. Method a) of power density measurement of KDB 662911 is using for calculating total power density. Total power density is summing entire spectra across corresponding frequency bins on the various outputs by computer.
2. For UNII-1: Directional gain = 6.14dBi > 6dBi , so the power density limit shall be reduced to 17-(6.14-6) = 16.86dBm.
3. For UNII-2A: Directional gain = 6.26dBi > 6dBi , so the power density limit shall be reduced to 11-(6.26-6) = 10.74dBm.
4. For UNII-2C: Directional gain = 6.33dBi > 6dBi , so the power density limit shall be reduced to 11-(6.33-6) = 10.67dBm.

802.11ax (HE80)

Chan.	Chan. Freq. (MHz)	PSD w/o Duty Factor (dBm/MHz)			Total PSD (dBm/MHz)	Max. PSD Limit (dBm/MHz)	Pass / Fail
		Chain 0	Chain 1	Chain 2			
42	5210	0.80	0.92	1.29	5.78	16.86	Pass
58	5290	-2.11	-2.17	-3.17	2.31	10.74	Pass
106	5530	-3.04	-1.34	-2.37	2.58	10.67	Pass
122	5610	-2.60	-1.33	-2.15	2.78	10.67	Pass
138 (U-NII-2C Band)	5690	-2.86	-0.79	-2.20	2.91	10.67	Pass

- Note: 1. Method a) of power density measurement of KDB 662911 is using for calculating total power density. Total power density is summing entire spectra across corresponding frequency bins on the various outputs by computer.
2. For UNII-1: Directional gain = 6.14dBi > 6dBi , so the power density limit shall be reduced to 17-(6.14-6) = 16.86dBm.
3. For UNII-2A: Directional gain = 6.26dBi > 6dBi , so the power density limit shall be reduced to 11-(6.26-6) = 10.74dBm.
4. For UNII-2C: Directional gain = 6.33dBi > 6dBi , so the power density limit shall be reduced to 11-(6.33-6) = 10.67dBm.

802.11ax (HE160)

Chan.	Chan. Freq. (MHz)	PSD w/o Duty Factor (dBm/MHz)			Duty Factor (dB)	Total PSD (dBm/MHz)	Max. PSD Limit (dBm/MHz)	Pass / Fail
		Chain 0	Chain 1	Chain 2				
50 (U-NII-1)	5250	-4.67	-4.15	-5.85	0.54	0.48	16.86	Pass
50 (U-NII-2A)	5250	-4.76	-4.26	-6.00	0.54	0.36	10.74	Pass
114	5570	-5.47	-4.07	-5.24	0.54	0.43	10.67	Pass

- Note: 1. Method a) of power density measurement of KDB 662911 is using for calculating total power density. Total power density is summing entire spectra across corresponding frequency bins on the various outputs by computer.
2. For UNII-1: Directional gain = 6.14dBi > 6dBi , so the power density limit shall be reduced to 17-(6.14-6) = 16.86dBm.
3. For UNII-2A: Directional gain = 6.26dBi > 6dBi , so the power density limit shall be reduced to 11-(6.26-6) = 10.74dBm.
4. For UNII-2C: Directional gain = 6.33dBi > 6dBi , so the power density limit shall be reduced to 11-(6.33-6) = 10.67dBm.

Spectrum Plot of Worst Value

802.11a_Chain 2 / CH48

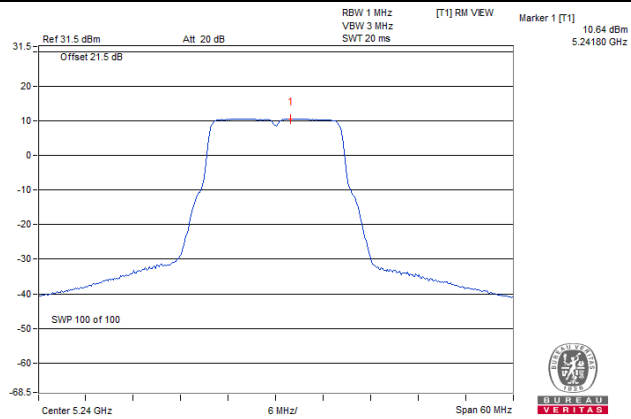

802.11ax (HE20)_Chain 2 / CH48

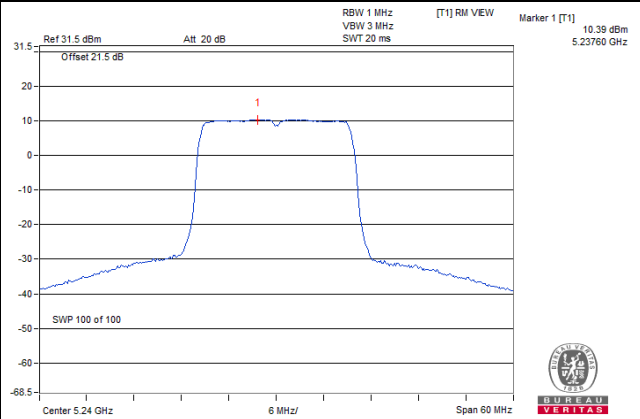

802.11ax (HE40)_Chain 2 / CH46

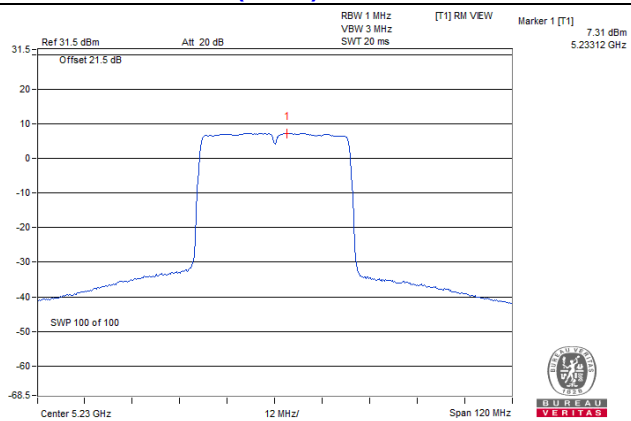

802.11ax (HE80)_Chain 2 / CH42

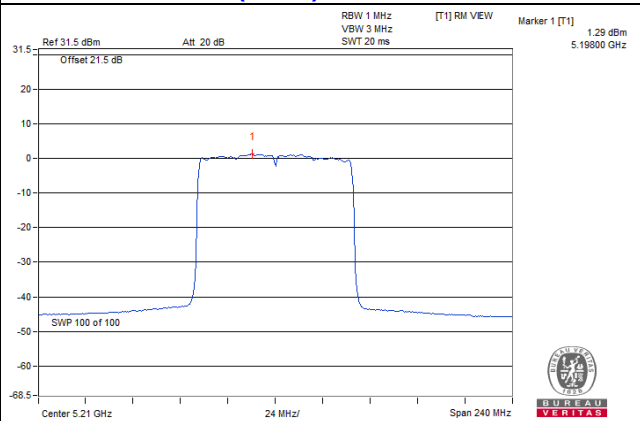

802.11ax (HE160)_Chain 1 / CH114 (U-NII-1 Band)

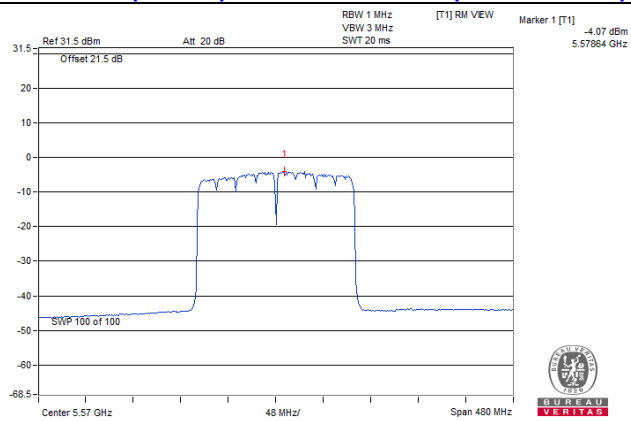

For U-NII-3 band:

CDD Mode

802.11a

Chan.	Chan. Freq. (MHz)	PSD (dBm/300kHz)			Total PSD (dBm/300kHz)	Total PSD (dBm/500kHz)	PSD Limit (dBm/500kHz)	Pass / Fail
		Chain 0	Chain 1	Chain 2				
144 (U-NII-3 Band)	5720	-5.73	-4.65	-4.81	-0.27	1.95	29.71	Pass
149	5745	1.57	2.41	3.01	7.14	9.36	29.71	Pass
157	5785	1.45	1.55	2.55	6.65	8.87	29.71	Pass
165	5825	1.27	1.35	2.50	6.52	8.74	29.71	Pass

- Note: 1. Method b) Measure and sum spectral maxima across the outputs of KDB 662911 is using for calculating total power density.
 2. Directional gain = 6.29dBi > 6dBi , so the power density limit shall be reduced to $30-(6.29-6) = 29.71$ dBm.

802.11ax (HE20)

Chan.	Chan. Freq. (MHz)	PSD (dBm/300kHz)			Total PSD (dBm/300kHz)	Total PSD (dBm/500kHz)	PSD Limit (dBm/500kHz)	Pass / Fail
		Chain 0	Chain 1	Chain 2				
144 (U-NII-3 Band)	5720	-6.12	-5.49	-6.97	-1.38	0.84	29.71	Pass
149	5745	0.76	1.78	1.47	6.13	8.35	29.71	Pass
157	5785	0.89	1.33	1.37	5.97	8.19	29.71	Pass
165	5825	0.40	1.51	1.55	5.96	8.18	29.71	Pass

- Note: 1. Method b) Measure and sum spectral maxima across the outputs of KDB 662911 is using for calculating total power density.
 2. Directional gain = 6.29dBi > 6dBi , so the power density limit shall be reduced to $30-(6.29-6) = 29.71$ dBm.

802.11ax (HE40)

Chan.	Chan. Freq. (MHz)	PSD (dBm/300kHz)			Total PSD (dBm/300kHz)	Total PSD (dBm/500kHz)	PSD Limit (dBm/500kHz)	Pass / Fail
		Chain 0	Chain 1	Chain 2				
142 (U-NII-3 Band)	5710	-10.29	-8.02	-9.73	-4.46	-2.24	29.71	Pass
151	5755	-1.36	-2.81	-1.55	2.91	5.13	29.71	Pass
159	5795	-1.28	-2.42	-1.88	2.94	5.16	29.71	Pass

- Note: 1. Method b) Measure and sum spectral maxima across the outputs of KDB 662911 is using for calculating total power density.
 2. Directional gain = 6.29dBi > 6dBi , so the power density limit shall be reduced to $30-(6.29-6) = 29.71$ dBm.

802.11ax (HE80)

Chan.	Chan. Freq. (MHz)	PSD (dBm/300kHz)			Total PSD (dBm/300kHz)	Total PSD (dBm/500kHz)	PSD Limit (dBm/500kHz)	Pass / Fail
		Chain 0	Chain 1	Chain 2				
138 (U-NII-3 Band)	5710	-14.04	-11.54	-13.38	-8.08	-5.86	29.71	Pass
155	5755	-4.79	-5.20	-4.60	-0.08	2.14	29.71	Pass

Note: 1. Method b) Measure and sum spectral maxima across the outputs of KDB 662911 is using for calculating total power density.
 2. Directional gain = 6.29dBi > 6dBi , so the power density limit shall be reduced to $30 - (6.29 - 6) = 29.71$ dBm.

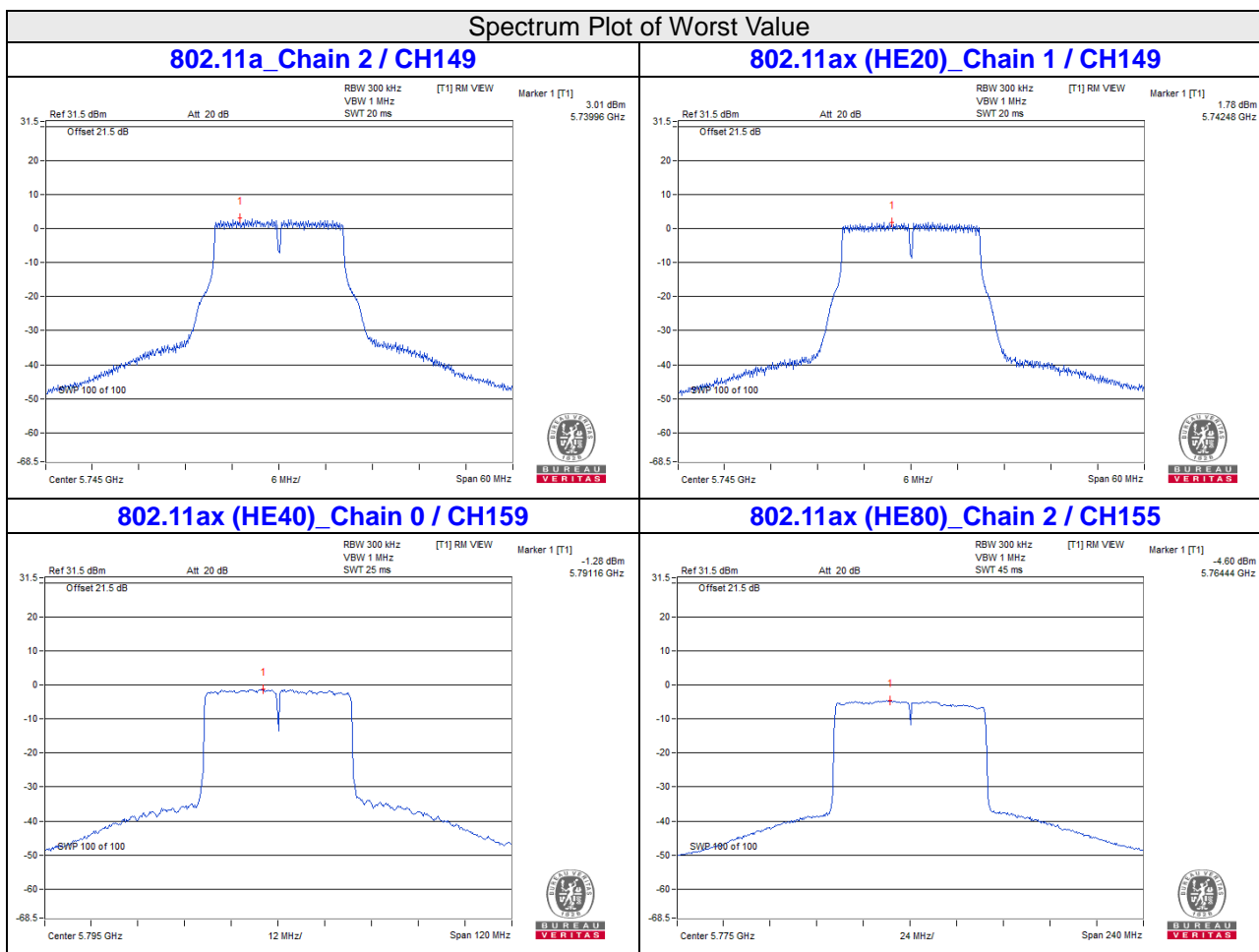

4.6 Frequency Stability Measurement

4.6.1 Limits of Frequency Stability Measurement

The frequency of the carrier signal shall be maintained within band of operation

4.6.2 Test Setup

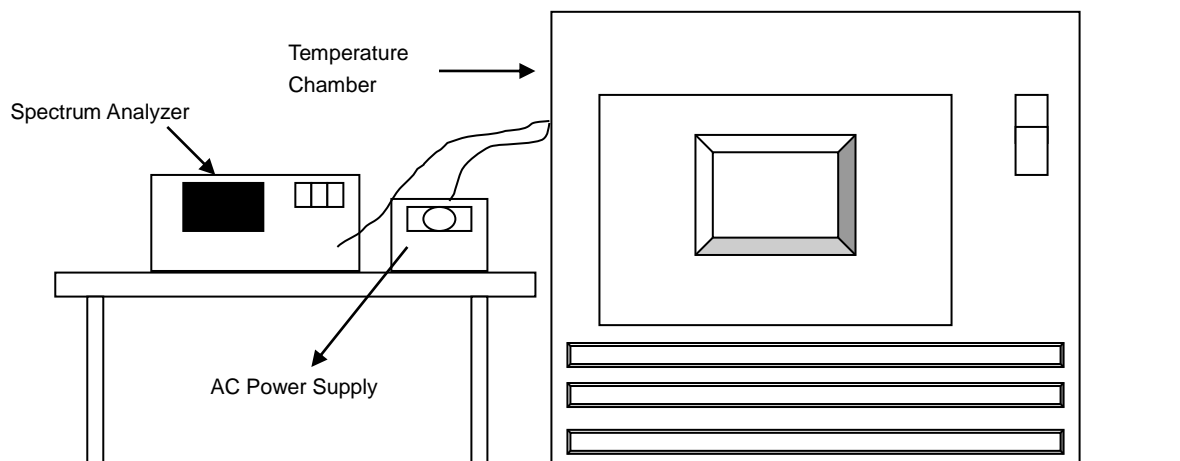

4.6.3 Test Instruments

Refer to section 4.1.2 to get information of above instrument.

4.6.4 Test Procedure

- The EUT was placed inside the environmental test chamber and powered by nominal AC voltage.
- Turn the EUT on and couple its output to a spectrum analyzer.
- Turn the EUT off and set the chamber to the highest temperature specified.
- Allow sufficient time (approximately 30 min) for the temperature of the chamber to stabilize, turn the EUT on and measure the operating frequency after 2, 5, and 10 Minutes.
- Repeat step (d) with the temperature chamber set to the next desired temperature until measurements down to the lowest specified temperature have been completed.
- The test chamber was allowed to stabilize at +20 degree C for a minimum of 30 Minutes. The supply voltage was then adjusted on the EUT from 85% to 115% and the frequency record.

4.6.5 Deviation from Test Standard

No deviation.

4.6.6 EUT Operating Condition

Set the EUT transmit at un-modulation mode to test frequency stability.

4.6.7 Test Results

Frequency Stability Versus Temp.									
Operating Frequency: 5180 MHz									
TEMP. (°C)	Power Supply (Vac)	0 Minute		2 Minutes		5 Minutes		10 Minutes	
		Measured Frequency (MHz)	Pass/Fail	Measured Frequency (MHz)	Pass/Fail	Measured Frequency (MHz)	Pass/Fail	Measured Frequency (MHz)	Pass/Fail
50	120	5179.9788	Pass	5179.978	Pass	5179.9787	Pass	5179.9802	Pass
40	120	5180.021	Pass	5180.0193	Pass	5180.0183	Pass	5180.0182	Pass
30	120	5179.9895	Pass	5179.9926	Pass	5179.9914	Pass	5179.992	Pass
20	120	5179.9984	Pass	5179.9993	Pass	5179.9991	Pass	5179.9991	Pass
10	120	5179.9902	Pass	5179.9903	Pass	5179.9912	Pass	5179.9886	Pass
0	120	5179.9901	Pass	5179.9889	Pass	5179.9887	Pass	5179.9902	Pass
-10	120	5179.9803	Pass	5179.9805	Pass	5179.9799	Pass	5179.9827	Pass
-20	120	5180.0228	Pass	5180.026	Pass	5180.0225	Pass	5180.0271	Pass
-30	120	5179.9868	Pass	5179.9896	Pass	5179.9875	Pass	5179.9893	Pass

Frequency Stability Versus Voltage									
Operating Frequency: 5180 MHz									
TEMP. (°C)	Power Supply (Vac)	0 Minute		2 Minutes		5 Minutes		10 Minutes	
		Measured Frequency (MHz)	Pass/Fail	Measured Frequency (MHz)	Pass/Fail	Measured Frequency (MHz)	Pass/Fail	Measured Frequency (MHz)	Pass/Fail
20	138	5179.9977	Pass	5179.9988	Pass	5179.9997	Pass	5179.9983	Pass
	120	5179.9984	Pass	5179.9993	Pass	5179.9991	Pass	5179.9991	Pass
	102	5179.9982	Pass	5179.9999	Pass	5179.9989	Pass	5179.9996	Pass

4.7 6dB Bandwidth Measurement

4.7.1 Limits of 6dB Bandwidth Measurement

The minimum of 6dB Bandwidth Measurement is 0.5MHz.

4.7.2 Test Setup

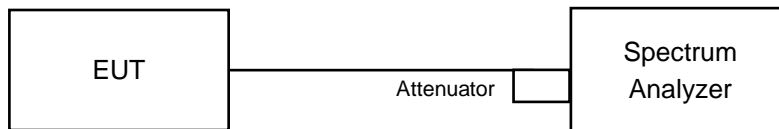

4.7.3 Test Instruments

Refer to section 4.1.2 to get information of above instrument.

4.7.4 Test Procedure

MEASUREMENT PROCEDURE REF

- Set resolution bandwidth (RBW) = 100kHz
- Set the video bandwidth (VBW) $\geq 3 \times$ RBW, Detector = Peak.
- Trace mode = max hold.
- Sweep = auto couple.
- Measure the maximum width of the emission that is constrained by the frequencies associated with the two amplitude points (upper and lower) that are attenuated by 6 dB relative to the maximum level measured in the fundamental emission

4.7.5 Deviation from Test Standard

No deviation.

4.7.6 EUT Operating Condition

The software provided by client to enable the EUT under transmission condition continuously at lowest, middle and highest channel frequencies individually.

4.7.7 Test Results

CDD Mode

802.11a

Channel	Frequency (MHz)	6dB Bandwidth (MHz)			Pass / Fail
		Chain 0	Chain 1	Chain 2	
144 (U-NII-3 Band)	5720	3.18	3.18	3.18	Pass
149	5745	16.47	16.45	16.43	Pass
157	5785	16.46	16.48	16.45	Pass
165	5825	16.46	16.47	16.44	Pass

802.11ax (HE20)

Channel	Frequency (MHz)	6dB Bandwidth (MHz)			Pass / Fail
		Chain 0	Chain 1	Chain 2	
144 (U-NII-3 Band)	5720	4.55	4.46	4.47	Pass
149	5745	19.07	17.67	19.04	Pass
157	5785	19.05	17.69	19.04	Pass
165	5825	19.1	17.69	19	Pass

802.11ax (HE40)

Channel	Frequency (MHz)	6dB Bandwidth (MHz)			Pass / Fail
		Chain 0	Chain 1	Chain 2	
142 (U-NII-3 Band)	5710	3.87	3.24	3.9	Pass
151	5755	37.86	37.86	37.75	Pass
159	5795	37.89	36.55	37.79	Pass

802.11ax (HE80)

Channel	Frequency (MHz)	6dB Bandwidth (MHz)			Pass / Fail
		Chain 0	Chain 1	Chain 2	
138 (U-NII-3 Band)	5690	3.76	3.8	3.72	Pass
155	5775	77.97	77.57	77.81	Pass

Spectrum Plot of Worst Value

802.11a_Chain 0 / CH144 (U-NII-3 Band)

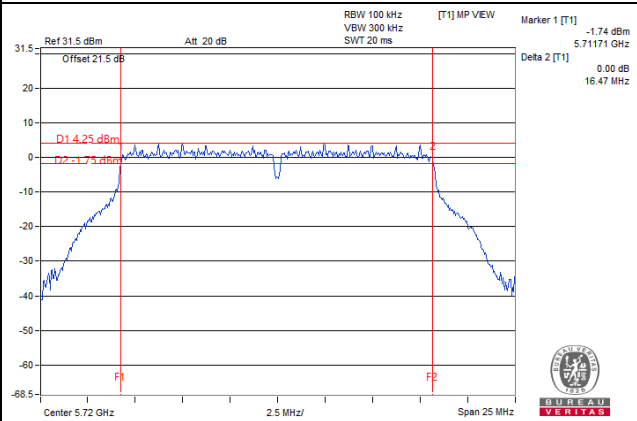

802.11ax (HE20)_Chain 1 / CH144 (U-NII-3 Band)

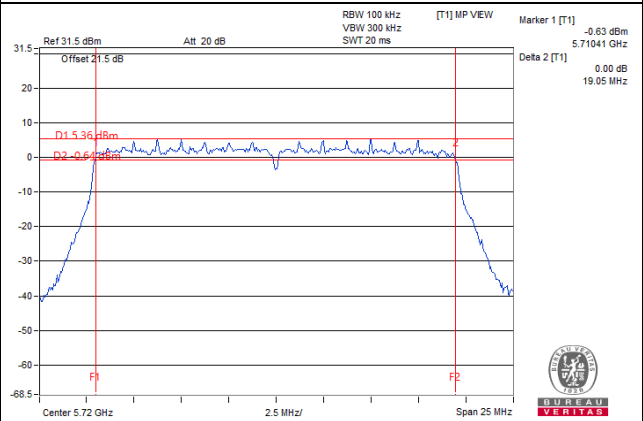

802.11ax (HE40)_Chain 1 / CH142 (U-NII-3 Band)

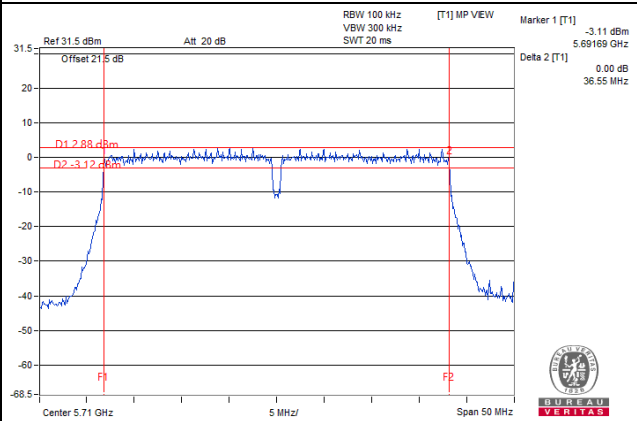

802.11ax (HE80)_Chain 2 / CH138 (U-NII-3 Band)

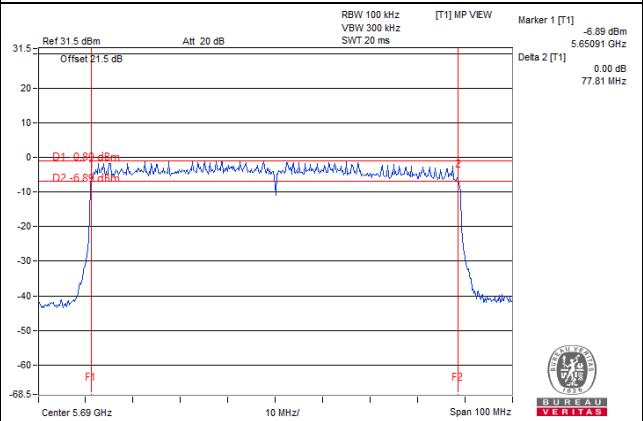

Note: The 6dB bandwidth above 5725MHz = Marker 1 + Delta 2 - 5725MHz

5 Pictures of Test Arrangements

Please refer to the attached file (Test Setup Photo).

Annex A - Radiated Out of Band Emission (OOBE) Measurement (For U-NII-3 band)

802.11a

CH 149 5745 MHz

Horizontal

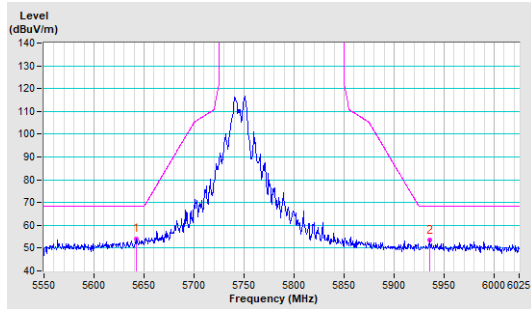

Vertical

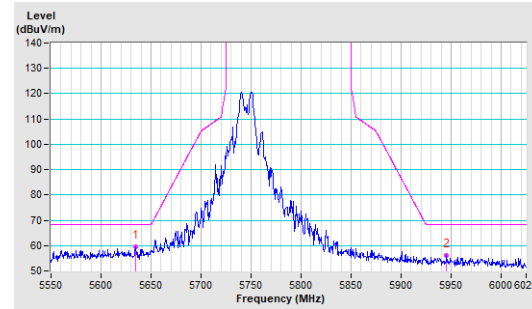

CH 157 5785 MHz

Horizontal

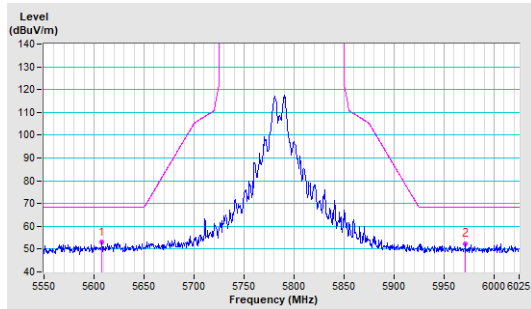

Vertical

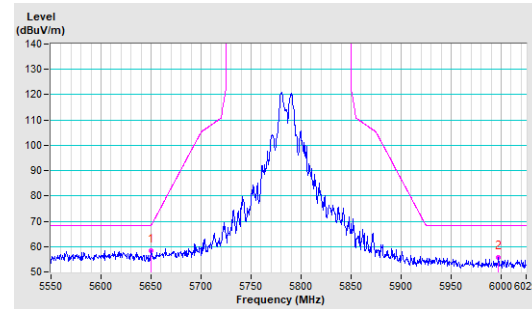

CH 165 5825 MHz

Horizontal

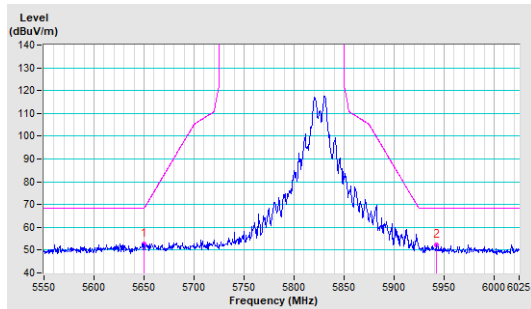

Vertical

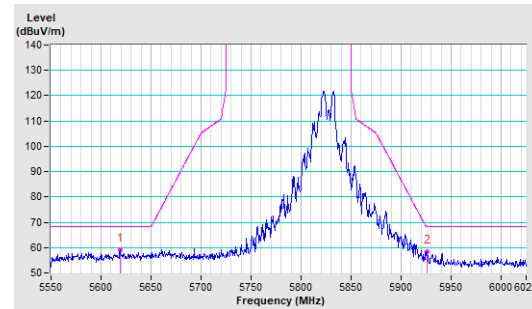

802.11ax (HE20)

CH 149 5745 MHz

Horizontal

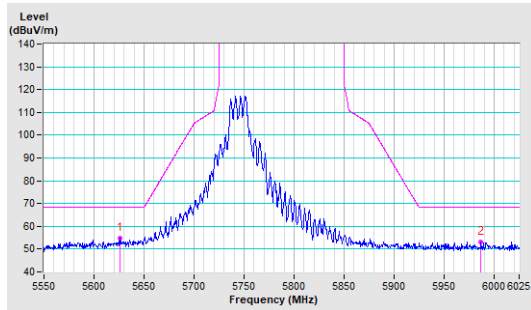

Vertical

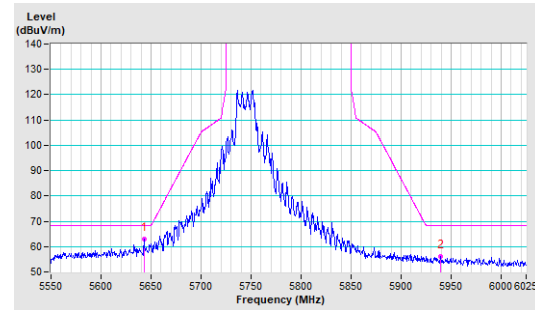

CH 157 5785 MHz

Horizontal

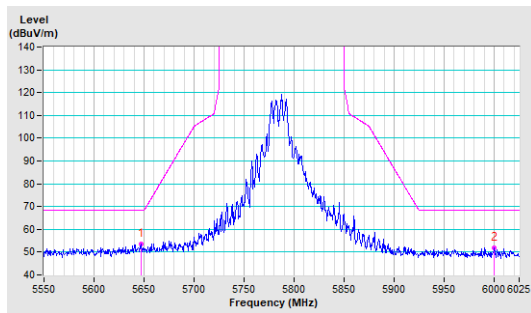

Vertical

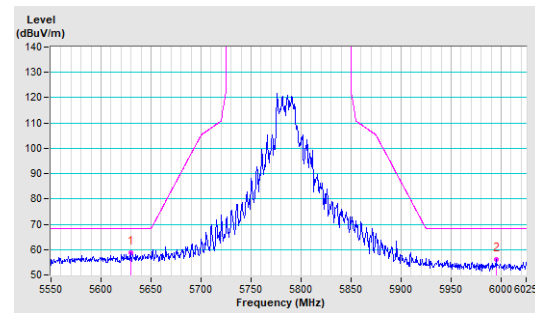

CH 165 5825 MHz

Horizontal

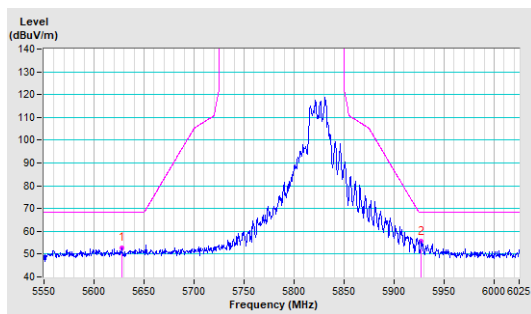

Vertical

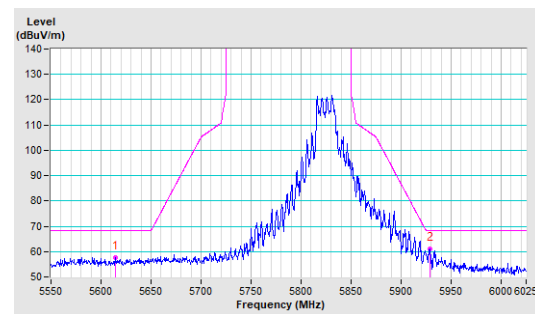

802.11ax (HE40)

CH 151 5755 MHz

Horizontal

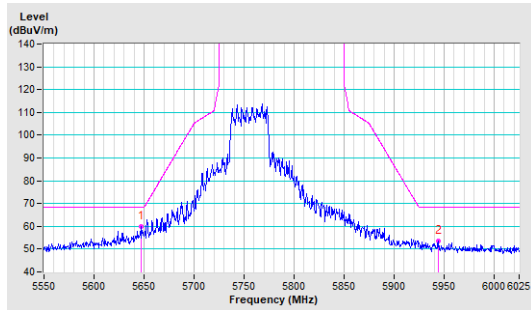

Vertical

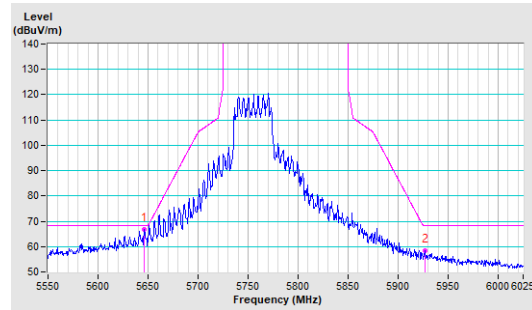

CH 159 5795 MHz

Horizontal

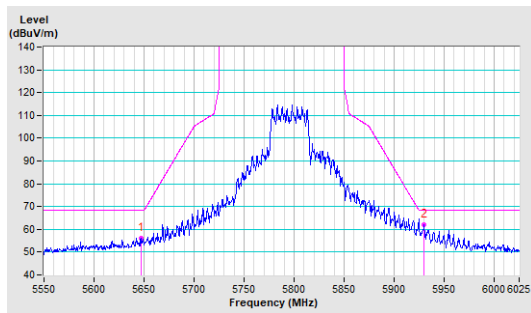

Vertical

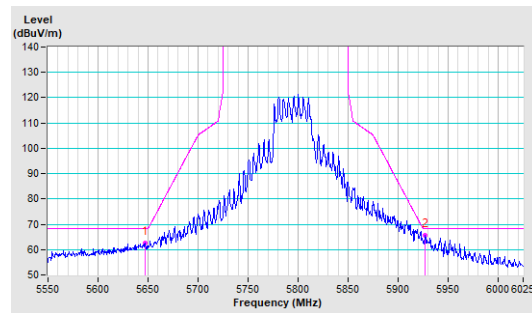

802.11ax (HE80)

CH 155 5775 MHz

Horizontal

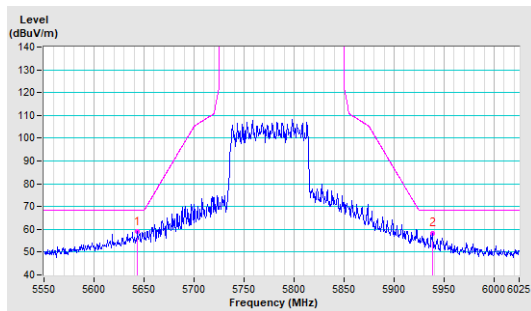

Vertical

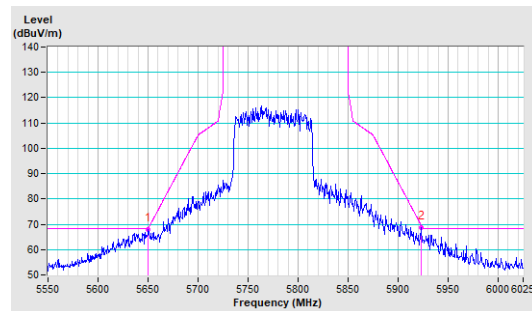

Annex B - Band-Edge Measurement (For U-NII-1, U-NII-2A, U-NII-2C band)

802.11a

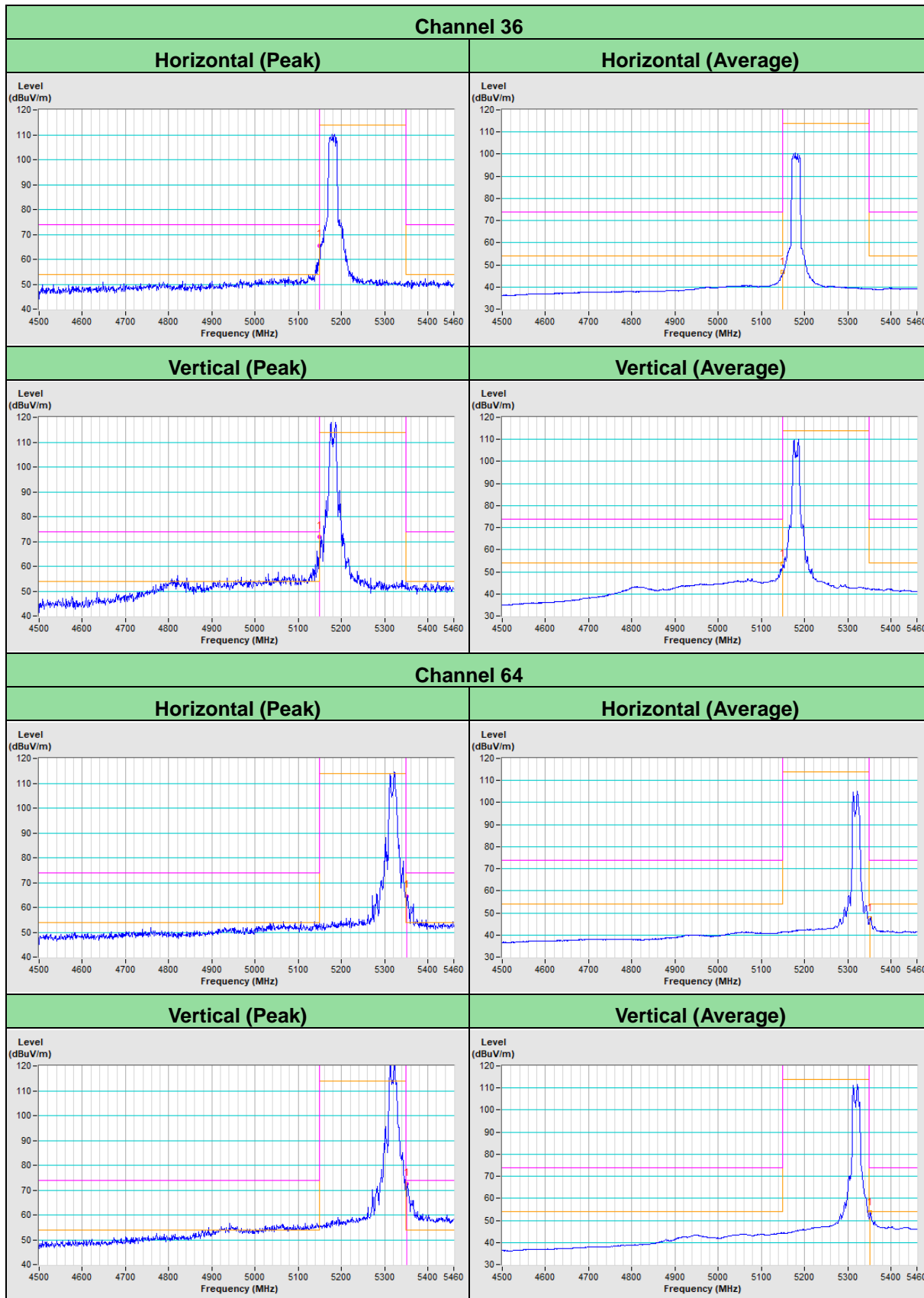

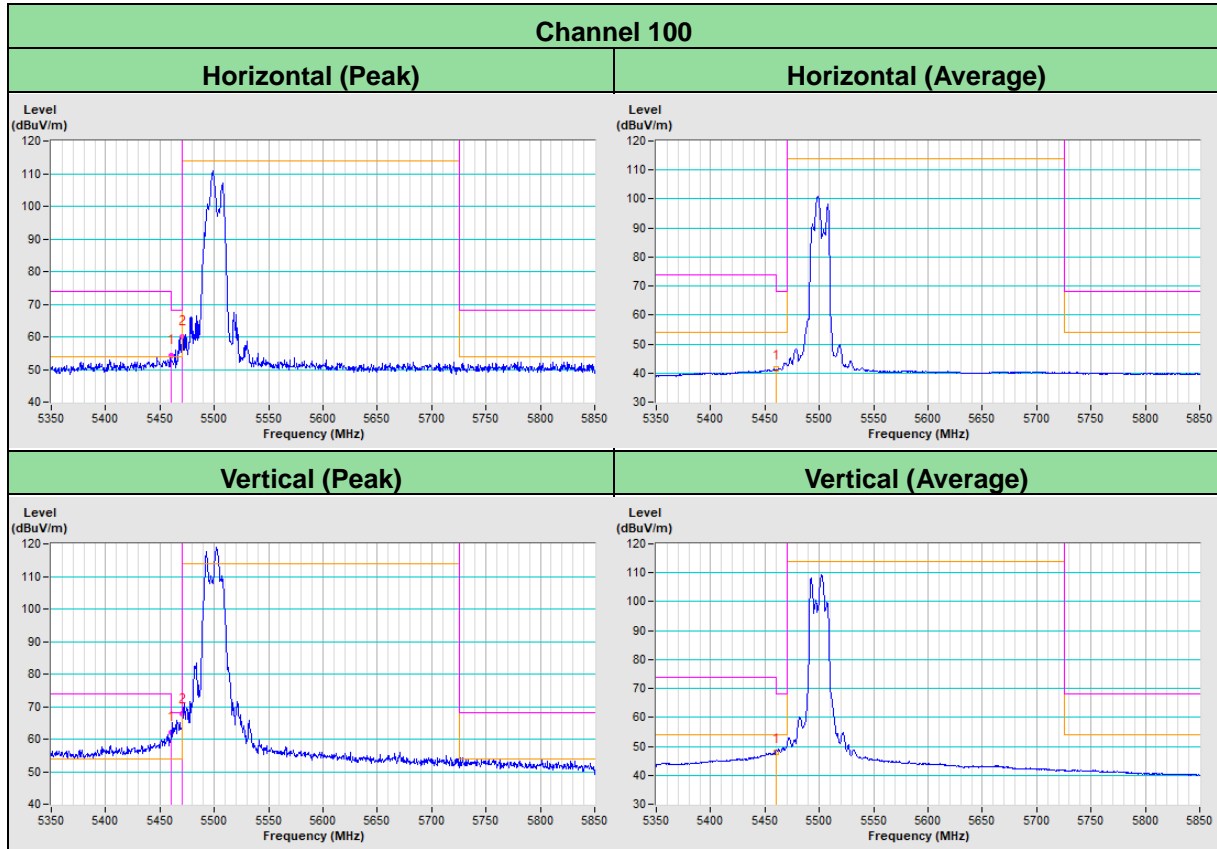

802.11ax (HE20)

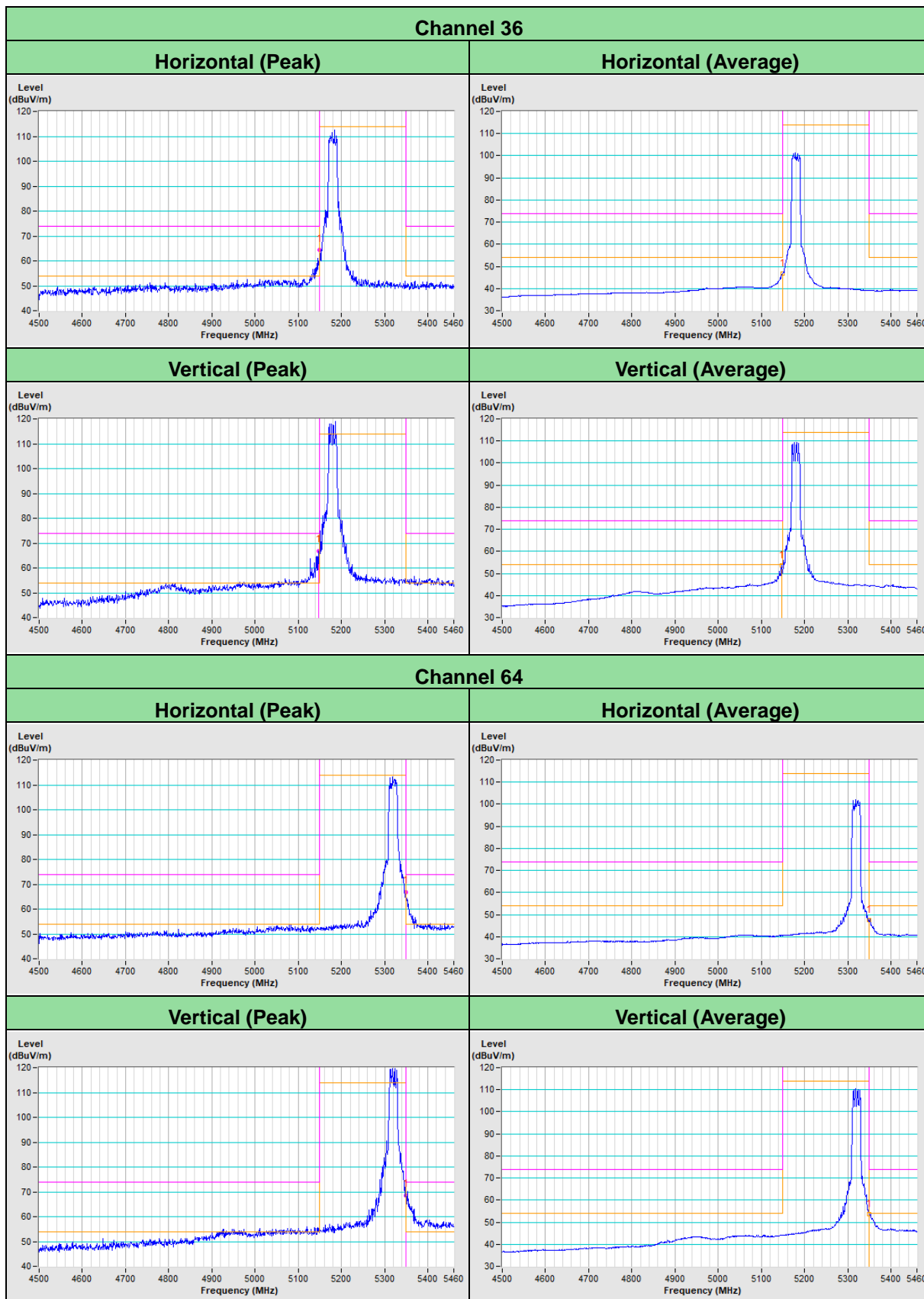

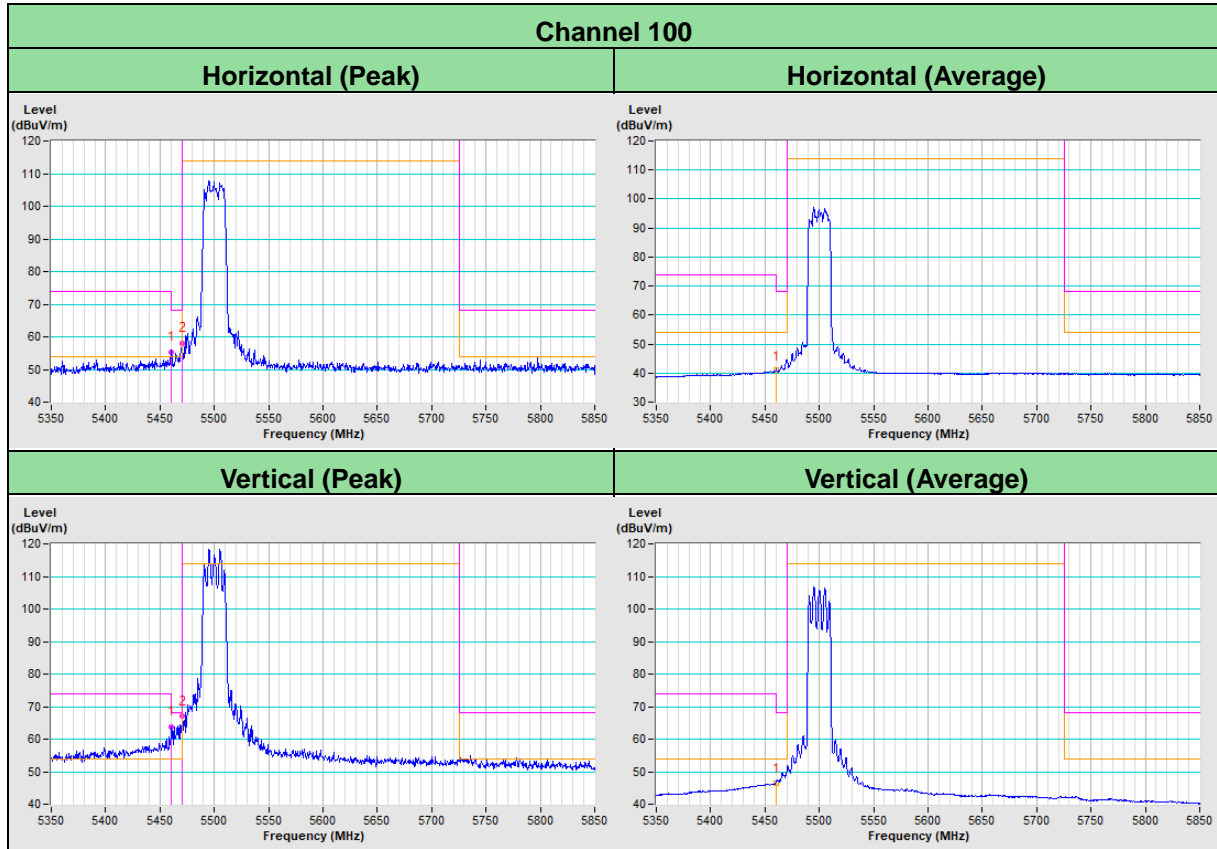

802.11ax (HE40)

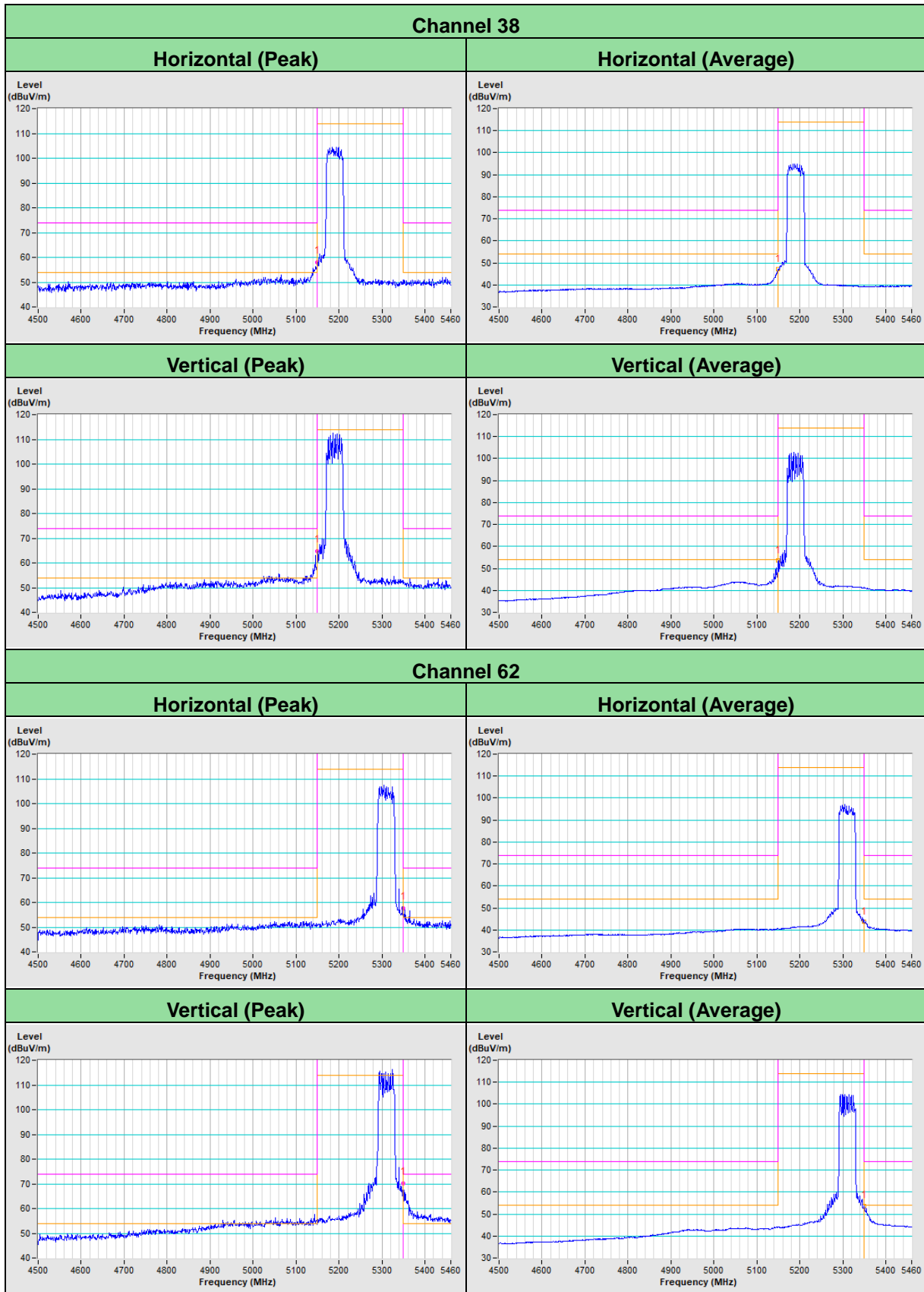

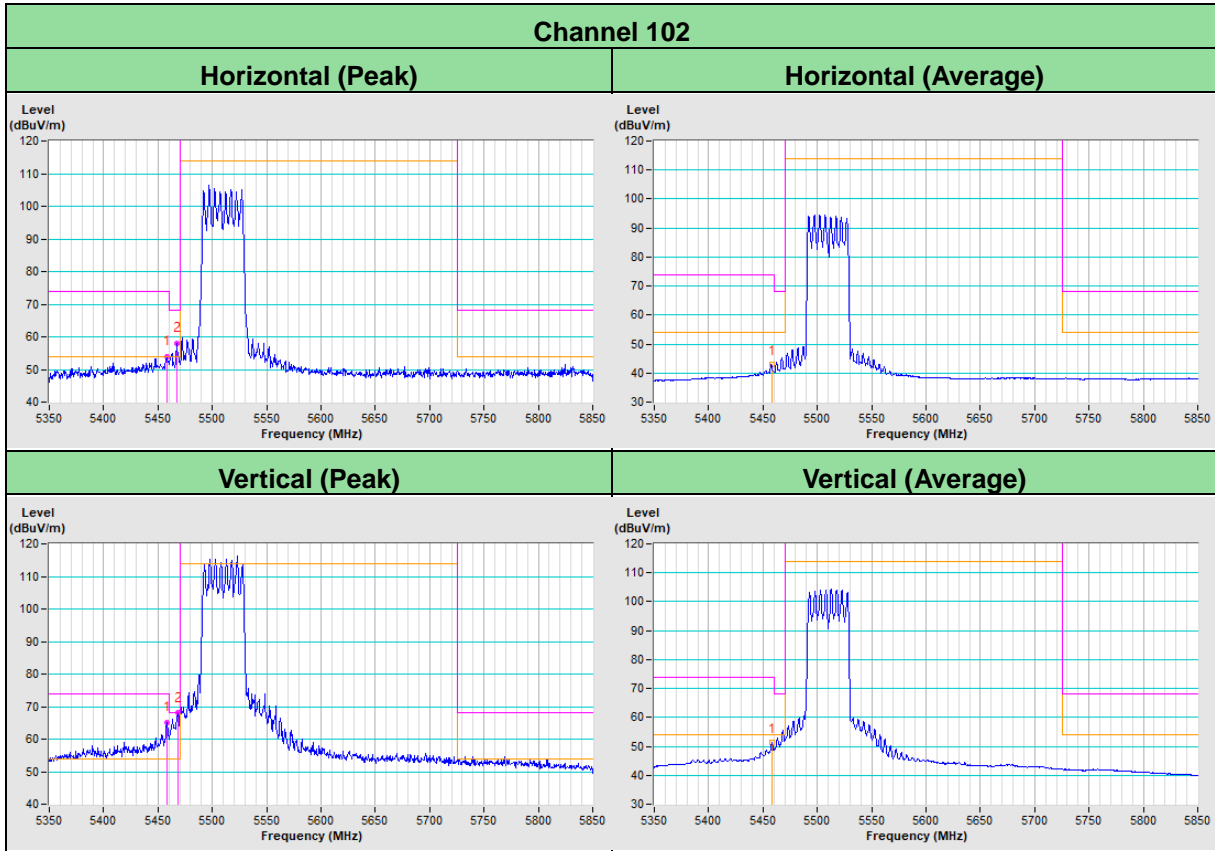

802.11ax (HE80)

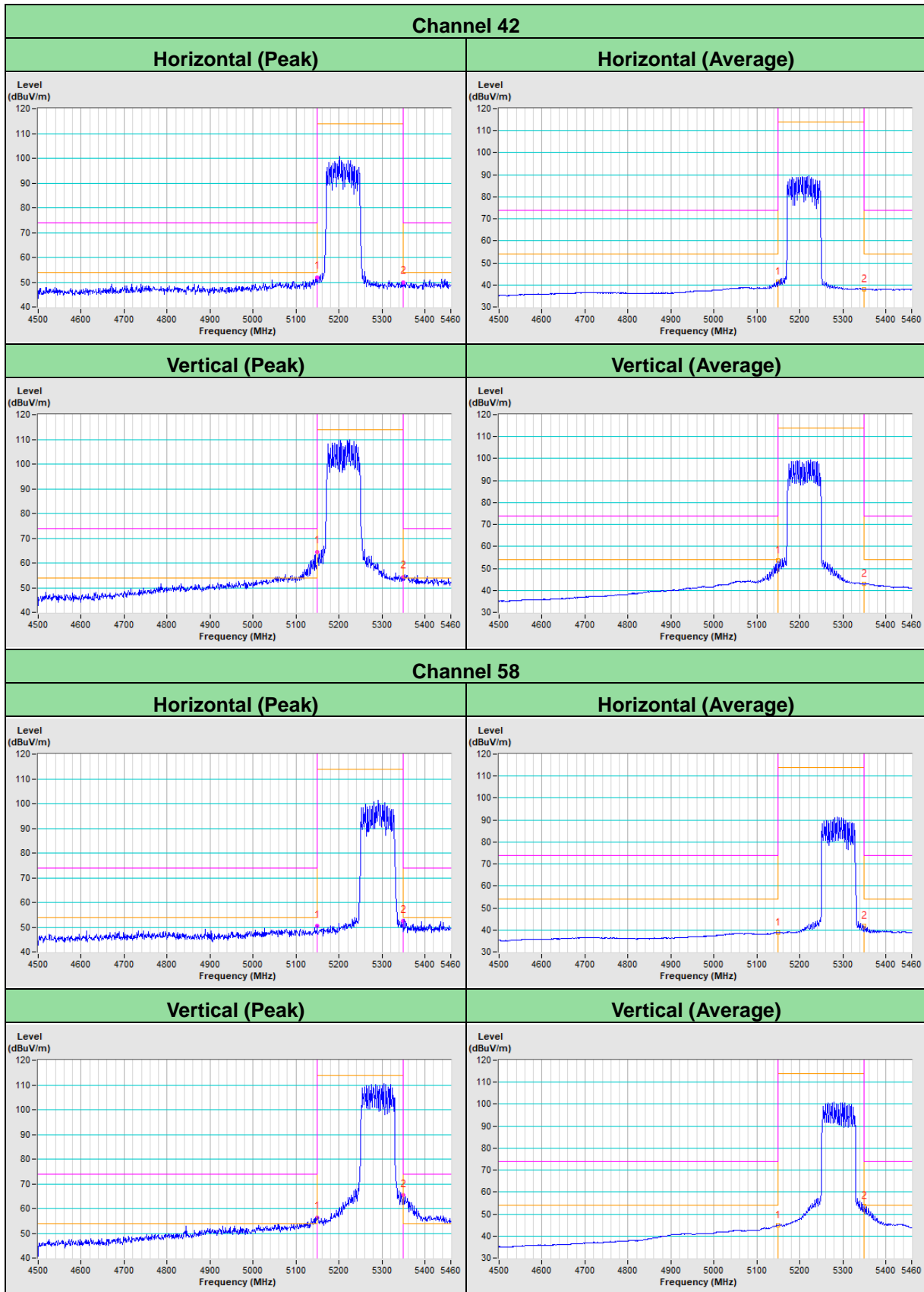

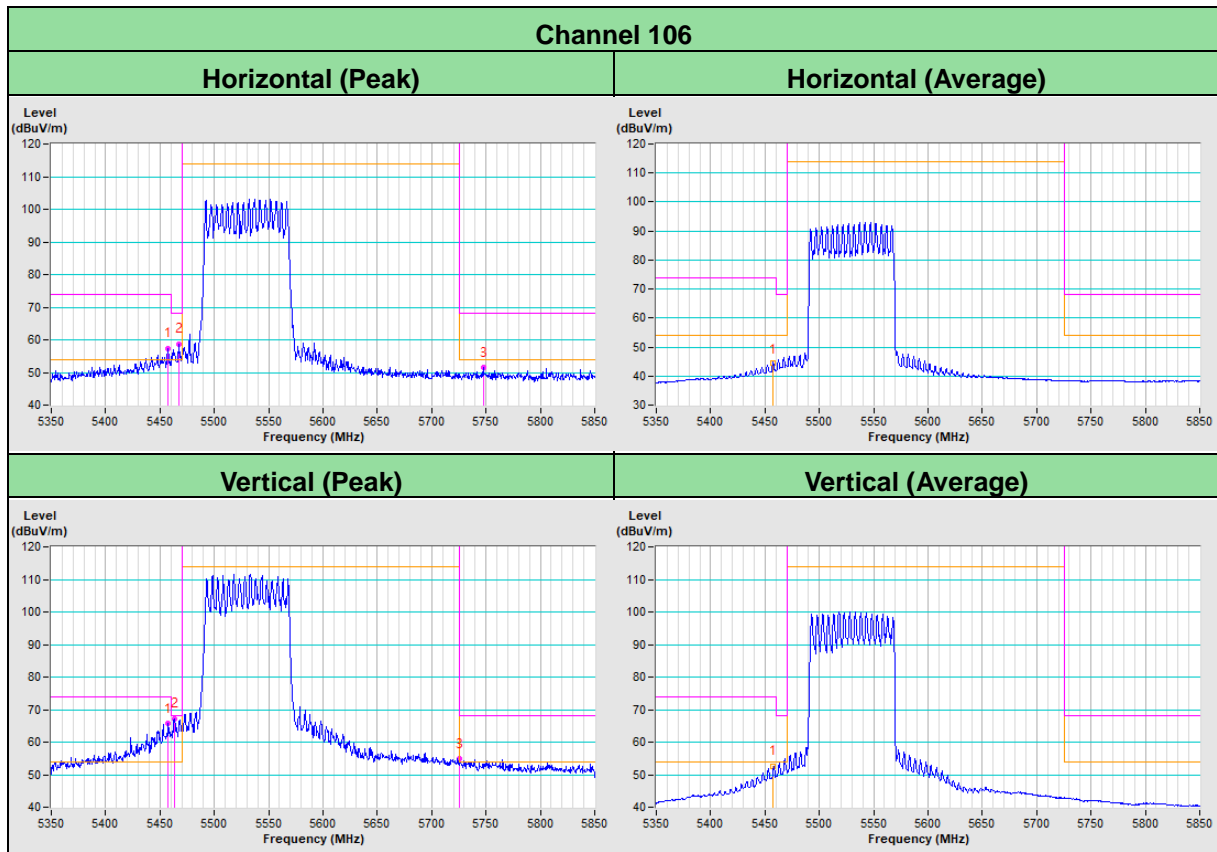

802.11ax (HE160)

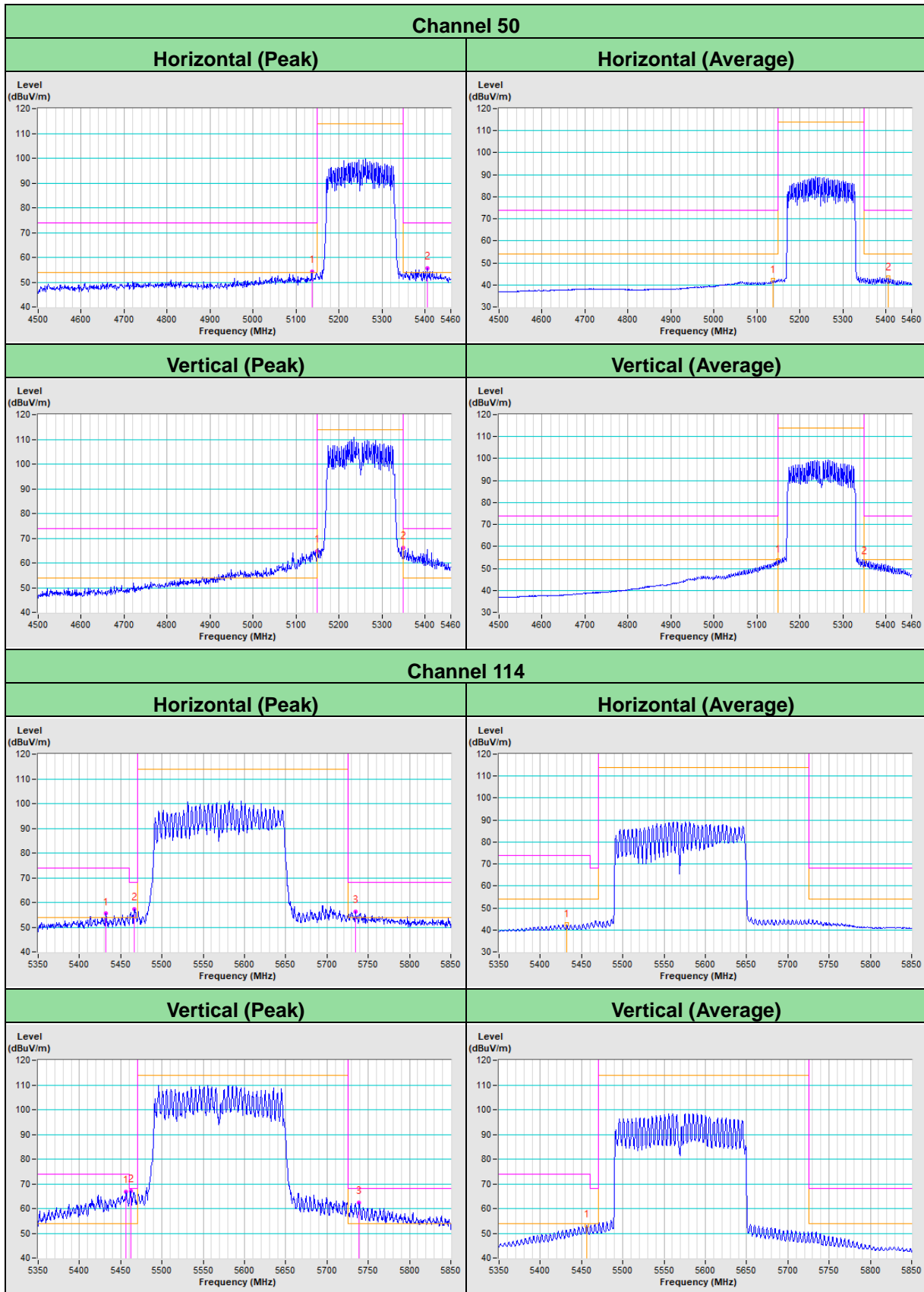

Appendix – Information of the Testing Laboratories

We, Bureau Veritas Consumer Products Services (H.K.) Ltd., Taoyuan Branch, were founded in 1988 to provide our best service in EMC, Radio, Telecom and Safety consultation. Our laboratories are FCC recognized accredited test firms and accredited according to ISO/IEC 17025.

If you have any comments, please feel free to contact us at the following:

Lin Kou EMC/RF Lab

Tel: 886-2-26052180

Fax: 886-2-26051924

Hsin Chu EMC/RF/Telecom Lab

Tel: 886-3-6668565

Fax: 886-3-6668323

Hwa Ya EMC/RF/Safety Lab

Tel: 886-3-3183232

Fax: 886-3-3270892

Email: service.adt@tw.bureauveritas.com

Web Site: www.bureauveritas-adt.com

The address and road map of all our labs can be found in our web site also.

--- END ---