

## FCC Test Report

**Report No.:** RF190731E05-1

**FCC ID:** PY319200454

**Test Model:** MR60

**Series Model:** MS60

**Received Date:** Aug. 01, 2019

**Test Date:** Aug. 02 to 29, 2019

**Issued Date:** Sep. 03, 2019

**Applicant:** NETGEAR, Inc.

**Address:** 350 East Plumeria Drive San Jose, CA 95134

**Issued By:** Bureau Veritas Consumer Products Services (H.K.) Ltd., Taoyuan Branch  
Hsin Chu Laboratory

**Lab Address:** E-2, No.1, Li Hsin 1st Road, Hsinchu Science Park, Hsinchu City 300,  
Taiwan R.O.C.

**Test Location:** E-2, No.1, Li Hsin 1st Road, Hsinchu Science Park, Hsinchu City 300,  
Taiwan R.O.C.

**FCC Registration /  
Designation Number:** 723255 / TW2022



This report is for your exclusive use. Any copying or replication of this report to or for any other person or entity, or use of our name or trademark, is permitted only with our prior written permission. This report sets forth our findings solely with respect to the test samples identified herein. The results set forth in this report are not indicative or representative of the quality or characteristics of the lot from which a test sample was taken or any similar or identical product unless specifically and expressly noted. Our report includes all of the tests requested by you and the results thereof based upon the information that you provided to us. You have 60 days from date of issuance of this report to notify us of any material error or omission caused by our negligence, provided, however, that such notice shall be in writing and shall specifically address the issue you wish to raise. A failure to raise such issue within the prescribed time shall constitute your unqualified acceptance of the completeness of this report, the tests conducted and the correctness of the report contents. Unless specific mention, the uncertainty of measurement has been explicitly taken into account to declare the compliance or non-compliance to the specification. The report must not be used by the client to claim product certification, approval, or endorsement by TAF or any government agencies.

## Table of Contents

<b>Release Control Record</b> .....	<b>4</b>
<b>1 Certificate of Conformity</b> .....	<b>5</b>
<b>2 Summary of Test Results</b> .....	<b>6</b>
2.1 Measurement Uncertainty .....	6
2.2 Modification Record .....	6
<b>3 General Information</b> .....	<b>7</b>
3.1 General Description of EUT .....	7
3.2 Description of Test Modes .....	10
3.2.1 Test Mode Applicability and Tested Channel Detail .....	11
3.3 Duty Cycle of Test Signal .....	13
3.4 Description of Support Units .....	15
3.4.1 Configuration of System under Test .....	16
3.5 General Description of Applied Standard .....	17
<b>4 Test Types and Results</b> .....	<b>18</b>
4.1 Radiated Emission and Bandedge Measurement .....	18
4.1.1 Limits of Radiated Emission and Bandedge Measurement .....	18
4.1.2 Test Instruments .....	19
4.1.3 Test Procedure .....	21
4.1.4 Deviation from Test Standard .....	22
4.1.5 Test Setup .....	22
4.1.6 EUT Operating Condition .....	23
4.1.7 Test Results .....	24
4.2 Conducted Emission Measurement .....	44
4.2.1 Limits of Conducted Emission Measurement .....	44
4.2.2 Test Instruments .....	44
4.2.3 Test Procedure .....	45
4.2.4 Deviation from Test Standard .....	45
4.2.5 Test Setup .....	45
4.2.6 EUT Operating Condition .....	45
4.2.7 Test Results .....	46
4.3 Transmit Power Measurement .....	48
4.3.1 Limits of Transmit Power Measurement .....	48
4.3.2 Test Setup .....	48
4.3.3 Test Instruments .....	48
4.3.4 Test Procedure .....	48
4.3.5 Deviation from Test Standard .....	48
4.3.6 EUT Operating Condition .....	48
4.3.7 Test Results .....	49
4.4 Occupied Bandwidth Measurement .....	53
4.4.1 Test Setup .....	53
4.4.2 Test Instruments .....	53
4.4.3 Test Procedure .....	53
4.4.4 Test Results .....	54
4.5 Peak Power Spectral Density Measurement .....	56
4.5.1 Limits of Peak Power Spectral Density Measurement .....	56
4.5.2 Test Setup .....	56
4.5.3 Test Instruments .....	56
4.5.4 Test Procedure .....	56
4.5.5 Deviation from Test Standard .....	57
4.5.6 EUT Operating Condition .....	57
4.5.7 Test Results .....	58
4.6 Frequency Stability Measurement .....	62
4.6.1 Limits of Frequency Stability Measurement .....	62

4.6.2	Test Setup.....	62
4.6.3	Test Instruments .....	62
4.6.4	Test Procedure .....	62
4.6.5	Deviation from Test Standard .....	62
4.6.6	EUT Operating Condition .....	62
4.6.7	Test Results .....	63
4.7	6dB Bandwidth Measurement .....	64
4.7.1	Limits of 6dB Bandwidth Measurement.....	64
4.7.2	Test Setup.....	64
4.7.3	Test Instruments .....	64
4.7.4	Test Procedure .....	64
4.7.5	Deviation from Test Standard .....	64
4.7.6	EUT Operating Condition .....	64
4.7.7	Test Results .....	65
<b>5</b>	<b>Pictures of Test Arrangements.....</b>	<b>67</b>
	<b>Annex A- Radiated Out of Band Emission (OOBE) Measurement (For U-NII-3 band).....</b>	<b>68</b>
	<b>Appendix – Information of the Testing Laboratories .....</b>	<b>71</b>

### Release Control Record

Issue No.	Description	Date Issued
RF190731E05-1	Original release.	Sep. 03, 2019

## 1 Certificate of Conformity

**Product:** Mesh WiFi 6 Router, Mesh WiFi 6 Satellite

**Brand:** NETGEAR

**Test Model:** MR60

**Series Model:** MS60

**Sample Status:** ENGINEERING SAMPLE

**Applicant:** NETGEAR, Inc.

**Test Date:** Aug. 02 to 29, 2019

**Standard:** 47 CFR FCC Part 15, Subpart E (Section 15.407)  
ANSI C63.10: 2013

The above equipment has been tested by **Bureau Veritas Consumer Products Services (H.K.) Ltd., Taoyuan Branch**, and found compliance with the requirement of the above standards. The test record, data evaluation & Equipment Under Test (EUT) configurations represented herein are true and accurate accounts of the measurements of the sample's EMC characteristics under the conditions specified in this report.

:  
**Prepared by** Wendy Wu, **Date:** Sep. 03, 2019  
Wendy Wu / Specialist

**Approved by :** May Chen, **Date:** Sep. 03, 2019  
May Chen / Manager

## 2 Summary of Test Results

47 CFR FCC Part 15, Subpart E (Section 15.407)			
FCC Clause	Test Item	Result	Remarks
15.407(b)(6)	AC Power Conducted Emissions	Pass	Meet the requirement of limit. Minimum passing margin is -11.14dB at 0.15000MHz.
15.407(b) (1/2/3/4(i/ii)/6)	Radiated Emissions & Band Edge Measurement*	Pass	Meet the requirement of limit. Minimum passing margin is -0.1dB at 5148.60MHz, 5150.00MHz.
15.407(a)(1/2/3)	Max Average Transmit Power	Pass	Meet the requirement of limit.
---	Occupied Bandwidth Measurement	-	Reference only.
15.407(a)(1/2/3)	Peak Power Spectral Density	Pass	Meet the requirement of limit.
15.407(e)	6dB bandwidth	Pass	Meet the requirement of limit. (U-NII-3 Band only)
15.407(g)	Frequency Stability	Pass	Meet the requirement of limit.
15.203	Antenna Requirement	Pass	Antenna connector is i-pex(MHF) not a standard connector.

\*For U-NII-3 band compliance with rule part 15.407(b)(4)(i), the OOB test plots were recorded in Annex A.

Note:

Determining compliance based on the results of the compliance measurement, not taking into account measurement instrumentation uncertainty.

### 2.1 Measurement Uncertainty

Where relevant, the following measurement uncertainty levels have been estimated for tests performed on the EUT as specified in CISPR 16-4-2:

Measurement	Frequency	Expanded Uncertainty (k=2) ( $\pm$ )
Conducted Emissions at mains ports	150kHz ~ 30MHz	1.8 dB
Radiated Emissions up to 1 GHz	30MHz ~ 1GHz	4.9 dB
Radiated Emissions above 1 GHz	1GHz ~ 6GHz	5.1 dB
	6GHz ~ 18GHz	4.9 dB
	18GHz ~ 40GHz	5.2 dB

### 2.2 Modification Record

There were no modifications required for compliance.

### 3 General Information

#### 3.1 General Description of EUT

Product	Mesh WiFi 6 Router, Mesh WiFi 6 Satellite
Brand	NETGEAR
Test Model	MR60
Series Model	MS60
Status of EUT	ENGINEERING SAMPLE
Power Supply Rating	DC 12V from power adapter
Modulation Type	CCK, DQPSK, DBPSK for DSSS 64QAM, 16QAM, QPSK, BPSK for OFDM 256QAM for OFDM in VHT20/40 mode 1024QAM for OFDM in 11ac mode 1024QAM for OFDMA in 11ax HE mode
Modulation Technology	DSSS, OFDM, OFDMA
Transfer Rate	802.11b: up to 11Mbps 802.11a/g: up to 54Mbps 802.11n: up to 300Mbps 802.11ac: up to 866.7Mbps 802.11ax: up to 1201Mbps
Operating Frequency	<b>2.4GHz:</b> 2.412 ~ 2.462 GHz <b>5GHz:</b> 5.18~ 5.24 GHz, 5.745 ~ 5.825 GHz
Number of Channel	<b>2.4GHz:</b> 802.11b, 802.11g, 802.11n (HT20), VHT20, 802.11ax (HE20): 11 802.11n (HT40), VHT40, 802.11ax (HE40): 7 <b>5GHz:</b> 802.11a, 802.11n (HT20), 802.11ac (VHT20), 802.11ax (HE20): 9 802.11n (HT40), 802.11ac (VHT40), 802.11ax (HE40): 4 802.11ac (VHT80), 802.11ax (HE80): 2
Output Power	<b>Non-Beamforming Mode:</b> <b>2.412 ~ 2.462 GHz:</b> 801.045 mW <b>5.18 ~ 5.24 GHz:</b> 674.577 mW <b>5.745 ~ 5.825 GHz:</b> 886.057 mW <b>Beamforming Mode:</b> <b>2.412 ~ 2.462 GHz:</b> 592.844 mW <b>5.18 ~ 5.24 GHz:</b> 529.192 mW <b>5.745 ~ 5.825 GHz:</b> 886.057 mW
Antenna Type	Refer to Note
Antenna Connector	Refer to Note
Accessory Device	Adapter x 1
Data Cable Supplied	RJ45 cable x 1 (Unshielded, 1.8m)

Note:

1. The EUT has below product names and model names which are identical to each other in all aspects except for the followings:

Product Name	Model Name	Description
Mesh WiFi 6 Router	MR60	Function: Master More for WAN port and single GPHY
Mesh WiFi 6 Satellite	MS60	Function: Client

Note: From the above models, model: MR60 was selected as representative model for the test and its data was recorded in this report.

2. Simultaneously transmission condition.

Condition	Technology	
1	WLAN (2.4GHz)	WLAN 5GHz

Note: The emission of the simultaneous operation has been evaluated and no non-compliance was found.

3. The EUT must be supplied one power adapter and following different models could be chosen as following table:

No.	Brand	Model No.	P/N	Spec.
1	NETGEAR	2ABB018F 1 NJ	332-10927-01	Input: 100-120Vac, 0.6A, 50/60Hz Output: 12V, 1.5A DC Output cable: Unshielded, 1.8m
2	NETGEAR	AD2076F10	332-10993-01	Input: 100-120Vac, 0.56A, 50/60Hz Output: 12V, 1.5A DC Output cable: Unshielded, 1.8m

Note:

1. From the above adapters, the AC Power Conducted Emissions worse case was found in **Adapter 2**. Therefore only the test data of the mode was recorded in this report.  
 2. From the above adapters, the Radiated Emissions worse case was found in **Adapter 1**. Therefore only the test data of the mode was recorded in this report.

4. The antennas provided to the EUT, please refer to the following table:

Antenna No.	Transmitter Circuit	Antenna Net Gain (dBi)	Frequency Range (GHz)	Antenna Type	Connector Type	Cable Length (mm)
1	Chain 0	1.38	2.4~2.4835	Dipole	i-pex(MHF)	65
2	Chain 1	1.03	2.4~2.4835	Dipole	i-pex(MHF)	105
3	Chain 0	1.73	5.15~5.25	Dipole	i-pex(MHF)	105
		2.04	5.725~5.85			
4	Chain 1	1.71	5.15~5.25	Dipole	i-pex(MHF)	65
		1.89	5.725~5.85			



5. The EUT incorporates a MIMO function:

2.4GHz Band		
MODULATION MODE	TX & RX CONFIGURATION	
802.11b	2TX	2RX
802.11g	2TX	2RX
802.11n (HT20)	2TX	2RX
802.11n (HT40)	2TX	2RX
VHT20	2TX	2RX
VHT40	2TX	2RX
802.11ax (HE20)	2TX	2RX
802.11ax (HE40)	2TX	2RX
5GHz Band		
MODULATION MODE	TX & RX CONFIGURATION	
802.11a	2TX	2RX
802.11n (HT20)	2TX	2RX
802.11n (HT40)	2TX	2RX
802.11ac (VHT20)	2TX	2RX
802.11ac (VHT40)	2TX	2RX
802.11ac (VHT80)	2TX	2RX
802.11ax (HE20)	2TX	2RX
802.11ax (HE40)	2TX	2RX
802.11ax (HE80)	2TX	2RX

Note:

1. All of modulation mode support beamforming function except 802.11a/b/g modulation mode.
2. The EUT support Beamforming and Non-Beamforming mode, therefore both mode were investigated and the worst case scenario was identified. The worst case data were presented in test report.
3. The modulation and bandwidth are similar for 802.11n mode for 20MHz (40MHz), 802.11ac mode for 20MHz (40MHz, 80MHz) and 802.11ax mode for 20MHz (40MHz, 80MHz), therefore investigated worst case to representative mode in test report. (Final test mode refer section 3.2.1)

6. The above EUT information is declared by manufacturer and for more detailed features description, please refers to the manufacturer's specifications or user's manual.

### 3.2 Description of Test Modes

#### FOR 5180 ~ 5240MHz

4 channels are provided for 802.11a, 802.11n (HT20), 802.11ac (VHT20), 802.11ax (HE20):

Channel	Frequency	Channel	Frequency
36	5180 MHz	44	5220 MHz
40	5200 MHz	48	5240 MHz

2 channels are provided for 802.11n (HT40), 802.11ac (VHT40), 802.11ax (HE40):

Channel	Frequency	Channel	Frequency
38	5190 MHz	46	5230 MHz

1 channel is provided for 802.11ac (VHT80), 802.11ax (HE80):

Channel	Frequency
42	5210 MHz

#### FOR 5745 ~ 5825MHz:

5 channels are provided for 802.11a, 802.11n (HT20), 802.11ac (VHT20), 802.11ax (HE20):

Channel	Frequency	Channel	Frequency
149	5745 MHz	161	5805 MHz
153	5765 MHz	165	5825 MHz
157	5785 MHz		

2 channels are provided for 802.11n (HT40), 802.11ac (VHT40), 802.11ax (HE40):

Channel	Frequency	Channel	Frequency
151	5755 MHz	159	5795 MHz

1 channel is provided for 802.11ac (VHT80), 802.11ax (HE80):

Channel	Frequency
155	5775 MHz

### 3.2.1 Test Mode Applicability and Tested Channel Detail

EUT Configure Mode	Applicable To				Description
	RE $\geq$ 1G	RE $<$ 1G	PLC	APCM	
1	√	√	√	√	-

Where **RE $\geq$ 1G**: Radiated Emission above 1GHz  
**RE $<$ 1G**: Radiated Emission below 1GHz  
**PLC**: Power Line Conducted Emission  
**APCM**: Antenna Port Conducted Measurement

#### **Radiated Emission Test (Above 1GHz):**

- Pre-Scan has been conducted to determine the worst-case mode from all possible combinations between available modulations, data rates and antenna ports (if EUT with antenna diversity architecture).
- Following channel(s) was (were) selected for the final test as listed below.

Non-Beamforming Mode						
Mode	Freq. Band (MHz)	Available Channel	Tested Channel	Modulation Technology	Modulation Type	Data Rate Parameter
802.11a	5180-5240	36 to 48	36, 40, 48	OFDM	BPSK	6Mb/s
802.11ax (HE20)		36 to 48	36, 40, 48	OFDMA	BPSK	MCS0
802.11ax (HE40)		38 to 46	38, 46	OFDMA	BPSK	MCS0
802.11ax (HE80)		42	42	OFDMA	BPSK	MCS0
802.11a	5745-5825	149 to 165	149, 157, 165	OFDM	BPSK	6Mb/s
802.11ax (HE20)		149 to 165	149, 157, 165	OFDMA	BPSK	MCS0
802.11ax (HE40)		151 to 159	151, 159	OFDMA	BPSK	MCS0
802.11ax (HE80)		155	155	OFDMA	BPSK	MCS0

#### **Radiated Emission Test (Below 1GHz):**

- Pre-Scan has been conducted to determine the worst-case mode from all possible combinations between available modulations, data rates and antenna ports (if EUT with antenna diversity architecture).
- Following channel(s) was (were) selected for the final test as listed below.

Non-Beamforming Mode						
Mode	Freq. Band (MHz)	Available Channel	Tested Channel	Modulation Technology	Modulation Type	Data Rate Parameter
802.11ax (HE20)	5180-5240 5745-5825	36 to 48 149 to 165	165	OFDMA	BPSK	MCS0

#### **Power Line Conducted Emission Test:**

- Pre-Scan has been conducted to determine the worst-case mode from all possible combinations between available modulations, data rates and antenna ports (if EUT with antenna diversity architecture).
- Following channel(s) was (were) selected for the final test as listed below.

Non-Beamforming Mode						
Mode	Freq. Band (MHz)	Available Channel	Tested Channel	Modulation Technology	Modulation Type	Data Rate Parameter
802.11ax (HE20)	5180-5240 5745-5825	36 to 48 149 to 165	165	OFDMA	BPSK	MCS0

### Antenna Port Conducted Measurement:

- This item includes all test value of each mode, but only includes spectrum plot of worst value of each mode.
- Pre-Scan has been conducted to determine the worst-case mode from all possible combinations between available modulations, data rates and antenna ports (if EUT with antenna diversity architecture).
- Following channel(s) was (were) selected for the final test as listed below.

Non-Beamforming Mode						
Mode	Freq. Band (MHz)	Available Channel	Tested Channel	Modulation Technology	Modulation Type	Data Rate Parameter
802.11a	5180-5240	36 to 48	36, 40, 48	OFDM	BPSK	6Mb/s
802.11ac (VHT20) (Output power only)		36 to 48	36, 40, 48	OFDM	BPSK	MCS0
802.11ac (VHT40) (Output power only)		38 to 46	38, 46	OFDM	BPSK	MCS0
802.11ac (VHT80) (Output power only)		42	42	OFDM	BPSK	MCS0
802.11ax (HE20)		36 to 48	36, 40, 48	OFDMA	BPSK	MCS0
802.11ax (HE40)		38 to 46	38, 46	OFDMA	BPSK	MCS0
802.11ax (HE80)		42	42	OFDMA	BPSK	MCS0
802.11a	5745-5825	149 to 165	149, 157, 165	OFDM	BPSK	6Mb/s
802.11ac (VHT20) (Output power only)		149 to 165	149, 157, 165	OFDM	BPSK	MCS0
802.11ac (VHT40) (Output power only)		151 to 159	151, 159	OFDM	BPSK	MCS0
802.11ac (VHT80) (Output power only)		155	155	OFDM	BPSK	MCS0
802.11ax (HE20)		149 to 165	149, 157, 165	OFDMA	BPSK	MCS0
802.11ax (HE40)		151 to 159	151, 159	OFDMA	BPSK	MCS0
802.11ax (HE80)		155	155	OFDMA	BPSK	MCS0
Beamforming Mode (output power only)						
Mode	Freq. Band (MHz)	Available Channel	Tested Channel	Modulation Technology	Modulation Type	Data Rate Parameter
802.11ac (VHT20)	5180-5240	36 to 48	36, 40, 48	OFDM	BPSK	MCS0
802.11ac (VHT40)		38 to 46	38, 46	OFDM	BPSK	MCS0
802.11ac (VHT80)		42	42	OFDM	BPSK	MCS0
802.11ax (HE20)		36 to 48	36, 40, 48	OFDMA	BPSK	MCS0
802.11ax (HE40)		38 to 46	38, 46	OFDMA	BPSK	MCS0
802.11ax (HE80)		42	42	OFDMA	BPSK	MCS0
802.11ac (VHT20)	5745-5825	149 to 165	149, 157, 165	OFDM	BPSK	MCS0
802.11ac (VHT40)		151 to 159	151, 159	OFDM	BPSK	MCS0
802.11ac (VHT80)		155	155	OFDM	BPSK	MCS0
802.11ax (HE20)		149 to 165	149, 157, 165	OFDMA	BPSK	MCS0
802.11ax (HE40)		151 to 159	151, 159	OFDMA	BPSK	MCS0
802.11ax (HE80)		155	155	OFDMA	BPSK	MCS0

### Test Condition:

Applicable To	Environmental Conditions	Input Power	Tested By
RE <sub>≥</sub> 1G	23deg. C, 68%RH	120Vac, 60Hz	Tank Wu
RE <sub>&lt;</sub> 1G	23deg. C, 70%RH	120Vac, 60Hz	Andy Ho
PLC	23deg. C, 75%RH	120Vac, 60Hz	Andy Ho
APCM	25deg. C, 60%RH	120Vac, 60Hz	Anderson Chen

### 3.3 Duty Cycle of Test Signal

If duty cycle of test signal is  $\geq 98\%$ , duty factor is not required.

**802.11a:** Duty cycle =  $2.962 \text{ ms} / 3.002 \text{ ms} = 0.987$

**802.11ac (VHT20):** Duty cycle =  $2.97 \text{ ms} / 3.004 \text{ ms} = 0.989$

**802.11ac (VHT40):** Duty cycle =  $2.967 \text{ ms} / 3.006 \text{ ms} = 0.987$

**802.11ac (VHT80):** Duty cycle =  $2.955 \text{ ms} / 3.004 \text{ ms} = 0.984$

**802.11ax (HE20):** Duty cycle =  $2.272 \text{ ms} / 2.312 \text{ ms} = 0.983$

**802.11ax (HE40):** Duty cycle =  $2.356 \text{ ms} / 2.369 \text{ ms} = 0.983$

**802.11ax (HE80):** Duty cycle =  $2.437 \text{ ms} / 2.478 \text{ ms} = 0.983$

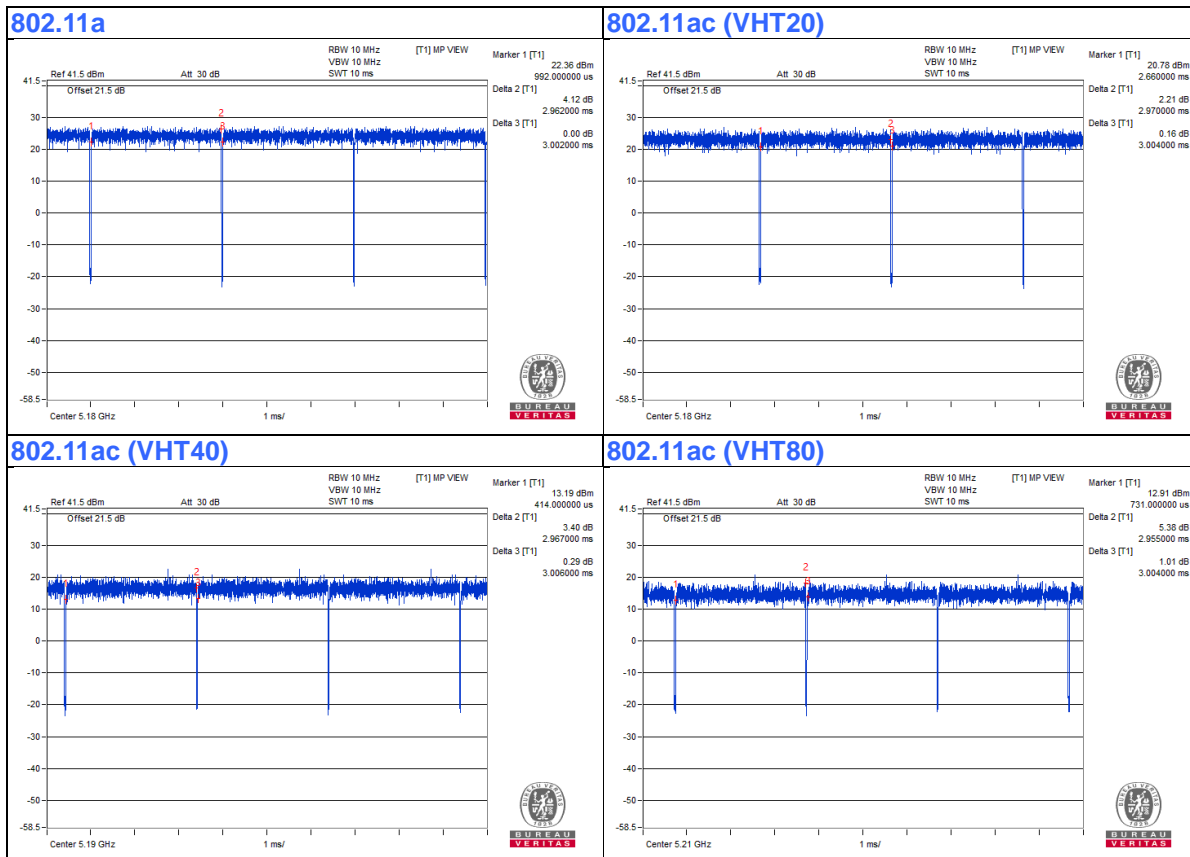

### 802.11ax (HE20)

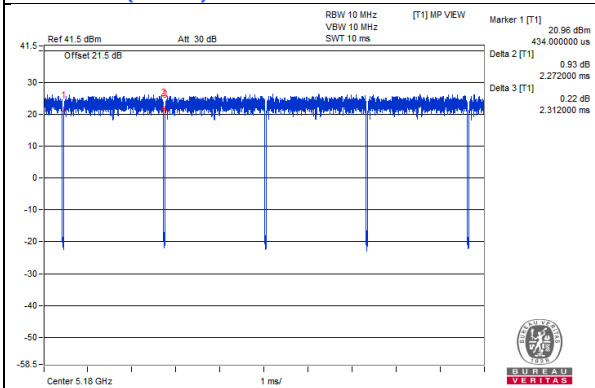

### 802.11ax (HE40)

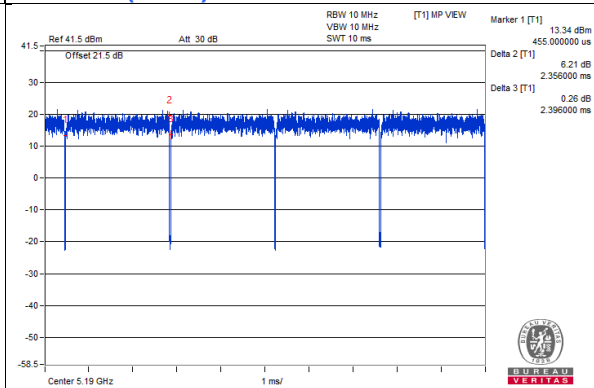

### 802.11ax (HE80)

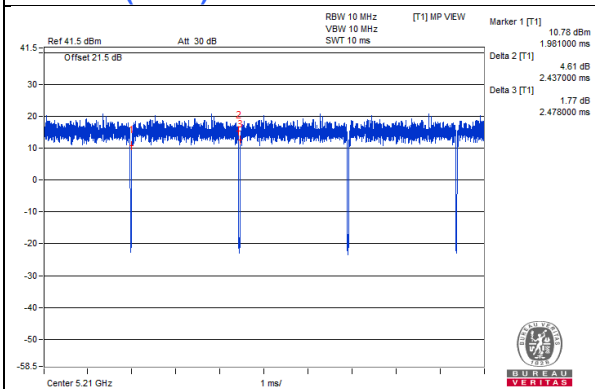

### 3.4 Description of Support Units

The EUT has been tested as an independent unit together with other necessary accessories or support units. The following support units or accessories were used to form a representative test configuration during the tests.

ID	Product	Brand	Model No.	Serial No.	FCC ID	Remarks
A.	Laptop	DELL	E6420	B92T3R1	FCC DoC	Provided by Lab
B.	Laptop	DELL	E6420	482T3R1	FCC DoC	Provided by Lab

Note:

1. All power cords of the above support units are non-shielded (1.8m).

ID	Descriptions	Qty.	Length (m)	Shielding (Yes/No)	Cores (Qty.)	Remarks
1.	DC Cable	1	1.8	No	0	Supplied by client
2.	RJ-45 Cable	1	10	No	0	Provided by Lab
3.	RJ-45 Cable	1	10	No	0	Provided by Lab

### 3.4.1 Configuration of System under Test

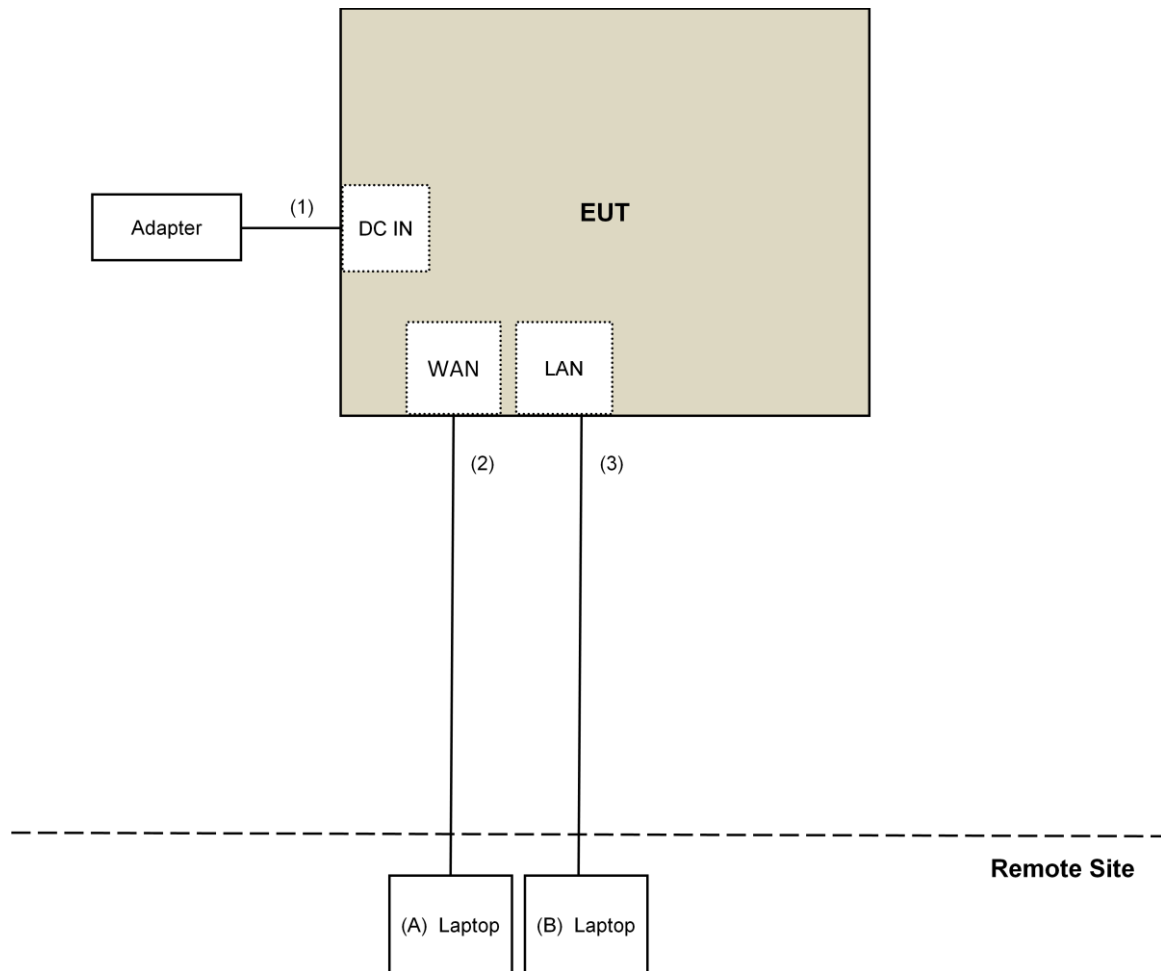



### 3.5 General Description of Applied Standard

The EUT is a RF Product. According to the specifications of the manufacturer, it must comply with the requirements of the following standards:

**FCC Part 15, Subpart E (15.407)**

**KDB 789033 D02 General UNII Test Procedure New Rules v02r01**

**KDB 662911 D01 Multiple Transmitter Output v02r01**

**ANSI C63.10-2013**

All test items have been performed and recorded as per the above standards.

## 4 Test Types and Results

### 4.1 Radiated Emission and Bandedge Measurement

#### 4.1.1 Limits of Radiated Emission and Bandedge Measurement

Radiated emissions which fall in the restricted bands must comply with the radiated emission limits specified as below table.

Frequencies (MHz)	Field Strength (microvolts/meter)	Measurement Distance (meters)
0.009 ~ 0.490	2400/F(kHz)	300
0.490 ~ 1.705	24000/F(kHz)	30
1.705 ~ 30.0	30	30
30 ~ 88	100	3
88 ~ 216	150	3
216 ~ 960	200	3
Above 960	500	3

#### NOTE:

1. The lower limit shall apply at the transition frequencies.
2. Emission level (dBuV/m) = 20 log Emission level (uV/m).
3. For frequencies above 1000MHz, the field strength limits are based on average detector, however, the peak field strength of any emission shall not exceed the maximum permitted average limits, specified above by more than 20dB under any condition of modulation.

Limits of unwanted emission out of the restricted bands

Applicable To		Limit	
789033 D02 General UNII Test Procedure New Rules v02r01		Field Strength at 3m	
		PK:74 (dBuV/m)	AV:54 (dBuV/m)
Frequency Band	Applicable To	EIRP Limit	Equivalent Field Strength at 3m
5150~5250 MHz	15.407(b)(1)	PK:-27 (dBm/MHz)	PK:68.2(dBuV/m)
5250~5350 MHz	15.407(b)(2)		
5470~5725 MHz	15.407(b)(3)		
5725~5850 MHz	<input checked="" type="checkbox"/> 15.407(b)(4)(i)	PK:-27 (dBm/MHz) <sup>*1</sup> PK:10 (dBm/MHz) <sup>*2</sup> PK:15.6 (dBm/MHz) <sup>*3</sup> PK:27 (dBm/MHz) <sup>*4</sup>	PK: 68.2(dBuV/m) <sup>*1</sup> PK:105.2 (dBuV/m) <sup>*2</sup> PK: 110.8(dBuV/m) <sup>*3</sup> PK:122.2 (dBuV/m) <sup>*4</sup>
	<input type="checkbox"/> 15.407(b)(4)(ii)	Emission limits in section 15.247(d)	
<sup>*1</sup> beyond 75 MHz or more above of the band edge.		<sup>*2</sup> below the band edge increasing linearly to 10 dBm/MHz at 25 MHz above.	
<sup>*3</sup> below the band edge increasing linearly to a level of 15.6 dBm/MHz at 5 MHz above.		<sup>*4</sup> from 5 MHz above or below the band edge increasing linearly to a level of 27 dBm/MHz at the band edge.	

#### Note:

The following formula is used to convert the equipment isotropic radiated power (eirp) to field strength:

$$E = \frac{1000000\sqrt{30P}}{3} \mu\text{V/m, where } P \text{ is the eirp (Watts).}$$

## 4.1.2 Test Instruments

## For OOB test:

DESCRIPTION & MANUFACTURER	MODEL NO.	SERIAL NO.	CALIBRATED DATE	CALIBRATED UNTIL
Test Receiver Keysight	N9038A	MY54450088	July 03, 2019	July 02, 2020
Horn_Antenna SCHWARZBECK	BBHA 9120D	9120D-783	Nov. 25, 2018	Nov. 24, 2019
Pre-Amplifier EMCI	EMC12630SE	980385	Aug. 16, 2018	Aug. 15, 2019
RF Cable	EMC104-SM-SM-1200	160923	Jan. 28, 2019	Jan. 27, 2020
RF Cable	104 RF cable	131215	Jan. 10, 2019	Jan. 09, 2020
RF Cable	EMC104-SM-SM-6000	180418	May 03, 2019	May 02, 2020
Pre-Amplifier EMCI	EMC184045SE	980387	Jan. 28, 2019	Jan. 27, 2020
Horn_Antenna SCHWARZBECK	BBHA 9170	BBHA9170519	Nov. 25, 2018	Nov. 24, 2019
RF Cable	EMC102-KM-KM-1200	160924	Jan. 28, 2019	Jan. 27, 2020
RF Cable	EMC102-KM-KM-1200	160925	Jan. 28, 2019	Jan. 27, 2020
Software	ADT_Radiated_V8.7.08	NA	NA	NA
Boresight Antenna Tower & Turn Table Max-Full	MF-7802BS	MF780208530	NA	NA

**Note:**

1. The calibration interval of the above test instruments is 12 months and the calibrations are traceable to NML/ROC and NIST/USA.
2. The test was performed in 966 Chamber No. 4.
3. Loop antenna was used for all emissions below 30 MHz.
4. Tested Date: Aug. 02, 2019

**For other test:**

DESCRIPTION & MANUFACTURER	MODEL NO.	SERIAL NO.	CALIBRATED DATE	CALIBRATED UNTIL
Test Receiver Keysight	N9038A	MY54450088	July 03, 2019	July 02, 2020
Pre-Amplifier EMCI	EMC001340	980142	May 30, 2019	May 29, 2020
Loop Antenna Electro-Metrics	EM-6879	264	Jan. 22, 2019	Jan. 21, 2020
RF Cable	NA	LOOPCAB-001	Jan. 14, 2019	Jan. 13, 2020
RF Cable	NA	LOOPCAB-002	Jan. 14, 2019	Jan. 13, 2020
Pre-Amplifier Mini-Circuits	ZFL-1000VH2B	AMP-ZFL-01	Oct. 30, 2018	Oct. 29, 2019
Trilog Broadband Antenna SCHWARZBECK	VULB 9168	9168-406	Nov. 22, 2018	Nov. 21, 2019
RF Cable	8D	966-4-1	Mar. 19, 2019	Mar. 18, 2020
RF Cable	8D	966-4-2	Mar. 19, 2019	Mar. 18, 2020
RF Cable	8D	966-4-3	Mar. 19, 2019	Mar. 18, 2020
Fixed attenuator Mini-Circuits	UNAT-5+	PAD-3m-4-01	Sep. 27, 2018	Sep. 26, 2019
Horn Antenna SCHWARZBECK	BBHA 9120D	9120D-783	Nov. 25, 2018	Nov. 24, 2019
Pre-Amplifier EMCI	EMC12630SE	980385	Aug. 15, 2019	Aug. 14, 2020
RF Cable	EMC104-SM-SM-1200	160923	Jan. 28, 2019	Jan. 27, 2020
RF Cable	104 RF cable	131215	Jan. 10, 2019	Jan. 09, 2020
RF Cable	EMC104-SM-SM-6000	180418	May 03, 2019	May 02, 2020
Pre-Amplifier EMCI	EMC184045SE	980387	Jan. 28, 2019	Jan. 27, 2020
Horn Antenna SCHWARZBECK	BBHA 9170	BBHA9170519	Nov. 25, 2018	Nov. 24, 2019
RF Cable	EMC102-KM-KM-1200	160924	Jan. 28, 2019	Jan. 27, 2020
RF Cable	EMC102-KM-KM-1200	160925	Jan. 28, 2019	Jan. 27, 2020
Software	ADT_Radiated_V8.7.08	NA	NA	NA
Boresight Antenna Tower & Turn Table Max-Full	MF-7802BS	MF780208530	NA	NA
Spectrum Analyzer R&S	FSV40	100964	June 04, 2019	June 03, 2020
Power meter Anritsu	ML2495A	1014008	May 13, 2019	May 12, 2020
Power sensor Anritsu	MA2411B	0917122	May 13, 2019	May 12, 2020
Fixed Attenuator Mini-Circuits	MDCS18N-10	MDCS18N-10-01	Apr. 15, 2019	Apr. 14, 2020
AC Power Source Extech Electronics	6205	1440452	NA	NA
Temperature & Humidity Chamber Giant Force	GTH-150-40-SP-AR	MAA0812-008	Jan. 09, 2019	Jan. 08, 2020
True RMS Clamp Meter FLUKE	325	31130711WS	May 21, 2019	May 20, 2020

**Note:**

1. The calibration interval of the above test instruments is 12 months and the calibrations are traceable to NML/ROC and NIST/USA.
2. The test was performed in 966 Chamber No. 4.
3. Loop antenna was used for all emissions below 30 MHz.
4. Tested Date: Aug. 17 to 19, 2019

#### 4.1.3 Test Procedure

##### **For Radiated emission below 30MHz**

- a. The EUT was placed on the top of a rotating table 0.8 meters above the ground at a 3 meter chamber room. The table was rotated 360 degrees to determine the position of the highest radiation.
- b. The EUT was set 3 meters away from the interference-receiving antenna, which was mounted on the top of a variable-height antenna tower.
- c. Parallel, perpendicular, and ground-parallel orientations of the antenna are set to make the measurement.
- d. For each suspected emission, the EUT was arranged to its worst case and the rotatable table was turned from 0 degrees to 360 degrees to find the maximum reading.
- e. The test-receiver system was set to Quasi-Peak Detect Function and Specified Bandwidth with Maximum Hold Mode.

##### **Note:**

1. The resolution bandwidth and video bandwidth of test receiver/spectrum analyzer is 9kHz at frequency below 30MHz.

##### **For Radiated emission above 30MHz**

- a. The EUT was placed on the top of a rotating table 0.8 meters (for 30MHz ~ 1GHz) / 1.5 meters (for above 1GHz) above the ground at 3 meter chamber room for test. The table was rotated 360 degrees to determine the position of the highest radiation.
- b. The EUT was set 3 meters away from the interference-receiving antenna, which was mounted on the top of a variable-height antenna tower.
- c. The height of antenna is varied from one meter to four meters above the ground to determine the maximum value of the field strength. Both horizontal and vertical polarizations of the antenna are set to make the measurement.
- d. For each suspected emission, the EUT was arranged to its worst case and then the antenna was tuned to heights from 1 meter to 4 meters and the rotatable table was turned from 0 degrees to 360 degrees to find the maximum reading.
- e. The test-receiver system was set to quasi-peak detect function and specified bandwidth with maximum hold mode when the test frequency is below 1 GHz.
- f. The test-receiver system was set to peak and average detects function and specified bandwidth with maximum hold mode when the test frequency is above 1 GHz. If the peak reading value also meets average limit, measurement with the average detector is unnecessary.

##### **Note:**

1. The resolution bandwidth and video bandwidth of test receiver/spectrum analyzer is 120kHz for Quasi-peak detection (QP) at frequency below 1GHz.
2. The resolution bandwidth of test receiver/spectrum analyzer is 1 MHz and the video bandwidth is 3 MHz for Peak detection (PK) at frequency above 1GHz.
3. The resolution bandwidth of test receiver/spectrum analyzer is 1MHz and the video bandwidth is  $\geq 1/T$  (Duty cycle < 98%) or 10Hz (Duty cycle  $\geq 98\%$ ) for Average detection (AV) at frequency above 1GHz.
4. All modes of operation were investigated and the worst-case emissions are reported.

4.1.4 Deviation from Test Standard

No deviation.

4.1.5 Test Setup

**For Radiated emission below 30MHz**

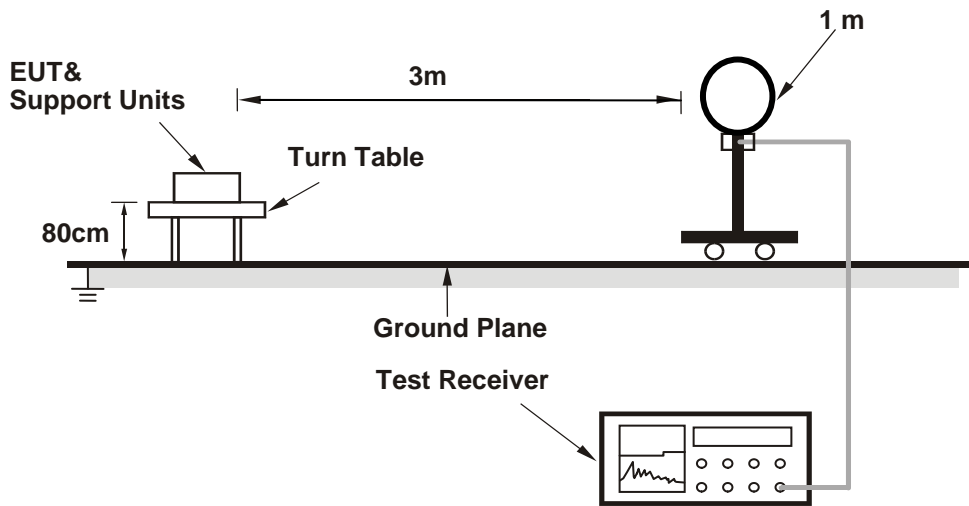

**For Radiated emission 30MHz to 1GHz**

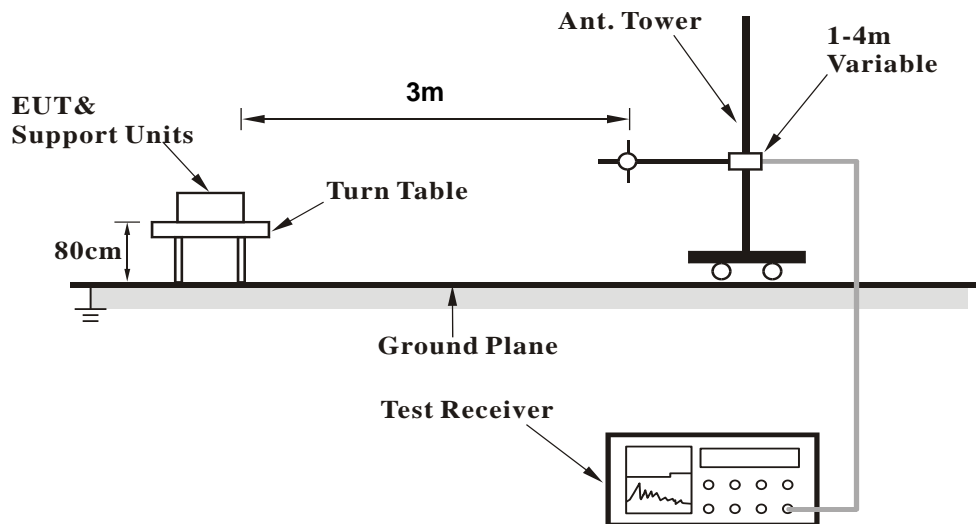

**For Radiated emission above 1GHz**

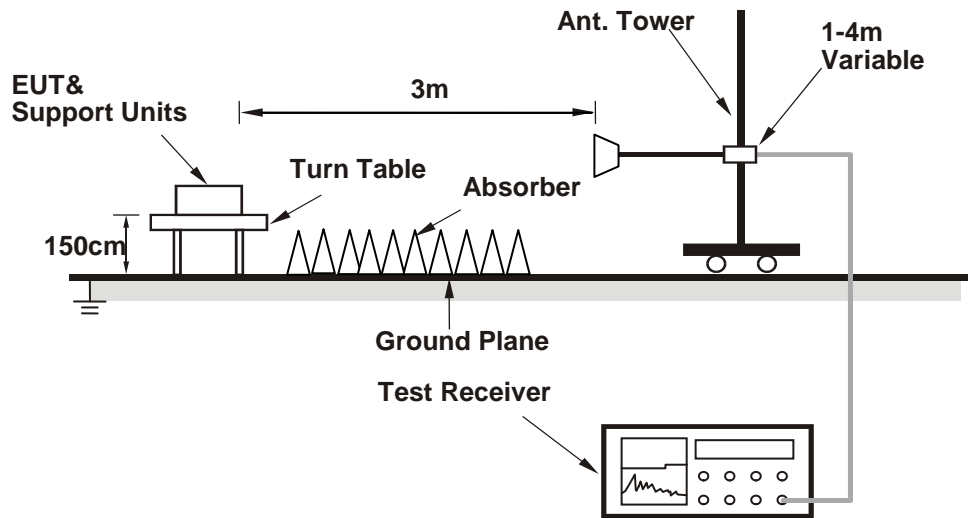

For the actual test configuration, please refer to the attached file (Test Setup Photo).

**4.1.6 EUT Operating Condition**

- a. Connected the EUT with the Laptop which is placed on remote site.
- b. Controlling software (Mtool 3.1.0.1) has been activated to set the EUT under transmission condition continuously at specific channel frequency.

## 4.1.7 Test Results

## Above 1GHz Data:

## 802.11a

<b>CHANNEL</b>	TX Channel 36	<b>DETECTOR FUNCTION</b>	Peak (PK)
<b>FREQUENCY RANGE</b>	1GHz ~ 40GHz		Average (AV)

**ANTENNA POLARITY & TEST DISTANCE: HORIZONTAL AT 3 M**

NO.	FREQ. (MHz)	EMISSION LEVEL (dBuV/m)	LIMIT (dBuV/m)	MARGIN (dB)	ANTENNA HEIGHT (m)	TABLE ANGLE (Degree)	RAW VALUE (dBuV)	CORRECTION FACTOR (dB/m)
1	5150.00	67.1 PK	74.0	-6.9	1.00 H	139	63.6	3.5
2	5150.00	49.3 AV	54.0	-4.7	1.00 H	139	45.8	3.5
3	*5180.00	112.0 PK			1.00 H	139	108.6	3.4
4	*5180.00	102.4 AV			1.00 H	139	99.0	3.4
5	#10360.00	54.8 PK	68.2	-13.4	3.93 H	360	41.7	13.1
6	15540.00	58.2 PK	74.0	-15.8	1.29 H	17	44.6	13.6
7	15540.00	46.1 AV	54.0	-7.9	1.29 H	17	32.5	13.6

**ANTENNA POLARITY & TEST DISTANCE: VERTICAL AT 3 M**

NO.	FREQ. (MHz)	EMISSION LEVEL (dBuV/m)	LIMIT (dBuV/m)	MARGIN (dB)	ANTENNA HEIGHT (m)	TABLE ANGLE (Degree)	RAW VALUE (dBuV)	CORRECTION FACTOR (dB/m)
1	5150.00	70.6 PK	74.0	-3.4	2.50 V	146	67.1	3.5
2	5150.00	53.2 AV	54.0	-0.8	2.50 V	146	49.7	3.5
3	*5180.00	117.4 PK			2.50 V	146	114.0	3.4
4	*5180.00	108.1 AV			2.50 V	146	104.7	3.4
5	#10360.00	60.2 PK	68.2	-8.0	1.10 V	7	47.1	13.1
6	15540.00	62.2 PK	74.0	-11.8	1.00 V	307	48.6	13.6
7	15540.00	50.2 AV	54.0	-3.8	1.00 V	307	36.6	13.6

**REMARKS:**

1. Emission Level(dBuV/m) = Raw Value(dBuV) + Correction Factor(dB/m)
2. Correction Factor(dB/m) = Antenna Factor(dB/m) + Cable Factor(dB) – Pre-Amplifier Factor(dB)
3. Margin value = Emission Level – Limit value
4. The other emission levels were very low against the limit.
5. " \* ": Fundamental frequency.
6. " # ": The radiated frequency is out of the restricted band.



<b>CHANNEL</b>	TX Channel 40	<b>DETECTOR FUNCTION</b>	Peak (PK)
<b>FREQUENCY RANGE</b>	1GHz ~ 40GHz		Average (AV)

**ANTENNA POLARITY & TEST DISTANCE: HORIZONTAL AT 3 M**

NO.	FREQ. (MHz)	EMISSION LEVEL (dBuV/m)	LIMIT (dBuV/m)	MARGIN (dB)	ANTENNA HEIGHT (m)	TABLE ANGLE (Degree)	RAW VALUE (dBuV)	CORRECTION FACTOR (dB/m)
1	5150.00	62.6 PK	74.0	-11.4	1.00 H	66	59.1	3.5
2	5150.00	47.1 AV	54.0	-6.9	1.00 H	66	43.6	3.5
3	*5200.00	114.5 PK			1.00 H	66	111.1	3.4
4	*5200.00	106.0 AV			1.00 H	66	102.6	3.4
5	#10400.00	57.9 PK	68.2	-10.3	3.96 H	360	44.5	13.4
6	15600.00	60.7 PK	74.0	-13.3	1.26 H	8	47.3	13.4
7	15600.00	48.9 AV	54.0	-5.1	1.26 H	8	35.5	13.4

**ANTENNA POLARITY & TEST DISTANCE: VERTICAL AT 3 M**

NO.	FREQ. (MHz)	EMISSION LEVEL (dBuV/m)	LIMIT (dBuV/m)	MARGIN (dB)	ANTENNA HEIGHT (m)	TABLE ANGLE (Degree)	RAW VALUE (dBuV)	CORRECTION FACTOR (dB/m)
1	5150.00	68.1 PK	74.0	-5.9	2.44 V	332	64.6	3.5
2	5150.00	53.8 AV	54.0	-0.2	2.44 V	332	50.3	3.5
3	*5200.00	121.2 PK			2.44 V	332	117.8	3.4
4	*5200.00	112.4 AV			2.44 V	332	109.0	3.4
5	#10400.00	63.4 PK	68.2	-4.8	1.14 V	12	50.0	13.4
6	15600.00	65.4 PK	74.0	-8.6	1.02 V	319	52.0	13.4
7	15600.00	53.2 AV	54.0	-0.8	1.02 V	319	39.8	13.4

**REMARKS:**

1. Emission Level(dBuV/m) = Raw Value(dBuV) + Correction Factor(dB/m)
2. Correction Factor(dB/m) = Antenna Factor(dB/m) + Cable Factor(dB) – Pre-Amplifier Factor(dB)
3. Margin value = Emission Level – Limit value
4. The other emission levels were very low against the limit.
5. " \* ": Fundamental frequency.
6. " # ": The radiated frequency is out of the restricted band.

<b>CHANNEL</b>	TX Channel 48	<b>DETECTOR FUNCTION</b>	Peak (PK)
<b>FREQUENCY RANGE</b>	1GHz ~ 40GHz		Average (AV)

**ANTENNA POLARITY & TEST DISTANCE: HORIZONTAL AT 3 M**

NO.	FREQ. (MHz)	EMISSION LEVEL (dBuV/m)	LIMIT (dBuV/m)	MARGIN (dB)	ANTENNA HEIGHT (m)	TABLE ANGLE (Degree)	RAW VALUE (dBuV)	CORRECTION FACTOR (dB/m)
1	5150.00	55.6 PK	74.0	-18.4	1.02 H	76	52.1	3.5
2	5150.00	45.2 AV	54.0	-8.8	1.02 H	76	41.7	3.5
3	*5240.00	113.6 PK			1.02 H	76	110.6	3.0
4	*5240.00	104.9 AV			1.02 H	76	101.9	3.0
5	5350.00	52.1 PK	74.0	-21.9	1.02 H	76	48.8	3.3
6	5350.00	40.8 AV	54.0	-13.2	1.02 H	76	37.5	3.3
7	#10480.00	57.8 PK	68.2	-10.4	3.93 H	359	44.3	13.5
8	15720.00	61.3 PK	74.0	-12.7	1.26 H	1	48.5	12.8
9	15720.00	49.2 AV	54.0	-4.8	1.26 H	1	36.4	12.8

**ANTENNA POLARITY & TEST DISTANCE: VERTICAL AT 3 M**

NO.	FREQ. (MHz)	EMISSION LEVEL (dBuV/m)	LIMIT (dBuV/m)	MARGIN (dB)	ANTENNA HEIGHT (m)	TABLE ANGLE (Degree)	RAW VALUE (dBuV)	CORRECTION FACTOR (dB/m)
1	5150.00	59.8 PK	74.0	-14.2	1.00 V	302	56.3	3.5
2	5150.00	49.3 AV	54.0	-4.7	1.00 V	302	45.8	3.5
3	*5240.00	121.1 PK			1.00 V	302	118.1	3.0
4	*5240.00	111.6 AV			1.00 V	302	108.6	3.0
5	5350.00	55.7 PK	74.0	-18.3	1.00 V	302	52.4	3.3
6	5350.00	44.9 AV	54.0	-9.1	1.00 V	302	41.6	3.3
7	#10480.00	63.5 PK	68.2	-4.7	1.16 V	1	50.0	13.5
8	15720.00	65.7 PK	74.0	-8.3	1.03 V	322	52.9	12.8
9	15720.00	53.5 AV	54.0	-0.5	1.03 V	322	40.7	12.8

**REMARKS:**

1. Emission Level(dBuV/m) = Raw Value(dBuV) + Correction Factor(dB/m)
2. Correction Factor(dB/m) = Antenna Factor(dB/m) + Cable Factor(dB) – Pre-Amplifier Factor(dB)
3. Margin value = Emission Level – Limit value
4. The other emission levels were very low against the limit.
5. " \* ": Fundamental frequency.
6. " # ": The radiated frequency is out of the restricted band.

<b>CHANNEL</b>	TX Channel 149	<b>DETECTOR FUNCTION</b>	Peak (PK)
<b>FREQUENCY RANGE</b>	1GHz ~ 40GHz		Average (AV)

**ANTENNA POLARITY & TEST DISTANCE: HORIZONTAL AT 3 M**

NO.	FREQ. (MHz)	EMISSION LEVEL (dBuV/m)	LIMIT (dBuV/m)	MARGIN (dB)	ANTENNA HEIGHT (m)	TABLE ANGLE (Degree)	RAW VALUE (dBuV)	CORRECTION FACTOR (dB/m)
1	#5638.64	55.3 PK	68.2	-12.9	1.05 H	121	51.7	3.6
2	*5745.00	117.8 PK			1.05 H	122	113.9	3.9
3	*5745.00	106.6 AV			1.05 H	122	102.7	3.9
4	#5991.04	55.1 PK	68.2	-13.1	1.05 H	121	50.7	4.4
5	11490.00	57.2 PK	74.0	-16.8	3.86 H	349	43.0	14.2
6	11490.00	47.4 AV	54.0	-6.6	3.86 H	349	33.2	14.2
7	#17235.00	58.6 PK	68.2	-9.6	1.15 H	54	41.3	17.3

**ANTENNA POLARITY & TEST DISTANCE: VERTICAL AT 3 M**

NO.	FREQ. (MHz)	EMISSION LEVEL (dBuV/m)	LIMIT (dBuV/m)	MARGIN (dB)	ANTENNA HEIGHT (m)	TABLE ANGLE (Degree)	RAW VALUE (dBuV)	CORRECTION FACTOR (dB/m)
1	#5640.64	58.1 PK	68.2	-10.1	1.50 V	357	54.5	3.6
2	*5745.00	120.8 PK			1.50 V	358	116.9	3.9
3	*5745.00	110.3 AV			1.50 V	358	106.4	3.9
4	#6001.46	56.2 PK	68.2	-12.0	1.50 V	357	51.8	4.4
5	11490.00	62.0 PK	74.0	-12.0	1.25 V	1	47.8	14.2
6	11490.00	50.9 AV	54.0	-3.1	1.25 V	1	36.7	14.2
7	#17235.00	64.2 PK	68.2	-4.0	1.20 V	4	46.9	17.3

**REMARKS:**

1. Emission Level(dBuV/m) = Raw Value(dBuV) + Correction Factor(dB/m)
2. Correction Factor(dB/m) = Antenna Factor(dB/m) + Cable Factor(dB) – Pre-Amplifier Factor(dB)
3. Margin value = Emission Level – Limit value
4. The other emission levels were very low against the limit.
5. " \* ": Fundamental frequency.
6. " # ": The radiated frequency is out of the restricted band.

<b>CHANNEL</b>	TX Channel 157	<b>DETECTOR FUNCTION</b>	Peak (PK)
<b>FREQUENCY RANGE</b>	1GHz ~ 40GHz		Average (AV)

**ANTENNA POLARITY & TEST DISTANCE: HORIZONTAL AT 3 M**

NO.	FREQ. (MHz)	EMISSION LEVEL (dBuV/m)	LIMIT (dBuV/m)	MARGIN (dB)	ANTENNA HEIGHT (m)	TABLE ANGLE (Degree)	RAW VALUE (dBuV)	CORRECTION FACTOR (dB/m)
1	#5604.80	54.8 PK	68.2	-13.4	1.09 H	119	51.1	3.7
2	*5785.00	118.2 PK			1.09 H	120	114.2	4.0
3	*5785.00	106.4 AV			1.09 H	120	102.4	4.0
4	#5942.08	55.6 PK	68.2	-12.6	1.09 H	119	51.3	4.3
5	11570.00	56.7 PK	74.0	-17.3	3.92 H	335	42.5	14.2
6	11570.00	47.1 AV	54.0	-6.9	3.92 H	335	32.9	14.2
7	#17355.00	58.7 PK	68.2	-9.5	1.10 H	51	41.0	17.7

**ANTENNA POLARITY & TEST DISTANCE: VERTICAL AT 3 M**

NO.	FREQ. (MHz)	EMISSION LEVEL (dBuV/m)	LIMIT (dBuV/m)	MARGIN (dB)	ANTENNA HEIGHT (m)	TABLE ANGLE (Degree)	RAW VALUE (dBuV)	CORRECTION FACTOR (dB/m)
1	#5626.65	54.6 PK	68.2	-13.6	1.56 V	332	51.0	3.6
2	*5785.00	118.6 PK			1.56 V	332	114.6	4.0
3	*5785.00	109.5 AV			1.56 V	332	105.5	4.0
4	#5981.06	56.6 PK	68.2	-11.6	1.56 V	332	52.2	4.4
5	11570.00	62.2 PK	74.0	-11.8	1.23 V	9	48.0	14.2
6	11570.00	50.8 AV	54.0	-3.2	1.23 V	9	36.6	14.2
7	#17355.00	64.3 PK	68.2	-3.9	1.19 V	3	46.6	17.7

**REMARKS:**

1. Emission Level(dBuV/m) = Raw Value(dBuV) + Correction Factor(dB/m)
2. Correction Factor(dB/m) = Antenna Factor(dB/m) + Cable Factor(dB) – Pre-Amplifier Factor(dB)
3. Margin value = Emission Level – Limit value
4. The other emission levels were very low against the limit.
5. " \* ": Fundamental frequency.
6. " # ": The radiated frequency is out of the restricted band.

<b>CHANNEL</b>	TX Channel 165	<b>DETECTOR FUNCTION</b>	Peak (PK)
<b>FREQUENCY RANGE</b>	1GHz ~ 40GHz		Average (AV)

**ANTENNA POLARITY & TEST DISTANCE: HORIZONTAL AT 3 M**

NO.	FREQ. (MHz)	EMISSION LEVEL (dBuV/m)	LIMIT (dBuV/m)	MARGIN (dB)	ANTENNA HEIGHT (m)	TABLE ANGLE (Degree)	RAW VALUE (dBuV)	CORRECTION FACTOR (dB/m)
1	#5597.39	54.7 PK	68.2	-13.5	1.02 H	120	51.0	3.7
2	*5825.00	117.6 PK			1.02 H	121	113.4	4.2
3	*5825.00	106.5 AV			1.02 H	121	102.3	4.2
4	#5944.86	55.7 PK	68.2	-12.5	1.02 H	120	51.3	4.4
5	11650.00	57.2 PK	74.0	-16.8	3.94 H	322	43.3	13.9
6	11650.00	47.5 AV	54.0	-6.5	3.94 H	322	33.6	13.9
7	#17475.00	59.2 PK	68.2	-9.0	1.05 H	52	40.4	18.8

**ANTENNA POLARITY & TEST DISTANCE: VERTICAL AT 3 M**

NO.	FREQ. (MHz)	EMISSION LEVEL (dBuV/m)	LIMIT (dBuV/m)	MARGIN (dB)	ANTENNA HEIGHT (m)	TABLE ANGLE (Degree)	RAW VALUE (dBuV)	CORRECTION FACTOR (dB/m)
1	#5596.22	57.3 PK	68.2	-10.9	2.30 V	333	53.6	3.7
2	*5825.00	122.2 PK			2.30 V	333	118.0	4.2
3	*5825.00	110.6 AV			2.30 V	333	106.4	4.2
4	#5958.56	58.5 PK	68.2	-9.7	2.30 V	333	54.1	4.4
5	11650.00	61.3 PK	74.0	-12.7	1.22 V	4	47.4	13.9
6	11650.00	50.3 AV	54.0	-3.7	1.22 V	4	36.4	13.9
7	#17475.00	64.2 PK	68.2	-4.0	1.22 V	19	45.4	18.8

**REMARKS:**

1. Emission Level(dBuV/m) = Raw Value(dBuV) + Correction Factor(dB/m)
2. Correction Factor(dB/m) = Antenna Factor(dB/m) + Cable Factor(dB) – Pre-Amplifier Factor(dB)
3. Margin value = Emission Level – Limit value
4. The other emission levels were very low against the limit.
5. " \* ": Fundamental frequency.
6. " # ": The radiated frequency is out of the restricted band.

**802.11ax (HE20)**

<b>CHANNEL</b>	TX Channel 36	<b>DETECTOR FUNCTION</b>	Peak (PK)
<b>FREQUENCY RANGE</b>	1GHz ~ 40GHz		Average (AV)

**ANTENNA POLARITY & TEST DISTANCE: HORIZONTAL AT 3 M**

NO.	FREQ. (MHz)	EMISSION LEVEL (dBuV/m)	LIMIT (dBuV/m)	MARGIN (dB)	ANTENNA HEIGHT (m)	TABLE ANGLE (Degree)	RAW VALUE (dBuV)	CORRECTION FACTOR (dB/m)
1	5150.00	66.2 PK	74.0	-7.8	1.09 H	50	62.7	3.5
2	5150.00	50.7 AV	54.0	-3.3	1.09 H	50	47.2	3.5
3	*5180.00	111.7 PK			1.09 H	50	108.3	3.4
4	*5180.00	99.8 AV			1.09 H	50	96.4	3.4
5	#10360.00	56.4 PK	68.2	-11.8	3.91 H	360	43.3	13.1
6	15540.00	58.1 PK	74.0	-15.9	1.23 H	1	44.5	13.6
7	15540.00	46.2 AV	54.0	-7.8	1.23 H	1	32.6	13.6

**ANTENNA POLARITY & TEST DISTANCE: VERTICAL AT 3 M**

NO.	FREQ. (MHz)	EMISSION LEVEL (dBuV/m)	LIMIT (dBuV/m)	MARGIN (dB)	ANTENNA HEIGHT (m)	TABLE ANGLE (Degree)	RAW VALUE (dBuV)	CORRECTION FACTOR (dB/m)
1	5150.00	69.3 PK	74.0	-4.7	2.45 V	145	65.8	3.5
2	5150.00	53.8 AV	54.0	-0.2	2.45 V	145	50.3	3.5
3	*5180.00	119.5 PK			2.45 V	145	116.1	3.4
4	*5180.00	106.8 AV			2.45 V	145	103.4	3.4
5	#10360.00	61.1 PK	68.2	-7.1	1.10 V	3	48.0	13.1
6	15540.00	62.9 PK	74.0	-11.1	1.03 V	314	49.3	13.6
7	15540.00	50.6 AV	54.0	-3.4	1.03 V	314	37.0	13.6

**REMARKS:**

1. Emission Level(dBuV/m) = Raw Value(dBuV) + Correction Factor(dB/m)
2. Correction Factor(dB/m) = Antenna Factor(dB/m) + Cable Factor(dB) – Pre-Amplifier Factor(dB)
3. Margin value = Emission Level – Limit value
4. The other emission levels were very low against the limit.
5. " \* ": Fundamental frequency.
6. " # ": The radiated frequency is out of the restricted band.

<b>CHANNEL</b>	TX Channel 40	<b>DETECTOR FUNCTION</b>	Peak (PK)
<b>FREQUENCY RANGE</b>	1GHz ~ 40GHz		Average (AV)

**ANTENNA POLARITY & TEST DISTANCE: HORIZONTAL AT 3 M**

NO.	FREQ. (MHz)	EMISSION LEVEL (dBuV/m)	LIMIT (dBuV/m)	MARGIN (dB)	ANTENNA HEIGHT (m)	TABLE ANGLE (Degree)	RAW VALUE (dBuV)	CORRECTION FACTOR (dB/m)
1	5150.00	65.3 PK	74.0	-8.7	1.08 H	41	61.8	3.5
2	5150.00	50.8 AV	54.0	-3.2	1.08 H	41	47.3	3.5
3	*5200.00	115.2 PK			1.08 H	41	111.8	3.4
4	*5200.00	102.8 AV			1.08 H	41	99.4	3.4
5	#10400.00	58.6 PK	68.2	-9.6	3.85 H	360	45.2	13.4
6	15600.00	60.6 PK	74.0	-13.4	1.26 H	1	47.2	13.4
7	15600.00	48.3 AV	54.0	-5.7	1.26 H	1	34.9	13.4

**ANTENNA POLARITY & TEST DISTANCE: VERTICAL AT 3 M**

NO.	FREQ. (MHz)	EMISSION LEVEL (dBuV/m)	LIMIT (dBuV/m)	MARGIN (dB)	ANTENNA HEIGHT (m)	TABLE ANGLE (Degree)	RAW VALUE (dBuV)	CORRECTION FACTOR (dB/m)
1	5150.00	68.6 PK	74.0	-5.4	2.32 V	147	65.1	3.5
<b>2</b>	<b>5150.00</b>	<b>53.9 AV</b>	<b>54.0</b>	<b>-0.1</b>	<b>2.32 V</b>	<b>147</b>	<b>50.4</b>	<b>3.5</b>
3	*5200.00	123.0 PK			2.32 V	147	119.6	3.4
4	*5200.00	109.8 AV			2.32 V	147	106.4	3.4
5	#10400.00	62.7 PK	68.2	-5.5	1.07 V	18	49.3	13.4
6	15600.00	64.3 PK	74.0	-9.7	1.03 V	308	50.9	13.4
7	15600.00	52.6 AV	54.0	-1.4	1.03 V	308	39.2	13.4

**REMARKS:**

- Emission Level(dBuV/m) = Raw Value(dBuV) + Correction Factor(dB/m)
- Correction Factor(dB/m) = Antenna Factor(dB/m) + Cable Factor(dB) – Pre-Amplifier Factor(dB)
- Margin value = Emission Level – Limit value
- The other emission levels were very low against the limit.
- " \* ": Fundamental frequency.
- " # ": The radiated frequency is out of the restricted band.

<b>CHANNEL</b>	TX Channel 48	<b>DETECTOR FUNCTION</b>	Peak (PK)
<b>FREQUENCY RANGE</b>	1GHz ~ 40GHz		Average (AV)

**ANTENNA POLARITY & TEST DISTANCE: HORIZONTAL AT 3 M**

NO.	FREQ. (MHz)	EMISSION LEVEL (dBuV/m)	LIMIT (dBuV/m)	MARGIN (dB)	ANTENNA HEIGHT (m)	TABLE ANGLE (Degree)	RAW VALUE (dBuV)	CORRECTION FACTOR (dB/m)
1	5150.00	58.2 PK	74.0	-15.8	1.09 H	30	54.7	3.5
2	5150.00	44.2 AV	54.0	-9.8	1.09 H	30	40.7	3.5
3	*5240.00	113.5 PK			1.09 H	30	110.5	3.0
4	*5240.00	101.6 AV			1.09 H	30	98.6	3.0
5	5350.00	54.1 PK	74.0	-19.9	1.09 H	30	50.8	3.3
6	5350.00	40.1 AV	54.0	-13.9	1.09 H	30	36.8	3.3
7	#10480.00	58.6 PK	68.2	-9.6	3.89 H	354	45.1	13.5
8	15720.00	60.3 PK	74.0	-13.7	1.25 H	9	47.5	12.8
9	15720.00	48.1 AV	54.0	-5.9	1.25 H	9	35.3	12.8

**ANTENNA POLARITY & TEST DISTANCE: VERTICAL AT 3 M**

NO.	FREQ. (MHz)	EMISSION LEVEL (dBuV/m)	LIMIT (dBuV/m)	MARGIN (dB)	ANTENNA HEIGHT (m)	TABLE ANGLE (Degree)	RAW VALUE (dBuV)	CORRECTION FACTOR (dB/m)
1	5150.00	61.1 PK	74.0	-12.9	2.26 V	146	57.6	3.5
2	5150.00	47.3 AV	54.0	-6.7	2.26 V	146	43.8	3.5
3	*5240.00	121.3 PK			2.26 V	146	118.3	3.0
4	*5240.00	108.7 AV			2.26 V	146	105.7	3.0
5	5350.00	57.2 PK	74.0	-16.8	2.26 V	146	53.9	3.3
6	5350.00	43.2 AV	54.0	-10.8	2.26 V	146	39.9	3.3
7	#10480.00	63.1 PK	68.2	-5.1	1.12 V	0	49.6	13.5
8	15720.00	64.3 PK	74.0	-9.7	1.02 V	312	51.5	12.8
9	15720.00	52.4 AV	54.0	-1.6	1.02 V	312	39.6	12.8

**REMARKS:**

1. Emission Level(dBuV/m) = Raw Value(dBuV) + Correction Factor(dB/m)
2. Correction Factor(dB/m) = Antenna Factor(dB/m) + Cable Factor(dB) – Pre-Amplifier Factor(dB)
3. Margin value = Emission Level – Limit value
4. The other emission levels were very low against the limit.
5. " \* ": Fundamental frequency.
6. " # ": The radiated frequency is out of the restricted band.



<b>CHANNEL</b>	TX Channel 149	<b>DETECTOR FUNCTION</b>	Peak (PK)
<b>FREQUENCY RANGE</b>	1GHz ~ 40GHz		Average (AV)

**ANTENNA POLARITY & TEST DISTANCE: HORIZONTAL AT 3 M**

NO.	FREQ. (MHz)	EMISSION LEVEL (dBuV/m)	LIMIT (dBuV/m)	MARGIN (dB)	ANTENNA HEIGHT (m)	TABLE ANGLE (Degree)	RAW VALUE (dBuV)	CORRECTION FACTOR (dB/m)
1	#5573.56	53.8 PK	68.2	-14.4	1.15 H	295	50.1	3.7
2	*5745.00	116.5 PK			1.15 H	295	112.6	3.9
3	*5745.00	103.4 AV			1.15 H	295	99.5	3.9
4	#6004.10	53.0 PK	68.2	-15.2	1.15 H	295	48.6	4.4
5	11490.00	57.7 PK	74.0	-16.3	3.87 H	360	43.5	14.2
6	11490.00	48.0 AV	54.0	-6.0	3.87 H	360	33.8	14.2
7	#17235.00	59.1 PK	68.2	-9.1	1.14 H	24	41.8	17.3

**ANTENNA POLARITY & TEST DISTANCE: VERTICAL AT 3 M**

NO.	FREQ. (MHz)	EMISSION LEVEL (dBuV/m)	LIMIT (dBuV/m)	MARGIN (dB)	ANTENNA HEIGHT (m)	TABLE ANGLE (Degree)	RAW VALUE (dBuV)	CORRECTION FACTOR (dB/m)
1	#5646.81	56.9 PK	68.2	-11.3	2.67 V	151	53.3	3.6
2	*5745.00	120.8 PK			2.67 V	151	116.9	3.9
3	*5745.00	109.4 AV			2.67 V	151	105.5	3.9
4	#5976.16	56.2 PK	68.2	-12.0	2.67 V	151	51.8	4.4
5	11490.00	61.6 PK	74.0	-12.4	1.29 V	15	47.4	14.2
6	11490.00	50.5 AV	54.0	-3.5	1.29 V	15	36.3	14.2
7	#17235.00	64.3 PK	68.2	-3.9	1.19 V	9	47.0	17.3

**REMARKS:**

1. Emission Level(dBuV/m) = Raw Value(dBuV) + Correction Factor(dB/m)
2. Correction Factor(dB/m) = Antenna Factor(dB/m) + Cable Factor(dB) – Pre-Amplifier Factor(dB)
3. Margin value = Emission Level – Limit value
4. The other emission levels were very low against the limit.
5. " \* ": Fundamental frequency.
6. " # ": The radiated frequency is out of the restricted band.

<b>CHANNEL</b>	TX Channel 157	<b>DETECTOR FUNCTION</b>	Peak (PK)
<b>FREQUENCY RANGE</b>	1GHz ~ 40GHz		Average (AV)

**ANTENNA POLARITY & TEST DISTANCE: HORIZONTAL AT 3 M**

NO.	FREQ. (MHz)	EMISSION LEVEL (dBuV/m)	LIMIT (dBuV/m)	MARGIN (dB)	ANTENNA HEIGHT (m)	TABLE ANGLE (Degree)	RAW VALUE (dBuV)	CORRECTION FACTOR (dB/m)
1	#5585.84	53.9 PK	68.2	-14.3	1.16 H	293	50.2	3.7
2	*5785.00	116.7 PK			1.16 H	293	112.7	4.0
3	*5785.00	103.9 AV			1.16 H	293	99.9	4.0
4	#5987.51	53.3 PK	68.2	-14.9	1.16 H	293	48.9	4.4
5	11570.00	57.5 PK	74.0	-16.5	3.92 H	360	43.3	14.2
6	11570.00	48.1 AV	54.0	-5.9	3.92 H	360	33.9	14.2
7	#17355.00	58.6 PK	68.2	-9.6	1.15 H	28	40.9	17.7

**ANTENNA POLARITY & TEST DISTANCE: VERTICAL AT 3 M**

NO.	FREQ. (MHz)	EMISSION LEVEL (dBuV/m)	LIMIT (dBuV/m)	MARGIN (dB)	ANTENNA HEIGHT (m)	TABLE ANGLE (Degree)	RAW VALUE (dBuV)	CORRECTION FACTOR (dB/m)
1	#5592.63	56.3 PK	68.2	-11.9	2.46 V	154	52.6	3.7
2	*5785.00	121.5 PK			2.46 V	154	117.5	4.0
3	*5785.00	109.8 AV			2.46 V	154	105.8	4.0
4	#5948.03	56.8 PK	68.2	-11.4	2.46 V	154	52.4	4.4
5	11570.00	61.9 PK	74.0	-12.1	1.31 V	17	47.7	14.2
6	11570.00	50.8 AV	54.0	-3.2	1.31 V	17	36.6	14.2
7	#17355.00	64.6 PK	68.2	-3.6	1.13 V	4	46.9	17.7

**REMARKS:**

1. Emission Level(dBuV/m) = Raw Value(dBuV) + Correction Factor(dB/m)
2. Correction Factor(dB/m) = Antenna Factor(dB/m) + Cable Factor(dB) – Pre-Amplifier Factor(dB)
3. Margin value = Emission Level – Limit value
4. The other emission levels were very low against the limit.
5. " \* ": Fundamental frequency.
6. " # ": The radiated frequency is out of the restricted band.

<b>CHANNEL</b>	TX Channel 165	<b>DETECTOR FUNCTION</b>	Peak (PK)
<b>FREQUENCY RANGE</b>	1GHz ~ 40GHz		Average (AV)

**ANTENNA POLARITY & TEST DISTANCE: HORIZONTAL AT 3 M**

NO.	FREQ. (MHz)	EMISSION LEVEL (dBuV/m)	LIMIT (dBuV/m)	MARGIN (dB)	ANTENNA HEIGHT (m)	TABLE ANGLE (Degree)	RAW VALUE (dBuV)	CORRECTION FACTOR (dB/m)
1	#5613.80	52.5 PK	68.2	-15.7	1.00 H	302	48.8	3.7
2	*5825.00	116.9 PK			1.00 H	302	112.7	4.2
3	*5825.00	104.1 AV			1.00 H	302	99.9	4.2
4	#5931.33	54.6 PK	68.2	-13.6	1.00 H	302	50.3	4.3
5	11650.00	57.3 PK	74.0	-16.7	3.86 H	360	43.4	13.9
6	11650.00	48.0 AV	54.0	-6.0	3.86 H	360	34.1	13.9
7	#17475.00	58.7 PK	68.2	-9.5	1.16 H	34	39.9	18.8

**ANTENNA POLARITY & TEST DISTANCE: VERTICAL AT 3 M**

NO.	FREQ. (MHz)	EMISSION LEVEL (dBuV/m)	LIMIT (dBuV/m)	MARGIN (dB)	ANTENNA HEIGHT (m)	TABLE ANGLE (Degree)	RAW VALUE (dBuV)	CORRECTION FACTOR (dB/m)
1	#5559.69	54.6 PK	68.2	-13.6	2.38 V	153	50.9	3.7
2	*5825.00	122.3 PK			2.38 V	153	118.1	4.2
3	*5825.00	110.1 AV			2.38 V	153	105.9	4.2
4	#5927.53	58.0 PK	68.2	-10.2	2.38 V	153	53.8	4.2
5	11650.00	62.0 PK	74.0	-12.0	1.29 V	21	48.1	13.9
6	11650.00	50.8 AV	54.0	-3.2	1.29 V	21	36.9	13.9
7	#17475.00	64.7 PK	68.2	-3.5	1.18 V	15	45.9	18.8

**REMARKS:**

1. Emission Level(dBuV/m) = Raw Value(dBuV) + Correction Factor(dB/m)
2. Correction Factor(dB/m) = Antenna Factor(dB/m) + Cable Factor(dB) – Pre-Amplifier Factor(dB)
3. Margin value = Emission Level – Limit value
4. The other emission levels were very low against the limit.
5. " \* ": Fundamental frequency.
6. " # ": The radiated frequency is out of the restricted band.

**802.11ax (HE40)**

<b>CHANNEL</b>	TX Channel 38	<b>DETECTOR FUNCTION</b>	Peak (PK)
<b>FREQUENCY RANGE</b>	1GHz ~ 40GHz		Average (AV)

**ANTENNA POLARITY & TEST DISTANCE: HORIZONTAL AT 3 M**

NO.	FREQ. (MHz)	EMISSION LEVEL (dBuV/m)	LIMIT (dBuV/m)	MARGIN (dB)	ANTENNA HEIGHT (m)	TABLE ANGLE (Degree)	RAW VALUE (dBuV)	CORRECTION FACTOR (dB/m)
1	5150.00	62.3 PK	74.0	-11.7	1.10 H	37	58.8	3.5
2	5150.00	50.5 AV	54.0	-3.5	1.10 H	37	47.0	3.5
3	*5190.00	106.6 PK			1.10 H	37	103.2	3.4
4	*5190.00	96.0 AV			1.10 H	37	92.6	3.4
5	#10380.00	51.2 PK	68.2	-17.0	3.92 H	360	37.9	13.3
6	15570.00	52.3 PK	74.0	-21.7	1.16 H	1	38.9	13.4
7	15570.00	39.6 AV	54.0	-14.4	1.16 H	1	26.2	13.4

**ANTENNA POLARITY & TEST DISTANCE: VERTICAL AT 3 M**

NO.	FREQ. (MHz)	EMISSION LEVEL (dBuV/m)	LIMIT (dBuV/m)	MARGIN (dB)	ANTENNA HEIGHT (m)	TABLE ANGLE (Degree)	RAW VALUE (dBuV)	CORRECTION FACTOR (dB/m)
1	5150.00	65.7 PK	74.0	-8.3	1.00 V	303	62.2	3.5
2	<b>5150.00</b>	<b>53.9 AV</b>	<b>54.0</b>	<b>-0.1</b>	<b>1.00 V</b>	<b>303</b>	<b>50.4</b>	<b>3.5</b>
3	*5190.00	114.4 PK			1.00 V	303	111.0	3.4
4	*5190.00	103.0 AV			1.00 V	303	99.6	3.4
5	#10380.00	56.2 PK	68.2	-12.0	1.14 V	21	42.9	13.3
6	15570.00	57.3 PK	74.0	-16.7	1.00 V	308	43.9	13.4
7	15570.00	44.9 AV	54.0	-9.1	1.00 V	308	31.5	13.4

**REMARKS:**

- Emission Level(dBuV/m) = Raw Value(dBuV) + Correction Factor(dB/m)
- Correction Factor(dB/m) = Antenna Factor(dB/m) + Cable Factor(dB) – Pre-Amplifier Factor(dB)
- Margin value = Emission Level – Limit value
- The other emission levels were very low against the limit.
- " \* ": Fundamental frequency.
- " # ": The radiated frequency is out of the restricted band.

<b>CHANNEL</b>	TX Channel 46	<b>DETECTOR FUNCTION</b>	Peak (PK)
<b>FREQUENCY RANGE</b>	1GHz ~ 40GHz		Average (AV)

**ANTENNA POLARITY & TEST DISTANCE: HORIZONTAL AT 3 M**

NO.	FREQ. (MHz)	EMISSION LEVEL (dBuV/m)	LIMIT (dBuV/m)	MARGIN (dB)	ANTENNA HEIGHT (m)	TABLE ANGLE (Degree)	RAW VALUE (dBuV)	CORRECTION FACTOR (dB/m)
1	5148.60	64.9 PK	74.0	-9.1	1.12 H	36	61.4	3.5
2	5148.60	50.8 AV	54.0	-3.2	1.12 H	36	47.3	3.5
3	*5230.00	107.9 PK			1.12 H	36	104.8	3.1
4	*5230.00	99.0 AV			1.12 H	36	95.9	3.1
5	5350.00	57.2 PK	74.0	-16.8	1.12 H	36	53.9	3.3
6	5350.00	43.7 AV	54.0	-10.3	1.12 H	36	40.4	3.3
7	#10460.00	53.3 PK	68.2	-14.9	3.88 H	360	39.8	13.5
8	15690.00	54.4 PK	74.0	-19.6	1.22 H	16	41.5	12.9
9	15690.00	42.7 AV	54.0	-11.3	1.22 H	16	29.8	12.9

**ANTENNA POLARITY & TEST DISTANCE: VERTICAL AT 3 M**

NO.	FREQ. (MHz)	EMISSION LEVEL (dBuV/m)	LIMIT (dBuV/m)	MARGIN (dB)	ANTENNA HEIGHT (m)	TABLE ANGLE (Degree)	RAW VALUE (dBuV)	CORRECTION FACTOR (dB/m)
1	5148.60	68.0 PK	74.0	-6.0	2.67 V	329	64.5	3.5
2	5148.60	53.9 AV	54.0	-0.1	2.67 V	329	50.4	3.5
3	*5230.00	119.0 PK			2.67 V	329	115.9	3.1
4	*5230.00	106.8 AV			2.67 V	329	103.7	3.1
5	5350.00	61.0 PK	74.0	-13.0	2.67 V	329	57.7	3.3
6	5350.00	45.9 AV	54.0	-8.1	2.67 V	329	42.6	3.3
7	#10460.00	58.3 PK	68.2	-9.9	1.13 V	8	44.8	13.5
8	15690.00	60.4 PK	74.0	-13.6	1.00 V	311	47.5	12.9
9	15690.00	47.9 AV	54.0	-6.1	1.00 V	311	35.0	12.9

**REMARKS:**

1. Emission Level(dBuV/m) = Raw Value(dBuV) + Correction Factor(dB/m)
2. Correction Factor(dB/m) = Antenna Factor(dB/m) + Cable Factor(dB) – Pre-Amplifier Factor(dB)
3. Margin value = Emission Level – Limit value
4. The other emission levels were very low against the limit.
5. " \* ": Fundamental frequency.
6. " # ": The radiated frequency is out of the restricted band.

<b>CHANNEL</b>	TX Channel 151	<b>DETECTOR FUNCTION</b>	Peak (PK)
<b>FREQUENCY RANGE</b>	1GHz ~ 40GHz		Average (AV)

**ANTENNA POLARITY & TEST DISTANCE: HORIZONTAL AT 3 M**

NO.	FREQ. (MHz)	EMISSION LEVEL (dBuV/m)	LIMIT (dBuV/m)	MARGIN (dB)	ANTENNA HEIGHT (m)	TABLE ANGLE (Degree)	RAW VALUE (dBuV)	CORRECTION FACTOR (dB/m)
1	#5648.49	64.2 PK	68.2	-4.0	1.02 H	297	60.6	3.6
2	*5755.00	114.2 PK			1.02 H	297	110.3	3.9
3	*5755.00	101.1 AV			1.02 H	297	97.2	3.9
4	#5946.02	54.7 PK	68.2	-13.5	1.02 H	297	50.3	4.4
5	11510.00	56.0 PK	74.0	-18.0	4.00 H	360	41.8	14.2
6	11510.00	44.0 AV	54.0	-10.0	4.00 H	360	29.8	14.2
7	#17265.00	58.3 PK	68.2	-9.9	1.12 H	41	41.1	17.2

**ANTENNA POLARITY & TEST DISTANCE: VERTICAL AT 3 M**

NO.	FREQ. (MHz)	EMISSION LEVEL (dBuV/m)	LIMIT (dBuV/m)	MARGIN (dB)	ANTENNA HEIGHT (m)	TABLE ANGLE (Degree)	RAW VALUE (dBuV)	CORRECTION FACTOR (dB/m)
1	#5647.32	67.1 PK	68.2	-1.1	2.68 V	156	63.5	3.6
2	*5755.00	119.7 PK			2.68 V	156	115.8	3.9
3	*5755.00	107.3 AV			2.68 V	156	103.4	3.9
4	#5936.82	58.4 PK	68.2	-9.8	2.68 V	156	54.1	4.3
5	11510.00	59.6 PK	74.0	-14.4	1.28 V	5	45.4	14.2
6	11510.00	48.8 AV	54.0	-5.2	1.28 V	5	34.6	14.2
7	#17265.00	61.4 PK	68.2	-6.8	1.05 V	335	44.2	17.2

**REMARKS:**

1. Emission Level(dBuV/m) = Raw Value(dBuV) + Correction Factor(dB/m)
2. Correction Factor(dB/m) = Antenna Factor(dB/m) + Cable Factor(dB) – Pre-Amplifier Factor(dB)
3. Margin value = Emission Level – Limit value
4. The other emission levels were very low against the limit.
5. " \* ": Fundamental frequency.
6. " # ": The radiated frequency is out of the restricted band.

<b>CHANNEL</b>	TX Channel 159	<b>DETECTOR FUNCTION</b>	Peak (PK)
<b>FREQUENCY RANGE</b>	1GHz ~ 40GHz		Average (AV)

**ANTENNA POLARITY & TEST DISTANCE: HORIZONTAL AT 3 M**

NO.	FREQ. (MHz)	EMISSION LEVEL (dBuV/m)	LIMIT (dBuV/m)	MARGIN (dB)	ANTENNA HEIGHT (m)	TABLE ANGLE (Degree)	RAW VALUE (dBuV)	CORRECTION FACTOR (dB/m)
1	#5649.47	54.5 PK	68.2	-13.7	1.02 H	302	50.9	3.6
2	*5795.00	113.5 PK			1.02 H	302	109.5	4.0
3	*5795.00	101.2 AV			1.02 H	302	97.2	4.0
4	#5926.73	57.8 PK	68.2	-10.4	1.02 H	302	53.6	4.2
5	11590.00	56.4 PK	74.0	-17.6	4.00 H	360	42.2	14.2
6	11590.00	44.3 AV	54.0	-9.7	4.00 H	360	30.1	14.2
7	#17385.00	58.3 PK	68.2	-9.9	1.16 H	52	40.5	17.8

**ANTENNA POLARITY & TEST DISTANCE: VERTICAL AT 3 M**

NO.	FREQ. (MHz)	EMISSION LEVEL (dBuV/m)	LIMIT (dBuV/m)	MARGIN (dB)	ANTENNA HEIGHT (m)	TABLE ANGLE (Degree)	RAW VALUE (dBuV)	CORRECTION FACTOR (dB/m)
1	#5635.23	58.2 PK	68.2	-10.0	2.68 V	156	54.6	3.6
2	*5795.00	118.9 PK			2.28 V	155	114.9	4.0
3	*5795.00	106.7 AV			2.28 V	155	102.7	4.0
4	#5928.19	62.2 PK	68.2	-6.0	2.68 V	156	58.0	4.2
5	11590.00	59.3 PK	74.0	-14.7	1.26 V	14	45.1	14.2
6	11590.00	48.8 AV	54.0	-5.2	1.26 V	14	34.6	14.2
7	#17385.00	61.6 PK	68.2	-6.6	1.05 V	344	43.8	17.8

**REMARKS:**

1. Emission Level(dBuV/m) = Raw Value(dBuV) + Correction Factor(dB/m)
2. Correction Factor(dB/m) = Antenna Factor(dB/m) + Cable Factor(dB) – Pre-Amplifier Factor(dB)
3. Margin value = Emission Level – Limit value
4. The other emission levels were very low against the limit.
5. " \* ": Fundamental frequency.
6. " # ": The radiated frequency is out of the restricted band.

**802.11ax (HE80)**

<b>CHANNEL</b>	TX Channel 42	<b>DETECTOR FUNCTION</b>	Peak (PK)
<b>FREQUENCY RANGE</b>	1GHz ~ 40GHz		Average (AV)

**ANTENNA POLARITY & TEST DISTANCE: HORIZONTAL AT 3 M**

NO.	FREQ. (MHz)	EMISSION LEVEL (dBuV/m)	LIMIT (dBuV/m)	MARGIN (dB)	ANTENNA HEIGHT (m)	TABLE ANGLE (Degree)	RAW VALUE (dBuV)	CORRECTION FACTOR (dB/m)
1	5150.00	58.1 PK	74.0	-15.9	1.00 H	304	54.6	3.5
2	5150.00	43.3 AV	54.0	-10.7	1.00 H	304	39.8	3.5
3	*5210.00	100.6 PK			1.00 H	304	97.3	3.3
4	*5210.00	87.9 AV			1.00 H	304	84.6	3.3
5	5350.00	49.8 PK	74.0	-24.2	1.00 H	304	46.5	3.3
6	5350.00	37.3 AV	54.0	-16.7	1.00 H	304	34.0	3.3
7	#10420.00	56.9 PK	68.2	-11.3	3.95 H	329	43.4	13.5
8	15630.00	56.1 PK	74.0	-17.9	1.27 H	46	42.9	13.2
9	15630.00	44.7 AV	54.0	-9.3	1.27 H	46	31.5	13.2

**ANTENNA POLARITY & TEST DISTANCE: VERTICAL AT 3 M**

NO.	FREQ. (MHz)	EMISSION LEVEL (dBuV/m)	LIMIT (dBuV/m)	MARGIN (dB)	ANTENNA HEIGHT (m)	TABLE ANGLE (Degree)	RAW VALUE (dBuV)	CORRECTION FACTOR (dB/m)
1	5150.00	69.4 PK	74.0	-4.6	2.67 V	148	65.9	3.5
2	<b>5150.00</b>	<b>53.9 AV</b>	<b>54.0</b>	<b>-0.1</b>	<b>2.67 V</b>	<b>148</b>	<b>50.4</b>	<b>3.5</b>
3	*5210.00	109.6 PK			2.67 V	148	106.3	3.3
4	*5210.00	97.9 AV			2.67 V	148	94.6	3.3
5	5350.00	58.0 PK	74.0	-16.0	2.67 V	148	54.7	3.3
6	5350.00	45.7 AV	54.0	-8.3	2.67 V	148	42.4	3.3
7	#10420.00	59.9 PK	68.2	-8.3	1.16 V	15	46.4	13.5
8	15630.00	60.8 PK	74.0	-13.2	1.02 V	324	47.6	13.2
9	15630.00	49.7 AV	54.0	-4.3	1.02 V	324	36.5	13.2

**REMARKS:**

- Emission Level(dBuV/m) = Raw Value(dBuV) + Correction Factor(dB/m)
- Correction Factor(dB/m) = Antenna Factor(dB/m) + Cable Factor(dB) – Pre-Amplifier Factor(dB)
- Margin value = Emission Level – Limit value
- The other emission levels were very low against the limit.
- " \* ": Fundamental frequency.
- " # ": The radiated frequency is out of the restricted band.



<b>CHANNEL</b>	TX Channel 155	<b>DETECTOR FUNCTION</b>	Peak (PK)
<b>FREQUENCY RANGE</b>	1GHz ~ 40GHz		Average (AV)

**ANTENNA POLARITY & TEST DISTANCE: HORIZONTAL AT 3 M**

NO.	FREQ. (MHz)	EMISSION LEVEL (dBuV/m)	LIMIT (dBuV/m)	MARGIN (dB)	ANTENNA HEIGHT (m)	TABLE ANGLE (Degree)	RAW VALUE (dBuV)	CORRECTION FACTOR (dB/m)
1	#5648.65	65.3 PK	68.2	-2.9	1.10 H	300	61.7	3.6
2	*5775.00	108.1 PK			1.10 H	300	104.2	3.9
3	*5775.00	96.8 AV			1.10 H	300	92.9	3.9
4	#5928.39	61.2 PK	68.2	-7.0	1.10 H	300	57.0	4.2
5	11550.00	56.7 PK	74.0	-17.3	4.00 H	295	42.5	14.2
6	11550.00	45.3 AV	54.0	-8.7	4.00 H	295	31.1	14.2
7	#17325.00	57.6 PK	68.2	-10.6	1.32 H	63	40.2	17.4

**ANTENNA POLARITY & TEST DISTANCE: VERTICAL AT 3 M**

NO.	FREQ. (MHz)	EMISSION LEVEL (dBuV/m)	LIMIT (dBuV/m)	MARGIN (dB)	ANTENNA HEIGHT (m)	TABLE ANGLE (Degree)	RAW VALUE (dBuV)	CORRECTION FACTOR (dB/m)
1	#5630.94	67.8 PK	68.2	-0.4	2.42 V	153	64.2	3.6
2	*5775.00	113.1 PK			2.42 V	153	109.2	3.9
3	*5775.00	102.3 AV			2.42 V	153	98.4	3.9
4	#5939.02	64.3 PK	68.2	-3.9	2.42 V	153	60.0	4.3
5	11550.00	59.8 PK	74.0	-14.2	1.20 V	4	45.6	14.2
6	11550.00	48.9 AV	54.0	-5.1	1.20 V	4	34.7	14.2
7	#17325.00	60.9 PK	68.2	-7.3	1.10 V	339	43.5	17.4

**REMARKS:**

1. Emission Level(dBuV/m) = Raw Value(dBuV) + Correction Factor(dB/m)
2. Correction Factor(dB/m) = Antenna Factor(dB/m) + Cable Factor(dB) – Pre-Amplifier Factor(dB)
3. Margin value = Emission Level – Limit value
4. The other emission levels were very low against the limit.
5. " \* ": Fundamental frequency.
6. " # ": The radiated frequency is out of the restricted band.

Below 1GHz Data:

802.11ax (HE20)

<b>CHANNEL</b>	TX Channel 165	<b>DETECTOR FUNCTION</b>	Quasi-Peak (QP)
<b>FREQUENCY RANGE</b>	9kHz ~ 1GHz		

**ANTENNA POLARITY & TEST DISTANCE: HORIZONTAL AT 3 M**

NO.	FREQ. (MHz)	EMISSION LEVEL (dBuV/m)	LIMIT (dBuV/m)	MARGIN (dB)	ANTENNA HEIGHT (m)	TABLE ANGLE (Degree)	RAW VALUE (dBuV)	CORRECTION FACTOR (dB/m)
1	46.56	24.6 QP	40.0	-15.4	2.00 H	335	32.8	-8.2
2	125.01	31.3 QP	43.5	-12.2	2.49 H	302	40.7	-9.4
3	166.55	31.6 QP	43.5	-11.9	2.00 H	169	39.8	-8.2
4	375.00	32.5 QP	46.0	-13.5	2.00 H	164	37.4	-4.9
5	625.00	38.5 QP	46.0	-7.5	1.50 H	271	37.4	1.1
6	875.04	41.6 QP	46.0	-4.4	1.00 H	165	36.0	5.6

**REMARKS:**

1. Emission Level(dBuV/m) = Raw Value(dBuV) + Correction Factor(dB/m)
2. Correction Factor(dB/m) = Antenna Factor(dB/m) + Cable Factor(dB) – Pre-Amplifier Factor(dB)
3. Margin value = Emission Level – Limit value
4. The other emission levels were very low against the limit of frequency range 30MHz~1000MHz.
5. The emission levels were very low against the limit of frequency range 9kHz~30MHz: the amplitude of spurious emissions attenuated more than 20 dB below the permissible value to be report.

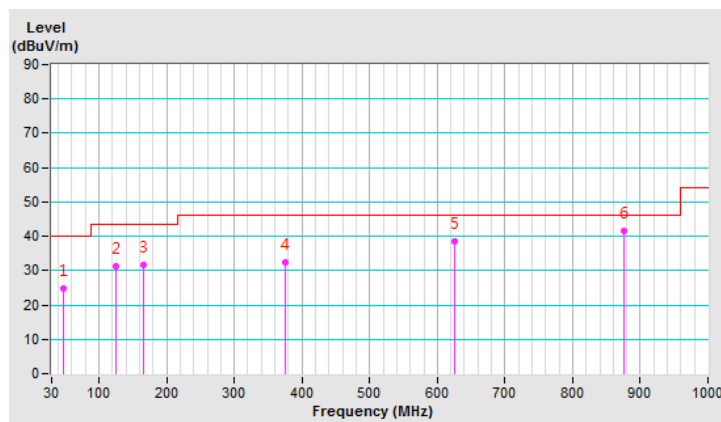

<b>CHANNEL</b>	TX Channel 165	<b>DETECTOR FUNCTION</b>	Quasi-Peak (QP)
<b>FREQUENCY RANGE</b>	9kHz ~ 1GHz		

**ANTENNA POLARITY & TEST DISTANCE: VERTICAL AT 3 M**

NO.	FREQ. (MHz)	EMISSION LEVEL (dBuV/m)	LIMIT (dBuV/m)	MARGIN (dB)	ANTENNA HEIGHT (m)	TABLE ANGLE (Degree)	RAW VALUE (dBuV)	CORRECTION FACTOR (dB/m)
1	49.93	35.8 QP	40.0	-4.2	1.02 V	319	43.9	-8.1
2	80.54	29.2 QP	40.0	-10.8	1.55 V	172	42.2	-13.0
3	152.05	29.3 QP	43.5	-14.2	1.65 V	247	37.2	-7.9
4	375.00	35.3 QP	46.0	-10.7	1.56 V	168	40.2	-4.9
5	625.02	37.3 QP	46.0	-8.7	1.59 V	273	36.2	1.1
6	875.02	37.6 QP	46.0	-8.4	1.00 V	114	32.0	5.6

**REMARKS:**

1. Emission Level(dBuV/m) = Raw Value(dBuV) + Correction Factor(dB/m)
2. Correction Factor(dB/m) = Antenna Factor(dB/m) + Cable Factor(dB) – Pre-Amplifier Factor(dB)
3. Margin value = Emission Level – Limit value
4. The other emission levels were very low against the limit of frequency range 30MHz~1000MHz.
5. The emission levels were very low against the limit of frequency range 9kHz~30MHz: the amplitude of spurious emissions attenuated more than 20 dB below the permissible value to be report.

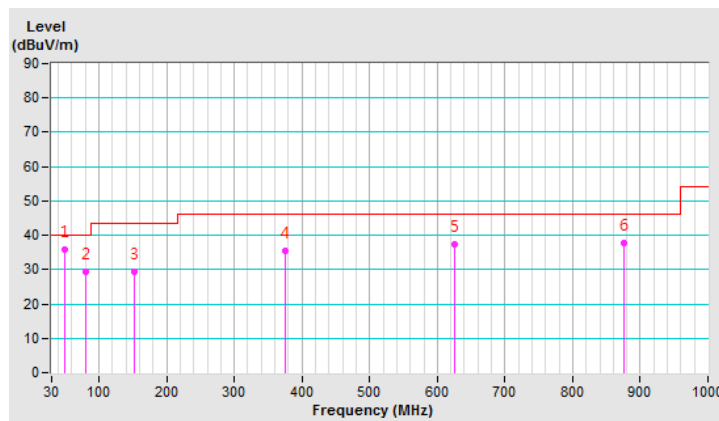

## 4.2 Conducted Emission Measurement

### 4.2.1 Limits of Conducted Emission Measurement

Frequency (MHz)	Conducted Limit (dBuV)	
	Quasi-peak	Average
0.15 - 0.5	66 - 56	56 - 46
0.50 - 5.0	56	46
5.0 - 30.0	60	50

Note: 1. The lower limit shall apply at the transition frequencies.

2. The limit decreases in line with the logarithm of the frequency in the range of 0.15 to 0.50MHz.

### 4.2.2 Test Instruments

DESCRIPTION & MANUFACTURER	MODEL NO.	SERIAL NO.	CALIBRATED DATE	CALIBRATED UNTIL
Test Receiver R&S	ESCS 30	847124/029	Oct. 24, 2018	Oct. 23, 2019
Line-Impedance Stabilization Network (for EUT) R&S	ESH3-Z5	848773/004	Oct. 22, 2018	Oct. 21, 2019
Line-Impedance Stabilization Network (for Peripheral) R&S	ESH3-Z5	835239/001	Mar. 17, 2019	Mar. 16, 2020
50 ohms Terminator	N/A	3	Oct. 22, 2018	Oct. 21, 2019
RF Cable	5D-FB	COCCAB-001	Sep. 28, 2018	Sep. 27, 2019
Fixed attenuator EMCI	STI02-2200-10	003	Mar. 14, 2019	Mar. 13, 2020
Software BVADT	BVADT_Cond_V7.3.7.4	NA	NA	NA

**Note:**

1. The calibration interval of the above test instruments are 12 months and the calibrations are traceable to NML/ROC and NIST/USA.
2. The test was performed in Conduction 1.
3. Tested Date: Aug. 29, 2019

#### 4.2.3 Test Procedure

- The EUT was placed 0.4 meters from the conducting wall of the shielded room with EUT being connected to the power mains through a line impedance stabilization network (LISN). Other support units were connected to the power mains through another LISN. The two LISNs provide 50 ohm/ 50uH of coupling impedance for the measuring instrument.
- Both lines of the power mains connected to the EUT were checked for maximum conducted interference.
- The frequency range from 150kHz to 30MHz was searched. Emission levels under (Limit - 20dB) was not recorded.

**Note:** All modes of operation were investigated and the worst-case emissions are reported.

#### 4.2.4 Deviation from Test Standard

No deviation.

#### 4.2.5 Test Setup

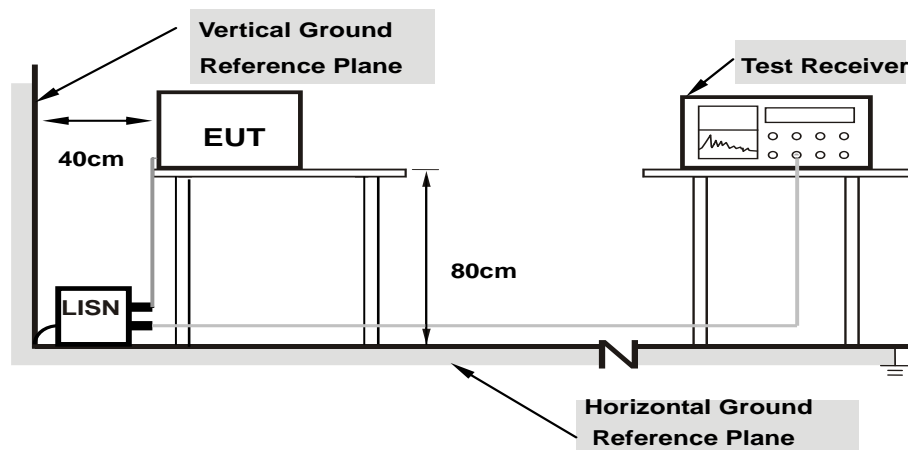

**Note: 1.Support units were connected to second LISN.**

For the actual test configuration, please refer to the attached file (Test Setup Photo).

#### 4.2.6 EUT Operating Condition

Same as 4.1.6.

#### 4.2.7 Test Results

Phase	Line (L)	Detector Function	Quasi-Peak (QP) / Average (AV)
-------	----------	-------------------	--------------------------------

Phase Of Power : Line (L)										
No	Frequency (MHz)	Correction Factor (dB)	Reading Value (dBuV)		Emission Level (dBuV)		Limit (dBuV)		Margin (dB)	
			Q.P.	AV.	Q.P.	AV.	Q.P.	AV.	Q.P.	AV.
1	0.15391	9.97	41.19	25.06	51.16	35.03	65.79	55.79	-14.63	-20.76
2	0.19687	9.97	39.65	27.25	49.62	37.22	63.74	53.74	-14.12	-16.52
3	0.20859	9.97	38.45	24.80	48.42	34.77	63.26	53.26	-14.84	-18.49
4	0.22812	9.97	31.94	19.18	41.91	29.15	62.52	52.52	-20.61	-23.37
5	0.25938	9.97	31.40	16.58	41.37	26.55	61.45	51.45	-20.08	-24.90
6	2.86328	10.17	25.64	18.83	35.81	29.00	56.00	46.00	-20.19	-17.00

**Remarks:**

1. Q.P. and AV. are abbreviations of quasi-peak and average individually.
2. The emission levels of other frequencies were very low against the limit.
3. Margin value = Emission level – Limit value
4. Correction factor = Insertion loss + Cable loss
5. Emission Level = Correction Factor + Reading Value

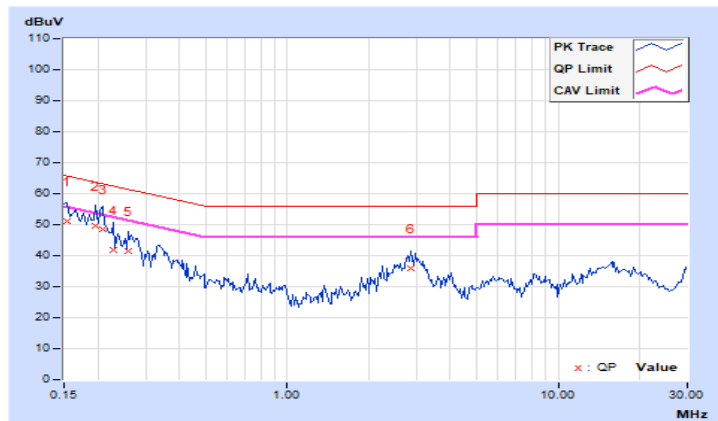

Phase	Neutral (N)	Detector Function	Quasi-Peak (QP) / Average (AV)
-------	-------------	-------------------	--------------------------------

Phase Of Power : Neutral (N)										
No	Frequency (MHz)	Correction Factor (dB)	Reading Value (dBuV)		Emission Level (dBuV)		Limit (dBuV)		Margin (dB)	
			Q.P.	AV.	Q.P.	AV.	Q.P.	AV.	Q.P.	AV.
<b>1</b>	<b>0.15000</b>	<b>9.94</b>	<b>44.92</b>	<b>30.93</b>	<b>54.86</b>	<b>40.87</b>	<b>66.00</b>	<b>56.00</b>	<b>-11.14</b>	<b>-15.13</b>
2	0.19687	9.95	41.70	30.74	51.65	40.69	63.74	53.74	-12.09	-13.05
3	0.22422	9.95	33.04	21.37	42.99	31.32	62.66	52.66	-19.67	-21.34
4	0.25938	9.96	32.95	20.93	42.91	30.89	61.45	51.45	-18.54	-20.56
5	0.32188	9.96	26.56	16.60	36.52	26.56	59.66	49.66	-23.14	-23.10
6	2.93359	10.14	27.72	22.16	37.86	32.30	56.00	46.00	-18.14	-13.70

**Remarks:**

1. Q.P. and AV. are abbreviations of quasi-peak and average individually.
2. The emission levels of other frequencies were very low against the limit.
3. Margin value = Emission level – Limit value
4. Correction factor = Insertion loss + Cable loss
5. Emission Level = Correction Factor + Reading Value

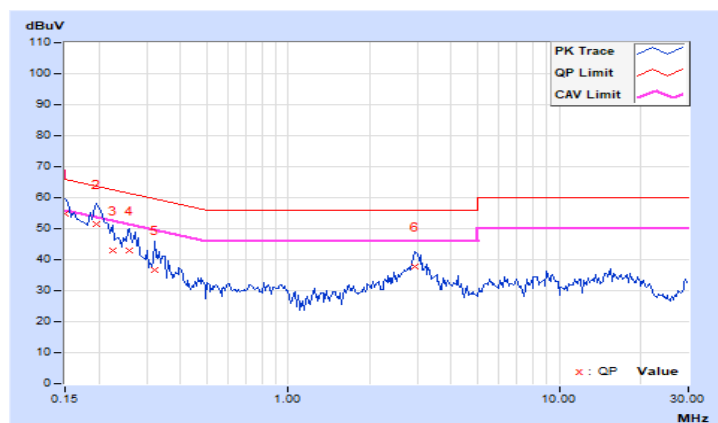

### 4.3 Transmit Power Measurement

#### 4.3.1 Limits of Transmit Power Measurement

Operation Band	EUT Category		Limit
U-NII-1		Outdoor Access Point	1 Watt (30 dBm) (Max. e.i.r.p $\leq$ 125mW(21 dBm) at any elevation angle above 30 degrees as measured from the horizon)
		Fixed point-to-point Access Point	1 Watt (30 dBm)
	√	Indoor Access Point	1 Watt (30 dBm)
		Client device	250mW (24 dBm)
U-NII-2A			250mW (24 dBm) or 11 dBm+10 log B*
U-NII-2C			250mW (24 dBm) or 11 dBm+10 log B*
U-NII-3	√		1 Watt (30 dBm)

\*B is the 26 dB emission bandwidth in megahertz

Per KDB 662911 Method of conducted output power measurement on IEEE 802.11 devices,

Array Gain = 0 dB (i.e., no array gain) for  $N_{ANT} \leq 4$ ;

Array Gain = 0 dB (i.e., no array gain) for channel widths  $\geq 40$  MHz for any  $N_{ANT}$ ;

Array Gain =  $5 \log(N_{ANT}/N_{SS})$  dB or 3 dB, whichever is less for 20-MHz channel widths with  $N_{ANT} \geq 5$ .

For power measurements on all other devices: Array Gain =  $10 \log(N_{ANT}/N_{SS})$  dB.

#### 4.3.2 Test Setup

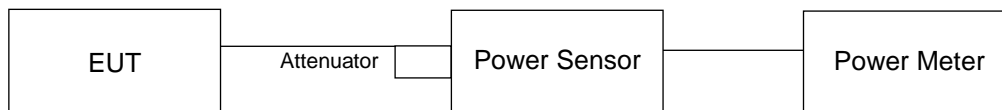

#### 4.3.3 Test Instruments

Refer to section 4.1.2 to get information of above instrument.

#### 4.3.4 Test Procedure

Method PM is used to perform output power measurement, trigger and gating function of wide band power meter is enabled to measure max output power of TX on burst. Duty factor is not added to measured value.

#### 4.3.5 Deviation from Test Standard

No deviation.

#### 4.3.6 EUT Operating Condition

The software provided by client to enable the EUT under transmission condition continuously at lowest, middle and highest channel frequencies individually.



## 4.3.7 Test Results

**Non-Beamforming Mode**
**802.11a**

Chan.	Chan. Freq. (MHz)	Maximum Conducted Power (dBm)		Total Power (mW)	Total Power (dBm)	Limit (dBm)	Pass / Fail
		Chain 0	Chain 1				
36	5180	21.28	21.62	279.487	24.46	30.00	Pass
40	5200	25.29	25.27	674.577	28.29	30.00	Pass
48	5240	24.39	24.36	547.687	27.39	30.00	Pass
149	5745	26.51	25.66	815.842	29.12	30.00	Pass
157	5785	26.59	25.81	837.103	29.23	30.00	Pass
165	5825	26.83	25.76	858.652	29.34	30.00	Pass

**802.11ac (VHT20)**

Chan.	Chan. Freq. (MHz)	Maximum Conducted Power (dBm)		Total Power (mW)	Total Power (dBm)	Limit (dBm)	Pass / Fail
		Chain 0	Chain 1				
36	5180	20.80	20.54	233.466	23.68	30.00	Pass
40	5200	23.84	23.77	480.335	26.82	30.00	Pass
48	5240	24.31	24.14	529.192	27.24	30.00	Pass
149	5745	26.71	25.75	844.65	29.27	30.00	Pass
157	5785	26.83	25.82	863.892	29.36	30.00	Pass
165	5825	26.90	25.98	886.057	29.47	30.00	Pass

**802.11ac (VHT40)**

Chan.	Chan. Freq. (MHz)	Maximum Conducted Power (dBm)		Total Power (mW)	Total Power (dBm)	Limit (dBm)	Pass / Fail
		Chain 0	Chain 1				
38	5190	17.30	17.80	113.959	20.57	30.00	Pass
46	5230	23.67	23.88	477.152	26.79	30.00	Pass
151	5755	26.35	25.76	808.223	29.08	30.00	Pass
159	5795	26.42	25.73	812.642	29.10	30.00	Pass

**802.11ac (VHT80)**

Chan.	Chan. Freq. (MHz)	Maximum Conducted Power (dBm)		Total Power (mW)	Total Power (dBm)	Limit (dBm)	Pass / Fail
		Chain 0	Chain 1				
42	5210	18.79	18.39	144.707	21.60	30.00	Pass
155	5775	23.97	23.40	468.235	26.70	30.00	Pass

**802.11ax (HE20)**

Chan.	Chan. Freq. (MHz)	Maximum Conducted Power (dBm)		Total Power (mW)	Total Power (dBm)	Limit (dBm)	Pass / Fail
		Chain 0	Chain 1				
36	5180	20.80	20.54	233.466	23.68	30.00	Pass
40	5200	23.84	23.77	480.335	26.82	30.00	Pass
48	5240	24.31	24.14	529.192	27.24	30.00	Pass
149	5745	26.71	25.75	844.65	29.27	30.00	Pass
157	5785	26.83	25.82	863.892	29.36	30.00	Pass
165	5825	26.90	25.98	886.057	29.47	30.00	Pass

**802.11ax (HE40)**

Chan.	Chan. Freq. (MHz)	Maximum Conducted Power (dBm)		Total Power (mW)	Total Power (dBm)	Limit (dBm)	Pass / Fail
		Chain 0	Chain 1				
38	5190	17.30	17.80	113.959	20.57	30.00	Pass
46	5230	23.67	23.88	477.152	26.79	30.00	Pass
151	5755	26.35	25.76	808.223	29.08	30.00	Pass
159	5795	26.42	25.73	812.642	29.10	30.00	Pass

**802.11ax (HE80)**

Chan.	Chan. Freq. (MHz)	Maximum Conducted Power (dBm)		Total Power (mW)	Total Power (dBm)	Limit (dBm)	Pass / Fail
		Chain 0	Chain 1				
42	5210	18.79	18.39	144.707	21.60	30.00	Pass
155	5775	23.97	23.40	468.235	26.70	30.00	Pass

## Beamforming Mode

### 802.11ac (VHT20)

Chan.	Chan. Freq. (MHz)	Maximum Conducted Power (dBm)		Total Power (mW)	Total Power (dBm)	Limit (dBm)	Pass / Fail
		Chain 0	Chain 1				
36	5180	20.80	20.54	233.466	23.68	30.00	Pass
40	5200	23.84	23.77	480.335	26.82	30.00	Pass
48	5240	24.31	24.14	529.192	27.24	30.00	Pass
149	5745	26.71	25.75	844.65	29.27	30.00	Pass
157	5785	26.83	25.82	863.892	29.36	30.00	Pass
165	5825	26.90	25.98	886.057	29.47	30.00	Pass

- Note:
1. For U-NII-1: The directional gain =  $10 \log[(10^{G0/20} + 10^{G1/20})^2 / 2] = 4.73\text{dBi} < 6\text{dBi}$ , so the power limit shall not be reduced.
  2. For U-NII-3: The directional gain =  $10 \log[(10^{G0/20} + 10^{G1/20})^2 / 2] = 4.98\text{dB} < 6\text{dBi}$ , so the power limit shall not be reduced.

### 802.11ac (VHT40)

Chan.	Chan. Freq. (MHz)	Maximum Conducted Power (dBm)		Total Power (mW)	Total Power (dBm)	Limit (dBm)	Pass / Fail
		Chain 0	Chain 1				
38	5190	17.30	17.80	113.959	20.57	30.00	Pass
46	5230	23.67	23.88	477.152	26.79	30.00	Pass
151	5755	26.35	25.76	808.223	29.08	30.00	Pass
159	5795	26.42	25.73	812.642	29.10	30.00	Pass

- Note:
1. For U-NII-1: The directional gain =  $10 \log[(10^{G0/20} + 10^{G1/20})^2 / 2] = 4.73\text{dBi} < 6\text{dBi}$ , so the power limit shall not be reduced.
  2. For U-NII-3: The directional gain =  $10 \log[(10^{G0/20} + 10^{G1/20})^2 / 2] = 4.98\text{dB} < 6\text{dBi}$ , so the power limit shall not be reduced.

### 802.11ac (VHT80)

Chan.	Chan. Freq. (MHz)	Maximum Conducted Power (dBm)		Total Power (mW)	Total Power (dBm)	Limit (dBm)	Pass / Fail
		Chain 0	Chain 1				
42	5210	18.79	18.39	144.707	21.60	30.00	Pass
155	5775	23.97	23.40	468.235	26.70	30.00	Pass

- Note:
1. For U-NII-1: The directional gain =  $10 \log[(10^{G0/20} + 10^{G1/20})^2 / 2] = 4.73\text{dBi} < 6\text{dBi}$ , so the power limit shall not be reduced.
  2. For U-NII-3: The directional gain =  $10 \log[(10^{G0/20} + 10^{G1/20})^2 / 2] = 4.98\text{dB} < 6\text{dBi}$ , so the power limit shall not be reduced.

### 802.11ax (HE20)

Chan.	Chan. Freq. (MHz)	Maximum Conducted Power (dBm)		Total Power (mW)	Total Power (dBm)	Limit (dBm)	Pass / Fail
		Chain 0	Chain 1				
36	5180	20.80	20.54	233.466	23.68	30.00	Pass
40	5200	23.84	23.77	480.335	26.82	30.00	Pass
48	5240	24.31	24.14	529.192	27.24	30.00	Pass
149	5745	26.71	25.75	844.65	29.27	30.00	Pass
157	5785	26.83	25.82	863.892	29.36	30.00	Pass
165	5825	26.90	25.98	886.057	29.47	30.00	Pass

- Note:
1. For U-NII-1: The directional gain =  $10 \log[(10^{G0/20} + 10^{G1/20})^2 / 2] = 4.73\text{dBi} < 6\text{dBi}$ , so the power limit shall not be reduced.
  2. For U-NII-3: The directional gain =  $10 \log[(10^{G0/20} + 10^{G1/20})^2 / 2] = 4.98\text{dB} < 6\text{dBi}$ , so the power limit shall not be reduced.

### 802.11ax (HE40)

Chan.	Chan. Freq. (MHz)	Maximum Conducted Power (dBm)		Total Power (mW)	Total Power (dBm)	Limit (dBm)	Pass / Fail
		Chain 0	Chain 1				
38	5190	17.30	17.80	113.959	20.57	30.00	Pass
46	5230	23.67	23.88	477.152	26.79	30.00	Pass
151	5755	26.35	25.76	808.223	29.08	30.00	Pass
159	5795	26.42	25.73	812.642	29.10	30.00	Pass

- Note:
1. For U-NII-1: The directional gain =  $10 \log[(10^{G0/20} + 10^{G1/20})^2 / 2] = 4.73\text{dBi} < 6\text{dBi}$ , so the power limit shall not be reduced.
  2. For U-NII-3: The directional gain =  $10 \log[(10^{G0/20} + 10^{G1/20})^2 / 2] = 4.98\text{dB} < 6\text{dBi}$ , so the power limit shall not be reduced.

### 802.11ax (HE80)

Chan.	Chan. Freq. (MHz)	Maximum Conducted Power (dBm)		Total Power (mW)	Total Power (dBm)	Limit (dBm)	Pass / Fail
		Chain 0	Chain 1				
42	5210	18.79	18.39	144.707	21.60	30.00	Pass
155	5775	23.97	23.40	468.235	26.70	30.00	Pass

- Note:
1. For U-NII-1: The directional gain =  $10 \log[(10^{G0/20} + 10^{G1/20})^2 / 2] = 4.73\text{dBi} < 6\text{dBi}$ , so the power limit shall not be reduced.
  2. For U-NII-3: The directional gain =  $10 \log[(10^{G0/20} + 10^{G1/20})^2 / 2] = 4.98\text{dB} < 6\text{dBi}$ , so the power limit shall not be reduced.

## 4.4 Occupied Bandwidth Measurement

### 4.4.1 Test Setup

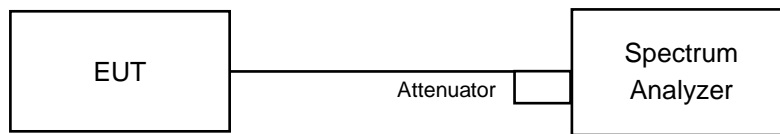

### 4.4.2 Test Instruments

Refer to section 4.1.2 to get information of above instrument.

### 4.4.3 Test Procedure

The transmitter output was connected to the spectrum analyzer through an attenuator. The bandwidth of the fundamental frequency was measured by spectrum analyzer with resolution bandwidth in the range of 1% to 5% of the anticipated emission bandwidth, and a video bandwidth at least 3x the resolution bandwidth and set the detector to SAMPLE. The width of a frequency band such that, below the lower and above the upper frequency limits, the mean powers emitted are each equal to a specified percentage 0.5% of the total mean power of a given emission.

#### 4.4.4 Test Results

##### 802.11a

Channel	Channel Frequency (MHz)	Occupied Bandwidth (MHz)	
		Chain 0	Chain 1
36	5180	17.28	17.16
40	5200	24.36	22.80
48	5240	19.32	19.20
149	5745	25.44	22.08
157	5785	25.56	22.32
165	5825	26.52	22.32

##### 802.11ax (HE20)

Channel	Channel Frequency (MHz)	Occupied Bandwidth (MHz)	
		Chain 0	Chain 1
36	5180	19.20	19.08
40	5200	19.68	19.32
48	5240	19.80	19.56
149	5745	26.88	24.36
157	5785	27.48	24.84
165	5825	29.52	24.24

##### 802.11ax (HE40)

Channel	Channel Frequency (MHz)	Occupied Bandwidth (MHz)	
		Chain 0	Chain 1
38	5190	37.92	37.92
46	5230	38.40	38.40
151	5755	49.44	46.80
159	5795	50.40	45.12

##### 802.11ax (HE80)

Channel	Channel Frequency (MHz)	Occupied Bandwidth (MHz)	
		Chain 0	Chain 1
42	5210	77.76	77.28
155	5775	77.76	77.28

Spectrum Plot of Max. Value

802.11a\_Chain 0 / CH165

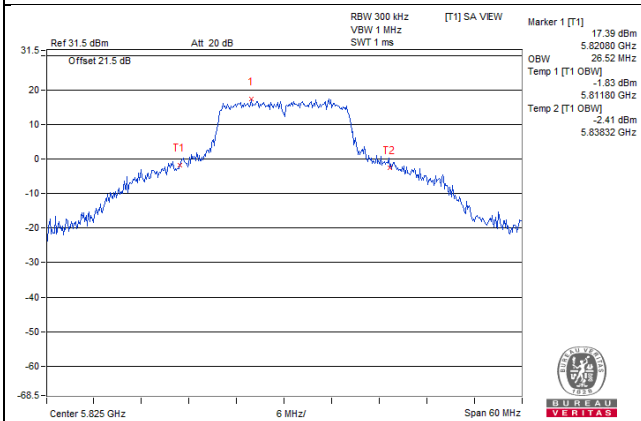

802.11ax (HE20)\_Chain 0 / CH165

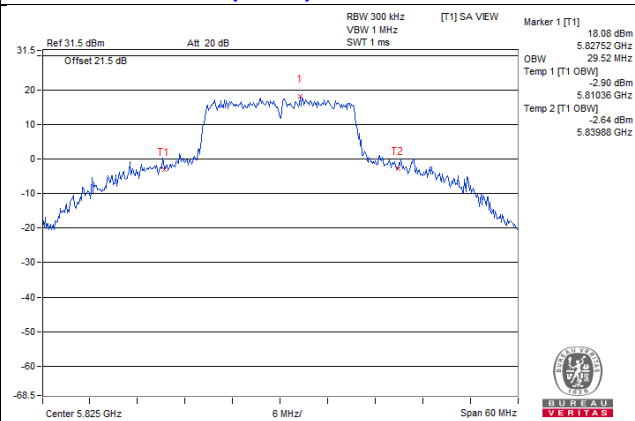

802.11ax (HE40)\_Chain 0 / CH159

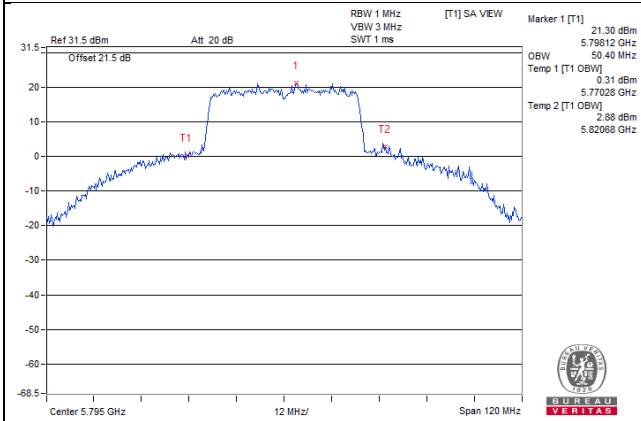

802.11ax (HE80)\_Chain 0 / CH42

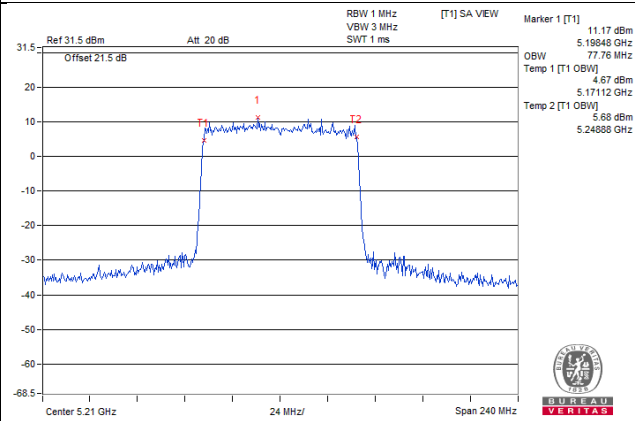

## 4.5 Peak Power Spectral Density Measurement

### 4.5.1 Limits of Peak Power Spectral Density Measurement

Operation Band	EUT Category		Limit
U-NII-1		Outdoor Access Point	17dBm/ MHz
		Fixed point-to-point Access Point	
	√	Indoor Access Point	
		Client device	11dBm/ MHz
U-NII-2A			11dBm/ MHz
U-NII-2C			11dBm/ MHz
U-NII-3		√	30dBm/ 500kHz

### 4.5.2 Test Setup

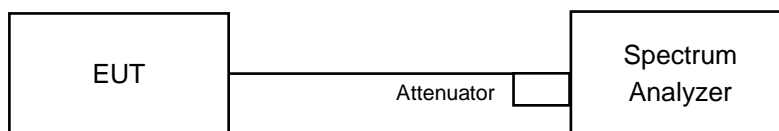

### 4.5.3 Test Instruments

Refer to section 4.1.2 to get information of above instrument.

### 4.5.4 Test Procedure

#### For U-NII-1:

Using method SA-1

1. Set span to encompass the entire emission bandwidth (EBW) of the signal.
2. Set RBW = 1 MHz, Set VBW ≥ 3 MHz, Detector = RMS
3. Sweep time = auto, trigger set to “free run”.
4. Trace average at least 100 traces in power averaging mode.
5. Record the max value

#### For U-NII-3:

1. Set span to encompass the entire emission bandwidth (EBW) of the signal.
2. Set RBW = 300 kHz, Set VBW ≥ 1 MHz, Detector = RMS
3. Use the peak marker function to determine the maximum power level in any 300 kHz band segment within the fundamental EBW.
4. Scale the observed power level to an equivalent value in 500 kHz by adjusting (reducing) the measured power by a bandwidth correction factor (BWCF) where  $BWCF = 10\log(500\text{kHz}/300\text{kHz})$
5. Sweep time = auto, trigger set to “free run”.
6. Trace average at least 100 traces in power averaging mode.
7. Record the max value



#### 4.5.5 Deviation from Test Standard

No deviation.

#### 4.5.6 EUT Operating Condition

Same as Item 4.3.6.

#### 4.5.7 Test Results

##### For U-NII-1:

##### 802.11a

Chan.	Chan. Freq. (MHz)	PSD (dBm/MHz)		Total Power Density (dBm/MHz)	Max. Limit (dBm/MHz)	Pass / Fail
		Chain 0	Chain 1			
36	5180	8.32	8.78	11.57	17.00	Pass
40	5200	11.63	12.27	14.97	17.00	Pass
48	5240	10.77	11.51	14.17	17.00	Pass

- Note: 1. Method a) of power density measurement of KDB 662911 is using for calculating total power density. Total power density is summing entire spectra across corresponding frequency bins on the various outputs by computer.
2. The directional gain =  $10 \log[(10^{G0/20} + 10^{G1/20})^2 / 2] = 4.73\text{dBi} < 6\text{dBi}$ , so the power density limit shall not be reduced.

##### 802.11ax (HE20)

Chan.	Chan. Freq. (MHz)	PSD (dBm/MHz)		Total Power Density (dBm/MHz)	Max. Limit (dBm/MHz)	Pass / Fail
		Chain 0	Chain 1			
36	5180	6.91	7.41	10.18	17.00	Pass
40	5200	9.92	10.53	13.25	17.00	Pass
48	5240	10.14	11.17	13.70	17.00	Pass

- Note: 1. Method a) of power density measurement of KDB 662911 is using for calculating total power density. Total power density is summing entire spectra across corresponding frequency bins on the various outputs by computer.
2. The directional gain =  $10 \log[(10^{G0/20} + 10^{G1/20})^2 / 2] = 4.73\text{dBi} < 6\text{dBi}$ , so the power density limit shall not be reduced.

##### 802.11ax (HE40)

Chan.	Chan. Freq. (MHz)	PSD (dBm/MHz)		Total Power Density (dBm/MHz)	Max. Limit (dBm/MHz)	Pass / Fail
		Chain 0	Chain 1			
38	5190	0.47	1.44	3.99	17.00	Pass
46	5230	6.82	7.58	10.23	17.00	Pass

- Note: 1. Method a) of power density measurement of KDB 662911 is using for calculating total power density. Total power density is summing entire spectra across corresponding frequency bins on the various outputs by computer.
2. The directional gain =  $10 \log[(10^{G0/20} + 10^{G1/20})^2 / 2] = 4.73\text{dBi} < 6\text{dBi}$ , so the power density limit shall not be reduced.

### 802.11ax (HE80)

Chan.	Chan. Freq. (MHz)	PSD (dBm/MHz)		Total Power Density (dBm/MHz)	Max. Limit (dBm/MHz)	Pass / Fail
		Chain 0	Chain 1			
42	5210	-1.13	-0.51	2.20	17.00	Pass

Note: 1. Method a) of power density measurement of KDB 662911 is using for calculating total power density. Total power density is summing entire spectra across corresponding frequency bins on the various outputs by computer.  
 2. The directional gain =  $10 \log[(10^{G0/20} + 10^{G1/20})^2 / 2] = 4.73\text{dBi} < 6\text{dBi}$ , so the power density limit shall not be reduced.

### Spectrum Plot of Worst Value

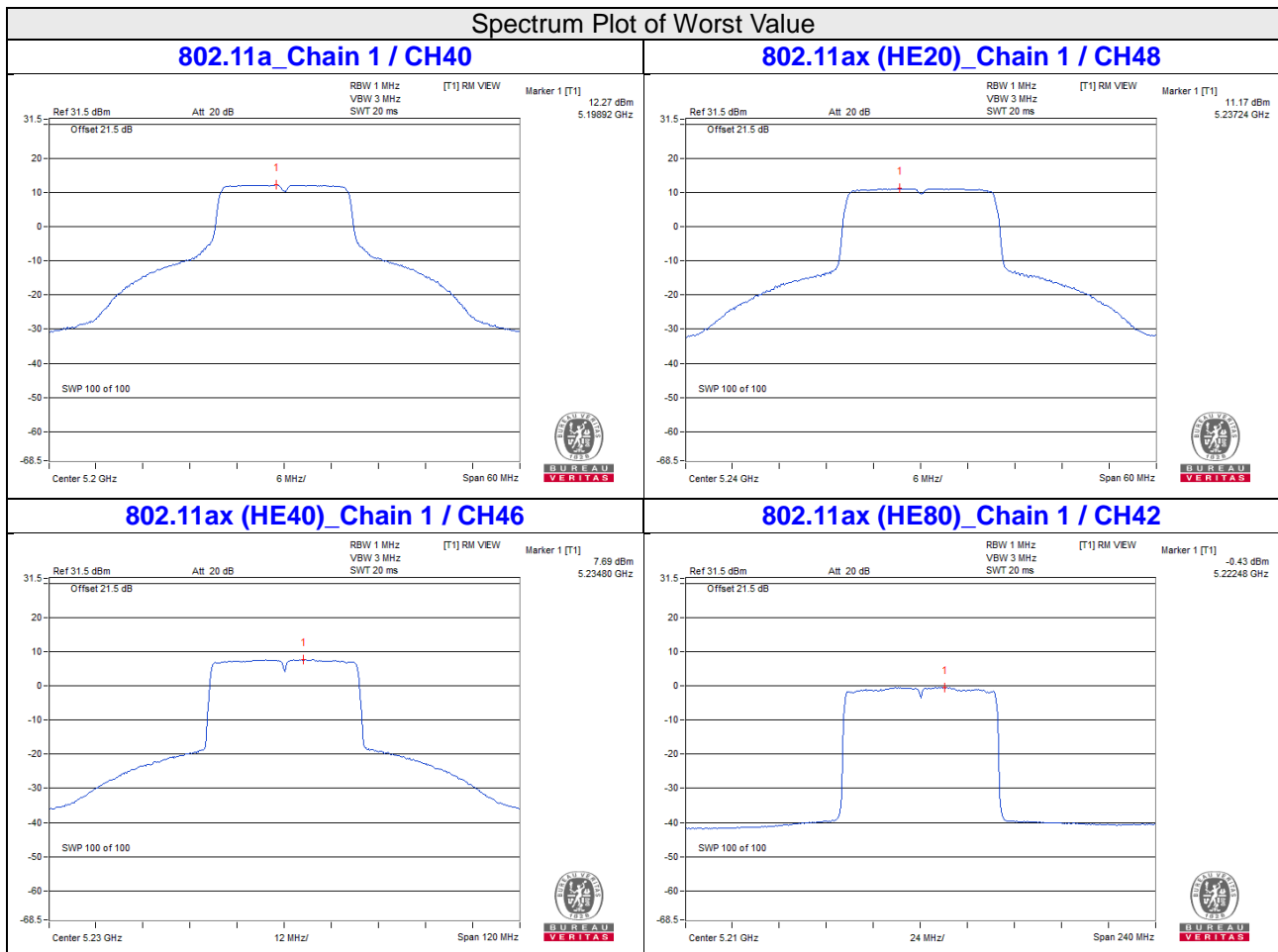

**For U-NII-3:**
**802.11a**

Chan.	Freq. (MHz)	PSD (dBm/300kHz)		Total PSD		Total PSD (dBm/500kHz)	Limit (dBm/500kHz)	Pass /Fail
		Chain 0	Chain 1	mW/300kHz	dBm/300kHz			
149	5745	3.98	4.62	5.3977	7.32	9.54	30.00	Pass
157	5785	4.45	4.43	5.5594	7.45	9.67	30.00	Pass
165	5825	4.34	4.70	5.6676	7.53	9.75	30.00	Pass

- Note: 1. Method b) Measure and sum spectral maxima across the outputs of KDB 662911 is using for calculating total power density.  
 2. The directional gain =  $10 \log[(10^{G_0/20} + 10^{G_1/20})^2 / 2] = 4.98\text{dBi} < 6\text{dBi}$ , so the power density limit shall not be reduced.

**802.11ax (HE20)**

Chan.	Freq. (MHz)	PSD (dBm/300kHz)		Total PSD		Total PSD (dBm/500kHz)	Limit (dBm/500kHz)	Pass /Fail
		Chain 0	Chain 1	mW/300kHz	dBm/300kHz			
149	5745	3.10	3.83	4.4572	6.49	8.71	30.00	Pass
157	5785	3.11	3.79	4.4398	6.47	8.69	30.00	Pass
165	5825	3.24	3.87	4.5464	6.58	8.80	30.00	Pass

- Note: 1. Method b) Measure and sum spectral maxima across the outputs of KDB 662911 is using for calculating total power density.  
 2. The directional gain =  $10 \log[(10^{G_0/20} + 10^{G_1/20})^2 / 2] = 4.98\text{dBi} < 6\text{dBi}$ , so the power density limit shall not be reduced.

**802.11ax (HE40)**

Chan.	Freq. (MHz)	PSD (dBm/300kHz)		Total PSD		Total PSD (dBm/500kHz)	Limit (dBm/500kHz)	Pass /Fail
		Chain 0	Chain 1	mW/300kHz	dBm/300kHz			
151	5755	-0.14	0.70	2.1432	3.31	5.53	30.00	Pass
159	5795	-0.02	0.63	2.1515	3.33	5.55	30.00	Pass

- Note: 1. Method b) Measure and sum spectral maxima across the outputs of KDB 662911 is using for calculating total power density.  
 2. The directional gain =  $10 \log[(10^{G_0/20} + 10^{G_1/20})^2 / 2] = 4.98\text{dBi} < 6\text{dBi}$ , so the power density limit shall not be reduced.

### 802.11ax (HE80)

Chan.	Freq. (MHz)	PSD (dBm/300kHz)		Total PSD		Total PSD (dBm/500kHz)	Limit (dBm/500kHz)	Pass /Fail
		Chain 0	Chain 1	mW/300kHz	dBm/300kHz			
155	5775	-5.49	-4.71	0.6206	-2.07	0.15	30.00	Pass

- Note: 1. Method b) Measure and sum spectral maxima across the outputs of KDB 662911 is using for calculating total power density.  
 2. The directional gain =  $10 \log[(10^{G0/20} + 10^{G1/20})^2 / 2] = 4.98\text{dBi} < 6\text{dBi}$ , so the power density limit shall not be reduced.

#### Spectrum Plot of Worst Value

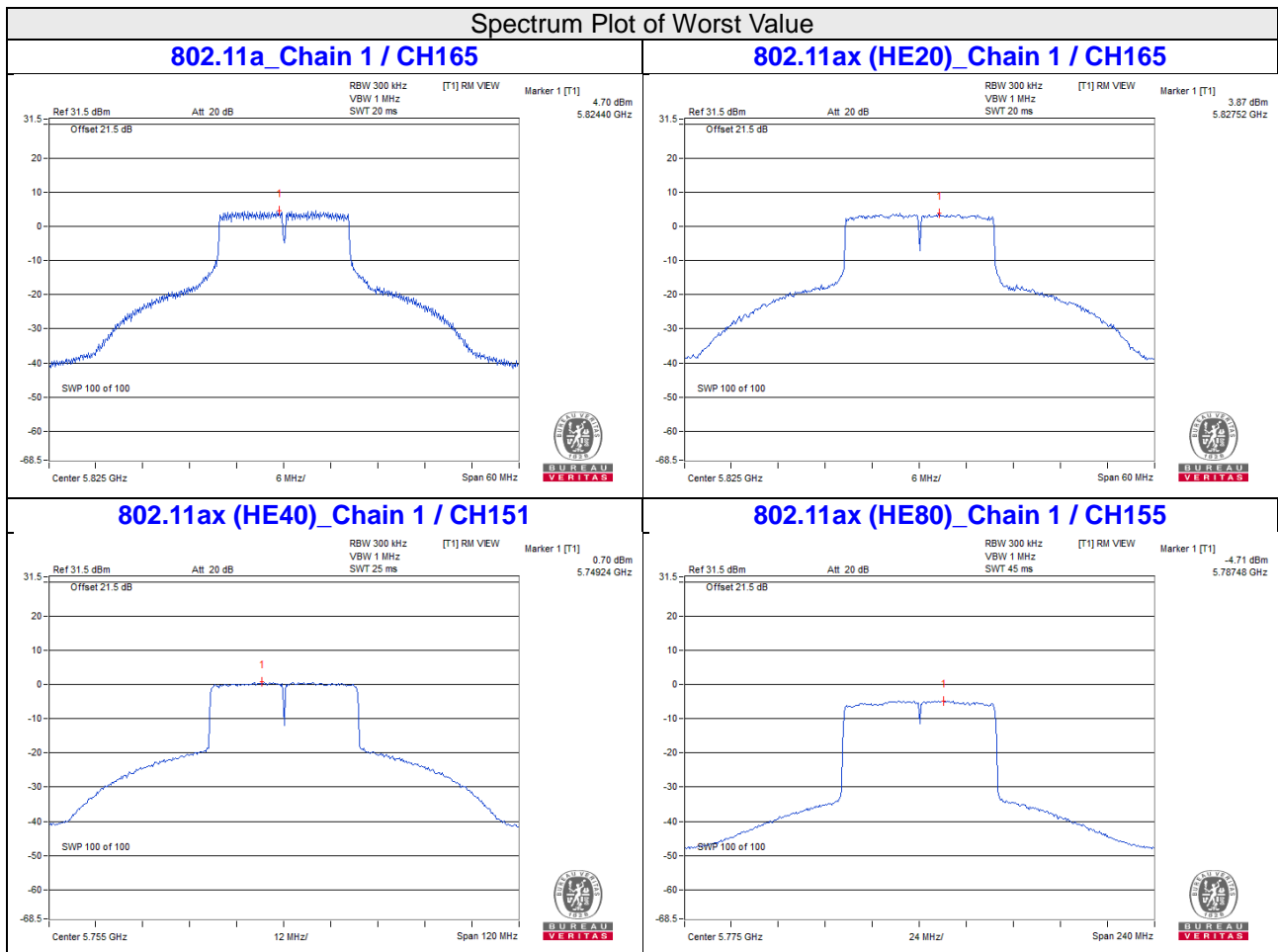

## 4.6 Frequency Stability Measurement

### 4.6.1 Limits of Frequency Stability Measurement

The frequency of the carrier signal shall be maintained within band of operation

### 4.6.2 Test Setup

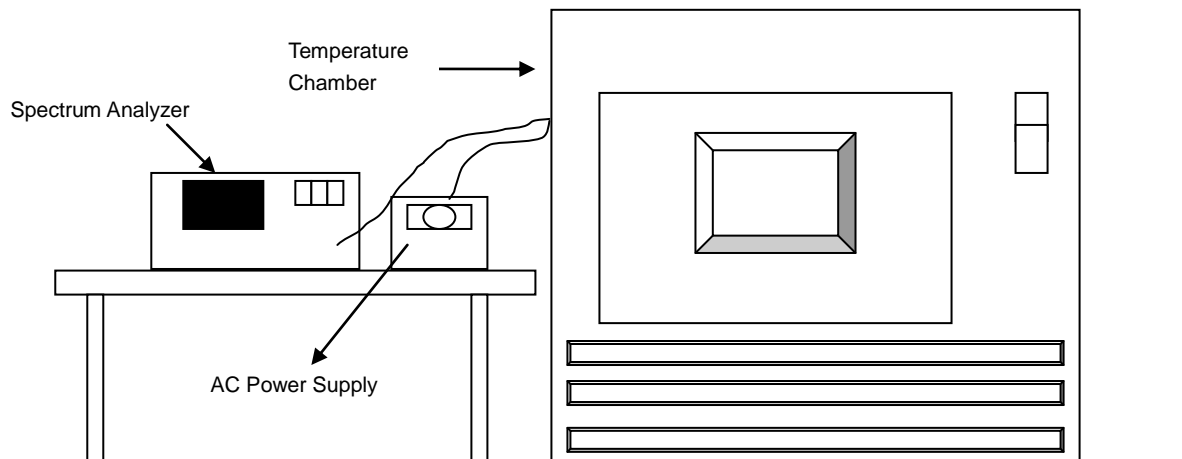

### 4.6.3 Test Instruments

Refer to section 4.1.2 to get information of above instrument.

### 4.6.4 Test Procedure

- The EUT was placed inside the environmental test chamber and powered by nominal AC voltage.
- Turn the EUT on and couple its output to a spectrum analyzer.
- Turn the EUT off and set the chamber to the highest temperature specified.
- Allow sufficient time (approximately 30 min) for the temperature of the chamber to stabilize, turn the EUT on and measure the operating frequency after 2, 5, and 10 Minutes.
- Repeat step (d) with the temperature chamber set to the next desired temperature until measurements down to the lowest specified temperature have been completed.
- The test chamber was allowed to stabilize at +20 degree C for a minimum of 30 Minutes. The supply voltage was then adjusted on the EUT from 85% to 115% and the frequency record.

### 4.6.5 Deviation from Test Standard

No deviation.

### 4.6.6 EUT Operating Condition

Set the EUT transmit at un-modulation mode to test frequency stability.

#### 4.6.7 Test Results

<b>Frequency Stability Versus Temp.</b>									
<b>Operating Frequency: 5180 MHz</b>									
<b>TEMP. (°C)</b>	<b>Power Supply (Vac)</b>	<b>0 Minute</b>		<b>2 Minutes</b>		<b>5 Minutes</b>		<b>10 Minutes</b>	
		<b>Measured Frequency (MHz)</b>	<b>Pass/Fail</b>	<b>Measured Frequency (MHz)</b>	<b>Pass/Fail</b>	<b>Measured Frequency (MHz)</b>	<b>Pass/Fail</b>	<b>Measured Frequency (MHz)</b>	<b>Pass/Fail</b>
40	120	5180.0034	PASS	5180.0061	PASS	5180.0046	PASS	5180.0081	PASS
30	120	5179.9948	PASS	5179.991	PASS	5179.992	PASS	5179.9941	PASS
20	120	5180.0131	PASS	5180.0101	PASS	5180.0098	PASS	5180.0137	PASS
10	120	5179.9876	PASS	5179.9894	PASS	5179.9873	PASS	5179.9911	PASS
0	120	5180.0116	PASS	5180.0129	PASS	5180.0132	PASS	5180.0081	PASS

<b>Frequency Stability Versus Voltage</b>									
<b>Operating Frequency: 5180 MHz</b>									
<b>TEMP. (°C)</b>	<b>Power Supply (Vac)</b>	<b>0 Minute</b>		<b>2 Minutes</b>		<b>5 Minutes</b>		<b>10 Minutes</b>	
		<b>Measured Frequency (MHz)</b>	<b>Pass/Fail</b>	<b>Measured Frequency (MHz)</b>	<b>Pass/Fail</b>	<b>Measured Frequency (MHz)</b>	<b>Pass/Fail</b>	<b>Measured Frequency (MHz)</b>	<b>Pass/Fail</b>
20	138	5180.0128	PASS	5180.0105	PASS	5180.0096	PASS	5180.0146	PASS
	120	5180.0131	PASS	5180.0101	PASS	5180.0098	PASS	5180.0137	PASS
	102	5180.0129	PASS	5180.0095	PASS	5180.0101	PASS	5180.0137	PASS

## 4.7 6dB Bandwidth Measurement

### 4.7.1 Limits of 6dB Bandwidth Measurement

The minimum of 6dB Bandwidth Measurement is 0.5MHz.

### 4.7.2 Test Setup

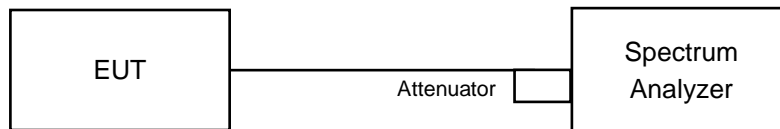

### 4.7.3 Test Instruments

Refer to section 4.1.2 to get information of above instrument.

### 4.7.4 Test Procedure

#### MEASUREMENT PROCEDURE REF

- Set resolution bandwidth (RBW) = 100kHz
- Set the video bandwidth (VBW)  $\geq 3 \times$  RBW, Detector = Peak.
- Trace mode = max hold.
- Sweep = auto couple.
- Measure the maximum width of the emission that is constrained by the frequencies associated with the two amplitude points (upper and lower) that are attenuated by 6 dB relative to the maximum level measured in the fundamental emission

### 4.7.5 Deviation from Test Standard

No deviation.

### 4.7.6 EUT Operating Condition

The software provided by client to enable the EUT under transmission condition continuously at lowest, middle and highest channel frequencies individually.



#### 4.7.7 Test Results

##### 802.11a

Channel	Frequency (MHz)	6dB Bandwidth (MHz)		Minimum Limit (MHz)	Pass / Fail
		Chain 0	Chain 1		
149	5745	16.43	16.40	0.5	Pass
157	5785	16.41	16.39	0.5	Pass
165	5825	16.41	16.41	0.5	Pass

##### 802.11ax (HE20)

Channel	Frequency (MHz)	6dB Bandwidth (MHz)		Minimum Limit (MHz)	Pass / Fail
		Chain 0	Chain 1		
149	5745	18.89	18.88	0.5	Pass
157	5785	18.87	18.86	0.5	Pass
165	5825	18.91	18.89	0.5	Pass

##### 802.11ax (HE40)

Channel	Frequency (MHz)	6dB Bandwidth (MHz)		Minimum Limit (MHz)	Pass / Fail
		Chain 0	Chain 1		
151	5755	37.88	37.59	0.5	Pass
159	5795	37.74	37.46	0.5	Pass

##### 802.11ax (HE80)

Channel	Frequency (MHz)	6dB Bandwidth (MHz)		Minimum Limit (MHz)	Pass / Fail
		Chain 0	Chain 1		
155	5775	77.94	77.40	0.5	Pass

### Spectrum Plot of Worst Value

**802.11a\_Chain 1 / CH157**

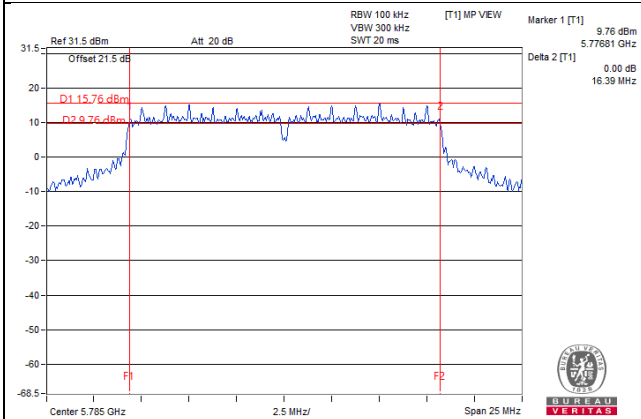

**802.11ax (HE20)\_Chain 1 / CH157**

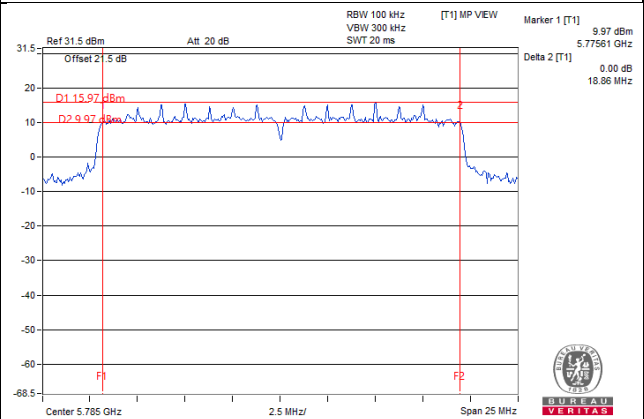

**802.11ax (HE40)\_Chain 1 / CH159**

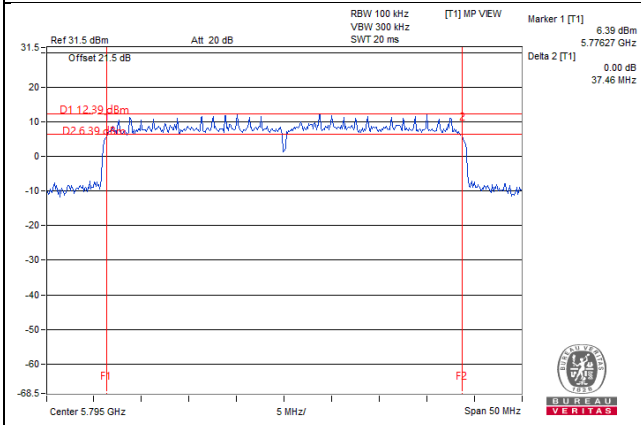

**802.11ax (HE80)\_Chain 1 / CH155**

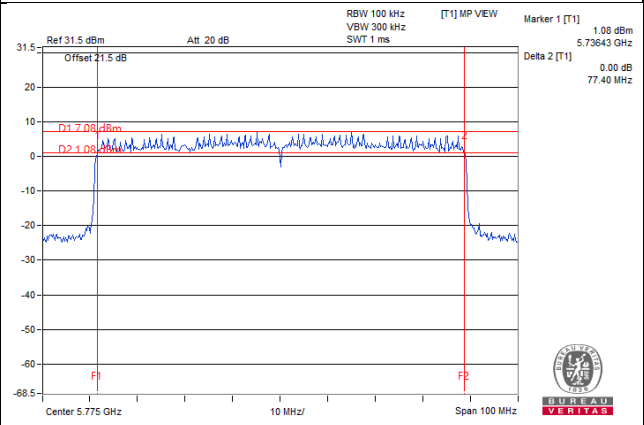

## 5 Pictures of Test Arrangements

Please refer to the attached file (Test Setup Photo).

### Annex A- Radiated Out of Band Emission (OOBE) Measurement (For U-NII-3 band)

802.11a

**CH 149 5745 MHz**

**Horizontal**

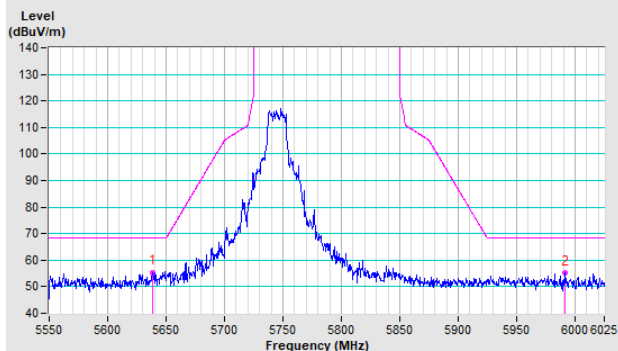

**Vertical**

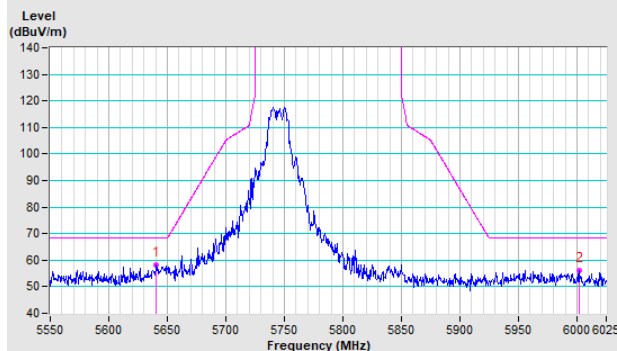

**CH 157 5785 MHz**

**Horizontal**

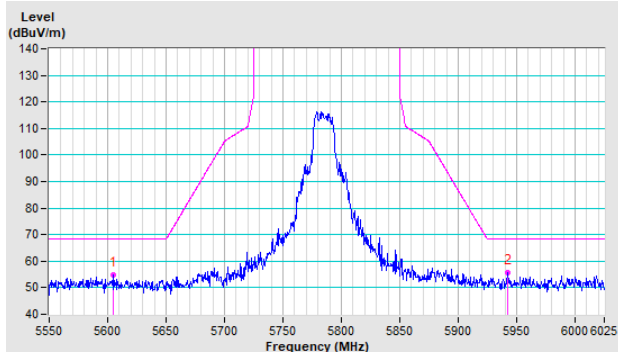

**Vertical**

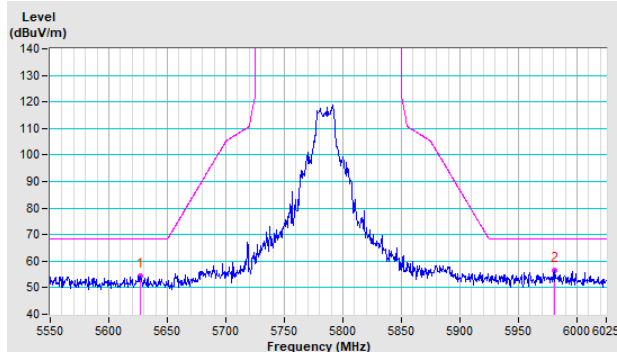

**CH 165 5825 MHz**

**Horizontal**

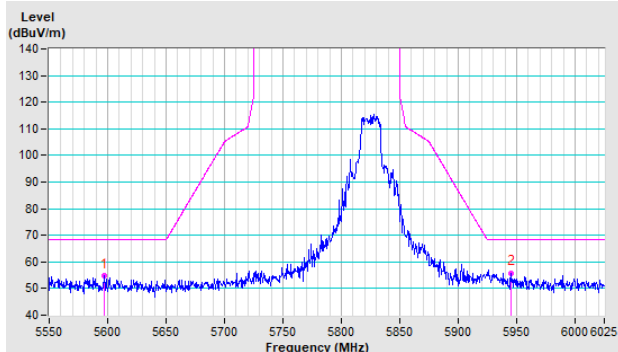

**Vertical**

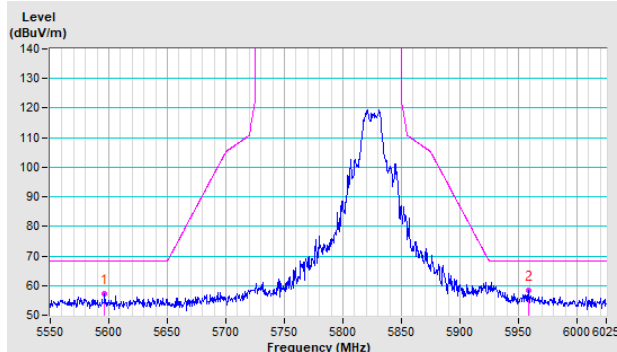

### 802.11ac (VHT20)

**CH 149 5745 MHz**

**Horizontal**

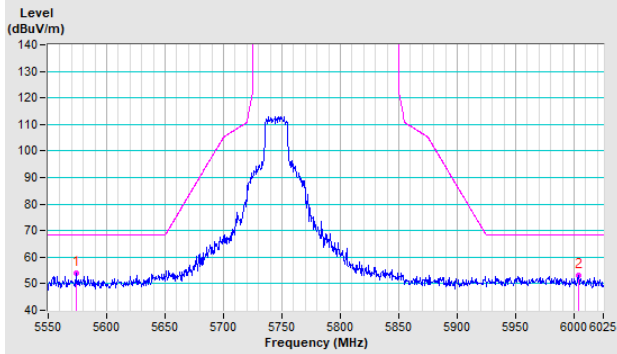

**Vertical**

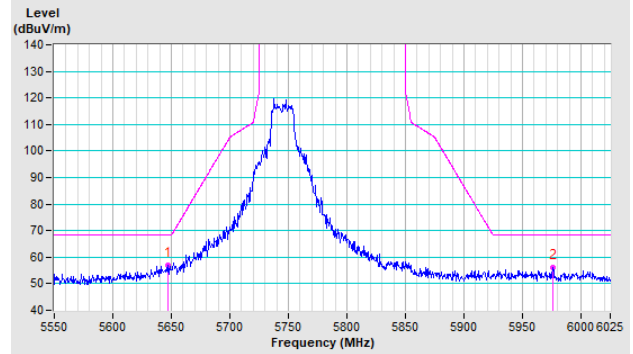

**CH 157 5785 MHz**

**Horizontal**

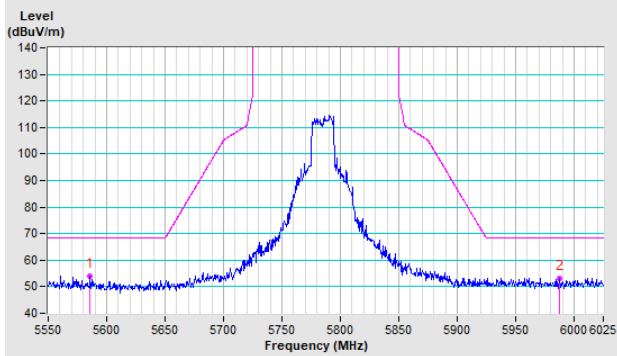

**Vertical**

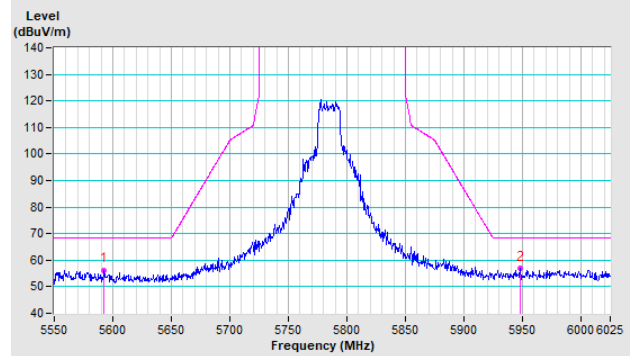

**CH 165 5825 MHz**

**Horizontal**

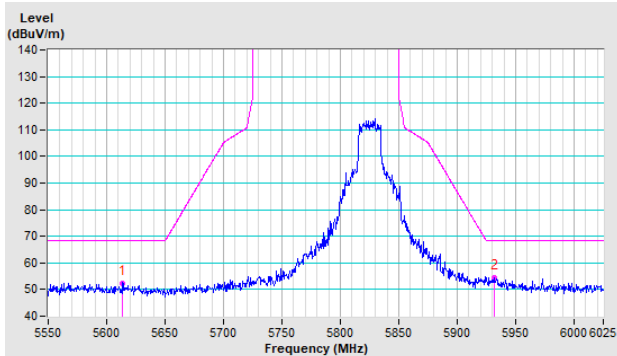

**Vertical**

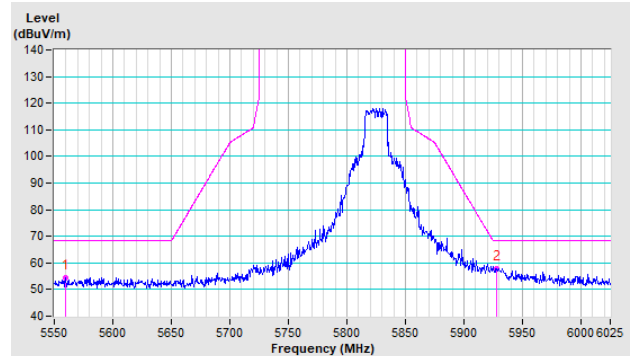

### 802.11ac (VHT40)

**CH 151 5755 MHz**

**Horizontal**

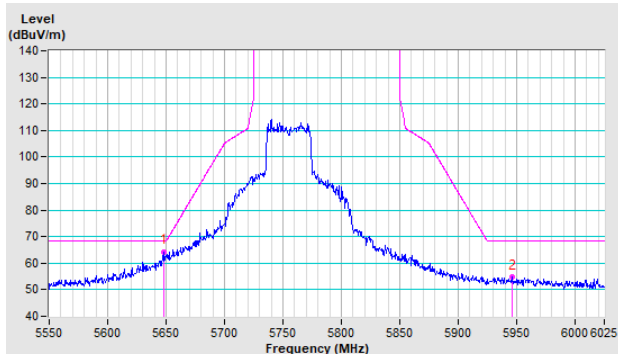

**Vertical**

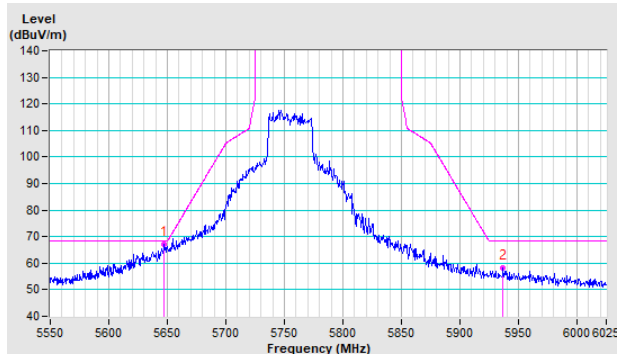

**CH 159 5795 MHz**

**Horizontal**

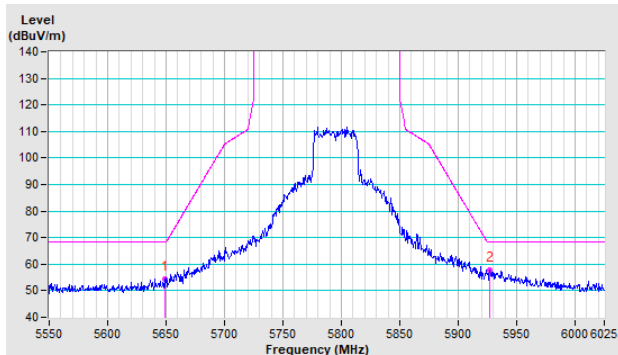

**Vertical**

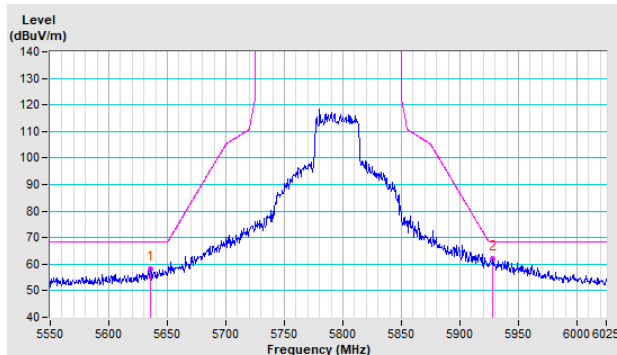

### 802.11ac (VHT80)

**CH 155 5775 MHz**

**Horizontal**

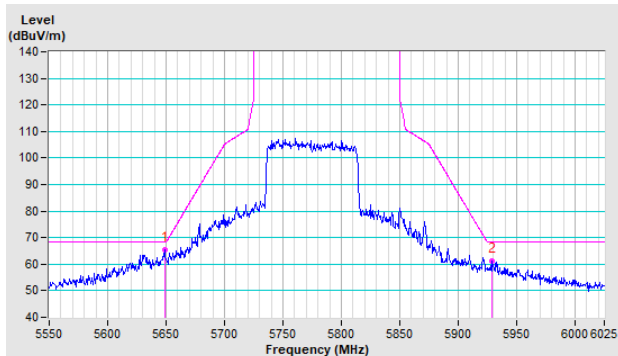

**Vertical**

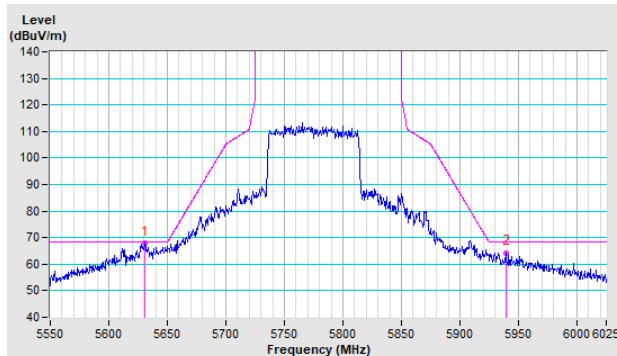

## Appendix – Information of the Testing Laboratories

We, Bureau Veritas Consumer Products Services (H.K.) Ltd., Taoyuan Branch, were founded in 1988 to provide our best service in EMC, Radio, Telecom and Safety consultation. Our laboratories are FCC recognized accredited test firms and accredited according to ISO/IEC 17025.

If you have any comments, please feel free to contact us at the following:

**Lin Kou EMC/RF Lab**

Tel: 886-2-26052180

Fax: 886-2-26051924

**Hsin Chu EMC/RF/Telecom Lab**

Tel: 886-3-6668565

Fax: 886-3-6668323

**Hwa Ya EMC/RF/Safety Lab**

Tel: 886-3-3183232

Fax: 886-3-3270892

**Email:** [service.adt@tw.bureauveritas.com](mailto:service.adt@tw.bureauveritas.com)

**Web Site:** [www.bureauveritas-adt.com](http://www.bureauveritas-adt.com)

The address and road map of all our labs can be found in our web site also.

--- END ---