

FCC Test Report

Report No.: RF190715C10-1

FCC ID: PY319200449

Test Model: RBR10

Received Date: Jul. 15, 2019

Test Date: Jul. 23 ~ Jul. 25, 2019

Issued Date: Jul. 26, 2019

Applicant: NETGEAR, INC.

Address: 350 East Plumeria Drive San Jose, CA 95134

Issued By: Bureau Veritas Consumer Products Services (H.K.) Ltd., Taoyuan Branch

Lab Address: No. 47-2, 14th Ling, Chia Pau Vil., Lin Kou Dist., New Taipei City, Taiwan (R.O.C.)

Test Location: No. 19, Hwa Ya 2nd Rd., Wen Hwa Vil., Kwei Shan Dist., Taoyuan City 33383, TAIWAN (R.O.C.)

**FCC Registration /
Designation Number:** 788550 / TW0003



This report is for your exclusive use. Any copying or replication of this report to or for any other person or entity, or use of our name or trademark, is permitted only with our prior written permission. This report sets forth our findings solely with respect to the test samples identified herein. The results set forth in this report are not indicative or representative of the quality or characteristics of the lot from which a test sample was taken or any similar or identical product specifically and expressly noted. Our report includes all of the tests requested by you and the results thereof based upon the information that you provided to us. You have 60 days from date of issuance of this report to notify us of any material error or omission caused by our negligence, provided, however, that such notice shall be in writing and shall specifically address the issue you wish to raise. A failure to raise such issue within the prescribed time shall constitute your unqualified acceptance of the completeness of this report, the tests conducted and the correctness of the report contents. Unless specific mention, the uncertainty of measurement has been explicitly taken into account to declare the compliance or non-compliance to the specification. The report must not be used by the client to claim product certification, approval, or endorsement by TAF or any government agencies.

Table of Contents

Release Control Record	4
1 Certificate of Conformity	5
2 Summary of Test Results	6
2.1 Measurement Uncertainty	6
2.2 Modification Record	6
3 General Information	7
3.1 General Description of EUT	7
3.2 Description of Test Modes	9
3.2.1 Test Mode Applicability and Tested Channel Detail	10
3.3 Duty Cycle of Test Signal	12
3.4 Description of Support Units	13
3.4.1 Configuration of System under Test	13
3.5 General Description of Applied Standards	13
4 Test Types and Results	14
4.1 Radiated Emission and Bandedge Measurement.....	14
4.1.1 Limits of Radiated Emission and Bandedge Measurement	14
4.1.2 Test Instruments	15
4.1.3 Test Procedures.....	16
4.1.4 Deviation from Test Standard	16
4.1.5 Test Setup.....	17
4.1.6 EUT Operating Conditions.....	18
4.1.7 Test Results	19
4.2 Conducted Emission Measurement	41
4.2.1 Limits of Conducted Emission Measurement	41
4.2.2 Test Instruments	41
4.2.3 Test Procedures.....	42
4.2.4 Deviation from Test Standard	42
4.2.5 Test Setup.....	42
4.2.6 EUT Operating Conditions.....	42
4.2.7 Test Results	43
4.3 Transmit Power Measurement	47
4.3.1 Limits of Transmit Power Measurement	47
4.3.2 Test Setup.....	47
4.3.3 Test Instruments	48
4.3.4 Test Procedure	48
4.3.5 Deviation from Test Standard	48
4.3.6 EUT Operating Conditions.....	48
4.3.7 Test Result.....	49
4.4 Occupied Bandwidth Measurement	53
4.4.1 Test Setup.....	53
4.4.2 Test Instruments	53
4.4.3 Test Procedure	53
4.4.4 Test Result.....	54
4.5 Peak Power Spectral Density Measurement	56
4.5.1 Limits of Peak Power Spectral Density Measurement	56
4.5.2 Test Setup.....	56
4.5.3 Test Instruments	56
4.5.4 Test Procedures.....	57
4.5.5 Deviation from Test Standard	57
4.5.6 EUT Operating Conditions.....	57
4.5.7 Test Results	58
4.6 Frequency Stability.....	63
4.6.1 Limits of Frequency Stability Measurement	63

4.6.2	Test Setup.....	63
4.6.3	Test Instruments	63
4.6.4	Test Procedure	63
4.6.5	Deviation from Test Standard	64
4.6.6	EUT Operating Condition	64
4.6.7	Test Results	64
4.7	6dB Bandwidth Measurement.....	65
4.7.1	Limits of 6dB Bandwidth Measurement.....	65
4.7.2	Test Setup.....	65
4.7.3	Test Instruments	65
4.7.4	Test Procedure	65
4.7.5	Deviation from Test Standard	65
4.7.6	EUT Operating Condition	65
4.7.7	Test Results	66
5	Pictures of Test Arrangements.....	68
	Annex A- Radiated Out of Band Emission (OOBE) Measurement (For U-NII-3 band).....	69
	Appendix – Information of the Testing Laboratories	72

Release Control Record

Issue No.	Description	Date Issued
RF190715C10-1	Original release.	Jul. 26, 2019

1 Certificate of Conformity

Product: Orbi Router

Brand: NETGEAR

Test Model: RBR10

Sample Status: Engineering sample

Applicant: NETGEAR, INC.

Test Date: Jul. 23 ~ Jul. 25, 2019

Standards: 47 CFR FCC Part 15, Subpart E (Section 15.407)
ANSI C63.10:2013

The above equipment has been tested by **Bureau Veritas Consumer Products Services (H.K.) Ltd., Taoyuan Branch**, and found compliance with the requirement of the above standards. The test record, data evaluation & Equipment Under Test (EUT) configurations represented herein are true and accurate accounts of the measurements of the sample's RF characteristics under the conditions specified in this report.

Prepared by : Pettie Chen , **Date:** Jul. 26, 2019
Pettie Chen / Senior Specialist

Approved by : Bruce Chen , **Date:** Jul. 26, 2019
Bruce Chen / Project Engineer

2 Summary of Test Results

47 CFR FCC Part 15, Subpart E (Section 15.407)			
FCC Clause	Test Item	Result	Remarks
15.407(b)(6)	AC Power Conducted Emissions	Pass	Meet the requirement of limit. Minimum passing margin is -6.50dB at 0.39635MHz.
15.407(b)(1/2/3/4(i/ii)/6)	Radiated Emissions & Band Edge Measurement	Pass	Meet the requirement of limit. Minimum passing margin is -0.1dB at 5150.00MHz.
15.407(a)(1/2/3)	Max Average Transmit Power	Pass	Meet the requirement of limit.
---	Occupied Bandwidth Measurement	Pass	Meet the requirement of limit.
15.407(a)(1/2/3)	Peak Power Spectral Density	Pass	Meet the requirement of limit.
15.407(e)	6dB bandwidth	Pass	Meet the requirement of limit. (U-NII-3 Band only)
15.407(g)	Frequency Stability	Pass	Meet the requirement of limit.
15.203	Antenna Requirement	Pass	Antenna connector is I-PEX not a standard connector.

*For U-NII-3 band compliance with rule part 15.407(b)(4)(i), the OOB test plots were recorded in Annex A.
 Note: Determining compliance based on the results of the compliance measurement, not taking into account measurement instrumentation uncertainty.

2.1 Measurement Uncertainty

Where relevant, the following measurement uncertainty levels have been estimated for tests performed on the EUT as specified in CISPR 16-4-2:

Measurement	Frequency	Expanded Uncertainty (k=2) (±)
Conducted Emissions at mains ports	150kHz ~ 30MHz	2.94 dB
Radiated Emissions up to 1 GHz	9kHz ~ 30MHz	3.04 dB
	30MHz ~ 200MHz	3.86 dB
	200MHz ~ 1000MHz	3.87 dB
Radiated Emissions above 1 GHz	1GHz ~ 18GHz	2.29 dB
	18GHz ~ 40GHz	2.29 dB

2.2 Modification Record

There were no modifications required for compliance.

3 General Information

3.1 General Description of EUT

Product	Orbi Router
Brand	NETGEAR
Test Model	RBR10
Sample Status	Engineering sample
Power Supply Rating	12Vdc (adapter)
Modulation Type	256QAM, 64QAM, 16QAM, QPSK, BPSK
Modulation Technology	OFDM
Transfer Rate	802.11a: 54/48/36/24/18/12/9/6Mbps 802.11n: up to 300Mbps 802.11ac: up to 867Mbps
Operating Frequency	5180~5240MHz, 5745~5825MHz
Number of Channel	5180~5240MHz: 802.11a, 802.11n (HT20), 802.11ac (VHT20): 4 802.11n (HT40), 802.11ac (VHT40): 2 802.11ac (VHT80): 1 5745~5825MHz: 802.11a, 802.11n (HT20), 802.11ac (VHT20): 5 802.11n (HT40), 802.11ac (VHT40): 2 802.11ac (VHT80): 1
Output Power	5180~5240MHz: CDD Mode: 381.574mW Beamforming Mode: 371.025mW 5745~5825MHz: CDD Mode: 413.312mW Beamforming Mode: 413.312mW
Antenna Type	Refer to Note
Antenna Connector	Refer to Note
Accessory Device	Adapter
Cable Supplied	NA

Note:

1. The EUT incorporates a MIMO function. Physically, the EUT provides 2 completed transmitters and 2 receivers.

Modulation Mode	CDD Mode	Beamforming Mode	TX Function
802.11a	Support	Not Support	2TX
802.11n (HT20)	Support	Not Support	2TX
802.11n (HT40)	Support	Not Support	2TX
802.11ac (VHT20)	Support	Support	2TX
802.11ac (VHT40)	Support	Support	2TX
802.11ac (VHT80)	Support	Support	2TX

* The modulation and bandwidth are similar for 802.11n mode for HT20/HT40 and 802.11ac mode for VHT20/VHT40, therefore investigated worst case to representative mode in test report. (Final test mode refer section 3.2.1)

* For 802.11n and 802.11ac, CDD mode and Beamforming mode are presented in power output test item. For other test items, CDD mode is the worst case for final tests after pretesting.

2. The EUT uses following adapters.

Adapter 1	
Brand	NETGEAR
Model	2AAJ012F1
P/N	332-11510-01
Input Power	100-120Vac~50/60Hz 0.35A
Output Power	12.0Vdc / 1.0A
Power Line	1.85m power cable without core attached on adapter

Adapter 2	
Brand	NETGEAR
Model	AD2071F10
P/N	332-11515-01
Input Power	100-120Vac~50/60Hz 0.3A
Output Power	12Vdc / 1A
Power Line	1.80m power cable without core attached on adapter

3. The following antennas were provided to the EUT.

Ant. Type	PIFA		
Connector	I-PEX		
Gain (dBi)	Ant. 0	Ant. 1	Directional Gain
2.4GHz	1.54	1.41	4.49
5GHz Band 1	2.51	2.49	5.51
5GHz Band 4	3.88	3.09	6.50

3.2 Description of Test Modes

5180~5240MHz:

4 channels are provided for 802.11a, 802.11n (HT20), 802.11ac (VHT20):

Channel	Frequency	Channel	Frequency
36	5180MHz	44	5220MHz
40	5200MHz	48	5240MHz

2 channels are provided for 802.11n (HT40), 802.11ac (VHT40):

Channel	Frequency	Channel	Frequency
38	5190MHz	46	5230MHz

1 channel is provided for 802.11ac (VHT80):

Channel	Frequency
42	5210MHz

5745~5825MHz:

5 channels are provided for 802.11a, 802.11n (HT20), 802.11ac (VHT20):

Channel	Frequency	Channel	Frequency
149	5745MHz	161	5805MHz
153	5765MHz	165	5825MHz
157	5785MHz		

2 channels are provided for 802.11n (HT40), 802.11ac (VHT40):

Channel	Frequency	Channel	Frequency
151	5755MHz	159	5795MHz

1 channel is provided for 802.11ac (VHT80):

Channel	Frequency
155	5775MHz

3.2.1 Test Mode Applicability and Tested Channel Detail

EUT Configure Mode	Applicable to				Description
	RE \geq 1G	RE<1G	PLC	APCM	
A	√	√	√	√	Power from adapter 1
B	-	√	√	-	Power from adapter 2

Where RE \geq 1G: Radiated Emission above 1GHz & Bandedge Measurement
 RE<1G: Radiated Emission below 1GHz
 PLC: Power Line Conducted Emission
 APCM: Antenna Port Conducted Measurement

Note:

1. The EUT had been pre-tested on the positioned of each 3 axis. The worst case was found when positioned on X-plane.
2. Radiated emission test (below 1GHz) and power line conducted emission test items chosen the worst maximum power.
3. "-": Means no effect.

Radiated Emission Test (Above 1GHz):

- Pre-Scan has been conducted to determine the worst-case mode from all possible combinations between available modulations, data rates and antenna ports (if EUT with antenna diversity architecture).
- Following channel(s) was (were) selected for the final test as listed below.

EUT Configure Mode	Mode	Frequency Band (MHz)	Available Channel	Tested Channel	Modulation Technology	Data Rate (Mbps)
A	802.11a	5180-5240	36 to 48	36, 40, 48	OFDM	6.0
	802.11ac (VHT20)		36 to 48	36, 40, 48	OFDM	6.5
	802.11ac (VHT40)		38 to 46	38, 46	OFDM	13.5
	802.11ac (VHT80)		42	42	OFDM	29.3
A	802.11a	5745-5825	149 to 165	149, 157, 165	OFDM	6.0
	802.11ac (VHT20)		149 to 165	149, 157, 165	OFDM	6.5
	802.11ac (VHT40)		151 to 159	151, 159	OFDM	13.5
	802.11ac (VHT80)		155	155	OFDM	29.3

Radiated Emission Test (Below 1GHz):

- Pre-Scan has been conducted to determine the worst-case mode from all possible combinations between available modulations, data rates and antenna ports (if EUT with antenna diversity architecture).
- Following channel(s) was (were) selected for the final test as listed below.

EUT Configure Mode	Mode	Frequency Band (MHz)	Available Channel	Tested Channel	Modulation Technology	Data Rate (Mbps)
A, B	802.11ac (VHT40)	5180-5240	38 to 46	151	OFDM	13.5
		5745-5825	151 to 159		OFDM	13.5

Power Line Conducted Emission Test:

- Pre-Scan has been conducted to determine the worst-case mode from all possible combinations between available modulations, data rates and antenna ports (if EUT with antenna diversity architecture).
- Following channel(s) was (were) selected for the final test as listed below.

EUT Configure Mode	Mode	Frequency Band (MHz)	Available Channel	Tested Channel	Modulation Technology	Data Rate (Mbps)
A, B	802.11ac (VHT40)	5180-5240	38 to 46	151	OFDM	13.5
		5745-5825	151 to 159		OFDM	13.5

Antenna Port Conducted Measurement:

- This item includes all test value of each mode, but only includes spectrum plot of worst value of each mode.
- Pre-Scan has been conducted to determine the worst-case mode from all possible combinations between available modulations, data rates and antenna ports (if EUT with antenna diversity architecture).
- Following channel(s) was (were) selected for the final test as listed below.

EUT Configure Mode	Mode	Frequency Band (MHz)	Available Channel	Tested Channel	Modulation Technology	Data Rate (Mbps)
A	802.11a	5180-5240	36 to 48	36, 40, 48	OFDM	6.0
	802.11ac (VHT20)		36 to 48	36, 40, 48	OFDM	6.5
	802.11ac (VHT40)		38 to 46	38, 46	OFDM	13.5
	802.11ac (VHT80)		42	42	OFDM	29.3
A	802.11a	5745-5825	149 to 165	149, 157, 165	OFDM	6.0
	802.11ac (VHT20)		149 to 165	149, 157, 165	OFDM	6.5
	802.11ac (VHT40)		151 to 159	151, 159	OFDM	13.5
	802.11ac (VHT80)		155	155	OFDM	29.3

Test Condition:

Applicable to	Environmental Conditions	Input Power	Tested by
RE \geq 1G	25 deg. C, 70% RH	120Vac, 60Hz	Noah Chang
RE $<$ 1G	25 deg. C, 70% RH	120Vac, 60Hz	Noah Chang
PLC	24 deg. C, 67% RH	120Vac, 60Hz	Willy Cheng
APCM	25 deg. C, 60% RH	120Vac, 60Hz	Frank Liu

3.3 Duty Cycle of Test Signal

Duty cycle of test signal is $\geq 98\%$, duty factor is not required.

Duty cycle of test signal is $< 98\%$, duty factor shall be considered.

802.11a: Duty cycle = $2.012/2.125 = 0.947$, Duty factor = $10 * \log(1/0.947) = 0.24$

802.11ac (VHT20): Duty cycle = $4.963/5.076 = 0.978$, Duty factor = $10 * \log(1/0.978) = 0.10$

802.11ac (VHT40): Duty cycle = $2.376/2.510 = 0.947$, Duty factor = $10 * \log(1/0.947) = 0.24$

802.11ac (VHT80): Duty cycle = $1.108/1.240 = 0.894$, Duty factor = $10 * \log(1/0.894) = 0.49$



3.4 Description of Support Units

The EUT has been tested as an independent unit together with other necessary accessories or support units. The following support units or accessories were used to form a representative test configuration during the tests.

ID	Product	Brand	Model No.	Serial No.	FCC ID	Remarks
A.	Notebook	DELL	E5410	1HC2XM1	FCC DoC Approved	-
B.	Load	NA	NA	NA	NA	-

Note:

1. All power cords of the above support units are non-shielded (1.8m).
2. Item A acted as a communication partner to transfer data.

ID	Descriptions	Qty.	Length (m)	Shielding (Yes/No)	Cores (Qty.)	Remarks
1.	RJ45, Cat5e	1	6	N	0	-
2.	RJ45, Cat5e	1	1.5	N	0	-

3.4.1 Configuration of System under Test

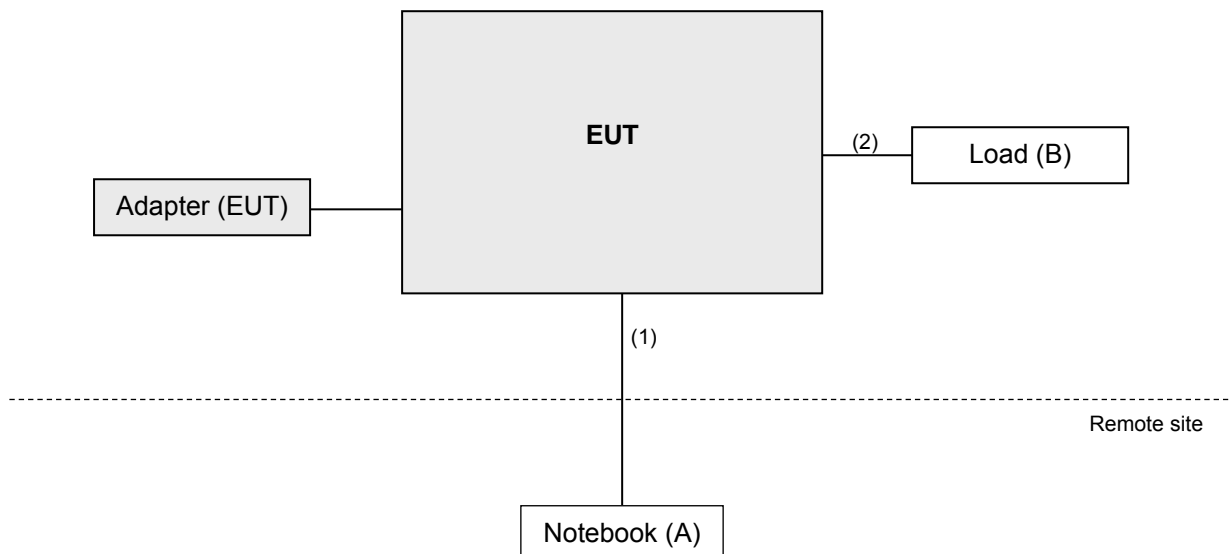

3.5 General Description of Applied Standards

The EUT is a RF Product. According to the specifications of the manufacturer, it must comply with the requirements of the following standards:

FCC Part 15, Subpart E (15.407)

KDB 789033 D02 General UNII Test Procedure New Rules v02r01

KDB 662911 D01 Multiple Transmitter Output v02r01

ANSI C63.10:2013

All test items have been performed and recorded as per the above standards.

4 Test Types and Results

4.1 Radiated Emission and Bandedge Measurement

4.1.1 Limits of Radiated Emission and Bandedge Measurement

Radiated emissions which fall in the restricted bands must comply with the radiated emission limits specified as below table.

Frequencies (MHz)	Field Strength (microvolts/meter)	Measurement Distance (meters)
0.009 ~ 0.490	2400/F(kHz)	300
0.490 ~ 1.705	24000/F(kHz)	30
1.705 ~ 30.0	30	30
30 ~ 88	100	3
88 ~ 216	150	3
216 ~ 960	200	3
Above 960	500	3

NOTE:

1. The lower limit shall apply at the transition frequencies.
2. Emission level (dBuV/m) = 20 log Emission level (uV/m).
3. For frequencies above 1000MHz, the field strength limits are based on average detector, however, the peak field strength of any emission shall not exceed the maximum permitted average limits, specified above by more than 20dB under any condition of modulation.

Limits of unwanted emission out of the restricted bands

Applicable To		Limit	
789033 D02 General UNII Test Procedure New Rules v02r01		Field Strength at 3m	
		PK: 74 (dBµV/m)	AV: 54 (dBµV/m)
Frequency Band	Applicable To	EIRP Limit	Equivalent Field Strength at 3m
5150~5250 MHz	15.407(b)(1)	PK: -27 (dBm/MHz)	PK: 68.2(dBµV/m)
5250~5350 MHz	15.407(b)(2)		
5470~5725 MHz	15.407(b)(3)		
5725~5850 MHz	<input checked="" type="checkbox"/> 15.407(b)(4)(i)	PK: -27 (dBm/MHz) ^{*1} PK: 10 (dBm/MHz) ^{*2} PK: 15.6 (dBm/MHz) ^{*3} PK: 27 (dBm/MHz) ^{*4}	PK: 68.2 (dBµV/m) ^{*1} PK: 105.2 (dBµV/m) ^{*2} PK: 110.8 (dBµV/m) ^{*3} PK: 122.2 (dBµV/m) ^{*4}
	<input type="checkbox"/> 15.407(b)(4)(ii)	Emission limits in section 15.247(d)	
^{*1} beyond 75 MHz or more above of the band edge. ^{*3} below the band edge increasing linearly to a level of 15.6 dBm/MHz at 5 MHz above.		^{*2} below the band edge increasing linearly to 10 dBm/MHz at 25 MHz above. ^{*4} from 5 MHz above or below the band edge increasing linearly to a level of 27 dBm/MHz at the band edge.	

Note: The following formula is used to convert the equipment isotropic radiated power (eirp) to field strength:

$$E = \frac{1000000 \sqrt{30 P}}{3} \mu\text{V/m, where P is the eirp (Watts).}$$

4.1.2 Test Instruments

Description & Manufacturer	Model No.	Serial No.	Cal. Date	Cal. Due
Test Receiver ROHDE & SCHWARZ	ESCI	100424	Jan. 03, 2019	Jan. 02, 2020
Spectrum Analyzer ROHDE & SCHWARZ	FSP40	100040	Sep. 25, 2018	Sep. 24, 2019
BILOG Antenna SCHWARZBECK	VULB9168	9168-155	Nov. 21, 2018	Nov. 20, 2019
HORN Antenna SCHWARZBECK	BBHA 9120D	9120D-408	Nov. 25, 2018	Nov. 24, 2019
HORN Antenna SCHWARZBECK	BBHA 9170	BBHA9170241	Nov. 25, 2018	Nov. 24, 2019
Loop Antenna TESEQ	HLA 6121	45745	Jul. 01, 2019	Jun. 30, 2020
Preamplifier Agilent (Below 1GHz)	8447D	2944A10631	Aug. 08, 2018	Aug. 07, 2019
Preamplifier KEYSIGHT (Above 1GHz)	83017A	MY53270295	Jun. 11, 2019	Jun. 10, 2020
RF signal cable WOKEN	8D-FB	Cable-CH4-01	Aug. 29, 2018	Aug. 28, 2019
RF signal cable HUBER+SUHNER	SUCOFLEX 104	MY 13380+295012/04	Aug. 08, 2018	Aug. 07, 2019
RF signal cable HUBER+SUHNER	SUCOFLEX 104	Cable-CH4-03 (250724)	Aug. 08, 2018	Aug. 07, 2019
Software BV ADT	ADT_Radiated_ V7.6.15.9.5	NA	NA	NA
Antenna Tower inn-co GmbH	MA 4000	010303	NA	NA
Antenna Tower Controller BV ADT	AT100	AT93021703	NA	NA
Turn Table BV ADT	TT100	TT93021703	NA	NA
Turn Table Controller BV ADT	SC100	SC93021703	NA	NA
Boresight Antenna Fixture	FBA-01	FBA-SIP01	NA	NA
Pre-amplifier (18GHz-40GHz) EMC	EMC184045B	980175	Nov. 14, 2018	Nov. 13, 2019
USB Wideband Power Sensor KEYSIGHT	U2021XA	MY55050005/MY5519 0004/MY55190007/MY 55210005	Jul. 15, 2019	Jul. 14, 2020

Note: 1. The calibration interval of the above test instruments is 12 months and the calibrations are traceable to NML/ROC and NIST/USA.
2. The test was performed in HwaYa Chamber 4.

4.1.3 Test Procedures

For Radiated emission below 30MHz

- a. The EUT was placed on the top of a rotating table 0.8 meters above the ground at a 3 meter chamber room. The table was rotated 360 degrees to determine the position of the highest radiation.
- b. The EUT was set 3 meters away from the interference-receiving antenna, which was mounted on the top of a variable-height antenna tower.
- c. Parallel, perpendicular, and ground-parallel orientations of the antenna are set to make the measurement.
- d. For each suspected emission, the EUT was arranged to its worst case and the rotatable table was turned from 0 degrees to 360 degrees to find the maximum reading.
- e. The test-receiver system was set to Quasi-Peak Detect Function and Specified Bandwidth with Maximum Hold Mode.

Note:

1. The resolution bandwidth and video bandwidth of test receiver/spectrum analyzer is 9kHz at frequency below 30MHz.

For Radiated emission above 30MHz

- a. The EUT was placed on the top of a rotating table 0.8 meters (for 30MHz ~ 1GHz) / 1.5 meters (for above 1GHz) above the ground at 3 meter chamber room for test. The table was rotated 360 degrees to determine the position of the highest radiation.
- b. The EUT was set 3 meters away from the interference-receiving antenna, which was mounted on the top of a variable-height antenna tower.
- c. The height of antenna is varied from one meter to four meters above the ground to determine the maximum value of the field strength. Both horizontal and vertical polarizations of the antenna are set to make the measurement.
- d. For each suspected emission, the EUT was arranged to its worst case and then the antenna was tuned to heights from 1 meter to 4 meters and the rotatable table was turned from 0 degrees to 360 degrees to find the maximum reading.
- e. The test-receiver system was set to quasi-peak detect function and specified bandwidth with maximum hold mode when the test frequency is below 1 GHz.
- f. The test-receiver system was set to peak and average detect function and specified bandwidth with maximum hold mode when the test frequency is above 1 GHz. If the peak reading value also meets average limit, measurement with the average detector is unnecessary.

Note:

1. The resolution bandwidth and video bandwidth of test receiver/spectrum analyzer is 120kHz for Quasi-peak detection (QP) at frequency below 1GHz.
2. The resolution bandwidth of test receiver/spectrum analyzer is 1 MHz and the video bandwidth is 3 MHz for Peak detection (PK) at frequency above 1GHz.
3. The resolution bandwidth of test receiver/spectrum analyzer is 1MHz and the video bandwidth is $\geq 1/T$ (Duty cycle < 98%) or 10Hz (Duty cycle $\geq 98\%$) for Average detection (AV) at frequency above 1GHz.
(802.11a: RBW = 1MHz, VBW = 1kHz; 802.11ac (VHT20): RBW = 1MHz, VBW = 1kHz;
802.11ac (VHT40): RBW = 1MHz, VBW = 1kHz; 802.11ac (VHT80): RBW = 1MHz, VBW = 1kHz)
4. All modes of operation were investigated and the worst-case emissions are reported.

4.1.4 Deviation from Test Standard

No deviation.

4.1.5 Test Setup

For Radiated emission below 30MHz

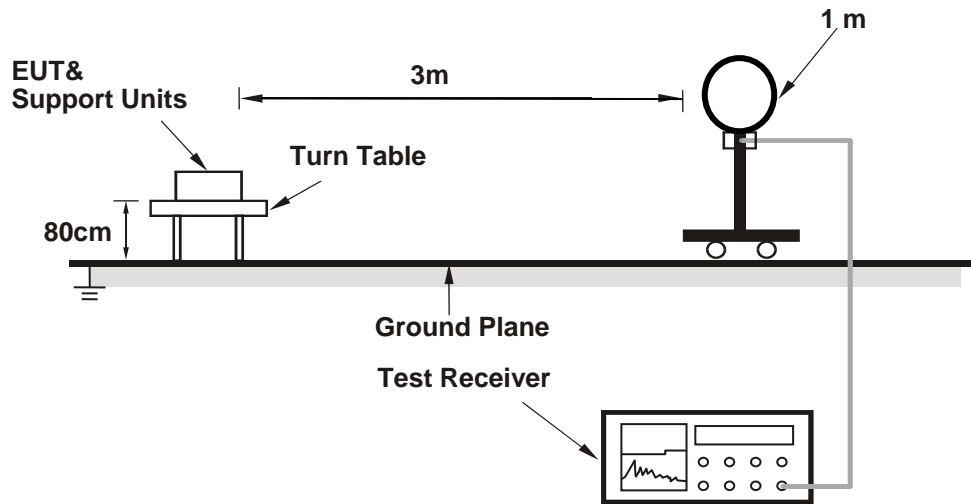

For Radiated emission 30MHz to 1GHz

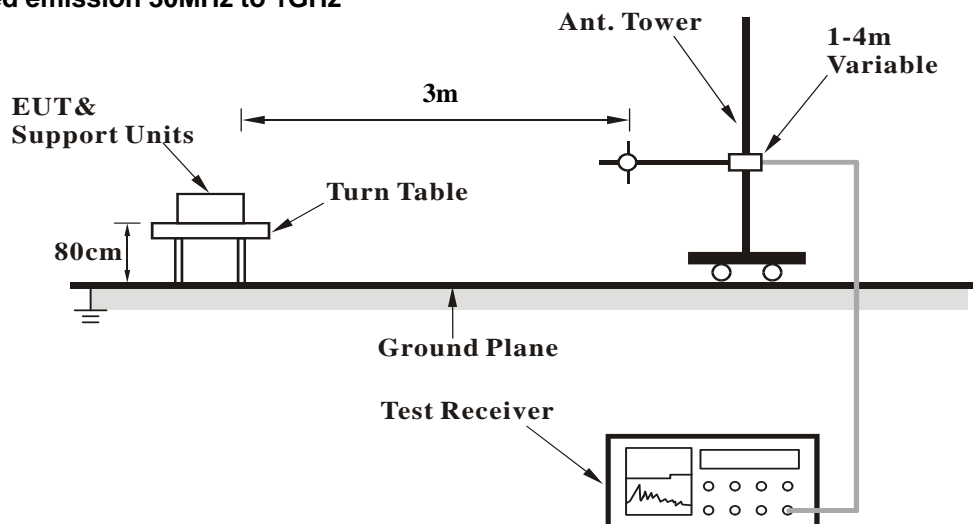

For Radiated emission above 1GHz

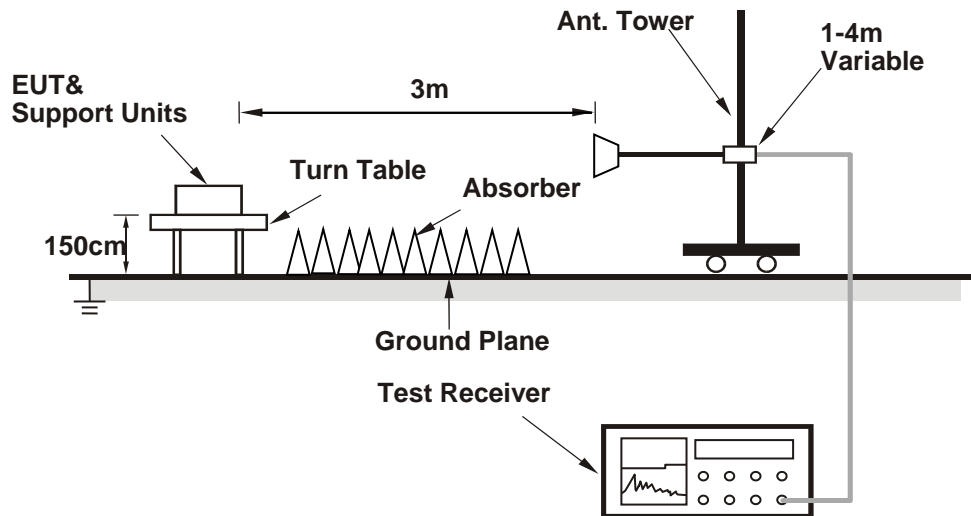

For the actual test configuration, please refer to the attached file (Test Setup Photo).

4.1.6 EUT Operating Conditions

- Placed the EUT on the testing table.
- Prepared a notebook to act as a communication partner and placed it outside of testing area.
- The communication partner connected with EUT via a RJ45 cable and ran a test program (provided by manufacturer) to enable EUT under transmission condition continuously at specific channel frequency.
- The communication partner sent data to EUT by command "PING".

4.1.7 Test Results

Above 1GHz data:

802.11a

CHANNEL	TX Channel 36	DETECTOR	Peak (PK)
FREQUENCY RANGE	1GHz ~ 40GHz	FUNCTION	Average (AV)

ANTENNA POLARITY & TEST DISTANCE: HORIZONTAL AT 3 M								
NO.	FREQ. (MHz)	EMISSION LEVEL (dBuV/m)	LIMIT (dBuV/m)	MARGIN (dB)	ANTENNA HEIGHT (m)	TABLE ANGLE (Degree)	RAW VALUE (dBuV)	CORRECTION FACTOR (dB/m)
1	5150.00	69.6 PK	74.0	-4.4	3.00 H	210	57.0	12.6
2	5150.00	48.3 AV	54.0	-5.7	3.00 H	210	35.7	12.6
3	*5180.00	112.5 PK			3.00 H	210	71.0	41.5
4	*5180.00	102.2 AV			3.00 H	210	60.7	41.5
5	#10360.00	62.0 PK	68.2	-6.2	3.09 H	263	39.5	22.5
ANTENNA POLARITY & TEST DISTANCE: VERTICAL AT 3 M								
NO.	FREQ. (MHz)	EMISSION LEVEL (dBuV/m)	LIMIT (dBuV/m)	MARGIN (dB)	ANTENNA HEIGHT (m)	TABLE ANGLE (Degree)	RAW VALUE (dBuV)	CORRECTION FACTOR (dB/m)
1	5150.00	73.6 PK	74.0	-0.4	2.26 V	159	61.0	12.6
2	5150.00	52.3 AV	54.0	-1.7	2.26 V	159	39.7	12.6
3	*5180.00	116.5 PK			2.26 V	159	75.0	41.5
4	*5180.00	106.2 AV			2.26 V	159	64.7	41.5
5	#10360.00	62.3 PK	68.2	-5.9	1.15 V	199	39.8	22.5

Remarks:

1. Emission Level(dBuV/m) = Raw Value(dBuV) + Correction Factor(dB/m)
2. Correction Factor(dB/m) = Antenna Factor(dB/m) + Cable Factor(dB) – Pre-Amplifier Factor(dB)
3. The other emission levels were very low against the limit.
4. Margin value = Emission Level – Limit value
5. " * ": Fundamental frequency.
6. " # ": The radiated frequency is out of the restricted band.

CHANNEL	TX Channel 40	DETECTOR	Peak (PK)
FREQUENCY RANGE	1GHz ~ 40GHz	FUNCTION	Average (AV)

ANTENNA POLARITY & TEST DISTANCE: HORIZONTAL AT 3 M

NO.	FREQ. (MHz)	EMISSION LEVEL (dBuV/m)	LIMIT (dBuV/m)	MARGIN (dB)	ANTENNA HEIGHT (m)	TABLE ANGLE (Degree)	RAW VALUE (dBuV)	CORRECTION FACTOR (dB/m)
1	*5200.00	116.6 PK			3.05 H	210	75.1	41.5
2	*5200.00	105.7 AV			3.05 H	210	64.2	41.5
3	#10400.00	62.3 PK	68.2	-5.9	2.22 H	215	39.4	22.9

ANTENNA POLARITY & TEST DISTANCE: VERTICAL AT 3 M

NO.	FREQ. (MHz)	EMISSION LEVEL (dBuV/m)	LIMIT (dBuV/m)	MARGIN (dB)	ANTENNA HEIGHT (m)	TABLE ANGLE (Degree)	RAW VALUE (dBuV)	CORRECTION FACTOR (dB/m)
1	*5200.00	120.6 PK			1.72 V	159	79.1	41.5
2	*5200.00	109.7 AV			1.72 V	159	68.2	41.5
3	#10400.00	62.7 PK	68.2	-5.5	3.16 V	259	39.8	22.9

Remarks:

1. Emission Level(dBuV/m) = Raw Value(dBuV) + Correction Factor(dB/m)
2. Correction Factor(dB/m) = Antenna Factor(dB/m) + Cable Factor(dB) – Pre-Amplifier Factor(dB)
3. The other emission levels were very low against the limit.
4. Margin value = Emission Level – Limit value
5. " * ": Fundamental frequency.
6. " # ": The radiated frequency is out of the restricted band.

CHANNEL	TX Channel 48	DETECTOR FUNCTION	Peak (PK)
FREQUENCY RANGE	1GHz ~ 40GHz		Average (AV)

ANTENNA POLARITY & TEST DISTANCE: HORIZONTAL AT 3 M								
NO.	FREQ. (MHz)	EMISSION LEVEL (dBuV/m)	LIMIT (dBuV/m)	MARGIN (dB)	ANTENNA HEIGHT (m)	TABLE ANGLE (Degree)	RAW VALUE (dBuV)	CORRECTION FACTOR (dB/m)
1	*5240.00	115.5 PK			3.01 H	259	74.3	41.2
2	*5240.00	105.1 AV			3.01 H	259	63.9	41.2
3	5350.00	60.3 PK	74.0	-13.7	3.01 H	259	47.9	12.4
4	5350.00	47.9 AV	54.0	-6.1	3.01 H	259	35.5	12.4
5	#10480.00	62.2 PK	68.2	-6.0	3.09 H	311	39.4	22.8
ANTENNA POLARITY & TEST DISTANCE: VERTICAL AT 3 M								
NO.	FREQ. (MHz)	EMISSION LEVEL (dBuV/m)	LIMIT (dBuV/m)	MARGIN (dB)	ANTENNA HEIGHT (m)	TABLE ANGLE (Degree)	RAW VALUE (dBuV)	CORRECTION FACTOR (dB/m)
1	*5240.00	119.5 PK			2.06 V	159	78.3	41.2
2	*5240.00	109.1 AV			2.06 V	159	67.9	41.2
3	5350.00	60.7 PK	74.0	-13.3	2.06 V	159	48.3	12.4
4	5350.00	48.2 AV	54.0	-5.8	2.06 V	159	35.8	12.4
5	#10480.00	62.6 PK	68.2	-5.6	2.99 V	263	39.8	22.8

Remarks:

1. Emission Level(dBuV/m) = Raw Value(dBuV) + Correction Factor(dB/m)
2. Correction Factor(dB/m) = Antenna Factor(dB/m) + Cable Factor(dB) – Pre-Amplifier Factor(dB)
3. The other emission levels were very low against the limit.
4. Margin value = Emission Level – Limit value
5. " * ": Fundamental frequency.
6. " # ": The radiated frequency is out of the restricted band.

CHANNEL	TX Channel 149	DETECTOR FUNCTION	Peak (PK)
FREQUENCY RANGE	1GHz ~ 40GHz		Average (AV)

ANTENNA POLARITY & TEST DISTANCE: HORIZONTAL AT 3 M								
NO.	FREQ. (MHz)	EMISSION LEVEL (dBuV/m)	LIMIT (dBuV/m)	MARGIN (dB)	ANTENNA HEIGHT (m)	TABLE ANGLE (Degree)	RAW VALUE (dBuV)	CORRECTION FACTOR (dB/m)
1	#5606.40	63.9 PK	68.2	-4.3	1.00 H	301	51.3	12.6
2	*5745.00	114.2 PK			1.00 H	301	71.7	42.5
3	*5745.00	104.5 AV			1.00 H	301	62.0	42.5
4	#5942.40	65.0 PK	68.2	-3.2	1.00 H	301	51.4	13.6
5	11490.00	63.1 PK	74.0	-10.9	2.11 H	202	39.0	24.1
6	11490.00	50.6 AV	54.0	-3.4	2.11 H	202	26.5	24.1

ANTENNA POLARITY & TEST DISTANCE: VERTICAL AT 3 M								
NO.	FREQ. (MHz)	EMISSION LEVEL (dBuV/m)	LIMIT (dBuV/m)	MARGIN (dB)	ANTENNA HEIGHT (m)	TABLE ANGLE (Degree)	RAW VALUE (dBuV)	CORRECTION FACTOR (dB/m)
1	#5646.40	64.2 PK	68.2	-4.0	3.44 V	188	51.6	12.6
2	*5745.00	118.6 PK			3.44 V	188	76.1	42.5
3	*5745.00	108.4 AV			3.44 V	188	65.9	42.5
4	#5987.20	64.3 PK	68.2	-3.9	3.44 V	188	50.5	13.8
5	11490.00	63.5 PK	74.0	-10.5	2.52 V	266	39.4	24.1
6	11490.00	50.8 AV	54.0	-3.2	2.52 V	266	26.7	24.1

Remarks:

1. Emission Level(dBuV/m) = Raw Value(dBuV) + Correction Factor(dB/m)
2. Correction Factor(dB/m) = Antenna Factor(dB/m) + Cable Factor(dB) – Pre-Amplifier Factor(dB)
3. The other emission levels were very low against the limit.
4. Margin value = Emission Level – Limit value
5. " * ": Fundamental frequency.
6. " # ": The radiated frequency is out of the restricted band.

CHANNEL	TX Channel 157	DETECTOR FUNCTION	Peak (PK)
FREQUENCY RANGE	1GHz ~ 40GHz		Average (AV)

ANTENNA POLARITY & TEST DISTANCE: HORIZONTAL AT 3 M

NO.	FREQ. (MHz)	EMISSION LEVEL (dBuV/m)	LIMIT (dBuV/m)	MARGIN (dB)	ANTENNA HEIGHT (m)	TABLE ANGLE (Degree)	RAW VALUE (dBuV)	CORRECTION FACTOR (dB/m)
1	#5618.40	62.7 PK	68.2	-5.5	1.02 H	303	50.0	12.7
2	*5785.00	114.4 PK			1.02 H	303	71.8	42.6
3	*5785.00	103.5 AV			1.02 H	303	60.9	42.6
4	#5983.20	63.3 PK	68.2	-4.9	1.02 H	303	49.5	13.8
5	11570.00	62.5 PK	74.0	-11.5	2.69 H	241	38.5	24.0
6	11570.00	50.0 AV	54.0	-4.0	2.69 H	241	26.0	24.0

ANTENNA POLARITY & TEST DISTANCE: VERTICAL AT 3 M

NO.	FREQ. (MHz)	EMISSION LEVEL (dBuV/m)	LIMIT (dBuV/m)	MARGIN (dB)	ANTENNA HEIGHT (m)	TABLE ANGLE (Degree)	RAW VALUE (dBuV)	CORRECTION FACTOR (dB/m)
1	#5616.80	63.9 PK	68.2	-4.3	3.39 V	180	51.2	12.7
2	*5785.00	118.4 PK			3.39 V	180	75.8	42.6
3	*5785.00	107.5 AV			3.39 V	180	64.9	42.6
4	#5959.20	64.3 PK	68.2	-3.9	3.39 V	180	50.7	13.6
5	11570.00	62.9 PK	74.0	-11.1	2.62 V	326	38.9	24.0
6	11570.00	50.3 AV	54.0	-3.7	2.62 V	326	26.3	24.0

Remarks:

1. Emission Level(dBuV/m) = Raw Value(dBuV) + Correction Factor(dB/m)
2. Correction Factor(dB/m) = Antenna Factor(dB/m) + Cable Factor(dB) – Pre-Amplifier Factor(dB)
3. The other emission levels were very low against the limit.
4. Margin value = Emission Level – Limit value
5. " * ": Fundamental frequency.
6. " # ": The radiated frequency is out of the restricted band.

CHANNEL	TX Channel 165	DETECTOR FUNCTION	Peak (PK)
FREQUENCY RANGE	1GHz ~ 40GHz		Average (AV)

ANTENNA POLARITY & TEST DISTANCE: HORIZONTAL AT 3 M

NO.	FREQ. (MHz)	EMISSION LEVEL (dBuV/m)	LIMIT (dBuV/m)	MARGIN (dB)	ANTENNA HEIGHT (m)	TABLE ANGLE (Degree)	RAW VALUE (dBuV)	CORRECTION FACTOR (dB/m)
1	#5611.20	64.1 PK	68.2	-4.1	1.05 H	305	51.4	12.7
2	*5825.00	114.3 PK			1.05 H	305	71.7	42.6
3	*5825.00	103.4 AV			1.05 H	305	60.8	42.6
4	#5981.60	64.1 PK	68.2	-4.1	1.05 H	305	50.3	13.8
5	11650.00	62.0 PK	74.0	-12.0	1.11 H	115	38.4	23.6
6	11650.00	49.9 AV	54.0	-4.1	1.11 H	115	26.3	23.6

ANTENNA POLARITY & TEST DISTANCE: VERTICAL AT 3 M

NO.	FREQ. (MHz)	EMISSION LEVEL (dBuV/m)	LIMIT (dBuV/m)	MARGIN (dB)	ANTENNA HEIGHT (m)	TABLE ANGLE (Degree)	RAW VALUE (dBuV)	CORRECTION FACTOR (dB/m)
1	#5646.40	64.0 PK	68.2	-4.2	3.38 V	179	51.4	12.6
2	*5825.00	118.3 PK			3.38 V	179	75.7	42.6
3	*5825.00	107.4 AV			3.38 V	179	64.8	42.6
4	#5963.20	64.3 PK	68.2	-3.9	3.38 V	179	50.6	13.7
5	11650.00	62.2 PK	74.0	-11.8	3.16 V	315	38.6	23.6
6	11650.00	50.1 AV	54.0	-3.9	3.16 V	315	26.5	23.6

Remarks:

1. Emission Level(dBuV/m) = Raw Value(dBuV) + Correction Factor(dB/m)
2. Correction Factor(dB/m) = Antenna Factor(dB/m) + Cable Factor(dB) – Pre-Amplifier Factor(dB)
3. The other emission levels were very low against the limit.
4. Margin value = Emission Level – Limit value
5. " * ": Fundamental frequency.
6. " # ": The radiated frequency is out of the restricted band.

802.11ac (VHT20)

CHANNEL	TX Channel 36	DETECTOR FUNCTION	Peak (PK)
FREQUENCY RANGE	1GHz ~ 40GHz		Average (AV)

ANTENNA POLARITY & TEST DISTANCE: HORIZONTAL AT 3 M

NO.	FREQ. (MHz)	EMISSION LEVEL (dBuV/m)	LIMIT (dBuV/m)	MARGIN (dB)	ANTENNA HEIGHT (m)	TABLE ANGLE (Degree)	RAW VALUE (dBuV)	CORRECTION FACTOR (dB/m)
1	5150.00	69.8 PK	74.0	-4.2	2.00 H	300	57.2	12.6
2	5150.00	48.5 AV	54.0	-5.5	2.00 H	300	35.9	12.6
3	*5180.00	111.3 PK			3.00 H	200	69.8	41.5
4	*5180.00	100.5 AV			3.00 H	200	59.0	41.5
5	#10360.00	62.0 PK	68.2	-6.2	1.55 H	26	39.5	22.5

ANTENNA POLARITY & TEST DISTANCE: VERTICAL AT 3 M

NO.	FREQ. (MHz)	EMISSION LEVEL (dBuV/m)	LIMIT (dBuV/m)	MARGIN (dB)	ANTENNA HEIGHT (m)	TABLE ANGLE (Degree)	RAW VALUE (dBuV)	CORRECTION FACTOR (dB/m)
1	5150.00	73.7 PK	74.0	-0.3	2.10 V	161	61.1	12.6
2	5150.00	52.5 AV	54.0	-1.5	2.10 V	161	39.9	12.6
3	*5180.00	115.3 PK			2.10 V	161	73.8	41.5
4	*5180.00	104.5 AV			2.10 V	161	63.0	41.5
5	#10360.00	62.5 PK	68.2	-5.7	1.99 V	151	40.0	22.5

Remarks:

1. Emission Level(dBuV/m) = Raw Value(dBuV) + Correction Factor(dB/m)
2. Correction Factor(dB/m) = Antenna Factor(dB/m) + Cable Factor(dB) – Pre-Amplifier Factor(dB)
3. The other emission levels were very low against the limit.
4. Margin value = Emission Level – Limit value
5. " * ": Fundamental frequency.
6. " # ": The radiated frequency is out of the restricted band.

CHANNEL	TX Channel 40	DETECTOR FUNCTION	Peak (PK)
FREQUENCY RANGE	1GHz ~ 40GHz		Average (AV)

ANTENNA POLARITY & TEST DISTANCE: HORIZONTAL AT 3 M

NO.	FREQ. (MHz)	EMISSION LEVEL (dBuV/m)	LIMIT (dBuV/m)	MARGIN (dB)	ANTENNA HEIGHT (m)	TABLE ANGLE (Degree)	RAW VALUE (dBuV)	CORRECTION FACTOR (dB/m)
1	5150.00	69.6 PK	74.0	-4.4	3.01 H	215	57.0	12.6
2	5150.00	48.8 AV	54.0	-5.2	3.01 H	215	36.2	12.6
3	*5200.00	115.0 PK			3.01 H	215	73.5	41.5
4	*5200.00	104.3 AV			3.01 H	215	62.8	41.5
5	#10400.00	62.3 PK	68.2	-5.9	1.55 H	22	39.4	22.9

ANTENNA POLARITY & TEST DISTANCE: VERTICAL AT 3 M

NO.	FREQ. (MHz)	EMISSION LEVEL (dBuV/m)	LIMIT (dBuV/m)	MARGIN (dB)	ANTENNA HEIGHT (m)	TABLE ANGLE (Degree)	RAW VALUE (dBuV)	CORRECTION FACTOR (dB/m)
1	5150.00	73.6 PK	74.0	-0.4	2.48 V	167	61.0	12.6
2	5150.00	52.8 AV	54.0	-1.2	2.48 V	167	40.2	12.6
3	*5200.00	119.0 PK			2.48 V	167	77.5	41.5
4	*5200.00	108.3 AV			2.48 V	167	66.8	41.5
5	#10400.00	62.6 PK	68.2	-5.6	1.99 V	153	39.7	22.9

Remarks:

1. Emission Level(dBuV/m) = Raw Value(dBuV) + Correction Factor(dB/m)
2. Correction Factor(dB/m) = Antenna Factor(dB/m) + Cable Factor(dB) – Pre-Amplifier Factor(dB)
3. The other emission levels were very low against the limit.
4. Margin value = Emission Level – Limit value
5. " * " : Fundamental frequency.
6. " # " : The radiated frequency is out of the restricted band.

CHANNEL	TX Channel 48	DETECTOR	Peak (PK)
FREQUENCY RANGE	1GHz ~ 40GHz	FUNCTION	Average (AV)

ANTENNA POLARITY & TEST DISTANCE: HORIZONTAL AT 3 M

NO.	FREQ. (MHz)	EMISSION LEVEL (dBuV/m)	LIMIT (dBuV/m)	MARGIN (dB)	ANTENNA HEIGHT (m)	TABLE ANGLE (Degree)	RAW VALUE (dBuV)	CORRECTION FACTOR (dB/m)
1	*5240.00	115.3 PK			3.10 H	215	74.1	41.2
2	*5240.00	104.7 AV			3.10 H	215	63.5	41.2
3	5350.00	60.4 PK	74.0	-13.6	3.10 H	215	48.0	12.4
4	5350.00	47.6 AV	54.0	-6.4	3.10 H	215	35.2	12.4
5	#10480.00	62.4 PK	68.2	-5.8	1.55 H	100	39.6	22.8

ANTENNA POLARITY & TEST DISTANCE: VERTICAL AT 3 M

NO.	FREQ. (MHz)	EMISSION LEVEL (dBuV/m)	LIMIT (dBuV/m)	MARGIN (dB)	ANTENNA HEIGHT (m)	TABLE ANGLE (Degree)	RAW VALUE (dBuV)	CORRECTION FACTOR (dB/m)
1	*5240.00	119.3 PK			3.14 V	168	78.1	41.2
2	*5240.00	108.7 AV			3.14 V	168	67.5	41.2
3	5350.00	60.9 PK	74.0	-13.1	3.14 V	168	48.5	12.4
4	5350.00	48.1 AV	54.0	-5.9	3.14 V	168	35.7	12.4
5	#10480.00	62.8 PK	68.2	-5.4	1.11 V	112	40.0	22.8

Remarks:

1. Emission Level(dBuV/m) = Raw Value(dBuV) + Correction Factor(dB/m)
2. Correction Factor(dB/m) = Antenna Factor(dB/m) + Cable Factor(dB) – Pre-Amplifier Factor(dB)
3. The other emission levels were very low against the limit.
4. Margin value = Emission Level – Limit value
5. " * ": Fundamental frequency.
6. " # ": The radiated frequency is out of the restricted band.

CHANNEL	TX Channel 149	DETECTOR FUNCTION	Peak (PK)
FREQUENCY RANGE	1GHz ~ 40GHz		Average (AV)

ANTENNA POLARITY & TEST DISTANCE: HORIZONTAL AT 3 M								
NO.	FREQ. (MHz)	EMISSION LEVEL (dBuV/m)	LIMIT (dBuV/m)	MARGIN (dB)	ANTENNA HEIGHT (m)	TABLE ANGLE (Degree)	RAW VALUE (dBuV)	CORRECTION FACTOR (dB/m)
1	#5620.80	63.1 PK	68.2	-5.1	1.02 H	303	50.4	12.7
2	*5745.00	113.6 PK			1.02 H	303	71.1	42.5
3	*5745.00	103.8 AV			1.02 H	303	61.3	42.5
4	#5970.40	63.4 PK	68.2	-4.8	1.02 H	303	49.7	13.7
5	11490.00	63.6 PK	74.0	-10.4	3.09 H	336	39.5	24.1
6	11490.00	50.6 AV	54.0	-3.4	3.09 H	336	26.5	24.1

ANTENNA POLARITY & TEST DISTANCE: VERTICAL AT 3 M								
NO.	FREQ. (MHz)	EMISSION LEVEL (dBuV/m)	LIMIT (dBuV/m)	MARGIN (dB)	ANTENNA HEIGHT (m)	TABLE ANGLE (Degree)	RAW VALUE (dBuV)	CORRECTION FACTOR (dB/m)
1	#5604.80	63.3 PK	68.2	-4.9	2.79 V	173	50.7	12.6
2	*5745.00	117.6 PK			2.79 V	173	75.1	42.5
3	*5745.00	107.8 AV			2.79 V	173	65.3	42.5
4	#5995.20	64.3 PK	68.2	-3.9	2.79 V	173	50.5	13.8
5	11490.00	64.0 PK	74.0	-10.0	3.33 V	311	39.9	24.1
6	11490.00	50.9 AV	54.0	-3.1	3.33 V	311	26.8	24.1

Remarks:

1. Emission Level(dBuV/m) = Raw Value(dBuV) + Correction Factor(dB/m)
2. Correction Factor(dB/m) = Antenna Factor(dB/m) + Cable Factor(dB) – Pre-Amplifier Factor(dB)
3. The other emission levels were very low against the limit.
4. Margin value = Emission Level – Limit value
5. " * ": Fundamental frequency.
6. " # ": The radiated frequency is out of the restricted band.

CHANNEL	TX Channel 157	DETECTOR FUNCTION	Peak (PK)
FREQUENCY RANGE	1GHz ~ 40GHz		Average (AV)

ANTENNA POLARITY & TEST DISTANCE: HORIZONTAL AT 3 M

NO.	FREQ. (MHz)	EMISSION LEVEL (dBuV/m)	LIMIT (dBuV/m)	MARGIN (dB)	ANTENNA HEIGHT (m)	TABLE ANGLE (Degree)	RAW VALUE (dBuV)	CORRECTION FACTOR (dB/m)
1	#5607.20	63.1 PK	68.2	-5.1	1.09 H	309	50.4	12.7
2	*5785.00	113.8 PK			1.09 H	309	71.2	42.6
3	*5785.00	103.2 AV			1.09 H	309	60.6	42.6
4	#5929.60	63.3 PK	68.2	-4.9	1.09 H	309	49.7	13.6
5	11570.00	63.5 PK	74.0	-10.5	2.22 H	215	39.5	24.0
6	11570.00	50.5 AV	54.0	-3.5	2.22 H	215	26.5	24.0

ANTENNA POLARITY & TEST DISTANCE: VERTICAL AT 3 M

NO.	FREQ. (MHz)	EMISSION LEVEL (dBuV/m)	LIMIT (dBuV/m)	MARGIN (dB)	ANTENNA HEIGHT (m)	TABLE ANGLE (Degree)	RAW VALUE (dBuV)	CORRECTION FACTOR (dB/m)
1	#5607.20	62.9 PK	68.2	-5.3	2.77 V	175	50.2	12.7
2	*5785.00	117.8 PK			2.77 V	175	75.2	42.6
3	*5785.00	107.2 AV			2.77 V	175	64.6	42.6
4	#5979.20	63.4 PK	68.2	-4.8	2.77 V	175	49.6	13.8
5	11570.00	64.0 PK	74.0	-10.0	3.32 V	215	40.0	24.0
6	11570.00	50.8 AV	54.0	-3.2	3.32 V	215	26.8	24.0

Remarks:

1. Emission Level(dBuV/m) = Raw Value(dBuV) + Correction Factor(dB/m)
2. Correction Factor(dB/m) = Antenna Factor(dB/m) + Cable Factor(dB) – Pre-Amplifier Factor(dB)
3. The other emission levels were very low against the limit.
4. Margin value = Emission Level – Limit value
5. " * ": Fundamental frequency.
6. " # ": The radiated frequency is out of the restricted band.

CHANNEL	TX Channel 165	DETECTOR FUNCTION	Peak (PK)
FREQUENCY RANGE	1GHz ~ 40GHz		Average (AV)

ANTENNA POLARITY & TEST DISTANCE: HORIZONTAL AT 3 M

NO.	FREQ. (MHz)	EMISSION LEVEL (dBuV/m)	LIMIT (dBuV/m)	MARGIN (dB)	ANTENNA HEIGHT (m)	TABLE ANGLE (Degree)	RAW VALUE (dBuV)	CORRECTION FACTOR (dB/m)
1	#5609.60	62.7 PK	68.2	-5.5	1.09 H	300	50.0	12.7
2	*5825.00	115.5 PK			1.09 H	300	72.9	42.6
3	*5825.00	103.9 AV			1.09 H	300	61.3	42.6
4	#5950.40	63.4 PK	68.2	-4.8	1.09 H	300	49.8	13.6
5	11650.00	62.6 PK	74.0	-11.4	2.88 H	244	39.0	23.6
6	11650.00	50.1 AV	54.0	-3.9	2.88 H	244	26.5	23.6

ANTENNA POLARITY & TEST DISTANCE: VERTICAL AT 3 M

NO.	FREQ. (MHz)	EMISSION LEVEL (dBuV/m)	LIMIT (dBuV/m)	MARGIN (dB)	ANTENNA HEIGHT (m)	TABLE ANGLE (Degree)	RAW VALUE (dBuV)	CORRECTION FACTOR (dB/m)
1	#5641.60	63.9 PK	68.2	-4.3	2.98 V	179	51.2	12.7
2	*5825.00	119.5 PK			2.98 V	179	76.9	42.6
3	*5825.00	107.9 AV			2.98 V	179	65.3	42.6
4	#5997.60	64.5 PK	68.2	-3.7	2.98 V	179	50.7	13.8
5	11650.00	63.4 PK	74.0	-10.6	3.32 V	263	39.8	23.6
6	11650.00	50.5 AV	54.0	-3.5	3.32 V	263	26.9	23.6

Remarks:

1. Emission Level(dBuV/m) = Raw Value(dBuV) + Correction Factor(dB/m)
2. Correction Factor(dB/m) = Antenna Factor(dB/m) + Cable Factor(dB) – Pre-Amplifier Factor(dB)
3. The other emission levels were very low against the limit.
4. Margin value = Emission Level – Limit value
5. " * ": Fundamental frequency.
6. " # ": The radiated frequency is out of the restricted band.

802.11ac (VHT40)

CHANNEL	TX Channel 38	DETECTOR	Peak (PK)
FREQUENCY RANGE	1GHz ~ 40GHz	FUNCTION	Average (AV)

ANTENNA POLARITY & TEST DISTANCE: HORIZONTAL AT 3 M

NO.	FREQ. (MHz)	EMISSION LEVEL (dBuV/m)	LIMIT (dBuV/m)	MARGIN (dB)	ANTENNA HEIGHT (m)	TABLE ANGLE (Degree)	RAW VALUE (dBuV)	CORRECTION FACTOR (dB/m)
1	5150.00	70.8 PK	74.0	-3.2	3.10 H	210	58.2	12.6
2	5150.00	49.2 AV	54.0	-4.8	3.10 H	210	36.6	12.6
3	*5190.00	106.3 PK			3.10 H	210	64.8	41.5
4	*5190.00	96.3 AV			3.10 H	210	54.8	41.5
5	#10380.00	62.5 PK	68.2	-5.7	3.20 H	310	39.8	22.7

ANTENNA POLARITY & TEST DISTANCE: VERTICAL AT 3 M

NO.	FREQ. (MHz)	EMISSION LEVEL (dBuV/m)	LIMIT (dBuV/m)	MARGIN (dB)	ANTENNA HEIGHT (m)	TABLE ANGLE (Degree)	RAW VALUE (dBuV)	CORRECTION FACTOR (dB/m)
1	5150.00	73.8 PK	74.0	-0.2	3.50 V	168	61.2	12.6
2	5150.00	52.4 AV	54.0	-1.6	3.50 V	168	39.8	12.6
3	*5190.00	110.3 PK			3.50 V	168	68.8	41.5
4	*5190.00	100.3 AV			3.50 V	168	58.8	41.5
5	#10380.00	62.8 PK	68.2	-5.4	3.11 V	299	40.1	22.7

Remarks:

1. Emission Level(dBuV/m) = Raw Value(dBuV) + Correction Factor(dB/m)
2. Correction Factor(dB/m) = Antenna Factor(dB/m) + Cable Factor(dB) – Pre-Amplifier Factor(dB)
3. The other emission levels were very low against the limit.
4. Margin value = Emission Level – Limit value
5. " * ": Fundamental frequency.
6. " # ": The radiated frequency is out of the restricted band.

CHANNEL	TX Channel 46	DETECTOR FUNCTION	Peak (PK)
FREQUENCY RANGE	1GHz ~ 40GHz		Average (AV)

ANTENNA POLARITY & TEST DISTANCE: HORIZONTAL AT 3 M								
NO.	FREQ. (MHz)	EMISSION LEVEL (dBuV/m)	LIMIT (dBuV/m)	MARGIN (dB)	ANTENNA HEIGHT (m)	TABLE ANGLE (Degree)	RAW VALUE (dBuV)	CORRECTION FACTOR (dB/m)
1	5150.00	67.1 PK	74.0	-6.9	3.00 H	200	54.5	12.6
2	5150.00	49.4 AV	54.0	-4.6	3.00 H	200	36.8	12.6
3	*5230.00	110.7 PK			3.00 H	200	69.4	41.3
4	*5230.00	100.0 AV			3.00 H	200	58.7	41.3
5	5350.00	62.1 PK	74.0	-11.9	3.00 H	200	49.7	12.4
6	5350.00	47.6 AV	54.0	-6.4	3.00 H	200	35.2	12.4
7	#10460.00	61.4 PK	68.2	-6.8	1.09 H	222	38.5	22.9

ANTENNA POLARITY & TEST DISTANCE: VERTICAL AT 3 M								
NO.	FREQ. (MHz)	EMISSION LEVEL (dBuV/m)	LIMIT (dBuV/m)	MARGIN (dB)	ANTENNA HEIGHT (m)	TABLE ANGLE (Degree)	RAW VALUE (dBuV)	CORRECTION FACTOR (dB/m)
1	5150.00	71.1 PK	74.0	-2.9	3.50 V	168	58.5	12.6
2	5150.00	53.4 AV	54.0	-0.6	3.50 V	168	40.8	12.6
3	*5230.00	114.7 PK			3.50 V	168	73.4	41.3
4	*5230.00	104.0 AV			3.50 V	168	62.7	41.3
5	5350.00	65.5 PK	74.0	-8.5	3.50 V	168	53.1	12.4
6	5350.00	48.8 AV	54.0	-5.2	3.50 V	168	36.4	12.4
7	#10460.00	61.5 PK	68.2	-6.7	2.05 V	216	38.6	22.9

Remarks:

1. Emission Level(dBuV/m) = Raw Value(dBuV) + Correction Factor(dB/m)
2. Correction Factor(dB/m) = Antenna Factor(dB/m) + Cable Factor(dB) – Pre-Amplifier Factor(dB)
3. The other emission levels were very low against the limit.
4. Margin value = Emission Level – Limit value
5. " * ": Fundamental frequency.
6. " # ": The radiated frequency is out of the restricted band.

CHANNEL	TX Channel 151	DETECTOR FUNCTION	Peak (PK)
FREQUENCY RANGE	1GHz ~ 40GHz		Average (AV)

ANTENNA POLARITY & TEST DISTANCE: HORIZONTAL AT 3 M								
NO.	FREQ. (MHz)	EMISSION LEVEL (dBuV/m)	LIMIT (dBuV/m)	MARGIN (dB)	ANTENNA HEIGHT (m)	TABLE ANGLE (Degree)	RAW VALUE (dBuV)	CORRECTION FACTOR (dB/m)
1	#5648.00	61.0 PK	68.2	-7.2	1.05 H	300	50.4	10.6
2	*5755.00	112.7 PK			1.05 H	300	70.2	42.5
3	*5755.00	103.9 AV			1.05 H	300	61.4	42.5
4	#5967.20	61.2 PK	68.2	-7.0	1.05 H	300	49.5	11.7
5	11510.00	63.0 PK	74.0	-11.0	1.59 H	166	39.1	23.9
6	11510.00	50.2 AV	54.0	-3.8	1.59 H	166	26.3	23.9

ANTENNA POLARITY & TEST DISTANCE: VERTICAL AT 3 M								
NO.	FREQ. (MHz)	EMISSION LEVEL (dBuV/m)	LIMIT (dBuV/m)	MARGIN (dB)	ANTENNA HEIGHT (m)	TABLE ANGLE (Degree)	RAW VALUE (dBuV)	CORRECTION FACTOR (dB/m)
1	#5644.80	65.0 PK	68.2	-3.2	1.00 V	298	54.4	10.6
2	*5755.00	116.7 PK			1.00 V	298	74.2	42.5
3	*5755.00	107.9 AV			1.00 V	298	65.4	42.5
4	#5939.20	61.9 PK	68.2	-6.3	1.00 V	298	50.3	11.6
5	11510.00	63.4 PK	74.0	-10.6	3.11 V	322	39.5	23.9
6	11510.00	50.7 AV	54.0	-3.3	3.11 V	322	26.8	23.9

Remarks:

1. Emission Level(dBuV/m) = Raw Value(dBuV) + Correction Factor(dB/m)
2. Correction Factor(dB/m) = Antenna Factor(dB/m) + Cable Factor(dB) – Pre-Amplifier Factor(dB)
3. The other emission levels were very low against the limit.
4. Margin value = Emission Level – Limit value
5. " * ": Fundamental frequency.
6. " # ": The radiated frequency is out of the restricted band.

CHANNEL	TX Channel 159	DETECTOR FUNCTION	Peak (PK)
FREQUENCY RANGE	1GHz ~ 40GHz		Average (AV)

ANTENNA POLARITY & TEST DISTANCE: HORIZONTAL AT 3 M

NO.	FREQ. (MHz)	EMISSION LEVEL (dBuV/m)	LIMIT (dBuV/m)	MARGIN (dB)	ANTENNA HEIGHT (m)	TABLE ANGLE (Degree)	RAW VALUE (dBuV)	CORRECTION FACTOR (dB/m)
1	#5633.60	61.3 PK	68.2	-6.9	1.05 H	302	50.7	10.6
2	*5795.00	114.0 PK			1.05 H	302	71.4	42.6
3	*5795.00	103.0 AV			1.05 H	302	60.4	42.6
4	#5928.80	61.5 PK	68.2	-6.7	1.05 H	302	49.9	11.6
5	11590.00	63.4 PK	74.0	-10.6	2.08 H	209	39.2	24.2
6	11590.00	50.5 AV	54.0	-3.5	2.08 H	209	26.3	24.2

ANTENNA POLARITY & TEST DISTANCE: VERTICAL AT 3 M

NO.	FREQ. (MHz)	EMISSION LEVEL (dBuV/m)	LIMIT (dBuV/m)	MARGIN (dB)	ANTENNA HEIGHT (m)	TABLE ANGLE (Degree)	RAW VALUE (dBuV)	CORRECTION FACTOR (dB/m)
1	#5662.40	61.5 PK	77.4	-15.9	1.00 V	296	50.9	10.6
2	*5795.00	118.0 PK			1.00 V	296	75.4	42.6
3	*5795.00	107.0 AV			1.00 V	296	64.4	42.6
4	#5925.60	62.6 PK	68.2	-5.6	1.00 V	296	51.0	11.6
5	11590.00	63.8 PK	74.0	-10.2	3.16 V	318	39.6	24.2
6	11590.00	51.0 AV	54.0	-3.0	3.16 V	318	26.8	24.2

Remarks:

1. Emission Level(dBuV/m) = Raw Value(dBuV) + Correction Factor(dB/m)
2. Correction Factor(dB/m) = Antenna Factor(dB/m) + Cable Factor(dB) – Pre-Amplifier Factor(dB)
3. The other emission levels were very low against the limit.
4. Margin value = Emission Level – Limit value
5. " * ": Fundamental frequency.
6. " # ": The radiated frequency is out of the restricted band.

802.11ac (VHT80)

CHANNEL	TX Channel 42	DETECTOR FUNCTION	Peak (PK)
FREQUENCY RANGE	1GHz ~ 40GHz		Average (AV)

ANTENNA POLARITY & TEST DISTANCE: HORIZONTAL AT 3 M

NO.	FREQ. (MHz)	EMISSION LEVEL (dBuV/m)	LIMIT (dBuV/m)	MARGIN (dB)	ANTENNA HEIGHT (m)	TABLE ANGLE (Degree)	RAW VALUE (dBuV)	CORRECTION FACTOR (dB/m)
1	5150.00	69.9 PK	74.0	-4.1	3.15 H	210	57.3	12.6
2	5150.00	47.8 AV	54.0	-6.2	3.15 H	210	35.2	12.6
3	*5210.00	102.2 PK			3.15 H	210	60.8	41.4
4	*5210.00	92.5 AV			3.15 H	210	51.1	41.4
5	5350.00	60.9 PK	74.0	-13.1	3.15 H	210	48.5	12.4
6	5350.00	47.6 AV	54.0	-6.4	3.15 H	210	35.2	12.4
7	#10420.00	62.0 PK	68.2	-6.2	1.05 H	155	39.2	22.8

ANTENNA POLARITY & TEST DISTANCE: VERTICAL AT 3 M

NO.	FREQ. (MHz)	EMISSION LEVEL (dBuV/m)	LIMIT (dBuV/m)	MARGIN (dB)	ANTENNA HEIGHT (m)	TABLE ANGLE (Degree)	RAW VALUE (dBuV)	CORRECTION FACTOR (dB/m)
1	5150.00	73.9 PK	74.0	-0.1	3.57 V	172	61.3	12.6
2	5150.00	51.5 AV	54.0	-2.5	3.57 V	172	38.9	12.6
3	*5210.00	106.2 PK			3.57 V	172	64.8	41.4
4	*5210.00	96.5 AV			3.57 V	172	55.1	41.4
5	5350.00	61.0 PK	74.0	-13.0	3.57 V	172	48.6	12.4
6	5350.00	48.2 AV	54.0	-5.8	3.57 V	172	35.8	12.4
7	#10420.00	62.4 PK	68.2	-5.8	2.63 V	326	39.6	22.8

Remarks:

1. Emission Level(dBuV/m) = Raw Value(dBuV) + Correction Factor(dB/m)
2. Correction Factor(dB/m) = Antenna Factor(dB/m) + Cable Factor(dB) – Pre-Amplifier Factor(dB)
3. The other emission levels were very low against the limit.
4. Margin value = Emission Level – Limit value
5. " * ": Fundamental frequency.
6. " # ": The radiated frequency is out of the restricted band.

CHANNEL	TX Channel 155	DETECTOR FUNCTION	Peak (PK)
FREQUENCY RANGE	1GHz ~ 40GHz		Average (AV)

ANTENNA POLARITY & TEST DISTANCE: HORIZONTAL AT 3 M

NO.	FREQ. (MHz)	EMISSION LEVEL (dBuV/m)	LIMIT (dBuV/m)	MARGIN (dB)	ANTENNA HEIGHT (m)	TABLE ANGLE (Degree)	RAW VALUE (dBuV)	CORRECTION FACTOR (dB/m)
1	#5632.00	62.7 PK	68.2	-5.5	1.00 H	300	52.1	10.6
2	*5775.00	107.6 PK			1.00 H	300	65.0	42.6
3	*5775.00	97.8 AV			1.00 H	300	55.2	42.6
4	#5971.20	62.2 PK	68.2	-6.0	1.00 H	300	50.5	11.7
5	11550.00	62.6 PK	74.0	-11.4	2.05 H	299	38.5	24.1
6	11550.00	50.6 AV	54.0	-3.4	2.05 H	299	26.5	24.1

ANTENNA POLARITY & TEST DISTANCE: VERTICAL AT 3 M

NO.	FREQ. (MHz)	EMISSION LEVEL (dBuV/m)	LIMIT (dBuV/m)	MARGIN (dB)	ANTENNA HEIGHT (m)	TABLE ANGLE (Degree)	RAW VALUE (dBuV)	CORRECTION FACTOR (dB/m)
1	#5640.80	67.8 PK	68.2	-0.4	1.00 V	296	57.2	10.6
2	*5775.00	111.6 PK			1.00 V	296	69.0	42.6
3	*5775.00	101.8 AV			1.00 V	296	59.2	42.6
4	#5937.60	66.5 PK	68.2	-1.7	1.00 V	296	54.9	11.6
5	11550.00	63.1 PK	74.0	-10.9	3.22 V	360	39.0	24.1
6	11550.00	51.0 AV	54.0	-3.0	3.22 V	360	26.9	24.1

Remarks:

1. Emission Level(dBuV/m) = Raw Value(dBuV) + Correction Factor(dB/m)
2. Correction Factor(dB/m) = Antenna Factor(dB/m) + Cable Factor(dB) – Pre-Amplifier Factor(dB)
3. The other emission levels were very low against the limit.
4. Margin value = Emission Level – Limit value
5. " * ": Fundamental frequency.
6. " # ": The radiated frequency is out of the restricted band.

Below 1GHz Worst-Case

802.11ac (VHT40)

CHANNEL	TX Channel 151	DETECTOR FUNCTION	Quasi-Peak (QP)
FREQUENCY RANGE	9kHz ~ 1GHz		
TEST MODE	A		

ANTENNA POLARITY & TEST DISTANCE: HORIZONTAL AT 3 M

NO.	FREQ. (MHz)	EMISSION LEVEL (dBuV/m)	LIMIT (dBuV/m)	MARGIN (dB)	ANTENNA HEIGHT (m)	TABLE ANGLE (Degree)	RAW VALUE (dBuV)	CORRECTION FACTOR (dB/m)
1	33.78	29.5 QP	40.0	-10.5	2.00 H	231	40.1	-10.6
2	156.03	27.1 QP	43.5	-16.4	1.50 H	146	35.8	-8.7
3	423.80	34.5 QP	46.0	-11.5	1.50 H	231	40.7	-6.2
4	633.36	36.4 QP	46.0	-9.6	1.50 H	252	38.2	-1.8
5	689.64	32.5 QP	46.0	-13.5	1.00 H	188	33.3	-0.8
6	932.19	37.4 QP	46.0	-8.6	1.50 H	244	33.4	4.0

Remarks:

1. Emission Level(dBuV/m) = Raw Value(dBuV) + Correction Factor(dB/m)
2. Correction Factor(dB/m) = Antenna Factor(dB/m) + Cable Factor(dB) – Pre-Amplifier Factor(dB)
3. Margin value = Emission Level – Limit value
4. The emission levels were very low against the limit of frequency range 9kHz~30MHz: the amplitude of spurious emissions attenuated more than 20dB below the permissible value to be report.

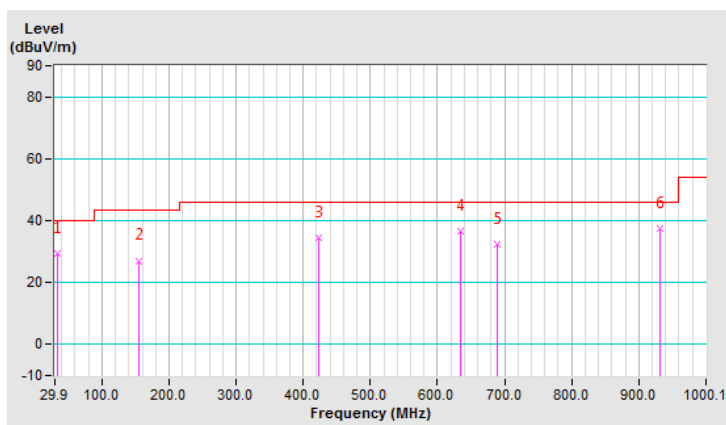

CHANNEL	TX Channel 151	DETECTOR FUNCTION	Quasi-Peak (QP)
FREQUENCY RANGE	9kHz ~ 1GHz		
TEST MODE	A		

ANTENNA POLARITY & TEST DISTANCE: VERTICAL AT 3 M

NO.	FREQ. (MHz)	EMISSION LEVEL (dBuV/m)	LIMIT (dBuV/m)	MARGIN (dB)	ANTENNA HEIGHT (m)	TABLE ANGLE (Degree)	RAW VALUE (dBuV)	CORRECTION FACTOR (dB/m)
1	31.84	34.0 QP	40.0	-6.0	1.50 V	27	45.0	-11.0
2	60.95	30.3 QP	40.0	-9.7	1.01 V	173	40.4	-10.1
3	91.99	29.6 QP	43.5	-13.9	1.50 V	23	43.7	-14.1
4	148.26	27.9 QP	43.5	-15.6	1.01 V	78	36.8	-8.9
5	858.45	30.9 QP	46.0	-15.1	1.50 V	10	28.3	2.6
6	932.19	35.7 QP	46.0	-10.3	1.50 V	287	31.7	4.0

Remarks:

1. Emission Level(dBuV/m) = Raw Value(dBuV) + Correction Factor(dB/m)
2. Correction Factor(dB/m) = Antenna Factor(dB/m) + Cable Factor(dB) – Pre-Amplifier Factor(dB)
3. Margin value = Emission Level – Limit value
4. The emission levels were very low against the limit of frequency range 9kHz~30MHz: the amplitude of spurious emissions attenuated more than 20dB below the permissible value to be report.

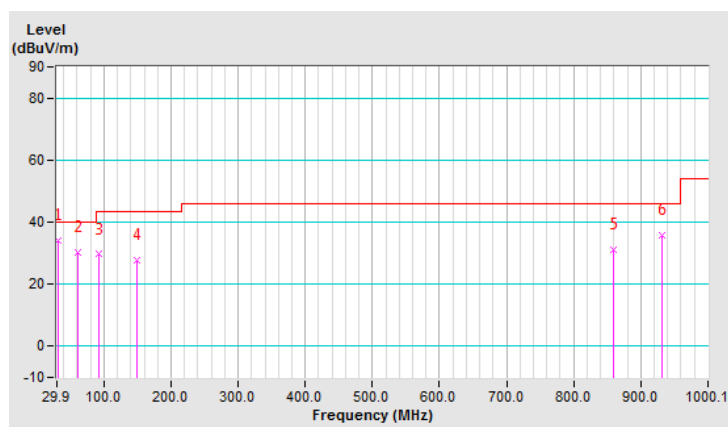

CHANNEL	TX Channel 151	DETECTOR FUNCTION	Quasi-Peak (QP)
FREQUENCY RANGE	9kHz ~ 1GHz		
TEST MODE	B		

ANTENNA POLARITY & TEST DISTANCE: HORIZONTAL AT 3 M

NO.	FREQ. (MHz)	EMISSION LEVEL (dBuV/m)	LIMIT (dBuV/m)	MARGIN (dB)	ANTENNA HEIGHT (m)	TABLE ANGLE (Degree)	RAW VALUE (dBuV)	CORRECTION FACTOR (dB/m)
1	51.24	23.9 QP	40.0	-16.1	1.49 H	129	32.9	-9.0
2	105.58	26.2 QP	43.5	-17.3	1.49 H	129	38.7	-12.5
3	192.89	31.2 QP	43.5	-12.3	1.00 H	300	42.4	-11.2
4	412.16	29.2 QP	46.0	-16.8	1.00 H	27	35.7	-6.5
5	740.09	38.1 QP	46.0	-7.9	1.00 H	9	37.4	0.7
6	932.19	34.8 QP	46.0	-11.2	1.49 H	302	30.8	4.0

Remarks:

- Emission Level(dBuV/m) = Raw Value(dBuV) + Correction Factor(dB/m)
- Correction Factor(dB/m) = Antenna Factor(dB/m) + Cable Factor(dB) – Pre-Amplifier Factor(dB)
- Margin value = Emission Level – Limit value
- The emission levels were very low against the limit of frequency range 9kHz~30MHz: the amplitude of spurious emissions attenuated more than 20dB below the permissible value to be report.

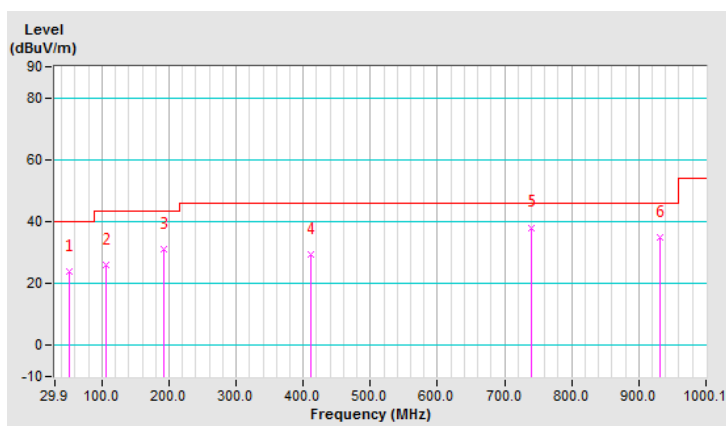

CHANNEL	TX Channel 151	DETECTOR FUNCTION	Quasi-Peak (QP)
FREQUENCY RANGE	9kHz ~ 1GHz		
TEST MODE	B		

ANTENNA POLARITY & TEST DISTANCE: VERTICAL AT 3 M

NO.	FREQ. (MHz)	EMISSION LEVEL (dBuV/m)	LIMIT (dBuV/m)	MARGIN (dB)	ANTENNA HEIGHT (m)	TABLE ANGLE (Degree)	RAW VALUE (dBuV)	CORRECTION FACTOR (dB/m)
1	49.30	37.9 QP	40.0	-2.1	1.01 V	330	46.8	-8.9
2	103.64	28.1 QP	43.5	-15.4	1.01 V	255	40.8	-12.7
3	159.91	23.6 QP	43.5	-19.9	1.01 V	84	32.5	-8.9
4	730.38	39.5 QP	46.0	-6.5	1.50 V	9	39.1	0.4
5	862.33	30.8 QP	46.0	-15.2	1.50 V	271	28.1	2.7
6	932.19	34.4 QP	46.0	-11.6	1.50 V	157	30.4	4.0

Remarks:

1. Emission Level(dBuV/m) = Raw Value(dBuV) + Correction Factor(dB/m)
2. Correction Factor(dB/m) = Antenna Factor(dB/m) + Cable Factor(dB) – Pre-Amplifier Factor(dB)
3. Margin value = Emission Level – Limit value
4. The emission levels were very low against the limit of frequency range 9kHz~30MHz: the amplitude of spurious emissions attenuated more than 20dB below the permissible value to be report.

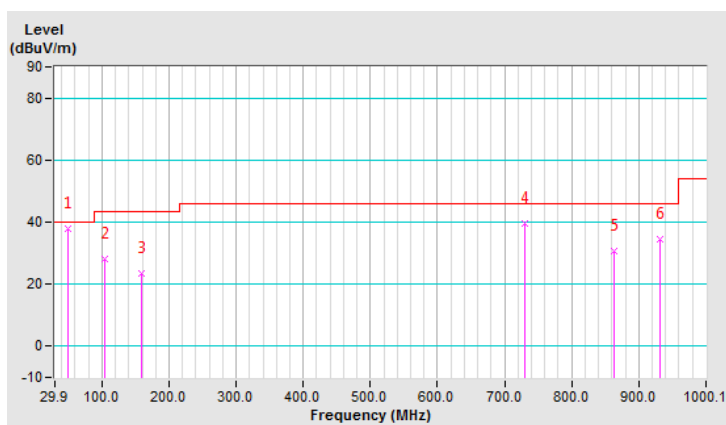

4.2 Conducted Emission Measurement

4.2.1 Limits of Conducted Emission Measurement

Frequency (MHz)	Conducted Limit (dBuV)	
	Quasi-peak	Average
0.15 - 0.5	66 - 56	56 - 46
0.50 - 5.0	56	46
5.0 - 30.0	60	50

Note: 1. The lower limit shall apply at the transition frequencies.

2. The limit decreases in line with the logarithm of the frequency in the range of 0.15 to 0.50MHz.

4.2.2 Test Instruments

Description & Manufacturer	Model No.	Serial No.	Cal. Date	Cal. Due
Test Receiver ROHDE & SCHWARZ	ESCI	100613	Dec. 10, 2018	Dec. 09, 2019
RF signal cable Woken	5D-FB	Cable-cond1-01	Sep. 05, 2018	Sep. 04, 2019
LISN ROHDE & SCHWARZ (EUT)	ENV216	101826	Feb. 21, 2019	Feb. 20, 2020
LISN ROHDE & SCHWARZ (Peripheral)	ESH3-Z5	100311	Aug. 19, 2018	Aug. 18, 2019
Software ADT	BV ADT_Cond_ V7.3.7.4	NA	NA	NA

Note: 1. The calibration interval of the above test instruments is 12 months and the calibrations are traceable to NML/ROC and NIST/USA.

2. The test was performed in HwaYa Shielded Room 1.

3. The VCCI Site Registration No. is C-12040.

4.2.3 Test Procedures

- The EUT was placed 0.4 meters from the conducting wall of the shielded room with EUT being connected to the power mains through a line impedance stabilization network (LISN). Other support units were connected to the power mains through another LISN. The two LISNs provide 50 ohm/ 50uH of coupling impedance for the measuring instrument.
- Both lines of the power mains connected to the EUT were checked for maximum conducted interference.
- The frequency range from 150kHz to 30MHz was searched. Emission levels under (Limit - 20dB) was not recorded.

NOTE: The resolution bandwidth and video bandwidth of test receiver is 9kHz for quasi-peak detection (QP) and average detection (AV) at frequency 0.15MHz-30MHz.

4.2.4 Deviation from Test Standard

No deviation.

4.2.5 Test Setup

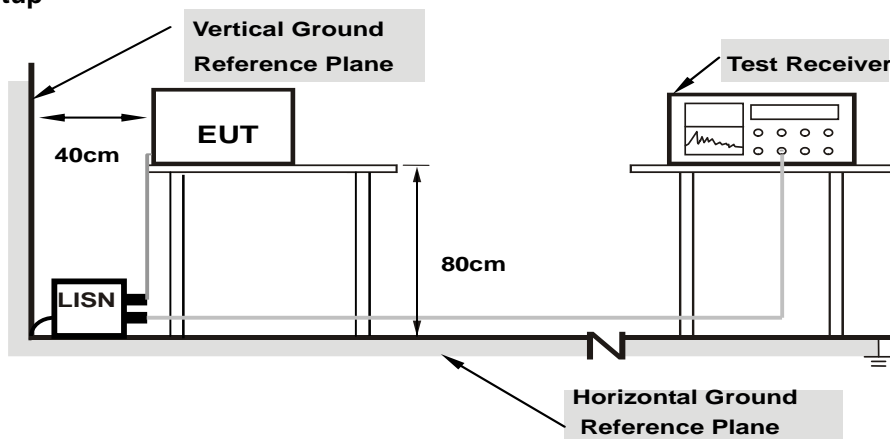

Note: 1.Support units were connected to second LISN.

For the actual test configuration, please refer to the attached file (Test Setup Photo).

4.2.6 EUT Operating Conditions

Same as 4.1.6.

4.2.7 Test Results

Worst-case data:

802.11ac (VHT40)

Phase	Line (L)	Detector Function	Quasi-Peak (QP) / Average (AV)
Channel	TX Channel 151	Test Mode	A

No	Freq. [MHz]	Corr. Factor (dB)	Reading Value [dB (uV)]		Emission Level [dB (uV)]		Limit [dB (uV)]		Margin (dB)	
			Q.P.	AV.	Q.P.	AV.	Q.P.	AV.	Q.P.	AV.
			1	0.15782	9.84	41.97	22.93	51.81	32.77	65.58
2	0.21256	9.85	32.27	17.61	42.12	27.46	63.10	53.10	-20.98	-25.64
3	0.36896	9.88	28.72	21.02	38.60	30.90	58.52	48.52	-19.92	-17.62
4	5.88597	10.06	16.63	9.65	26.69	19.71	60.00	50.00	-33.31	-30.29
5	11.10582	10.17	17.39	9.91	27.56	20.08	60.00	50.00	-32.44	-29.92
6	20.74788	10.25	19.48	10.45	29.73	20.70	60.00	50.00	-30.27	-29.30

REMARKS:

1. Q.P. and AV. are abbreviations of quasi-peak and average individually.
2. The emission levels of other frequencies were very low against the limit.
3. Margin value = Emission level - Limit value
4. Correction factor = Insertion loss + Cable loss
5. Emission Level = Correction Factor + Reading Value.

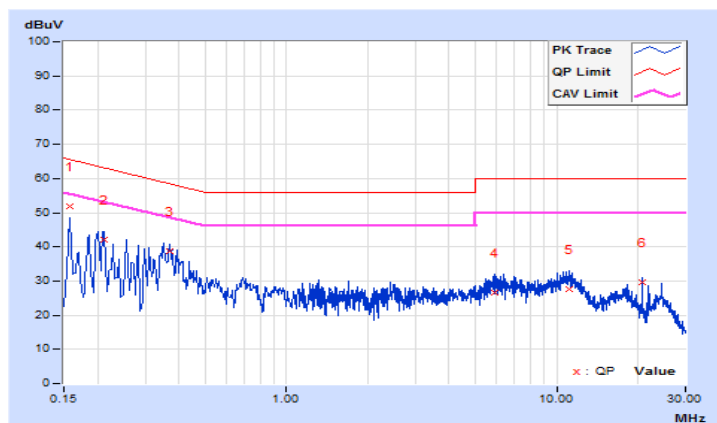

Phase	Neutral (N)	Detector Function	Quasi-Peak (QP) / Average (AV)
Channel	TX Channel 151	Test Mode	A

No	Freq. [MHz]	Corr. Factor (dB)	Reading Value [dB (uV)]		Emission Level [dB (uV)]		Limit [dB (uV)]		Margin (dB)	
			Q.P.	AV.	Q.P.	AV.	Q.P.	AV.	Q.P.	AV.
			1	0.16955	9.83	40.32	25.93	50.15	35.76	64.98
2	0.37678	9.87	29.35	23.03	39.22	32.90	58.35	48.35	-19.13	-15.45
3	2.44126	9.95	21.91	18.16	31.86	28.11	56.00	46.00	-24.14	-17.89
4	10.80084	10.17	23.79	15.58	33.96	25.75	60.00	50.00	-26.04	-24.25
5	20.73224	10.31	18.93	8.70	29.24	19.01	60.00	50.00	-30.76	-30.99
6	24.40373	10.33	20.56	14.28	30.89	24.61	60.00	50.00	-29.11	-25.39

REMARKS:

1. Q.P. and AV. are abbreviations of quasi-peak and average individually.
2. The emission levels of other frequencies were very low against the limit.
3. Margin value = Emission level - Limit value
4. Correction factor = Insertion loss + Cable loss
5. Emission Level = Correction Factor + Reading Value.

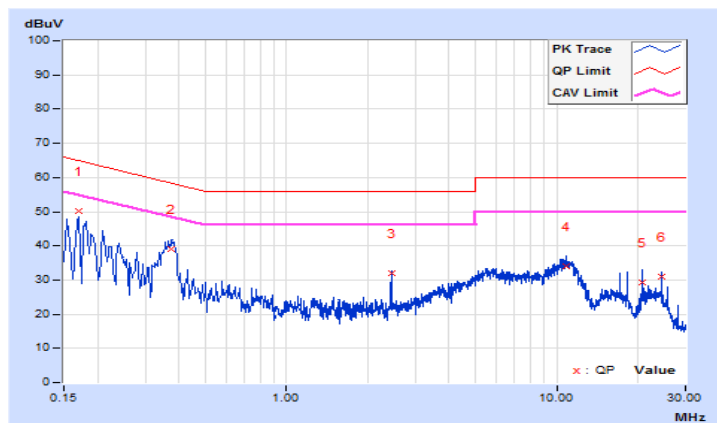

Phase	Line (L)	Detector Function	Quasi-Peak (QP) / Average (AV)
Channel	TX Channel 151	Test Mode	B

No	Freq. [MHz]	Corr. Factor (dB)	Reading Value [dB (uV)]		Emission Level [dB (uV)]		Limit [dB (uV)]		Margin (dB)	
			Q.P.	AV.	Q.P.	AV.	Q.P.	AV.	Q.P.	AV.
			1	0.15000	9.84	26.37	15.53	36.21	25.37	66.00
2	0.36896	9.88	31.44	27.10	41.32	36.98	58.52	48.52	-17.20	-11.54
3	0.39635	9.88	33.65	30.62	43.53	40.50	57.93	47.93	-14.40	-7.43
4	18.31586	10.24	16.53	8.67	26.77	18.91	60.00	50.00	-33.23	-31.09
5	20.77134	10.25	19.25	10.10	29.50	20.35	60.00	50.00	-30.50	-29.65
6	23.21118	10.26	13.98	7.43	24.24	17.69	60.00	50.00	-35.76	-32.31

REMARKS:

1. Q.P. and AV. are abbreviations of quasi-peak and average individually.
2. The emission levels of other frequencies were very low against the limit.
3. Margin value = Emission level - Limit value
4. Correction factor = Insertion loss + Cable loss
5. Emission Level = Correction Factor + Reading Value.

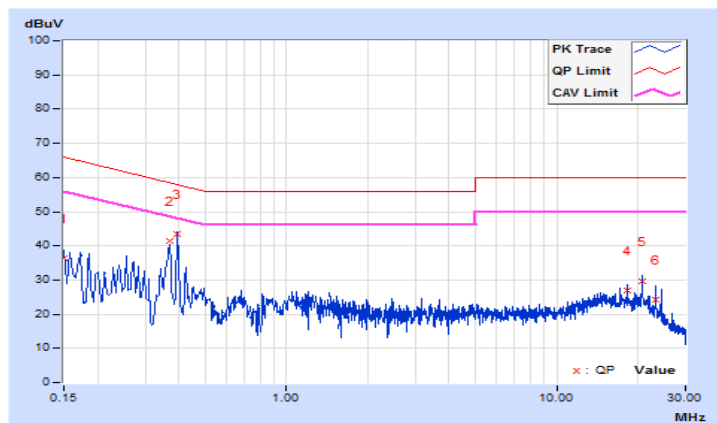

Phase	Neutral (N)	Detector Function	Quasi-Peak (QP) / Average (AV)
Channel	TX Channel 151	Test Mode	B

No	Freq. [MHz]	Corr. Factor (dB)	Reading Value [dB (uV)]		Emission Level [dB (uV)]		Limit [dB (uV)]		Margin (dB)	
			Q.P.	AV.	Q.P.	AV.	Q.P.	AV.	Q.P.	AV.
			1	0.15000	9.82	25.57	17.68	35.39	27.50	66.00
2	0.36719	9.87	29.62	27.94	39.49	37.81	58.56	48.56	-19.07	-10.75
3	0.39635	9.87	32.40	31.56	42.27	41.43	57.93	47.93	-15.66	-6.50
4	2.44126	9.95	20.90	17.08	30.85	27.03	56.00	46.00	-25.15	-18.97
5	14.66001	10.23	15.35	7.34	25.58	17.57	60.00	50.00	-34.42	-32.43
6	20.78698	10.31	17.06	10.82	27.37	21.13	60.00	50.00	-32.63	-28.87

REMARKS:

1. Q.P. and AV. are abbreviations of quasi-peak and average individually.
2. The emission levels of other frequencies were very low against the limit.
3. Margin value = Emission level - Limit value
4. Correction factor = Insertion loss + Cable loss
5. Emission Level = Correction Factor + Reading Value.

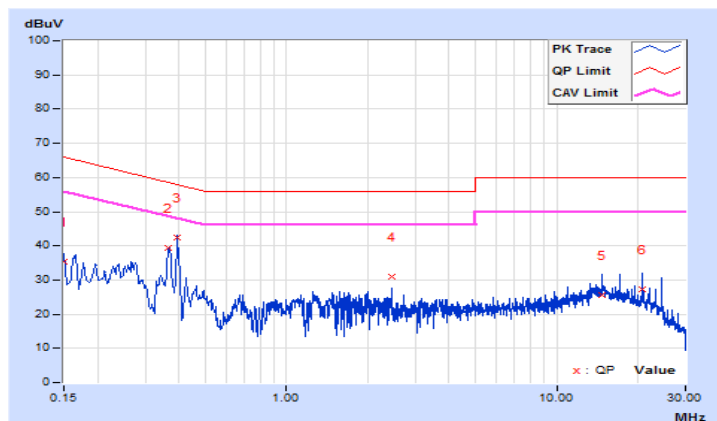

4.3 Transmit Power Measurement

4.3.1 Limits of Transmit Power Measurement

Operation Band	EUT Category		LIMIT
U-NII-1	-	Outdoor Access Point	1 Watt (30 dBm) (Max. e.i.r.p \leq 125mW(21 dBm) at any elevation angle above 30 degrees as measured from the horizon)
	-	Fixed point-to-point Access Point	1 Watt (30 dBm)
	√	Indoor Access Point	1 Watt (30 dBm)
	-	Mobile and Portable client device	250mW (24 dBm)
U-NII-2A	-		250mW (24 dBm) or 11 dBm+10 log B*
U-NII-2C	-		250mW (24 dBm) or 11 dBm+10 log B*
U-NII-3	√		1 Watt (30 dBm)

*B is the 26 dB emission bandwidth in megahertz

Per KDB 662911 Method of conducted output power measurement on IEEE 802.11 devices,

Array Gain = 0 dB (i.e., no array gain) for $N_{ANT} \leq 4$;

Array Gain = 0 dB (i.e., no array gain) for channel widths ≥ 40 MHz for any N_{ANT} ;

Array Gain = $5 \log(N_{ANT}/N_{SS})$ dB or 3 dB, whichever is less for 20-MHz channel widths with $N_{ANT} \geq 5$.

For power measurements on all other devices: Array Gain = $10 \log(N_{ANT}/N_{SS})$ dB.

4.3.2 Test Setup

For Power Output

802.11a, 802.11ac (VHT20), 802.11ac (VHT40)

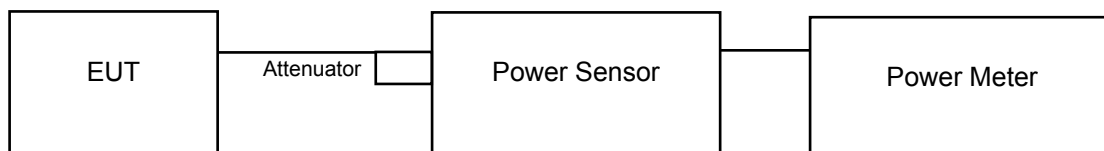

802.11ac (VHT80)

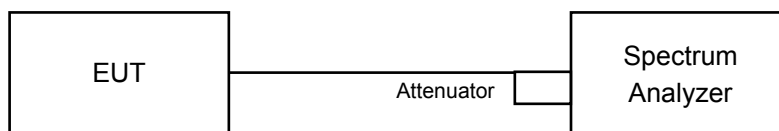

For Bandwidth

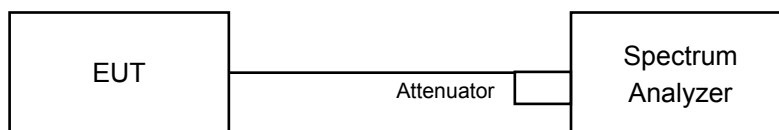

4.3.3 Test Instruments

Refer to section 4.1.2 to get information of above instrument.

4.3.4 Test Procedure

For Average Power Measurement

For 802.11a, 802.11ac (VHT20), 802.11ac (VHT40)

Method PM is used to perform output power measurement, trigger and gating function of wide band power meter is enabled to measure max output power of TX on burst and set the detector to AVERAGE. Duty factor is not added to measured value.

For 802.11ac (VHT80)

- 1) Set span to encompass the entire 26 dB EBW (or, alternatively, the entire 99% occupied bandwidth) of the signal.
- 2) Set sweep trigger to "free run".
- 3) Set RBW = 1 MHz.
- 4) Set VBW \geq 3 MHz.
- 5) Number of points in sweep \geq 2 Span / RBW.
- 6) Sweep time \leq (number of points in sweep) * T
- 7) Using emission bandwidth to determine the frequency span for integration the channel bandwidth.
- 8) Detector = RMS.
- 9) Trace mode = max hold.
- 10) Allow max hold to run for at least 60 seconds, or longer as needed to allow the trace to stabilize.
- 11) Compute power by integrating the spectrum across the EBW (or, alternatively, the entire 99% occupied bandwidth) of the signal using the instrument's band power measurement function with band limits set equal to the EBW (or occupied bandwidth) band edges. If the instrument does not have a band power function, sum the spectrum levels (in power units) at 1 MHz intervals extending across the EBW (or, alternatively, the entire 99% occupied bandwidth) of the spectrum.

For 26dB Bandwidth

- 1) Set RBW = approximately 1% of the emission bandwidth.
- 2) Set the VBW > RBW.
- 3) Detector = Peak.
- 4) Trace mode = max hold.
- 5) Measure the maximum width of the emission that is 26 dB down from the peak of the emission. Compare this with the RBW setting of the analyzer. Readjust RBW and repeat measurement as needed until the RBW/EBW ratio is approximately 1%.

4.3.5 Deviation from Test Standard

No deviation.

4.3.6 EUT Operating Conditions

The software provided by client to enable the EUT under transmission condition continuously at lowest, middle and highest channel frequencies individually.

4.3.7 Test Result

Power Output:

CDD Mode

802.11a

Chan.	Freq. (MHz)	Maximum Conducted Power (dBm)		Total Power (mW)	Total Power (dBm)	Power Limit (dBm)	Pass / Fail
		Chain 0	Chain 1				
36	5180	19.61	19.72	185.167	22.68	30.00	Pass
40	5200	22.74	22.87	381.574	25.82	30.00	Pass
48	5240	22.67	22.92	380.811	25.81	30.00	Pass
149	5745	22.44	22.83	367.255	25.65	30.00	Pass
157	5785	22.39	22.69	359.160	25.55	30.00	Pass
165	5825	22.41	22.70	360.390	25.57	30.00	Pass

802.11ac (VHT20)

Chan.	Freq. (MHz)	Maximum Conducted Power (dBm)		Total Power (mW)	Total Power (dBm)	Power Limit (dBm)	Pass / Fail
		Chain 0	Chain 1				
36	5180	18.89	19.02	157.245	21.97	30.00	Pass
40	5200	22.04	22.37	332.540	25.22	30.00	Pass
48	5240	22.50	22.86	371.025	25.69	30.00	Pass
149	5745	22.38	22.80	363.528	25.61	30.00	Pass
157	5785	22.49	22.92	373.303	25.72	30.00	Pass
165	5825	22.41	22.79	364.289	25.61	30.00	Pass

802.11ac (VHT40)

Chan.	Freq. (MHz)	Maximum Conducted Power (dBm)		Total Power (mW)	Total Power (dBm)	Power Limit (dBm)	Pass / Fail
		Chain 0	Chain 1				
38	5190	16.92	17.06	100.020	20.00	30.00	Pass
46	5230	21.81	21.65	297.923	24.74	30.00	Pass
151	5755	22.89	23.40	413.312	26.16	30.00	Pass
159	5795	22.87	23.20	402.572	26.05	30.00	Pass

802.11ac (VHT80)

Chan.	Freq. (MHz)	Maximum Conducted Power (dBm)		Total Power (mW)	Total Power (dBm)	Power Limit (dBm)	Pass / Fail
		Chain 0	Chain 1				
42	5210	16.97	17.23	102.619	20.11	30.00	Pass
155	5775	20.15	20.42	213.668	23.30	30.00	Pass

Beamforming Mode

802.11ac (VHT20)

Chan.	Freq. (MHz)	Maximum Conducted Power (dBm)		Total Power (mW)	Total Power (dBm)	Power Limit (dBm)	Pass / Fail
		Chain 0	Chain 1				
36	5180	18.89	19.02	157.245	21.97	30.00	Pass
40	5200	22.04	22.37	332.540	25.22	30.00	Pass
48	5240	22.50	22.86	371.025	25.69	30.00	Pass
149	5745	22.38	22.80	363.528	25.61	29.50	Pass
157	5785	22.49	22.92	373.303	25.72	29.50	Pass
165	5825	22.41	22.79	364.289	25.61	29.50	Pass

Note:

- 5180~5240MHz Max. Beamforming Gain = $10 \log[(10^{G1/10} + 10^{G2/10} + \dots + 10^{GN/10})/N_{ANT}] = 5.51\text{dBi} < 6\text{dBi}$, so the limit no need to reduced.
5745~5825MHz Max. Beamforming Gain = $10 \log[(10^{G1/10} + 10^{G2/10} + \dots + 10^{GN/10})/N_{ANT}] = 6.50\text{dBi} > 6\text{dBi}$, so the limit shall be reduced to $30-(6.50-6) = 29.50\text{dBm}$.

802.11ac (VHT40)

Chan.	Freq. (MHz)	Maximum Conducted Power (dBm)		Total Power (mW)	Total Power (dBm)	Power Limit (dBm)	Pass / Fail
		Chain 0	Chain 1				
38	5190	16.92	17.06	100.020	20.00	30.00	Pass
46	5230	21.81	21.65	297.923	24.74	30.00	Pass
151	5755	22.89	23.40	413.312	26.16	29.50	Pass
159	5795	22.87	23.20	402.572	26.05	29.50	Pass

Note:

- 5180~5240MHz Max. Beamforming Gain = $10 \log[(10^{G1/10} + 10^{G2/10} + \dots + 10^{GN/10})/N_{ANT}] = 5.51\text{dBi} < 6\text{dBi}$, so the limit no need to reduced.
5745~5825MHz Max. Beamforming Gain = $10 \log[(10^{G1/10} + 10^{G2/10} + \dots + 10^{GN/10})/N_{ANT}] = 6.50\text{dBi} > 6\text{dBi}$, so the limit shall be reduced to $30-(6.50-6) = 29.50\text{dBm}$.

802.11ac (VHT80)

Chan.	Freq. (MHz)	Maximum Conducted Power (dBm)		Total Power (mW)	Total Power (dBm)	Power Limit (dBm)	Pass / Fail
		Chain 0	Chain 1				
42	5210	16.97	17.23	102.619	20.11	30.00	Pass
155	5775	20.15	20.42	213.668	23.30	29.50	Pass

Note:

- 5180~5240MHz Max. Beamforming Gain = $10 \log[(10^{G1/10} + 10^{G2/10} + \dots + 10^{GN/10})/N_{ANT}] = 5.51\text{dBi} < 6\text{dBi}$, so the limit no need to reduced.
5745~5825MHz Max. Beamforming Gain = $10 \log[(10^{G1/10} + 10^{G2/10} + \dots + 10^{GN/10})/N_{ANT}] = 6.50\text{dBi} > 6\text{dBi}$, so the limit shall be reduced to $30-(6.50-6) = 29.50\text{dBm}$.

26dB Bandwidth:

802.11a

Channel	Frequency (MHz)	26dBc Bandwidth (MHz)	
		Chain 0	Chain 1
36	5180	32.92	31.25
40	5200	41.44	39.40
48	5240	42.82	39.91

802.11ac (VHT20)

Channel	Frequency (MHz)	26dBc Bandwidth (MHz)	
		Chain 0	Chain 1
36	5180	28.39	31.70
40	5200	45.09	46.12
48	5240	46.47	45.50

802.11ac (VHT40)

Channel	Frequency (MHz)	26dBc Bandwidth (MHz)	
		Chain 0	Chain 1
38	5190	47.57	47.43
46	5230	85.87	85.70

802.11ac (VHT80)

Channel	Frequency (MHz)	26dBc Bandwidth (MHz)	
		Chain 0	Chain 1
42	5210	89.26	90.48

Spectrum Plot of Worst Value

802.11a

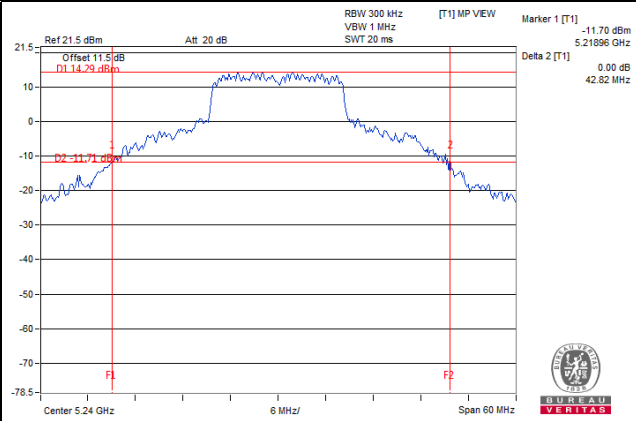

802.11ac (VHT20)

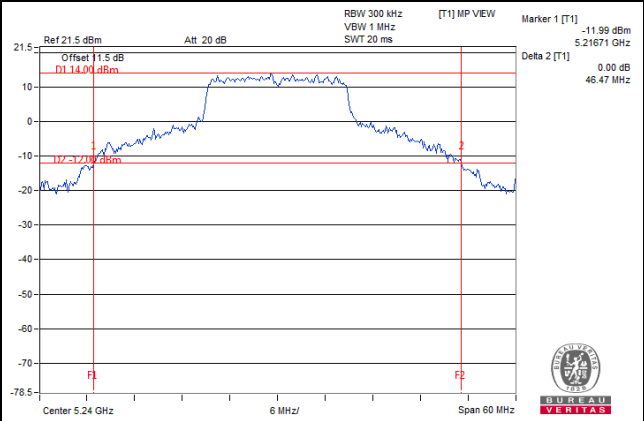

802.11ac (VHT40)

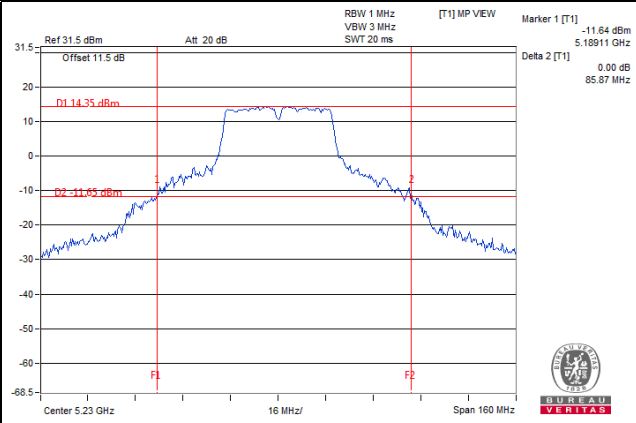

802.11ac (VHT80)

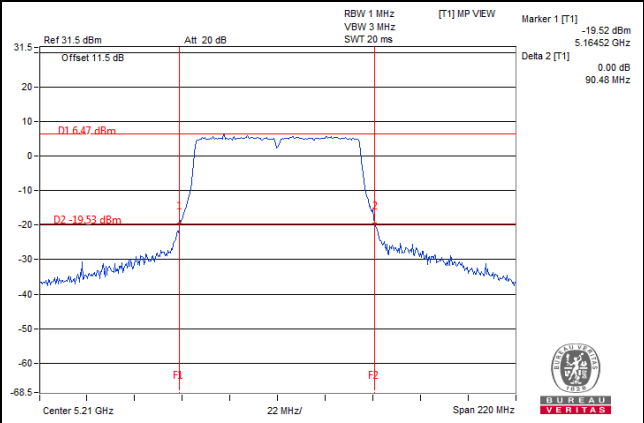

4.4 Occupied Bandwidth Measurement

4.4.1 Test Setup

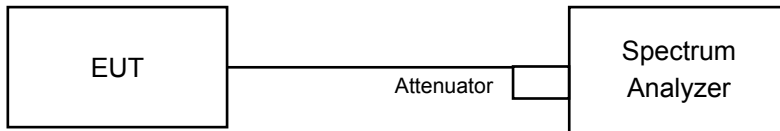

4.4.2 Test Instruments

Refer to section 4.1.2 to get information of above instrument.

4.4.3 Test Procedure

The transmitter output was connected to the spectrum analyzer through an attenuator. The bandwidth of the fundamental frequency was measured by spectrum analyzer with resolution bandwidth in the range of 1% to 5% of the anticipated emission bandwidth, and a video bandwidth at least 3x the resolution bandwidth and set the detector to sampling. The width of a frequency band such that, below the lower and above the upper frequency limits, the mean powers emitted are each equal to a specified percentage 0.5 %of the total mean power of a given emission.

4.4.4 Test Result

802.11a

Channel	Frequency (MHz)	Occupied Bandwidth (MHz)	
		Chain 0	Chain 1
36	5180	17.16	17.28
40	5200	27.48	26.16
48	5240	18.26	18.00
149	5745	23.13	27.39
157	5785	24.00	27.84
165	5825	23.04	28.08

802.11ac (VHT20)

Channel	Frequency (MHz)	Occupied Bandwidth (MHz)	
		Chain 0	Chain 1
36	5180	18.00	18.24
40	5200	29.52	28.20
48	5240	18.78	18.78
149	5745	25.56	30.24
157	5785	26.40	30.24
165	5825	24.60	30.72

802.11ac (VHT40)

Channel	Frequency (MHz)	Occupied Bandwidth (MHz)	
		Chain 0	Chain 1
38	5190	37.08	36.96
46	5230	39.72	38.28
151	5755	43.44	46.44
159	5795	43.68	47.04

802.11ac (VHT80)

Channel	Frequency (MHz)	Occupied Bandwidth (MHz)	
		Chain 0	Chain 1
42	5210	76.08	76.32
155	5775	76.80	77.04

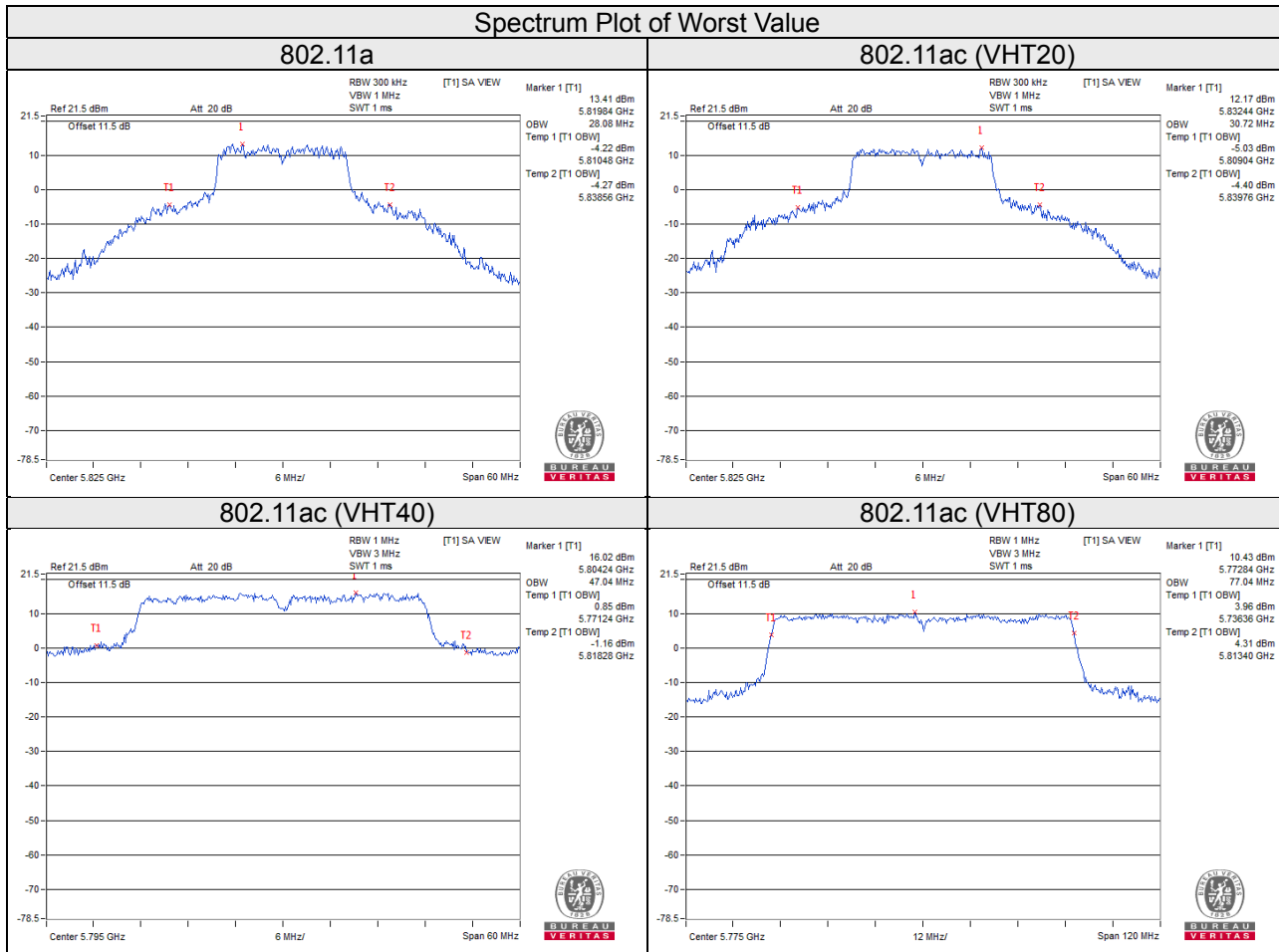

4.5 Peak Power Spectral Density Measurement

4.5.1 Limits of Peak Power Spectral Density Measurement

Operation Band	EUT Category		LIMIT
U-NII-1		Outdoor Access Point	17dBm/ MHz
		Fixed point-to-point Access Point	
	√	Indoor Access Point	
		Mobile and Portable client device	11dBm/ MHz
U-NII-2A	-		11dBm/ MHz
U-NII-2C	-		11dBm/ MHz
U-NII-3	√		30dBm/ 500kHz

4.5.2 Test Setup

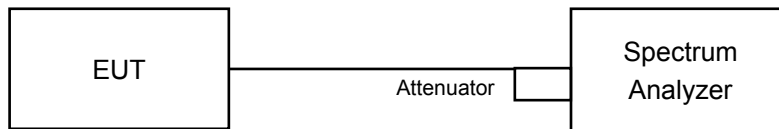

4.5.3 Test Instruments

Refer to section 4.1.2 to get information of above instrument.

4.5.4 Test Procedures

For U-NII-1 band:

Duty cycle of test signal is $\geq 98\%$

Using method SA-1

- 1) Set span to encompass the entire emission bandwidth (EBW) of the signal.
- 2) Set RBW = 1MHz, Set VBW ≥ 3 MHz, Detector = RMS.
- 3) Set Channel power measure = 1MHz.
- 4) Sweep time = auto, trigger set to "free run".
- 5) Trace average at least 100 traces in power averaging mode.
- 6) Record the max value.

Duty cycle of test signal is $< 98\%$

Using method SA-2

- 1) Set span to encompass the entire emission bandwidth (EBW) of the signal.
- 2) Set RBW = 1MHz, Set VBW ≥ 3 MHz, Detector = RMS.
- 3) Set Channel power measure = 1MHz.
- 4) Sweep time = auto, trigger set to "free run".
- 5) Trace average at least 100 traces in power averaging mode.
- 6) Record the max value and add $10 \log (1/\text{duty cycle})$.

For U-NII-3 band:

Duty cycle of test signal is $\geq 98\%$

Using method SA-1

- 1) Set span to encompass the entire emission bandwidth (EBW) of the signal.
- 2) Set RBW = 300 kHz, Set VBW ≥ 1 MHz, Detector = RMS.
- 3) Use the peak marker function to determine the maximum power level in any 300 kHz band segment within the fundamental EBW.
- 4) Scale the observed power level to an equivalent value in 500 kHz by adjusting (reducing) the measured power by a bandwidth correction factor (BWCF) where $BWCF = 10\log(500 \text{ kHz} / 300 \text{ kHz})$.
- 5) Sweep time = auto, trigger set to "free run".
- 6) Trace average at least 100 traces in power averaging mode.
- 7) Record the max value.

Duty cycle of test signal is $< 98\%$

- 1) Set span to encompass the entire emission bandwidth (EBW) of the signal.
- 2) Set RBW = 300 kHz, Set VBW ≥ 1 MHz, Detector = RMS.
- 3) Use the peak marker function to determine the maximum power level in any 300 kHz band segment within the fundamental EBW.
- 4) Scale the observed power level to an equivalent value in 500 kHz by adjusting (reducing) the measured power by a bandwidth correction factor (BWCF) where $BWCF = 10\log(500 \text{ kHz} / 300 \text{ kHz})$.
- 5) Sweep time = auto, trigger set to "free run".
- 6) Trace average at least 100 traces in power averaging mode.
- 7) Record the max value and add $10 \log (1/\text{duty cycle})$.

4.5.5 Deviation from Test Standard

No deviation.

4.5.6 EUT Operating Conditions

Same as 4.3.6.

4.5.7 Test Results

For U-NII-1 band:

802.11a

Chan.	Freq. (MHz)	PSD W/O Duty Factor (dBm/MHz)		Duty Factor (dB)	Total PSD With Duty Factor (dBm/MHz)	Max. Limit (dBm/MHz)	Pass / Fail
		Chain 0	Chain 1				
36	5180	5.87	5.15	0.24	8.78	17.00	Pass
40	5200	8.58	7.75	0.24	11.44	17.00	Pass
48	5240	9.04	8.17	0.24	11.88	17.00	Pass

Note:

- Method E) 2) a) of power density measurement of KDB 662911 is using for calculating total power density. Total power density is summing entire spectra across corresponding frequency bins on the various outputs by computer.
- Max. Directional Gain = $10 \log[(10^{G1/10} + 10^{G2/10} + \dots + 10^{GN/10})/N_{ANT}] = 5.51 \text{ dBi} < 6 \text{ dBi}$, so the limit no need to reduced.
- Refer to section 3.3 for duty cycle spectrum plot.

802.11ac (VHT20)

Chan.	Freq. (MHz)	PSD W/O Duty Factor (dBm/MHz)		Duty Factor (dB)	Total PSD With Duty Factor (dBm/MHz)	Max. Limit (dBm/MHz)	Pass / Fail
		Chain 0	Chain 1				
36	5180	5.02	4.56	0.10	7.91	17.00	Pass
40	5200	8.29	7.57	0.10	11.06	17.00	Pass
48	5240	8.81	7.75	0.10	11.42	17.00	Pass

Note:

- Method E) 2) a) of power density measurement of KDB 662911 is using for calculating total power density. Total power density is summing entire spectra across corresponding frequency bins on the various outputs by computer.
- Max. Directional Gain = $10 \log[(10^{G1/10} + 10^{G2/10} + \dots + 10^{GN/10})/N_{ANT}] = 5.51 \text{ dBi} < 6 \text{ dBi}$, so the limit no need to reduced.
- Refer to section 3.3 for duty cycle spectrum plot.

802.11ac (VHT40)

Chan.	Freq. (MHz)	PSD W/O Duty Factor (dBm/MHz)		Duty Factor (dB)	Total PSD With Duty Factor (dBm/MHz)	Max. Limit (dBm/MHz)	Pass / Fail
		Chain 0	Chain 1				
38	5190	0.41	-0.09	0.24	3.42	17.00	Pass
46	5230	4.36	3.51	0.24	7.21	17.00	Pass

Note:

- Method E) 2) a) of power density measurement of KDB 662911 is using for calculating total power density. Total power density is summing entire spectra across corresponding frequency bins on the various outputs by computer.
- Max. Directional Gain = $10 \log[(10^{G1/10} + 10^{G2/10} + \dots + 10^{GN/10})/N_{ANT}] = 5.51 \text{ dBi} < 6 \text{ dBi}$, so the limit no need to reduced.
- Refer to section 3.3 for duty cycle spectrum plot.

802.11ac (VHT80)

Chan.	Freq. (MHz)	PSD W/O Duty Factor (dBm/MHz)		Duty Factor (dB)	Total PSD With Duty Factor (dBm/MHz)	Max. Limit (dBm/MHz)	Pass / Fail
		Chain 0	Chain 1				
42	5210	-4.11	-4.59	0.49	-0.84	17.00	Pass

Note:

- Method E) 2) a) of power density measurement of KDB 662911 is using for calculating total power density. Total power density is summing entire spectra across corresponding frequency bins on the various outputs by computer.
- Max. Directional Gain = $10 \log[(10^{G1/10} + 10^{G2/10} + \dots + 10^{GN/10})/N_{ANT}] = 5.51 \text{ dBi} < 6 \text{ dBi}$, so the limit no need to reduced.
- Refer to section 3.3 for duty cycle spectrum plot.

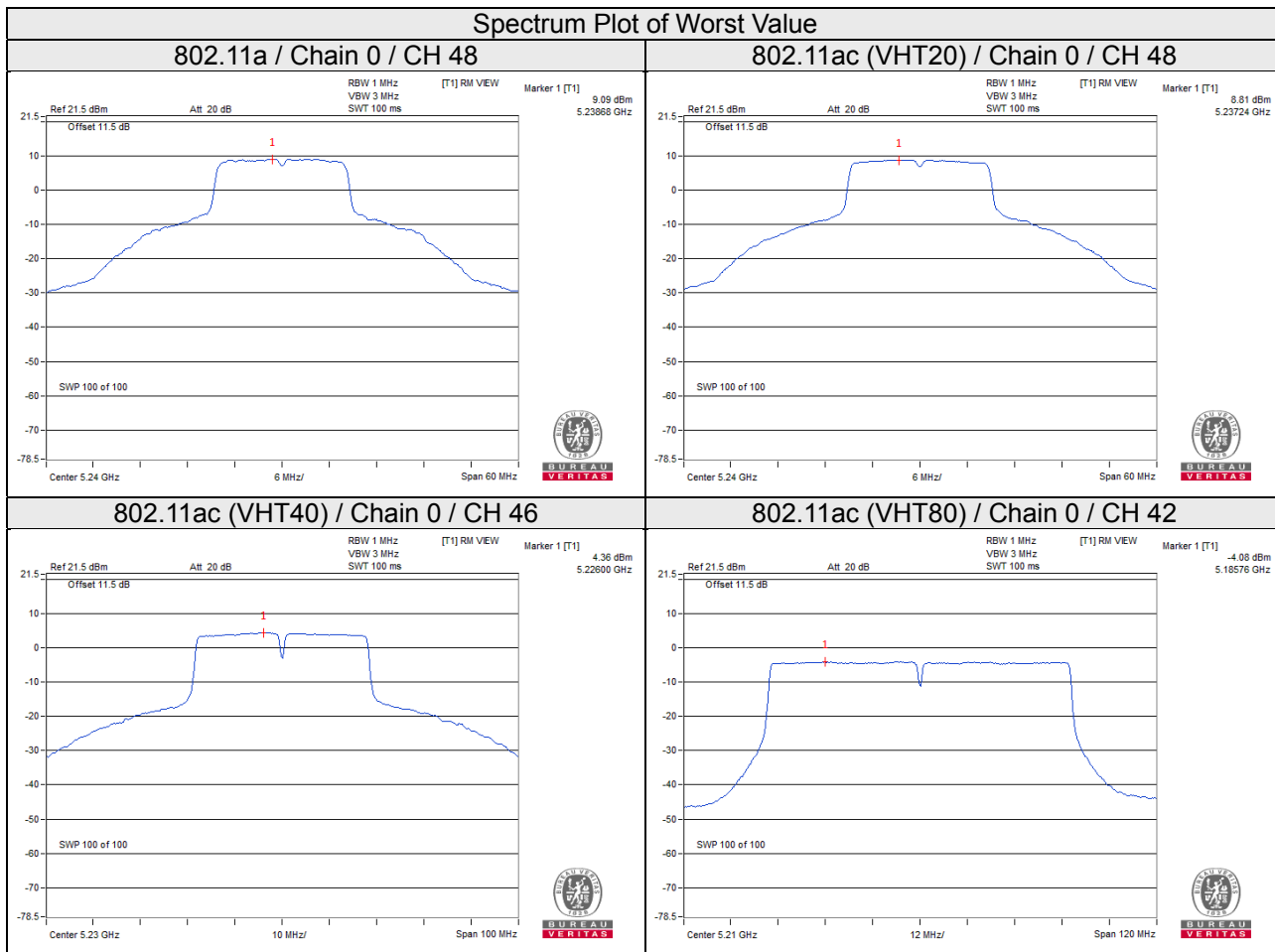

For U-NII-3 band:

802.11a

TX chain	Chan.	Freq. (MHz)	PSD W/O Duty Factor		10 log (N=2) dB	Duty Factor (dB)	Total PSD With Duty Factor (dBm/500kHz)	Limit (dBm/500kHz)	Pass / Fail
			(dBm/300kHz)	(dBm/500kHz)					
0	149	5745	0.25	2.47	3.01	0.24	5.72	29.50	Pass
	157	5785	0.48	2.70	3.01	0.24	5.95	29.50	Pass
	165	5825	0.19	2.41	3.01	0.24	5.66	29.50	Pass
1	149	5745	0.54	2.76	3.01	0.24	6.01	29.50	Pass
	157	5785	0.43	2.65	3.01	0.24	5.90	29.50	Pass
	165	5825	0.44	2.66	3.01	0.24	5.91	29.50	Pass

Note:

1. Method E) 2) c) of power density measurement of KDB 662911 is using for calculating total power density.
2. Max. Directional Gain = $10 \log[(10^{G1/10} + 10^{G2/10} + \dots + 10^{GN/10})/N_{ANT}] = 6.50\text{dBi} > 6\text{dBi}$, so the limit shall be reduced to $30-(6.50-6) = 29.50\text{dBm}$.
3. Refer to section 3.3 for duty cycle spectrum plot.

802.11ac (VHT20)

TX chain	Chan.	Freq. (MHz)	PSD W/O Duty Factor		10 log (N=2) dB	Duty Factor (dB)	Total PSD With Duty Factor (dBm/500kHz)	Limit (dBm/500kHz)	Pass / Fail
			(dBm/300kHz)	(dBm/500kHz)					
0	149	5745	-0.59	1.63	3.01	0.10	4.74	29.50	Pass
	157	5785	-0.32	1.90	3.01	0.10	5.01	29.50	Pass
	165	5825	-0.39	1.83	3.01	0.10	4.94	29.50	Pass
1	149	5745	0.27	2.49	3.01	0.10	5.60	29.50	Pass
	157	5785	0.10	2.32	3.01	0.10	5.43	29.50	Pass
	165	5825	-0.07	2.15	3.01	0.10	5.26	29.50	Pass

Note:

1. Method E) 2) c) of power density measurement of KDB 662911 is using for calculating total power density.
2. Max. Directional Gain = $10 \log[(10^{G1/10} + 10^{G2/10} + \dots + 10^{GN/10})/N_{ANT}] = 6.50\text{dBi} > 6\text{dBi}$, so the limit shall be reduced to $30-(6.50-6) = 29.50\text{dBm}$.
3. Refer to section 3.3 for duty cycle spectrum plot.

802.11ac (VHT40)

TX chain	Chan.	Freq. (MHz)	PSD W/O Duty Factor		10 log (N=2) dB	Duty Factor (dB)	Total PSD With Duty Factor (dBm/500kHz)	Limit (dBm/500kHz)	Pass / Fail
			(dBm/300kHz)	(dBm/500kHz)					
0	151	5755	-3.05	-0.83	3.01	0.24	2.42	29.50	Pass
	159	5795	-3.00	-0.78	3.01	0.24	2.47	29.50	Pass
1	151	5755	-2.92	-0.70	3.01	0.24	2.55	29.50	Pass
	159	5795	-2.94	-0.72	3.01	0.24	2.53	29.50	Pass

Note:

1. Method E) 2) c) of power density measurement of KDB 662911 is using for calculating total power density.
2. Max. Directional Gain = $10 \log[(10^{G1/10} + 10^{G2/10} + \dots + 10^{GN/10})/N_{ANT}] = 6.50\text{dBi} > 6\text{dBi}$, so the limit shall be reduced to $30-(6.50-6) = 29.50\text{dBm}$.
3. Refer to section 3.3 for duty cycle spectrum plot.

802.11ac (VHT80)

TX chain	Chan.	Freq. (MHz)	PSD W/O Duty Factor		10 log (N=2) dB	Duty Factor (dB)	Total PSD With Duty Factor (dBm/500kHz)	Limit (dBm/500kHz)	Pass / Fail
			(dBm/300kHz)	(dBm/500kHz)					
0	155	5775	-9.50	-7.28	3.01	0.49	-3.78	29.50	Pass
1	155	5775	-9.02	-6.80	3.01	0.49	-3.30	29.50	Pass

Note:

1. Method E) 2) c) of power density measurement of KDB 662911 is using for calculating total power density.
2. Max. Directional Gain = $10 \log[(10^{G1/10} + 10^{G2/10} + \dots + 10^{GN/10})/N_{ANT}] = 6.50\text{dBi} > 6\text{dBi}$, so the limit shall be reduced to $30-(6.50-6) = 29.50\text{dBm}$.
3. Refer to section 3.3 for duty cycle spectrum plot.

Spectrum Plot of Worst Value

802.11a

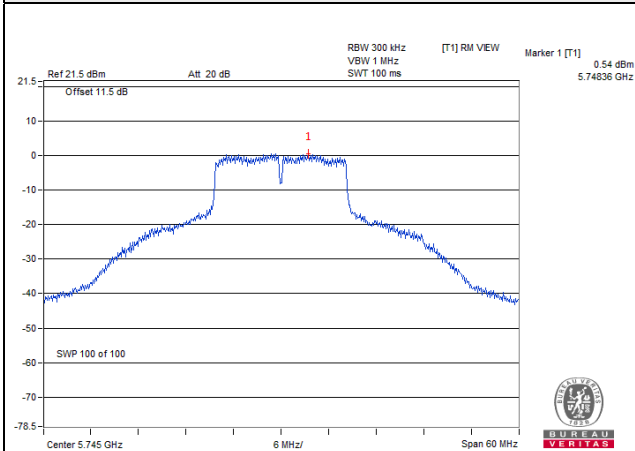

802.11ac (VHT20)

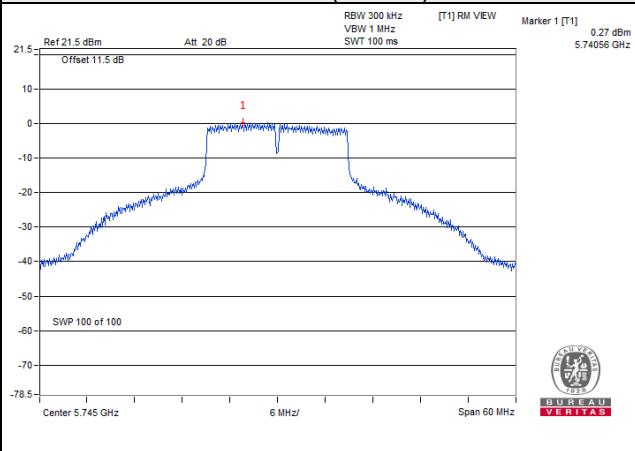

802.11ac (VHT40)

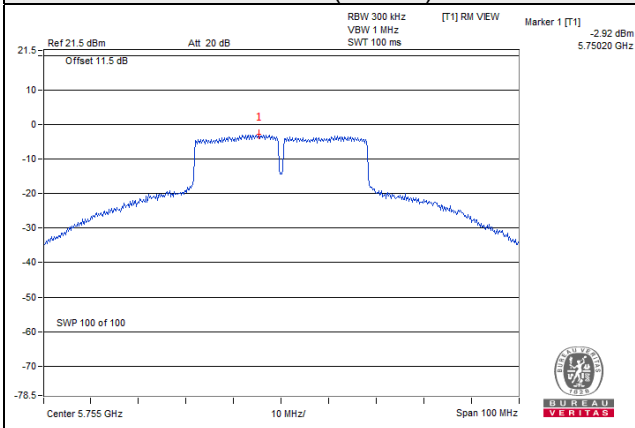

802.11ac (VHT80)

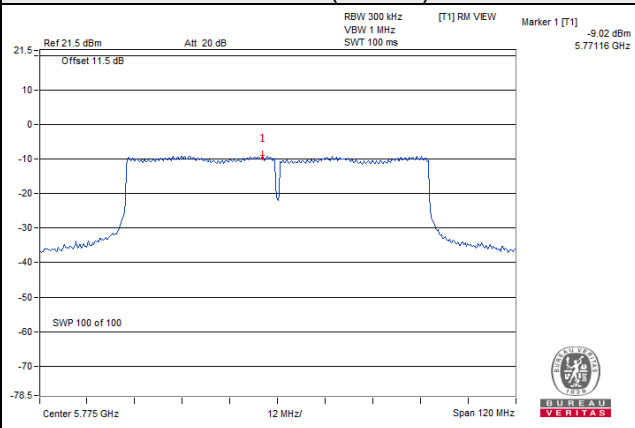

4.6 Frequency Stability

4.6.1 Limits of Frequency Stability Measurement

The frequency of the carrier signal shall be maintained within band of operation

4.6.2 Test Setup

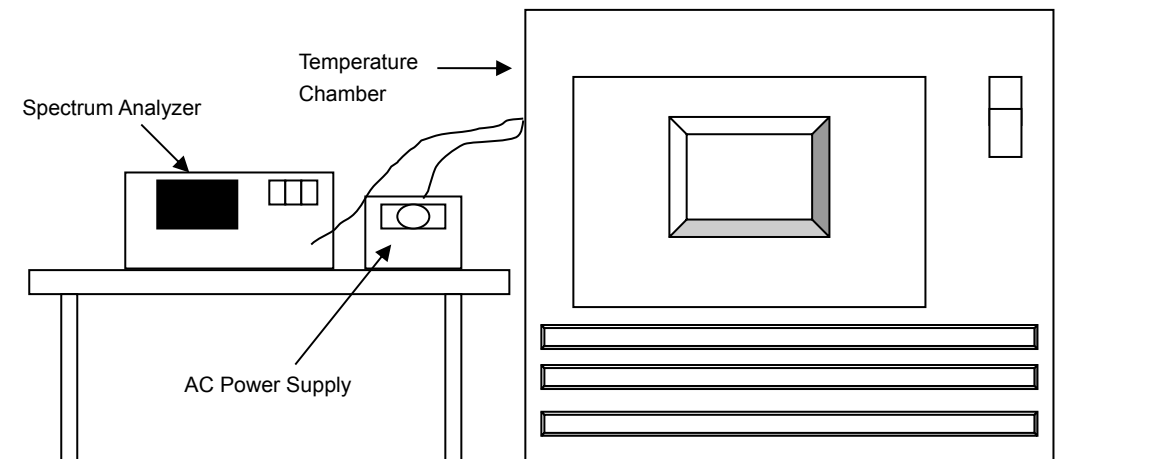

4.6.3 Test Instruments

Description & Manufacturer	Model No.	Serial No.	Cal. Date	Cal. Due
Spectrum Analyzer ROHDE & SCHWARZ	FSP40	100040	Sep. 25, 2018	Sep. 26, 2019
WIT Standard Temperature And Humidity Chamber	TH-4S-C	W981030	Jun. 03, 2019	Jun. 02, 2020
Digital Multimeter Fluke	87-III	70360742	Jun. 27, 2019	Jun. 26, 2020
AC Power Supply Extech	CFW-105	E000603	NA	NA

4.6.4 Test Procedure

- The EUT was placed inside the environmental test chamber and powered by nominal AC voltage.
- Turn the EUT on and couple its output to a spectrum analyzer.
- Turn the EUT off and set the chamber to the highest temperature specified.
- Allow sufficient time (approximately 30 min) for the temperature of the chamber to stabilize, turn the EUT on and measure the operating frequency after 2, 5, and 10 minutes.
- Repeat step 2 and 3 with the temperature chamber set to the lowest temperature.
- The test chamber was allowed to stabilize at +20 degree C for a minimum of 30 minutes. The supply voltage was then adjusted on the EUT from 85% to 115% and the frequency record.

4.6.5 Deviation from Test Standard

No deviation.

4.6.6 EUT Operating Condition

Set the EUT transmit at un-modulation mode to test frequency stability.

4.6.7 Test Results

Frequency Stability Versus Temp.									
Operating Frequency: 5180MHz									
Temp. (°C)	Power Supply (Vac)	0 Minute		2 Minute		5 Minute		10 Minute	
		Measured Frequency (MHz)	Pass/Fail	Measured Frequency (MHz)	Pass/Fail	Measured Frequency (MHz)	Pass/Fail	Measured Frequency (MHz)	Pass/Fail
50	120	5180.0230	PASS	5180.0257	PASS	5180.0265	PASS	5180.0266	PASS
40	120	5179.9810	PASS	5179.9837	PASS	5179.9841	PASS	5179.9826	PASS
30	120	5180.0068	PASS	5180.0079	PASS	5180.0106	PASS	5180.0062	PASS
20	120	5180.0218	PASS	5180.0214	PASS	5180.0218	PASS	5180.0204	PASS
10	120	5180.0183	PASS	5180.0160	PASS	5180.0190	PASS	5180.0147	PASS
0	120	5180.0214	PASS	5180.0206	PASS	5180.0233	PASS	5180.0191	PASS
-10	120	5180.0048	PASS	5180.0022	PASS	5180.0025	PASS	5180.0042	PASS
-20	120	5180.0080	PASS	5180.0095	PASS	5180.0076	PASS	5180.0079	PASS
-30	120	5179.9766	PASS	5179.9765	PASS	5179.9780	PASS	5179.9786	PASS

Frequency Stability Versus Voltage									
Operating Frequency: 5180MHz									
Temp. (°C)	Power Supply (Vac)	0 Minute		2 Minute		5 Minute		10 Minute	
		Measured Frequency (MHz)	Pass/Fail	Measured Frequency (MHz)	Pass/Fail	Measured Frequency (MHz)	Pass/Fail	Measured Frequency (MHz)	Pass/Fail
20	138	5180.0223	PASS	5180.0222	PASS	5180.0217	PASS	5180.0203	PASS
	120	5180.0218	PASS	5180.0214	PASS	5180.0218	PASS	5180.0204	PASS
	102	5180.0217	PASS	5180.0216	PASS	5180.0225	PASS	5180.0195	PASS

4.7 6dB Bandwidth Measurement

4.7.1 Limits of 6dB Bandwidth Measurement

The minimum of 6dB Bandwidth Measurement is 0.5MHz.

4.7.2 Test Setup

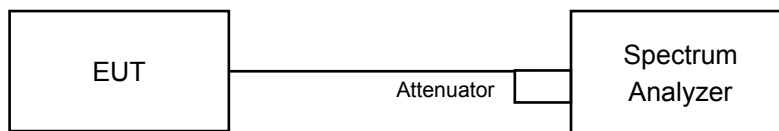

4.7.3 Test Instruments

Refer to section 4.1.2 to get information of above instrument.

4.7.4 Test Procedure

Measurement Procedure REF

- Set resolution bandwidth (RBW) = 100kHz
- Set the video bandwidth (VBW) $\geq 3 \times$ RBW, Detector = Peak.
- Trace mode = max hold.
- Sweep = auto couple.
- Measure the maximum width of the emission that is constrained by the frequencies associated with the two amplitude points (upper and lower) that are attenuated by 6 dB relative to the maximum level measured in the fundamental emission

4.7.5 Deviation from Test Standard

No deviation.

4.7.6 EUT Operating Condition

The software provided by client to enable the EUT under transmission condition continuously at lowest, middle and highest channel frequencies individually.

4.7.7 Test Results

802.11a

Chan.	Freq. (MHz)	6dB Bandwidth (MHz)		Minimum Limit (MHz)	Pass / Fail
		Chain 0	Chain 1		
149	5745	16.36	16.35	0.5	Pass
157	5785	16.39	16.39	0.5	Pass
165	5825	16.38	16.38	0.5	Pass

802.11ac (VHT20)

Chan.	Freq. (MHz)	6dB Bandwidth (MHz)		Minimum Limit (MHz)	Pass / Fail
		Chain 0	Chain 1		
149	5745	17.65	17.63	0.5	Pass
157	5785	17.66	17.62	0.5	Pass
165	5825	17.65	17.63	0.5	Pass

802.11ac (VHT40)

Chan.	Freq. (MHz)	6dB Bandwidth (MHz)		Minimum Limit (MHz)	Pass / Fail
		Chain 0	Chain 1		
151	5755	36.43	36.43	0.5	Pass
159	5795	36.45	36.43	0.5	Pass

802.11ac (VHT80)

Chan.	Freq. (MHz)	6dB Bandwidth (MHz)		Minimum Limit (MHz)	Pass / Fail
		Chain 0	Chain 1		
155	5775	76.62	76.63	0.5	Pass

Spectrum Plot of Worst Value

802.11a

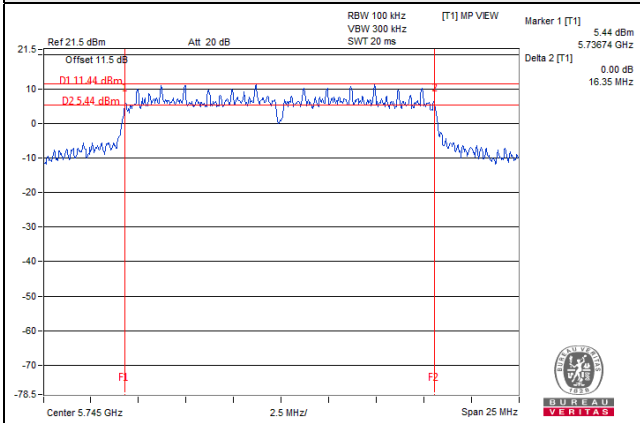

802.11ac (VHT20)

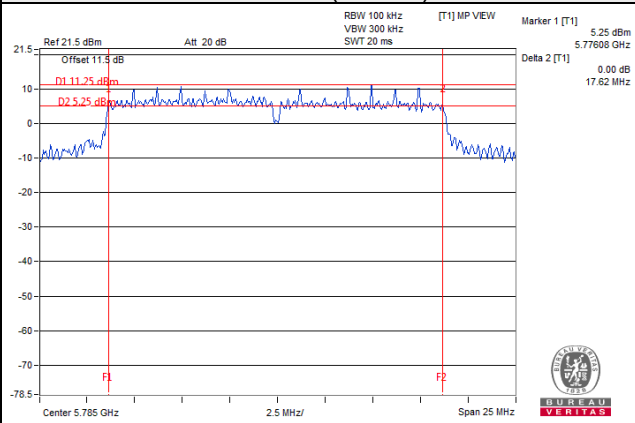

802.11ac (VHT40)

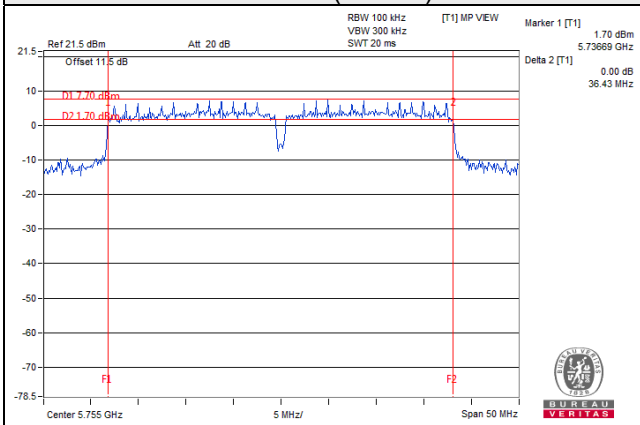

802.11ac (VHT80)

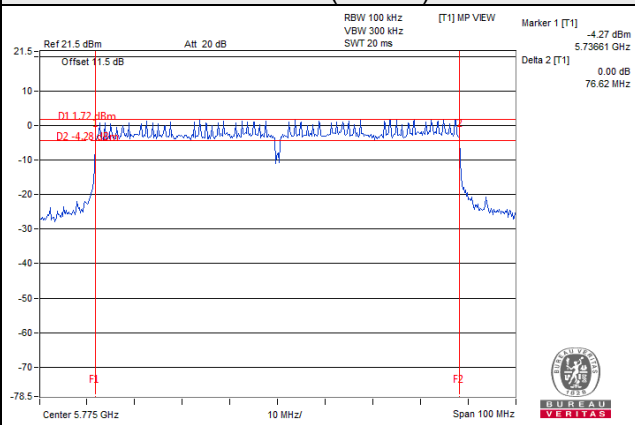

5 Pictures of Test Arrangements

Please refer to the attached file (Test Setup Photo).

Annex A- Radiated Out of Band Emission (OOBE) Measurement (For U-NII-3 band)

802.11a

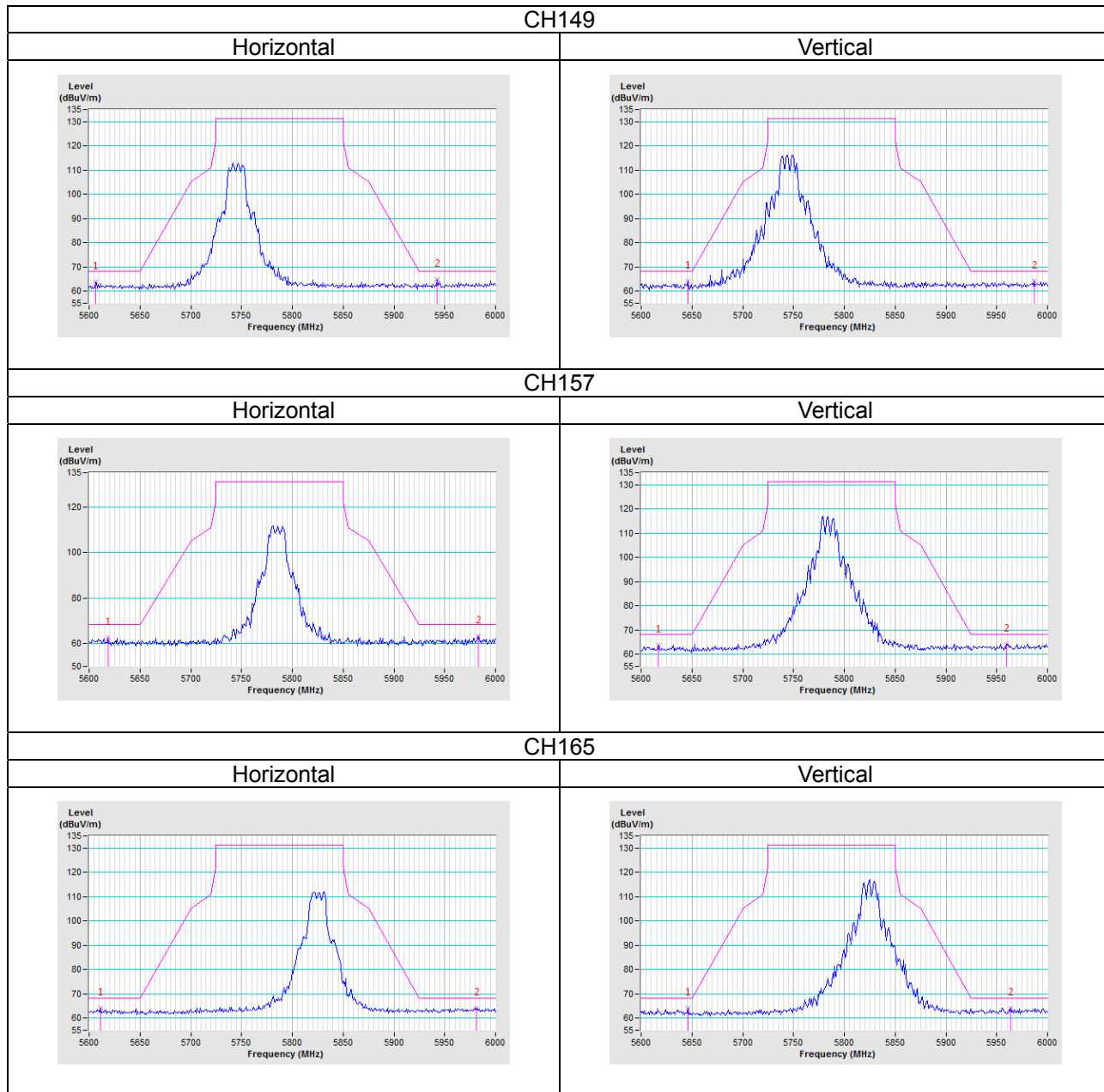

802.11ac (VHT20)

CH149

Horizontal

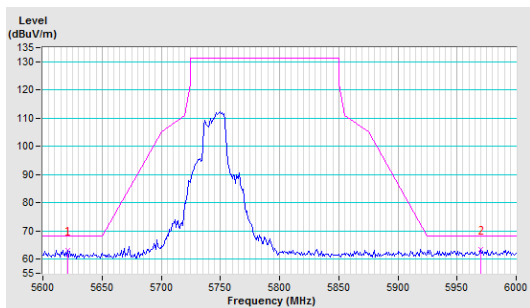

Vertical

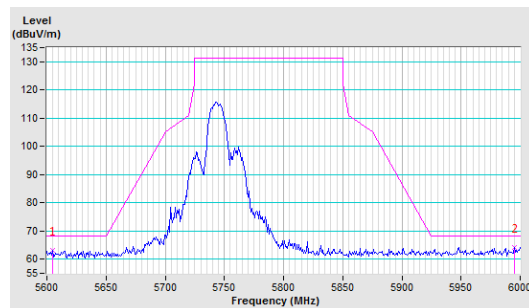

CH157

Horizontal

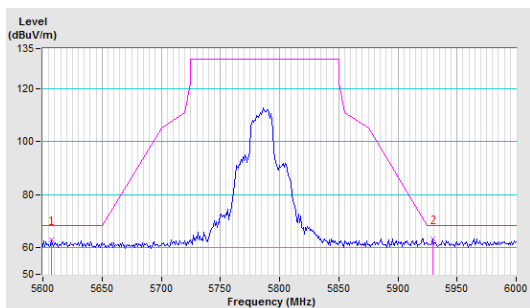

Vertical

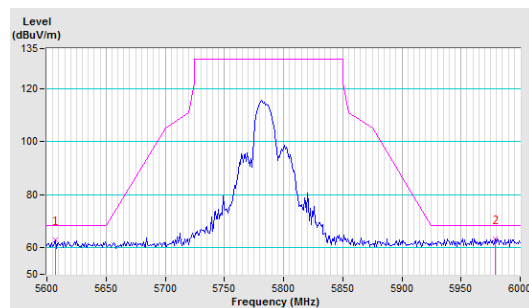

CH165

Horizontal

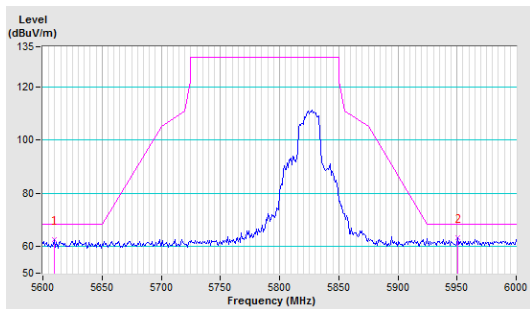

Vertical

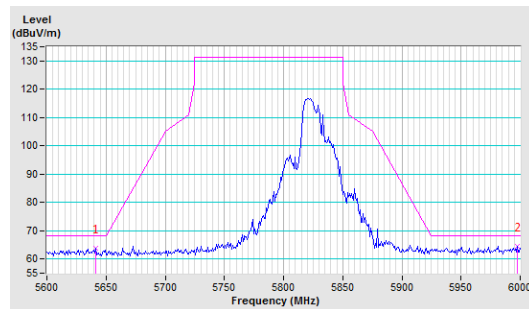

802.11ac (VHT40)

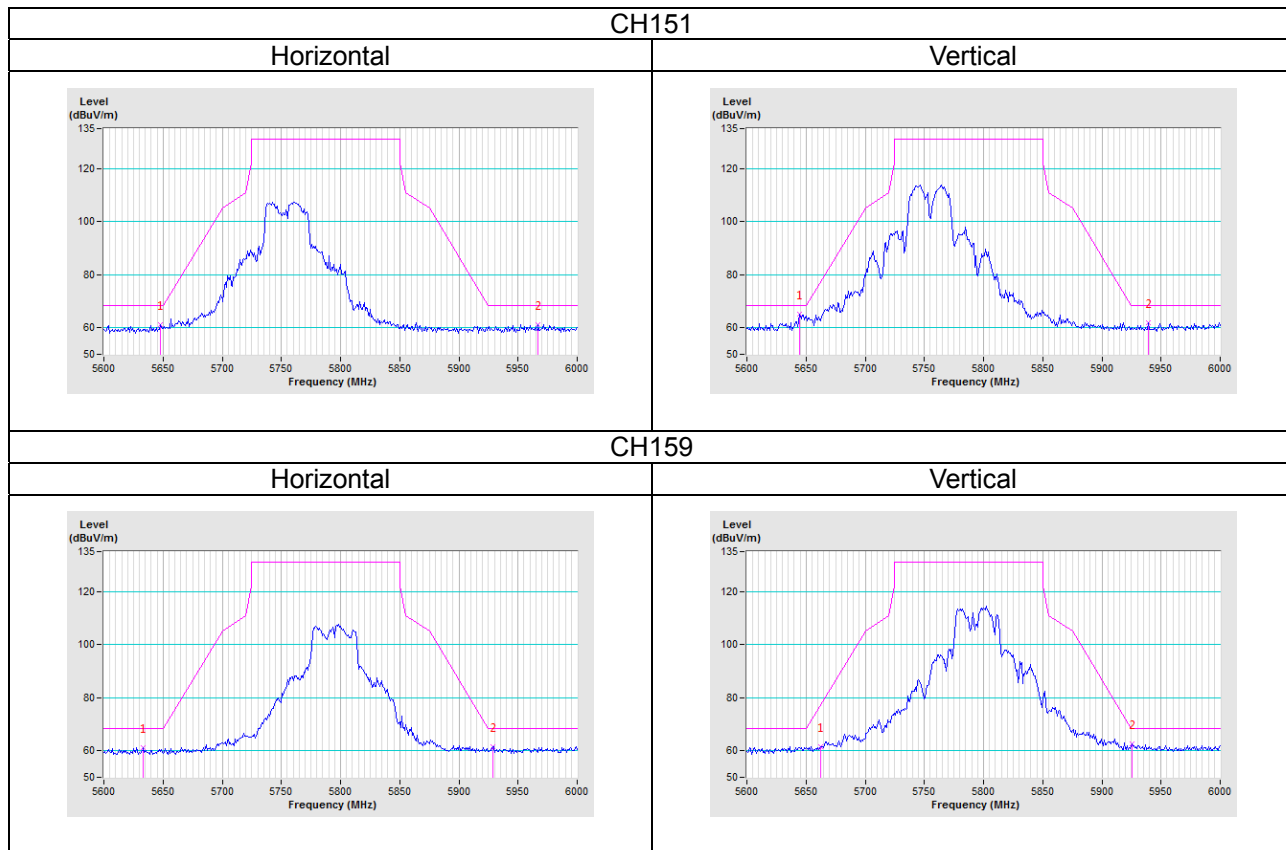

802.11ac (VHT80)

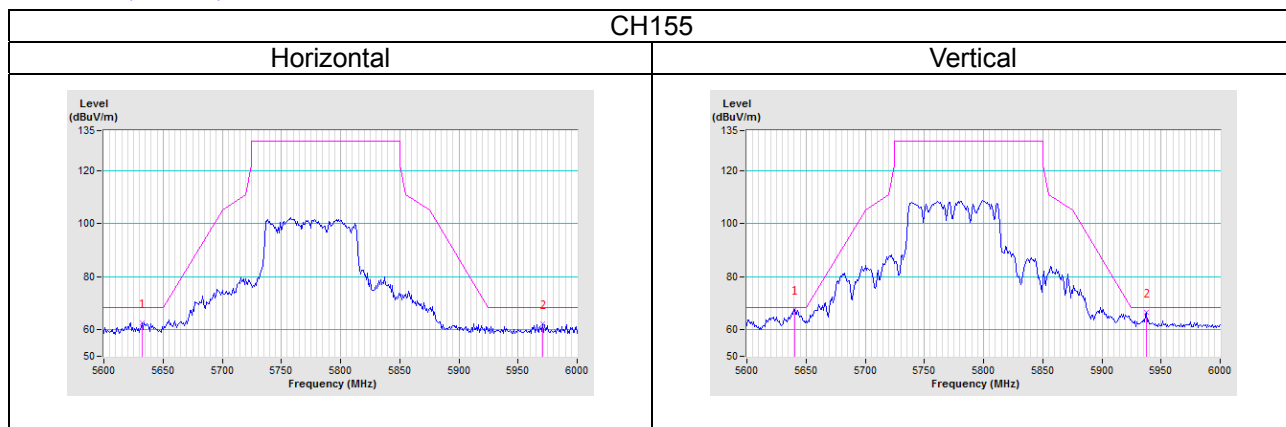

Appendix – Information of the Testing Laboratories

We, Bureau Veritas Consumer Products Services (H.K.) Ltd., Taoyuan Branch, were founded in 1988 to provide our best service in EMC, Radio, Telecom and Safety consultation. Our laboratories are FCC recognized accredited test firms and accredited and approved according to ISO/IEC 17025.

If you have any comments, please feel free to contact us at the following:

Linko EMC/RF Lab

Tel: 886-2-26052180

Fax: 886-2-26051924

Hsin Chu EMC/RF/Telecom Lab

Tel: 886-3-6668565

Fax: 886-3-6668323

Hwa Ya EMC/RF/Safety Lab

Tel: 886-3-3183232

Fax: 886-3-3270892

Email: service.adt@tw.bureauveritas.com

Web Site: www.bureauveritas-adt.com

The address and road map of all our labs can be found in our web site also.

--- END ---