

FCC Test Report (WLAN)

Report No.: RF190725E05-1

FCC ID: PY319200445

Test Model: RAX20

Series Model: RAX15

Received Date: July 25, 2019

Test Date: July 26 to Aug. 06, 2019

Issued Date: Aug. 12, 2019

Applicant: NETGEAR, Inc.

Address: 350 East Plumeria Drive San Jose, CA 95134

Issued By: Bureau Veritas Consumer Products Services (H.K.) Ltd., Taoyuan Branch
Hsin Chu Laboratory

Lab Address: E-2, No.1, Li Hsin 1st Road, Hsinchu Science Park, Hsinchu City 300,
Taiwan R.O.C.

Test Location: E-2, No.1, Li Hsin 1st Road, Hsinchu Science Park, Hsinchu City 300,
Taiwan R.O.C.

**FCC Registration /
Designation Number:** 723255 / TW2022



This report is for your exclusive use. Any copying or replication of this report to or for any other person or entity, or use of our name or trademark, is permitted only with our prior written permission. This report sets forth our findings solely with respect to the test samples identified herein. The results set forth in this report are not indicative or representative of the quality or characteristics of the lot from which a test sample was taken or any similar or identical product specifically and expressly noted. Our report includes all of the tests requested by you and the results thereof based upon the information that you provided to us. You have 60 days from date of issuance of this report to notify us of any material error or omission caused by our negligence, provided, however, that such notice shall be in writing and shall specifically address the issue you wish to raise. A failure to raise such issue within the prescribed time shall constitute your unqualified acceptance of the completeness of this report, the tests conducted and the correctness of the report contents. Unless specific mention, the uncertainty of measurement has been explicitly taken into account to declare the compliance or non-compliance to the specification. The report must not be used by the client to claim product certification, approval, or endorsement by TAF or any government agencies.

Table of Contents

Release Control Record	4
1 Certificate of Conformity	5
2 Summary of Test Results	6
2.1 Measurement Uncertainty	6
2.2 Modification Record	6
3 General Information	7
3.1 General Description of EUT	7
3.2 Description of Test Modes	10
3.2.1 Test Mode Applicability and Tested Channel Detail	11
3.3 Duty Cycle of Test Signal	13
3.4 Description of Support Units	15
3.4.1 Configuration of System under Test	16
3.5 General Description of Applied Standard	17
4 Test Types and Results	18
4.1 Radiated Emission and Bandedge Measurement.....	18
4.1.1 Limits of Radiated Emission and Bandedge Measurement	18
4.1.2 Test Instruments	19
4.1.3 Test Procedure	20
4.1.4 Deviation from Test Standard	20
4.1.5 Test Setup.....	21
4.1.6 EUT Operating Condition	22
4.1.7 Test Results	23
4.2 Conducted Emission Measurement	43
4.2.1 Limits of Conducted Emission Measurement	43
4.2.2 Test Instruments	43
4.2.3 Test Procedure	44
4.2.4 Deviation from Test Standard	44
4.2.5 Test Setup.....	44
4.2.6 EUT Operating Condition	44
4.2.7 Test Results	45
4.3 Transmit Power Measurement	47
4.3.1 Limits of Transmit Power Measurement	47
4.3.2 Test Setup.....	47
4.3.3 Test Instruments	47
4.3.4 Test Procedure	48
4.3.5 Deviation from Test Standard	48
4.3.6 EUT Operating Condition	48
4.3.7 Test Results	49
4.4 Occupied Bandwidth Measurement	53
4.4.1 Test Setup.....	53
4.4.2 Test Instruments	53
4.4.3 Test Procedure	53
4.4.4 Test Results	54
4.5 Peak Power Spectral Density Measurement	56
4.5.1 Limits of Peak Power Spectral Density Measurement	56
4.5.2 Test Setup.....	56
4.5.3 Test Instruments	56
4.5.4 Test Procedure	56
4.5.5 Deviation from Test Standard	57
4.5.6 EUT Operating Condition	57
4.5.7 Test Results	58
4.6 Frequency Stability Measurement	62
4.6.1 Limits of Frequency Stability Measurement	62

4.6.2	Test Setup.....	62
4.6.3	Test Instruments	62
4.6.4	Test Procedure	62
4.6.5	Deviation from Test Standard	62
4.6.6	EUT Operating Condition	62
4.6.7	Test Results	63
4.7	6dB Bandwidth Measurement.....	64
4.7.1	Limits of 6dB Bandwidth Measurement.....	64
4.7.2	Test Setup.....	64
4.7.3	Test Instruments	64
4.7.4	Test Procedure	64
4.7.5	Deviation from Test Standard	64
4.7.6	EUT Operating Condition	64
4.7.7	Test Results	65
5	Pictures of Test Arrangements.....	67
	Annex A- Radiated Out of Band Emission (OOBE) Measurement (For U-NII-3 band).....	68
	Appendix – Information of the Testing Laboratories	71

Release Control Record

Issue No.	Description	Date Issued
RF190725E05-1	Original release.	Aug. 12, 2019

1 Certificate of Conformity

Product: AX1800 Wi-Fi Router
Brand: NETGEAR
Test Model: RAX20
Series Model: RAX15
Sample Status: ENGINEERING SAMPLE
Applicant: NETGEAR, Inc.
Test Date: July 26 to Aug. 06, 2019
Standard: 47 CFR FCC Part 15, Subpart E (Section 15.407)
ANSI C63.10: 2013

The above equipment has been tested by **Bureau Veritas Consumer Products Services (H.K.) Ltd., Taoyuan Branch**, and found compliance with the requirement of the above standards. The test record, data evaluation & Equipment Under Test (EUT) configurations represented herein are true and accurate accounts of the measurements of the sample's EMC characteristics under the conditions specified in this report.

Prepared by : Phoenix Huang , **Date:** Aug. 12, 2019
Phoenix Huang / Specialist

Approved by : May Chen , **Date:** Aug. 12, 2019
May Chen / Manager

2 Summary of Test Results

47 CFR FCC Part 15, Subpart E (Section 15.407)			
FCC Clause	Test Item	Result	Remarks
15.407(b)(6)	AC Power Conducted Emissions	Pass	Meet the requirement of limit. Minimum passing margin is -10.61dB at 0.30625MHz.
15.407(b) (1/2/3/4(i/ii)/6)	Radiated Emissions & Band Edge Measurement*	Pass	Meet the requirement of limit. Minimum passing margin is -0.1 Test IN PROGRESS dB at , 5148.80MHz, 5149.00MHz, 5149.40MHz, 5150.00MHz, 5649.83MHz & 5926.72MHz.
15.407(a)(1/2/3)	Max Average Transmit Power	Pass	Meet the requirement of limit.
---	Occupied Bandwidth Measurement	-	Reference only.
15.407(a)(1/2/3)	Peak Power Spectral Density	Pass	Meet the requirement of limit.
15.407(e)	6dB bandwidth	Pass	Meet the requirement of limit. (U-NII-3 Band only)
15.407(g)	Frequency Stability	Pass	Meet the requirement of limit.
15.203	Antenna Requirement	Pass	Antenna connector is i-pex(MHF) not a standard connector.

*For U-NII-3 band compliance with rule part 15.407(b)(4)(i), the OOB test plots were recorded in Annex A.

Note:

Determining compliance based on the results of the compliance measurement, not taking into account measurement instrumentation uncertainty.

2.1 Measurement Uncertainty

Where relevant, the following measurement uncertainty levels have been estimated for tests performed on the EUT as specified in CISPR 16-4-2:

Measurement	Frequency	Expanded Uncertainty (k=2) (\pm)
Conducted Emissions at mains ports	150kHz ~ 30MHz	1.8 dB
Radiated Emissions up to 1 GHz	30MHz ~ 1GHz	4.9 dB
Radiated Emissions above 1 GHz	1GHz ~ 6GHz	5.1 dB
	6GHz ~ 18GHz	4.9 dB
	18GHz ~ 40GHz	5.2 dB

2.2 Modification Record

There were no modifications required for compliance.

3 General Information

3.1 General Description of EUT

Product	AX1800 Wi-Fi Router
Brand	NETGEAR
Test Model	RAX20
Series Model	RAX15
Status of EUT	ENGINEERING SAMPLE
Power Supply Rating	DC 12V from power adapter
Modulation Type	CCK, DQPSK, DBPSK for DSSS 64QAM, 16QAM, QPSK, BPSK for OFDM 256QAM for OFDM in VHT20/40 mode 1024QAM for OFDM in 11ac mode 1024QAM for OFDMA in 11ax HE mode
Modulation Technology	DSSS, OFDM, OFDMA
Transfer Rate	802.11b: up to 11Mbps 802.11a/g: up to 54Mbps 802.11n: up to 600Mbps 802.11ac: up to 866.7Mbps 802.11ax: up to 1201Mbps
Operating Frequency	2.4GHz: 2.412 ~ 2.462 GHz 5GHz: 5.18~ 5.24 GHz, 5.745 ~ 5.825 GHz
Number of Channel	2.4GHz: 802.11b, 802.11g, 802.11n (HT20), VHT20, 802.11ax (HE20): 11 802.11n (HT40), VHT40, 802.11ax (HE40): 7 5GHz: 802.11a, 802.11n (HT20), 802.11ac (VHT20), 802.11ax (HE20): 9 802.11n (HT40), 802.11ac (VHT40), 802.11ax (HE40): 4 802.11ac (VHT80), 802.11ax (HE80): 2
Output Power	Non-Beamforming Mode: 2.412 ~ 2.462 GHz: 980.128 mW 5.18 ~ 5.24 GHz: 867.058 mW 5.745 ~ 5.825 GHz: 931.038 mW Beamforming Mode: 2.412 ~ 2.462 GHz: 799.892 mW 5.18 ~ 5.24 GHz: 867.058 mW 5.745 ~ 5.825 GHz: 928.632 mW
Antenna Type	Refer to Note
Antenna Connector	Refer to Note
Accessory Device	Adapter x 1
Data Cable Supplied	RJ45 cable x 1 (Unshielded, 1.8m)

Note:

1. The EUT has two model names which are identical to each other in all aspects except for the followings:

Brand Name	Model Name	Description
NETGEAR	RAX20	For different marketing
NETGEAR	RAX15	

Note: From the above models, model: RAX20 was selected as representative model for the test and its data was recorded in this report.

2. Simultaneously transmission condition.

Condition	Technology	
1	WLAN (2.4GHz)	WLAN 5GHz

Note: The emission of the simultaneous operation has been evaluated and no non-compliance was found.

3. The EUT must be supplied one power adapter and following different models could be chosen as following table:

No.	Brand	Model No.	P/N	Spec.
1	NETGEAR	2ABL030F 1 NA	332-10758-01	Input: 100-120Vac, 1.0A, 50/60Hz Output: 12V, 2.5A DC Output cable: Unshielded, 1.8m
2	NETGEAR	AD2067F10	332-10797-01	Input: 100-120Vac, 1.0A, 50/60Hz Output: 12V, 2.5A DC Output cable: Unshielded, 1.8m

Note: From the above adapters, the AC Power Conducted Emissions and Radiated Emissions worse case was found in **Adapter 1**. Therefore only the test data of the mode was recorded in this report.

4. The antennas provided to the EUT, please refer to the following table:

Antenna No.	Transmitter Circuit	Antenna Net Gain (dBi)	Frequency Range (GHz)	Antenna Type	Connector Type	Cable Length (mm)
1	Chain 0	2.36	2.4~2.4835	Dipole	i-pex(MHF)	140
		3.38	5.15~5.25			
		2.94	5.25~5.35			
		2.25	5.47~5.725			
		2.12	5.725~5.85			
2	Chain 1	1.86	2.4~2.4835	Dipole	i-pex(MHF)	210
		3.39	5.15~5.25			
		2.8	5.25~5.35			
		1.83	5.47~5.725			
		1.65	5.725~5.85			

5. The EUT incorporates a MIMO function:

2.4GHz Band		
MODULATION MODE	TX & RX CONFIGURATION	
802.11b	2TX	2RX
802.11g	2TX	2RX
802.11n (HT20)	2TX	2RX
802.11n (HT40)	2TX	2RX
VHT20	2TX	2RX
VHT40	2TX	2RX
802.11ax (HE20)	2TX	2RX
802.11ax (HE40)	2TX	2RX
5GHz Band		
MODULATION MODE	TX & RX CONFIGURATION	
802.11a	2TX	2RX
802.11n (HT20)	2TX	2RX
802.11n (HT40)	2TX	2RX
802.11ac (VHT20)	2TX	2RX
802.11ac (VHT40)	2TX	2RX
802.11ac (VHT80)	2TX	2RX
802.11ax (HE20)	2TX	2RX
802.11ax (HE40)	2TX	2RX
802.11ax (HE80)	2TX	2RX

Note:

1. All of modulation mode support beamforming function except 802.11a/b/g modulation mode.
2. The EUT support Beamforming and Non-Beamforming mode, therefore both mode were investigated and the worst case scenario was identified. The worst case data were presented in test report.
3. The modulation and bandwidth are similar for 802.11n mode for 20MHz (40MHz), 802.11ac mode for 20MHz (40MHz, 80MHz) and 802.11ax mode for 20MHz (40MHz, 80MHz), therefore investigated worst case to representative mode in test report. (Final test mode refer section 3.2.1)

6. The above EUT information is declared by manufacturer and for more detailed features description, please refers to the manufacturer's specifications or user's manual.

3.2 Description of Test Modes

FOR 5180 ~ 5240MHz

4 channels are provided for 802.11a, 802.11n (HT20), 802.11ac (VHT20), 802.11ax (HE20):

Channel	Frequency	Channel	Frequency
36	5180 MHz	44	5220 MHz
40	5200 MHz	48	5240 MHz

2 channels are provided for 802.11n (HT40), 802.11ac (VHT40), 802.11ax (HE40):

Channel	Frequency	Channel	Frequency
38	5190 MHz	46	5230 MHz

1 channel is provided for 802.11ac (VHT80), 802.11ax (HE80):

Channel	Frequency
42	5210 MHz

FOR 5745 ~ 5825MHz:

5 channels are provided for 802.11a, 802.11n (HT20), 802.11ac (VHT20), 802.11ax (HE20):

Channel	Frequency	Channel	Frequency
149	5745 MHz	161	5805 MHz
153	5765 MHz	165	5825 MHz
157	5785 MHz		

2 channels are provided for 802.11n (HT40), 802.11ac (VHT40), 802.11ax (HE40):

Channel	Frequency	Channel	Frequency
151	5755 MHz	159	5795 MHz

1 channel is provided for 802.11ac (VHT80), 802.11ax (HE80):

Channel	Frequency
155	5775 MHz

3.2.1 Test Mode Applicability and Tested Channel Detail

EUT Configure Mode	Applicable To				Description
	RE≥1G	RE<1G	PLC	APCM	
1	√	√	√	√	-

Where **RE≥1G**: Radiated Emission above 1GHz

RE<1G: Radiated Emission below 1GHz

PLC: Power Line Conducted Emission

APCM: Antenna Port Conducted Measurement

Note: The EUT had been pre-tested on the positioned of each 3 axis. The worst case was found when positioned on **X-plane (below 1GHz) & Z-plane (above 1GHz)**.

Radiated Emission Test (Above 1GHz):

- Pre-Scan has been conducted to determine the worst-case mode from all possible combinations between available modulations, data rates and antenna ports (if EUT with antenna diversity architecture).
- Following channel(s) was (were) selected for the final test as listed below.

Non-Beamforming Mode						
Mode	Freq. Band (MHz)	Available Channel	Tested Channel	Modulation Technology	Modulation Type	Data Rate Parameter
802.11a	5180-5240	36 to 48	36, 40, 48	OFDM	BPSK	6Mb/s
802.11ax (HE20)		36 to 48	36, 40, 48	OFDMA	BPSK	MCS0
802.11ax (HE40)		38 to 46	38, 46	OFDMA	BPSK	MCS0
802.11ax (HE80)		42	42	OFDMA	BPSK	MCS0
802.11a	5745-5825	149 to 165	149, 157, 165	OFDM	BPSK	6Mb/s
802.11ax (HE20)		149 to 165	149, 157, 165	OFDMA	BPSK	MCS0
802.11ax (HE40)		151 to 159	151, 159	OFDMA	BPSK	MCS0
802.11ax (HE80)		155	155	OFDMA	BPSK	MCS0

Radiated Emission Test (Below 1GHz):

- Pre-Scan has been conducted to determine the worst-case mode from all possible combinations between available modulations, data rates and antenna ports (if EUT with antenna diversity architecture).
- Following channel(s) was (were) selected for the final test as listed below.

Non-Beamforming Mode						
Mode	Freq. Band (MHz)	Available Channel	Tested Channel	Modulation Technology	Modulation Type	Data Rate Parameter
802.11ax (HE20)	5180-5240 5745-5825	36 to 48 149 to 165	48	OFDMA	BPSK	MCS0

Power Line Conducted Emission Test:

- Pre-Scan has been conducted to determine the worst-case mode from all possible combinations between available modulations, data rates and antenna ports (if EUT with antenna diversity architecture).
- Following channel(s) was (were) selected for the final test as listed below.

Non-Beamforming Mode						
Mode	Freq. Band (MHz)	Available Channel	Tested Channel	Modulation Technology	Modulation Type	Data Rate Parameter
802.11ax (HE20)	5180-5240 5745-5825	36 to 48 149 to 165	48	OFDMA	BPSK	MCS0

Antenna Port Conducted Measurement:

- This item includes all test value of each mode, but only includes spectrum plot of worst value of each mode.
- Pre-Scan has been conducted to determine the worst-case mode from all possible combinations between available modulations, data rates and antenna ports (if EUT with antenna diversity architecture).
- Following channel(s) was (were) selected for the final test as listed below.

Non-Beamforming Mode						
Mode	Freq. Band (MHz)	Available Channel	Tested Channel	Modulation Technology	Modulation Type	Data Rate Parameter
802.11a	5180-5240	36 to 48	36, 40, 48	OFDM	BPSK	6Mb/s
802.11ac (VHT20) (Output power only)		36 to 48	36, 40, 48	OFDM	BPSK	MCS0
802.11ac (VHT40) (Output power only)		38 to 46	38, 46	OFDM	BPSK	MCS0
802.11ac (VHT80) (Output power only)		42	42	OFDM	BPSK	MCS0
802.11ax (HE20)		36 to 48	36, 40, 48	OFDMA	BPSK	MCS0
802.11ax (HE40)		38 to 46	38, 46	OFDMA	BPSK	MCS0
802.11ax (HE80)		42	42	OFDMA	BPSK	MCS0
802.11a	5745-5825	149 to 165	149, 157, 165	OFDM	BPSK	6Mb/s
802.11ac (VHT20) (Output power only)		149 to 165	149, 157, 165	OFDM	BPSK	MCS0
802.11ac (VHT40) (Output power only)		151 to 159	151, 159	OFDM	BPSK	MCS0
802.11ac (VHT80) (Output power only)		155	155	OFDM	BPSK	MCS0
802.11ax (HE20)		149 to 165	149, 157, 165	OFDMA	BPSK	MCS0
802.11ax (HE40)		151 to 159	151, 159	OFDMA	BPSK	MCS0
802.11ax (HE80)		155	155	OFDMA	BPSK	MCS0
Beamforming Mode (output power only)						
Mode	Freq. Band (MHz)	Available Channel	Tested Channel	Modulation Technology	Modulation Type	Data Rate Parameter
802.11ac (VHT20)	5180-5240	36 to 48	36, 40, 48	OFDM	BPSK	MCS0
802.11ac (VHT40)		38 to 46	38, 46	OFDM	BPSK	MCS0
802.11ac (VHT80)		42	42	OFDM	BPSK	MCS0
802.11ax (HE20)		36 to 48	36, 40, 48	OFDMA	BPSK	MCS0
802.11ax (HE40)		38 to 46	38, 46	OFDMA	BPSK	MCS0
802.11ax (HE80)		42	42	OFDMA	BPSK	MCS0
802.11ac (VHT20)	5745-5825	149 to 165	149, 157, 165	OFDM	BPSK	MCS0
802.11ac (VHT40)		151 to 159	151, 159	OFDM	BPSK	MCS0
802.11ac (VHT80)		155	155	OFDM	BPSK	MCS0
802.11ax (HE20)		149 to 165	149, 157, 165	OFDMA	BPSK	MCS0
802.11ax (HE40)		151 to 159	151, 159	OFDMA	BPSK	MCS0
802.11ax (HE80)		155	155	OFDMA	BPSK	MCS0

Test Condition:

Applicable To	Environmental Conditions	Input Power	Tested By
RE _≥ 1G	20deg. C, 70%RH	120Vac, 60Hz	Tank Wu
RE _{<} 1G	25deg. C, 65%RH	120Vac, 60Hz	Chris Lin
PLC	23deg. C, 67%RH	120Vac, 60Hz	Ryan Chen
APCM	23deg. C, 76%RH	120Vac, 60Hz	Andy Ho

3.3 Duty Cycle of Test Signal

If duty cycle of test signal is $\geq 98\%$, duty factor is not required.

If duty cycle of test signal is $< 98\%$, duty factor shall be considered.

802.11a: Duty cycle = $4.042 \text{ ms} / 4.094 \text{ ms} = 0.987$

802.11ac (VHT20): Duty cycle = $3.755 \text{ ms} / 3.797 \text{ ms} = 0.989$

802.11ac (VHT40): Duty cycle = $1.827 \text{ ms} / 1.866 \text{ ms} = 0.979$, Duty factor = $10 * \log(1/\text{Duty cycle}) = 0.09$

802.11ac (VHT80): Duty cycle = $0.87 \text{ ms} / 0.902 \text{ ms} = 0.965$, Duty factor = $10 * \log(1/\text{Duty cycle}) = 0.16$

802.11ax (HE20): Duty cycle = $2.871 \text{ ms} / 2.919 \text{ ms} = 0.984$

802.11ax (HE40): Duty cycle = $1.466 \text{ ms} / 1.506 \text{ ms} = 0.973$, Duty factor = $10 * \log(1/\text{Duty cycle}) = 0.12$

802.11ax (HE80): Duty cycle = $0.734 \text{ ms} / 0.766 \text{ ms} = 0.958$, Duty factor = $10 * \log(1/\text{Duty cycle}) = 0.19$

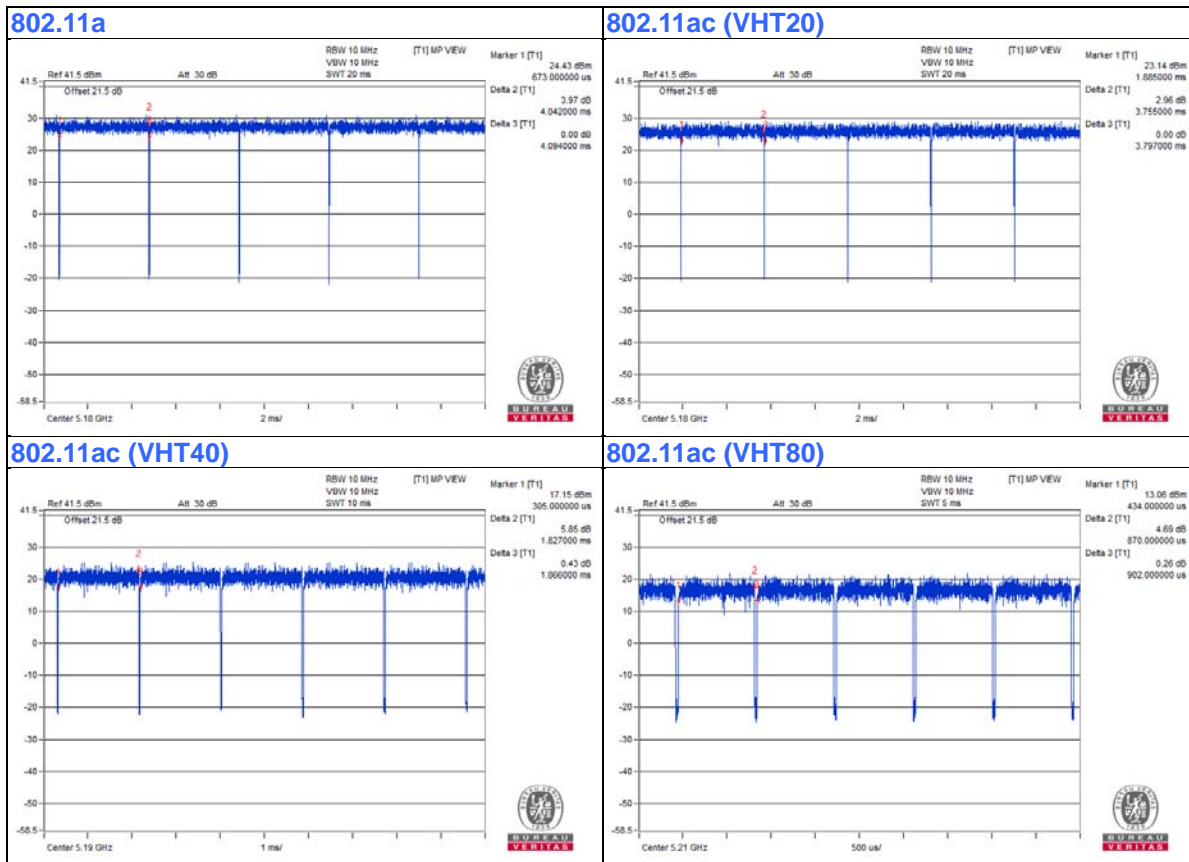

802.11ax (HE20)

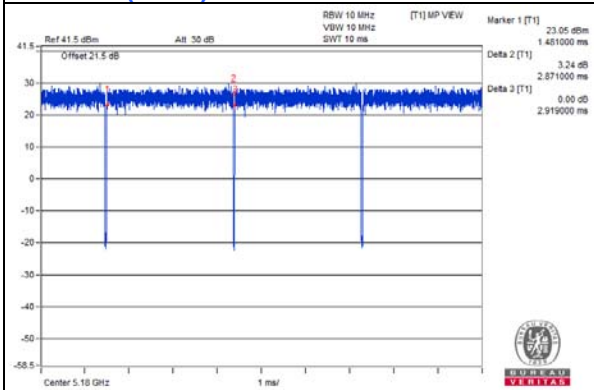

802.11ax (HE40)

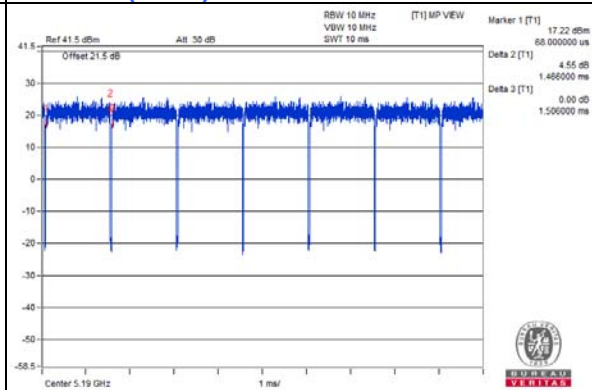

802.11ax (HE80)

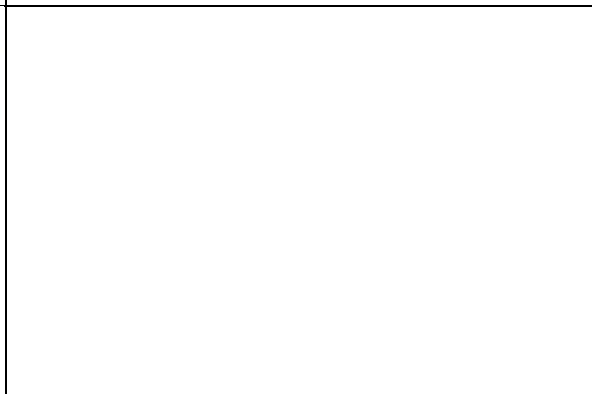
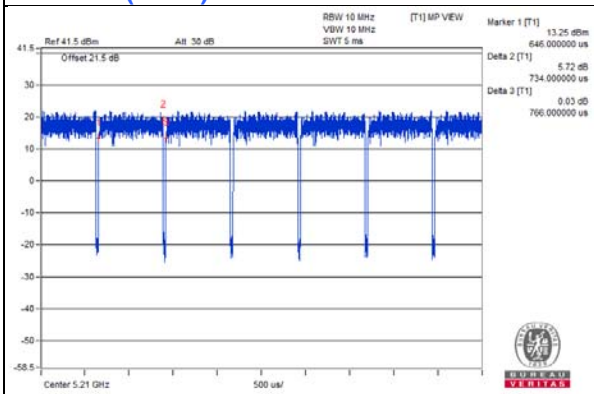

3.4 Description of Support Units

The EUT has been tested as an independent unit together with other necessary accessories or support units. The following support units or accessories were used to form a representative test configuration during the tests.

ID	Product	Brand	Model No.	Serial No.	FCC ID	Remarks
A.	Laptop	Lenovo	81A4	YD02YN2A	PD93165NGU	Provided by Lab
B.	Laptop	Lenovo	81A4	YD02YN22	PD93165NGU	Provided by Lab
C.	USB Disk	SanDisk	USB 3.0 Flash Drive	NA	NA	Provided by Lab

Note:

1. All power cords of the above support units are non-shielded (1.8m).

ID	Descriptions	Qty.	Length (m)	Shielding (Yes/No)	Cores (Qty.)	Remarks
1.	DC Cable	1	1.8	No	0	Supplied by client
2.	RJ-45 Cable	1	10	No	0	Provided by Lab
3.	RJ-45 Cable	1	10	No	0	Provided by Lab

3.4.1 Configuration of System under Test

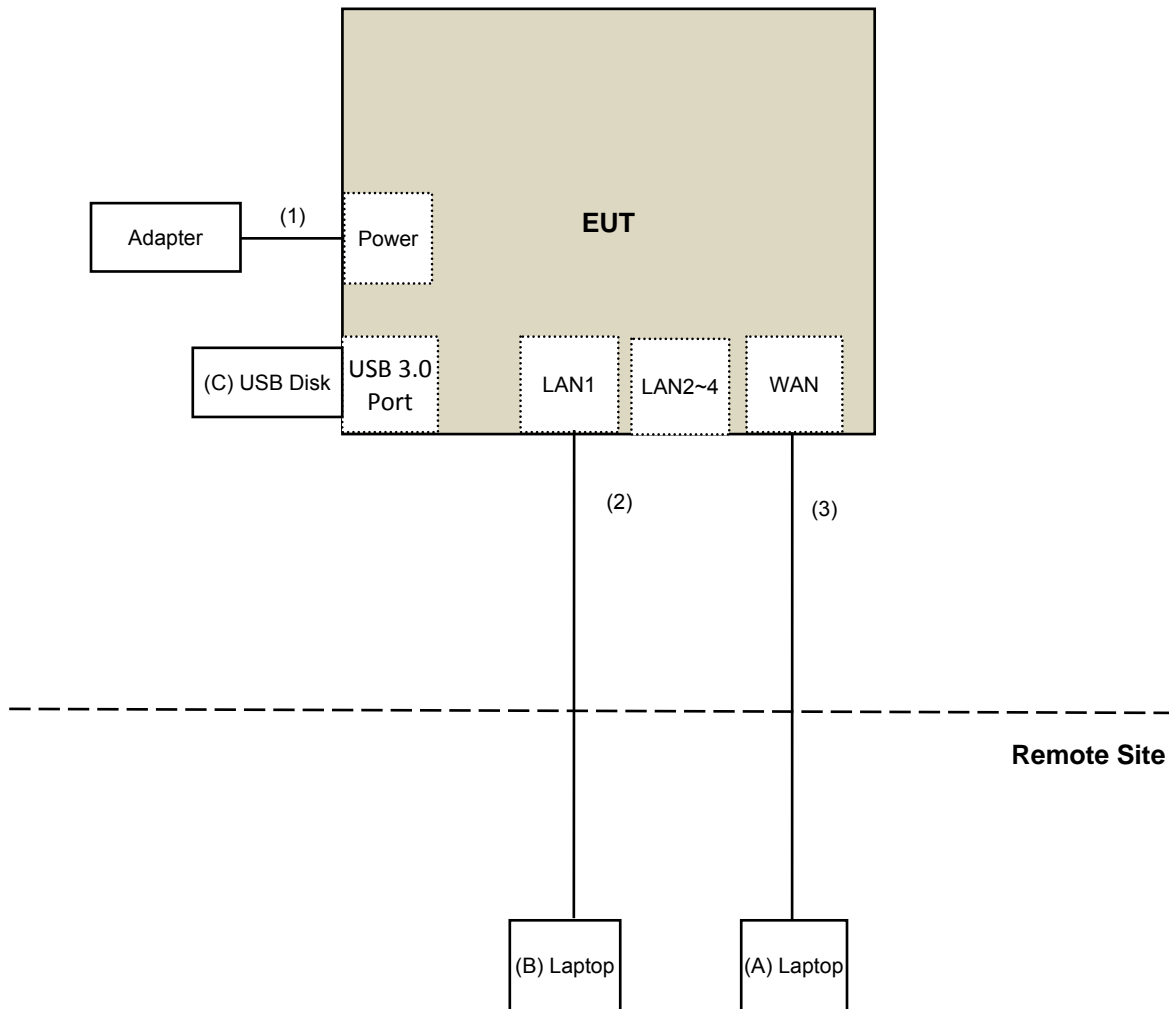

3.5 General Description of Applied Standard

The EUT is a RF Product. According to the specifications of the manufacturer, it must comply with the requirements of the following standards:

FCC Part 15, Subpart E (15.407)

KDB 789033 D02 General UNII Test Procedure New Rules v02r01

KDB 662911 D01 Multiple Transmitter Output v02r01

ANSI C63.10-2013

All test items have been performed and recorded as per the above standards.

4 Test Types and Results

4.1 Radiated Emission and Bandedge Measurement

4.1.1 Limits of Radiated Emission and Bandedge Measurement

Radiated emissions which fall in the restricted bands must comply with the radiated emission limits specified as below table.

Frequencies (MHz)	Field Strength (microvolts/meter)	Measurement Distance (meters)
0.009 ~ 0.490	2400/F(kHz)	300
0.490 ~ 1.705	24000/F(kHz)	30
1.705 ~ 30.0	30	30
30 ~ 88	100	3
88 ~ 216	150	3
216 ~ 960	200	3
Above 960	500	3

NOTE:

- The lower limit shall apply at the transition frequencies.
- Emission level (dBuV/m) = 20 log Emission level (uV/m).
- For frequencies above 1000MHz, the field strength limits are based on average detector, however, the peak field strength of any emission shall not exceed the maximum permitted average limits, specified above by more than 20dB under any condition of modulation.

Limits of unwanted emission out of the restricted bands

Applicable To		Limit	
789033 D02 General UNII Test Procedure New Rules v02r01		Field Strength at 3m	
		PK:74 (dBuV/m)	AV:54 (dBuV/m)
Frequency Band	Applicable To	EIRP Limit	Equivalent Field Strength at 3m
5150~5250 MHz	15.407(b)(1)	PK:-27 (dBm/MHz)	PK:68.2(dBuV/m)
5250~5350 MHz	15.407(b)(2)		
5470~5725 MHz	15.407(b)(3)		
5725~5850 MHz	<input checked="" type="checkbox"/> 15.407(b)(4)(i)	PK:-27 (dBm/MHz) ^{*1} PK:10 (dBm/MHz) ^{*2} PK:15.6 (dBm/MHz) ^{*3} PK:27 (dBm/MHz) ^{*4}	PK: 68.2(dBuV/m) ^{*1} PK:105.2 (dBuV/m) ^{*2} PK: 110.8(dBuV/m) ^{*3} PK:122.2 (dBuV/m) ^{*4}
	<input type="checkbox"/> 15.407(b)(4)(ii)	Emission limits in section 15.247(d)	
*1 beyond 75 MHz or more above of the band edge.		*2 below the band edge increasing linearly to 10 dBm/MHz at 25 MHz above.	
*3 below the band edge increasing linearly to a level of 15.6 dBm/MHz at 5 MHz above.		*4 from 5 MHz above or below the band edge increasing linearly to a level of 27 dBm/MHz at the band edge.	

Note:

The following formula is used to convert the equipment isotropic radiated power (eirp) to field strength:

$$E = \frac{1000000\sqrt{30P}}{3} \mu\text{V/m, where } P \text{ is the eirp (Watts).}$$

4.1.2 Test Instruments

DESCRIPTION & MANUFACTURER	MODEL NO.	SERIAL NO.	CALIBRATED DATE	CALIBRATED UNTIL
Test Receiver Keysight	N9038A	MY54450088	July 03, 2019	July 02, 2020
Pre-Amplifier EMCI	EMC001340	980142	Jan. 25, 2019	Jan. 24, 2020
Loop Antenna Electro-Metrics	EM-6879	269	Sep. 07, 2018	Sep. 06, 2019
RF Cable	NA	LOOPCAB-001	Jan. 14, 2019	Jan. 13, 2020
RF Cable	NA	LOOPCAB-002	Jan. 14, 2019	Jan. 13, 2020
Pre-Amplifier Mini-Circuits	ZFL-1000VH2B	AMP-ZFL-01	Oct. 30, 2018	Oct. 29, 2019
Trilog Broadband Antenna SCHWARZBECK	VULB 9168	9168-406	Nov. 22, 2018	Nov. 21, 2019
RF Cable	8D	966-4-1	Mar. 19, 2019	Mar. 18, 2020
RF Cable	8D	966-4-2	Mar. 19, 2019	Mar. 18, 2020
RF Cable	8D	966-4-3	Mar. 19, 2019	Mar. 18, 2020
Fixed attenuator Mini-Circuits	UNAT-5+	PAD-3m-4-01	Sep. 27, 2018	Sep. 26, 2019
Horn_Antenna SCHWARZBECK	BBHA 9120D	9120D-783	Nov. 25, 2018	Nov. 24, 2019
Pre-Amplifier EMCI	EMC12630SE	980385	Aug. 16, 2018	Aug. 15, 2019
RF Cable	EMC104-SM-SM-1200	160923	Jan. 28, 2019	Jan. 27, 2020
RF Cable	104 RF cable	131215	Jan. 10, 2019	Jan. 09, 2020
RF Cable	EMC104-SM-SM-6000	180418	May 03, 2019	May 02, 2020
Pre-Amplifier EMCI	EMC184045SE	980387	Jan. 28, 2019	Jan. 27, 2020
Horn_Antenna SCHWARZBECK	BBHA 9170	BBHA9170519	Nov. 25, 2018	Nov. 24, 2019
RF Cable	EMC102-KM-KM-1200	160924	Jan. 28, 2019	Jan. 27, 2020
RF Cable	EMC102-KM-KM-1200	160925	Jan. 28, 2019	Jan. 27, 2020
Software	ADT_Radiated_V8.7.08	NA	NA	NA
Boresight Antenna Tower & Turn Table Max-Full	MF-7802BS	MF780208530	NA	NA
Spectrum Analyzer R&S	FSV40	100964	June 04, 2019	June 03, 2020
Power meter Anritsu	ML2495A	1014008	May 13, 2019	May 12, 2020
Power sensor Anritsu	MA2411B	0917122	May 13, 2019	May 12, 2020
Fixed Attenuator Mini-Circuits	MDCS18N-10	MDCS18N-10-01	Apr. 15, 2019	Apr. 14, 2020
AC Power Source Extech Electronics	6205	1440452	NA	NA
Temperature & Humidity Chamber Giant Force	GTH-150-40-SP-AR	MAA0812-008	Jan. 09, 2019	Jan. 08, 2020
True RMS Clamp Meter FLUKE	325	31130711WS	May 21, 2019	May 20, 2020

Note:

1. The calibration interval of the above test instruments is 12 months and the calibrations are traceable to NML/ROC and NIST/USA.
2. The test was performed in 966 Chamber No. 4.
3. Loop antenna was used for all emissions below 30 MHz.
4. Tested Date: July 26 to Aug. 06, 2019

4.1.3 Test Procedure

For Radiated emission below 30MHz

- a. The EUT was placed on the top of a rotating table 0.8 meters above the ground at a 3 meter chamber room. The table was rotated 360 degrees to determine the position of the highest radiation.
- b. The EUT was set 3 meters away from the interference-receiving antenna, which was mounted on the top of a variable-height antenna tower.
- c. Parallel, perpendicular, and ground-parallel orientations of the antenna are set to make the measurement.
- d. For each suspected emission, the EUT was arranged to its worst case and the rotatable table was turned from 0 degrees to 360 degrees to find the maximum reading.
- e. The test-receiver system was set to Quasi-Peak Detect Function and Specified Bandwidth with Maximum Hold Mode.

Note:

1. The resolution bandwidth and video bandwidth of test receiver/spectrum analyzer is 9kHz at frequency below 30MHz.

For Radiated emission above 30MHz

- a. The EUT was placed on the top of a rotating table 0.8 meters (for 30MHz ~ 1GHz) / 1.5 meters (for above 1GHz) above the ground at 3 meter chamber room for test. The table was rotated 360 degrees to determine the position of the highest radiation.
- b. The EUT was set 3 meters away from the interference-receiving antenna, which was mounted on the top of a variable-height antenna tower.
- c. The height of antenna is varied from one meter to four meters above the ground to determine the maximum value of the field strength. Both horizontal and vertical polarizations of the antenna are set to make the measurement.
- d. For each suspected emission, the EUT was arranged to its worst case and then the antenna was tuned to heights from 1 meter to 4 meters and the rotatable table was turned from 0 degrees to 360 degrees to find the maximum reading.
- e. The test-receiver system was set to quasi-peak detect function and specified bandwidth with maximum hold mode when the test frequency is below 1 GHz.
- f. The test-receiver system was set to peak and average detects function and specified bandwidth with maximum hold mode when the test frequency is above 1 GHz. If the peak reading value also meets average limit, measurement with the average detector is unnecessary.

Note:

1. The resolution bandwidth and video bandwidth of test receiver/spectrum analyzer is 120kHz for Quasi-peak detection (QP) at frequency below 1GHz.
2. The resolution bandwidth of test receiver/spectrum analyzer is 1 MHz and the video bandwidth is 3 MHz for Peak detection (PK) at frequency above 1GHz.
3. The resolution bandwidth of test receiver/spectrum analyzer is 1MHz and the video bandwidth is $\geq 1/T$ (Duty cycle < 98%) or 10Hz (Duty cycle $\geq 98\%$) for Average detection (AV) at frequency above 1GHz.
4. All modes of operation were investigated and the worst-case emissions are reported.

4.1.4 Deviation from Test Standard

No deviation.

4.1.5 Test Setup

For Radiated emission below 30MHz

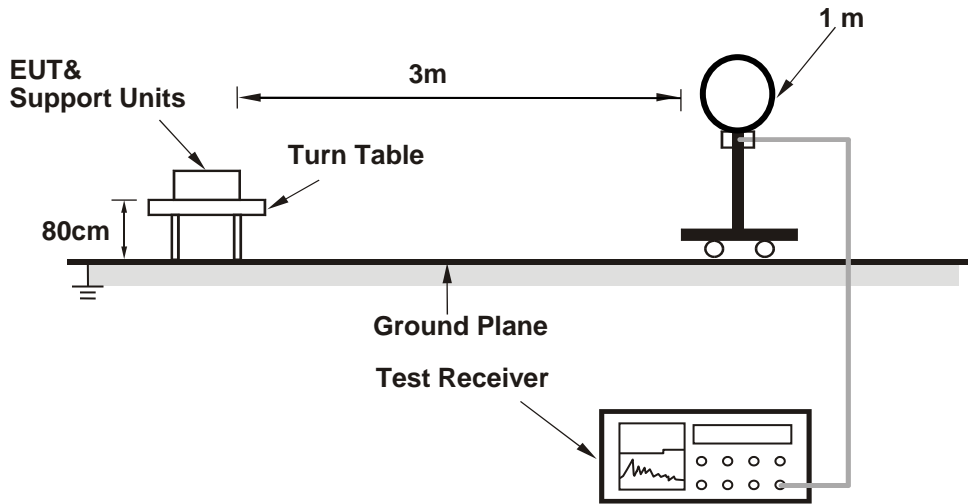

For Radiated emission 30MHz to 1GHz

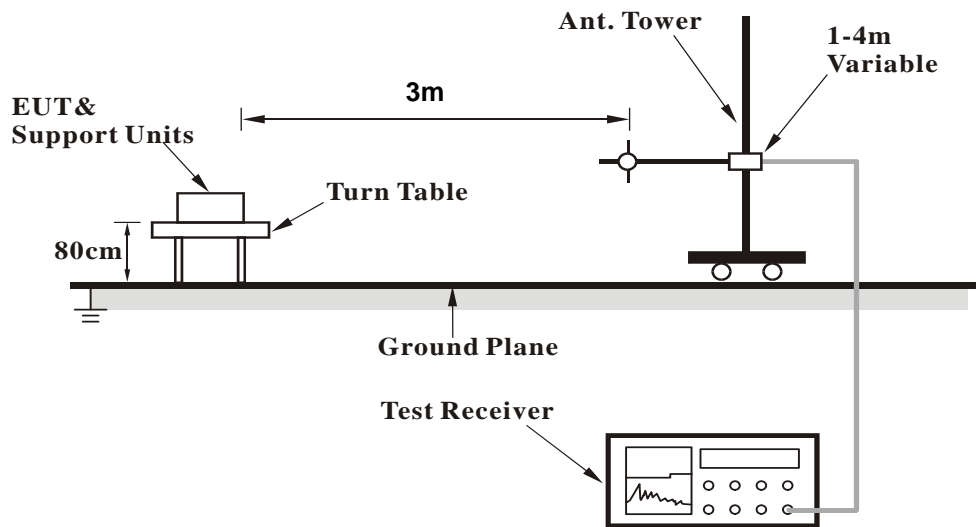

For Radiated emission above 1GHz

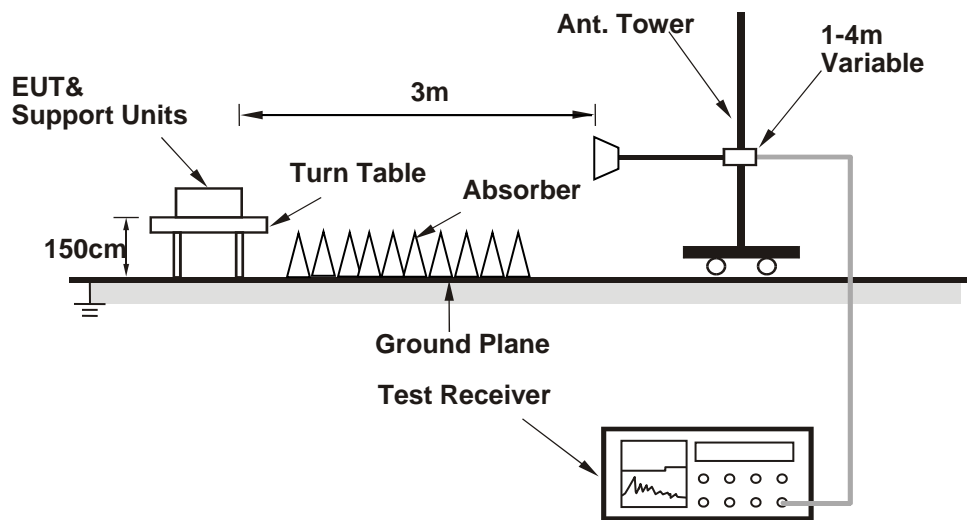

For the actual test configuration, please refer to the attached file (Test Setup Photo).

4.1.6 EUT Operating Condition

- a. Connected the EUT with the Laptop which is placed on remote site.
- b. Controlling software (accessMTool_REL_3_1_0_1) has been activated to set the EUT under transmission condition continuously.

4.1.7 Test Results

Above 1GHz Data:

802.11a

CHANNEL	TX Channel 36	DETECTOR FUNCTION	Peak (PK)
FREQUENCY RANGE	1GHz ~ 40GHz		Average (AV)

ANTENNA POLARITY & TEST DISTANCE: HORIZONTAL AT 3 M								
NO.	FREQ. (MHz)	EMISSION LEVEL (dBuV/m)	LIMIT (dBuV/m)	MARGIN (dB)	ANTENNA HEIGHT (m)	TABLE ANGLE (Degree)	RAW VALUE (dBuV)	CORRECTION FACTOR (dB/m)
1	5150.00	69.9 PK	74.0	-4.1	1.35 H	269	66.4	3.5
2	5150.00	50.3 AV	54.0	-3.7	1.35 H	269	46.8	3.5
3	*5180.00	112.2 PK			1.35 H	269	108.8	3.4
4	*5180.00	101.7 AV			1.35 H	269	98.3	3.4
5	#10360.00	44.8 PK	68.2	-23.4	1.36 H	310	31.7	13.1
6	15540.00	51.6 PK	74.0	-22.4	1.22 H	133	38.0	13.6
7	15540.00	39.6 AV	54.0	-14.4	1.22 H	133	26.0	13.6
ANTENNA POLARITY & TEST DISTANCE: VERTICAL AT 3 M								
NO.	FREQ. (MHz)	EMISSION LEVEL (dBuV/m)	LIMIT (dBuV/m)	MARGIN (dB)	ANTENNA HEIGHT (m)	TABLE ANGLE (Degree)	RAW VALUE (dBuV)	CORRECTION FACTOR (dB/m)
1	5150.00	71.9 PK	74.0	-2.1	1.88 V	174	68.4	3.5
2	5150.00	53.9 AV	54.0	-0.1	1.88 V	174	50.4	3.5
3	*5180.00	118.9 PK			1.88 V	174	115.5	3.4
4	*5180.00	109.3 AV			1.88 V	174	105.9	3.4
5	#10360.00	55.5 PK	68.2	-12.7	1.31 V	159	42.4	13.1
6	15540.00	52.2 PK	74.0	-21.8	1.26 V	338	38.6	13.6
7	15540.00	40.0 AV	54.0	-14.0	1.26 V	338	26.4	13.6

REMARKS:

1. Emission Level(dBuV/m) = Raw Value(dBuV) + Correction Factor(dB/m)
2. Correction Factor(dB/m) = Antenna Factor(dB/m) + Cable Factor(dB) – Pre-Amplifier Factor(dB)
3. Margin value = Emission Level – Limit value
4. The other emission levels were very low against the limit.
5. " * ": Fundamental frequency.
6. " # ": The radiated frequency is out of the restricted band.

CHANNEL	TX Channel 40	DETECTOR FUNCTION	Peak (PK)
FREQUENCY RANGE	1GHz ~ 40GHz		Average (AV)

ANTENNA POLARITY & TEST DISTANCE: HORIZONTAL AT 3 M

NO.	FREQ. (MHz)	EMISSION LEVEL (dBuV/m)	LIMIT (dBuV/m)	MARGIN (dB)	ANTENNA HEIGHT (m)	TABLE ANGLE (Degree)	RAW VALUE (dBuV)	CORRECTION FACTOR (dB/m)
1	5150.00	69.5 PK	74.0	-4.5	1.34 H	275	66.0	3.5
2	5150.00	50.1 AV	54.0	-3.9	1.34 H	275	46.6	3.5
3	*5200.00	110.8 PK			1.34 H	275	107.4	3.4
4	*5200.00	100.7 AV			1.34 H	275	97.3	3.4
5	5350.00	54.9 PK	74.0	-19.1	1.34 H	275	51.6	3.3
6	5350.00	43.7 AV	54.0	-10.3	1.34 H	275	40.4	3.3
7	#10400.00	48.5 PK	68.2	-19.7	1.39 H	306	35.1	13.4
8	15600.00	54.5 PK	74.0	-19.5	1.25 H	125	41.1	13.4
9	15600.00	42.7 AV	54.0	-11.3	1.25 H	125	29.3	13.4

ANTENNA POLARITY & TEST DISTANCE: VERTICAL AT 3 M

NO.	FREQ. (MHz)	EMISSION LEVEL (dBuV/m)	LIMIT (dBuV/m)	MARGIN (dB)	ANTENNA HEIGHT (m)	TABLE ANGLE (Degree)	RAW VALUE (dBuV)	CORRECTION FACTOR (dB/m)
1	5150.00	73.1 PK	74.0	-0.9	1.88 V	171	69.6	3.5
2	5150.00	53.9 AV	54.0	-0.1	1.88 V	171	50.4	3.5
3	*5200.00	122.6 PK			1.88 V	171	119.2	3.4
4	*5200.00	113.0 AV			1.88 V	171	109.6	3.4
5	5350.00	58.8 PK	74.0	-15.2	1.88 V	171	55.5	3.3
6	5350.00	47.6 AV	54.0	-6.4	1.88 V	171	44.3	3.3
7	#10400.00	59.3 PK	68.2	-8.9	1.28 V	155	45.9	13.4
8	15600.00	55.1 PK	74.0	-18.9	1.24 V	321	41.7	13.4
9	15600.00	43.0 AV	54.0	-11.0	1.24 V	321	29.6	13.4

REMARKS:

1. Emission Level(dBuV/m) = Raw Value(dBuV) + Correction Factor(dB/m)
2. Correction Factor(dB/m) = Antenna Factor(dB/m) + Cable Factor(dB) – Pre-Amplifier Factor(dB)
3. Margin value = Emission Level – Limit value
4. The other emission levels were very low against the limit.
5. " * ": Fundamental frequency.
6. " # ": The radiated frequency is out of the restricted band.

CHANNEL	TX Channel 48	DETECTOR FUNCTION	Peak (PK)
FREQUENCY RANGE	1GHz ~ 40GHz		Average (AV)

ANTENNA POLARITY & TEST DISTANCE: HORIZONTAL AT 3 M

NO.	FREQ. (MHz)	EMISSION LEVEL (dBuV/m)	LIMIT (dBuV/m)	MARGIN (dB)	ANTENNA HEIGHT (m)	TABLE ANGLE (Degree)	RAW VALUE (dBuV)	CORRECTION FACTOR (dB/m)
1	5142.30	57.5 PK	74.0	-16.5	1.29 H	272	54.0	3.5
2	5142.30	46.1 AV	54.0	-7.9	1.29 H	272	42.6	3.5
3	5150.00	57.2 PK	74.0	-16.8	1.29 H	272	53.7	3.5
4	5150.00	45.8 AV	54.0	-8.2	1.29 H	272	42.3	3.5
5	*5240.00	111.0 PK			1.29 H	272	108.0	3.0
6	*5240.00	101.0 AV			1.29 H	272	98.0	3.0
7	5350.00	55.2 PK	74.0	-18.8	1.29 H	272	51.9	3.3
8	5350.00	43.5 AV	54.0	-10.5	1.29 H	272	40.2	3.3
9	#10480.00	48.7 PK	68.2	-19.5	1.36 H	310	35.2	13.5
10	15720.00	54.7 PK	74.0	-19.3	1.27 H	129	41.9	12.8
11	15720.00	42.8 AV	54.0	-11.2	1.27 H	129	30.0	12.8

ANTENNA POLARITY & TEST DISTANCE: VERTICAL AT 3 M

NO.	FREQ. (MHz)	EMISSION LEVEL (dBuV/m)	LIMIT (dBuV/m)	MARGIN (dB)	ANTENNA HEIGHT (m)	TABLE ANGLE (Degree)	RAW VALUE (dBuV)	CORRECTION FACTOR (dB/m)
1	5142.30	61.3 PK	74.0	-12.7	1.92 V	171	57.8	3.5
2	5142.30	49.8 AV	54.0	-4.2	1.92 V	171	46.3	3.5
3	5150.00	60.5 PK	74.0	-13.5	1.92 V	171	57.0	3.5
4	5150.00	48.6 AV	54.0	-5.4	1.92 V	171	45.1	3.5
5	*5240.00	123.6 PK			1.92 V	171	120.6	3.0
6	*5240.00	113.3 AV			1.92 V	171	110.3	3.0
7	5350.00	59.0 PK	74.0	-15.0	1.92 V	171	55.7	3.3
8	5350.00	47.3 AV	54.0	-6.7	1.92 V	171	44.0	3.3
9	#10480.00	59.6 PK	68.2	-8.6	1.33 V	160	46.1	13.5
10	15720.00	55.3 PK	74.0	-18.7	1.22 V	319	42.5	12.8
11	15720.00	43.3 AV	54.0	-10.7	1.22 V	319	30.5	12.8

REMARKS:

1. Emission Level(dBuV/m) = Raw Value(dBuV) + Correction Factor(dB/m)
2. Correction Factor(dB/m) = Antenna Factor(dB/m) + Cable Factor(dB) – Pre-Amplifier Factor(dB)
3. Margin value = Emission Level – Limit value
4. The other emission levels were very low against the limit.
5. " * ": Fundamental frequency.
6. " # ": The radiated frequency is out of the restricted band.

CHANNEL	TX Channel 149	DETECTOR FUNCTION	Peak (PK)
FREQUENCY RANGE	1GHz ~ 40GHz		Average (AV)

ANTENNA POLARITY & TEST DISTANCE: HORIZONTAL AT 3 M

NO.	FREQ. (MHz)	EMISSION LEVEL (dBuV/m)	LIMIT (dBuV/m)	MARGIN (dB)	ANTENNA HEIGHT (m)	TABLE ANGLE (Degree)	RAW VALUE (dBuV)	CORRECTION FACTOR (dB/m)
1	#5642.28	58.9 PK	68.2	-9.3	1.28 H	269	55.3	3.6
2	*5745.00	114.6 PK			1.28 H	269	110.7	3.9
3	*5745.00	103.6 AV			1.28 H	269	99.7	3.9
4	#5978.66	54.4 PK	68.2	-13.8	1.28 H	269	50.0	4.4
5	11490.00	50.6 PK	74.0	-23.4	1.34 H	311	36.4	14.2
6	11490.00	39.5 AV	54.0	-14.5	1.34 H	311	25.3	14.2
7	#17235.00	54.3 PK	68.2	-13.9	1.26 H	124	37.0	17.3

ANTENNA POLARITY & TEST DISTANCE: VERTICAL AT 3 M

NO.	FREQ. (MHz)	EMISSION LEVEL (dBuV/m)	LIMIT (dBuV/m)	MARGIN (dB)	ANTENNA HEIGHT (m)	TABLE ANGLE (Degree)	RAW VALUE (dBuV)	CORRECTION FACTOR (dB/m)
1	#5649.83	68.1 PK	68.2	-0.1	1.55 V	1	64.5	3.6
2	*5745.00	127.2 PK			1.55 V	1	123.3	3.9
3	*5745.00	115.9 AV			1.55 V	1	112.0	3.9
4	#6020.37	60.2 PK	68.2	-8.0	1.55 V	1	55.8	4.4
5	11490.00	61.5 PK	74.0	-12.5	1.32 V	156	47.3	14.2
6	11490.00	50.8 AV	54.0	-3.2	1.32 V	156	36.6	14.2
7	#17235.00	56.1 PK	68.2	-12.1	1.20 V	316	38.8	17.3

REMARKS:

- Emission Level(dBuV/m) = Raw Value(dBuV) + Correction Factor(dB/m)
- Correction Factor(dB/m) = Antenna Factor(dB/m) + Cable Factor(dB) – Pre-Amplifier Factor(dB)
- Margin value = Emission Level – Limit value
- The other emission levels were very low against the limit.
- " * ": Fundamental frequency.
- " # ": The radiated frequency is out of the restricted band.

CHANNEL	TX Channel 157	DETECTOR FUNCTION	Peak (PK)
FREQUENCY RANGE	1GHz ~ 40GHz		Average (AV)

ANTENNA POLARITY & TEST DISTANCE: HORIZONTAL AT 3 M

NO.	FREQ. (MHz)	EMISSION LEVEL (dBuV/m)	LIMIT (dBuV/m)	MARGIN (dB)	ANTENNA HEIGHT (m)	TABLE ANGLE (Degree)	RAW VALUE (dBuV)	CORRECTION FACTOR (dB/m)
1	#5587.48	54.2 PK	68.2	-14.0	1.49 H	334	50.5	3.7
2	*5785.00	114.8 PK			1.49 H	335	110.8	4.0
3	*5785.00	103.7 AV			1.49 H	335	99.7	4.0
4	#6001.14	53.4 PK	68.2	-14.8	1.49 H	334	49.0	4.4
5	11570.00	50.6 PK	74.0	-23.4	1.50 H	319	36.4	14.2
6	11570.00	39.6 AV	54.0	-14.4	1.50 H	319	25.4	14.2
7	#17355.00	54.1 PK	68.2	-14.1	1.31 H	81	36.4	17.7

ANTENNA POLARITY & TEST DISTANCE: VERTICAL AT 3 M

NO.	FREQ. (MHz)	EMISSION LEVEL (dBuV/m)	LIMIT (dBuV/m)	MARGIN (dB)	ANTENNA HEIGHT (m)	TABLE ANGLE (Degree)	RAW VALUE (dBuV)	CORRECTION FACTOR (dB/m)
1	#5576.87	61.3 PK	68.2	-6.9	1.62 V	2	57.6	3.7
2	*5785.00	126.2 PK			1.63 V	2	122.2	4.0
3	*5785.00	115.1 AV			1.63 V	2	111.1	4.0
4	#5928.37	59.5 PK	68.2	-8.7	1.62 V	2	55.3	4.2
5	11570.00	61.6 PK	74.0	-12.4	1.25 V	112	47.4	14.2
6	11570.00	50.9 AV	54.0	-3.1	1.25 V	112	36.7	14.2
7	#17355.00	56.3 PK	68.2	-11.9	1.00 V	307	38.6	17.7

REMARKS:

1. Emission Level(dBuV/m) = Raw Value(dBuV) + Correction Factor(dB/m)
2. Correction Factor(dB/m) = Antenna Factor(dB/m) + Cable Factor(dB) – Pre-Amplifier Factor(dB)
3. Margin value = Emission Level – Limit value
4. The other emission levels were very low against the limit.
5. " * ": Fundamental frequency.
6. " # ": The radiated frequency is out of the restricted band.

CHANNEL	TX Channel 165	DETECTOR FUNCTION	Peak (PK)
FREQUENCY RANGE	1GHz ~ 40GHz		Average (AV)

ANTENNA POLARITY & TEST DISTANCE: HORIZONTAL AT 3 M

NO.	FREQ. (MHz)	EMISSION LEVEL (dBuV/m)	LIMIT (dBuV/m)	MARGIN (dB)	ANTENNA HEIGHT (m)	TABLE ANGLE (Degree)	RAW VALUE (dBuV)	CORRECTION FACTOR (dB/m)
1	#5586.90	53.0 PK	68.2	-15.2	1.50 H	336	49.3	3.7
2	*5825.00	113.9 PK			1.51 H	336	109.7	4.2
3	*5825.00	102.7 AV			1.51 H	336	98.5	4.2
4	#5947.94	52.7 PK	68.2	-15.5	1.50 H	336	48.3	4.4
5	11650.00	50.5 PK	74.0	-23.5	1.60 H	278	36.6	13.9
6	11650.00	39.4 AV	54.0	-14.6	1.60 H	278	25.5	13.9
7	#17475.00	54.0 PK	68.2	-14.2	1.45 H	100	35.2	18.8

ANTENNA POLARITY & TEST DISTANCE: VERTICAL AT 3 M

NO.	FREQ. (MHz)	EMISSION LEVEL (dBuV/m)	LIMIT (dBuV/m)	MARGIN (dB)	ANTENNA HEIGHT (m)	TABLE ANGLE (Degree)	RAW VALUE (dBuV)	CORRECTION FACTOR (dB/m)
1	#5583.82	60.6 PK	68.2	-7.6	1.51 V	3	56.9	3.7
2	*5825.00	126.8 PK			1.51 V	3	122.6	4.2
3	*5825.00	115.2 AV			1.51 V	3	111.0	4.2
4	#5932.97	66.7 PK	68.2	-1.5	1.51 V	3	62.4	4.3
5	11650.00	61.3 PK	74.0	-12.7	1.46 V	144	47.4	13.9
6	11650.00	50.7 AV	54.0	-3.3	1.46 V	144	36.8	13.9
7	#17475.00	56.0 PK	68.2	-12.2	1.22 V	345	37.2	18.8

REMARKS:

1. Emission Level(dBuV/m) = Raw Value(dBuV) + Correction Factor(dB/m)
2. Correction Factor(dB/m) = Antenna Factor(dB/m) + Cable Factor(dB) – Pre-Amplifier Factor(dB)
3. Margin value = Emission Level – Limit value
4. The other emission levels were very low against the limit.
5. " * ": Fundamental frequency.
6. " # ": The radiated frequency is out of the restricted band.

802.11ax (HE20)

CHANNEL	TX Channel 36	DETECTOR FUNCTION	Peak (PK)
FREQUENCY RANGE	1GHz ~ 40GHz		Average (AV)

ANTENNA POLARITY & TEST DISTANCE: HORIZONTAL AT 3 M

NO.	FREQ. (MHz)	EMISSION LEVEL (dBuV/m)	LIMIT (dBuV/m)	MARGIN (dB)	ANTENNA HEIGHT (m)	TABLE ANGLE (Degree)	RAW VALUE (dBuV)	CORRECTION FACTOR (dB/m)
1	5149.40	67.9 PK	74.0	-6.1	1.62 H	306	64.4	3.5
2	5149.40	49.5 AV	54.0	-4.5	1.62 H	306	46.0	3.5
3	5150.00	67.4 PK	74.0	-6.6	1.62 H	306	63.9	3.5
4	5150.00	49.0 AV	54.0	-5.0	1.62 H	306	45.5	3.5
5	*5180.00	105.7 PK			1.62 H	306	102.3	3.4
6	*5180.00	94.5 AV			1.62 H	306	91.1	3.4
7	#10360.00	45.8 PK	68.2	-22.4	1.47 H	260	32.7	13.1
8	15540.00	52.4 PK	74.0	-21.6	1.31 H	77	38.8	13.6
9	15540.00	40.6 AV	54.0	-13.4	1.31 H	77	27.0	13.6

ANTENNA POLARITY & TEST DISTANCE: VERTICAL AT 3 M

NO.	FREQ. (MHz)	EMISSION LEVEL (dBuV/m)	LIMIT (dBuV/m)	MARGIN (dB)	ANTENNA HEIGHT (m)	TABLE ANGLE (Degree)	RAW VALUE (dBuV)	CORRECTION FACTOR (dB/m)
1	5149.40	72.1 PK	74.0	-1.9	1.91 V	177	68.6	3.5
2	5149.40	53.9 AV	54.0	-0.1	1.91 V	177	50.4	3.5
3	5150.00	71.8 PK	74.0	-2.2	1.91 V	177	68.3	3.5
4	5150.00	53.2 AV	54.0	-0.8	1.91 V	177	49.7	3.5
5	*5180.00	121.4 PK			1.91 V	177	118.0	3.4
6	*5180.00	107.8 AV			1.91 V	177	104.4	3.4
7	#10360.00	57.5 PK	68.2	-10.7	1.46 V	150	44.4	13.1
8	15540.00	53.5 PK	74.0	-20.5	1.19 V	355	39.9	13.6
9	15540.00	41.0 AV	54.0	-13.0	1.19 V	355	27.4	13.6

REMARKS:

- Emission Level(dBuV/m) = Raw Value(dBuV) + Correction Factor(dB/m)
- Correction Factor(dB/m) = Antenna Factor(dB/m) + Cable Factor(dB) – Pre-Amplifier Factor(dB)
- Margin value = Emission Level – Limit value
- The other emission levels were very low against the limit.
- " * ": Fundamental frequency.
- " # ": The radiated frequency is out of the restricted band.

CHANNEL	TX Channel 40	DETECTOR FUNCTION	Peak (PK)
FREQUENCY RANGE	1GHz ~ 40GHz		Average (AV)

ANTENNA POLARITY & TEST DISTANCE: HORIZONTAL AT 3 M

NO.	FREQ. (MHz)	EMISSION LEVEL (dBuV/m)	LIMIT (dBuV/m)	MARGIN (dB)	ANTENNA HEIGHT (m)	TABLE ANGLE (Degree)	RAW VALUE (dBuV)	CORRECTION FACTOR (dB/m)
1	5150.00	67.7 PK	74.0	-6.3	1.66 H	300	64.2	3.5
2	5150.00	49.2 AV	54.0	-4.8	1.66 H	300	45.7	3.5
3	*5200.00	109.3 PK			1.66 H	300	105.9	3.4
4	*5200.00	98.0 AV			1.66 H	300	94.6	3.4
5	5350.00	54.6 PK	74.0	-19.4	1.66 H	300	51.3	3.3
6	5350.00	43.2 AV	54.0	-10.8	1.66 H	300	39.9	3.3
7	#10400.00	50.2 PK	68.2	-18.0	1.59 H	245	36.8	13.4
8	15600.00	56.3 PK	74.0	-17.7	1.26 H	68	42.9	13.4
9	15600.00	44.0 AV	54.0	-10.0	1.26 H	68	30.6	13.4

ANTENNA POLARITY & TEST DISTANCE: VERTICAL AT 3 M

NO.	FREQ. (MHz)	EMISSION LEVEL (dBuV/m)	LIMIT (dBuV/m)	MARGIN (dB)	ANTENNA HEIGHT (m)	TABLE ANGLE (Degree)	RAW VALUE (dBuV)	CORRECTION FACTOR (dB/m)
1	5150.00	70.9 PK	74.0	-3.1	1.87 V	170	67.4	3.5
2	5150.00	53.6 AV	54.0	-0.4	1.87 V	170	50.1	3.5
3	*5200.00	124.4 PK			1.87 V	170	121.0	3.4
4	*5200.00	111.3 AV			1.87 V	170	107.9	3.4
5	5350.00	58.7 PK	74.0	-15.3	1.87 V	170	55.4	3.3
6	5350.00	47.6 AV	54.0	-6.4	1.87 V	170	44.3	3.3
7	#10400.00	61.2 PK	68.2	-7.0	1.44 V	152	47.8	13.4
8	15600.00	57.2 PK	74.0	-16.8	1.19 V	346	43.8	13.4
9	15600.00	44.5 AV	54.0	-9.5	1.19 V	346	31.1	13.4

REMARKS:

1. Emission Level(dBuV/m) = Raw Value(dBuV) + Correction Factor(dB/m)
2. Correction Factor(dB/m) = Antenna Factor(dB/m) + Cable Factor(dB) – Pre-Amplifier Factor(dB)
3. Margin value = Emission Level – Limit value
4. The other emission levels were very low against the limit.
5. " * ": Fundamental frequency.
6. " # ": The radiated frequency is out of the restricted band.

CHANNEL	TX Channel 48	DETECTOR FUNCTION	Peak (PK)
FREQUENCY RANGE	1GHz ~ 40GHz		Average (AV)

ANTENNA POLARITY & TEST DISTANCE: HORIZONTAL AT 3 M

NO.	FREQ. (MHz)	EMISSION LEVEL (dBuV/m)	LIMIT (dBuV/m)	MARGIN (dB)	ANTENNA HEIGHT (m)	TABLE ANGLE (Degree)	RAW VALUE (dBuV)	CORRECTION FACTOR (dB/m)
1	5143.70	56.8 PK	74.0	-17.2	1.58 H	279	53.3	3.5
2	5143.70	45.5 AV	54.0	-8.5	1.58 H	279	42.0	3.5
3	5150.00	55.7 PK	74.0	-18.3	1.58 H	279	52.2	3.5
4	5150.00	45.1 AV	54.0	-8.9	1.58 H	279	41.6	3.5
5	*5240.00	109.8 PK			1.58 H	279	106.8	3.0
6	*5240.00	98.5 AV			1.58 H	279	95.5	3.0
7	5350.00	54.7 PK	74.0	-19.3	1.58 H	279	51.4	3.3
8	5350.00	43.3 AV	54.0	-10.7	1.58 H	279	40.0	3.3
9	#10480.00	50.8 PK	68.2	-17.4	1.52 H	234	37.3	13.5
10	15720.00	56.9 PK	74.0	-17.1	1.25 H	70	44.1	12.8
11	15720.00	44.6 AV	54.0	-9.4	1.25 H	70	31.8	12.8

ANTENNA POLARITY & TEST DISTANCE: VERTICAL AT 3 M

NO.	FREQ. (MHz)	EMISSION LEVEL (dBuV/m)	LIMIT (dBuV/m)	MARGIN (dB)	ANTENNA HEIGHT (m)	TABLE ANGLE (Degree)	RAW VALUE (dBuV)	CORRECTION FACTOR (dB/m)
1	5143.70	63.7 PK	74.0	-10.3	1.86 V	171	60.2	3.5
2	5143.70	49.4 AV	54.0	-4.6	1.86 V	171	45.9	3.5
3	5150.00	62.6 PK	74.0	-11.4	1.86 V	171	59.1	3.5
4	5150.00	48.7 AV	54.0	-5.3	1.86 V	171	45.2	3.5
5	*5240.00	123.3 PK			1.86 V	171	120.3	3.0
6	*5240.00	111.7 AV			1.86 V	171	108.7	3.0
7	5350.00	59.1 PK	74.0	-14.9	1.86 V	171	55.8	3.3
8	5350.00	47.5 AV	54.0	-6.5	1.86 V	171	44.2	3.3
9	#10480.00	61.9 PK	68.2	-6.3	1.33 V	166	48.4	13.5
10	15720.00	57.9 PK	74.0	-16.1	1.18 V	349	45.1	12.8
11	15720.00	45.2 AV	54.0	-8.8	1.18 V	349	32.4	12.8

REMARKS:

1. Emission Level(dBuV/m) = Raw Value(dBuV) + Correction Factor(dB/m)
2. Correction Factor(dB/m) = Antenna Factor(dB/m) + Cable Factor(dB) – Pre-Amplifier Factor(dB)
3. Margin value = Emission Level – Limit value
4. The other emission levels were very low against the limit.
5. " * ": Fundamental frequency.
6. " # ": The radiated frequency is out of the restricted band.

CHANNEL	TX Channel 149	DETECTOR FUNCTION	Peak (PK)
FREQUENCY RANGE	1GHz ~ 40GHz		Average (AV)

ANTENNA POLARITY & TEST DISTANCE: HORIZONTAL AT 3 M

NO.	FREQ. (MHz)	EMISSION LEVEL (dBuV/m)	LIMIT (dBuV/m)	MARGIN (dB)	ANTENNA HEIGHT (m)	TABLE ANGLE (Degree)	RAW VALUE (dBuV)	CORRECTION FACTOR (dB/m)
1	#5636.95	58.7 PK	68.2	-9.5	1.32 H	272	55.1	3.6
2	*5745.00	118.7 PK			1.32 H	273	114.8	3.9
3	*5745.00	103.8 AV			1.32 H	273	99.9	3.9
4	#6006.99	53.5 PK	68.2	-14.7	1.32 H	272	49.1	4.4
5	11490.00	51.2 PK	74.0	-22.8	1.62 H	245	37.0	14.2
6	11490.00	40.0 AV	54.0	-14.0	1.62 H	245	25.8	14.2
7	#17235.00	50.7 PK	68.2	-17.5	1.29 H	73	33.4	17.3

ANTENNA POLARITY & TEST DISTANCE: VERTICAL AT 3 M

NO.	FREQ. (MHz)	EMISSION LEVEL (dBuV/m)	LIMIT (dBuV/m)	MARGIN (dB)	ANTENNA HEIGHT (m)	TABLE ANGLE (Degree)	RAW VALUE (dBuV)	CORRECTION FACTOR (dB/m)
1	#5647.98	66.6 PK	68.2	-1.6	1.52 V	2	63.0	3.6
2	*5745.00	126.4 PK			1.52 V	2	122.5	3.9
3	*5745.00	113.4 AV			1.52 V	2	109.5	3.9
4	#5986.34	60.4 PK	68.2	-7.8	1.52 V	2	56.0	4.4
5	11490.00	61.6 PK	74.0	-12.4	1.30 V	158	47.4	14.2
6	11490.00	50.8 AV	54.0	-3.2	1.30 V	158	36.6	14.2
7	#17235.00	59.2 PK	68.2	-9.0	1.21 V	332	41.9	17.3

REMARKS:

1. Emission Level(dBuV/m) = Raw Value(dBuV) + Correction Factor(dB/m)
2. Correction Factor(dB/m) = Antenna Factor(dB/m) + Cable Factor(dB) – Pre-Amplifier Factor(dB)
3. Margin value = Emission Level – Limit value
4. The other emission levels were very low against the limit.
5. " * ": Fundamental frequency.
6. " # ": The radiated frequency is out of the restricted band.

CHANNEL	TX Channel 157	DETECTOR FUNCTION	Peak (PK)
FREQUENCY RANGE	1GHz ~ 40GHz		Average (AV)

ANTENNA POLARITY & TEST DISTANCE: HORIZONTAL AT 3 M

NO.	FREQ. (MHz)	EMISSION LEVEL (dBuV/m)	LIMIT (dBuV/m)	MARGIN (dB)	ANTENNA HEIGHT (m)	TABLE ANGLE (Degree)	RAW VALUE (dBuV)	CORRECTION FACTOR (dB/m)
1	#5558.68	54.0 PK	68.2	-14.2	1.42 H	267	50.3	3.7
2	*5785.00	114.8 PK			1.42 H	268	110.8	4.0
3	*5785.00	101.9 AV			1.42 H	268	97.9	4.0
4	#5980.15	53.2 PK	68.2	-15.0	1.42 H	267	48.8	4.4
5	11570.00	50.8 PK	74.0	-23.2	1.47 H	330	36.6	14.2
6	11570.00	39.8 AV	54.0	-14.2	1.47 H	330	25.6	14.2
7	#17355.00	54.6 PK	68.2	-13.6	1.25 H	76	36.9	17.7

ANTENNA POLARITY & TEST DISTANCE: VERTICAL AT 3 M

NO.	FREQ. (MHz)	EMISSION LEVEL (dBuV/m)	LIMIT (dBuV/m)	MARGIN (dB)	ANTENNA HEIGHT (m)	TABLE ANGLE (Degree)	RAW VALUE (dBuV)	CORRECTION FACTOR (dB/m)
1	#5637.69	60.9 PK	68.2	-7.3	1.53 V	1	57.3	3.6
2	*5785.00	127.1 PK			1.53 V	1	123.1	4.0
3	*5785.00	113.6 AV			1.53 V	1	109.6	4.0
4	#5937.20	62.9 PK	68.2	-5.3	1.53 V	1	58.6	4.3
5	11570.00	62.0 PK	74.0	-12.0	1.26 V	121	47.8	14.2
6	11570.00	51.3 AV	54.0	-2.7	1.26 V	121	37.1	14.2
7	#17355.00	56.5 PK	68.2	-11.7	1.33 V	301	38.8	17.7

REMARKS:

1. Emission Level(dBuV/m) = Raw Value(dBuV) + Correction Factor(dB/m)
2. Correction Factor(dB/m) = Antenna Factor(dB/m) + Cable Factor(dB) – Pre-Amplifier Factor(dB)
3. Margin value = Emission Level – Limit value
4. The other emission levels were very low against the limit.
5. " * ": Fundamental frequency.
6. " # ": The radiated frequency is out of the restricted band.

CHANNEL	TX Channel 165	DETECTOR FUNCTION	Peak (PK)
FREQUENCY RANGE	1GHz ~ 40GHz		Average (AV)

ANTENNA POLARITY & TEST DISTANCE: HORIZONTAL AT 3 M

NO.	FREQ. (MHz)	EMISSION LEVEL (dBuV/m)	LIMIT (dBuV/m)	MARGIN (dB)	ANTENNA HEIGHT (m)	TABLE ANGLE (Degree)	RAW VALUE (dBuV)	CORRECTION FACTOR (dB/m)
1	#5635.39	52.3 PK	68.2	-15.9	1.43 H	334	48.7	3.6
2	*5825.00	114.3 PK			1.44 H	334	110.1	4.2
3	*5825.00	101.7 AV			1.44 H	334	97.5	4.2
4	#5927.93	53.2 PK	68.2	-15.0	1.43 H	334	49.0	4.2
5	11650.00	50.2 PK	74.0	-23.8	1.55 H	271	36.3	13.9
6	11650.00	39.1 AV	54.0	-14.9	1.55 H	271	25.2	13.9
7	#17475.00	53.7 PK	68.2	-14.5	1.36 H	102	34.9	18.8

ANTENNA POLARITY & TEST DISTANCE: VERTICAL AT 3 M

NO.	FREQ. (MHz)	EMISSION LEVEL (dBuV/m)	LIMIT (dBuV/m)	MARGIN (dB)	ANTENNA HEIGHT (m)	TABLE ANGLE (Degree)	RAW VALUE (dBuV)	CORRECTION FACTOR (dB/m)
1	#5589.07	61.0 PK	68.2	-7.2	1.51 V	3	57.3	3.7
2	*5825.00	125.7 PK			1.52 V	3	121.5	4.2
3	*5825.00	113.7 AV			1.52 V	3	109.5	4.2
4	#5926.72	68.1 PK	68.2	-0.1	1.51 V	3	63.9	4.2
5	11650.00	60.9 PK	74.0	-13.1	1.42 V	148	47.0	13.9
6	11650.00	50.4 AV	54.0	-3.6	1.42 V	148	36.5	13.9
7	#17475.00	55.7 PK	68.2	-12.5	1.23 V	332	36.9	18.8

REMARKS:

1. Emission Level(dBuV/m) = Raw Value(dBuV) + Correction Factor(dB/m)
2. Correction Factor(dB/m) = Antenna Factor(dB/m) + Cable Factor(dB) – Pre-Amplifier Factor(dB)
3. Margin value = Emission Level – Limit value
4. The other emission levels were very low against the limit.
5. " * ": Fundamental frequency.
6. " # ": The radiated frequency is out of the restricted band.

802.11ax (HE40)

CHANNEL	TX Channel 38	DETECTOR FUNCTION	Peak (PK)
FREQUENCY RANGE	1GHz ~ 40GHz		Average (AV)

ANTENNA POLARITY & TEST DISTANCE: HORIZONTAL AT 3 M

NO.	FREQ. (MHz)	EMISSION LEVEL (dBuV/m)	LIMIT (dBuV/m)	MARGIN (dB)	ANTENNA HEIGHT (m)	TABLE ANGLE (Degree)	RAW VALUE (dBuV)	CORRECTION FACTOR (dB/m)
1	5149.00	63.1 PK	74.0	-10.9	1.72 H	329	59.6	3.5
2	5149.00	49.6 AV	54.0	-4.4	1.72 H	329	46.1	3.5
3	5150.00	62.8 PK	74.0	-11.2	1.72 H	329	59.3	3.5
4	5150.00	49.2 AV	54.0	-4.8	1.72 H	329	45.7	3.5
5	*5190.00	104.1 PK			1.72 H	329	100.7	3.4
6	*5190.00	92.4 AV			1.72 H	329	89.0	3.4
7	#10380.00	49.8 PK	68.2	-18.4	1.34 H	321	36.5	13.3
8	15570.00	54.8 PK	74.0	-19.2	1.29 H	72	41.4	13.4
9	15570.00	42.6 AV	54.0	-11.4	1.29 H	72	29.2	13.4

ANTENNA POLARITY & TEST DISTANCE: VERTICAL AT 3 M

NO.	FREQ. (MHz)	EMISSION LEVEL (dBuV/m)	LIMIT (dBuV/m)	MARGIN (dB)	ANTENNA HEIGHT (m)	TABLE ANGLE (Degree)	RAW VALUE (dBuV)	CORRECTION FACTOR (dB/m)
1	5149.00	67.5 PK	74.0	-6.5	1.90 V	172	64.0	3.5
2	5149.00	53.9 AV	54.0	-0.1	1.90 V	172	50.4	3.5
3	5150.00	66.9 PK	74.0	-7.1	1.90 V	172	63.4	3.5
4	5150.00	52.9 AV	54.0	-1.1	1.90 V	172	49.4	3.5
5	*5190.00	116.0 PK			1.90 V	172	112.6	3.4
6	*5190.00	104.3 AV			1.90 V	172	100.9	3.4
7	#10380.00	51.6 PK	68.2	-16.6	1.50 V	167	38.3	13.3
8	15570.00	56.2 PK	74.0	-17.8	1.12 V	309	42.8	13.4
9	15570.00	44.0 AV	54.0	-10.0	1.12 V	309	30.6	13.4

REMARKS:

- Emission Level(dBuV/m) = Raw Value(dBuV) + Correction Factor(dB/m)
- Correction Factor(dB/m) = Antenna Factor(dB/m) + Cable Factor(dB) – Pre-Amplifier Factor(dB)
- Margin value = Emission Level – Limit value
- The other emission levels were very low against the limit.
- " * ": Fundamental frequency.
- " # ": The radiated frequency is out of the restricted band.

CHANNEL	TX Channel 46	DETECTOR FUNCTION	Peak (PK)
FREQUENCY RANGE	1GHz ~ 40GHz		Average (AV)

ANTENNA POLARITY & TEST DISTANCE: HORIZONTAL AT 3 M

NO.	FREQ. (MHz)	EMISSION LEVEL (dBuV/m)	LIMIT (dBuV/m)	MARGIN (dB)	ANTENNA HEIGHT (m)	TABLE ANGLE (Degree)	RAW VALUE (dBuV)	CORRECTION FACTOR (dB/m)
1	5148.80	62.9 PK	74.0	-11.1	1.81 H	317	59.4	3.5
2	5148.80	49.4 AV	54.0	-4.6	1.81 H	317	45.9	3.5
3	5150.00	62.3 PK	74.0	-11.7	1.81 H	317	58.8	3.5
4	5150.00	48.7 AV	54.0	-5.3	1.81 H	317	45.2	3.5
5	*5230.00	106.6 PK			1.81 H	317	103.5	3.1
6	*5230.00	97.0 AV			1.81 H	317	93.9	3.1
7	5350.00	57.6 PK	74.0	-16.4	1.81 H	317	54.3	3.3
8	5350.00	45.6 AV	54.0	-8.4	1.81 H	317	42.3	3.3
9	#10460.00	53.6 PK	68.2	-14.6	1.44 H	308	40.1	13.5
10	15690.00	57.1 PK	74.0	-16.9	1.32 H	88	44.2	12.9
11	15690.00	45.2 AV	54.0	-8.8	1.32 H	88	32.3	12.9

ANTENNA POLARITY & TEST DISTANCE: VERTICAL AT 3 M

NO.	FREQ. (MHz)	EMISSION LEVEL (dBuV/m)	LIMIT (dBuV/m)	MARGIN (dB)	ANTENNA HEIGHT (m)	TABLE ANGLE (Degree)	RAW VALUE (dBuV)	CORRECTION FACTOR (dB/m)
1	5148.80	67.2 PK	74.0	-6.8	1.86 V	171	63.7	3.5
2	5148.80	53.9 AV	54.0	-0.1	1.86 V	171	50.4	3.5
3	5150.00	66.5 PK	74.0	-7.5	1.86 V	171	63.0	3.5
4	5150.00	52.6 AV	54.0	-1.4	1.86 V	171	49.1	3.5
5	*5230.00	118.6 PK			1.86 V	171	115.5	3.1
6	*5230.00	109.1 AV			1.86 V	171	106.0	3.1
7	5350.00	60.1 PK	74.0	-13.9	1.86 V	171	56.8	3.3
8	5350.00	49.0 AV	54.0	-5.0	1.86 V	171	45.7	3.3
9	#10460.00	54.0 PK	68.2	-14.2	1.44 V	154	40.5	13.5
10	15690.00	58.3 PK	74.0	-15.7	1.17 V	303	45.4	12.9
11	15690.00	46.6 AV	54.0	-7.4	1.17 V	303	33.7	12.9

REMARKS:

- Emission Level(dBuV/m) = Raw Value(dBuV) + Correction Factor(dB/m)
- Correction Factor(dB/m) = Antenna Factor(dB/m) + Cable Factor(dB) – Pre-Amplifier Factor(dB)
- Margin value = Emission Level – Limit value
- The other emission levels were very low against the limit.
- " * ": Fundamental frequency.
- " # ": The radiated frequency is out of the restricted band.

CHANNEL	TX Channel 151	DETECTOR FUNCTION	Peak (PK)
FREQUENCY RANGE	1GHz ~ 40GHz		Average (AV)

ANTENNA POLARITY & TEST DISTANCE: HORIZONTAL AT 3 M

NO.	FREQ. (MHz)	EMISSION LEVEL (dBuV/m)	LIMIT (dBuV/m)	MARGIN (dB)	ANTENNA HEIGHT (m)	TABLE ANGLE (Degree)	RAW VALUE (dBuV)	CORRECTION FACTOR (dB/m)
1	#5648.10	58.5 PK	68.2	-9.7	1.31 H	269	54.9	3.6
2	*5755.00	110.7 PK			1.32 H	270	106.8	3.9
3	*5755.00	100.0 AV			1.32 H	270	96.1	3.9
4	#5935.72	53.0 PK	68.2	-15.2	1.31 H	269	48.7	4.3
5	11510.00	54.5 PK	74.0	-19.5	1.43 H	305	40.3	14.2
6	11510.00	44.8 AV	54.0	-9.2	1.43 H	305	30.6	14.2
7	#17265.00	58.9 PK	68.2	-9.3	1.19 H	82	41.7	17.2

ANTENNA POLARITY & TEST DISTANCE: VERTICAL AT 3 M

NO.	FREQ. (MHz)	EMISSION LEVEL (dBuV/m)	LIMIT (dBuV/m)	MARGIN (dB)	ANTENNA HEIGHT (m)	TABLE ANGLE (Degree)	RAW VALUE (dBuV)	CORRECTION FACTOR (dB/m)
1	#5650.69	67.9 PK	68.7	-0.8	1.81 V	179	64.3	3.6
2	*5755.00	118.4 PK			1.81 V	179	114.5	3.9
3	*5755.00	108.9 AV			1.81 V	179	105.0	3.9
4	#5935.44	59.3 PK	68.2	-8.9	1.81 V	179	55.0	4.3
5	11510.00	55.2 PK	74.0	-18.8	1.43 V	167	41.0	14.2
6	11510.00	45.4 AV	54.0	-8.6	1.43 V	167	31.2	14.2
7	#17265.00	60.1 PK	68.2	-8.1	1.26 V	328	42.9	17.2

REMARKS:

1. Emission Level(dBuV/m) = Raw Value(dBuV) + Correction Factor(dB/m)
2. Correction Factor(dB/m) = Antenna Factor(dB/m) + Cable Factor(dB) – Pre-Amplifier Factor(dB)
3. Margin value = Emission Level – Limit value
4. The other emission levels were very low against the limit.
5. " * ": Fundamental frequency.
6. " # ": The radiated frequency is out of the restricted band.

CHANNEL	TX Channel 159	DETECTOR FUNCTION	Peak (PK)
FREQUENCY RANGE	1GHz ~ 40GHz		Average (AV)

ANTENNA POLARITY & TEST DISTANCE: HORIZONTAL AT 3 M

NO.	FREQ. (MHz)	EMISSION LEVEL (dBuV/m)	LIMIT (dBuV/m)	MARGIN (dB)	ANTENNA HEIGHT (m)	TABLE ANGLE (Degree)	RAW VALUE (dBuV)	CORRECTION FACTOR (dB/m)
1	#5611.61	54.4 PK	68.2	-13.8	1.29 H	274	50.7	3.7
2	*5795.00	109.9 PK			1.30 H	274	105.9	4.0
3	*5795.00	99.4 AV			1.30 H	274	95.4	4.0
4	#5927.46	57.9 PK	68.2	-10.3	1.29 H	274	53.7	4.2
5	11590.00	54.8 PK	74.0	-19.2	1.43 H	309	40.6	14.2
6	11590.00	45.0 AV	54.0	-9.0	1.43 H	309	30.8	14.2
7	#17385.00	59.2 PK	68.2	-9.0	1.22 H	73	41.4	17.8

ANTENNA POLARITY & TEST DISTANCE: VERTICAL AT 3 M

NO.	FREQ. (MHz)	EMISSION LEVEL (dBuV/m)	LIMIT (dBuV/m)	MARGIN (dB)	ANTENNA HEIGHT (m)	TABLE ANGLE (Degree)	RAW VALUE (dBuV)	CORRECTION FACTOR (dB/m)
1	#5626.82	63.0 PK	68.2	-5.2	1.83 V	180	59.4	3.6
2	*5795.00	118.7 PK			1.83 V	180	114.7	4.0
3	*5795.00	109.1 AV			1.83 V	180	105.1	4.0
4	#5938.02	68.0 PK	68.2	-0.2	1.83 V	180	63.7	4.3
5	11590.00	55.4 PK	74.0	-18.6	1.39 V	177	41.2	14.2
6	11590.00	45.5 AV	54.0	-8.5	1.39 V	177	31.3	14.2
7	#17385.00	60.5 PK	68.2	-7.7	1.32 V	333	42.7	17.8

REMARKS:

1. Emission Level(dBuV/m) = Raw Value(dBuV) + Correction Factor(dB/m)
2. Correction Factor(dB/m) = Antenna Factor(dB/m) + Cable Factor(dB) – Pre-Amplifier Factor(dB)
3. Margin value = Emission Level – Limit value
4. The other emission levels were very low against the limit.
5. " * ": Fundamental frequency.
6. " # ": The radiated frequency is out of the restricted band.

802.11ax (HE80)

CHANNEL	TX Channel 42	DETECTOR FUNCTION	Peak (PK)
FREQUENCY RANGE	1GHz ~ 40GHz		Average (AV)

ANTENNA POLARITY & TEST DISTANCE: HORIZONTAL AT 3 M

NO.	FREQ. (MHz)	EMISSION LEVEL (dBuV/m)	LIMIT (dBuV/m)	MARGIN (dB)	ANTENNA HEIGHT (m)	TABLE ANGLE (Degree)	RAW VALUE (dBuV)	CORRECTION FACTOR (dB/m)
1	5150.00	60.2 PK	74.0	-13.8	1.11 H	301	56.7	3.5
2	5150.00	49.1 AV	54.0	-4.9	1.11 H	301	45.6	3.5
3	*5210.00	102.0 PK			1.11 H	301	98.7	3.3
4	*5210.00	91.6 AV			1.11 H	301	88.3	3.3
5	5350.00	55.0 PK	74.0	-19.0	1.11 H	301	51.7	3.3
6	5350.00	44.3 AV	54.0	-9.7	1.11 H	301	41.0	3.3
7	#10420.00	50.1 PK	68.2	-18.1	1.33 H	314	36.6	13.5
8	15630.00	54.8 PK	74.0	-19.2	1.32 H	76	41.6	13.2
9	15630.00	42.6 AV	54.0	-11.4	1.32 H	76	29.4	13.2

ANTENNA POLARITY & TEST DISTANCE: VERTICAL AT 3 M

NO.	FREQ. (MHz)	EMISSION LEVEL (dBuV/m)	LIMIT (dBuV/m)	MARGIN (dB)	ANTENNA HEIGHT (m)	TABLE ANGLE (Degree)	RAW VALUE (dBuV)	CORRECTION FACTOR (dB/m)
1	5150.00	64.9 PK	74.0	-9.1	1.82 V	83	61.4	3.5
2	5150.00	53.9 AV	54.0	-0.1	1.82 V	83	50.4	3.5
3	*5210.00	111.9 PK			1.82 V	83	108.6	3.3
4	*5210.00	101.4 AV			1.82 V	83	98.1	3.3
5	5350.00	59.1 PK	74.0	-14.9	1.82 V	83	55.8	3.3
6	5350.00	48.4 AV	54.0	-5.6	1.82 V	83	45.1	3.3
7	#10420.00	50.5 PK	68.2	-17.7	1.34 V	172	37.0	13.5
8	15630.00	55.3 PK	74.0	-18.7	1.21 V	309	42.1	13.2
9	15630.00	43.0 AV	54.0	-11.0	1.21 V	309	29.8	13.2

REMARKS:

- Emission Level(dBuV/m) = Raw Value(dBuV) + Correction Factor(dB/m)
- Correction Factor(dB/m) = Antenna Factor(dB/m) + Cable Factor(dB) – Pre-Amplifier Factor(dB)
- Margin value = Emission Level – Limit value
- The other emission levels were very low against the limit.
- " * ": Fundamental frequency.
- " # ": The radiated frequency is out of the restricted band.

CHANNEL	TX Channel 155	DETECTOR FUNCTION	Peak (PK)
FREQUENCY RANGE	1GHz ~ 40GHz		Average (AV)

ANTENNA POLARITY & TEST DISTANCE: HORIZONTAL AT 3 M

NO.	FREQ. (MHz)	EMISSION LEVEL (dBuV/m)	LIMIT (dBuV/m)	MARGIN (dB)	ANTENNA HEIGHT (m)	TABLE ANGLE (Degree)	RAW VALUE (dBuV)	CORRECTION FACTOR (dB/m)
1	#5629.79	60.1 PK	68.2	-8.1	1.12 H	269	56.5	3.6
2	*5775.00	105.4 PK			1.12 H	270	101.5	3.9
3	*5775.00	94.8 AV			1.12 H	270	90.9	3.9
4	#5929.22	56.5 PK	68.2	-11.7	1.12 H	269	52.3	4.2
5	11550.00	52.5 PK	74.0	-21.5	1.28 H	320	38.3	14.2
6	11550.00	42.8 AV	54.0	-11.2	1.28 H	320	28.6	14.2
7	#17325.00	57.5 PK	68.2	-10.7	1.36 H	80	40.1	17.4

ANTENNA POLARITY & TEST DISTANCE: VERTICAL AT 3 M

NO.	FREQ. (MHz)	EMISSION LEVEL (dBuV/m)	LIMIT (dBuV/m)	MARGIN (dB)	ANTENNA HEIGHT (m)	TABLE ANGLE (Degree)	RAW VALUE (dBuV)	CORRECTION FACTOR (dB/m)
1	#5647.80	67.3 PK	68.2	-0.9	1.81 V	180	63.7	3.6
2	*5775.00	113.8 PK			1.81 V	180	109.9	3.9
3	*5775.00	102.7 AV			1.81 V	180	98.8	3.9
4	#5922.00	65.7 PK	70.4	-4.7	1.81 V	180	61.5	4.2
5	11550.00	52.9 PK	74.0	-21.1	1.33 V	189	38.7	14.2
6	11550.00	43.2 AV	54.0	-10.8	1.33 V	189	29.0	14.2
7	#17325.00	57.6 PK	68.2	-10.6	1.25 V	303	40.2	17.4

REMARKS:

1. Emission Level(dBuV/m) = Raw Value(dBuV) + Correction Factor(dB/m)
2. Correction Factor(dB/m) = Antenna Factor(dB/m) + Cable Factor(dB) – Pre-Amplifier Factor(dB)
3. Margin value = Emission Level – Limit value
4. The other emission levels were very low against the limit.
5. " * ": Fundamental frequency.
6. " # ": The radiated frequency is out of the restricted band.

Below 1GHz Data:

802.11ax (HE20)

CHANNEL	TX Channel 48	DETECTOR FUNCTION	Quasi-Peak (QP)
FREQUENCY RANGE	9kHz ~ 1GHz		

ANTENNA POLARITY & TEST DISTANCE: HORIZONTAL AT 3 M

NO.	FREQ. (MHz)	EMISSION LEVEL (dBuV/m)	LIMIT (dBuV/m)	MARGIN (dB)	ANTENNA HEIGHT (m)	TABLE ANGLE (Degree)	RAW VALUE (dBuV)	CORRECTION FACTOR (dB/m)
1	125.01	30.1 QP	43.5	-13.4	2.50 H	77	39.5	-9.4
2	202.85	26.7 QP	43.5	-16.8	1.50 H	356	37.0	-10.3
3	375.00	26.8 QP	46.0	-19.2	1.00 H	152	31.7	-4.9
4	578.22	29.2 QP	46.0	-16.8	2.50 H	355	29.2	0.0
5	759.36	36.3 QP	46.0	-9.7	1.00 H	168	32.6	3.7
6	875.02	37.3 QP	46.0	-8.7	1.00 H	122	31.7	5.6

REMARKS:

1. Emission Level(dBuV/m) = Raw Value(dBuV) + Correction Factor(dB/m)
2. Correction Factor(dB/m) = Antenna Factor(dB/m) + Cable Factor(dB) – Pre-Amplifier Factor(dB)
3. Margin value = Emission Level – Limit value
4. The other emission levels were very low against the limit of frequency range 30MHz~1000MHz.
5. The emission levels were very low against the limit of frequency range 9kHz~30MHz: the amplitude of spurious emissions attenuated more than 20 dB below the permissible value to be report.

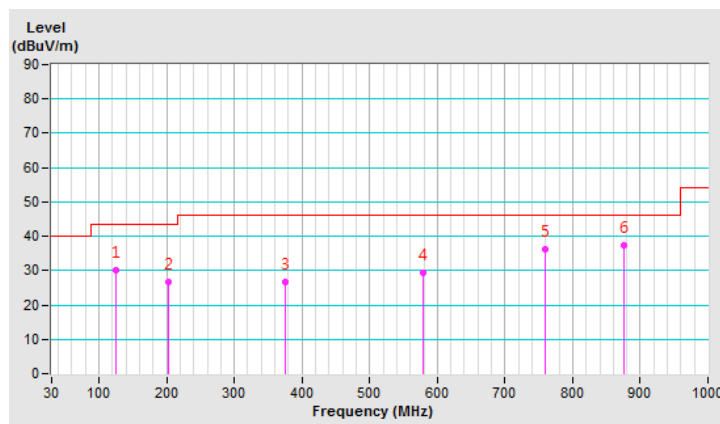

CHANNEL	TX Channel 48	DETECTOR FUNCTION	Quasi-Peak (QP)
FREQUENCY RANGE	9kHz ~ 1GHz		

ANTENNA POLARITY & TEST DISTANCE: VERTICAL AT 3 M								
NO.	FREQ. (MHz)	EMISSION LEVEL (dBuV/m)	LIMIT (dBuV/m)	MARGIN (dB)	ANTENNA HEIGHT (m)	TABLE ANGLE (Degree)	RAW VALUE (dBuV)	CORRECTION FACTOR (dB/m)
1	44.31	36.7 QP	40.0	-3.3	1.00 V	179	44.9	-8.2
2	114.78	34.8 QP	43.5	-8.7	1.00 V	257	45.1	-10.3
3	512.68	30.7 QP	46.0	-15.3	1.00 V	225	32.0	-1.3
4	662.33	30.5 QP	46.0	-15.5	2.00 V	312	28.9	1.6
5	762.31	36.3 QP	46.0	-9.7	1.50 V	264	32.6	3.7
6	875.25	35.9 QP	46.0	-10.1	1.50 V	209	30.3	5.6

REMARKS:

1. Emission Level(dBuV/m) = Raw Value(dBuV) + Correction Factor(dB/m)
2. Correction Factor(dB/m) = Antenna Factor(dB/m) + Cable Factor(dB) – Pre-Amplifier Factor(dB)
3. Margin value = Emission Level – Limit value
4. The other emission levels were very low against the limit of frequency range 30MHz~1000MHz.
5. The emission levels were very low against the limit of frequency range 9kHz~30MHz: the amplitude of spurious emissions attenuated more than 20 dB below the permissible value to be report.

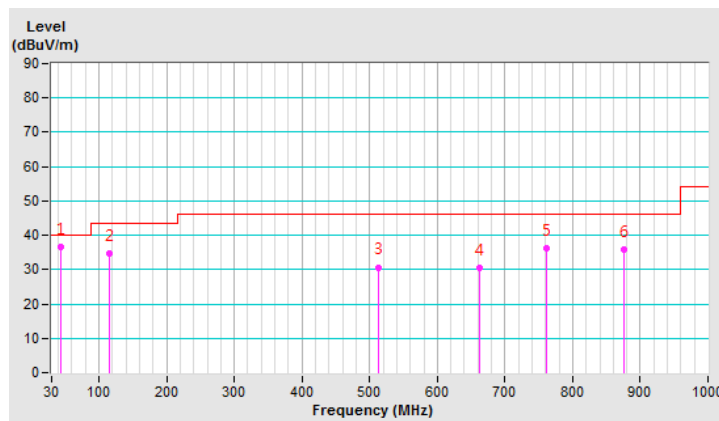

4.2 Conducted Emission Measurement

4.2.1 Limits of Conducted Emission Measurement

Frequency (MHz)	Conducted Limit (dBuV)	
	Quasi-peak	Average
0.15 - 0.5	66 - 56	56 - 46
0.50 - 5.0	56	46
5.0 - 30.0	60	50

Note: 1. The lower limit shall apply at the transition frequencies.

2. The limit decreases in line with the logarithm of the frequency in the range of 0.15 to 0.50MHz.

4.2.2 Test Instruments

DESCRIPTION & MANUFACTURER	MODEL NO.	SERIAL NO.	CALIBRATED DATE	CALIBRATED UNTIL
Test Receiver R&S	ESCS 30	847124/029	Oct. 24, 2018	Oct. 23, 2019
Line-Impedance Stabilization Network (for EUT) R&S	ESH3-Z5	848773/004	Oct. 22, 2018	Oct. 21, 2019
Line-Impedance Stabilization Network (for Peripheral) R&S	ESH3-Z5	835239/001	Mar. 17, 2019	Mar. 16, 2020
50 ohms Terminator	N/A	3	Oct. 22, 2018	Oct. 21, 2019
RF Cable	5D-FB	COCCAB-001	Sep. 28, 2018	Sep. 27, 2019
Fixed attenuator EMCI	STI02-2200-10	003	Mar. 14, 2019	Mar. 13, 2020
Software BVADT	BVADT_Cond_V7.3.7.4	NA	NA	NA

Note:

1. The calibration interval of the above test instruments are 12 months and the calibrations are traceable to NML/ROC and NIST/USA.
2. The test was performed in Conduction 1.
3. Tested Date: Aug. 02, 2019

4.2.3 Test Procedure

- The EUT was placed 0.4 meters from the conducting wall of the shielded room with EUT being connected to the power mains through a line impedance stabilization network (LISN). Other support units were connected to the power mains through another LISN. The two LISNs provide 50 ohm/ 50uH of coupling impedance for the measuring instrument.
- Both lines of the power mains connected to the EUT were checked for maximum conducted interference.
- The frequency range from 150kHz to 30MHz was searched. Emission levels under (Limit - 20dB) was not recorded.

Note: All modes of operation were investigated and the worst-case emissions are reported.

4.2.4 Deviation from Test Standard

No deviation.

4.2.5 Test Setup

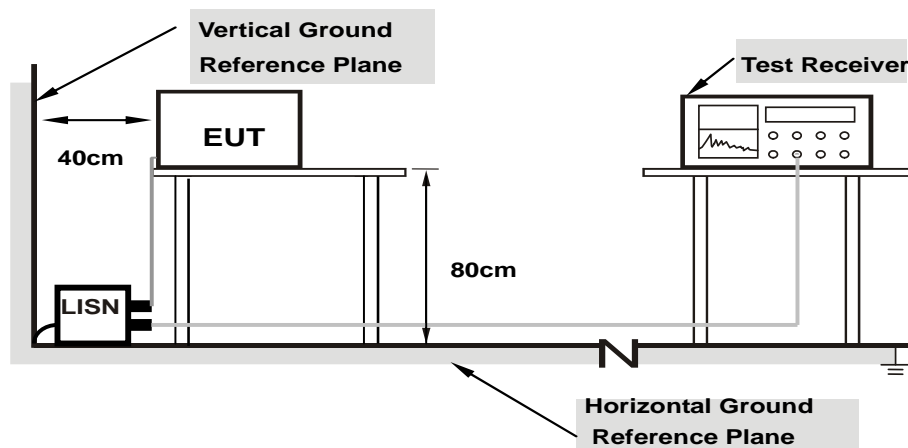

Note: 1.Support units were connected to second LISN.

For the actual test configuration, please refer to the attached file (Test Setup Photo).

4.2.6 EUT Operating Condition

Same as 4.1.6.

4.2.7 Test Results

Phase	Line (L)	Detector Function	Quasi-Peak (QP) / Average (AV)
-------	----------	-------------------	--------------------------------

Phase Of Power : Line (L)										
No	Frequency (MHz)	Correction Factor (dB)	Reading Value (dBuV)		Emission Level (dBuV)		Limit (dBuV)		Margin (dB)	
			Q.P.	AV.	Q.P.	AV.	Q.P.	AV.	Q.P.	AV.
1	0.15391	9.97	40.71	29.31	50.68	39.28	65.79	55.79	-15.11	-16.51
2	0.18516	9.97	36.02	25.79	45.99	35.76	64.25	54.25	-18.26	-18.49
3	0.27109	9.97	34.51	25.41	44.48	35.38	61.08	51.08	-16.60	-15.70
4	0.29844	9.97	37.64	29.44	47.61	39.41	60.29	50.29	-12.68	-10.88
5	3.11719	10.19	6.11	-0.09	16.30	10.10	56.00	46.00	-39.70	-35.90
6	10.44141	10.67	13.07	7.64	23.74	18.31	60.00	50.00	-36.26	-31.69

Remarks:

1. Q.P. and AV. are abbreviations of quasi-peak and average individually.
2. The emission levels of other frequencies were very low against the limit.
3. Margin value = Emission level – Limit value
4. Correction factor = Insertion loss + Cable loss
5. Emission Level = Correction Factor + Reading Value

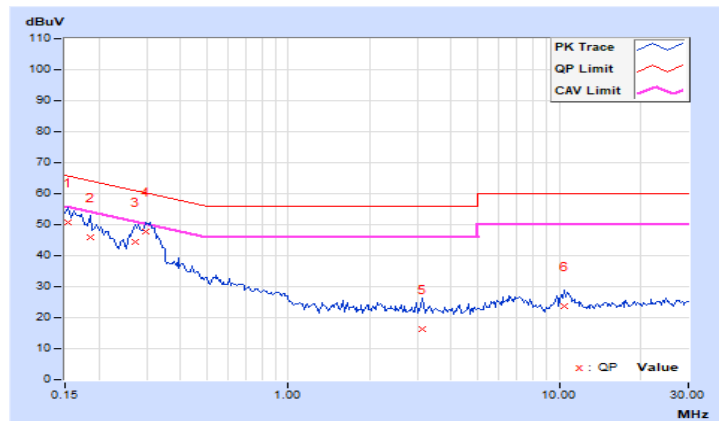

Phase	Neutral (N)	Detector Function	Quasi-Peak (QP) / Average (AV)
-------	-------------	-------------------	--------------------------------

Phase Of Power : Neutral (N)										
No	Frequency (MHz)	Correction Factor (dB)	Reading Value (dBuV)		Emission Level (dBuV)		Limit (dBuV)		Margin (dB)	
			Q.P.	AV.	Q.P.	AV.	Q.P.	AV.	Q.P.	AV.
1	0.15000	9.94	39.41	26.35	49.35	36.29	66.00	56.00	-16.65	-19.71
2	0.16562	9.95	37.83	26.39	47.78	36.34	65.18	55.18	-17.40	-18.84
3	0.27109	9.96	30.20	20.01	40.16	29.97	61.08	51.08	-20.92	-21.11
4	0.30625	9.96	36.68	29.50	46.64	39.46	60.07	50.07	-13.43	-10.61
5	4.21875	10.20	6.56	-0.06	16.76	10.14	56.00	46.00	-39.24	-35.86
6	10.85938	10.60	13.45	6.68	24.05	17.28	60.00	50.00	-35.95	-32.72

Remarks:

1. Q.P. and AV. are abbreviations of quasi-peak and average individually.
2. The emission levels of other frequencies were very low against the limit.
3. Margin value = Emission level – Limit value
4. Correction factor = Insertion loss + Cable loss
5. Emission Level = Correction Factor + Reading Value

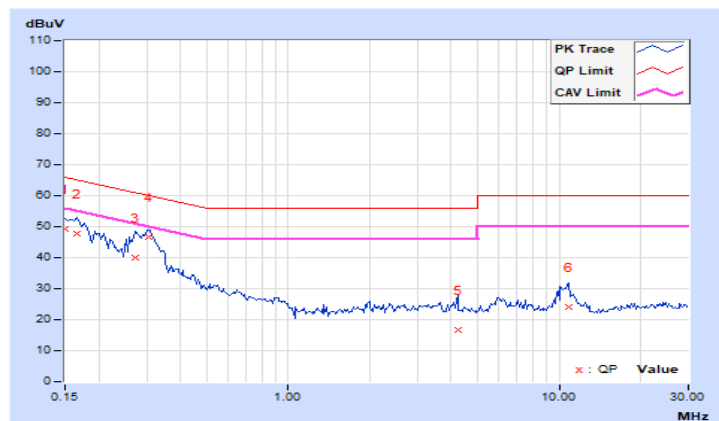

4.3 Transmit Power Measurement

4.3.1 Limits of Transmit Power Measurement

Operation Band	EUT Category		Limit
U-NII-1		Outdoor Access Point	1 Watt (30 dBm) (Max. e.i.r.p \leq 125mW(21 dBm) at any elevation angle above 30 degrees as measured from the horizon)
		Fixed point-to-point Access Point	1 Watt (30 dBm)
	√	Indoor Access Point	1 Watt (30 dBm)
		Client device	250mW (24 dBm)
U-NII-2A			250mW (24 dBm) or 11 dBm+10 log B*
U-NII-2C			250mW (24 dBm) or 11 dBm+10 log B*
U-NII-3	√		1 Watt (30 dBm)

*B is the 26 dB emission bandwidth in megahertz

Per KDB 662911 Method of conducted output power measurement on IEEE 802.11 devices,

Array Gain = 0 dB (i.e., no array gain) for $N_{ANT} \leq 4$;

Array Gain = 0 dB (i.e., no array gain) for channel widths ≥ 40 MHz for any N_{ANT} ;

Array Gain = $5 \log(N_{ANT}/N_{SS})$ dB or 3 dB, whichever is less for 20-MHz channel widths with $N_{ANT} \geq 5$.

For power measurements on all other devices: Array Gain = $10 \log(N_{ANT}/N_{SS})$ dB.

4.3.2 Test Setup

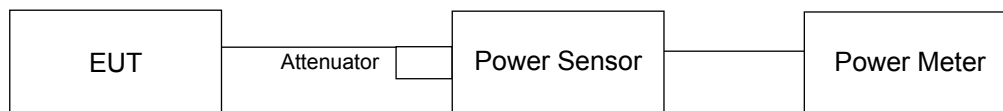

FOR 26dB OCCUPIED BANDWIDTH

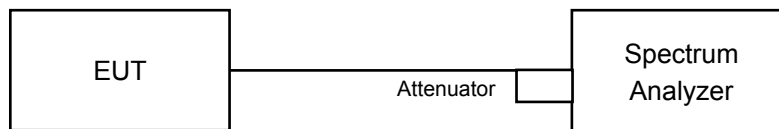

4.3.3 Test Instruments

Refer to section 4.1.2 to get information of above instrument.

4.3.4 Test Procedure

FOR POWER OUTPUT MEASUREMENT

Method PM is used to perform output power measurement, trigger and gating function of wide band power meter is enabled to measure max output power of TX on burst. Duty factor is not added to measured value.

FOR 26dB OCCUPIED BANDWIDTH

1. Set RBW = approximately 1% of the emission bandwidth.
2. Set the VBW > RBW.
3. Detector = Peak.
4. Trace mode = max hold.
5. Measure the maximum width of the emission that is 26 dB down from the peak of the emission. Compare this with the RBW setting of the analyzer. Readjust RBW and repeat measurement as needed until the RBW/EBW ratio is approximately 1%.

4.3.5 Deviation from Test Standard

No deviation.

4.3.6 EUT Operating Condition

The software provided by client to enable the EUT under transmission condition continuously at lowest, middle and highest channel frequencies individually.

4.3.7 Test Results

Non-Beamforming Mode

802.11a

Chan.	Chan. Freq. (MHz)	Maximum Conducted Power (dBm)		Total Power (mW)	Total Power (dBm)	Limit (dBm)	Pass / Fail
		Chain 0	Chain 1				
36	5180	22.96	22.91	393.131	25.95	30	Pass
40	5200	26.37	26.33	863.047	29.36	30	Pass
48	5240	26.32	26.37	862.06	29.36	30	Pass
149	5745	26.87	26.48	931.038	29.69	30	Pass
157	5785	26.89	26.43	928.194	29.68	30	Pass
165	5825	26.77	26.33	904.871	29.57	30	Pass

802.11ac (VHT20)

Chan.	Chan. Freq. (MHz)	Maximum Conducted Power (dBm)		Total Power (mW)	Total Power (dBm)	Limit (dBm)	Pass / Fail
		Chain 0	Chain 1				
36	5180	22.75	22.51	366.603	25.64	30	Pass
40	5200	26.36	26.21	850.344	29.30	30	Pass
48	5240	26.41	26.33	867.058	29.38	30	Pass
149	5745	26.83	26.50	928.632	29.68	30	Pass
157	5785	26.69	26.23	886.418	29.48	30	Pass
165	5825	26.70	26.28	892.355	29.51	30	Pass

802.11ac (VHT40)

Chan.	Chan. Freq. (MHz)	Maximum Conducted Power (dBm)		Total Power (mW)	Total Power (dBm)	Limit (dBm)	Pass / Fail
		Chain 0	Chain 1				
38	5190	20.63	20.87	237.791	23.76	30	Pass
46	5230	25.07	25.36	664.924	28.23	30	Pass
151	5755	26.24	25.79	800.042	29.03	30	Pass
159	5795	26.73	26.33	900.513	29.54	30	Pass

802.11ac (VHT80)

Chan.	Chan. Freq. (MHz)	Maximum Conducted Power (dBm)		Total Power (mW)	Total Power (dBm)	Limit (dBm)	Pass / Fail
		Chain 0	Chain 1				
42	5210	20.66	20.21	221.367	23.45	30	Pass
155	5775	23.97	24.08	505.318	27.04	30	Pass

802.11ax (HE20)

Chan.	Chan. Freq. (MHz)	Maximum Conducted Power (dBm)		Total Power (mW)	Total Power (dBm)	Limit (dBm)	Pass / Fail
		Chain 0	Chain 1				
36	5180	22.75	22.51	366.603	25.64	30	Pass
40	5200	26.36	26.21	850.344	29.30	30	Pass
48	5240	26.41	26.33	867.058	29.38	30	Pass
149	5745	26.83	26.50	928.632	29.68	30	Pass
157	5785	26.69	26.23	886.418	29.48	30	Pass
165	5825	26.70	26.28	892.355	29.51	30	Pass

802.11ax (HE40)

Chan.	Chan. Freq. (MHz)	Maximum Conducted Power (dBm)		Total Power (mW)	Total Power (dBm)	Limit (dBm)	Pass / Fail
		Chain 0	Chain 1				
38	5190	20.63	20.87	237.791	23.76	30	Pass
46	5230	25.07	25.36	664.924	28.23	30	Pass
151	5755	26.24	25.79	800.042	29.03	30	Pass
159	5795	26.73	26.33	900.513	29.54	30	Pass

802.11ax (HE80)

Chan.	Chan. Freq. (MHz)	Maximum Conducted Power (dBm)		Total Power (mW)	Total Power (dBm)	Limit (dBm)	Pass / Fail
		Chain 0	Chain 1				
42	5210	20.66	20.21	221.367	23.45	30	Pass
155	5775	23.97	24.08	505.318	27.04	30	Pass

Beamforming Mode

802.11ac (VHT20)

Chan.	Chan. Freq. (MHz)	Maximum Conducted Power (dBm)		Total Power (mW)	Total Power (dBm)	Limit (dBm)	Pass / Fail
		Chain 0	Chain 1				
36	5180	22.75	22.51	366.603	25.64	29.6	Pass
40	5200	26.36	26.21	850.344	29.30	29.6	Pass
48	5240	26.41	26.33	867.058	29.38	29.6	Pass
149	5745	26.83	26.50	928.632	29.68	30	Pass
157	5785	26.69	26.23	886.418	29.48	30	Pass
165	5825	26.70	26.28	892.355	29.51	30	Pass

- Note:
1. For U-NII-1: The directional gain = $10 \log[(10^{G0/20} + 10^{G1/20})^2 / 2] = 6.4\text{dBi} > 6\text{dBi}$, so the power limit shall be reduced to $30 - (6.4 - 6) = 29.6\text{dBm}$.
 2. For U-NII-3: The directional gain = $10 \log[(10^{G0/20} + 10^{G1/20})^2 / 2] = 4.9\text{dB} < 6\text{dBi}$, so the power limit shall not be reduced.

802.11ac (VHT40)

Chan.	Chan. Freq. (MHz)	Maximum Conducted Power (dBm)		Total Power (mW)	Total Power (dBm)	Limit (dBm)	Pass / Fail
		Chain 0	Chain 1				
38	5190	20.63	20.87	237.791	23.76	29.6	Pass
46	5230	25.07	25.35	664.134	28.22	29.6	Pass
151	5755	26.24	25.79	800.042	29.03	30	Pass
159	5795	26.73	26.33	900.513	29.54	30	Pass

- Note:
1. For U-NII-1: The directional gain = $10 \log[(10^{G0/20} + 10^{G1/20})^2 / 2] = 6.4\text{dBi} > 6\text{dBi}$, so the power limit shall be reduced to $30 - (6.4 - 6) = 29.6\text{dBm}$.
 2. For U-NII-3: The directional gain = $10 \log[(10^{G0/20} + 10^{G1/20})^2 / 2] = 4.9\text{dB} < 6\text{dBi}$, so the power limit shall not be reduced.

802.11ac (VHT80)

Chan.	Chan. Freq. (MHz)	Maximum Conducted Power (dBm)		Total Power (mW)	Total Power (dBm)	Limit (dBm)	Pass / Fail
		Chain 0	Chain 1				
42	5210	20.66	20.21	221.367	23.45	29.6	Pass
155	5775	23.97	24.08	505.318	27.04	30	Pass

- Note:
1. For U-NII-1: The directional gain = $10 \log[(10^{G0/20} + 10^{G1/20})^2 / 2] = 6.4\text{dBi} > 6\text{dBi}$, so the power limit shall be reduced to $30 - (6.4 - 6) = 29.6\text{dBm}$.
 2. For U-NII-3: The directional gain = $10 \log[(10^{G0/20} + 10^{G1/20})^2 / 2] = 4.9\text{dB} < 6\text{dBi}$, so the power limit shall not be reduced.

802.11ax (HE20)

Chan.	Chan. Freq. (MHz)	Maximum Conducted Power (dBm)		Total Power (mW)	Total Power (dBm)	Limit (dBm)	Pass / Fail
		Chain 0	Chain 1				
36	5180	22.75	22.51	366.603	25.64	29.6	Pass
40	5200	26.36	26.21	850.344	29.30	29.6	Pass
48	5240	26.41	26.33	867.058	29.38	29.6	Pass
149	5745	26.83	26.50	928.632	29.68	30	Pass
157	5785	26.69	26.23	886.418	29.48	30	Pass
165	5825	26.70	26.28	892.355	29.51	30	Pass

- Note:
1. For U-NII-1: The directional gain = $10 \log[(10^{G0/20} + 10^{G1/20})^2 / 2] = 6.4\text{dBi} > 6\text{dBi}$, so the power limit shall be reduced to $30-(6.4-6) = 29.6\text{dBm}$.
 2. For U-NII-3: The directional gain = $10 \log[(10^{G0/20} + 10^{G1/20})^2 / 2] = 4.9\text{dB} < 6\text{dBi}$, so the power limit shall not be reduced.

802.11ax (HE40)

Chan.	Chan. Freq. (MHz)	Maximum Conducted Power (dBm)		Total Power (mW)	Total Power (dBm)	Limit (dBm)	Pass / Fail
		Chain 0	Chain 1				
38	5190	20.63	20.87	237.791	23.76	29.6	Pass
46	5230	25.07	25.35	664.134	28.22	29.6	Pass
151	5755	26.24	25.79	800.042	29.03	30	Pass
159	5795	26.73	26.33	900.513	29.54	30	Pass

- Note:
1. For U-NII-1: The directional gain = $10 \log[(10^{G0/20} + 10^{G1/20})^2 / 2] = 6.4\text{dBi} > 6\text{dBi}$, so the power limit shall be reduced to $30-(6.4-6) = 29.6\text{dBm}$.
 2. For U-NII-3: The directional gain = $10 \log[(10^{G0/20} + 10^{G1/20})^2 / 2] = 4.9\text{dB} < 6\text{dBi}$, so the power limit shall not be reduced.

802.11ax (HE80)

Chan.	Chan. Freq. (MHz)	Maximum Conducted Power (dBm)		Total Power (mW)	Total Power (dBm)	Limit (dBm)	Pass / Fail
		Chain 0	Chain 1				
42	5210	20.66	20.21	221.367	23.45	29.6	Pass
155	5775	23.97	24.08	505.318	27.04	30	Pass

- Note:
1. For U-NII-1: The directional gain = $10 \log[(10^{G0/20} + 10^{G1/20})^2 / 2] = 6.4\text{dBi} > 6\text{dBi}$, so the power limit shall be reduced to $30-(6.4-6) = 29.6\text{dBm}$.
 2. For U-NII-3: The directional gain = $10 \log[(10^{G0/20} + 10^{G1/20})^2 / 2] = 4.9\text{dB} < 6\text{dBi}$, so the power limit shall not be reduced.

4.4 Occupied Bandwidth Measurement

4.4.1 Test Setup

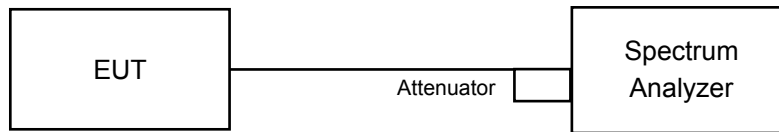

4.4.2 Test Instruments

Refer to section 4.1.2 to get information of above instrument.

4.4.3 Test Procedure

The transmitter output was connected to the spectrum analyzer through an attenuator. The bandwidth of the fundamental frequency was measured by spectrum analyzer with resolution bandwidth in the range of 1% to 5% of the anticipated emission bandwidth, and a video bandwidth at least 3x the resolution bandwidth and set the detector to SAMPLE. The width of a frequency band such that, below the lower and above the upper frequency limits, the mean powers emitted are each equal to a specified percentage 0.5% of the total mean power of a given emission.

4.4.4 Test Results

802.11a

Channel	Channel Frequency (MHz)	Occupied Bandwidth (MHz)	
		Chain 0	Chain 1
36	5180	17.16	17.04
40	5200	17.88	18.36
48	5240	18.00	18.48
149	5745	21.36	20.40
157	5785	20.76	19.08
165	5825	23.28	20.16

802.11ax (HE20)

Channel	Channel Frequency (MHz)	Occupied Bandwidth (MHz)	
		Chain 0	Chain 1
36	5180	19.20	19.08
40	5200	19.20	19.44
48	5240	19.32	19.56
149	5745	20.28	19.80
157	5785	21.00	20.04
165	5825	22.32	19.56

802.11ax (HE40)

Channel	Channel Frequency (MHz)	Occupied Bandwidth (MHz)	
		Chain 0	Chain 1
38	5190	37.92	37.92
46	5230	37.92	37.92
151	5755	39.12	38.88
159	5795	43.68	39.12

802.11ax (HE80)

Channel	Channel Frequency (MHz)	Occupied Bandwidth (MHz)	
		Chain 0	Chain 1
42	5210	76.80	76.80
155	5775	76.80	77.28

Spectrum Plot of Max. Value

802.11a_Chain 0 / CH165

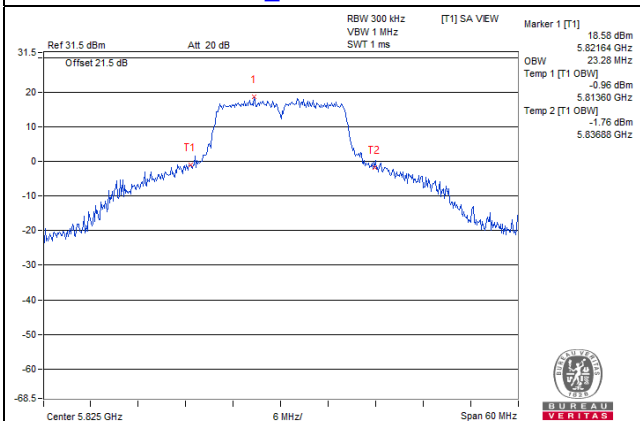

802.11ax (HE20)_Chain 0 / CH165

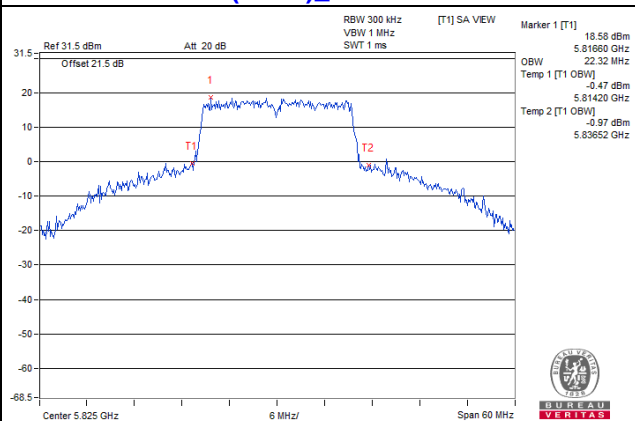

802.11ax (HE40)_Chain 0 / CH159

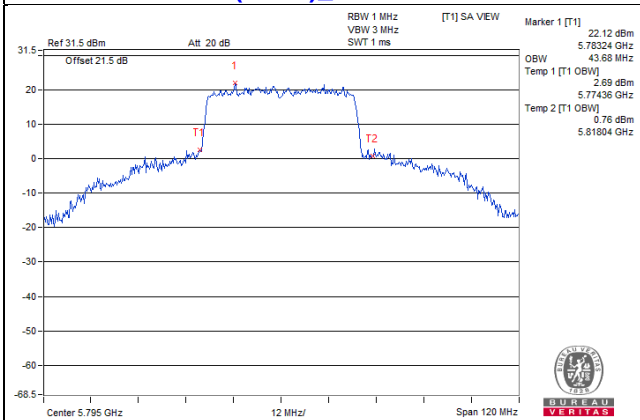

802.11ax (HE80)_Chain 1 / CH155

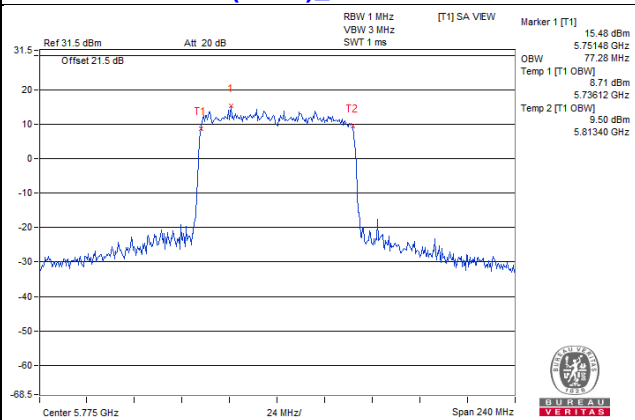

4.5 Peak Power Spectral Density Measurement

4.5.1 Limits of Peak Power Spectral Density Measurement

Operation Band	EUT Category		Limit
U-NII-1		Outdoor Access Point	17dBm/ MHz
		Fixed point-to-point Access Point	
	√	Indoor Access Point	
		Client device	11dBm/ MHz
U-NII-2A			11dBm/ MHz
U-NII-2C			11dBm/ MHz
U-NII-3		√	30dBm/ 500kHz

4.5.2 Test Setup

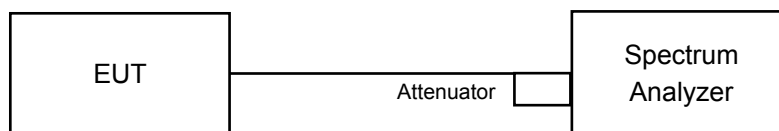

4.5.3 Test Instruments

Refer to section 4.1.2 to get information of above instrument.

4.5.4 Test Procedure

For 802.11a, 802.11ac (VHT20), 802.11ax (HE20):

For U-NII-1:

Using method SA-1

1. Set span to encompass the entire emission bandwidth (EBW) of the signal.
2. Set RBW = 1 MHz, Set VBW ≥ 3 MHz, Detector = RMS
3. Sweep time = auto, trigger set to “free run”.
4. Trace average at least 100 traces in power averaging mode.
5. Record the max value

For U-NII-3:

1. Set span to encompass the entire emission bandwidth (EBW) of the signal.
2. Set RBW = 300 kHz, Set VBW ≥ 1 MHz, Detector = RMS
3. Use the peak marker function to determine the maximum power level in any 300 kHz band segment within the fundamental EBW.
4. Scale the observed power level to an equivalent value in 500 kHz by adjusting (reducing) the measured power by a bandwidth correction factor (BWCF) where $BWCF = 10\log(500\text{kHz}/300\text{kHz})$
5. Sweep time = auto, trigger set to “free run”.
6. Trace average at least 100 traces in power averaging mode.
7. Record the max value

For Other Modulation Mode:

For U-NII-1:

Using method SA-2

1. Set span to encompass the entire emission bandwidth (EBW) of the signal.
2. Set RBW = 1 MHz, Set VBW \geq 3 MHz, Detector = RMS
3. Sweep time = auto, trigger set to "free run".
4. Trace average at least 100 traces in power averaging mode.
5. Record the max value and add 10 log (1/duty cycle)

For U-NII-3:

1. Set span to encompass the entire emission bandwidth (EBW) of the signal.
2. Set RBW = 300 kHz, Set VBW \geq 1 MHz, Detector = RMS
3. Use the peak marker function to determine the maximum power level in any 300 kHz band segment within the fundamental EBW.
4. Scale the observed power level to an equivalent value in 500 kHz by adjusting (reducing) the measured power by a bandwidth correction factor (BWCF) where $BWCF = 10\log(500\text{kHz}/300\text{kHz})$
5. Sweep time = auto, trigger set to "free run".
6. Trace average at least 100 traces in power averaging mode.
7. Record the max value and add 10 log (1/duty cycle)

4.5.5 Deviation from Test Standard

No deviation.

4.5.6 EUT Operating Condition

Same as Item 4.3.6.

4.5.7 Test Results

For U-NII-1:

802.11a

Chan.	Chan. Freq. (MHz)	PSD (dBm/MHz)		Total Power Density (dBm/MHz)	Max. Limit (dBm/MHz)	Pass / Fail
		Chain 0	Chain 1			
36	5180	10.32	11.14	13.76	16.6	Pass
40	5200	13.20	13.66	16.45	16.6	Pass
48	5240	13.34	13.53	16.45	16.6	Pass

- Note: 1. Method a) of power density measurement of KDB 662911 is using for calculating total power density. Total power density is summing entire spectra across corresponding frequency bins on the various outputs by computer.
2. The directional gain = $10 \log[(10^{G0/20} + 10^{G1/20})^2 / 2] = 6.4\text{dBi} > 6\text{dBi}$, so the power density limit shall be reduced to $17-(6.4-6) = 16.6\text{dBm}$.

802.11ax (HE20)

Chan.	Chan. Freq. (MHz)	PSD (dBm/MHz)		Total Power Density (dBm/MHz)	Max. Limit (dBm/MHz)	Pass / Fail
		Chain 0	Chain 1			
36	5180	8.66	8.74	11.71	16.6	Pass
40	5200	13.27	12.88	16.09	16.6	Pass
48	5240	13.53	13.31	16.43	16.6	Pass

- Note: 1. Method a) of power density measurement of KDB 662911 is using for calculating total power density. Total power density is summing entire spectra across corresponding frequency bins on the various outputs by computer.
2. The directional gain = $10 \log[(10^{G0/20} + 10^{G1/20})^2 / 2] = 6.4\text{dBi} > 6\text{dBi}$, so the power density limit shall be reduced to $17-(6.4-6) = 16.6\text{dBm}$.

802.11ax (HE40)

Chan.	Chan. Freq. (MHz)	PSD W/O Duty Factor (dBm/MHz)		Duty Factor (dB)	Total PSD With Duty Factor (dBm/MHz)	Max. Limit (dBm/MHz)	Pass / Fail
		Chain 0	Chain 1				
38	5190	4.45	4.13	0.12	7.42	16.6	Pass
46	5230	8.41	8.51	0.12	11.59	16.60	Pass

- Note: 1. Method a) of power density measurement of KDB 662911 is using for calculating total power density. Total power density is summing entire spectra across corresponding frequency bins on the various outputs by computer.
2. The directional gain = $10 \log[(10^{G0/20} + 10^{G1/20})^2 / 2] = 6.4\text{dBi} > 6\text{dBi}$, so the power density limit shall be reduced to $17-(6.4-6) = 16.6\text{dBm}$.
3. Refer to section 3.3 for duty cycle spectrum plot.

802.11ax (HE80)

Chan.	Chan. Freq. (MHz)	PSD W/O Duty Factor (dBm/MHz)		Duty Factor (dB)	Total PSD With Duty Factor (dBm/MHz)	Max. Limit (dBm/MHz)	Pass / Fail
		Chain 0	Chain 1				
42	5210	1.80	1.18	0.19	4.70	16.6	Pass

- Note: 1. Method a) of power density measurement of KDB 662911 is using for calculating total power density. Total power density is summing entire spectra across corresponding frequency bins on the various outputs by computer.
2. The directional gain = $10 \log[(10^{G0/20} + 10^{G1/20})^2 / 2] = 6.4\text{dBi} > 6\text{dBi}$, so the power density limit shall be reduced to $17-(6.4-6) = 16.6\text{dBm}$.
3. Refer to section 3.3 for duty cycle spectrum plot.

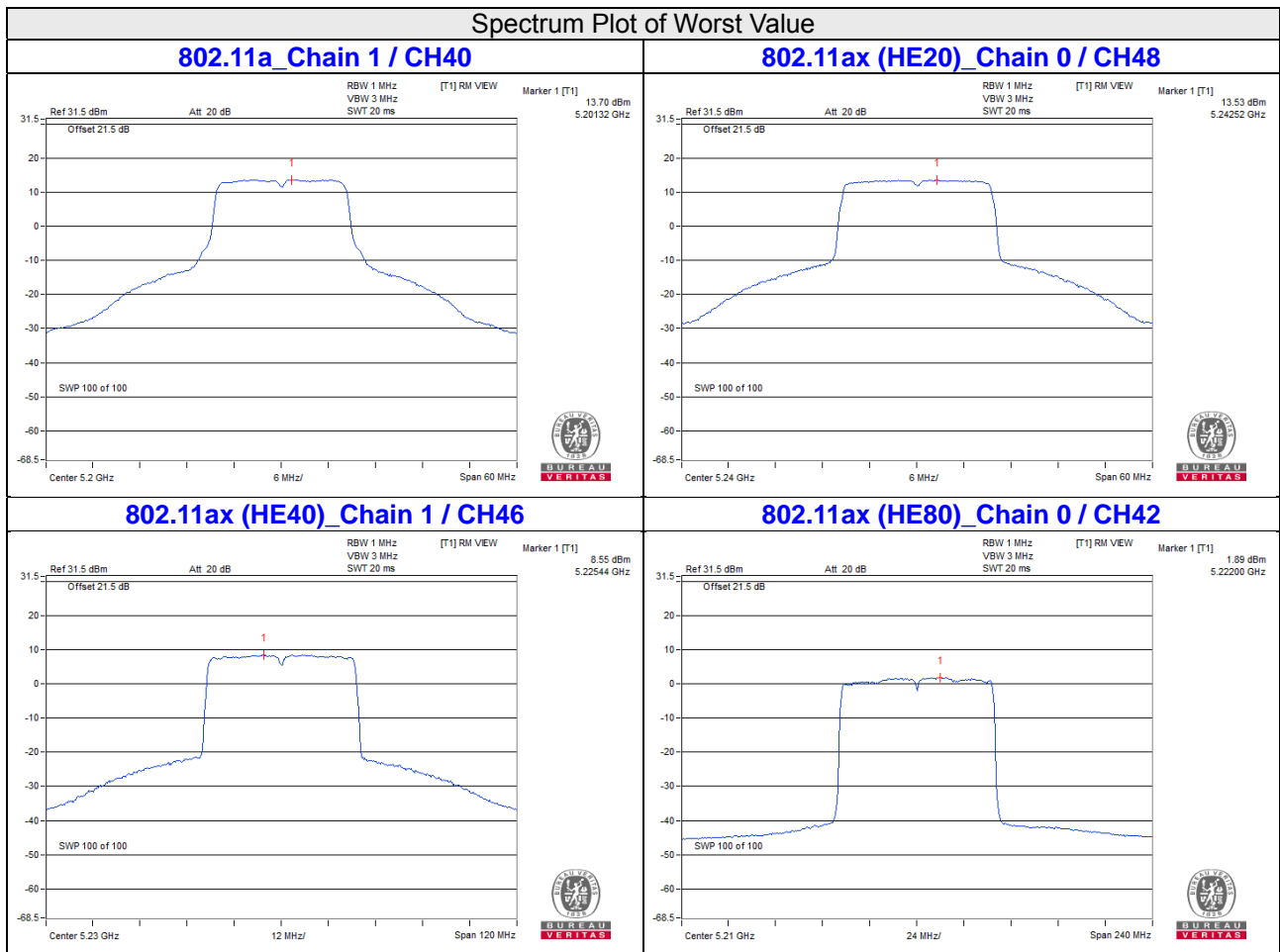

For U-NII-3:
802.11a

Chan.	Freq. (MHz)	PSD (dBm/300kHz)		Total PSD		Total PSD (dBm/500kHz)	Limit (dBm/500kHz)	Pass /Fail
		Chain 0	Chain 1	mW/ 300kHz	dBm/ 300kHz			
149	5745	5.52	5.72	7.297	8.63	10.85	30.00	Pass
157	5785	5.20	5.29	6.692	8.26	10.48	30.00	Pass
165	5825	5.49	5.50	7.0881	8.51	10.73	30.00	Pass

- Note: 1. Method b) Measure and sum spectral maxima across the outputs of KDB 662911 is using for calculating total power density.
 2. The directional gain = $10 \log[(10^{G0/20} + 10^{G1/20})^2 / 2]$ = 4.9dBi < 6dBi, so the power density limit shall not be reduced.

802.11ax (HE20)

Chan.	Freq. (MHz)	PSD (dBm/300kHz)		Total PSD		Total PSD (dBm/500kHz)	Limit (dBm/500kHz)	Pass /Fail
		Chain 0	Chain 1	mW/ 300kHz	dBm/ 300kHz			
149	5745	4.09	4.12	5.1467	7.12	9.34	30.00	Pass
157	5785	3.91	3.97	4.955	6.95	9.17	30.00	Pass
165	5825	3.80	3.67	4.7269	6.75	8.97	30.00	Pass

- Note: 1. Method b) Measure and sum spectral maxima across the outputs of KDB 662911 is using for calculating total power density.
 2. The directional gain = $10 \log[(10^{G0/20} + 10^{G1/20})^2 / 2]$ = 4.9dBi < 6dBi, so the power density limit shall not be reduced.

802.11ax (HE40)

Chan.	Freq. (MHz)	PSD W/O Duty Factor (dBm/300kHz)		Duty Factor (dB)	Total PSD With Duty Factor		Total PSD With Duty Factor (dBm/500kHz)	Limit (dBm/500kHz)	Pass /Fail
		Chain 0	Chain 1		mW/ 300kHz	dBm/ 300kHz			
151	5755	0.66	0.92	0.12	2.4656	3.92	6.14	30.00	Pass
159	5795	0.76	0.52	0.12	2.3817	3.77	5.99	30.00	Pass

- Note: 1. Method b) Measure and sum spectral maxima across the outputs of KDB 662911 is using for calculating total power density.
 2. The directional gain = $10 \log[(10^{G0/20} + 10^{G1/20})^2 / 2]$ = 4.9dBi < 6dBi, so the power density limit shall not be reduced.
 3. Refer to section 3.3 for duty cycle spectrum plot.

802.11ax (HE80)

Chan.	Freq. (MHz)	PSD W/O Duty Factor (dBm/300kHz)		Duty Factor (dB)	Total PSD With Duty Factor		Total PSD With Duty Factor (dBm/500kHz)	Limit (dBm/500kHz)	Pass /Fail
		Chain 0	Chain 1		mW/ 300kHz	dBm/ 300kHz			
155	5775	-6.11	-6.33	0.19	0.4985	-3.02	-0.80	30.00	Pass

- Note: 1. Method b) Measure and sum spectral maxima across the outputs of KDB 662911 is using for calculating total power density.
 2. The directional gain = $10 \log[(10^{G0/20} + 10^{G1/20})^2 / 2] = 4.9\text{dBi} < 6\text{dBi}$, so the power density limit shall not be reduced.
 3. Refer to section 3.3 for duty cycle spectrum plot.

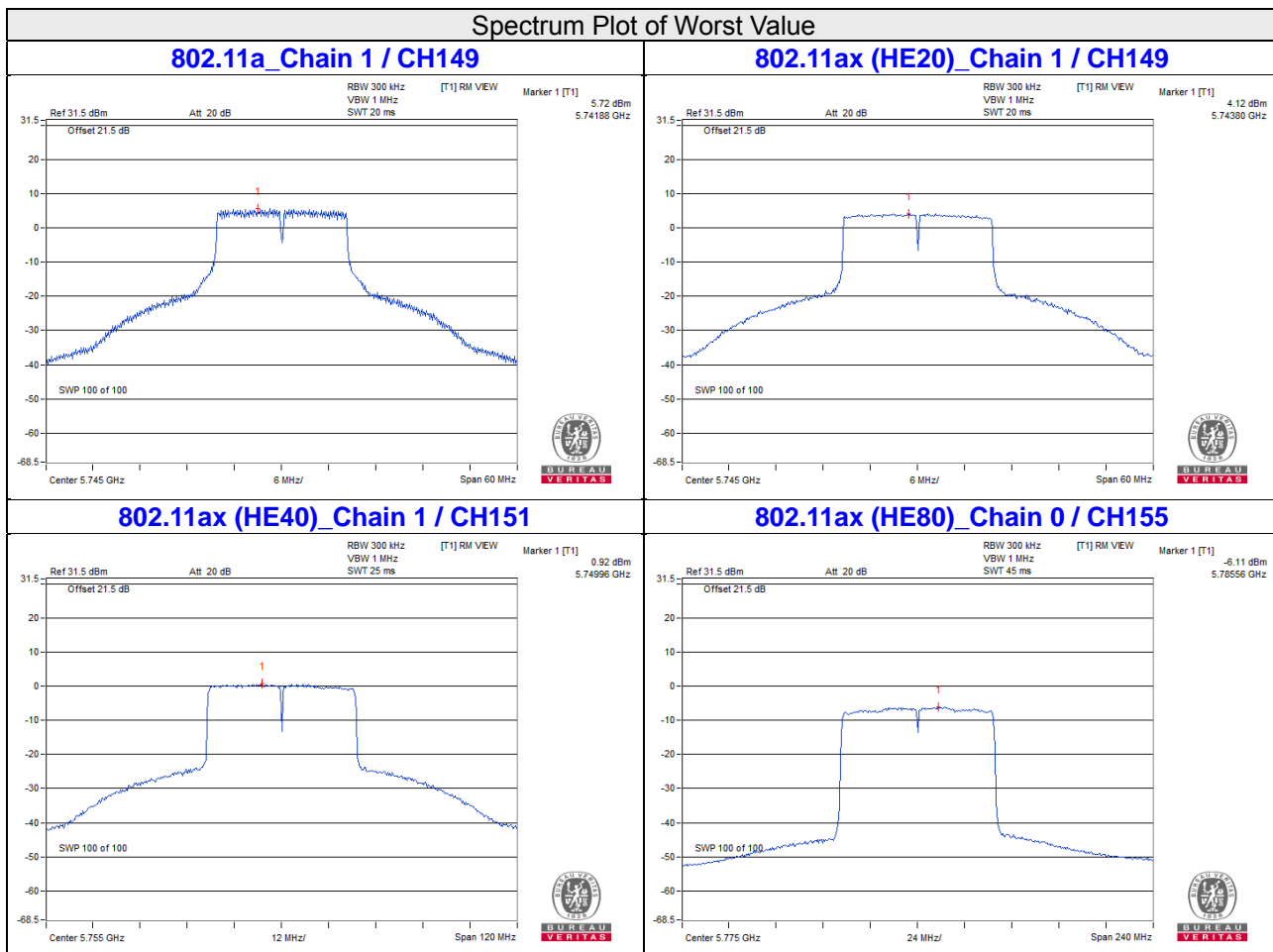

4.6 Frequency Stability Measurement

4.6.1 Limits of Frequency Stability Measurement

The frequency of the carrier signal shall be maintained within band of operation

4.6.2 Test Setup

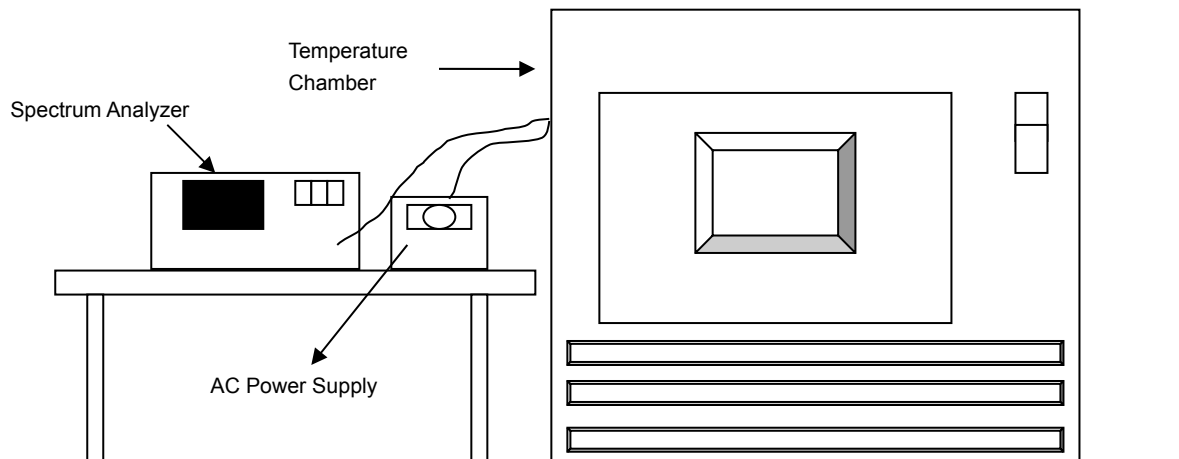

4.6.3 Test Instruments

Refer to section 4.1.2 to get information of above instrument.

4.6.4 Test Procedure

- The EUT was placed inside the environmental test chamber and powered by nominal AC voltage.
- Turn the EUT on and couple its output to a spectrum analyzer.
- Turn the EUT off and set the chamber to the highest temperature specified.
- Allow sufficient time (approximately 30 min) for the temperature of the chamber to stabilize, turn the EUT on and measure the operating frequency after 2, 5, and 10 Minutes.
- Repeat step (d) with the temperature chamber set to the next desired temperature until measurements down to the lowest specified temperature have been completed.
- The test chamber was allowed to stabilize at +20 degree C for a minimum of 30 Minutes. The supply voltage was then adjusted on the EUT from 85% to 115% and the frequency record.

4.6.5 Deviation from Test Standard

No deviation.

4.6.6 EUT Operating Condition

Set the EUT transmit at un-modulation mode to test frequency stability.

4.6.7 Test Results

Frequency Stability Versus Temp.									
Operating Frequency: 5180 MHz									
TEMP. (°C)	Power Supply (Vac)	0 Minute		2 Minutes		5 Minutes		10 Minutes	
		Measured Frequency (MHz)	Pass/Fail	Measured Frequency (MHz)	Pass/Fail	Measured Frequency (MHz)	Pass/Fail	Measured Frequency (MHz)	Pass/Fail
50	120	5179.9814	Pass	5179.9808	Pass	5179.9815	Pass	5179.9811	Pass
40	120	5180.0106	Pass	5180.011	Pass	5180.0123	Pass	5180.011	Pass
30	120	5180.0231	Pass	5180.0265	Pass	5180.0252	Pass	5180.0244	Pass
20	120	5179.9751	Pass	5179.9724	Pass	5179.9759	Pass	5179.9759	Pass
10	120	5179.9959	Pass	5179.9944	Pass	5179.9955	Pass	5179.9957	Pass
0	120	5179.9983	Pass	5179.9994	Pass	5179.9955	Pass	5179.9984	Pass
-10	120	5179.9872	Pass	5179.9889	Pass	5179.9896	Pass	5179.9866	Pass
-20	120	5180.0145	Pass	5180.0171	Pass	5180.0187	Pass	5180.019	Pass
-30	120	5179.9912	Pass	5179.9921	Pass	5179.9963	Pass	5179.9929	Pass

Frequency Stability Versus Voltage									
Operating Frequency: 5180 MHz									
TEMP. (°C)	Power Supply (Vac)	0 Minute		2 Minutes		5 Minutes		10 Minutes	
		Measured Frequency (MHz)	Pass/Fail	Measured Frequency (MHz)	Pass/Fail	Measured Frequency (MHz)	Pass/Fail	Measured Frequency (MHz)	Pass/Fail
20	138	5179.9759	Pass	5179.9724	Pass	5179.9766	Pass	5179.9753	Pass
	120	5179.9751	Pass	5179.9724	Pass	5179.9759	Pass	5179.9759	Pass
	102	5179.975	Pass	5179.9716	Pass	5179.9749	Pass	5179.9768	Pass

4.7 6dB Bandwidth Measurement

4.7.1 Limits of 6dB Bandwidth Measurement

The minimum of 6dB Bandwidth Measurement is 0.5MHz.

4.7.2 Test Setup

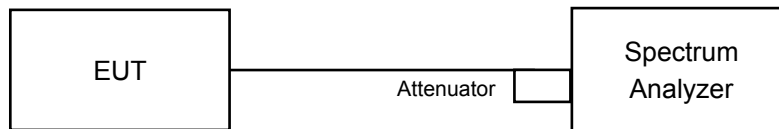

4.7.3 Test Instruments

Refer to section 4.1.2 to get information of above instrument.

4.7.4 Test Procedure

MEASUREMENT PROCEDURE REF

- Set resolution bandwidth (RBW) = 100kHz
- Set the video bandwidth (VBW) $\geq 3 \times$ RBW, Detector = Peak.
- Trace mode = max hold.
- Sweep = auto couple.
- Measure the maximum width of the emission that is constrained by the frequencies associated with the two amplitude points (upper and lower) that are attenuated by 6 dB relative to the maximum level measured in the fundamental emission

4.7.5 Deviation from Test Standard

No deviation.

4.7.6 EUT Operating Condition

The software provided by client to enable the EUT under transmission condition continuously at lowest, middle and highest channel frequencies individually.

4.7.7 Test Results

802.11a

Channel	Frequency (MHz)	6dB Bandwidth (MHz)		Minimum Limit (MHz)	Pass / Fail
		Chain 0	Chain 1		
149	5745	16.42	16.43	0.5	Pass
157	5785	16.43	16.44	0.5	Pass
165	5825	16.42	16.42	0.5	Pass

802.11ax (HE20)

Channel	Frequency (MHz)	6dB Bandwidth (MHz)		Minimum Limit (MHz)	Pass / Fail
		Chain 0	Chain 1		
149	5745	19.10	19.03	0.5	Pass
157	5785	19.08	19.03	0.5	Pass
165	5825	19.12	19.04	0.5	Pass

802.11ax (HE40)

Channel	Frequency (MHz)	6dB Bandwidth (MHz)		Minimum Limit (MHz)	Pass / Fail
		Chain 0	Chain 1		
151	5755	37.87	37.44	0.5	Pass
159	5795	37.88	37.39	0.5	Pass

802.11ax (HE80)

Channel	Frequency (MHz)	6dB Bandwidth (MHz)		Minimum Limit (MHz)	Pass / Fail
		Chain 0	Chain 1		
155	5775	77.61	77.57	0.5	Pass

Spectrum Plot of Worst Value

802.11a_Chain 0 / CH149

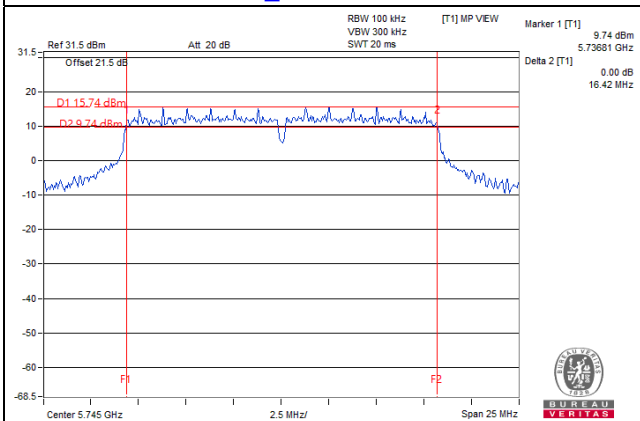

802.11ax (HE20)_Chain 1 / CH149

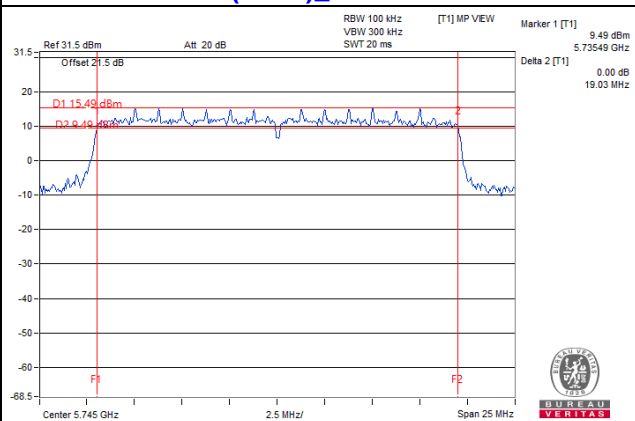

802.11ax (HE40)_Chain 1 / CH159

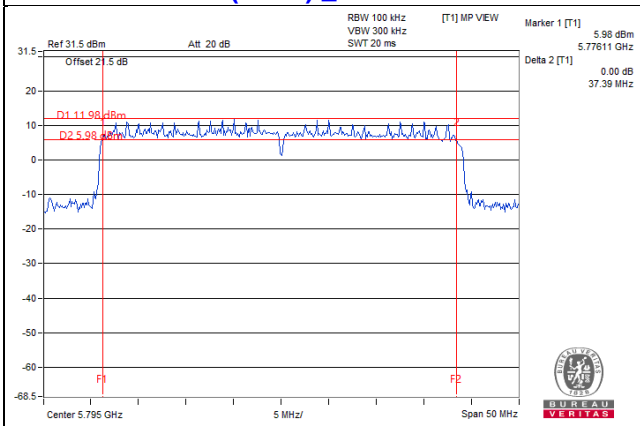

802.11ax (HE80)_Chain 1 / CH155

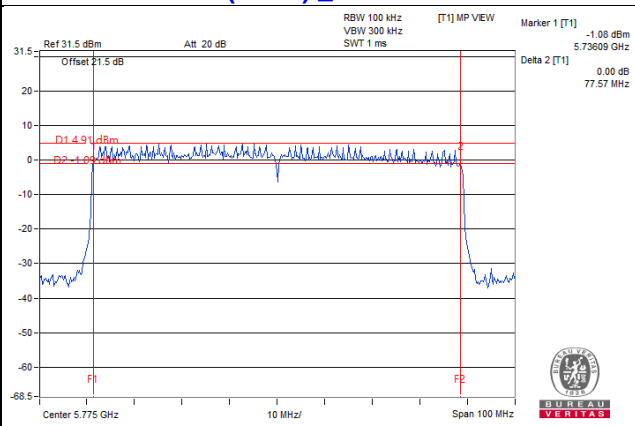

5 Pictures of Test Arrangements

Please refer to the attached file (Test Setup Photo).

Annex A- Radiated Out of Band Emission (OOBE) Measurement (For U-NII-3 band)

802.11a

CH 149 5745 MHz

Horizontal

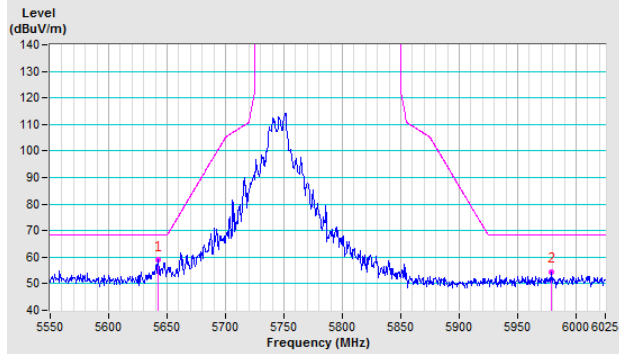

Vertical

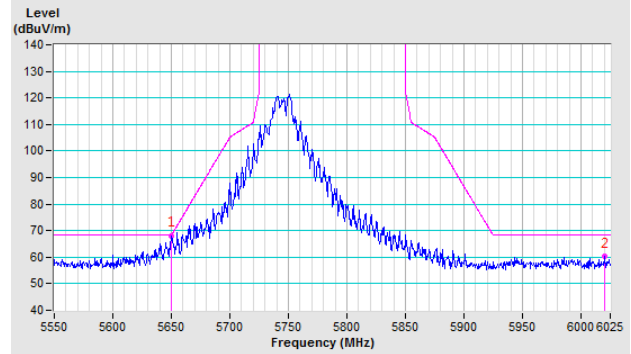

CH 157 5785 MHz

Horizontal

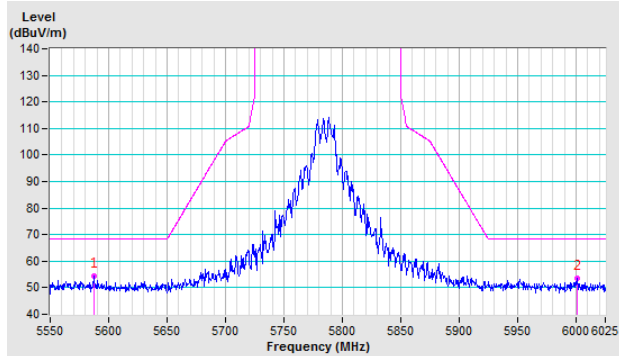

Vertical

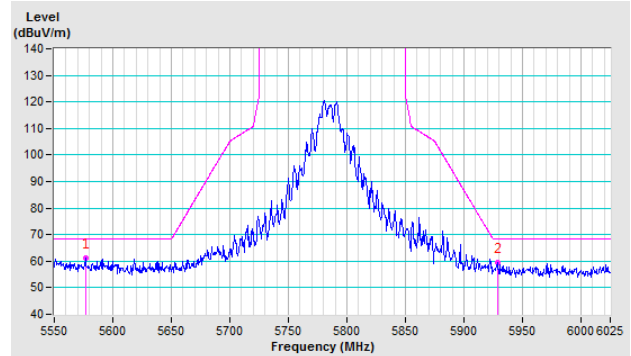

CH 165 5825 MHz

Horizontal

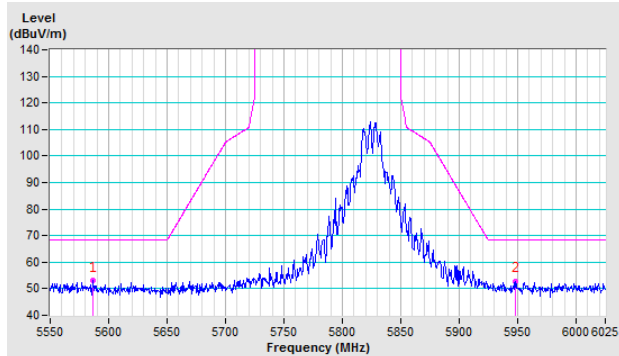

Vertical

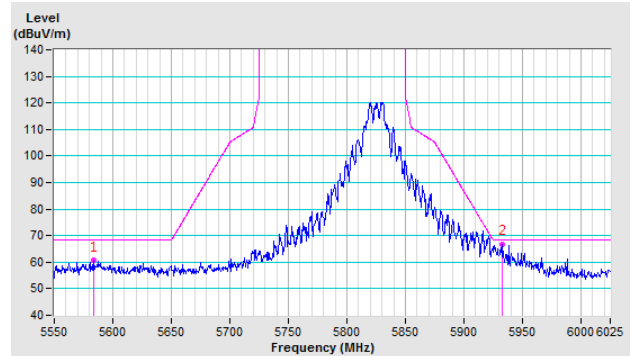

802.11ac (VHT20)

CH 149 5745 MHz

Horizontal

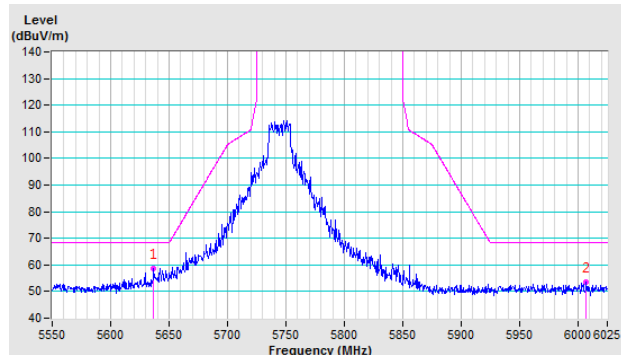

Vertical

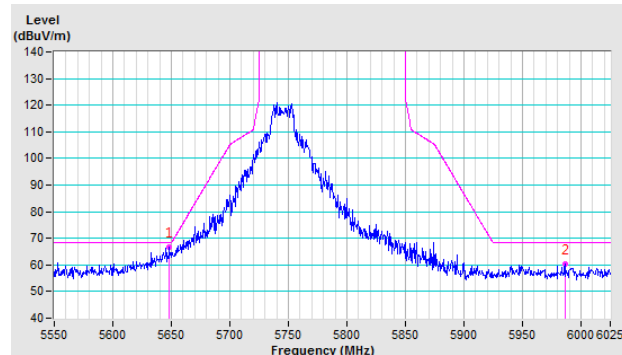

CH 157 5785 MHz

Horizontal

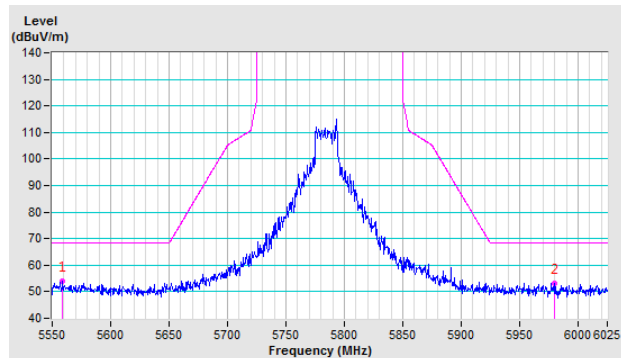

Vertical

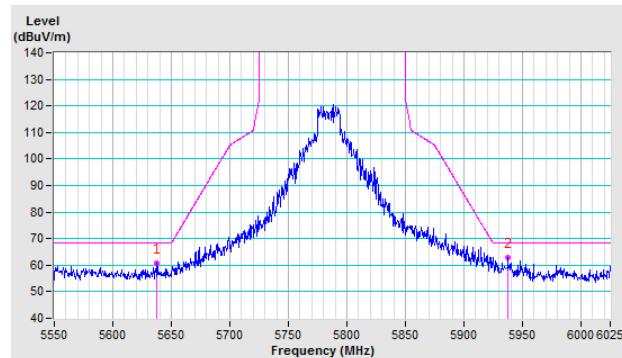

CH 165 5825 MHz

Horizontal

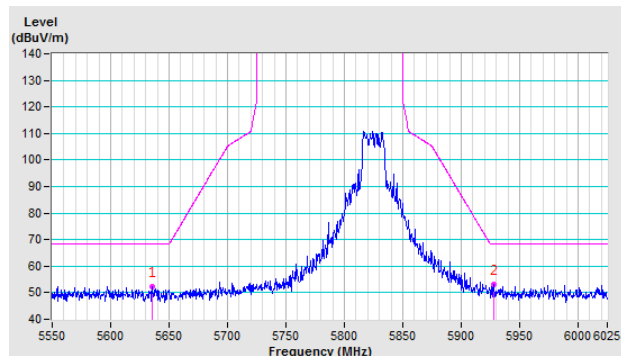

Vertical

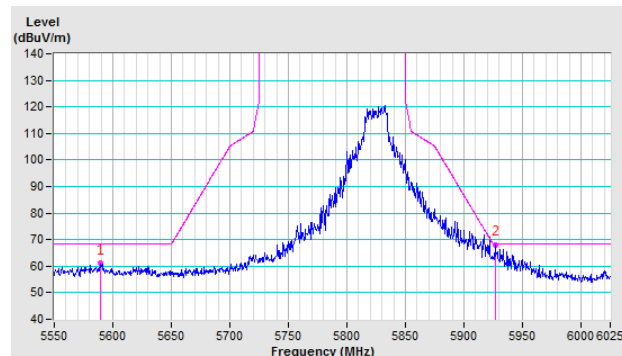

802.11ac (VHT40)

CH 151 5755 MHz

Horizontal

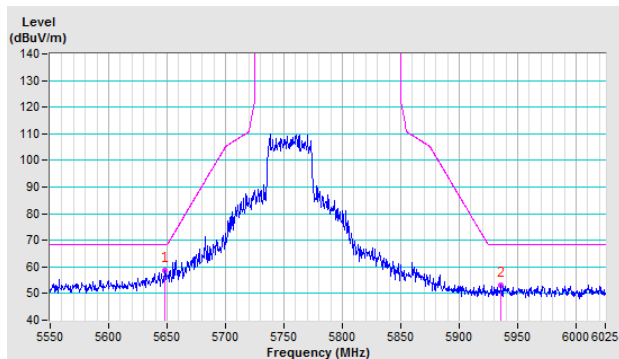

Vertical

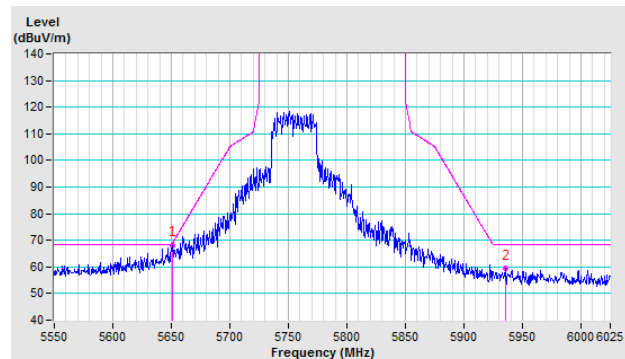

CH 159 5795 MHz

Horizontal

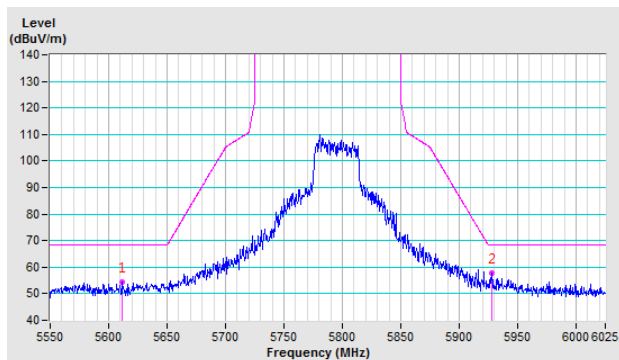

Vertical

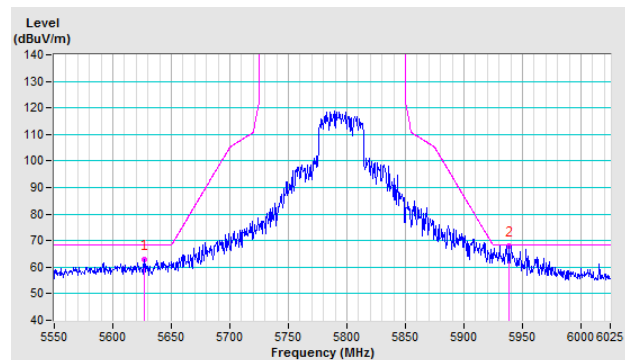

802.11ac (VHT80)

CH 155 5775 MHz

Horizontal

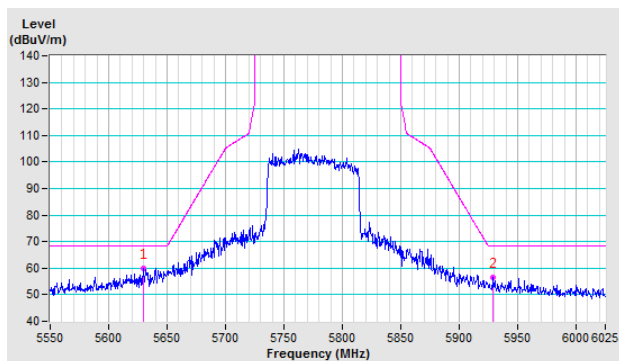

Vertical

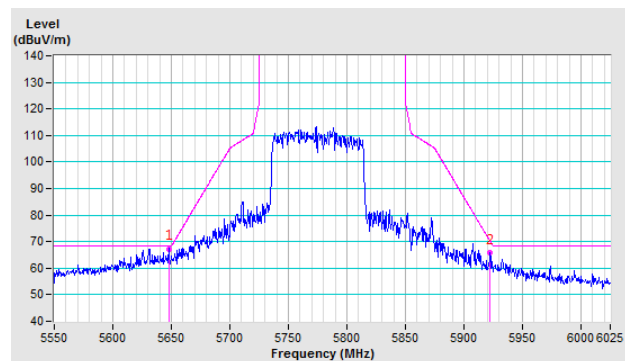

Appendix – Information of the Testing Laboratories

We, Bureau Veritas Consumer Products Services (H.K.) Ltd., Taoyuan Branch, were founded in 1988 to provide our best service in EMC, Radio, Telecom and Safety consultation. Our laboratories are FCC recognized accredited test firms and accredited according to ISO/IEC 17025.

If you have any comments, please feel free to contact us at the following:

Lin Kou EMC/RF Lab

Tel: 886-2-26052180

Fax: 886-2-26051924

Hsin Chu EMC/RF/Telecom Lab

Tel: 886-3-6668565

Fax: 886-3-6668323

Hwa Ya EMC/RF/Safety Lab

Tel: 886-3-3183232

Fax: 886-3-3270892

Email: service.adt@tw.bureauveritas.com

Web Site: www.bureauveritas-adt.com

The address and road map of all our labs can be found in our web site also.

--- END ---