

FCC Test Report (WLAN)

Report No.: RF181101C08-1

FCC ID: PY318300430

Test Model: AAA

Received Date: Nov. 01, 2018

Test Date: Dec. 03, 2018 to Jan. 09, 2019

Issued Date: Jan. 28, 2019

Applicant: NETGEAR, INC.

Address: 350 East Plumeria Drive San Jose, CA 95134

Issued By: Bureau Veritas Consumer Products Services (H.K.) Ltd., Taoyuan Branch
Hsin Chu Laboratory

Lab Address: E-2, No.1, Li Hsin 1st Road, Hsinchu Science Park, Hsinchu City 300,
Taiwan R.O.C.

Test Location: E-2, No.1, Li Hsin 1st Road, Hsinchu Science Park, Hsinchu City 300,
Taiwan R.O.C.

**FCC Registration /
Designation Number:** 723255 / TW2022



This report is for your exclusive use. Any copying or replication of this report to or for any other person or entity, or use of our name or trademark, is permitted only with our prior written permission. This report sets forth our findings solely with respect to the test samples identified herein. The results set forth in this report are not indicative or representative of the quality or characteristics of the lot from which a test sample was taken or any similar or identical product unless specifically and expressly noted. Our report includes all of the tests requested by you and the results thereof based upon the information that you provided to us. You have 60 days from date of issuance of this report to notify us of any material error or omission caused by our negligence, provided, however, that such notice shall be in writing and shall specifically address the issue you wish to raise. A failure to raise such issue within the prescribed time shall constitute your unqualified acceptance of the completeness of this report, the tests conducted and the correctness of the report contents. Unless specific mention, the uncertainty of measurement has been explicitly taken into account to declare the compliance or non-compliance to the specification. The report must not be used by the client to claim product certification, approval, or endorsement by TAF or any government agencies.

Table of Contents

Release Control Record	4
1 Certificate of Conformity	5
2 Summary of Test Results	6
2.1 Measurement Uncertainty	6
2.2 Modification Record	6
3 General Information	7
3.1 General Description of EUT (WLAN)	7
3.2 Description of Test Modes	9
3.2.1 Test Mode Applicability and Tested Channel Detail	11
3.3 Duty Cycle of Test Signal	14
3.4 Description of Support Units	15
3.4.1 Configuration of System under Test	15
3.5 General Description of Applied Standard	16
4 Test Types and Results	17
4.1 Radiated Emission and Bandedge Measurement	17
4.1.1 Limits of Radiated Emission and Bandedge Measurement	17
4.1.2 Test Instruments	18
4.1.3 Test Procedure	20
4.1.4 Deviation from Test Standard	20
4.1.5 Test Setup	21
4.1.6 EUT Operating Condition	22
4.1.7 Test Results	23
4.2 Conducted Emission Measurement	69
4.2.1 Limits of Conducted Emission Measurement	69
4.2.2 Test Instruments	69
4.2.3 Test Procedure	70
4.2.4 Deviation from Test Standard	70
4.2.5 Test Setup	70
4.2.6 EUT Operating Condition	70
4.2.7 Test Results	71
4.3 Transmit Power Measurement	73
4.3.1 Limits of Transmit Power Measurement	73
4.3.2 Test Setup	73
4.3.3 Test Instruments	74
4.3.4 Test Procedure	74
4.3.5 Deviation from Test Standard	74
4.3.6 EUT Operating Condition	74
4.3.7 Test Results	75
4.4 Occupied Bandwidth Measurement	94
4.4.1 Test Setup	94
4.4.2 Test Instruments	94
4.4.3 Test Procedure	94
4.4.4 Test Results	95
4.5 Peak Power Spectral Density Measurement	100
4.5.1 Limits of Peak Power Spectral Density Measurement	100
4.5.2 Test Setup	100
4.5.3 Test Instruments	100
4.5.4 Test Procedure	101
4.5.5 Deviation from Test Standard	101
4.5.6 EUT Operating Condition	101
4.5.7 Test Results	102
4.6 Frequency Stability Measurement	110
4.6.1 Limits of Frequency Stability Measurement	110

4.6.2	Test Setup.....	110
4.6.3	Test Instruments	110
4.6.4	Test Procedure	110
4.6.5	Deviation from Test Standard	110
4.6.6	EUT Operating Condition	110
4.6.7	Test Results	111
4.7	6dB Bandwidth Measurement	112
4.7.1	Limits of 6dB Bandwidth Measurement.....	112
4.7.2	Test Setup.....	112
4.7.3	Test Instruments	112
4.7.4	Test Procedure	112
4.7.5	Deviation from Test Standard	112
4.7.6	EUT Operating Condition	112
4.7.7	Test Results	113
5	Pictures of Test Arrangements.....	115
	Annex A- Radiated Out of Band Emission (OOBE) Measurement (For U-NII-3 band)	116
	Appendix – Information of the Testing Laboratories	119

Release Control Record

Issue No.	Description	Date Issued
RF181101C08-1	Original release.	Jan. 28, 2019

1 Certificate of Conformity

Product: Nighthawk AX4 AX3000 4-Stream WiFi Router

Brand: Netgear

Test Model: AAA

Sample Status: ENGINEERING SAMPLE

Applicant: NETGEAR, INC.

Test Date: Dec. 03, 2018 to Jan. 09, 2019

Standard: 47 CFR FCC Part 15, Subpart E (Section 15.407)
ANSI C63.10: 2013

The above equipment has been tested by **Bureau Veritas Consumer Products Services (H.K.) Ltd., Taoyuan Branch**, and found compliance with the requirement of the above standards. The test record, data evaluation & Equipment Under Test (EUT) configurations represented herein are true and accurate accounts of the measurements of the sample's EMC characteristics under the conditions specified in this report.

Prepared by :  _____, **Date:** _____ Jan. 28, 2019
Claire Kuan / Specialist

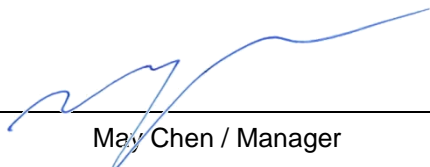
Approved by :  _____, **Date:** _____ Jan. 28, 2019
May Chen / Manager

2 Summary of Test Results

47 CFR FCC Part 15, Subpart E (Section 15.407)			
FCC Clause	Test Item	Result	Remarks
15.407(b)(6)	AC Power Conducted Emissions	Pass	Meet the requirement of limit. Minimum passing margin is -9.83dB at 0.40781MHz.
15.407(b)(1/2/3/4(i/ii)/6)	Radiated Emissions & Band Edge Measurement*	Pass	Meet the requirement of limit. Minimum passing margin is -0.1dB at 5150.00MHz, 5460.00MHz and 5725.00MHz.
15.407(a)(1/2/3)	Max Average Transmit Power	Pass	Meet the requirement of limit.
---	Occupied Bandwidth Measurement	-	Reference only.
15.407(a)(1/2/3)	Peak Power Spectral Density	Pass	Meet the requirement of limit.
15.407(e)	6dB bandwidth	Pass	Meet the requirement of limit. (U-NII-3 Band only)
15.407(g)	Frequency Stability	Pass	Meet the requirement of limit.
15.203	Antenna Requirement	Pass	Antenna connector is i-pex(MHF) not a standard connector.s

*For U-NII-3 band compliance with rule part 15.407(b)(4)(i), the OOB test plots were recorded in Annex A.

Note:

Determining compliance based on the results of the compliance measurement, not taking into account measurement instrumentation uncertainty.

2.1 Measurement Uncertainty

Where relevant, the following measurement uncertainty levels have been estimated for tests performed on the EUT as specified in CISPR 16-4-2:

Measurement	Frequency	Expanded Uncertainty (k=2) (±)
Conducted Emissions at mains ports	150kHz ~ 30MHz	1.84 dB
Radiated Emissions up to 1 GHz	30MHz ~ 1GHz	5.33 dB
Radiated Emissions above 1 GHz	1GHz ~ 6GHz	5.10 dB
	6GHz ~ 18GHz	4.85 dB
	18GHz ~ 40GHz	5.24 dB

2.2 Modification Record

There were no modifications required for compliance.

3 General Information

3.1 General Description of EUT (WLAN)

Product	NIGHTHAWK AX4 AX3000 4-Stream WiFi Router
Brand	Netgear
Test Model	AAA
Status of EUT	ENGINEERING SAMPLE
Power Supply Rating	12Vdc from power adapter
Modulation Type	CCK, DQPSK, DBPSK for DSSS 64QAM, 16QAM, QPSK, BPSK for OFDM 256QAM for OFDM in 11ac mode and VHT (20/40) mode in 2.4GHz 1024QAM for OFDMA in 11ax HE mode
Modulation Technology	DSSS, OFDM, OFDMA
Transfer Rate	802.11b: up to 11Mbps 802.11a/g: up to 54Mbps 802.11n: up to 300Mbps 802.11ac: up to 1733.3Mbps 802.11ax: up to 2401.9Mbps
Operating Frequency	2.4GHz: 2.412 ~ 2.462GHz 5GHz: 5.18~ 5.24GHz, 5.26 ~ 5.32GHz, 5.5 ~ 5.72GHz, 5.745 ~ 5.825GHz
Number of Channel	2.4GHz: 802.11b, 802.11g, 802.11n (HT20), VHT20, 802.11ax (HE20): 11 802.11n (HT40), VHT40, 802.11ax (HE40): 7 5GHz: 802.11a, 802.11n (HT20), 802.11ac (VHT20), 802.11ax (HE20): 25 802.11n (HT40), 802.11ac (VHT40), 802.11ax (HE40): 12 802.11ac (VHT80), 802.11ax (HE80): 6 802.11ac (VHT160), 802.11ax (HE160): 2
Output Power	Non-Beamforming Mode: 2.4GHz: 455.166mW 5.18 ~ 5.24GHz: 857.679mW 5.26 ~ 5.32GHz: 222.315mW 5.5 ~ 5.72GHz: 230.935mW 5.745 ~ 5.825GHz: 920.206mW Beamforming Mode: 2.4GHz: 671.379mW 5.18 ~ 5.24GHz: 886.409mW 5.26 ~ 5.32GHz: 225.092mW 5.5 ~ 5.72GHz: 230.865mW 5.745 ~ 5.825GHz: 912.355mW
Antenna Type	Refer to Note
Antenna Connector	Refer to Note
Accessory Device	Adapter x 1
Data Cable Supplied	RJ45 cable x 1 (Unshielded, 1.5m)

Note:

1. Simultaneously transmission condition.

Condition	Technology	
1	WLAN (2.4GHz)	WLAN (5GHz)

Note: The emission of the simultaneous operation has been evaluated and no non-compliance was found.

2. The EUT must be supplied a power adapter and following different models could be chosen as following table:

No.	Brand	Model No.	P/N	Spec.
1	NETGEAR	AD2096F10	332-10935-01	Input: 100-120V~50/60Hz 1.0A Output: 12V / 2.5A DC Output cable: Unshielded, 1.8m
2	NETGEAR	2ABL030F 1 NA	332-10758-01	Input: 100-120V~50/60Hz 1.0A Output: 12V / 2.5A DC Output cable: Unshielded, 1.85m

Note: From the above adapters, the worst radiated emission and AC power conducted emission test was found in **Adapter 1**. Therefore only the test data of the mode was recorded in this report.

3. The antennas provided to the EUT, please refer to the following table:

Antenna No.	Antenna Net Gain (dBi)	Frequency range	Antenna Type	Connector Type
1	3.01	2.4~2.4835GHz	Dipole	i-pex(MHF)
	3.3	5.15~5.85GHz		
2	3.19	2.4~2.4835GHz	Dipole	i-pex(MHF)
	3.38	5.15~5.85GHz		

4. The EUT incorporates a MIMO function:

2.4GHz Band		
MODULATION MODE	TX & RX CONFIGURATION	
802.11b	1TX (Fixed Chain 0)	2RX
802.11g	2TX	2RX
802.11n (HT20)	2TX	2RX
802.11n (HT40)	2TX	2RX
VHT20	2TX	2RX
VHT40	2TX	2RX
802.11ax (HE20)	2TX	2RX
802.11ax (HE40)	2TX	2RX
5GHz Band		
MODULATION MODE	TX & RX CONFIGURATION	
802.11a	2TX	2RX
802.11n (HT20)	2TX	2RX
802.11n (HT40)	2TX	2RX
802.11ac (VHT20)	2TX	2RX
802.11ac (VHT40)	2TX	2RX
802.11ac (VHT80)	2TX	2RX
802.11ac (VHT160)	2TX	2RX
802.11ax (HE20)	2TX	2RX
802.11ax (HE40)	2TX	2RX
802.11ax (HE80)	2TX	2RX
802.11ax (HE160)	2TX	2RX

Note:

- All of modulation mode support beamforming function except 802.11a/b/g modulation mode.
- The EUT support Beamforming and non-beamforming mode, therefore both mode were investigated and the worst case scenario was identified. The worst case data were presented in test report.
- The modulation and bandwidth are similar for 802.11n mode for 20MHz (40MHz), 802.11ac mode for 20MHz (40MHz, 80MHz, 160MHz) and 802.11ax mode for 20MHz (40MHz, 80MHz, 160MHz), therefore investigated worst case to representative mode in test report. (Final test mode refer section 3.2.1)

5. The above EUT information is declared by manufacturer and for more detailed features description, please refers to the manufacturer's specifications or user's manual.

3.2 Description of Test Modes

FOR 5180 ~ 5240MHz

4 channels are provided for 802.11a, 802.11n (HT20), 802.11ac (VHT20), 802.11ax (HE20):

Channel	Frequency	Channel	Frequency
36	5180 MHz	44	5220 MHz
40	5200 MHz	48	5240 MHz

2 channels are provided for 802.11n (HT40), 802.11ac (VHT40), 802.11ax (HE40):

Channel	Frequency	Channel	Frequency
38	5190 MHz	46	5230 MHz

1 channel is provided for 802.11ac (VHT80), 802.11ax (HE80):

Channel	Frequency
42	5210 MHz

1 straddle channel is provided for 802.11ac (VHT160), 802.11ax (HE160):

Channel	Frequency
50	5250 MHz

FOR 5260 ~ 5320MHz

4 channels are provided for 802.11a, 802.11n (HT20), 802.11ac (VHT20), 802.11ax (HE20):

Channel	Frequency	Channel	Frequency
52	5260 MHz	60	5300 MHz
56	5280 MHz	64	5320 MHz

2 channels are provided for 802.11n (HT40), 802.11ac (VHT40), 802.11ax (HE40):

Channel	Frequency	Channel	Frequency
54	5270 MHz	62	5310 MHz

1 channel is provided for 802.11ac (VHT80), 802.11ax (HE80):

Channel	Frequency
58	5290 MHz

1 straddle channel is provided for 802.11ac (VHT160), 802.11ax (HE160):

Channel	Frequency
50	5250 MHz

FOR 5500 ~ 5720MHz

12 channels are provided for 802.11a, 802.11n (HT20), 802.11ac (VHT20), 802.11ax (HE20):

Channel	Frequency	Channel	Frequency
100	5500 MHz	124	5620 MHz
104	5520 MHz	128	5640 MHz
108	5540 MHz	132	5660 MHz
112	5560 MHz	136	5680 MHz
116	5580 MHz	140	5700 MHz
120	5600 MHz	144	5720 MHz

6 channels are provided for 802.11n (HT40), 802.11ac (VHT40), 802.11ax (HE40):

Channel	Frequency	Channel	Frequency
102	5510 MHz	126	5630 MHz
110	5550 MHz	134	5670 MHz
118	5590 MHz	142	5710 MHz

3 channels are provided for 802.11ac (VHT80), 802.11ax (HE80):

Channel	Frequency	Channel	Frequency
106	5530 MHz	138	5690 MHz
122	5610 MHz		

1 straddle channel is provided for 802.11ac (VHT160), 802.11ax (HE160):

Channel	Frequency
114	5570 MHz

FOR 5745 ~ 5825MHz:

5 channels are provided for 802.11a, 802.11n (HT20), 802.11ac (VHT20), 802.11ax (HE20):

Channel	Frequency	Channel	Frequency
149	5745 MHz	161	5805 MHz
153	5765 MHz	165	5825 MHz
157	5785 MHz		

2 channels are provided for 802.11n (HT40), 802.11ac (VHT40), 802.11ax (HE40):

Channel	Frequency	Channel	Frequency
151	5755 MHz	159	5795 MHz

1 channel is provided for 802.11ac (VHT80), 802.11ax (HE80):

Channel	Frequency
155	5775 MHz

3.2.1 Test Mode Applicability and Tested Channel Detail

EUT Configure Mode	Applicable To				Description
	RE \geq 1G	RE $<$ 1G	PLC	APCM	
-	√	√	√	√	-

Where **RE \geq 1G**: Radiated Emission above 1GHz

RE $<$ 1G: Radiated Emission below 1GHz

PLC: Power Line Conducted Emission

APCM: Antenna Port Conducted Measurement

Note: The EUT had been pre-tested on the positioned of each 2 axis. The worst case was found when positioned on **X-plane**.

Radiated Emission Test (Above 1GHz):

- Pre-Scan has been conducted to determine the worst-case mode from all possible combinations between available modulations, data rates and antenna ports (if EUT with antenna diversity architecture).
- Following channel(s) was (were) selected for the final test as listed below.

Non-Beamforming Mode						
Mode	FREQ. Band (MHz)	Available Channel	Tested Channel	Modulation Technology	Modulation Type	Data Rate Parameter
802.11a	5180-5240	36 to 48	36, 40, 48	OFDM	BPSK	6Mb/s
	5260-5320	52 to 64	52, 60, 64			
	5500-5720	100 to 144	100, 116, 140, 144			
	5745-5825	149 to 165	149, 157, 165			
Beamforming Mode						
Mode	FREQ. Band (MHz)	Available Channel	Tested Channel	Modulation Technology	Modulation Type	Data Rate Parameter
802.11ax (HE20)	5180-5240	36 to 48	36, 40, 48	OFDMA	BPSK	MCS0
802.11ax (HE40)		38 to 46	38, 46	OFDMA	BPSK	MCS0
802.11ax (HE80)		42	42	OFDMA	BPSK	MCS0
802.11ax (HE20)	5260-5320	52 to 64	52, 60, 64	OFDMA	BPSK	MCS0
802.11ax (HE40)		54 to 62	54, 62	OFDMA	BPSK	MCS0
802.11ax (HE80)		58	58	OFDMA	BPSK	MCS0
802.11ax (HE160)		50	50	OFDMA	BPSK	MCS0
802.11ax (HE20)	5500-5720	100 to 144	100, 116, 140, 144	OFDMA	BPSK	MCS0
802.11ax (HE40)		102 to 142	102, 110, 134, 142	OFDMA	BPSK	MCS0
802.11ax (HE80)		106 to 138	106, 122, 138	OFDMA	BPSK	MCS0
802.11ax (HE160)		114	114	OFDMA	BPSK	MCS0
802.11ax (HE20)	5745-5825	149 to 165	149, 157, 165	OFDMA	BPSK	MCS0
802.11ax (HE40)		151 to 159	151, 159	OFDMA	BPSK	MCS0
802.11ax (HE80)		155	155	OFDMA	BPSK	MCS0

Radiated Emission Test (Below 1GHz):

- Pre-Scan has been conducted to determine the worst-case mode from all possible combinations between available modulations, data rates and antenna ports (if EUT with antenna diversity architecture).
- Following channel(s) was (were) selected for the final test as listed below.

Non-Beamforming Mode						
Mode	FREQ. Band (MHz)	Available Channel	Tested Channel	Modulation Technology	Modulation Type	Data Rate Parameter
802.11a	5180-5320, 5500-5720, 5745-5825	36 to 64, 100 to 144, 149 to 165	157	OFDM	BPSK	6Mb/s

Power Line Conducted Emission Test:

- Pre-Scan has been conducted to determine the worst-case mode from all possible combinations between available modulations, data rates and antenna ports (if EUT with antenna diversity architecture).
- Following channel(s) was (were) selected for the final test as listed below.

Non-Beamforming Mode						
Mode	FREQ. Band (MHz)	Available Channel	Tested Channel	Modulation Technology	Modulation Type	Data Rate Parameter
802.11a	5180-5320, 5500-5720, 5745-5825	36 to 64, 100 to 144, 149 to 165	157	OFDM	BPSK	6Mb/s

Antenna Port Conducted Measurement:

- This item includes all test value of each mode, but only includes spectrum plot of worst value of each mode.
- Pre-Scan has been conducted to determine the worst-case mode from all possible combinations between available modulations, data rates and antenna ports (if EUT with antenna diversity architecture).
- Following channel(s) was (were) selected for the final test as listed below.

Non-Beamforming Mode						
Mode	FREQ. Band (MHz)	Available Channel	Tested Channel	Modulation Technology	Modulation Type	Data Rate Parameter
802.11a	5180-5240	36 to 48	36, 40, 48	OFDM	BPSK	6Mb/s
	5260-5320	52 to 64	52, 60, 64			
	5500-5720	100 to 144	100, 116, 140, 144			
	5745-5825	149 to 165	149, 157, 165			

Beamforming Mode						
Mode	FREQ. Band (MHz)	Available Channel	Tested Channel	Modulation Technology	Modulation Type	Data Rate Parameter
802.11ac (VHT20) (Output power only)	5180-5240	36 to 48	36, 40, 48	OFDM	BPSK	MCS0
802.11ac (VHT40) (Output power only)		38 to 46	38, 46	OFDM	BPSK	MCS0
802.11ac (VHT80) (Output power only)		42	42	OFDM	BPSK	MCS0
802.11ax (HE20)		36 to 48	36, 40, 48	OFDMA	BPSK	MCS0
802.11ax (HE40)		38 to 46	38, 46	OFDMA	BPSK	MCS0
802.11ax (HE80)		42	42	OFDMA	BPSK	MCS0
802.11ac (VHT20) (Output power only)	5260-5320	52 to 64	52, 60, 64	OFDM	BPSK	MCS0
802.11ac (VHT40) (Output power only)		54 to 62	54, 62	OFDM	BPSK	MCS0
802.11ac (VHT80) (Output power only)		58	58	OFDM	BPSK	MCS0
802.11ac (VHT160) (Output power only)		50	50	OFDM	BPSK	MCS0
802.11ax (HE20)		52 to 64	52, 60, 64	OFDMA	BPSK	MCS0
802.11ax (HE40)		54 to 62	54, 62	OFDMA	BPSK	MCS0
802.11ax (HE80)		58	58	OFDMA	BPSK	MCS0
802.11ax (HE160)		50	50	OFDMA	BPSK	MCS0
802.11ac (VHT20) (Output power only)	5500-5720	100 to 144	100, 116, 140, 144	OFDM	BPSK	MCS0
802.11ac (VHT40) (Output power only)		102 to 142	102, 110, 134, 142	OFDM	BPSK	MCS0
802.11ac (VHT80) (Output power only)		106 to 138	106, 122, 138	OFDM	BPSK	MCS0
802.11ac (VHT160) (Output power only)		114	114	OFDM	BPSK	MCS0
802.11ax (HE20)		100 to 144	100, 116, 140, 144	OFDMA	BPSK	MCS0
802.11ax (HE40)		102 to 142	102, 110, 134, 142	OFDMA	BPSK	MCS0
802.11ax (HE80)		106 to 138	106, 122, 138	OFDMA	BPSK	MCS0
802.11ax (HE160)		114	114	OFDMA	BPSK	MCS0
802.11ac (VHT20) (Output power only)	5745-5825	149 to 165	149, 157, 165	OFDM	BPSK	MCS0
802.11ac (VHT40) (Output power only)		151 to 159	151, 159	OFDM	BPSK	MCS0
802.11ac (VHT80) (Output power only)		155	155	OFDM	BPSK	MCS0
802.11ax (HE20)		149 to 165	149, 157, 165	OFDMA	BPSK	MCS0
802.11ax (HE40)		151 to 159	151, 159	OFDMA	BPSK	MCS0
802.11ax (HE80)		155	155	OFDMA	BPSK	MCS0

Test Condition:

Applicable To	Environmental Conditions	Input Power	Tested By
RE \geq 1G	23deg. C, 66%RH	120Vac, 60Hz	Steven Chiang
RE $<$ 1G	22deg. C, 67%RH	120Vac, 60Hz	Steven Chiang
PLC	25deg. C, 75%RH	120Vac, 60Hz	Frank Chuang
APCM	25deg. C, 60%RH	120Vac, 60Hz	Jyunchun Lin

3.3 Duty Cycle of Test Signal

If duty cycle of test signal is $\geq 98\%$, duty factor is not required.

If duty cycle of test signal is $< 98\%$, duty factor shall be considered.

802.11a: Duty cycle = $1.81 \text{ ms}/1.865 \text{ ms} = 0.971$, Duty factor = $10 * \log(1/\text{Duty cycle}) = 0.13$

802.11ax (HE20): Duty cycle = $3.796 \text{ ms}/3.839 \text{ ms} = 0.989$

802.11ax (HE40): Duty cycle = $1.918 \text{ ms}/1.96 \text{ ms} = 0.979$, Duty factor = $10 * \log(1/\text{Duty cycle}) = 0.09$

802.11ax (HE80): Duty cycle = $0.94 \text{ ms}/0.984 \text{ ms} = 0.955$, Duty factor = $10 * \log(1/\text{Duty cycle}) = 0.20$

802.11ax (HE160): Duty cycle = $0.49 \text{ ms}/0.532 \text{ ms} = 0.921$, Duty factor = $10 * \log(1/\text{Duty cycle}) = 0.36$

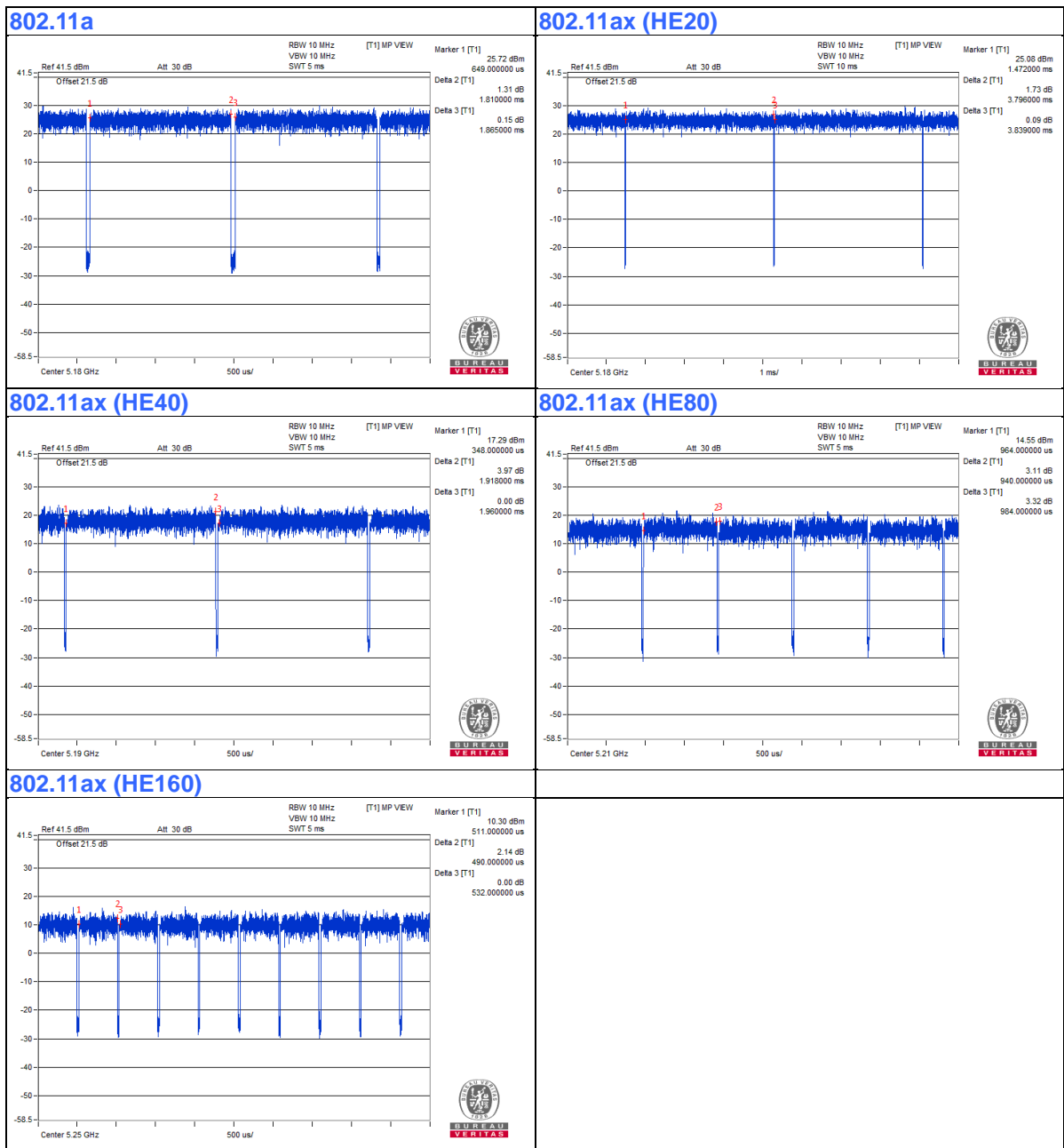

3.4 Description of Support Units

The EUT has been tested as an independent unit together with other necessary accessories or support units. The following support units or accessories were used to form a representative test configuration during the tests.

ID	Product	Brand	Model No.	Serial No.	FCC ID	Remarks
A.	Laptop	DELL	E6420	B92T3R1	FCC DoC	Provided by Lab
B.	Laptop	HP	Pavilion 14-ab023TU	5CD5340WXZ	NA	Provided by Lab
C.	iPod	Apple	MD778TA/A	CC4JMFL0F4T1	NA	Provided by Lab

Note:

1. All power cords of the above support units are non-shielded (1.8m).

ID	Descriptions	Qty.	Length (m)	Shielding (Yes/No)	Cores (Qty.)	Remarks
1.	DC Cable	1	1.8	No	0	Supplied by client
2.	RJ-45 Cable	1	10	No	0	Provided by Lab
3.	RJ-45 Cable	1	10	No	0	Provided by Lab
4.	USB Cable	1	0.1	Yes	0	Provided by Lab

3.4.1 Configuration of System under Test

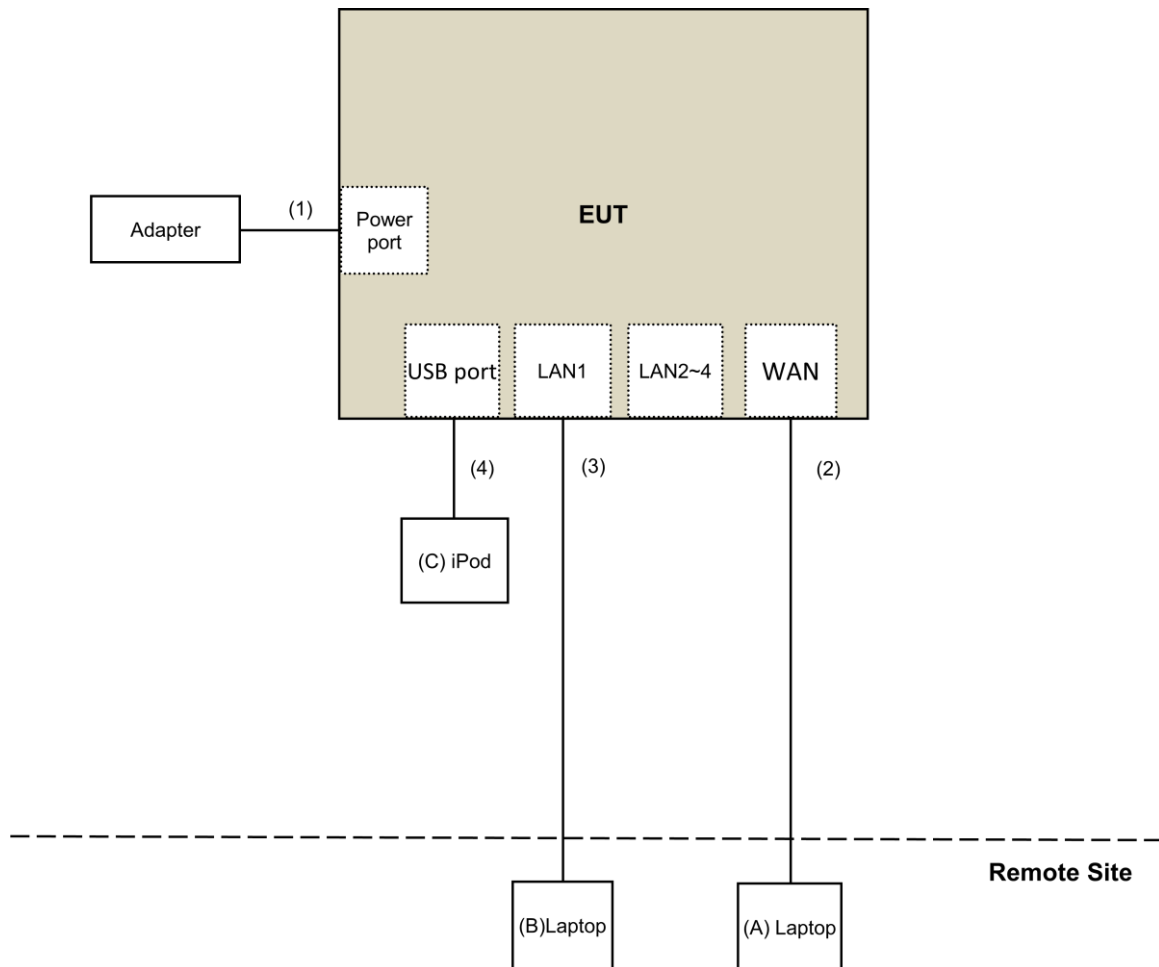

3.5 General Description of Applied Standard

The EUT is a RF Product. According to the specifications of the manufacturer, it must comply with the requirements of the following standards:

FCC Part 15, Subpart E (15.407)

KDB 789033 D02 General UNII Test Procedure New Rules v02r01

KDB 662911 D01 Multiple Transmitter Output v02r01

ANSI C63.10-2013

All test items have been performed and recorded as per the above standards.

4 Test Types and Results

4.1 Radiated Emission and Bandedge Measurement

4.1.1 Limits of Radiated Emission and Bandedge Measurement

Radiated emissions which fall in the restricted bands must comply with the radiated emission limits specified as below table.

Frequencies (MHz)	Field Strength (microvolts/meter)	Measurement Distance (meters)
0.009 ~ 0.490	2400/F(kHz)	300
0.490 ~ 1.705	24000/F(kHz)	30
1.705 ~ 30.0	30	30
30 ~ 88	100	3
88 ~ 216	150	3
216 ~ 960	200	3
Above 960	500	3

NOTE:

1. The lower limit shall apply at the transition frequencies.
2. Emission level (dBuV/m) = 20 log Emission level (uV/m).
3. For frequencies above 1000MHz, the field strength limits are based on average detector, however, the peak field strength of any emission shall not exceed the maximum permitted average limits, specified above by more than 20dB under any condition of modulation.

Limits of unwanted emission out of the restricted bands

Applicable To		Limit	
789033 D02 General UNII Test Procedure New Rules v02r01		Field Strength at 3m	
		PK:74 (dBuV/m)	AV:54 (dBuV/m)
Frequency Band	Applicable To	EIRP Limit	Equivalent Field Strength at 3m
5150~5250 MHz	15.407(b)(1)	PK:-27 (dBm/MHz)	PK:68.2(dBuV/m)
5250~5350 MHz	15.407(b)(2)		
5470~5725 MHz	15.407(b)(3)		
5725~5850 MHz	<input checked="" type="checkbox"/> 15.407(b)(4)(i)	PK:-27 (dBm/MHz) ^{*1} PK:10 (dBm/MHz) ^{*2} PK:15.6 (dBm/MHz) ^{*3} PK:27 (dBm/MHz) ^{*4}	PK: 68.2(dBuV/m) ^{*1} PK:105.2 (dBuV/m) ^{*2} PK: 110.8(dBuV/m) ^{*3} PK:122.2 (dBuV/m) ^{*4}
	<input type="checkbox"/> 15.407(b)(4)(ii)	Emission limits in section 15.247(d)	
*1 beyond 75 MHz or more above of the band edge.		*2 below the band edge increasing linearly to 10 dBm/MHz at 25 MHz above.	
*3 below the band edge increasing linearly to a level of 15.6 dBm/MHz at 5 MHz above.		*4 from 5 MHz above or below the band edge increasing linearly to a level of 27 dBm/MHz at the band edge.	

Note:

The following formula is used to convert the equipment isotropic radiated power (eirp) to field strength:

$$E = \frac{1000000\sqrt{30P}}{3} \mu\text{V/m, where P is the eirp (Watts).}$$

4.1.2 Test Instruments

For OOB test item:

DESCRIPTION & MANUFACTURER	MODEL NO.	SERIAL NO.	CALIBRATED DATE	CALIBRATED UNTIL
Test Receiver Keysight	N9038A	MY54450088	July 05, 2018	July 04, 2019
Horn_Antenna SCHWARZBECK	BBHA 9120D	9120D-783	Dec. 12, 2017	Dec. 11, 2018
Pre-Amplifier Mini-Circuits	ZVA-183-S+	AMP-ZVA-03	May 10, 2018	May 09, 2019
RF Cable	EMC104-SM-SM-1200	160923	Jan. 29, 2018	Jan. 28, 2019
RF Cable	EMC104-SM-SM-2000	150318	Jan. 29, 2018	Jan. 28, 2019
RF Cable	EMC104-SM-SM-5000	150321	Jan. 29, 2018	Jan. 28, 2019
Pre-Amplifier EMCI	EMC184045SE	980387	Jan. 29, 2018	Jan. 28, 2019
Horn_Antenna SCHWARZBECK	BBHA 9170	BBHA9170608	Dec. 14, 2017	Dec. 13, 2018
RF Cable	EMC102-KM-KM-1200	160925	Jan. 29, 2018	Jan. 28, 2019
Software	ADT_Radiated_V8.7.08	NA	NA	NA
Boresight Antenna Tower & Turn Table Max-Full	MF-7802BS	MF780208530	NA	NA

Note:

1. The calibration interval of the above test instruments is 12 months and the calibrations are traceable to NML/ROC and NIST/USA.
2. The test was performed in 966 Chamber No. 4.
3. The CANADA Site Registration No. is 20331-2
4. Tested Date: Dec. 03, 2018

For other test items:

DESCRIPTION & MANUFACTURER	MODEL NO.	SERIAL NO.	CALIBRATED DATE	CALIBRATED UNTIL
Test Receiver Keysight	N9038A	MY54450088	July 05, 2018	July 04, 2019
Pre-Amplifier EMC1	EMC001340	980142	Feb. 09, 2018	Feb. 08, 2019
Loop Antenna Electro-Metrics	EM-6879	269	Sep. 07, 2018	Sep. 06, 2019
RF Cable	NA	LOOPCAB-001	Jan. 15, 2018	Jan. 14, 2019
RF Cable	NA	LOOPCAB-002	Jan. 15, 2018	Jan. 14, 2019
Pre-Amplifier Mini-Circuits	ZFL-1000VH2B	AMP-ZFL-01	Oct. 30, 2018	Oct. 29, 2019
Trilog Broadband Antenna SCHWARZBECK	VULB 9168	9168-406	Nov. 22, 2018	Nov. 21, 2019
RF Cable	8D	966-4-1	Mar. 21, 2018	Mar. 20, 2019
RF Cable	8D	966-4-2	Mar. 21, 2018	Mar. 20, 2019
RF Cable	8D	966-4-3	Mar. 21, 2018	Mar. 20, 2019
Fixed attenuator Mini-Circuits	UNAT-5+	PAD-3m-4-01	Sep. 27, 2018	Sep. 26, 2019
Horn_Antenna SCHWARZBECK	BBHA 9120D	9120D-783	Nov. 25, 2018	Nov. 24, 2019
Pre-Amplifier Mini-Circuits	ZVA-183-S+	AMP-ZVA-03	May 10, 2018	May 09, 2019
RF Cable	EMC104-SM-SM-1200	160923	Jan. 29, 2018	Jan. 28, 2019
RF Cable	EMC104-SM-SM-2000	150318	Jan. 29, 2018	Jan. 28, 2019
RF Cable	EMC104-SM-SM-5000	150321	Jan. 29, 2018	Jan. 28, 2019
Pre-Amplifier EMC1	EMC184045SE	980387	Jan. 29, 2018	Jan. 28, 2019
Horn_Antenna SCHWARZBECK	BBHA 9170	BBHA9170608	Nov. 25, 2018	Nov. 24, 2019
RF Cable	EMC102-KM-KM-1200	160925	Jan. 29, 2018	Jan. 28, 2019
Software	ADT_Radiated_V8.7.08	NA	NA	NA
Boresight Antenna Tower & Turn Table Max-Full	MF-7802BS	MF780208530	NA	NA
Spectrum Analyzer R&S	FSV40	100964	June 20, 2018	June 19, 2019
Power meter Anritsu	ML2495A	1014008	May 09, 2018	May 08, 2019
Power sensor Anritsu	MA2411B	0917122	May 09, 2018	May 08, 2019
Fixed Attenuator Mini-Circuits	MDCS18N-10	MDCS18N-10-01	Apr. 16, 2018	Apr. 15, 2019
AC Power Source Extech Electronics	6205	1440452	NA	NA
Temperature & Humidity Chamber Giant Force	GTH-150-40-SP-AR	MAA0812-008	Jan. 10, 2018	Jan. 09, 2019
True RMS Clamp Meter FLUKE	325	31130711WS	May 22, 2018	May 21, 2019

Note:

1. The calibration interval of the above test instruments is 12 months and the calibrations are traceable to NML/ROC and NIST/USA.
2. The test was performed in 966 Chamber No. 4.
3. The CANADA Site Registration No. is 20331-2
4. Loop antenna was used for all emissions below 30 MHz.
5. Tested Date: Jan. 04 to 09, 2019

4.1.3 Test Procedure

For Radiated emission below 30MHz

- a. The EUT was placed on the top of a rotating table 0.8 meters above the ground at a 3 meter chamber room. The table was rotated 360 degrees to determine the position of the highest radiation.
- b. The EUT was set 3 meters away from the interference-receiving antenna, which was mounted on the top of a variable-height antenna tower.
- c. Parallel, perpendicular, and ground-parallel orientations of the antenna are set to make the measurement.
- d. For each suspected emission, the EUT was arranged to its worst case and the rotatable table was turned from 0 degrees to 360 degrees to find the maximum reading.
- e. The test-receiver system was set to Quasi-Peak Detect Function and Specified Bandwidth with Maximum Hold Mode.

Note:

1. The resolution bandwidth and video bandwidth of test receiver/spectrum analyzer is 9kHz at frequency below 30MHz.

For Radiated emission above 30MHz

- a. The EUT was placed on the top of a rotating table 0.8 meters (for 30MHz ~ 1GHz) / 1.5 meters (for above 1GHz) above the ground at 3 meter chamber room for test. The table was rotated 360 degrees to determine the position of the highest radiation.
- b. The EUT was set 3 meters away from the interference-receiving antenna, which was mounted on the top of a variable-height antenna tower.
- c. The height of antenna is varied from one meter to four meters above the ground to determine the maximum value of the field strength. Both horizontal and vertical polarizations of the antenna are set to make the measurement.
- d. For each suspected emission, the EUT was arranged to its worst case and then the antenna was tuned to heights from 1 meter to 4 meters and the rotatable table was turned from 0 degrees to 360 degrees to find the maximum reading.
- e. The test-receiver system was set to quasi-peak detect function and specified bandwidth with maximum hold mode when the test frequency is below 1 GHz.
- f. The test-receiver system was set to peak and average detects function and specified bandwidth with maximum hold mode when the test frequency is above 1 GHz. If the peak reading value also meets average limit, measurement with the average detector is unnecessary.

Note:

1. The resolution bandwidth and video bandwidth of test receiver/spectrum analyzer is 120kHz for Quasi-peak detection (QP) at frequency below 1GHz.
2. The resolution bandwidth of test receiver/spectrum analyzer is 1 MHz and the video bandwidth is 3 MHz for Peak detection (PK) at frequency above 1GHz.
3. The resolution bandwidth of test receiver/spectrum analyzer is 1MHz and the video bandwidth is $\geq 1/T$ (Duty cycle $< 98\%$) or 10Hz (Duty cycle $\geq 98\%$) for Average detection (AV) at frequency above 1GHz.
4. All modes of operation were investigated and the worst-case emissions are reported.

4.1.4 Deviation from Test Standard

No deviation.

4.1.5 Test Setup

For Radiated emission below 30MHz

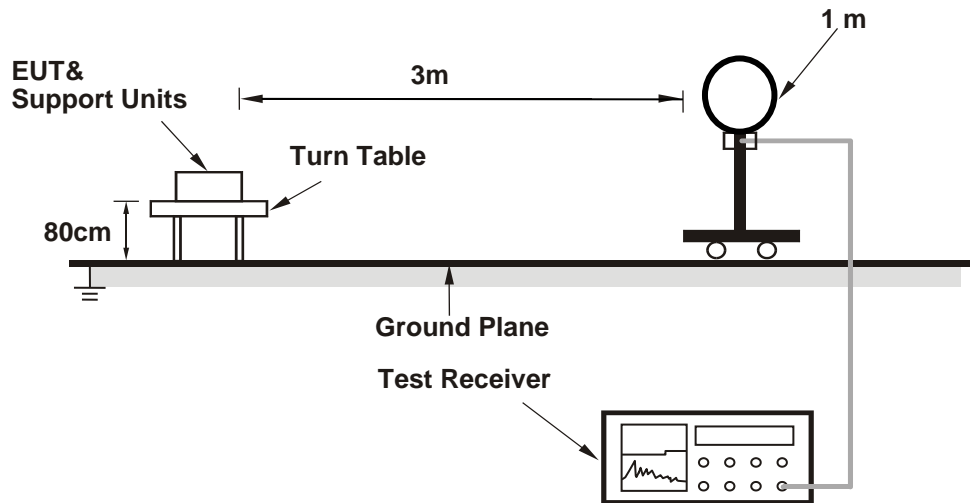

For Radiated emission 30MHz to 1GHz

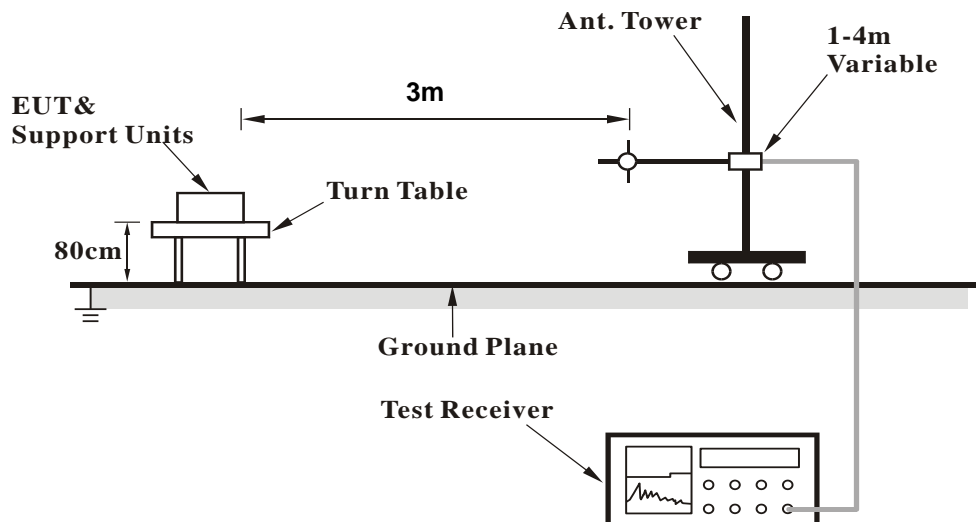

For Radiated emission above 1GHz

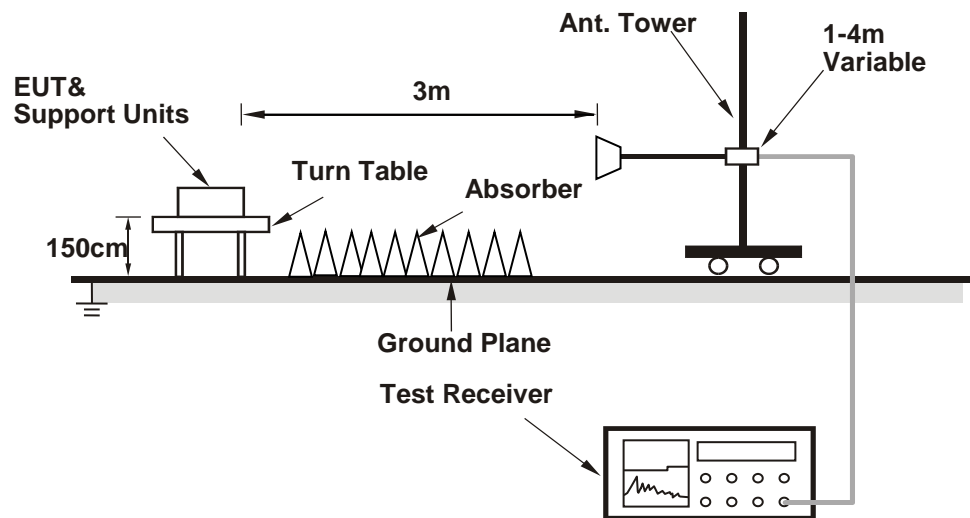

For the actual test configuration, please refer to the attached file (Test Setup Photo).

4.1.6 EUT Operating Condition

- Connected the EUT with the Laptop which is placed on remote site.
- Controlling software (Lantiq DUT [608.52]) has been activated to set the EUT under transmission/receiving condition continuously.

4.1.7 Test Results

Above 1GHz Data:

802.11a

CHANNEL	TX Channel 36	DETECTOR FUNCTION	Peak (PK)
FREQUENCY RANGE	1GHz ~ 40GHz		Average (AV)

ANTENNA POLARITY & TEST DISTANCE: HORIZONTAL AT 3 M								
NO.	FREQ. (MHz)	EMISSION LEVEL (dBuV/m)	LIMIT (dBuV/m)	MARGIN (dB)	ANTENNA HEIGHT (m)	TABLE ANGLE (Degree)	RAW VALUE (dBuV)	CORRECTION FACTOR (dB/m)
1	5150.00	61.2 PK	74.0	-12.8	3.87 H	201	58.2	3.0
2	5150.00	44.9 AV	54.0	-9.1	3.87 H	201	41.9	3.0
3	*5180.00	109.7 PK			3.87 H	201	106.8	2.9
4	*5180.00	100.4 AV			3.87 H	201	97.5	2.9
5	#10360.00	44.8 PK	68.2	-23.4	1.37 H	237	31.8	13.0
6	15540.00	46.1 PK	74.0	-27.9	1.51 H	347	33.0	13.1
7	15540.00	34.8 AV	54.0	-19.2	1.51 H	347	21.7	13.1

ANTENNA POLARITY & TEST DISTANCE: VERTICAL AT 3 M								
NO.	FREQ. (MHz)	EMISSION LEVEL (dBuV/m)	LIMIT (dBuV/m)	MARGIN (dB)	ANTENNA HEIGHT (m)	TABLE ANGLE (Degree)	RAW VALUE (dBuV)	CORRECTION FACTOR (dB/m)
1	5150.00	70.8 PK	74.0	-3.2	3.25 V	93	67.8	3.0
2	5150.00	53.6 AV	54.0	-0.4	3.25 V	93	50.6	3.0
3	*5180.00	117.6 PK			3.25 V	93	114.7	2.9
4	*5180.00	108.2 AV			3.25 V	93	105.3	2.9
5	#10360.00	48.6 PK	68.2	-19.6	1.12 V	140	35.6	13.0
6	15540.00	47.2 PK	74.0	-26.8	1.47 V	329	34.1	13.1
7	15540.00	35.5 AV	54.0	-18.5	1.47 V	329	22.4	13.1

REMARKS:

1. Emission Level(dBuV/m) = Raw Value(dBuV) + Correction Factor(dB/m)
2. Correction Factor(dB/m) = Antenna Factor(dB/m) + Cable Factor(dB) – Pre-Amplifier Factor(dB)
3. The other emission levels were very low against the limit.
4. Margin value = Emission Level – Limit value
5. " * ": Fundamental frequency.
6. " # ": The radiated frequency is out of the restricted band.

CHANNEL	TX Channel 40	DETECTOR FUNCTION	Peak (PK)
FREQUENCY RANGE	1GHz ~ 40GHz		Average (AV)

ANTENNA POLARITY & TEST DISTANCE: HORIZONTAL AT 3 M

NO.	FREQ. (MHz)	EMISSION LEVEL (dBuV/m)	LIMIT (dBuV/m)	MARGIN (dB)	ANTENNA HEIGHT (m)	TABLE ANGLE (Degree)	RAW VALUE (dBuV)	CORRECTION FACTOR (dB/m)
1	5150.00	56.5 PK	74.0	-17.5	3.89 H	212	53.5	3.0
2	5150.00	42.2 AV	54.0	-11.8	3.89 H	212	39.2	3.0
3	*5200.00	113.8 PK			3.89 H	212	110.9	2.9
4	*5200.00	104.1 AV			3.89 H	212	101.2	2.9
5	#10400.00	45.1 PK	68.2	-23.1	1.39 H	253	32.0	13.1
6	15600.00	46.2 PK	74.0	-27.8	1.60 H	347	33.2	13.0
7	15600.00	35.1 AV	54.0	-18.9	1.60 H	347	22.1	13.0

ANTENNA POLARITY & TEST DISTANCE: VERTICAL AT 3 M

NO.	FREQ. (MHz)	EMISSION LEVEL (dBuV/m)	LIMIT (dBuV/m)	MARGIN (dB)	ANTENNA HEIGHT (m)	TABLE ANGLE (Degree)	RAW VALUE (dBuV)	CORRECTION FACTOR (dB/m)
1	5150.00	66.1 PK	74.0	-7.9	3.21 V	92	63.1	3.0
2	5150.00	50.5 AV	54.0	-3.5	3.21 V	92	47.5	3.0
3	*5200.00	121.1 PK			3.21 V	92	118.2	2.9
4	*5200.00	111.9 AV			3.21 V	92	109.0	2.9
5	#10400.00	49.5 PK	68.2	-18.7	1.18 V	129	36.4	13.1
6	15600.00	47.2 PK	74.0	-26.8	1.46 V	316	34.2	13.0
7	15600.00	35.9 AV	54.0	-18.1	1.46 V	316	22.9	13.0

REMARKS:

1. Emission Level(dBuV/m) = Raw Value(dBuV) + Correction Factor(dB/m)
2. Correction Factor(dB/m) = Antenna Factor(dB/m) + Cable Factor(dB) – Pre-Amplifier Factor(dB)
3. The other emission levels were very low against the limit.
4. Margin value = Emission Level – Limit value
5. " * ": Fundamental frequency.
6. " # ": The radiated frequency is out of the restricted band.

CHANNEL	TX Channel 48	DETECTOR FUNCTION	Peak (PK)
FREQUENCY RANGE	1GHz ~ 40GHz		Average (AV)

ANTENNA POLARITY & TEST DISTANCE: HORIZONTAL AT 3 M

NO.	FREQ. (MHz)	EMISSION LEVEL (dBuV/m)	LIMIT (dBuV/m)	MARGIN (dB)	ANTENNA HEIGHT (m)	TABLE ANGLE (Degree)	RAW VALUE (dBuV)	CORRECTION FACTOR (dB/m)
1	*5240.00	112.1 PK			3.84 H	198	109.6	2.5
2	*5240.00	102.7 AV			3.84 H	198	100.2	2.5
3	5350.00	57.4 PK	74.0	-16.6	3.84 H	198	54.6	2.8
4	5350.00	41.3 AV	54.0	-12.7	3.84 H	198	38.5	2.8
5	#10480.00	45.0 PK	68.2	-23.2	1.36 H	248	31.8	13.2
6	15720.00	46.5 PK	74.0	-27.5	1.56 H	333	34.1	12.4
7	15720.00	35.2 AV	54.0	-18.8	1.56 H	333	22.8	12.4

ANTENNA POLARITY & TEST DISTANCE: VERTICAL AT 3 M

NO.	FREQ. (MHz)	EMISSION LEVEL (dBuV/m)	LIMIT (dBuV/m)	MARGIN (dB)	ANTENNA HEIGHT (m)	TABLE ANGLE (Degree)	RAW VALUE (dBuV)	CORRECTION FACTOR (dB/m)
1	*5240.00	119.7 PK			3.21 V	100	117.2	2.5
2	*5240.00	110.5 AV			3.21 V	100	108.0	2.5
3	5350.00	55.8 PK	74.0	-18.2	3.21 V	100	53.0	2.8
4	5350.00	43.9 AV	54.0	-10.1	3.21 V	100	41.1	2.8
5	#10480.00	49.2 PK	68.2	-19.0	1.15 V	142	36.0	13.2
6	15720.00	47.4 PK	74.0	-26.6	1.43 V	321	35.0	12.4
7	15720.00	35.9 AV	54.0	-18.1	1.43 V	321	23.5	12.4

REMARKS:

1. Emission Level(dBuV/m) = Raw Value(dBuV) + Correction Factor(dB/m)
2. Correction Factor(dB/m) = Antenna Factor(dB/m) + Cable Factor(dB) – Pre-Amplifier Factor(dB)
3. The other emission levels were very low against the limit.
4. Margin value = Emission Level – Limit value
5. " * ": Fundamental frequency.
6. " # ": The radiated frequency is out of the restricted band.

CHANNEL	TX Channel 52	DETECTOR FUNCTION	Peak (PK)
FREQUENCY RANGE	1GHz ~ 40GHz		Average (AV)

ANTENNA POLARITY & TEST DISTANCE: HORIZONTAL AT 3 M

NO.	FREQ. (MHz)	EMISSION LEVEL (dBuV/m)	LIMIT (dBuV/m)	MARGIN (dB)	ANTENNA HEIGHT (m)	TABLE ANGLE (Degree)	RAW VALUE (dBuV)	CORRECTION FACTOR (dB/m)
1	5150.00	55.6 PK	74.0	-18.4	3.83 H	192	52.6	3.0
2	5150.00	42.3 AV	54.0	-11.7	3.83 H	192	39.3	3.0
3	*5260.00	106.5 PK			3.83 H	192	104.0	2.5
4	*5260.00	97.3 AV			3.83 H	192	94.8	2.5
5	#10520.00	45.2 PK	68.2	-23.0	1.37 H	254	32.0	13.2
6	15780.00	46.7 PK	74.0	-27.3	1.53 H	324	34.1	12.6
7	15780.00	35.2 AV	54.0	-18.8	1.53 H	324	22.6	12.6

ANTENNA POLARITY & TEST DISTANCE: VERTICAL AT 3 M

NO.	FREQ. (MHz)	EMISSION LEVEL (dBuV/m)	LIMIT (dBuV/m)	MARGIN (dB)	ANTENNA HEIGHT (m)	TABLE ANGLE (Degree)	RAW VALUE (dBuV)	CORRECTION FACTOR (dB/m)
1	5150.00	57.2 PK	74.0	-16.8	3.23 V	104	54.2	3.0
2	5150.00	44.3 AV	54.0	-9.7	3.23 V	104	41.3	3.0
3	*5260.00	114.5 PK			3.23 V	104	112.0	2.5
4	*5260.00	105.2 AV			3.23 V	104	102.7	2.5
5	#10520.00	49.4 PK	68.2	-18.8	1.12 V	145	36.2	13.2
6	15780.00	47.1 PK	74.0	-26.9	1.45 V	316	34.5	12.6
7	15780.00	35.8 AV	54.0	-18.2	1.45 V	316	23.2	12.6

REMARKS:

1. Emission Level(dBuV/m) = Raw Value(dBuV) + Correction Factor(dB/m)
2. Correction Factor(dB/m) = Antenna Factor(dB/m) + Cable Factor(dB) – Pre-Amplifier Factor(dB)
3. The other emission levels were very low against the limit.
4. Margin value = Emission Level – Limit value
5. " * ": Fundamental frequency.
6. " # ": The radiated frequency is out of the restricted band.

CHANNEL	TX Channel 60	DETECTOR FUNCTION	Peak (PK)
FREQUENCY RANGE	1GHz ~ 40GHz		Average (AV)

ANTENNA POLARITY & TEST DISTANCE: HORIZONTAL AT 3 M

NO.	FREQ. (MHz)	EMISSION LEVEL (dBuV/m)	LIMIT (dBuV/m)	MARGIN (dB)	ANTENNA HEIGHT (m)	TABLE ANGLE (Degree)	RAW VALUE (dBuV)	CORRECTION FACTOR (dB/m)
1	*5300.00	106.3 PK			3.85 H	215	103.6	2.7
2	*5300.00	97.0 AV			3.85 H	215	94.3	2.7
3	5350.00	55.7 PK	74.0	-18.3	3.85 H	215	52.9	2.8
4	5350.00	42.2 AV	54.0	-11.8	3.85 H	215	39.4	2.8
5	10600.00	44.8 PK	74.0	-29.2	1.40 H	262	31.7	13.1
6	10600.00	38.3 AV	54.0	-15.7	1.40 H	262	25.2	13.1
7	15900.00	46.3 PK	74.0	-27.7	1.59 H	333	33.6	12.7
8	15900.00	35.0 AV	54.0	-19.0	1.59 H	333	22.3	12.7

ANTENNA POLARITY & TEST DISTANCE: VERTICAL AT 3 M

NO.	FREQ. (MHz)	EMISSION LEVEL (dBuV/m)	LIMIT (dBuV/m)	MARGIN (dB)	ANTENNA HEIGHT (m)	TABLE ANGLE (Degree)	RAW VALUE (dBuV)	CORRECTION FACTOR (dB/m)
1	*5300.00	114.3 PK			3.29 V	109	111.6	2.7
2	*5300.00	104.7 AV			3.29 V	109	102.0	2.7
3	5350.00	59.7 PK	74.0	-14.3	3.29 V	109	56.9	2.8
4	5350.00	45.7 AV	54.0	-8.3	3.29 V	109	42.9	2.8
5	10600.00	49.0 PK	74.0	-25.0	1.11 V	133	35.9	13.1
6	10600.00	42.5 AV	54.0	-11.5	1.11 V	133	29.4	13.1
7	15900.00	47.8 PK	74.0	-26.2	1.43 V	315	35.1	12.7
8	15900.00	36.3 AV	54.0	-17.7	1.43 V	315	23.6	12.7

REMARKS:

1. Emission Level(dBuV/m) = Raw Value(dBuV) + Correction Factor(dB/m)
2. Correction Factor(dB/m) = Antenna Factor(dB/m) + Cable Factor(dB) – Pre-Amplifier Factor(dB)
3. The other emission levels were very low against the limit.
4. Margin value = Emission Level – Limit value
5. " * ": Fundamental frequency.

CHANNEL	TX Channel 64	DETECTOR FUNCTION	Peak (PK)
FREQUENCY RANGE	1GHz ~ 40GHz		Average (AV)

ANTENNA POLARITY & TEST DISTANCE: HORIZONTAL AT 3 M

NO.	FREQ. (MHz)	EMISSION LEVEL (dBuV/m)	LIMIT (dBuV/m)	MARGIN (dB)	ANTENNA HEIGHT (m)	TABLE ANGLE (Degree)	RAW VALUE (dBuV)	CORRECTION FACTOR (dB/m)
1	*5320.00	106.0 PK			3.89 H	196	103.2	2.8
2	*5320.00	96.7 AV			3.89 H	196	93.9	2.8
3	5350.00	55.6 PK	74.0	-18.4	3.89 H	196	52.8	2.8
4	5350.00	42.0 AV	54.0	-12.0	3.89 H	196	39.2	2.8
5	10640.00	44.9 PK	74.0	-29.1	1.32 H	243	31.7	13.2
6	10640.00	38.5 AV	54.0	-15.5	1.32 H	243	25.3	13.2
7	15960.00	46.3 PK	74.0	-27.7	1.56 H	343	33.4	12.9
8	15960.00	35.3 AV	54.0	-18.7	1.56 H	343	22.4	12.9

ANTENNA POLARITY & TEST DISTANCE: VERTICAL AT 3 M

NO.	FREQ. (MHz)	EMISSION LEVEL (dBuV/m)	LIMIT (dBuV/m)	MARGIN (dB)	ANTENNA HEIGHT (m)	TABLE ANGLE (Degree)	RAW VALUE (dBuV)	CORRECTION FACTOR (dB/m)
1	*5320.00	113.8 PK			3.30 V	108	111.0	2.8
2	*5320.00	104.5 AV			3.30 V	108	101.7	2.8
3	5350.00	66.4 PK	74.0	-7.6	3.30 V	108	63.6	2.8
4	5350.00	49.6 AV	54.0	-4.4	3.30 V	108	46.8	2.8
5	10640.00	49.0 PK	74.0	-25.0	1.18 V	148	35.8	13.2
6	10640.00	42.5 AV	54.0	-11.5	1.18 V	148	29.3	13.2
7	15960.00	47.7 PK	74.0	-26.3	1.47 V	331	34.8	12.9
8	15960.00	36.2 AV	54.0	-17.8	1.47 V	331	23.3	12.9

REMARKS:

1. Emission Level(dBuV/m) = Raw Value(dBuV) + Correction Factor(dB/m)
2. Correction Factor(dB/m) = Antenna Factor(dB/m) + Cable Factor(dB) – Pre-Amplifier Factor(dB)
3. The other emission levels were very low against the limit.
4. Margin value = Emission Level – Limit value
5. " * ": Fundamental frequency.

CHANNEL	TX Channel 100	DETECTOR FUNCTION	Peak (PK)
FREQUENCY RANGE	1GHz ~ 40GHz		Average (AV)

ANTENNA POLARITY & TEST DISTANCE: HORIZONTAL AT 3 M

NO.	FREQ. (MHz)	EMISSION LEVEL (dBuV/m)	LIMIT (dBuV/m)	MARGIN (dB)	ANTENNA HEIGHT (m)	TABLE ANGLE (Degree)	RAW VALUE (dBuV)	CORRECTION FACTOR (dB/m)
1	5460.00	55.2 PK	74.0	-18.8	3.84 H	208	52.1	3.1
2	5460.00	42.2 AV	54.0	-11.8	3.84 H	208	39.1	3.1
3	#5470.00	57.1 PK	68.2	-11.1	3.84 H	208	54.0	3.1
4	*5500.00	106.7 PK			3.84 H	208	103.6	3.1
5	*5500.00	97.5 AV			3.84 H	208	94.4	3.1
6	11000.00	45.2 PK	74.0	-28.8	1.38 H	242	31.2	14.0
7	11000.00	38.7 AV	54.0	-15.3	1.38 H	242	24.7	14.0
8	#16500.00	46.3 PK	68.2	-21.9	1.52 H	339	31.3	15.0

ANTENNA POLARITY & TEST DISTANCE: VERTICAL AT 3 M

NO.	FREQ. (MHz)	EMISSION LEVEL (dBuV/m)	LIMIT (dBuV/m)	MARGIN (dB)	ANTENNA HEIGHT (m)	TABLE ANGLE (Degree)	RAW VALUE (dBuV)	CORRECTION FACTOR (dB/m)
1	5460.00	58.0 PK	74.0	-16.0	3.28 V	135	54.9	3.1
2	5460.00	45.5 AV	54.0	-8.5	3.28 V	135	42.4	3.1
3	#5470.00	64.9 PK	68.2	-3.3	3.28 V	135	61.8	3.1
4	*5500.00	115.3 PK			3.28 V	135	112.2	3.1
5	*5500.00	105.2 AV			3.28 V	135	102.1	3.1
6	11000.00	49.5 PK	74.0	-24.5	1.13 V	152	35.5	14.0
7	11000.00	42.9 AV	54.0	-11.1	1.13 V	152	28.9	14.0
8	#16500.00	47.3 PK	68.2	-20.9	1.40 V	314	32.3	15.0

REMARKS:

1. Emission Level(dBuV/m) = Raw Value(dBuV) + Correction Factor(dB/m)
2. Correction Factor(dB/m) = Antenna Factor(dB/m) + Cable Factor(dB) – Pre-Amplifier Factor(dB)
3. The other emission levels were very low against the limit.
4. Margin value = Emission Level – Limit value
5. " * ": Fundamental frequency.
6. " # ": The radiated frequency is out of the restricted band.

CHANNEL	TX Channel 116	DETECTOR FUNCTION	Peak (PK)
FREQUENCY RANGE	1GHz ~ 40GHz		Average (AV)

ANTENNA POLARITY & TEST DISTANCE: HORIZONTAL AT 3 M

NO.	FREQ. (MHz)	EMISSION LEVEL (dBuV/m)	LIMIT (dBuV/m)	MARGIN (dB)	ANTENNA HEIGHT (m)	TABLE ANGLE (Degree)	RAW VALUE (dBuV)	CORRECTION FACTOR (dB/m)
1	*5580.00	107.2 PK			3.92 H	207	103.9	3.3
2	*5580.00	98.0 AV			3.92 H	207	94.7	3.3
3	11160.00	45.1 PK	74.0	-28.9	1.41 H	262	31.7	13.4
4	11160.00	38.6 AV	54.0	-15.4	1.41 H	262	25.2	13.4
5	#16740.00	47.0 PK	68.2	-21.2	1.51 H	324	30.4	16.6

ANTENNA POLARITY & TEST DISTANCE: VERTICAL AT 3 M

NO.	FREQ. (MHz)	EMISSION LEVEL (dBuV/m)	LIMIT (dBuV/m)	MARGIN (dB)	ANTENNA HEIGHT (m)	TABLE ANGLE (Degree)	RAW VALUE (dBuV)	CORRECTION FACTOR (dB/m)
1	*5580.00	114.5 PK			2.50 V	211	111.2	3.3
2	*5580.00	105.8 AV			2.50 V	211	102.5	3.3
3	11160.00	49.0 PK	74.0	-25.0	1.11 V	131	35.6	13.4
4	11160.00	42.5 AV	54.0	-11.5	1.11 V	131	29.1	13.4
5	#16740.00	46.9 PK	68.2	-21.3	1.47 V	307	30.3	16.6

REMARKS:

1. Emission Level(dBuV/m) = Raw Value(dBuV) + Correction Factor(dB/m)
2. Correction Factor(dB/m) = Antenna Factor(dB/m) + Cable Factor(dB) – Pre-Amplifier Factor(dB)
3. The other emission levels were very low against the limit.
4. Margin value = Emission Level – Limit value
5. " * ": Fundamental frequency.
6. " # ": The radiated frequency is out of the restricted band.

CHANNEL	TX Channel 140	DETECTOR FUNCTION	Peak (PK)
FREQUENCY RANGE	1GHz ~ 40GHz		Average (AV)

ANTENNA POLARITY & TEST DISTANCE: HORIZONTAL AT 3 M

NO.	FREQ. (MHz)	EMISSION LEVEL (dBuV/m)	LIMIT (dBuV/m)	MARGIN (dB)	ANTENNA HEIGHT (m)	TABLE ANGLE (Degree)	RAW VALUE (dBuV)	CORRECTION FACTOR (dB/m)
1	*5700.00	117.2 PK			3.87 H	208	113.6	3.6
2	*5700.00	97.9 AV			3.87 H	208	94.3	3.6
3	#5725.00	60.5 PK	68.2	-7.7	3.87 H	208	57.0	3.5
4	11400.00	44.5 PK	74.0	-29.5	1.38 H	241	30.9	13.6
5	11400.00	38.1 AV	54.0	-15.9	1.38 H	241	24.5	13.6
6	#17100.00	46.3 PK	68.2	-21.9	1.59 H	325	30.0	16.3

ANTENNA POLARITY & TEST DISTANCE: VERTICAL AT 3 M

NO.	FREQ. (MHz)	EMISSION LEVEL (dBuV/m)	LIMIT (dBuV/m)	MARGIN (dB)	ANTENNA HEIGHT (m)	TABLE ANGLE (Degree)	RAW VALUE (dBuV)	CORRECTION FACTOR (dB/m)
1	*5700.00	115.0 PK			2.20 V	193	111.4	3.6
2	*5700.00	105.6 AV			2.20 V	193	102.0	3.6
3	#5725.00	68.1 PK	68.2	-0.1	2.20 V	193	64.6	3.5
4	11400.00	48.5 PK	74.0	-25.5	1.19 V	140	34.9	13.6
5	11400.00	42.5 AV	54.0	-11.5	1.19 V	140	28.9	13.6
6	#17100.00	47.8 PK	68.2	-20.4	1.47 V	318	31.5	16.3

REMARKS:

- Emission Level(dBuV/m) = Raw Value(dBuV) + Correction Factor(dB/m)
- Correction Factor(dB/m) = Antenna Factor(dB/m) + Cable Factor(dB) – Pre-Amplifier Factor(dB)
- The other emission levels were very low against the limit.
- Margin value = Emission Level – Limit value
- " * ": Fundamental frequency.
- " # ": The radiated frequency is out of the restricted band.

CHANNEL	TX Channel 144	DETECTOR FUNCTION	Peak (PK)
FREQUENCY RANGE	1GHz ~ 40GHz		Average (AV)

ANTENNA POLARITY & TEST DISTANCE: HORIZONTAL AT 3 M

NO.	FREQ. (MHz)	EMISSION LEVEL (dBuV/m)	LIMIT (dBuV/m)	MARGIN (dB)	ANTENNA HEIGHT (m)	TABLE ANGLE (Degree)	RAW VALUE (dBuV)	CORRECTION FACTOR (dB/m)
1	#5470.00	54.6 PK	68.2	-13.6	3.83 H	193	51.5	3.1
2	*5720.00	116.1 PK			3.83 H	193	112.6	3.5
3	*5720.00	97.3 AV			3.83 H	193	93.8	3.5
4	#5850.00	54.3 PK	68.2	-13.9	3.83 H	193	50.4	3.9
5	11440.00	48.2 PK	74.0	-25.8	1.30 H	261	34.5	13.7
6	11440.00	40.6 AV	54.0	-13.4	1.30 H	261	26.9	13.7
7	#17160.00	51.9 PK	68.2	-16.3	1.60 H	344	35.2	16.7

ANTENNA POLARITY & TEST DISTANCE: VERTICAL AT 3 M

NO.	FREQ. (MHz)	EMISSION LEVEL (dBuV/m)	LIMIT (dBuV/m)	MARGIN (dB)	ANTENNA HEIGHT (m)	TABLE ANGLE (Degree)	RAW VALUE (dBuV)	CORRECTION FACTOR (dB/m)
1	#5470.00	55.3 PK	68.2	-12.9	2.20 V	195	52.2	3.1
2	*5720.00	114.5 PK			2.20 V	195	111.0	3.5
3	*5720.00	105.0 AV			2.20 V	195	101.5	3.5
4	#5850.00	54.4 PK	68.2	-13.8	2.20 V	195	50.5	3.9
5	11440.00	51.1 PK	74.0	-22.9	1.00 V	91	37.4	13.7
6	11440.00	45.5 AV	54.0	-8.5	1.00 V	91	31.8	13.7
7	#17160.00	54.5 PK	68.2	-13.7	1.28 V	324	37.8	16.7

REMARKS:

1. Emission Level(dBuV/m) = Raw Value(dBuV) + Correction Factor(dB/m)
2. Correction Factor(dB/m) = Antenna Factor(dB/m) + Cable Factor(dB) – Pre-Amplifier Factor(dB)
3. The other emission levels were very low against the limit.
4. Margin value = Emission Level – Limit value
5. " * ": Fundamental frequency.
6. " # ": The radiated frequency is out of the restricted band.

CHANNEL	TX Channel 149	DETECTOR FUNCTION	Peak (PK)
FREQUENCY RANGE	1GHz ~ 40GHz		Average (AV)

ANTENNA POLARITY & TEST DISTANCE: HORIZONTAL AT 3 M

NO.	FREQ. (MHz)	EMISSION LEVEL (dBuV/m)	LIMIT (dBuV/m)	MARGIN (dB)	ANTENNA HEIGHT (m)	TABLE ANGLE (Degree)	RAW VALUE (dBuV)	CORRECTION FACTOR (dB/m)
1	*5745.00	113.7 PK			2.37 H	135	110.1	3.6
2	*5745.00	104.3 AV			2.37 H	135	100.7	3.6
3	11490.00	47.9 PK	74.0	-26.1	1.32 H	255	34.1	13.8
4	11490.00	40.6 AV	54.0	-13.4	1.32 H	255	26.8	13.8
5	#17235.00	51.7 PK	68.2	-16.5	1.50 H	352	34.6	17.1

ANTENNA POLARITY & TEST DISTANCE: VERTICAL AT 3 M

NO.	FREQ. (MHz)	EMISSION LEVEL (dBuV/m)	LIMIT (dBuV/m)	MARGIN (dB)	ANTENNA HEIGHT (m)	TABLE ANGLE (Degree)	RAW VALUE (dBuV)	CORRECTION FACTOR (dB/m)
1	*5745.00	120.0 PK			2.98 V	140	116.4	3.6
2	*5745.00	110.7 AV			2.98 V	140	107.1	3.6
3	11490.00	50.4 PK	74.0	-23.6	1.00 V	84	36.6	13.8
4	11490.00	45.3 AV	54.0	-8.7	1.00 V	84	31.5	13.8
5	#17235.00	54.5 PK	68.2	-13.7	1.33 V	318	37.4	17.1

REMARKS:

1. Emission Level(dBuV/m) = Raw Value(dBuV) + Correction Factor(dB/m)
2. Correction Factor(dB/m) = Antenna Factor(dB/m) + Cable Factor(dB) – Pre-Amplifier Factor(dB)
3. The other emission levels were very low against the limit.
4. Margin value = Emission Level – Limit value
5. " * ": Fundamental frequency.
6. " # ": The radiated frequency is out of the restricted band.

CHANNEL	TX Channel 157	DETECTOR FUNCTION	Peak (PK)
FREQUENCY RANGE	1GHz ~ 40GHz		Average (AV)

ANTENNA POLARITY & TEST DISTANCE: HORIZONTAL AT 3 M

NO.	FREQ. (MHz)	EMISSION LEVEL (dBuV/m)	LIMIT (dBuV/m)	MARGIN (dB)	ANTENNA HEIGHT (m)	TABLE ANGLE (Degree)	RAW VALUE (dBuV)	CORRECTION FACTOR (dB/m)
1	*5785.00	113.6 PK			2.53 H	134	110.0	3.6
2	*5785.00	104.4 AV			2.53 H	134	100.8	3.6
3	11570.00	48.4 PK	74.0	-25.6	1.34 H	231	34.7	13.7
4	11570.00	40.9 AV	54.0	-13.1	1.34 H	231	27.2	13.7
5	#17355.00	51.2 PK	68.2	-17.0	1.59 H	349	33.6	17.6

ANTENNA POLARITY & TEST DISTANCE: VERTICAL AT 3 M

NO.	FREQ. (MHz)	EMISSION LEVEL (dBuV/m)	LIMIT (dBuV/m)	MARGIN (dB)	ANTENNA HEIGHT (m)	TABLE ANGLE (Degree)	RAW VALUE (dBuV)	CORRECTION FACTOR (dB/m)
1	*5785.00	119.6 PK			3.01 V	287	116.0	3.6
2	*5785.00	110.3 AV			3.01 V	287	106.7	3.6
3	11570.00	50.5 PK	74.0	-23.5	1.06 V	96	36.8	13.7
4	11570.00	45.2 AV	54.0	-8.8	1.06 V	96	31.5	13.7
5	#17355.00	53.4 PK	68.2	-14.8	1.34 V	327	35.8	17.6

REMARKS:

1. Emission Level(dBuV/m) = Raw Value(dBuV) + Correction Factor(dB/m)
2. Correction Factor(dB/m) = Antenna Factor(dB/m) + Cable Factor(dB) – Pre-Amplifier Factor(dB)
3. The other emission levels were very low against the limit.
4. Margin value = Emission Level – Limit value
5. " * ": Fundamental frequency.
6. " # ": The radiated frequency is out of the restricted band.

CHANNEL	TX Channel 165	DETECTOR FUNCTION	Peak (PK)
FREQUENCY RANGE	1GHz ~ 40GHz		Average (AV)

ANTENNA POLARITY & TEST DISTANCE: HORIZONTAL AT 3 M

NO.	FREQ. (MHz)	EMISSION LEVEL (dBuV/m)	LIMIT (dBuV/m)	MARGIN (dB)	ANTENNA HEIGHT (m)	TABLE ANGLE (Degree)	RAW VALUE (dBuV)	CORRECTION FACTOR (dB/m)
1	*5825.00	114.0 PK			2.61 H	137	110.2	3.8
2	*5825.00	104.7 AV			2.61 H	137	100.9	3.8
3	11650.00	48.4 PK	74.0	-25.6	1.35 H	246	34.8	13.6
4	11650.00	40.9 AV	54.0	-13.1	1.35 H	246	27.3	13.6
5	#17475.00	51.7 PK	68.2	-16.5	1.54 H	347	33.1	18.6

ANTENNA POLARITY & TEST DISTANCE: VERTICAL AT 3 M

NO.	FREQ. (MHz)	EMISSION LEVEL (dBuV/m)	LIMIT (dBuV/m)	MARGIN (dB)	ANTENNA HEIGHT (m)	TABLE ANGLE (Degree)	RAW VALUE (dBuV)	CORRECTION FACTOR (dB/m)
1	*5825.00	119.8 PK			3.11 V	184	116.0	3.8
2	*5825.00	110.5 AV			3.11 V	184	106.7	3.8
3	11650.00	50.7 PK	74.0	-23.3	1.03 V	87	37.1	13.6
4	11650.00	45.4 AV	54.0	-8.6	1.03 V	87	31.8	13.6
5	#17475.00	53.8 PK	68.2	-14.4	1.31 V	333	35.2	18.6

REMARKS:

1. Emission Level(dBuV/m) = Raw Value(dBuV) + Correction Factor(dB/m)
2. Correction Factor(dB/m) = Antenna Factor(dB/m) + Cable Factor(dB) – Pre-Amplifier Factor(dB)
3. The other emission levels were very low against the limit.
4. Margin value = Emission Level – Limit value
5. " * ": Fundamental frequency.
6. " # ": The radiated frequency is out of the restricted band.

802.11ax (HE20)

CHANNEL	TX Channel 36	DETECTOR FUNCTION	Peak (PK)
FREQUENCY RANGE	1GHz ~ 40GHz		Average (AV)

ANTENNA POLARITY & TEST DISTANCE: HORIZONTAL AT 3 M

NO.	FREQ. (MHz)	EMISSION LEVEL (dBuV/m)	LIMIT (dBuV/m)	MARGIN (dB)	ANTENNA HEIGHT (m)	TABLE ANGLE (Degree)	RAW VALUE (dBuV)	CORRECTION FACTOR (dB/m)
1	5150.00	59.6 PK	74.0	-14.4	3.91 H	204	56.6	3.0
2	5150.00	46.5 AV	54.0	-7.5	3.91 H	204	43.5	3.0
3	*5180.00	109.9 PK			3.91 H	204	107.0	2.9
4	*5180.00	99.7 AV			3.91 H	204	96.8	2.9
5	#10360.00	44.5 PK	68.2	-23.7	1.33 H	245	31.5	13.0
6	15540.00	45.9 PK	74.0	-28.1	1.51 H	322	32.8	13.1
7	15540.00	34.8 AV	54.0	-19.2	1.51 H	322	21.7	13.1

ANTENNA POLARITY & TEST DISTANCE: VERTICAL AT 3 M

NO.	FREQ. (MHz)	EMISSION LEVEL (dBuV/m)	LIMIT (dBuV/m)	MARGIN (dB)	ANTENNA HEIGHT (m)	TABLE ANGLE (Degree)	RAW VALUE (dBuV)	CORRECTION FACTOR (dB/m)
1	5150.00	66.3 PK	74.0	-7.7	2.74 V	192	63.3	3.0
2	5150.00	53.9 AV	54.0	-0.1	2.74 V	192	50.9	3.0
3	*5180.00	116.3 PK			2.74 V	192	113.4	2.9
4	*5180.00	107.5 AV			2.74 V	192	104.6	2.9
5	#10360.00	49.7 PK	68.2	-18.5	1.22 V	127	36.7	13.0
6	15540.00	47.5 PK	74.0	-26.5	1.44 V	307	34.4	13.1
7	15540.00	36.1 AV	54.0	-17.9	1.44 V	307	23.0	13.1

REMARKS:

- Emission Level(dBuV/m) = Raw Value(dBuV) + Correction Factor(dB/m)
- Correction Factor(dB/m) = Antenna Factor(dB/m) + Cable Factor(dB) – Pre-Amplifier Factor(dB)
- The other emission levels were very low against the limit.
- Margin value = Emission Level – Limit value
- " * ": Fundamental frequency.
- " # ": The radiated frequency is out of the restricted band.

CHANNEL	TX Channel 40	DETECTOR FUNCTION	Peak (PK)
FREQUENCY RANGE	1GHz ~ 40GHz		Average (AV)

ANTENNA POLARITY & TEST DISTANCE: HORIZONTAL AT 3 M

NO.	FREQ. (MHz)	EMISSION LEVEL (dBuV/m)	LIMIT (dBuV/m)	MARGIN (dB)	ANTENNA HEIGHT (m)	TABLE ANGLE (Degree)	RAW VALUE (dBuV)	CORRECTION FACTOR (dB/m)
1	5150.00	59.9 PK	74.0	-14.1	3.89 H	201	56.9	3.0
2	5150.00	46.8 AV	54.0	-7.2	3.89 H	201	43.8	3.0
3	*5200.00	112.4 PK			3.89 H	201	109.5	2.9
4	*5200.00	103.3 AV			3.89 H	201	100.4	2.9
5	#10400.00	45.2 PK	68.2	-23.0	1.37 H	258	32.1	13.1
6	15600.00	46.8 PK	74.0	-27.2	1.62 H	326	33.8	13.0
7	15600.00	35.4 AV	54.0	-18.6	1.62 H	326	22.4	13.0

ANTENNA POLARITY & TEST DISTANCE: VERTICAL AT 3 M

NO.	FREQ. (MHz)	EMISSION LEVEL (dBuV/m)	LIMIT (dBuV/m)	MARGIN (dB)	ANTENNA HEIGHT (m)	TABLE ANGLE (Degree)	RAW VALUE (dBuV)	CORRECTION FACTOR (dB/m)
1	5150.00	67.7 PK	74.0	-6.3	2.69 V	191	64.7	3.0
2	5150.00	53.5 AV	54.0	-0.5	2.69 V	191	50.5	3.0
3	*5200.00	120.2 PK			2.69 V	191	117.3	2.9
4	*5200.00	111.1 AV			2.69 V	191	108.2	2.9
5	#10400.00	49.7 PK	68.2	-18.5	1.19 V	117	36.6	13.1
6	15600.00	47.0 PK	74.0	-27.0	1.42 V	303	34.0	13.0
7	15600.00	35.7 AV	54.0	-18.3	1.42 V	303	22.7	13.0

REMARKS:

1. Emission Level(dBuV/m) = Raw Value(dBuV) + Correction Factor(dB/m)
2. Correction Factor(dB/m) = Antenna Factor(dB/m) + Cable Factor(dB) – Pre-Amplifier Factor(dB)
3. The other emission levels were very low against the limit.
4. Margin value = Emission Level – Limit value
5. " * ": Fundamental frequency.
6. " # ": The radiated frequency is out of the restricted band.

CHANNEL	TX Channel 48	DETECTOR FUNCTION	Peak (PK)
FREQUENCY RANGE	1GHz ~ 40GHz		Average (AV)

ANTENNA POLARITY & TEST DISTANCE: HORIZONTAL AT 3 M

NO.	FREQ. (MHz)	EMISSION LEVEL (dBuV/m)	LIMIT (dBuV/m)	MARGIN (dB)	ANTENNA HEIGHT (m)	TABLE ANGLE (Degree)	RAW VALUE (dBuV)	CORRECTION FACTOR (dB/m)
1	5150.00	55.5 PK	74.0	-18.5	3.92 H	191	52.5	3.0
2	5150.00	42.6 AV	54.0	-11.4	3.92 H	191	39.6	3.0
3	*5240.00	111.7 PK			3.92 H	191	109.2	2.5
4	*5240.00	102.6 AV			3.92 H	191	100.1	2.5
5	#10480.00	45.3 PK	68.2	-22.9	1.38 H	252	32.1	13.2
6	15720.00	46.5 PK	74.0	-27.5	1.59 H	318	34.1	12.4
7	15720.00	35.4 AV	54.0	-18.6	1.59 H	318	23.0	12.4

ANTENNA POLARITY & TEST DISTANCE: VERTICAL AT 3 M

NO.	FREQ. (MHz)	EMISSION LEVEL (dBuV/m)	LIMIT (dBuV/m)	MARGIN (dB)	ANTENNA HEIGHT (m)	TABLE ANGLE (Degree)	RAW VALUE (dBuV)	CORRECTION FACTOR (dB/m)
1	5150.00	59.5 PK	74.0	-14.5	2.67 V	196	56.5	3.0
2	5150.00	46.9 AV	54.0	-7.1	2.67 V	196	43.9	3.0
3	*5240.00	118.5 PK			2.67 V	196	116.0	2.5
4	*5240.00	110.2 AV			2.67 V	196	107.7	2.5
5	#10480.00	49.5 PK	68.2	-18.7	1.19 V	125	36.3	13.2
6	15720.00	47.0 PK	74.0	-27.0	1.48 V	308	34.6	12.4
7	15720.00	35.6 AV	54.0	-18.4	1.48 V	308	23.2	12.4

REMARKS:

1. Emission Level(dBuV/m) = Raw Value(dBuV) + Correction Factor(dB/m)
2. Correction Factor(dB/m) = Antenna Factor(dB/m) + Cable Factor(dB) – Pre-Amplifier Factor(dB)
3. The other emission levels were very low against the limit.
4. Margin value = Emission Level – Limit value
5. " * ": Fundamental frequency.
6. " # ": The radiated frequency is out of the restricted band.

CHANNEL	TX Channel 52	DETECTOR FUNCTION	Peak (PK)
FREQUENCY RANGE	1GHz ~ 40GHz		Average (AV)

ANTENNA POLARITY & TEST DISTANCE: HORIZONTAL AT 3 M

NO.	FREQ. (MHz)	EMISSION LEVEL (dBuV/m)	LIMIT (dBuV/m)	MARGIN (dB)	ANTENNA HEIGHT (m)	TABLE ANGLE (Degree)	RAW VALUE (dBuV)	CORRECTION FACTOR (dB/m)
1	*5260.00	106.8 PK			3.89 H	188	104.3	2.5
2	*5260.00	97.5 AV			3.89 H	188	95.0	2.5
3	5350.00	55.6 PK	74.0	-18.4	3.89 H	188	52.8	2.8
4	5350.00	42.7 AV	54.0	-11.3	3.89 H	188	39.9	2.8
5	#10520.00	44.8 PK	68.2	-23.4	1.37 H	247	31.6	13.2
6	15780.00	45.9 PK	74.0	-28.1	1.58 H	322	33.3	12.6
7	15780.00	34.9 AV	54.0	-19.1	1.58 H	322	22.3	12.6

ANTENNA POLARITY & TEST DISTANCE: VERTICAL AT 3 M

NO.	FREQ. (MHz)	EMISSION LEVEL (dBuV/m)	LIMIT (dBuV/m)	MARGIN (dB)	ANTENNA HEIGHT (m)	TABLE ANGLE (Degree)	RAW VALUE (dBuV)	CORRECTION FACTOR (dB/m)
1	*5260.00	114.2 PK			2.65 V	195	111.7	2.5
2	*5260.00	105.3 AV			2.65 V	195	102.8	2.5
3	5350.00	58.1 PK	74.0	-15.9	2.65 V	195	55.3	2.8
4	5350.00	46.3 AV	54.0	-7.7	2.65 V	195	43.5	2.8
5	#10520.00	49.5 PK	68.2	-18.7	1.24 V	119	36.3	13.2
6	15780.00	46.8 PK	74.0	-27.2	1.50 V	327	34.2	12.6
7	15780.00	35.7 AV	54.0	-18.3	1.50 V	327	23.1	12.6

REMARKS:

1. Emission Level(dBuV/m) = Raw Value(dBuV) + Correction Factor(dB/m)
2. Correction Factor(dB/m) = Antenna Factor(dB/m) + Cable Factor(dB) – Pre-Amplifier Factor(dB)
3. The other emission levels were very low against the limit.
4. Margin value = Emission Level – Limit value
5. " * ": Fundamental frequency.
6. " # ": The radiated frequency is out of the restricted band.

CHANNEL	TX Channel 60	DETECTOR FUNCTION	Peak (PK)
FREQUENCY RANGE	1GHz ~ 40GHz		Average (AV)

ANTENNA POLARITY & TEST DISTANCE: HORIZONTAL AT 3 M

NO.	FREQ. (MHz)	EMISSION LEVEL (dBuV/m)	LIMIT (dBuV/m)	MARGIN (dB)	ANTENNA HEIGHT (m)	TABLE ANGLE (Degree)	RAW VALUE (dBuV)	CORRECTION FACTOR (dB/m)
1	*5300.00	106.5 PK			3.82 H	207	103.8	2.7
2	*5300.00	97.3 AV			3.82 H	207	94.6	2.7
3	10600.00	44.6 PK	74.0	-29.4	1.40 H	256	31.5	13.1
4	10600.00	38.1 AV	54.0	-15.9	1.40 H	256	25.0	13.1
5	15900.00	46.0 PK	74.0	-28.0	1.52 H	318	33.3	12.7
6	15900.00	34.8 AV	54.0	-19.2	1.52 H	318	22.1	12.7

ANTENNA POLARITY & TEST DISTANCE: VERTICAL AT 3 M

NO.	FREQ. (MHz)	EMISSION LEVEL (dBuV/m)	LIMIT (dBuV/m)	MARGIN (dB)	ANTENNA HEIGHT (m)	TABLE ANGLE (Degree)	RAW VALUE (dBuV)	CORRECTION FACTOR (dB/m)
1	*5300.00	114.3 PK			2.57 V	190	111.6	2.7
2	*5300.00	104.9 AV			2.57 V	190	102.2	2.7
3	10600.00	49.0 PK	74.0	-25.0	1.21 V	142	35.9	13.1
4	10600.00	42.6 AV	54.0	-11.4	1.21 V	142	29.5	13.1
5	15900.00	46.6 PK	74.0	-27.4	1.50 V	313	33.9	12.7
6	15900.00	35.6 AV	54.0	-18.4	1.50 V	313	22.9	12.7

REMARKS:

1. Emission Level(dBuV/m) = Raw Value(dBuV) + Correction Factor(dB/m)
2. Correction Factor(dB/m) = Antenna Factor(dB/m) + Cable Factor(dB) – Pre-Amplifier Factor(dB)
3. The other emission levels were very low against the limit.
4. Margin value = Emission Level – Limit value
5. " * ": Fundamental frequency.

CHANNEL	TX Channel 64	DETECTOR FUNCTION	Peak (PK)
FREQUENCY RANGE	1GHz ~ 40GHz		Average (AV)

ANTENNA POLARITY & TEST DISTANCE: HORIZONTAL AT 3 M

NO.	FREQ. (MHz)	EMISSION LEVEL (dBuV/m)	LIMIT (dBuV/m)	MARGIN (dB)	ANTENNA HEIGHT (m)	TABLE ANGLE (Degree)	RAW VALUE (dBuV)	CORRECTION FACTOR (dB/m)
1	*5320.00	106.7 PK			3.83 H	187	103.9	2.8
2	*5320.00	97.6 AV			3.83 H	187	94.8	2.8
3	5350.00	55.5 PK	74.0	-18.5	3.83 H	187	52.7	2.8
4	5350.00	42.6 AV	54.0	-11.4	3.83 H	187	39.8	2.8
5	10640.00	45.2 PK	74.0	-28.8	1.34 H	251	32.0	13.2
6	10640.00	38.8 AV	54.0	-15.2	1.34 H	251	25.6	13.2
7	15960.00	46.6 PK	74.0	-27.4	1.55 H	347	33.7	12.9
8	15960.00	35.3 AV	54.0	-18.7	1.55 H	347	22.4	12.9

ANTENNA POLARITY & TEST DISTANCE: VERTICAL AT 3 M

NO.	FREQ. (MHz)	EMISSION LEVEL (dBuV/m)	LIMIT (dBuV/m)	MARGIN (dB)	ANTENNA HEIGHT (m)	TABLE ANGLE (Degree)	RAW VALUE (dBuV)	CORRECTION FACTOR (dB/m)
1	*5320.00	114.2 PK			2.65 V	197	111.4	2.8
2	*5320.00	105.5 AV			2.65 V	197	102.7	2.8
3	5350.00	65.8 PK	74.0	-8.2	2.65 V	197	63.0	2.8
4	5350.00	49.9 AV	54.0	-4.1	2.65 V	197	47.1	2.8
5	10640.00	49.1 PK	74.0	-24.9	1.14 V	118	35.9	13.2
6	10640.00	42.9 AV	54.0	-11.1	1.14 V	118	29.7	13.2
7	15960.00	47.1 PK	74.0	-26.9	1.45 V	323	34.2	12.9
8	15960.00	35.6 AV	54.0	-18.4	1.45 V	323	22.7	12.9

REMARKS:

1. Emission Level(dBuV/m) = Raw Value(dBuV) + Correction Factor(dB/m)
2. Correction Factor(dB/m) = Antenna Factor(dB/m) + Cable Factor(dB) – Pre-Amplifier Factor(dB)
3. The other emission levels were very low against the limit.
4. Margin value = Emission Level – Limit value
5. " * ": Fundamental frequency.

CHANNEL	TX Channel 100	DETECTOR FUNCTION	Peak (PK)
FREQUENCY RANGE	1GHz ~ 40GHz		Average (AV)

ANTENNA POLARITY & TEST DISTANCE: HORIZONTAL AT 3 M

NO.	FREQ. (MHz)	EMISSION LEVEL (dBuV/m)	LIMIT (dBuV/m)	MARGIN (dB)	ANTENNA HEIGHT (m)	TABLE ANGLE (Degree)	RAW VALUE (dBuV)	CORRECTION FACTOR (dB/m)
1	5460.00	55.2 PK	74.0	-18.8	3.89 H	196	52.1	3.1
2	5460.00	41.9 AV	54.0	-12.1	3.89 H	196	38.8	3.1
3	#5470.00	56.8 PK	68.2	-11.4	3.89 H	196	53.7	3.1
4	*5500.00	106.5 PK			3.89 H	196	103.4	3.1
5	*5500.00	97.3 AV			3.89 H	196	94.2	3.1
6	11000.00	44.6 PK	74.0	-29.4	1.39 H	257	30.6	14.0
7	11000.00	38.1 AV	54.0	-15.9	1.39 H	257	24.1	14.0
8	#16500.00	46.6 PK	68.2	-21.6	1.62 H	333	31.6	15.0

ANTENNA POLARITY & TEST DISTANCE: VERTICAL AT 3 M

NO.	FREQ. (MHz)	EMISSION LEVEL (dBuV/m)	LIMIT (dBuV/m)	MARGIN (dB)	ANTENNA HEIGHT (m)	TABLE ANGLE (Degree)	RAW VALUE (dBuV)	CORRECTION FACTOR (dB/m)
1	5460.00	56.5 PK	74.0	-17.5	3.28 V	135	53.4	3.1
2	5460.00	42.8 AV	54.0	-11.2	3.28 V	135	39.7	3.1
3	#5470.00	64.1 PK	68.2	-4.1	2.47 V	232	61.0	3.1
4	*5500.00	114.9 PK			2.47 V	232	111.8	3.1
5	*5500.00	105.2 AV			2.47 V	232	102.1	3.1
6	11000.00	49.0 PK	74.0	-25.0	1.18 V	137	35.0	14.0
7	11000.00	42.8 AV	54.0	-11.2	1.18 V	137	28.8	14.0
8	#16500.00	46.8 PK	68.2	-21.4	1.50 V	309	31.8	15.0

REMARKS:

1. Emission Level(dBuV/m) = Raw Value(dBuV) + Correction Factor(dB/m)
2. Correction Factor(dB/m) = Antenna Factor(dB/m) + Cable Factor(dB) – Pre-Amplifier Factor(dB)
3. The other emission levels were very low against the limit.
4. Margin value = Emission Level – Limit value
5. " * ": Fundamental frequency.
6. " # ": The radiated frequency is out of the restricted band.

CHANNEL	TX Channel 116	DETECTOR FUNCTION	Peak (PK)
FREQUENCY RANGE	1GHz ~ 40GHz		Average (AV)

ANTENNA POLARITY & TEST DISTANCE: HORIZONTAL AT 3 M

NO.	FREQ. (MHz)	EMISSION LEVEL (dBuV/m)	LIMIT (dBuV/m)	MARGIN (dB)	ANTENNA HEIGHT (m)	TABLE ANGLE (Degree)	RAW VALUE (dBuV)	CORRECTION FACTOR (dB/m)
1	*5580.00	106.3 PK			3.86 H	202	103.0	3.3
2	*5580.00	97.1 AV			3.86 H	202	93.8	3.3
3	11160.00	45.3 PK	74.0	-28.7	1.41 H	261	31.9	13.4
4	11160.00	38.8 AV	54.0	-15.2	1.41 H	261	25.4	13.4
5	#16740.00	46.1 PK	68.2	-22.1	1.58 H	329	29.5	16.6

ANTENNA POLARITY & TEST DISTANCE: VERTICAL AT 3 M

NO.	FREQ. (MHz)	EMISSION LEVEL (dBuV/m)	LIMIT (dBuV/m)	MARGIN (dB)	ANTENNA HEIGHT (m)	TABLE ANGLE (Degree)	RAW VALUE (dBuV)	CORRECTION FACTOR (dB/m)
1	*5580.00	114.6 PK			2.49 V	228	111.3	3.3
2	*5580.00	105.0 AV			2.49 V	228	101.7	3.3
3	11160.00	49.3 PK	74.0	-24.7	1.23 V	120	35.9	13.4
4	11160.00	42.7 AV	54.0	-11.3	1.23 V	120	29.3	13.4
5	#16740.00	46.7 PK	68.2	-21.5	1.43 V	308	30.1	16.6

REMARKS:

1. Emission Level(dBuV/m) = Raw Value(dBuV) + Correction Factor(dB/m)
2. Correction Factor(dB/m) = Antenna Factor(dB/m) + Cable Factor(dB) – Pre-Amplifier Factor(dB)
3. The other emission levels were very low against the limit.
4. Margin value = Emission Level – Limit value
5. " * ": Fundamental frequency.
6. " # ": The radiated frequency is out of the restricted band.

CHANNEL	TX Channel 140	DETECTOR FUNCTION	Peak (PK)
FREQUENCY RANGE	1GHz ~ 40GHz		Average (AV)

ANTENNA POLARITY & TEST DISTANCE: HORIZONTAL AT 3 M

NO.	FREQ. (MHz)	EMISSION LEVEL (dBuV/m)	LIMIT (dBuV/m)	MARGIN (dB)	ANTENNA HEIGHT (m)	TABLE ANGLE (Degree)	RAW VALUE (dBuV)	CORRECTION FACTOR (dB/m)
1	*5700.00	105.4 PK			3.91 H	213	101.8	3.6
2	*5700.00	96.1 AV			3.91 H	213	92.5	3.6
3	#5725.00	59.5 PK	68.2	-8.7	3.91 H	213	56.0	3.5
4	11400.00	44.7 PK	74.0	-29.3	1.33 H	244	31.1	13.6
5	11400.00	38.3 AV	54.0	-15.7	1.33 H	244	24.7	13.6
6	#17100.00	46.3 PK	68.2	-21.9	1.55 H	332	30.0	16.3

ANTENNA POLARITY & TEST DISTANCE: VERTICAL AT 3 M

NO.	FREQ. (MHz)	EMISSION LEVEL (dBuV/m)	LIMIT (dBuV/m)	MARGIN (dB)	ANTENNA HEIGHT (m)	TABLE ANGLE (Degree)	RAW VALUE (dBuV)	CORRECTION FACTOR (dB/m)
1	*5700.00	113.0 PK			2.12 V	196	109.4	3.6
2	*5700.00	103.8 AV			2.12 V	196	100.2	3.6
3	#5725.00	67.8 PK	68.2	-0.4	2.12 V	196	64.3	3.5
4	11400.00	49.6 PK	74.0	-24.4	1.13 V	128	36.0	13.6
5	11400.00	43.2 AV	54.0	-10.8	1.13 V	128	29.6	13.6
6	#17100.00	46.9 PK	68.2	-21.3	1.43 V	320	30.6	16.3

REMARKS:

1. Emission Level(dBuV/m) = Raw Value(dBuV) + Correction Factor(dB/m)
2. Correction Factor(dB/m) = Antenna Factor(dB/m) + Cable Factor(dB) – Pre-Amplifier Factor(dB)
3. The other emission levels were very low against the limit.
4. Margin value = Emission Level – Limit value
5. " * ": Fundamental frequency.
6. " # ": The radiated frequency is out of the restricted band.

CHANNEL	TX Channel 144	DETECTOR FUNCTION	Peak (PK)
FREQUENCY RANGE	1GHz ~ 40GHz		Average (AV)

ANTENNA POLARITY & TEST DISTANCE: HORIZONTAL AT 3 M

NO.	FREQ. (MHz)	EMISSION LEVEL (dBuV/m)	LIMIT (dBuV/m)	MARGIN (dB)	ANTENNA HEIGHT (m)	TABLE ANGLE (Degree)	RAW VALUE (dBuV)	CORRECTION FACTOR (dB/m)
1	#5470.00	52.6 PK	68.2	-15.6	3.85 H	200	49.5	3.1
2	*5720.00	106.5 PK			3.85 H	200	103.0	3.5
3	*5720.00	97.4 AV			3.85 H	200	93.9	3.5
4	#5850.00	53.3 PK	68.2	-14.9	3.85 H	200	49.4	3.9
5	11440.00	44.8 PK	74.0	-29.2	1.36 H	229	31.1	13.7
6	11440.00	38.4 AV	54.0	-15.6	1.36 H	229	24.7	13.7
7	#17160.00	46.5 PK	68.2	-21.7	1.59 H	347	29.8	16.7

ANTENNA POLARITY & TEST DISTANCE: VERTICAL AT 3 M

NO.	FREQ. (MHz)	EMISSION LEVEL (dBuV/m)	LIMIT (dBuV/m)	MARGIN (dB)	ANTENNA HEIGHT (m)	TABLE ANGLE (Degree)	RAW VALUE (dBuV)	CORRECTION FACTOR (dB/m)
1	#5470.00	55.7 PK	68.2	-12.5	2.11 V	190	52.6	3.1
2	*5720.00	114.7 PK			2.11 V	190	111.2	3.5
3	*5720.00	105.2 AV			2.11 V	190	101.7	3.5
4	#5850.00	56.4 PK	68.2	-11.8	2.11 V	190	52.5	3.9
5	11440.00	49.7 PK	74.0	-24.3	1.15 V	126	36.0	13.7
6	11440.00	43.5 AV	54.0	-10.5	1.15 V	126	29.8	13.7
7	#17160.00	47.0 PK	68.2	-21.2	1.42 V	329	30.3	16.7

REMARKS:

1. Emission Level(dBuV/m) = Raw Value(dBuV) + Correction Factor(dB/m)
2. Correction Factor(dB/m) = Antenna Factor(dB/m) + Cable Factor(dB) – Pre-Amplifier Factor(dB)
3. The other emission levels were very low against the limit.
4. Margin value = Emission Level – Limit value
5. " * ": Fundamental frequency.
6. " # ": The radiated frequency is out of the restricted band.

CHANNEL	TX Channel 149	DETECTOR FUNCTION	Peak (PK)
FREQUENCY RANGE	1GHz ~ 40GHz		Average (AV)

ANTENNA POLARITY & TEST DISTANCE: HORIZONTAL AT 3 M

NO.	FREQ. (MHz)	EMISSION LEVEL (dBuV/m)	LIMIT (dBuV/m)	MARGIN (dB)	ANTENNA HEIGHT (m)	TABLE ANGLE (Degree)	RAW VALUE (dBuV)	CORRECTION FACTOR (dB/m)
1	*5745.00	114.2 PK			2.56 H	134	110.6	3.6
2	*5745.00	104.6 AV			2.56 H	134	101.0	3.6
3	11490.00	47.7 PK	74.0	-26.3	1.39 H	248	33.9	13.8
4	11490.00	40.5 AV	54.0	-13.5	1.39 H	248	26.7	13.8
5	#17235.00	51.5 PK	68.2	-16.7	1.58 H	341	34.4	17.1

ANTENNA POLARITY & TEST DISTANCE: VERTICAL AT 3 M

NO.	FREQ. (MHz)	EMISSION LEVEL (dBuV/m)	LIMIT (dBuV/m)	MARGIN (dB)	ANTENNA HEIGHT (m)	TABLE ANGLE (Degree)	RAW VALUE (dBuV)	CORRECTION FACTOR (dB/m)
1	*5745.00	120.7 PK			2.99 V	138	117.1	3.6
2	*5745.00	110.8 AV			2.99 V	138	107.2	3.6
3	11490.00	50.3 PK	74.0	-23.7	1.09 V	99	36.5	13.8
4	11490.00	45.1 AV	54.0	-8.9	1.09 V	99	31.3	13.8
5	#17235.00	53.6 PK	68.2	-14.6	1.35 V	339	36.5	17.1

REMARKS:

1. Emission Level(dBuV/m) = Raw Value(dBuV) + Correction Factor(dB/m)
2. Correction Factor(dB/m) = Antenna Factor(dB/m) + Cable Factor(dB) – Pre-Amplifier Factor(dB)
3. The other emission levels were very low against the limit.
4. Margin value = Emission Level – Limit value
5. " * ": Fundamental frequency.
6. " # ": The radiated frequency is out of the restricted band.

CHANNEL	TX Channel 157	DETECTOR FUNCTION	Peak (PK)
FREQUENCY RANGE	1GHz ~ 40GHz		Average (AV)

ANTENNA POLARITY & TEST DISTANCE: HORIZONTAL AT 3 M

NO.	FREQ. (MHz)	EMISSION LEVEL (dBuV/m)	LIMIT (dBuV/m)	MARGIN (dB)	ANTENNA HEIGHT (m)	TABLE ANGLE (Degree)	RAW VALUE (dBuV)	CORRECTION FACTOR (dB/m)
1	*5785.00	114.7 PK			2.44 H	131	111.1	3.6
2	*5785.00	104.9 AV			2.44 H	131	101.3	3.6
3	11570.00	47.8 PK	74.0	-26.2	1.32 H	254	34.1	13.7
4	11570.00	40.5 AV	54.0	-13.5	1.32 H	254	26.8	13.7
5	#17355.00	51.2 PK	68.2	-17.0	1.56 H	335	33.6	17.6

ANTENNA POLARITY & TEST DISTANCE: VERTICAL AT 3 M

NO.	FREQ. (MHz)	EMISSION LEVEL (dBuV/m)	LIMIT (dBuV/m)	MARGIN (dB)	ANTENNA HEIGHT (m)	TABLE ANGLE (Degree)	RAW VALUE (dBuV)	CORRECTION FACTOR (dB/m)
1	*5785.00	120.9 PK			3.03 V	141	117.3	3.6
2	*5785.00	111.0 AV			3.03 V	141	107.4	3.6
3	11570.00	50.5 PK	74.0	-23.5	1.06 V	97	36.8	13.7
4	11570.00	45.1 AV	54.0	-8.9	1.06 V	97	31.4	13.7
5	#17355.00	53.2 PK	68.2	-15.0	1.29 V	333	35.6	17.6

REMARKS:

1. Emission Level(dBuV/m) = Raw Value(dBuV) + Correction Factor(dB/m)
2. Correction Factor(dB/m) = Antenna Factor(dB/m) + Cable Factor(dB) – Pre-Amplifier Factor(dB)
3. The other emission levels were very low against the limit.
4. Margin value = Emission Level – Limit value
5. " * ": Fundamental frequency.
6. " # ": The radiated frequency is out of the restricted band.

CHANNEL	TX Channel 165	DETECTOR FUNCTION	Peak (PK)
FREQUENCY RANGE	1GHz ~ 40GHz		Average (AV)

ANTENNA POLARITY & TEST DISTANCE: HORIZONTAL AT 3 M

NO.	FREQ. (MHz)	EMISSION LEVEL (dBuV/m)	LIMIT (dBuV/m)	MARGIN (dB)	ANTENNA HEIGHT (m)	TABLE ANGLE (Degree)	RAW VALUE (dBuV)	CORRECTION FACTOR (dB/m)
1	*5825.00	114.4 PK			2.59 H	133	110.6	3.8
2	*5825.00	104.7 AV			2.59 H	133	100.9	3.8
3	11650.00	48.0 PK	74.0	-26.0	1.33 H	256	34.4	13.6
4	11650.00	40.8 AV	54.0	-13.2	1.33 H	256	27.2	13.6
5	#17475.00	51.7 PK	68.2	-16.5	1.52 H	357	33.1	18.6

ANTENNA POLARITY & TEST DISTANCE: VERTICAL AT 3 M

NO.	FREQ. (MHz)	EMISSION LEVEL (dBuV/m)	LIMIT (dBuV/m)	MARGIN (dB)	ANTENNA HEIGHT (m)	TABLE ANGLE (Degree)	RAW VALUE (dBuV)	CORRECTION FACTOR (dB/m)
1	*5825.00	120.5 PK			3.06 V	142	116.7	3.8
2	*5825.00	110.4 AV			3.06 V	142	106.6	3.8
3	11650.00	50.9 PK	74.0	-23.1	1.04 V	94	37.3	13.6
4	11650.00	45.7 AV	54.0	-8.3	1.04 V	94	32.1	13.6
5	#17475.00	54.0 PK	68.2	-14.2	1.31 V	345	35.4	18.6

REMARKS:

1. Emission Level(dBuV/m) = Raw Value(dBuV) + Correction Factor(dB/m)
2. Correction Factor(dB/m) = Antenna Factor(dB/m) + Cable Factor(dB) – Pre-Amplifier Factor(dB)
3. The other emission levels were very low against the limit.
4. Margin value = Emission Level – Limit value
5. " * ": Fundamental frequency.
6. " # ": The radiated frequency is out of the restricted band.

802.11ax (HE40)

CHANNEL	TX Channel 38	DETECTOR FUNCTION	Peak (PK)
FREQUENCY RANGE	1GHz ~ 40GHz		Average (AV)

ANTENNA POLARITY & TEST DISTANCE: HORIZONTAL AT 3 M

NO.	FREQ. (MHz)	EMISSION LEVEL (dBuV/m)	LIMIT (dBuV/m)	MARGIN (dB)	ANTENNA HEIGHT (m)	TABLE ANGLE (Degree)	RAW VALUE (dBuV)	CORRECTION FACTOR (dB/m)
1	5150.00	57.5 PK	74.0	-16.5	3.87 H	205	54.5	3.0
2	5150.00	46.6 AV	54.0	-7.4	3.87 H	205	43.6	3.0
3	*5190.00	104.3 PK			3.87 H	205	101.4	2.9
4	*5190.00	94.8 AV			3.87 H	205	91.9	2.9
5	5350.00	56.0 PK	74.0	-18.0	3.87 H	205	53.2	2.8
6	5350.00	42.2 AV	54.0	-11.8	3.87 H	205	39.4	2.8
7	#10380.00	45.6 PK	68.2	-22.6	1.41 H	257	32.6	13.0
8	15570.00	46.1 PK	74.0	-27.9	1.60 H	336	33.1	13.0
9	15570.00	34.9 AV	54.0	-19.1	1.60 H	336	21.9	13.0

ANTENNA POLARITY & TEST DISTANCE: VERTICAL AT 3 M

NO.	FREQ. (MHz)	EMISSION LEVEL (dBuV/m)	LIMIT (dBuV/m)	MARGIN (dB)	ANTENNA HEIGHT (m)	TABLE ANGLE (Degree)	RAW VALUE (dBuV)	CORRECTION FACTOR (dB/m)
1	5150.00	64.2 PK	74.0	-9.8	3.39 V	93	61.2	3.0
2	5150.00	53.5 AV	54.0	-0.5	3.39 V	93	50.5	3.0
3	*5190.00	113.2 PK			3.39 V	93	110.3	2.9
4	*5190.00	103.0 AV			3.39 V	93	100.1	2.9
5	5350.00	57.4 PK	74.0	-16.6	3.39 V	93	54.6	2.8
6	5350.00	43.2 AV	54.0	-10.8	3.39 V	93	40.4	2.8
7	#10380.00	49.5 PK	68.2	-18.7	1.17 V	113	36.5	13.0
8	15570.00	47.4 PK	74.0	-26.6	1.42 V	323	34.4	13.0
9	15570.00	36.5 AV	54.0	-17.5	1.42 V	323	23.5	13.0

REMARKS:

- Emission Level(dBuV/m) = Raw Value(dBuV) + Correction Factor(dB/m)
- Correction Factor(dB/m) = Antenna Factor(dB/m) + Cable Factor(dB) – Pre-Amplifier Factor(dB)
- The other emission levels were very low against the limit.
- Margin value = Emission Level – Limit value
- " * ": Fundamental frequency.
- " # ": The radiated frequency is out of the restricted band.

CHANNEL	TX Channel 46	DETECTOR FUNCTION	Peak (PK)
FREQUENCY RANGE	1GHz ~ 40GHz		Average (AV)

ANTENNA POLARITY & TEST DISTANCE: HORIZONTAL AT 3 M

NO.	FREQ. (MHz)	EMISSION LEVEL (dBuV/m)	LIMIT (dBuV/m)	MARGIN (dB)	ANTENNA HEIGHT (m)	TABLE ANGLE (Degree)	RAW VALUE (dBuV)	CORRECTION FACTOR (dB/m)
1	*5230.00	109.5 PK			3.85 H	211	106.9	2.6
2	*5230.00	100.3 AV			3.85 H	211	97.7	2.6
3	5350.00	57.2 PK	74.0	-16.8	3.85 H	211	54.4	2.8
4	5350.00	46.3 AV	54.0	-7.7	3.85 H	211	43.5	2.8
5	#10460.00	45.3 PK	68.2	-22.9	1.37 H	251	32.1	13.2
6	15690.00	45.9 PK	74.0	-28.1	1.60 H	339	33.6	12.3
7	15690.00	34.7 AV	54.0	-19.3	1.60 H	339	22.4	12.3

ANTENNA POLARITY & TEST DISTANCE: VERTICAL AT 3 M

NO.	FREQ. (MHz)	EMISSION LEVEL (dBuV/m)	LIMIT (dBuV/m)	MARGIN (dB)	ANTENNA HEIGHT (m)	TABLE ANGLE (Degree)	RAW VALUE (dBuV)	CORRECTION FACTOR (dB/m)
1	*5230.00	117.0 PK			3.36 V	93	114.4	2.6
2	*5230.00	108.1 AV			3.36 V	93	105.5	2.6
3	5350.00	64.5 PK	74.0	-9.5	3.36 V	93	61.7	2.8
4	5350.00	53.5 AV	54.0	-0.5	3.36 V	93	50.7	2.8
5	#10460.00	49.3 PK	68.2	-18.9	1.13 V	112	36.1	13.2
6	15690.00	46.9 PK	74.0	-27.1	1.42 V	334	34.6	12.3
7	15690.00	36.1 AV	54.0	-17.9	1.42 V	334	23.8	12.3

REMARKS:

- Emission Level(dBuV/m) = Raw Value(dBuV) + Correction Factor(dB/m)
- Correction Factor(dB/m) = Antenna Factor(dB/m) + Cable Factor(dB) – Pre-Amplifier Factor(dB)
- The other emission levels were very low against the limit.
- Margin value = Emission Level – Limit value
- " * ": Fundamental frequency.
- " # ": The radiated frequency is out of the restricted band.

CHANNEL	TX Channel 54	DETECTOR FUNCTION	Peak (PK)
FREQUENCY RANGE	1GHz ~ 40GHz		Average (AV)

ANTENNA POLARITY & TEST DISTANCE: HORIZONTAL AT 3 M

NO.	FREQ. (MHz)	EMISSION LEVEL (dBuV/m)	LIMIT (dBuV/m)	MARGIN (dB)	ANTENNA HEIGHT (m)	TABLE ANGLE (Degree)	RAW VALUE (dBuV)	CORRECTION FACTOR (dB/m)
1	5150.00	55.6 PK	74.0	-18.4	3.92 H	202	52.6	3.0
2	5150.00	44.5 AV	54.0	-9.5	3.92 H	202	41.5	3.0
3	*5270.00	105.5 PK			3.92 H	202	103.0	2.5
4	*5270.00	96.2 AV			3.92 H	202	93.7	2.5
5	#10540.00	45.0 PK	68.2	-23.2	1.37 H	260	31.8	13.2
6	15810.00	46.7 PK	74.0	-27.3	1.51 H	334	34.0	12.7
7	15810.00	35.3 AV	54.0	-18.7	1.51 H	334	22.6	12.7

ANTENNA POLARITY & TEST DISTANCE: VERTICAL AT 3 M

NO.	FREQ. (MHz)	EMISSION LEVEL (dBuV/m)	LIMIT (dBuV/m)	MARGIN (dB)	ANTENNA HEIGHT (m)	TABLE ANGLE (Degree)	RAW VALUE (dBuV)	CORRECTION FACTOR (dB/m)
1	5150.00	62.8 PK	74.0	-11.2	3.28 V	126	59.8	3.0
2	5150.00	51.5 AV	54.0	-2.5	3.28 V	126	48.5	3.0
3	*5270.00	113.1 PK			3.28 V	126	110.6	2.5
4	*5270.00	103.8 AV			3.28 V	126	101.3	2.5
5	#10540.00	49.9 PK	68.2	-18.3	1.11 V	121	36.7	13.2
6	15810.00	46.7 PK	74.0	-27.3	1.47 V	327	34.0	12.7
7	15810.00	35.7 AV	54.0	-18.3	1.47 V	327	23.0	12.7

REMARKS:

1. Emission Level(dBuV/m) = Raw Value(dBuV) + Correction Factor(dB/m)
2. Correction Factor(dB/m) = Antenna Factor(dB/m) + Cable Factor(dB) – Pre-Amplifier Factor(dB)
3. The other emission levels were very low against the limit.
4. Margin value = Emission Level – Limit value
5. " * ": Fundamental frequency.
6. " # ": The radiated frequency is out of the restricted band.

CHANNEL	TX Channel 62	DETECTOR FUNCTION	Peak (PK)
FREQUENCY RANGE	1GHz ~ 40GHz		Average (AV)

ANTENNA POLARITY & TEST DISTANCE: HORIZONTAL AT 3 M

NO.	FREQ. (MHz)	EMISSION LEVEL (dBuV/m)	LIMIT (dBuV/m)	MARGIN (dB)	ANTENNA HEIGHT (m)	TABLE ANGLE (Degree)	RAW VALUE (dBuV)	CORRECTION FACTOR (dB/m)
1	*5310.00	105.1 PK			3.90 H	193	102.4	2.7
2	*5310.00	95.8 AV			3.90 H	193	93.1	2.7
3	5350.00	56.3 PK	74.0	-17.7	3.90 H	193	53.5	2.8
4	5350.00	45.2 AV	54.0	-8.8	3.90 H	193	42.4	2.8
5	10620.00	45.3 PK	74.0	-28.7	1.35 H	240	32.2	13.1
6	10620.00	38.8 AV	54.0	-15.2	1.35 H	240	25.7	13.1
7	15930.00	46.1 PK	74.0	-27.9	1.58 H	327	33.4	12.7
8	15930.00	35.0 AV	54.0	-19.0	1.58 H	327	22.3	12.7

ANTENNA POLARITY & TEST DISTANCE: VERTICAL AT 3 M

NO.	FREQ. (MHz)	EMISSION LEVEL (dBuV/m)	LIMIT (dBuV/m)	MARGIN (dB)	ANTENNA HEIGHT (m)	TABLE ANGLE (Degree)	RAW VALUE (dBuV)	CORRECTION FACTOR (dB/m)
1	*5310.00	112.8 PK			3.44 V	130	110.1	2.7
2	*5310.00	103.6 AV			3.44 V	130	100.9	2.7
3	5350.00	63.4 PK	74.0	-10.6	3.44 V	130	60.6	2.8
4	5350.00	51.8 AV	54.0	-2.2	3.44 V	130	49.0	2.8
5	10620.00	50.3 PK	74.0	-23.7	1.13 V	115	37.2	13.1
6	10620.00	44.0 AV	54.0	-10.0	1.13 V	115	30.9	13.1
7	15930.00	46.7 PK	74.0	-27.3	1.43 V	329	34.0	12.7
8	15930.00	36.0 AV	54.0	-18.0	1.43 V	329	23.3	12.7

REMARKS:

1. Emission Level(dBuV/m) = Raw Value(dBuV) + Correction Factor(dB/m)
2. Correction Factor(dB/m) = Antenna Factor(dB/m) + Cable Factor(dB) – Pre-Amplifier Factor(dB)
3. The other emission levels were very low against the limit.
4. Margin value = Emission Level – Limit value
5. " * ": Fundamental frequency.

CHANNEL	TX Channel 102	DETECTOR FUNCTION	Peak (PK)
FREQUENCY RANGE	1GHz ~ 40GHz		Average (AV)

ANTENNA POLARITY & TEST DISTANCE: HORIZONTAL AT 3 M

NO.	FREQ. (MHz)	EMISSION LEVEL (dBuV/m)	LIMIT (dBuV/m)	MARGIN (dB)	ANTENNA HEIGHT (m)	TABLE ANGLE (Degree)	RAW VALUE (dBuV)	CORRECTION FACTOR (dB/m)
1	5460.00	56.2 PK	74.0	-17.8	3.87 H	191	53.1	3.1
2	5460.00	42.1 AV	54.0	-11.9	3.87 H	191	39.0	3.1
3	#5470.00	56.8 PK	68.2	-11.4	3.87 H	191	53.7	3.1
4	*5510.00	104.9 PK			3.87 H	191	101.8	3.1
5	*5510.00	95.6 AV			3.87 H	191	92.5	3.1
6	11020.00	45.1 PK	74.0	-28.9	1.33 H	243	31.2	13.9
7	11020.00	38.6 AV	54.0	-15.4	1.33 H	243	24.7	13.9
8	#16530.00	46.4 PK	68.2	-21.8	1.55 H	329	31.5	14.9

ANTENNA POLARITY & TEST DISTANCE: VERTICAL AT 3 M

NO.	FREQ. (MHz)	EMISSION LEVEL (dBuV/m)	LIMIT (dBuV/m)	MARGIN (dB)	ANTENNA HEIGHT (m)	TABLE ANGLE (Degree)	RAW VALUE (dBuV)	CORRECTION FACTOR (dB/m)
1	5460.00	63.1 PK	74.0	-10.9	2.36 V	235	60.0	3.1
2	5460.00	47.3 AV	54.0	-6.7	2.36 V	235	44.2	3.1
3	#5470.00	63.6 PK	68.2	-4.6	2.36 V	235	60.5	3.1
4	*5510.00	112.8 PK			2.36 V	235	109.7	3.1
5	*5510.00	103.3 AV			2.36 V	235	100.2	3.1
6	11020.00	49.9 PK	74.0	-24.1	1.10 V	117	36.0	13.9
7	11020.00	43.6 AV	54.0	-10.4	1.10 V	117	29.7	13.9
8	#16530.00	47.4 PK	68.2	-20.8	1.45 V	339	32.5	14.9

REMARKS:

1. Emission Level(dBuV/m) = Raw Value(dBuV) + Correction Factor(dB/m)
2. Correction Factor(dB/m) = Antenna Factor(dB/m) + Cable Factor(dB) – Pre-Amplifier Factor(dB)
3. The other emission levels were very low against the limit.
4. Margin value = Emission Level – Limit value
5. " * ": Fundamental frequency.
6. " # ": The radiated frequency is out of the restricted band.

CHANNEL	TX Channel 110	DETECTOR FUNCTION	Peak (PK)
FREQUENCY RANGE	1GHz ~ 40GHz		Average (AV)

ANTENNA POLARITY & TEST DISTANCE: HORIZONTAL AT 3 M

NO.	FREQ. (MHz)	EMISSION LEVEL (dBuV/m)	LIMIT (dBuV/m)	MARGIN (dB)	ANTENNA HEIGHT (m)	TABLE ANGLE (Degree)	RAW VALUE (dBuV)	CORRECTION FACTOR (dB/m)
1	*5550.00	105.1 PK			3.88 H	209	101.9	3.2
2	*5550.00	95.8 AV			3.88 H	209	92.6	3.2
3	11100.00	45.0 PK	74.0	-29.0	1.37 H	244	31.7	13.3
4	11100.00	38.8 AV	54.0	-15.2	1.37 H	244	25.5	13.3
5	#16650.00	46.4 PK	68.2	-21.8	1.61 H	329	30.8	15.6

ANTENNA POLARITY & TEST DISTANCE: VERTICAL AT 3 M

NO.	FREQ. (MHz)	EMISSION LEVEL (dBuV/m)	LIMIT (dBuV/m)	MARGIN (dB)	ANTENNA HEIGHT (m)	TABLE ANGLE (Degree)	RAW VALUE (dBuV)	CORRECTION FACTOR (dB/m)
1	*5550.00	113.1 PK			2.45 V	236	109.9	3.2
2	*5550.00	103.8 AV			2.45 V	236	100.6	3.2
3	11100.00	50.0 PK	74.0	-24.0	1.17 V	118	36.7	13.3
4	11100.00	43.8 AV	54.0	-10.2	1.17 V	118	30.5	13.3
5	#16650.00	47.5 PK	68.2	-20.7	1.39 V	319	31.9	15.6

REMARKS:

1. Emission Level(dBuV/m) = Raw Value(dBuV) + Correction Factor(dB/m)
2. Correction Factor(dB/m) = Antenna Factor(dB/m) + Cable Factor(dB) – Pre-Amplifier Factor(dB)
3. The other emission levels were very low against the limit.
4. Margin value = Emission Level – Limit value
5. " * ": Fundamental frequency.
6. " # ": The radiated frequency is out of the restricted band.

CHANNEL	TX Channel 134	DETECTOR FUNCTION	Peak (PK)
FREQUENCY RANGE	1GHz ~ 40GHz		Average (AV)

ANTENNA POLARITY & TEST DISTANCE: HORIZONTAL AT 3 M

NO.	FREQ. (MHz)	EMISSION LEVEL (dBuV/m)	LIMIT (dBuV/m)	MARGIN (dB)	ANTENNA HEIGHT (m)	TABLE ANGLE (Degree)	RAW VALUE (dBuV)	CORRECTION FACTOR (dB/m)
1	*5670.00	105.1 PK			3.82 H	192	101.7	3.4
2	*5670.00	95.7 AV			3.82 H	192	92.3	3.4
3	#5725.00	57.2 PK	68.2	-11.0	3.82 H	192	53.7	3.5
4	11340.00	44.7 PK	74.0	-29.3	1.40 H	244	31.0	13.7
5	11340.00	38.1 AV	54.0	-15.9	1.40 H	244	24.4	13.7
6	#17010.00	46.3 PK	68.2	-21.9	1.57 H	347	29.7	16.6

ANTENNA POLARITY & TEST DISTANCE: VERTICAL AT 3 M

NO.	FREQ. (MHz)	EMISSION LEVEL (dBuV/m)	LIMIT (dBuV/m)	MARGIN (dB)	ANTENNA HEIGHT (m)	TABLE ANGLE (Degree)	RAW VALUE (dBuV)	CORRECTION FACTOR (dB/m)
1	*5670.00	112.9 PK			2.41 V	211	109.5	3.4
2	*5670.00	103.6 AV			2.41 V	211	100.2	3.4
3	#5725.00	64.0 PK	68.2	-4.2	2.41 V	211	60.5	3.5
4	11340.00	49.3 PK	74.0	-24.7	1.13 V	118	35.6	13.7
5	11340.00	43.3 AV	54.0	-10.7	1.13 V	118	29.6	13.7
6	#17010.00	46.7 PK	68.2	-21.5	1.44 V	333	30.1	16.6

REMARKS:

1. Emission Level(dBuV/m) = Raw Value(dBuV) + Correction Factor(dB/m)
2. Correction Factor(dB/m) = Antenna Factor(dB/m) + Cable Factor(dB) – Pre-Amplifier Factor(dB)
3. The other emission levels were very low against the limit.
4. Margin value = Emission Level – Limit value
5. " * ": Fundamental frequency.
6. " # ": The radiated frequency is out of the restricted band.

CHANNEL	TX Channel 142	DETECTOR FUNCTION	Peak (PK)
FREQUENCY RANGE	1GHz ~ 40GHz		Average (AV)

ANTENNA POLARITY & TEST DISTANCE: HORIZONTAL AT 3 M

NO.	FREQ. (MHz)	EMISSION LEVEL (dBuV/m)	LIMIT (dBuV/m)	MARGIN (dB)	ANTENNA HEIGHT (m)	TABLE ANGLE (Degree)	RAW VALUE (dBuV)	CORRECTION FACTOR (dB/m)
1	#5470.00	54.6 PK	68.2	-13.6	3.86 H	198	51.5	3.1
2	*5710.00	105.0 PK			3.86 H	198	101.5	3.5
3	*5710.00	95.7 AV			3.86 H	198	92.2	3.5
4	#5850.00	54.2 PK	68.2	-14.0	3.86 H	198	50.3	3.9
5	11420.00	44.8 PK	74.0	-29.2	1.41 H	260	31.2	13.6
6	11420.00	38.2 AV	54.0	-15.8	1.41 H	260	24.6	13.6
7	#17130.00	46.2 PK	68.2	-22.0	1.58 H	341	29.6	16.6

ANTENNA POLARITY & TEST DISTANCE: VERTICAL AT 3 M

NO.	FREQ. (MHz)	EMISSION LEVEL (dBuV/m)	LIMIT (dBuV/m)	MARGIN (dB)	ANTENNA HEIGHT (m)	TABLE ANGLE (Degree)	RAW VALUE (dBuV)	CORRECTION FACTOR (dB/m)
1	#5470.00	56.4 PK	68.2	-11.8	2.44 V	212	53.3	3.1
2	*5710.00	112.6 PK			2.44 V	212	109.1	3.5
3	*5710.00	103.5 AV			2.44 V	212	100.0	3.5
4	#5850.00	54.6 PK	68.2	-13.6	2.44 V	212	50.7	3.9
5	11420.00	49.4 PK	74.0	-24.6	1.19 V	137	35.8	13.6
6	11420.00	43.3 AV	54.0	-10.7	1.19 V	137	29.7	13.6
7	#17130.00	46.9 PK	68.2	-21.3	1.39 V	326	30.3	16.6

REMARKS:

1. Emission Level(dBuV/m) = Raw Value(dBuV) + Correction Factor(dB/m)
2. Correction Factor(dB/m) = Antenna Factor(dB/m) + Cable Factor(dB) – Pre-Amplifier Factor(dB)
3. The other emission levels were very low against the limit.
4. Margin value = Emission Level – Limit value
5. " * ": Fundamental frequency.
6. " # ": The radiated frequency is out of the restricted band.

CHANNEL	TX Channel 151	DETECTOR FUNCTION	Peak (PK)
FREQUENCY RANGE	1GHz ~ 40GHz		Average (AV)

ANTENNA POLARITY & TEST DISTANCE: HORIZONTAL AT 3 M

NO.	FREQ. (MHz)	EMISSION LEVEL (dBuV/m)	LIMIT (dBuV/m)	MARGIN (dB)	ANTENNA HEIGHT (m)	TABLE ANGLE (Degree)	RAW VALUE (dBuV)	CORRECTION FACTOR (dB/m)
1	*5755.00	112.0 PK			1.11 H	136	108.4	3.6
2	*5755.00	102.7 AV			1.11 H	136	99.1	3.6
3	11510.00	48.4 PK	74.0	-25.6	1.39 H	237	34.6	13.8
4	11510.00	41.0 AV	54.0	-13.0	1.39 H	237	27.2	13.8
5	#17265.00	51.5 PK	68.2	-16.7	1.57 H	338	34.4	17.1

ANTENNA POLARITY & TEST DISTANCE: VERTICAL AT 3 M

NO.	FREQ. (MHz)	EMISSION LEVEL (dBuV/m)	LIMIT (dBuV/m)	MARGIN (dB)	ANTENNA HEIGHT (m)	TABLE ANGLE (Degree)	RAW VALUE (dBuV)	CORRECTION FACTOR (dB/m)
1	*5755.00	117.7 PK			3.06 V	287	114.1	3.6
2	*5755.00	109.2 AV			3.06 V	287	105.6	3.6
3	11510.00	50.9 PK	74.0	-23.1	1.00 V	93	37.1	13.8
4	11510.00	45.4 AV	54.0	-8.6	1.00 V	93	31.6	13.8
5	#17265.00	53.8 PK	68.2	-14.4	1.27 V	331	36.7	17.1

REMARKS:

1. Emission Level(dBuV/m) = Raw Value(dBuV) + Correction Factor(dB/m)
2. Correction Factor(dB/m) = Antenna Factor(dB/m) + Cable Factor(dB) – Pre-Amplifier Factor(dB)
3. The other emission levels were very low against the limit.
4. Margin value = Emission Level – Limit value
5. " * ": Fundamental frequency.
6. " # ": The radiated frequency is out of the restricted band.

CHANNEL	TX Channel 159	DETECTOR FUNCTION	Peak (PK)
FREQUENCY RANGE	1GHz ~ 40GHz		Average (AV)

ANTENNA POLARITY & TEST DISTANCE: HORIZONTAL AT 3 M

NO.	FREQ. (MHz)	EMISSION LEVEL (dBuV/m)	LIMIT (dBuV/m)	MARGIN (dB)	ANTENNA HEIGHT (m)	TABLE ANGLE (Degree)	RAW VALUE (dBuV)	CORRECTION FACTOR (dB/m)
1	*5795.00	112.4 PK			1.25 H	138	108.8	3.6
2	*5795.00	103.0 AV			1.25 H	138	99.4	3.6
3	11590.00	47.8 PK	74.0	-26.2	1.37 H	241	34.2	13.6
4	11590.00	40.6 AV	54.0	-13.4	1.37 H	241	27.0	13.6
5	#17385.00	51.4 PK	68.2	-16.8	1.53 H	346	33.5	17.9

ANTENNA POLARITY & TEST DISTANCE: VERTICAL AT 3 M

NO.	FREQ. (MHz)	EMISSION LEVEL (dBuV/m)	LIMIT (dBuV/m)	MARGIN (dB)	ANTENNA HEIGHT (m)	TABLE ANGLE (Degree)	RAW VALUE (dBuV)	CORRECTION FACTOR (dB/m)
1	*5795.00	117.9 PK			2.95 V	274	114.3	3.6
2	*5795.00	109.3 AV			2.95 V	274	105.7	3.6
3	11590.00	50.6 PK	74.0	-23.4	1.00 V	81	37.0	13.6
4	11590.00	45.6 AV	54.0	-8.4	1.00 V	81	32.0	13.6
5	#17385.00	53.8 PK	68.2	-14.4	1.25 V	324	35.9	17.9

REMARKS:

1. Emission Level(dBuV/m) = Raw Value(dBuV) + Correction Factor(dB/m)
2. Correction Factor(dB/m) = Antenna Factor(dB/m) + Cable Factor(dB) – Pre-Amplifier Factor(dB)
3. The other emission levels were very low against the limit.
4. Margin value = Emission Level – Limit value
5. " * ": Fundamental frequency.
6. " # ": The radiated frequency is out of the restricted band.

802.11ax (HE80)

CHANNEL	TX Channel 42	DETECTOR FUNCTION	Peak (PK)
FREQUENCY RANGE	1GHz ~ 40GHz		Average (AV)

ANTENNA POLARITY & TEST DISTANCE: HORIZONTAL AT 3 M

NO.	FREQ. (MHz)	EMISSION LEVEL (dBuV/m)	LIMIT (dBuV/m)	MARGIN (dB)	ANTENNA HEIGHT (m)	TABLE ANGLE (Degree)	RAW VALUE (dBuV)	CORRECTION FACTOR (dB/m)
1	5150.00	56.5 PK	74.0	-17.5	3.85 H	188	53.5	3.0
2	5150.00	46.7 AV	54.0	-7.3	3.85 H	188	43.7	3.0
3	*5210.00	99.2 PK			3.85 H	188	96.4	2.8
4	*5210.00	90.1 AV			3.85 H	188	87.3	2.8
5	5350.00	52.7 PK	74.0	-21.3	3.85 H	188	49.9	2.8
6	5350.00	41.2 AV	54.0	-12.8	3.85 H	188	38.4	2.8
7	#10420.00	44.8 PK	68.2	-23.4	1.39 H	249	31.7	13.1
8	15630.00	46.7 PK	74.0	-27.3	1.59 H	318	33.9	12.8
9	15630.00	35.2 AV	54.0	-18.8	1.59 H	318	22.4	12.8

ANTENNA POLARITY & TEST DISTANCE: VERTICAL AT 3 M

NO.	FREQ. (MHz)	EMISSION LEVEL (dBuV/m)	LIMIT (dBuV/m)	MARGIN (dB)	ANTENNA HEIGHT (m)	TABLE ANGLE (Degree)	RAW VALUE (dBuV)	CORRECTION FACTOR (dB/m)
1	5150.00	62.9 PK	74.0	-11.1	2.78 V	194	59.9	3.0
2	5150.00	53.5 AV	54.0	-0.5	2.78 V	194	50.5	3.0
3	*5210.00	107.4 PK			2.78 V	194	104.6	2.8
4	*5210.00	98.2 AV			2.78 V	194	95.4	2.8
5	5350.00	54.6 PK	74.0	-19.4	2.78 V	194	51.8	2.8
6	5350.00	42.9 AV	54.0	-11.1	2.78 V	194	40.1	2.8
7	#10420.00	49.3 PK	68.2	-18.9	1.21 V	112	36.2	13.1
8	15630.00	46.8 PK	74.0	-27.2	1.45 V	333	34.0	12.8
9	15630.00	35.6 AV	54.0	-18.4	1.45 V	333	22.8	12.8

REMARKS:

1. Emission Level(dBuV/m) = Raw Value(dBuV) + Correction Factor(dB/m)
2. Correction Factor(dB/m) = Antenna Factor(dB/m) + Cable Factor(dB) – Pre-Amplifier Factor(dB)
3. The other emission levels were very low against the limit.
4. Margin value = Emission Level – Limit value
5. " * ": Fundamental frequency.
6. " # ": The radiated frequency is out of the restricted band.

CHANNEL	TX Channel 58	DETECTOR FUNCTION	Peak (PK)
FREQUENCY RANGE	1GHz ~ 40GHz		Average (AV)

ANTENNA POLARITY & TEST DISTANCE: HORIZONTAL AT 3 M

NO.	FREQ. (MHz)	EMISSION LEVEL (dBuV/m)	LIMIT (dBuV/m)	MARGIN (dB)	ANTENNA HEIGHT (m)	TABLE ANGLE (Degree)	RAW VALUE (dBuV)	CORRECTION FACTOR (dB/m)
1	5150.00	52.8 PK	74.0	-21.2	3.92 H	216	49.8	3.0
2	5150.00	41.3 AV	54.0	-12.7	3.92 H	216	38.3	3.0
3	*5290.00	98.7 PK			3.92 H	216	96.1	2.6
4	*5290.00	89.3 AV			3.92 H	216	86.7	2.6
5	5350.00	56.3 PK	74.0	-17.7	3.92 H	216	53.5	2.8
6	5350.00	46.5 AV	54.0	-7.5	3.92 H	216	43.7	2.8
7	#10580.00	45.2 PK	68.2	-23.0	1.33 H	251	32.0	13.2
8	15870.00	46.4 PK	74.0	-27.6	1.57 H	323	33.7	12.7
9	15870.00	35.0 AV	54.0	-19.0	1.57 H	323	22.3	12.7

ANTENNA POLARITY & TEST DISTANCE: VERTICAL AT 3 M

NO.	FREQ. (MHz)	EMISSION LEVEL (dBuV/m)	LIMIT (dBuV/m)	MARGIN (dB)	ANTENNA HEIGHT (m)	TABLE ANGLE (Degree)	RAW VALUE (dBuV)	CORRECTION FACTOR (dB/m)
1	5150.00	55.0 PK	74.0	-19.0	2.62 V	196	52.0	3.0
2	5150.00	42.4 AV	54.0	-11.6	2.62 V	196	39.4	3.0
3	*5290.00	106.7 PK			2.62 V	196	104.1	2.6
4	*5290.00	97.3 AV			2.62 V	196	94.7	2.6
5	5350.00	63.1 PK	74.0	-10.9	2.62 V	196	60.3	2.8
6	5350.00	53.7 AV	54.0	-0.3	2.62 V	196	50.9	2.8
7	#10580.00	49.5 PK	68.2	-18.7	1.19 V	120	36.3	13.2
8	15870.00	47.7 PK	74.0	-26.3	1.42 V	333	35.0	12.7
9	15870.00	36.4 AV	54.0	-17.6	1.42 V	333	23.7	12.7

REMARKS:

1. Emission Level(dBuV/m) = Raw Value(dBuV) + Correction Factor(dB/m)
2. Correction Factor(dB/m) = Antenna Factor(dB/m) + Cable Factor(dB) – Pre-Amplifier Factor(dB)
3. The other emission levels were very low against the limit.
4. Margin value = Emission Level – Limit value
5. " * ": Fundamental frequency.
6. " # ": The radiated frequency is out of the restricted band.

CHANNEL	TX Channel 106	DETECTOR FUNCTION	Peak (PK)
FREQUENCY RANGE	1GHz ~ 40GHz		Average (AV)

ANTENNA POLARITY & TEST DISTANCE: HORIZONTAL AT 3 M

NO.	FREQ. (MHz)	EMISSION LEVEL (dBuV/m)	LIMIT (dBuV/m)	MARGIN (dB)	ANTENNA HEIGHT (m)	TABLE ANGLE (Degree)	RAW VALUE (dBuV)	CORRECTION FACTOR (dB/m)
1	5460.00	54.6 PK	74.0	-19.4	3.85 H	214	51.5	3.1
2	5460.00	42.7 AV	54.0	-11.3	3.85 H	214	39.6	3.1
3	#5470.00	59.7 PK	68.2	-8.5	3.85 H	214	56.6	3.1
4	*5530.00	99.8 PK			3.85 H	214	96.6	3.2
5	*5530.00	90.2 AV			3.85 H	214	87.0	3.2
6	#5725.00	52.4 PK	68.2	-15.8	3.85 H	214	48.9	3.5
7	11060.00	45.0 PK	74.0	-29.0	1.37 H	235	31.4	13.6
8	11060.00	38.3 AV	54.0	-15.7	1.37 H	235	24.7	13.6
9	#16590.00	45.8 PK	68.2	-22.4	1.52 H	330	30.9	14.9

ANTENNA POLARITY & TEST DISTANCE: VERTICAL AT 3 M

NO.	FREQ. (MHz)	EMISSION LEVEL (dBuV/m)	LIMIT (dBuV/m)	MARGIN (dB)	ANTENNA HEIGHT (m)	TABLE ANGLE (Degree)	RAW VALUE (dBuV)	CORRECTION FACTOR (dB/m)
1	5460.00	64.4 PK	74.0	-9.6	2.35 V	236	61.3	3.1
2	5460.00	50.5 AV	54.0	-3.5	2.35 V	236	47.4	3.1
3	#5470.00	67.6 PK	68.2	-0.6	2.35 V	236	64.5	3.1
4	*5530.00	107.6 PK			2.35 V	236	104.4	3.2
5	*5530.00	98.0 AV			2.35 V	236	94.8	3.2
6	#5725.00	52.5 PK	68.2	-15.7	2.35 V	236	49.0	3.5
7	11060.00	49.8 PK	74.0	-24.2	1.19 V	136	36.2	13.6
8	11060.00	43.4 AV	54.0	-10.6	1.19 V	136	29.8	13.6
9	#16590.00	47.0 PK	68.2	-21.2	1.40 V	341	32.1	14.9

REMARKS:

1. Emission Level(dBuV/m) = Raw Value(dBuV) + Correction Factor(dB/m)
2. Correction Factor(dB/m) = Antenna Factor(dB/m) + Cable Factor(dB) – Pre-Amplifier Factor(dB)
3. The other emission levels were very low against the limit.
4. Margin value = Emission Level – Limit value
5. " * ": Fundamental frequency.
6. " # ": The radiated frequency is out of the restricted band.

CHANNEL	TX Channel 122	DETECTOR FUNCTION	Peak (PK)
FREQUENCY RANGE	1GHz ~ 40GHz		Average (AV)

ANTENNA POLARITY & TEST DISTANCE: HORIZONTAL AT 3 M

NO.	FREQ. (MHz)	EMISSION LEVEL (dBuV/m)	LIMIT (dBuV/m)	MARGIN (dB)	ANTENNA HEIGHT (m)	TABLE ANGLE (Degree)	RAW VALUE (dBuV)	CORRECTION FACTOR (dB/m)
1	*5610.00	100.8 PK			3.88 H	195	97.4	3.4
2	*5610.00	91.6 AV			3.88 H	195	88.2	3.4
3	#5725.00	56.0 PK	68.2	-12.2	3.88 H	195	52.5	3.5
4	11220.00	45.0 PK	74.0	-29.0	1.30 H	256	31.6	13.4
5	11220.00	38.6 AV	54.0	-15.4	1.30 H	256	25.2	13.4
6	#16830.00	47.0 PK	68.2	-21.2	1.59 H	338	30.3	16.7

ANTENNA POLARITY & TEST DISTANCE: VERTICAL AT 3 M

NO.	FREQ. (MHz)	EMISSION LEVEL (dBuV/m)	LIMIT (dBuV/m)	MARGIN (dB)	ANTENNA HEIGHT (m)	TABLE ANGLE (Degree)	RAW VALUE (dBuV)	CORRECTION FACTOR (dB/m)
1	*5610.00	108.8 PK			2.40 V	237	105.4	3.4
2	*5610.00	99.6 AV			2.40 V	237	96.2	3.4
3	#5725.00	63.8 PK	68.2	-4.4	2.40 V	237	60.3	3.5
4	11220.00	49.6 PK	74.0	-24.4	1.15 V	124	36.2	13.4
5	11220.00	43.6 AV	54.0	-10.4	1.15 V	124	30.2	13.4
6	#16830.00	46.9 PK	68.2	-21.3	1.41 V	314	30.2	16.7

REMARKS:

1. Emission Level(dBuV/m) = Raw Value(dBuV) + Correction Factor(dB/m)
2. Correction Factor(dB/m) = Antenna Factor(dB/m) + Cable Factor(dB) – Pre-Amplifier Factor(dB)
3. The other emission levels were very low against the limit.
4. Margin value = Emission Level – Limit value
5. " * ": Fundamental frequency.
6. " # ": The radiated frequency is out of the restricted band.

CHANNEL	TX Channel 138	DETECTOR FUNCTION	Peak (PK)
FREQUENCY RANGE	1GHz ~ 40GHz		Average (AV)

ANTENNA POLARITY & TEST DISTANCE: HORIZONTAL AT 3 M

NO.	FREQ. (MHz)	EMISSION LEVEL (dBuV/m)	LIMIT (dBuV/m)	MARGIN (dB)	ANTENNA HEIGHT (m)	TABLE ANGLE (Degree)	RAW VALUE (dBuV)	CORRECTION FACTOR (dB/m)
1	5460.00	52.6 PK	74.0	-21.4	3.82 H	202	49.5	3.1
2	5460.00	41.0 AV	54.0	-13.0	3.82 H	202	37.9	3.1
3	#5470.00	52.6 PK	68.2	-15.6	3.82 H	202	49.5	3.1
4	*5690.00	101.3 PK			3.82 H	202	97.7	3.6
5	*5690.00	92.0 AV			3.82 H	202	88.4	3.6
6	#5850.00	53.4 PK	68.2	-14.8	3.82 H	202	49.5	3.9
7	11380.00	44.3 PK	74.0	-29.7	1.38 H	239	30.6	13.7
8	11380.00	38.0 AV	54.0	-16.0	1.38 H	239	24.3	13.7
9	#17070.00	46.8 PK	68.2	-21.4	1.61 H	340	30.4	16.4

ANTENNA POLARITY & TEST DISTANCE: VERTICAL AT 3 M

NO.	FREQ. (MHz)	EMISSION LEVEL (dBuV/m)	LIMIT (dBuV/m)	MARGIN (dB)	ANTENNA HEIGHT (m)	TABLE ANGLE (Degree)	RAW VALUE (dBuV)	CORRECTION FACTOR (dB/m)
1	5460.00	57.6 PK	74.0	-16.4	2.36 V	213	54.5	3.1
2	5460.00	44.2 AV	54.0	-9.8	2.36 V	213	41.1	3.1
3	#5470.00	57.4 PK	68.2	-10.8	2.36 V	213	54.3	3.1
4	*5690.00	109.3 PK			2.36 V	213	105.7	3.6
5	*5690.00	100.0 AV			2.36 V	213	96.4	3.6
6	#5850.00	59.4 PK	68.2	-8.8	2.36 V	213	55.5	3.9
7	11380.00	50.3 PK	74.0	-23.7	1.09 V	140	36.6	13.7
8	11380.00	44.0 AV	54.0	-10.0	1.09 V	140	30.3	13.7
9	#17070.00	46.9 PK	68.2	-21.3	1.39 V	330	30.5	16.4

REMARKS:

1. Emission Level(dBuV/m) = Raw Value(dBuV) + Correction Factor(dB/m)
2. Correction Factor(dB/m) = Antenna Factor(dB/m) + Cable Factor(dB) – Pre-Amplifier Factor(dB)
3. The other emission levels were very low against the limit.
4. Margin value = Emission Level – Limit value
5. " * ": Fundamental frequency.
6. " # ": The radiated frequency is out of the restricted band.

CHANNEL	TX Channel 155	DETECTOR FUNCTION	Peak (PK)
FREQUENCY RANGE	1GHz ~ 40GHz		Average (AV)

ANTENNA POLARITY & TEST DISTANCE: HORIZONTAL AT 3 M

NO.	FREQ. (MHz)	EMISSION LEVEL (dBuV/m)	LIMIT (dBuV/m)	MARGIN (dB)	ANTENNA HEIGHT (m)	TABLE ANGLE (Degree)	RAW VALUE (dBuV)	CORRECTION FACTOR (dB/m)
1	*5775.00	107.4 PK			1.11 H	129	103.8	3.6
2	*5775.00	98.1 AV			1.11 H	129	94.5	3.6
3	11550.00	48.4 PK	74.0	-25.6	1.40 H	232	34.8	13.6
4	11550.00	41.0 AV	54.0	-13.0	1.40 H	232	27.4	13.6
5	#17325.00	51.7 PK	68.2	-16.5	1.50 H	356	34.3	17.4

ANTENNA POLARITY & TEST DISTANCE: VERTICAL AT 3 M

NO.	FREQ. (MHz)	EMISSION LEVEL (dBuV/m)	LIMIT (dBuV/m)	MARGIN (dB)	ANTENNA HEIGHT (m)	TABLE ANGLE (Degree)	RAW VALUE (dBuV)	CORRECTION FACTOR (dB/m)
1	*5775.00	113.2 PK			3.01 V	287	109.6	3.6
2	*5775.00	104.4 AV			3.01 V	287	100.8	3.6
3	11550.00	50.6 PK	74.0	-23.4	1.06 V	91	37.0	13.6
4	11550.00	45.2 AV	54.0	-8.8	1.06 V	91	31.6	13.6
5	#17325.00	53.6 PK	68.2	-14.6	1.35 V	348	36.2	17.4

REMARKS:

1. Emission Level(dBuV/m) = Raw Value(dBuV) + Correction Factor(dB/m)
2. Correction Factor(dB/m) = Antenna Factor(dB/m) + Cable Factor(dB) – Pre-Amplifier Factor(dB)
3. The other emission levels were very low against the limit.
4. Margin value = Emission Level – Limit value
5. " * ": Fundamental frequency.
6. " # ": The radiated frequency is out of the restricted band.

802.11ax (HE160)

CHANNEL	TX Channel 50	DETECTOR FUNCTION	Peak (PK)
FREQUENCY RANGE	1GHz ~ 40GHz		Average (AV)

ANTENNA POLARITY & TEST DISTANCE: HORIZONTAL AT 3 M

NO.	FREQ. (MHz)	EMISSION LEVEL (dBuV/m)	LIMIT (dBuV/m)	MARGIN (dB)	ANTENNA HEIGHT (m)	TABLE ANGLE (Degree)	RAW VALUE (dBuV)	CORRECTION FACTOR (dB/m)
1	5150.00	58.5 PK	74.0	-15.5	3.83 H	189	55.5	3.0
2	5150.00	47.1 AV	54.0	-6.9	3.83 H	189	44.1	3.0
3	*5250.00	98.0 PK			3.83 H	189	95.6	2.4
4	*5250.00	89.5 AV			3.83 H	189	87.1	2.4
5	5350.00	62.2 PK	74.0	-11.8	3.83 H	189	59.4	2.8
6	5350.00	51.3 AV	54.0	-2.7	3.83 H	189	48.5	2.8
7	#10500.00	45.1 PK	68.2	-23.1	1.35 H	239	31.8	13.3
8	15750.00	47.2 PK	74.0	-26.8	1.53 H	320	34.7	12.5
9	15750.00	35.6 AV	54.0	-18.4	1.53 H	320	23.1	12.5

ANTENNA POLARITY & TEST DISTANCE: VERTICAL AT 3 M

NO.	FREQ. (MHz)	EMISSION LEVEL (dBuV/m)	LIMIT (dBuV/m)	MARGIN (dB)	ANTENNA HEIGHT (m)	TABLE ANGLE (Degree)	RAW VALUE (dBuV)	CORRECTION FACTOR (dB/m)
1	5150.00	64.1 PK	74.0	-9.9	3.22 V	309	61.1	3.0
2	5150.00	53.7 AV	54.0	-0.3	3.22 V	309	50.7	3.0
3	*5250.00	105.8 PK			3.22 V	309	103.4	2.4
4	*5250.00	97.3 AV			3.22 V	309	94.9	2.4
5	5350.00	62.7 PK	74.0	-11.3	3.22 V	309	59.9	2.8
6	5350.00	51.8 AV	54.0	-2.2	3.22 V	309	49.0	2.8
7	#10500.00	50.1 PK	68.2	-18.1	1.19 V	124	36.8	13.3
8	15750.00	47.2 PK	74.0	-26.8	1.41 V	331	34.7	12.5
9	15750.00	36.1 AV	54.0	-17.9	1.41 V	331	23.6	12.5

REMARKS:

1. Emission Level(dBuV/m) = Raw Value(dBuV) + Correction Factor(dB/m)
2. Correction Factor(dB/m) = Antenna Factor(dB/m) + Cable Factor(dB) – Pre-Amplifier Factor(dB)
3. The other emission levels were very low against the limit.
4. Margin value = Emission Level – Limit value
5. " * ": Fundamental frequency.
6. " # ": The radiated frequency is out of the restricted band.

CHANNEL	TX Channel 114	DETECTOR FUNCTION	Peak (PK)
FREQUENCY RANGE	1GHz ~ 40GHz		Average (AV)

ANTENNA POLARITY & TEST DISTANCE: HORIZONTAL AT 3 M

NO.	FREQ. (MHz)	EMISSION LEVEL (dBuV/m)	LIMIT (dBuV/m)	MARGIN (dB)	ANTENNA HEIGHT (m)	TABLE ANGLE (Degree)	RAW VALUE (dBuV)	CORRECTION FACTOR (dB/m)
1	5460.00	58.7 PK	74.0	-15.3	3.91 H	194	55.6	3.1
2	5460.00	47.2 AV	54.0	-6.8	3.91 H	194	44.1	3.1
3	#5470.00	62.5 PK	68.2	-5.7	3.91 H	194	59.4	3.1
4	*5570.00	98.7 PK			3.91 H	194	95.4	3.3
5	*5570.00	90.3 AV			3.91 H	194	87.0	3.3
6	#5725.00	61.6 PK	68.2	-6.6	3.91 H	194	58.1	3.5
7	11140.00	44.8 PK	74.0	-29.2	1.41 H	240	31.5	13.3
8	11140.00	38.3 AV	54.0	-15.7	1.41 H	240	25.0	13.3
9	#16710.00	46.3 PK	68.2	-21.9	1.61 H	321	29.9	16.4

ANTENNA POLARITY & TEST DISTANCE: VERTICAL AT 3 M

NO.	FREQ. (MHz)	EMISSION LEVEL (dBuV/m)	LIMIT (dBuV/m)	MARGIN (dB)	ANTENNA HEIGHT (m)	TABLE ANGLE (Degree)	RAW VALUE (dBuV)	CORRECTION FACTOR (dB/m)
1	5460.00	67.3 PK	74.0	-6.7	2.38 V	235	64.2	3.1
2	5460.00	53.9 AV	54.0	-0.1	2.38 V	235	50.8	3.1
3	#5470.00	67.9 PK	68.2	-0.3	2.38 V	235	64.8	3.1
4	*5570.00	106.6 PK			2.38 V	235	103.3	3.3
5	*5570.00	98.2 AV			2.38 V	235	94.9	3.3
6	#5725.00	61.8 PK	68.2	-6.4	2.38 V	235	58.3	3.5
7	11140.00	49.3 PK	74.0	-24.7	1.12 V	118	36.0	13.3
8	11140.00	43.0 AV	54.0	-11.0	1.12 V	118	29.7	13.3
9	#16710.00	47.0 PK	68.2	-21.2	1.44 V	317	30.6	16.4

REMARKS:

1. Emission Level(dBuV/m) = Raw Value(dBuV) + Correction Factor(dB/m)
2. Correction Factor(dB/m) = Antenna Factor(dB/m) + Cable Factor(dB) – Pre-Amplifier Factor(dB)
3. The other emission levels were very low against the limit.
4. Margin value = Emission Level – Limit value
5. " * ": Fundamental frequency.
6. " # ": The radiated frequency is out of the restricted band.

Below 1GHz Data:

802.11a

CHANNEL	TX Channel 157	DETECTOR FUNCTION	Quasi-Peak (QP)
FREQUENCY RANGE	9kHz ~ 1GHz		

ANTENNA POLARITY & TEST DISTANCE: HORIZONTAL AT 3 M

NO.	FREQ. (MHz)	EMISSION LEVEL (dBuV/m)	LIMIT (dBuV/m)	MARGIN (dB)	ANTENNA HEIGHT (m)	TABLE ANGLE (Degree)	RAW VALUE (dBuV)	CORRECTION FACTOR (dB/m)
1	33.10	26.5 QP	40.0	-13.5	1.00 H	317	36.1	-9.6
2	94.36	28.3 QP	43.5	-15.2	2.00 H	64	41.2	-12.9
3	143.27	27.6 QP	43.5	-15.9	2.00 H	82	35.7	-8.1
4	223.44	28.9 QP	46.0	-17.1	2.00 H	0	39.2	-10.3
5	308.73	25.9 QP	46.0	-20.1	1.00 H	104	32.8	-6.9
6	952.08	34.2 QP	46.0	-11.8	1.00 H	152	27.9	6.3

REMARKS:

1. Emission Level(dBuV/m) = Raw Value(dBuV) + Correction Factor(dB/m)
2. Correction Factor(dB/m) = Antenna Factor(dB/m) + Cable Factor(dB) – Pre-Amplifier Factor(dB)
3. Margin value = Emission Level – Limit value
4. The emission levels were very low against the limit of frequency range 9kHz~30MHz: the amplitude of spurious emissions attenuated more than 20 dB below the permissible value to be report.

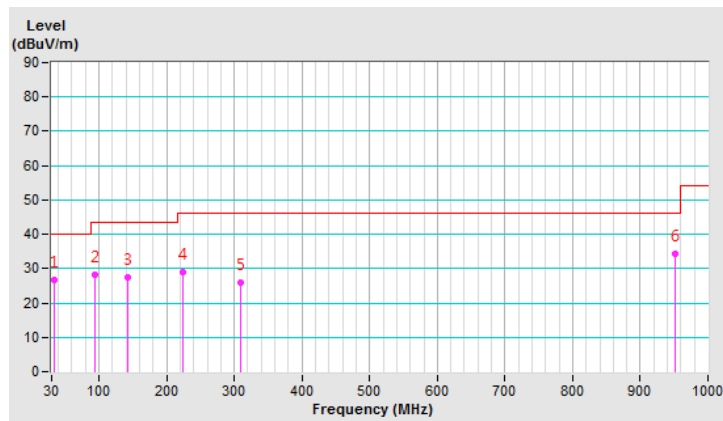

CHANNEL	TX Channel 157	DETECTOR FUNCTION	Quasi-Peak (QP)
FREQUENCY RANGE	9kHz ~ 1GHz		

ANTENNA POLARITY & TEST DISTANCE: VERTICAL AT 3 M

NO.	FREQ. (MHz)	EMISSION LEVEL (dBuV/m)	LIMIT (dBuV/m)	MARGIN (dB)	ANTENNA HEIGHT (m)	TABLE ANGLE (Degree)	RAW VALUE (dBuV)	CORRECTION FACTOR (dB/m)
1	40.33	32.8 QP	40.0	-7.2	1.00 V	243	41.4	-8.6
2	71.44	29.6 QP	40.0	-10.4	2.00 V	360	40.4	-10.8
3	143.30	27.5 QP	43.5	-16.0	1.00 V	47	35.6	-8.1
4	301.02	24.0 QP	46.0	-22.0	1.50 V	18	31.1	-7.1
5	403.52	27.1 QP	46.0	-18.9	1.50 V	284	31.4	-4.3
6	909.57	33.9 QP	46.0	-12.1	1.00 V	360	28.0	5.9

REMARKS:

1. Emission Level(dBuV/m) = Raw Value(dBuV) + Correction Factor(dB/m)
2. Correction Factor(dB/m) = Antenna Factor(dB/m) + Cable Factor(dB) – Pre-Amplifier Factor(dB)
3. Margin value = Emission Level – Limit value
4. The emission levels were very low against the limit of frequency range 9kHz~30MHz: the amplitude of spurious emissions attenuated more than 20 dB below the permissible value to be report.

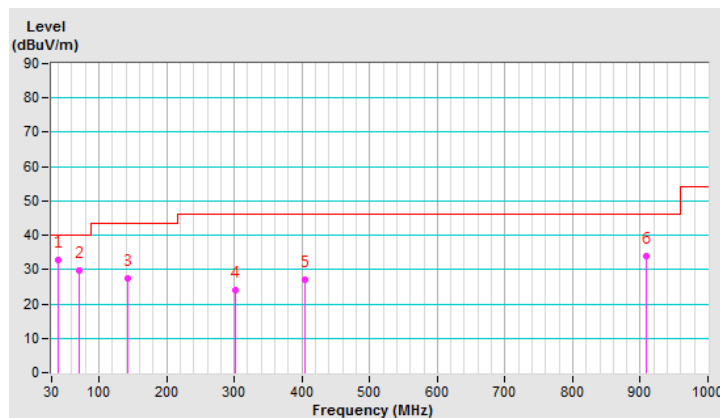

4.2 Conducted Emission Measurement

4.2.1 Limits of Conducted Emission Measurement

Frequency (MHz)	Conducted Limit (dBuV)	
	Quasi-peak	Average
0.15 - 0.5	66 - 56	56 - 46
0.50 - 5.0	56	46
5.0 - 30.0	60	50

Note: 1. The lower limit shall apply at the transition frequencies.

2. The limit decreases in line with the logarithm of the frequency in the range of 0.15 to 0.50MHz.

4.2.2 Test Instruments

DESCRIPTION & MANUFACTURER	MODEL NO.	SERIAL NO.	CALIBRATED DATE	CALIBRATED UNTIL
Test Receiver R&S	ESCS 30	847124/029	Oct. 24, 2018	Oct. 23, 2019
Line-Impedance Stabilization Network (for EUT) R&S	ESH3-Z5	848773/004	Oct. 22, 2018	Oct. 21, 2019
Line-Impedance Stabilization Network (for Peripheral) R&S	ENV216	100072	June 04, 2018	June 03, 2019
50 ohms Terminator	N/A	3	Oct. 22, 2018	Oct. 21, 2019
RF Cable	5D-FB	COCCAB-001	Sep. 28, 2018	Sep. 27, 2019
Fixed attenuator EMCI	STI02-2200-10	003	Mar. 16, 2018	Mar. 15, 2019
Software BVADT	BVADT_Cond_ V7.3.7.4	NA	NA	NA

Note:

1. The calibration interval of the above test instruments are 12 months and the calibrations are traceable to NML/ROC and NIST/USA.
2. The test was performed in Conduction 1.
3. Tested Date: Jan. 08, 2019

4.2.3 Test Procedure

- The EUT was placed 0.4 meters from the conducting wall of the shielded room with EUT being connected to the power mains through a line impedance stabilization network (LISN). Other support units were connected to the power mains through another LISN. The two LISNs provide 50 ohm/ 50uH of coupling impedance for the measuring instrument.
- Both lines of the power mains connected to the EUT were checked for maximum conducted interference.
- The frequency range from 150kHz to 30MHz was searched. Emission levels under (Limit - 20dB) was not recorded.

Note: All modes of operation were investigated and the worst-case emissions are reported.

4.2.4 Deviation from Test Standard

No deviation.

4.2.5 Test Setup

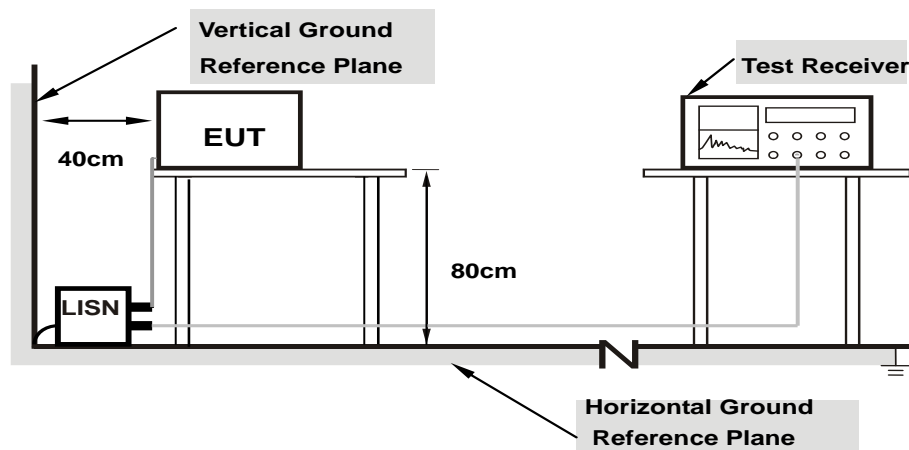

Note: 1.Support units were connected to second LISN.

For the actual test configuration, please refer to the attached file (Test Setup Photo).

4.2.6 EUT Operating Condition

Same as 4.1.6.

4.2.7 Test Results

Phase	Line (L)	Detector Function	Quasi-Peak (QP) / Average (AV)
-------	----------	-------------------	--------------------------------

No	Freq. [MHz]	Corr. Factor	Reading Value [dB (uV)]		Emission Level [dB (uV)]		Limit [dB (uV)]		Margin (dB)	
		(dB)	Q.P.	AV.	Q.P.	AV.	Q.P.	AV.	Q.P.	AV.
	1	0.15391	10.03	34.65	18.09	44.68	28.12	65.79	55.79	-21.11
2	0.16953	10.04	40.22	28.78	50.26	38.82	64.98	54.98	-14.72	-16.16
3	0.22422	10.05	32.18	21.85	42.23	31.90	62.66	52.66	-20.43	-20.76
4	0.40781	10.08	31.27	27.78	41.35	37.86	57.69	47.69	-16.34	-9.83
5	0.61094	10.10	16.40	11.47	26.50	21.57	56.00	46.00	-29.50	-24.43
6	18.51953	11.26	12.43	7.37	23.69	18.63	60.00	50.00	-36.31	-31.37

Remarks:

1. Q.P. and AV. are abbreviations of quasi-peak and average individually.
2. The emission levels of other frequencies were very low against the limit.
3. Margin value = Emission level – Limit value
4. Correction factor = Insertion loss + Cable loss
5. Emission Level = Correction Factor + Reading Value

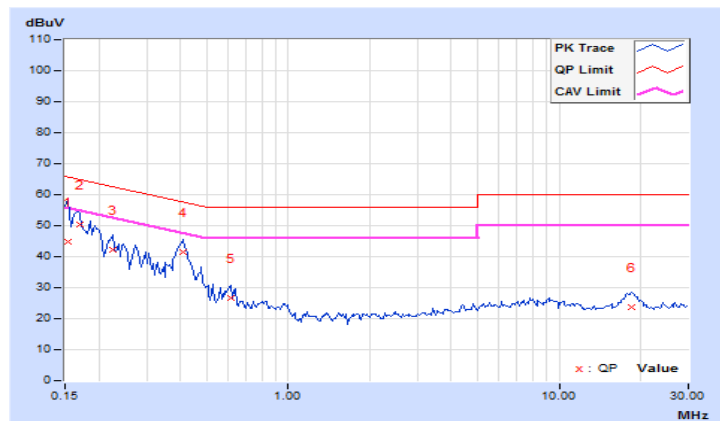

Phase	Neutral (N)	Detector Function	Quasi-Peak (QP) / Average (AV)
-------	-------------	-------------------	--------------------------------

No	Freq. [MHz]	Corr. Factor	Reading Value [dB (uV)]		Emission Level [dB (uV)]		Limit [dB (uV)]		Margin (dB)	
		(dB)	Q.P.	AV.	Q.P.	AV.	Q.P.	AV.	Q.P.	AV.
	1	0.15000	9.94	40.26	20.72	50.20	30.66	66.00	56.00	-15.80
2	0.19297	9.95	37.54	28.17	47.49	38.12	63.91	53.91	-16.42	-15.79
3	0.26328	9.96	26.94	16.50	36.90	26.46	61.33	51.33	-24.43	-24.87
4	0.59141	9.99	19.99	14.84	29.98	24.83	56.00	46.00	-26.02	-21.17
5	0.78672	9.99	19.77	15.73	29.76	25.72	56.00	46.00	-26.24	-20.28
6	18.79688	11.07	13.73	9.07	24.80	20.14	60.00	50.00	-35.20	-29.86

Remarks:

1. Q.P. and AV. are abbreviations of quasi-peak and average individually.
2. The emission levels of other frequencies were very low against the limit.
3. Margin value = Emission level – Limit value
4. Correction factor = Insertion loss + Cable loss
5. Emission Level = Correction Factor + Reading Value

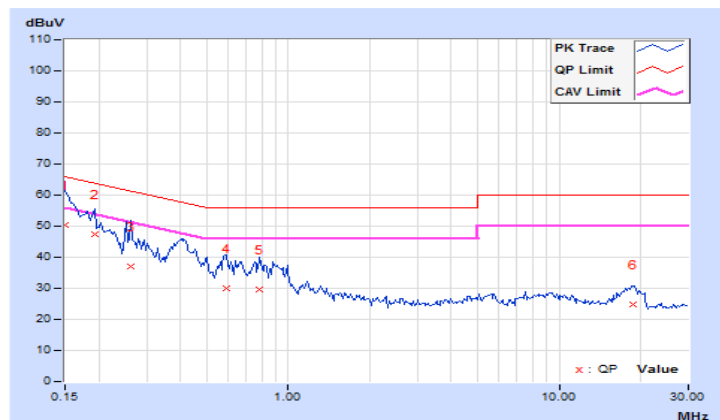

4.3 Transmit Power Measurement

4.3.1 Limits of Transmit Power Measurement

Operation Band	EUT Category		Limit
U-NII-1		Outdoor Access Point	1 Watt (30 dBm) (Max. e.i.r.p \leq 125mW(21 dBm) at any elevation angle above 30 degrees as measured from the horizon)
		Fixed point-to-point Access Point	1 Watt (30 dBm)
	√	Indoor Access Point	1 Watt (30 dBm)
		Client device	250mW (24 dBm)
U-NII-2A	√		250mW (24 dBm) or 11 dBm+10 log B*
U-NII-2C	√		250mW (24 dBm) or 11 dBm+10 log B*
U-NII-3	√		1 Watt (30 dBm)

*B is the 26 dB emission bandwidth in megahertz

Per KDB 662911 Method of conducted output power measurement on IEEE 802.11 devices,

Array Gain = 0 dB (i.e., no array gain) for $N_{ANT} \leq 4$;

Array Gain = 0 dB (i.e., no array gain) for channel widths ≥ 40 MHz for any N_{ANT} ;

Array Gain = $5 \log(N_{ANT}/N_{SS})$ dB or 3 dB, whichever is less for 20-MHz channel widths with $N_{ANT} \geq 5$.

For power measurements on all other devices: Array Gain = $10 \log(N_{ANT}/N_{SS})$ dB.

4.3.2 Test Setup

FOR POWER OUTPUT MEASUREMENT

For channel straddling 5725MHz:

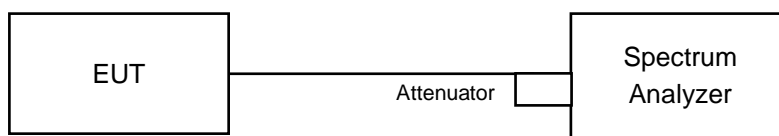

For other channels:

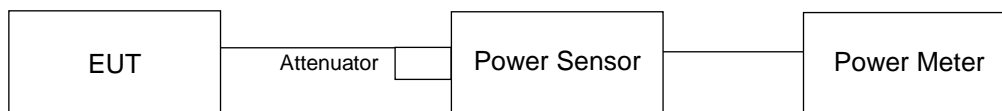

FOR 26dB OCCUPIED BANDWIDTH

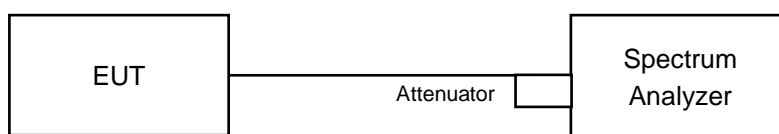

4.3.3 Test Instruments

Refer to section 4.1.2 to get information of above instrument.

4.3.4 Test Procedure

FOR POWER OUTPUT MEASUREMENT

For channel straddling 5725MHz:

For 802.11ac (VHT20), 802.11ax (HE20):

Follow FCC KDB 789033 UNII test procedure:

Method SA-1

1. Set span to encompass the entire emission bandwidth (EBW) of the signal.
2. Set RBW =1MHz.
3. Set the VBW $\geq 3 \times$ RBW.
4. Number of points in sweep ≥ 2 Span / RBW.
5. Sweep time = auto.
6. Set trigger to free run (duty cycle ≥ 98 percent)
7. Detector = RMS.
8. Trace average at least 100 traces in power averaging mode
9. Compute power by integrating the spectrum across the 26 dB EBW of the signal.

For other Modulation test:

Follow FCC KDB 789033 UNII test procedure:

Method SA-2

1. Set span to encompass the emission bandwidth (EBW) of the signal.
2. Set RBW =1MHz.
3. Set the VBW $\geq 3 \times$ RBW.
4. Number of points in sweep ≥ 2 Span / RBW.
5. Sweep time = auto.
6. Detector = RMS.
7. Trace average at least 100 traces in power averaging mode
8. Compute power by integrating the spectrum across the 26 dB EBW of the signal.
9. Duty factor need added to measured value (duty cycle < 98 percent).

For other channels:

Method PM is used to perform output power measurement, trigger and gating function of wide band power meter is enabled to measure max output power of TX on burst. Duty factor is not added to measured value.

FOR 26dB OCCUPIED BANDWIDTH

1. Set RBW = approximately 1% of the emission bandwidth.
2. Set the VBW > RBW.
3. Detector = Peak.
4. Trace mode = max hold.
5. Measure the maximum width of the emission that is 26 dB down from the peak of the emission. Compare this with the RBW setting of the analyzer. Readjust RBW and repeat measurement as needed until the RBW/EBW ratio is approximately 1%.

4.3.5 Deviation from Test Standard

No deviation.

4.3.6 EUT Operating Condition

The software provided by client to enable the EUT under transmission condition continuously at lowest, middle and highest channel frequencies individually.

4.3.7 Test Results

Non-Beamforming Mode

802.11a

Chan.	Chan. Freq. (MHz)	Maximum Conducted Power (dBm)		Total Power (mW)	Total Power (dBm)	Limit (dBm)	Pass / Fail
		Chain 0	Chain 1				
36	5180	23.22	23.42	429.68	26.33	30.00	Pass
40	5200	26.48	26.16	857.679	29.33	30.00	Pass
48	5240	25.14	25.10	650.182	28.13	30.00	Pass
52	5260	20.65	20.26	222.315	23.47	24.00	Pass
60	5300	20.63	20.21	220.565	23.44	24.00	Pass
64	5320	20.75	20.11	221.415	23.45	24.00	Pass
100	5500	20.71	19.80	213.26	23.29	24.00	Pass
116	5580	20.82	20.42	230.935	23.63	24.00	Pass
140	5700	19.64	18.42	161.547	22.08	24.00	Pass
*144 (U-NII-2C Band)	5720	18.13	16.49	112.909	20.53	23.67	Pass
*144 (U-NII-3 Band)	5720	12.08	10.46	28.089	14.49	30.00	Pass
149	5745	27.00	26.16	914.235	29.61	30.00	Pass
157	5785	27.42	25.66	920.206	29.64	30.00	Pass
165	5825	27.28	25.46	886.124	29.47	30.00	Pass

Note: * Test was performed in accordance with Measurement follow FCC KDB 789033 UNII test procedure Method SA-2 and use spectrum analyzer test.

1. The max. gain is 3.38dBi < 6dBi, so the power limit shall not be reduced.

The Total Power for the straddle channel:

Chan.	Chan. Freq. (MHz)	Average Power (mW)	Average Power (dBm)
144	5720	140.998	21.49

Note: The total power was calculated through formula and record the value for reference only.

For Reference only – Power meter value

The power value was measured by power meter with average sensor.

Chan.	Chan. Freq. (MHz)	Average Power (dBm)		Total Power (mW)	Total Power (dBm)
		Chain 0	Chain 1		
144	5720	21.10	20.02	229.287	23.60

Power Limit = 11dBm + 10logB <U-NII-2A, U-NII-2C>			
Channel Number	Freq.(MHz)	Min. B(MHz)	Determined Conducted Limit (dBm)
52	5260	26.93	25.3 > 24
60	5300	27.34	25.36 > 24
64	5320	26.71	25.26 > 24
100	5500	26.96	25.3 > 24
116	5580	27.42	25.38 > 24
140	5700	26.69	25.26 > 24
144 (U-NII-2C Band)	5720	18.53	23.67 < 24

Note: For U-NII-2A, U-NII-2C Band output power limitation is determined based on 26dBc bandwidth

Beamforming Mode

802.11ac (VHT20)

Chan.	Chan. Freq. (MHz)	Maximum Conducted Power (dBm)		Total Power (mW)	Total Power (dBm)	Limit (dBm)	Pass / Fail
		Chain 0	Chain 1				
36	5180	22.83	22.72	378.935	25.79	29.65	Pass
40	5200	26.53	26.35	881.299	29.45	29.65	Pass
48	5240	25.12	25.10	648.681	28.12	29.65	Pass
52	5260	20.27	20.10	208.743	23.20	23.65	Pass
60	5300	20.81	20.14	223.78	23.50	23.65	Pass
64	5320	20.75	20.02	219.312	23.41	23.65	Pass
100	5500	20.90	19.56	213.392	23.29	23.65	Pass
116	5580	20.13	19.50	192.164	22.84	23.65	Pass
140	5700	19.60	18.52	162.322	22.10	23.65	Pass
*144 (U-NII-2C Band)	5720	17.12	16.45	95.68	19.81	23.07	Pass
*144 (U-NII-3 Band)	5720	11.65	10.94	27.039	14.32	29.65	Pass
149	5745	27.00	25.28	838.474	29.23	29.65	Pass
157	5785	27.42	25.50	906.89	29.58	29.65	Pass
165	5825	27.40	25.44	899.486	29.54	29.65	Pass

Note: * Test was performed in accordance with Measurement follow FCC KDB 789033 UNII test procedure Method SA-1 and use spectrum analyzer test.

1. For U-NII-1, U-NII-3: The directional gain is 6.35dBi > 6dBi, so the power limit shall be reduced to $30-(6.35-6) = 29.65\text{dBm}$.
2. For U-NII-2A, U-NII-2C: The directional gain is 6.35dBi > 6dBi, so the power limit shall be reduced to "Determined Conducted Limit- (6.35-6)".

The Total Power for the straddle channel:

Chan.	Chan. Freq. (MHz)	Average Power (mW)	Average Power (dBm)
144	5720	122.719	20.89

Note: The total power was calculated through formula and record the value for reference only.

For Reference only – Power meter value

The power value was measured by power meter with average sensor.

Chan.	Chan. Freq. (MHz)	Average Power (dBm)		Total Power (mW)	Total Power (dBm)
		Chain 0	Chain 1		
144	5720	20.20	19.99	204.483	23.11

Power Limit = 11dBm + 10logB <U-NII-2A, U-NII-2C>			
Channel Number	Freq.(MHz)	Min. B(MHz)	Determined Conducted Limit (dBm)
52	5260	24.84	24.95 > 24
60	5300	25.34	25.03 > 24
64	5320	25.41	25.05 > 24
100	5500	25.40	25.04 > 24
116	5580	25.12	25 > 24
140	5700	25.52	25.06 > 24
144 (U-NII-2C Band)	5720	17.47	23.42 < 24

Note: For U-NII-2A, U-NII-2C Band output power limitation is determined based on 26dBc bandwidth

802.11ac (VHT40)

Chan.	Chan. Freq. (MHz)	Maximum Conducted Power (dBm)		Total Power (mW)	Total Power (dBm)	Limit (dBm)	Pass / Fail
		Chain 0	Chain 1				
38	5190	20.34	19.35	194.242	22.88	29.65	Pass
46	5230	25.68	25.01	686.785	28.37	29.65	Pass
54	5270	20.28	19.58	197.442	22.95	23.65	Pass
62	5310	20.44	19.62	202.284	23.06	23.65	Pass
102	5510	20.39	19.00	188.829	22.76	23.65	Pass
110	5550	20.52	19.50	201.845	23.05	23.65	Pass
134	5670	20.41	19.85	206.506	23.15	23.65	Pass
*142 (U-NII-2C Band)	5710	18.43	17.16	124.327	20.95	23.65	Pass
*142 (U-NII-3 Band)	5710	8.33	6.97	12.043	10.81	29.65	Pass
151	5755	27.16	25.35	862.764	29.36	29.65	Pass
159	5795	27.12	25.27	851.741	29.30	29.65	Pass

Note: * Test was performed in accordance with Measurement follow FCC KDB 789033 UNII test procedure Method SA-2 and use spectrum analyzer test.

1. For U-NII-1, U-NII-3: The directional gain is 6.35dBi > 6dBi, so the power limit shall be reduced to $30-(6.35-6) = 29.65\text{dBm}$.
2. For U-NII-2A, U-NII-2C: The directional gain is 6.35dBi > 6dBi, so the power limit shall be reduced to "Determined Conducted Limit- (6.35-6)".

The Total Power for the straddle channel:

Chan.	Chan. Freq. (MHz)	Average Power (mW)	Average Power (dBm)
142	5710	136.37	21.35

Note: The total power was calculated through formula and record the value for reference only.

For Reference only – Power meter value

The power value was measured by power meter with average sensor.

Chan.	Chan. Freq. (MHz)	Average Power (dBm)		Total Power (mW)	Total Power (dBm)
		Chain 0	Chain 1		
142	5710	21.08	20.00	228.233	23.58

Power Limit = 11dBm + 10logB <U-NII-2A, U-NII-2C>			
Channel Number	Freq.(MHz)	Min. B(MHz)	Determined Conducted Limit (dBm)
54	5270	47.02	27.72 > 24
62	5310	47.33	27.75 > 24
102	5510	47.92	27.8 > 24
110	5550	47.60	27.77 > 24
134	5670	48.57	27.86 > 24
142 (U-NII-2C Band)	5710	39.09	26.92 > 24

Note: For U-NII-2A, U-NII-2C Band output power limitation is determined based on 26dBc bandwidth

802.11ac (VHT80)

Chan.	Chan. Freq. (MHz)	Maximum Conducted Power (dBm)		Total Power (mW)	Total Power (dBm)	Limit (dBm)	Pass / Fail
		Chain 0	Chain 1				
42	5210	20.07	19.38	188.321	22.75	29.65	Pass
58	5290	18.38	17.55	125.75	21.00	23.65	Pass
106	5530	19.22	18.67	157.181	21.96	23.65	Pass
122	5610	20.94	20.25	230.09	23.62	23.65	Pass
*138 (U-NII-2C Band)	5690	17.28	16.09	98.505	19.93	23.65	Pass
*138 (U-NII-3 Band)	5690	3.73	2.07	4.157	6.19	29.65	Pass
155	5775	24.50	23.52	506.743	27.05	29.65	Pass

Note: * Test was performed in accordance with Measurement follow FCC KDB 789033 UNII test procedure Method SA-2 and use spectrum analyzer test.

1. For U-NII-1, U-NII-3: The directional gain is 6.35dBi > 6dBi, so the power limit shall be reduced to $30-(6.35-6) = 29.65\text{dBm}$.
2. For U-NII-2A, U-NII-2C: The directional gain is 6.35dBi > 6dBi, so the power limit shall be reduced to "Determined Conducted Limit- (6.35-6)".

The Total Power for the straddle channel:

Chan.	Chan. Freq. (MHz)	Average Power (mW)	Average Power (dBm)
138	5690	102.662	20.11

Note: The total power was calculated through formula and record the value for reference only.

For Reference only – Power meter value

The power value was measured by power meter with average sensor.

Chan.	Chan. Freq. (MHz)	Average Power (dBm)		Total Power (mW)	Total Power (dBm)
		Chain 0	Chain 1		
138	5690	20.90	20.20	227.74	23.57

Power Limit = 11dBm + 10logB <U-NII-2A, U-NII-2C>			
Channel Number	Freq.(MHz)	Min. B(MHz)	Determined Conducted Limit (dBm)
58	5290	88.02	30.44 > 24
106	5530	87.23	30.4 > 24
122	5610	87.68	30.42 > 24
138 (U-NII-2C Band)	5690	77.75	29.9 > 24

Note: For U-NII-2A, U-NII-2C Band output power limitation is determined based on 26dBc bandwidth

802.11ac (VHT160)

Chan.	Chan. Freq. (MHz)	Maximum Conducted Power (dBm)		Total Power (mW)	Total Power (dBm)	Limit (dBm)	Pass / Fail
		Chain 0	Chain 1				
*50 (U-NII-1 Band)	5250	11.61	12.16	33.583	15.26	29.65	Pass
*50 (U-NII-2A Band)	5250	12.25	12.87	39.251	15.94	23.65	Pass
114	5570	19.57	18.40	159.756	22.03	23.65	Pass

Note: * Test was performed in accordance with Measurement follow FCC KDB 789033 UNII test procedure Method SA-2 and use spectrum analyzer test.

1. For U-NII-1: The directional gain is 6.35dBi > 6dBi, so the power limit shall be reduced to $30 - (6.35 - 6) = 29.65$ dBm.
2. For U-NII-2A, U-NII-2C: The directional gain is 6.35dBi > 6dBi, so the power limit shall be reduced to "Determined Conducted Limit- (6.35-6)".

The Total Power for the straddle channel:

Chan.	Chan. Freq. (MHz)	Average Power (mW)	Average Power (dBm)
50	5250	72.834	18.62

Note: The total power was calculated through formula and record the value for reference only.

For Reference only – Power meter value

The power value was measured by power meter with average sensor.

Chan.	Chan. Freq. (MHz)	Average Power (dBm)		Total Power (mW)	Total Power (dBm)
		Chain 0	Chain 1		
50	5250	18.80	18.10	140.423	21.47

Power Limit = 11dBm + 10logB <U-NII-2A, U-NII-2C>

Channel Number	Freq.(MHz)	Min. B(MHz)	Determined Conducted Limit (dBm)
50 (U-NII-2A Band)	5250	84.74	30.28 > 24
114	5570	167.05	33.22 > 24

Note: For U-NII-2A, U-NII-2C Band output power limitation is determined based on 26dBc bandwidth

802.11ax (HE20)

Chan.	Chan. Freq. (MHz)	Maximum Conducted Power (dBm)		Total Power (mW)	Total Power (dBm)	Limit (dBm)	Pass / Fail
		Chain 0	Chain 1				
36	5180	22.85	22.78	382.423	25.83	29.65	Pass
40	5200	26.56	26.37	886.409	29.48	29.65	Pass
48	5240	25.16	25.12	653.182	28.15	29.65	Pass
52	5260	20.30	20.11	209.717	23.22	23.65	Pass
60	5300	20.84	20.16	225.092	23.52	23.65	Pass
64	5320	20.77	20.04	220.324	23.43	23.65	Pass
100	5500	20.92	19.56	213.96	23.30	23.65	Pass
116	5580	20.16	19.51	193.084	22.86	23.65	Pass
140	5700	19.62	18.53	162.907	22.12	23.65	Pass
*144 (U-NII-2C Band)	5720	16.49	16.22	86.445	19.37	23.07	Pass
*144 (U-NII-3 Band)	5720	11.44	11.17	27.024	14.32	29.65	Pass
149	5745	27.02	25.30	842.345	29.25	29.65	Pass
157	5785	27.45	25.52	912.355	29.60	29.65	Pass
165	5825	27.42	25.48	905.26	29.57	29.65	Pass

Note: * Test was performed in accordance with Measurement follow FCC KDB 789033 UNII test procedure Method SA-1 and use spectrum analyzer test.

1. For U-NII-1, U-NII-3: The directional gain is 6.35dBi > 6dBi, so the power limit shall be reduced to $30-(6.35-6) = 29.65\text{dBm}$.
2. For U-NII-2A, U-NII-2C: The directional gain is 6.35dBi > 6dBi, so the power limit shall be reduced to "Determined Conducted Limit- (6.35-6)".

The Total Power for the straddle channel:

Chan.	Chan. Freq. (MHz)	Average Power (mW)	Average Power (dBm)
144	5720	113.469	20.55

Note: The total power was calculated through formula and record the value for reference only.

For Reference only – Power meter value

The power value was measured by power meter with average sensor.

Chan.	Chan. Freq. (MHz)	Average Power (dBm)		Total Power (mW)	Total Power (dBm)
		Chain 0	Chain 1		
144	5720	20.23	20.00	205.439	23.13

Power Limit = 11dBm + 10logB <U-NII-2A, U-NII-2C>			
Channel Number	Freq.(MHz)	Min. B(MHz)	Determined Conducted Limit (dBm)
52	5260	24.84	24.95 > 24
60	5300	25.34	25.03 > 24
64	5320	25.41	25.05 > 24
100	5500	25.40	25.04 > 24
116	5580	25.12	25 > 24
140	5700	25.52	25.06 > 24
144 (U-NII-2C Band)	5720	17.47	23.42 < 24

Note: For U-NII-2A, U-NII-2C Band output power limitation is determined based on 26dBc bandwidth

802.11ax (HE40)

Chan.	Chan. Freq. (MHz)	Maximum Conducted Power (dBm)		Total Power (mW)	Total Power (dBm)	Limit (dBm)	Pass / Fail
		Chain 0	Chain 1				
38	5190	20.36	19.37	195.14	22.90	29.65	Pass
46	5230	25.70	25.05	691.425	28.40	29.65	Pass
54	5270	20.30	19.60	198.353	22.97	23.65	Pass
62	5310	20.45	19.66	203.387	23.08	23.65	Pass
102	5510	20.41	19.01	189.517	22.78	23.65	Pass
110	5550	20.56	19.52	203.299	23.08	23.65	Pass
134	5670	20.43	19.89	207.907	23.18	23.65	Pass
*142 (U-NII-2C Band)	5710	18.88	16.98	129.94	21.14	23.65	Pass
*142 (U-NII-3 Band)	5710	9.52	7.51	14.909	11.73	29.65	Pass
151	5755	27.19	25.37	867.95	29.38	29.65	Pass
159	5795	27.15	25.30	857.644	29.33	29.65	Pass

Note: * Test was performed in accordance with Measurement follow FCC KDB 789033 UNII test procedure Method SA-2 and use spectrum analyzer test.

1. For U-NII-1, U-NII-3: The directional gain is 6.35dBi > 6dBi, so the power limit shall be reduced to $30-(6.35-6) = 29.65\text{dBm}$.
2. For U-NII-2A, U-NII-2C: The directional gain is 6.35dBi > 6dBi, so the power limit shall be reduced to "Determined Conducted Limit- (6.35-6)".

The Total Power for the straddle channel:

Chan.	Chan. Freq. (MHz)	Average Power (mW)	Average Power (dBm)
142	5710	144.849	21.61

Note: The total power was calculated through formula and record the value for reference only.

For Reference only – Power meter value

The power value was measured by power meter with average sensor.

Chan.	Chan. Freq. (MHz)	Average Power (dBm)		Total Power (mW)	Total Power (dBm)
		Chain 0	Chain 1		
142	5710	21.11	20.02	229.584	23.61

Power Limit = 11dBm + 10logB <U-NII-2A, U-NII-2C>			
Channel Number	Freq.(MHz)	Min. B(MHz)	Determined Conducted Limit (dBm)
54	5270	47.02	27.72 > 24
62	5310	47.33	27.75 > 24
102	5510	47.92	27.8 > 24
110	5550	47.60	27.77 > 24
134	5670	48.57	27.86 > 24
142 (U-NII-2C Band)	5710	39.09	26.92 > 24

Note: For U-NII-2A, U-NII-2C Band output power limitation is determined based on 26dBc bandwidth

802.11ax (HE80)

Chan.	Chan. Freq. (MHz)	Maximum Conducted Power (dBm)		Total Power (mW)	Total Power (dBm)	Limit (dBm)	Pass / Fail
		Chain 0	Chain 1				
42	5210	20.11	19.47	191.077	22.81	29.65	Pass
58	5290	18.40	17.59	126.595	21.02	23.65	Pass
106	5530	19.24	18.71	158.248	21.99	23.65	Pass
122	5610	20.95	20.27	230.865	23.63	23.65	Pass
*138 (U-NII-2C Band)	5690	17.73	17.40	119.595	20.78	23.65	Pass
*138 (U-NII-3 Band)	5690	4.97	4.35	6.138	7.88	29.65	Pass
155	5775	24.60	23.65	520.142	27.16	29.65	Pass

Note: * Test was performed in accordance with Measurement follow FCC KDB 789033 UNII test procedure Method SA-2 and use spectrum analyzer test.

1. For U-NII-1, U-NII-3: The directional gain is 6.35dBi > 6dBi, so the power limit shall be reduced to $30-(6.35-6) = 29.65\text{dBm}$.
2. For U-NII-2A, U-NII-2C: The directional gain is 6.35dBi > 6dBi, so the power limit shall be reduced to "Determined Conducted Limit- (6.35-6)".

The Total Power for the straddle channel:

Chan.	Chan. Freq. (MHz)	Average Power (mW)	Average Power (dBm)
138	5690	125.733	20.99

Note: The total power was calculated through formula and record the value for reference only.

For Reference only – Power meter value

The power value was measured by power meter with average sensor.

Chan.	Chan. Freq. (MHz)	Average Power (dBm)		Total Power (mW)	Total Power (dBm)
		Chain 0	Chain 1		
138	5690	20.93	20.22	229.076	23.60

Power Limit = 11dBm + 10logB <U-NII-2A, U-NII-2C>			
Channel Number	Freq.(MHz)	Min. B(MHz)	Determined Conducted Limit (dBm)
58	5290	88.02	30.44 > 24
106	5530	87.23	30.4 > 24
122	5610	87.68	30.42 > 24
138 (U-NII-2C Band)	5690	77.75	29.9 > 24

Note: For U-NII-2A, U-NII-2C Band output power limitation is determined based on 26dBc bandwidth

802.11ax (HE160)

Chan.	Chan. Freq. (MHz)	Maximum Conducted Power (dBm)		Total Power (mW)	Total Power (dBm)	Limit (dBm)	Pass / Fail
		Chain 0	Chain 1				
*50 (U-NII-1 Band)	5250	13.64	12.77	45.648	16.59	29.65	Pass
*50 (U-NII-2A Band)	5250	13.99	13.41	51.017	17.08	23.65	Pass
114	5570	19.62	18.45	161.606	22.08	23.65	Pass

Note: * Test was performed in accordance with Measurement follow FCC KDB 789033 UNII test procedure Method SA-2 and use spectrum analyzer test.

1. For U-NII-1: The directional gain is 6.35dBi > 6dBi, so the power limit shall be reduced to $30 - (6.35 - 6) = 29.65\text{dBm}$.
2. For U-NII-2A, U-NII-2C: The directional gain is 6.35dBi > 6dBi, so the power limit shall be reduced to "Determined Conducted Limit- (6.35-6)".

The Total Power for the straddle channel:

Chan.	Chan. Freq. (MHz)	Average Power (mW)	Average Power (dBm)
50	5250	96.665	19.85

Note: The total power was calculated through formula and record the value for reference only.

For Reference only – Power meter value

The power value was measured by power meter with average sensor.

Chan.	Chan. Freq. (MHz)	Average Power (dBm)		Total Power (mW)	Total Power (dBm)
		Chain 0	Chain 1		
50	5250	18.89	18.19	143.363	21.56

Power Limit = 11dBm + 10logB <U-NII-2A, U-NII-2C>			
Channel Number	Freq.(MHz)	Min. B(MHz)	Determined Conducted Limit (dBm)
50 (U-NII-2A Band)	5250	84.74	30.28 > 24
114	5570	167.05	33.22 > 24

Note: For U-NII-2A, U-NII-2C Band output power limitation is determined based on 26dBc bandwidth

26dB OCCUPIED BANDWIDTH

802.11a

Channel	Frequency (MHz)	26dBc Bandwidth (MHz)	
		Chain 0	Chain 1
52	5260	26.93	28.15
60	5300	27.34	27.42
64	5320	26.71	28.01
100	5500	26.96	28.48
116	5580	27.42	28.68
140	5700	26.69	28.52
144 (U-NII-2C Band)	5720	18.53	19.08

802.11ax (HE20)

Channel	Frequency (MHz)	26dBc Bandwidth (MHz)	
		Chain 0	Chain 1
52	5260	26.36	24.84
60	5300	25.65	25.34
64	5320	25.41	25.41
100	5500	25.40	25.84
116	5580	25.88	25.12
140	5700	25.52	25.85
144 (U-NII-2C Band)	5720	17.47	17.67

802.11ax (HE40)

Channel	Frequency (MHz)	26dBc Bandwidth (MHz)	
		Chain 0	Chain 1
54	5270	47.02	50.01
62	5310	47.33	49.62
102	5510	48.22	47.92
110	5550	48.00	47.60
134	5670	48.57	51.53
142 (U-NII-2C Band)	5710	39.34	39.09

802.11ax (HE80)

Channel	Frequency (MHz)	26dBc Bandwidth (MHz)	
		Chain 0	Chain 1
58	5290	88.91	88.02
106	5530	87.23	88.17
122	5610	87.68	88.71
138 (U-NII-2C Band)	5690	77.75	78.48

802.11ax (HE160)

Channel	Frequency (MHz)	26dBc Bandwidth (MHz)	
		Chain 0	Chain 1
50 (U-NII-2A Band)	5250	84.74	89.36
114	5570	169.32	167.05

Spectrum Plot of Worst Value

802.11a_Chain 1 / CH16

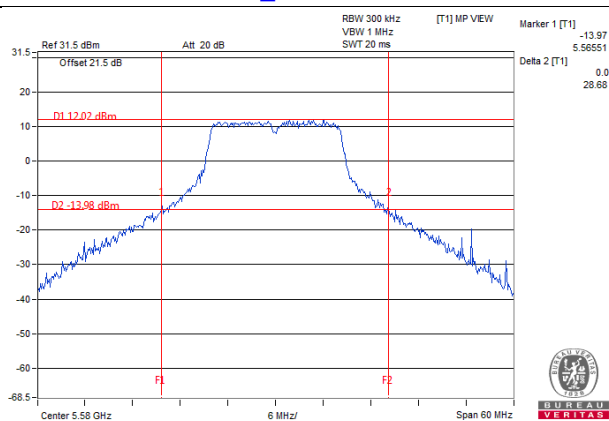

802.11ax (VHT20)_Chain 0 / CH52

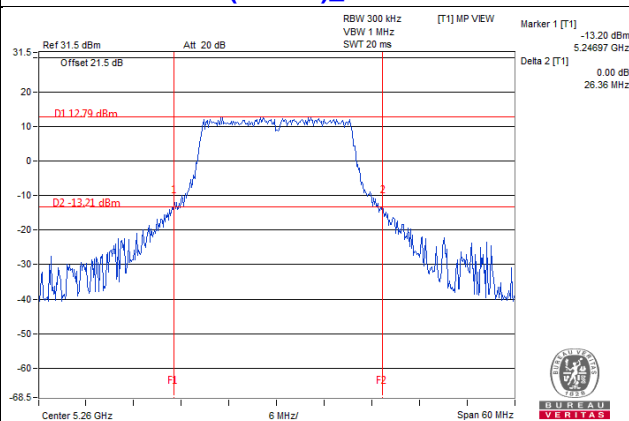

802.11ax (VHT40)_Chain 1 / CH54

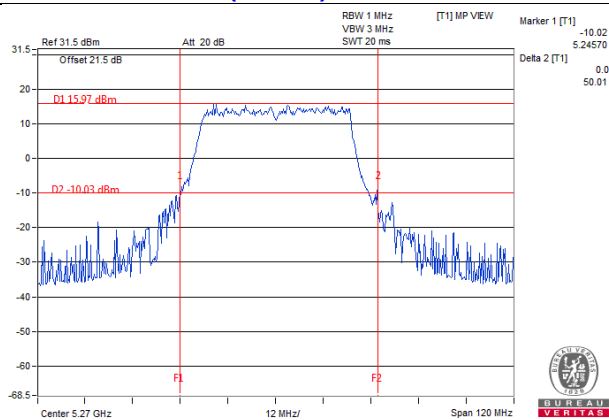

802.11ax (VHT80)_Chain 0 / CH58

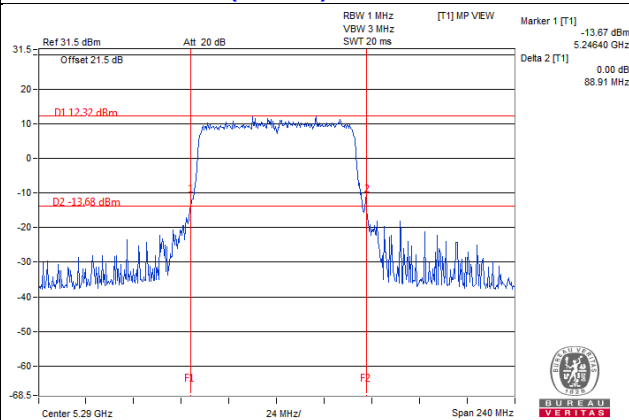

802.11ax (VHT160)_Chain 0 / CH114

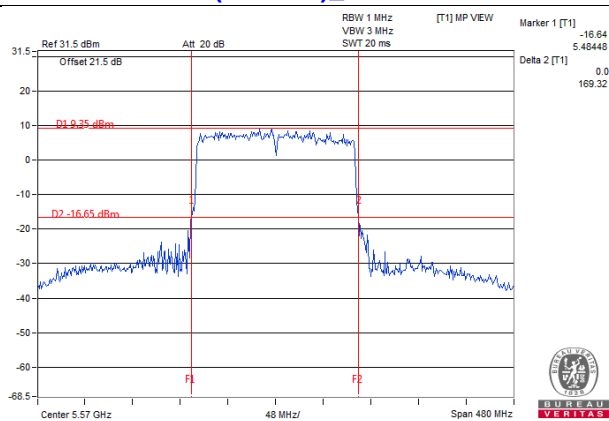

4.4 Occupied Bandwidth Measurement

4.4.1 Test Setup

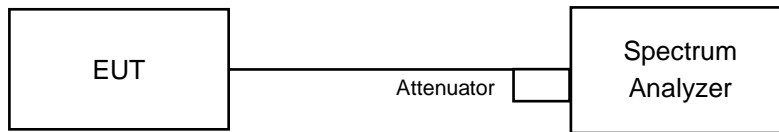

4.4.2 Test Instruments

Refer to section 4.1.2 to get information of above instrument.

4.4.3 Test Procedure

The transmitter output was connected to the spectrum analyzer through an attenuator. The bandwidth of the fundamental frequency was measured by spectrum analyzer with resolution bandwidth in the range of 1% to 5% of the anticipated emission bandwidth, and a video bandwidth at least 3x the resolution bandwidth and set the detector to SAMPLE. The width of a frequency band such that, below the lower and above the upper frequency limits, the mean powers emitted are each equal to a specified percentage 0.5 %of the total mean power of a given emission.

4.4.4 Test Results

Non-Beamforming Mode

802.11a

Channel	Channel Frequency (MHz)	Occupied Bandwidth (MHz)	
		Chain 0	Chain 1
36	5180	17.28	17.28
40	5200	17.52	17.64
48	5240	17.28	17.28
52	5260	17.76	17.76
60	5300	17.64	17.68
64	5320	17.62	17.68
100	5500	17.04	17.28
116	5580	18.38	18.38
140	5700	17.04	17.28
144 (U-NII-2C Band)	5720	13.64	13.76
144 (U-NII-3 Band)	5720	3.52	3.64
149	5745	17.76	17.16
157	5785	17.64	17.16
165	5825	18.24	17.16

Beamforming Mode

802.11ax (HE20)

Channel	Channel Frequency (MHz)	Occupied Bandwidth (MHz)	
		Chain 0	Chain 1
36	5180	19.20	19.20
40	5200	19.20	19.56
48	5240	19.20	19.20
52	5260	19.20	19.20
60	5300	19.42	19.42
64	5320	19.20	19.20
100	5500	19.32	19.20
116	5580	19.32	19.32
140	5700	19.20	19.20
144 (U-NII-2C Band)	5720	14.60	14.72
144 (U-NII-3 Band)	5720	4.60	4.48
149	5745	19.32	19.20
157	5785	19.20	19.32
165	5825	19.32	19.20

802.11ax (HE40)

Channel	Channel Frequency (MHz)	Occupied Bandwidth (MHz)	
		Chain 0	Chain 1
38	5190	38.16	38.16
46	5230	38.64	38.64
54	5270	38.16	38.16
62	5310	38.40	38.16
102	5510	38.16	38.40
110	5550	38.40	38.40
134	5670	38.16	38.40
142 (U-NII-2C Band)	5710	34.20	34.44
142 (U-NII-3 Band)	5710	3.96	3.96
151	5755	38.64	38.88
159	5795	38.88	38.88

802.11ax (HE80)

Channel	Channel Frequency (MHz)	Occupied Bandwidth (MHz)	
		Chain 0	Chain 1
42	5210	77.28	77.28
58	5290	77.76	77.28
106	5530	77.28	77.76
122	5610	77.76	77.28
138 (U-NII-2C Band)	5690	73.88	73.88
138 (U-NII-3 Band)	5690	3.40	3.40
155	5775	78.24	78.24

802.11ax (HE160)

Channel	Channel Frequency (MHz)	Occupied Bandwidth (MHz)	
		Chain 0	Chain 1
50 (U-NII-1 Band)	5250	78.72	78.72
50 (U-NII-2A Band)	5250	77.76	77.76
114	5570	156.48	156.48

Spectrum Plot of Max. Value

802.11a_Chain 0 / CH116

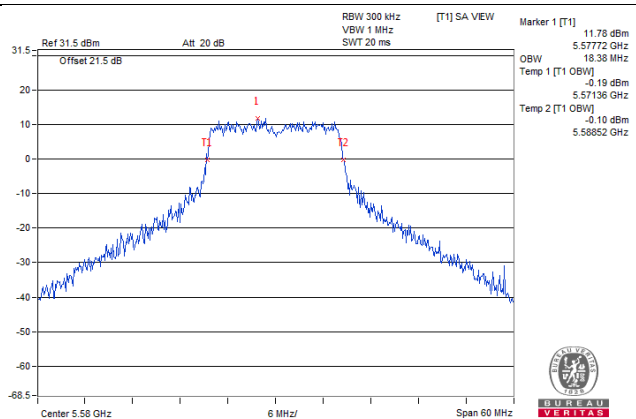

802.11ax (HE20)_Chain 1 / CH40

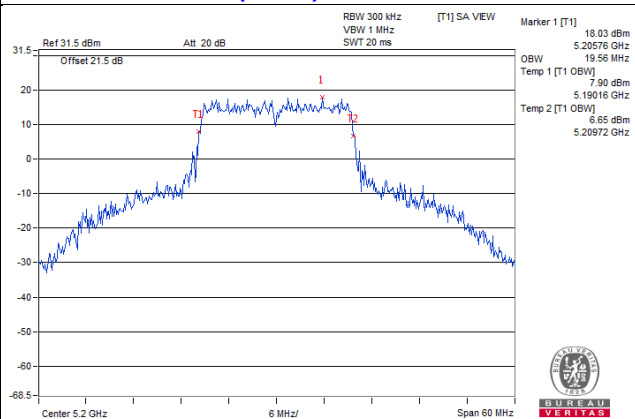

802.11ax (HE40)_Chain 0 / CH159

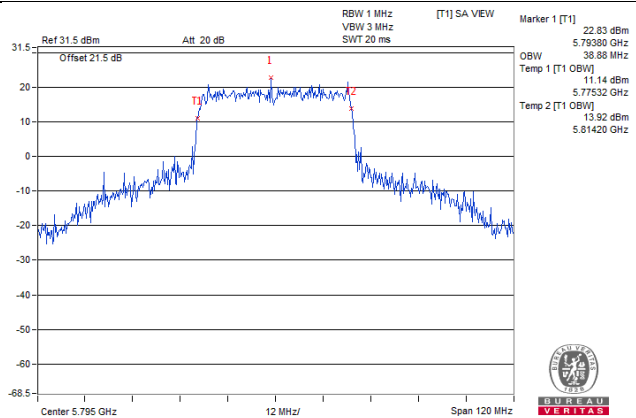

802.11ax (HE80)_Chain 0 / CH155

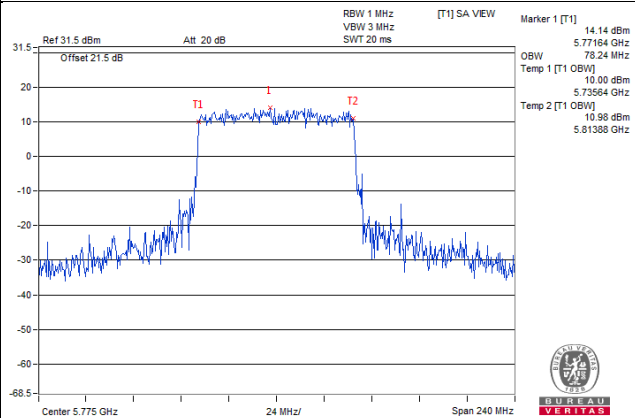

802.11ax (HE160)_Chain 0 / CH114

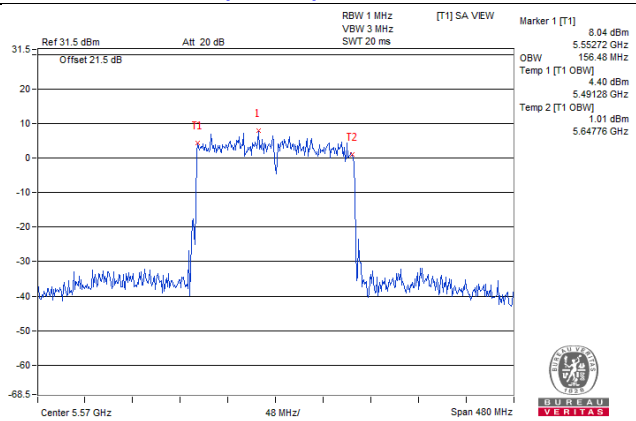

Spectrum Plot for near by DFS band
(DFS is required, if 99% OCP straddle into U-NII-2A band)

802.11a_Chain 0 / CH48

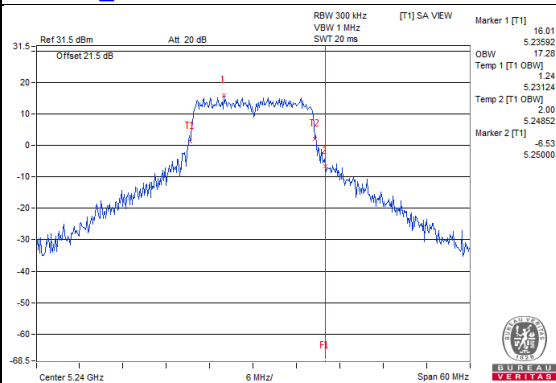

802.11a_Chain 1 / CH48

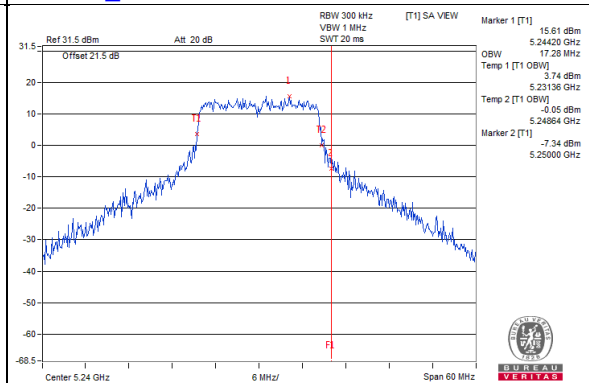

802.11ax (HE20)_Chain 0 / CH48

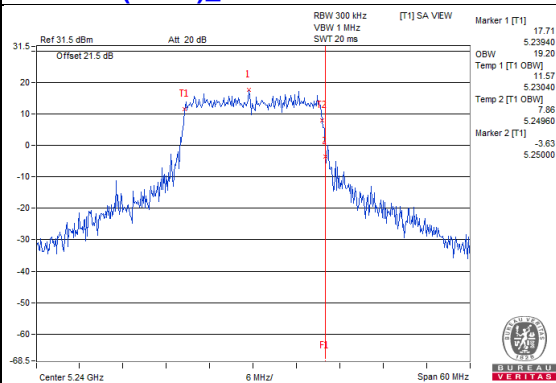

802.11ax (HE20)_Chain 1 / CH48

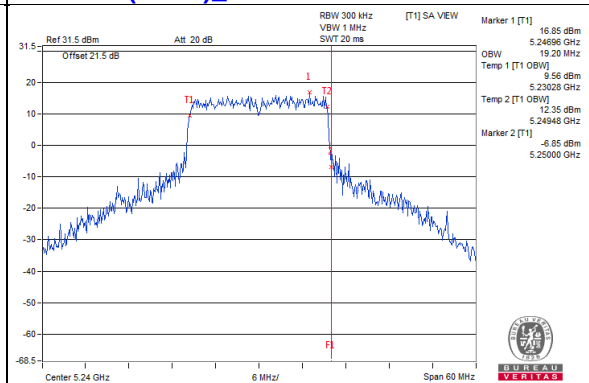

802.11ax (HE40)_Chain 0 / CH46

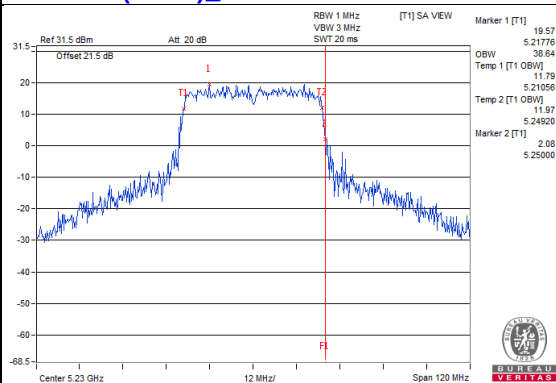

802.11ax (HE40)_Chain 1 / CH46

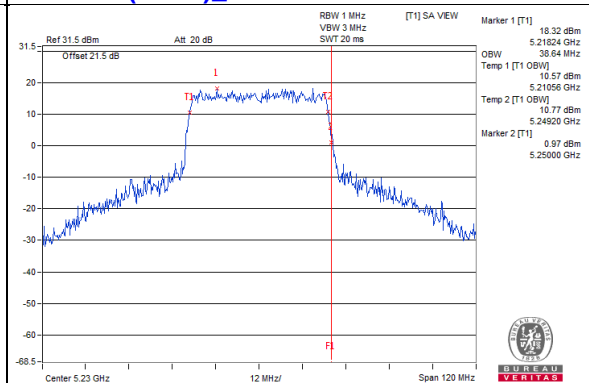

802.11ax (HE80)_Chain 0 / CH42

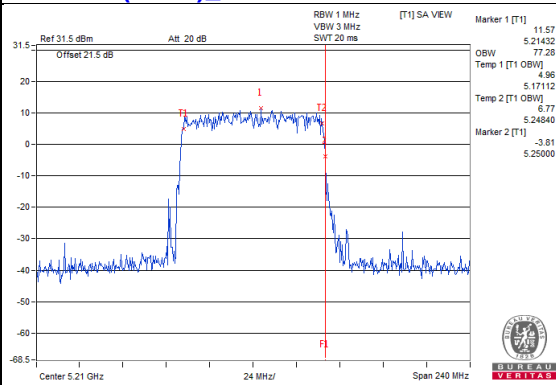

802.11ax (HE80)_Chain 1 / CH42

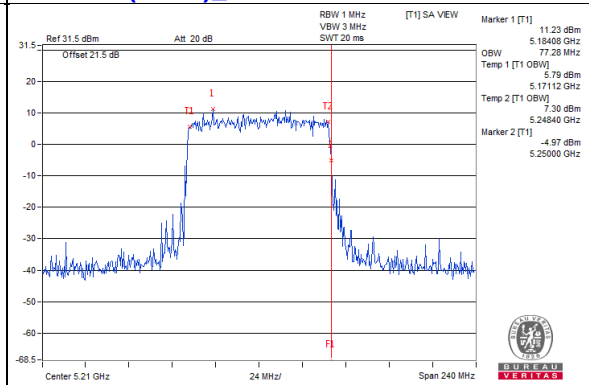

**Spectrum Plot for near by DFS band
(DFS is required, if 99% OCP straddle into U-NII-2C band)**

802.11a_Chain 0 / CH149

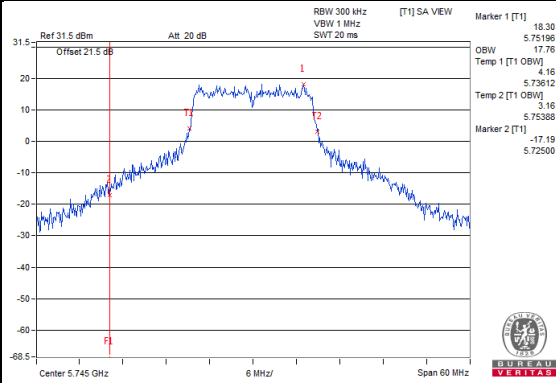

802.11a_Chain 1 / CH149

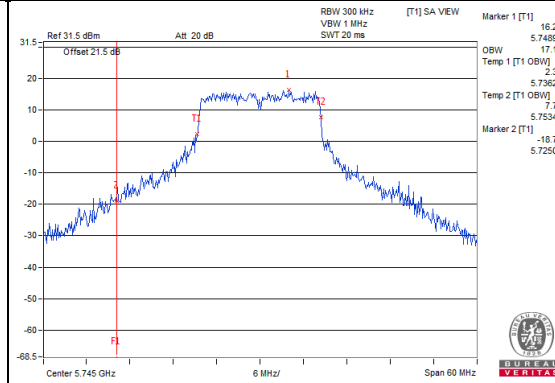

802.11ax (HE20)_Chain 0 / CH149

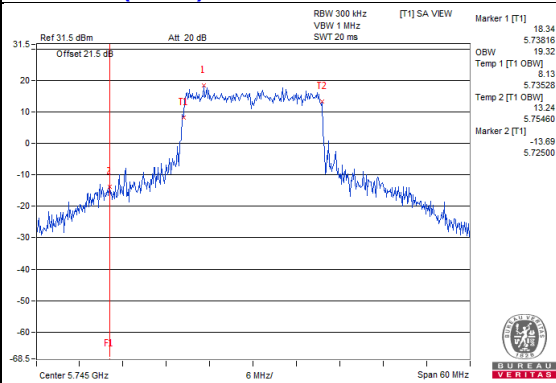

802.11ax (HE20)_Chain 1 / CH149

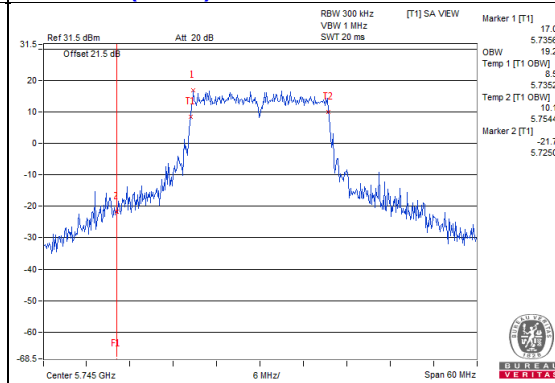

802.11ax (HE40)_Chain 0 / CH151

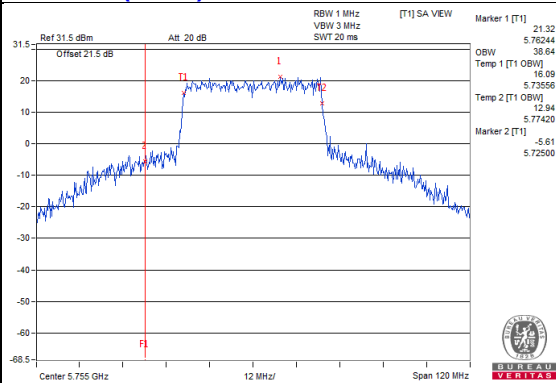

802.11ax (HE40)_Chain 1 / CH151

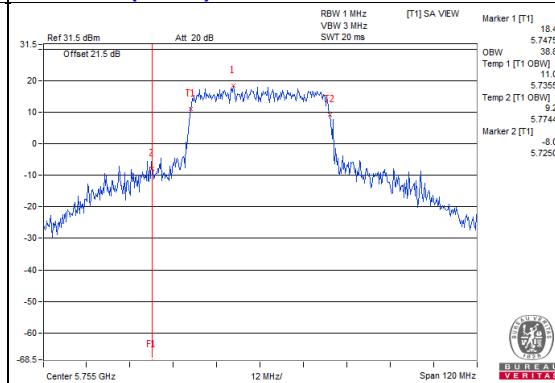

802.11ax (HE80)_Chain 0 / CH155

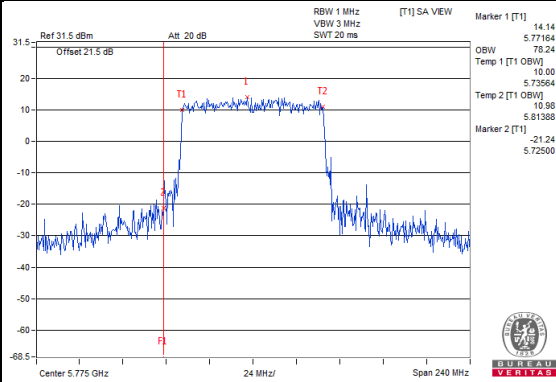

802.11ax (HE80)_Chain 1 / CH155

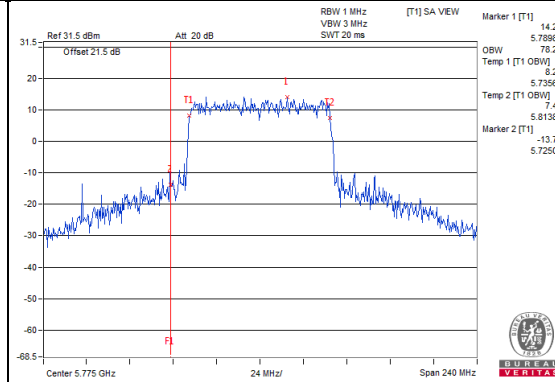

4.5 Peak Power Spectral Density Measurement

4.5.1 Limits of Peak Power Spectral Density Measurement

Operation Band	EUT Category		Limit
U-NII-1		Outdoor Access Point	17dBm/ MHz
		Fixed point-to-point Access Point	
	√	Indoor Access Point	
		Client device	11dBm/ MHz
U-NII-2A	√		11dBm/ MHz
U-NII-2C	√		11dBm/ MHz
U-NII-3	√		30dBm/ 500kHz

4.5.2 Test Setup

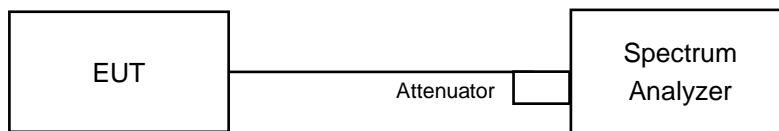

4.5.3 Test Instruments

Refer to section 4.1.2 to get information of above instrument.

4.5.4 Test Procedure

For U-NII-1, U-NII-2A and UNII-2C band:

For 802.11ax (HE20):

Using method SA-1

1. Set span to encompass the entire emission bandwidth (EBW) of the signal.
2. Set RBW = 1 MHz, Set VBW \geq 3 MHz, Detector = RMS
3. Sweep time = auto, trigger set to "free run".
4. Trace average at least 100 traces in power averaging mode.
5. Record the max value

For other Modulation test:

Using method SA-2

1. Set span to encompass the entire emission bandwidth (EBW) of the signal.
2. Set RBW = 1 MHz, Set VBW \geq 3 MHz, Detector = RMS
3. Sweep time = auto, trigger set to "free run".
4. Trace average at least 100 traces in power averaging mode.
5. Record the max value and add $10 \log (1/\text{duty cycle})$

For U-NII-3:

For 802.11ax (HE20):

1. Set span to encompass the entire emission bandwidth (EBW) of the signal.
2. Set RBW = 300 kHz, Set VBW \geq 1 MHz, Detector = RMS
3. Use the peak marker function to determine the maximum power level in any 300 kHz band segment within the fundamental EBW.
4. Scale the observed power level to an equivalent value in 500 kHz by adjusting (reducing) the measured power by a bandwidth correction factor (BWCF) where $BWCF = 10 \log(500\text{kHz}/300\text{kHz})$
5. Sweep time = auto, trigger set to "free run".
6. Trace average at least 100 traces in power averaging mode.
7. Record the max value

For other Modulation test:

1. Set span to encompass the entire emission bandwidth (EBW) of the signal.
2. Set RBW = 300 kHz, Set VBW \geq 1 MHz, Detector = RMS
3. Use the peak marker function to determine the maximum power level in any 300 kHz band segment within the fundamental EBW.
4. Scale the observed power level to an equivalent value in 500 kHz by adjusting (reducing) the measured power by a bandwidth correction factor (BWCF) where $BWCF = 10 \log(500\text{kHz}/300\text{kHz})$
5. Sweep time = auto, trigger set to "free run".
6. Trace average at least 100 traces in power averaging mode.
7. Record the max value and add $10 \log (1/\text{duty cycle})$

4.5.5 Deviation from Test Standard

No deviation.

4.5.6 EUT Operating Condition

Same as Item 4.3.6.

4.5.7 Test Results

Non-Beamforming Mode

For U-NII-1, U-NII-2A, U-NII-2C:

802.11a

Chan.	Chan. Freq. (MHz)	PSD W/O Duty Factor (dBm/MHz)		Duty Factor (dB)	Total PSD With Duty Factor (dBm/MHz)	MAX. Limit (dBm/MHz)	Pass / Fail
		Chain 0	Chain 1				
36	5180	9.69	9.73	0.13	12.85	16.65	Pass
40	5200	12.79	12.75	0.13	15.91	16.65	Pass
48	5240	11.62	11.14	0.13	14.53	16.65	Pass
52	5260	7.12	6.46	0.13	9.94	10.65	Pass
60	5300	7.47	6.82	0.13	10.30	10.65	Pass
64	5320	7.56	6.15	0.13	10.05	10.65	Pass
100	5500	7.69	6.26	0.13	10.17	10.65	Pass
116	5580	7.38	6.73	0.13	10.21	10.65	Pass
140	5700	5.86	5.21	0.13	8.69	10.65	Pass
144 (U-NII-2C Band)	5720	8.10	6.06	0.13	10.34	10.65	Pass

- Note:**
- Method a) of power density measurement of KDB 662911 is using for calculating total power density. Total power density is summing entire spectra across corresponding frequency bins on the various outputs by computer.
 - For U-NII-1: The directional gain = 6.35dBi > 6dBi, so the power density limit shall be reduced to $17-(6.35-6) = 16.65\text{dBm}$.
 - For U-NII-2A, U-NII-2C: The directional gain = 6.35dBi > 6dBi, so the power density limit shall be reduced to $11-(6.35-6) = 10.65\text{dBm}$.
 - Refer to section 3.3 for duty cycle spectrum plot.

Beamforming Mode

802.11ax (HE20)

Chan.	Chan. Freq. (MHz)	PSD (dBm/MHz)		Total Power Density (dBm/MHz)	MAX. Limit (dBm/MHz)	Pass / Fail
		Chain 0	Chain 1			
36	5180	8.80	8.61	11.72	16.65	Pass
40	5200	12.10	12.23	15.18	16.65	Pass
48	5240	10.95	11.02	14.00	16.65	Pass
52	5260	6.00	6.14	9.08	10.65	Pass
60	5300	6.27	5.64	8.98	10.65	Pass
64	5320	6.31	5.46	8.92	10.65	Pass
100	5500	6.91	5.18	9.14	10.65	Pass
116	5580	5.59	4.76	8.21	10.65	Pass
140	5700	5.88	4.13	8.10	10.65	Pass
144 (U-NII-2C Band)	5720	5.80	5.53	8.68	10.65	Pass

- Note:**
- Method a) of power density measurement of KDB 662911 is using for calculating total power density. Total power density is summing entire spectra across corresponding frequency bins on the various outputs by computer.
 - For U-NII-1: The directional gain = 6.35dBi > 6dBi, so the power density limit shall be reduced to $17 - (6.35 - 6) = 16.65\text{dBm}$.
 - For U-NII-2A, U-NII-2C: The directional gain = 6.35dBi > 6dBi, so the power density limit shall be reduced to $11 - (6.35 - 6) = 10.65\text{dBm}$.

802.11ax (HE40)

Chan.	Chan. Freq. (MHz)	PSD W/O Duty Factor (dBm/MHz)		Duty Factor (dB)	Total PSD With Duty Factor (dBm/MHz)	MAX. Limit (dBm/MHz)	Pass / Fail
		Chain 0	Chain 1				
38	5190	3.52	2.75	0.09	6.25	16.65	Pass
46	5230	8.59	7.41	0.09	11.14	16.65	Pass
54	5270	2.94	2.56	0.09	5.85	10.65	Pass
62	5310	2.80	2.41	0.09	5.71	10.65	Pass
102	5510	3.01	2.34	0.09	5.79	10.65	Pass
110	5550	3.22	2.67	0.09	6.05	10.65	Pass
134	5670	3.29	2.57	0.09	6.05	10.65	Pass
142 (U-NII-2C Band)	5710	4.48	2.64	0.09	6.76	10.65	Pass

- Note:**
- Method a) of power density measurement of KDB 662911 is using for calculating total power density. Total power density is summing entire spectra across corresponding frequency bins on the various outputs by computer.
 - For U-NII-1: The directional gain = 6.35dBi > 6dBi, so the power density limit shall be reduced to $17-(6.35-6) = 16.65\text{dBm}$.
 - For U-NII-2A, U-NII-2C: The directional gain = 6.35dBi > 6dBi, so the power density limit shall be reduced to $11-(6.35-6) = 10.65\text{dBm}$.
 - Refer to section 3.3 for duty cycle spectrum plot.

802.11ax (HE80)

Chan.	Chan. Freq. (MHz)	PSD W/O Duty Factor (dBm/MHz)		Duty Factor (dB)	Total PSD With Duty Factor (dBm/MHz)	MAX. Limit (dBm/MHz)	Pass / Fail
		Chain 0	Chain 1				
42	5210	0.23	-0.56	0.20	3.06	16.65	Pass
58	5290	-1.28	-2.68	0.20	1.29	10.65	Pass
106	5530	-1.08	-1.88	0.20	1.75	10.65	Pass
122	5610	0.41	0.30	0.20	3.57	10.65	Pass
138 (U-NII-2C Band)	5690	0.21	-0.20	0.20	3.22	10.65	Pass

- Note:**
- Method a) of power density measurement of KDB 662911 is using for calculating total power density. Total power density is summing entire spectra across corresponding frequency bins on the various outputs by computer.
 - For U-NII-1: The directional gain = 6.35dBi > 6dBi, so the power density limit shall be reduced to $17-(6.35-6) = 16.65\text{dBm}$.
 - For U-NII-2A, U-NII-2C: The directional gain = 6.35dBi > 6dBi, so the power density limit shall be reduced to $11-(6.35-6) = 10.65\text{dBm}$.
 - Refer to section 3.3 for duty cycle spectrum plot.

802.11ax (HE160)

Chan.	Chan. Freq. (MHz)	PSD W/O Duty Factor (dBm/MHz)		Duty Factor (dB)	Total PSD With Duty Factor (dBm/MHz)	MAX. Limit (dBm/MHz)	Pass / Fail
		Chain 0	Chain 1				
50 (U-NII-1 Band)	5250	-3.65	-4.53	0.36	-0.70	16.65	Pass
50 (U-NII-2A Band)	5250	-3.65	-4.53	0.36	-0.70	10.65	Pass
114	5570	-4.16	-4.91	0.36	-1.15	10.65	Pass

- Note:**
- Method a) of power density measurement of KDB 662911 is using for calculating total power density. Total power density is summing entire spectra across corresponding frequency bins on the various outputs by computer.
 - For U-NII-1: The directional gain = 6.35dBi > 6dBi, so the power density limit shall be reduced to $17-(6.35-6) = 16.65\text{dBm}$.
 - For U-NII-2A, U-NII-2C: The directional gain = 6.35dBi > 6dBi, so the power density limit shall be reduced to $11-(6.35-6) = 10.65\text{dBm}$.
 - Refer to section 3.3 for duty cycle spectrum plot.

Spectrum Plot of Worst Value

802.11a_Chain 0 / CH40

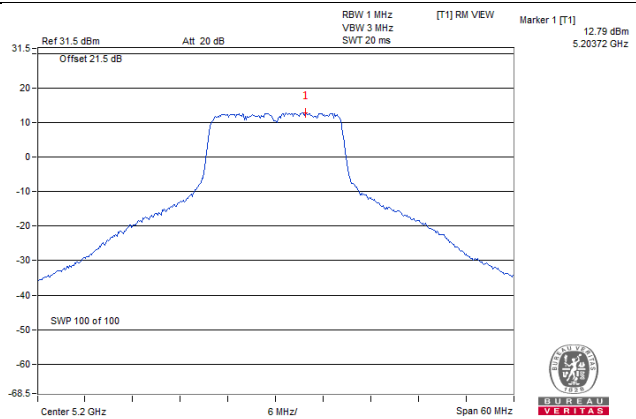

802.11ax (HE20)_Chain 1 / CH40

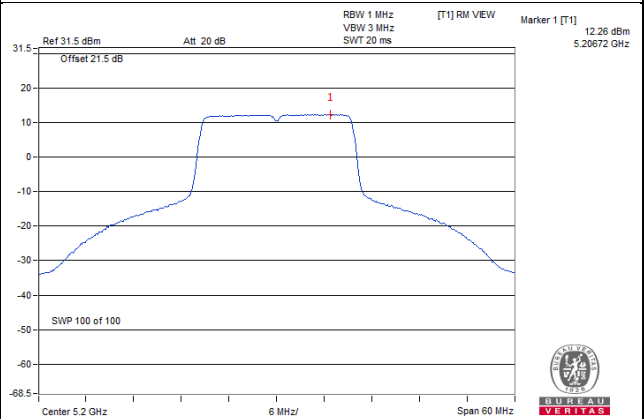

802.11ax (HE40)_Chain 0 / CH46

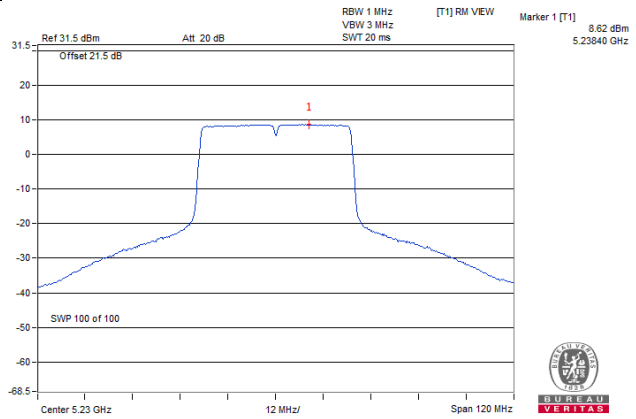

802.11ax (HE80)_Chain 0 / CH122

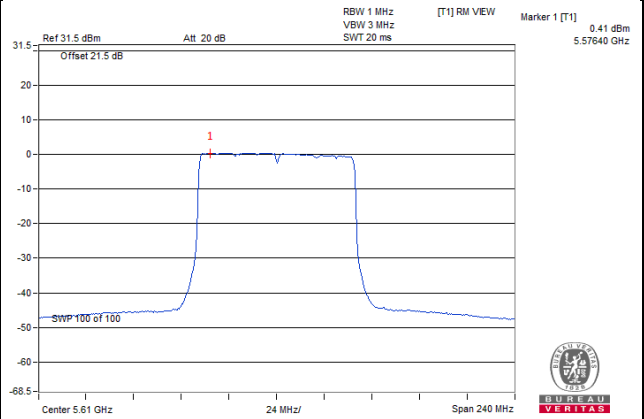

802.11ax (HE160)_Chain 0 / CH50 (U-NII-1)

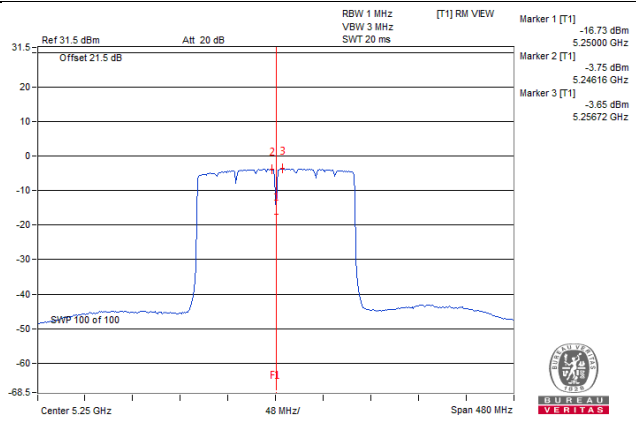

For U-NII-3:
Non-Beamforming Mode
802.11a

Chan.	Freq. (MHz)	PSD W/O Duty Factor (dBm/300kHz)		Duty Factor (dB)	Total PSD With Duty Factor		Total PSD With Duty Factor (dBm/500kHz)	Limit (dBm/500kHz)	Pass /Fail
		Chain 0	Chain 1		mW/300kHz	dBm/300kHz			
144 (U-NII-3 Band)	5720	-0.37	-2.08	0.13	1.5845	2.00	4.22	29.65	Pass
149	5745	5.80	4.17	0.13	6.609	8.20	10.42	29.65	Pass
157	5785	6.12	3.82	0.13	6.7001	8.26	10.48	29.65	Pass
165	5825	5.97	3.40	0.13	6.328	8.01	10.23	29.65	Pass

- Note: 1. Method b) Measure and sum spectral maxima across the outputs of KDB 662911 is using for calculating total power density.
 2. The directional gain = 6.35dBi > 6dBi, so the power density limit shall be reduced to $30-(6.35-6) = 29.65\text{dBm}$.
 3. Refer to section 3.3 for duty cycle spectrum plot.

Beamforming Mode
802.11ax (HE20)

Chan.	Freq. (MHz)	PSD (dBm/300kHz)		Total PSD		Total PSD (dBm/500kHz)	Limit (dBm/500kHz)	Pass /Fail
		Chain 0	Chain 1	mW/300kHz	dBm/300kHz			
144 (U-NII-3 Band)	5720	-3.28	-3.46	0.9207	-0.36	1.86	29.65	Pass
149	5745	3.61	2.49	4.0703	6.10	8.32	29.65	Pass
157	5785	3.23	2.30	3.802	5.80	8.02	29.65	Pass
165	5825	3.99	2.50	4.2844	6.32	8.54	29.65	Pass

- Note: 1. Method b) Measure and sum spectral maxima across the outputs of KDB 662911 is using for calculating total power density.
 2. The directional gain = 6.35dBi > 6dBi, so the power density limit shall be reduced to $30-(6.35-6) = 29.65\text{dBm}$.

802.11ax (HE40)

Chan.	Freq. (MHz)	PSD W/O Duty Factor (dBm/300kHz)		Duty Factor (dB)	Total PSD With Duty Factor		Total PSD With Duty Factor (dBm/500kHz)	Limit (dBm/500kHz)	Pass /Fail
		Chain 0	Chain 1		mW/300kHz	dBm/300kHz			
142 (U-NII-3 Band)	5710	-4.53	-6.54	0.09	0.5868	-2.32	-0.10	29.65	Pass
151	5755	1.61	-1.36	0.09	2.2276	3.48	5.70	29.65	Pass
159	5795	1.43	-0.93	0.09	2.2453	3.51	5.73	29.65	Pass

- Note: 1. Method b) Measure and sum spectral maxima across the outputs of KDB 662911 is using for calculating total power density.
 2. The directional gain = 6.35dBi > 6dBi, so the power density limit shall be reduced to $30 - (6.35 - 6) = 29.65$ dBm.
 3. Refer to section 3.3 for duty cycle spectrum plot.

802.11ax (HE80)

Chan.	Freq. (MHz)	PSD W/O Duty Factor (dBm/300kHz)		Duty Factor (dB)	Total PSD With Duty Factor		Total PSD With Duty Factor (dBm/500kHz)	Limit (dBm/500kHz)	Pass /Fail
		Chain 0	Chain 1		mW/300kHz	dBm/300kHz			
138 (U-NII-3 Band)	5690	-9.10	-9.77	0.20	0.2392	-6.21	-3.99	29.65	Pass
155	5775	-4.83	-5.42	0.20	0.6448	-1.91	0.31	29.65	Pass

- Note: 1. Method b) Measure and sum spectral maxima across the outputs of KDB 662911 is using for calculating total power density.
 2. The directional gain = 6.35dBi > 6dBi, so the power density limit shall be reduced to $30 - (6.35 - 6) = 29.65$ dBm.
 3. Refer to section 3.3 for duty cycle spectrum plot.

Spectrum Plot of Worst Value

802.11a_Chain 0 / CH157

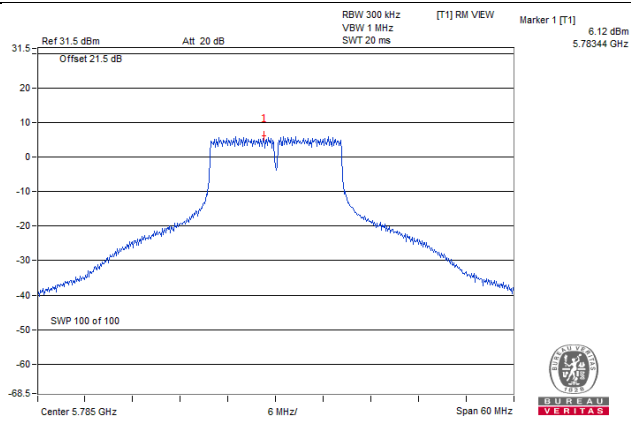

802.11ax (HE20)_Chain 0 / CH165

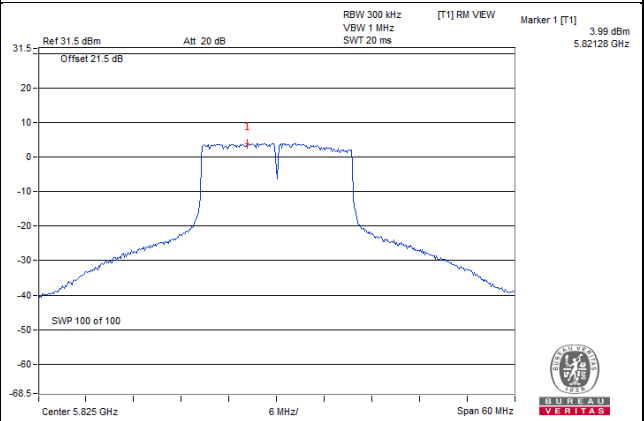

802.11ax (HE40)_Chain 0 / CH151

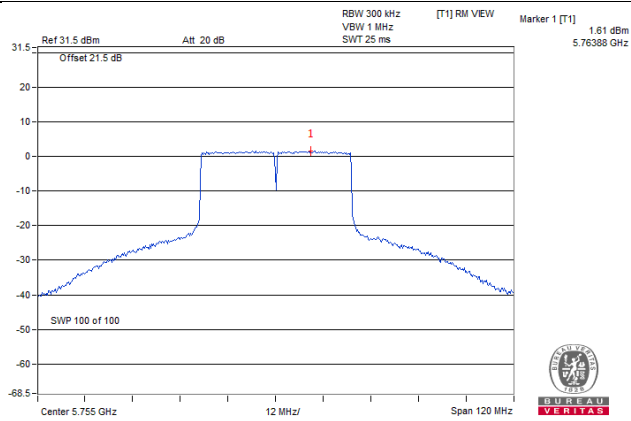

802.11ax (HE80)_Chain 0 / CH155

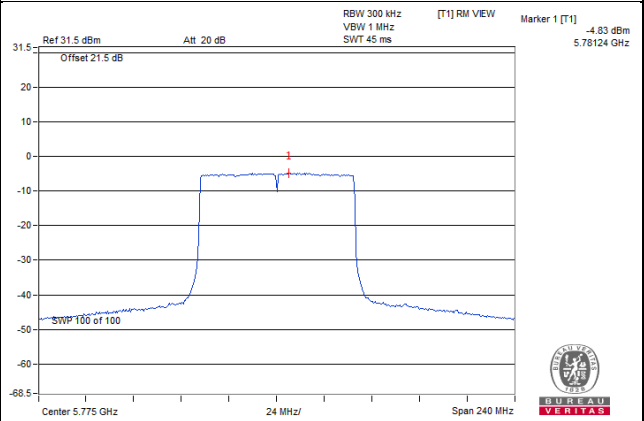

4.6 Frequency Stability Measurement

4.6.1 Limits of Frequency Stability Measurement

The frequency of the carrier signal shall be maintained within band of operation

4.6.2 Test Setup

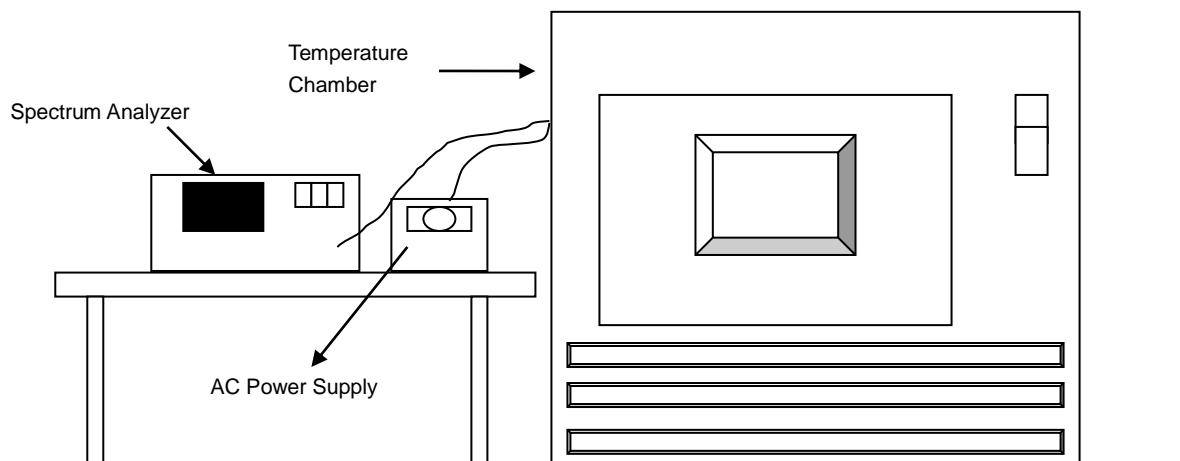

4.6.3 Test Instruments

Refer to section 4.1.2 to get information of above instrument.

4.6.4 Test Procedure

- The EUT was placed inside the environmental test chamber and powered by nominal AC voltage.
- Turn the EUT on and couple its output to a spectrum analyzer.
- Turn the EUT off and set the chamber to the highest temperature specified.
- Allow sufficient time (approximately 30 min) for the temperature of the chamber to stabilize, turn the EUT on and measure the operating frequency after 2, 5, and 10 Minutes.
- Repeat step 2 and 3 with the temperature chamber set to the lowest temperature.
- The test chamber was allowed to stabilize at +20 degree C for a minimum of 30 Minutes. The supply voltage was then adjusted on the EUT from 85% to 115% and the frequency record.

4.6.5 Deviation from Test Standard

No deviation.

4.6.6 EUT Operating Condition

Set the EUT transmit at un-modulation mode to test frequency stability.

4.6.7 Test Results

Frequency Stability Versus Temp.									
Operating Frequency: 5180 MHz									
TEMP. (°C)	Power Supply (Vac)	0 Minute		2 Minutes		5 Minutes		10 Minutes	
		Measured Frequency (MHz)	Pass/Fail	Measured Frequency (MHz)	Pass/Fail	Measured Frequency (MHz)	Pass/Fail	Measured Frequency (MHz)	Pass/Fail
50	120	5180.0114	PASS	5180.0129	PASS	5180.0093	PASS	5180.0108	Pass
40	120	5180.0268	PASS	5180.0233	PASS	5180.0252	PASS	5180.0241	Pass
30	120	5179.9998	PASS	5180.0017	PASS	5180.0016	PASS	5180.0013	Pass
20	120	5180.0126	PASS	5180.0123	PASS	5180.0081	PASS	5180.0123	Pass
10	120	5180.0221	PASS	5180.0233	PASS	5180.0233	PASS	5180.0212	Pass
0	120	5180.0109	PASS	5180.0092	PASS	5180.0079	PASS	5180.0101	Pass
-10	120	5179.9916	PASS	5179.9924	PASS	5179.9926	PASS	5179.9902	Pass
-20	120	5179.9759	PASS	5179.9756	PASS	5179.9748	PASS	5179.9792	Pass
-30	120	5180.017	PASS	5180.0179	PASS	5180.0187	PASS	5180.0196	Pass

Frequency Stability Versus Voltage									
Operating Frequency: 5180 MHz									
TEMP. (°C)	Power Supply (Vac)	0 Minute		2 Minutes		5 Minutes		10 Minutes	
		Measured Frequency (MHz)	Pass/Fail	Measured Frequency (MHz)	Pass/Fail	Measured Frequency (MHz)	Pass/Fail	Measured Frequency (MHz)	Pass/Fail
20	138	5180.0124	PASS	5180.0117	PASS	5180.009	PASS	5180.0117	Pass
	120	5180.0126	PASS	5180.0123	PASS	5180.0081	PASS	5180.0123	Pass
	102	5180.0117	PASS	5180.012	PASS	5180.0078	PASS	5180.0132	Pass

4.7 6dB Bandwidth Measurement

4.7.1 Limits of 6dB Bandwidth Measurement

The minimum of 6dB Bandwidth Measurement is 0.5MHz.

4.7.2 Test Setup

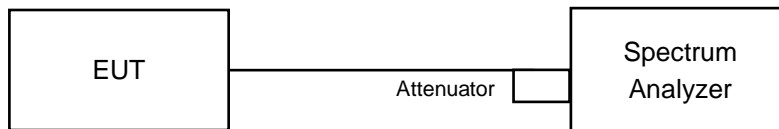

4.7.3 Test Instruments

Refer to section 4.1.2 to get information of above instrument.

4.7.4 Test Procedure

MEASUREMENT PROCEDURE REF

- Set resolution bandwidth (RBW) = 100kHz
- Set the video bandwidth (VBW) $\geq 3 \times$ RBW, Detector = Peak.
- Trace mode = max hold.
- Sweep = auto couple.
- Measure the maximum width of the emission that is constrained by the frequencies associated with the two amplitude points (upper and lower) that are attenuated by 6 dB relative to the maximum level measured in the fundamental emission

4.7.5 Deviation from Test Standard

No deviation.

4.7.6 EUT Operating Condition

The software provided by client to enable the EUT under transmission condition continuously at lowest, middle and highest channel frequencies individually.

4.7.7 Test Results

Non-Beamforming Mode
802.11a

Channel	Frequency (MHz)	6dB Bandwidth (MHz)		Minimum Limit (MHz)	Pass / Fail
		Chain 0	Chain 1		
144 (U-NII-3 Band)	5720	3.21	3.21	0.5	Pass
149	5745	16.35	16.39	0.5	Pass
157	5785	16.31	16.42	0.5	Pass
165	5825	16.36	16.42	0.5	Pass

Beamforming Mode
802.11ax (HE20)

Channel	Frequency (MHz)	6dB Bandwidth (MHz)		Minimum Limit (MHz)	Pass / Fail
		Chain 0	Chain 1		
144 (U-NII-3 Band)	5720	4.55	4.48	0.5	Pass
149	5745	19.02	19.08	0.5	Pass
157	5785	19.09	18.99	0.5	Pass
165	5825	19.04	19.06	0.5	Pass

802.11ax (HE40)

Channel	Frequency (MHz)	6dB Bandwidth (MHz)		Minimum Limit (MHz)	Pass / Fail
		Chain 0	Chain 1		
142 (U-NII-3 Band)	5710	4.04	4.03	0.5	Pass
151	5755	37.97	38.16	0.5	Pass
159	5795	38.04	38.04	0.5	Pass

802.11ax (HE80)

Channel	Frequency (MHz)	6dB Bandwidth (MHz)		Minimum Limit (MHz)	Pass / Fail
		Chain 0	Chain 1		
138 (U-NII-3 Band)	5690	4.07	4.06	0.5	Pass
155	5775	78.09	78.14	0.5	Pass

Spectrum Plot of Worst Value

802.11a_Chain 0 / CH144 (U-NII-3)

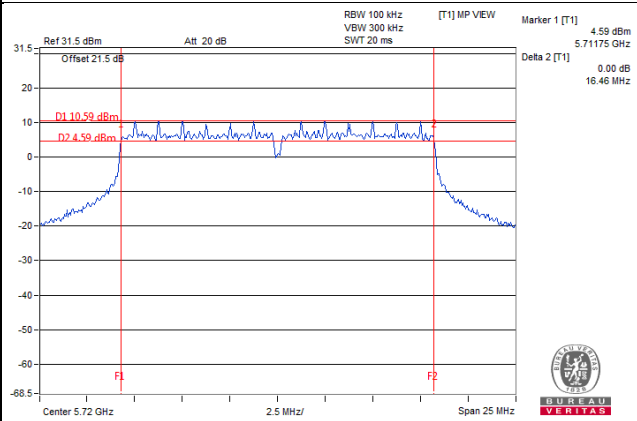

802.11ax (HE20)_Chain 1 / CH144 (U-NII-3)

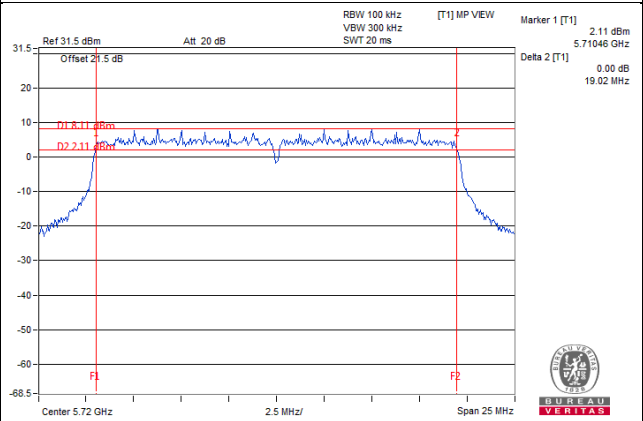

802.11ax (HE40)_Chain 1 / CH142 (U-NII-3)

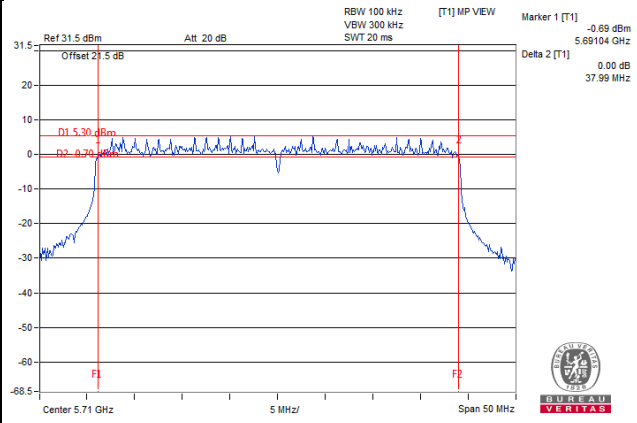

802.11ax (HE80)_Chain 1 / CH138 (U-NII-3)

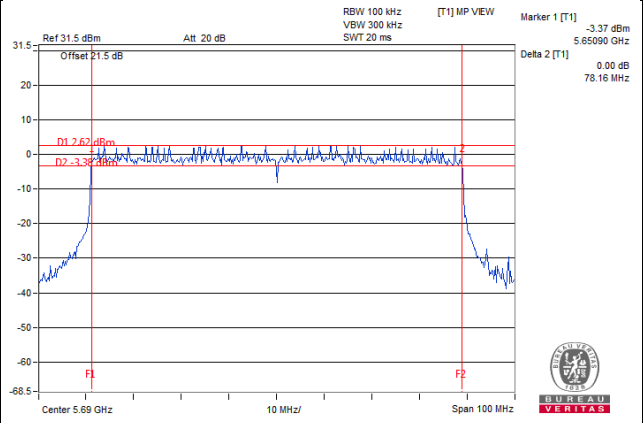

Note: The 6dB bandwidth above 5725MHz = Marker 1 + Delta 2 - 5725MHz

5 Pictures of Test Arrangements

Please refer to the attached file (Test Setup Photo).

Annex A- Radiated Out of Band Emission (OOBE) Measurement (For U-NII-3 band)

802.11a

CH 149 5745 MHz

Horizontal

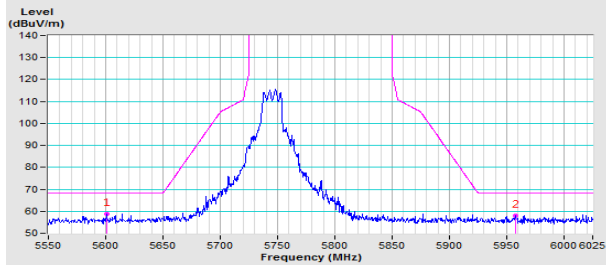

Vertical

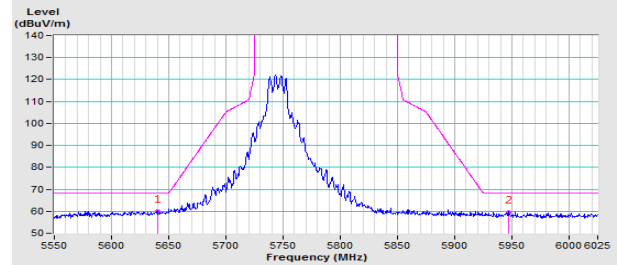

CH 157 5785 MHz

Horizontal

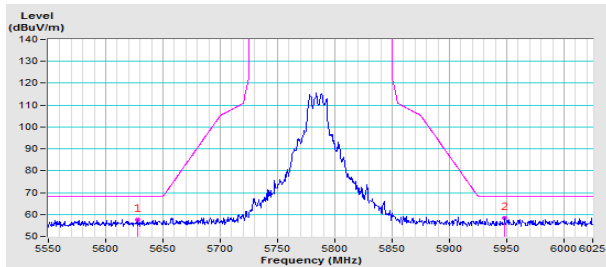

Vertical

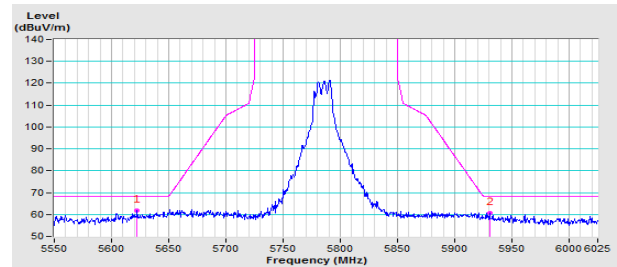

CH 165 5825 MHz

Horizontal

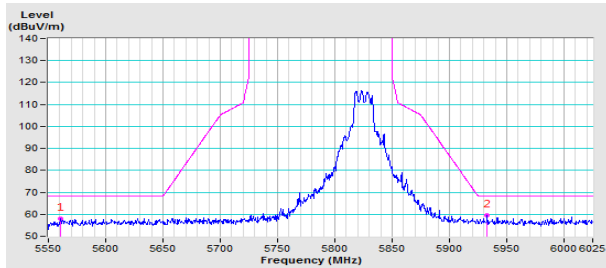

Vertical

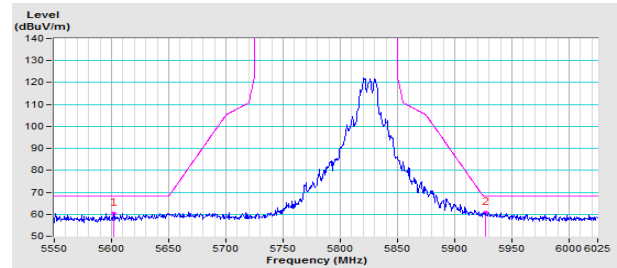

802.11ax (HE20)

CH 149 5745 MHz

Horizontal

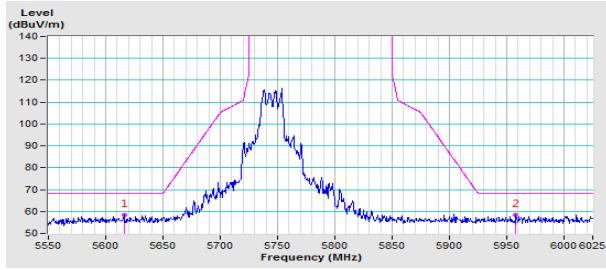

Vertical

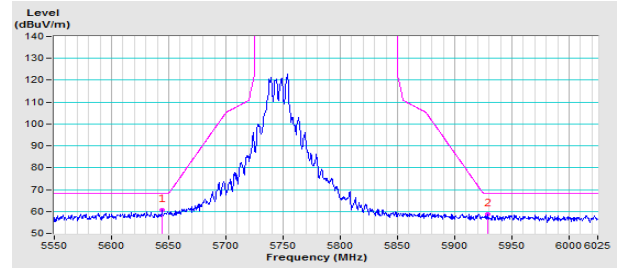

CH 157 5785 MHz

Horizontal

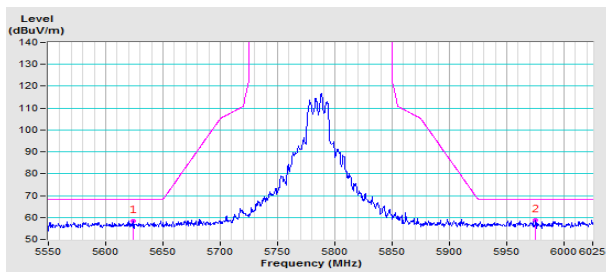

Vertical

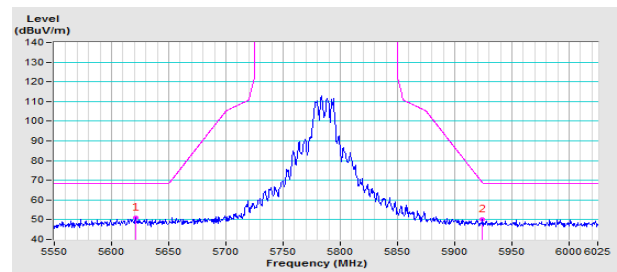

CH 165 5825 MHz

Horizontal

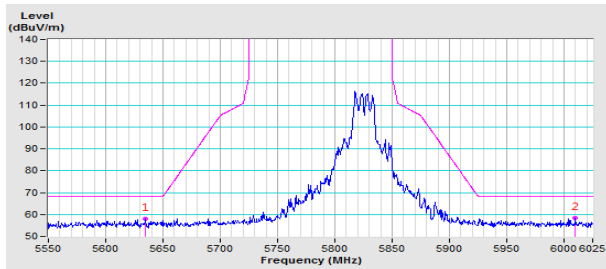

Vertical

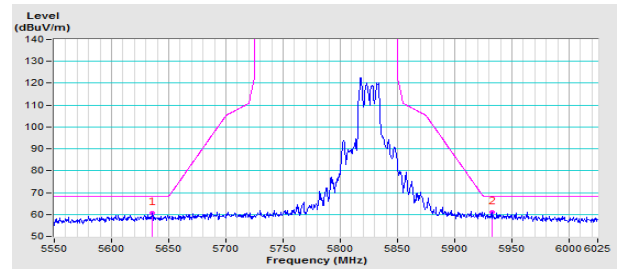

802.11ax (HE40)

CH 151 5755 MHz

Horizontal

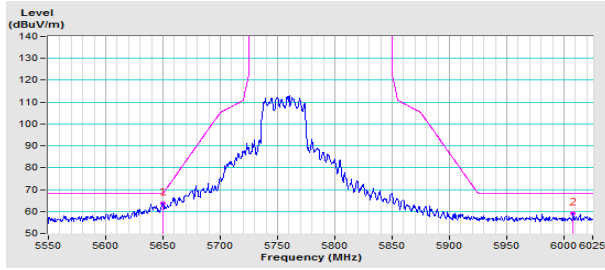

Vertical

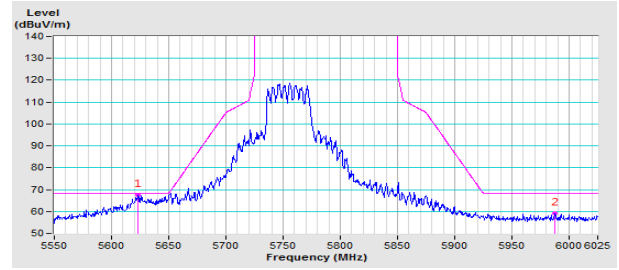

CH 159 5795 MHz

Horizontal

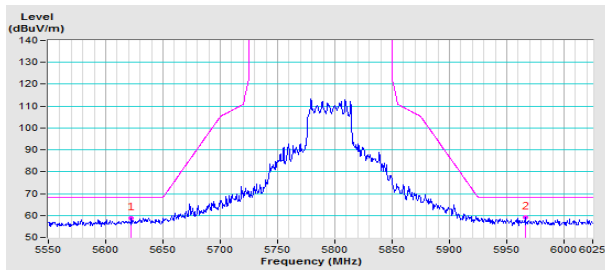

Vertical

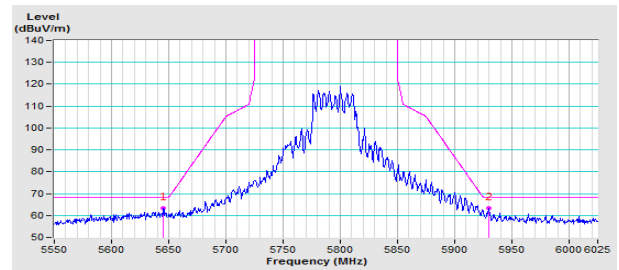

802.11ax (HE80)

CH 155 5775 MHz

Horizontal

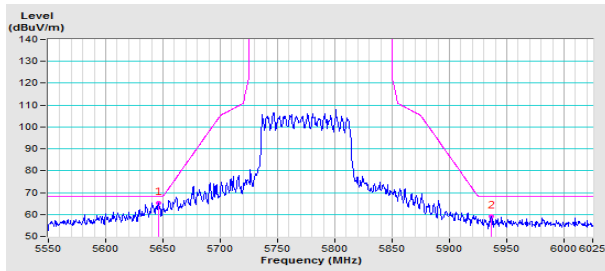

Vertical

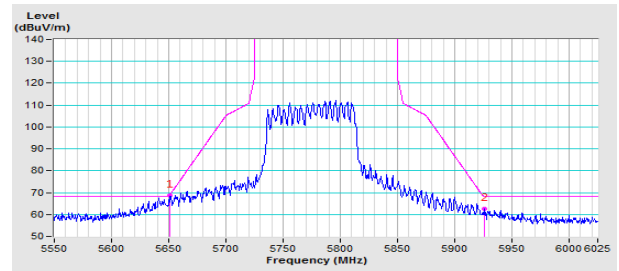

Appendix – Information of the Testing Laboratories

We, Bureau Veritas Consumer Products Services (H.K.) Ltd., Taoyuan Branch, were founded in 1988 to provide our best service in EMC, Radio, Telecom and Safety consultation. Our laboratories are FCC recognized accredited test firms and accredited according to ISO/IEC 17025.

If you have any comments, please feel free to contact us at the following:

Linkou EMC/RF Lab

Tel: 886-2-26052180

Fax: 886-2-26051924

Hsin Chu EMC/RF/Telecom Lab

Tel: 886-3-6668565

Fax: 886-3-6668323

Hwa Ya EMC/RF/Safety Lab

Tel: 886-3-3183232

Fax: 886-3-3270892

Email: service.adt@tw.bureauveritas.com

Web Site: www.bureauveritas-adt.com

The address and road map of all our labs can be found in our web site also.

--- END ---