

FCC Test Report (Part 90R)

Report No.: RF181015C09-3

FCC ID: PY318300428

Test Model: MR5000

Received Date: Oct. 15, 2018

Test Date: Oct. 27 ~ Nov. 05, 2018

Issued Date: Nov. 15, 2018

Applicant: NETGEAR INC.

Address: 350 East Plumeria Drive, San Jose, CA 95134, USA

Issued By: Bureau Veritas Consumer Products Services (H.K.) Ltd., Taoyuan Branch

Lab Address: No. 47-2, 14th Ling, Chia Pau Vil., Lin Kou Dist., New Taipei City, Taiwan (R.O.C.)

Test Location: No. 19, Hwa Ya 2nd Rd., Wen Hwa Vil., Kwei Shan Dist., Taoyuan City 33383, TAIWAN (R.O.C.)

**FCC Registration /
Designation Number:** 788550 / TW0003



This report is for your exclusive use. Any copying or replication of this report to or for any other person or entity, or use of our name or trademark, is permitted only with our prior written permission. This report sets forth our findings solely with respect to the test samples identified herein. The results set forth in this report are not indicative or representative of the quality or characteristics of the lot from which a test sample was taken or any similar or identical product unless specifically and expressly noted. Our report includes all of the tests requested by you and the results thereof based upon the information that you provided to us. You have 60 days from date of issuance of this report to notify us of any material error or omission caused by our negligence, provided, however, that such notice shall be in writing and shall specifically address the issue you wish to raise. A failure to raise such issue within the prescribed time shall constitute your unqualified acceptance of the completeness of this report, the tests conducted and the correctness of the report contents. Unless specific mention, the uncertainty of measurement has been explicitly taken into account to declare the compliance or non-compliance to the specification. The report must not be used by the client to claim product certification, approval, or endorsement by TAF or any government agency

Table of Contents

Release Control Record	4
1 Certificate of Conformity	5
2 Summary of Test Results	6
2.1 Measurement Uncertainty.....	6
2.2 Test Site and Instruments.....	7
3 General Information	8
3.1 General Description of EUT.....	8
3.2 Configuration of System under Test.....	9
3.2.1 Description of Support Units.....	9
3.3 Test Mode Applicability and Tested Channel Detail.....	10
3.4 EUT Operating Conditions.....	11
3.5 General Description of Applied Standards.....	11
4 Test Types and Results	12
4.1 Output Power Measurement.....	12
4.1.1 Limits of Output Power Measurement.....	12
4.1.2 Test Procedures.....	12
4.1.3 Test Setup.....	13
4.1.4 Test Results.....	14
4.2 Modulation Characteristics Measurement.....	19
4.2.1 Limits of Modulation Characteristics.....	19
4.2.2 Test Procedure.....	19
4.2.3 Test Setup.....	19
4.2.4 Test Results.....	20
4.3 Frequency Stability Measurement.....	21
4.3.1 Limits of Frequency Stability Measurement.....	21
4.3.2 Test Procedure.....	21
4.3.3 Test Setup.....	21
4.3.4 Test Results.....	22
4.4 Occupied Bandwidth Measurement.....	24
4.4.1 Limits of Occupied Bandwidth Measurement.....	24
4.4.2 Test Procedure.....	24
4.4.3 Test Setup.....	24
4.4.4 Test Result.....	25
4.5 Emission Mask Measurement.....	26
4.5.1 Limits of Emission Mask Measurement.....	26
4.5.2 Test Procedures.....	26
4.5.3 Test Setup.....	26
4.5.4 Test Results.....	27
4.6 Band Edge Measurement.....	29
4.6.1 Limits of Band Edge Measurement.....	29
4.6.2 Test Setup.....	29
4.6.3 Test Procedures.....	29
4.6.4 Test Results.....	30
4.7 Conducted Spurious Emissions.....	32
4.7.1 Limits of Conducted Spurious Emissions Measurement.....	32
4.7.2 Test Setup.....	32
4.7.3 Test Procedure.....	32
4.7.4 Test Results.....	33
4.8 Radiated Emission Measurement.....	37
4.8.1 Limits of Radiated Emission Measuremen.....	37
4.8.2 Test Procedure.....	37
4.8.3 Deviation from Test Standard.....	37
4.8.4 Test Setup.....	38

4.8.5 Test Results	39
5 Pictures of Test Arrangements.....	46
Appendix – Information on the Testing Laboratories	47

Release Control Record

Issue No.	Description	Date Issued
RF181015C09-3	Original release	Nov. 15, 2018

1 Certificate of Conformity

Product: 5G MHS Travel Router

Brand: Netgear

Test Model: MR5000

Sample Status: Engineering sample

Applicant: NETGEAR INC.

Test Date: Oct. 27 ~ Nov. 05, 2018

Standards: FCC Part 90, Subpart R

The above equipment has been tested by **Bureau Veritas Consumer Products Services (H.K.) Ltd., Taoyuan Branch**, and found compliance with the requirement of the above standards. The test record, data evaluation & Equipment Under Test (EUT) configurations represented herein are true and accurate accounts of the measurements of the sample's RF characteristics under the conditions specified in this report.

Prepared by : *Polly Chien* , **Date:** Nov. 15, 2018
Polly Chien / Specialist

Approved by : *Bruce Chen* , **Date:** Nov. 15, 2018
Bruce Chen / Project Engineer

2 Summary of Test Results

Applied Standard: FCC Part 90 & Part 2			
FCC Clause	Test Item	Result	Remarks
2.1046 90.542 (a)(7)	Effective Radiated Power	Pass	Meet the requirement of limit.
2.1047	Modulation Characteristics	Pass	Meet the requirement.
2.1055 90.539 (e)	Frequency Stability	Pass	Meet the requirement of limit.
2.1049	Occupied Bandwidth (*)	Pass	Meet the requirement of limit.
90.210 (n)	Emission Masks	Pass	Meet the requirement of limit.
2.1053 90.543 (e)(2)(3)	Band Edge Measurements	Pass	Meet the requirement of limit.
2.1051 90.543 (e)(3)	Conducted Spurious Emissions	Pass	Meet the requirement of limit.
2.1053 90.543 (e)(f)	Radiated Spurious Emissions	Pass	Meet the requirement of limit. Minimum passing margin is -11.1dB at 1581.00MHz.

2.1 Measurement Uncertainty

Where relevant, the following measurement uncertainty levels have been estimated for tests performed on the EUT as specified in CISPR 16-4-2:

Measurement	Frequency	Expanded Uncertainty (k=2) (±)
Radiated Emissions up to 1 GHz	30MHz ~ 200MHz	3.59 dB
	200MHz ~1000MHz	3.60 dB
Radiated Emissions above 1 GHz	1GHz ~ 18GHz	2.29 dB
	18GHz ~ 40GHz	2.29 dB

2.2 Test Site and Instruments

Description & Manufacturer	Model No.	Serial No.	Cal. Date	Cal. Due
Test Receiver KEYSIGHT	N9038A	MY55420137	Apr. 11, 2018	Apr. 10, 2019
Spectrum Analyzer ROHDE & SCHWARZ	FSP40	100269	May 29, 2018	May 28, 2019
BILOG Antenna SCHWARZBECK	VULB9168	9168-148	Dec. 11, 2017	Dec. 10, 2018
HORN Antenna SCHWARZBECK	BBHA 9120 D	9120D-1169	Dec. 12, 2017	Dec. 11, 2018
HORN Antenna SCHWARZBECK	BBHA 9170	BBHA9170241	Dec. 01, 2017	Nov. 30, 2018
Preamplifier Agilent (Below 1GHz)	8447D	2944A10638	Aug. 08, 2018	Aug. 07, 2019
Preamplifier Agilent (Above 1GHz)	8449B	3008A01638	Feb. 22, 2018	Feb. 21, 2019
RF signal cable HUBER+SUHNER&EMCI	SUCOFLEX 104 & EMC104-SM-SM80 00	CABLE-CH9-02 (248780+171006)	Jan. 15, 2018	Jan. 14, 2019
RF signal cable HUBER+SUHNER	SUCOFLEX 104	CABLE-CH9-(250795/4)	Aug. 08, 2018	Aug. 07, 2019
RF signal cable Woken	8D-FB	Cable-CH9-01	Jul. 31, 2018	Jul. 30, 2019
Software BV ADT	ADT_Radiated_ V7.6.15.9.5	NA	NA	NA
Antenna Tower EMCO	2070/2080	512.835.4684	NA	NA
Turn Table EMCO	2087-2.03	NA	NA	NA
Antenna Tower & Turn BV ADT	AT100	AT93021705	NA	NA
Turn Table BV ADT	TT100	TT93021705	NA	NA
Turn Table Controller BV ADT	SC100	SC93021705	NA	NA
Boresight Antenna Fixture	FBA-01	FBA-SIP01	NA	NA
WIT Standard Temperature And Humidity Chamber	TH-4S-C	W981030	Jun. 04, 2018	Jun. 03, 2019
Mini-Circuits Power Splitter	ZN2PD-9G	NA	Jun. 21, 2018	Jun. 20, 2019
JFW 20dB attenuation	50HF-020-SMA	NA	NA	NA

- Note:
1. The calibration interval of the above test instruments is 12 months and the calibrations are traceable to NML/ROC and NIST/USA.
 2. The test was performed in HwaYa Chamber 9.
 3. The FCC Designation Number is TW0003. The number will be varied with the Lab location and scope as attached.
 4. The IC Site Registration No. is 7450F-9.

3 General Information

3.1 General Description of EUT

Product	5G MHS Travel Router			
Brand	Netgear			
Test Model	MR5000			
Status of EUT	Engineering sample			
Power Supply Rating	5.0 Vdc or 9Vdc (adapter) 3.85Vdc (battery)			
Modulation Type	QPSK, 16QAM, 64QAM			
Operating Frequency	Channel Bandwidth 5MHz	790.50MHz ~ 795.5MHz		
	Channel Bandwidth 10MHz	793MHz		
Max. ERP Power		QPSK	16QAM	64QAM
	Channel Bandwidth 5MHz	123.027mW (20.9dBm)	95.499mW (19.8dBm)	81.283mW (19.1dBm)
	Channel Bandwidth 10MHz	144.544mW (21.6dBm)	107.152mW (20.3dBm)	95.499mW (19.8dBm)
Emission Designator		QPSK	16QAM	64QAM
	Channel Bandwidth 5MHz	4M49G7D	4M49D7W	4M50D7W
	Channel Bandwidth 10MHz	8M96G7D	8M96D7W	8M97D7W
Antenna Type	Internal IFA antenna with 1.09dBi			
Antenna Connector	NA			
Accessory Device	Adapter, battery			
Data Cable Supplied	0.95m shielded USB cable without core			

Note:

1. The EUT consumes power from the following adapter and battery.

Adapter	
Brand	NETGEAR
Model	AD2122F20
Input	100-240Vac, 50/60Hz, 0.5A
Output	5.0Vdc, 2.0A or 9Vdc /1.8A

Lithium ion battery	
Brand	NETGEAR
Model	W-10a
P/N	308-10084-01
Rating	3.85Vdc, 19.78Wh, 5040mAh

3.2 Configuration of System under Test

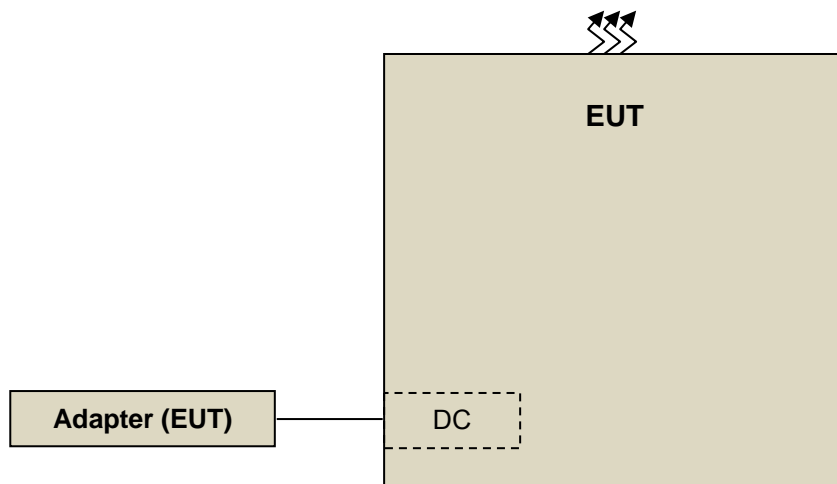

Remote site

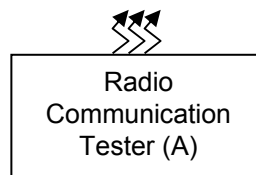

3.2.1 Description of Support Units

The EUT has been tested as an independent unit together with other necessary accessories or support units. The following support units or accessories were used to form a representative test configuration during the tests.

ID	Product	Brand	Model No.	Serial No.	FCC ID	Remarks
A.	Radio Communication Tester	Anritsu	MT8820C	6201010284	NA	-

Note:

1. All power cords of the above support units are non-shielded (1.8m).
2. Item A acted as a communication partner to transfer data.

3.3 Test Mode Applicability and Tested Channel Detail

Pre-Scan has been conducted to determine the worst-case mode from all possible combinations between available modulations, data rates, XYZ axis and antenna ports. The worst case was found when positioned on X-plane. Following channel(s) was (were) selected for the final test as listed below:

EUT Configure Mode	Test item	Available channel	Tested channel	Channel Bandwidth	Modulation	Mode
-	ERP	23305 to 23355	23305(790.5MHz), 23330(793.0MHz), 23355(795.5MHz)	5MHz	QPSK / 16QAM / 64QAM	1 RB / 0 RB Offset
		23330	23330(793.0MHz)	10MHz	QPSK / 16QAM / 64QAM	1 RB / 0 RB Offset
-	Modulation Characteristics	23305 to 23355	23330(793.0MHz)	10MHz	QPSK / 16QAM / 64QAM	1 RB / 0 RB Offset
-	Frequency Stability	23305 to 23355	23305(790.5MHz), 23355(795.5MHz)	5MHz	QPSK	1 RB / 0 RB Offset
		23330	23330(793.0MHz)	10MHz	QPSK	1 RB / 0 RB Offset
-	Occupied Bandwidth	23305 to 23355	23305(790.5MHz), 23330(793.0MHz), 23355(795.5MHz)	5MHz	QPSK / 16QAM / 64QAM	25 RB / 0 RB Offset
		23330	23330(793.0MHz)	10MHz	QPSK / 16QAM / 64QAM	50 RB / 0 RB Offset
-	Emission Mask	23305 to 23355	23305(790.5MHz), 23330(793.0MHz), 23355(795.5MHz)	5MHz	QPSK / 16QAM / 64QAM	25 RB / 0 RB Offset
		23330	23330(793.0MHz)	10MHz	QPSK / 16QAM / 64QAM	50 RB / 0 RB Offset
-	Band Edge	23305 to 23355	23305(790.5MHz), 23355(795.5MHz)	5MHz	QPSK	1 RB / 0 RB Offset 25 RB / 0 RB Offset
		23330	23330(793.0MHz)	10MHz	QPSK	1 RB / 0 RB Offset 1 RB / 49 RB Offset 50 RB / 0 RB Offset
-	Conducted Emission	23305 to 23355	23305(790.5MHz), 23330(793.0MHz), 23355(795.5MHz)	5MHz	QPSK	1 RB / 0 RB Offset
		23330	23330(793.0MHz)	10MHz	QPSK	1 RB / 0 RB Offset
-	Radiated Emission below 1GHz	23305 to 23355	23305(790.5MHz)	5MHz	QPSK	1 RB / 0 RB Offset
		23330	23330(793.0MHz)	10MHz	QPSK	1 RB / 0 RB Offset
-	Radiated Emission above 1GHz	23305 to 23355	23305(790.5MHz), 23330(793.0MHz), 23355(795.5MHz)	5MHz	QPSK	1 RB / 0 RB Offset
		23330	23330(793.0MHz)	10MHz	QPSK	1 RB / 0 RB Offset

Note: The output power for QPSK, 16QAM and 64QAM, measured value of QPSK is higher than 16QAM and 64QAM mode. Therefore, only ERP, Modulation Characteristics, Occupied Bandwidth, Emission Mask and Band Edge had been tested under QPSK, 16QAM and 64QAM modes, the other test items were performed under QPSK mode only.

Test Condition:

Test Item	Environmental Conditions	Input Power	Tested By
ERP	25deg. C, 66%RH	120Vac, 60Hz	Tim Chen
Modulation characteristics	24deg. C, 64%RH	120Vac, 60Hz	Wayne Lin
Frequency Stability	24deg. C, 64%RH	120Vac, 60Hz	Wayne Lin
Occupied Bandwidth	24deg. C, 64%RH	120Vac, 60Hz	Wayne Lin
Emission Mask	24deg. C, 64%RH	120Vac, 60Hz	Wayne Lin
Band Edge	24deg. C, 64%RH	120Vac, 60Hz	Wayne Lin
Conducted Emission	24deg. C, 64%RH	120Vac, 60Hz	Wayne Lin
Radiated Emission	25deg. C, 66%RH	120Vac, 60Hz	Greg Lin Tim Chen

3.4 EUT Operating Conditions

The EUT makes a call to the communication simulator. The communication simulator station system controlled a EUT to export maximum output power under transmission mode and specific channel frequency

3.5 General Description of Applied Standards

The EUT is a RF Product. According to the specifications of the manufacturer, it must comply with the requirements of the following standards:

FCC 47 CFR Part 2

FCC 47 CFR Part 90

KDB 971168 D01 Power Meas License Digital Systems v03r01

ANSI/TIA/EIA-603-E 2016

ANSI 63.26-2015

Note: All test items have been performed and recorded as per the above standards.

4 Test Types and Results

4.1 Output Power Measurement

4.1.1 Limits of Output Power Measurement

Portable stations (hand-held devices) transmitting in the 758-768 MHz band and the 788-798 MHz band are limited to 3 watts ERP.

4.1.2 Test Procedures

EIRP / ERP Measurement:

- a. The EUT was set up for the maximum power with LTE link data modulation. The power was measured with Agilent Spectrum Analyzer. All measurements were done at 1 channel. RWB is 1MHz and VBW is 3MHz.
- b. Substitution method is used for E.I.R.P measurement. In the semi-anechoic chamber, EUT placed on the 0.8m(below or equal 1GHz) and/or 1.5m(above 1GHz) height of Turn Table, rotated the table around 360 degrees to search the maximum radiation power and receiver antenna shall be rotated vertical and horizontal polarization and moved height from 1m to 4m to find the maximum polar radiated power. The "Read Value" is the spectrum reading the maximum power value.
- c. The substitution horn antenna is substituted for EUT at the same position and signals generator export the CW signal to the substitution antenna via a tx cable. Rotated the Turn Table and moved receiving antenna to find the maximum radiation power. Adjust output power level of S.G to get a Value of spectrum reading equal to "Read Value" of step b. Record the power level of S.G
- d. $EIRP = \text{Output power level of S.G} - \text{TX cable loss} + \text{Antenna gain of substitution horn}$. E.R.P power can be calculated form E.I.R.P power by subtracting the gain of dipole, $E.R.P \text{ power} = E.I.R.P \text{ power} - 2.15\text{dBi}$.

Conducted Power Measurement:

The EUT was set up for the maximum power with LTE link data modulation and link up with simulator. Set the EUT to transmit under low, middle and high channel and record the power level shown on simulator.

4.1.3 Test Setup

EIRP / ERP MEASUREMENT:

For Radiated Emission below or equal 1GHz

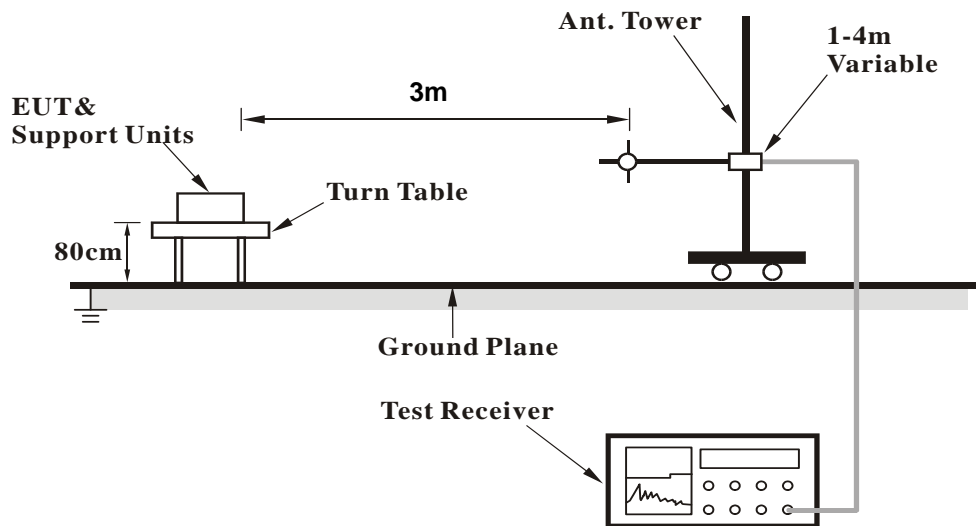

For Radiated Emission above 1GHz

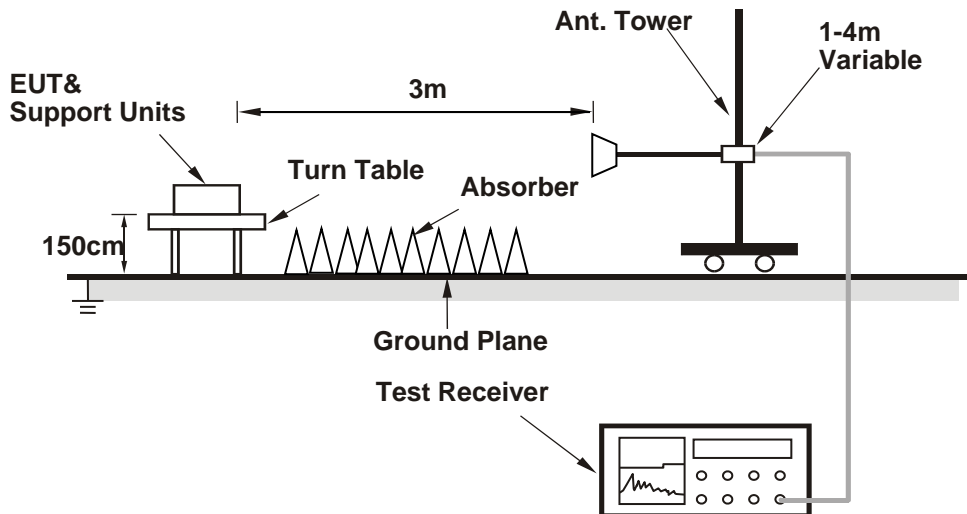

For the actual test configuration, please refer to the attached file (Test Setup Photo).

CONDUCTED POWER MEASUREMENT:



For the actual test configuration, please refer to the attached file (Test Setup Photo).

4.1.4 Test Results

Conducted Output Power (dBm)

LTE Band 14				
BW	MCS Index	RB Size	RB Offset	Mid
		Channel		23330
		Frequency (MHz)		793
10M	QPSK	1	0	23.31
		1	24	22.76
		1	49	23.09
		25	0	22.36
		25	12	22.32
		25	25	22.23
		50	0	22.31
	16QAM	1	0	22.30
		1	24	21.71
		1	49	21.99
		25	0	21.35
		25	12	21.31
		25	25	21.23
		50	0	21.28
	64QAM	1	0	21.29
		1	24	20.75
		1	49	21.05
		25	0	20.32
		25	12	20.28
		25	25	20.14
		50	0	20.29

LTE Band 14						
BW	MCS Index	RB Size	RB Offset	Low	Mid	High
		Channel		23305	23330	23355
		Frequency (MHz)		790.5	793	795.5
5M	QPSK	1	0	22.95	23.04	22.87
		1	12	22.74	22.83	22.66
		1	24	22.72	22.81	22.64
		12	0	22.19	22.28	22.11
		12	6	22.16	22.25	22.08
		12	13	22.18	22.27	22.10
		25	0	22.27	22.36	22.19
	16QAM	1	0	21.94	21.97	21.91
		1	12	22.18	21.81	22.33
		1	24	22.24	21.78	22.30
		12	0	21.15	21.21	21.32
		12	6	21.49	21.22	21.32
		12	13	21.47	21.18	21.46
		25	0	21.44	21.34	21.43
	64QAM	1	0	20.95	21.03	20.90
		1	12	21.26	20.77	21.19
		1	24	21.41	20.73	21.24
		12	0	20.27	20.22	20.09
		12	6	20.48	20.22	20.49
		12	13	20.46	20.25	20.42
		25	0	20.49	20.30	20.48

ERP Power (dBm)

Modulation Type: QPSK

Channel Bandwidth: 5MHz

MODE		TX channel 23335					
Antenna Polarity & Test Distance: Horizontal at 3 M							
No.	Freq. (MHz)	Reading (dBm)	S.G Power Value (dBm)	Correction Factor (dB)	ERP (dBm)	Limit (dBm)	Margin (dB)
1	790.50	-9.6	16.6	4.0	20.6	34.8	-14.2
Antenna Polarity & Test Distance: Vertical at 3 M							
No.	Freq. (MHz)	Reading (dBm)	S.G Power Value (dBm)	Correction Factor (dB)	ERP (dBm)	Limit (dBm)	Margin (dB)
1	790.50	-17.1	10.7	4.0	14.7	34.8	-20.1

MODE		TX channel 23330					
Antenna Polarity & Test Distance: Horizontal at 3 M							
No.	Freq. (MHz)	Reading (dBm)	S.G Power Value (dBm)	Correction Factor (dB)	ERP (dBm)	Limit (dBm)	Margin (dB)
1	793.00	-9.4	16.9	4.0	20.9	34.8	-13.9
Antenna Polarity & Test Distance: Vertical at 3 M							
No.	Freq. (MHz)	Reading (dBm)	S.G Power Value (dBm)	Correction Factor (dB)	ERP (dBm)	Limit (dBm)	Margin (dB)
1	793.00	-16.6	11.1	4.0	15.1	34.8	-19.7

MODE		TX channel 23355					
Antenna Polarity & Test Distance: Horizontal at 3 M							
No.	Freq. (MHz)	Reading (dBm)	S.G Power Value (dBm)	Correction Factor (dB)	ERP (dBm)	Limit (dBm)	Margin (dB)
1	795.50	-9.8	16.6	4.0	20.6	34.8	-14.2
Antenna Polarity & Test Distance: Vertical at 3 M							
No.	Freq. (MHz)	Reading (dBm)	S.G Power Value (dBm)	Correction Factor (dB)	ERP (dBm)	Limit (dBm)	Margin (dB)
1	795.50	-17.1	10.5	4.0	14.5	34.8	-20.3

Note: ERP (dBm) = S.G Power Value (dBm) + Correction Factor (dB).

Channel Bandwidth: 10MHz

MODE		TX channel 23330					
Antenna Polarity & Test Distance: Horizontal at 3 M							
No.	Freq. (MHz)	Reading (dBm)	S.G Power Value (dBm)	Correction Factor (dB)	ERP (dBm)	Limit (dBm)	Margin (dB)
1	793.00	-8.6	17.6	4.0	21.6	34.8	-13.2
Antenna Polarity & Test Distance: Vertical at 3 M							
No.	Freq. (MHz)	Reading (dBm)	S.G Power Value (dBm)	Correction Factor (dB)	ERP (dBm)	Limit (dBm)	Margin (dB)
1	793.00	-14.8	13.0	4.0	17.0	34.8	-17.8

Note: ERP (dBm) = S.G Power Value (dBm) + Correction Factor (dB).

Modulation Type: 16QAM

Channel Bandwidth: 5MHz

MODE		TX channel 23335					
Antenna Polarity & Test Distance: Horizontal at 3 M							
No.	Freq. (MHz)	Reading (dBm)	S.G Power Value (dBm)	Correction Factor (dB)	ERP (dBm)	Limit (dBm)	Margin (dB)
1	790.50	-10.4	15.8	4.0	19.8	34.8	-15.0
Antenna Polarity & Test Distance: Vertical at 3 M							
No.	Freq. (MHz)	Reading (dBm)	S.G Power Value (dBm)	Correction Factor (dB)	ERP (dBm)	Limit (dBm)	Margin (dB)
1	790.50	-17.9	9.9	4.0	13.9	34.8	-20.9

MODE		TX channel 23330					
Antenna Polarity & Test Distance: Horizontal at 3 M							
No.	Freq. (MHz)	Reading (dBm)	S.G Power Value (dBm)	Correction Factor (dB)	ERP (dBm)	Limit (dBm)	Margin (dB)
1	793.00	-10.6	15.6	4.0	19.6	34.8	-15.2
Antenna Polarity & Test Distance: Vertical at 3 M							
No.	Freq. (MHz)	Reading (dBm)	S.G Power Value (dBm)	Correction Factor (dB)	ERP (dBm)	Limit (dBm)	Margin (dB)
1	793.00	-18.6	9.1	4.0	13.1	34.8	-21.7

MODE		TX channel 23355					
Antenna Polarity & Test Distance: Horizontal at 3 M							
No.	Freq. (MHz)	Reading (dBm)	S.G Power Value (dBm)	Correction Factor (dB)	ERP (dBm)	Limit (dBm)	Margin (dB)
1	795.50	-11.1	15.3	4.0	19.3	34.8	-15.5
Antenna Polarity & Test Distance: Vertical at 3 M							
No.	Freq. (MHz)	Reading (dBm)	S.G Power Value (dBm)	Correction Factor (dB)	ERP (dBm)	Limit (dBm)	Margin (dB)
1	795.50	-19.2	8.4	4.0	12.4	34.8	-22.4

Note: ERP (dBm) = S.G Power Value (dBm) + Correction Factor (dB).

Channel Bandwidth: 10MHz

MODE		TX channel 23330					
Antenna Polarity & Test Distance: Horizontal at 3 M							
No.	Freq. (MHz)	Reading (dBm)	S.G Power Value (dBm)	Correction Factor (dB)	ERP (dBm)	Limit (dBm)	Margin (dB)
1	793.00	-9.9	16.3	4.0	20.3	34.8	-14.5
Antenna Polarity & Test Distance: Vertical at 3 M							
No.	Freq. (MHz)	Reading (dBm)	S.G Power Value (dBm)	Correction Factor (dB)	ERP (dBm)	Limit (dBm)	Margin (dB)
1	793.00	-15.8	11.9	4.0	15.9	34.8	-18.9

Note: ERP (dBm) = S.G Power Value (dBm) + Correction Factor (dB).

Modulation Type: 64QAM

Channel Bandwidth: 5MHz

MODE		TX channel 23335					
Antenna Polarity & Test Distance: Horizontal at 3 M							
No.	Freq. (MHz)	Reading (dBm)	S.G Power Value (dBm)	Correction Factor (dB)	ERP (dBm)	Limit (dBm)	Margin (dB)
1	790.50	-11.9	14.3	4.0	18.3	34.8	-16.5
Antenna Polarity & Test Distance: Vertical at 3 M							
No.	Freq. (MHz)	Reading (dBm)	S.G Power Value (dBm)	Correction Factor (dB)	ERP (dBm)	Limit (dBm)	Margin (dB)
1	790.50	-19.6	8.1	4.0	12.1	34.8	-22.7

MODE		TX channel 23330					
Antenna Polarity & Test Distance: Horizontal at 3 M							
No.	Freq. (MHz)	Reading (dBm)	S.G Power Value (dBm)	Correction Factor (dB)	ERP (dBm)	Limit (dBm)	Margin (dB)
1	793.00	-11.1	15.1	4.0	19.1	34.8	-15.7
Antenna Polarity & Test Distance: Vertical at 3 M							
No.	Freq. (MHz)	Reading (dBm)	S.G Power Value (dBm)	Correction Factor (dB)	ERP (dBm)	Limit (dBm)	Margin (dB)
1	793.00	-18.1	9.6	4.0	13.6	34.8	-21.2

MODE		TX channel 23355					
Antenna Polarity & Test Distance: Horizontal at 3 M							
No.	Freq. (MHz)	Reading (dBm)	S.G Power Value (dBm)	Correction Factor (dB)	ERP (dBm)	Limit (dBm)	Margin (dB)
1	795.50	-11.6	14.8	4.0	18.8	34.8	-16.0
Antenna Polarity & Test Distance: Vertical at 3 M							
No.	Freq. (MHz)	Reading (dBm)	S.G Power Value (dBm)	Correction Factor (dB)	ERP (dBm)	Limit (dBm)	Margin (dB)
1	795.50	-19.8	7.8	4.0	11.8	34.8	-23.0

Note: ERP (dBm) = S.G Power Value (dBm) + Correction Factor (dB).

Channel Bandwidth: 10MHz

MODE		TX channel 23330					
Antenna Polarity & Test Distance: Horizontal at 3 M							
No.	Freq. (MHz)	Reading (dBm)	S.G Power Value (dBm)	Correction Factor (dB)	ERP (dBm)	Limit (dBm)	Margin (dB)
1	793.00	-10.4	15.8	4.0	19.8	34.8	-15.0
Antenna Polarity & Test Distance: Vertical at 3 M							
No.	Freq. (MHz)	Reading (dBm)	S.G Power Value (dBm)	Correction Factor (dB)	ERP (dBm)	Limit (dBm)	Margin (dB)
1	793.00	-16.4	11.4	4.0	15.4	34.8	-19.4

Note: ERP (dBm) = S.G Power Value (dBm) + Correction Factor (dB).

4.2 Modulation Characteristics Measurement

4.2.1 Limits of Modulation Characteristics

N/A

4.2.2 Test Procedure

Connect the EUT to Communication Simulator via the antenna connector, the frequency band is set as EUT supported Modulation and Channels, the EUT output is matched with 50 ohm load, the waveform quality and constellation of the EUT was tested.

4.2.3 Test Setup

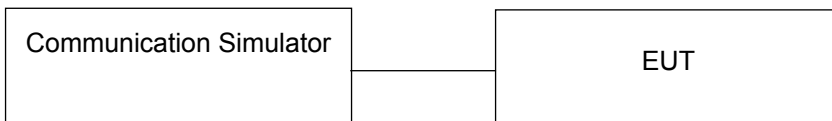

4.2.4 Test Results

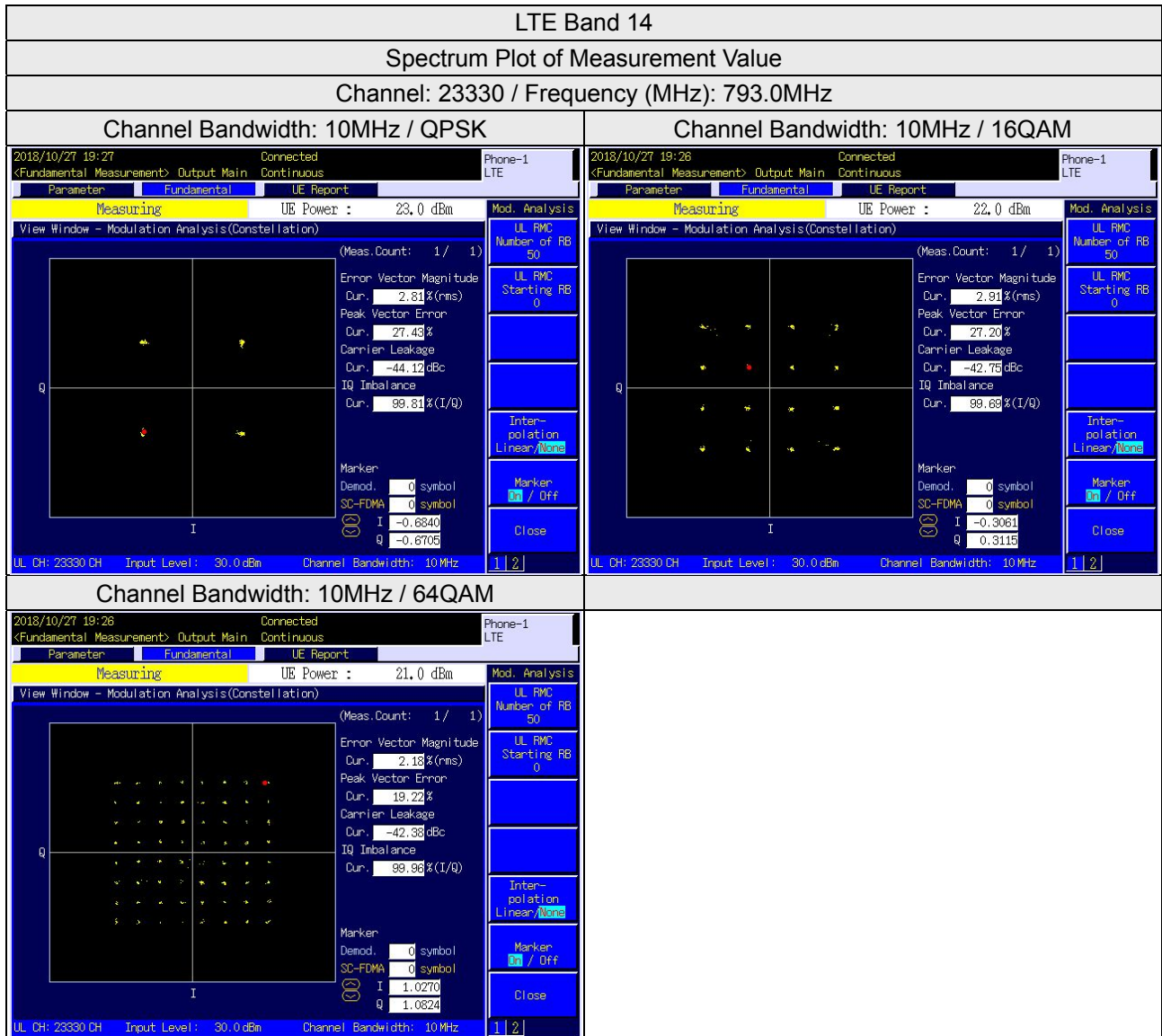

4.3 Frequency Stability Measurement

4.3.1 Limits of Frequency Stability Measurement

The frequency stability of mobile, portable and control transmitters operating in the wideband segment must be 1.25 parts per million or better when AFC is locked to a base station, and 5 parts per million or better when AFC is not locked.

4.3.2 Test Procedure

- a. Device is placed at the oven room. The oven room could control the temperatures and humidity. Power warm up is at least 15 min and power applied should perform before recording frequency error.
- b. EUT is connected the external power supply to control the DC input power. The test voltage range is from minimum to maximum working voltage. Each step shall be record the frequency error rate.
- c. The temperature range step is 10 degrees in this test items. All temperature levels shall be hold the $\pm 0.5^{\circ}\text{C}$ during the measurement testing. The each temperature step shall be at least 0.5 hours, consider the EUT could be test under the stability condition.

Note: The frequency error was recorded frequency error from the communication simulator.

4.3.3 Test Setup

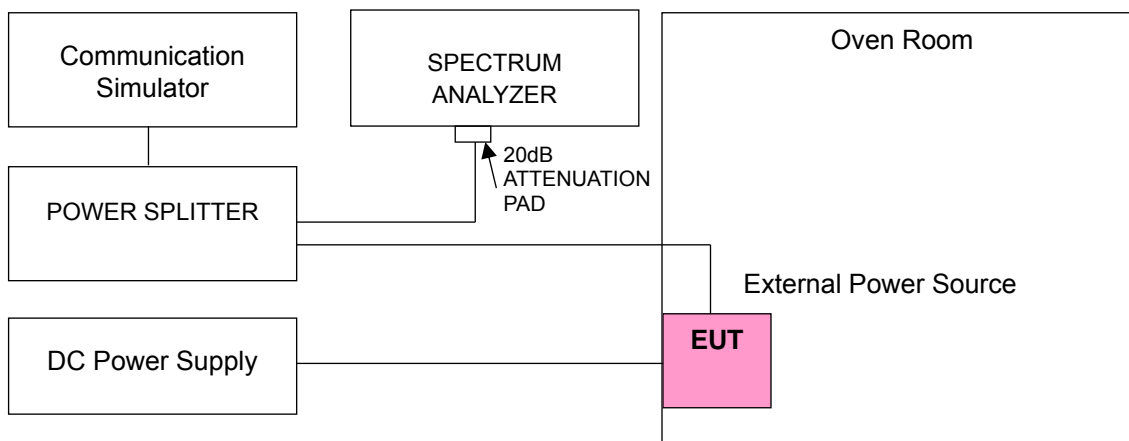

4.3.4 Test Results

Frequency Error vs. Voltage

Voltage (Volts)	LTE Band 14			
	Channel Bandwidth: 5 MHz			
	Low Channel		High Channel	
	Frequency (MHz)	Frequency Error (ppm)	Frequency (MHz)	Frequency Error (ppm)
3.80	790.500000	-0.001	795.500000	-0.001
3.23	790.499995	-0.006	795.500000	-0.005
4.37	790.500004	0.005	795.500000	0.005

Note: The applicant defined the normal working voltage is from 3.23 Vdc to 4.37 Vdc.

Frequency Error vs. Temperature

Temp. (°C)	LTE Band 14			
	Channel Bandwidth: 5 MHz			
	Low Channel		High Channel	
	Frequency (MHz)	Frequency Error (ppm)	Frequency (MHz)	Frequency Error (ppm)
-30	790.500009	0.011	795.500000	0.010
-20	790.500006	0.008	795.500000	0.007
-10	790.500004	0.004	795.500000	0.004
0	790.500002	0.003	795.500000	0.003
10	790.499999	-0.001	795.500000	0.001
20	790.499998	-0.002	795.500000	-0.004
30	790.499996	-0.005	795.500000	-0.006
40	790.499993	-0.008	795.500000	-0.007
50	790.499991	-0.011	795.500000	-0.010

Frequency Error vs. Voltage

Voltage (Volts)	LTE Band 14	
	Channel Bandwidth: 10 MHz	
	Frequency (MHz)	Frequency Error (ppm)
3.80	793.000000	-0.001
3.23	792.999996	-0.006
4.37	793.000005	0.006

Note: The applicant defined the normal working voltage is from 3.23 Vdc to 4.37 Vdc.

Frequency Error vs. Temperature

Temp. (°C)	LTE Band 14	
	Channel Bandwidth: 10 MHz	
	Frequency (MHz)	Frequency Error (ppm)
-30	793.000009	0.011
-20	793.000007	0.008
-10	793.000004	0.005
0	793.000002	0.003
10	793.000000	0.000
20	792.999999	-0.001
30	792.999996	-0.005
40	792.999993	-0.008
50	792.999991	-0.011

4.4 Occupied Bandwidth Measurement

4.4.1 Limits of Occupied Bandwidth Measurement

The width of a frequency band such that, below the lower and above the upper frequency limits, the mean powers emitted are each equal to a specified percentage 0.5 % of the total mean power of a given emission.

4.4.2 Test Procedure

The EUT makes a call to the communication simulator. All measurements were done at low, middle and high operational frequency range, RB of the spectrum is 1% of occupied bandwidth and VB of the spectrum is 3 times RBW. The communication simulator station system controlled a EUT to export maximum output power under transmission mode and specific channel frequency. Use OBW measurement function of Spectrum analyzer to measure 99 % occupied bandwidth.

4.4.3 Test Setup

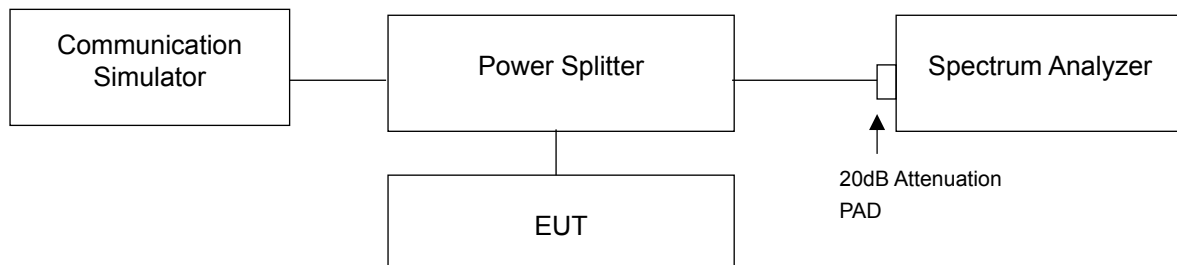

4.4.4 Test Result

Channel Bandwidth: 5MHz				
Channel	Frequency (MHz)	Occupied Bandwidth (MHz)		
		QPSK	16QAM	64QAM
23305	790.5	4.48	4.48	4.49
23330	793.0	4.49	4.49	4.49
23355	795.5	4.49	4.49	4.50

Channel Bandwidth: 10MHz				
Channel	Frequency (MHz)	Occupied Bandwidth (MHz)		
		QPSK	16QAM	64QAM
23330	793.0	8.96	8.96	8.97

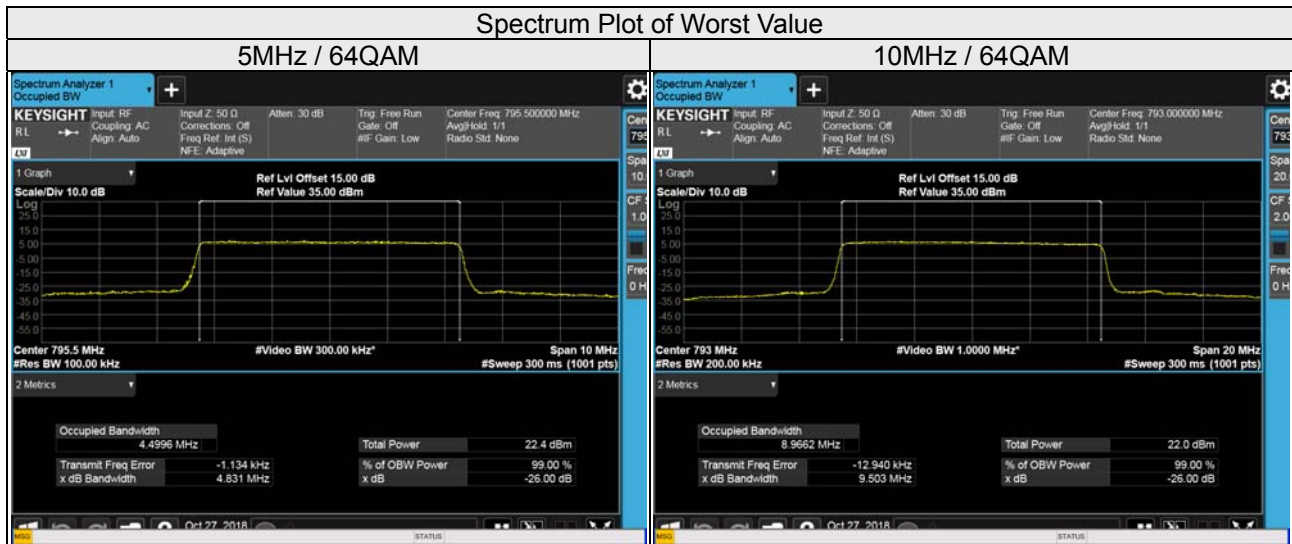

4.5 Emission Mask Measurement

4.5.1 Limits of Emission Mask Measurement

Per 90.210(n), Emission mask shall comply with 90.210(b)

- (1) On any frequency removed from the assigned frequency by more than 50 percent, but not more than 100 percent of the authorized bandwidth: At least 25 dB.
- (2) On any frequency removed from the assigned frequency by more than 100 percent, but not more than 250 percent of the authorized bandwidth: At least 35 dB.
- (3) On any frequency removed from the assigned frequency by more than 250 percent of the authorized bandwidth: At least $43 + 10 \log (P)$ dB

4.5.2 Test Procedures

- a. The measurement used the power splitter via EUT RF power connector between signal generator and spectrum analyzer.
- b. Record the test plot.

4.5.3 Test Setup

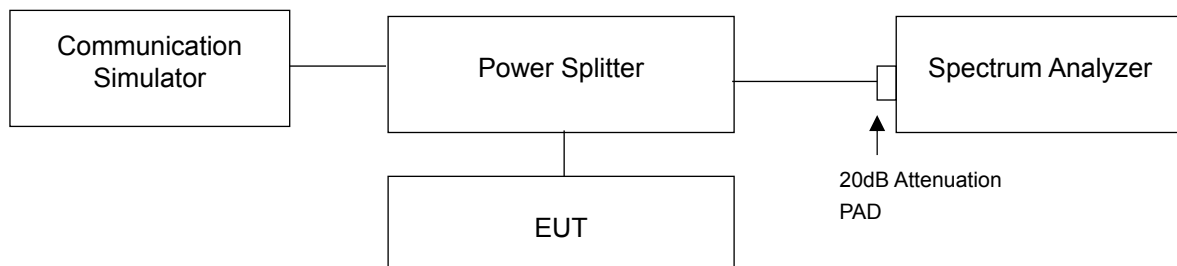

4.5.4 Test Results

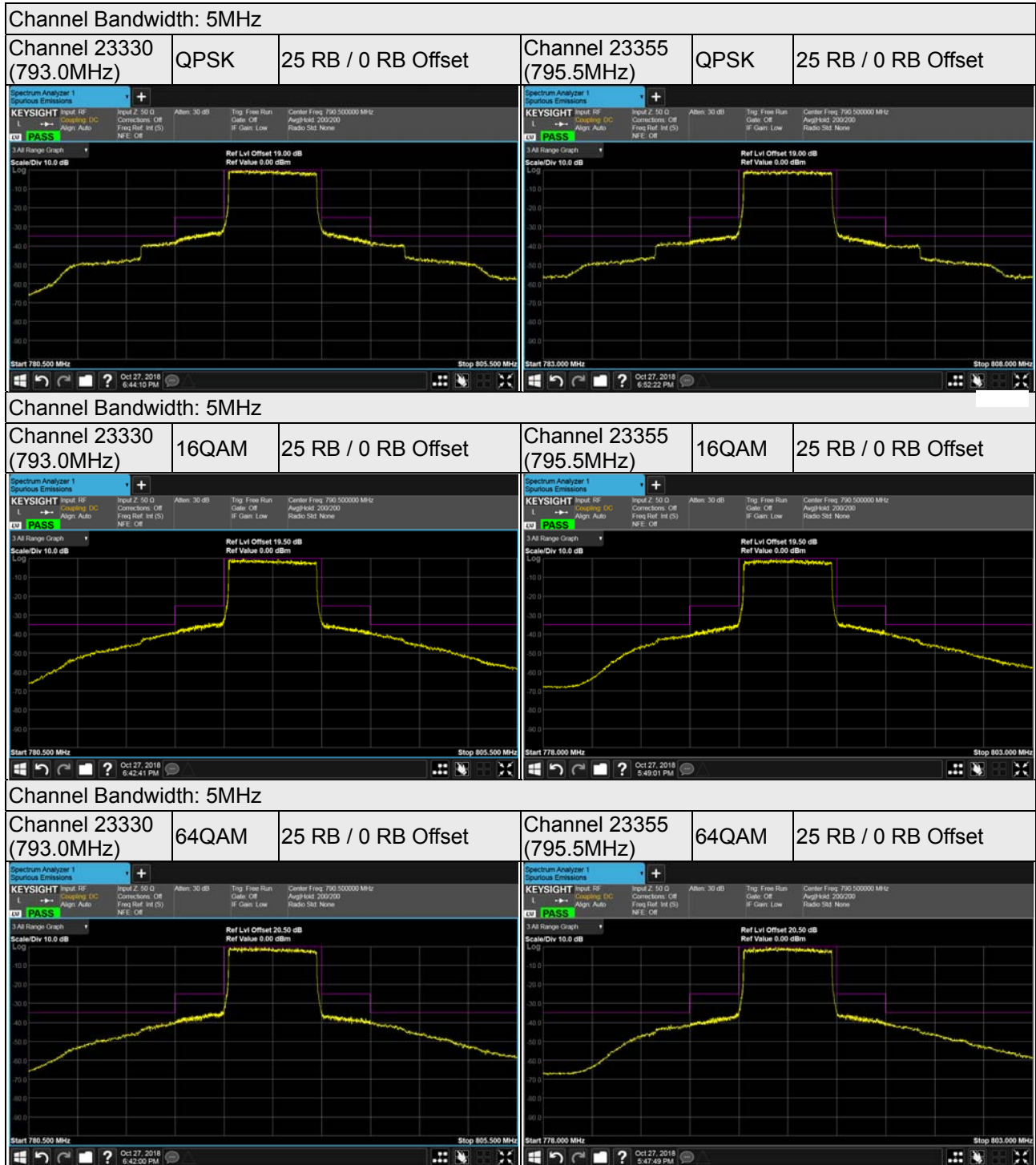

Channel Bandwidth: 10MHz

Channel 23330 (793.0MHz)	QPSK	50 RB / 0 RB Offset	Channel 23330 (793.0MHz)	16QAM	50 RB / 0 RB Offset
-----------------------------	------	---------------------	-----------------------------	-------	---------------------

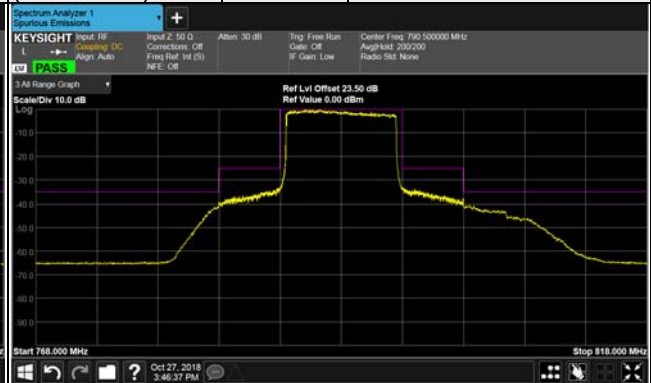
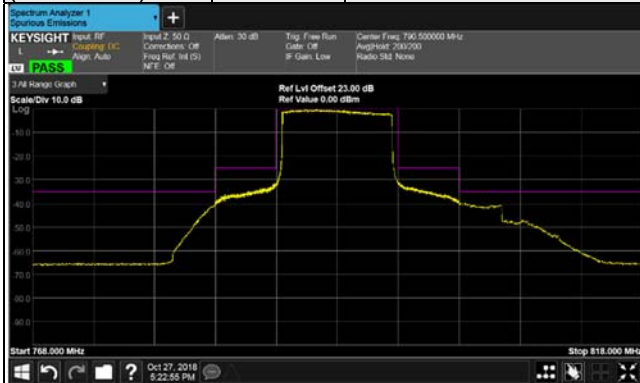

Channel 23330 (793.0MHz)	64QAM	50 RB / 0 RB Offset
-----------------------------	-------	---------------------

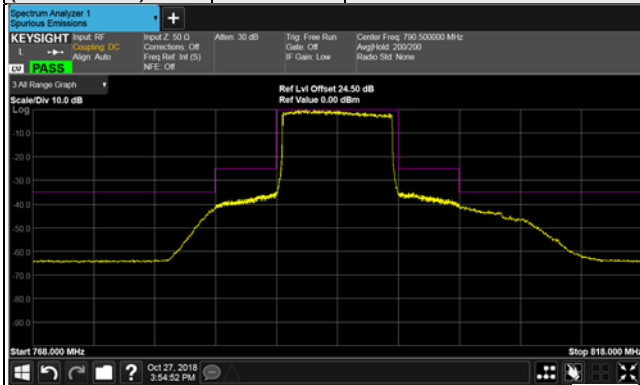

4.6 Band Edge Measurement

4.6.1 Limits of Band Edge Measurement

- (1) On all frequencies between 769 - 775 MHz and 799 - 805 MHz, by a factor not less than $76 + 10 \log (P)$ dB in a 6.25 kHz band segment, for base and fixed stations.
- (2) On all frequencies between 769 - 775 MHz and 799 - 805 MHz, by a factor not less than $65 + 10 \log (P)$ dB in a 6.25 kHz band segment, for mobile and portable stations.
- (3) On any frequency between 775 - 788 MHz, above 805 MHz, and below 758 MHz, by at least $43 + 10 \log (P)$.

4.6.2 Test Setup

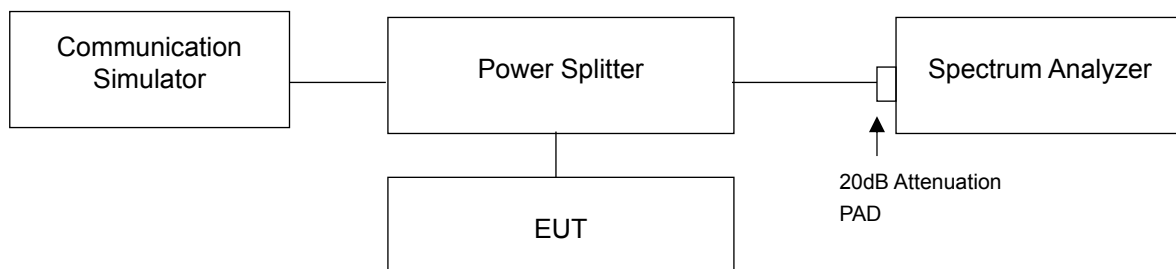

4.6.3 Test Procedures

- a. All measurements were done at low and high operational frequency range.
- b. The band edge measurement used the power splitter via EUT RF power connector between signal generator and spectrum analyzer. This splitter loss, attenuator loss and cable loss are the worst loss 21 dB in the transmitted path track.
- c. Record the max trace plot into the test report.

4.6.4 Test Results

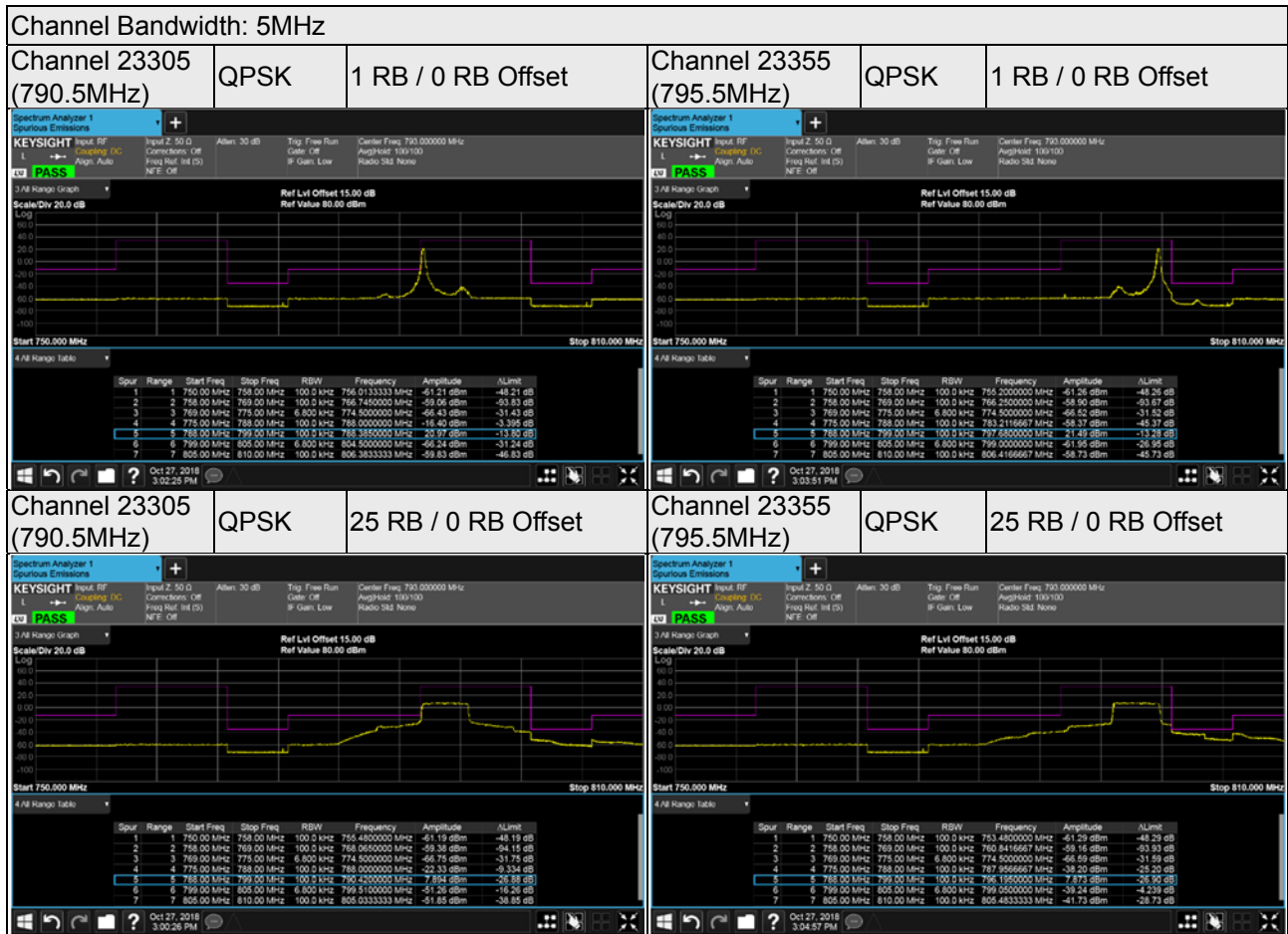

Channel Bandwidth: 10MHz

Channel 23330
(793.0MHz)

QPSK

1 RB / 0 RB Offset

Channel 23330
(793.0MHz)

QPSK

1 RB / 49 RB Offset

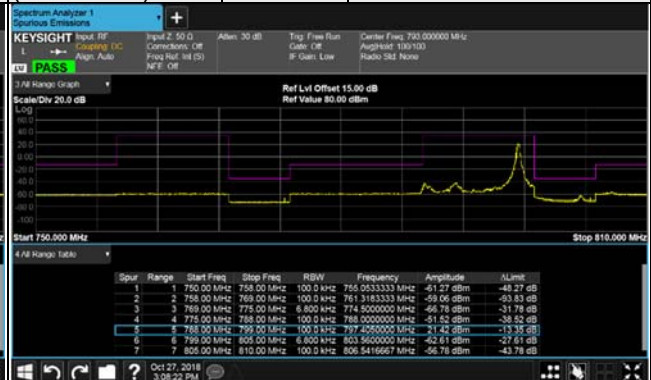
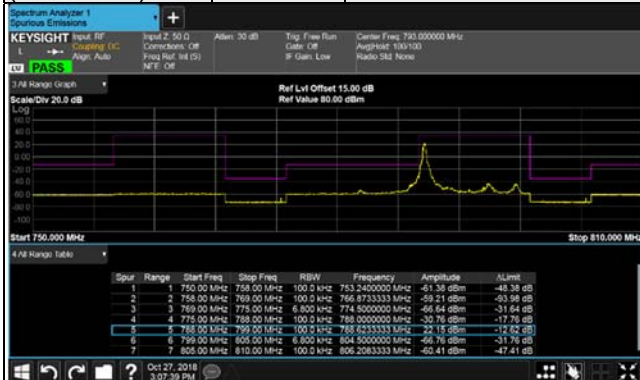

Channel 23330
(793.0MHz)

QPSK

50 RB / 0 RB Offset

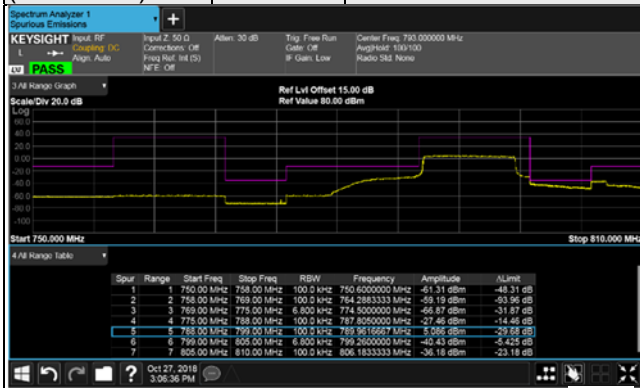

4.7 Conducted Spurious Emissions

4.7.1 Limits of Conducted Spurious Emissions Measurement

The power of any emission outside a licensee's frequency block shall be attenuated below the transmitter power (P) by at least $43 + 10 \log_{10}(P)$ dB. The limit of emission equal to -13dBm .

On all frequencies between 769–775 MHz and 799–805 MHz, by a factor not less than $65 + 10 \log(P)$ dB in a 6.25 kHz band segment, for mobile and portable stations.

4.7.2 Test Setup

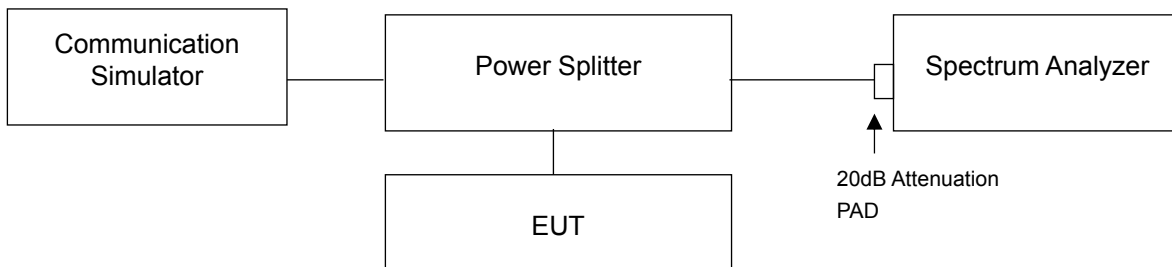

4.7.3 Test Procedure

- The EUT makes a phone call to the communication simulator. All measurements were done at low, middle and high operational frequency range.
- Measuring frequency range is from 9 kHz to 27 GHz. 10 dB attenuation pad is connected with spectrum. RBW = 100 kHz and VBW = 300 kHz for 9 kHz to 1 GHz and RBW = 1 MHz and VBW = 3 MHz for 1 GHz to 27 GHz are used for conducted emission measurement.

4.7.4 Test Results

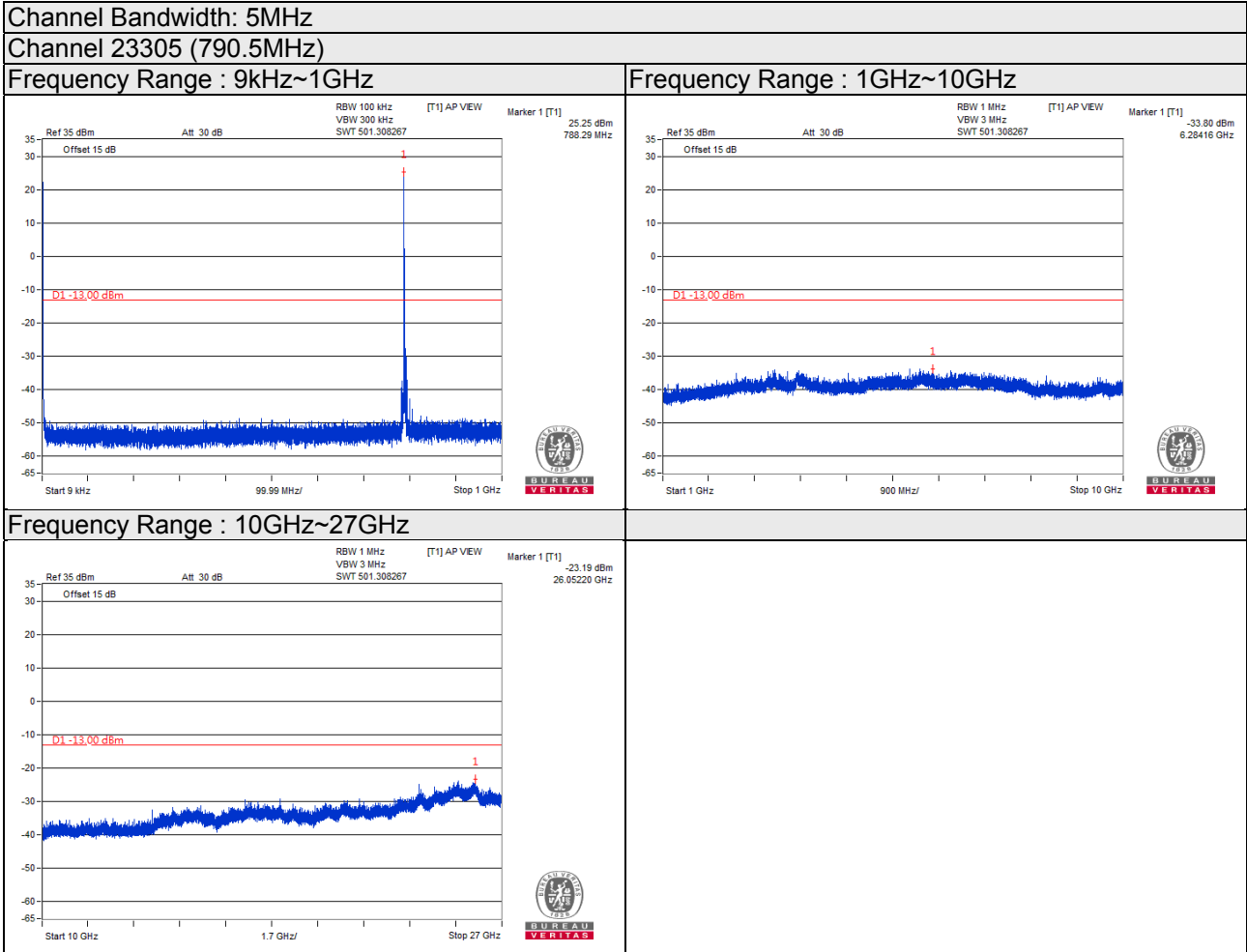

Channel Bandwidth: 5MHz

Channel 23330 (793.0MHz)

Frequency Range : 9kHz~1GHz

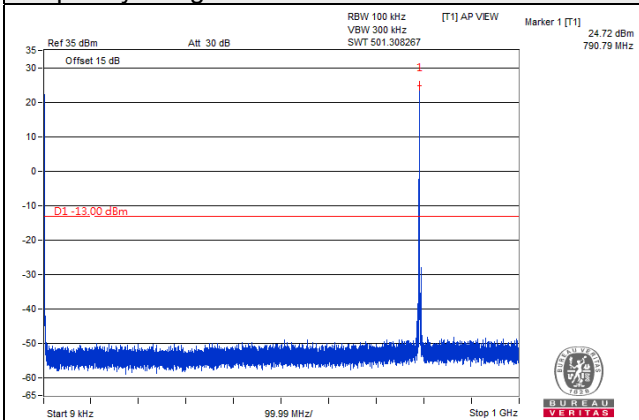

Frequency Range : 1GHz~10GHz

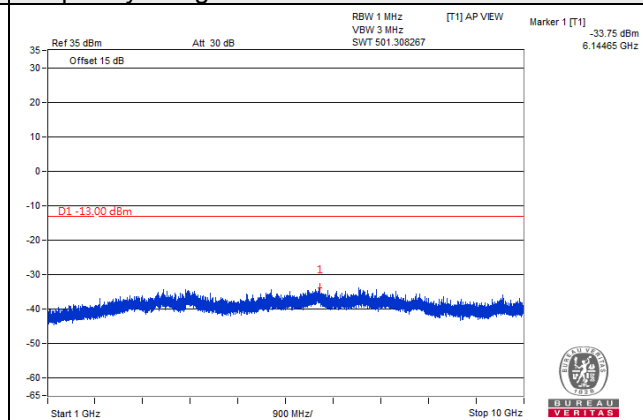

Frequency Range : 10GHz~27GHz

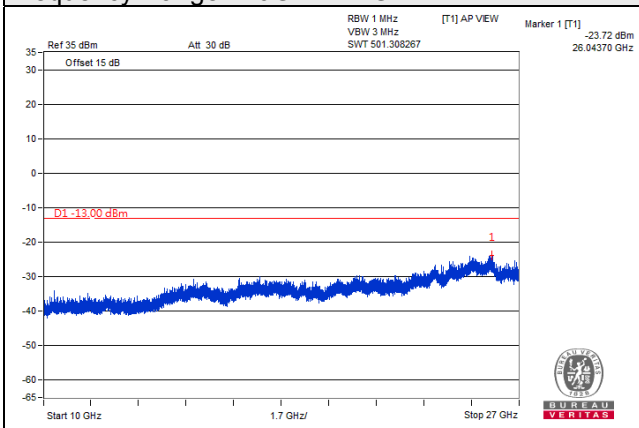

Channel Bandwidth: 5MHz

Channel 23355 (795.5MHz)

Frequency Range : 9kHz~1GHz

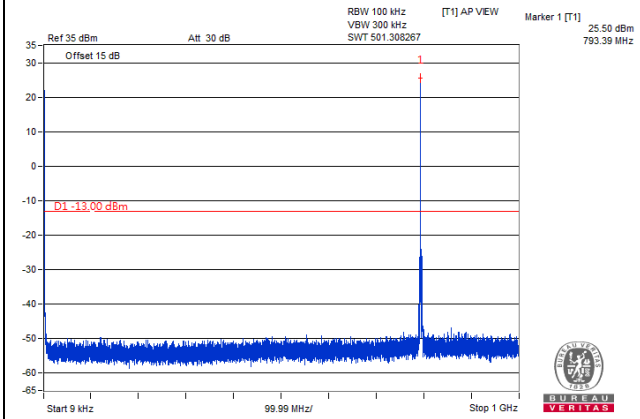

Frequency Range : 1GHz~10GHz

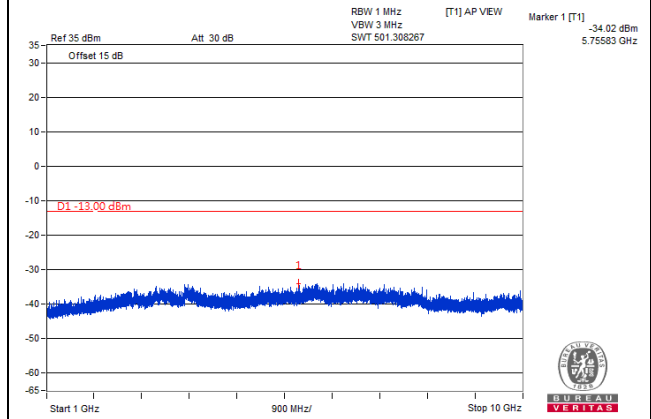

Frequency Range : 10GHz~27GHz

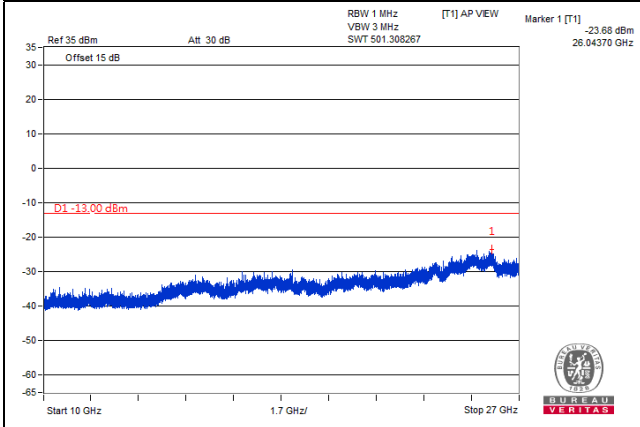

Channel Bandwidth: 10MHz

Channel 23330 (793.0MHz)

Frequency Range : 9kHz~1GHz

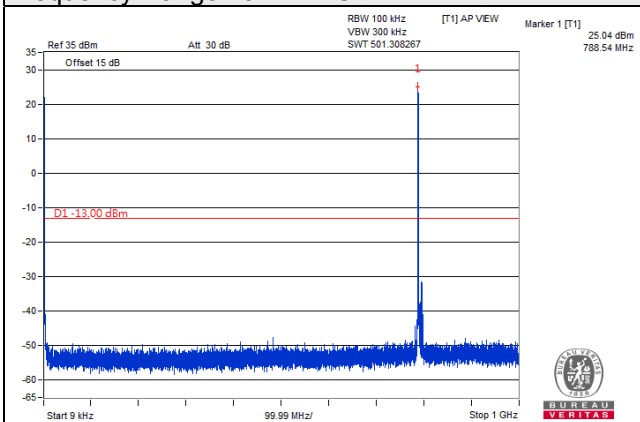

Frequency Range : 1GHz~10GHz

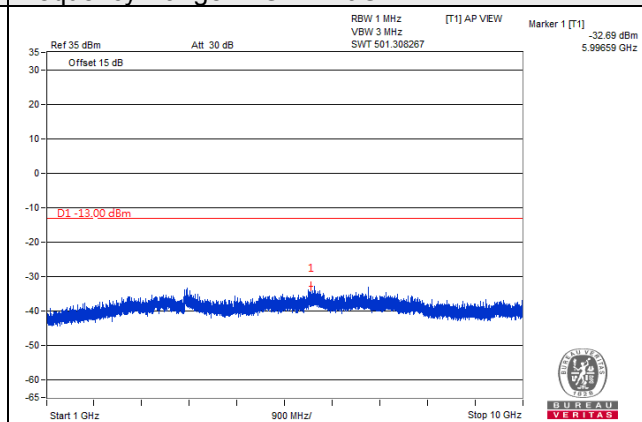

Frequency Range : 10GHz~27GHz

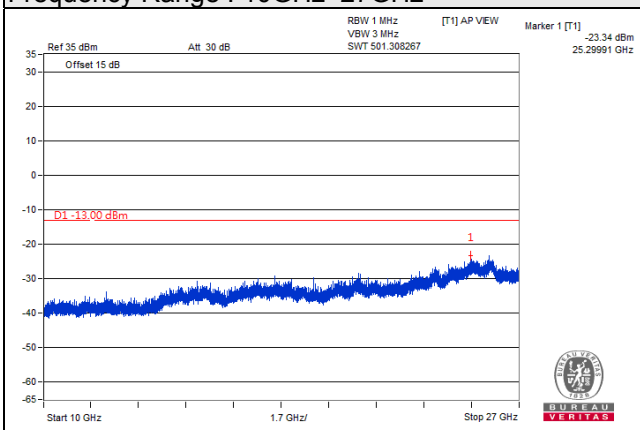

4.8 Radiated Emission Measurement

4.8.1 Limits of Radiated Emission Measuremen

- (1) The power of any emission outside a licensee's frequency block shall be attenuated below the transmitter power (P) by at least $43 + 10 \log_{10}(P)$ dB. The limit of emission equal to -13dBm
- (2) For operations in the 758-775 MHz and 788-805 MHz bands, all emissions including harmonics in the band 1559-1610 MHz shall be limited to -70 dBW/MHz equivalent isotropically radiated power (EIRP) for wideband signals, and -80 dBW EIRP for discrete emissions of less than 700 Hz bandwidth.

4.8.2 Test Procedure

- a. Substitution method is used for E.I.R.P measurement. In the semi-anechoic chamber, EUT placed on the 0.8m height of Turn Table, rotated the table around 360 degrees to search the maximum radiation power and receiver antenna shall be rotated vertical and horizontal polarization and moved height from 1m to 4m to find the maximum polar radiated power. The "Read Value" is the spectrum reading the maximum power value.
- b. The substitution horn antenna is substituted for EUT at the same position and signals generator export the CW signal to the substitution antenna via a TX cable. Rotated the Turn Table and moved receiving antenna to find the maximum radiation power. Adjust output power level of S.G to get a Value of spectrum reading equal to "Read Value" of step a. Record the power level of S.G
- c. $\text{EIRP} = \text{Output power level of S.G} - \text{TX cable loss} + \text{Antenna gain of substitution horn}$.
- d. E.R.P power can be calculated form E.I.R.P power by subtracting the gain of dipole, $\text{E.R.P power} = \text{E.I.R.P power} - 2.15\text{dBi}$.

Note: The resolution bandwidth and video bandwidth of test receiver/spectrum analyzer is 1MHz/3MHz.

4.8.3 Deviation from Test Standard

No deviation.

4.8.4 Test Setup

For Radiated Emission below or equal 1GHz

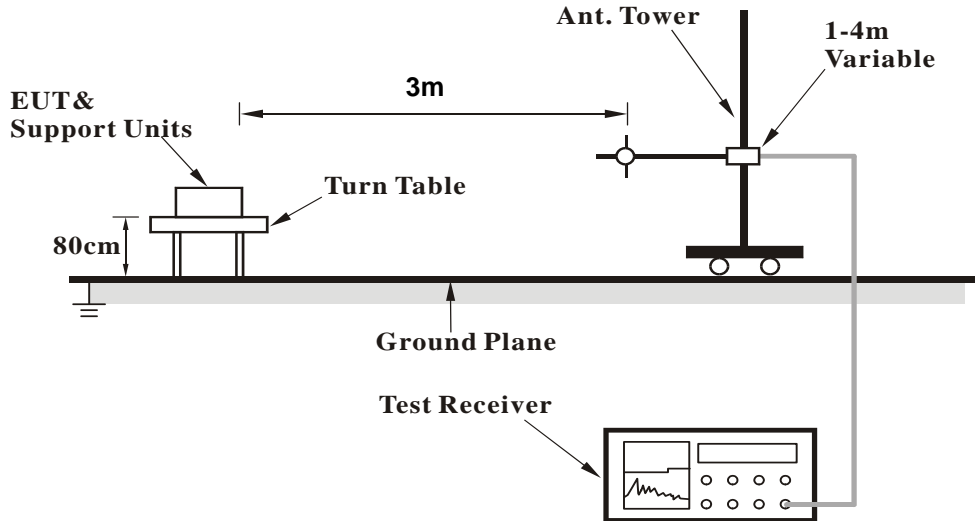

For Radiated Emission above 1GHz

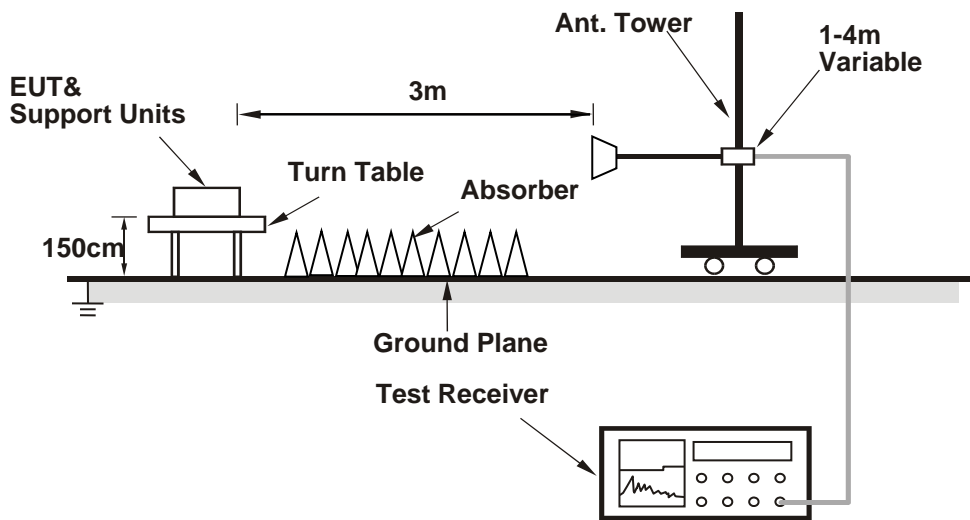

For the actual test configuration, please refer to the attached file (Test Setup Photo).

4.8.5 Test Results

Below 1GHz

Channel Bandwidth: 5MHz

Mode	TX channel 23305 (790.5MHz)	Frequency Range	Below 1000 MHz
Environmental Conditions	25deg. C, 66%RH	Input Power	120Vac, 60Hz
Tested By	Greg Lin		

Antenna Polarity & Test Distance: Horizontal at 3 M							
No.	Freq. (MHz)	Reading (dBm)	S.G Power Value (dBm)	Correction Factor (dB)	ERP (dBm)	Limit (dBm)	Margin (dB)
1	30.97	-49.5	-29.2	-18.8	-48.0	-13.0	-35.0
2	63.95	-41.5	-47.8	-2.0	-49.8	-13.0	-36.8
3	177.44	-43.3	-50.4	-3.0	-53.4	-13.0	-40.4
4	247.28	-56.0	-63.5	-1.5	-65.0	-13.0	-52.0
5	663.41	-70.0	-73.4	3.6	-69.8	-13.0	-56.8
6	940.83	-70.9	-68.5	3.8	-64.7	-13.0	-51.7

Remarks:

1. ERP (dBm) = S.G Value (dBm) + Correction Factor (dB).
2. Correction Factor (dB) = Substitution Antenna Gain (dB) + Cable Loss (dB).

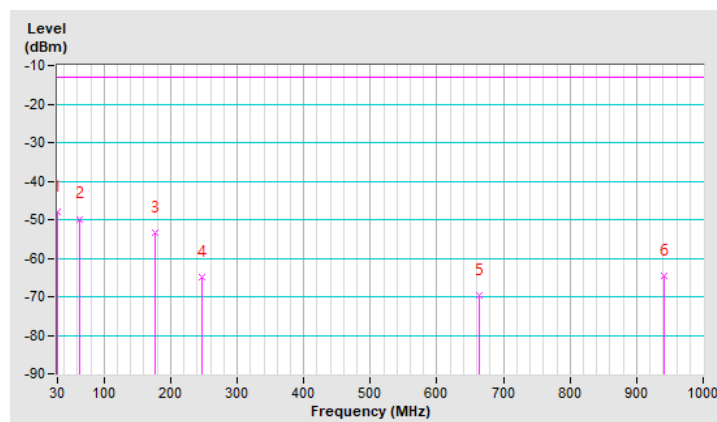

Mode	TX channel 23305 (790.5MHz)	Frequency Range	Below 1000 MHz
Environmental Conditions	25deg. C, 66%RH	Input Power	120Vac, 60Hz
Tested By	Greg Lin		

Antenna Polarity & Test Distance: Vertical at 3 M							
No.	Freq. (MHz)	Reading (dBm)	S.G Power Value (dBm)	Correction Factor (dB)	ERP (dBm)	Limit (dBm)	Margin (dB)
1	30.97	-35.9	-29.4	-18.8	-48.2	-13.0	-35.2
2	138.64	-48.0	-49.9	-3.2	-53.1	-13.0	-40.1
3	174.53	-43.5	-46.5	-2.8	-49.3	-13.0	-36.3
4	264.74	-63.6	-63.1	-1.6	-64.7	-13.0	-51.7
5	635.28	-69.6	-70.6	3.7	-66.9	-13.0	-53.9
6	941.80	-70.5	-67.3	3.8	-63.5	-13.0	-50.5

Remarks:

1. ERP (dBm) = S.G Value (dBm) + Correction Factor (dB).
2. Correction Factor (dB) = Substitution Antenna Gain (dB) + Cable Loss (dB).

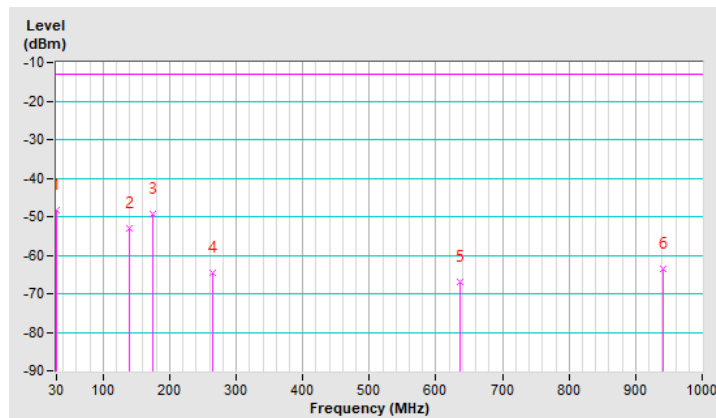

Channel Bandwidth: 10MHz

Mode	TX channel 23330 (793.0MHz)	Frequency Range	Below 1000 MHz
Environmental Conditions	25deg. C, 66%RH	Input Power	120Vac, 60Hz
Tested By	Greg Lin		

Antenna Polarity & Test Distance: Horizontal at 3 M							
No.	Freq. (MHz)	Reading (dBm)	S.G Power Value (dBm)	Correction Factor (dB)	ERP (dBm)	Limit (dBm)	Margin (dB)
1	34.85	-49.6	-32.1	-16.5	-48.6	-13.0	-35.6
2	75.59	-40.5	-48.6	0.2	-48.4	-13.0	-35.4
3	143.49	-40.9	-45.1	-3.1	-48.2	-13.0	-35.2
4	296.75	-62.5	-65.6	-1.8	-67.4	-13.0	-54.4
5	731.31	-67.0	-68.8	3.6	-65.2	-13.0	-52.2
6	818.61	-66.9	-66.6	3.9	-62.7	-13.0	-49.7

Remarks:

1. ERP (dBm) = S.G Value (dBm) + Correction Factor (dB).
2. Correction Factor (dB) = Substitution Antenna Gain (dB) + Cable Loss (dB).

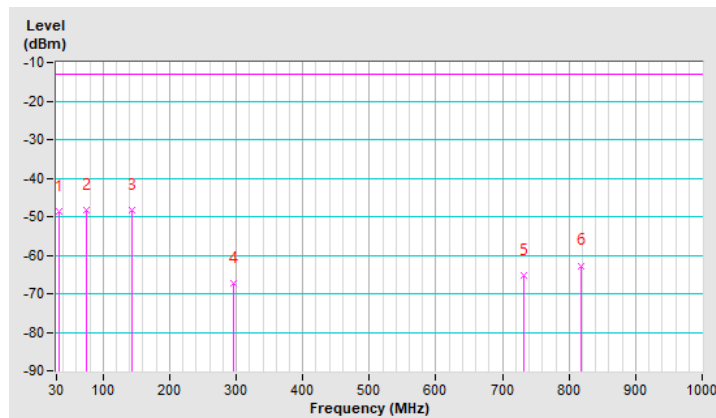

Mode	TX channel 23330 (793.0MHz)	Frequency Range	Below 1000 MHz
Environmental Conditions	25deg. C, 66%RH	Input Power	120Vac, 60Hz
Tested By	Greg Lin		

Antenna Polarity & Test Distance: Vertical at 3 M							
No.	Freq. (MHz)	Reading (dBm)	S.G Power Value (dBm)	Correction Factor (dB)	ERP (dBm)	Limit (dBm)	Margin (dB)
1	30.97	-35.9	-29.4	-18.8	-48.2	-13.0	-35.2
2	138.64	-48.0	-49.9	-3.2	-53.1	-13.0	-40.1
3	174.53	-43.5	-46.5	-2.8	-49.3	-13.0	-36.3
4	264.74	-63.6	-63.1	-1.6	-64.7	-13.0	-51.7
5	635.28	-69.6	-70.6	3.7	-66.9	-13.0	-53.9
6	941.80	-70.5	-67.3	3.8	-63.5	-13.0	-50.5

Remarks:

1. ERP (dBm) = S.G Value (dBm) + Correction Factor (dB).
2. Correction Factor (dB) = Substitution Antenna Gain (dB) + Cable Loss (dB).

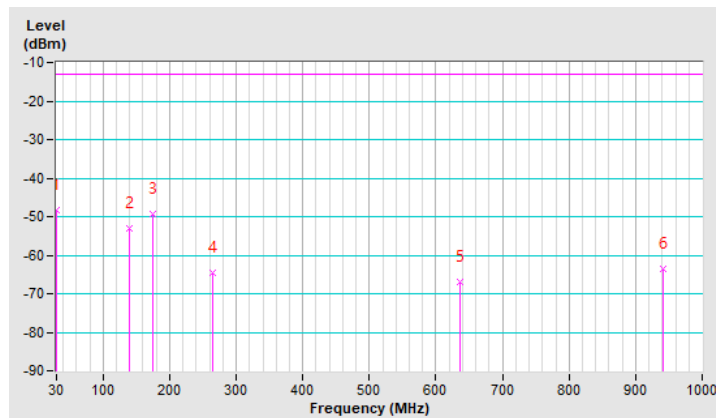

Above 1GHz

Channel Bandwidth: 5MHz

Mode	TX channel 23305 (790.5MHz)	Frequency Range	1GHz ~ 18GHz
Environmental Conditions	25deg. C, 66%RH	Input Power	120Vac, 60Hz
Tested By	Tim Chen		

Antenna Polarity & Test Distance: Horizontal at 3 M							
No.	Freq. (MHz)	Reading (dBm)	S.G Power Value (dBm)	Correction Factor (dB)	ERP (dBm)	Limit (dBm)	Margin (dB)
1	1581.00	-60.1	-52.3	1.2	-51.1	-40.0	-11.1
2	2371.50	-75.6	-69.6	0.0	-69.6	-13.0	-56.6
Antenna Polarity & Test Distance: Vertical at 3 M							
No.	Freq. (MHz)	Reading (dBm)	S.G Power Value (dBm)	Correction Factor (dB)	ERP (dBm)	Limit (dBm)	Margin (dB)
1	1581.00	-68.3	-61.3	1.2	-60.1	-40.0	-20.1
2	2371.50	-75.0	-71.0	0.0	-71.0	-13.0	-58.0

Remarks:

1. ERP (dBm) = S.G Value (dBm) + Correction Factor (dB).
2. Correction Factor (dB) = Substitution Antenna Gain (dB) + Cable Loss (dB).

Mode	TX channel 23330 (793.0MHz)	Frequency Range	1GHz ~ 18GHz
Environmental Conditions	25deg. C, 66%RH	Input Power	120Vac, 60Hz
Tested By	Tim Chen		

Antenna Polarity & Test Distance: Horizontal at 3 M							
No.	Freq. (MHz)	Reading (dBm)	S.G Power Value (dBm)	Correction Factor (dB)	ERP (dBm)	Limit (dBm)	Margin (dB)
1	1586.00	-62.1	-54.2	1.1	-53.1	-40.0	-13.1
2	2379.00	-75.1	-69.1	0.0	-69.1	-13.0	-56.1
Antenna Polarity & Test Distance: Vertical at 3 M							
No.	Freq. (MHz)	Reading (dBm)	S.G Power Value (dBm)	Correction Factor (dB)	ERP (dBm)	Limit (dBm)	Margin (dB)
1	1586.00	-67.8	-60.7	1.1	-59.6	-40.0	-19.6
2	2379.00	-75.4	-71.2	0.0	-71.2	-13.0	-58.2

Remarks:

1. ERP (dBm) = S.G Value (dBm) + Correction Factor (dB).
2. Correction Factor (dB) = Substitution Antenna Gain (dB) + Cable Loss (dB).

Mode	TX channel 23355 (795.5MHz)	Frequency Range	1GHz ~ 18GHz
Environmental Conditions	25deg. C, 66%RH	Input Power	120Vac, 60Hz
Tested By	Tim Chen		

Antenna Polarity & Test Distance: Horizontal at 3 M							
No.	Freq. (MHz)	Reading (dBm)	S.G Power Value (dBm)	Correction Factor (dB)	ERP (dBm)	Limit (dBm)	Margin (dB)
1	1591.00	-63.0	-55.1	1.1	-54.0	-40.0	-14.0
2	2386.50	-75.3	-69.3	0.0	-69.3	-13.0	-56.3
Antenna Polarity & Test Distance: Vertical at 3 M							
No.	Freq. (MHz)	Reading (dBm)	S.G Power Value (dBm)	Correction Factor (dB)	ERP (dBm)	Limit (dBm)	Margin (dB)
1	1591.00	-68.8	-61.6	1.1	-60.5	-40.0	-20.5
2	2386.50	-75.3	-71.1	0.0	-71.1	-13.0	-58.1

Remarks:

1. ERP (dBm) = S.G Value (dBm) + Correction Factor (dB).
2. Correction Factor (dB) = Substitution Antenna Gain (dB) + Cable Loss (dB).

Channel Bandwidth: 10MHz

Mode	TX channel 23330 (793.0MHz)	Frequency Range	1GHz ~ 18GHz
Environmental Conditions	25deg. C, 66%RH	Input Power	120Vac, 60Hz
Tested By	Tim Chen		

Antenna Polarity & Test Distance: Horizontal at 3 M							
No.	Freq. (MHz)	Reading (dBm)	S.G Power Value (dBm)	Correction Factor (dB)	ERP (dBm)	Limit (dBm)	Margin (dB)
1	1586.00	-63.4	-55.5	1.1	-54.4	-40.0	-14.4
2	2379.00	-75.0	-69.0	0.0	-69.0	-13.0	-56.0
Antenna Polarity & Test Distance: Vertical at 3 M							
No.	Freq. (MHz)	Reading (dBm)	S.G Power Value (dBm)	Correction Factor (dB)	ERP (dBm)	Limit (dBm)	Margin (dB)
1	1586.00	-67.5	-60.4	1.1	-59.3	-40.0	-19.3
2	2379.00	-75.2	-71.0	0.0	-71.0	-13.0	-58.0

Remarks:

1. ERP (dBm) = S.G Value (dBm) + Correction Factor (dB).
2. Correction Factor (dB) = Substitution Antenna Gain (dB) + Cable Loss (dB).

5 Pictures of Test Arrangements

Please refer to the attached file (Test Setup Photo).

Appendix – Information on the Testing Laboratories

We, Bureau Veritas Consumer Products Services (H.K.) Ltd., Taoyuan Branch, were founded in 1988 to provide our best service in EMC, Radio, Telecom and Safety consultation. Our laboratories are FCC recognized accredited test firms and accredited and approved according to ISO/IEC 17025.

If you have any comments, please feel free to contact us at the following:

Linko EMC/RF Lab

Tel: 886-2-26052180

Fax: 886-2-26051924

Hsin Chu EMC/RF/Telecom Lab

Tel: 886-3-6668565

Fax: 886-3-6668323

Hwa Ya EMC/RF/Safety Lab

Tel: 886-3-3183232

Fax: 886-3-3270892

Email: service.adt@tw.bureauveritas.com

Web Site: www.bureauveritas-adt.com

The address and road map of all our labs can be found in our web site also.

--- END ---