

FCC Test Report (Part 24)

Report No.: RF181015C09-1

FCC ID: PY318300428

Test Model: MR5000

Received Date: Oct. 15, 2018

Test Date: Oct. 22 ~ Nov. 03, 2018

Issued Date: Nov. 15, 2018

Applicant: NETGEAR INC.

Address: 350 East Plumeria Drive, San Jose, CA 95134, USA

Issued By: Bureau Veritas Consumer Products Services (H.K.) Ltd., Taoyuan Branch

Lab Address: No. 47-2, 14th Ling, Chia Pau Vil., Lin Kou Dist., New Taipei City, Taiwan (R.O.C.)

Test Location: No. 19, Hwa Ya 2nd Rd., Wen Hwa Vil., Kwei Shan Dist., Taoyuan City 33383, TAIWAN (R.O.C.)

**FCC Registration /
Designation Number:** 788550 / TW0003



This report is for your exclusive use. Any copying or replication of this report to or for any other person or entity, or use of our name or trademark, is permitted only with our prior written permission. This report sets forth our findings solely with respect to the test samples identified herein. The results set forth in this report are not indicative or representative of the quality or characteristics of the lot from which a test sample was taken or any similar or identical product specifically and expressly noted. Our report includes all of the tests requested by you and the results thereof based upon the information that you provided to us. You have 60 days from date of issuance of this report to notify us of any material error or omission caused by our negligence, provided, however, that such notice shall be in writing and shall specifically address the issue you wish to raise. A failure to raise such issue within the prescribed time shall constitute your unqualified acceptance of the completeness of this report, the tests conducted and the correctness of the report contents. Unless specific mention, the uncertainty of measurement has been explicitly taken into account to declare the compliance or non-compliance to the specification. The report must not be used by the client to claim product certification, approval, or endorsement by TAF or any government agencies

Table of Contents

Release Control Record	4
1 Certificate of Conformity	5
2 Summary of Test Results	6
2.1 Measurement Uncertainty.....	6
2.2 Test Site and Instruments.....	7
3 General Information	8
3.1 General Description of EUT.....	8
3.2 Configuration of System under Test.....	10
3.2.1 Description of Support Units.....	10
3.3 Test Mode Applicability and Tested Channel Detail.....	11
3.4 EUT Operating Conditions.....	13
3.5 General Description of Applied Standards.....	13
4 Test Types and Results	14
4.1 Output Power Measurement.....	14
4.1.1 Limits of Output Power Measurement.....	14
4.1.2 Test Procedures.....	14
4.1.3 Test Setup.....	15
4.1.4 Test Results.....	16
4.2 Modulation Characteristics Measurement.....	40
4.2.1 Limits of Modulation Characteristics.....	40
4.2.2 Test Procedure.....	40
4.2.3 Test Setup.....	40
4.2.4 Test Results.....	41
4.3 Frequency Stability Measurement.....	42
4.3.1 Limits of Frequency Stability Measurement.....	42
4.3.2 Test Procedure.....	42
4.3.3 Test Setup.....	42
4.3.4 Test Results.....	43
4.4 Occupied Bandwidth Measurement.....	49
4.4.1 Test Procedure.....	49
4.4.2 Test Setup.....	49
4.4.3 Test Result.....	50
4.5 Band Edge Measurement.....	53
4.5.1 Limits of Band Edge Measurement.....	53
4.5.2 Test Setup.....	53
4.5.3 Test Procedures.....	53
4.5.4 Test Results.....	54
4.6 Peak to Average Ratio.....	60
4.6.1 Limits of Peak to Average Ratio Measurement.....	60
4.6.2 Test Setup.....	60
4.6.3 Test Procedures.....	60
4.6.4 Test Results.....	61
4.7 Conducted Spurious Emissions.....	63
4.7.1 Limits of Conducted Spurious Emissions Measurement.....	63
4.7.2 Test Setup.....	63
4.7.3 Test Procedure.....	63
4.7.4 Test Results.....	64
4.8 Radiated Emission Measurement.....	82
4.8.1 Limits of Radiated Emission Measurement.....	82
4.8.2 Test Procedure.....	82
4.8.3 Deviation from Test Standard.....	82
4.8.4 Test Setup.....	83
4.8.5 Test Results.....	84

5	Pictures of Test Arrangements.....	96
	Appendix – Information on the Testing Laboratories	97

Release Control Record

Issue No.	Description	Date Issued
RF181015C09-1	Original release.	Nov. 15, 2018

1 Certificate of Conformity

Product: 5G MHS Travel Router

Brand: Netgear

Test Model: MR5000

Sample Status: Engineering sample

Applicant: NETGEAR INC.

Test Date: Oct. 22 ~ Nov. 03, 2018

Standards: FCC Part 24, Subpart E

The above equipment has been tested by **Bureau Veritas Consumer Products Services (H.K.) Ltd., Taoyuan Branch**, and found compliance with the requirement of the above standards. The test record, data evaluation & Equipment Under Test (EUT) configurations represented herein are true and accurate accounts of the measurements of the sample's RF characteristics under the conditions specified in this report.

Prepared by :  , **Date:** Nov. 15, 2018
Polly Chien / Specialist

Approved by :  , **Date:** Nov. 15, 2018
Bruce Chen / Project Engineer

2 Summary of Test Results

Applied Standard: FCC Part 24 & Part 2			
FCC Clause	Test Item	Result	Remarks
2.1046 24.232	Effective radiated power	Pass	Meet the requirement of limit.
2.1046 24.232(d)	Peak To Average Ratio	Pass	Meet the requirement of limit.
2.1047	Modulation characteristics	Pass	Meet the requirement
2.1055 24.235	Frequency Stability	Pass	Meet the requirement of limit.
2.1049 24.238(b)	Occupied Bandwidth	Pass	Meet the requirement of limit.
24.238(b)	Band Edge Measurements	Pass	Meet the requirement of limit.
2.1051 24.238	Conducted Spurious Emissions	Pass	Meet the requirement of limit.
2.1053 24.238	Radiated Spurious Emissions	Pass	Meet the requirement of limit. Minimum passing margin is -30.2dB at 62.98MHz.

2.1 Measurement Uncertainty

Where relevant, the following measurement uncertainty levels have been estimated for tests performed on the EUT as specified in CISPR 16-4-2:

Measurement	Frequency	Expanded Uncertainty (k=2) (\pm)
Radiated Emissions up to 1 GHz	30MHz ~ 200MHz	3.59 dB
	200MHz ~1000MHz	3.60 dB
Radiated Emissions above 1 GHz	1GHz ~ 18GHz	2.29 dB
	18GHz ~ 40GHz	2.29 dB

2.2 Test Site and Instruments

Description & Manufacturer	Model No.	Serial No.	Cal. Date	Cal. Due
Test Receiver KEYSIGHT	N9038A	MY55420137	Apr. 11, 2018	Apr. 10, 2019
Spectrum Analyzer ROHDE & SCHWARZ	FSP40	100269	May 29, 2018	May 28, 2019
BILOG Antenna SCHWARZBECK	VULB9168	9168-148	Dec. 11, 2017	Dec. 10, 2018
HORN Antenna SCHWARZBECK	BBHA 9120 D	9120D-1169	Dec. 12, 2017	Dec. 11, 2018
HORN Antenna SCHWARZBECK	BBHA 9170	BBHA9170241	Dec. 01, 2017	Nov. 30, 2018
Loop Antenna EMCI	EM-6879	269	Sep. 07, 2018	Sep. 06, 2019
Preamplifier Agilent (Below 1GHz)	8447D	2944A10638	Aug. 08, 2018	Aug. 07, 2019
Preamplifier Agilent (Above 1GHz)	8449B	3008A01638	Feb. 22, 2018	Feb. 21, 2019
RF signal cable HUBER+SUHNER&EMCI	SUCOFLEX 104 & EMC104-SM-SM8000	CABLE-CH9-02 (248780+171006)	Jan. 15, 2018	Jan. 14, 2019
RF signal cable HUBER+SUHNER	SUCOFLEX 104	CABLE-CH9-(250795/4)	Aug. 08, 2018	Aug. 07, 2019
RF signal cable Woken	8D-FB	Cable-CH9-01	Jul. 31, 2018	Jul. 30, 2019
Software BV ADT	ADT_Radiated_ V7.6.15.9.5	NA	NA	NA
Antenna Tower EMCO	2070/2080	512.835.4684	NA	NA
Turn Table EMCO	2087-2.03	NA	NA	NA
Antenna Tower & Turn BV ADT	AT100	AT93021705	NA	NA
Turn Table BV ADT	TT100	TT93021705	NA	NA
Turn Table Controller BV ADT	SC100	SC93021705	NA	NA
Boresight Antenna Fixture	FBA-01	FBA-SIP01	NA	NA
Turn Table Controller BV ADT	SC100	SC93021702	NA	NA
Temperature And Humidity Chamber TERCHY	HRM-120RF	931022	Nov. 20, 2017	Nov. 19, 2018
JFW 20dB attenuation	50HF-020-SMA	NA	NA	NA
Radio Communication Analyzer	MT8821C	6261786083	Dec. 21, 2017	Dec. 20, 2018

- Note: 1. The calibration interval of the above test instruments is 12 months and the calibrations are traceable to NML/ROC and NIST/USA.
 2. The test was performed in HwaYa Chamber 9.
 3. The FCC Designation Number is TW0003. The number will be varied with the Lab location and scope as attached.
 4. The IC Site Registration No. is 7450F-9.

3 General Information

3.1 General Description of EUT

Product	5G MHS Travel Router			
Brand	Netgear			
Test Model	MR5000			
Sample Status	Engineering sample			
Power Supply Rating	5.0 Vdc or 9Vdc (adapter) 3.85Vdc (battery)			
Modulation Type	QPSK, 16QAM, 64QAM			
Operating Frequency	LTE Band 2 (Channel Bandwidth 1.4MHz)	1850.7MHz ~ 1909.3MHz		
	LTE Band 2 (Channel Bandwidth 3MHz)	1851.5MHz ~ 1908.5MHz		
	LTE Band 2 (Channel Bandwidth 5MHz)	1852.5MHz ~ 1907.5MHz		
	LTE Band 2 (Channel Bandwidth 10MHz)	1855.0MHz ~ 1905.0MHz		
	LTE Band 2 (Channel Bandwidth 15MHz)	1857.5MHz ~ 1902.5MHz		
	LTE Band 2 (Channel Bandwidth 20MHz)	1860.0MHz ~ 1900.0MHz		
Max. EIRP Power		QPSK	16QAM	64QAM
	LTE Band 2 (Channel Bandwidth 1.4MHz)	562.341mW (27.5dBm)	457.088mW (26.6dBm)	398.107mW (26.0dBm)
	LTE Band 2 (Channel Bandwidth 3MHz)	616.595mW (27.9dBm)	512.861mW (27.1dBm)	446.684mW (26.5dBm)
	LTE Band 2 (Channel Bandwidth 5MHz)	588.844mW (27.7dBm)	457.088mW (26.6dBm)	426.580mW (26.3dBm)
	LTE Band 2 (Channel Bandwidth 10MHz)	549.541mW (27.4dBm)	426.580mW (26.3dBm)	380.189mW (25.8dBm)
	LTE Band 2 (Channel Bandwidth 15MHz)	549.541mW (27.4dBm)	446.684mW (26.5dBm)	407.380mW (26.1dBm)
	LTE Band 2 (Channel Bandwidth 20MHz)	588.844mW (27.7dBm)	467.735mW (26.7dBm)	407.380mW (26.1dBm)
Emission Designator		QPSK	16QAM	64QAM
	LTE Band 2 (Channel Bandwidth 1.4MHz)	1M09G7D	1M09D7W	1M09D7W
	LTE Band 2 (Channel Bandwidth 3MHz)	2M71G7D	2M70D7W	2M71D7W
	LTE Band 2 (Channel Bandwidth 5MHz)	4M49G7D	4M49D7W	4M49D7W
	LTE Band 2 (Channel Bandwidth 10MHz)	8M98G7D	8M98D7W	8M97D7W
	LTE Band 2 (Channel Bandwidth 15MHz)	13M5G7D	13M4D7W	13M4D7W
LTE Band 2 (Channel Bandwidth 20MHz)	18M0G7D	18M0D7W	18M0D7W	
Antenna Type	Internal IFA antenna with 2.73dBi			
Antenna Connector	NA			
Accessory Device	Adapter, battery			
Data Cable Supplied	0.95m shielded USB cable without core			

Note:

1. The EUT consumes power from the following adapter and battery.

Adapter	
Brand	NETGEAR
Model	AD2122F20
P/N	332-11106-01
Input	100-240Vac, 50/60Hz, 0.5A
Output	5.0Vdc, 2.0A or 9Vdc /1.8A

Lithium ion battery	
Brand	NETGEAR
Model	W-10a
P/N	308-10084-01
Rating	3.85Vdc, 19.78Wh, 5040mAh

3.2 Configuration of System under Test

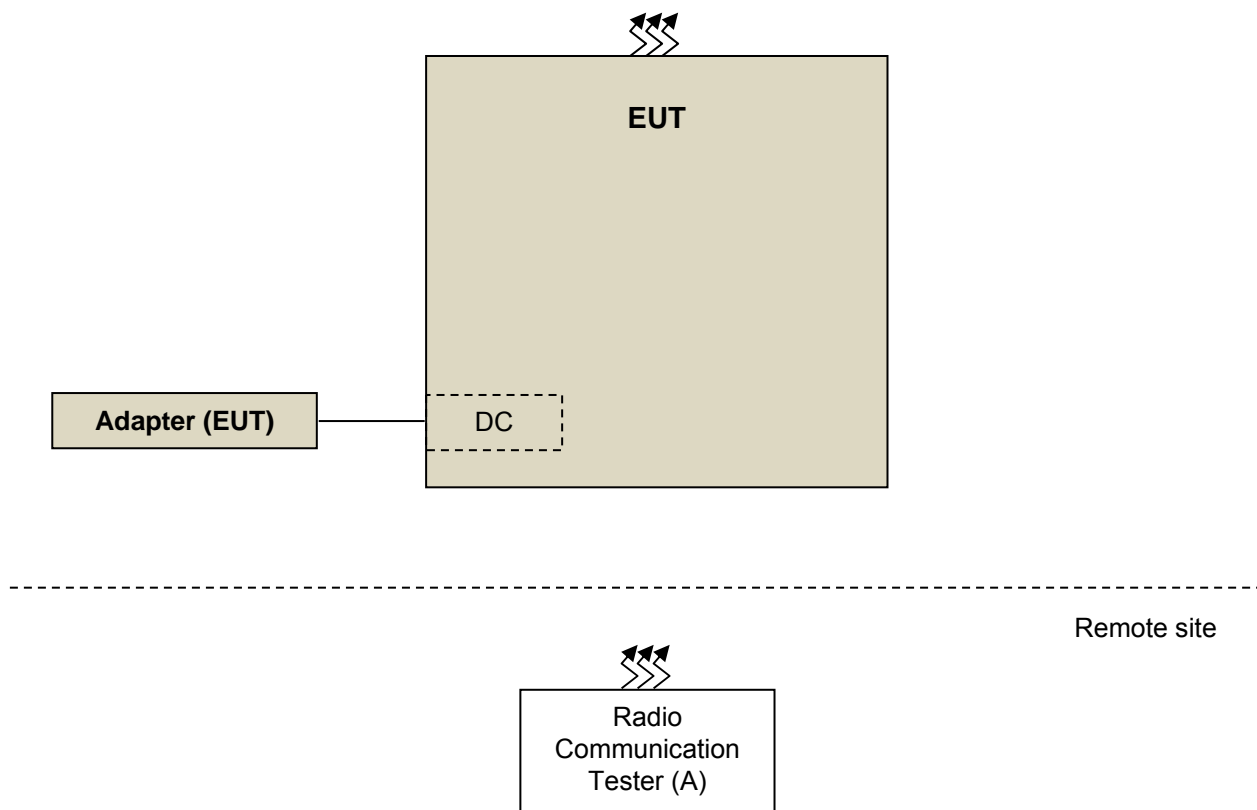

3.2.1 Description of Support Units

The EUT has been tested as an independent unit together with other necessary accessories or support units. The following support units or accessories were used to form a representative test configuration during the tests.

ID	Product	Brand	Model No.	Serial No.	FCC ID	Remarks
A.	Radio Communication Tester	Anritsu	MT8820C	6201010284	NA	-

Note:

1. All power cords of the above support units are non-shielded (1.8m).
2. Item A acted as a communication partner to transfer data.

3.3 Test Mode Applicability and Tested Channel Detail

Pre-Scan has been conducted to determine the worst-case mode from all possible combinations between available modulations, data rates, XYZ axis and antenna ports. The worst case was found when positioned on X-plane. Following channel(s) was (were) selected for the final test as listed below:

LTE Band 2

EUT Configure Mode	Test item	Available channel	Tested Channel	Channel Bandwidth	Modulation	Mode
-	EIRP	18607 to 19193	18607(1850.70MHz), 18900(1880.00MHz), 19193(1909.30MHz)	1.4MHz	QPSK / 16QAM / 64QAM	1 RB / 5 RB Offset
		18615 to 19185	18615(1851.50MHz), 18900(1880.00MHz), 19185(1908.50MHz)	3MHz	QPSK / 16QAM / 64QAM	1 RB / 14 RB Offset
		18625 to 19175	18625(1852.50MHz), 18900(1880.00MHz), 19175(1907.50MHz)	5MHz	QPSK / 16QAM / 64QAM	1 RB / 24 RB Offset
		18650 to 19150	18650(1855.00MHz), 18900(1880.00MHz), 19150(1905.00MHz)	10MHz	QPSK / 16QAM / 64QAM	1 RB / 49 RB Offset
		18675 to 19125	18675(1857.50MHz), 18900(1880.00MHz), 19125(1902.50MHz)	15MHz	QPSK / 16QAM / 64QAM	1 RB / 74 RB Offset
		18700 to 19100	18700(1860.00MHz), 18900(1880.00MHz), 19100(1900.00MHz)	20MHz	QPSK / 16QAM / 64QAM	1 RB / 99 RB Offset
-	Modulation characteristics	18700 to 19100	18900(1880.00MHz)	20MHz	QPSK / 16QAM / 64QAM	1 RB / 99 RB Offset
-	Frequency Stability	18607 to 19193	18607(1850.70MHz), 19193(1909.30MHz)	1.4MHz	QPSK	1 RB / 5 RB Offset
		18615 to 19185	18615(1851.50MHz), 19185(1908.50MHz)	3MHz	QPSK	1 RB / 14 RB Offset
		18625 to 19175	18625(1852.50MHz), 19175(1907.50MHz)	5MHz	QPSK	1 RB / 24 RB Offset
		18650 to 19150	18650(1855.00MHz), 19150(1905.00MHz)	10MHz	QPSK	1 RB / 49 RB Offset
		18675 to 19125	18675(1857.50MHz), 19125(1902.50MHz)	15MHz	QPSK	1 RB / 74 RB Offset
		18700 to 19100	18700(1860.00MHz), 19100(1900.00MHz)	20MHz	QPSK	1 RB / 99 RB Offset
-	Occupied Bandwidth	18607 to 19193	18607(1850.70MHz), 18900(1880.00MHz), 19193(1909.30MHz)	1.4MHz	QPSK / 16QAM / 64QAM	1 RB / 5 RB Offset
		18615 to 19185	18615(1851.50MHz), 18900(1880.00MHz), 19185(1908.50MHz)	3MHz	QPSK / 16QAM / 64QAM	1 RB / 14 RB Offset
		18625 to 19175	18625(1852.50MHz), 18900(1880.00MHz), 19175(1907.50MHz)	5MHz	QPSK / 16QAM / 64QAM	1 RB / 24 RB Offset
		18650 to 19150	18650(1855.00MHz), 18900(1880.00MHz), 19150(1905.00MHz)	10MHz	QPSK / 16QAM / 64QAM	1 RB / 49 RB Offset
		18675 to 19125	18675(1857.50MHz), 18900(1880.00MHz), 19125(1902.50MHz)	15MHz	QPSK / 16QAM / 64QAM	1 RB / 74 RB Offset
		18700 to 19100	18700(1860.00MHz), 18900(1880.00MHz), 19100(1900.00MHz)	20MHz	QPSK / 16QAM / 64QAM	1 RB / 99 RB Offset

EUT Configure Mode	Test item	Available channel	Tested Channel	Channel Bandwidth	Modulation	Mode
-	Band Edge	18607 to 19193	18607(1850.70MHz), 19193(1909.30MHz)	1.4MHz	QPSK	1 RB / 0 RB Offset 1 RB / 5 RB Offset 6 RB / 0 RB Offset
		18615 to 19185	18615(1851.50MHz), 19185(1908.50MHz)	3MHz	QPSK	1 RB / 0 RB Offset 1 RB / 14 RB Offset 15 RB / 0 RB Offset
		18625 to 19175	18625(1852.50MHz), 19175(1907.50MHz)	5MHz	QPSK	1 RB / 0 RB Offset 1 RB / 24 RB Offset 25 RB / 0 RB Offset
		18650 to 19150	18650(1855.00MHz), 19150(1905.00MHz)	10MHz	QPSK	1 RB / 0 RB Offset 1 RB / 49 RB Offset 50 RB / 0 RB Offset
		18675 to 19125	18675(1857.50MHz), 19125(1902.50MHz)	15MHz	QPSK	1 RB / 0 RB Offset 1 RB / 74 RB Offset 75 RB / 0 RB Offset
		18700 to 19100	18700(1860.00MHz), 19100(1900.00MHz)	20MHz	QPSK	1 RB / 0 RB Offset 1 RB / 99 RB Offset 100 RB / 0 RB Offset
-	Peak to Average Ratio	18607 to 19193	18607(1850.70MHz), 18900(1880.00MHz), 19193(1909.30MHz)	1.4MHz	QPSK / 16QAM / 64QAM	1 RB / 5 RB Offset
		18615 to 19185	18615(1851.50MHz), 18900(1880.00MHz), 19185(1908.50MHz)	3MHz	QPSK / 16QAM / 64QAM	1 RB / 14 RB Offset
		18625 to 19175	18625(1852.50MHz), 18900(1880.00MHz), 19175(1907.50MHz)	5MHz	QPSK / 16QAM / 64QAM	1 RB / 24 RB Offset
		18650 to 19150	18650(1855.00MHz), 18900(1880.00MHz), 19150(1905.00MHz)	10MHz	QPSK / 16QAM / 64QAM	1 RB / 49 RB Offset
		18675 to 19125	18675(1857.50MHz), 18900(1880.00MHz), 19125(1902.50MHz)	15MHz	QPSK / 16QAM / 64QAM	1 RB / 74 RB Offset
		18700 to 19100	18700(1860.00MHz), 18900(1880.00MHz), 19100(1900.00MHz)	20MHz	QPSK / 16QAM / 64QAM	1 RB / 99 RB Offset
-	Conducted Emission	18607 to 19193	18607(1850.70MHz), 18900(1880.00MHz), 19193(1909.30MHz)	1.4MHz	QPSK	1 RB / 5 RB Offset
		18615 to 19185	18615(1851.50MHz), 18900(1880.00MHz), 19185(1908.50MHz)	3MHz	QPSK	1 RB / 14 RB Offset
		18625 to 19175	18625(1852.50MHz), 18900(1880.00MHz), 19175(1907.50MHz)	5MHz	QPSK	1 RB / 24 RB Offset
		18650 to 19150	18650(1855.00MHz), 18900(1880.00MHz), 19150(1905.00MHz)	10MHz	QPSK	1 RB / 49 RB Offset
		18675 to 19125	18675(1857.50MHz), 18900(1880.00MHz), 19125(1902.50MHz)	15MHz	QPSK	1 RB / 74 RB Offset
		18700 to 19100	18700(1860.00MHz), 18900(1880.00MHz), 19100(1900.00MHz)	20MHz	QPSK	1 RB / 99 RB Offset
-	Radiated Emission Below 1GHz	18607 to 19193	18607(1850.70MHz)	1.4MHz	QPSK	1 RB / 5 RB Offset
		18625 to 19175	18625(1852.50MHz)	5MHz	QPSK	1 RB / 24 RB Offset
		18700 to 19100	18700(1860.00MHz)	20MHz	QPSK	1 RB / 99 RB Offset
-	Radiated Emission Above 1GHz	18607 to 19193	18607(1850.70MHz), 18900(1880.00MHz), 19193(1909.30MHz)	1.4MHz	QPSK	1 RB / 5 RB Offset
		18625 to 19175	18625(1852.50MHz), 18900(1880.00MHz), 19175(1907.50MHz)	5MHz	QPSK	1 RB / 24 RB Offset
		18700 to 19100	18700(1860.00MHz), 18900(1880.00MHz), 19100(1900.00MHz)	20MHz	QPSK	1 RB / 99 RB Offset

Note: The conducted output power for QPSK, 16QAM and 64QAM, measured value of QPSK is higher than 16QAM and 64QAM mode. Therefore, only occupied bandwidth and Peak to average ratio items had been tested under QPSK, 16QAM and 64QAM modes, the other test items were performed under QPSK mode only.

Test Condition:

Test Item	Environmental Conditions	Input Power	Tested By
EIRP	25deg. C, 66%RH 24deg. C, 66%RH	120Vac, 60Hz	Greg Lin Tim Chen
Modulation characteristics	24deg. C, 64%RH	120Vac, 60Hz	Wayne Huang
Frequency Stability	24deg. C, 64%RH	120Vac, 60Hz	Wayne Huang
Occupied Bandwidth	24deg. C, 64%RH	120Vac, 60Hz	Wayne Huang
Band Edge	24deg. C, 64%RH	120Vac, 60Hz	Wayne Huang
Peak To Average Ratio	24deg. C, 64%RH	120Vac, 60Hz	Wayne Huang
Conducted Emission	24deg. C, 64%RH	120Vac, 60Hz	Wayne Huang
Radiated Emission	25deg. C, 66%RH	120Vac, 60Hz	Greg Lin

3.4 EUT Operating Conditions

The EUT makes a call to the communication simulator. The communication simulator station system controlled a EUT to export maximum output power under transmission mode and specific channel frequency

3.5 General Description of Applied Standards

The EUT is a RF Product. According to the specifications of the manufacturer, it must comply with the requirements of the following standards:

FCC 47 CFR Part 2

FCC 47 CFR Part 24

KDB 971168 D01 Power Meas License Digital Systems v03r01

ANSI/TIA/EIA-603-E 2016

ANSI 63.26-2015

All test items have been performed and recorded as per the above standards.

4 Test Types and Results

4.1 Output Power Measurement

4.1.1 Limits of Output Power Measurement

Mobile / Portable station are limited to 2 watts e.r.p.

4.1.2 Test Procedures

EIRP / ERP Measurement:

- a. All measurements were done at low, middle and high operational frequency range. RBW and VBW is 10MHz for LTE mode.
- b. Substitution method is used for E.I.R.P measurement. In the semi-anechoic chamber, EUT placed on the 0.8m(below or equal 1GHz) and/or 1.5m(above 1GHz) height of Turn Table, rotated the table around 360 degrees to search the maximum radiation power and receiver antenna shall be rotated vertical and horizontal polarization and moved height from 1m to 4m to find the maximum polar radiated power. The "Read Value" is the spectrum reading the maximum power value.
- c. The substitution horn antenna is substituted for EUT at the same position and signals generator export the CW signal to the substitution antenna via a TX cable. Rotated the Turn Table and moved receiving antenna to find the maximum radiation power. Adjust output power level of S.G to get a Value of spectrum reading equal to "Read Value" of step b. Record the power level of S.G
- d. EIRP = Output power level of S.G – TX cable loss + Antenna gain of substitution horn.E.R.P power can be calculated form E.I.R.P power by subtracting the gain of dipole, E.R.P power = E.I.R.P power - 2.15dB.

Where:

$$ERP/EIRP = P_{Meas} + G_T - L_C$$

P_{Meas} : Measure transmitter output power.

G_T : Gain of the transmitting antenna.

L_C : signal attenuation in the connecting cable between the transmitter and antenna.

Conducted Power Measurement:

The EUT was set up for the maximum power with PCS, WCDMA, LTE link data modulation and link up with simulator. Set the EUT to transmit under low, middle and high channel and record the power level shown on simulator.

4.1.3 Test Setup

EIRP / ERP Measurement:

For Radiated Emission below or equal 1GHz

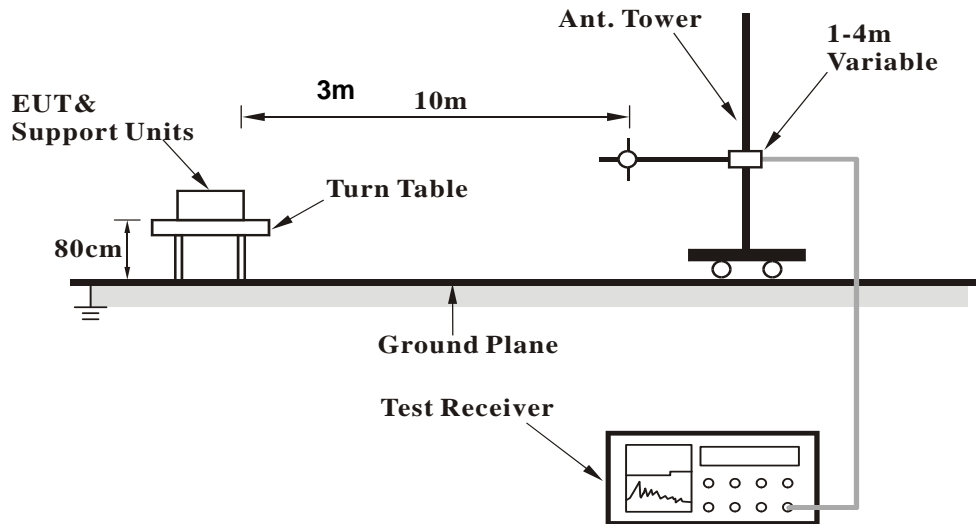

For Radiated Emission above 1GHz

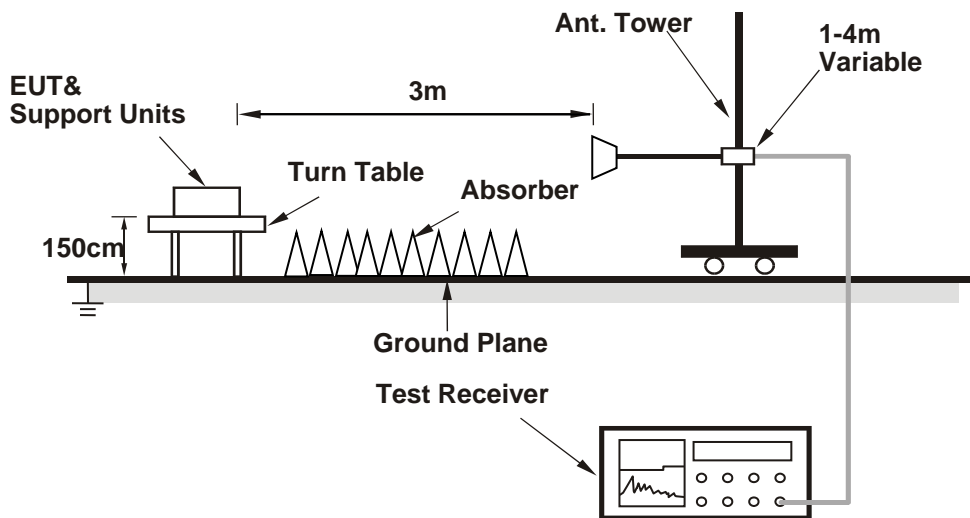

For the actual test configuration, please refer to the attached file (Test Setup Photo).

Conducted Power Measurement:



For the actual test configuration, please refer to the attached file (Test Setup Photo).

4.1.4 Test Results

Conducted Output Power (dBm)

LTE Band 2						
BW	MCS Index	RB Size	RB Offset	Low	Mid	High
		Channel		18700	18900	19100
		Frequency (MHz)		1860	1880	1900
20M	QPSK	1	0	23.74	23.88	23.68
		1	50	23.38	23.47	23.31
		1	99	23.62	23.71	23.57
		50	0	22.93	22.99	22.85
		50	25	22.92	22.96	22.82
		50	50	22.86	22.97	22.80
		100	0	22.91	22.98	22.81
	16QAM	1	0	22.64	22.83	22.58
		1	50	22.34	22.37	22.24
		1	99	22.57	22.68	22.51
		50	0	21.89	21.95	21.80
		50	25	21.82	21.93	21.76
		50	50	21.84	21.89	21.71
		100	0	21.87	21.96	21.74
	64QAM	1	0	21.64	21.83	21.60
		1	50	21.35	21.47	21.24
		1	99	21.58	21.65	21.53
		50	0	20.84	20.97	20.79
		50	25	20.87	20.97	20.74
		50	50	20.80	20.89	20.73
		100	0	20.91	20.91	20.71

LTE Band 2						
BW	MCS Index	RB Size	RB Offset	Low	Mid	High
		Channel		18675	18900	19125
		Frequency (MHz)		1857.5	1880	1902.5
15M	QPSK	1	0	23.65	23.82	23.64
		1	37	23.38	23.41	23.21
		1	74	23.61	23.69	23.56
		36	0	22.87	22.99	22.84
		36	19	22.84	22.93	22.79
		36	39	22.83	22.90	22.79
		75	0	22.87	22.90	22.72
	16QAM	1	0	22.59	22.74	22.60
		1	37	22.37	22.37	22.24
		1	74	22.62	22.60	22.44
		36	0	21.76	21.97	21.72
		36	19	21.82	21.94	21.70
		36	39	21.78	21.92	21.69
		75	0	21.89	21.86	21.71
	64QAM	1	0	21.63	21.74	21.53
		1	37	21.36	21.42	21.18
		1	74	21.49	21.66	21.47
		36	0	20.83	20.99	20.74
		36	19	20.80	20.92	20.65
		36	39	20.77	20.94	20.73
		75	0	20.77	20.91	20.71

LTE Band 2						
BW	MCS Index	RB Size	RB Offset	Low	Mid	High
		Channel		18650	18900	19150
		Frequency (MHz)		1855	1880	1905
10M	QPSK	1	0	23.64	23.70	23.60
		1	24	23.33	23.38	23.23
		1	49	23.52	23.68	23.48
		25	0	22.82	22.85	22.63
		25	12	22.75	22.90	22.71
		25	25	22.75	22.82	22.58
		50	0	22.79	22.84	22.64
	16QAM	1	0	22.59	22.73	22.57
		1	24	22.12	22.35	22.09
		1	49	22.42	22.58	22.43
		25	0	21.82	21.89	21.73
		25	12	21.71	21.90	21.58
		25	25	21.64	21.76	21.56
		50	0	21.71	21.67	21.58
	64QAM	1	0	21.59	21.84	21.48
		1	24	21.18	21.18	21.11
		1	49	21.42	21.60	21.37
		25	0	20.74	20.88	20.54
		25	12	20.73	20.97	20.53
		25	25	20.67	20.85	20.58
		50	0	20.67	20.86	20.59

LTE Band 2						
BW	MCS Index	RB Size	RB Offset	Low	Mid	High
		Channel		18625	18900	19175
		Frequency (MHz)		1852.5	1880	1907.5
5M	QPSK	1	0	23.68	23.71	23.58
		1	12	23.24	23.40	23.14
		1	24	23.50	23.68	23.25
		12	0	22.79	22.90	22.55
		12	6	22.76	22.98	22.57
		12	13	22.79	22.75	22.56
		25	0	22.81	22.81	22.56
	16QAM	1	0	22.54	22.64	22.42
		1	12	22.33	22.30	22.15
		1	24	22.43	22.53	22.54
		12	0	21.70	21.93	21.71
		12	6	21.66	21.77	21.59
		12	13	21.57	21.89	21.59
		25	0	21.68	21.91	21.66
	64QAM	1	0	21.53	21.64	21.48
		1	12	21.25	21.36	21.22
		1	24	21.41	21.59	21.46
		12	0	20.67	20.85	20.66
		12	6	20.68	20.85	20.72
		12	13	20.64	20.78	20.69
		25	0	20.81	20.82	20.71

LTE Band 2						
BW	MCS Index	RB Size	RB Offset	Low	Mid	High
		Channel		18615	18900	19185
		Frequency (MHz)		1851.5	1880	1908.5
3M	QPSK	1	0	23.59	23.83	23.60
		1	7	23.31	23.33	23.19
		1	14	23.48	23.61	23.54
		8	0	22.80	22.93	22.80
		8	3	22.78	23.00	22.74
		8	7	22.76	22.80	22.69
		15	0	22.72	22.87	22.61
	16QAM	1	0	22.61	22.68	22.43
		1	7	22.21	22.19	22.16
		1	14	22.52	22.51	22.48
		8	0	21.74	21.85	21.75
		8	3	21.75	21.85	21.60
		8	7	21.71	21.89	21.74
		15	0	21.76	21.86	21.67
	64QAM	1	0	21.63	21.65	21.51
		1	7	21.12	21.35	21.13
		1	14	21.37	21.59	21.41
		8	0	20.77	20.82	20.67
		8	3	20.75	20.97	20.63
		8	7	20.69	20.91	20.57
		15	0	20.75	20.79	20.63

LTE Band 2						
BW	MCS Index	RB Size	RB Offset	Low	Mid	High
		Channel		18607	18900	19193
		Frequency (MHz)		1850.7	1880	1909.3
1.4M	QPSK	1	0	23.56	23.86	23.45
		1	2	23.26	23.38	23.14
		1	5	23.58	23.62	23.35
		3	0	23.80	23.87	23.74
		3	1	23.71	23.85	23.62
		3	3	23.73	23.81	23.66
		6	0	22.89	22.98	22.78
	16QAM	1	0	22.61	22.55	22.60
		1	2	22.10	22.20	22.13
		1	5	22.41	22.54	22.42
		3	0	22.75	22.88	22.59
		3	1	22.81	22.80	22.71
		3	3	22.67	22.88	22.65
		6	0	21.75	21.82	21.48
	64QAM	1	0	21.47	21.69	21.60
		1	2	21.15	21.42	21.12
		1	5	21.37	21.61	21.34
		3	0	21.80	21.98	21.74
		3	1	21.70	21.81	21.62
		3	3	21.54	21.89	21.64
		6	0	20.65	20.83	20.60

EIRP Power (dBm)

Modulation Type: QPSK

LTE Band 2, Channel Bandwidth: 1.4MHz

MODE		TX channel 18607					
Antenna Polarity & Test Distance: Horizontal at 3 M							
No.	Freq. (MHz)	Reading (dBm)	S.G Power Value (dBm)	Correction Factor (dB)	EIRP (dBm)	Limit (dBm)	Margin (dB)
1	1850.70	-12.9	27.3	0.1	27.4	33.0	-5.6
Antenna Polarity & Test Distance: Vertical at 3 M							
No.	Freq. (MHz)	Reading (dBm)	S.G Power Value (dBm)	Correction Factor (dB)	EIRP (dBm)	Limit (dBm)	Margin (dB)
1	1850.70	-16.5	23.9	0.1	24.0	33.0	-9.0

MODE		TX channel 18900					
Antenna Polarity & Test Distance: Horizontal at 3 M							
No.	Freq. (MHz)	Reading (dBm)	S.G Power Value (dBm)	Correction Factor (dB)	EIRP (dBm)	Limit (dBm)	Margin (dB)
1	1880.00	-13.0	27.5	0.0	27.5	33.0	-5.5
Antenna Polarity & Test Distance: Vertical at 3 M							
No.	Freq. (MHz)	Reading (dBm)	S.G Power Value (dBm)	Correction Factor (dB)	EIRP (dBm)	Limit (dBm)	Margin (dB)
1	1880.00	-15.9	24.7	0.0	24.7	33.0	-8.3

MODE		TX channel 19193					
Antenna Polarity & Test Distance: Horizontal at 3 M							
No.	Freq. (MHz)	Reading (dBm)	S.G Power Value (dBm)	Correction Factor (dB)	EIRP (dBm)	Limit (dBm)	Margin (dB)
1	1909.30	-13.1	27.6	-0.1	27.5	33.0	-5.5
Antenna Polarity & Test Distance: Vertical at 3 M							
No.	Freq. (MHz)	Reading (dBm)	S.G Power Value (dBm)	Correction Factor (dB)	EIRP (dBm)	Limit (dBm)	Margin (dB)
1	1909.30	-16.4	24.4	-0.1	24.3	33.0	-8.7

Note: EIRP (dBm) = S.G Power Value (dBm) + Correction Factor (dB).

LTE Band 2, Channel Bandwidth: 3MHz

MODE		TX channel 18615					
Antenna Polarity & Test Distance: Horizontal at 3 M							
No.	Freq. (MHz)	Reading (dBm)	S.G Power Value (dBm)	Correction Factor (dB)	EIRP (dBm)	Limit (dBm)	Margin (dB)
1	1851.50	-12.4	27.8	0.1	27.9	33.0	-5.1
Antenna Polarity & Test Distance: Vertical at 3 M							
No.	Freq. (MHz)	Reading (dBm)	S.G Power Value (dBm)	Correction Factor (dB)	EIRP (dBm)	Limit (dBm)	Margin (dB)
1	1851.50	-16.1	24.3	0.1	24.4	33.0	-8.6

MODE		TX channel 18900					
Antenna Polarity & Test Distance: Horizontal at 3 M							
No.	Freq. (MHz)	Reading (dBm)	S.G Power Value (dBm)	Correction Factor (dB)	EIRP (dBm)	Limit (dBm)	Margin (dB)
1	1880.00	-12.7	27.8	0.0	27.8	33.0	-5.2
Antenna Polarity & Test Distance: Vertical at 3 M							
No.	Freq. (MHz)	Reading (dBm)	S.G Power Value (dBm)	Correction Factor (dB)	EIRP (dBm)	Limit (dBm)	Margin (dB)
1	1880.00	-15.6	25.0	0.0	25.0	33.0	-8.0

MODE		TX channel 19185					
Antenna Polarity & Test Distance: Horizontal at 3 M							
No.	Freq. (MHz)	Reading (dBm)	S.G Power Value (dBm)	Correction Factor (dB)	EIRP (dBm)	Limit (dBm)	Margin (dB)
1	1908.50	-12.8	27.9	-0.1	27.8	33.0	-5.2
Antenna Polarity & Test Distance: Vertical at 3 M							
No.	Freq. (MHz)	Reading (dBm)	S.G Power Value (dBm)	Correction Factor (dB)	EIRP (dBm)	Limit (dBm)	Margin (dB)
1	1908.50	-16.5	24.3	-0.1	24.2	33.0	-8.8

Note: EIRP (dBm) = S.G Power Value (dBm) + Correction Factor (dB).

LTE Band 2, Channel Bandwidth: 5MHz

MODE		TX channel 18625					
Antenna Polarity & Test Distance: Horizontal at 3 M							
No.	Freq. (MHz)	Reading (dBm)	S.G Power Value (dBm)	Correction Factor (dB)	EIRP (dBm)	Limit (dBm)	Margin (dB)
1	1852.50	-13.7	26.5	0.1	26.6	33.0	-6.4
Antenna Polarity & Test Distance: Vertical at 3 M							
No.	Freq. (MHz)	Reading (dBm)	S.G Power Value (dBm)	Correction Factor (dB)	EIRP (dBm)	Limit (dBm)	Margin (dB)
1	1852.50	-16.4	24.0	0.1	24.1	33.0	-8.9

MODE		TX channel 18900					
Antenna Polarity & Test Distance: Horizontal at 3 M							
No.	Freq. (MHz)	Reading (dBm)	S.G Power Value (dBm)	Correction Factor (dB)	EIRP (dBm)	Limit (dBm)	Margin (dB)
1	1880.00	-13.5	27.0	0.0	27.0	33.0	-6.0
Antenna Polarity & Test Distance: Vertical at 3 M							
No.	Freq. (MHz)	Reading (dBm)	S.G Power Value (dBm)	Correction Factor (dB)	EIRP (dBm)	Limit (dBm)	Margin (dB)
1	1880.00	-16.0	24.6	0.0	24.6	33.0	-8.4

MODE		TX channel 19175					
Antenna Polarity & Test Distance: Horizontal at 3 M							
No.	Freq. (MHz)	Reading (dBm)	S.G Power Value (dBm)	Correction Factor (dB)	EIRP (dBm)	Limit (dBm)	Margin (dB)
1	1907.50	-12.9	27.8	-0.1	27.7	33.0	-5.3
Antenna Polarity & Test Distance: Vertical at 3 M							
No.	Freq. (MHz)	Reading (dBm)	S.G Power Value (dBm)	Correction Factor (dB)	EIRP (dBm)	Limit (dBm)	Margin (dB)
1	1907.50	-16.2	24.6	-0.1	24.5	33.0	-8.5

Note: EIRP (dBm) = S.G Power Value (dBm) + Correction Factor (dB).

LTE Band 2, Channel Bandwidth: 10MHz

MODE		TX channel 18650					
Antenna Polarity & Test Distance: Horizontal at 3 M							
No.	Freq. (MHz)	Reading (dBm)	S.G Power Value (dBm)	Correction Factor (dB)	EIRP (dBm)	Limit (dBm)	Margin (dB)
1	1855.00	-13.5	26.8	0.0	26.8	33.0	-6.2
Antenna Polarity & Test Distance: Vertical at 3 M							
No.	Freq. (MHz)	Reading (dBm)	S.G Power Value (dBm)	Correction Factor (dB)	EIRP (dBm)	Limit (dBm)	Margin (dB)
1	1855.00	-16.4	24.1	0.0	24.1	33.0	-8.9

MODE		TX channel 18900					
Antenna Polarity & Test Distance: Horizontal at 3 M							
No.	Freq. (MHz)	Reading (dBm)	S.G Power Value (dBm)	Correction Factor (dB)	EIRP (dBm)	Limit (dBm)	Margin (dB)
1	1880.00	-13.3	27.2	0.0	27.2	33.0	-5.8
Antenna Polarity & Test Distance: Vertical at 3 M							
No.	Freq. (MHz)	Reading (dBm)	S.G Power Value (dBm)	Correction Factor (dB)	EIRP (dBm)	Limit (dBm)	Margin (dB)
1	1880.00	-16.1	24.5	0.0	24.5	33.0	-8.5

MODE		TX channel 19150					
Antenna Polarity & Test Distance: Horizontal at 3 M							
No.	Freq. (MHz)	Reading (dBm)	S.G Power Value (dBm)	Correction Factor (dB)	EIRP (dBm)	Limit (dBm)	Margin (dB)
1	1905.00	-13.2	27.5	-0.1	27.4	33.0	-5.6
Antenna Polarity & Test Distance: Vertical at 3 M							
No.	Freq. (MHz)	Reading (dBm)	S.G Power Value (dBm)	Correction Factor (dB)	EIRP (dBm)	Limit (dBm)	Margin (dB)
1	1905.00	-16.2	24.6	-0.1	24.5	33.0	-8.5

Note: EIRP (dBm) = S.G Power Value (dBm) + Correction Factor (dB).

LTE Band 2, Channel Bandwidth: 15MHz

MODE		TX channel 18675					
Antenna Polarity & Test Distance: Horizontal at 3 M							
No.	Freq. (MHz)	Reading (dBm)	S.G Power Value (dBm)	Correction Factor (dB)	EIRP (dBm)	Limit (dBm)	Margin (dB)
1	1857.50	-13.7	26.6	0.0	26.6	33.0	-6.4
Antenna Polarity & Test Distance: Vertical at 3 M							
No.	Freq. (MHz)	Reading (dBm)	S.G Power Value (dBm)	Correction Factor (dB)	EIRP (dBm)	Limit (dBm)	Margin (dB)
1	1857.50	-16.2	24.3	0.0	24.3	33.0	-8.7

MODE		TX channel 18900					
Antenna Polarity & Test Distance: Horizontal at 3 M							
No.	Freq. (MHz)	Reading (dBm)	S.G Power Value (dBm)	Correction Factor (dB)	EIRP (dBm)	Limit (dBm)	Margin (dB)
1	1880.00	-13.1	27.4	0.0	27.4	33.0	-5.6
Antenna Polarity & Test Distance: Vertical at 3 M							
No.	Freq. (MHz)	Reading (dBm)	S.G Power Value (dBm)	Correction Factor (dB)	EIRP (dBm)	Limit (dBm)	Margin (dB)
1	1880.00	-16.6	24.0	0.0	24.0	33.0	-9.0

MODE		TX channel 19125					
Antenna Polarity & Test Distance: Horizontal at 3 M							
No.	Freq. (MHz)	Reading (dBm)	S.G Power Value (dBm)	Correction Factor (dB)	EIRP (dBm)	Limit (dBm)	Margin (dB)
1	1902.50	-13.8	26.9	-0.1	26.8	33.0	-6.2
Antenna Polarity & Test Distance: Vertical at 3 M							
No.	Freq. (MHz)	Reading (dBm)	S.G Power Value (dBm)	Correction Factor (dB)	EIRP (dBm)	Limit (dBm)	Margin (dB)
1	1902.50	-16.1	24.7	-0.1	24.6	33.0	-8.4

Note: EIRP (dBm) = S.G Power Value (dBm) + Correction Factor (dB).

LTE Band 2, Channel Bandwidth: 20MHz

MODE		TX channel 18700					
Antenna Polarity & Test Distance: Horizontal at 3 M							
No.	Freq. (MHz)	Reading (dBm)	S.G Power Value (dBm)	Correction Factor (dB)	EIRP (dBm)	Limit (dBm)	Margin (dB)
1	1860.00	-13.3	27.0	0.0	27.0	33.0	-6.0
Antenna Polarity & Test Distance: Vertical at 3 M							
No.	Freq. (MHz)	Reading (dBm)	S.G Power Value (dBm)	Correction Factor (dB)	EIRP (dBm)	Limit (dBm)	Margin (dB)
1	1860.00	-16.5	24.0	0.0	24.0	33.0	-9.0

MODE		TX channel 18900					
Antenna Polarity & Test Distance: Horizontal at 3 M							
No.	Freq. (MHz)	Reading (dBm)	S.G Power Value (dBm)	Correction Factor (dB)	EIRP (dBm)	Limit (dBm)	Margin (dB)
1	1880.00	-12.8	27.7	0.0	27.7	33.0	-5.3
Antenna Polarity & Test Distance: Vertical at 3 M							
No.	Freq. (MHz)	Reading (dBm)	S.G Power Value (dBm)	Correction Factor (dB)	EIRP (dBm)	Limit (dBm)	Margin (dB)
1	1880.00	-16.2	24.4	0.0	24.4	33.0	-8.6

MODE		TX channel 19100					
Antenna Polarity & Test Distance: Horizontal at 3 M							
No.	Freq. (MHz)	Reading (dBm)	S.G Power Value (dBm)	Correction Factor (dB)	EIRP (dBm)	Limit (dBm)	Margin (dB)
1	1900.00	-13.0	27.7	-0.1	27.6	33.0	-5.4
Antenna Polarity & Test Distance: Vertical at 3 M							
No.	Freq. (MHz)	Reading (dBm)	S.G Power Value (dBm)	Correction Factor (dB)	EIRP (dBm)	Limit (dBm)	Margin (dB)
1	1900.00	-16.0	24.8	-0.1	24.7	33.0	-8.3

Note: EIRP (dBm) = S.G Power Value (dBm) + Correction Factor (dB).

Modulation Type: 16QAM

LTE Band 2, Channel Bandwidth: 1.4MHz

MODE		TX channel 18607					
Antenna Polarity & Test Distance: Horizontal at 3 M							
No.	Freq. (MHz)	Reading (dBm)	S.G Power Value (dBm)	Correction Factor (dB)	EIRP (dBm)	Limit (dBm)	Margin (dB)
1	1850.70	-13.8	26.4	0.1	26.5	33.0	-6.5
Antenna Polarity & Test Distance: Vertical at 3 M							
No.	Freq. (MHz)	Reading (dBm)	S.G Power Value (dBm)	Correction Factor (dB)	EIRP (dBm)	Limit (dBm)	Margin (dB)
1	1850.70	-17.5	22.9	0.1	23.0	33.0	-10.0

MODE		TX channel 18900					
Antenna Polarity & Test Distance: Horizontal at 3 M							
No.	Freq. (MHz)	Reading (dBm)	S.G Power Value (dBm)	Correction Factor (dB)	EIRP (dBm)	Limit (dBm)	Margin (dB)
1	1880.00	-13.9	26.6	0.0	26.6	33.0	-6.4
Antenna Polarity & Test Distance: Vertical at 3 M							
No.	Freq. (MHz)	Reading (dBm)	S.G Power Value (dBm)	Correction Factor (dB)	EIRP (dBm)	Limit (dBm)	Margin (dB)
1	1880.00	-16.9	23.7	0.0	23.7	33.0	-9.3

MODE		TX channel 19193					
Antenna Polarity & Test Distance: Horizontal at 3 M							
No.	Freq. (MHz)	Reading (dBm)	S.G Power Value (dBm)	Correction Factor (dB)	EIRP (dBm)	Limit (dBm)	Margin (dB)
1	1909.30	-14.1	26.6	-0.1	26.5	33.0	-6.5
Antenna Polarity & Test Distance: Vertical at 3 M							
No.	Freq. (MHz)	Reading (dBm)	S.G Power Value (dBm)	Correction Factor (dB)	EIRP (dBm)	Limit (dBm)	Margin (dB)
1	1909.30	-17.4	23.4	-0.1	23.3	33.0	-9.7

Note: EIRP (dBm) = S.G Power Value (dBm) + Correction Factor (dB).

LTE Band 2, Channel Bandwidth: 3MHz

MODE		TX channel 18615					
Antenna Polarity & Test Distance: Horizontal at 3 M							
No.	Freq. (MHz)	Reading (dBm)	S.G Power Value (dBm)	Correction Factor (dB)	EIRP (dBm)	Limit (dBm)	Margin (dB)
1	1851.50	-13.2	27.0	0.1	27.1	33.0	-5.9
Antenna Polarity & Test Distance: Vertical at 3 M							
No.	Freq. (MHz)	Reading (dBm)	S.G Power Value (dBm)	Correction Factor (dB)	EIRP (dBm)	Limit (dBm)	Margin (dB)
1	1851.50	-17.0	23.4	0.1	23.5	33.0	-9.5

MODE		TX channel 18900					
Antenna Polarity & Test Distance: Horizontal at 3 M							
No.	Freq. (MHz)	Reading (dBm)	S.G Power Value (dBm)	Correction Factor (dB)	EIRP (dBm)	Limit (dBm)	Margin (dB)
1	1880.00	-13.8	26.7	0.0	26.7	33.0	-6.3
Antenna Polarity & Test Distance: Vertical at 3 M							
No.	Freq. (MHz)	Reading (dBm)	S.G Power Value (dBm)	Correction Factor (dB)	EIRP (dBm)	Limit (dBm)	Margin (dB)
1	1880.00	-17.2	23.4	0.0	23.4	33.0	-9.6

MODE		TX channel 19185					
Antenna Polarity & Test Distance: Horizontal at 3 M							
No.	Freq. (MHz)	Reading (dBm)	S.G Power Value (dBm)	Correction Factor (dB)	EIRP (dBm)	Limit (dBm)	Margin (dB)
1	1908.50	-13.8	26.9	-0.1	26.8	33.0	-6.2
Antenna Polarity & Test Distance: Vertical at 3 M							
No.	Freq. (MHz)	Reading (dBm)	S.G Power Value (dBm)	Correction Factor (dB)	EIRP (dBm)	Limit (dBm)	Margin (dB)
1	1908.50	-17.4	23.4	-0.1	23.3	33.0	-9.7

Note: EIRP (dBm) = S.G Power Value (dBm) + Correction Factor (dB).

LTE Band 2, Channel Bandwidth: 5MHz

MODE		TX channel 18625					
Antenna Polarity & Test Distance: Horizontal at 3 M							
No.	Freq. (MHz)	Reading (dBm)	S.G Power Value (dBm)	Correction Factor (dB)	EIRP (dBm)	Limit (dBm)	Margin (dB)
1	1852.50	-14.6	25.6	0.1	25.7	33.0	-7.3
Antenna Polarity & Test Distance: Vertical at 3 M							
No.	Freq. (MHz)	Reading (dBm)	S.G Power Value (dBm)	Correction Factor (dB)	EIRP (dBm)	Limit (dBm)	Margin (dB)
1	1852.50	-17.3	23.1	0.1	23.2	33.0	-9.8

MODE		TX channel 18900					
Antenna Polarity & Test Distance: Horizontal at 3 M							
No.	Freq. (MHz)	Reading (dBm)	S.G Power Value (dBm)	Correction Factor (dB)	EIRP (dBm)	Limit (dBm)	Margin (dB)
1	1880.00	-14.5	26.0	0.0	26.0	33.0	-7.0
Antenna Polarity & Test Distance: Vertical at 3 M							
No.	Freq. (MHz)	Reading (dBm)	S.G Power Value (dBm)	Correction Factor (dB)	EIRP (dBm)	Limit (dBm)	Margin (dB)
1	1880.00	-17.0	23.6	0.0	23.6	33.0	-9.4

MODE		TX channel 19175					
Antenna Polarity & Test Distance: Horizontal at 3 M							
No.	Freq. (MHz)	Reading (dBm)	S.G Power Value (dBm)	Correction Factor (dB)	EIRP (dBm)	Limit (dBm)	Margin (dB)
1	1907.50	-14.0	26.7	-0.1	26.6	33.0	-6.4
Antenna Polarity & Test Distance: Vertical at 3 M							
No.	Freq. (MHz)	Reading (dBm)	S.G Power Value (dBm)	Correction Factor (dB)	EIRP (dBm)	Limit (dBm)	Margin (dB)
1	1907.50	-17.3	23.5	-0.1	23.4	33.0	-9.6

Note: EIRP (dBm) = S.G Power Value (dBm) + Correction Factor (dB).

LTE Band 2, Channel Bandwidth: 10MHz

MODE		TX channel 18650					
Antenna Polarity & Test Distance: Horizontal at 3 M							
No.	Freq. (MHz)	Reading (dBm)	S.G Power Value (dBm)	Correction Factor (dB)	EIRP (dBm)	Limit (dBm)	Margin (dB)
1	1855.00	-14.3	26.0	0.0	26.0	33.0	-7.0
Antenna Polarity & Test Distance: Vertical at 3 M							
No.	Freq. (MHz)	Reading (dBm)	S.G Power Value (dBm)	Correction Factor (dB)	EIRP (dBm)	Limit (dBm)	Margin (dB)
1	1855.00	-17.5	23.0	0.0	23.0	33.0	-10.0

MODE		TX channel 18900					
Antenna Polarity & Test Distance: Horizontal at 3 M							
No.	Freq. (MHz)	Reading (dBm)	S.G Power Value (dBm)	Correction Factor (dB)	EIRP (dBm)	Limit (dBm)	Margin (dB)
1	1880.00	-14.2	26.3	0.0	26.3	33.0	-6.7
Antenna Polarity & Test Distance: Vertical at 3 M							
No.	Freq. (MHz)	Reading (dBm)	S.G Power Value (dBm)	Correction Factor (dB)	EIRP (dBm)	Limit (dBm)	Margin (dB)
1	1880.00	-17.2	23.4	0.0	23.4	33.0	-9.6

MODE		TX channel 19150					
Antenna Polarity & Test Distance: Horizontal at 3 M							
No.	Freq. (MHz)	Reading (dBm)	S.G Power Value (dBm)	Correction Factor (dB)	EIRP (dBm)	Limit (dBm)	Margin (dB)
1	1905.00	-14.3	26.4	-0.1	26.3	33.0	-6.7
Antenna Polarity & Test Distance: Vertical at 3 M							
No.	Freq. (MHz)	Reading (dBm)	S.G Power Value (dBm)	Correction Factor (dB)	EIRP (dBm)	Limit (dBm)	Margin (dB)
1	1905.00	-17.3	23.5	-0.1	23.4	33.0	-9.6

Note: EIRP (dBm) = S.G Power Value (dBm) + Correction Factor (dB).

LTE Band 2, Channel Bandwidth: 15MHz

MODE		TX channel 18675					
Antenna Polarity & Test Distance: Horizontal at 3 M							
No.	Freq. (MHz)	Reading (dBm)	S.G Power Value (dBm)	Correction Factor (dB)	EIRP (dBm)	Limit (dBm)	Margin (dB)
1	1857.50	-14.6	25.7	0.0	25.7	33.0	-7.3
Antenna Polarity & Test Distance: Vertical at 3 M							
No.	Freq. (MHz)	Reading (dBm)	S.G Power Value (dBm)	Correction Factor (dB)	EIRP (dBm)	Limit (dBm)	Margin (dB)
1	1857.50	-17.6	22.9	0.0	22.9	33.0	-10.1

MODE		TX channel 18900					
Antenna Polarity & Test Distance: Horizontal at 3 M							
No.	Freq. (MHz)	Reading (dBm)	S.G Power Value (dBm)	Correction Factor (dB)	EIRP (dBm)	Limit (dBm)	Margin (dB)
1	1880.00	-14.0	26.5	0.0	26.5	33.0	-6.5
Antenna Polarity & Test Distance: Vertical at 3 M							
No.	Freq. (MHz)	Reading (dBm)	S.G Power Value (dBm)	Correction Factor (dB)	EIRP (dBm)	Limit (dBm)	Margin (dB)
1	1880.00	-17.5	23.1	0.0	23.1	33.0	-9.9

MODE		TX channel 19125					
Antenna Polarity & Test Distance: Horizontal at 3 M							
No.	Freq. (MHz)	Reading (dBm)	S.G Power Value (dBm)	Correction Factor (dB)	EIRP (dBm)	Limit (dBm)	Margin (dB)
1	1902.50	-14.6	26.1	-0.1	26.0	33.0	-7.0
Antenna Polarity & Test Distance: Vertical at 3 M							
No.	Freq. (MHz)	Reading (dBm)	S.G Power Value (dBm)	Correction Factor (dB)	EIRP (dBm)	Limit (dBm)	Margin (dB)
1	1902.50	-17.3	23.5	-0.1	23.4	33.0	-9.6

Note: EIRP (dBm) = S.G Power Value (dBm) + Correction Factor (dB).

LTE Band 2, Channel Bandwidth: 20MHz

MODE		TX channel 18700					
Antenna Polarity & Test Distance: Horizontal at 3 M							
No.	Freq. (MHz)	Reading (dBm)	S.G Power Value (dBm)	Correction Factor (dB)	EIRP (dBm)	Limit (dBm)	Margin (dB)
1	1860.00	-14.3	26.0	0.0	26.0	33.0	-7.0
Antenna Polarity & Test Distance: Vertical at 3 M							
No.	Freq. (MHz)	Reading (dBm)	S.G Power Value (dBm)	Correction Factor (dB)	EIRP (dBm)	Limit (dBm)	Margin (dB)
1	1860.00	-17.4	23.1	0.0	23.1	33.0	-9.9

MODE		TX channel 18900					
Antenna Polarity & Test Distance: Horizontal at 3 M							
No.	Freq. (MHz)	Reading (dBm)	S.G Power Value (dBm)	Correction Factor (dB)	EIRP (dBm)	Limit (dBm)	Margin (dB)
1	1880.00	-13.8	26.7	0.0	26.7	33.0	-6.3
Antenna Polarity & Test Distance: Vertical at 3 M							
No.	Freq. (MHz)	Reading (dBm)	S.G Power Value (dBm)	Correction Factor (dB)	EIRP (dBm)	Limit (dBm)	Margin (dB)
1	1880.00	-17.2	23.4	0.0	23.4	33.0	-9.6

MODE		TX channel 19100					
Antenna Polarity & Test Distance: Horizontal at 3 M							
No.	Freq. (MHz)	Reading (dBm)	S.G Power Value (dBm)	Correction Factor (dB)	EIRP (dBm)	Limit (dBm)	Margin (dB)
1	1900.00	-14.1	26.6	-0.1	26.5	33.0	-6.5
Antenna Polarity & Test Distance: Vertical at 3 M							
No.	Freq. (MHz)	Reading (dBm)	S.G Power Value (dBm)	Correction Factor (dB)	EIRP (dBm)	Limit (dBm)	Margin (dB)
1	1900.00	-17.2	23.6	-0.1	23.5	33.0	-9.5

Note: EIRP (dBm) = S.G Power Value (dBm) + Correction Factor (dB).

Modulation Type: 64QAM

LTE Band 2, Channel Bandwidth: 1.4MHz

MODE		TX channel 18607					
Antenna Polarity & Test Distance: Horizontal at 3 M							
No.	Freq. (MHz)	Reading (dBm)	S.G Power Value (dBm)	Correction Factor (dB)	EIRP (dBm)	Limit (dBm)	Margin (dB)
1	1850.70	-14.5	25.7	0.1	25.8	33.0	-7.2
Antenna Polarity & Test Distance: Vertical at 3 M							
No.	Freq. (MHz)	Reading (dBm)	S.G Power Value (dBm)	Correction Factor (dB)	EIRP (dBm)	Limit (dBm)	Margin (dB)
1	1850.70	-18.1	22.3	0.1	22.4	33.0	-10.6

MODE		TX channel 18900					
Antenna Polarity & Test Distance: Horizontal at 3 M							
No.	Freq. (MHz)	Reading (dBm)	S.G Power Value (dBm)	Correction Factor (dB)	EIRP (dBm)	Limit (dBm)	Margin (dB)
1	1880.00	-14.5	26.0	0.0	26.0	33.0	-7.0
Antenna Polarity & Test Distance: Vertical at 3 M							
No.	Freq. (MHz)	Reading (dBm)	S.G Power Value (dBm)	Correction Factor (dB)	EIRP (dBm)	Limit (dBm)	Margin (dB)
1	1880.00	-17.5	23.1	0.0	23.1	33.0	-9.9

MODE		TX channel 19193					
Antenna Polarity & Test Distance: Horizontal at 3 M							
No.	Freq. (MHz)	Reading (dBm)	S.G Power Value (dBm)	Correction Factor (dB)	EIRP (dBm)	Limit (dBm)	Margin (dB)
1	1909.30	-14.8	25.9	-0.1	25.8	33.0	-7.2
Antenna Polarity & Test Distance: Vertical at 3 M							
No.	Freq. (MHz)	Reading (dBm)	S.G Power Value (dBm)	Correction Factor (dB)	EIRP (dBm)	Limit (dBm)	Margin (dB)
1	1909.30	-17.9	22.9	-0.1	22.8	33.0	-10.2

Note: EIRP (dBm) = S.G Power Value (dBm) + Correction Factor (dB).

LTE Band 2, Channel Bandwidth: 3MHz

MODE		TX channel 18615					
Antenna Polarity & Test Distance: Horizontal at 3 M							
No.	Freq. (MHz)	Reading (dBm)	S.G Power Value (dBm)	Correction Factor (dB)	EIRP (dBm)	Limit (dBm)	Margin (dB)
1	1851.50	-13.8	26.4	0.1	26.5	33.0	-6.5
Antenna Polarity & Test Distance: Vertical at 3 M							
No.	Freq. (MHz)	Reading (dBm)	S.G Power Value (dBm)	Correction Factor (dB)	EIRP (dBm)	Limit (dBm)	Margin (dB)
1	1851.50	-17.4	23.0	0.1	23.1	33.0	-9.9

MODE		TX channel 18900					
Antenna Polarity & Test Distance: Horizontal at 3 M							
No.	Freq. (MHz)	Reading (dBm)	S.G Power Value (dBm)	Correction Factor (dB)	EIRP (dBm)	Limit (dBm)	Margin (dB)
1	1880.00	-14.3	26.2	0.0	26.2	33.0	-6.8
Antenna Polarity & Test Distance: Vertical at 3 M							
No.	Freq. (MHz)	Reading (dBm)	S.G Power Value (dBm)	Correction Factor (dB)	EIRP (dBm)	Limit (dBm)	Margin (dB)
1	1880.00	-17.7	22.9	0.0	22.9	33.0	-10.1

MODE		TX channel 19185					
Antenna Polarity & Test Distance: Horizontal at 3 M							
No.	Freq. (MHz)	Reading (dBm)	S.G Power Value (dBm)	Correction Factor (dB)	EIRP (dBm)	Limit (dBm)	Margin (dB)
1	1908.50	-14.3	26.4	-0.1	26.3	33.0	-6.7
Antenna Polarity & Test Distance: Vertical at 3 M							
No.	Freq. (MHz)	Reading (dBm)	S.G Power Value (dBm)	Correction Factor (dB)	EIRP (dBm)	Limit (dBm)	Margin (dB)
1	1908.50	-17.9	22.9	-0.1	22.8	33.0	-10.2

Note: EIRP (dBm) = S.G Power Value (dBm) + Correction Factor (dB).

LTE Band 2, Channel Bandwidth: 5MHz

MODE		TX channel 18625					
Antenna Polarity & Test Distance: Horizontal at 3 M							
No.	Freq. (MHz)	Reading (dBm)	S.G Power Value (dBm)	Correction Factor (dB)	EIRP (dBm)	Limit (dBm)	Margin (dB)
1	1852.50	-15.2	25.0	0.1	25.1	33.0	-7.9
Antenna Polarity & Test Distance: Vertical at 3 M							
No.	Freq. (MHz)	Reading (dBm)	S.G Power Value (dBm)	Correction Factor (dB)	EIRP (dBm)	Limit (dBm)	Margin (dB)
1	1852.50	-17.6	22.8	0.1	22.9	33.0	-10.1

MODE		TX channel 18900					
Antenna Polarity & Test Distance: Horizontal at 3 M							
No.	Freq. (MHz)	Reading (dBm)	S.G Power Value (dBm)	Correction Factor (dB)	EIRP (dBm)	Limit (dBm)	Margin (dB)
1	1880.00	-14.9	25.6	0.0	25.6	33.0	-7.4
Antenna Polarity & Test Distance: Vertical at 3 M							
No.	Freq. (MHz)	Reading (dBm)	S.G Power Value (dBm)	Correction Factor (dB)	EIRP (dBm)	Limit (dBm)	Margin (dB)
1	1880.00	-17.4	23.2	0.0	23.2	33.0	-9.8

MODE		TX channel 19175					
Antenna Polarity & Test Distance: Horizontal at 3 M							
No.	Freq. (MHz)	Reading (dBm)	S.G Power Value (dBm)	Correction Factor (dB)	EIRP (dBm)	Limit (dBm)	Margin (dB)
1	1907.50	-14.3	26.4	-0.1	26.3	33.0	-6.7
Antenna Polarity & Test Distance: Vertical at 3 M							
No.	Freq. (MHz)	Reading (dBm)	S.G Power Value (dBm)	Correction Factor (dB)	EIRP (dBm)	Limit (dBm)	Margin (dB)
1	1907.50	-17.8	23.0	-0.1	22.9	33.0	-10.1

Note: EIRP (dBm) = S.G Power Value (dBm) + Correction Factor (dB).

LTE Band 2, Channel Bandwidth: 10MHz

MODE		TX channel 18650					
Antenna Polarity & Test Distance: Horizontal at 3 M							
No.	Freq. (MHz)	Reading (dBm)	S.G Power Value (dBm)	Correction Factor (dB)	EIRP (dBm)	Limit (dBm)	Margin (dB)
1	1855.00	-14.8	25.5	0.0	25.5	33.0	-7.5
Antenna Polarity & Test Distance: Vertical at 3 M							
No.	Freq. (MHz)	Reading (dBm)	S.G Power Value (dBm)	Correction Factor (dB)	EIRP (dBm)	Limit (dBm)	Margin (dB)
1	1855.00	-18.0	22.5	0.0	22.5	33.0	-10.5

MODE		TX channel 18900					
Antenna Polarity & Test Distance: Horizontal at 3 M							
No.	Freq. (MHz)	Reading (dBm)	S.G Power Value (dBm)	Correction Factor (dB)	EIRP (dBm)	Limit (dBm)	Margin (dB)
1	1880.00	-14.7	25.8	0.0	25.8	33.0	-7.2
Antenna Polarity & Test Distance: Vertical at 3 M							
No.	Freq. (MHz)	Reading (dBm)	S.G Power Value (dBm)	Correction Factor (dB)	EIRP (dBm)	Limit (dBm)	Margin (dB)
1	1880.00	-17.6	23.0	0.0	23.0	33.0	-10.0

MODE		TX channel 19150					
Antenna Polarity & Test Distance: Horizontal at 3 M							
No.	Freq. (MHz)	Reading (dBm)	S.G Power Value (dBm)	Correction Factor (dB)	EIRP (dBm)	Limit (dBm)	Margin (dB)
1	1905.00	-14.8	25.9	-0.1	25.8	33.0	-7.2
Antenna Polarity & Test Distance: Vertical at 3 M							
No.	Freq. (MHz)	Reading (dBm)	S.G Power Value (dBm)	Correction Factor (dB)	EIRP (dBm)	Limit (dBm)	Margin (dB)
1	1905.00	-17.8	23.0	-0.1	22.9	33.0	-10.1

Note: EIRP (dBm) = S.G Power Value (dBm) + Correction Factor (dB).

LTE Band 2, Channel Bandwidth: 15MHz

MODE		TX channel 18675					
Antenna Polarity & Test Distance: Horizontal at 3 M							
No.	Freq. (MHz)	Reading (dBm)	S.G Power Value (dBm)	Correction Factor (dB)	EIRP (dBm)	Limit (dBm)	Margin (dB)
1	1857.50	-14.9	25.4	0.0	25.4	33.0	-7.6
Antenna Polarity & Test Distance: Vertical at 3 M							
No.	Freq. (MHz)	Reading (dBm)	S.G Power Value (dBm)	Correction Factor (dB)	EIRP (dBm)	Limit (dBm)	Margin (dB)
1	1857.50	-18.1	22.4	0.0	22.4	33.0	-10.6

MODE		TX channel 18900					
Antenna Polarity & Test Distance: Horizontal at 3 M							
No.	Freq. (MHz)	Reading (dBm)	S.G Power Value (dBm)	Correction Factor (dB)	EIRP (dBm)	Limit (dBm)	Margin (dB)
1	1880.00	-14.4	26.1	0.0	26.1	33.0	-6.9
Antenna Polarity & Test Distance: Vertical at 3 M							
No.	Freq. (MHz)	Reading (dBm)	S.G Power Value (dBm)	Correction Factor (dB)	EIRP (dBm)	Limit (dBm)	Margin (dB)
1	1880.00	-18.1	22.5	0.0	22.5	33.0	-10.5

MODE		TX channel 19125					
Antenna Polarity & Test Distance: Horizontal at 3 M							
No.	Freq. (MHz)	Reading (dBm)	S.G Power Value (dBm)	Correction Factor (dB)	EIRP (dBm)	Limit (dBm)	Margin (dB)
1	1902.50	-15.1	25.6	-0.1	25.5	33.0	-7.5
Antenna Polarity & Test Distance: Vertical at 3 M							
No.	Freq. (MHz)	Reading (dBm)	S.G Power Value (dBm)	Correction Factor (dB)	EIRP (dBm)	Limit (dBm)	Margin (dB)
1	1902.50	-17.7	23.1	-0.1	23.0	33.0	-10.0

Note: EIRP (dBm) = S.G Power Value (dBm) + Correction Factor (dB).

LTE Band 2, Channel Bandwidth: 20MHz

MODE		TX channel 18700					
Antenna Polarity & Test Distance: Horizontal at 3 M							
No.	Freq. (MHz)	Reading (dBm)	S.G Power Value (dBm)	Correction Factor (dB)	EIRP (dBm)	Limit (dBm)	Margin (dB)
1	1860.00	-14.8	25.5	0.0	25.5	33.0	-7.5
Antenna Polarity & Test Distance: Vertical at 3 M							
No.	Freq. (MHz)	Reading (dBm)	S.G Power Value (dBm)	Correction Factor (dB)	EIRP (dBm)	Limit (dBm)	Margin (dB)
1	1860.00	-17.9	22.6	0.0	22.6	33.0	-10.4

MODE		TX channel 18900					
Antenna Polarity & Test Distance: Horizontal at 3 M							
No.	Freq. (MHz)	Reading (dBm)	S.G Power Value (dBm)	Correction Factor (dB)	EIRP (dBm)	Limit (dBm)	Margin (dB)
1	1880.00	-14.3	26.2	0.0	26.2	33.0	-6.8
Antenna Polarity & Test Distance: Vertical at 3 M							
No.	Freq. (MHz)	Reading (dBm)	S.G Power Value (dBm)	Correction Factor (dB)	EIRP (dBm)	Limit (dBm)	Margin (dB)
1	1880.00	-17.8	22.8	0.0	22.8	33.0	-10.2

MODE		TX channel 19100					
Antenna Polarity & Test Distance: Horizontal at 3 M							
No.	Freq. (MHz)	Reading (dBm)	S.G Power Value (dBm)	Correction Factor (dB)	EIRP (dBm)	Limit (dBm)	Margin (dB)
1	1900.00	-14.5	26.2	-0.1	26.1	33.0	-6.9
Antenna Polarity & Test Distance: Vertical at 3 M							
No.	Freq. (MHz)	Reading (dBm)	S.G Power Value (dBm)	Correction Factor (dB)	EIRP (dBm)	Limit (dBm)	Margin (dB)
1	1900.00	-18.3	22.5	-0.1	22.4	33.0	-10.6

Note: EIRP (dBm) = S.G Power Value (dBm) + Correction Factor (dB).

4.2 Modulation Characteristics Measurement

4.2.1 Limits of Modulation Characteristics

N/A

4.2.2 Test Procedure

Connect the EUT to Communication Simulator via the antenna connector, The frequency band is set as EUT supported Modulation and Channels, the EUT output is matched with 50 ohm load, the waveform quality and constellation of the EUT was tested.

4.2.3 Test Setup



4.2.4 Test Results

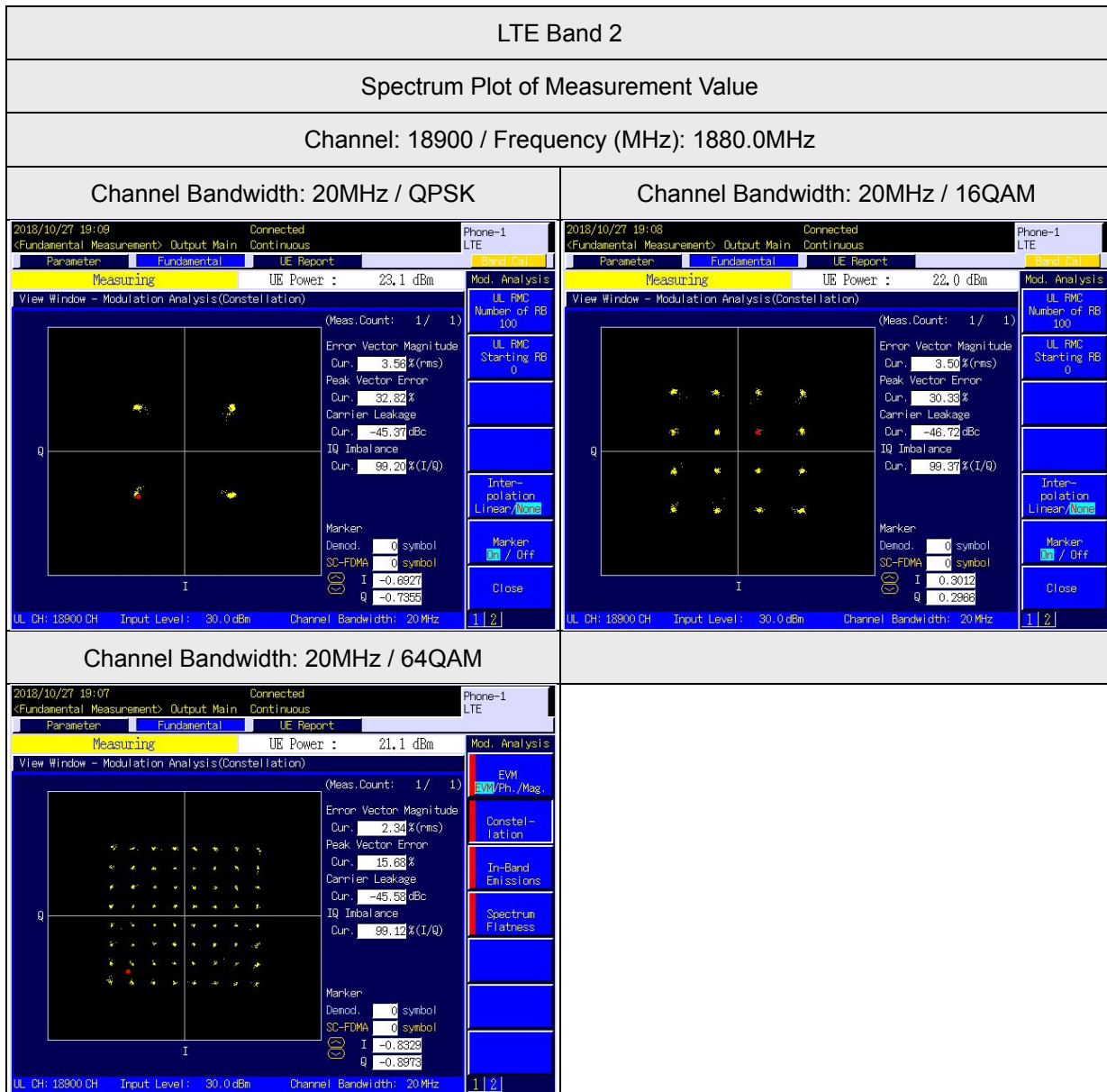

4.3 Frequency Stability Measurement

4.3.1 Limits of Frequency Stability Measurement

1.5 ppm is for base and fixed station. 2.5 ppm is for mobile station.

4.3.2 Test Procedure

- Device is placed at the oven room. The oven room could control the temperatures and humidity. Power warm up is at least 15 min and power applied should perform before recording frequency error.
- EUT is connected the external power supply to control the DC input power. The test voltage range is from minimum to maximum working voltage. Each step shall be record the frequency error rate.
- The temperature range step is 10 degrees in this test items. All temperature levels shall be hold the ± 0.5 °C during the measurement testing. The each temperature step shall be at least 0.5 hours, consider the EUT could be test under the stability condition.

NOTE: The frequency error was recorded frequency error from the communication simulator.

4.3.3 Test Setup

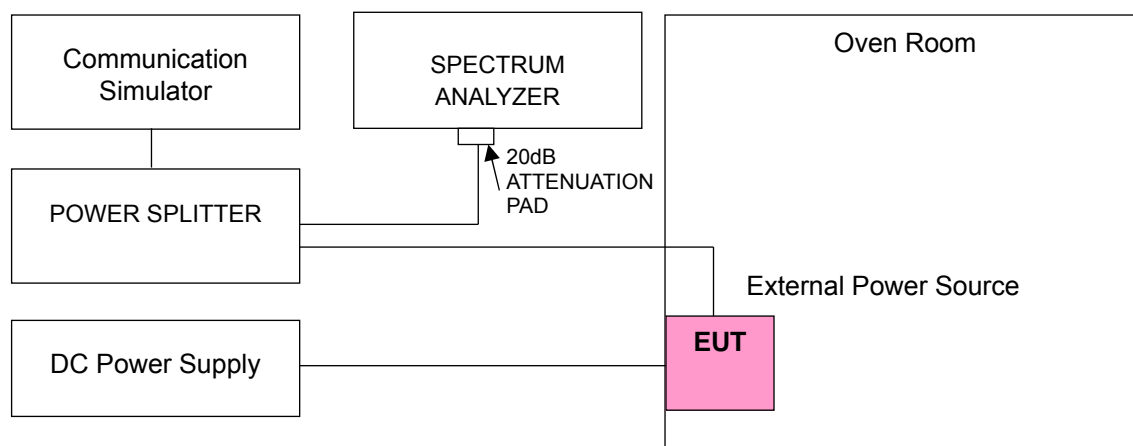

4.3.4 Test Results

Frequency Error vs. Voltage

Voltage (Volts)	LTE Band 2			
	Channel Bandwidth: 1.4 MHz			
	Low Channel		High Channel	
	Frequency (MHz)	Frequency Error (ppm)	Frequency (MHz)	Frequency Error (ppm)
3.85	1850.700001	0.000	1909.300000	0.000
3.23	1850.699995	-0.003	1909.299997	-0.002
4.37	1850.700004	0.002	1909.300004	0.002

Note: The applicant defined the normal working voltage is from 3.23 Vdc to 4.37 Vdc.

Frequency Error vs. Temperature

Temp. (°C)	LTE Band 2			
	Channel Bandwidth: 1.4 MHz			
	Low Channel		High Channel	
	Frequency (MHz)	Frequency Error (ppm)	Frequency (MHz)	Frequency Error (ppm)
-30	1850.700008	0.004	1909.300009	0.005
-20	1850.700006	0.003	1909.300005	0.003
-10	1850.700004	0.002	1909.300004	0.002
0	1850.700001	0.001	1909.300002	0.001
10	1850.699999	0.000	1909.300001	0.000
20	1850.699997	-0.001	1909.299997	-0.001
30	1850.699997	-0.002	1909.299996	-0.002
40	1850.699994	-0.004	1909.299993	-0.004
50	1850.699992	-0.004	1909.299991	-0.005

Frequency Error vs. Voltage

Voltage (Volts)	LTE Band 2			
	Channel Bandwidth: 3 MHz			
	Low Channel		High Channel	
	Frequency (MHz)	Frequency Error (ppm)	Frequency (MHz)	Frequency Error (ppm)
3.80	1851.499999	0.000	1907.500001	0.000
3.23	1851.499996	-0.002	1907.499995	-0.003
4.37	1851.500003	0.002	1907.500004	0.002

Note: The applicant defined the normal working voltage is from 3.23 Vdc to 4.37 Vdc.

Frequency Error vs. Temperature

Temp. (°C)	LTE Band 2			
	Channel Bandwidth: 3 MHz			
	Low Channel		High Channel	
	Frequency (MHz)	Frequency Error (ppm)	Frequency (MHz)	Frequency Error (ppm)
-30	1851.500008	0.004	1907.500009	0.005
-20	1851.500005	0.003	1907.500006	0.003
-10	1851.500003	0.002	1907.500004	0.002
0	1851.500003	0.001	1907.500001	0.001
10	1851.500000	0.000	1907.499999	0.000
20	1851.499999	-0.001	1907.499998	-0.001
30	1851.499996	-0.002	1907.499996	-0.002
40	1851.499993	-0.004	1907.499994	-0.003
50	1851.499991	-0.005	1907.499992	-0.004

Frequency Error vs. Voltage

Voltage (Volts)	LTE Band 2			
	Channel Bandwidth: 5 MHz			
	Low Channel		High Channel	
	Frequency (MHz)	Frequency Error (ppm)	Frequency (MHz)	Frequency Error (ppm)
3.80	1852.500000	0.000	1907.500000	0.000
3.23	1852.499995	-0.003	1907.499995	-0.003
4.37	1852.500004	0.002	1907.500003	0.002

Note: The applicant defined the normal working voltage is from 3.23 Vdc to 4.37 Vdc.

Frequency Error vs. Temperature

Temp. (°C)	LTE Band 2			
	Channel Bandwidth: 5 MHz			
	Low Channel		High Channel	
	Frequency (MHz)	Frequency Error (ppm)	Frequency (MHz)	Frequency Error (ppm)
-30	1852.500008	0.004	1907.500009	0.004
-20	1852.500005	0.003	1907.500006	0.003
-10	1852.500004	0.002	1907.500004	0.002
0	1852.500003	0.001	1907.500002	0.001
10	1852.499999	0.000	1907.500001	0.001
20	1852.499998	-0.001	1907.499998	-0.001
30	1852.499996	-0.002	1907.499995	-0.003
40	1852.499993	-0.004	1907.499994	-0.003
50	1852.499992	-0.004	1907.499992	-0.004

Frequency Error vs. Voltage

Voltage (Volts)	LTE Band 2			
	Channel Bandwidth: 10 MHz			
	Low Channel		High Channel	
	Frequency (MHz)	Frequency Error (ppm)	Frequency (MHz)	Frequency Error (ppm)
3.80	1854.999999	0.000	1904.999999	-0.001
3.23	1854.999997	-0.002	1904.999995	-0.003
4.37	1855.000003	0.002	1905.000004	0.002

Note: The applicant defined the normal working voltage is from 3.23 Vdc to 4.37 Vdc.

Frequency Error vs. Temperature

Temp. (°C)	LTE Band 2			
	Channel Bandwidth: 10 MHz			
	Low Channel		High Channel	
	Frequency (MHz)	Frequency Error (ppm)	Frequency (MHz)	Frequency Error (ppm)
-30	1855.000009	0.005	1905.000007	0.004
-20	1855.000005	0.003	1905.000006	0.003
-10	1855.000004	0.002	1905.000004	0.002
0	1855.000002	0.001	1905.000002	0.001
10	1854.999999	0.000	1905.000000	0.000
20	1854.999997	-0.001	1904.999999	-0.001
30	1854.999995	-0.003	1904.999996	-0.002
40	1854.999993	-0.004	1904.999993	-0.004
50	1854.999992	-0.004	1904.999991	-0.005

Frequency Error vs. Voltage

Voltage (Volts)	LTE Band 2			
	Channel Bandwidth: 15 MHz			
	Low Channel		High Channel	
	Frequency (MHz)	Frequency Error (ppm)	Frequency (MHz)	Frequency Error (ppm)
3.80	1857.499999	0.000	1902.500001	0.000
3.23	1857.499995	-0.003	1902.499996	-0.002
4.37	1857.500003	0.002	1902.500003	0.001

Note: The applicant defined the normal working voltage is from 3.23 Vdc to 4.37 Vdc.

Frequency Error vs. Temperature

Temp. (°C)	LTE Band 2			
	Channel Bandwidth: 15 MHz			
	Low Channel		High Channel	
	Frequency (MHz)	Frequency Error (ppm)	Frequency (MHz)	Frequency Error (ppm)
-30	1857.500007	0.004	1902.500007	0.004
-20	1857.500006	0.003	1902.500007	0.004
-10	1857.500003	0.002	1902.500004	0.002
0	1857.500002	0.001	1902.500001	0.001
10	1857.500001	0.000	1902.500000	0.000
20	1857.499998	-0.001	1902.499998	-0.001
30	1857.499995	-0.003	1902.499997	-0.002
40	1857.499994	-0.003	1902.499993	-0.003
50	1857.499991	-0.005	1902.499993	-0.004

Frequency Error vs. Voltage

Voltage (Volts)	LTE Band 2			
	Channel Bandwidth: 20 MHz			
	Low Channel		High Channel	
	Frequency (MHz)	Frequency Error (ppm)	Frequency (MHz)	Frequency Error (ppm)
3.80	1859.999999	-0.001	1900.000000	0.000
3.23	1859.999995	-0.003	1899.999995	-0.003
4.37	1860.000003	0.002	1900.000004	0.002

Note: The applicant defined the normal working voltage is from 3.23 Vdc to 4.37 Vdc.

Frequency Error vs. Temperature

Temp. (°C)	LTE Band 2			
	Channel Bandwidth: 20 MHz			
	Low Channel		High Channel	
	Frequency (MHz)	Frequency Error (ppm)	Frequency (MHz)	Frequency Error (ppm)
-30	1860.000009	0.005	1900.000009	0.005
-20	1860.000005	0.003	1900.000007	0.004
-10	1860.000004	0.002	1900.000004	0.002
0	1860.000001	0.001	1900.000001	0.001
10	1860.000000	0.000	1900.000000	0.000
20	1859.999999	0.000	1899.999998	-0.001
30	1859.999996	-0.002	1899.999996	-0.002
40	1859.999994	-0.003	1899.999994	-0.003
50	1859.999992	-0.004	1899.999992	-0.004

4.4 Occupied Bandwidth Measurement

4.4.1 Test Procedure

The EUT makes a call to the communication simulator. All measurements were done at low, middle and high operational frequency range. The communication simulator station system controlled a EUT to export maximum output power under transmission mode and specific channel frequency. Use OBW measurement function of Spectrum analyzer to measure 99 % occupied bandwidth.

4.4.2 Test Setup

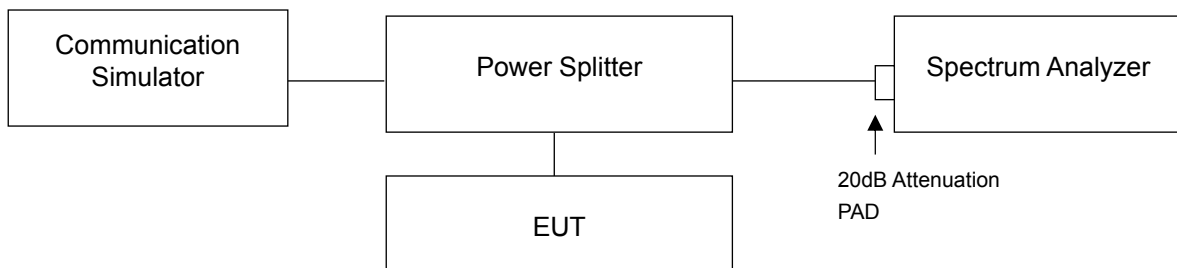

4.4.3 Test Result

LTE Band 2, Channel Bandwidth: 1.4MHz							
Channel	Frequency (MHz)	Occupied Bandwidth (MHz)			26dBc Bandwidth (MHz)		
		QPSK	16QAM	64QAM	QPSK	16QAM	64QAM
18607	1850.7	1.09	1.09	1.09	1.24	1.22	1.23
18900	1880.0	1.09	1.09	1.09	1.23	1.22	1.23
19193	1909.3	1.09	1.09	1.09	1.30	1.23	1.24
LTE Band 2, Channel Bandwidth: 3MHz							
Channel	Frequency (MHz)	Occupied Bandwidth (MHz)			26dBc Bandwidth (MHz)		
		QPSK	16QAM	64QAM	QPSK	16QAM	64QAM
18615	1851.5	2.70	2.70	2.70	2.94	2.95	2.95
18900	1880.0	2.70	2.70	2.71	2.93	2.94	2.93
19185	1908.5	2.71	2.70	2.71	3.15	2.98	2.99
LTE Band 2, Channel Bandwidth: 5MHz							
Channel	Frequency (MHz)	Occupied Bandwidth (MHz)			26dBc Bandwidth (MHz)		
		QPSK	16QAM	64QAM	QPSK	16QAM	64QAM
18625	1852.5	4.49	4.49	4.49	4.82	4.81	4.82
18900	1880.0	4.49	4.49	4.49	4.82	4.82	4.81
19175	1907.5	4.49	4.49	4.49	4.90	4.83	4.87
LTE Band 2, Channel Bandwidth: 10MHz							
Channel	Frequency (MHz)	Occupied Bandwidth (MHz)			26dBc Bandwidth (MHz)		
		QPSK	16QAM	64QAM	QPSK	16QAM	64QAM
18650	1855.0	8.96	8.97	8.96	9.51	9.51	9.50
18900	1880.0	8.98	8.97	8.97	9.54	9.53	9.52
19150	1905.0	8.97	8.98	8.97	9.62	9.55	9.55
LTE Band 2, Channel Bandwidth: 15MHz							
Channel	Frequency (MHz)	Occupied Bandwidth (MHz)			26dBc Bandwidth (MHz)		
		QPSK	16QAM	64QAM	QPSK	16QAM	64QAM
18675	1857.5	13.43	13.42	13.41	14.26	14.23	14.24
18900	1880.0	13.50	13.48	13.48	14.32	14.29	14.30
19125	1902.5	13.49	13.48	13.47	14.71	14.34	14.35
LTE Band 2, Channel Bandwidth: 20MHz							
Channel	Frequency (MHz)	Occupied Bandwidth (MHz)			26dBc Bandwidth (MHz)		
		QPSK	16QAM	64QAM	QPSK	16QAM	64QAM
18700	1860.0	17.83	17.85	17.84	18.99	18.98	18.99
18900	1880.0	18.02	18.02	18.02	19.31	19.13	19.12
19100	1900.0	17.97	17.98	17.99	19.51	19.12	19.09

Occupied Bandwidth Spectrum Plot of Worst Value

1.4MHz / QPSK

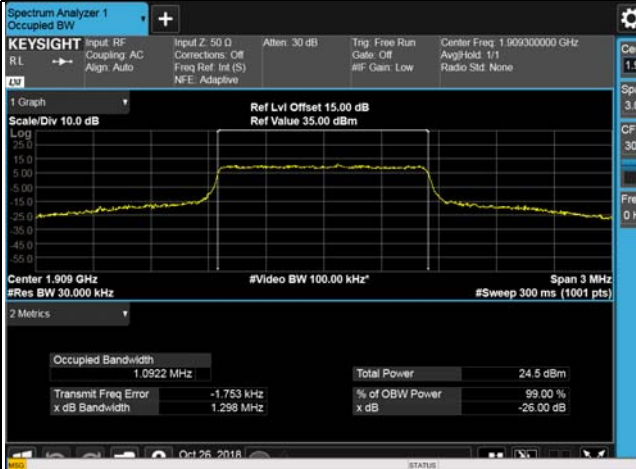

3MHz / 64QAM

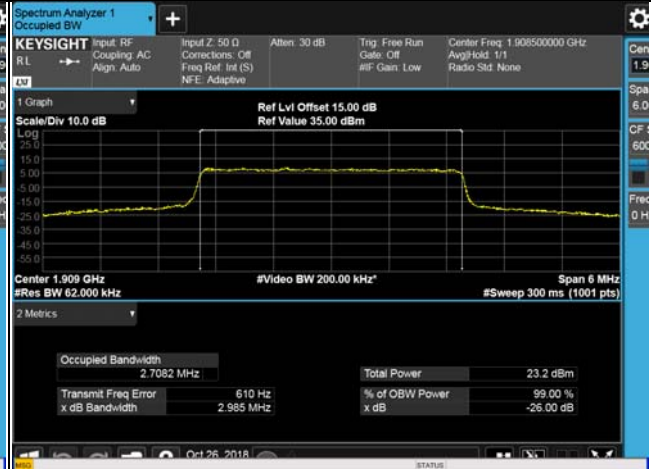

5MHz / QPSK



10MHz / QPSK



15MHz / QPSK

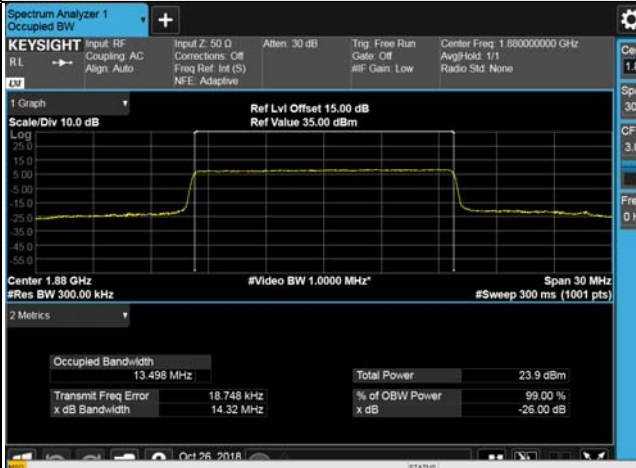

20MHz / QPSK



**26dBc Bandwidth
Spectrum Plot of Worst Value**

1.4MHz / QPSK

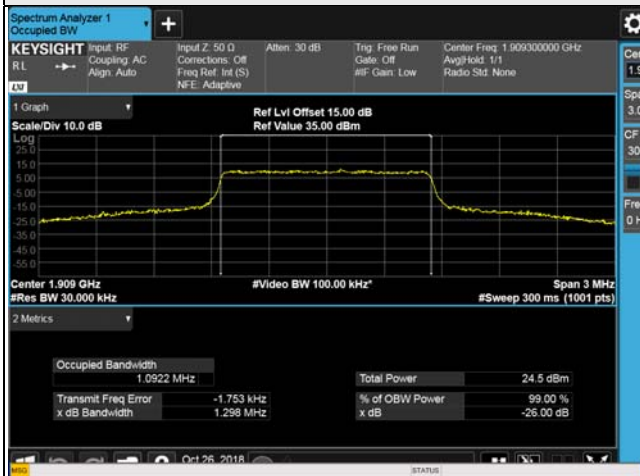

3MHz / QPSK

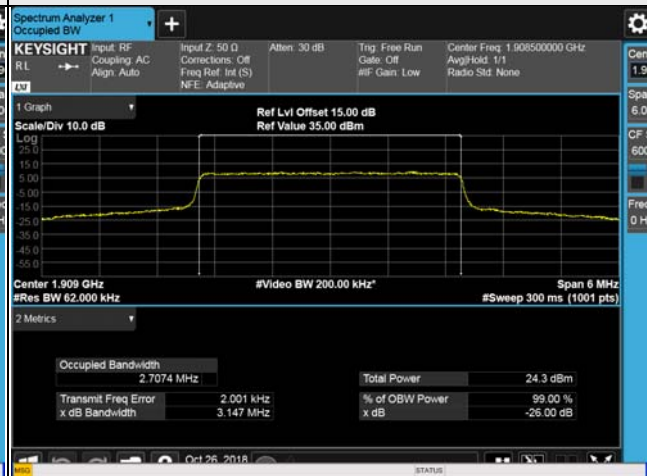

5MHz / QPSK

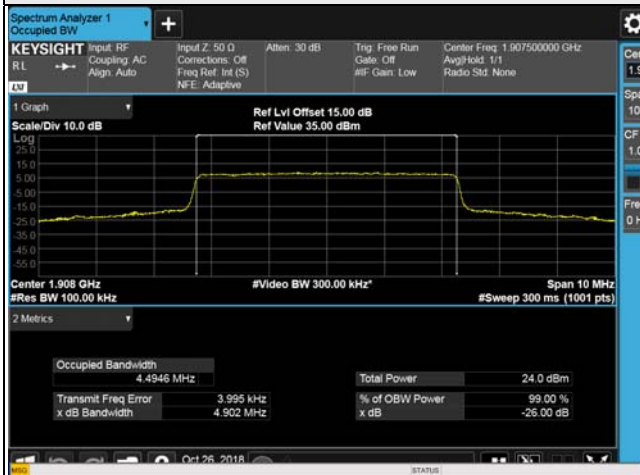

10MHz / QPSK

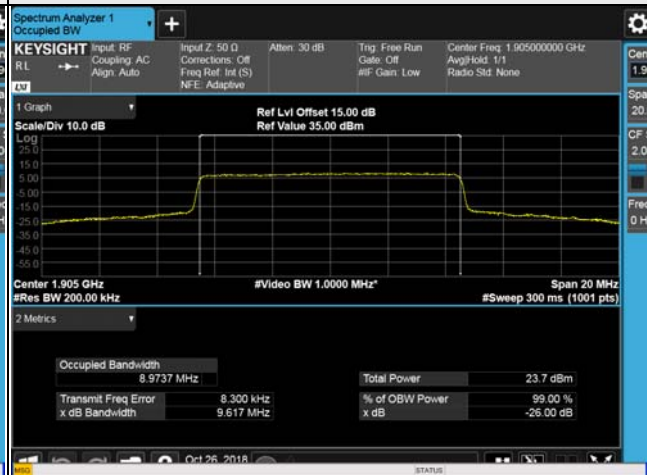

15MHz / QPSK



20MHz / QPSK

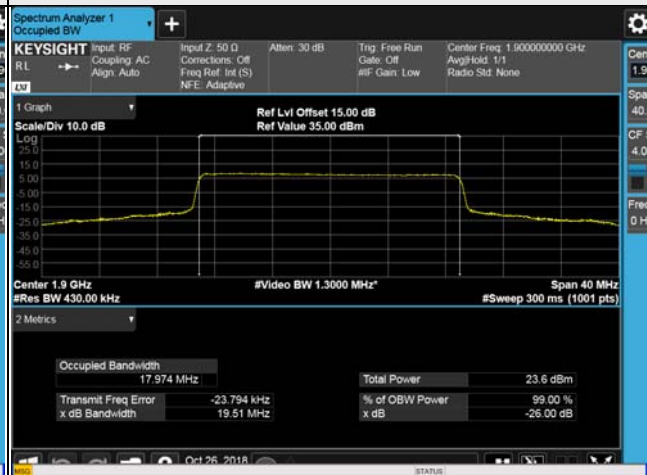

4.5 Band Edge Measurement

4.5.1 Limits of Band Edge Measurement

Power of any emission outside of the authorized operating frequency ranges must be attenuated below the transmitting power (P) by a factor of at least $43 + 10 \log(P)$ dB. In the 1 MHz bands immediately outside and adjacent to the frequency block a resolution bandwidth of at least one percent of the emission bandwidth of the fundamental emission of the transmitter may be employed.

4.5.2 Test Setup

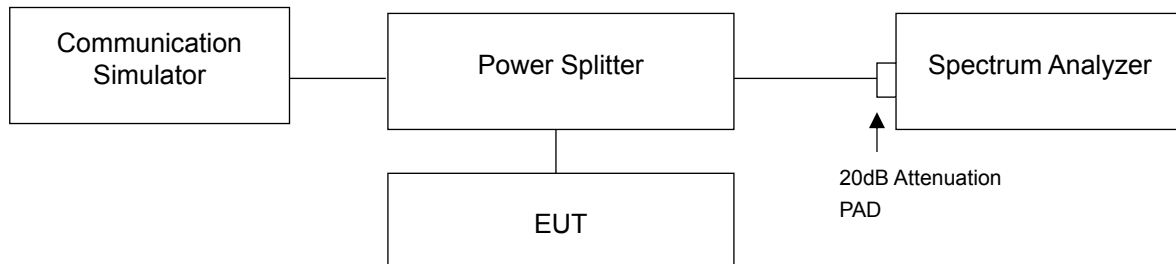

4.5.3 Test Procedures

- a. All measurements were done at low and high operational frequency range.
- b. The center frequency of spectrum is the band edge frequency and span is 1.5MHz. RB of the spectrum is 15kHz and VB of the spectrum is 51kHz (LTE Channel Bandwidth 1.4MHz).
- c. The center frequency of spectrum is the band edge frequency and span is 1.5MHz. RB of the spectrum is 30kHz and VB of the spectrum is 100kHz (LTE Channel Bandwidth 3MHz).
- d. The center frequency of spectrum is the band edge frequency and span is 1.5MHz. RB of the spectrum is 62kHz and VB of the spectrum is 200kHz (LTE Channel Bandwidth 5MHz).
- e. The center frequency of spectrum is the band edge frequency and span is 1.5MHz. RB of the spectrum is 100kHz and VB of the spectrum is 300kHz (LTE Channel Bandwidth 10MHz).
- f. The center frequency of spectrum is the band edge frequency and span is 1MHz. RB of the spectrum is 150kHz and VB of the spectrum is 470kHz (LTE Channel Bandwidth 15MHz).
- g. The center frequency of spectrum is the band edge frequency and span is 1MHz. RB of the spectrum is 200kHz and VB of the spectrum is 1MHz (LTE Channel Bandwidth 20MHz).
- h. Record the max trace plot into the test report.

4.5.4 Test Results

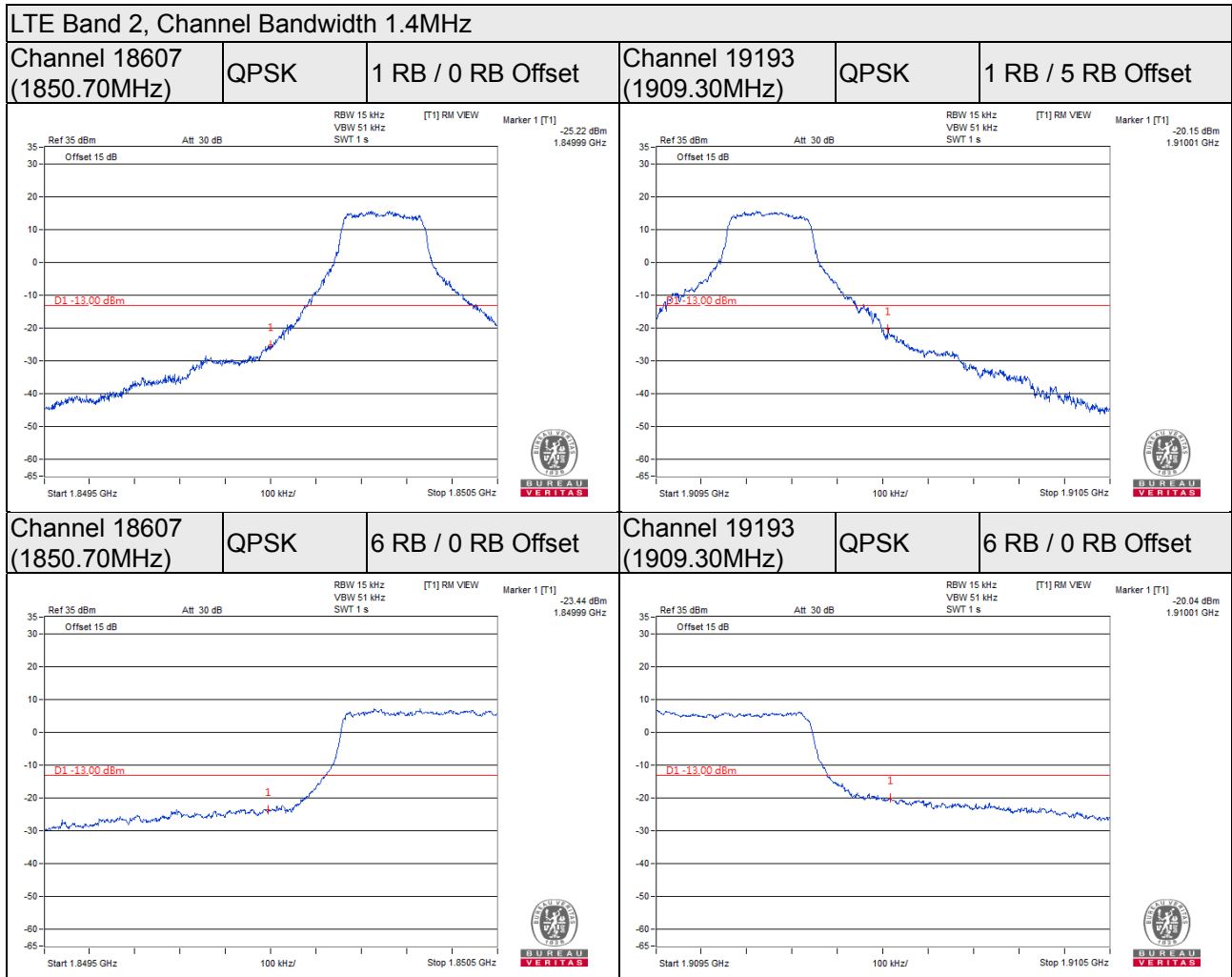

LTE Band 2, Channel Bandwidth 3MHz

Channel 18615 (1851.50MHz)	QPSK	1 RB / 0 RB Offset	Channel 19185 (1908.50MHz)	QPSK	1 RB / 14 RB Offset
---------------------------------------	-------------	---------------------------	---------------------------------------	-------------	----------------------------

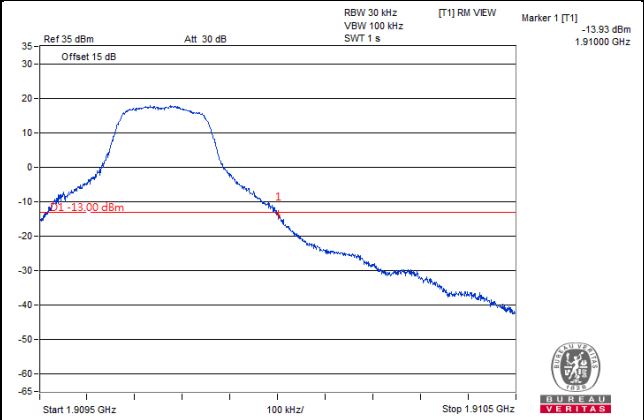
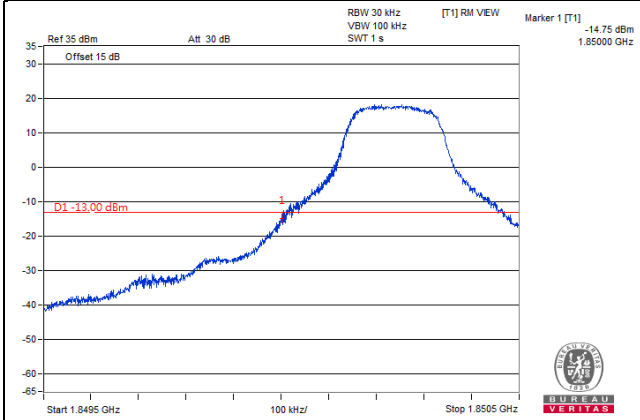

Channel 18615 (1851.50MHz)	QPSK	15 RB / 0 RB Offset	Channel 19185 (1908.50MHz)	QPSK	15 RB / 0 RB Offset
---------------------------------------	-------------	----------------------------	---------------------------------------	-------------	----------------------------

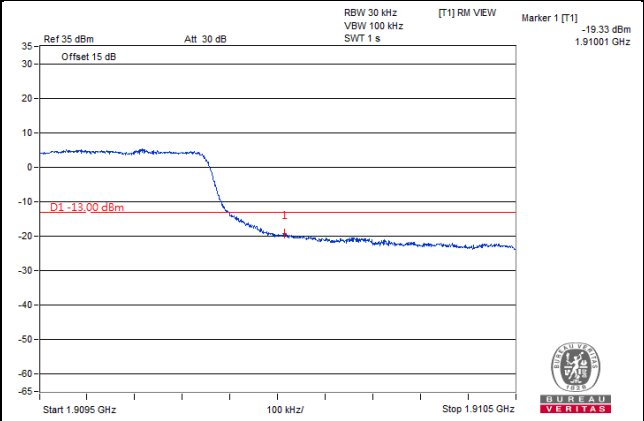
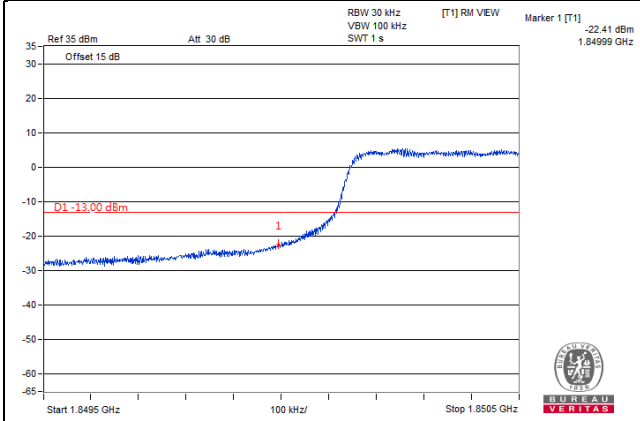

LTE Band 2, Channel Bandwidth 5MHz

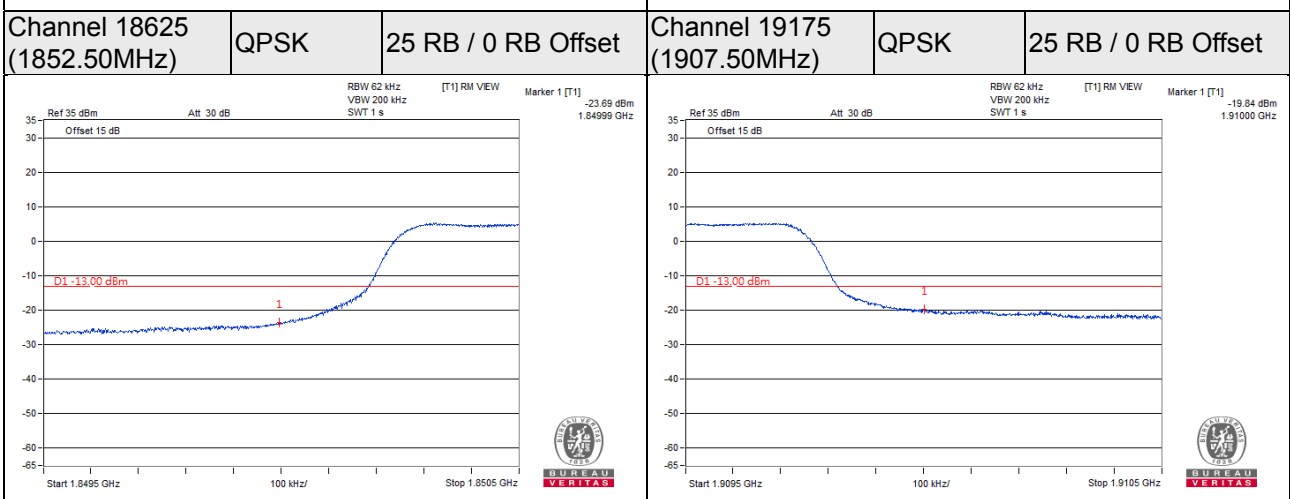
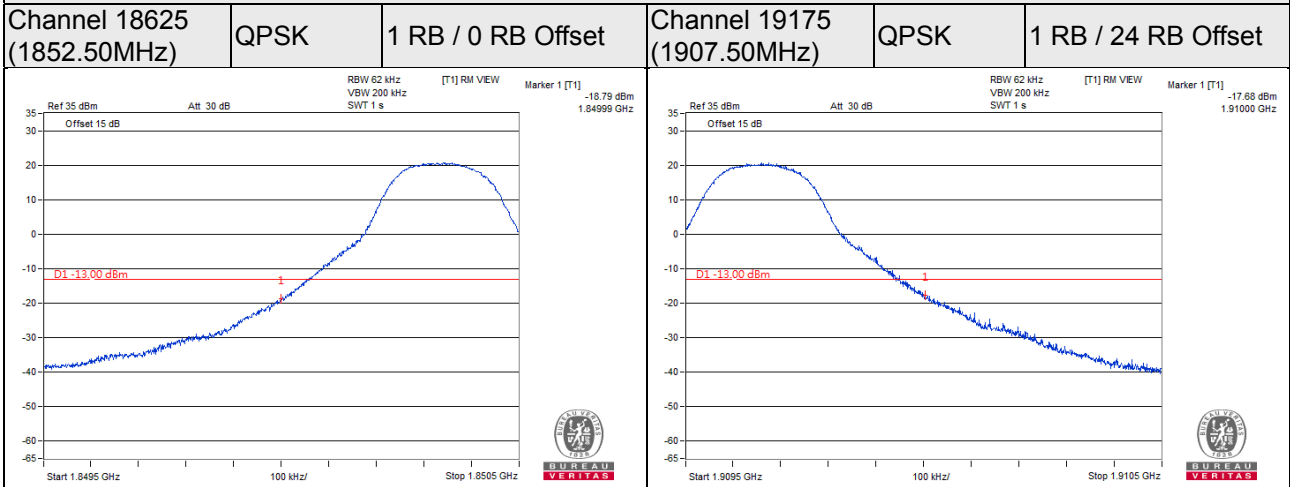

LTE Band 2, Channel Bandwidth 10MHz

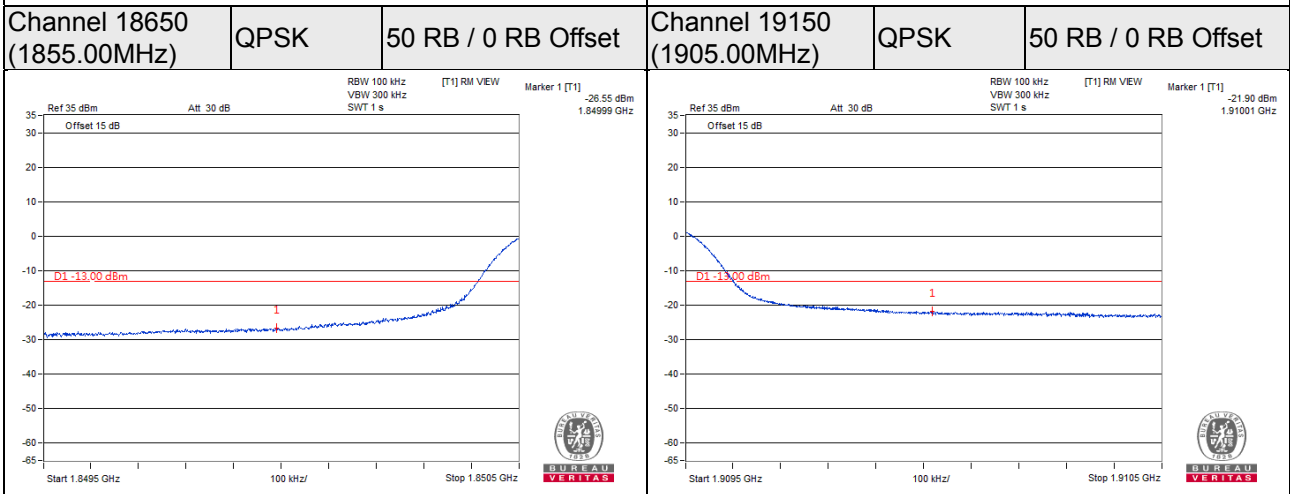
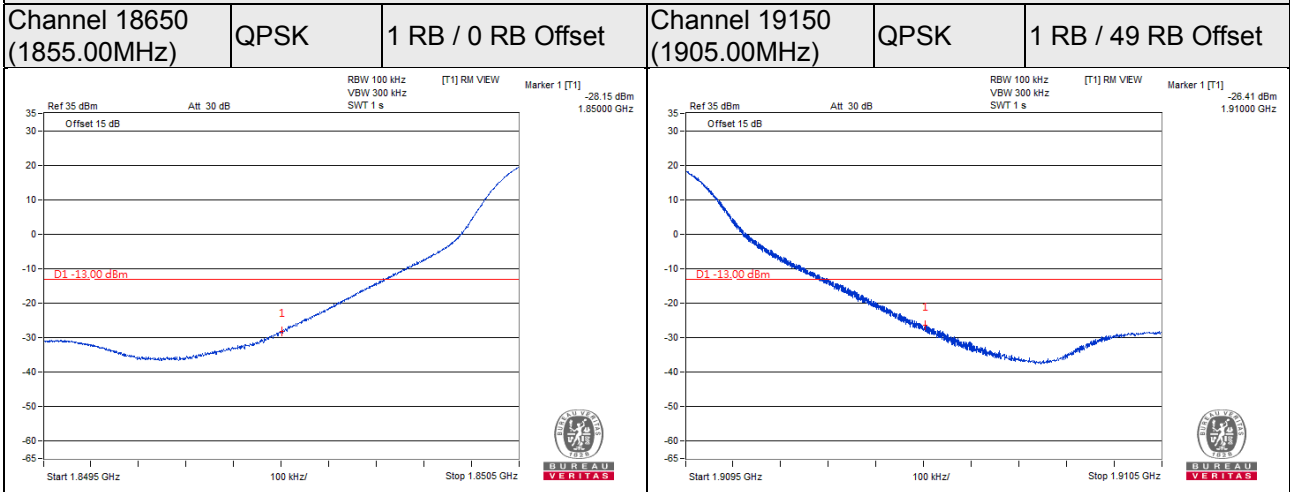

LTE Band 2, Channel Bandwidth 15MHz

Channel 18675 (1857.50MHz)	QPSK	1 RB / 0 RB Offset	Channel 19125 (1902.50MHz)	QPSK	1 RB / 74 RB Offset
-------------------------------	------	--------------------	-------------------------------	------	---------------------

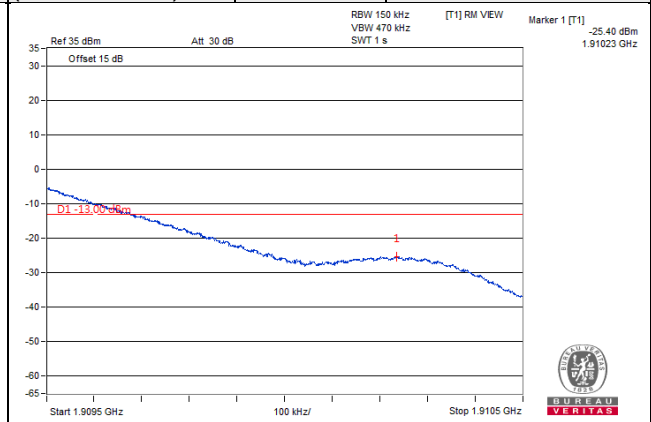
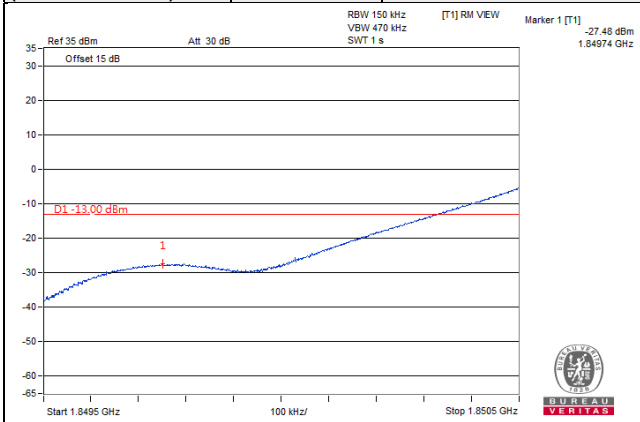

Channel 18675 (1857.50MHz)	QPSK	75 RB / 0 RB Offset	Channel 19125 (1902.50MHz)	QPSK	75 RB / 0 RB Offset
-------------------------------	------	---------------------	-------------------------------	------	---------------------

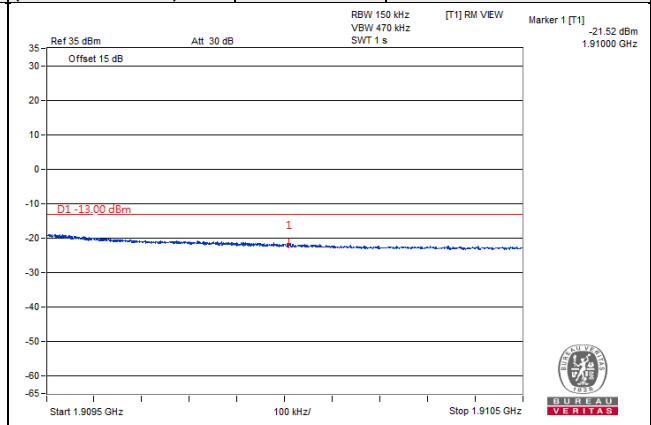
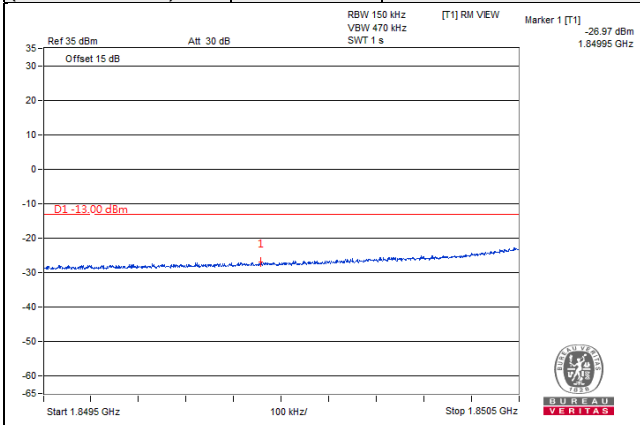

LTE Band 2, Channel Bandwidth 20MHz

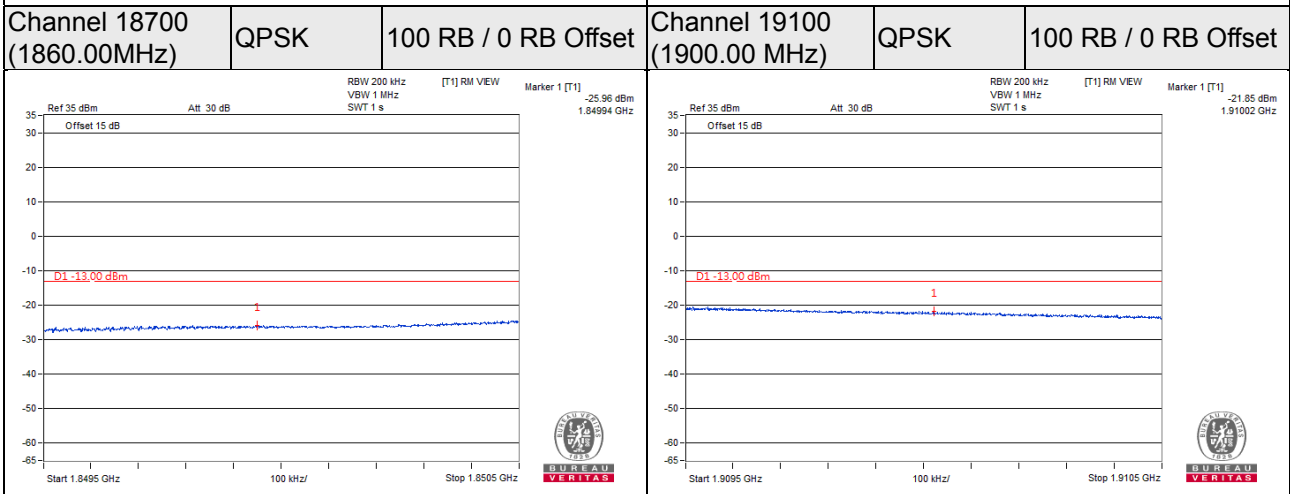
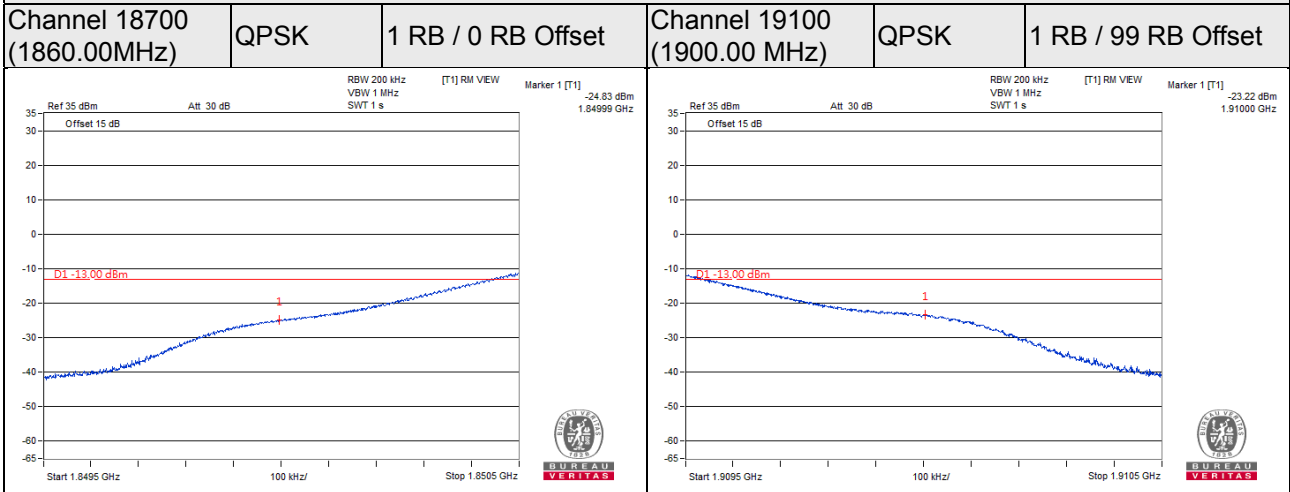

4.6 Peak to Average Ratio

4.6.1 Limits of Peak to Average Ratio Measurement

In measuring transmissions in this band using an average power technique, the peak to-average ratio (PAR) of the transmission may not exceed 13 dB

4.6.2 Test Setup

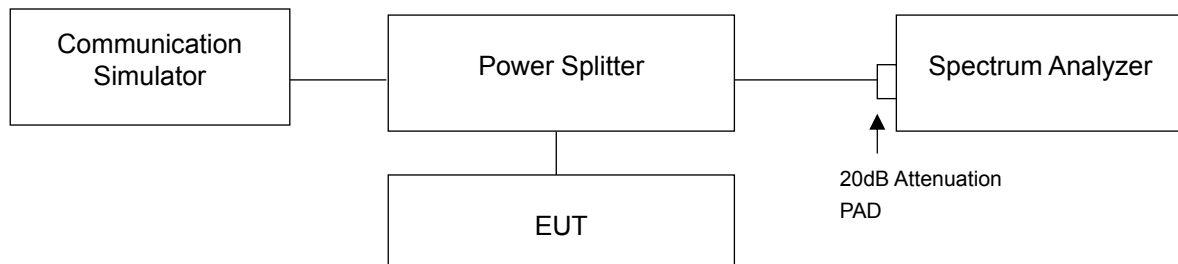

4.6.3 Test Procedures

- Set resolution/measurement bandwidth \geq signal's occupied bandwidth;
- Set the number of counts to a value that stabilizes the measured CCDF curve;
- Record the maximum PAPR level associated with a probability of 0.1%.

4.6.4 Test Results

LTE Band 2, Channel Bandwidth 1.4MHz				
Channel	Frequency (MHz)	Peak To Average Ratio (dB)		
		QPSK	16QAM	64QAM
18607	1850.7	3.55	4.85	4.76
18900	1880.0	3.85	5.16	5.13
19193	1909.3	3.00	4.21	3.99
LTE Band 2, Channel Bandwidth 3MHz				
Channel	Frequency (MHz)	Peak To Average Ratio (dB)		
		QPSK	16QAM	64QAM
18615	1851.5	3.34	4.71	4.58
18900	1880.0	3.52	4.90	4.79
19185	1908.5	3.09	4.51	4.32
LTE Band 2, Channel Bandwidth 5MHz				
Channel	Frequency (MHz)	Peak To Average Ratio (dB)		
		QPSK	16QAM	64QAM
18625	1852.5	3.27	4.62	4.51
18900	1880.0	3.40	4.76	4.79
19175	1907.5	3.43	4.80	4.73
LTE Band 2, Channel Bandwidth 10MHz				
Channel	Frequency (MHz)	Peak To Average Ratio (dB)		
		QPSK	16QAM	64QAM
18650	1855.0	2.90	4.36	4.33
18900	1880.0	3.00	4.51	4.39
19150	1905.0	3.07	4.50	4.44
LTE Band 2, Channel Bandwidth 15MHz				
Channel	Frequency (MHz)	Peak To Average Ratio (dB)		
		QPSK	16QAM	64QAM
18675	1857.5	2.84	4.27	4.25
18900	1880.0	2.90	4.36	4.31
19125	1902.5	2.97	4.35	4.30
LTE Band 2, Channel Bandwidth 20MHz				
Channel	Frequency (MHz)	Peak To Average Ratio (dB)		
		QPSK	16QAM	64QAM
18700	1860.0	2.85	4.20	4.25
18900	1880.0	2.84	4.20	4.26
19100	1900.0	3.07	4.42	4.46

Spectrum Plot of Worst Value

1.4MHz / 16QAM

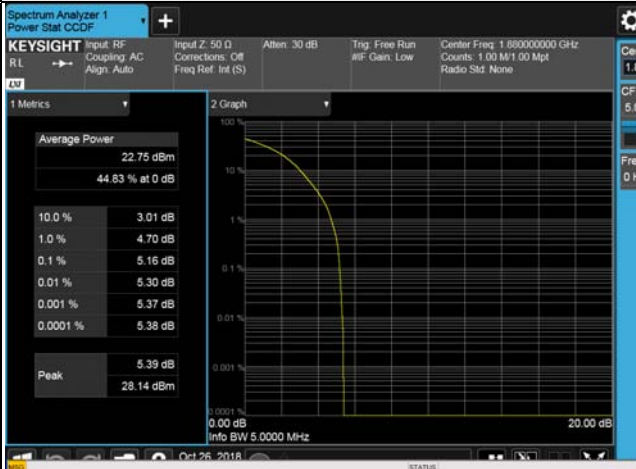

3MHz / 16QAM

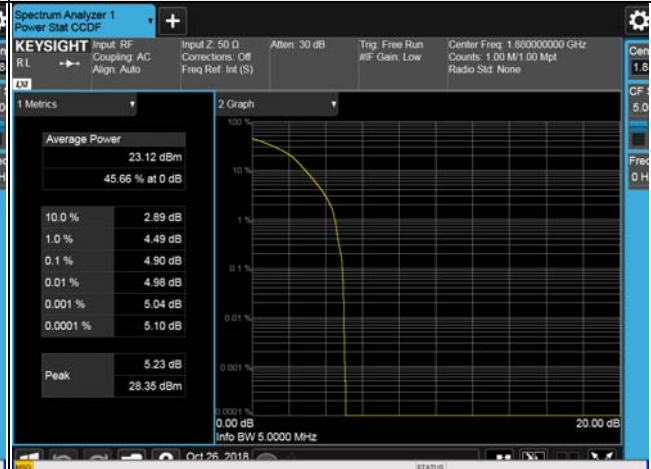

5MHz / 16QAM

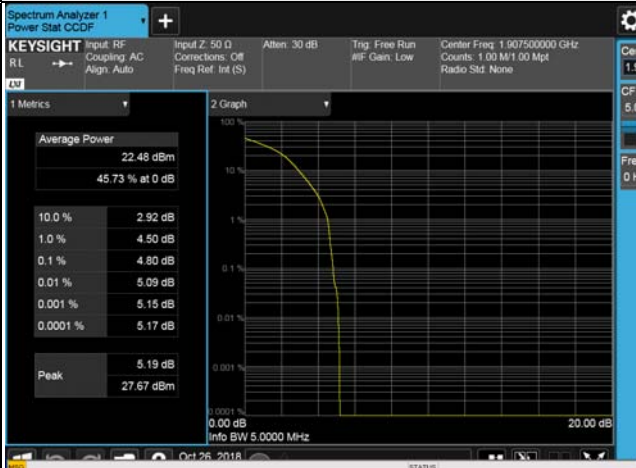

10MHz / 16QAM

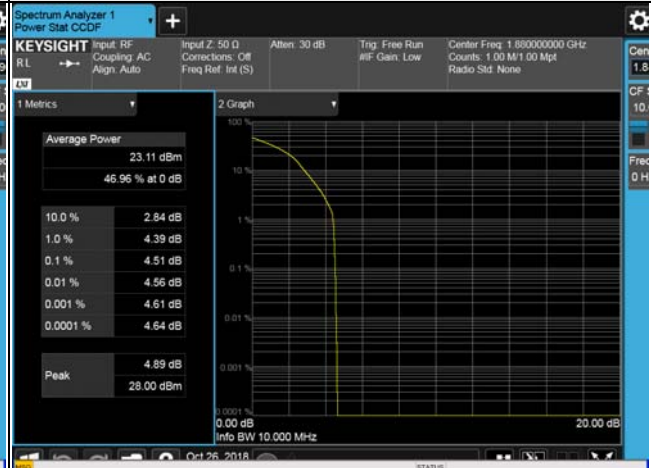

15MHz / 16QAM

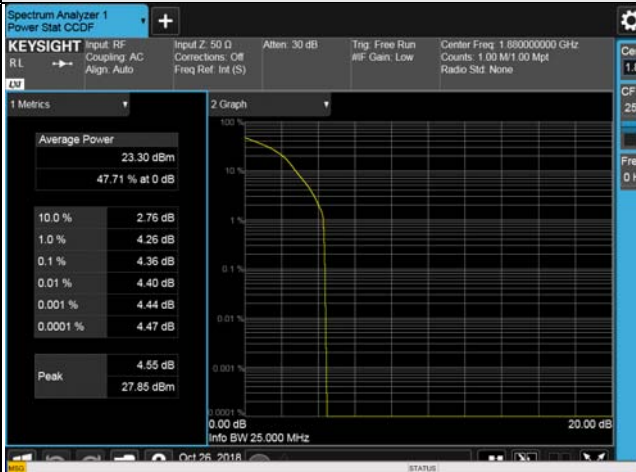

20MHz / 64QAM

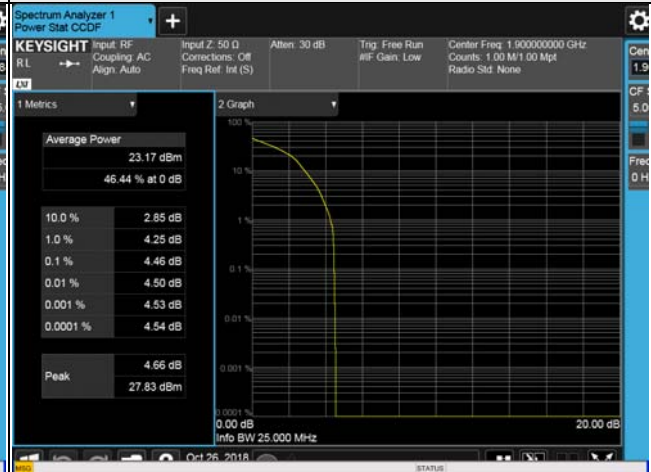

4.7 Conducted Spurious Emissions

4.7.1 Limits of Conducted Spurious Emissions Measurement

The power of any emission outside of the authorized operating frequency ranges must be attenuated below the transmitting power (P) by a factor of at least $43 + 10 \log(P)$ dB. The emission limit equal to -13dBm .

4.7.2 Test Setup

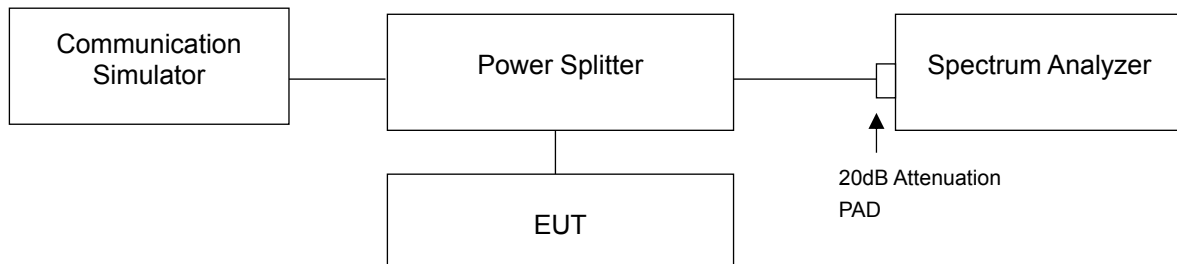

4.7.3 Test Procedure

- The EUT makes a phone call to the communication simulator. All measurements were done at low, middle and high operational frequency range.
- Measuring frequency range is from 9 kHz to 1GHz. 20dB attenuation pad is connected with spectrum. RBW=100kHz and VBW=300kHz is used for conducted emission measurement.
- Measuring frequency range is from 1GHz to 27GHz. 20dB attenuation pad is connected with spectrum. RBW=1MHz and VBW=3MHz is used for conducted emission measurement.

4.7.4 Test Results

LTE Band 2, Channel Bandwidth 1.4MHz

Channel 18607 (1850.70MHz)

Frequency Range : 9kHz~1GHz

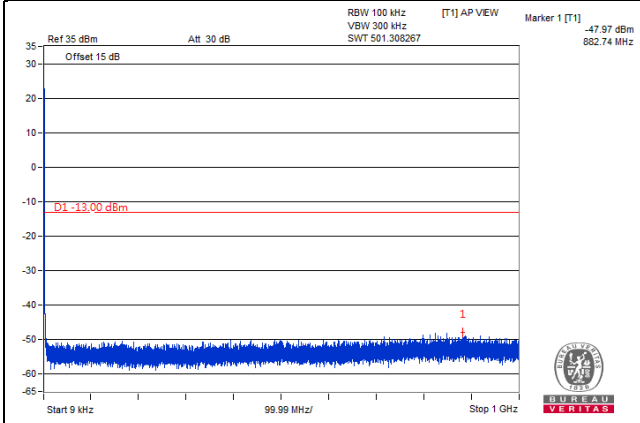

Frequency Range : 1GHz~10GHz

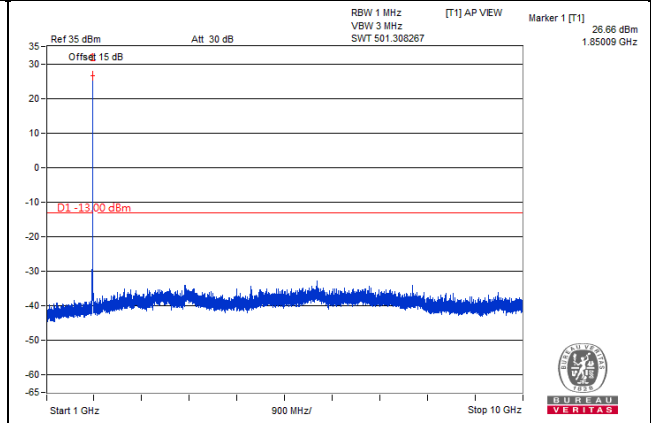

Frequency Range : 10GHz~27GHz

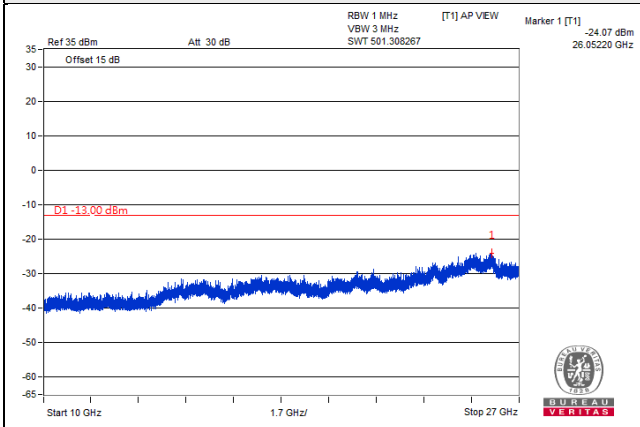

LTE Band 2, Channel Bandwidth 1.4MHz

Channel 18900 (1880.00MHz)

Frequency Range : 9kHz~1GHz

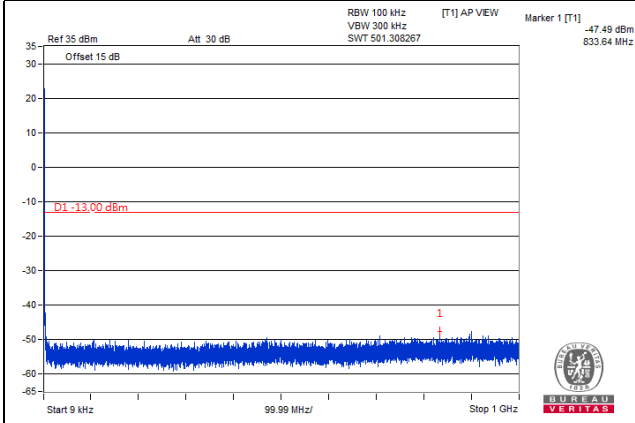

Frequency Range : 1GHz~10GHz

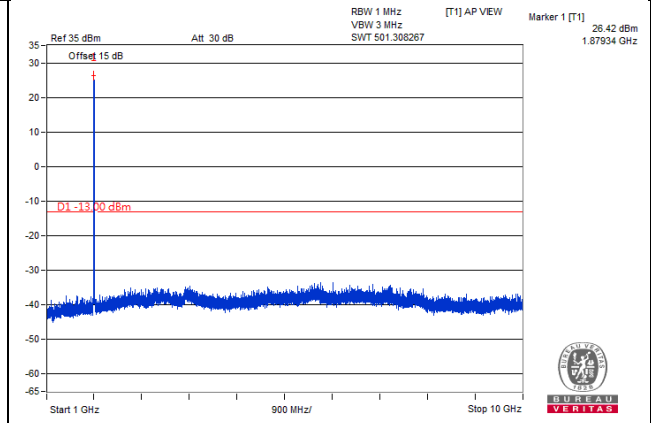

Frequency Range : 10GHz~27GHz

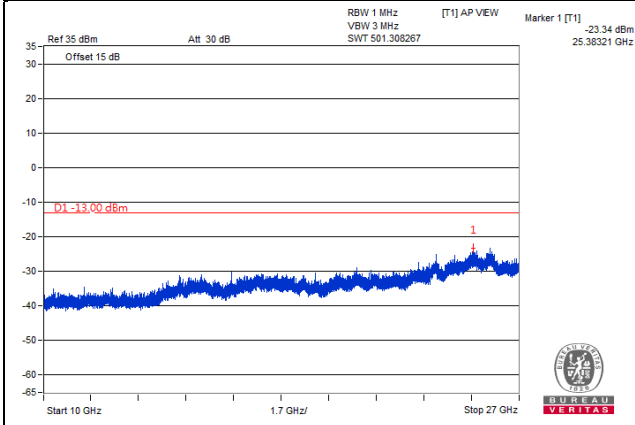

LTE Band 2, Channel Bandwidth 1.4MHz

Channel 19193 (1909.30MHz)

Frequency Range : 9kHz~1GHz

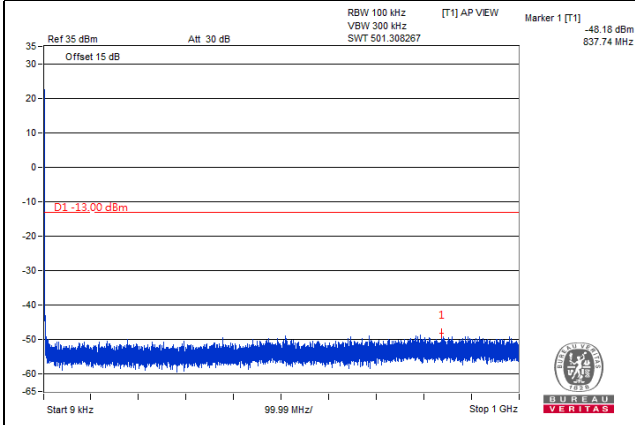

Frequency Range : 1GHz~10GHz

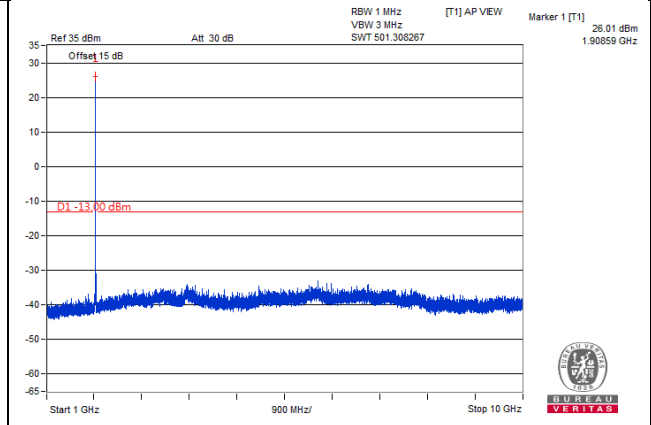

Frequency Range : 10GHz~27GHz

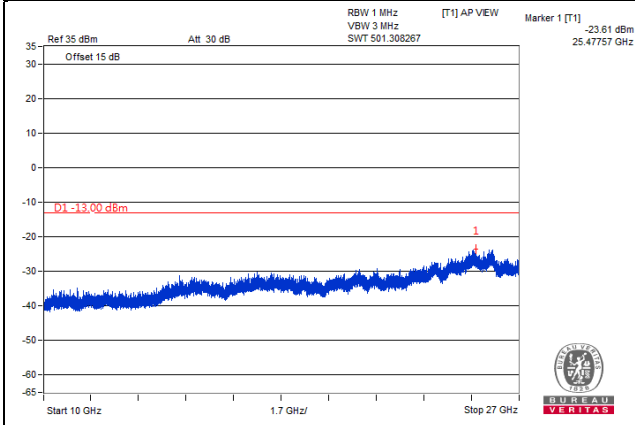

LTE Band 2, Channel Bandwidth 3MHz

Channel 18615 (1851.50MHz)

Frequency Range : 9kHz~1GHz

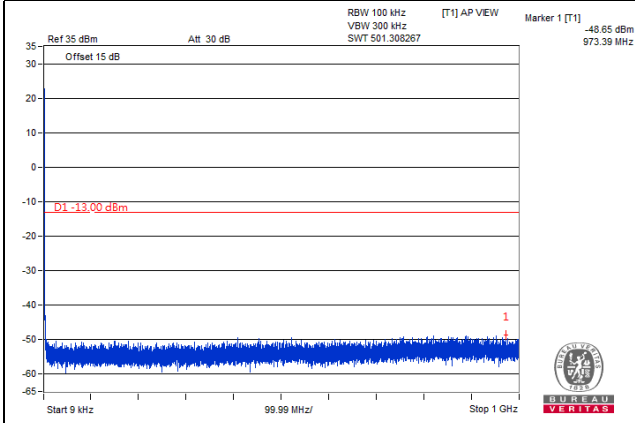

Frequency Range : 1GHz~10GHz

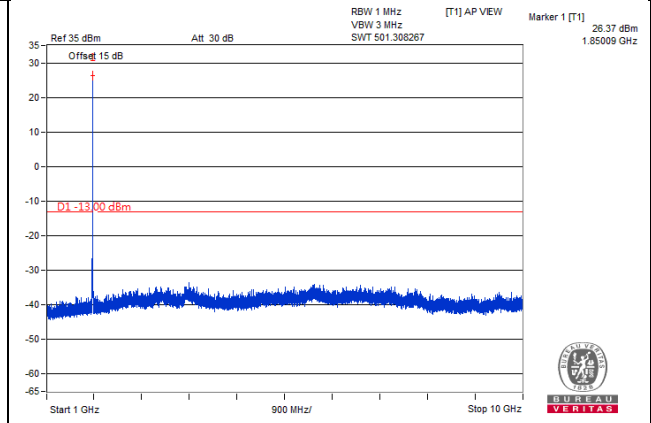

Frequency Range : 10GHz~27GHz

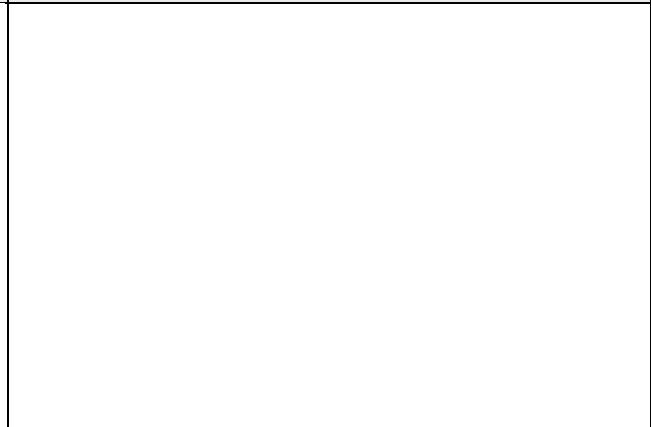
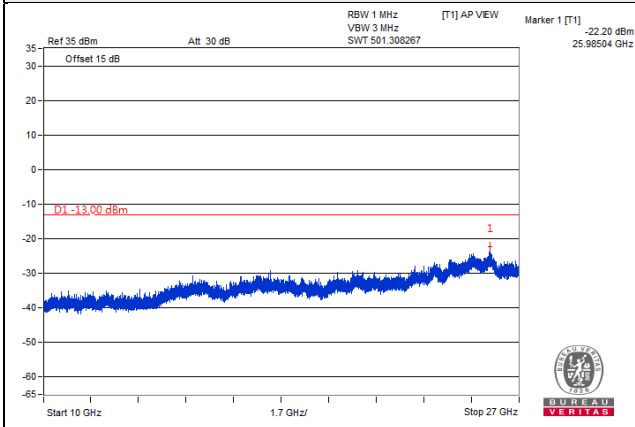

LTE Band 2, Channel Bandwidth 3MHz

Channel 18900 (1880.00MHz)

Frequency Range : 9kHz~1GHz

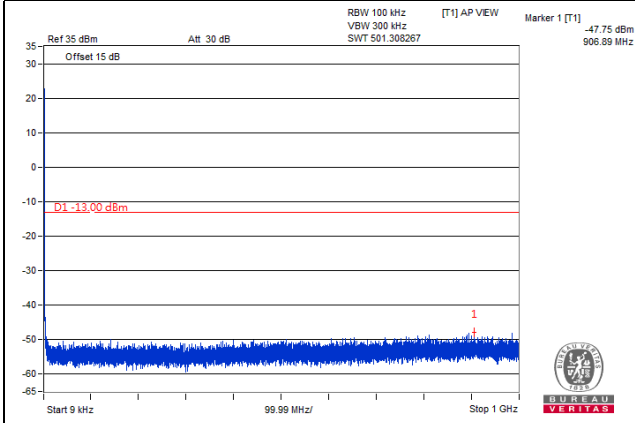

Frequency Range : 1GHz~10GHz

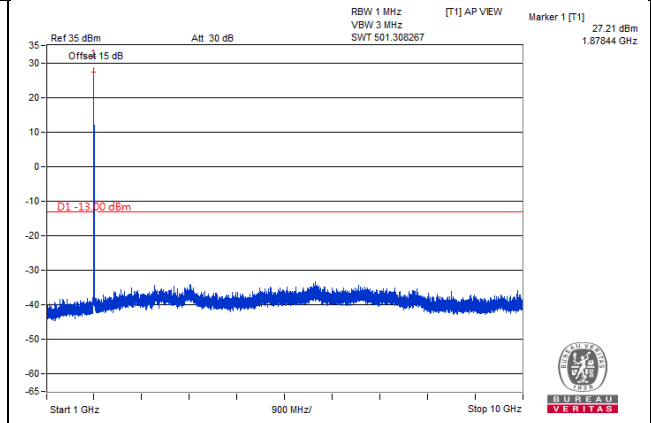

Frequency Range : 10GHz~27GHz

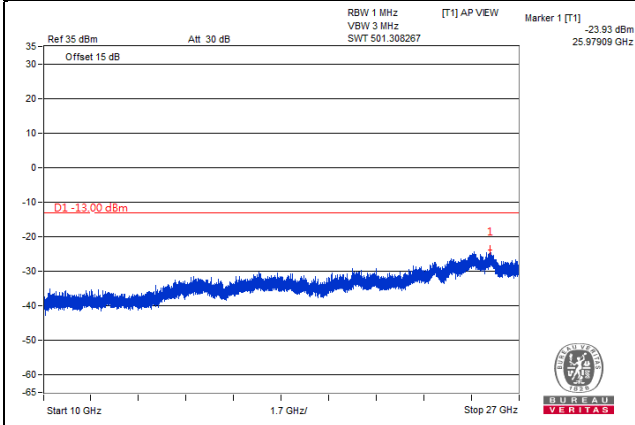

LTE Band 2, Channel Bandwidth 3MHz

Channel 19185 (1908.50MHz)

Frequency Range : 9kHz~1GHz

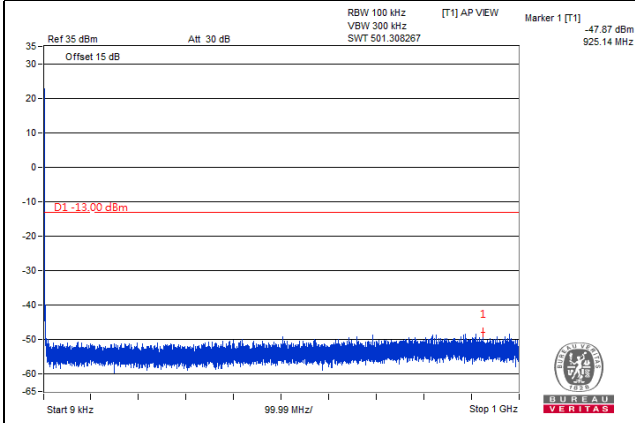

Frequency Range : 1GHz~10GHz

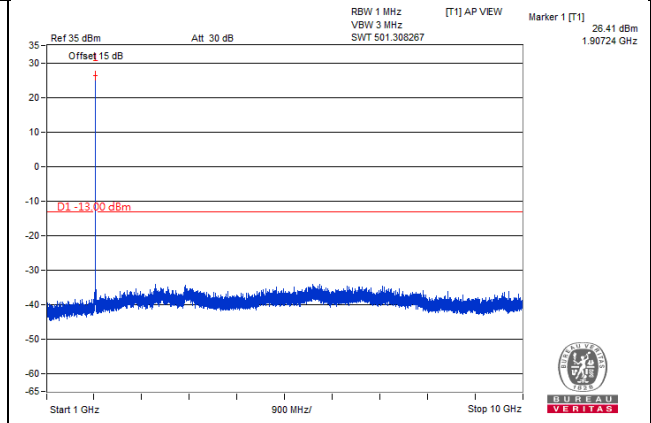

Frequency Range : 10GHz~27GHz

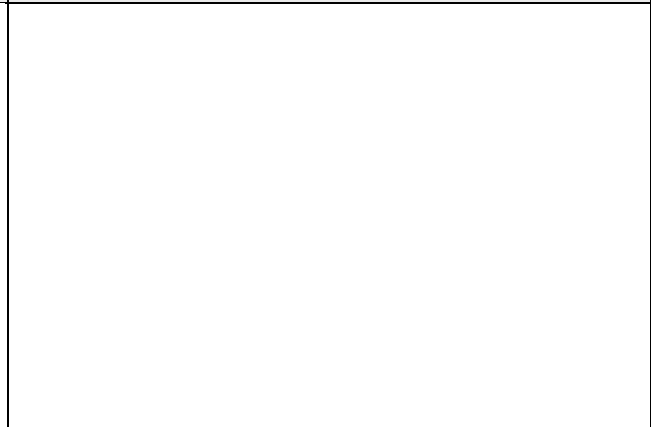
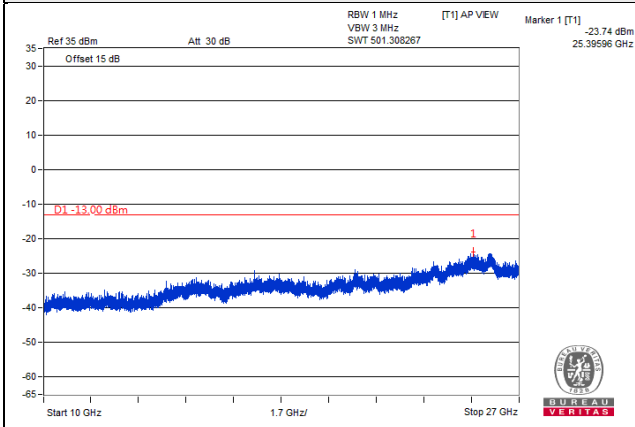

LTE Band 2, Channel Bandwidth 5MHz

Channel 18625 (1852.50MHz)

Frequency Range : 9kHz~1GHz

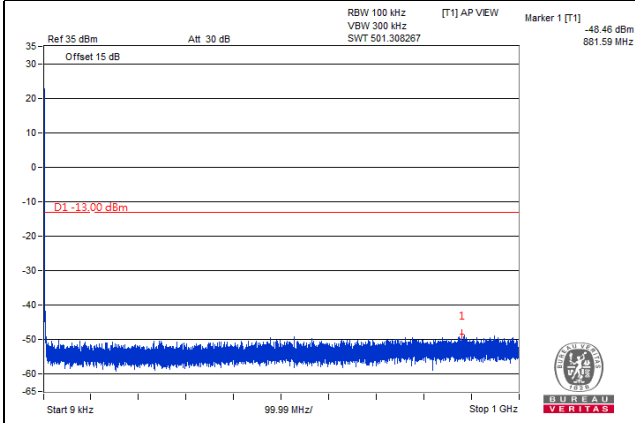

Frequency Range : 1GHz~10GHz

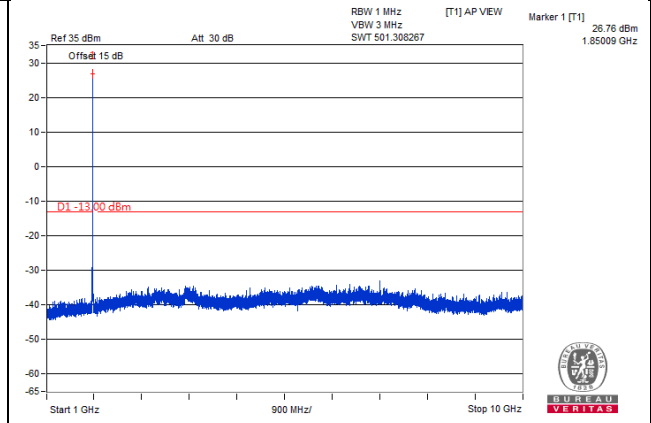

Frequency Range : 10GHz~27GHz

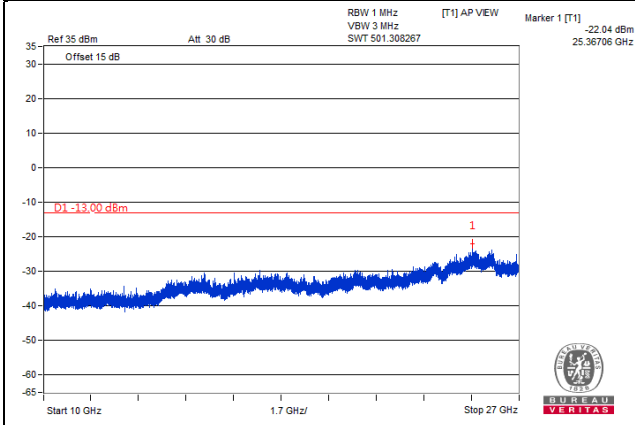

LTE Band 2, Channel Bandwidth 5MHz

Channel 18900 (1880.00MHz)

Frequency Range : 9kHz~1GHz

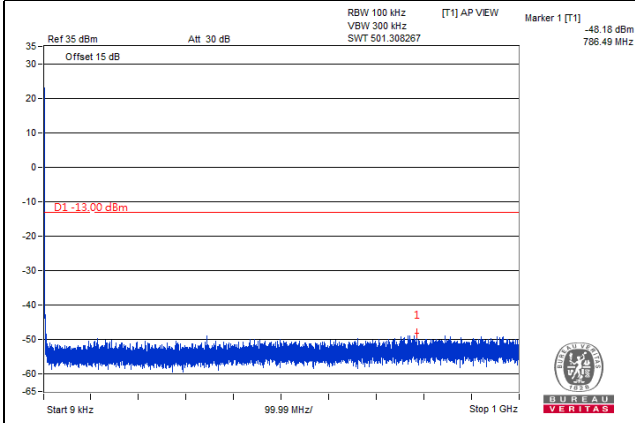

Frequency Range : 1GHz~10GHz

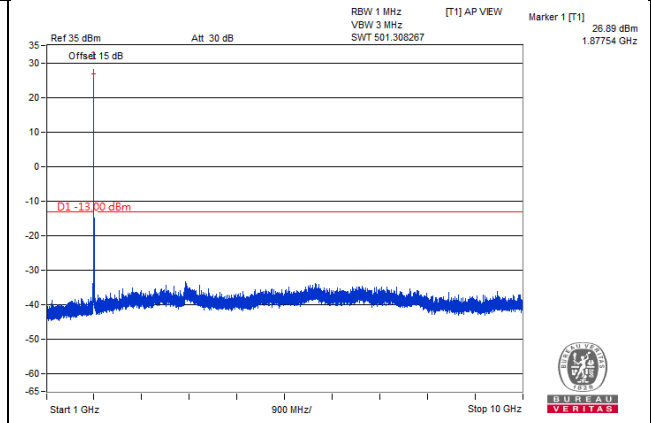

Frequency Range : 10GHz~27GHz

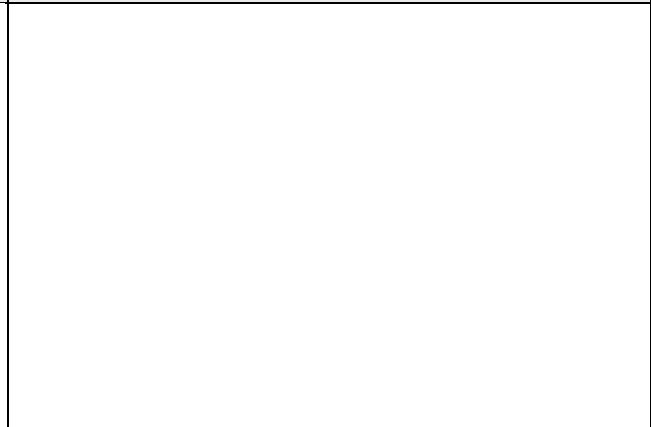
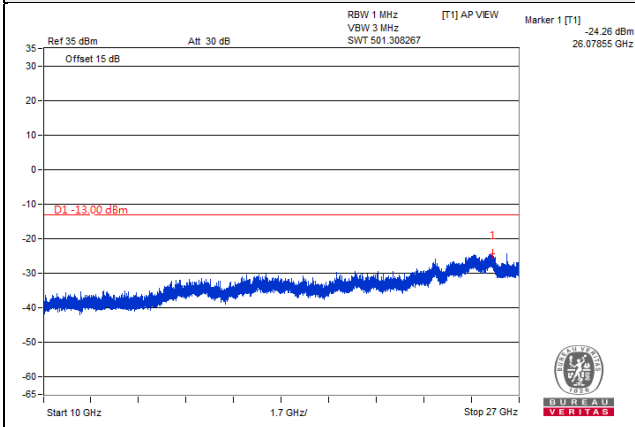

LTE Band 2, Channel Bandwidth 5MHz

Channel 19175 (1907.50MHz)

Frequency Range : 9kHz~1GHz

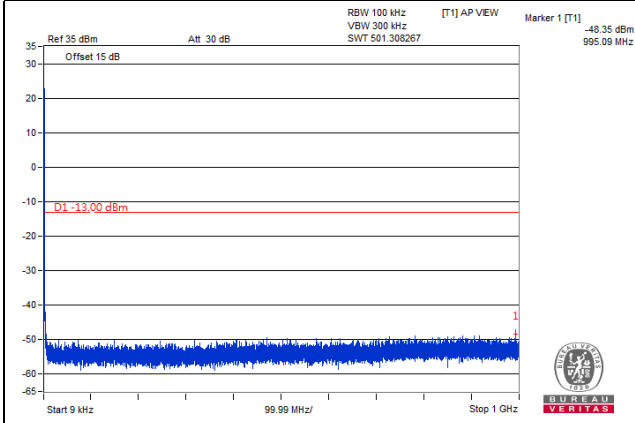

Frequency Range : 1GHz~10GHz

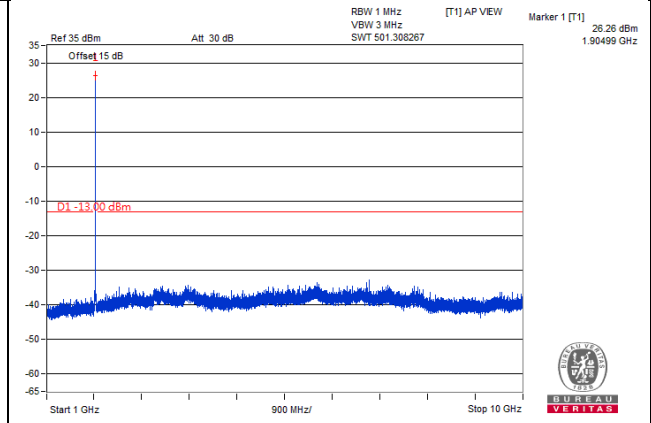

Frequency Range : 10GHz~27GHz

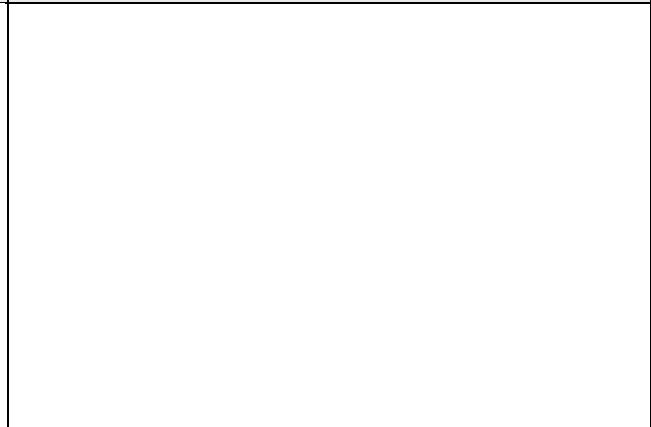
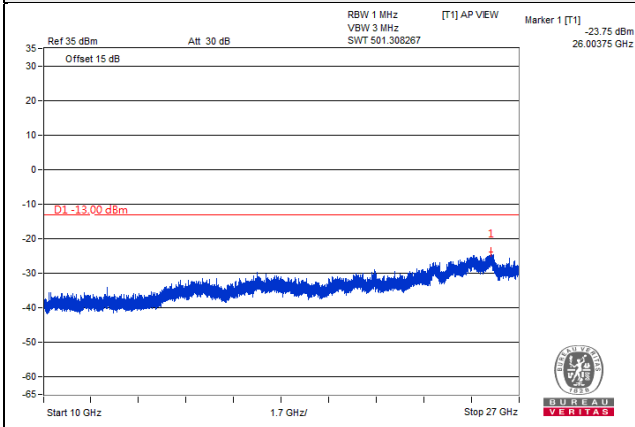

LTE Band 2, Channel Bandwidth 10MHz

Channel 18650 (1855.00MHz)

Frequency Range : 9kHz~1GHz

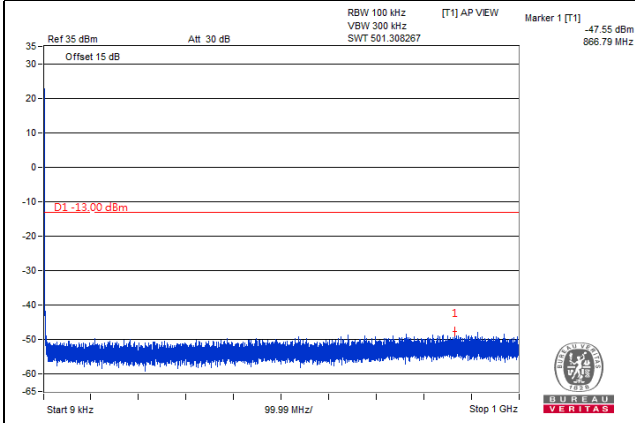

Frequency Range : 1GHz~10GHz

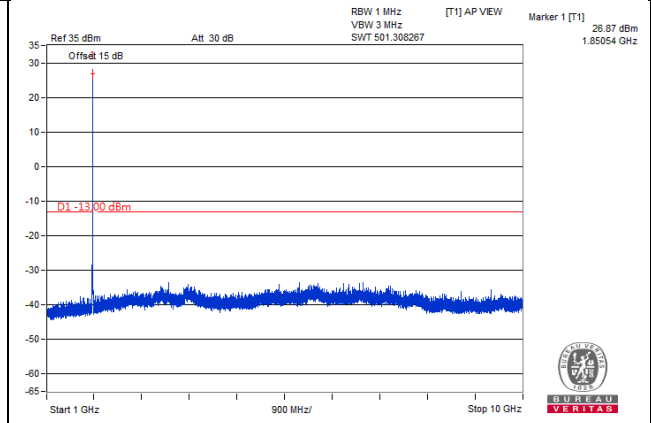

Frequency Range : 10GHz~27GHz

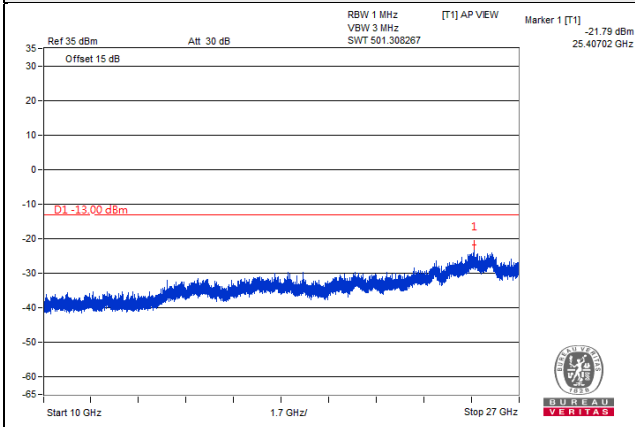

LTE Band 2, Channel Bandwidth 10MHz

Channel 18900 (1880.00MHz)

Frequency Range : 9kHz~1GHz

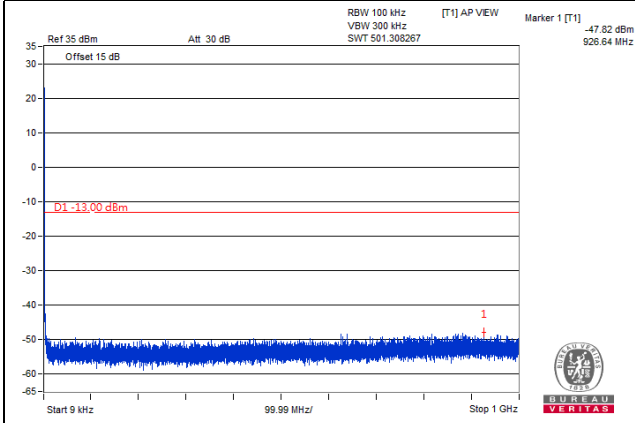

Frequency Range : 1GHz~10GHz

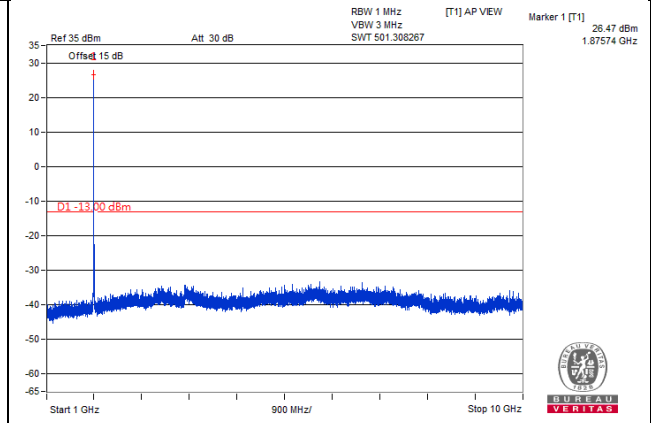

Frequency Range : 10GHz~27GHz

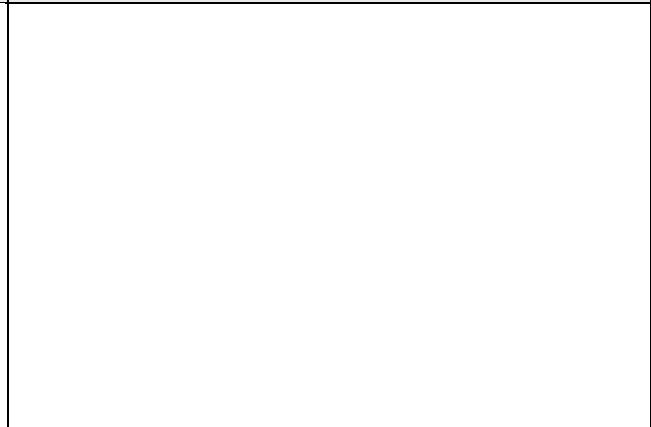
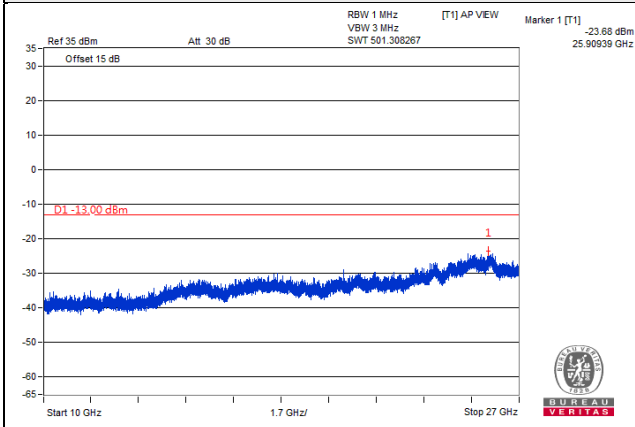

LTE Band 2, Channel Bandwidth 10MHz

Channel 19150 (1905.00MHz)

Frequency Range : 9kHz~1GHz

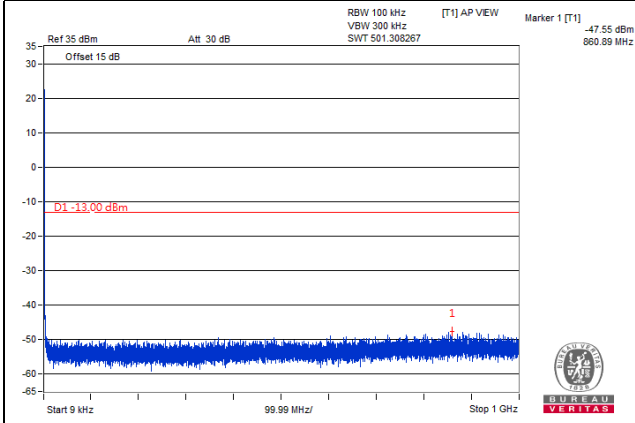

Frequency Range : 1GHz~10GHz

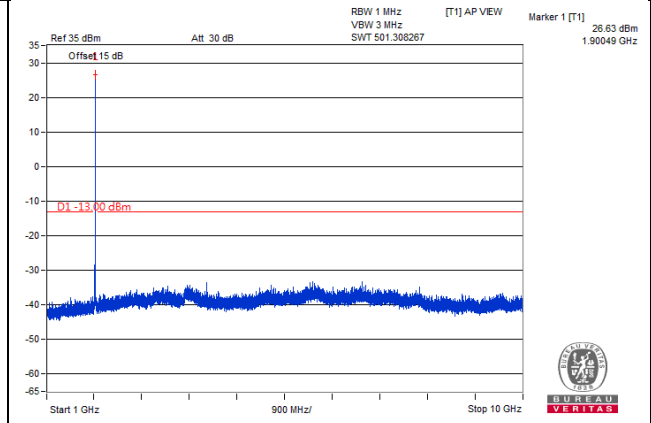

Frequency Range : 10GHz~27GHz

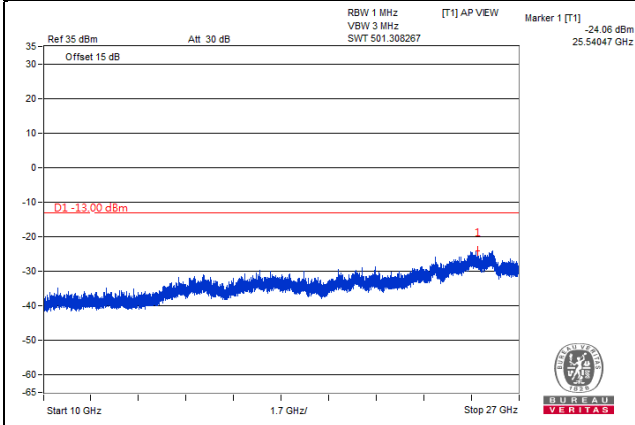

LTE Band 2, Channel Bandwidth 15MHz

Channel 18675 (1857.50MHz)

Frequency Range : 9kHz~1GHz

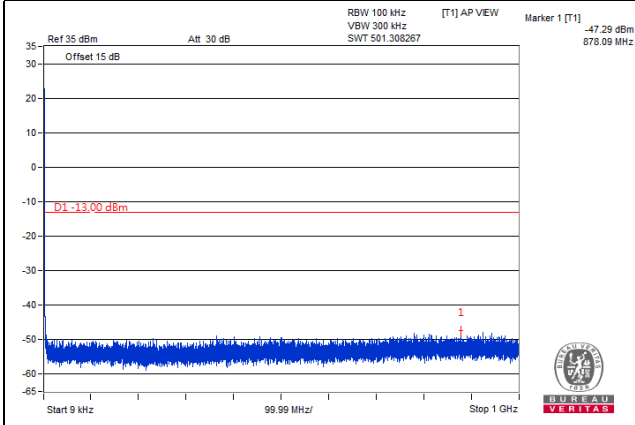

Frequency Range : 1GHz~10GHz

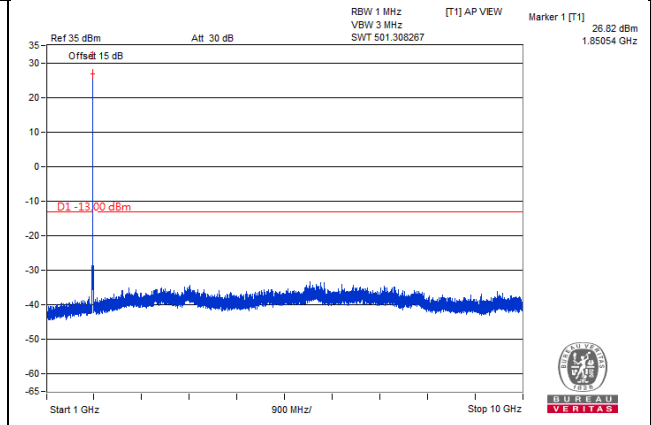

Frequency Range : 10GHz~27GHz

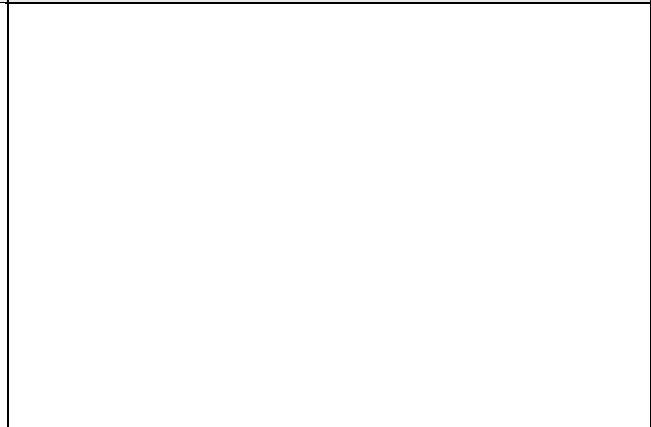
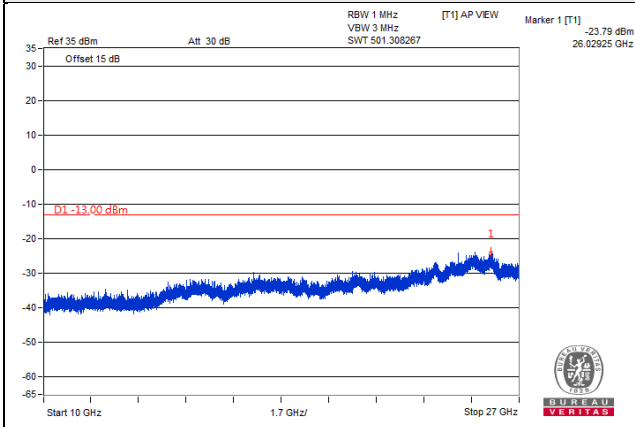

LTE Band 2, Channel Bandwidth 15MHz

Channel 18900 (1880.00MHz)

Frequency Range : 9kHz~1GHz

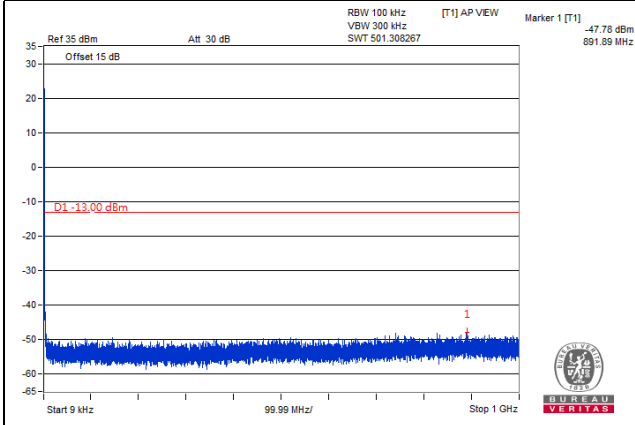

Frequency Range : 1GHz~10GHz

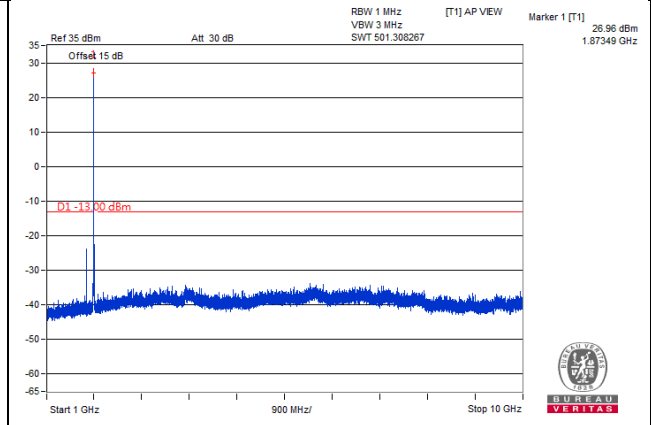

Frequency Range : 10GHz~27GHz

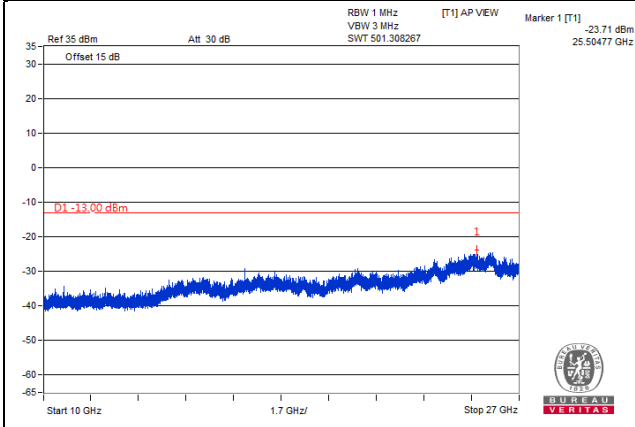

LTE Band 2, Channel Bandwidth 15MHz

Channel 19125 (1902.50MHz)

Frequency Range : 9kHz~1GHz

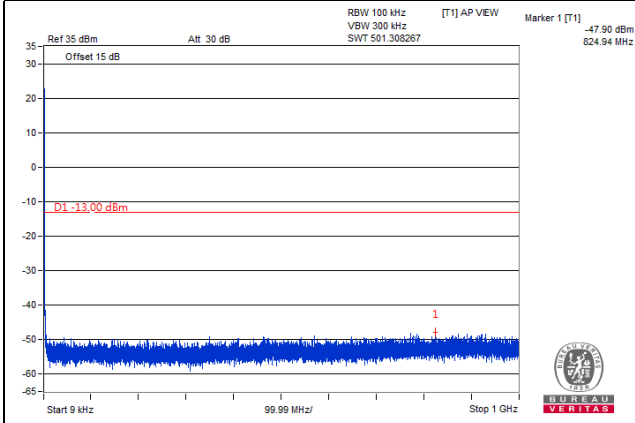

Frequency Range : 1GHz~10GHz

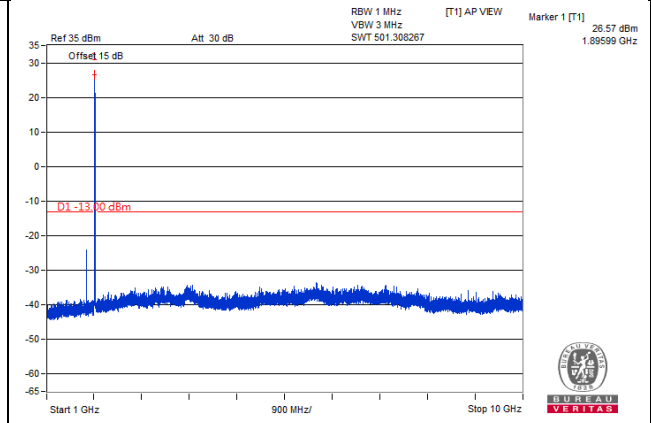

Frequency Range : 10GHz~27GHz

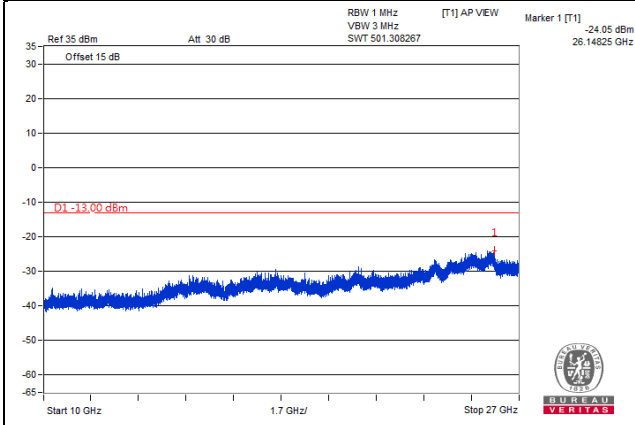

LTE Band 2, Channel Bandwidth 20MHz

Channel 18700 (1860.00MHz)

Frequency Range : 9kHz~1GHz

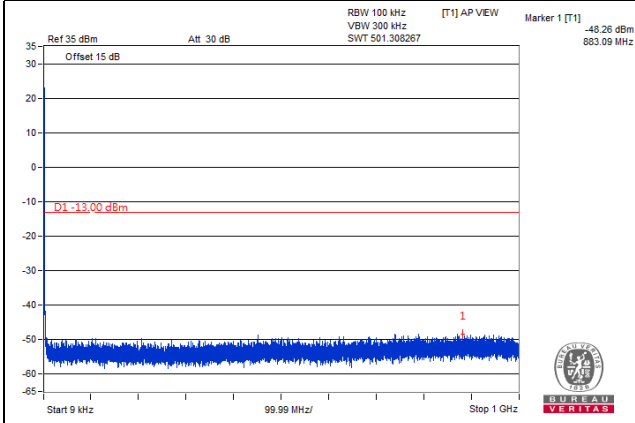

Frequency Range : 1GHz~10GHz

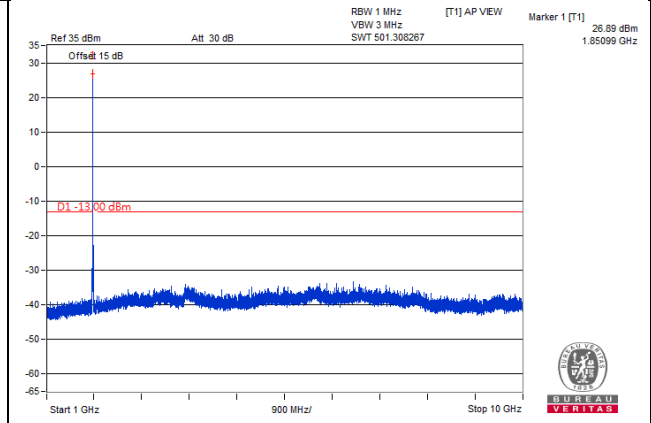

Frequency Range : 10GHz~27GHz

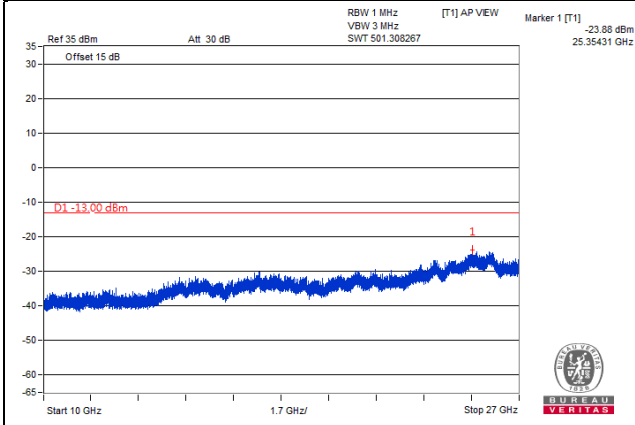

LTE Band 2, Channel Bandwidth 20MHz

Channel 18900 (1880.00MHz)

Frequency Range : 9kHz~1GHz

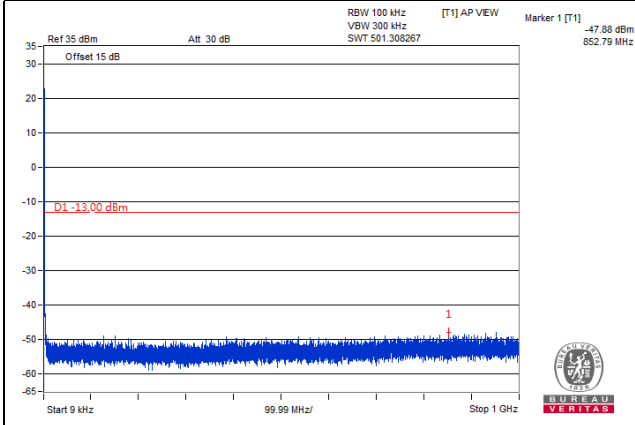

Frequency Range : 1GHz~10GHz

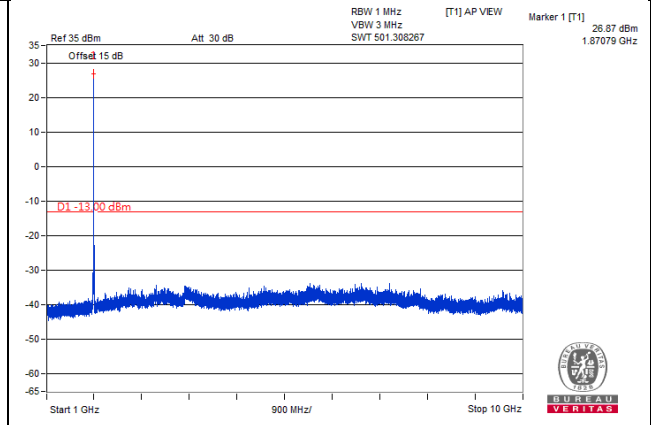

Frequency Range : 10GHz~27GHz

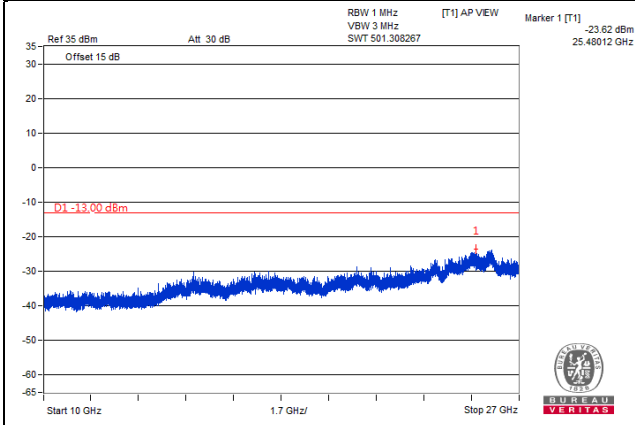

LTE Band 2, Channel Bandwidth 20MHz

Channel 19100 (1900.00MHz)

Frequency Range : 9kHz~1GHz

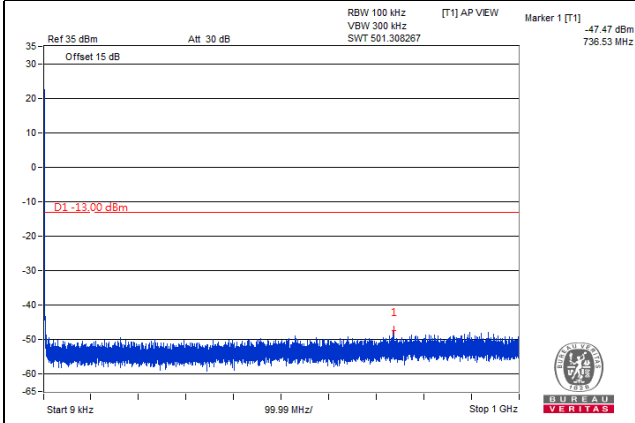

Frequency Range : 1GHz~10GHz

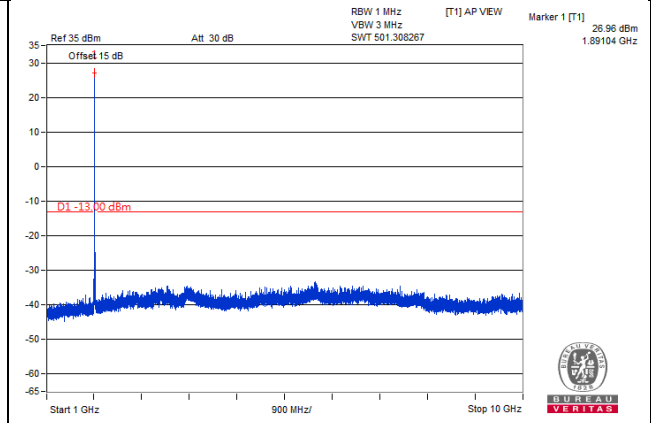

Frequency Range : 10GHz~27GHz

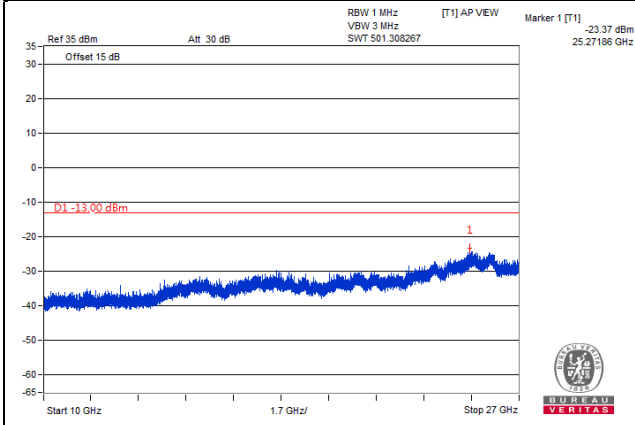

4.8 Radiated Emission Measurement

4.8.1 Limits of Radiated Emission Measurement

The power of any emission outside of the authorized operating frequency ranges must be attenuated below the transmitting power (P) by a factor of at least $43 + 10 \log(P)$ dB. The emission limit equal to -13dBm .

4.8.2 Test Procedure

- a. Substitution method is used for E.I.R.P measurement. In the semi-anechoic chamber, EUT placed on the 0.8m height of Turn Table, rotated the table around 360 degrees to search the maximum radiation power and receiver antenna shall be rotated vertical and horizontal polarization and moved height from 1m to 4m to find the maximum polar radiated power. The "Read Value" is the spectrum reading the maximum power value.
- b. The substitution horn antenna is substituted for EUT at the same position and signals generator export the CW signal to the substitution antenna via a TX cable. Rotated the Turn Table and moved receiving antenna to find the maximum radiation power. Adjust output power level of S.G to get a Value of spectrum reading equal to "Read Value" of step a. Record the power level of S.G
- c. $\text{EIRP} = \text{Output power level of S.G} - \text{TX cable loss} + \text{Antenna gain of substitution horn}$.
- d. E.R.P power can be calculated form E.I.R.P power by subtracting the gain of dipole, $\text{E.R.P power} = \text{E.I.R.P power} - 2.15\text{dBi}$.

NOTE: The resolution bandwidth and video bandwidth of test receiver/spectrum analyzer is 1MHz/3MHz.

4.8.3 Deviation from Test Standard

No deviation.

4.8.4 Test Setup

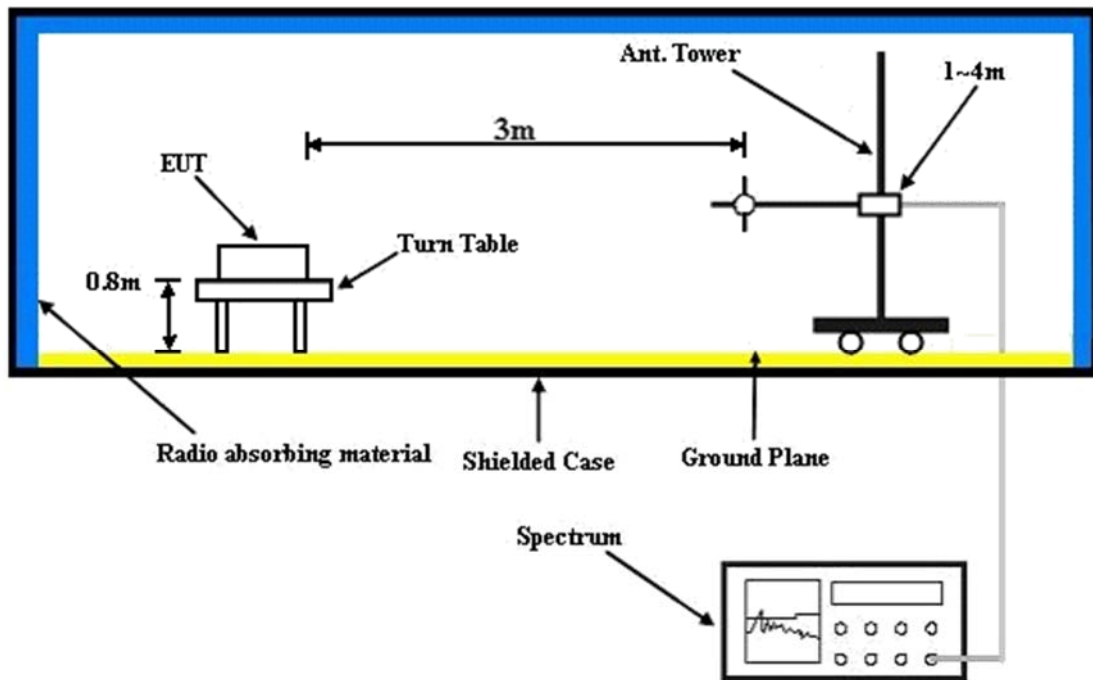

For the actual test configuration, please refer to the attached file (Test Setup Photo).

4.8.5 Test Results

Below 1GHz

LTE Band 2, Channel Bandwidth: 1.4MHz

Mode	TX channel 18607 (1850.70MHz)	Frequency Range	Below 1000 MHz
Environmental Conditions	25deg. C, 66%RH	Input Power	120Vac, 60Hz
Tested By	Greg Lin		

Antenna Polarity & Test Distance: Horizontal at 3 M							
No.	Freq. (MHz)	Reading (dBm)	S.G Power Value (dBm)	Correction Factor (dB)	EIRP (dBm)	Limit (dBm)	Margin (dB)
1	35.82	-55.2	-35.8	-15.9	-51.7	-13.0	-38.7
2	106.63	-42.1	-47.9	-2.2	-50.1	-13.0	-37.1
3	242.43	-55.3	-60.8	-1.4	-62.2	-13.0	-49.2
4	458.74	-68.3	-71.8	3.5	-68.3	-13.0	-55.3
5	753.62	-68.6	-68.5	3.9	-64.6	-13.0	-51.6
6	957.32	-68.6	-63.9	3.8	-60.1	-13.0	-47.1

Remarks:

1. EIRP (dBm) = S.G Value (dBm) + Correction Factor (dB).
2. Correction Factor (dB) = Substitution Antenna Gain (dB) + Cable Loss (dB).

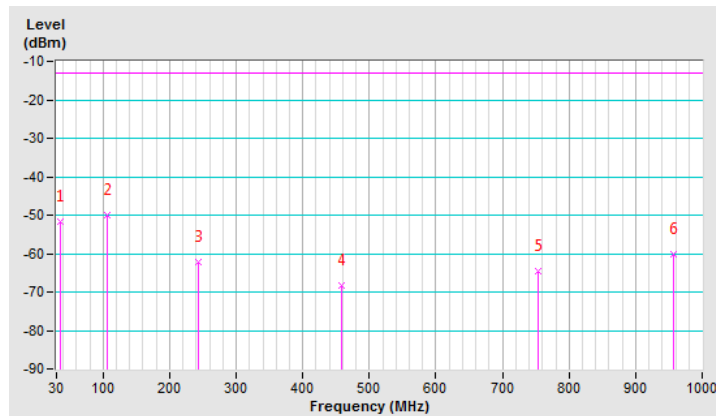

Mode	TX channel 18607 (1850.70MHz)	Frequency Range	Below 1000 MHz
Environmental Conditions	25deg. C, 66%RH	Input Power	120Vac, 60Hz
Tested By	Greg Lin		

Antenna Polarity & Test Distance: Vertical at 3 M							
No.	Freq. (MHz)	Reading (dBm)	S.G Power Value (dBm)	Correction Factor (dB)	EIRP (dBm)	Limit (dBm)	Margin (dB)
1	34.85	-42.2	-35.9	-16.5	-52.4	-13.0	-39.4
2	180.35	-45.9	-46.4	-2.9	-49.3	-13.0	-36.3
3	313.24	-61.3	-65.4	4.0	-61.4	-13.0	-48.4
4	595.51	-68.5	-68.9	3.8	-65.1	-13.0	-52.1
5	835.10	-68.9	-65.5	3.8	-61.7	-13.0	-48.7
6	955.38	-68.6	-63.0	3.8	-59.2	-13.0	-46.2

Remarks:

1. EIRP (dBm) = S.G Value (dBm) + Correction Factor (dB).
2. Correction Factor (dB) = Substitution Antenna Gain (dB) + Cable Loss (dB).

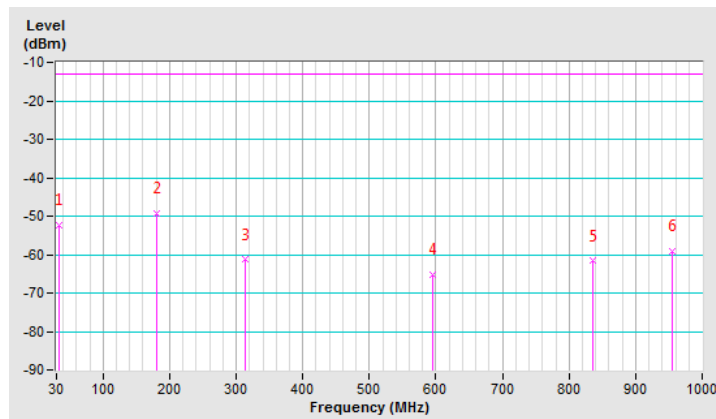

LTE Band 2, Channel Bandwidth: 5MHz

Mode	TX channel 18625 (1852.50MHz)	Frequency Range	Below 1000 MHz
Environmental Conditions	25deg. C, 66%RH	Input Power	120Vac, 60Hz
Tested By	Greg Lin		

Antenna Polarity & Test Distance: Horizontal at 3 M							
No.	Freq. (MHz)	Reading (dBm)	S.G Power Value (dBm)	Correction Factor (dB)	EIRP (dBm)	Limit (dBm)	Margin (dB)
1	30.97	-49.0	-26.5	-18.8	-45.3	-13.0	-32.3
2	177.44	-43.3	-48.2	-3.0	-51.2	-13.0	-38.2
3	268.62	-58.9	-61.5	-1.5	-63.0	-13.0	-50.0
4	538.28	-68.1	-71.6	3.8	-67.8	-13.0	-54.8
5	753.62	-68.6	-68.5	3.9	-64.6	-13.0	-51.6
6	957.32	-68.6	-63.9	3.8	-60.1	-13.0	-47.1

Remarks:

1. EIRP (dBm) = S.G Value (dBm) + Correction Factor (dB).
2. Correction Factor (dB) = Substitution Antenna Gain (dB) + Cable Loss (dB).

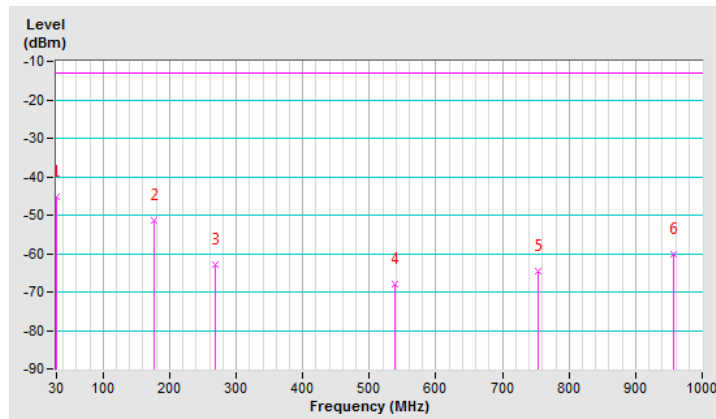

Mode	TX channel 18625 (1852.50MHz)	Frequency Range	Below 1000 MHz
Environmental Conditions	25deg. C, 66%RH	Input Power	120Vac, 60Hz
Tested By	Greg Lin		

Antenna Polarity & Test Distance: Vertical at 3 M							
No.	Freq. (MHz)	Reading (dBm)	S.G Power Value (dBm)	Correction Factor (dB)	EIRP (dBm)	Limit (dBm)	Margin (dB)
1	30.00	-44.8	-35.3	-19.4	-54.7	-13.0	-41.7
2	172.59	-47.7	-48.3	-2.9	-51.2	-13.0	-38.2
3	260.86	-65.3	-62.8	-1.5	-64.3	-13.0	-51.3
4	432.55	-67.6	-71.3	3.5	-67.8	-13.0	-54.8
5	649.83	-68.6	-66.7	3.6	-63.1	-13.0	-50.1
6	950.53	-69.1	-63.5	3.7	-59.8	-13.0	-46.8

Remarks:

1. EIRP (dBm) = S.G Value (dBm) + Correction Factor (dB).
2. Correction Factor (dB) = Substitution Antenna Gain (dB) + Cable Loss (dB).

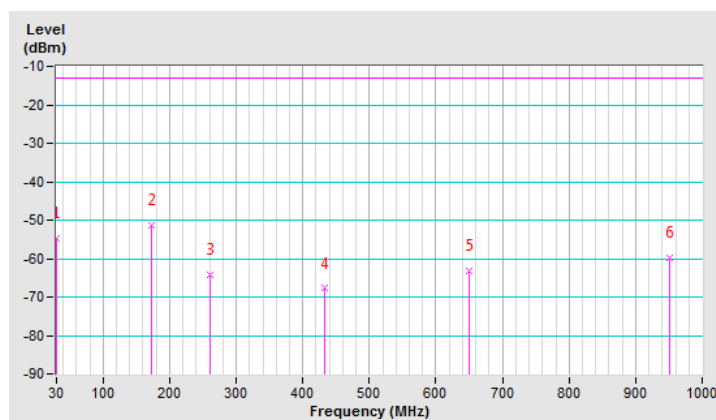

LTE Band 2, Channel Bandwidth: 20MHz

Mode	TX channel 18700 (1860.00MHz)	Frequency Range	Below 1000 MHz
Environmental Conditions	25deg. C, 66%RH	Input Power	120Vac, 60Hz
Tested By	Greg Lin		

Antenna Polarity & Test Distance: Horizontal at 3 M							
No.	Freq. (MHz)	Reading (dBm)	S.G Power Value (dBm)	Correction Factor (dB)	EIRP (dBm)	Limit (dBm)	Margin (dB)
1	32.91	-49.3	-28.5	-17.7	-46.2	-13.0	-33.2
2	175.50	-43.9	-48.7	-2.8	-51.5	-13.0	-38.5
3	246.31	-54.8	-60.1	-1.6	-61.7	-13.0	-48.7
4	541.19	-68.4	-71.9	3.9	-68.0	-13.0	-55.0
5	728.40	-67.8	-67.7	3.6	-64.1	-13.0	-51.1
6	925.31	-68.0	-63.5	3.7	-59.8	-13.0	-46.8

Remarks:

1. EIRP (dBm) = S.G Value (dBm) + Correction Factor (dB).
2. Correction Factor (dB) = Substitution Antenna Gain (dB) + Cable Loss (dB).

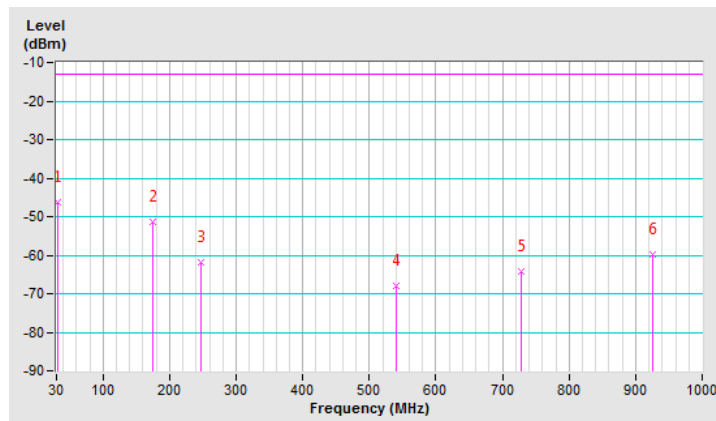

Mode	TX channel 18700 (1860.00MHz)	Frequency Range	Below 1000 MHz
Environmental Conditions	25deg. C, 66%RH	Input Power	120Vac, 60Hz
Tested By	Greg Lin		

Antenna Polarity & Test Distance: Vertical at 3 M							
No.	Freq. (MHz)	Reading (dBm)	S.G Power Value (dBm)	Correction Factor (dB)	EIRP (dBm)	Limit (dBm)	Margin (dB)
1	62.98	-36.5	-40.8	-2.4	-43.2	-13.0	-30.2
2	176.47	-43.8	-44.6	-2.9	-47.5	-13.0	-34.5
3	276.38	-67.3	-62.4	-1.6	-64.0	-13.0	-51.0
4	440.31	-68.2	-71.7	3.5	-68.2	-13.0	-55.2
5	692.51	-67.2	-65.0	3.6	-61.4	-13.0	-48.4
6	950.53	-67.5	-61.9	3.7	-58.2	-13.0	-45.2

Remarks:

1. EIRP (dBm) = S.G Value (dBm) + Correction Factor (dB).
2. Correction Factor (dB) = Substitution Antenna Gain (dB) + Cable Loss (dB).

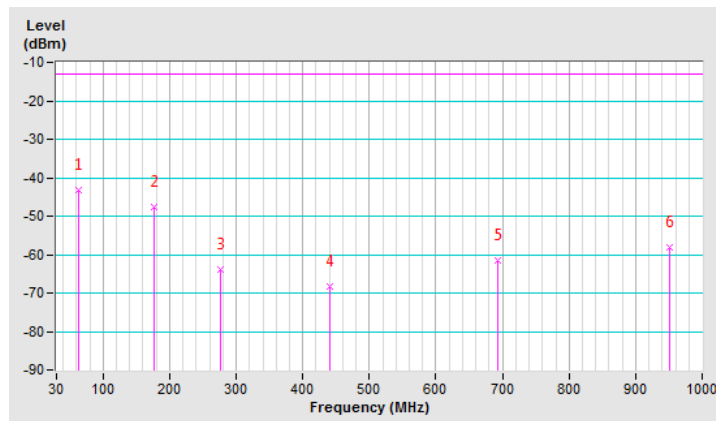

Above 1GHz

LTE Band 2, Channel Bandwidth: 1.4MHz

Mode	TX channel 18607 (1850.70MHz)	Frequency Range	1GHz ~ 18GHz
Environmental Conditions	25deg. C, 66%RH	Input Power	120Vac, 60Hz
Tested By	Han Wu		

Antenna Polarity & Test Distance: Horizontal at 3 M							
No.	Freq. (MHz)	Reading (dBm)	S.G Power Value (dBm)	Correction Factor (dB)	EIRP (dBm)	Limit (dBm)	Margin (dB)
1	3701.40	-57.5	-49.0	1.4	-47.6	-13.0	-34.6
Antenna Polarity & Test Distance: Vertical at 3 M							
No.	Freq. (MHz)	Reading (dBm)	S.G Power Value (dBm)	Correction Factor (dB)	EIRP (dBm)	Limit (dBm)	Margin (dB)
1	3701.40	-58.4	-50.2	1.4	-48.8	-13.0	-35.8

Remarks:

1. EIRP (dBm) = S.G Value (dBm) + Correction Factor (dB).
2. Correction Factor (dB) = Substitution Antenna Gain (dB) + Cable Loss (dB).

Mode	TX channel 18900 (1880.00MHz)	Frequency Range	1GHz ~ 18GHz
Environmental Conditions	25deg. C, 66%RH	Input Power	120Vac, 60Hz
Tested By	Han Wu		

Antenna Polarity & Test Distance: Horizontal at 3 M							
No.	Freq. (MHz)	Reading (dBm)	S.G Power Value (dBm)	Correction Factor (dB)	EIRP (dBm)	Limit (dBm)	Margin (dB)
1	3760.00	-57.1	-48.6	1.3	-47.3	-13.0	-34.3
Antenna Polarity & Test Distance: Vertical at 3 M							
No.	Freq. (MHz)	Reading (dBm)	S.G Power Value (dBm)	Correction Factor (dB)	EIRP (dBm)	Limit (dBm)	Margin (dB)
1	3760.00	-58.0	-49.7	1.3	-48.4	-13.0	-35.4

Remarks:

1. EIRP (dBm) = S.G Value (dBm) + Correction Factor (dB).
2. Correction Factor (dB) = Substitution Antenna Gain (dB) + Cable Loss (dB).

Mode	TX channel 19193 (1909.30MHz)	Frequency Range	1GHz ~ 18GHz
Environmental Conditions	25deg. C, 66%RH	Input Power	120Vac, 60Hz
Tested By	Han Wu		

Antenna Polarity & Test Distance: Horizontal at 3 M							
No.	Freq. (MHz)	Reading (dBm)	S.G Power Value (dBm)	Correction Factor (dB)	EIRP (dBm)	Limit (dBm)	Margin (dB)
1	3818.60	-57.7	-49.4	1.4	-48.0	-13.0	-35.0
Antenna Polarity & Test Distance: Vertical at 3 M							
No.	Freq. (MHz)	Reading (dBm)	S.G Power Value (dBm)	Correction Factor (dB)	EIRP (dBm)	Limit (dBm)	Margin (dB)
1	3818.60	-58.4	-50.2	1.4	-48.8	-13.0	-35.8

Remarks:

1. EIRP (dBm) = S.G Value (dBm) + Correction Factor (dB).
2. Correction Factor (dB) = Substitution Antenna Gain (dB) + Cable Loss (dB).

LTE Band 2, Channel Bandwidth: 5MHz

Mode	TX channel 18625 (1852.50MHz)	Frequency Range	1GHz ~ 18GHz
Environmental Conditions	25deg. C, 66%RH	Input Power	120Vac, 60Hz
Tested By	Han Wu		

Antenna Polarity & Test Distance: Horizontal at 3 M							
No.	Freq. (MHz)	Reading (dBm)	S.G Power Value (dBm)	Correction Factor (dB)	EIRP (dBm)	Limit (dBm)	Margin (dB)
1	3705.00	-56.9	-48.4	1.4	-47.0	-13.0	-34.0
Antenna Polarity & Test Distance: Vertical at 3 M							
No.	Freq. (MHz)	Reading (dBm)	S.G Power Value (dBm)	Correction Factor (dB)	EIRP (dBm)	Limit (dBm)	Margin (dB)
1	3705.00	-58.0	-49.8	1.4	-48.4	-13.0	-35.4

Remarks:

1. EIRP (dBm) = S.G Value (dBm) + Correction Factor (dB).
2. Correction Factor (dB) = Substitution Antenna Gain (dB) + Cable Loss (dB).

Mode	TX channel 18900 (1880.00MHz)	Frequency Range	1GHz ~ 18GHz
Environmental Conditions	25deg. C, 66%RH	Input Power	120Vac, 60Hz
Tested By	Han Wu		

Antenna Polarity & Test Distance: Horizontal at 3 M							
No.	Freq. (MHz)	Reading (dBm)	S.G Power Value (dBm)	Correction Factor (dB)	EIRP (dBm)	Limit (dBm)	Margin (dB)
1	3760.00	-56.8	-48.3	1.3	-47.0	-13.0	-34.0
Antenna Polarity & Test Distance: Vertical at 3 M							
No.	Freq. (MHz)	Reading (dBm)	S.G Power Value (dBm)	Correction Factor (dB)	EIRP (dBm)	Limit (dBm)	Margin (dB)
1	3760.00	-58.5	-50.2	1.3	-48.9	-13.0	-35.9

Remarks:

1. EIRP (dBm) = S.G Value (dBm) + Correction Factor (dB).
2. Correction Factor (dB) = Substitution Antenna Gain (dB) + Cable Loss (dB).

Mode	TX channel 19175 (1907.50MHz)	Frequency Range	1GHz ~ 18GHz
Environmental Conditions	25deg. C, 66%RH	Input Power	120Vac, 60Hz
Tested By	Han Wu		

Antenna Polarity & Test Distance: Horizontal at 3 M							
No.	Freq. (MHz)	Reading (dBm)	S.G Power Value (dBm)	Correction Factor (dB)	EIRP (dBm)	Limit (dBm)	Margin (dB)
1	3815.00	-57.5	-49.2	1.4	-47.8	-13.0	-34.8
Antenna Polarity & Test Distance: Vertical at 3 M							
No.	Freq. (MHz)	Reading (dBm)	S.G Power Value (dBm)	Correction Factor (dB)	EIRP (dBm)	Limit (dBm)	Margin (dB)
1	3815.00	-58.3	-50.1	1.4	-48.7	-13.0	-35.7

Remarks:

1. EIRP (dBm) = S.G Value (dBm) + Correction Factor (dB).
2. Correction Factor (dB) = Substitution Antenna Gain (dB) + Cable Loss (dB).

LTE Band 2, Channel Bandwidth: 20MHz

Mode	TX channel 18700 (1860.00MHz)	Frequency Range	1GHz ~ 18GHz
Environmental Conditions	25deg. C, 66%RH	Input Power	120Vac, 60Hz
Tested By	Han Wu		

Antenna Polarity & Test Distance: Horizontal at 3 M							
No.	Freq. (MHz)	Reading (dBm)	S.G Power Value (dBm)	Correction Factor (dB)	EIRP (dBm)	Limit (dBm)	Margin (dB)
1	3720.00	-57.1	-48.6	1.4	-47.2	-13.0	-34.2
Antenna Polarity & Test Distance: Vertical at 3 M							
No.	Freq. (MHz)	Reading (dBm)	S.G Power Value (dBm)	Correction Factor (dB)	EIRP (dBm)	Limit (dBm)	Margin (dB)
1	3720.00	-58.3	-50.1	1.4	-48.7	-13.0	-35.7

Remarks:

1. EIRP (dBm) = S.G Value (dBm) + Correction Factor (dB).
2. Correction Factor (dB) = Substitution Antenna Gain (dB) + Cable Loss (dB).

Mode	TX channel 18900 (1880.00MHz)	Frequency Range	1GHz ~ 18GHz
Environmental Conditions	25deg. C, 66%RH	Input Power	120Vac, 60Hz
Tested By	Han Wu		

Antenna Polarity & Test Distance: Horizontal at 3 M							
No.	Freq. (MHz)	Reading (dBm)	S.G Power Value (dBm)	Correction Factor (dB)	EIRP (dBm)	Limit (dBm)	Margin (dB)
1	3760.00	-57.2	-48.7	1.3	-47.4	-13.0	-34.4
Antenna Polarity & Test Distance: Vertical at 3 M							
No.	Freq. (MHz)	Reading (dBm)	S.G Power Value (dBm)	Correction Factor (dB)	EIRP (dBm)	Limit (dBm)	Margin (dB)
1	3760.00	-58.2	-49.9	1.3	-48.6	-13.0	-35.6

Remarks:

1. EIRP (dBm) = S.G Value (dBm) + Correction Factor (dB).
2. Correction Factor (dB) = Substitution Antenna Gain (dB) + Cable Loss (dB).

Mode	TX channel 19100 (1900.00MHz)	Frequency Range	1GHz ~ 18GHz
Environmental Conditions	25deg. C, 66%RH	Input Power	120Vac, 60Hz
Tested By	Han Wu		

Antenna Polarity & Test Distance: Horizontal at 3 M							
No.	Freq. (MHz)	Reading (dBm)	S.G Power Value (dBm)	Correction Factor (dB)	EIRP (dBm)	Limit (dBm)	Margin (dB)
1	3800.00	-57.5	-49.1	1.3	-47.8	-13.0	-34.8
Antenna Polarity & Test Distance: Vertical at 3 M							
No.	Freq. (MHz)	Reading (dBm)	S.G Power Value (dBm)	Correction Factor (dB)	EIRP (dBm)	Limit (dBm)	Margin (dB)
1	3800.00	-58.8	-50.6	1.3	-49.3	-13.0	-36.3

Remarks:

1. EIRP (dBm) = S.G Value (dBm) + Correction Factor (dB).
2. Correction Factor (dB) = Substitution Antenna Gain (dB) + Cable Loss (dB).

5 Pictures of Test Arrangements

Please refer to the attached file (Test Setup Photo).

Appendix – Information on the Testing Laboratories

We, Bureau Veritas Consumer Products Services (H.K.) Ltd., Taoyuan Branch, were founded in 1988 to provide our best service in EMC, Radio, Telecom and Safety consultation. Our laboratories are FCC recognized accredited test firms and accredited and approved according to ISO/IEC 17025.

If you have any comments, please feel free to contact us at the following:

Linko EMC/RF Lab

Tel: 886-2-26052180

Fax: 886-2-26051924

Hsin Chu EMC/RF/Telecom Lab

Tel: 886-3-6668565

Fax: 886-3-6668323

Hwa Ya EMC/RF/Safety Lab

Tel: 886-3-3183232

Fax: 886-3-3270892

Email: service.adt@tw.bureauveritas.com

Web Site: www.bureauveritas-adt.com

The address and road map of all our labs can be found in our web site also.

--- END ---