

## FCC Test Report (WLAN)

**Report No.:** RF181004C17-1

**FCC ID:** PY318300428

**Test Model:** MR5000

**Received Date:** Oct. 04, 2018

**Test Date:** Nov. 07 to 14, 2018

**Issued Date:** Nov. 19, 2018

**Applicant:** NETGEAR INC.

**Address:** 350 East Plumeria Drive, San Jose, CA 95134, USA

**Issued By:** Bureau Veritas Consumer Products Services (H.K.) Ltd., Taoyuan Branch  
Hsin Chu Laboratory

**Lab Address:** E-2, No.1, Li Hsin 1st Road, Hsinchu Science Park, Hsinchu City 300,  
Taiwan R.O.C.

**Test Location:** E-2, No.1, Li Hsin 1st Road, Hsinchu Science Park, Hsinchu City 300,  
Taiwan R.O.C.

**FCC Registration /  
Designation Number:** 723255 / TW2022



This report is for your exclusive use. Any copying or replication of this report to or for any other person or entity, or use of our name or trademark, is permitted only with our prior written permission. This report sets forth our findings solely with respect to the test samples identified herein. The results set forth in this report are not indicative or representative of the quality or characteristics of the lot from which a test sample was taken or any similar or identical product unless specifically and expressly noted. Our report includes all of the tests requested by you and the results thereof based upon the information that you provided to us. You have 60 days from date of issuance of this report to notify us of any material error or omission caused by our negligence, provided, however, that such notice shall be in writing and shall specifically address the issue you wish to raise. A failure to raise such issue within the prescribed time shall constitute your unqualified acceptance of the completeness of this report, the tests conducted and the correctness of the report contents. Unless specific mention, the uncertainty of measurement has been explicitly taken into account to declare the compliance or non-compliance to the specification. The report must not be used by the client to claim product certification, approval, or endorsement by TAF or any government agencies.

## Table of Contents

<b>Release Control Record</b> .....	<b>4</b>
<b>1 Certificate of Conformity</b> .....	<b>5</b>
<b>2 Summary of Test Results</b> .....	<b>6</b>
2.1 Measurement Uncertainty .....	6
2.2 Modification Record .....	6
<b>3 General Information</b> .....	<b>7</b>
3.1 General Description of EUT (WLAN) .....	7
3.2 Description of Test Modes .....	9
3.2.1 Test Mode Applicability and Tested Channel Detail .....	10
3.3 Duty Cycle of Test Signal .....	12
3.4 Description of Support Units .....	13
3.4.1 Configuration of System under Test .....	14
3.5 General Description of Applied Standard .....	15
<b>4 Test Types and Results</b> .....	<b>16</b>
4.1 Radiated Emission and Bandedge Measurement .....	16
4.1.1 Limits of Radiated Emission and Bandedge Measurement .....	16
4.1.2 Test Instruments .....	17
4.1.3 Test Procedure .....	19
4.1.4 Deviation from Test Standard .....	19
4.1.5 Test Setup .....	20
4.1.6 EUT Operating Condition .....	21
4.1.7 Test Results .....	22
4.2 Conducted Emission Measurement .....	42
4.2.1 Limits of Conducted Emission Measurement .....	42
4.2.2 Test Instruments .....	42
4.2.3 Test Procedure .....	43
4.2.4 Deviation from Test Standard .....	43
4.2.5 Test Setup .....	43
4.2.6 EUT Operating Condition .....	43
4.2.7 Test Results (Mode 1) .....	44
4.2.8 Test Results (Mode 2) .....	46
4.3 Transmit Power Measurement .....	48
4.3.1 Limits of Transmit Power Measurement .....	48
4.3.2 Test Setup .....	48
4.3.3 Test Instruments .....	48
4.3.4 Test Procedure .....	48
4.3.5 Deviation from Test Standard .....	48
4.3.6 EUT Operating Condition .....	48
4.3.7 Test Results .....	49
4.4 Occupied Bandwidth Measurement .....	50
4.4.1 Test Setup .....	50
4.4.2 Test Instruments .....	50
4.4.3 Test Procedure .....	50
4.4.4 Test Results .....	51
4.5 Peak Power Spectral Density Measurement .....	55
4.5.1 Limits of Peak Power Spectral Density Measurement .....	55
4.5.2 Test Setup .....	55
4.5.3 Test Instruments .....	55
4.5.4 Test Procedure .....	56
4.5.5 Deviation from Test Standard .....	56
4.5.6 EUT Operating Condition .....	56
4.5.7 Test Results .....	57
4.6 Frequency Stability Measurement .....	63

4.6.1	Limits of Frequency Stability Measurement .....	63
4.6.2	Test Setup.....	63
4.6.3	Test Instruments .....	63
4.6.4	Test Procedure .....	63
4.6.5	Deviation from Test Standard .....	63
4.6.6	EUT Operating Condition .....	63
4.6.7	Test Results .....	64
4.7	6dB Bandwidth Measurement .....	65
4.7.1	Limits of 6dB Bandwidth Measurement.....	65
4.7.2	Test Setup.....	65
4.7.3	Test Instruments .....	65
4.7.4	Test Procedure .....	65
4.7.5	Deviation from Test Standard .....	65
4.7.6	EUT Operating Condition .....	65
4.7.7	Test Results .....	66
<b>5</b>	<b>Pictures of Test Arrangements.....</b>	<b>68</b>
	<b>Annex A- Radiated Out of Band Emission (OOBE) Measurement (For U-NII-3 band).....</b>	<b>69</b>
	<b>Appendix – Information on the Testing Laboratories .....</b>	<b>72</b>

### Release Control Record

Issue No.	Description	Date Issued
RF181004C17-1	Original release.	Nov. 19, 2018

## 1 Certificate of Conformity

**Product:** 5G MHS Travel Router

**Brand:** Netgear

**Test Model:** MR5000

**Sample Status:** ENGINEERING SAMPLE

**Applicant:** NETGEAR INC.

**Test Date:** Nov. 07 to 14, 2018

**Standard:** 47 CFR FCC Part 15, Subpart E (Section 15.407)  
ANSI C63.10: 2013

The above equipment has been tested by **Bureau Veritas Consumer Products Services (H.K.) Ltd., Taoyuan Branch**, and found compliance with the requirement of the above standards. The test record, data evaluation & Equipment Under Test (EUT) configurations represented herein are true and accurate accounts of the measurements of the sample's EMC characteristics under the conditions specified in this report.

**Prepared by :**  , **Date:** Nov. 19, 2018  
Claire Kuan / Specialist

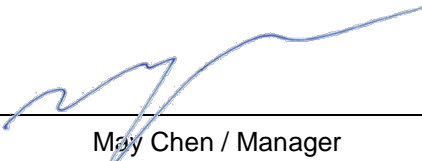
**Approved by :**  , **Date:** Nov. 19, 2018  
May Chen / Manager

## 2 Summary of Test Results

47 CFR FCC Part 15, Subpart E (Section 15.407)			
FCC Clause	Test Item	Result	Remarks
15.407(b)(6)	AC Power Conducted Emissions	Pass	Meet the requirement of limit. Minimum passing margin is -13.30dB at 0.19687MHz.
15.407(b) (1/2/3/4(i/ii)/6)	Radiated Emissions & Band Edge Measurement*	Pass	Meet the requirement of limit. Minimum passing margin is -4.1dB at 73.64MHz.
15.407(a)(1/2/3)	Max Average Transmit Power	Pass	Meet the requirement of limit.
---	Occupied Bandwidth Measurement	-	Reference only.
15.407(a)(1/2/3)	Peak Power Spectral Density	Pass	Meet the requirement of limit.
15.407(e)	6dB bandwidth	Pass	Meet the requirement of limit. (U-NII-3 Band only)
15.407(g)	Frequency Stability	Pass	Meet the requirement of limit.
15.203	Antenna Requirement	Pass	There is no antenna connector

\*For U-NII-3 band compliance with rule part 15.407(b)(4)(i), the OOB test plots were recorded in Annex A.

### 2.1 Measurement Uncertainty

Where relevant, the following measurement uncertainty levels have been estimated for tests performed on the EUT as specified in CISPR 16-4-2:

Measurement	Frequency	Expanded Uncertainty (k=2) ( $\pm$ )
Conducted Emissions at mains ports	150kHz ~ 30MHz	1.84 dB
Radiated Emissions up to 1 GHz	30MHz ~ 1GHz	5.53 dB
Radiated Emissions above 1 GHz	1GHz ~ 6GHz	5.08 dB
	6GHz ~ 18GHz	4.98 dB
	18GHz ~ 40GHz	5.19 dB

### 2.2 Modification Record

There were no modifications required for compliance.

### 3 General Information

#### 3.1 General Description of EUT (WLAN)

Product	5G MHS Travel Router
Brand	Netgear
Test Model	MR5000
Status of EUT	ENGINEERING SAMPLE
Power Supply Rating	5Vdc from power adapter or 5Vdc from USB interface or 3.8V dc from battery
Modulation Type	CCK, DQPSK, DBPSK for DSSS 64QAM, 16QAM, QPSK, BPSK for OFDM 256QAM for OFDM in 11ac mode and VHT (20/40) mode in 2.4GHz
Modulation Technology	DSSS, OFDM
Transfer Rate	802.11b: up to 11Mbps 802.11a/g: up to 54Mbps 802.11n: up to 300Mbps 802.11ac: up to 866.7Mbps
Operating Frequency	<b>2.4GHz:</b> 2.412 ~ 2.462GHz <b>5GHz:</b> 5.18~ 5.24GHz, 5.745 ~ 5.825GHz
Number of Channel	<b>2.4GHz:</b> 802.11b, 802.11g, 802.11n (HT20), VHT20: 11 802.11n (HT40), VHT40: 7 <b>5GHz:</b> 802.11a, 802.11n (HT20), 802.11ac (VHT20): 9 802.11n (HT40), 802.11ac (VHT40): 4 802.11ac (VHT80): 2
Output Power	<b>2.412 ~ 2.462GHz:</b> 58.084mW <b>5.18 ~ 5.24GHz:</b> 19.455mW <b>5.745 ~ 5.825GHz:</b> 19.455mW
Antenna Type	Refer to Note
Antenna Connector	Refer to Note
Accessory Device	Adapter x1 , Battery x1
Data Cable Supplied	USB cable x 1 (Shielded, 0.95m)

Note:

1. Simultaneously transmission condition.

Condition	Technology		
1	WLAN 2.4GHz 1Tx	WLAN 5GHz 1Tx	WWAN or 5G NR

Note: The emission of the simultaneous operation has been evaluated and no non-compliance was found.

2. The EUT must be supplied with a power adapter or battery as following table:

Items	Brand	Model No.	P/N No.	Spec.
Adapter	NETGEAR	AD2122F20	332-11106-01	Input: 100-240V~50/60Hz 0.5A Output: 5V / 2.0A or 9V /1.8A
Battery	NETGEAR	W-10a	308-10084-01	3.85V dc 19.78Wh

3. The antennas provided to the EUT, please refer to the following table:

Ant No.	Antenna Net Gain (dBi)	Frequency rang (GHz)	Antenna type	Connector type
1	2.03	2.4~2.4835	Internal IFA	NA
	2.59	5.15~5.85		
2	2.03	2.4~2.4835	Internal IFA	NA
	2.59	5.15~5.85		

4. The EUT incorporates a MIMO function.

2.4GHz Band			
MODULATION MODE	DATA RATE (MCS)	TX & RX CONFIGURATION	
802.11b	1 ~ 11Mbps	2TX	2RX
802.11g	6 ~ 54Mbps	2TX	2RX
802.11n (HT20)	MCS 0~7	2TX	2RX
	MCS 8~15	2TX	2RX
802.11n (HT40)	MCS 0~7	2TX	2RX
	MCS 8~15	2TX	2RX
VHT20	MCS0~8 Nss=1	2TX	2RX
	MCS0~8 Nss=2	2TX	2RX
VHT40	MCS0~9 Nss=1	2TX	2RX
	MCS0~9 Nss=2	2TX	2RX
5GHz Band			
MODULATION MODE	DATA RATE (MCS)	TX & RX CONFIGURATION	
802.11a	6 ~ 54Mbps	2TX	2RX
802.11n (HT20)	MCS 0~7	2TX	2RX
	MCS 8~15	2TX	2RX
802.11n (HT40)	MCS 0~7	2TX	2RX
	MCS 8~15	2TX	2RX
802.11ac (VHT20)	MCS0~8 Nss=1	2TX	2RX
	MCS0~8 Nss=2	2TX	2RX
802.11ac (VHT40)	MCS0~9 Nss=1	2TX	2RX
	MCS0~9 Nss=2	2TX	2RX
802.11ac (VHT80)	MCS0~9 Nss=1	2TX	2RX
	MCS0~9 Nss=2	2TX	2RX

5. The EUT was pre-tested under the following modes:

Test Mode	Description
<b>Mode A</b>	<b>With adapter mode</b>
Mode B	With Laptop mode
Mode C	Power from battery

Note: From the above modes, radiated emission the worst case was found in **Mode A**. Therefore only the test data of the mode was recorded in this report.

6. The above EUT information is declared by manufacturer and for more detailed features description, please refers to the manufacturer's specifications or user's manual.



### 3.2 Description of Test Modes

#### FOR 5180 ~ 5240MHz

4 channels are provided for 802.11a, 802.11n (HT20), 802.11ac (VHT20):

Channel	Frequency	Channel	Frequency
36	5180 MHz	44	5220 MHz
40	5200 MHz	48	5240 MHz

2 channels are provided for 802.11n (HT40), 802.11ac (VHT40):

Channel	Frequency	Channel	Frequency
38	5190 MHz	46	5230 MHz

1 channel is provided for 802.11ac (VHT80):

Channel	Frequency
42	5210 MHz

#### FOR 5745 ~ 5825MHz:

5 channels are provided for 802.11a, 802.11n (HT20), 802.11ac (VHT20):

Channel	Frequency	Channel	Frequency
149	5745 MHz	161	5805 MHz
153	5765 MHz	165	5825 MHz
157	5785 MHz		

2 channels are provided for 802.11n (HT40), 802.11ac (VHT40):

Channel	Frequency	Channel	Frequency
151	5755 MHz	159	5795 MHz

1 channel is provided for 802.11ac (VHT80):

Channel	Frequency
155	5775 MHz

### 3.2.1 Test Mode Applicability and Tested Channel Detail

EUT Configure Mode	Applicable To				Description
	RE $\geq$ 1G	RE<1G	PLC	APCM	
1	√	√	√	√	With adapter mode
2	-	-	√	-	With Laptop mode

Where **RE $\geq$ 1G**: Radiated Emission above 1GHz      **RE<1G**: Radiated Emission below 1GHz  
**PLC**: Power Line Conducted Emission      **APCM**: Antenna Port Conducted Measurement

#### **Radiated Emission Test (Above 1GHz):**

- Pre-Scan has been conducted to determine the worst-case mode from all possible combinations between available modulations, data rates and antenna ports (if EUT with antenna diversity architecture).
- Following channel(s) was (were) selected for the final test as listed below.

Mode	FREQ. Band (MHz)	Available Channel	Tested Channel	Modulation Technology	Modulation Type	Data Rate (Mbps)
802.11a	5180-5240	36 to 48	36, 40, 48	OFDM	BPSK	6
802.11ac (VHT20)		36 to 48	36, 40, 48	OFDM	BPSK	6.5
802.11ac (VHT40)		38 to 46	38, 46	OFDM	BPSK	13.5
802.11ac (VHT80)		42	42	OFDM	BPSK	29.3
802.11a	5745-5825	149 to 165	149, 157, 165	OFDM	BPSK	6
802.11ac (VHT20)		149 to 165	149, 157, 165	OFDM	BPSK	6.5
802.11ac (VHT40)		151 to 159	151, 159	OFDM	BPSK	13.5
802.11ac (VHT80)		155	155	OFDM	BPSK	29.3

#### **Radiated Emission Test (Below 1GHz):**

- Pre-Scan has been conducted to determine the worst-case mode from all possible combinations between available modulations, data rates and antenna ports (if EUT with antenna diversity architecture).
- Following channel(s) was (were) selected for the final test as listed below.

Mode	FREQ. Band (MHz)	Available Channel	Tested Channel	Modulation Technology	Modulation Type	Data Rate (Mbps)
802.11ac (VHT80)	5180-5240, 5745-5825	42, 155	155	OFDM	BPSK	29.3

#### **Power Line Conducted Emission Test:**

- Pre-Scan has been conducted to determine the worst-case mode from all possible combinations between available modulations, data rates and antenna ports (if EUT with antenna diversity architecture).
- Following channel(s) was (were) selected for the final test as listed below.

Mode	FREQ. Band (MHz)	Available Channel	Tested Channel	Modulation Technology	Modulation Type	Data Rate (Mbps)
802.11ac (VHT80)	5180-5240, 5745-5825	42, 155	155	OFDM	BPSK	29.3

### Antenna Port Conducted Measurement:

- This item includes all test value of each mode, but only includes spectrum plot of worst value of each mode.
- Pre-Scan has been conducted to determine the worst-case mode from all possible combinations between available modulations, data rates and antenna ports (if EUT with antenna diversity architecture).
- Following channel(s) was (were) selected for the final test as listed below.

Mode	FREQ. Band (MHz)	Available Channel	Tested Channel	Modulation Technology	Modulation Type	Data Rate (Mbps)
802.11a	5180-5240	36 to 48	36, 40, 48	OFDM	BPSK	6
802.11ac (VHT20)		36 to 48	36, 40, 48	OFDM	BPSK	6.5
802.11ac (VHT40)		38 to 46	38, 46	OFDM	BPSK	13.5
802.11ac (VHT80)		42	42	OFDM	BPSK	29.3
802.11a	5745-5825	149 to 165	149, 157, 165	OFDM	BPSK	6
802.11ac (VHT20)		149 to 165	149, 157, 165	OFDM	BPSK	6.5
802.11ac (VHT40)		151 to 159	151, 159	OFDM	BPSK	13.5
802.11ac (VHT80)		155	155	OFDM	BPSK	29.3

### Test Condition:

Applicable To	Environmental Conditions	Input Power	Tested By
RE $\geq$ 1G	24deg. C, 63%RH	120Vac, 60Hz	Rey Chen
RE $<$ 1G	23deg. C, 68%RH	120Vac, 60Hz	Andy Ho
PLC	25deg. C, 75%RH	120Vac, 60Hz	Andy Ho
APCM	25deg. C, 60%RH	120Vac, 60Hz	Anderson Chen

### 3.3 Duty Cycle of Test Signal

If duty cycle of test signal is  $\geq 98\%$ , duty factor is not required.

If duty cycle of test signal is  $< 98\%$ , duty factor shall be considered.

**802.11a:** Duty cycle = Duty cycle =  $2.027 \text{ ms} / 2.097 \text{ ms} = 0.967$ , Duty factor =  $10 * \log (1/\text{Duty cycle}) = 0.15$

**802.11ac (VHT20):** Duty cycle =  $4.97 \text{ ms} / 5.035 \text{ ms} = 0.987$

**802.11ac (VHT40):** Duty cycle =  $2.412 \text{ ms} / 2.477 \text{ ms} = 0.974$ , Duty factor =  $10 * \log (1/\text{Duty cycle}) = 0.12$

**802.11ac (VHT80):** Duty cycle =  $1.135 \text{ ms} / 1.199 \text{ ms} = 0.947$ , Duty factor =  $10 * \log (1/\text{Duty cycle}) = 0.24$

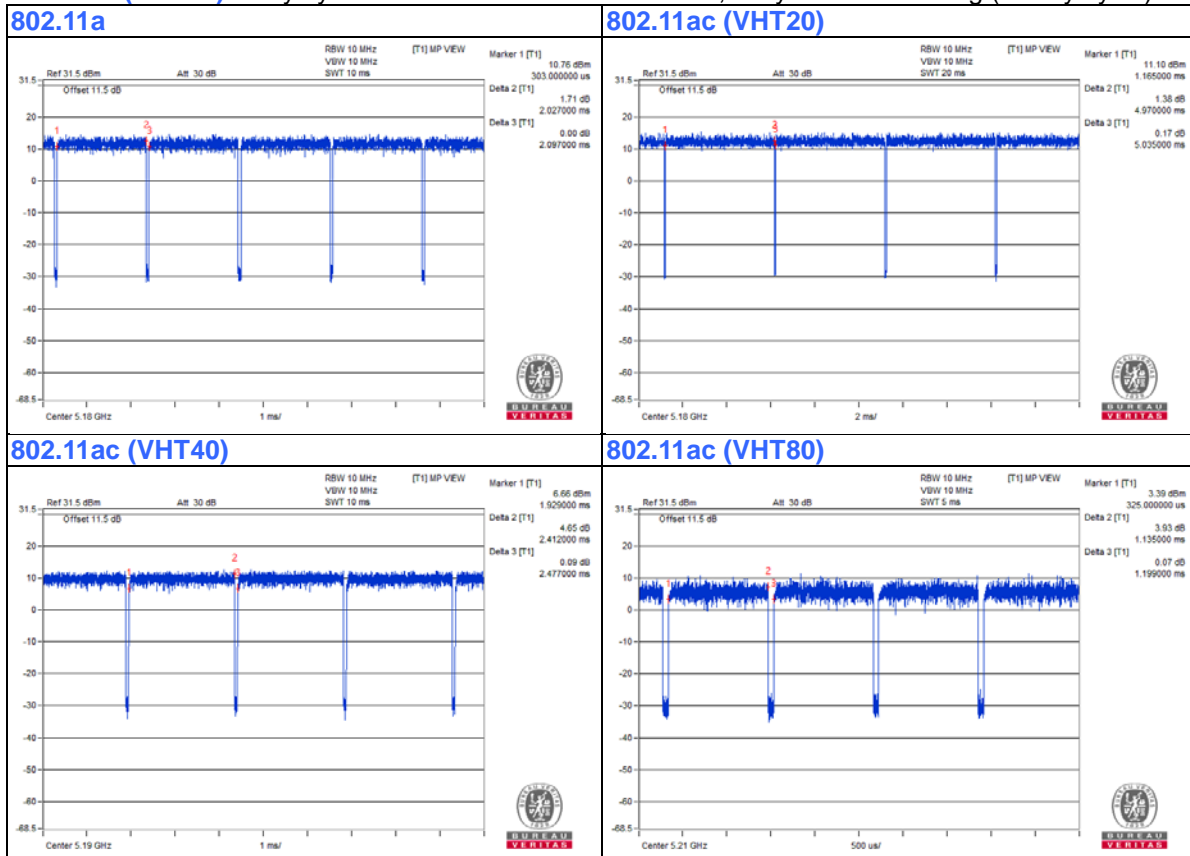

### 3.4 Description of Support Units

The EUT has been tested as an independent unit together with other necessary accessories or support units. The following support units or accessories were used to form a representative test configuration during the tests.

ID	Product	Brand	Model No.	Serial No.	FCC ID	Remarks
A.	SIM Card	R&S	CMW-Z05	NA	NA	Provided by Lab
B.	Laptop	DELL	E6420	B92T3R1	FCC DoC	Provided by Lab

Note:

1. All power cords of the above support units are non-shielded (1.8m).

ID	Descriptions	Qty.	Length (m)	Shielding (Yes/No)	Cores (Qty.)	Remarks
1.	USB type C Cable	1	0.95	Yes	0	Supplied by client

### 3.4.1 Configuration of System under Test

Adapter mode:

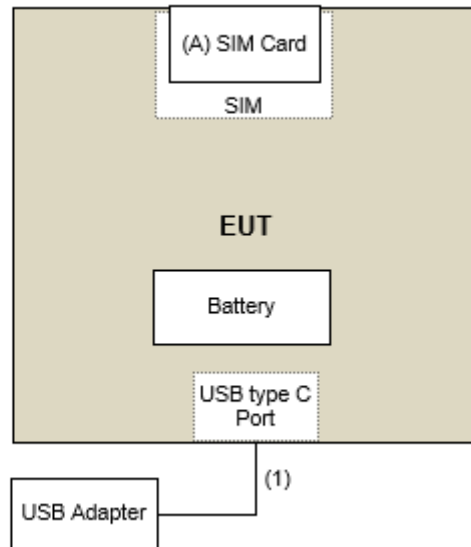

Laptop mode:

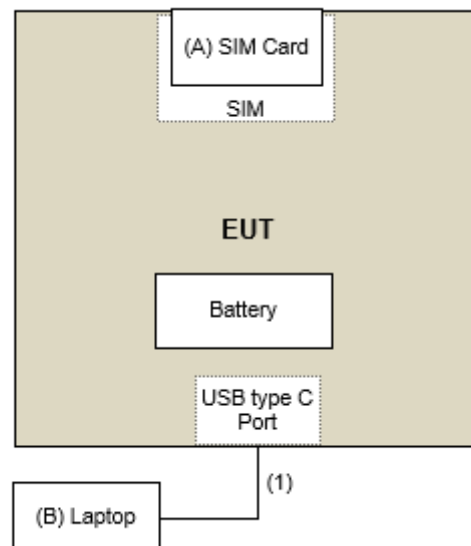

### 3.5 General Description of Applied Standard

The EUT is a RF Product. According to the specifications of the manufacturer, it must comply with the requirements of the following standards:

**FCC Part 15, Subpart E (15.407)**

**KDB 789033 D02 General UNII Test Procedure New Rules v02r01**

**KDB 662911 D01 Multiple Transmitter Output v02r01**

**ANSI C63.10-2013**

All test items have been performed and recorded as per the above standards.

## 4 Test Types and Results

### 4.1 Radiated Emission and Bandedge Measurement

#### 4.1.1 Limits of Radiated Emission and Bandedge Measurement

Radiated emissions which fall in the restricted bands must comply with the radiated emission limits specified as below table.

Frequencies (MHz)	Field Strength (microvolts/meter)	Measurement Distance (meters)
0.009 ~ 0.490	2400/F(kHz)	300
0.490 ~ 1.705	24000/F(kHz)	30
1.705 ~ 30.0	30	30
30 ~ 88	100	3
88 ~ 216	150	3
216 ~ 960	200	3
Above 960	500	3

#### NOTE:

- The lower limit shall apply at the transition frequencies.
- Emission level (dBuV/m) = 20 log Emission level (uV/m).
- For frequencies above 1000MHz, the field strength limits are based on average detector, however, the peak field strength of any emission shall not exceed the maximum permitted average limits, specified above by more than 20dB under any condition of modulation.

Limits of unwanted emission out of the restricted bands

Applicable To		Limit	
789033 D02 General UNII Test Procedure New Rules v02r01		Field Strength at 3m	
		PK:74 (dBuV/m)	AV:54 (dBuV/m)
Frequency Band	Applicable To	EIRP Limit	Equivalent Field Strength at 3m
5150~5250 MHz	15.407(b)(1)	PK:-27 (dBm/MHz)	PK:68.2(dBuV/m)
5250~5350 MHz	15.407(b)(2)		
5470~5725 MHz	15.407(b)(3)		
5725~5850 MHz	<input checked="" type="checkbox"/> 15.407(b)(4)(i)	PK:-27 (dBm/MHz) <sup>*1</sup> PK:10 (dBm/MHz) <sup>*2</sup> PK:15.6 (dBm/MHz) <sup>*3</sup> PK:27 (dBm/MHz) <sup>*4</sup>	PK: 68.2(dBuV/m) <sup>*1</sup> PK:105.2 (dBuV/m) <sup>*2</sup> PK: 110.8(dBuV/m) <sup>*3</sup> PK:122.2 (dBuV/m) <sup>*4</sup>
	<input type="checkbox"/> 15.407(b)(4)(ii)	Emission limits in section 15.247(d)	
<sup>*1</sup> beyond 75 MHz or more above of the band edge. <sup>*3</sup> below the band edge increasing linearly to a level of 15.6 dBm/MHz at 5 MHz above.		<sup>*2</sup> below the band edge increasing linearly to 10 dBm/MHz at 25 MHz above. <sup>*4</sup> from 5 MHz above or below the band edge increasing linearly to a level of 27 dBm/MHz at the band edge.	

#### Note:

The following formula is used to convert the equipment isotropic radiated power (eirp) to field strength:

$$E = \frac{1000000\sqrt{30P}}{3} \mu\text{V/m, where } P \text{ is the eirp (Watts).}$$



## 4.1.2 Test Instruments

DESCRIPTION & MANUFACTURER	MODEL NO.	SERIAL NO.	CALIBRATED DATE	CALIBRATED UNTIL
Test Receiver Agilent	N9038A	MY50010156	July 12, 2018	July 11, 2019
Pre-Amplifier EMCI	EMC001340	980142	Feb. 09, 2018	Feb. 08, 2019
Loop Antenna(*) Electro-Metrics	EM-6879	264	Dec. 16, 2016	Dec. 15, 2018
RF Cable	NA	LOOPCAB-001	Jan. 15, 2018	Jan. 14, 2019
RF Cable	NA	LOOPCAB-002	Jan. 15, 2018	Jan. 14, 2019
Pre-Amplifier Mini-Circuits	ZFL-1000VH2B	AMP-ZFL-05	May 05, 2018	May 04, 2019
Trilog Broadband Antenna SCHWARZBECK	VULB 9168	9168-361	Nov. 29, 2017	Nov. 28, 2018
RF Cable	8D	966-3-1	Mar. 20, 2018	Mar. 19, 2019
RF Cable	8D	966-3-2	Mar. 20, 2018	Mar. 19, 2019
RF Cable	8D	966-3-3	Mar. 20, 2018	Mar. 19, 2019
Fixed attenuator Mini-Circuits	UNAT-5+	PAD-3m-3-01	Sep. 27, 2018	Sep. 26, 2019
Horn_Antenna SCHWARZBECK	BBHA9120-D	9120D-406	Dec. 12, 2017	Dec. 11, 2018
Pre-Amplifier EMCI	EMC12630SE	980384	Jan. 29, 2018	Jan. 28, 2019
RF Cable	EMC104-SM-SM-1200	160922	Jan. 29, 2018	Jan. 28, 2019
RF Cable	EMC104-SM-SM-2000	150317	Jan. 29, 2018	Jan. 28, 2019
RF Cable	EMC104-SM-SM-5000	150322	Jan. 29, 2018	Jan. 28, 2019
Spectrum Analyzer Keysight	N9030A	MY54490679	July 23, 2018	July 22, 2019
Pre-Amplifier EMCI	EMC184045SE	980386	Jan. 29, 2018	Jan. 28, 2019
Horn_Antenna SCHWARZBECK	BBHA 9170	BBHA9170608	Dec. 14, 2017	Dec. 13, 2018
RF Cable	EMC102-KM-KM-1200	160924	Jan. 29, 2018	Jan. 28, 2019
Software	ADT_Radiated_V8.7.08	NA	NA	NA
Antenna Tower & Turn Table Max-Full	MF-7802	MF780208406	NA	NA
Boresight Antenna Fixture	FBA-01	FBA-SIP01	NA	NA
Spectrum Analyzer Agilent	E4446A	MY48250254	Nov. 21, 2017	Nov. 20, 2018
Power meter Anritsu	ML2495A	1014008	May 09, 2018	May 08, 2019
Power sensor Anritsu	MA2411B	0917122	May 09, 2018	May 08, 2019
DC Power Supply Topward	6603D	795558	NA	NA
Temperature & Humidity Chamber Giant Force	GTH-150-40-SP-AR	MAA0812-008	Jan. 10, 2018	Jan. 09, 2019
True RMS Clamp Meter FLUKE	325	31130711WS	May 22, 2018	May 21, 2019

**Note:**

1. The calibration interval of the above test instruments is 12 months and the calibrations are traceable to NML/ROC and NIST/USA.
2. \*The calibration interval of the above test instruments is 24 months and the calibrations are traceable to NML/ROC and NIST/USA.
3. The test was performed in 966 Chamber No. 3.
4. The CANADA Site Registration No. is 20331-1
5. Loop antenna was used for all emissions below 30 MHz.
6. Tested Date: Nov. 07 to 14, 2018

#### 4.1.3 Test Procedure

##### **For Radiated emission below 30MHz**

- a. The EUT was placed on the top of a rotating table 0.8 meters above the ground at a 3 meter chamber room. The table was rotated 360 degrees to determine the position of the highest radiation.
- b. The EUT was set 3 meters away from the interference-receiving antenna, which was mounted on the top of a variable-height antenna tower.
- c. Parallel, perpendicular, and ground-parallel orientations of the antenna are set to make the measurement.
- d. For each suspected emission, the EUT was arranged to its worst case and the rotatable table was turned from 0 degrees to 360 degrees to find the maximum reading.
- e. The test-receiver system was set to Quasi-Peak Detect Function and Specified Bandwidth with Maximum Hold Mode.

##### **Note:**

1. The resolution bandwidth and video bandwidth of test receiver/spectrum analyzer is 9kHz at frequency below 30MHz.

##### **For Radiated emission above 30MHz**

- a. The EUT was placed on the top of a rotating table 0.8 meters (for 30MHz ~ 1GHz) / 1.5 meters (for above 1GHz) above the ground at 3 meter chamber room for test. The table was rotated 360 degrees to determine the position of the highest radiation.
- b. The EUT was set 3 meters away from the interference-receiving antenna, which was mounted on the top of a variable-height antenna tower.
- c. The height of antenna is varied from one meter to four meters above the ground to determine the maximum value of the field strength. Both horizontal and vertical polarizations of the antenna are set to make the measurement.
- d. For each suspected emission, the EUT was arranged to its worst case and then the antenna was tuned to heights from 1 meter to 4 meters and the rotatable table was turned from 0 degrees to 360 degrees to find the maximum reading.
- e. The test-receiver system was set to quasi-peak detect function and specified bandwidth with maximum hold mode when the test frequency is below 1 GHz.
- f. The test-receiver system was set to peak and average detects function and specified bandwidth with maximum hold mode when the test frequency is above 1 GHz. If the peak reading value also meets average limit, measurement with the average detector is unnecessary.

##### **Note:**

1. The resolution bandwidth and video bandwidth of test receiver/spectrum analyzer is 120kHz for Quasi-peak detection (QP) at frequency below 1GHz.
2. The resolution bandwidth of test receiver/spectrum analyzer is 1 MHz and the video bandwidth is 3 MHz for Peak detection (PK) at frequency above 1GHz.
3. The resolution bandwidth of test receiver/spectrum analyzer is 1MHz and the video bandwidth is  $\geq 1/T$  (Duty cycle < 98%) or 10Hz (Duty cycle  $\geq 98\%$ ) for Average detection (AV) at frequency above 1GHz.
4. All modes of operation were investigated and the worst-case emissions are reported.

#### 4.1.4 Deviation from Test Standard

No deviation.

#### 4.1.5 Test Setup

##### For Radiated emission below 30MHz

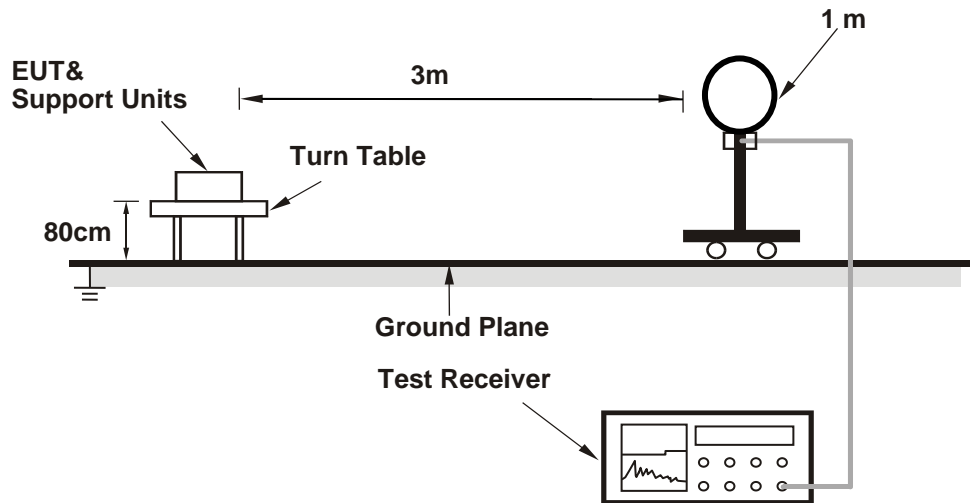

##### For Radiated emission 30MHz to 1GHz

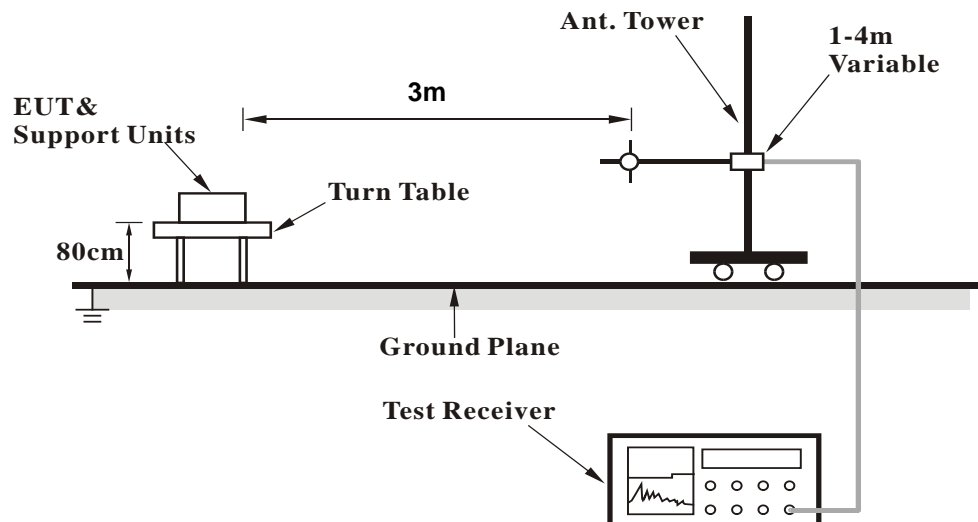

### For Radiated emission above 1GHz

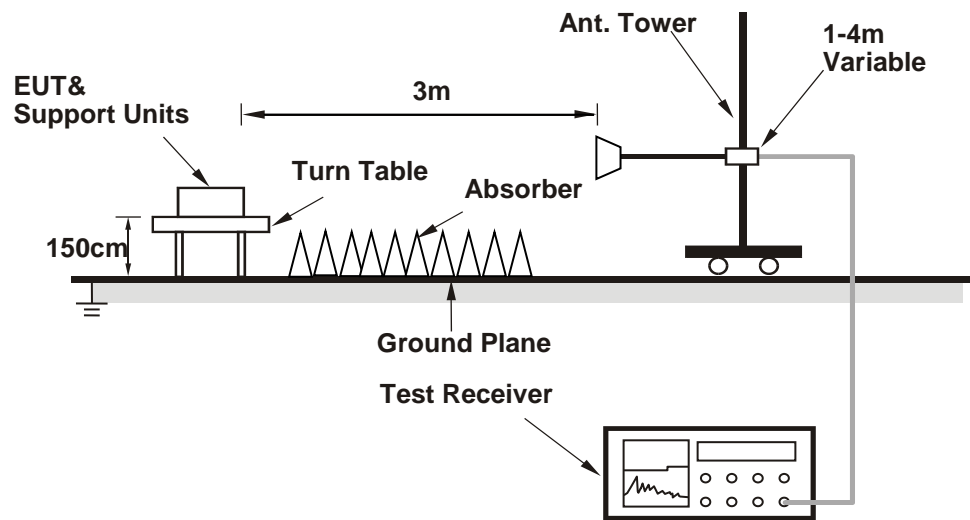

For the actual test configuration, please refer to the attached file (Test Setup Photo).

#### 4.1.6 EUT Operating Condition

- a. Connected the EUT with the Laptop which is placed on remote site.
- b. Controlling software (QDART (4.8.00059)) has been activated to set the EUT on specific status.

## 4.1.7 Test Results

## Above 1GHz Data:

## 802.11a

<b>CHANNEL</b>	TX Channel 36	<b>DETECTOR FUNCTION</b>	Peak (PK)
<b>FREQUENCY RANGE</b>	1GHz ~ 40GHz		Average (AV)

ANTENNA POLARITY & TEST DISTANCE: HORIZONTAL AT 3 M								
NO.	FREQ. (MHz)	EMISSION LEVEL (dBuV/m)	LIMIT (dBuV/m)	MARGIN (dB)	ANTENNA HEIGHT (m)	TABLE ANGLE (Degree)	RAW VALUE (dBuV)	CORRECTION FACTOR (dB/m)
1	5150.00	64.7 PK	74.0	-9.3	1.40 H	344	62.1	2.6
2	5150.00	39.6 AV	54.0	-14.4	1.40 H	344	37.0	2.6
3	*5180.00	109.3 PK			1.40 H	344	106.8	2.5
4	*5180.00	97.0 AV			1.40 H	344	94.5	2.5
5	#10360.00	49.9 PK	68.2	-18.3	1.62 H	212	38.0	11.9
6	15540.00	52.4 PK	74.0	-21.6	3.00 H	90	40.0	12.4
7	15540.00	41.2 AV	54.0	-12.8	3.00 H	90	28.8	12.4
ANTENNA POLARITY & TEST DISTANCE: VERTICAL AT 3 M								
NO.	FREQ. (MHz)	EMISSION LEVEL (dBuV/m)	LIMIT (dBuV/m)	MARGIN (dB)	ANTENNA HEIGHT (m)	TABLE ANGLE (Degree)	RAW VALUE (dBuV)	CORRECTION FACTOR (dB/m)
1	5150.00	50.1 PK	74.0	-23.9	1.55 V	341	47.5	2.6
2	5150.00	39.3 AV	54.0	-14.7	1.55 V	341	36.7	2.6
3	*5180.00	97.2 PK			1.55 V	341	94.7	2.5
4	*5180.00	86.7 AV			1.55 V	341	84.2	2.5
5	#10360.00	50.1 PK	68.2	-18.1	2.68 V	172	38.2	11.9
6	15540.00	52.4 PK	74.0	-21.6	2.26 V	252	40.0	12.4
7	15540.00	41.0 AV	54.0	-13.0	2.26 V	252	28.6	12.4

## REMARKS:

1. Emission Level(dBuV/m) = Raw Value(dBuV) + Correction Factor(dB/m)
2. Correction Factor(dB/m) = Antenna Factor(dB/m) + Cable Factor(dB) – Pre-Amplifier Factor(dB)
3. The other emission levels were very low against the limit.
4. Margin value = Emission Level – Limit value
5. " \* ": Fundamental frequency.
6. " # ": The radiated frequency is out of the restricted band.

<b>CHANNEL</b>	TX Channel 40	<b>DETECTOR FUNCTION</b>	Peak (PK)
<b>FREQUENCY RANGE</b>	1GHz ~ 40GHz		Average (AV)

**ANTENNA POLARITY & TEST DISTANCE: HORIZONTAL AT 3 M**

NO.	FREQ. (MHz)	EMISSION LEVEL (dBuV/m)	LIMIT (dBuV/m)	MARGIN (dB)	ANTENNA HEIGHT (m)	TABLE ANGLE (Degree)	RAW VALUE (dBuV)	CORRECTION FACTOR (dB/m)
1	*5200.00	108.8 PK			1.38 H	353	106.4	2.4
2	*5200.00	96.7 AV			1.38 H	353	94.3	2.4
3	#10400.00	50.1 PK	68.2	-18.1	1.70 H	216	37.9	12.2
4	15600.00	52.3 PK	74.0	-21.7	2.99 H	104	39.4	12.9
5	15600.00	40.8 AV	54.0	-13.2	2.99 H	104	27.9	12.9

**ANTENNA POLARITY & TEST DISTANCE: VERTICAL AT 3 M**

NO.	FREQ. (MHz)	EMISSION LEVEL (dBuV/m)	LIMIT (dBuV/m)	MARGIN (dB)	ANTENNA HEIGHT (m)	TABLE ANGLE (Degree)	RAW VALUE (dBuV)	CORRECTION FACTOR (dB/m)
1	*5200.00	96.7 PK			1.51 V	334	94.3	2.4
2	*5200.00	86.4 AV			1.51 V	334	84.0	2.4
3	#10400.00	50.2 PK	68.2	-18.0	2.66 V	184	38.0	12.2
4	15600.00	52.1 PK	74.0	-21.9	2.29 V	263	39.2	12.9
5	15600.00	41.0 AV	54.0	-13.0	2.29 V	263	28.1	12.9

**REMARKS:**

1. Emission Level(dBuV/m) = Raw Value(dBuV) + Correction Factor(dB/m)
2. Correction Factor(dB/m) = Antenna Factor(dB/m) + Cable Factor(dB) – Pre-Amplifier Factor(dB)
3. The other emission levels were very low against the limit.
4. Margin value = Emission Level – Limit value
5. " \* ": Fundamental frequency.
6. " # ": The radiated frequency is out of the restricted band.

<b>CHANNEL</b>	TX Channel 48	<b>DETECTOR FUNCTION</b>	Peak (PK)
<b>FREQUENCY RANGE</b>	1GHz ~ 40GHz		Average (AV)

**ANTENNA POLARITY & TEST DISTANCE: HORIZONTAL AT 3 M**

NO.	FREQ. (MHz)	EMISSION LEVEL (dBuV/m)	LIMIT (dBuV/m)	MARGIN (dB)	ANTENNA HEIGHT (m)	TABLE ANGLE (Degree)	RAW VALUE (dBuV)	CORRECTION FACTOR (dB/m)
1	*5240.00	108.3 PK			1.48 H	341	106.1	2.2
2	*5240.00	97.4 AV			1.48 H	341	95.2	2.2
3	5350.00	52.3 PK	74.0	-21.7	1.48 H	341	50.0	2.3
4	5350.00	39.1 AV	54.0	-14.9	1.48 H	341	36.8	2.3
5	#10480.00	50.0 PK	68.2	-18.2	1.68 H	208	37.6	12.4
6	15720.00	51.8 PK	74.0	-22.2	2.93 H	78	39.8	12.0
7	15720.00	40.7 AV	54.0	-13.3	2.93 H	78	28.7	12.0

**ANTENNA POLARITY & TEST DISTANCE: VERTICAL AT 3 M**

NO.	FREQ. (MHz)	EMISSION LEVEL (dBuV/m)	LIMIT (dBuV/m)	MARGIN (dB)	ANTENNA HEIGHT (m)	TABLE ANGLE (Degree)	RAW VALUE (dBuV)	CORRECTION FACTOR (dB/m)
1	*5240.00	96.6 PK			1.58 V	339	94.4	2.2
2	*5240.00	86.3 AV			1.58 V	339	84.1	2.2
3	5350.00	49.5 PK	74.0	-24.5	1.58 V	339	47.2	2.3
4	5350.00	38.2 AV	54.0	-15.8	1.58 V	339	35.9	2.3
5	#10480.00	50.1 PK	68.2	-18.1	2.74 V	183	37.7	12.4
6	15720.00	52.6 PK	74.0	-21.4	2.24 V	238	40.6	12.0
7	15720.00	41.2 AV	54.0	-12.8	2.24 V	238	29.2	12.0

**REMARKS:**

- Emission Level(dBuV/m) = Raw Value(dBuV) + Correction Factor(dB/m)
- Correction Factor(dB/m) = Antenna Factor(dB/m) + Cable Factor(dB) – Pre-Amplifier Factor(dB)
- The other emission levels were very low against the limit.
- Margin value = Emission Level – Limit value
- " \* ": Fundamental frequency.
- " # ": The radiated frequency is out of the restricted band.



<b>CHANNEL</b>	TX Channel 149	<b>DETECTOR FUNCTION</b>	Peak (PK)
<b>FREQUENCY RANGE</b>	1GHz ~ 40GHz		Average (AV)

**ANTENNA POLARITY & TEST DISTANCE: HORIZONTAL AT 3 M**

NO.	FREQ. (MHz)	EMISSION LEVEL (dBuV/m)	LIMIT (dBuV/m)	MARGIN (dB)	ANTENNA HEIGHT (m)	TABLE ANGLE (Degree)	RAW VALUE (dBuV)	CORRECTION FACTOR (dB/m)
1	#5636.45	52.9 PK	68.2	-15.3	1.41 H	334	50.2	2.7
2	*5745.00	108.4 PK			1.41 H	334	105.5	2.9
3	*5745.00	98.2 AV			1.41 H	334	95.3	2.9
4	#5972.75	52.8 PK	68.2	-15.4	1.41 H	334	49.6	3.2
5	11490.00	50.1 PK	74.0	-23.9	1.69 H	208	37.8	12.3
6	11490.00	39.3 AV	54.0	-14.7	1.69 H	208	27.0	12.3
7	#17235.00	52.5 PK	68.2	-15.7	3.00 H	90	37.2	15.3

**ANTENNA POLARITY & TEST DISTANCE: VERTICAL AT 3 M**

NO.	FREQ. (MHz)	EMISSION LEVEL (dBuV/m)	LIMIT (dBuV/m)	MARGIN (dB)	ANTENNA HEIGHT (m)	TABLE ANGLE (Degree)	RAW VALUE (dBuV)	CORRECTION FACTOR (dB/m)
1	#5596.07	51.3 PK	68.2	-16.9	2.46 V	297	48.5	2.8
2	*5745.00	102.5 PK			2.46 V	297	99.6	2.9
3	*5745.00	92.0 AV			2.46 V	297	89.1	2.9
4	#5981.30	51.8 PK	68.2	-16.4	2.46 V	297	48.6	3.2
5	11490.00	50.6 PK	74.0	-23.4	2.71 V	166	38.3	12.3
6	11490.00	39.6 AV	54.0	-14.4	2.71 V	166	27.3	12.3
7	#17235.00	52.4 PK	68.2	-15.8	2.24 V	263	37.1	15.3

**REMARKS:**

1. Emission Level(dBuV/m) = Raw Value(dBuV) + Correction Factor(dB/m)
2. Correction Factor(dB/m) = Antenna Factor(dB/m) + Cable Factor(dB) – Pre-Amplifier Factor(dB)
3. The other emission levels were very low against the limit.
4. Margin value = Emission Level – Limit value
5. " \* ": Fundamental frequency.
6. " # ": The radiated frequency is out of the restricted band.

<b>CHANNEL</b>	TX Channel 157	<b>DETECTOR FUNCTION</b>	Peak (PK)
<b>FREQUENCY RANGE</b>	1GHz ~ 40GHz		Average (AV)

**ANTENNA POLARITY & TEST DISTANCE: HORIZONTAL AT 3 M**

NO.	FREQ. (MHz)	EMISSION LEVEL (dBuV/m)	LIMIT (dBuV/m)	MARGIN (dB)	ANTENNA HEIGHT (m)	TABLE ANGLE (Degree)	RAW VALUE (dBuV)	CORRECTION FACTOR (dB/m)
1	#5642.15	53.2 PK	68.2	-15.0	1.46 H	336	50.5	2.7
2	*5785.00	108.1 PK			1.46 H	336	105.0	3.1
3	*5785.00	97.7 AV			1.46 H	336	94.6	3.1
4	#6012.18	52.4 PK	68.2	-15.8	1.46 H	336	49.2	3.2
5	11570.00	50.2 PK	74.0	-23.8	1.69 H	215	37.8	12.4
6	11570.00	38.9 AV	54.0	-15.1	1.69 H	215	26.5	12.4
7	#17355.00	52.5 PK	68.2	-15.7	2.99 H	95	36.5	16.0

**ANTENNA POLARITY & TEST DISTANCE: VERTICAL AT 3 M**

NO.	FREQ. (MHz)	EMISSION LEVEL (dBuV/m)	LIMIT (dBuV/m)	MARGIN (dB)	ANTENNA HEIGHT (m)	TABLE ANGLE (Degree)	RAW VALUE (dBuV)	CORRECTION FACTOR (dB/m)
1	#5580.87	51.6 PK	68.2	-16.6	2.56 V	300	48.8	2.8
2	*5785.00	103.2 PK			2.56 V	300	100.1	3.1
3	*5785.00	92.5 AV			2.56 V	300	89.4	3.1
4	#5928.10	51.8 PK	68.2	-16.4	2.56 V	300	48.4	3.4
5	11570.00	49.7 PK	74.0	-24.3	2.71 V	164	37.3	12.4
6	11570.00	38.7 AV	54.0	-15.3	2.71 V	164	26.3	12.4
7	#17355.00	52.7 PK	68.2	-15.5	2.25 V	257	36.7	16.0

**REMARKS:**

1. Emission Level(dBuV/m) = Raw Value(dBuV) + Correction Factor(dB/m)
2. Correction Factor(dB/m) = Antenna Factor(dB/m) + Cable Factor(dB) – Pre-Amplifier Factor(dB)
3. The other emission levels were very low against the limit.
4. Margin value = Emission Level – Limit value
5. " \* ": Fundamental frequency.
6. " # ": The radiated frequency is out of the restricted band.

<b>CHANNEL</b>	TX Channel 165	<b>DETECTOR FUNCTION</b>	Peak (PK)
<b>FREQUENCY RANGE</b>	1GHz ~ 40GHz		Average (AV)

**ANTENNA POLARITY & TEST DISTANCE: HORIZONTAL AT 3 M**

NO.	FREQ. (MHz)	EMISSION LEVEL (dBuV/m)	LIMIT (dBuV/m)	MARGIN (dB)	ANTENNA HEIGHT (m)	TABLE ANGLE (Degree)	RAW VALUE (dBuV)	CORRECTION FACTOR (dB/m)
1	#5587.52	51.8 PK	68.2	-16.4	1.42 H	337	49.0	2.8
2	*5825.00	107.8 PK			1.42 H	337	104.6	3.2
3	*5825.00	97.9 AV			1.42 H	337	94.7	3.2
4	#5952.80	53.1 PK	68.2	-15.1	1.42 H	337	49.9	3.2
5	11650.00	50.4 PK	74.0	-23.6	1.62 H	206	38.0	12.4
6	11650.00	39.5 AV	54.0	-14.5	1.62 H	206	27.1	12.4
7	#17475.00	52.5 PK	68.2	-15.7	3.00 H	102	35.1	17.4

**ANTENNA POLARITY & TEST DISTANCE: VERTICAL AT 3 M**

NO.	FREQ. (MHz)	EMISSION LEVEL (dBuV/m)	LIMIT (dBuV/m)	MARGIN (dB)	ANTENNA HEIGHT (m)	TABLE ANGLE (Degree)	RAW VALUE (dBuV)	CORRECTION FACTOR (dB/m)
1	#5643.57	51.6 PK	68.2	-16.6	2.58 V	295	48.9	2.7
2	*5825.00	102.3 PK			2.58 V	295	99.1	3.2
3	*5825.00	92.2 AV			2.58 V	295	89.0	3.2
4	#6008.37	52.3 PK	68.2	-15.9	2.58 V	295	49.1	3.2
5	11650.00	50.1 PK	74.0	-23.9	2.73 V	175	37.7	12.4
6	11650.00	39.4 AV	54.0	-14.6	2.73 V	175	27.0	12.4
7	#17475.00	52.5 PK	68.2	-15.7	2.24 V	249	35.1	17.4

**REMARKS:**

1. Emission Level(dBuV/m) = Raw Value(dBuV) + Correction Factor(dB/m)
2. Correction Factor(dB/m) = Antenna Factor(dB/m) + Cable Factor(dB) – Pre-Amplifier Factor(dB)
3. The other emission levels were very low against the limit.
4. Margin value = Emission Level – Limit value
5. " \* ": Fundamental frequency.
6. " # ": The radiated frequency is out of the restricted band.

**802.11ac (VHT20)**

<b>CHANNEL</b>	TX Channel 36	<b>DETECTOR FUNCTION</b>	Peak (PK)
<b>FREQUENCY RANGE</b>	1GHz ~ 40GHz		Average (AV)

**ANTENNA POLARITY & TEST DISTANCE: HORIZONTAL AT 3 M**

NO.	FREQ. (MHz)	EMISSION LEVEL (dBuV/m)	LIMIT (dBuV/m)	MARGIN (dB)	ANTENNA HEIGHT (m)	TABLE ANGLE (Degree)	RAW VALUE (dBuV)	CORRECTION FACTOR (dB/m)
1	5150.00	64.7 PK	74.0	-9.3	1.41 H	339	62.1	2.6
2	5150.00	39.9 AV	54.0	-14.1	1.41 H	339	37.3	2.6
3	*5180.00	109.1 PK			1.41 H	339	106.6	2.5
4	*5180.00	97.0 AV			1.41 H	339	94.5	2.5
5	#10360.00	50.1 PK	68.2	-18.1	1.65 H	201	38.2	11.9
6	15540.00	52.5 PK	74.0	-21.5	2.98 H	90	40.1	12.4
7	15540.00	41.1 AV	54.0	-12.9	2.98 H	90	28.7	12.4

**ANTENNA POLARITY & TEST DISTANCE: VERTICAL AT 3 M**

NO.	FREQ. (MHz)	EMISSION LEVEL (dBuV/m)	LIMIT (dBuV/m)	MARGIN (dB)	ANTENNA HEIGHT (m)	TABLE ANGLE (Degree)	RAW VALUE (dBuV)	CORRECTION FACTOR (dB/m)
1	5150.00	50.3 PK	74.0	-23.7	1.50 V	350	47.7	2.6
2	5150.00	38.6 AV	54.0	-15.4	1.50 V	350	36.0	2.6
3	*5180.00	97.3 PK			1.50 V	350	94.8	2.5
4	*5180.00	86.7 AV			1.50 V	350	84.2	2.5
5	#10360.00	50.1 PK	68.2	-18.1	2.64 V	170	38.2	11.9
6	15540.00	52.1 PK	74.0	-21.9	2.32 V	252	39.7	12.4
7	15540.00	40.9 AV	54.0	-13.1	2.32 V	252	28.5	12.4

**REMARKS:**

1. Emission Level(dBuV/m) = Raw Value(dBuV) + Correction Factor(dB/m)
2. Correction Factor(dB/m) = Antenna Factor(dB/m) + Cable Factor(dB) – Pre-Amplifier Factor(dB)
3. The other emission levels were very low against the limit.
4. Margin value = Emission Level – Limit value
5. " \* ": Fundamental frequency.
6. " # ": The radiated frequency is out of the restricted band.

<b>CHANNEL</b>	TX Channel 40	<b>DETECTOR FUNCTION</b>	Peak (PK)
<b>FREQUENCY RANGE</b>	1GHz ~ 40GHz		Average (AV)

**ANTENNA POLARITY & TEST DISTANCE: HORIZONTAL AT 3 M**

NO.	FREQ. (MHz)	EMISSION LEVEL (dBuV/m)	LIMIT (dBuV/m)	MARGIN (dB)	ANTENNA HEIGHT (m)	TABLE ANGLE (Degree)	RAW VALUE (dBuV)	CORRECTION FACTOR (dB/m)
1	*5200.00	109.4 PK			1.38 H	360	107.0	2.4
2	*5200.00	97.2 AV			1.38 H	360	94.8	2.4
3	#10400.00	49.8 PK	68.2	-18.4	1.66 H	220	37.6	12.2
4	15600.00	52.3 PK	74.0	-21.7	3.02 H	107	39.4	12.9
5	15600.00	41.1 AV	54.0	-12.9	3.02 H	107	28.2	12.9

**ANTENNA POLARITY & TEST DISTANCE: VERTICAL AT 3 M**

NO.	FREQ. (MHz)	EMISSION LEVEL (dBuV/m)	LIMIT (dBuV/m)	MARGIN (dB)	ANTENNA HEIGHT (m)	TABLE ANGLE (Degree)	RAW VALUE (dBuV)	CORRECTION FACTOR (dB/m)
1	*5200.00	97.6 PK			1.60 V	343	95.2	2.4
2	*5200.00	87.1 AV			1.60 V	343	84.7	2.4
3	#10400.00	50.0 PK	68.2	-18.2	2.65 V	170	37.8	12.2
4	15600.00	52.6 PK	74.0	-21.4	2.25 V	240	39.7	12.9
5	15600.00	41.4 AV	54.0	-12.6	2.25 V	240	28.5	12.9

**REMARKS:**

1. Emission Level(dBuV/m) = Raw Value(dBuV) + Correction Factor(dB/m)
2. Correction Factor(dB/m) = Antenna Factor(dB/m) + Cable Factor(dB) – Pre-Amplifier Factor(dB)
3. The other emission levels were very low against the limit.
4. Margin value = Emission Level – Limit value
5. " \* ": Fundamental frequency.
6. " # ": The radiated frequency is out of the restricted band.

<b>CHANNEL</b>	TX Channel 48	<b>DETECTOR FUNCTION</b>	Peak (PK)
<b>FREQUENCY RANGE</b>	1GHz ~ 40GHz		Average (AV)

**ANTENNA POLARITY & TEST DISTANCE: HORIZONTAL AT 3 M**

NO.	FREQ. (MHz)	EMISSION LEVEL (dBuV/m)	LIMIT (dBuV/m)	MARGIN (dB)	ANTENNA HEIGHT (m)	TABLE ANGLE (Degree)	RAW VALUE (dBuV)	CORRECTION FACTOR (dB/m)
1	*5240.00	108.0 PK			1.48 H	343	105.8	2.2
2	*5240.00	97.1 AV			1.48 H	343	94.9	2.2
3	5350.00	52.5 PK	74.0	-21.5	1.48 H	343	50.2	2.3
4	5350.00	39.5 AV	54.0	-14.5	1.48 H	343	37.2	2.3
5	#10480.00	49.7 PK	68.2	-18.5	1.69 H	208	37.3	12.4
6	15720.00	52.7 PK	74.0	-21.3	2.98 H	86	40.7	12.0
7	15720.00	41.4 AV	54.0	-12.6	2.98 H	86	29.4	12.0

**ANTENNA POLARITY & TEST DISTANCE: VERTICAL AT 3 M**

NO.	FREQ. (MHz)	EMISSION LEVEL (dBuV/m)	LIMIT (dBuV/m)	MARGIN (dB)	ANTENNA HEIGHT (m)	TABLE ANGLE (Degree)	RAW VALUE (dBuV)	CORRECTION FACTOR (dB/m)
1	*5240.00	97.1 PK			1.61 V	348	94.9	2.2
2	*5240.00	86.3 AV			1.61 V	348	84.1	2.2
3	5350.00	49.2 PK	74.0	-24.8	1.61 V	348	46.9	2.3
4	5350.00	37.9 AV	54.0	-16.1	1.61 V	348	35.6	2.3
5	#10480.00	50.2 PK	68.2	-18.0	2.71 V	164	37.8	12.4
6	15720.00	52.3 PK	74.0	-21.7	2.23 V	237	40.3	12.0
7	15720.00	41.1 AV	54.0	-12.9	2.23 V	237	29.1	12.0

**REMARKS:**

1. Emission Level(dBuV/m) = Raw Value(dBuV) + Correction Factor(dB/m)
2. Correction Factor(dB/m) = Antenna Factor(dB/m) + Cable Factor(dB) – Pre-Amplifier Factor(dB)
3. The other emission levels were very low against the limit.
4. Margin value = Emission Level – Limit value
5. " \* ": Fundamental frequency.
6. " # ": The radiated frequency is out of the restricted band.

<b>CHANNEL</b>	TX Channel 149	<b>DETECTOR FUNCTION</b>	Peak (PK)
<b>FREQUENCY RANGE</b>	1GHz ~ 40GHz		Average (AV)

**ANTENNA POLARITY & TEST DISTANCE: HORIZONTAL AT 3 M**

NO.	FREQ. (MHz)	EMISSION LEVEL (dBuV/m)	LIMIT (dBuV/m)	MARGIN (dB)	ANTENNA HEIGHT (m)	TABLE ANGLE (Degree)	RAW VALUE (dBuV)	CORRECTION FACTOR (dB/m)
1	#5616.98	51.7 PK	68.2	-16.5	1.40 H	9	48.9	2.8
2	*5745.00	108.3 PK			1.40 H	9	105.4	2.9
3	*5745.00	96.7 AV			1.40 H	9	93.8	2.9
4	#6015.50	51.8 PK	68.2	-16.4	1.40 H	9	48.6	3.2
5	11490.00	50.0 PK	74.0	-24.0	1.65 H	209	37.7	12.3
6	11490.00	39.1 AV	54.0	-14.9	1.65 H	209	26.8	12.3
7	#17235.00	52.5 PK	68.2	-15.7	3.04 H	97	37.2	15.3

**ANTENNA POLARITY & TEST DISTANCE: VERTICAL AT 3 M**

NO.	FREQ. (MHz)	EMISSION LEVEL (dBuV/m)	LIMIT (dBuV/m)	MARGIN (dB)	ANTENNA HEIGHT (m)	TABLE ANGLE (Degree)	RAW VALUE (dBuV)	CORRECTION FACTOR (dB/m)
1	#5583.73	52.9 PK	68.2	-15.3	2.60 V	302	50.1	2.8
2	*5745.00	102.2 PK			2.60 V	302	99.3	2.9
3	*5745.00	92.2 AV			2.60 V	302	89.3	2.9
4	#6006.48	52.2 PK	68.2	-16.0	2.60 V	302	49.0	3.2
5	11490.00	50.3 PK	74.0	-23.7	2.77 V	172	38.0	12.3
6	11490.00	39.6 AV	54.0	-14.4	2.77 V	172	27.3	12.3
7	#17235.00	52.5 PK	68.2	-15.7	2.28 V	232	37.2	15.3

**REMARKS:**

1. Emission Level(dBuV/m) = Raw Value(dBuV) + Correction Factor(dB/m)
2. Correction Factor(dB/m) = Antenna Factor(dB/m) + Cable Factor(dB) – Pre-Amplifier Factor(dB)
3. The other emission levels were very low against the limit.
4. Margin value = Emission Level – Limit value
5. " \* ": Fundamental frequency.
6. " # ": The radiated frequency is out of the restricted band.

<b>CHANNEL</b>	TX Channel 157	<b>DETECTOR FUNCTION</b>	Peak (PK)
<b>FREQUENCY RANGE</b>	1GHz ~ 40GHz		Average (AV)

**ANTENNA POLARITY & TEST DISTANCE: HORIZONTAL AT 3 M**

NO.	FREQ. (MHz)	EMISSION LEVEL (dBuV/m)	LIMIT (dBuV/m)	MARGIN (dB)	ANTENNA HEIGHT (m)	TABLE ANGLE (Degree)	RAW VALUE (dBuV)	CORRECTION FACTOR (dB/m)
1	#5630.27	51.2 PK	68.2	-17.0	1.19 H	7	48.4	2.8
2	*5785.00	108.6 PK			1.19 H	7	105.5	3.1
3	*5785.00	96.8 AV			1.19 H	7	93.7	3.1
4	#5949.48	52.0 PK	68.2	-16.2	1.19 H	7	48.8	3.2
5	11570.00	49.4 PK	74.0	-24.6	1.65 H	210	37.0	12.4
6	11570.00	38.3 AV	54.0	-15.7	1.65 H	210	25.9	12.4
7	#17355.00	52.5 PK	68.2	-15.7	3.01 H	92	36.5	16.0

**ANTENNA POLARITY & TEST DISTANCE: VERTICAL AT 3 M**

NO.	FREQ. (MHz)	EMISSION LEVEL (dBuV/m)	LIMIT (dBuV/m)	MARGIN (dB)	ANTENNA HEIGHT (m)	TABLE ANGLE (Degree)	RAW VALUE (dBuV)	CORRECTION FACTOR (dB/m)
1	#5598.93	52.4 PK	68.2	-15.8	2.57 V	303	49.6	2.8
2	*5785.00	102.8 PK			2.57 V	303	99.7	3.1
3	*5785.00	93.4 AV			2.57 V	303	90.3	3.1
4	#6004.57	53.9 PK	68.2	-14.3	2.57 V	303	50.7	3.2
5	11570.00	50.1 PK	74.0	-23.9	2.73 V	171	37.7	12.4
6	11570.00	39.4 AV	54.0	-14.6	2.73 V	171	27.0	12.4
7	#17355.00	52.7 PK	68.2	-15.5	2.30 V	246	36.7	16.0

**REMARKS:**

1. Emission Level(dBuV/m) = Raw Value(dBuV) + Correction Factor(dB/m)
2. Correction Factor(dB/m) = Antenna Factor(dB/m) + Cable Factor(dB) – Pre-Amplifier Factor(dB)
3. The other emission levels were very low against the limit.
4. Margin value = Emission Level – Limit value
5. " \* ": Fundamental frequency.
6. " # ": The radiated frequency is out of the restricted band.



<b>CHANNEL</b>	TX Channel 165	<b>DETECTOR FUNCTION</b>	Peak (PK)
<b>FREQUENCY RANGE</b>	1GHz ~ 40GHz		Average (AV)

**ANTENNA POLARITY & TEST DISTANCE: HORIZONTAL AT 3 M**

NO.	FREQ. (MHz)	EMISSION LEVEL (dBuV/m)	LIMIT (dBuV/m)	MARGIN (dB)	ANTENNA HEIGHT (m)	TABLE ANGLE (Degree)	RAW VALUE (dBuV)	CORRECTION FACTOR (dB/m)
1	#5619.35	51.7 PK	68.2	-16.5	1.16 H	3	48.9	2.8
2	*5825.00	108.5 PK			1.16 H	3	105.3	3.2
3	*5825.00	96.6 AV			1.16 H	3	93.4	3.2
4	#5973.23	52.4 PK	68.2	-15.8	1.16 H	3	49.2	3.2
5	11650.00	49.4 PK	74.0	-24.6	1.68 H	197	37.0	12.4
6	11650.00	38.6 AV	54.0	-15.4	1.68 H	197	26.2	12.4
7	#17475.00	52.8 PK	68.2	-15.4	3.03 H	84	35.4	17.4

**ANTENNA POLARITY & TEST DISTANCE: VERTICAL AT 3 M**

NO.	FREQ. (MHz)	EMISSION LEVEL (dBuV/m)	LIMIT (dBuV/m)	MARGIN (dB)	ANTENNA HEIGHT (m)	TABLE ANGLE (Degree)	RAW VALUE (dBuV)	CORRECTION FACTOR (dB/m)
1	#5621.25	51.2 PK	68.2	-17.0	2.64 V	304	48.4	2.8
2	*5825.00	103.2 PK			2.64 V	304	100.0	3.2
3	*5825.00	92.3 AV			2.64 V	304	89.1	3.2
4	#6002.20	52.0 PK	68.2	-16.2	2.64 V	304	48.8	3.2
5	11650.00	50.3 PK	74.0	-23.7	2.64 V	167	37.9	12.4
6	11650.00	39.4 AV	54.0	-14.6	2.64 V	167	27.0	12.4
7	#17475.00	52.9 PK	68.2	-15.3	2.31 V	257	35.5	17.4

**REMARKS:**

1. Emission Level(dBuV/m) = Raw Value(dBuV) + Correction Factor(dB/m)
2. Correction Factor(dB/m) = Antenna Factor(dB/m) + Cable Factor(dB) – Pre-Amplifier Factor(dB)
3. The other emission levels were very low against the limit.
4. Margin value = Emission Level – Limit value
5. " \* ": Fundamental frequency.
6. " # ": The radiated frequency is out of the restricted band.

**802.11ac (VHT40)**

<b>CHANNEL</b>	TX Channel 38	<b>DETECTOR FUNCTION</b>	Peak (PK)
<b>FREQUENCY RANGE</b>	1GHz ~ 40GHz		Average (AV)

**ANTENNA POLARITY & TEST DISTANCE: HORIZONTAL AT 3 M**

NO.	FREQ. (MHz)	EMISSION LEVEL (dBuV/m)	LIMIT (dBuV/m)	MARGIN (dB)	ANTENNA HEIGHT (m)	TABLE ANGLE (Degree)	RAW VALUE (dBuV)	CORRECTION FACTOR (dB/m)
1	5150.00	63.6 PK	74.0	-10.4	1.36 H	358	61.0	2.6
2	5150.00	40.3 AV	54.0	-13.7	1.36 H	358	37.7	2.6
3	*5190.00	103.9 PK			1.36 H	358	101.4	2.5
4	*5190.00	94.6 AV			1.36 H	358	92.1	2.5
5	#10380.00	49.7 PK	68.2	-18.5	1.65 H	217	37.7	12.0
6	15570.00	53.1 PK	74.0	-20.9	3.03 H	103	40.5	12.6
7	15570.00	41.8 AV	54.0	-12.2	3.03 H	103	29.2	12.6

**ANTENNA POLARITY & TEST DISTANCE: VERTICAL AT 3 M**

NO.	FREQ. (MHz)	EMISSION LEVEL (dBuV/m)	LIMIT (dBuV/m)	MARGIN (dB)	ANTENNA HEIGHT (m)	TABLE ANGLE (Degree)	RAW VALUE (dBuV)	CORRECTION FACTOR (dB/m)
1	5150.00	49.6 PK	74.0	-24.4	2.74 V	275	47.0	2.6
2	5150.00	38.1 AV	54.0	-15.9	2.74 V	275	35.5	2.6
3	*5190.00	95.3 PK			2.74 V	275	92.8	2.5
4	*5190.00	86.2 AV			2.74 V	275	83.7	2.5
5	#10380.00	50.3 PK	68.2	-17.9	2.68 V	160	38.3	12.0
6	15570.00	52.1 PK	74.0	-21.9	2.25 V	236	39.5	12.6
7	15570.00	40.9 AV	54.0	-13.1	2.25 V	236	28.3	12.6

**REMARKS:**

1. Emission Level(dBuV/m) = Raw Value(dBuV) + Correction Factor(dB/m)
2. Correction Factor(dB/m) = Antenna Factor(dB/m) + Cable Factor(dB) – Pre-Amplifier Factor(dB)
3. The other emission levels were very low against the limit.
4. Margin value = Emission Level – Limit value
5. " \* ": Fundamental frequency.
6. " # ": The radiated frequency is out of the restricted band.

<b>CHANNEL</b>	TX Channel 46	<b>DETECTOR FUNCTION</b>	Peak (PK)
<b>FREQUENCY RANGE</b>	1GHz ~ 40GHz		Average (AV)

**ANTENNA POLARITY & TEST DISTANCE: HORIZONTAL AT 3 M**

NO.	FREQ. (MHz)	EMISSION LEVEL (dBuV/m)	LIMIT (dBuV/m)	MARGIN (dB)	ANTENNA HEIGHT (m)	TABLE ANGLE (Degree)	RAW VALUE (dBuV)	CORRECTION FACTOR (dB/m)
1	*5230.00	103.3 PK			1.34 H	360	101.1	2.2
2	*5230.00	95.2 AV			1.34 H	360	93.0	2.2
3	5350.00	51.2 PK	74.0	-22.8	1.34 H	360	48.9	2.3
4	5350.00	39.9 AV	54.0	-14.1	1.34 H	360	37.6	2.3
5	#10460.00	49.7 PK	68.2	-18.5	1.61 H	200	37.3	12.4
6	15690.00	52.4 PK	74.0	-21.6	3.02 H	99	40.2	12.2
7	15690.00	41.2 AV	54.0	-12.8	3.02 H	99	29.0	12.2

**ANTENNA POLARITY & TEST DISTANCE: VERTICAL AT 3 M**

NO.	FREQ. (MHz)	EMISSION LEVEL (dBuV/m)	LIMIT (dBuV/m)	MARGIN (dB)	ANTENNA HEIGHT (m)	TABLE ANGLE (Degree)	RAW VALUE (dBuV)	CORRECTION FACTOR (dB/m)
1	*5230.00	95.8 PK			2.77 V	278	93.6	2.2
2	*5230.00	86.8 AV			2.77 V	278	84.6	2.2
3	5350.00	49.8 PK	74.0	-24.2	2.77 V	278	47.5	2.3
4	5350.00	38.1 AV	54.0	-15.9	2.77 V	278	35.8	2.3
5	#10460.00	50.0 PK	68.2	-18.2	2.64 V	177	37.6	12.4
6	15690.00	52.9 PK	74.0	-21.1	2.21 V	247	40.7	12.2
7	15690.00	41.4 AV	54.0	-12.6	2.21 V	247	29.2	12.2

**REMARKS:**

1. Emission Level(dBuV/m) = Raw Value(dBuV) + Correction Factor(dB/m)
2. Correction Factor(dB/m) = Antenna Factor(dB/m) + Cable Factor(dB) – Pre-Amplifier Factor(dB)
3. The other emission levels were very low against the limit.
4. Margin value = Emission Level – Limit value
5. " \* ": Fundamental frequency.
6. " # ": The radiated frequency is out of the restricted band.

<b>CHANNEL</b>	TX Channel 151	<b>DETECTOR FUNCTION</b>	Peak (PK)
<b>FREQUENCY RANGE</b>	1GHz ~ 40GHz		Average (AV)

**ANTENNA POLARITY & TEST DISTANCE: HORIZONTAL AT 3 M**

NO.	FREQ. (MHz)	EMISSION LEVEL (dBuV/m)	LIMIT (dBuV/m)	MARGIN (dB)	ANTENNA HEIGHT (m)	TABLE ANGLE (Degree)	RAW VALUE (dBuV)	CORRECTION FACTOR (dB/m)
1	#5643.57	52.6 PK	68.2	-15.6	1.57 H	337	49.9	2.7
2	*5755.00	105.7 PK			1.57 H	337	102.7	3.0
3	*5755.00	94.8 AV			1.57 H	337	91.8	3.0
4	#5986.05	52.9 PK	68.2	-15.3	1.57 H	337	49.7	3.2
5	11510.00	49.8 PK	74.0	-24.2	1.67 H	196	37.5	12.3
6	11510.00	38.7 AV	54.0	-15.3	1.67 H	196	26.4	12.3
7	#17265.00	52.8 PK	68.2	-15.4	3.00 H	105	37.4	15.4

**ANTENNA POLARITY & TEST DISTANCE: VERTICAL AT 3 M**

NO.	FREQ. (MHz)	EMISSION LEVEL (dBuV/m)	LIMIT (dBuV/m)	MARGIN (dB)	ANTENNA HEIGHT (m)	TABLE ANGLE (Degree)	RAW VALUE (dBuV)	CORRECTION FACTOR (dB/m)
1	#5629.32	51.8 PK	68.2	-16.4	2.75 V	278	49.0	2.8
2	*5755.00	95.4 PK			2.75 V	278	92.4	3.0
3	*5755.00	86.4 AV			2.75 V	278	83.4	3.0
4	#5957.07	52.2 PK	68.2	-16.0	2.75 V	278	49.0	3.2
5	11510.00	49.8 PK	74.0	-24.2	2.69 V	184	37.5	12.3
6	11510.00	38.9 AV	54.0	-15.1	2.69 V	184	26.6	12.3
7	#17265.00	52.0 PK	68.2	-16.2	2.30 V	243	36.6	15.4

**REMARKS:**

1. Emission Level(dBuV/m) = Raw Value(dBuV) + Correction Factor(dB/m)
2. Correction Factor(dB/m) = Antenna Factor(dB/m) + Cable Factor(dB) – Pre-Amplifier Factor(dB)
3. The other emission levels were very low against the limit.
4. Margin value = Emission Level – Limit value
5. " \* ": Fundamental frequency.
6. " # ": The radiated frequency is out of the restricted band.

<b>CHANNEL</b>	TX Channel 159	<b>DETECTOR FUNCTION</b>	Peak (PK)
<b>FREQUENCY RANGE</b>	1GHz ~ 40GHz		Average (AV)

**ANTENNA POLARITY & TEST DISTANCE: HORIZONTAL AT 3 M**

NO.	FREQ. (MHz)	EMISSION LEVEL (dBuV/m)	LIMIT (dBuV/m)	MARGIN (dB)	ANTENNA HEIGHT (m)	TABLE ANGLE (Degree)	RAW VALUE (dBuV)	CORRECTION FACTOR (dB/m)
1	#5608.43	53.0 PK	68.2	-15.2	1.55 H	338	50.2	2.8
2	*5795.00	106.0 PK			1.55 H	338	103.0	3.0
3	*5795.00	95.2 AV			1.55 H	338	92.2	3.0
4	#5949.00	52.7 PK	68.2	-15.5	1.55 H	338	49.5	3.2
5	11590.00	49.3 PK	74.0	-24.7	1.69 H	216	36.9	12.4
6	11590.00	38.3 AV	54.0	-15.7	1.69 H	216	25.9	12.4
7	#17385.00	52.4 PK	68.2	-15.8	3.06 H	89	36.2	16.2

**ANTENNA POLARITY & TEST DISTANCE: VERTICAL AT 3 M**

NO.	FREQ. (MHz)	EMISSION LEVEL (dBuV/m)	LIMIT (dBuV/m)	MARGIN (dB)	ANTENNA HEIGHT (m)	TABLE ANGLE (Degree)	RAW VALUE (dBuV)	CORRECTION FACTOR (dB/m)
1	#5586.10	51.4 PK	68.2	-16.8	2.80 V	276	48.6	2.8
2	*5795.00	94.8 PK			2.80 V	276	91.8	3.0
3	*5795.00	85.8 AV			2.80 V	276	82.8	3.0
4	#5999.35	52.2 PK	68.2	-16.0	2.80 V	276	49.0	3.2
5	11590.00	50.2 PK	74.0	-23.8	2.63 V	185	37.8	12.4
6	11590.00	39.1 AV	54.0	-14.9	2.63 V	185	26.7	12.4
7	#17385.00	52.6 PK	68.2	-15.6	2.32 V	264	36.4	16.2

**REMARKS:**

1. Emission Level(dBuV/m) = Raw Value(dBuV) + Correction Factor(dB/m)
2. Correction Factor(dB/m) = Antenna Factor(dB/m) + Cable Factor(dB) – Pre-Amplifier Factor(dB)
3. The other emission levels were very low against the limit.
4. Margin value = Emission Level – Limit value
5. " \* ": Fundamental frequency.
6. " # ": The radiated frequency is out of the restricted band.

802.11ac (VHT80)

<b>CHANNEL</b>	TX Channel 42	<b>DETECTOR FUNCTION</b>	Peak (PK)
<b>FREQUENCY RANGE</b>	1GHz ~ 40GHz		Average (AV)

ANTENNA POLARITY & TEST DISTANCE: HORIZONTAL AT 3 M								
NO.	FREQ. (MHz)	EMISSION LEVEL (dBuV/m)	LIMIT (dBuV/m)	MARGIN (dB)	ANTENNA HEIGHT (m)	TABLE ANGLE (Degree)	RAW VALUE (dBuV)	CORRECTION FACTOR (dB/m)
1	5150.00	50.5 PK	74.0	-23.5	1.30 H	350	47.9	2.6
2	5150.00	39.7 AV	54.0	-14.3	1.30 H	350	37.1	2.6
3	*5210.00	101.2 PK			1.30 H	350	98.8	2.4
4	*5210.00	91.2 AV			1.30 H	350	88.8	2.4
5	5350.00	50.9 PK	74.0	-23.1	1.30 H	350	48.6	2.3
6	5350.00	39.8 AV	54.0	-14.2	1.30 H	350	37.5	2.3
7	#10420.00	50.1 PK	68.2	-18.1	1.70 H	225	37.9	12.2
8	15630.00	52.6 PK	74.0	-21.4	3.04 H	94	39.9	12.7
9	15630.00	41.2 AV	54.0	-12.8	3.04 H	94	28.5	12.7

ANTENNA POLARITY & TEST DISTANCE: VERTICAL AT 3 M								
NO.	FREQ. (MHz)	EMISSION LEVEL (dBuV/m)	LIMIT (dBuV/m)	MARGIN (dB)	ANTENNA HEIGHT (m)	TABLE ANGLE (Degree)	RAW VALUE (dBuV)	CORRECTION FACTOR (dB/m)
1	5150.00	49.5 PK	74.0	-24.5	3.08 V	270	46.9	2.6
2	5150.00	38.1 AV	54.0	-15.9	3.08 V	270	35.5	2.6
3	*5210.00	91.3 PK			3.08 V	270	88.9	2.4
4	*5210.00	83.7 AV			3.08 V	270	81.3	2.4
5	5350.00	50.5 PK	74.0	-23.5	3.08 V	270	48.2	2.3
6	5350.00	39.3 AV	54.0	-14.7	3.08 V	270	37.0	2.3
7	#10420.00	50.1 PK	68.2	-18.1	2.70 V	168	37.9	12.2
8	15630.00	52.1 PK	74.0	-21.9	2.20 V	264	39.4	12.7
9	15630.00	40.7 AV	54.0	-13.3	2.20 V	264	28.0	12.7

**REMARKS:**

1. Emission Level(dBuV/m) = Raw Value(dBuV) + Correction Factor(dB/m)
2. Correction Factor(dB/m) = Antenna Factor(dB/m) + Cable Factor(dB) – Pre-Amplifier Factor(dB)
3. The other emission levels were very low against the limit.
4. Margin value = Emission Level – Limit value
5. " \* ": Fundamental frequency.
6. " # ": The radiated frequency is out of the restricted band.

<b>CHANNEL</b>	TX Channel 155	<b>DETECTOR FUNCTION</b>	Peak (PK)
<b>FREQUENCY RANGE</b>	1GHz ~ 40GHz		Average (AV)

**ANTENNA POLARITY & TEST DISTANCE: HORIZONTAL AT 3 M**

NO.	FREQ. (MHz)	EMISSION LEVEL (dBuV/m)	LIMIT (dBuV/m)	MARGIN (dB)	ANTENNA HEIGHT (m)	TABLE ANGLE (Degree)	RAW VALUE (dBuV)	CORRECTION FACTOR (dB/m)
1	#5583.73	51.9 PK	68.2	-16.3	1.27 H	340	49.1	2.8
2	*5775.00	101.7 PK			1.27 H	340	98.7	3.0
3	*5775.00	91.8 AV			1.27 H	340	88.8	3.0
4	#5981.77	52.4 PK	68.2	-15.8	1.27 H	340	49.2	3.2
5	11550.00	49.8 PK	74.0	-24.2	1.65 H	211	37.4	12.4
6	11550.00	38.7 AV	54.0	-15.3	1.65 H	211	26.3	12.4
7	#17325.00	52.7 PK	68.2	-15.5	3.02 H	99	37.0	15.7

**ANTENNA POLARITY & TEST DISTANCE: VERTICAL AT 3 M**

NO.	FREQ. (MHz)	EMISSION LEVEL (dBuV/m)	LIMIT (dBuV/m)	MARGIN (dB)	ANTENNA HEIGHT (m)	TABLE ANGLE (Degree)	RAW VALUE (dBuV)	CORRECTION FACTOR (dB/m)
1	#5591.32	51.2 PK	68.2	-17.0	3.05 V	278	48.4	2.8
2	*5775.00	91.7 PK			3.05 V	278	88.7	3.0
3	*5775.00	83.9 AV			3.05 V	278	80.9	3.0
4	#6012.65	52.7 PK	68.2	-15.5	3.05 V	278	49.5	3.2
5	11550.00	49.8 PK	74.0	-24.2	2.67 V	172	37.4	12.4
6	11550.00	39.0 AV	54.0	-15.0	2.67 V	172	26.6	12.4
7	#17325.00	52.3 PK	68.2	-15.9	2.29 V	236	36.6	15.7

**REMARKS:**

1. Emission Level(dBuV/m) = Raw Value(dBuV) + Correction Factor(dB/m)
2. Correction Factor(dB/m) = Antenna Factor(dB/m) + Cable Factor(dB) – Pre-Amplifier Factor(dB)
3. The other emission levels were very low against the limit.
4. Margin value = Emission Level – Limit value
5. " \* ": Fundamental frequency.
6. " # ": The radiated frequency is out of the restricted band.

**Below 1GHz Data:**  
**802.11ac (VHT80)**

<b>CHANNEL</b>	TX Channel 155	<b>DETECTOR FUNCTION</b>	Quasi-Peak (QP)
<b>FREQUENCY RANGE</b>	9kHz ~ 1GHz		

**ANTENNA POLARITY & TEST DISTANCE: HORIZONTAL AT 3 M**

NO.	FREQ. (MHz)	EMISSION LEVEL (dBuV/m)	LIMIT (dBuV/m)	MARGIN (dB)	ANTENNA HEIGHT (m)	TABLE ANGLE (Degree)	RAW VALUE (dBuV)	CORRECTION FACTOR (dB/m)
1	42.17	29.6 QP	40.0	-10.4	3.00 H	115	37.7	-8.1
2	164.49	36.6 QP	43.5	-6.9	1.84 H	332	44.7	-8.1
3	222.93	28.8 QP	46.0	-17.2	3.00 H	268	39.6	-10.8
4	322.38	26.4 QP	46.0	-19.6	2.50 H	138	32.5	-6.1
5	540.73	28.8 QP	46.0	-17.2	1.50 H	231	30.2	-1.4
6	800.45	33.8 QP	46.0	-12.2	1.50 H	143	30.1	3.7

**REMARKS:**

1. Emission Level(dBuV/m) = Raw Value(dBuV) + Correction Factor(dB/m)
2. Correction Factor(dB/m) = Antenna Factor(dB/m) + Cable Factor(dB) – Pre-Amplifier Factor(dB)
3. Margin value = Emission Level – Limit value
4. The emission levels were very low against the limit of frequency range 9kHz~30MHz: the amplitude of spurious emissions attenuated more than 20 dB below the permissible value to be report.

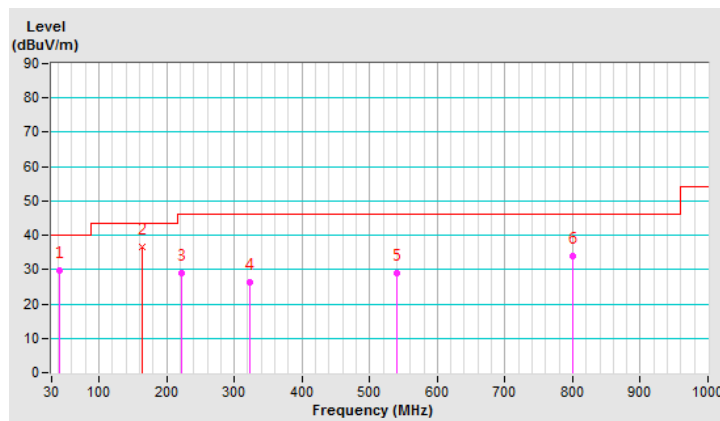



<b>CHANNEL</b>	TX Channel 155	<b>DETECTOR FUNCTION</b>	Quasi-Peak (QP)
<b>FREQUENCY RANGE</b>	9kHz ~ 1GHz		

**ANTENNA POLARITY & TEST DISTANCE: VERTICAL AT 3 M**

NO.	FREQ. (MHz)	EMISSION LEVEL (dBUV/m)	LIMIT (dBUV/m)	MARGIN (dB)	ANTENNA HEIGHT (m)	TABLE ANGLE (Degree)	RAW VALUE (dBUV)	CORRECTION FACTOR (dB/m)
1	73.64	35.9 QP	40.0	-4.1	1.00 V	115	46.8	-10.9
2	168.71	37.4 QP	43.5	-6.1	2.00 V	264	45.7	-8.3
3	265.06	23.9 QP	46.0	-22.1	1.50 V	173	32.2	-8.3
4	443.03	27.5 QP	46.0	-18.5	1.00 V	263	30.6	-3.1
5	640.49	32.2 QP	46.0	-13.8	1.50 V	255	31.0	1.2
6	762.54	32.6 QP	46.0	-13.4	1.00 V	241	29.1	3.5

**REMARKS:**

1. Emission Level(dBUV/m) = Raw Value(dBUV) + Correction Factor(dB/m)
2. Correction Factor(dB/m) = Antenna Factor(dB/m) + Cable Factor(dB) – Pre-Amplifier Factor(dB)
3. Margin value = Emission Level – Limit value
4. The emission levels were very low against the limit of frequency range 9kHz~30MHz: the amplitude of spurious emissions attenuated more than 20 dB below the permissible value to be report.

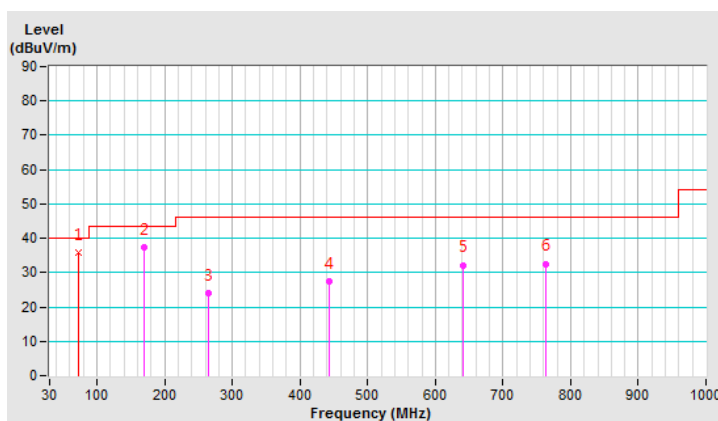

## 4.2 Conducted Emission Measurement

### 4.2.1 Limits of Conducted Emission Measurement

Frequency (MHz)	Conducted Limit (dBuV)	
	Quasi-peak	Average
0.15 - 0.5	66 - 56	56 - 46
0.50 - 5.0	56	46
5.0 - 30.0	60	50

Note: 1. The lower limit shall apply at the transition frequencies.

2. The limit decreases in line with the logarithm of the frequency in the range of 0.15 to 0.50MHz.

### 4.2.2 Test Instruments

DESCRIPTION & MANUFACTURER	MODEL NO.	SERIAL NO.	CALIBRATED DATE	CALIBRATED UNTIL
Test Receiver R&S	ESCS 30	847124/029	Oct. 24, 2018	Oct. 23, 2019
Line-Impedance Stabilization Network (for EUT) R&S	ESH3-Z5	848773/004	Nov. 15, 2017	Nov. 14, 2018
Line-Impedance Stabilization Network (for Peripheral) R&S	ENV216	100072	June 04, 2018	June 03, 2019
50 ohms Terminator	N/A	3	Oct. 22, 2018	Oct. 21, 2019
RF Cable	5D-FB	COCCAB-001	Sep. 28, 2018	Sep. 27, 2019
Fixed attenuator EMCI	STI02-2200-10	003	Mar. 16, 2018	Mar. 15, 2019
Software BVADT	BVADT_Cond_ V7.3.7.4	NA	NA	NA

**Note:**

1. The calibration interval of the above test instruments are 12 months and the calibrations are traceable to NML/ROC and NIST/USA.
2. The test was performed in Conduction 1.
3. Tested Date: Nov. 08, 2018

#### 4.2.3 Test Procedure

- The EUT was placed 0.4 meters from the conducting wall of the shielded room with EUT being connected to the power mains through a line impedance stabilization network (LISN). Other support units were connected to the power mains through another LISN. The two LISNs provide 50 ohm/ 50uH of coupling impedance for the measuring instrument.
- Both lines of the power mains connected to the EUT were checked for maximum conducted interference.
- The frequency range from 150kHz to 30MHz was searched. Emission levels under (Limit - 20dB) was not recorded.

**Note:** All modes of operation were investigated and the worst-case emissions are reported.

#### 4.2.4 Deviation from Test Standard

No deviation.

#### 4.2.5 Test Setup

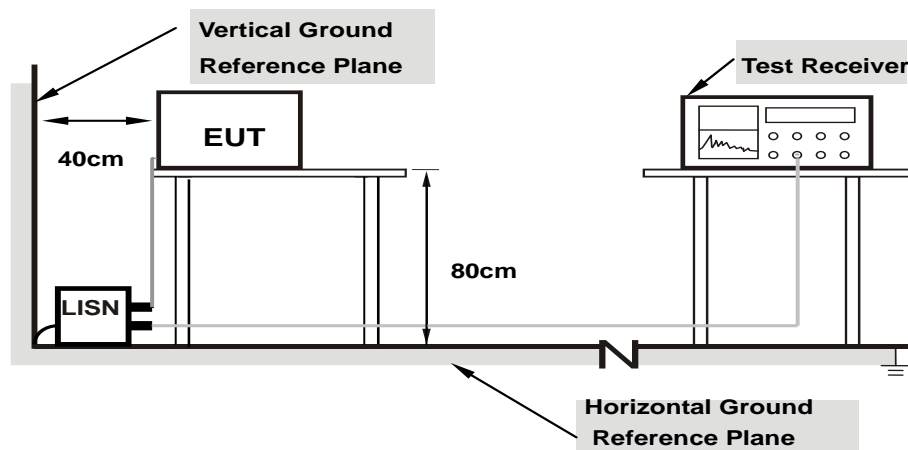

**Note: 1.Support units were connected to second LISN.**

For the actual test configuration, please refer to the attached file (Test Setup Photo).

#### 4.2.6 EUT Operating Condition

Same as 4.1.6.

#### 4.2.7 Test Results (Mode 1)

Phase	Line (L)	Detector Function	Quasi-Peak (QP) / Average (AV)
-------	----------	-------------------	--------------------------------

No	Freq. [MHz]	Corr.	Reading Value		Emission Level		Limit		Margin	
		Factor (dB)	[dB (uV)]		[dB (uV)]		[dB (uV)]		(dB)	
		Q.P.	AV.	Q.P.	AV.	Q.P.	AV.	Q.P.	AV.	
1	0.15000	10.03	37.44	11.27	47.47	21.30	66.00	56.00	-18.53	-34.70
2	0.16172	10.03	38.43	11.60	48.46	21.63	65.38	55.38	-16.92	-33.75
3	0.17344	10.04	35.93	9.34	45.97	19.38	64.79	54.79	-18.82	-35.41
4	0.18125	10.04	33.13	8.02	43.17	18.06	64.43	54.43	-21.26	-36.37
5	0.22031	10.05	30.65	4.52	40.70	14.57	62.81	52.81	-22.11	-38.24
6	0.66563	10.10	22.22	6.41	32.32	16.51	56.00	46.00	-23.68	-29.49
7	3.41406	10.28	13.30	-3.22	23.58	7.06	56.00	46.00	-32.42	-38.94

#### Remarks:

1. Q.P. and AV. are abbreviations of quasi-peak and average individually.
2. The emission levels of other frequencies were very low against the limit.
3. Margin value = Emission level – Limit value
4. Correction factor = Insertion loss + Cable loss
5. Emission Level = Correction Factor + Reading Value

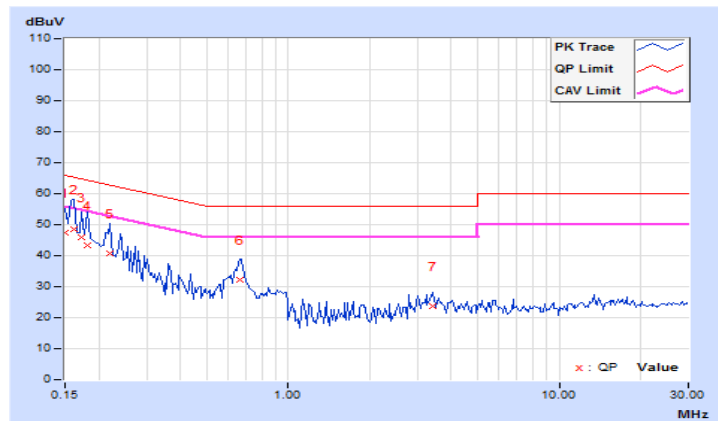

Phase	Neutral (N)	Detector Function	Quasi-Peak (QP) / Average (AV)
-------	-------------	-------------------	--------------------------------

No	Freq. [MHz]	Corr. Factor	Reading Value [dB (uV)]		Emission Level [dB (uV)]		Limit [dB (uV)]		Margin (dB)	
		(dB)	Q.P.	AV.	Q.P.	AV.	Q.P.	AV.	Q.P.	AV.
	1	0.16172	9.94	38.69	13.15	48.63	23.09	65.38	55.38	-16.75
2	0.17734	9.95	36.11	10.68	46.06	20.63	64.61	54.61	-18.55	-33.98
3	0.20078	9.95	33.80	9.69	43.75	19.64	63.58	53.58	-19.83	-33.94
4	0.24766	9.96	27.23	3.98	37.19	13.94	61.84	51.84	-24.65	-37.90
5	0.66953	9.99	22.78	5.63	32.77	15.62	56.00	46.00	-23.23	-30.38
6	5.64844	10.27	12.38	-3.68	22.65	6.59	60.00	50.00	-37.35	-43.41

#### Remarks:

1. Q.P. and AV. are abbreviations of quasi-peak and average individually.
2. The emission levels of other frequencies were very low against the limit.
3. Margin value = Emission level – Limit value
4. Correction factor = Insertion loss + Cable loss
5. Emission Level = Correction Factor + Reading Value

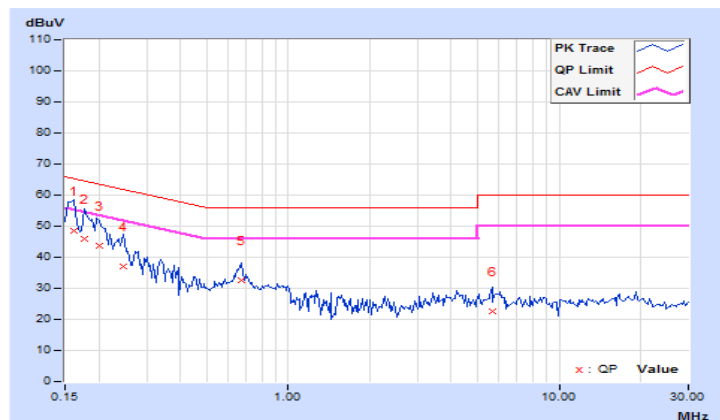

#### 4.2.8 Test Results (Mode 2)

Phase	Line (L)	Detector Function	Quasi-Peak (QP) / Average (AV)
-------	----------	-------------------	--------------------------------

No	Freq. [MHz]	Corr. Factor	Reading Value [dB (uV)]		Emission Level [dB (uV)]		Limit [dB (uV)]		Margin (dB)	
		(dB)	Q.P.	AV.	Q.P.	AV.	Q.P.	AV.	Q.P.	AV.
	1	0.15000	10.02	34.41	19.47	44.43	29.49	66.00	56.00	-21.57
2	0.19297	10.04	31.64	20.13	41.68	30.17	63.91	53.91	-22.23	-23.74
3	0.25938	10.05	31.20	14.57	41.25	24.62	61.45	51.45	-20.20	-26.83
4	0.59141	10.08	20.27	11.64	30.35	21.72	56.00	46.00	-25.65	-24.28
5	0.80625	10.10	18.25	6.31	28.35	16.41	56.00	46.00	-27.65	-29.59
6	2.94531	10.20	15.02	9.68	25.22	19.88	56.00	46.00	-30.78	-26.12

#### Remarks:

1. Q.P. and AV. are abbreviations of quasi-peak and average individually.
2. The emission levels of other frequencies were very low against the limit.
3. Margin value = Emission level – Limit value
4. Correction factor = Insertion loss + Cable loss
5. Emission Level = Correction Factor + Reading Value

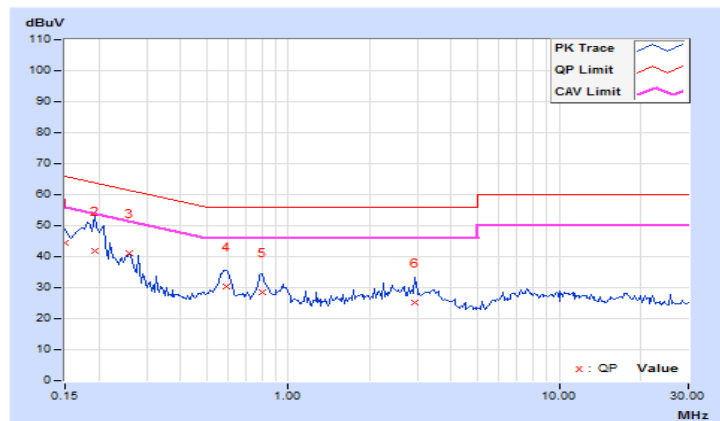

Phase	Neutral (N)	Detector Function	Quasi-Peak (QP) / Average (AV)
-------	-------------	-------------------	--------------------------------

No	Freq. [MHz]	Corr. Factor	Reading Value [dB (uV)]		Emission Level [dB (uV)]		Limit [dB (uV)]		Margin (dB)	
		(dB)	Q.P.	AV.	Q.P.	AV.	Q.P.	AV.	Q.P.	AV.
	1	0.15000	9.93	35.15	20.18	45.08	30.11	66.00	56.00	-20.92
2	0.17734	9.94	32.94	23.41	42.88	33.35	64.61	54.61	-21.73	-21.26
<b>3</b>	<b>0.19687</b>	<b>9.94</b>	<b>40.50</b>	<b>20.79</b>	<b>50.44</b>	<b>30.73</b>	<b>63.74</b>	<b>53.74</b>	<b>-13.30</b>	<b>-23.01</b>
4	0.25156	9.95	31.93	15.06	41.88	25.01	61.71	51.71	-19.83	-26.70
5	0.58359	9.97	20.67	11.60	30.64	21.57	56.00	46.00	-25.36	-24.43
6	0.79844	9.98	19.24	6.98	29.22	16.96	56.00	46.00	-26.78	-29.04

#### Remarks:

1. Q.P. and AV. are abbreviations of quasi-peak and average individually.
2. The emission levels of other frequencies were very low against the limit.
3. Margin value = Emission level – Limit value
4. Correction factor = Insertion loss + Cable loss
5. Emission Level = Correction Factor + Reading Value

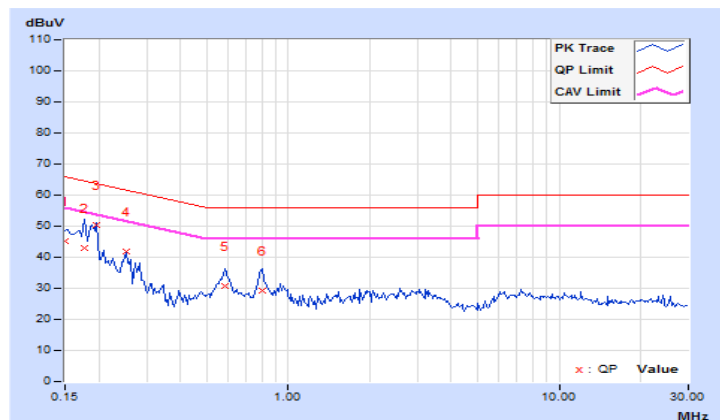

### 4.3 Transmit Power Measurement

#### 4.3.1 Limits of Transmit Power Measurement

Operation Band	EUT Category		Limit
U-NII-1		Outdoor Access Point	1 Watt (30 dBm) (Max. e.i.r.p $\leq$ 125mW(21 dBm) at any elevation angle above 30 degrees as measured from the horizon)
		Fixed point-to-point Access Point	1 Watt (30 dBm)
	√	Indoor Access Point	1 Watt (30 dBm)
		Client device	250mW (24 dBm)
U-NII-2A			250mW (24 dBm) or 11 dBm+10 log B*
U-NII-2C			250mW (24 dBm) or 11 dBm+10 log B*
U-NII-3		√	1 Watt (30 dBm)

\*B is the 26 dB emission bandwidth in megahertz

Per KDB 662911 Method of conducted output power measurement on IEEE 802.11 devices,

Array Gain = 0 dB (i.e., no array gain) for  $N_{ANT} \leq 4$ ;

Array Gain = 0 dB (i.e., no array gain) for channel widths  $\geq 40$  MHz for any  $N_{ANT}$ ;

Array Gain =  $5 \log(N_{ANT}/N_{SS})$  dB or 3 dB, whichever is less for 20-MHz channel widths with  $N_{ANT} \geq 5$ .

For power measurements on all other devices: Array Gain =  $10 \log(N_{ANT}/N_{SS})$  dB.

#### 4.3.2 Test Setup

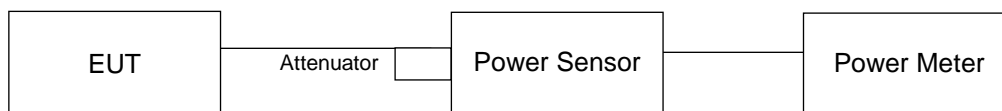

#### 4.3.3 Test Instruments

Refer to section 4.1.2 to get information of above instrument.

#### 4.3.4 Test Procedure

Method PM is used to perform output power measurement, trigger and gating function of wide band power meter is enabled to measure max output power of TX on burst. Duty factor is not added to measured value.

#### 4.3.5 Deviation from Test Standard

No deviation.

#### 4.3.6 EUT Operating Condition

The software provided by client to enable the EUT under transmission condition continuously at lowest, middle and highest channel frequencies individually.



#### 4.3.7 Test Results

##### 802.11a

Chan.	Chan. Freq. (MHz)	Maximum Conducted (dBm)		Total Power (mW)	Total Power (dBm)	Limit (dBm)	Pass / Fail
		Chain 0	Chain 1				
36	5180	9.81	9.77	19.056	12.80	30	Pass
40	5200	9.88	9.83	19.343	12.87	30	Pass
48	5240	9.86	9.81	19.255	12.85	30	Pass
149	5745	9.76	9.71	18.816	12.75	30	Pass
157	5785	9.74	9.75	18.86	12.76	30	Pass
165	5825	9.77	9.69	18.795	12.74	30	Pass

##### 802.11ac (VHT20)

Chan.	Chan. Freq. (MHz)	Maximum Conducted (dBm)		Total Power (mW)	Total Power (dBm)	Limit (dBm)	Pass / Fail
		Chain 0	Chain 1				
36	5180	9.83	9.78	19.122	12.82	30	Pass
40	5200	9.77	9.83	19.1	12.81	30	Pass
48	5240	9.79	9.81	19.1	12.81	30	Pass
149	5745	9.79	9.77	19.012	12.79	30	Pass
157	5785	9.77	9.76	18.946	12.78	30	Pass
165	5825	9.73	9.76	18.859	12.76	30	Pass

##### 802.11ac (VHT40)

Chan.	Chan. Freq. (MHz)	Maximum Conducted (dBm)		Total Power (mW)	Total Power (dBm)	Limit (dBm)	Pass / Fail
		Chain 0	Chain 1				
38	5190	9.82	9.85	19.255	12.85	30	Pass
46	5230	9.87	9.86	19.388	12.88	30	Pass
151	5755	9.78	9.75	18.947	12.78	30	Pass
159	5795	9.73	9.77	18.881	12.76	30	Pass

##### 802.11ac (VHT80)

Chan.	Chan. Freq. (MHz)	Maximum Conducted (dBm)		Total Power (mW)	Total Power (dBm)	Limit (dBm)	Pass / Fail
		Chain 0	Chain 1				
42	5210	9.87	9.89	19.455	12.89	30	Pass
155	5775	9.87	9.89	19.455	12.89	30	Pass

## 4.4 Occupied Bandwidth Measurement

### 4.4.1 Test Setup

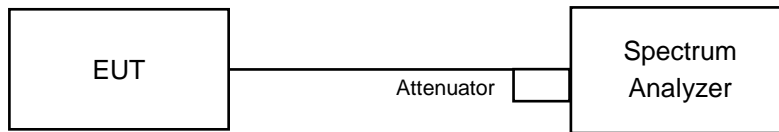

### 4.4.2 Test Instruments

Refer to section 4.1.2 to get information of above instrument.

### 4.4.3 Test Procedure

The transmitter output was connected to the spectrum analyzer through an attenuator. The bandwidth of the fundamental frequency was measured by spectrum analyzer with resolution bandwidth in the range of 1% to 5% of the anticipated emission bandwidth, and a video bandwidth at least 3x the resolution bandwidth and set the detector to SAMPLE. The width of a frequency band such that, below the lower and above the upper frequency limits, the mean powers emitted are each equal to a specified percentage 0.5 %of the total mean power of a given emission.

#### 4.4.4 Test Results

##### 802.11a

Channel	Channel Frequency (MHz)	Occupied Bandwidth (MHz)	
		Chain 0	Chain 1
36	5180	16.56	16.56
40	5200	16.56	16.56
48	5240	16.44	16.56
149	5745	16.44	16.44
157	5785	16.56	16.44
165	5825	16.56	16.44

##### 802.11ac (VHT20)

Channel	Channel Frequency (MHz)	Occupied Bandwidth (MHz)	
		Chain 0	Chain 1
36	5180	17.76	17.76
40	5200	17.76	17.64
48	5240	17.64	17.64
149	5745	17.76	17.76
157	5785	17.64	17.64
165	5825	17.76	17.64

##### 802.11ac (VHT40)

Channel	Channel Frequency (MHz)	Occupied Bandwidth (MHz)	
		Chain 0	Chain 1
38	5190	36.00	36.00
46	5230	36.00	36.00
151	5755	35.76	35.76
159	5795	36.24	36.00

##### 802.11ac (VHT80)

Channel	Channel Frequency (MHz)	Occupied Bandwidth (MHz)	
		Chain 0	Chain 1
42	5210	75.84	75.84
155	5775	76.32	75.84

Spectrum Plot of Max. Value

802.11a\_Chain 0 / CH48

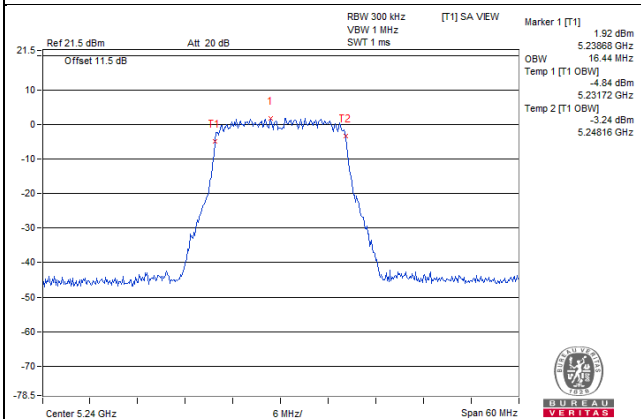

802.11ac (VHT20)\_Chain 0 / CH48

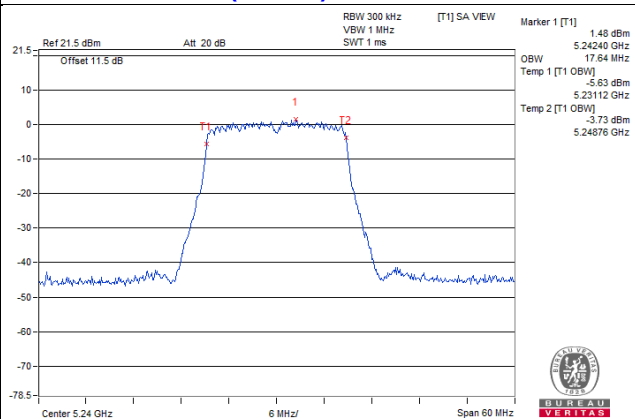

802.11ac (VHT40)\_Chain 0 / CH151

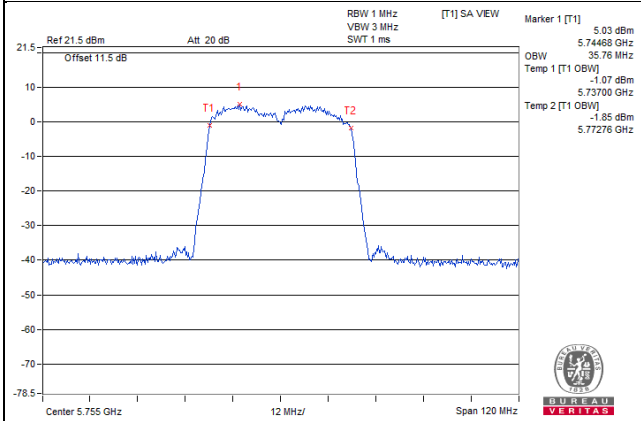

802.11ac (VHT80)\_Chain 0 / CH42

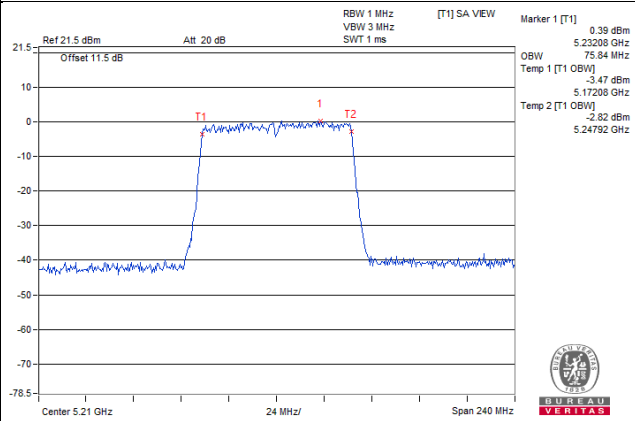

**Spectrum Plot for near by DFS band**  
(DFS is required, if 99% OCP straddle into U-NII-2A band)

**802.11a\_Chain0 / CH48**

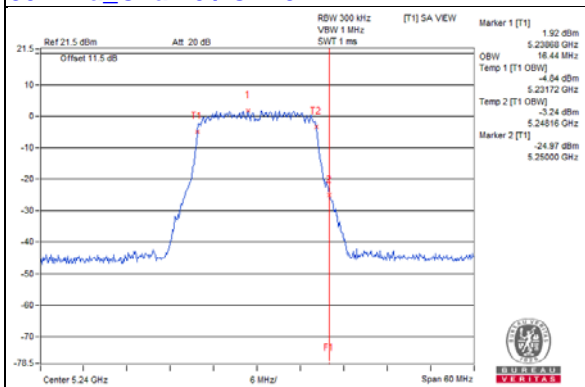

**802.11a\_Chain1 / CH48**

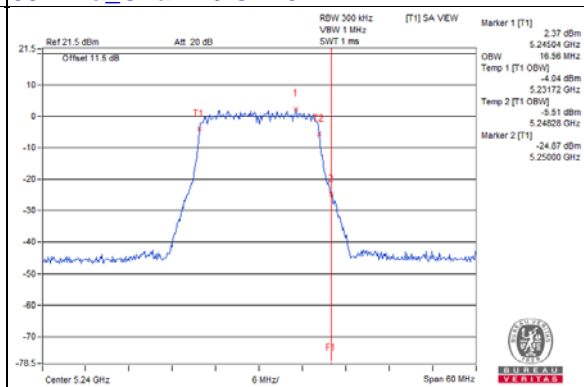

**802.11ac (VHT20)\_Chain0 / CH48**

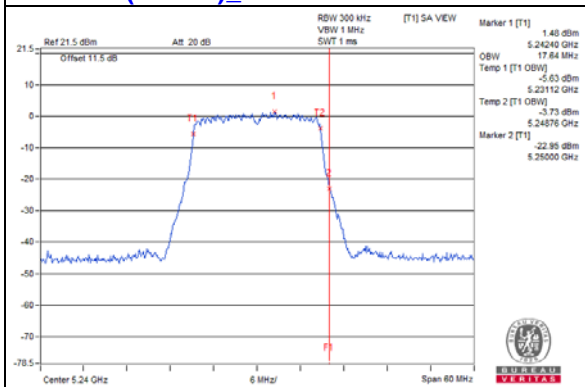

**802.11ac (VHT20)\_Chain1 / CH48**

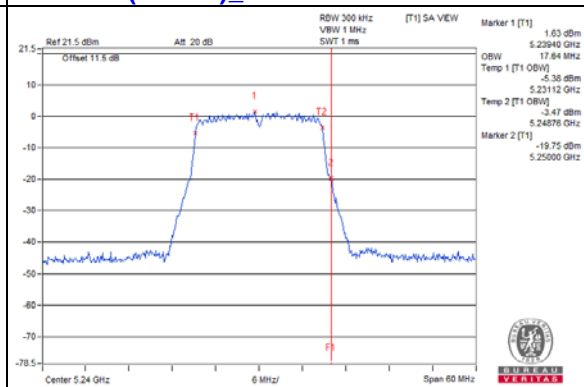

**802.11ac (VHT40)\_Chain0 / CH46**

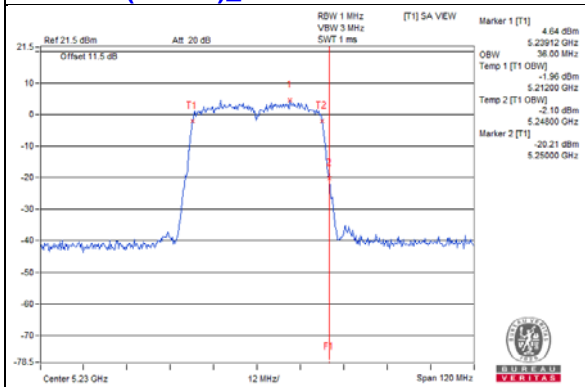

**802.11ac (VHT40)\_Chain1 / CH46**

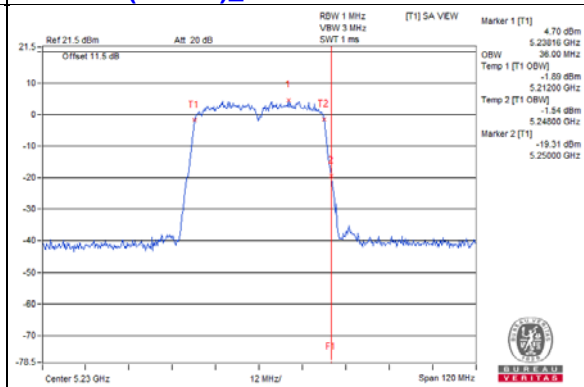

**802.11ac (VHT80)\_Chain0 / CH42**

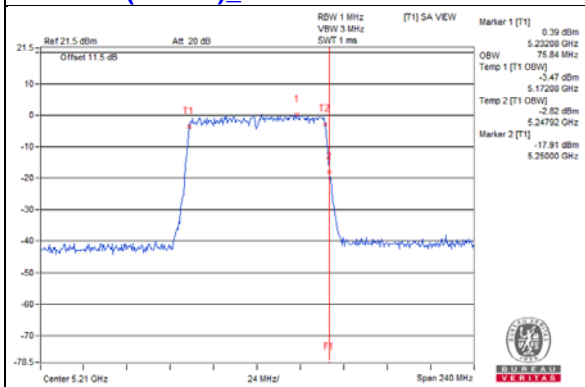

**802.11ac (VHT80)\_Chain1 / CH42**

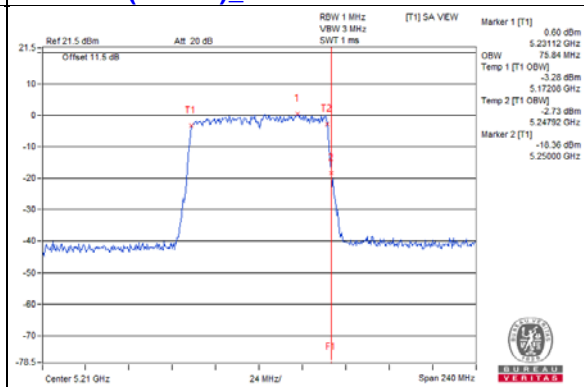

**Spectrum Plot for near by DFS band  
(DFS is required, if 99% OCP straddle into U-NII-2C band)**

**802.11a\_Chain0 / CH149**

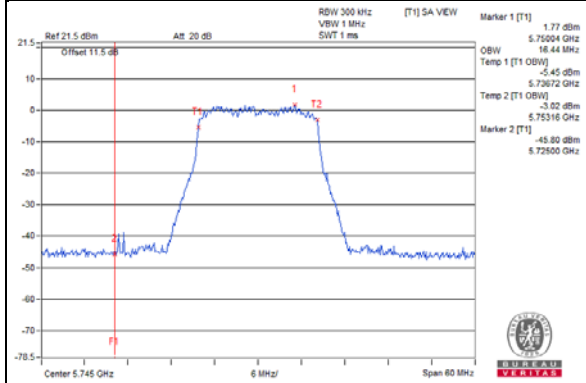

**802.11a\_Chain1 / CH149**

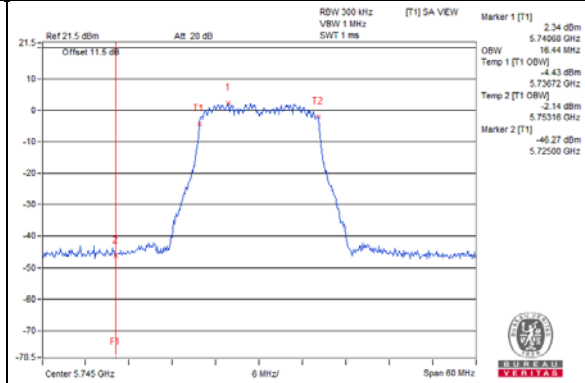

**802.11ac (VHT20)\_Chain0 / CH149**

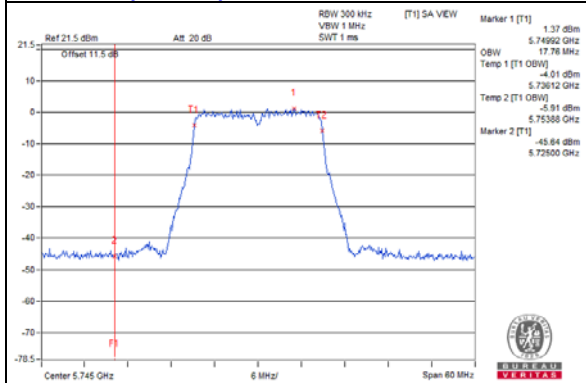

**802.11ac (VHT20)\_Chain1 / CH149**

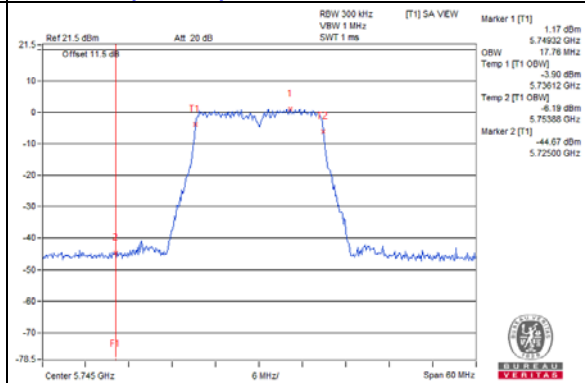

**802.11ac (VHT40)\_Chain0 / CH151**

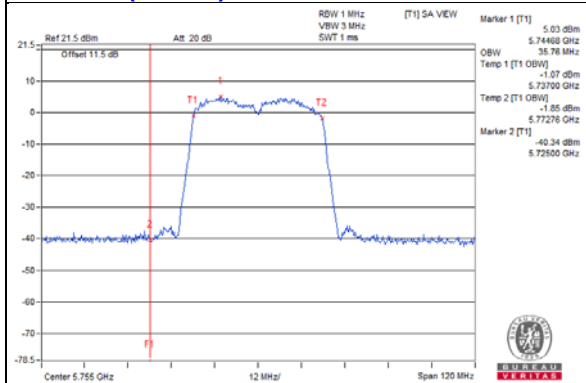

**802.11ac (VHT40)\_Chain1 / CH151**

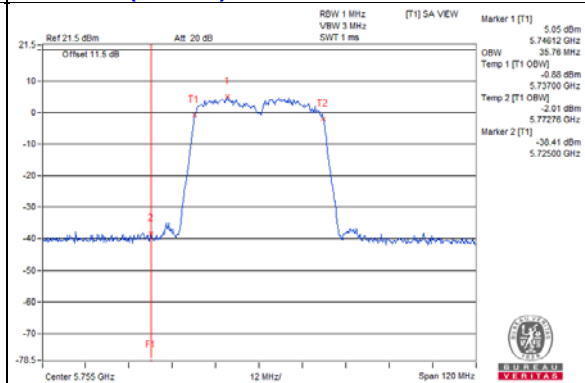

**802.11ac (VHT80)\_Chain0 / CH155**

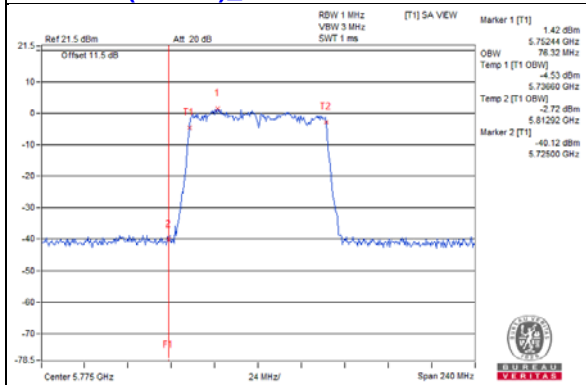

**802.11ac (VHT80)\_Chain1 / CH155**

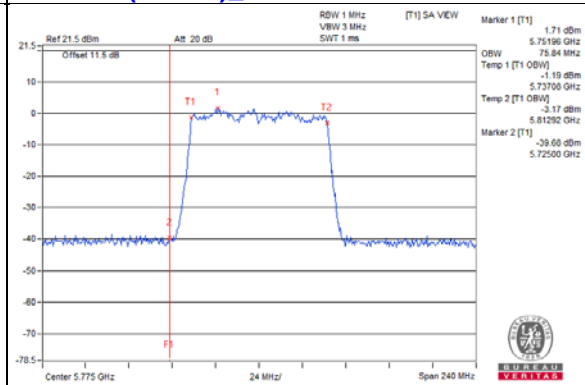

## 4.5 Peak Power Spectral Density Measurement

### 4.5.1 Limits of Peak Power Spectral Density Measurement

Operation Band	EUT Category		Limit
U-NII-1		Outdoor Access Point	17dBm/ MHz
		Fixed point-to-point Access Point	
	√	Indoor Access Point	
		Client device	
U-NII-2A			11dBm/ MHz
U-NII-2C			11dBm/ MHz
U-NII-3	√		30dBm/ 500kHz

### 4.5.2 Test Setup

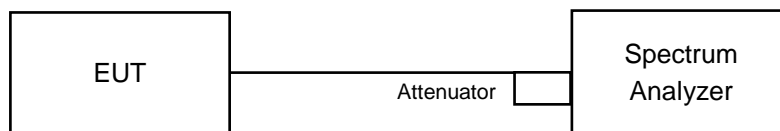

### 4.5.3 Test Instruments

Refer to section 4.1.2 to get information of above instrument.

#### 4.5.4 Test Procedure

##### For U-NII-1 band:

##### For 802.11ac (VHT20)

Using method SA-1

1. Set span to encompass the entire emission bandwidth (EBW) of the signal.
2. Set RBW = 1 MHz, Set VBW  $\geq$  3 MHz, Detector = RMS
3. Sweep time = auto, trigger set to "free run".
4. Trace average at least 100 traces in power averaging mode.
5. Record the max value

##### For 802.11a, 802.11ac (VHT40) & 802.11ac (VHT80)

Using method SA-2

1. Set span to encompass the entire emission bandwidth (EBW) of the signal.
2. Set RBW = 1 MHz, Set VBW  $\geq$  3 MHz, Detector = RMS
3. Sweep time = auto, trigger set to "free run".
4. Trace average at least 100 traces in power averaging mode.
5. Record the max value and add  $10 \log (1/\text{duty cycle})$

##### For U-NII-3:

##### For 802.11ac (VHT20)

1. Set span to encompass the entire emission bandwidth (EBW) of the signal.
2. Set RBW = 300 kHz, Set VBW  $\geq$  1 MHz, Detector = RMS
3. Use the peak marker function to determine the maximum power level in any 300 kHz band segment within the fundamental EBW.
4. Scale the observed power level to an equivalent value in 500 kHz by adjusting (reducing) the measured power by a bandwidth correction factor (BWCF) where  $BWCF = 10\log(500\text{kHz}/300\text{kHz})$
5. Sweep time = auto, trigger set to "free run".
6. Trace average at least 100 traces in power averaging mode.
7. Record the max value

##### For 802.11a, 802.11ac (VHT40) & 802.11ac (VHT80)

1. Set span to encompass the entire emission bandwidth (EBW) of the signal.
2. Set RBW = 300 kHz, Set VBW  $\geq$  1 MHz, Detector = RMS
3. Use the peak marker function to determine the maximum power level in any 300 kHz band segment within the fundamental EBW.
4. Scale the observed power level to an equivalent value in 500 kHz by adjusting (reducing) the measured power by a bandwidth correction factor (BWCF) where  $BWCF = 10\log(500\text{kHz}/300\text{kHz})$
5. Sweep time = auto, trigger set to "free run".
6. Trace average at least 100 traces in power averaging mode.
7. Record the max value and add  $10 \log (1/\text{duty cycle})$

#### 4.5.5 Deviation from Test Standard

No deviation.

#### 4.5.6 EUT Operating Condition

Same as Item 4.3.6.



#### 4.5.7 Test Results

##### For U-NII-1:

##### 802.11a

Chan.	Chan. Freq. (MHz)	PSD W/O Duty Factor (dBm/MHz)		Duty Factor (dB)	Total PSD With Duty Factor (dBm/MHz)	Max. Limit (dBm/MHz)	Pass / Fail
		Chain 0	Chain 1				
36	5180	-3.73	-3.27	0.15	-0.33	17	Pass
40	5200	-3.19	-3.11	0.15	0.01	17	Pass
48	5240	-2.83	-2.94	0.15	0.28	17	Pass

- Note: 1. Method a) of power density measurement of KDB 662911 is using for calculating total power density. Total power density is summing entire spectra across corresponding frequency bins on the various outputs by computer.
2. The Directional gain =  $2.59\text{dBi} + 10\log(2) = 5.6\text{dBi} < 6\text{dBi}$  , so the power density limit shall not be reduced.
3. Refer to section 3.3 for duty cycle spectrum plot.

##### 802.11ac (VHT20)

Chan.	Chan. Freq. (MHz)	PSD (dBm/MHz)		Total Power Density (dBm/MHz)	Max. Limit (dBm/MHz)	Pass / Fail
		Chain 0	Chain 1			
36	5180	-3.40	-3.71	-0.54	17	Pass
40	5200	-3.76	-3.19	-0.46	17	Pass
48	5240	-3.30	-3.23	-0.25	17	Pass

- Note: 1. Method a) of power density measurement of KDB 662911 is using for calculating total power density. Total power density is summing entire spectra across corresponding frequency bins on the various outputs by computer.
2. The Directional gain =  $2.59\text{dBi} + 10\log(2) = 5.6\text{dBi} < 6\text{dBi}$  , so the power density limit shall not be reduced.

##### 802.11ac (VHT40)

Chan.	Chan. Freq. (MHz)	PSD W/O Duty Factor (dBm/MHz)		Duty Factor (dB)	Total PSD With Duty Factor (dBm/MHz)	Max. Limit (dBm/MHz)	Pass / Fail
		Chain 0	Chain 1				
38	5190	-5.78	-6.19	0.12	-2.85	17	Pass
46	5230	-5.84	-5.88	0.12	-2.73	17	Pass

- Note: 1. Method a) of power density measurement of KDB 662911 is using for calculating total power density. Total power density is summing entire spectra across corresponding frequency bins on the various outputs by computer.
2. The Directional gain =  $2.59\text{dBi} + 10\log(2) = 5.6\text{dBi} < 6\text{dBi}$  , so the power density limit shall not be reduced.
3. Refer to section 3.3 for duty cycle spectrum plot.

**802.11ac (VHT80)**

Chan.	Chan. Freq. (MHz)	PSD W/O Duty Factor (dBm/MHz)		Duty Factor (dB)	Total PSD With Duty Factor (dBm/MHz)	Max. Limit (dBm/MHz)	Pass / Fail
		Chain 0	Chain 1				
42	5210	-9.64	-9.61	0.24	-6.38	17	Pass

- Note: 1. Method a) of power density measurement of KDB 662911 is using for calculating total power density. Total power density is summing entire spectra across corresponding frequency bins on the various outputs by computer.
2. The Directional gain =  $2.59\text{dBi} + 10\log(2) = 5.6\text{dBi} < 6\text{dBi}$  , so the power density limit shall not be reduced.
3. Refer to section 3.3 for duty cycle spectrum plot.

Spectrum Plot of Worst Value

802.11a\_Chain 0 / CH48

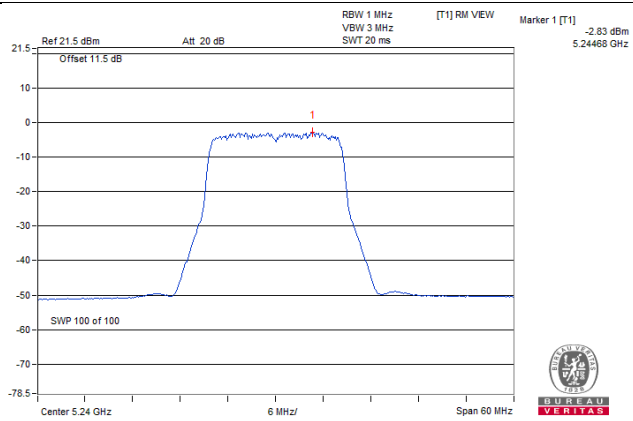

802.11ac (VHT20)\_Chain 1 / CH40

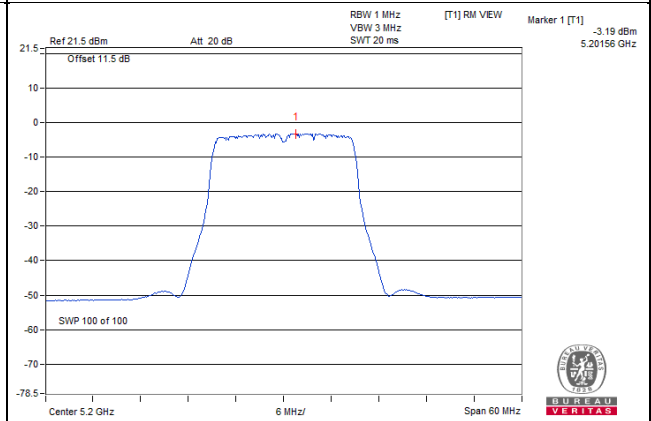

802.11ac (VHT40)\_Chain 0 / CH38

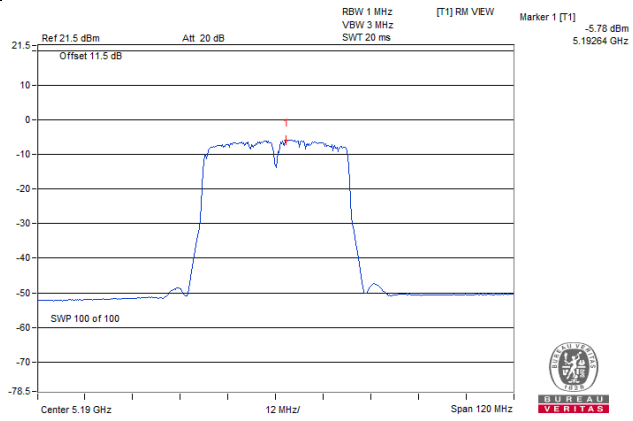

802.11ac (VHT80)\_Chain 1 / CH42

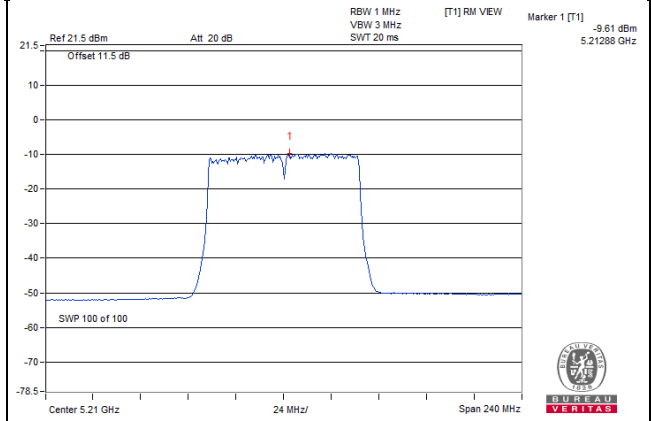

**For U-NII-3:**  
**802.11a**

Chan.	Freq. (MHz)	PSD W/O Duty Factor (dBm/300kHz)		Duty Factor (dB)	Total PSD With Duty Factor		Total PSD With Duty Factor (dBm/500kHz)	Limit (dBm/500kHz)	Pass /Fail
		Chain 0	Chain 1		mW/300kHz	dBm/300kHz			
149	5745	-11.64	-10.85	0.15	0.15598	-8.07	-5.85	30.00	Pass
157	5785	-12.02	-11.08	0.15	0.14565	-8.37	-6.15	30.00	Pass
165	5825	-11.39	-11.01	0.15	0.15711	-8.04	-5.82	30.00	Pass

- Note: 1. Method b) Measure and sum spectral maxima across the outputs of KDB 662911 is using for calculating total power density.  
 2. The Directional gain =  $2.59\text{dBi} + 10\log(2) = 5.6\text{dBi} < 6\text{dBi}$  , so the power density limit shall not be reduced.  
 3. Refer to section 3.3 for duty cycle spectrum plot.

**802.11ac (VHT20)**

Chan.	Freq. (MHz)	PSD (dBm/300kHz)		Total PSD		Total PSD (dBm/500kHz)	Limit (dBm/500kHz)	Pass /Fail
		Chain 0	Chain 1	mW/300kHz	dBm/300kHz			
149	5745	-12.00	-11.89	0.12781	-8.93	-6.71	30.00	Pass
157	5785	-11.20	-11.46	0.14731	-8.32	-6.10	30.00	Pass
165	5825	-11.84	-10.94	0.146	-8.36	-6.14	30.00	Pass

- Note: 1. Method b) Measure and sum spectral maxima across the outputs of KDB 662911 is using for calculating total power density.  
 2. The Directional gain =  $2.59\text{dBi} + 10\log(2) = 5.6\text{dBi} < 6\text{dBi}$  , so the power density limit shall not be reduced.

### 802.11ac (VHT40)

Chan.	Freq. (MHz)	PSD W/O Duty Factor (dBm/300kHz)		Duty Factor (dB)	Total PSD With Duty Factor		Total PSD With Duty Factor (dBm/500kHz)	Limit (dBm/500kHz)	Pass /Fail
		Chain 0	Chain 1		mW/300kHz	dBm/300kHz			
151	5755	-14.59	-14.61	0.12	0.07122	-11.47	-9.25	30.00	Pass
159	5795	-14.45	-14.58	0.12	0.07263	-11.39	-9.17	30.00	Pass

- Note:
- Method b) Measure and sum spectral maxima across the outputs of KDB 662911 is using for calculating total power density.
  - The Directional gain =  $2.59\text{dBi} + 10\log(2) = 5.6\text{dBi} < 6\text{dBi}$  , so the power density limit shall not be reduced.
  - Refer to section 3.3 for duty cycle spectrum plot.

### 802.11ac (VHT80)

Chan.	Freq. (MHz)	PSD W/O Duty Factor (dBm/300kHz)		Duty Factor (dB)	Total PSD With Duty Factor		Total PSD With Duty Factor (dBm/500kHz)	Limit (dBm/500kHz)	Pass /Fail
		Chain 0	Chain 1		mW/300kHz	dBm/300kHz			
155	5775	-17.73	-17.74	0.24	0.03559	-14.49	-12.27	30.00	Pass

- Note:
- Method b) Measure and sum spectral maxima across the outputs of KDB 662911 is using for calculating total power density.
  - The Directional gain =  $2.59\text{dBi} + 10\log(2) = 5.6\text{dBi} < 6\text{dBi}$  , so the power density limit shall not be reduced.
  - Refer to section 3.3 for duty cycle spectrum plot.

Spectrum Plot of Worst Value

802.11a\_Chain 1 / CH149

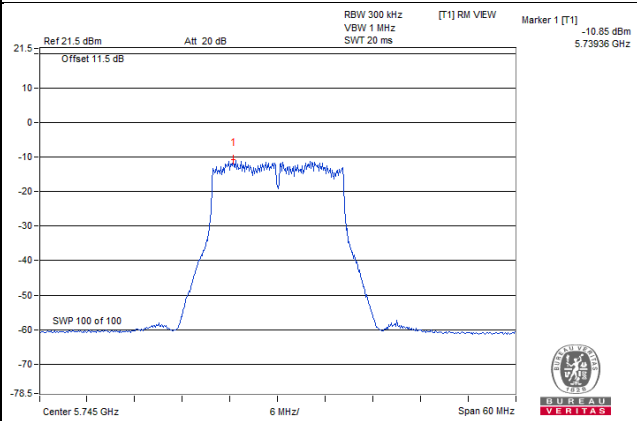

802.11ac (VHT20)\_Chain 1 / CH165

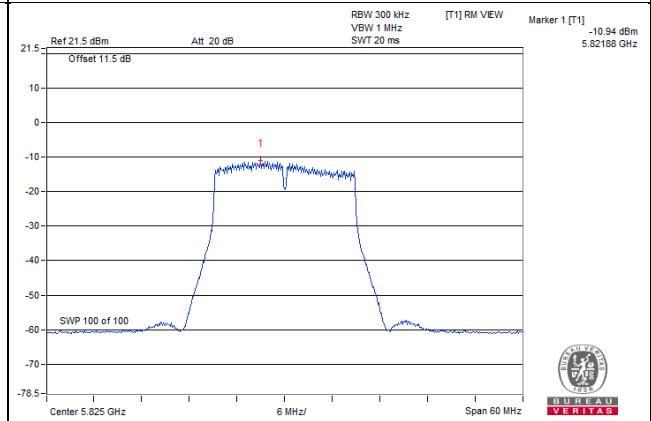

802.11ac (VHT40)\_Chain 0 / CH159

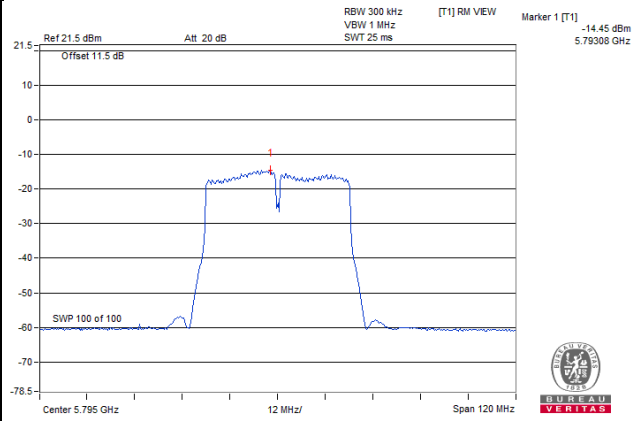

802.11ac (VHT80)\_Chain 0 / CH155

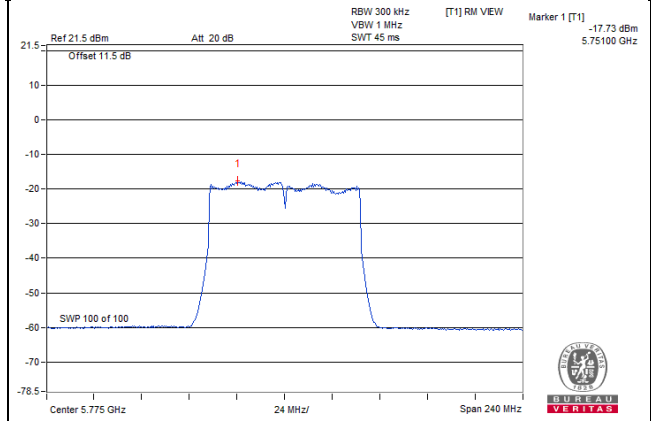

## 4.6 Frequency Stability Measurement

### 4.6.1 Limits of Frequency Stability Measurement

The frequency of the carrier signal shall be maintained within band of operation

### 4.6.2 Test Setup

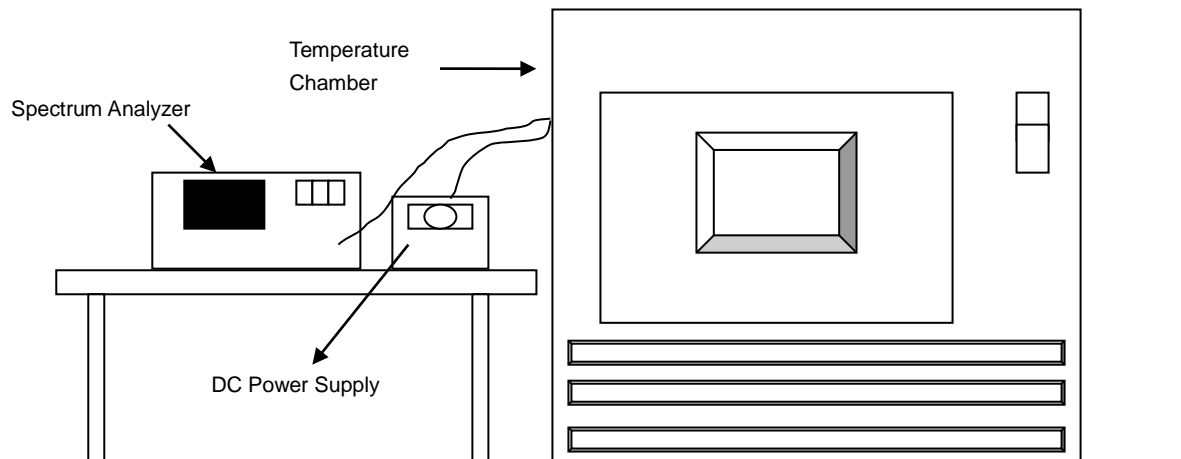

### 4.6.3 Test Instruments

Refer to section 4.1.2 to get information of above instrument.

### 4.6.4 Test Procedure

- The EUT was placed inside the environmental test chamber and powered by nominal DC voltage.
- Turn the EUT on and couple its output to a spectrum analyzer.
- Turn the EUT off and set the chamber to the highest temperature specified.
- Allow sufficient time (approximately 30 min) for the temperature of the chamber to stabilize, turn the EUT on and measure the operating frequency after 2, 5, and 10 Minutes.
- Repeat step 2 and 3 with the temperature chamber set to the lowest temperature.
- The test chamber was allowed to stabilize at +20 degree C for a minimum of 30 Minutes. The supply voltage was then adjusted on the EUT from 85% to 115% and the frequency record.

### 4.6.5 Deviation from Test Standard

No deviation.

### 4.6.6 EUT Operating Condition

Set the EUT transmit at un-modulation mode to test frequency stability.

#### 4.6.7 Test Results

Frequency Stability Versus Temp.									
Operating Frequency: 5180 MHz									
TEMP. (°C)	Power Supply (Vdc)	0 Minute		2 Minutes		5 Minutes		10 Minutes	
		Measured Frequency (MHz)	Pass/Fail	Measured Frequency (MHz)	Pass/Fail	Measured Frequency (MHz)	Pass/Fail	Measured Frequency (MHz)	Pass/Fail
50	3.7	5180.0118	PASS	5180.0094	PASS	5180.0111	PASS	5180.01	PASS
40	3.7	5179.9983	PASS	5179.999	PASS	5180.0017	PASS	5179.9996	PASS
30	3.7	5179.9778	PASS	5179.9799	PASS	5179.9809	PASS	5179.9779	PASS
20	3.7	5179.9905	PASS	5179.9862	PASS	5179.9891	PASS	5179.9867	PASS
10	3.7	5180.0027	PASS	5180.0018	PASS	5180.002	PASS	5180.0018	PASS
0	3.7	5180.01	PASS	5180.0118	PASS	5180.0133	PASS	5180.0139	PASS
-10	3.7	5180.0092	PASS	5180.0057	PASS	5180.01	PASS	5180.0062	PASS
-20	3.7	5180.0005	PASS	5180.0042	PASS	5180.0021	PASS	5180.0044	PASS
-30	3.7	5180.0105	PASS	5180.0133	PASS	5180.0128	PASS	5180.01	PASS

Frequency Stability Versus Voltage									
Operating Frequency: 5180 MHz									
TEMP. (°C)	Power Supply (Vdc)	0 Minute		2 Minutes		5 Minutes		10 Minutes	
		Measured Frequency (MHz)	Pass/Fail	Measured Frequency (MHz)	Pass/Fail	Measured Frequency (MHz)	Pass/Fail	Measured Frequency (MHz)	Pass/Fail
20	4.255	5179.9896	PASS	5179.9853	PASS	5179.9893	PASS	5179.9858	PASS
	3.7	5179.9905	PASS	5179.9862	PASS	5179.9891	PASS	5179.9867	PASS
	3.145	5179.9904	PASS	5179.9861	PASS	5179.9888	PASS	5179.9871	PASS



## 4.7 6dB Bandwidth Measurement

### 4.7.1 Limits of 6dB Bandwidth Measurement

The minimum of 6dB Bandwidth Measurement is 0.5MHz.

### 4.7.2 Test Setup

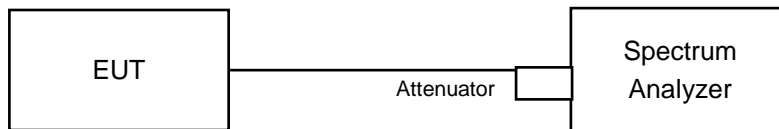

### 4.7.3 Test Instruments

Refer to section 4.1.2 to get information of above instrument.

### 4.7.4 Test Procedure

#### MEASUREMENT PROCEDURE REF

- Set resolution bandwidth (RBW) = 100kHz
- Set the video bandwidth (VBW)  $\geq 3 \times$  RBW, Detector = Peak.
- Trace mode = max hold.
- Sweep = auto couple.
- Measure the maximum width of the emission that is constrained by the frequencies associated with the two amplitude points (upper and lower) that are attenuated by 6 dB relative to the maximum level measured in the fundamental emission

### 4.7.5 Deviation from Test Standard

No deviation.

### 4.7.6 EUT Operating Condition

The software provided by client to enable the EUT under transmission condition continuously at lowest, middle and highest channel frequencies individually.

#### 4.7.7 Test Results

##### 802.11a

Channel	Frequency (MHz)	6dB Bandwidth (MHz)		Minimum Limit (MHz)	Pass / Fail
		Chain 0	Chain 1		
149	5745	15.77	15.93	0.5	Pass
157	5785	16.34	16.32	0.5	Pass
165	5825	16.34	16.38	0.5	Pass

##### 802.11ac (VHT20)

Channel	Frequency (MHz)	6dB Bandwidth (MHz)		Minimum Limit (MHz)	Pass / Fail
		Chain 0	Chain 1		
149	5745	17.62	17.62	0.5	Pass
157	5785	15.99	15.98	0.5	Pass
165	5825	17.56	16.17	0.5	Pass

##### 802.11ac (VHT40)

Channel	Frequency (MHz)	6dB Bandwidth (MHz)		Minimum Limit (MHz)	Pass / Fail
		Chain 0	Chain 1		
151	5755	35.22	35.28	0.5	Pass
159	5795	35.13	35.26	0.5	Pass

##### 802.11ac (VHT80)

Channel	Frequency (MHz)	6dB Bandwidth (MHz)		Minimum Limit (MHz)	Pass / Fail
		Chain 0	Chain 1		
155	5775	75.98	75.98	0.5	Pass

### Spectrum Plot of Worst Value

#### 802.11a\_Chain 0 / CH149

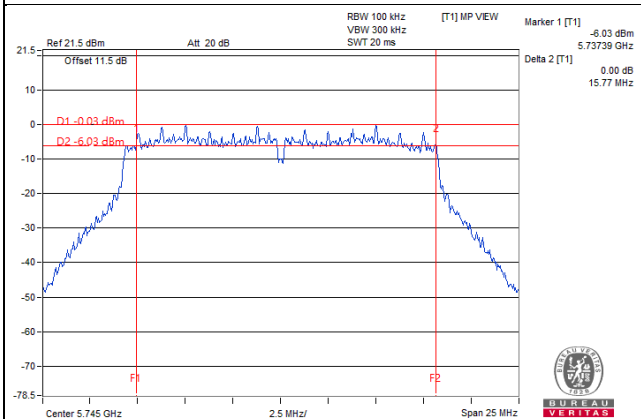

#### 802.11ac (VHT20)\_Chain 1 / CH157

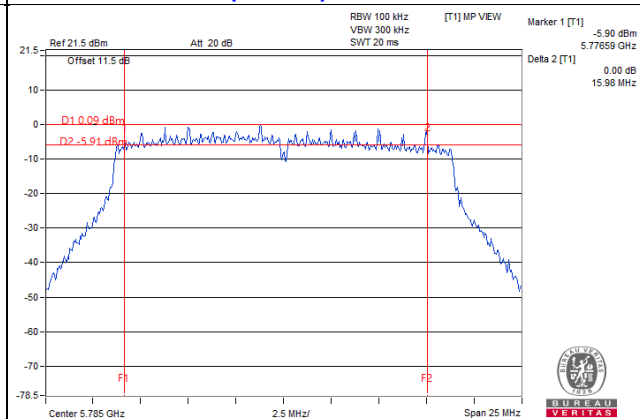

#### 802.11ac (VHT40)\_Chain 0 / CH159

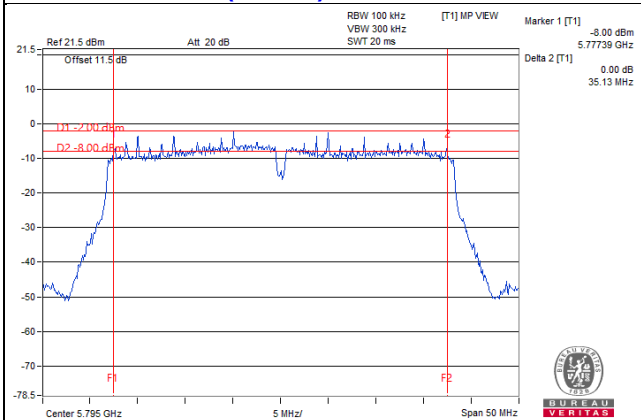

#### 802.11ac (VHT80)\_Chain 0 / CH155

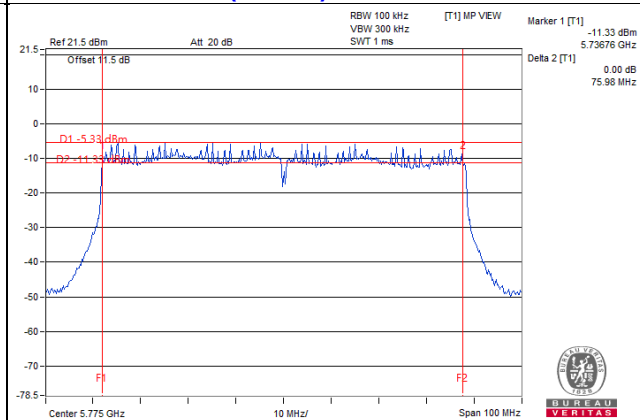

## 5 Pictures of Test Arrangements

Please refer to the attached file (Test Setup Photo).

### Annex A- Radiated Out of Band Emission (OOBE) Measurement (For U-NII-3 band)

802.11a

**CH 149 5745 MHz**

**Horizontal**

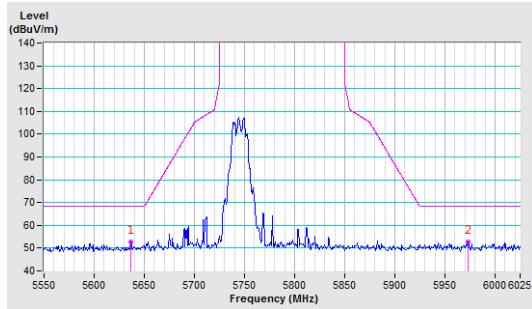

**Vertical**

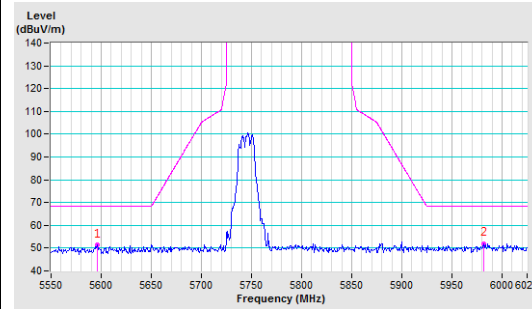

**CH 157 5785 MHz**

**Horizontal**

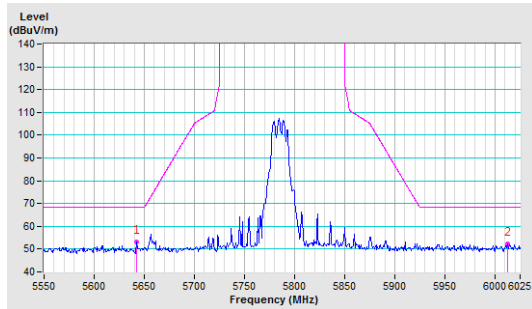

**Vertical**

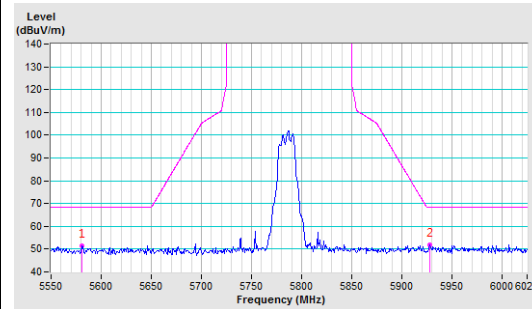

**CH 165 5825 MHz**

**Horizontal**

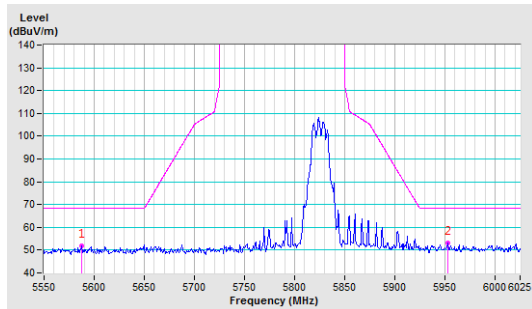

**Vertical**

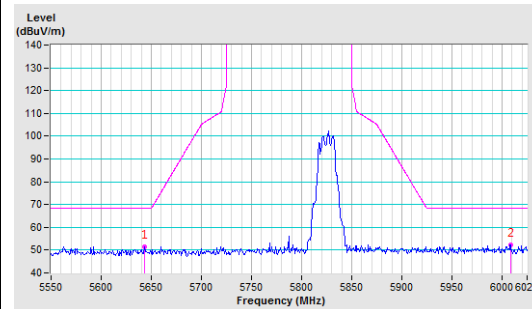

802.11ac (VHT20)

**CH 149 5745 MHz**

**Horizontal**

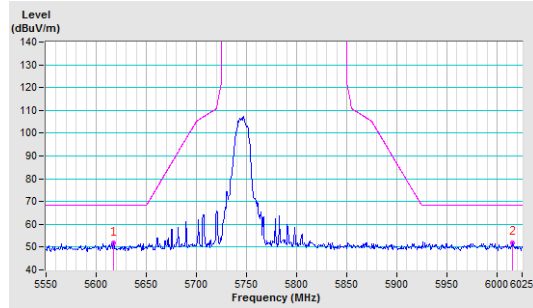

**Vertical**

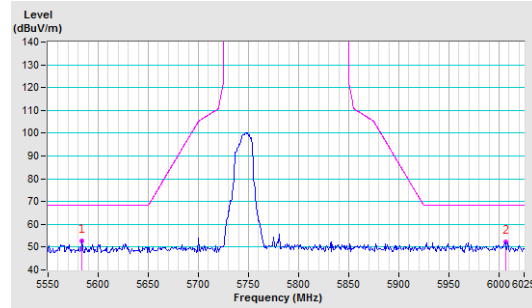

**CH 157 5785 MHz**

**Horizontal**

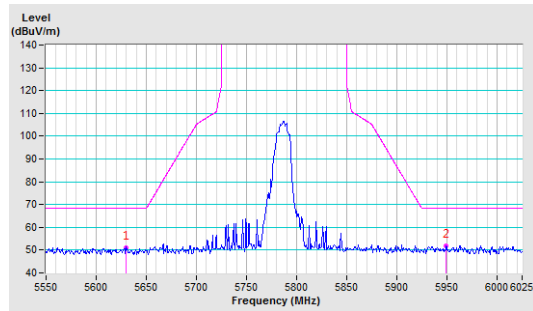

**Vertical**

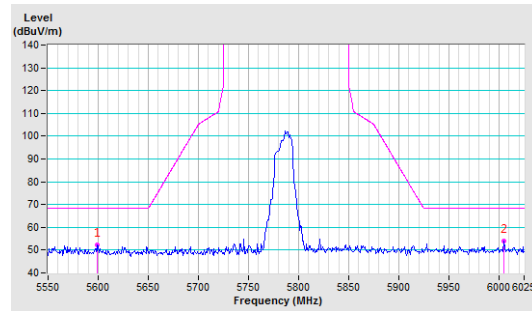

**CH 165 5825 MHz**

**Horizontal**

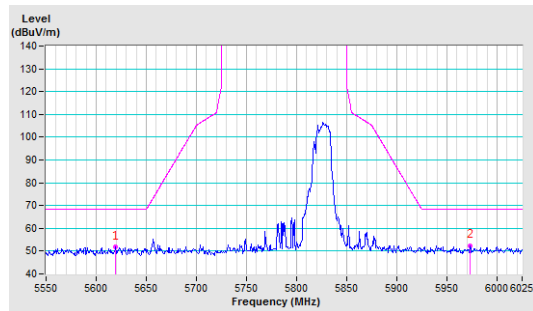

**Vertical**

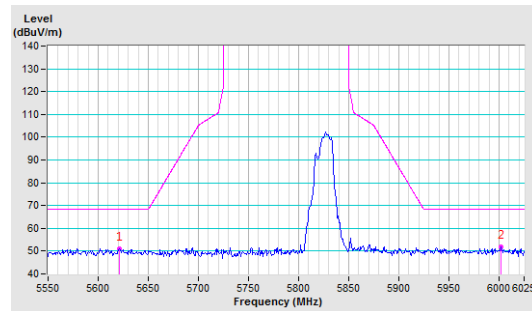

### 802.11ac (VHT40)

**CH 151 5755 MHz**

**Horizontal**

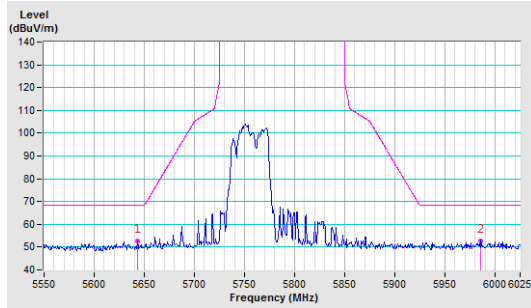

**Vertical**

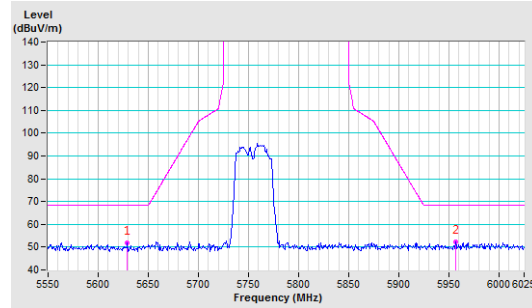

**CH 159 5795 MHz**

**Horizontal**

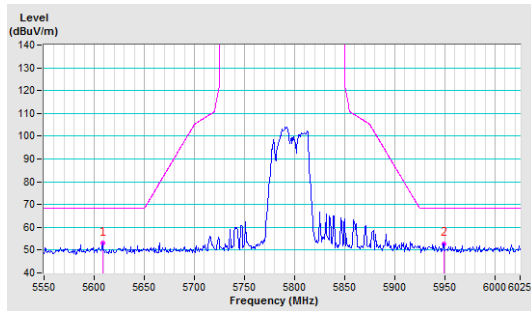

**Vertical**

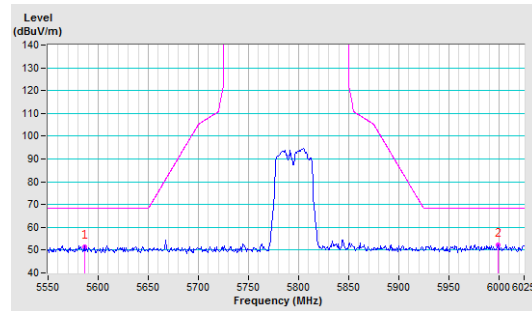

### 802.11ac (VHT80)

**CH 155 5775 MHz**

**Horizontal**

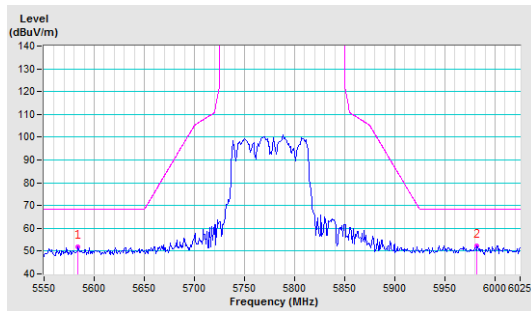

**Vertical**

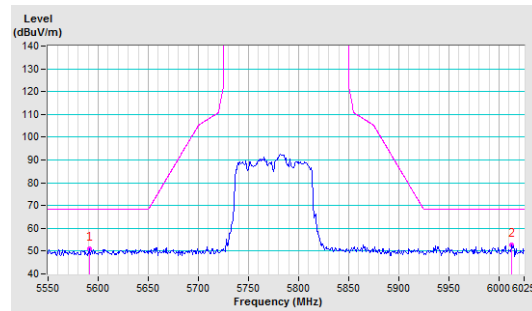

## Appendix – Information on the Testing Laboratories

We, Bureau Veritas Consumer Products Services (H.K.) Ltd., Taoyuan Branch, were founded in 1988 to provide our best service in EMC, Radio, Telecom and Safety consultation. Our laboratories are FCC recognized accredited test firms and accredited according to ISO/IEC 17025.

If you have any comments, please feel free to contact us at the following:

**Linkou EMC/RF Lab**

Tel: 886-2-26052180

Fax: 886-2-26051924

**Hsin Chu EMC/RF/Telecom Lab**

Tel: 886-3-6668565

Fax: 886-3-6668323

**Hwa Ya EMC/RF/Safety Lab**

Tel: 886-3-3183232

Fax: 886-3-3270892

**Email:** [service.adt@tw.bureauveritas.com](mailto:service.adt@tw.bureauveritas.com)

**Web Site:** [www.bureauveritas-adt.com](http://www.bureauveritas-adt.com)

The address and road map of all our labs can be found in our web site also.

--- END ---