

FCC Test Report (WLAN)

Report No.: RF181004C17

FCC ID: PY318300428

Test Model: MR5000

Received Date: Oct. 04, 2018

Test Date: Nov. 07 to 14, 2018

Issued Date: Nov. 19, 2018

Applicant: NETGEAR INC.

Address: 350 East Plumeria Drive, San Jose, CA 95134, USA

Issued By: Bureau Veritas Consumer Products Services (H.K.) Ltd., Taoyuan Branch
Hsin Chu Laboratory

Lab Address: E-2, No.1, Li Hsin 1st Road, Hsinchu Science Park, Hsinchu City 300,
Taiwan R.O.C.

Test Location: E-2, No.1, Li Hsin 1st Road, Hsinchu Science Park, Hsinchu City 300,
Taiwan R.O.C.

**FCC Registration /
Designation Number:** 723255 / TW2022



This report is for your exclusive use. Any copying or replication of this report to or for any other person or entity, or use of our name or trademark, is permitted only with our prior written permission. This report sets forth our findings solely with respect to the test samples identified herein. The results set forth in this report are not indicative or representative of the quality or characteristics of the lot from which a test sample was taken or any similar or identical product unless specifically and expressly noted. Our report includes all of the tests requested by you and the results thereof based upon the information that you provided to us. You have 60 days from date of issuance of this report to notify us of any material error or omission caused by our negligence, provided, however, that such notice shall be in writing and shall specifically address the issue you wish to raise. A failure to raise such issue within the prescribed time shall constitute your unqualified acceptance of the completeness of this report, the tests conducted and the correctness of the report contents. Unless specific mention, the uncertainty of measurement has been explicitly taken into account to declare the compliance or non-compliance to the specification. The report must not be used by the client to claim product certification, approval, or endorsement by TAF or any government agencies.

Table of Contents

Release Control Record	4
1 Certificate of Conformity	5
2 Summary of Test Results	6
2.1 Measurement Uncertainty	6
2.2 Modification Record	6
3 General Information	7
3.1 General Description of EUT (WLAN)	7
3.2 Description of Test Modes	9
3.2.1 Test Mode Applicability and Tested Channel Detail	10
3.3 Duty Cycle of Test Signal	12
3.4 Description of Support Units	13
3.4.1 Configuration of System under Test	14
3.5 General Description of Applied Standards	15
4 Test Types and Results	16
4.1 Radiated Emission and Bandedge Measurement	16
4.1.1 Limits of Radiated Emission and Bandedge Measurement	16
4.1.2 Test Instruments	17
4.1.3 Test Procedures	18
4.1.4 Deviation from Test Standard	18
4.1.5 Test Setup	19
4.1.6 EUT Operating Conditions	20
4.1.7 Test Results	21
4.2 Conducted Emission Measurement	35
4.2.1 Limits of Conducted Emission Measurement	35
4.2.2 Test Instruments	35
4.2.3 Test Procedures	36
4.2.4 Deviation from Test Standard	36
4.2.5 Test Setup	36
4.2.6 EUT Operating Conditions	36
4.2.7 Test Results (Mode 1)	37
4.2.8 Test Results (Mode 2)	39
4.3 6dB Bandwidth Measurement	41
4.3.1 Limits of 6dB Bandwidth Measurement	41
4.3.2 Test Setup	41
4.3.3 Test Instruments	41
4.3.4 Test Procedure	41
4.3.5 Deviation from Test Standard	41
4.3.6 EUT Operating Conditions	41
4.3.7 Test Result	42
4.4 Conducted Output Power Measurement	44
4.4.1 Limits of Conducted Output Power Measurement	44
4.4.2 Test Setup	44
4.4.3 Test Instruments	44
4.4.4 Test Procedures	44
4.4.5 Deviation from Test Standard	44
4.4.6 EUT Operating Conditions	44
4.4.7 Test Results	45
4.5 Power Spectral Density Measurement	47
4.5.1 Limits of Power Spectral Density Measurement	47
4.5.2 Test Setup	47
4.5.3 Test Instruments	47
4.5.4 Test Procedure	47
4.5.5 Deviation from Test Standard	48

4.5.6 EUT Operating Condition	48
4.5.7 Test Results	49
4.6 Conducted Out of Band Emission Measurement	52
4.6.1 Limits of Conducted Out of Band Emission Measurement.....	52
4.6.2 Test Setup.....	52
4.6.3 Test Instruments	52
4.6.4 Test Procedure	52
4.6.5 Deviation from Test Standard	52
4.6.6 EUT Operating Condition	52
4.6.7 Test Results	52
5 Pictures of Test Arrangements.....	61
Appendix – Information on the Testing Laboratories	62

Release Control Record

Issue No.	Description	Date Issued
RF181004C17	Original release.	Nov. 19, 2018

1 Certificate of Conformity

Product: 5G MHS Travel Router

Brand: Netgear

Test Model: MR5000

Sample Status: ENGINEERING SAMPLE

Applicant: NETGEAR INC.

Test Date: Nov. 07 to 14, 2018

Standards: 47 CFR FCC Part 15, Subpart C (Section 15.247)
ANSI C63.10: 2013

The above equipment has been tested by **Bureau Veritas Consumer Products Services (H.K.) Ltd., Taoyuan Branch**, and found compliance with the requirement of the above standards. The test record, data evaluation & Equipment Under Test (EUT) configurations represented herein are true and accurate accounts of the measurements of the sample's EMC characteristics under the conditions specified in this report.

Prepared by :  , **Date:** Nov. 19, 2018
Claire Kuan / Specialist

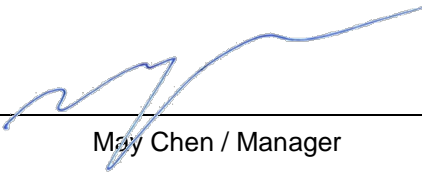
Approved by :  , **Date:** Nov. 19, 2018
May Chen / Manager

2 Summary of Test Results

47 CFR FCC Part 15, Subpart C (Section 15.247)			
FCC Clause	Test Item	Result	Remarks
15.207	AC Power Conducted Emission	PASS	Meet the requirement of limit. Minimum passing margin is -13.68 dB at 0.15781 MHz.
15.205 / 15.209 / 15.247(d)	Radiated Emissions and Band Edge Measurement	PASS	Meet the requirement of limit. Minimum passing margin is -3.0dB at 2390.00MHz.
15.247(d)	Antenna Port Emission	PASS	Meet the requirement of limit.
15.247(a)(2)	6dB bandwidth	PASS	Meet the requirement of limit.
15.247(b)	Conducted power	PASS	Meet the requirement of limit.
15.247(e)	Power Spectral Density	PASS	Meet the requirement of limit.
15.203	Antenna Requirement	PASS	There is no antenna connector

2.1 Measurement Uncertainty

Where relevant, the following measurement uncertainty levels have been estimated for tests performed on the EUT as specified in CISPR 16-4-2:

Measurement	Frequency	Expanded Uncertainty (k=2) (\pm)
Conducted Emissions at mains ports	150kHz ~ 30MHz	1.84 dB
Radiated Emissions up to 1 GHz	30MHz ~ 1GHz	5.53 dB
Radiated Emissions above 1 GHz	1GHz ~ 6GHz	5.08 dB
	6GHz ~ 18GHz	4.98 dB
	18GHz ~ 40GHz	5.19 dB

2.2 Modification Record

There were no modifications required for compliance.

3 General Information

3.1 General Description of EUT (WLAN)

Product	5G MHS Travel Router
Brand	Netgear
Test Model	MR5000
Status of EUT	ENGINEERING SAMPLE
Power Supply Rating	5Vdc from power adapter or 5Vdc from USB interface or 3.8V dc from battery
Modulation Type	CCK, DQPSK, DBPSK for DSSS 64QAM, 16QAM, QPSK, BPSK for OFDM 256QAM for OFDM in 11ac mode and VHT (20/40) mode in 2.4GHz
Modulation Technology	DSSS, OFDM
Transfer Rate	802.11b: up to 11Mbps 802.11a/g: up to 54Mbps 802.11n: up to 300Mbps 802.11ac: up to 866.7Mbps
Operating Frequency	2.4GHz: 2.412 ~ 2.462GHz 5GHz: 5.18~ 5.24GHz, 5.745 ~ 5.825GHz
Number of Channel	2.4GHz: 802.11b, 802.11g, 802.11n (HT20), VHT20: 11 802.11n (HT40), VHT40: 7 5GHz: 802.11a, 802.11n (HT20), 802.11ac (VHT20): 9 802.11n (HT40), 802.11ac (VHT40): 4 802.11ac (VHT80): 2
Output Power	2.412 ~ 2.462GHz: 58.084mW 5.18 ~ 5.24GHz: 19.455mW 5.745 ~ 5.825GHz: 19.455mW
Antenna Type	Refer to Note
Antenna Connector	Refer to Note
Accessory Device	Adapter x1 , Battery x1
Data Cable Supplied	USB cable x 1 (Shielded, 0.95m)

Note:

1. Simultaneously transmission condition.

Condition	Technology		
1	WLAN 2.4GHz 1Tx	WLAN 5GHz 1Tx	WWAN or 5G NR

Note: The emission of the simultaneous operation has been evaluated and no non-compliance was found.

2. The EUT must be supplied with a power adapter or battery as following table:

Items	Brand	Model No.	P/N No.	Spec.
Adapter	NETGEAR	AD2122F20	332-11106-01	Input: 100-240V~50/60Hz 0.5A Output: 5V / 2.0A or 9V /1.8A
Battery	NETGEAR	W-10a	308-10084-01	3.85V dc 19.78Wh

3. The antennas provided to the EUT, please refer to the following table:

Ant No.	Antenna Net Gain (dBi)	Frequency rang (GHz)	Antenna type	Connector type
1	2.03	2.4~2.4835	Internal IFA	NA
	2.59	5.15~5.85		
2	2.03	2.4~2.4835	Internal IFA	NA
	2.59	5.15~5.85		

4. The EUT incorporates a MIMO function.

2.4GHz Band			
MODULATION MODE	DATA RATE (MCS)	TX & RX CONFIGURATION	
802.11b	1 ~ 11Mbps	2TX	2RX
802.11g	6 ~ 54Mbps	2TX	2RX
802.11n (HT20)	MCS 0~7	2TX	2RX
	MCS 8~15	2TX	2RX
802.11n (HT40)	MCS 0~7	2TX	2RX
	MCS 8~15	2TX	2RX
VHT20	MCS0~8 Nss=1	2TX	2RX
	MCS0~8 Nss=2	2TX	2RX
VHT40	MCS0~9 Nss=1	2TX	2RX
	MCS0~9 Nss=2	2TX	2RX
5GHz Band			
MODULATION MODE	DATA RATE (MCS)	TX & RX CONFIGURATION	
802.11a	6 ~ 54Mbps	2TX	2RX
802.11n (HT20)	MCS 0~7	2TX	2RX
	MCS 8~15	2TX	2RX
802.11n (HT40)	MCS 0~7	2TX	2RX
	MCS 8~15	2TX	2RX
802.11ac (VHT20)	MCS0~8 Nss=1	2TX	2RX
	MCS0~8 Nss=2	2TX	2RX
802.11ac (VHT40)	MCS0~9 Nss=1	2TX	2RX
	MCS0~9 Nss=2	2TX	2RX
802.11ac (VHT80)	MCS0~9 Nss=1	2TX	2RX
	MCS0~9 Nss=2	2TX	2RX

5. The EUT was pre-tested under the following modes:

Test Mode	Description
Mode A	With adapter mode
Mode B	With Laptop mode
Mode C	Power from battery

Note: From the above modes, radiated emission the worst case was found in **Mode A**. Therefore only the test data of the mode was recorded in this report.

6. The above EUT information is declared by manufacturer and for more detailed features description, please refer to the manufacturer's specifications or user's manual.

3.2 Description of Test Modes

11 channels are provided for 802.11b, 802.11g and 802.11n (HT20), VHT20:

Channel	Frequency	Channel	Frequency
1	2412MHz	7	2442MHz
2	2417MHz	8	2447MHz
3	2422MHz	9	2452MHz
4	2427MHz	10	2457MHz
5	2432MHz	11	2462MHz
6	2437MHz		

7 channels are provided for 802.11n (HT40), VHT40:

Channel	Frequency	Channel	Frequency
3	2422MHz	7	2442MHz
4	2427MHz	8	2447MHz
5	2432MHz	9	2452MHz
6	2437MHz		

3.2.1 Test Mode Applicability and Tested Channel Detail

EUT CONFIGURE MODE	APPLICABLE TO				DESCRIPTION
	RE \geq 1G	RE $<$ 1G	PLC	APCM	
1	√	√	√	√	With adapter mode
2	-	-	√	-	With Laptop mode

Where **RE \geq 1G**: Radiated Emission above 1GHz & Bandedge Measurement

RE $<$ 1G: Radiated Emission below 1GHz

PLC: Power Line Conducted Emission

APCM: Antenna Port Conducted Measurement

Note: The EUT had been pre-tested on the positioned of each 3 axis. The worst case was found when positioned on **X-plane**.

Radiated Emission Test (Above 1GHz):

- Pre-Scan has been conducted to determine the worst-case mode from all possible combinations between available modulations, data rates and antenna ports (if EUT with antenna diversity architecture).
- Following channel(s) was (were) selected for the final test as listed below.

MODE	AVAILABLE CHANNEL	TESTED CHANNEL	MODULATION TECHNOLOGY	MODULATION TYPE	DATA RATE (Mbps)
802.11b	1 to 11	1, 6, 11	DSSS	DBPSK	1
802.11g	1 to 11	1, 6, 11	OFDM	BPSK	6
VHT20	1 to 11	1, 6, 11	OFDM	BPSK	6.5
VHT40	3 to 9	3, 6, 9	OFDM	BPSK	13.5

Radiated Emission Test (Below 1GHz):

- Pre-Scan has been conducted to determine the worst-case mode from all possible combinations between available modulations, data rates and antenna ports (if EUT with antenna diversity architecture).
- Following channel(s) was (were) selected for the final test as listed below.

MODE	AVAILABLE CHANNEL	TESTED CHANNEL	MODULATION TECHNOLOGY	MODULATION TYPE	DATA RATE (Mbps)
VHT20	1 to 11	11	OFDM	BPSK	6.5

Power Line Conducted Emission Test:

- Pre-Scan has been conducted to determine the worst-case mode from all possible combinations between available modulations, data rates and antenna ports (if EUT with antenna diversity architecture).
- Following channel(s) was (were) selected for the final test as listed below.

MODE	AVAILABLE CHANNEL	TESTED CHANNEL	MODULATION TECHNOLOGY	MODULATION TYPE	DATA RATE (Mbps)
VHT20	1 to 11	11	OFDM	BPSK	6.5

Antenna Port Conducted Measurement:

- This item includes all test value of each mode, but only includes spectrum plot of worst value of each mode.
- Pre-Scan has been conducted to determine the worst-case mode from all possible combinations between available modulations, data rates and antenna ports (if EUT with antenna diversity architecture).
- Following channel(s) was (were) selected for the final test as listed below.

MODE	AVAILABLE CHANNEL	TESTED CHANNEL	MODULATION TECHNOLOGY	MODULATION TYPE	DATA RATE (Mbps)
802.11b	1 to 11	1, 6, 11	DSSS	DBPSK	1
802.11g	1 to 11	1, 6, 11	OFDM	BPSK	6
VHT20	1 to 11	1, 6, 11	OFDM	BPSK	6.5
VHT40	3 to 9	3, 6, 9	OFDM	BPSK	13.5

Test Condition:

APPLICABLE TO	ENVIRONMENTAL CONDITIONS	INPUT POWER	TESTED BY
RE \geq 1G	24deg. C, 63%RH	120Vac, 60Hz	Rey Chen
RE $<$ 1G	23deg. C, 68%RH	120Vac, 60Hz	Andy Ho
PLC	25deg. C, 75%RH	120Vac, 60Hz	Andy Ho
APCM	25deg. C, 60%RH	120Vac, 60Hz	Anderson Chen

3.3 Duty Cycle of Test Signal

If duty cycle of test signal is $\geq 98\%$, duty factor is not required.

If duty cycle of test signal is $< 98\%$, duty factor shall be considered.

802.11b: Duty cycle = $8.172 \text{ ms} / 8.254 \text{ ms} = 0.99$

802.11g: Duty cycle = $1.357 \text{ ms} / 1.412 \text{ ms} = 0.961$, Duty factor = $10 * \log(1/\text{Duty cycle}) = 0.17$

VHT20: Duty cycle = $1.27 \text{ ms} / 1.323 \text{ ms} = 0.96$, Duty factor = $10 * \log(1/\text{Duty cycle}) = 0.18$

VHT40: Duty cycle = $0.632 \text{ ms} / 0.67 \text{ ms} = 0.943$, Duty factor = $10 * \log(1/\text{Duty cycle}) = 0.25$

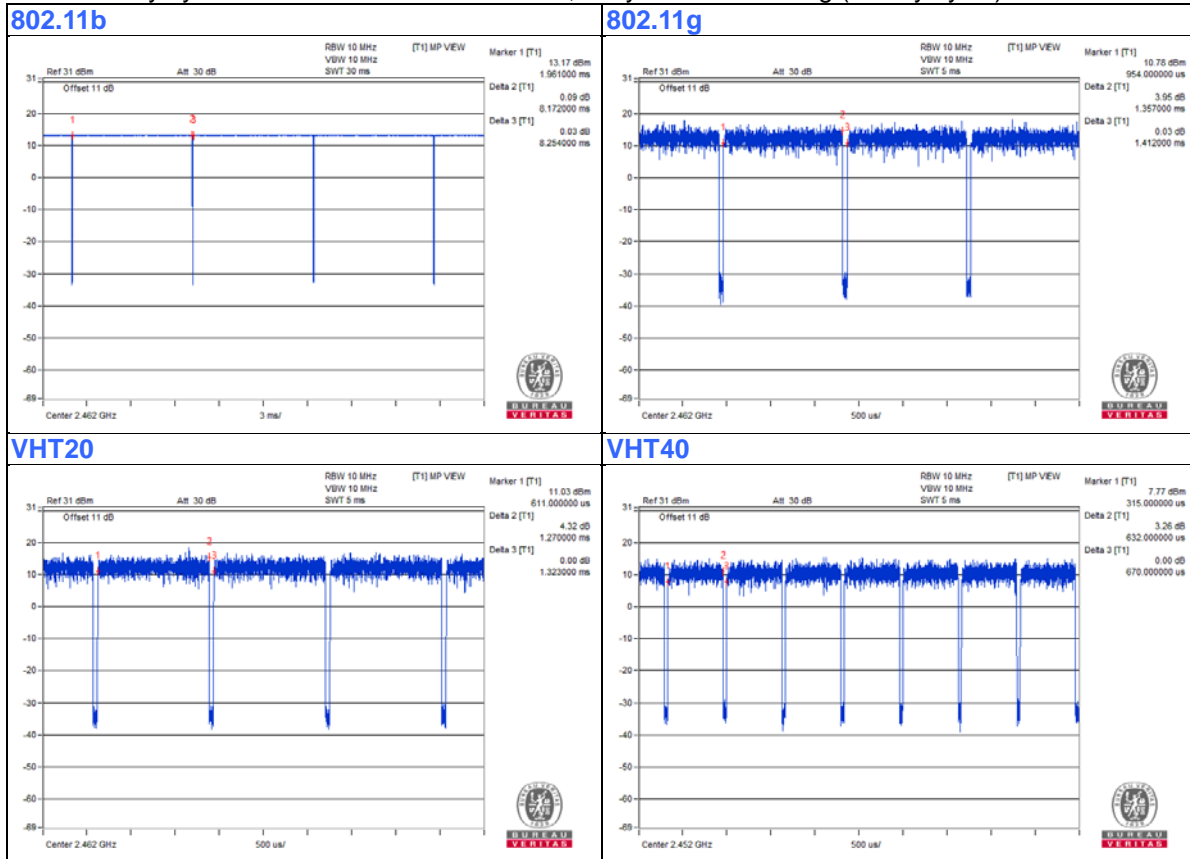

3.4 Description of Support Units

The EUT has been tested as an independent unit together with other necessary accessories or support units. The following support units or accessories were used to form a representative test configuration during the tests.

ID	Product	Brand	Model No.	Serial No.	FCC ID	Remarks
A.	SIM Card	R&S	CMW-Z05	NA	NA	Provided by Lab
B.	Laptop	DELL	E6420	B92T3R1	FCC DoC	Provided by Lab

Note:

1. All power cords of the above support units are non-shielded (1.8m).

ID	Descriptions	Qty.	Length (m)	Shielding (Yes/No)	Cores (Qty.)	Remarks
1.	USB type C Cable	1	0.95	Yes	0	Supplied by client

3.4.1 Configuration of System under Test

Adapter mode:

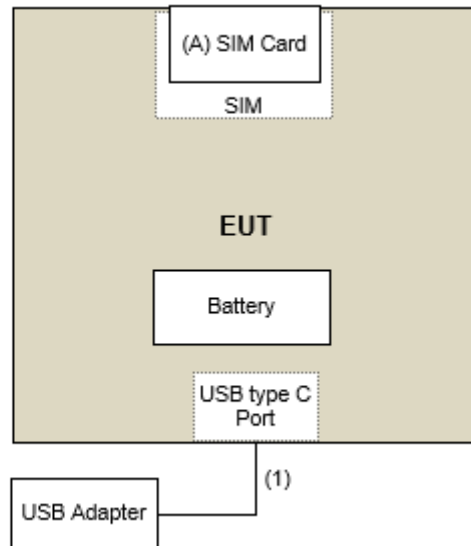

Laptop mode:

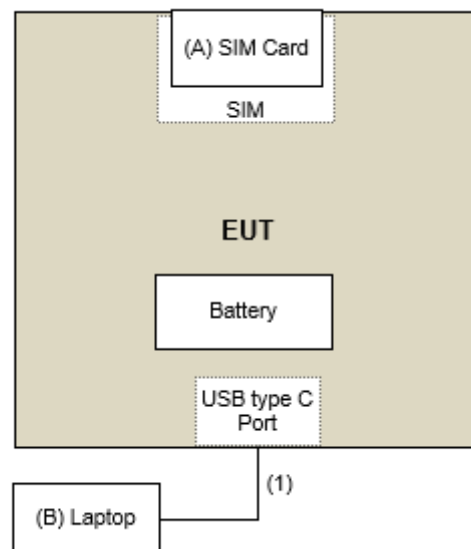

3.5 General Description of Applied Standards

The EUT is a RF Product. According to the specifications of the manufacturer, it must comply with the requirements of the following standards:

FCC Part 15, Subpart C (15.247)

KDB 558074 D01 15.247 Meas Guidance v05

KDB 662911 D01 Multiple Transmitter Output v02r01

ANSI C63.10-2013

All test items have been performed and recorded as per the above standards.

4 Test Types and Results

4.1 Radiated Emission and Bandedge Measurement

4.1.1 Limits of Radiated Emission and Bandedge Measurement

Radiated emissions which fall in the restricted bands must comply with the radiated emission limits specified as below table. Other emissions shall be at least 20dB below the highest level of the desired power:

Frequencies (MHz)	Field Strength (microvolts/meter)	Measurement Distance (meters)
0.009 ~ 0.490	2400/F(kHz)	300
0.490 ~ 1.705	24000/F(kHz)	30
1.705 ~ 30.0	30	30
30 ~ 88	100	3
88 ~ 216	150	3
216 ~ 960	200	3
Above 960	500	3

Note:

1. The lower limit shall apply at the transition frequencies.
2. Emission level (dBuV/m) = 20 log Emission level (uV/m).
3. For frequencies above 1000MHz, the field strength limits are based on average detector, however, the peak field strength of any emission shall not exceed the maximum permitted average limits, specified above by more than 20dB under any condition of modulation.

4.1.2 Test Instruments

DESCRIPTION & MANUFACTURER	MODEL NO.	SERIAL NO.	CALIBRATED DATE	CALIBRATED UNTIL
Test Receiver Agilent	N9038A	MY50010156	July 12, 2018	July 11, 2019
Pre-Amplifier EMCI	EMC001340	980142	Feb. 09, 2018	Feb. 08, 2019
Loop Antenna(*) Electro-Metrics	EM-6879	264	Dec. 16, 2016	Dec. 15, 2018
RF Cable	NA	LOOPCAB-001	Jan. 15, 2018	Jan. 14, 2019
RF Cable	NA	LOOPCAB-002	Jan. 15, 2018	Jan. 14, 2019
Pre-Amplifier Mini-Circuits	ZFL-1000VH2B	AMP-ZFL-05	May 05, 2018	May 04, 2019
Trilog Broadband Antenna SCHWARZBECK	VULB 9168	9168-361	Nov. 29, 2017	Nov. 28, 2018
RF Cable	8D	966-3-1	Mar. 20, 2018	Mar. 19, 2019
RF Cable	8D	966-3-2	Mar. 20, 2018	Mar. 19, 2019
RF Cable	8D	966-3-3	Mar. 20, 2018	Mar. 19, 2019
Fixed attenuator Mini-Circuits	UNAT-5+	PAD-3m-3-01	Sep. 27, 2018	Sep. 26, 2019
Horn_Antenna SCHWARZBECK	BBHA9120-D	9120D-406	Dec. 12, 2017	Dec. 11, 2018
Pre-Amplifier EMCI	EMC12630SE	980384	Jan. 29, 2018	Jan. 28, 2019
RF Cable	EMC104-SM-SM-1200	160922	Jan. 29, 2018	Jan. 28, 2019
RF Cable	EMC104-SM-SM-2000	150317	Jan. 29, 2018	Jan. 28, 2019
RF Cable	EMC104-SM-SM-5000	150322	Jan. 29, 2018	Jan. 28, 2019
Spectrum Analyzer Keysight	N9030A	MY54490679	July 23, 2018	July 22, 2019
Pre-Amplifier EMCI	EMC184045SE	980386	Jan. 29, 2018	Jan. 28, 2019
Horn_Antenna SCHWARZBECK	BBHA 9170	BBHA9170608	Dec. 14, 2017	Dec. 13, 2018
RF Cable	EMC102-KM-KM-1200	160924	Jan. 29, 2018	Jan. 28, 2019
Software	ADT_Radiated_V8.7.08	NA	NA	NA
Antenna Tower & Turn Table Max-Full	MF-7802	MF780208406	NA	NA
Boresight Antenna Fixture	FBA-01	FBA-SIP01	NA	NA
Spectrum Analyzer Agilent	E4446A	MY48250254	Nov. 21, 2017	Nov. 20, 2018
Power meter Anritsu	ML2495A	1014008	May 09, 2018	May 08, 2019
Power sensor Anritsu	MA2411B	0917122	May 09, 2018	May 08, 2019

Note:

1. The calibration interval of the above test instruments is 12 months and the calibrations are traceable to NML/ROC and NIST/USA.
2. *The calibration interval of the above test instruments is 24 months and the calibrations are traceable to NML/ROC and NIST/USA.
3. The test was performed in 966 Chamber No. 3.
4. The CANADA Site Registration No. is 20331-1
5. Loop antenna was used for all emissions below 30 MHz.
6. Tested Date: Nov. 07 to 14, 2018

4.1.3 Test Procedures

For Radiated emission below 30MHz

- a. The EUT was placed on the top of a rotating table 0.8 meters above the ground at a 3 meter chamber room. The table was rotated 360 degrees to determine the position of the highest radiation.
- b. The EUT was set 3 meters away from the interference-receiving antenna, which was mounted on the top of a variable-height antenna tower.
- c. Parallel, perpendicular, and ground-parallel orientations of the antenna are set to make the measurement.
- d. For each suspected emission, the EUT was arranged to its worst case and the rotatable table was turned from 0 degrees to 360 degrees to find the maximum reading.
- e. The test-receiver system was set to Quasi-Peak Detect Function and Specified Bandwidth with Maximum Hold Mode.

Note:

1. The resolution bandwidth and video bandwidth of test receiver/spectrum analyzer is 9kHz at frequency below 30MHz.

For Radiated emission above 30MHz

- a. The EUT was placed on the top of a rotating table 0.8 meters (for 30MHz ~ 1GHz) / 1.5 meters (for above 1GHz) above the ground at 3 meter chamber room for test. The table was rotated 360 degrees to determine the position of the highest radiation.
- b. The EUT was set 3 meters away from the interference-receiving antenna, which was mounted on the top of a variable-height antenna tower.
- c. The height of antenna is varied from one meter to four meters above the ground to determine the maximum value of the field strength. Both horizontal and vertical polarizations of the antenna are set to make the measurement.
- d. For each suspected emission, the EUT was arranged to its worst case and then the antenna was tuned to heights from 1 meter to 4 meters and the rotatable table was turned from 0 degrees to 360 degrees to find the maximum reading.
- e. The test-receiver system was set to quasi-peak detect function and specified bandwidth with maximum hold mode when the test frequency is below 1 GHz.
- f. The test-receiver system was set to peak and average detects function and specified bandwidth with maximum hold mode when the test frequency is above 1 GHz. If the peak reading value also meets average limit, measurement with the average detector is unnecessary.

Note:

1. The resolution bandwidth and video bandwidth of test receiver/spectrum analyzer is 120kHz for Quasi-peak detection (QP) at frequency below 1GHz.
2. The resolution bandwidth of test receiver/spectrum analyzer is 1 MHz and the video bandwidth is 3 MHz for Peak detection (PK) at frequency above 1GHz.
3. The resolution bandwidth of test receiver/spectrum analyzer is 1MHz and the video bandwidth is $\geq 1/T$ (Duty cycle $< 98\%$) or 10Hz (Duty cycle $\geq 98\%$) for Average detection (AV) at frequency above 1GHz.
4. All modes of operation were investigated and the worst-case emissions are reported.

4.1.4 Deviation from Test Standard

No deviation.

4.1.5 Test Setup

For Radiated emission below 30MHz

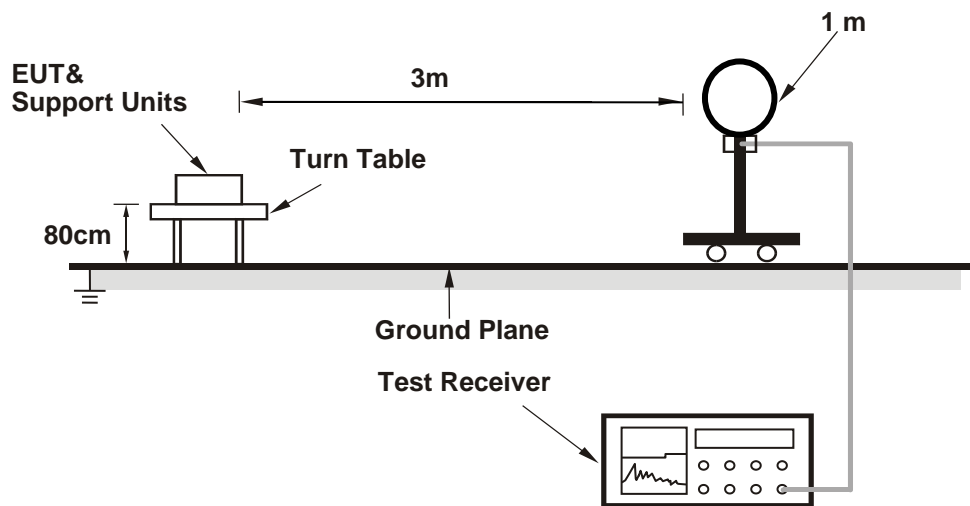

For Radiated emission 30MHz to 1GHz

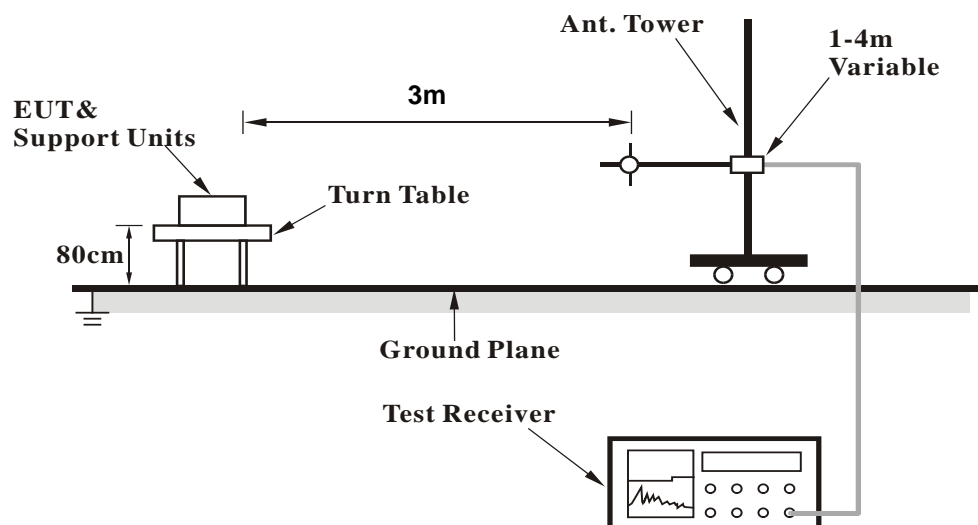

For Radiated emission above 1GHz

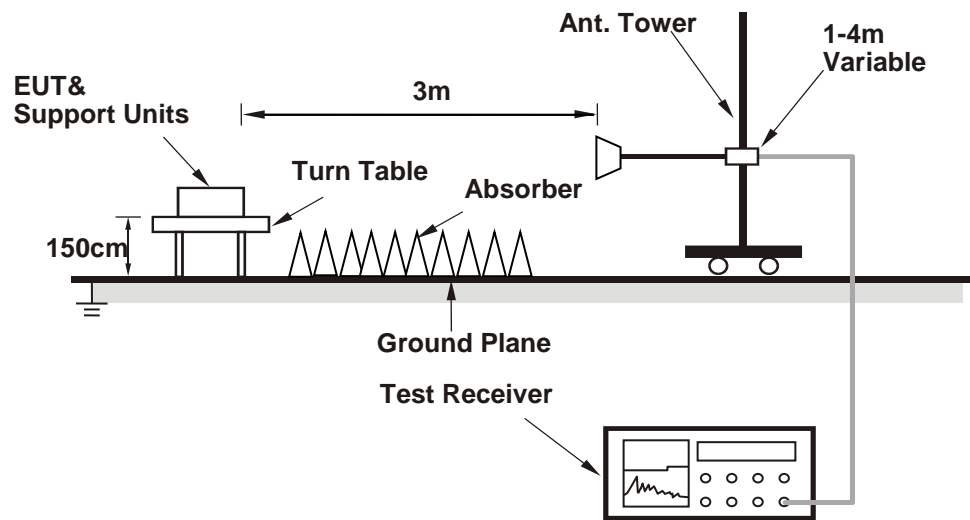

For the actual test configuration, please refer to the attached file (Test Setup Photo).

4.1.6 EUT Operating Conditions

- a. Connected the EUT with the Laptop which is placed on remote site.
- b. Controlling software (QDART (4.8.00059)) has been activated to set the EUT on specific status.

4.1.7 Test Results

Above 1GHz Data :

802.11b

CHANNEL	TX Channel 1	DETECTOR FUNCTION	Peak (PK)
FREQUENCY RANGE	1GHz ~ 25GHz		Average (AV)

ANTENNA POLARITY & TEST DISTANCE: HORIZONTAL AT 3 M

NO.	FREQ. (MHz)	EMISSION LEVEL (dBuV/m)	LIMIT (dBuV/m)	MARGIN (dB)	ANTENNA HEIGHT (m)	TABLE ANGLE (Degree)	RAW VALUE (dBuV)	CORRECTION FACTOR (dB/m)
1	2390.00	57.3 PK	74.0	-16.7	1.55 H	259	60.0	-2.7
2	2390.00	44.7 AV	54.0	-9.3	1.55 H	259	47.4	-2.7
3	*2412.00	106.0 PK			1.55 H	259	108.7	-2.7
4	*2412.00	103.6 AV			1.55 H	259	106.3	-2.7
5	4824.00	40.4 PK	74.0	-33.6	1.70 H	118	38.8	1.6
6	4824.00	28.0 AV	54.0	-26.0	1.70 H	118	26.4	1.6

ANTENNA POLARITY & TEST DISTANCE: VERTICAL AT 3 M

NO.	FREQ. (MHz)	EMISSION LEVEL (dBuV/m)	LIMIT (dBuV/m)	MARGIN (dB)	ANTENNA HEIGHT (m)	TABLE ANGLE (Degree)	RAW VALUE (dBuV)	CORRECTION FACTOR (dB/m)
1	2390.00	58.5 PK	74.0	-15.5	2.76 V	277	61.2	-2.7
2	2390.00	44.6 AV	54.0	-9.4	2.76 V	277	47.3	-2.7
3	*2412.00	101.2 PK			2.76 V	277	103.9	-2.7
4	*2412.00	98.5 AV			2.76 V	277	101.2	-2.7
5	4824.00	40.2 PK	74.0	-33.8	1.65 V	231	38.6	1.6
6	4824.00	28.5 AV	54.0	-25.5	1.65 V	231	26.9	1.6

REMARKS:

1. Emission Level(dBuV/m) = Raw Value(dBuV) + Correction Factor(dB/m)
2. Correction Factor(dB/m) = Antenna Factor(dB/m) + Cable Factor(dB) – Pre-Amplifier Factor(dB)
3. The other emission levels were very low against the limit.
4. Margin value = Emission Level – Limit value
5. " * ": Fundamental frequency.

CHANNEL	TX Channel 6	DETECTOR FUNCTION	Peak (PK)
FREQUENCY RANGE	1GHz ~ 25GHz		Average (AV)

ANTENNA POLARITY & TEST DISTANCE: HORIZONTAL AT 3 M

NO.	FREQ. (MHz)	EMISSION LEVEL (dBuV/m)	LIMIT (dBuV/m)	MARGIN (dB)	ANTENNA HEIGHT (m)	TABLE ANGLE (Degree)	RAW VALUE (dBuV)	CORRECTION FACTOR (dB/m)
1	2390.00	56.5 PK	74.0	-17.5	1.56 H	224	59.2	-2.7
2	2390.00	44.2 AV	54.0	-9.8	1.56 H	224	46.9	-2.7
3	*2437.00	105.7 PK			1.56 H	224	108.7	-3.0
4	*2437.00	103.1 AV			1.56 H	224	106.1	-3.0
5	2483.50	56.7 PK	74.0	-17.3	1.56 H	224	59.7	-3.0
6	2483.50	44.3 AV	54.0	-9.7	1.56 H	224	47.3	-3.0
7	4874.00	40.4 PK	74.0	-33.6	1.70 H	121	38.8	1.6
8	4874.00	28.4 AV	54.0	-25.6	1.70 H	121	26.8	1.6
9	7311.00	45.8 PK	74.0	-28.2	1.67 H	216	38.1	7.7
10	7311.00	34.5 AV	54.0	-19.5	1.67 H	216	26.8	7.7

ANTENNA POLARITY & TEST DISTANCE: VERTICAL AT 3 M

NO.	FREQ. (MHz)	EMISSION LEVEL (dBuV/m)	LIMIT (dBuV/m)	MARGIN (dB)	ANTENNA HEIGHT (m)	TABLE ANGLE (Degree)	RAW VALUE (dBuV)	CORRECTION FACTOR (dB/m)
1	2390.00	56.6 PK	74.0	-17.4	2.82 V	274	59.3	-2.7
2	2390.00	44.1 AV	54.0	-9.9	2.82 V	274	46.8	-2.7
3	*2437.00	100.4 PK			2.82 V	274	103.4	-3.0
4	*2437.00	98.0 AV			2.82 V	274	101.0	-3.0
5	2483.50	57.1 PK	74.0	-16.9	2.82 V	274	60.1	-3.0
6	2483.50	44.8 AV	54.0	-9.2	2.82 V	274	47.8	-3.0
7	4874.00	39.9 PK	74.0	-34.1	1.70 V	220	38.3	1.6
8	4874.00	27.9 AV	54.0	-26.1	1.70 V	220	26.3	1.6
9	7311.00	45.9 PK	74.0	-28.1	1.80 V	189	38.2	7.7
10	7311.00	33.8 AV	54.0	-20.2	1.80 V	189	26.1	7.7

REMARKS:

1. Emission Level(dBuV/m) = Raw Value(dBuV) + Correction Factor(dB/m)
2. Correction Factor(dB/m) = Antenna Factor(dB/m) + Cable Factor(dB) – Pre-Amplifier Factor(dB)
3. The other emission levels were very low against the limit.
4. Margin value = Emission Level – Limit value
5. " * ": Fundamental frequency.

CHANNEL	TX Channel 11	DETECTOR FUNCTION	Peak (PK)
FREQUENCY RANGE	1GHz ~ 25GHz		Average (AV)

ANTENNA POLARITY & TEST DISTANCE: HORIZONTAL AT 3 M

NO.	FREQ. (MHz)	EMISSION LEVEL (dBuV/m)	LIMIT (dBuV/m)	MARGIN (dB)	ANTENNA HEIGHT (m)	TABLE ANGLE (Degree)	RAW VALUE (dBuV)	CORRECTION FACTOR (dB/m)
1	*2462.00	105.5 PK			1.54 H	235	108.5	-3.0
2	*2462.00	102.9 AV			1.54 H	235	105.9	-3.0
3	2483.50	57.2 PK	74.0	-16.8	1.54 H	235	60.2	-3.0
4	2483.50	44.6 AV	54.0	-9.4	1.54 H	235	47.6	-3.0
5	4924.00	40.6 PK	74.0	-33.4	1.65 H	125	38.9	1.7
6	4924.00	28.5 AV	54.0	-25.5	1.65 H	125	26.8	1.7
7	7386.00	46.2 PK	74.0	-27.8	1.70 H	200	38.3	7.9
8	7386.00	34.8 AV	54.0	-19.2	1.70 H	200	26.9	7.9

ANTENNA POLARITY & TEST DISTANCE: VERTICAL AT 3 M

NO.	FREQ. (MHz)	EMISSION LEVEL (dBuV/m)	LIMIT (dBuV/m)	MARGIN (dB)	ANTENNA HEIGHT (m)	TABLE ANGLE (Degree)	RAW VALUE (dBuV)	CORRECTION FACTOR (dB/m)
1	*2462.00	101.0 PK			2.74 V	268	104.0	-3.0
2	*2462.00	98.1 AV			2.74 V	268	101.1	-3.0
3	2483.50	59.0 PK	74.0	-15.0	2.74 V	268	62.0	-3.0
4	2483.50	45.0 AV	54.0	-9.0	2.74 V	268	48.0	-3.0
5	4924.00	40.2 PK	74.0	-33.8	1.70 V	235	38.5	1.7
6	4924.00	28.3 AV	54.0	-25.7	1.70 V	235	26.6	1.7
7	7386.00	46.0 PK	74.0	-28.0	1.77 V	200	38.1	7.9
8	7386.00	34.2 AV	54.0	-19.8	1.77 V	200	26.3	7.9

REMARKS:

1. Emission Level(dBuV/m) = Raw Value(dBuV) + Correction Factor(dB/m)
2. Correction Factor(dB/m) = Antenna Factor(dB/m) + Cable Factor(dB) – Pre-Amplifier Factor(dB)
3. The other emission levels were very low against the limit.
4. Margin value = Emission Level – Limit value
5. " * ": Fundamental frequency.

802.11g

CHANNEL	TX Channel 1	DETECTOR FUNCTION	Peak (PK)
FREQUENCY RANGE	1GHz ~ 25GHz		Average (AV)

ANTENNA POLARITY & TEST DISTANCE: HORIZONTAL AT 3 M

NO.	FREQ. (MHz)	EMISSION LEVEL (dBuV/m)	LIMIT (dBuV/m)	MARGIN (dB)	ANTENNA HEIGHT (m)	TABLE ANGLE (Degree)	RAW VALUE (dBuV)	CORRECTION FACTOR (dB/m)
1	2390.00	65.4 PK	74.0	-8.6	1.50 H	235	68.1	-2.7
2	2390.00	46.8 AV	54.0	-7.2	1.50 H	235	49.5	-2.7
3	*2412.00	108.9 PK			1.50 H	235	111.6	-2.7
4	*2412.00	97.4 AV			1.50 H	235	100.1	-2.7
5	4824.00	41.2 PK	74.0	-32.8	1.65 H	128	39.6	1.6
6	4824.00	28.9 AV	54.0	-25.1	1.65 H	128	27.3	1.6

ANTENNA POLARITY & TEST DISTANCE: VERTICAL AT 3 M

NO.	FREQ. (MHz)	EMISSION LEVEL (dBuV/m)	LIMIT (dBuV/m)	MARGIN (dB)	ANTENNA HEIGHT (m)	TABLE ANGLE (Degree)	RAW VALUE (dBuV)	CORRECTION FACTOR (dB/m)
1	2390.00	58.6 PK	74.0	-15.4	2.77 V	274	61.3	-2.7
2	2390.00	44.6 AV	54.0	-9.4	2.77 V	274	47.3	-2.7
3	*2412.00	104.0 PK			2.77 V	274	106.7	-2.7
4	*2412.00	92.3 AV			2.77 V	274	95.0	-2.7
5	4824.00	39.9 PK	74.0	-34.1	1.72 V	240	38.3	1.6
6	4824.00	27.9 AV	54.0	-26.1	1.72 V	240	26.3	1.6

REMARKS:

1. Emission Level(dBuV/m) = Raw Value(dBuV) + Correction Factor(dB/m)
2. Correction Factor(dB/m) = Antenna Factor(dB/m) + Cable Factor(dB) – Pre-Amplifier Factor(dB)
3. The other emission levels were very low against the limit.
4. Margin value = Emission Level – Limit value
5. " * ": Fundamental frequency.

CHANNEL	TX Channel 6	DETECTOR FUNCTION	Peak (PK)
FREQUENCY RANGE	1GHz ~ 25GHz		Average (AV)

ANTENNA POLARITY & TEST DISTANCE: HORIZONTAL AT 3 M

NO.	FREQ. (MHz)	EMISSION LEVEL (dBuV/m)	LIMIT (dBuV/m)	MARGIN (dB)	ANTENNA HEIGHT (m)	TABLE ANGLE (Degree)	RAW VALUE (dBuV)	CORRECTION FACTOR (dB/m)
1	2390.00	64.8 PK	74.0	-9.2	1.62 H	238	67.5	-2.7
2	2390.00	46.4 AV	54.0	-7.6	1.62 H	238	49.1	-2.7
3	*2437.00	109.4 PK			1.62 H	238	112.4	-3.0
4	*2437.00	97.4 AV			1.62 H	238	100.4	-3.0
5	2483.50	63.8 PK	74.0	-10.2	1.62 H	238	66.8	-3.0
6	2483.50	46.0 AV	54.0	-8.0	1.62 H	238	49.0	-3.0
7	4874.00	41.4 PK	74.0	-32.6	1.66 H	139	39.8	1.6
8	4874.00	29.0 AV	54.0	-25.0	1.66 H	139	27.4	1.6
9	7311.00	45.0 PK	74.0	-29.0	1.69 H	193	37.3	7.7
10	7311.00	33.5 AV	54.0	-20.5	1.69 H	193	25.8	7.7

ANTENNA POLARITY & TEST DISTANCE: VERTICAL AT 3 M

NO.	FREQ. (MHz)	EMISSION LEVEL (dBuV/m)	LIMIT (dBuV/m)	MARGIN (dB)	ANTENNA HEIGHT (m)	TABLE ANGLE (Degree)	RAW VALUE (dBuV)	CORRECTION FACTOR (dB/m)
1	2390.00	57.2 PK	74.0	-16.8	2.79 V	285	59.9	-2.7
2	2390.00	44.6 AV	54.0	-9.4	2.79 V	285	47.3	-2.7
3	*2437.00	103.7 PK			2.79 V	285	106.7	-3.0
4	*2437.00	91.8 AV			2.79 V	285	94.8	-3.0
5	2483.50	56.3 PK	74.0	-17.7	2.79 V	285	59.3	-3.0
6	2483.50	44.0 AV	54.0	-10.0	2.79 V	285	47.0	-3.0
7	4874.00	39.7 PK	74.0	-34.3	1.74 V	234	38.1	1.6
8	4874.00	27.9 AV	54.0	-26.1	1.74 V	234	26.3	1.6
9	7311.00	45.8 PK	74.0	-28.2	1.72 V	187	38.1	7.7
10	7311.00	34.0 AV	54.0	-20.0	1.72 V	187	26.3	7.7

REMARKS:

1. Emission Level(dBuV/m) = Raw Value(dBuV) + Correction Factor(dB/m)
2. Correction Factor(dB/m) = Antenna Factor(dB/m) + Cable Factor(dB) – Pre-Amplifier Factor(dB)
3. The other emission levels were very low against the limit.
4. Margin value = Emission Level – Limit value
5. " * ": Fundamental frequency.

CHANNEL	TX Channel 11	DETECTOR FUNCTION	Peak (PK)
FREQUENCY RANGE	1GHz ~ 25GHz		Average (AV)

ANTENNA POLARITY & TEST DISTANCE: HORIZONTAL AT 3 M

NO.	FREQ. (MHz)	EMISSION LEVEL (dBuV/m)	LIMIT (dBuV/m)	MARGIN (dB)	ANTENNA HEIGHT (m)	TABLE ANGLE (Degree)	RAW VALUE (dBuV)	CORRECTION FACTOR (dB/m)
1	*2462.00	109.8 PK			1.61 H	258	112.8	-3.0
2	*2462.00	98.0 AV			1.61 H	258	101.0	-3.0
3	2483.50	64.8 PK	74.0	-9.2	1.61 H	258	67.8	-3.0
4	2483.50	46.6 AV	54.0	-7.4	1.61 H	258	49.6	-3.0
5	4924.00	41.0 PK	74.0	-33.0	1.66 H	125	39.3	1.7
6	4924.00	28.7 AV	54.0	-25.3	1.66 H	125	27.0	1.7
7	7386.00	45.1 PK	74.0	-28.9	1.66 H	194	37.2	7.9
8	7386.00	33.5 AV	54.0	-20.5	1.66 H	194	25.6	7.9

ANTENNA POLARITY & TEST DISTANCE: VERTICAL AT 3 M

NO.	FREQ. (MHz)	EMISSION LEVEL (dBuV/m)	LIMIT (dBuV/m)	MARGIN (dB)	ANTENNA HEIGHT (m)	TABLE ANGLE (Degree)	RAW VALUE (dBuV)	CORRECTION FACTOR (dB/m)
1	*2462.00	103.5 PK			2.83 V	279	106.5	-3.0
2	*2462.00	92.0 AV			2.83 V	279	95.0	-3.0
3	2483.50	58.9 PK	74.0	-15.1	2.83 V	279	61.9	-3.0
4	2483.50	44.7 AV	54.0	-9.3	2.83 V	279	47.7	-3.0
5	4924.00	40.2 PK	74.0	-33.8	1.79 V	218	38.5	1.7
6	4924.00	28.2 AV	54.0	-25.8	1.79 V	218	26.5	1.7
7	7386.00	45.9 PK	74.0	-28.1	1.68 V	179	38.0	7.9
8	7386.00	34.1 AV	54.0	-19.9	1.68 V	179	26.2	7.9

REMARKS:

1. Emission Level(dBuV/m) = Raw Value(dBuV) + Correction Factor(dB/m)
2. Correction Factor(dB/m) = Antenna Factor(dB/m) + Cable Factor(dB) – Pre-Amplifier Factor(dB)
3. The other emission levels were very low against the limit.
4. Margin value = Emission Level – Limit value
5. " * ": Fundamental frequency.

VHT20

CHANNEL	TX Channel 1	DETECTOR FUNCTION	Peak (PK)
FREQUENCY RANGE	1GHz ~ 25GHz		Average (AV)

ANTENNA POLARITY & TEST DISTANCE: HORIZONTAL AT 3 M

NO.	FREQ. (MHz)	EMISSION LEVEL (dBuV/m)	LIMIT (dBuV/m)	MARGIN (dB)	ANTENNA HEIGHT (m)	TABLE ANGLE (Degree)	RAW VALUE (dBuV)	CORRECTION FACTOR (dB/m)
1	2390.00	64.8 PK	74.0	-9.2	1.54 H	240	67.5	-2.7
2	2390.00	46.4 AV	54.0	-7.6	1.54 H	240	49.1	-2.7
3	*2412.00	109.2 PK			1.54 H	240	111.9	-2.7
4	*2412.00	97.6 AV			1.54 H	240	100.3	-2.7
5	4824.00	41.7 PK	74.0	-32.3	1.70 H	131	40.1	1.6
6	4824.00	29.2 AV	54.0	-24.8	1.70 H	131	27.6	1.6

ANTENNA POLARITY & TEST DISTANCE: VERTICAL AT 3 M

NO.	FREQ. (MHz)	EMISSION LEVEL (dBuV/m)	LIMIT (dBuV/m)	MARGIN (dB)	ANTENNA HEIGHT (m)	TABLE ANGLE (Degree)	RAW VALUE (dBuV)	CORRECTION FACTOR (dB/m)
1	2390.00	58.5 PK	74.0	-15.5	2.80 V	260	61.2	-2.7
2	2390.00	44.4 AV	54.0	-9.6	2.80 V	260	47.1	-2.7
3	*2412.00	104.0 PK			2.80 V	260	106.7	-2.7
4	*2412.00	92.2 AV			2.80 V	260	94.9	-2.7
5	4824.00	39.4 PK	74.0	-34.6	1.78 V	242	37.8	1.6
6	4824.00	27.8 AV	54.0	-26.2	1.78 V	242	26.2	1.6

REMARKS:

1. Emission Level(dBuV/m) = Raw Value(dBuV) + Correction Factor(dB/m)
2. Correction Factor(dB/m) = Antenna Factor(dB/m) + Cable Factor(dB) – Pre-Amplifier Factor(dB)
3. The other emission levels were very low against the limit.
4. Margin value = Emission Level – Limit value
5. " * ": Fundamental frequency.

CHANNEL	TX Channel 6	DETECTOR FUNCTION	Peak (PK)
FREQUENCY RANGE	1GHz ~ 25GHz		Average (AV)

ANTENNA POLARITY & TEST DISTANCE: HORIZONTAL AT 3 M

NO.	FREQ. (MHz)	EMISSION LEVEL (dBuV/m)	LIMIT (dBuV/m)	MARGIN (dB)	ANTENNA HEIGHT (m)	TABLE ANGLE (Degree)	RAW VALUE (dBuV)	CORRECTION FACTOR (dB/m)
1	2390.00	65.3 PK	74.0	-8.7	1.61 H	243	68.0	-2.7
2	2390.00	46.7 AV	54.0	-7.3	1.61 H	243	49.4	-2.7
3	*2437.00	109.1 PK			1.61 H	243	112.1	-3.0
4	*2437.00	97.2 AV			1.61 H	243	100.2	-3.0
5	2483.50	64.5 PK	74.0	-9.5	1.61 H	243	67.5	-3.0
6	2483.50	46.4 AV	54.0	-7.6	1.61 H	243	49.4	-3.0
7	4874.00	41.6 PK	74.0	-32.4	1.66 H	140	40.0	1.6
8	4874.00	29.5 AV	54.0	-24.5	1.66 H	140	27.9	1.6
9	7311.00	45.5 PK	74.0	-28.5	1.72 H	200	37.8	7.7
10	7311.00	33.7 AV	54.0	-20.3	1.72 H	200	26.0	7.7

ANTENNA POLARITY & TEST DISTANCE: VERTICAL AT 3 M

NO.	FREQ. (MHz)	EMISSION LEVEL (dBuV/m)	LIMIT (dBuV/m)	MARGIN (dB)	ANTENNA HEIGHT (m)	TABLE ANGLE (Degree)	RAW VALUE (dBuV)	CORRECTION FACTOR (dB/m)
1	2390.00	56.7 PK	74.0	-17.3	2.73 V	260	59.4	-2.7
2	2390.00	44.3 AV	54.0	-9.7	2.73 V	260	47.0	-2.7
3	*2437.00	104.1 PK			2.73 V	260	107.1	-3.0
4	*2437.00	92.1 AV			2.73 V	260	95.1	-3.0
5	2483.50	56.5 PK	74.0	-17.5	2.73 V	260	59.5	-3.0
6	2483.50	44.3 AV	54.0	-9.7	2.73 V	260	47.3	-3.0
7	4874.00	39.3 PK	74.0	-34.7	1.76 V	222	37.7	1.6
8	4874.00	27.6 AV	54.0	-26.4	1.76 V	222	26.0	1.6
9	7311.00	46.1 PK	74.0	-27.9	1.75 V	202	38.4	7.7
10	7311.00	34.1 AV	54.0	-19.9	1.75 V	202	26.4	7.7

REMARKS:

1. Emission Level(dBuV/m) = Raw Value(dBuV) + Correction Factor(dB/m)
2. Correction Factor(dB/m) = Antenna Factor(dB/m) + Cable Factor(dB) – Pre-Amplifier Factor(dB)
3. The other emission levels were very low against the limit.
4. Margin value = Emission Level – Limit value
5. " * ": Fundamental frequency.

CHANNEL	TX Channel 11	DETECTOR FUNCTION	Peak (PK)
FREQUENCY RANGE	1GHz ~ 25GHz		Average (AV)

ANTENNA POLARITY & TEST DISTANCE: HORIZONTAL AT 3 M

NO.	FREQ. (MHz)	EMISSION LEVEL (dBuV/m)	LIMIT (dBuV/m)	MARGIN (dB)	ANTENNA HEIGHT (m)	TABLE ANGLE (Degree)	RAW VALUE (dBuV)	CORRECTION FACTOR (dB/m)
1	*2462.00	109.3 PK			1.56 H	243	112.3	-3.0
2	*2462.00	97.5 AV			1.56 H	243	100.5	-3.0
3	2483.50	64.5 PK	74.0	-9.5	1.56 H	243	67.5	-3.0
4	2483.50	46.3 AV	54.0	-7.7	1.56 H	243	49.3	-3.0
5	4924.00	41.6 PK	74.0	-32.4	1.69 H	126	39.9	1.7
6	4924.00	29.0 AV	54.0	-25.0	1.69 H	126	27.3	1.7
7	7386.00	45.1 PK	74.0	-28.9	1.65 H	180	37.2	7.9
8	7386.00	33.7 AV	54.0	-20.3	1.65 H	180	25.8	7.9

ANTENNA POLARITY & TEST DISTANCE: VERTICAL AT 3 M

NO.	FREQ. (MHz)	EMISSION LEVEL (dBuV/m)	LIMIT (dBuV/m)	MARGIN (dB)	ANTENNA HEIGHT (m)	TABLE ANGLE (Degree)	RAW VALUE (dBuV)	CORRECTION FACTOR (dB/m)
1	*2462.00	104.5 PK			2.71 V	267	107.5	-3.0
2	*2462.00	92.7 AV			2.71 V	267	95.7	-3.0
3	2483.50	59.0 PK	74.0	-15.0	2.71 V	267	62.0	-3.0
4	2483.50	44.7 AV	54.0	-9.3	2.71 V	267	47.7	-3.0
5	4924.00	39.8 PK	74.0	-34.2	1.78 V	223	38.1	1.7
6	4924.00	27.9 AV	54.0	-26.1	1.78 V	223	26.2	1.7
7	7386.00	45.2 PK	74.0	-28.8	1.72 V	172	37.3	7.9
8	7386.00	33.6 AV	54.0	-20.4	1.72 V	172	25.7	7.9

REMARKS:

1. Emission Level(dBuV/m) = Raw Value(dBuV) + Correction Factor(dB/m)
2. Correction Factor(dB/m) = Antenna Factor(dB/m) + Cable Factor(dB) – Pre-Amplifier Factor(dB)
3. The other emission levels were very low against the limit.
4. Margin value = Emission Level – Limit value
5. " * ": Fundamental frequency.

VHT40

CHANNEL	TX Channel 3	DETECTOR FUNCTION	Peak (PK)
FREQUENCY RANGE	1GHz ~ 25GHz		Average (AV)

ANTENNA POLARITY & TEST DISTANCE: HORIZONTAL AT 3 M								
NO.	FREQ. (MHz)	EMISSION LEVEL (dBuV/m)	LIMIT (dBuV/m)	MARGIN (dB)	ANTENNA HEIGHT (m)	TABLE ANGLE (Degree)	RAW VALUE (dBuV)	CORRECTION FACTOR (dB/m)
1	2390.00	63.9 PK	74.0	-10.1	1.30 H	240	66.6	-2.7
2	2390.00	50.8 AV	54.0	-3.2	1.30 H	240	53.5	-2.7
3	*2422.00	106.1 PK			1.30 H	240	109.0	-2.9
4	*2422.00	95.6 AV			1.30 H	240	98.5	-2.9
5	4844.00	41.1 PK	74.0	-32.9	1.67 H	145	39.5	1.6
6	4844.00	28.5 AV	54.0	-25.5	1.67 H	145	26.9	1.6
7	7266.00	45.3 PK	74.0	-28.7	1.73 H	178	37.5	7.8
8	7266.00	33.7 AV	54.0	-20.3	1.73 H	178	25.9	7.8

ANTENNA POLARITY & TEST DISTANCE: VERTICAL AT 3 M								
NO.	FREQ. (MHz)	EMISSION LEVEL (dBuV/m)	LIMIT (dBuV/m)	MARGIN (dB)	ANTENNA HEIGHT (m)	TABLE ANGLE (Degree)	RAW VALUE (dBuV)	CORRECTION FACTOR (dB/m)
1	2390.00	58.7 PK	74.0	-15.3	2.76 V	263	61.4	-2.7
2	2390.00	44.5 AV	54.0	-9.5	2.76 V	263	47.2	-2.7
3	*2422.00	101.1 PK			2.76 V	263	104.0	-2.9
4	*2422.00	90.3 AV			2.76 V	263	93.2	-2.9
5	4844.00	39.4 PK	74.0	-34.6	1.74 V	235	37.8	1.6
6	4844.00	27.6 AV	54.0	-26.4	1.74 V	235	26.0	1.6
7	7266.00	45.1 PK	74.0	-28.9	1.70 V	198	37.3	7.8
8	7266.00	33.6 AV	54.0	-20.4	1.70 V	198	25.8	7.8

REMARKS:

1. Emission Level(dBuV/m) = Raw Value(dBuV) + Correction Factor(dB/m)
2. Correction Factor(dB/m) = Antenna Factor(dB/m) + Cable Factor(dB) – Pre-Amplifier Factor(dB)
3. The other emission levels were very low against the limit.
4. Margin value = Emission Level – Limit value
5. " * ": Fundamental frequency.

CHANNEL	TX Channel 6	DETECTOR FUNCTION	Peak (PK)
FREQUENCY RANGE	1GHz ~ 25GHz		Average (AV)

ANTENNA POLARITY & TEST DISTANCE: HORIZONTAL AT 3 M

NO.	FREQ. (MHz)	EMISSION LEVEL (dBuV/m)	LIMIT (dBuV/m)	MARGIN (dB)	ANTENNA HEIGHT (m)	TABLE ANGLE (Degree)	RAW VALUE (dBuV)	CORRECTION FACTOR (dB/m)
1	2390.00	64.4 PK	74.0	-9.6	1.36 H	243	67.1	-2.7
2	2390.00	51.0 AV	54.0	-3.0	1.36 H	243	53.7	-2.7
3	*2437.00	106.7 PK			1.36 H	243	109.7	-3.0
4	*2437.00	96.1 AV			1.36 H	243	99.1	-3.0
5	2483.50	65.0 PK	74.0	-9.0	1.36 H	243	68.0	-3.0
6	2483.50	48.8 AV	54.0	-5.2	1.36 H	243	51.8	-3.0
7	4874.00	41.6 PK	74.0	-32.4	1.67 H	144	40.0	1.6
8	4874.00	29.2 AV	54.0	-24.8	1.67 H	144	27.6	1.6
9	7311.00	45.0 PK	74.0	-29.0	1.73 H	197	37.3	7.7
10	7311.00	33.7 AV	54.0	-20.3	1.73 H	197	26.0	7.7

ANTENNA POLARITY & TEST DISTANCE: VERTICAL AT 3 M

NO.	FREQ. (MHz)	EMISSION LEVEL (dBuV/m)	LIMIT (dBuV/m)	MARGIN (dB)	ANTENNA HEIGHT (m)	TABLE ANGLE (Degree)	RAW VALUE (dBuV)	CORRECTION FACTOR (dB/m)
1	2390.00	55.9 PK	74.0	-18.1	2.79 V	265	58.6	-2.7
2	2390.00	43.7 AV	54.0	-10.3	2.79 V	265	46.4	-2.7
3	*2437.00	100.9 PK			2.79 V	265	103.9	-3.0
4	*2437.00	89.9 AV			2.79 V	265	92.9	-3.0
5	2483.50	56.9 PK	74.0	-17.1	2.79 V	265	59.9	-3.0
6	2483.50	44.2 AV	54.0	-9.8	2.79 V	265	47.2	-3.0
7	4874.00	40.3 PK	74.0	-33.7	1.76 V	230	38.7	1.6
8	4874.00	28.4 AV	54.0	-25.6	1.76 V	230	26.8	1.6
9	7311.00	45.9 PK	74.0	-28.1	1.78 V	179	38.2	7.7
10	7311.00	34.4 AV	54.0	-19.6	1.78 V	179	26.7	7.7

REMARKS:

1. Emission Level(dBuV/m) = Raw Value(dBuV) + Correction Factor(dB/m)
2. Correction Factor(dB/m) = Antenna Factor(dB/m) + Cable Factor(dB) – Pre-Amplifier Factor(dB)
3. The other emission levels were very low against the limit.
4. Margin value = Emission Level – Limit value
5. " * ": Fundamental frequency.

CHANNEL	TX Channel 9	DETECTOR FUNCTION	Peak (PK)
FREQUENCY RANGE	1GHz ~ 25GHz		Average (AV)

ANTENNA POLARITY & TEST DISTANCE: HORIZONTAL AT 3 M

NO.	FREQ. (MHz)	EMISSION LEVEL (dBuV/m)	LIMIT (dBuV/m)	MARGIN (dB)	ANTENNA HEIGHT (m)	TABLE ANGLE (Degree)	RAW VALUE (dBuV)	CORRECTION FACTOR (dB/m)
1	*2452.00	106.4 PK			1.31 H	254	109.4	-3.0
2	*2452.00	95.8 AV			1.31 H	254	98.8	-3.0
3	2483.50	64.9 PK	74.0	-9.1	1.31 H	254	67.9	-3.0
4	2483.50	48.9 AV	54.0	-5.1	1.31 H	254	51.9	-3.0
5	4904.00	41.1 PK	74.0	-32.9	1.71 H	133	39.4	1.7
6	4904.00	28.6 AV	54.0	-25.4	1.71 H	133	26.9	1.7
7	7356.00	44.7 PK	74.0	-29.3	1.71 H	193	36.8	7.9
8	7356.00	33.0 AV	54.0	-21.0	1.71 H	193	25.1	7.9

ANTENNA POLARITY & TEST DISTANCE: VERTICAL AT 3 M

NO.	FREQ. (MHz)	EMISSION LEVEL (dBuV/m)	LIMIT (dBuV/m)	MARGIN (dB)	ANTENNA HEIGHT (m)	TABLE ANGLE (Degree)	RAW VALUE (dBuV)	CORRECTION FACTOR (dB/m)
1	*2452.00	100.9 PK			2.74 V	274	103.9	-3.0
2	*2452.00	90.1 AV			2.74 V	274	93.1	-3.0
3	2483.50	59.3 PK	74.0	-14.7	2.74 V	274	62.3	-3.0
4	2483.50	44.9 AV	54.0	-9.1	2.74 V	274	47.9	-3.0
5	4904.00	39.3 PK	74.0	-34.7	1.80 V	229	37.6	1.7
6	4904.00	27.7 AV	54.0	-26.3	1.80 V	229	26.0	1.7
7	7356.00	45.9 PK	74.0	-28.1	1.70 V	203	38.0	7.9
8	7356.00	34.2 AV	54.0	-19.8	1.70 V	203	26.3	7.9

REMARKS:

1. Emission Level(dBuV/m) = Raw Value(dBuV) + Correction Factor(dB/m)
2. Correction Factor(dB/m) = Antenna Factor(dB/m) + Cable Factor(dB) – Pre-Amplifier Factor(dB)
3. The other emission levels were very low against the limit.
4. Margin value = Emission Level – Limit value
5. " * ": Fundamental frequency.

Below 1GHz Data:

VHT20

CHANNEL	TX Channel 11	DETECTOR FUNCTION	Quasi-Peak (QP)
FREQUENCY RANGE	9kHz ~ 1GHz		

ANTENNA POLARITY & TEST DISTANCE: HORIZONTAL AT 3 M								
NO.	FREQ. (MHz)	EMISSION LEVEL (dBuV/m)	LIMIT (dBuV/m)	MARGIN (dB)	ANTENNA HEIGHT (m)	TABLE ANGLE (Degree)	RAW VALUE (dBuV)	CORRECTION FACTOR (dB/m)
1	42.17	29.0 QP	40.0	-11.0	3.00 H	265	37.1	-8.1
2	164.49	36.2 QP	43.5	-7.3	1.91 H	53	44.3	-8.1
3	222.93	28.5 QP	46.0	-17.5	3.00 H	118	39.3	-10.8
4	322.38	25.8 QP	46.0	-20.2	2.50 H	193	31.9	-6.1
5	540.73	28.4 QP	46.0	-17.6	1.50 H	247	29.8	-1.4
6	800.45	33.6 QP	46.0	-12.4	1.00 H	261	29.9	3.7

REMARKS:

1. Emission Level(dBuV/m) = Raw Value(dBuV) + Correction Factor(dB/m)
2. Correction Factor(dB/m) = Antenna Factor(dB/m) + Cable Factor(dB) – Pre-Amplifier Factor(dB)
3. Margin value = Emission Level – Limit value
4. The emission levels were very low against the limit of frequency range 9kHz~30MHz: the amplitude of spurious emissions attenuated more than 20 dB below the permissible value to be report.

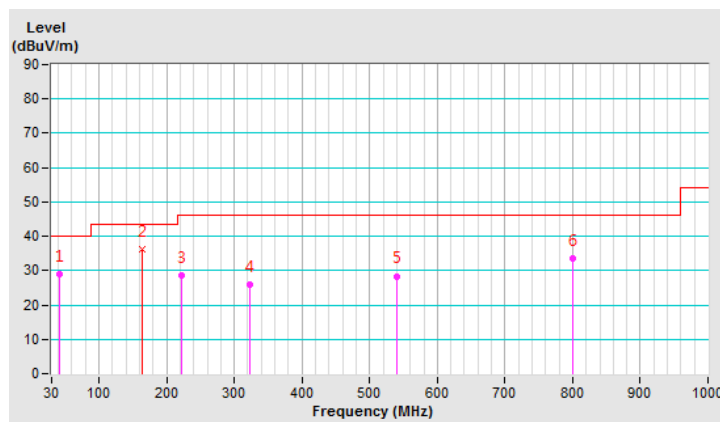

CHANNEL	TX Channel 11	DETECTOR FUNCTION	Quasi-Peak (QP)
FREQUENCY RANGE	9kHz ~ 1GHz		

ANTENNA POLARITY & TEST DISTANCE: VERTICAL AT 3 M

NO.	FREQ. (MHz)	EMISSION LEVEL (dBuV/m)	LIMIT (dBuV/m)	MARGIN (dB)	ANTENNA HEIGHT (m)	TABLE ANGLE (Degree)	RAW VALUE (dBuV)	CORRECTION FACTOR (dB/m)
1	73.64	36.0 QP	40.0	-4.0	1.01 V	6	46.9	-10.9
2	168.71	37.1 QP	43.5	-6.4	1.50 V	119	45.4	-8.3
3	265.06	22.9 QP	46.0	-23.1	2.00 V	241	31.2	-8.3
4	443.03	26.7 QP	46.0	-19.3	1.00 V	243	29.8	-3.1
5	640.49	31.6 QP	46.0	-14.4	1.50 V	247	30.4	1.2
6	762.54	32.4 QP	46.0	-13.6	1.50 V	311	28.9	3.5

REMARKS:

1. Emission Level(dBuV/m) = Raw Value(dBuV) + Correction Factor(dB/m)
2. Correction Factor(dB/m) = Antenna Factor(dB/m) + Cable Factor(dB) – Pre-Amplifier Factor(dB)
3. Margin value = Emission Level – Limit value
4. The emission levels were very low against the limit of frequency range 9kHz~30MHz: the amplitude of spurious emissions attenuated more than 20 dB below the permissible value to be report.

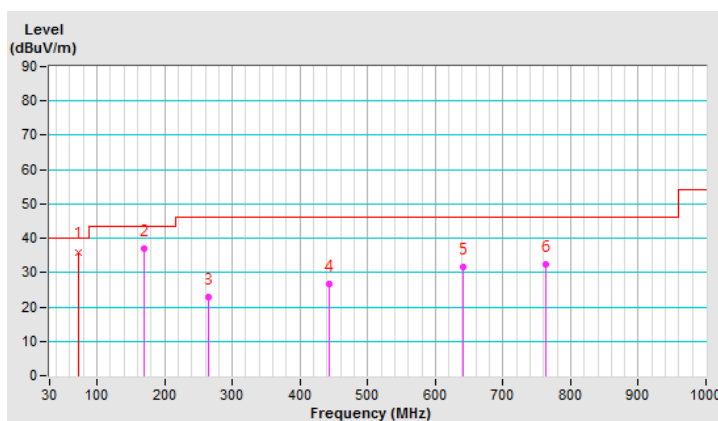

4.2 Conducted Emission Measurement

4.2.1 Limits of Conducted Emission Measurement

Frequency (MHz)	Conducted Limit (dBuV)	
	Quasi-peak	Average
0.15 - 0.5	66 - 56	56 - 46
0.50 - 5.0	56	46
5.0 - 30.0	60	50

Note: 1. The lower limit shall apply at the transition frequencies.

2. The limit decreases in line with the logarithm of the frequency in the range of 0.15 to 0.50MHz.

4.2.2 Test Instruments

DESCRIPTION & MANUFACTURER	MODEL NO.	SERIAL NO.	CALIBRATED DATE	CALIBRATED UNTIL
Test Receiver R&S	ESCS 30	847124/029	Oct. 24, 2018	Oct. 23, 2019
Line-Impedance Stabilization Network (for EUT) R&S	ESH3-Z5	848773/004	Nov. 15, 2017	Nov. 14, 2018
Line-Impedance Stabilization Network (for Peripheral) R&S	ENV216	100072	June 04, 2018	June 03, 2019
50 ohms Terminator	N/A	3	Oct. 22, 2018	Oct. 21, 2019
RF Cable	5D-FB	COCCAB-001	Sep. 28, 2018	Sep. 27, 2019
Fixed attenuator EMCI	STI02-2200-10	003	Mar. 16, 2018	Mar. 15, 2019
Software BVADT	BVADT_Cond_ V7.3.7.4	NA	NA	NA

Note:

1. The calibration interval of the above test instruments are 12 months and the calibrations are traceable to NML/ROC and NIST/USA.
2. The test was performed in Conduction 1.
3. Tested Date: Nov. 08, 2018

4.2.3 Test Procedures

- The EUT was placed 0.4 meters from the conducting wall of the shielded room with EUT being connected to the power mains through a line impedance stabilization network (LISN). Other support units were connected to the power mains through another LISN. The two LISNs provide 50 ohm/ 50uH of coupling impedance for the measuring instrument.
- Both lines of the power mains connected to the EUT were checked for maximum conducted interference.
- The frequency range from 150kHz to 30MHz was searched. Emission levels under (Limit - 20dB) was not recorded.

Note: The resolution bandwidth and video bandwidth of test receiver is 9kHz for quasi-peak detection (QP) and average detection (AV) at frequency 0.15MHz-30MHz.

4.2.4 Deviation from Test Standard

No deviation.

4.2.5 Test Setup

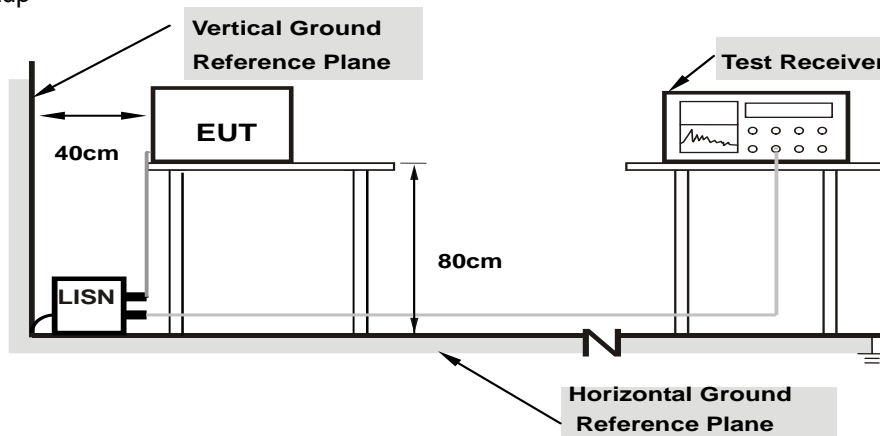

Note: 1.Support units were connected to second LISN.

For the actual test configuration, please refer to the attached file (Test Setup Photo).

4.2.6 EUT Operating Conditions

Same as 4.1.6.

4.2.7 Test Results (Mode 1)

Phase	Line (L)	Detector Function	Quasi-Peak (QP) / Average (AV)
-------	----------	-------------------	--------------------------------

No	Freq. [MHz]	Corr. Factor	Reading Value [dB (uV)]		Emission Level [dB (uV)]		Limit [dB (uV)]		Margin (dB)	
		(dB)	Q.P.	AV.	Q.P.	AV.	Q.P.	AV.	Q.P.	AV.
	1	0.15391	10.03	38.98	12.74	49.01	22.77	65.79	55.79	-16.78
2	0.16172	10.03	38.70	11.75	48.73	21.78	65.38	55.38	-16.65	-33.60
3	0.19687	10.05	33.60	8.35	43.65	18.40	63.74	53.74	-20.09	-35.34
4	0.22031	10.05	31.07	4.78	41.12	14.83	62.81	52.81	-21.69	-37.98
5	0.66172	10.10	21.63	5.84	31.73	15.94	56.00	46.00	-24.27	-30.06
6	3.44531	10.28	11.26	-4.27	21.54	6.01	56.00	46.00	-34.46	-39.99

Remarks:

1. Q.P. and AV. are abbreviations of quasi-peak and average individually.
2. The emission levels of other frequencies were very low against the limit.
3. Margin value = Emission level – Limit value
4. Correction factor = Insertion loss + Cable loss
5. Emission Level = Correction Factor + Reading Value

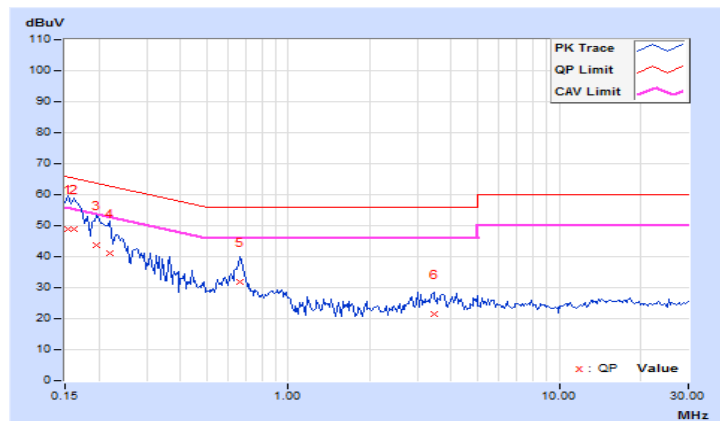

Phase	Neutral (N)	Detector Function	Quasi-Peak (QP) / Average (AV)
-------	-------------	-------------------	--------------------------------

No	Freq. [MHz]	Corr.	Reading Value		Emission Level		Limit		Margin	
		Factor (dB)	[dB (uV)]		[dB (uV)]		[dB (uV)]		(dB)	
			Q.P.	AV.	Q.P.	AV.	Q.P.	AV.	Q.P.	AV.
1	0.16172	9.94	38.63	13.33	48.57	23.27	65.38	55.38	-16.81	-32.11
2	0.18516	9.95	33.68	10.41	43.63	20.36	64.25	54.25	-20.62	-33.89
3	0.20078	9.95	33.56	9.96	43.51	19.91	63.58	53.58	-20.07	-33.67
4	0.22422	9.95	30.69	6.00	40.64	15.95	62.66	52.66	-22.02	-36.71
5	0.67344	9.99	22.92	5.53	32.91	15.52	56.00	46.00	-23.09	-30.48
6	3.23438	10.13	9.98	-6.55	20.11	3.58	56.00	46.00	-35.89	-42.42

Remarks:

1. Q.P. and AV. are abbreviations of quasi-peak and average individually.
2. The emission levels of other frequencies were very low against the limit.
3. Margin value = Emission level – Limit value
4. Correction factor = Insertion loss + Cable loss
5. Emission Level = Correction Factor + Reading Value

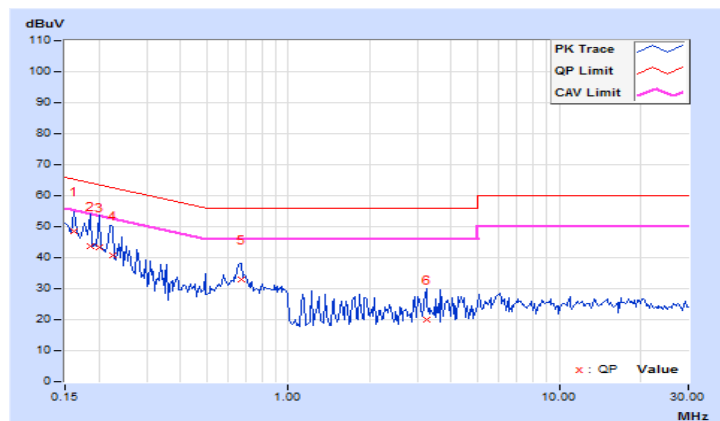

4.2.8 Test Results (Mode 2)

Phase	Line (L)	Detector Function	Quasi-Peak (QP) / Average (AV)
-------	----------	-------------------	--------------------------------

No	Freq. [MHz]	Corr. Factor	Reading Value [dB (uV)]		Emission Level [dB (uV)]		Limit [dB (uV)]		Margin (dB)	
		(dB)	Q.P.	AV.	Q.P.	AV.	Q.P.	AV.	Q.P.	AV.
	1	0.15000	10.02	34.74	19.59	44.76	29.61	66.00	56.00	-21.24
2	0.18906	10.04	33.31	20.82	43.35	30.86	64.08	54.08	-20.73	-23.22
3	0.25938	10.05	32.07	10.98	42.12	21.03	61.45	51.45	-19.33	-30.42
4	0.57969	10.08	20.85	12.00	30.93	22.08	56.00	46.00	-25.07	-23.92
5	0.80234	10.10	18.47	6.38	28.57	16.48	56.00	46.00	-27.43	-29.52
6	3.47266	10.23	14.07	8.53	24.30	18.76	56.00	46.00	-31.70	-27.24

Remarks:

1. Q.P. and AV. are abbreviations of quasi-peak and average individually.
2. The emission levels of other frequencies were very low against the limit.
3. Margin value = Emission level – Limit value
4. Correction factor = Insertion loss + Cable loss
5. Emission Level = Correction Factor + Reading Value

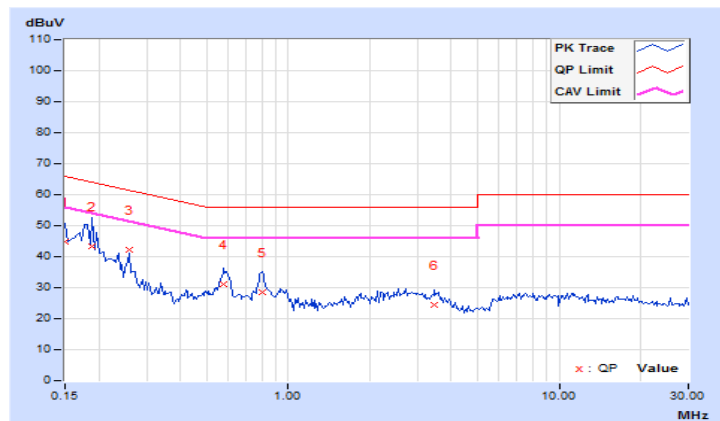

Phase	Neutral (N)	Detector Function	Quasi-Peak (QP) / Average (AV)
-------	-------------	-------------------	-----------------------------------

No	Freq. [MHz]	Corr.	Reading Value		Emission Level		Limit		Margin	
		Factor	[dB (uV)]		[dB (uV)]		[dB (uV)]		(dB)	
	(dB)	Q.P.	AV.	Q.P.	AV.	Q.P.	AV.	Q.P.	AV.	
1	0.15781	9.93	41.97	25.91	51.90	35.84	65.58	55.58	-13.68	-19.74
2	0.20859	9.94	25.56	11.44	35.50	21.38	63.26	53.26	-27.76	-31.88
3	0.27109	9.95	29.53	8.95	39.48	18.90	61.08	51.08	-21.60	-32.18
4	0.59531	9.97	19.99	11.15	29.96	21.12	56.00	46.00	-26.04	-24.88
5	0.79453	9.98	18.71	6.42	28.69	16.40	56.00	46.00	-27.31	-29.60
6	8.90234	10.33	12.31	7.31	22.64	17.64	60.00	50.00	-37.36	-32.36

Remarks:

1. Q.P. and AV. are abbreviations of quasi-peak and average individually.
2. The emission levels of other frequencies were very low against the limit.
3. Margin value = Emission level – Limit value
4. Correction factor = Insertion loss + Cable loss
5. Emission Level = Correction Factor + Reading Value

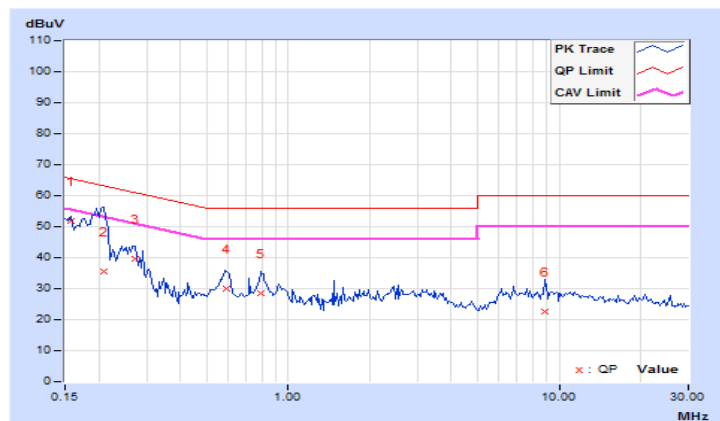

4.3 6dB Bandwidth Measurement

4.3.1 Limits of 6dB Bandwidth Measurement

The minimum of 6dB Bandwidth Measurement is 0.5 MHz.

4.3.2 Test Setup

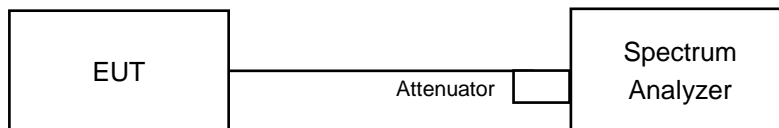

4.3.3 Test Instruments

Refer to section 4.1.2 to get information of above instrument.

4.3.4 Test Procedure

- a. Set resolution bandwidth (RBW) = 100kHz
- b. Set the video bandwidth (VBW) $\geq 3 \times$ RBW, Detector = Peak.
- c. Trace mode = max hold.
- d. Sweep = auto couple.
- e. Measure the maximum width of the emission that is constrained by the frequencies associated with the two amplitude points (upper and lower) that are attenuated by 6 dB relative to the maximum level measured in the fundamental emission

4.3.5 Deviation from Test Standard

No deviation.

4.3.6 EUT Operating Conditions

The software provided by client to enable the EUT under transmission condition continuously at lowest, middle and highest channel frequencies individually.

4.3.7 Test Result

802.11b

Channel	Frequency (MHz)	6dB Bandwidth (MHz)		Minimum Limit (MHz)	Pass / Fail
		Chain 0	Chain 1		
1	2412	7.06	7.07	0.5	Pass
6	2437	7.09	7.03	0.5	Pass
11	2462	7.09	6.62	0.5	Pass

802.11g

Channel	Frequency (MHz)	6dB Bandwidth (MHz)		Minimum Limit (MHz)	Pass / Fail
		Chain 0	Chain 1		
1	2412	15.19	15.16	0.5	Pass
6	2437	15.19	15.15	0.5	Pass
11	2462	15.18	15.32	0.5	Pass

VHT20

Channel	Frequency (MHz)	6dB Bandwidth (MHz)		Minimum Limit (MHz)	Pass / Fail
		Chain 0	Chain 1		
1	2412	15.19	15.18	0.5	Pass
6	2437	15.20	15.40	0.5	Pass
11	2462	15.53	15.34	0.5	Pass

VHT40

Channel	Frequency (MHz)	6dB Bandwidth (MHz)		Minimum Limit (MHz)	Pass / Fail
		Chain 0	Chain 1		
3	2422	33.86	35.08	0.5	Pass
6	2437	35.08	35.07	0.5	Pass
9	2452	31.47	32.66	0.5	Pass

Spectrum Plot of Worst Value

802.11b_Chain 1 / CH11

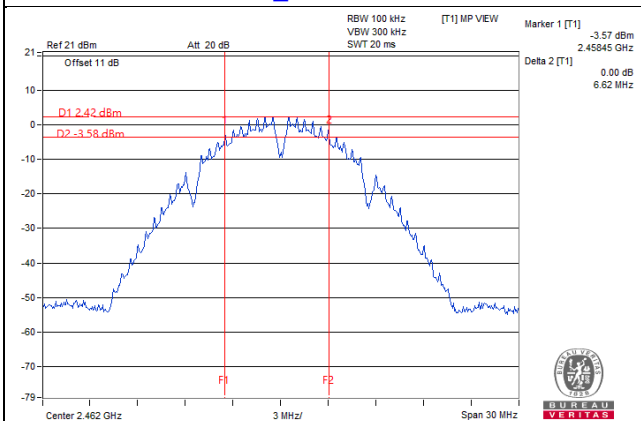

802.11g_Chain 1 / CH6

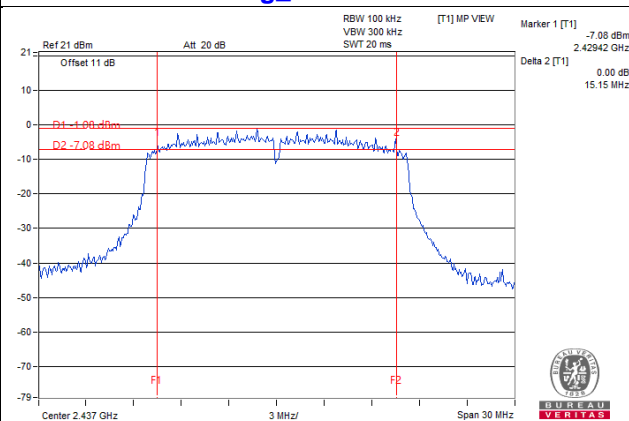

VHT20_Chain 1 / CH1

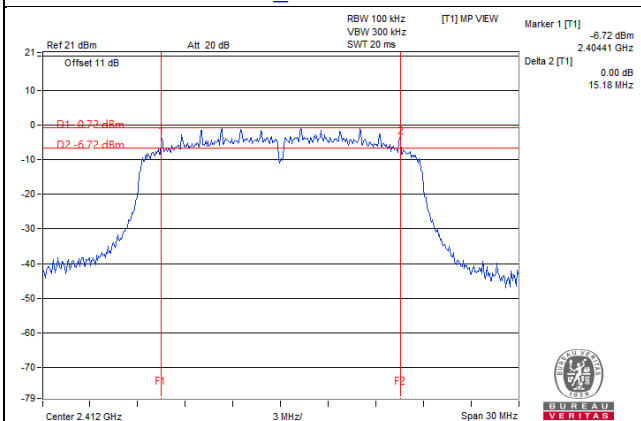

VHT40_Chain 0 / CH9

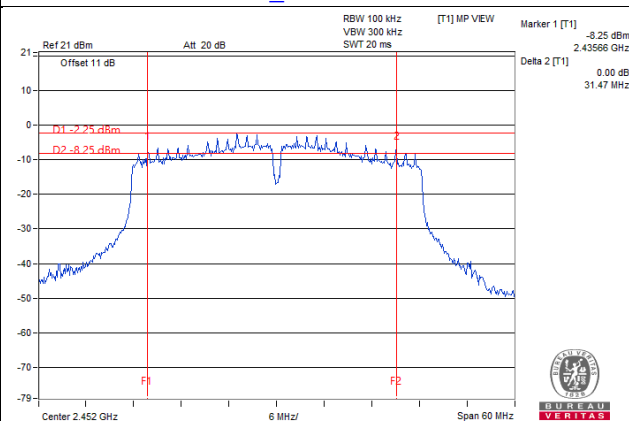

4.4 Conducted Output Power Measurement

4.4.1 Limits of Conducted Output Power Measurement

For systems using digital modulation in the 2400–2483.5 MHz bands: 1 Watt (30dBm)

Per KDB 662911 D01 Multiple Transmitter Output Method of conducted output power measurement on IEEE 802.11 devices,

Array Gain = 0 dB (i.e., no array gain) for $N_{ANT} \leq 4$;

Array Gain = 0 dB (i.e., no array gain) for channel widths ≥ 40 MHz for any N_{ANT} ;

Array Gain = $5 \log(N_{ANT}/N_{SS})$ dB or 3 dB, whichever is less for 20-MHz channel widths with $N_{ANT} \geq 5$.

For power measurements on all other devices: Array Gain = $10 \log(N_{ANT}/N_{SS})$ dB.

4.4.2 Test Setup

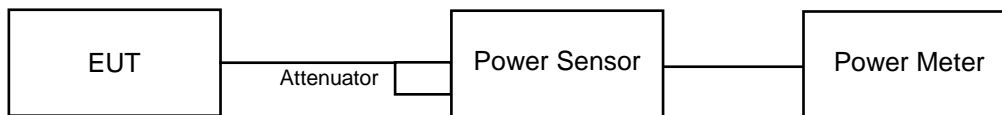

4.4.3 Test Instruments

Refer to section 4.1.2 to get information of above instrument.

4.4.4 Test Procedures

A peak power sensor was used on the output port of the EUT. A power meter was used to read the response of the peak power sensor. Record the power level.

Average power sensor was used to perform output power measurement, trigger and gating function of wide band power meter is enabled to measure max output power of TX on burst. Duty factor is not added to measured value.

4.4.5 Deviation from Test Standard

No deviation.

4.4.6 EUT Operating Conditions

Same as Item 4.3.6.

4.4.7 Test Results

FOR PEAK POWER

802.11b

Chan.	Freq. (MHz)	Peak Power (dBm)		Total Power (mW)	Total Power (dBm)	Limit (dBm)	Pass / Fail
		Chain 0	Chain 1				
1	2412	12.04	12.12	32.289	15.09	30.00	Pass
6	2437	11.72	11.91	30.383	14.83	30.00	Pass
11	2462	12.16	12.23	33.155	15.21	30.00	Pass

802.11g

Chan.	Freq. (MHz)	Peak Power (dBm)		Total Power (mW)	Total Power (dBm)	Limit (dBm)	Pass / Fail
		Chain 0	Chain 1				
1	2412	14.48	14.51	56.303	17.51	30.00	Pass
6	2437	14.41	14.48	55.66	17.46	30.00	Pass
11	2462	14.51	14.53	56.628	17.53	30.00	Pass

VHT20

Chan.	Freq. (MHz)	Peak Power (dBm)		Total Power (mW)	Total Power (dBm)	Limit (dBm)	Pass / Fail
		Chain 0	Chain 1				
1	2412	14.44	14.53	56.176	17.50	30.00	Pass
6	2437	14.39	14.47	55.469	17.44	30.00	Pass
11	2462	14.68	14.58	58.084	17.64	30.00	Pass

VHT40

Chan.	Freq. (MHz)	Peak Power (dBm)		Total Power (mW)	Total Power (dBm)	Limit (dBm)	Pass / Fail
		Chain 0	Chain 1				
3	2422	14.57	14.63	57.682	17.61	30.00	Pass
6	2437	14.61	14.59	57.681	17.61	30.00	Pass
9	2452	14.12	14.23	52.308	17.19	30.00	Pass

FOR AVERAGE POWER
802.11b

Chan.	Frequency (MHz)	Avg. Power (dBm)		Total Power (mW)	Total Power (dBm)
		Chain 0	Chain 1		
1	2412	9.88	9.83	19.343	12.87
6	2437	9.91	9.92	19.612	12.93
11	2462	9.85	9.81	19.233	12.84

802.11g

Chan.	Frequency (MHz)	Avg. Power (dBm)		Total Power (mW)	Total Power (dBm)
		Chain 0	Chain 1		
1	2412	9.69	9.72	18.687	12.72
6	2437	9.87	9.86	19.388	12.88
11	2462	9.85	9.81	19.233	12.84

VHT20

Chan.	Frequency (MHz)	Avg. Power (dBm)		Total Power (mW)	Total Power (dBm)
		Chain 0	Chain 1		
1	2412	9.82	9.85	19.255	12.85
6	2437	9.85	9.84	19.299	12.86
11	2462	9.83	9.81	19.188	12.83

VHT40

Chan.	Frequency (MHz)	Avg. Power (dBm)		Total Power (mW)	Total Power (dBm)
		Chain 0	Chain 1		
3	2422	9.85	9.86	19.344	12.87
6	2437	9.77	9.71	18.838	12.75
9	2452	9.72	9.76	18.838	12.75

4.5 Power Spectral Density Measurement

4.5.1 Limits of Power Spectral Density Measurement

The Maximum of Power Spectral Density Measurement is 8dBm in any 3 kHz.

4.5.2 Test Setup

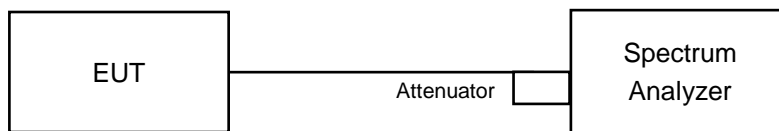

4.5.3 Test Instruments

Refer to section 4.1.2 to get information of above instrument.

4.5.4 Test Procedure

For 802.11b

- a. Set instrument center frequency to DTS channel center frequency.
- b. Set span to at least 1.5 times the OBW.
- c. Set RBW to: $3 \text{ kHz} \leq \text{RBW} \leq 100 \text{ kHz}$.
- d. Set VBW $\geq 3 \times \text{RBW}$.
- e. Detector = power averaging (RMS) or sample detector (when RMS not available).
- f. Ensure that the number of measurement points in the sweep $\geq 2 \times \text{span}/\text{RBW}$.
- g. Sweep time = auto couple.
- h. Employ trace averaging (RMS) mode over a minimum of 100 traces.
- i. Use the peak marker function to determine the maximum amplitude level.

For, 802.11g, VHT20, VHT40

- a. Measure the duty cycle (x).
- b. Set instrument center frequency to DTS channel center frequency.
- c. Set span to at least 1.5 times the OBW.
- d. Set RBW to: $3 \text{ kHz} \leq \text{RBW} \leq 100 \text{ kHz}$.
- e. Set VBW $\geq 3 \times \text{RBW}$.
- f. Detector = power averaging (RMS) or sample detector (when RMS not available).
- g. Ensure that the number of measurement points in the sweep $\geq 2 \times \text{span}/\text{RBW}$.
- h. Sweep time = auto couple.
- i. Do not use sweep triggering. Allow sweep to "free run".
- j. Employ trace averaging (RMS) mode over a minimum of 100 traces.
- k. Use the peak marker function to determine the maximum amplitude level.
- l. Add $10 \log(1/x)$, where x is the duty cycle measured in step (a), to the measured PSD to compute the average PSD during the actual transmission time.

4.5.5 Deviation from Test Standard

No deviation.

4.5.6 EUT Operating Condition

Same as Item 4.3.6

4.5.7 Test Results

802.11b

TX chain	Channel	Freq. (MHz)	PSD (dBm/3kHz)	10 log (N=2) dB	Total PSD (dBm/3kHz)	Limit (dBm/3kHz)	Pass /Fail
0	1	2412	-11.42	3.01	-8.41	8	Pass
	6	2437	-10.58	3.01	-7.57	8	Pass
	11	2462	-11.22	3.01	-8.21	8	Pass
1	1	2412	-11.87	3.01	-8.86	8	Pass
	6	2437	-11.44	3.01	-8.43	8	Pass
	11	2462	-11.81	3.01	-8.80	8	Pass

Note: 1. The directional gain = $2.3\text{dBi} + 10\log(2) = 5.04\text{dBi} < 6\text{dBi}$, so the power density limit shall not be reduced.

802.11g

TX chain	Channel	Freq. (MHz)	PSD W/O Duty Factor (dBm/3kHz)	10 log (N=2) dB	Duty Factor (dB)	Total PSD With Duty Factor (dBm/3kHz)	Limit (dBm/3kHz)	Pass /Fail
0	1	2412	-14.20	3.01	0.17	-11.19	8	Pass
	6	2437	-14.88	3.01	0.17	-11.87	8	Pass
	11	2462	-14.55	3.01	0.17	-11.54	8	Pass
1	1	2412	-14.33	3.01	0.17	-11.32	8	Pass
	6	2437	-14.33	3.01	0.17	-11.32	8	Pass
	11	2462	-14.61	3.01	0.17	-11.60	8	Pass

Note: 1. The directional gain = $2.3\text{dBi} + 10\log(2) = 5.04\text{dBi} < 6\text{dBi}$, so the power density limit shall not be reduced.

2. Refer to section 3.3 for duty cycle spectrum plot.

VHT20

TX chain	Channel	Freq. (MHz)	PSD W/O Duty Factor (dBm/3kHz)	10 log (N=2) dB	Duty Factor (dB)	Total PSD With Duty Factor (dBm/3kHz)	Limit (dBm/3kHz)	Pass /Fail
0	1	2412	-15.06	3.01	0.18	-12.05	8	Pass
	6	2437	-15.05	3.01	0.18	-12.04	8	Pass
	11	2462	-14.34	3.01	0.18	-11.33	8	Pass
1	1	2412	-14.11	3.01	0.18	-11.10	8	Pass
	6	2437	-13.95	3.01	0.18	-10.94	8	Pass
	11	2462	-14.35	3.01	0.18	-11.34	8	Pass

Note: 1. The directional gain = $2.3\text{dBi} + 10\log(2) = 5.04\text{dBi} < 6\text{dBi}$, so the power density limit shall not be reduced.

2. Refer to section 3.3 for duty cycle spectrum plot.

VHT40

TX chain	Channel	Freq. (MHz)	PSD W/O Duty Factor (dBm/3kHz)	10 log (N=2) dB	Duty Factor (dB)	Total PSD With Duty Factor (dBm/3kHz)	Limit (dBm/3kHz)	Pass /Fail
0	3	2422	-17.77	3.01	0.25	-14.76	8	Pass
	6	2437	-15.62	3.01	0.25	-12.61	8	Pass
	9	2452	-13.78	3.01	0.25	-10.77	8	Pass
1	3	2422	-15.28	3.01	0.25	-12.27	8	Pass
	6	2437	-17.27	3.01	0.25	-14.26	8	Pass
	9	2452	-17.60	3.01	0.25	-14.59	8	Pass

Note: 1. The directional gain = $2.3\text{dBi} + 10\log(2) = 5.04\text{dBi} < 6\text{dBi}$, so the power density limit shall not be reduced.

2. Refer to section 3.3 for duty cycle spectrum plot.

Spectrum Plot of Worst Value

802.11b_Chain 0 / CH6

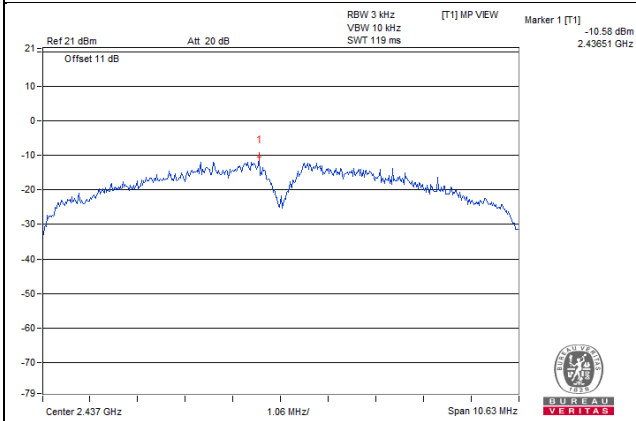

802.11g_Chain 0 / CH1

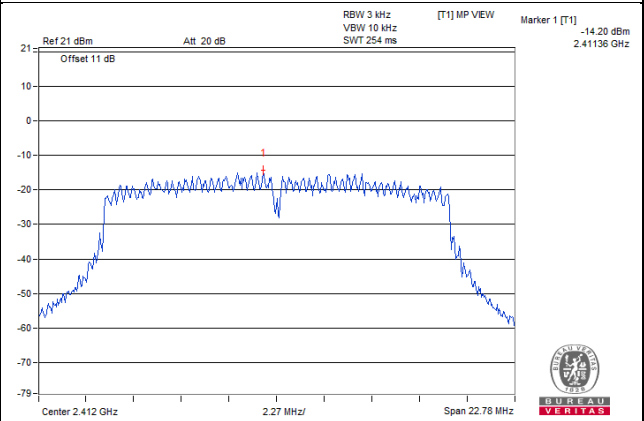

VHT20_Chain 1 / CH6

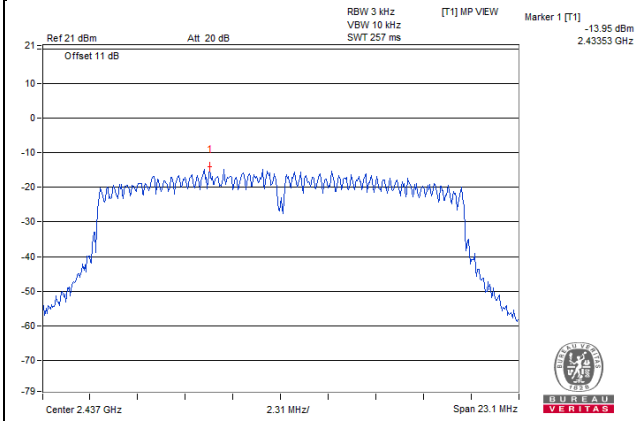

VHT40_Chain 0 / CH9

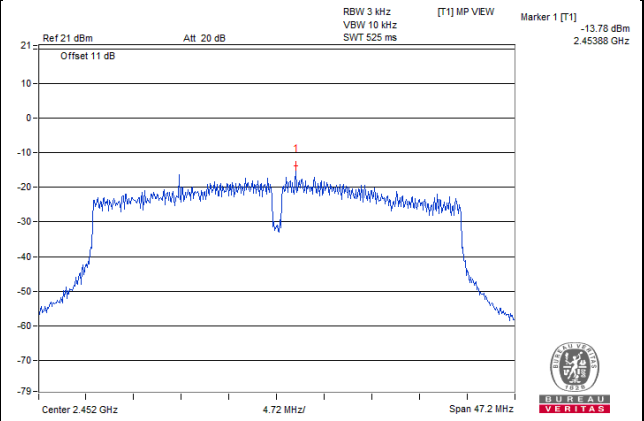

4.6 Conducted Out of Band Emission Measurement

4.6.1 Limits of Conducted Out of Band Emission Measurement

Below 20dB of the highest emission level of operating band (in 100kHz Resolution Bandwidth).

4.6.2 Test Setup

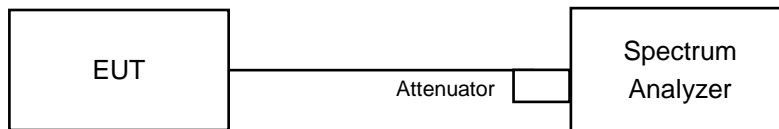

4.6.3 Test Instruments

Refer to section 4.1.2 to get information of above instrument.

4.6.4 Test Procedure

MEASUREMENT PROCEDURE REF

1. Set the RBW = 100 kHz.
2. Set the VBW \geq 300 kHz.
3. Detector = peak.
4. Sweep time = auto couple.
5. Trace mode = max hold.
6. Allow trace to fully stabilize.
7. Use the peak marker function to determine the maximum power level in any 100 kHz band segment within the fundamental EBW.

MEASUREMENT PROCEDURE OOB

1. Set RBW = 100 kHz.
2. Set VBW \geq 300 kHz.
3. Detector = peak.
4. Sweep = auto couple.
5. Trace Mode = max hold.
6. Allow trace to fully stabilize.
7. Use the peak marker function to determine the maximum amplitude level.

4.6.5 Deviation from Test Standard

No deviation.

4.6.6 EUT Operating Condition

Same as Item 4.3.6

4.6.7 Test Results

The spectrum plots are attached on the following pages. D1 line indicates the highest level, and D2 line indicates the 20dB offset below D1. It shows compliance with the requirement.

802.11b
Chain 0

CH 1

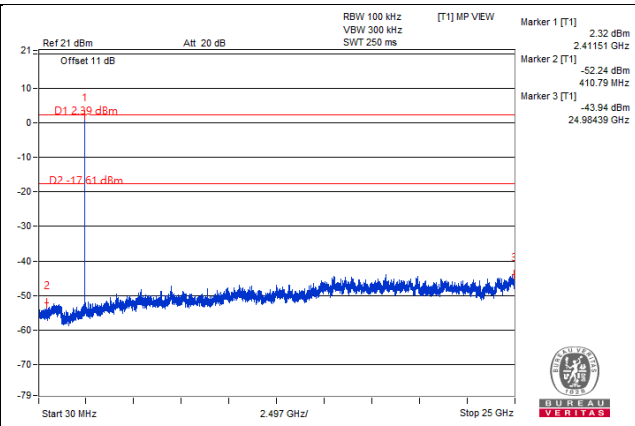
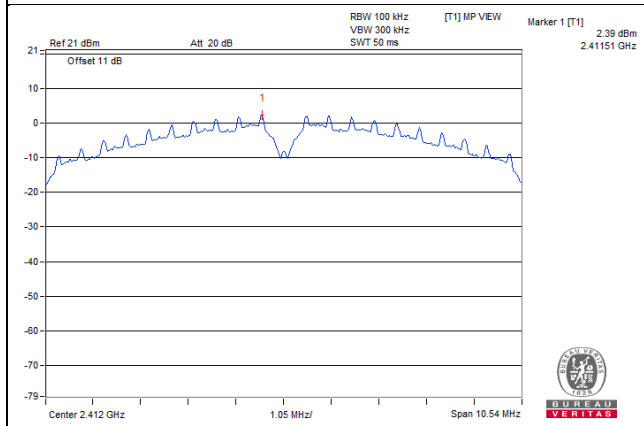

CH 6

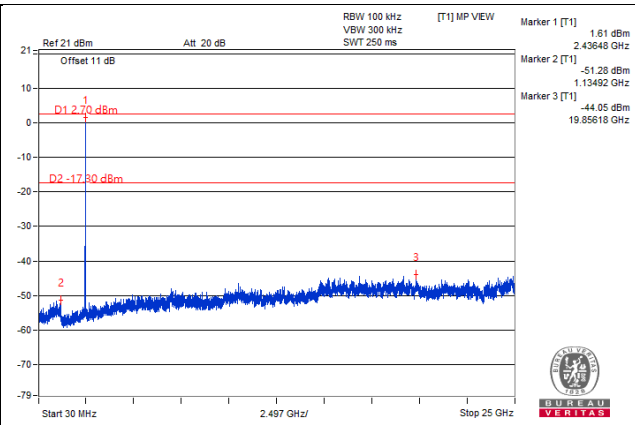
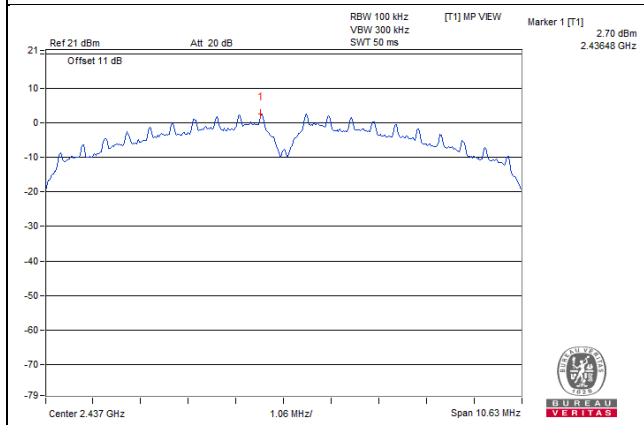

CH 11

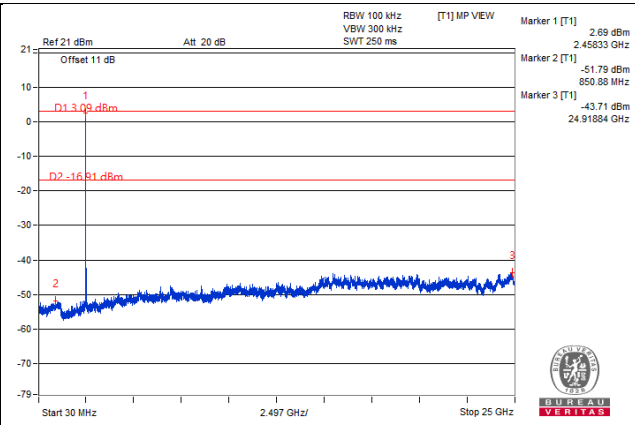
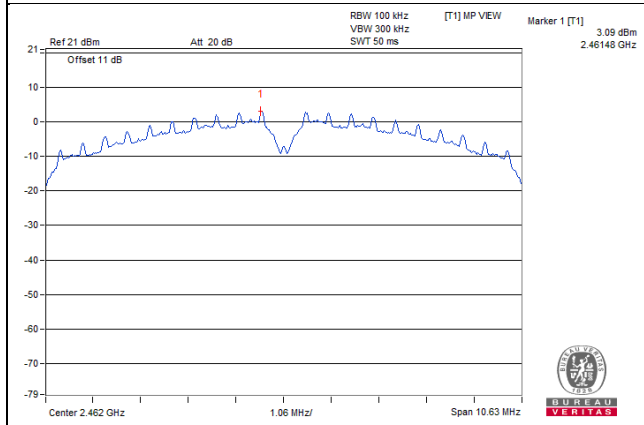

CH 1 Band edge

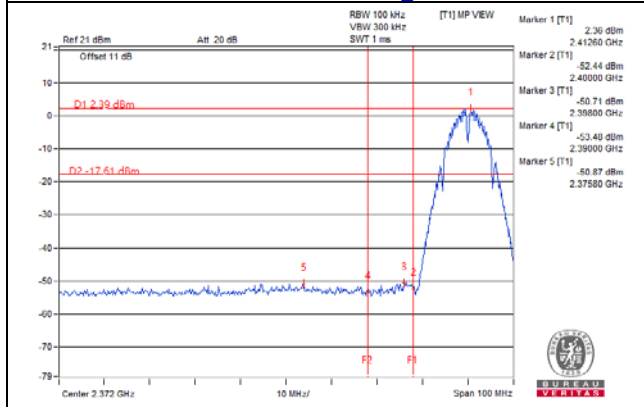

CH 11 Band edge

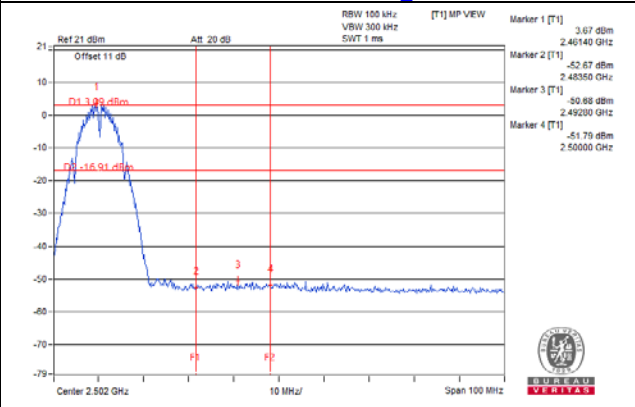

Chain 1

CH 1

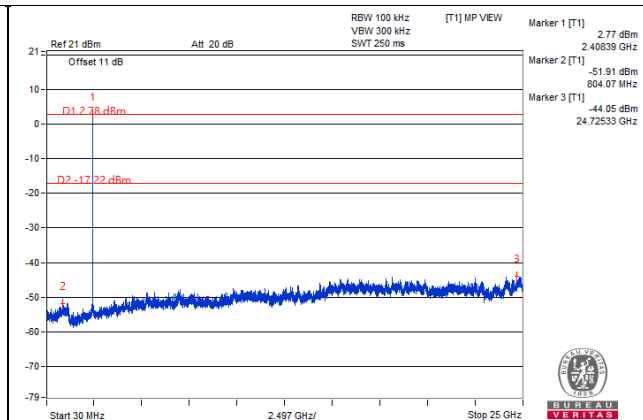
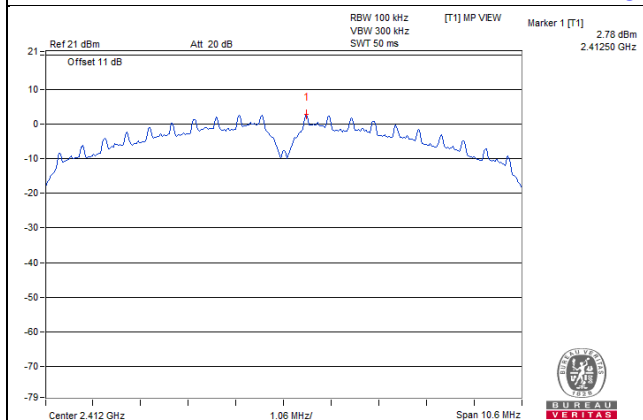

CH 6

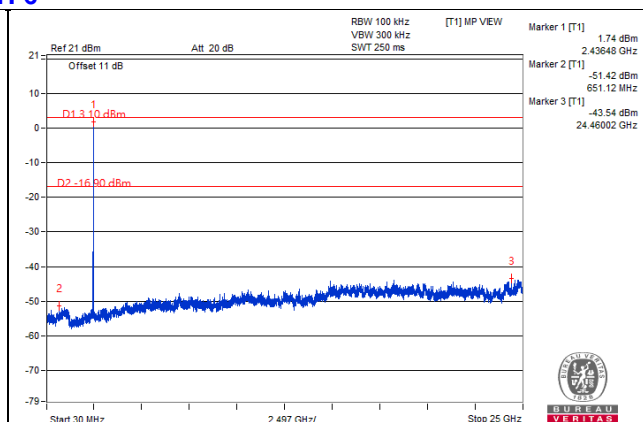
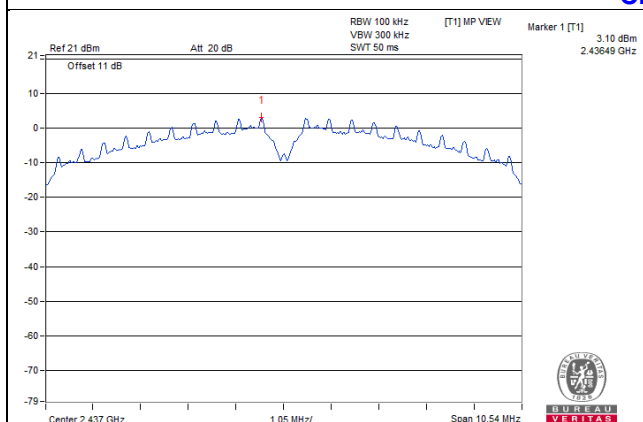

CH 11

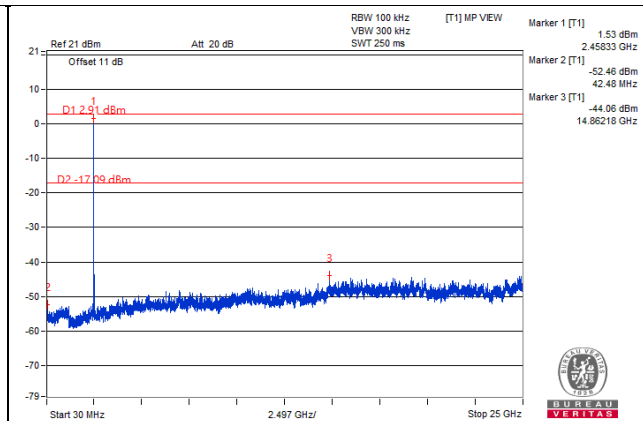
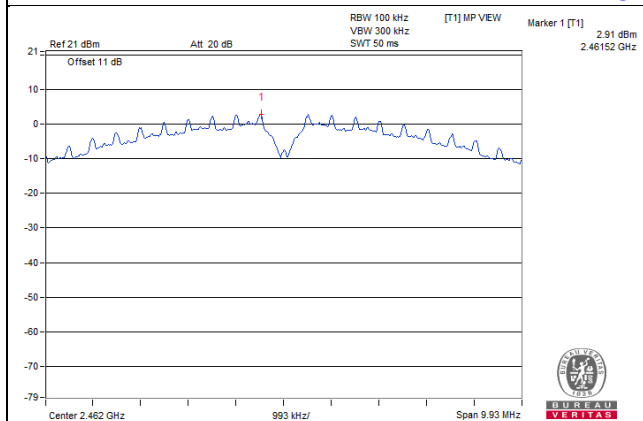

CH 1 Band edge

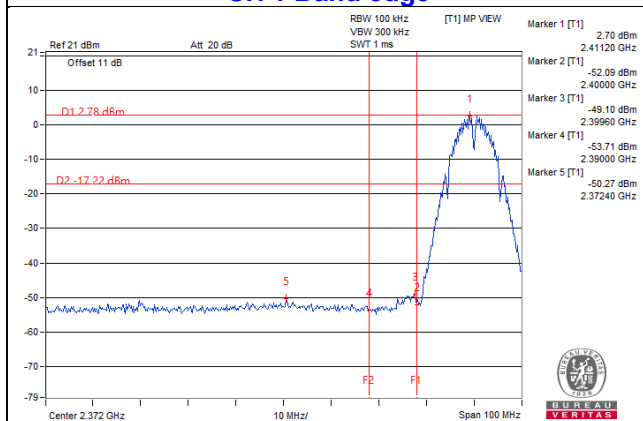

CH 11 Band edge

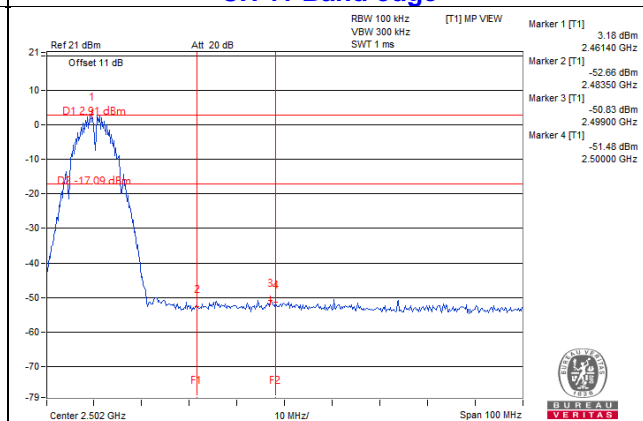

802.11g Chain 0

CH 1

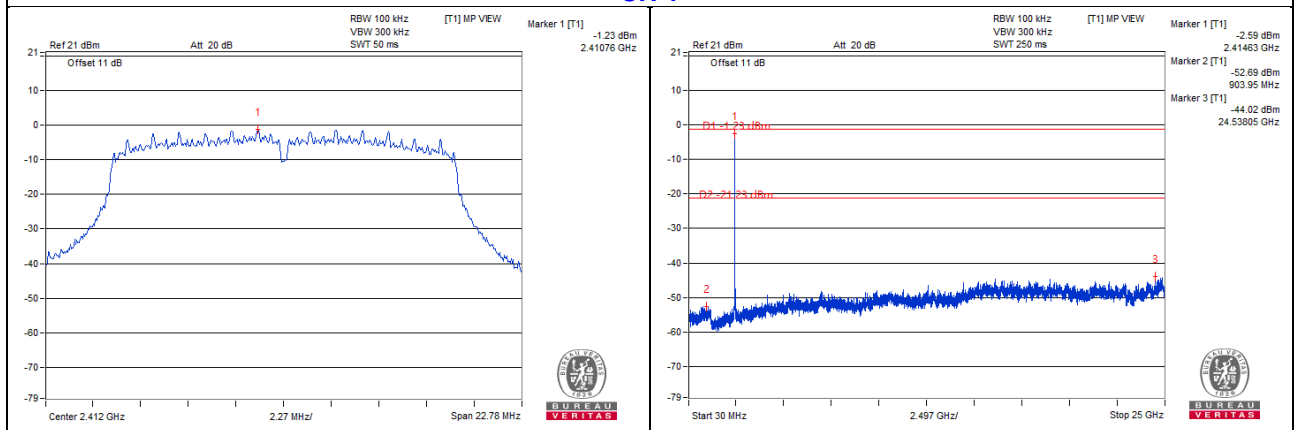

CH 6

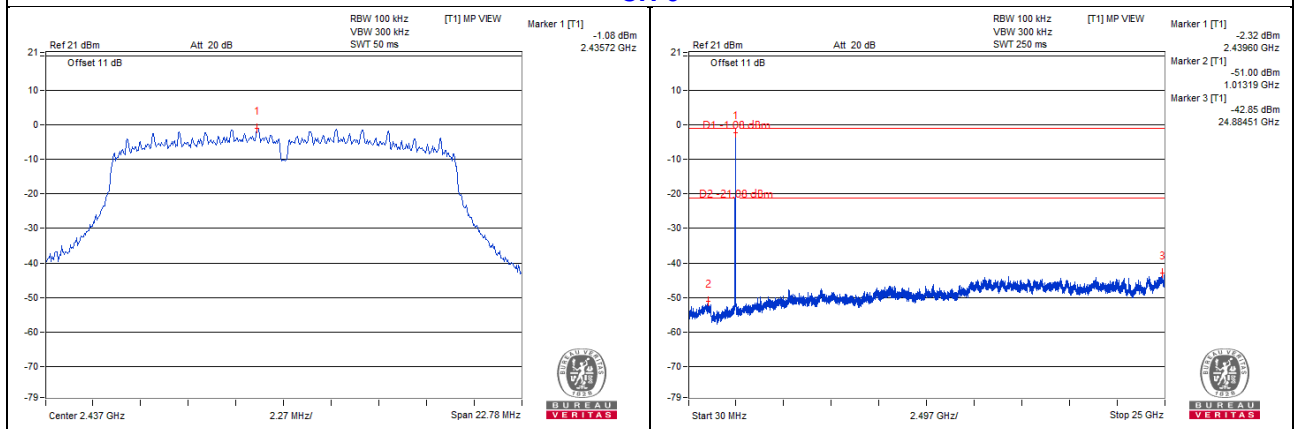

CH 11

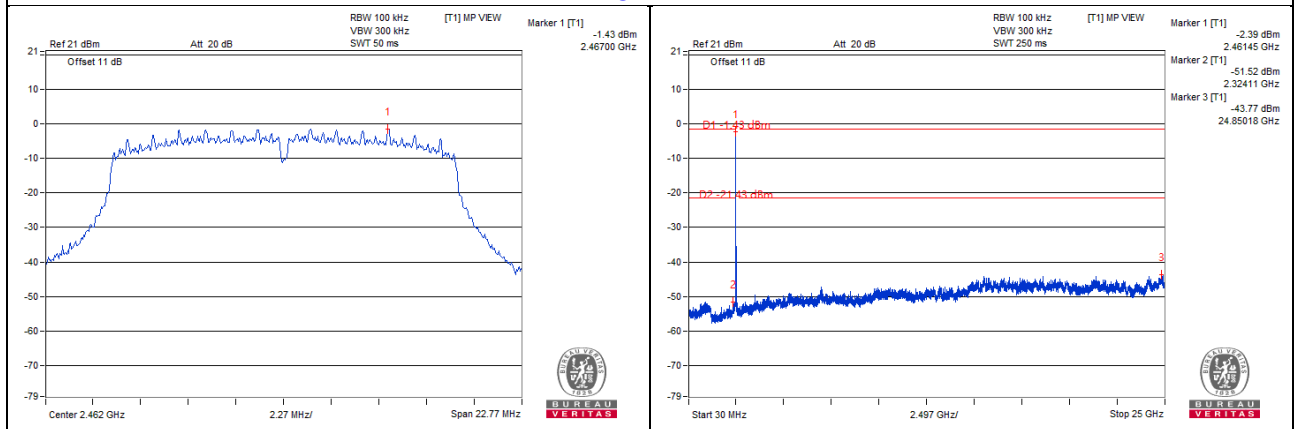

CH 1 Band edge

CH 11 Band edge

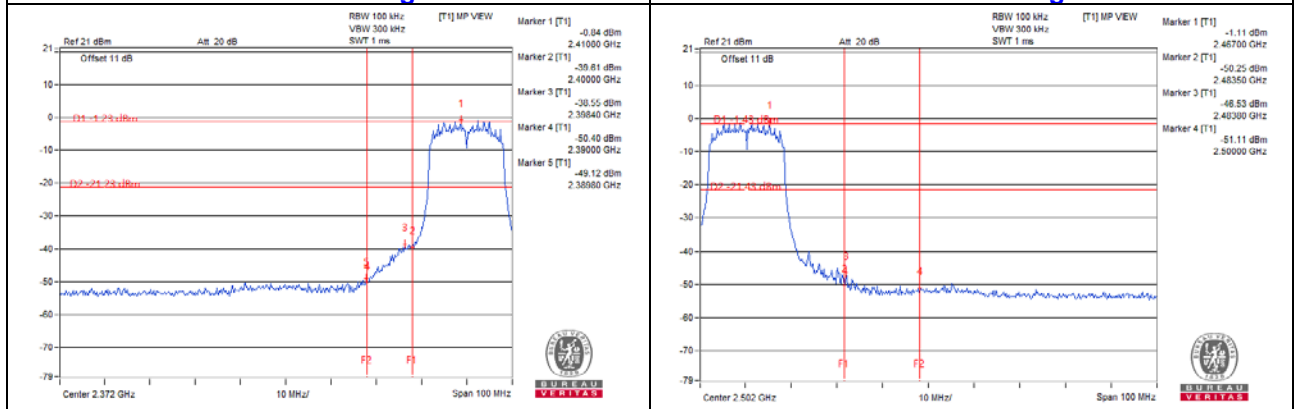

Chain 1

CH 1

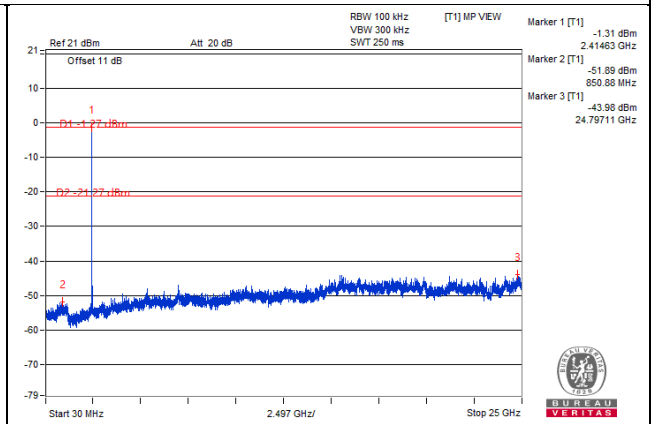
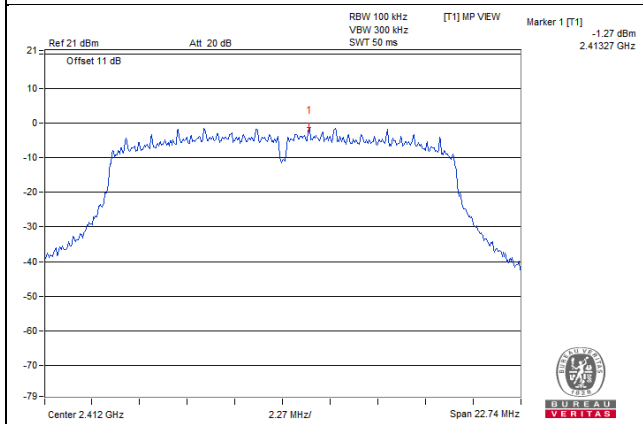

CH 6

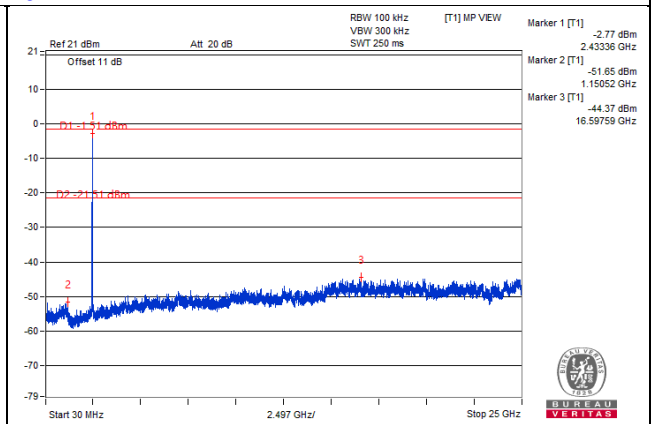
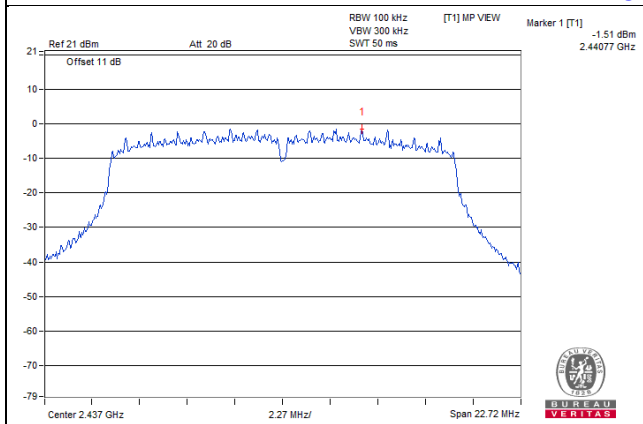

CH 11

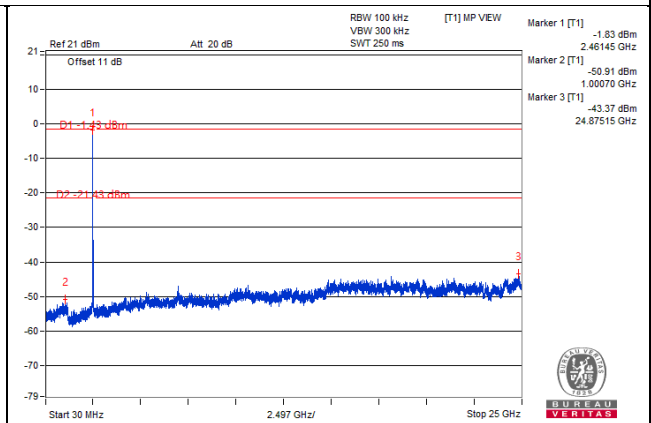
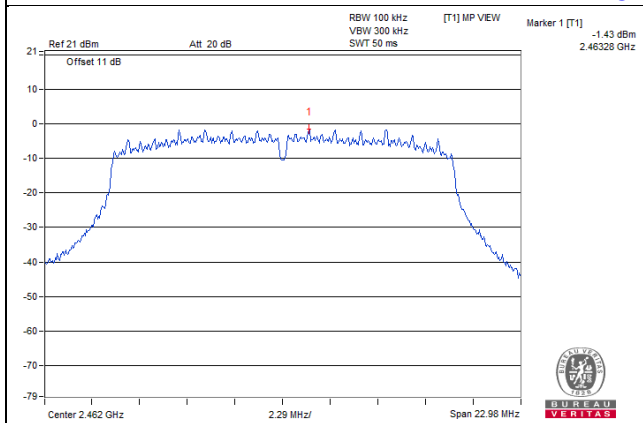

CH 1 Band edge

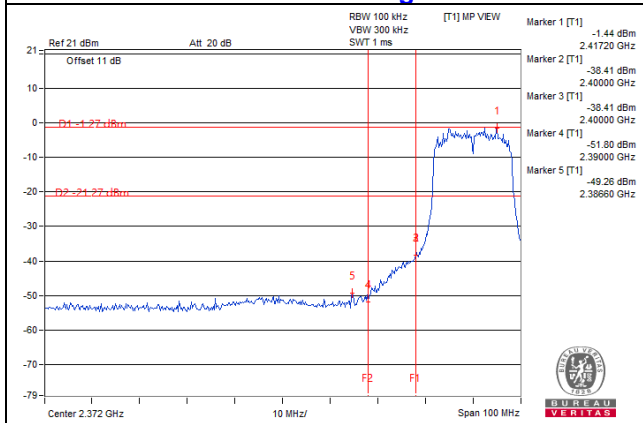

CH 11 Band edge

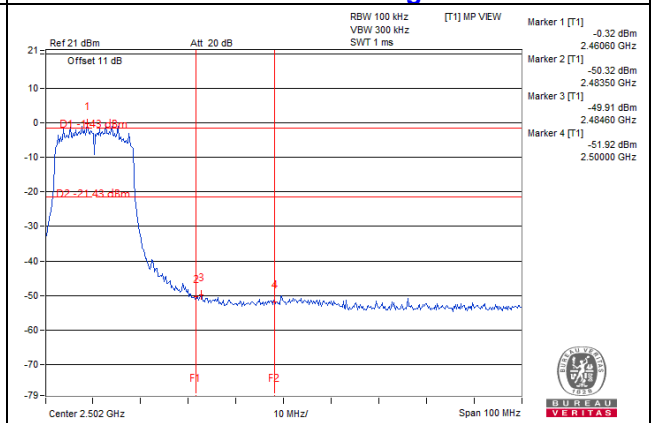

VHT20
Chain 0

CH 1

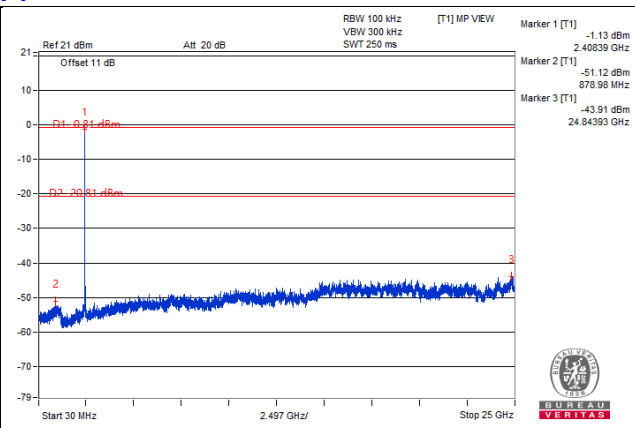
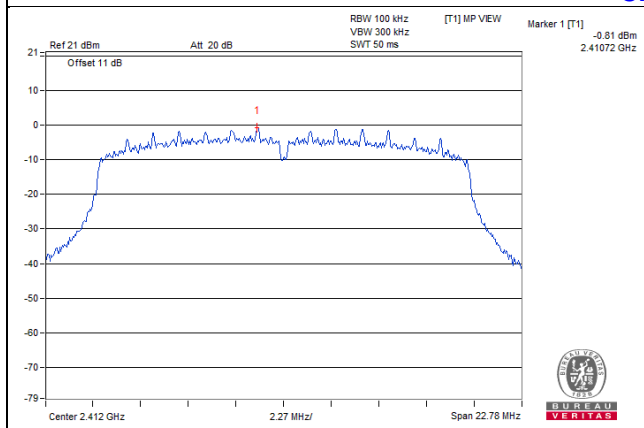

CH 6

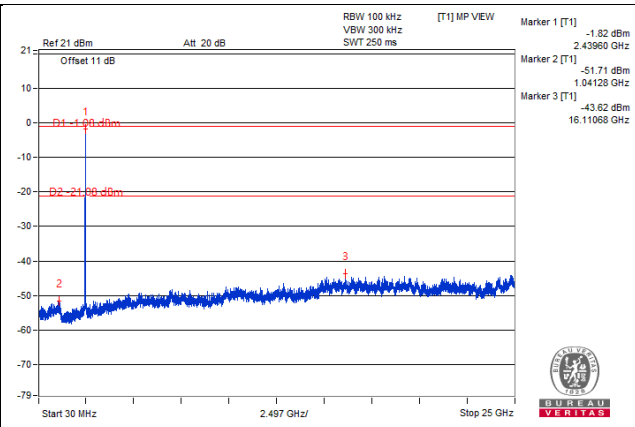
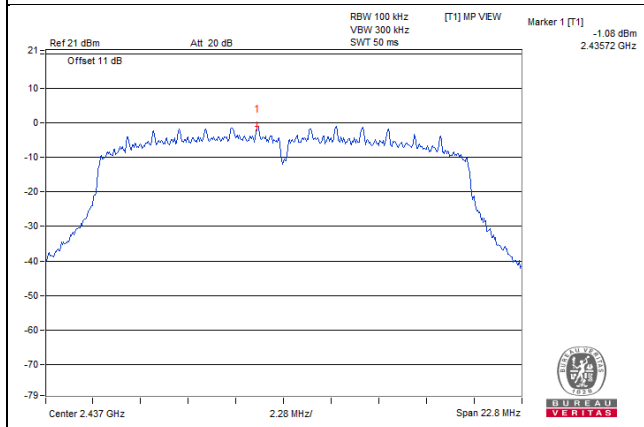

CH 11

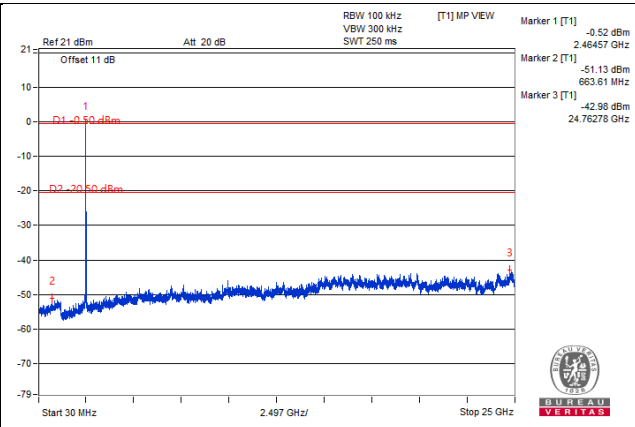
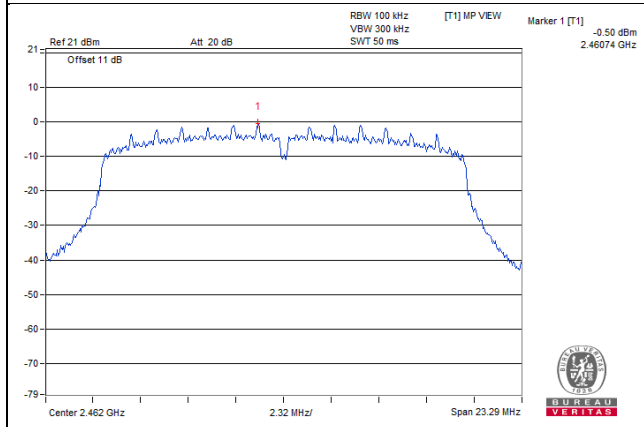

CH 1 Band edge

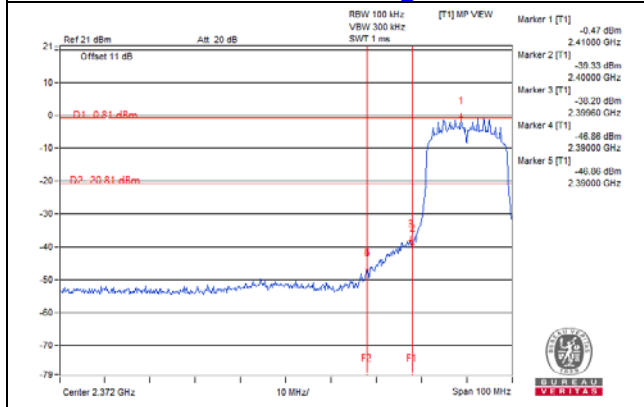

CH 11 Band edge

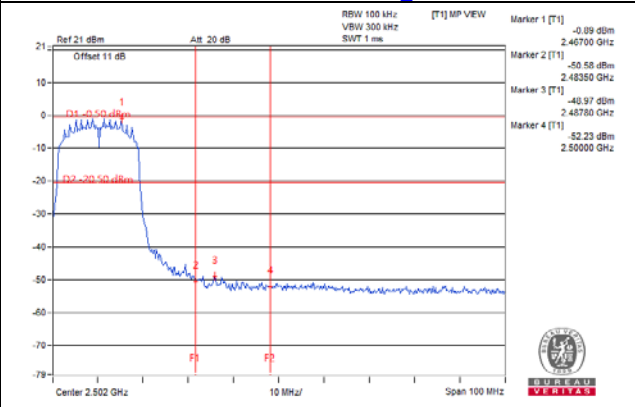

Chain 1

CH 1

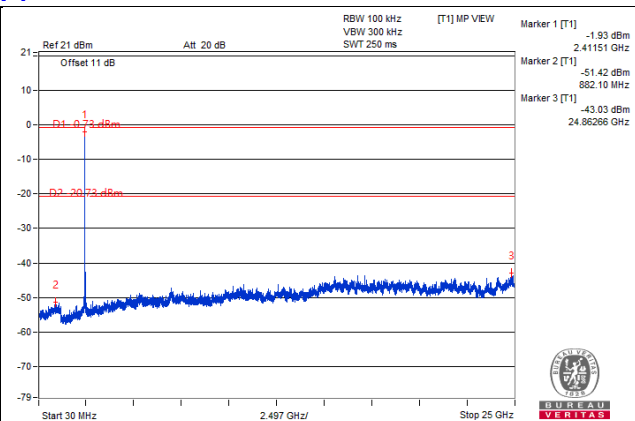
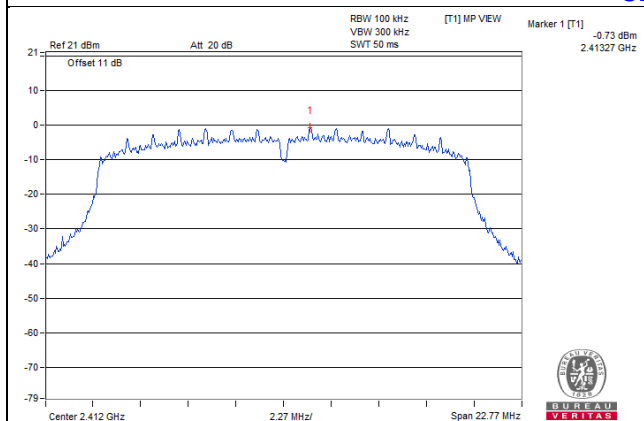

CH 6

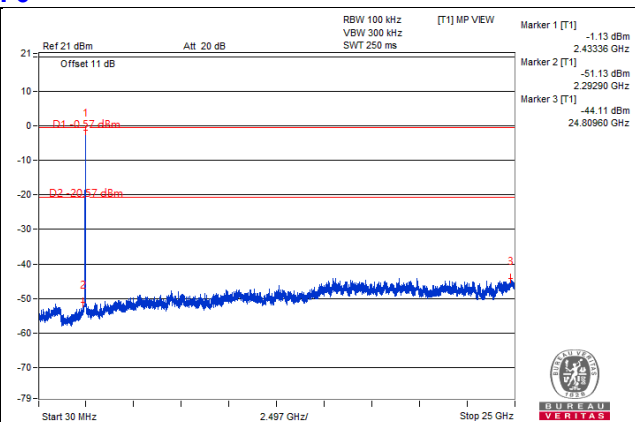
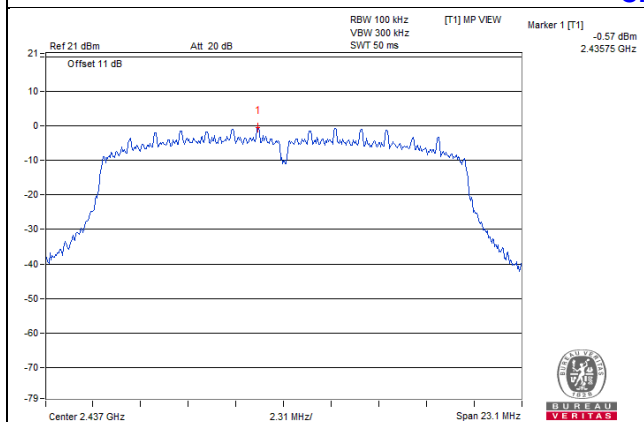

CH 11

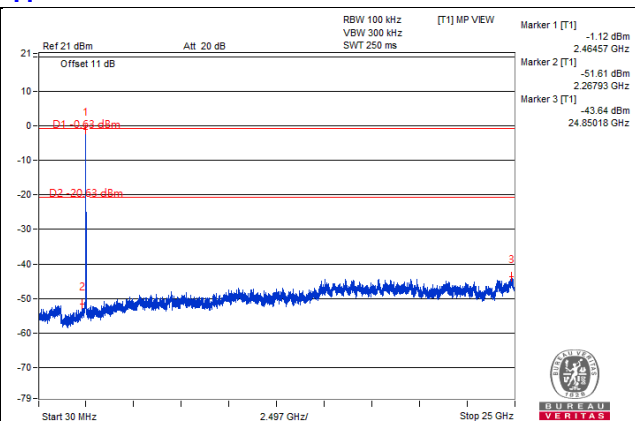
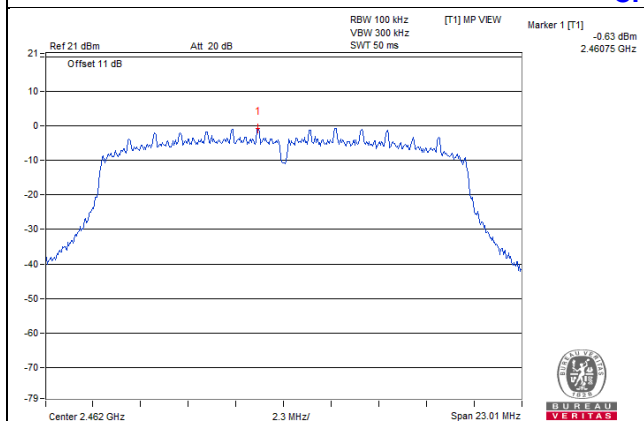

CH 1 Band edge

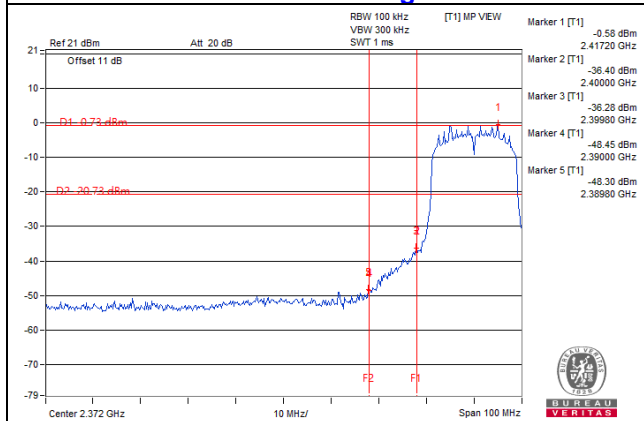

CH 11 Band edge

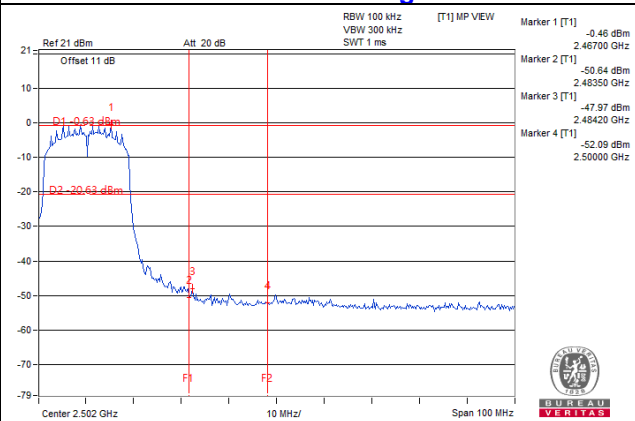

VHT40
Chain 0

CH 3

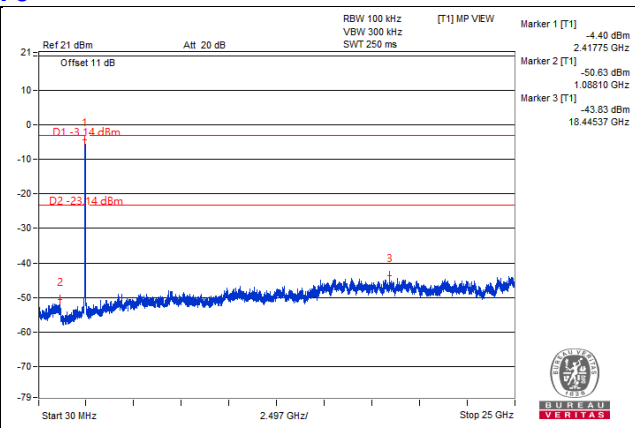
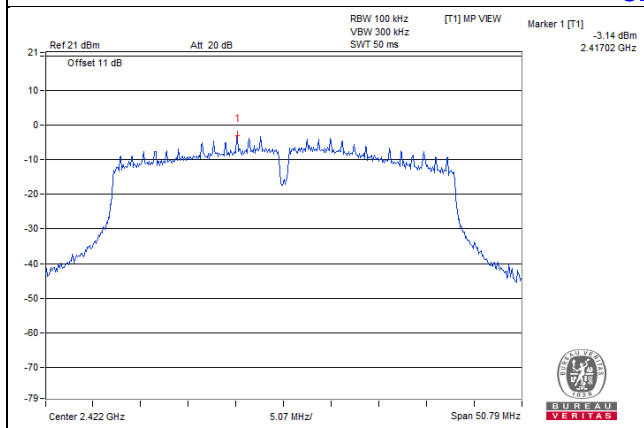

CH 6

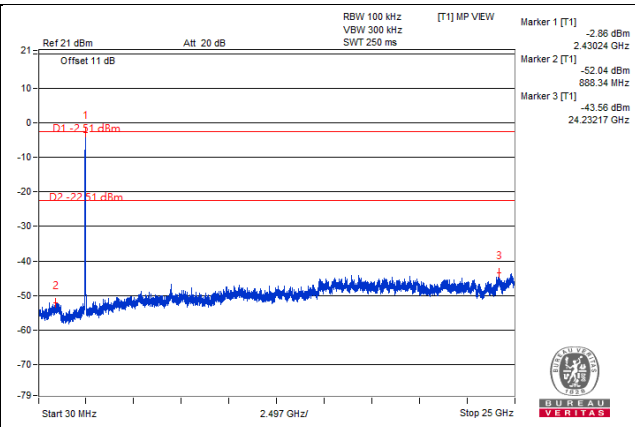
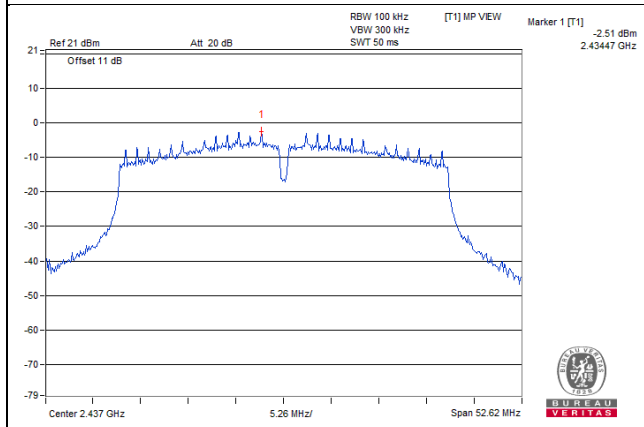

CH 9

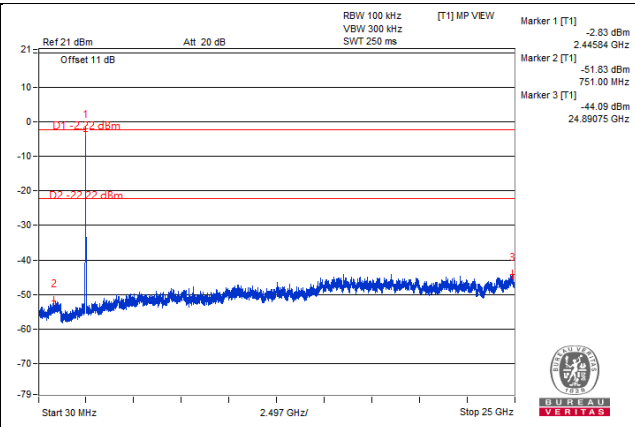
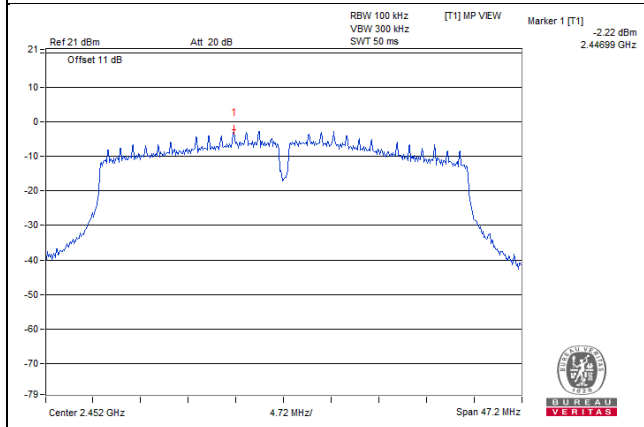

CH 3 Band edge

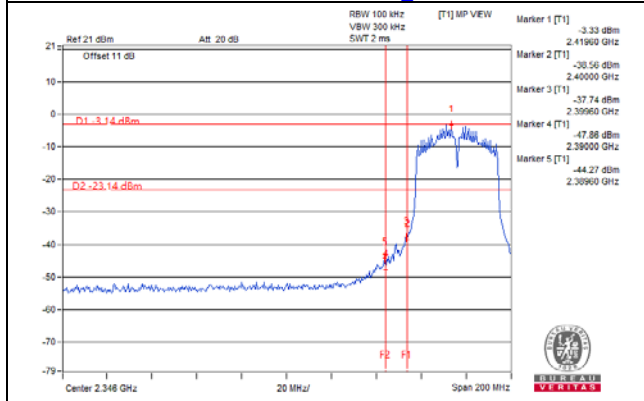

CH 9 Band edge

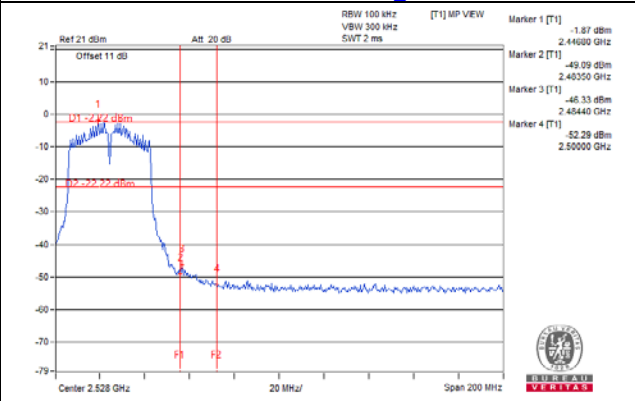

Chain 1

CH 3

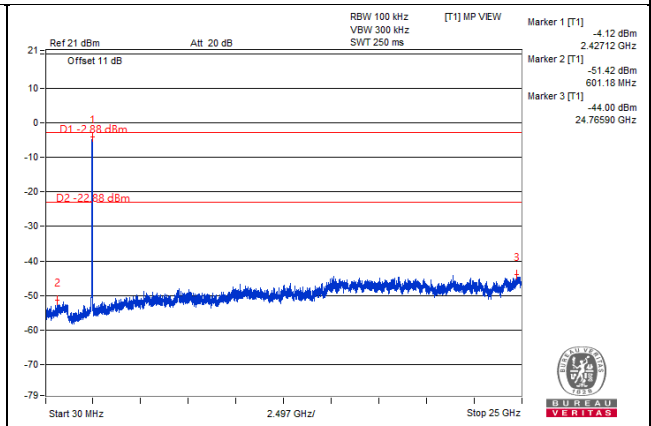
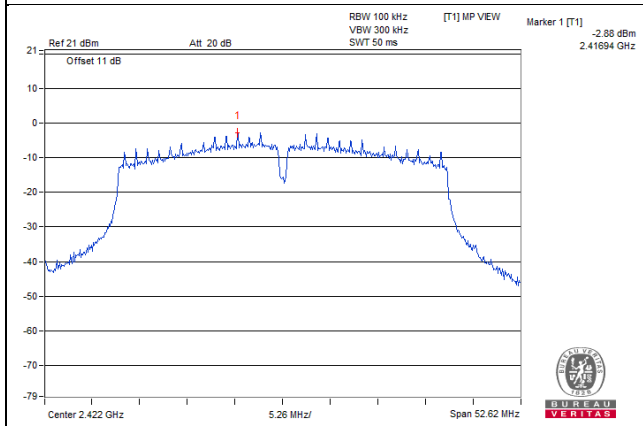

CH 6

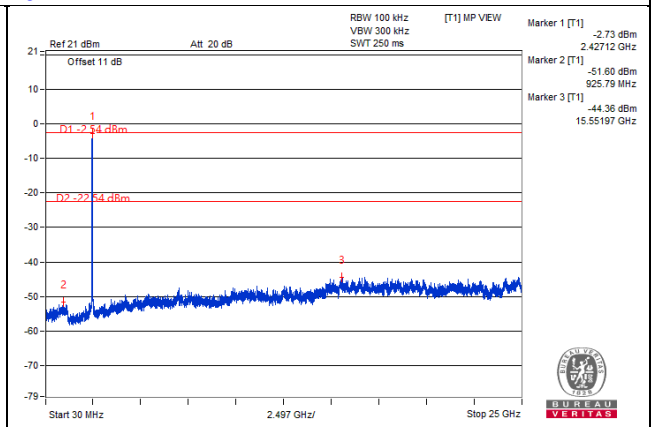
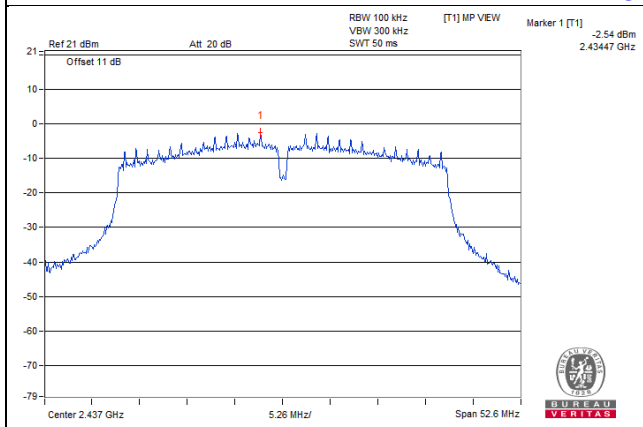

CH 9

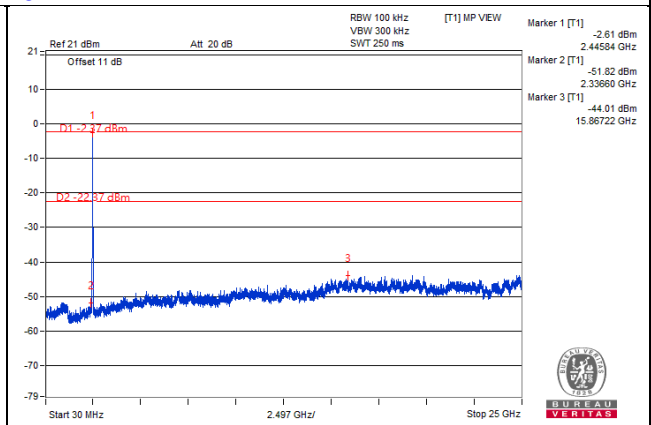
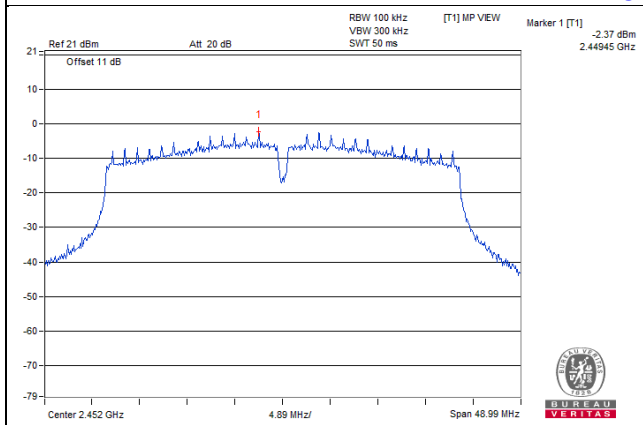

CH 3 Band edge

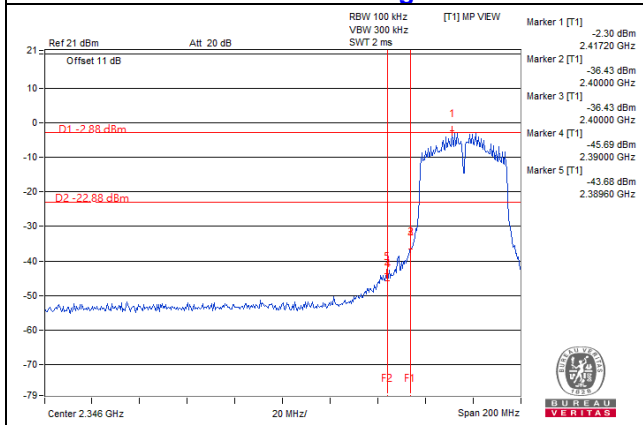

CH 9 Band edge

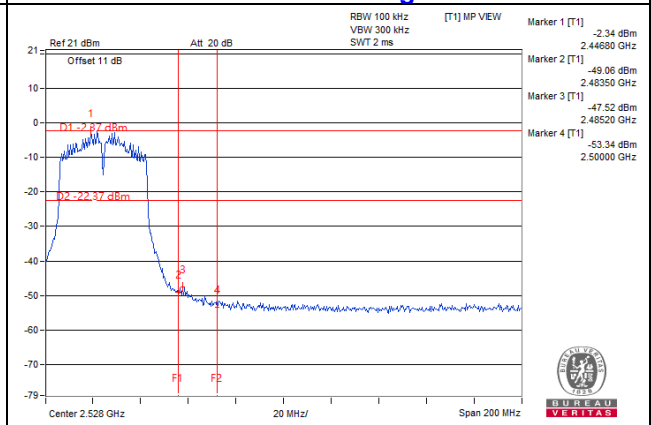

5 Pictures of Test Arrangements

Please refer to the attached file (Test Setup Photo).

Appendix – Information on the Testing Laboratories

We, Bureau Veritas Consumer Products Services (H.K.) Ltd., Taoyuan Branch, were founded in 1988 to provide our best service in EMC, Radio, Telecom and Safety consultation. Our laboratories are FCC recognized accredited test firms and accredited according to ISO/IEC 17025.

If you have any comments, please feel free to contact us at the following:

Linkou EMC/RF Lab

Tel: 886-2-26052180

Fax: 886-2-26051924

Hsin Chu EMC/RF/Telecom Lab

Tel: 886-3-6668565

Fax: 886-3-6668323

Hwa Ya EMC/RF/Safety Lab

Tel: 886-3-3183232

Fax: 886-3-3270892

Email: service.adt@tw.bureauveritas.com

Web Site: www.bureauveritas-adt.com

The address and road map of all our labs can be found in our web site also.

--- END ---