

Quick Start
Model SRC60

Package Contents

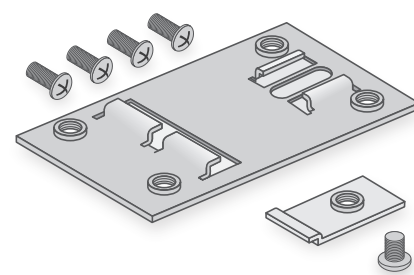

Orbi Pro Ceiling Satellite
(Model SRC60)



Metal bracket with T-bar
and lock screw for ceiling
mounting and 4 short
screws to attach the plastic
mount to the metal bracket

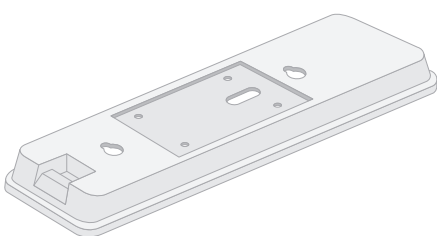

Plastic mount for either
ceiling mounting or wall
mounting

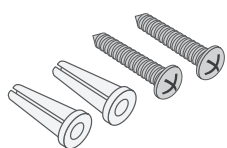

2 tall screws and anchors
to attach the plastic mount
to a wall

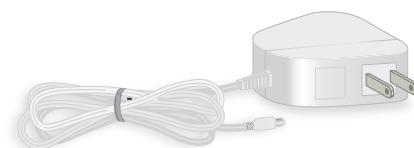

Power adapter
(varies by region)

Note: If you use a Power over Ethernet (PoE) connection to a PoE+ switch, the satellite does not require a power adapter.

Mount the Satellite on a Drop Ceiling

Before mounting the access point, first set up and test the access point to verify WiFi network connectivity.

Note: If you are mounting the access point on a hard ceiling, follow the instructions in [Mount the Satellite on a Wall](#).

1. Slide the T-bar partially into the metal bracket.
2. Attach the metal bracket to the ceiling bar.
3. Push the T-bar over the ceiling bar.
4. Use the lock screw to lock the metal bracket into place.
5. Use the four short screws to attach the plastic mount to the metal bracket.

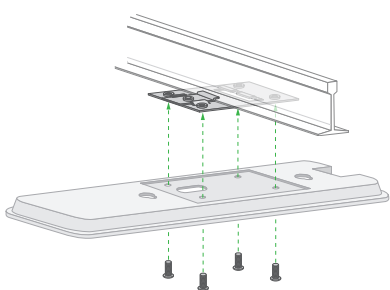
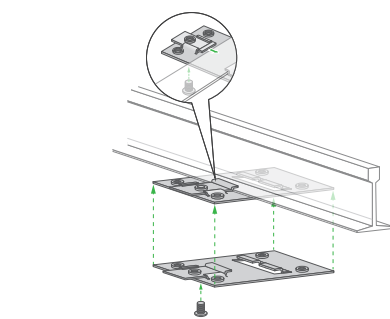

6. Slide the satellite onto the plastic mount.
7. Use the retaining clip to lock the satellite into place.



8. Cable the satellite to your network.

Mount the Satellite on a Wall

1. Place the plastic mount on the wall.
2. Mark the wall where the two mounting holes are.
3. If needed, drill holes.
4. Use the two wall anchors and tall screws to attach the plastic mount to the wall.
5. Slide the satellite onto the plastic mount.

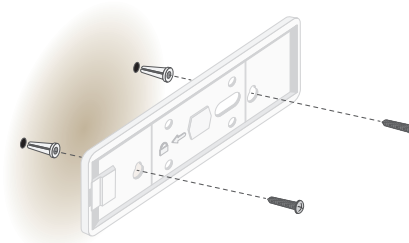

6. Use the retaining clip to lock the satellite into place.
7. Cable the satellite to your network.

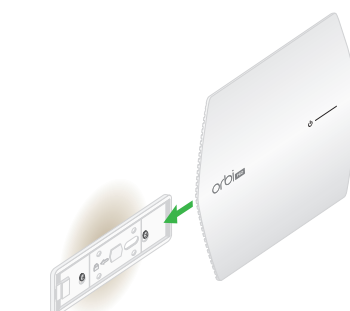

Orbi Pro Ceiling Satellite Overview

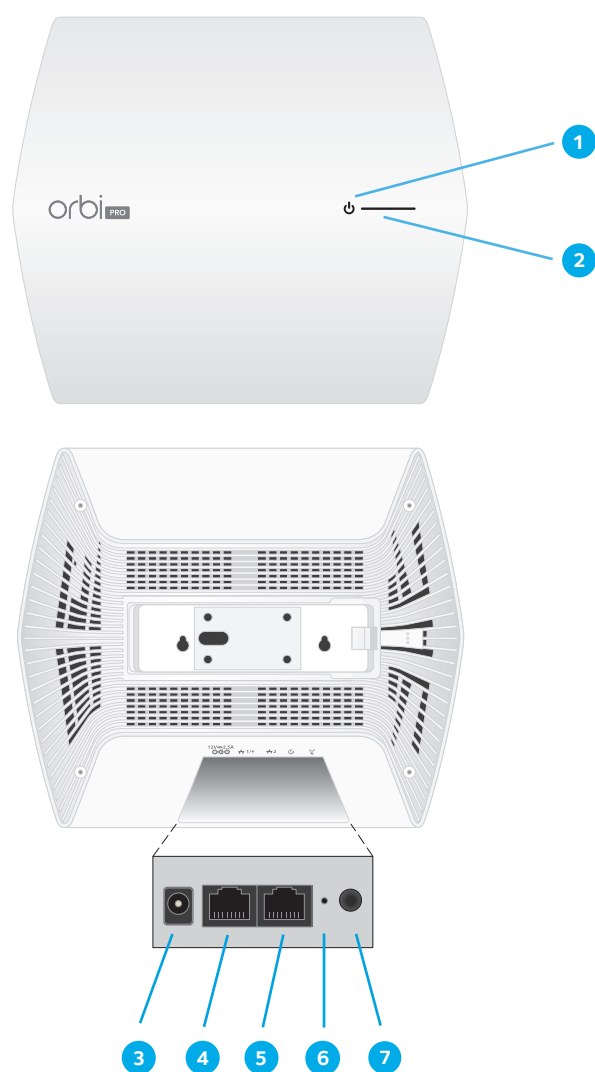

- 1 Power LED on the top panel
- 2 LED bar on the top panel
- 3 DC power connector
- 4 PoE+ LAN 1 port
- 5 LAN 2 port
- 6 Reset button
- 7 Sync button

Sync your Orbi Satellite With the NETGEAR Insight App

You can use the NETGEAR Insight app to sync your Orbi satellite with your Orbi Pro router. For more information about the app, visit <https://www.netgear.com/insight/>.



1. Download the NETGEAR Insight app from the Apple App Store or Google Play Store.



2. Launch the NETGEAR Insight app on your mobile device and follow the prompts.

Note: If you don't own a mobile device, follow the instructions in [Manually Sync Your Satellite Before You Install It](#).

Manually Sync Your Satellite Before You Install It

Place your Orbi Pro router and Orbi satellite near each other during the syncing process. After your router and satellite are synced, mount the satellite.

1. Place your Orbi satellite in an area near your Orbi Pro router.

2. Connect your satellite to a power source.

Either connect the power adapter to the satellite and to a power source or connect PoE+ LAN port 1 on the satellite to an Ethernet cable and to a Power over Ethernet Plus (PoE+) switch that can provide 802.3at (PoE+) power.

The Power LED on the top panel of the Orbi satellite lights solid green.

Note: If the Power LED does not light, check the power source or the PoE+ switch. If the Power LED lights red, the power is not at the required 802.3at (PoE+) level. Make sure that you use an 802.3at (PoE+) switch and not an 802.af (PoE) switch. For more information about the Power LED, see the user manual, which you can download by visiting <https://www.netgear.com/support/download/>.

3. Wait for the LED bar (next to the Power LED) to light solid white.

The following is the LED bar behavior during booting:

- **Pulsing white.** The satellite is booting.
- **Solid white.** The satellite finished booting and is ready to sync with your router.

4. Press the **Sync** button on the back of your satellite, and within two minutes, press the **Sync** button on the back of your Orbi Pro router.

5. Wait for the satellite to sync with the router.

The LED bar on the satellite lights pulsing white while it attempts to sync with your Orbi Pro router. It might take about six minutes for your satellite to sync.

After the LED bar lights pulsing white, it lights one of the following colors for about three minutes and then turns off:

- **Blue**
The Orbi Pro router and satellite successfully synced, and the connection between the router and satellite is good.
- **Amber**
The Orbi Pro router and satellite successfully synced, and the connection between the router and satellite is fair. Consider moving the satellite closer to the router.
- **Magenta**
The Orbi Pro router and satellite did not sync. Move the satellite closer to the router and try again.

6. Mount your satellite and connect it to a power source.

You can mount your satellite on a ceiling or on a wall. For more information, see [Mount the Satellite on a Drop Ceiling](#) or [Mount the Satellite on a Wall](#) on the other side of this quick start guide.

Either connect the power adapter to the satellite and to a power source or connect PoE+ LAN port 1 on the satellite to an Ethernet cable and to a PoE+ switch that can provide 802.3at (PoE+) power.

7. Make sure that the LED bar lights blue to indicate a good connection to the Orbi router.

Note: After your satellite syncs with your router, the satellite's **Sync** button is disabled for security reasons. If you press the **Sync** button and the satellite's LED bar pulses magenta, this LED behavior indicates that the **Sync** button is disabled. To enable the **Sync** button, log in to the router and go to the Attached Devices page. For more information, see the user manual.

Support

Thank you for purchasing this NETGEAR product. You can visit <https://www.netgear.com/support/> to register your product, get help, access the latest downloads and user manuals, and join our community. We recommend that you use only official NETGEAR support resources.

Si ce produit est vendu au Canada, vous pouvez accéder à ce document en français canadien à <https://www.netgear.com/support/download/>.

(If this product is sold in Canada, you can access this document in Canadian French at <https://www.netgear.com/support/download/>.)

For regulatory compliance information including the EU Declaration of Conformity, visit <https://www.netgear.com/about/regulatory/>.

See the regulatory compliance document before connecting the power supply.



201-23986-01

December 2018

NETGEAR, Inc.
350 East Plumeria Drive
San Jose, CA 95134, USA



NETGEAR INTL LTD
Building 3, University Technology
Centre
Curraheen Road, Cork, Ireland

© NETGEAR, Inc., NETGEAR and the NETGEAR Logo are trademarks of NETGEAR, Inc. Any non-NETGEAR trademarks are used for reference purposes only.