

FCC Test Report (Co-Located)

Report No.: RF181019C20-2

FCC ID: PY318300427

Test Model: SRC60

Series Model: WAC540 (refer to item 3.1 for more details)

Received Date: Oct. 19, 2018

Test Date: Dec. 24, 2018 ~ Jan. 03, 2019

Issued Date: Jan. 22, 2019

Applicant: NETGEAR, INC.

Address: 350 East Plumeria Drive San Jose, CA 95134

Issued By: Bureau Veritas Consumer Products Services (H.K.) Ltd., Taoyuan Branch

Lab Address: No. 47-2, 14th Ling, Chia Pau Vil., Lin Kou Dist., New Taipei City, Taiwan (R.O.C.)

Test Location: No. 19, Hwa Ya 2nd Rd., Wen Hwa Vil., Kwei Shan Dist., Taoyuan City 33383, TAIWAN (R.O.C.)

**FCC Registration /
Designation Number:** 788550 / TW0003



This report is for your exclusive use. Any copying or replication of this report to or for any other person or entity, or use of our name or trademark, is permitted only with our prior written permission. This report sets forth our findings solely with respect to the test samples identified herein. The results set forth in this report are not indicative or representative of the quality or characteristics of the lot from which a test sample was taken or any similar or identical product unless specifically and expressly noted. Our report includes all of the tests requested by you and the results thereof based upon the information that you provided to us. You have 60 days from date of issuance of this report to notify us of any material error or omission caused by our negligence, provided, however, that such notice shall be in writing and shall specifically address the issue you wish to raise. A failure to raise such issue within the prescribed time shall constitute your unqualified acceptance of the completeness of this report, the tests conducted and the correctness of the report contents. Unless specific mention, the uncertainty of measurement has been explicitly taken into account to declare the compliance or non-compliance to the specification. The report must not be used by the client to claim product certification, approval, or endorsement by TAF or any government agencies.

Table of Contents

Release Control Record	3
1 Certificate of Conformity	4
2 Summary of Test Results	5
2.1 Measurement Uncertainty	5
2.2 Modification Record	5
3 General Information	6
3.1 General Description of EUT	6
3.2 Description of Test Modes	9
3.2.1 Test Mode Applicability and Tested Channel Detail	10
3.3 Description of Support Units	11
3.3.1 Configuration of System under Test	11
3.4 General Description of Applied Standards	12
4 Test Types and Results	13
4.1 Radiated Emission and Bandedge Measurement.....	13
4.1.1 Limits of Radiated Emission and Bandedge Measurement	13
4.1.2 Test Instruments	14
4.1.3 Test Procedures.....	15
4.1.4 Deviation from Test Standard	15
4.1.5 Test Setup.....	16
4.1.6 EUT Operating Conditions.....	17
4.1.7 Test Results	18
4.2 Conducted Out of Band Emission Measurement.....	26
4.2.1 Limits of Conducted Out of Band Emission Measurement.....	26
4.2.2 Test Setup.....	26
4.2.3 Test Instruments	26
4.2.4 Test Procedure	26
4.2.5 Deviation from Test Standard	26
4.2.6 EUT Operating Condition	26
4.2.7 Test Results	27
5 Pictures of Test Arrangements	28
Annex A- Radiated Out of Band Emission (OOBE) Measurement (For U-NII-3 band)	29
Appendix – Information on the Testing Laboratories	30

Release Control Record

Issue No.	Description	Date Issued
RF181019C20-2	Original release	Jan. 22, 2019

1 Certificate of Conformity

Product: Orbi Pro AC3000 Tri-band Ceiling Add-on Satellite SRC60,
Insight Managed Smart Cloud Wireless Access Point (WAC540)

Brand: NETGEAR

Test Model: SRC60

Series Model: WAC540 (refer to item 3.1 for more details)

Sample Status: Engineering sample

Applicant: NETGEAR, INC.

Test Date: Dec. 24, 2018 ~ Jan. 03, 2019

Standards: 47 CFR FCC Part 15, Subpart C (Section 15.247)
47 CFR FCC Part 15, Subpart E (Section 15.407)
ANSI C63.10:2013

The above equipment has been tested by **Bureau Veritas Consumer Products Services (H.K.) Ltd., Taoyuan Branch**, and found compliance with the requirement of the above standards. The test record, data evaluation & Equipment Under Test (EUT) configurations represented herein are true and accurate accounts of the measurements of the sample's RF characteristics under the conditions specified in this report.

Prepared by : Celine Chou , **Date:** Jan. 22, 2019
Celine Chou / Senior Specialist

Approved by : Bruce Chen , **Date:** Jan. 22, 2019
Bruce Chen / Project Engineer

2 Summary of Test Results

Applied Standard:	47 CFR FCC Part 15, Subpart C (Section 15.247) 47 CFR FCC Part 15, Subpart E (Section 15.407)		
FCC Clause	Test Item	Result	Remarks
15.205 / 15.209 / 15.247(d) 15.407(b) (1/2/3/4(i/ii)/6)	Radiated Emissions	Pass	Meet the requirement of limit. Minimum passing margin is -3.0dB at 11490.00MHz.

2.1 Measurement Uncertainty

Where relevant, the following measurement uncertainty levels have been estimated for tests performed on the EUT as specified in CISPR 16-4-2:

Measurement	Frequency	Expanded Uncertainty (k=2) (\pm)
Radiated Emissions up to 1 GHz	30MHz ~ 200MHz	3.63 dB
	200MHz ~ 1000MHz	3.64 dB
Radiated Emissions above 1 GHz	1GHz ~ 18GHz	2.29 dB
	18GHz ~ 40GHz	2.29 dB

2.2 Modification Record

There were no modifications required for compliance.

3 General Information

3.1 General Description of EUT

Product	Orbi Pro AC3000 Tri-band Ceiling Add-on Satellite SRC60, Insight Managed Smart Cloud Wireless Access Point (WAC540)
Brand	NETGEAR
Test Model	SRC60
Series Model	WAC540
Model Difference	Refer to note for more details
Sample Status	Engineering sample
Power Supply Rating	12Vdc (Adapter) 54Vdc (POE)
Modulation Type	CCK, DQPSK, DBPSK for DSSS 256QAM, 64QAM, 16QAM, QPSK, BPSK for OFDM
Transfer Rate	802.11b: 11.0/ 5.5/ 2.0/ 1.0Mbps 802.11g: 54.0/ 48.0/ 36.0/ 24.0/ 18.0/ 12.0/ 9.0/ 6.0Mbps 802.11a: 54/48/36/24/18/12/9/6Mbps 802.11n: up to 300.0Mbps (For 2.4GHz Band) 802.11n: up to 600.0Mbps (For 5GHz Band) 802.11ac: up to 1733.3Mbps
Operating Frequency	2.4GHz: 2412 ~ 2462MHz 5.0GHz: 5180 ~ 5240MHz, 5745 ~ 5825MHz
Number of Channel	2412 ~ 2462MHz: 802.11b, 802.11g, 802.11n (HT20): 11 802.11n (HT40): 7 5180 ~ 5240MHz: 802.11a, 802.11n (HT20), 802.11ac (VHT20): 4 802.11n (HT40), 802.11ac (VHT40): 2 802.11ac (VHT80): 1 5745 ~ 5825MHz: 802.11a, 802.11n (HT20), 802.11ac (VHT20): 5 802.11n (HT40), 802.11ac (VHT40): 2 802.11ac (VHT80): 1
Output Power	CDD Mode: 2412 ~ 2462MHz: 722.161mW 5180 ~ 5240MHz: 758.703mW 5745 ~ 5825MHz: 927.751mW Beamforming Mode: 2412 ~ 2462MHz: 718.709mW 5180 ~ 5240MHz: 758.703mW 5745 ~ 5825MHz: 748.914mW
Antenna Type	Refer to Note
Antenna Connector	Refer to Note
Accessory Device	Adapter
Cable Supplied	N/A

Note:

1. The EUT incorporates a MIMO function. Physically, the EUT provides 4 completed transmitters and 4 receivers.

Band	Modulation Mode	Beamforming Mode	TX Function
2.4GHz Band	802.11b	Not Support	2TX
	802.11g	Not Support	2TX
	802.11n (HT20)	Support	2TX
	802.11n (HT40)	Support	2TX
5GHz Band 1	802.11a	Not Support	2TX
	802.11n (HT20)	Support	2TX
	802.11n (HT40)	Support	2TX
	802.11ac (VHT20)	Support	2TX
	802.11ac (VHT40)	Support	2TX
	802.11ac (VHT80)	Support	2TX
5GHz Band 4	802.11a	Not Support	4TX
	802.11n (HT20)	Support	4TX
	802.11n (HT40)	Support	4TX
	802.11ac (VHT20)	Support	4TX
	802.11ac (VHT40)	Support	4TX
	802.11ac (VHT80)	Support	4TX

* For 802.11n, CDD mode and Beamforming mode are presented in power output test item. For other test items, CDD mode is the worst case for final tests after pretesting.

* The modulation and bandwidth are similar for 802.11n mode for 20MHz/40MHz and 802.11ac mode for 20MHz/40MHz, therefore investigated worst case to representative mode in test report. (Final test mode refer section 3.2.1)

2. All models are listed as below. Model SRC60 is the representative for final test.

Brand	Product Name	Model	Difference
NETGEAR	Orbi Pro AC3000 Tri-band Ceiling Add-on Satellite SRC60	SRC60	Main test model. Same PCB with WAC540, only LED location and enclosures difference.
	Insight Managed Smart Cloud Wireless Access Point (WAC540)	WAC540	Series model.

3. The following RF Modules are for the EUT.

RF Module	Band	Antenna No.
Module 1	2.4G	5, 6
	UNII-1	5, 6
Module 2	UNII-3	1, 2, 3, 4

4. The EUT consumes power from the following adapters and POE.

Adapter 1	
Brand	NETGEAR
Model	2ABL030F1 NJ
P/N	332-10948-01
Input	100-120Vac, 50/60Hz, 1.0A
Output	12Vdc, 2.5A
Power Line	1.8m DC cable without core attached on adapter

Adapter 2	
Brand	NETGEAR
Model	AD2067M20
P/N	332-11074-01
Input	100-240Vac, 50/60Hz, 1.0A
Output	12Vdc, 2.5A
Power Line	1.8m DC cable without core attached on adapter

POE (Support unit only)	
Brand	NETGEAR
Model	GS110TP
Input Power	100-240Vac, 50/60Hz
Output Power	54Vdc, 1.25A

POE 's adapter (Support unit only)	
Brand	NETGEAR
Model	2ACL068S
P/N	332-11059-01
Input	100-240Vac, 50/60Hz, 1.7A Max
Output	54Vdc, 1.25A
Power Line	1.5m DC cable without core attached on adapter

5. The following antennas were provided to the EUT.

Ant. Type	Dipole		
Connecter Type	i-pex(MHF)		
Directional Antenna Gain (dBi)			
Item	2.4G	UNII-1	UNII-3
-	4.27	4.42	7.09

3.2 Description of Test Modes

For 2.4GHz

11 channels are provided for 802.11b, 802.11g and 802.11n (HT20):

Channel	Frequency	Channel	Frequency
1	2412MHz	7	2442MHz
2	2417MHz	8	2447MHz
3	2422MHz	9	2452MHz
4	2427MHz	10	2457MHz
5	2432MHz	11	2462MHz
6	2437MHz		

7 channels are provided for 802.11n (HT40):

Channel	Frequency	Channel	Frequency
3	2422MHz	7	2442MHz
4	2427MHz	8	2447MHz
5	2432MHz	9	2452MHz
6	2437MHz		

For 5180 ~ 5240MHz:

4 channels are provided for 802.11a, 802.11n (HT20):

Channel	Frequency	Channel	Frequency
36	5180 MHz	44	5220 MHz
40	5200 MHz	48	5240 MHz

2 channels are provided for 802.11n (HT40):

Channel	Frequency	Channel	Frequency
38	5190 MHz	46	5230 MHz

1 channel is provided for 802.11ac (VHT80):

Channel	Frequency
42	5210MHz

For 5745 ~ 5825MHz:

5 channels are provided for 802.11a, 802.11n (HT20):

Channel	Frequency	Channel	Frequency
149	5745MHz	161	5805MHz
153	5765MHz	165	5825MHz
157	5785MHz		

2 channels are provided for 802.11n (HT40):

Channel	Frequency	Channel	Frequency
151	5755MHz	159	5795MHz

1 channel is provided for 802.11ac (VHT80):

Channel	Frequency
155	5775MHz

3.2.1 Test Mode Applicability and Tested Channel Detail

EUT Configure Mode	Applicable to			Description
	RE \geq 1G	RE<1G	OB	
A	-	√	-	Powered by adapter 1
B	√	√	√	Powered by adapter 2
C	-	√	-	Powered by POE

Where RE \geq 1G: Radiated Emission above 1GHz & Bandedge Measurement
 RE<1G: Radiated Emission below 1GHz
 OB: Conducted Out-Band Emission Measurement

Note: The EUT had been pre-tested on the positioned of each 3 axis. The worst case was found when positioned on **X-plane**.

Radiated Emission Test (Above 1GHz):

- Pre-Scan has been conducted to determine the worst-case mode from all possible combinations between available modulations, data rates and antenna ports (if EUT with antenna diversity architecture).
- Following channel(s) was (were) selected for the final test as listed below.

EUT Configure Mode	Mode	Freq. Range (MHz)	Available Channel	Tested Channel	Modulation Technology
-	802.11g + 802.11a + 802.11a	2412 ~ 2462	1 to 11	6 + 48 + 149	OFDM
		5180 ~ 5240	38 to 46		OFDM
		5745 ~ 5825	149 to 165		OFDM

Radiated Emission Test (Below 1GHz):

- Pre-Scan has been conducted to determine the worst-case mode from all possible combinations between available modulations, data rates and antenna ports (if EUT with antenna diversity architecture).
- Following channel(s) was (were) selected for the final test as listed below.

EUT Configure Mode	Mode	Freq. Range (MHz)	Available Channel	Tested Channel	Modulation Technology
-	802.11g + 802.11a + 802.11a	2412 ~ 2462	1 to 11	6 + 48 + 149	OFDM
		5180 ~ 5240	38 to 46		OFDM
		5745 ~ 5825	149 to 165		OFDM

Conducted Out-Band Emission Measurement

- Pre-Scan has been conducted to determine the worst-case mode from all possible combinations between available modulations, data rates and antenna ports (if EUT with antenna diversity architecture).
- Following channel(s) was (were) selected for the final test as listed below.

EUT Configure Mode	Mode	Freq. Range (MHz)	Available Channel	Tested Channel	Modulation Technology
-	802.11g + 802.11a + 802.11a	2412 ~ 2462	1 to 11	6 + 48 + 149	OFDM
		5180 ~ 5240	38 to 46		OFDM
		5745 ~ 5825	149 to 165		OFDM

Test Condition:

Applicable to	Environmental Conditions	Input Power	Tested by
RE≥1G	25 deg. C, 70% RH	120Vac, 60Hz	Luis Lee
RE<1G	25 deg. C, 70% RH	120Vac, 60Hz 54Vdc	Noah Chang
OB	25 deg. C, 70% RH	120Vac, 60Hz	Luis Lee

3.3 Description of Support Units

The EUT has been tested as an independent unit together with other necessary accessories or support units. The following support units or accessories were used to form a representative test configuration during the tests.

ID	Product	Brand	Model No.	Serial No.	FCC ID	Remarks
A.	Notebook	Lenovo	81A4	YD02TWF5	PPD-QCNFA435	-
B.	Load	NA	NA	NA	NA	-
C.	POE	NETGEAR	GS110TP	NA	NA	Provided by client

Note:

1. All power cords of the above support units are non-shielded (1.8m).
2. Item A acted as a communication partner to transfer data.

ID	Descriptions	Qty.	Length (m)	Shielding (Yes/No)	Cores (Qty.)	Remarks
1.	RJ45, Cat5e	1	5	N	0	-
2.	RJ45, Cat5e	1	1.5	N	0	-
3.	RJ45, Cat5e	1	1	N	0	-

3.3.1 Configuration of System under Test

Test Mode A

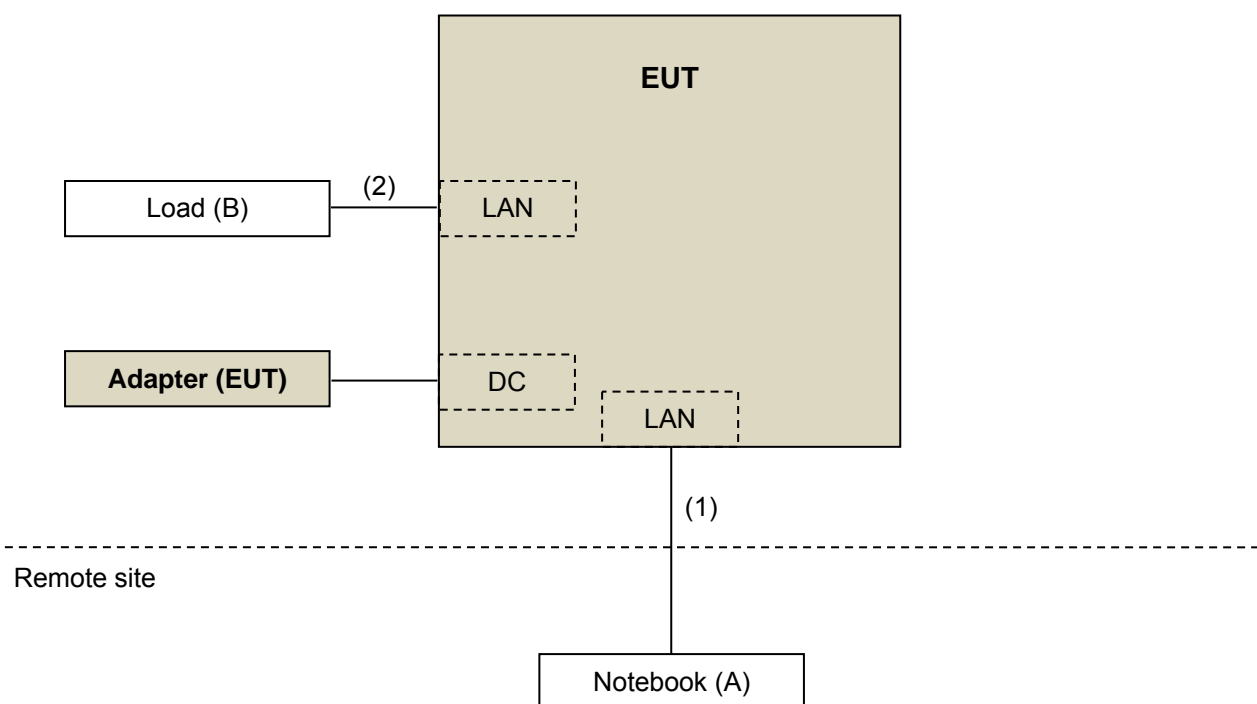

Test Mode B

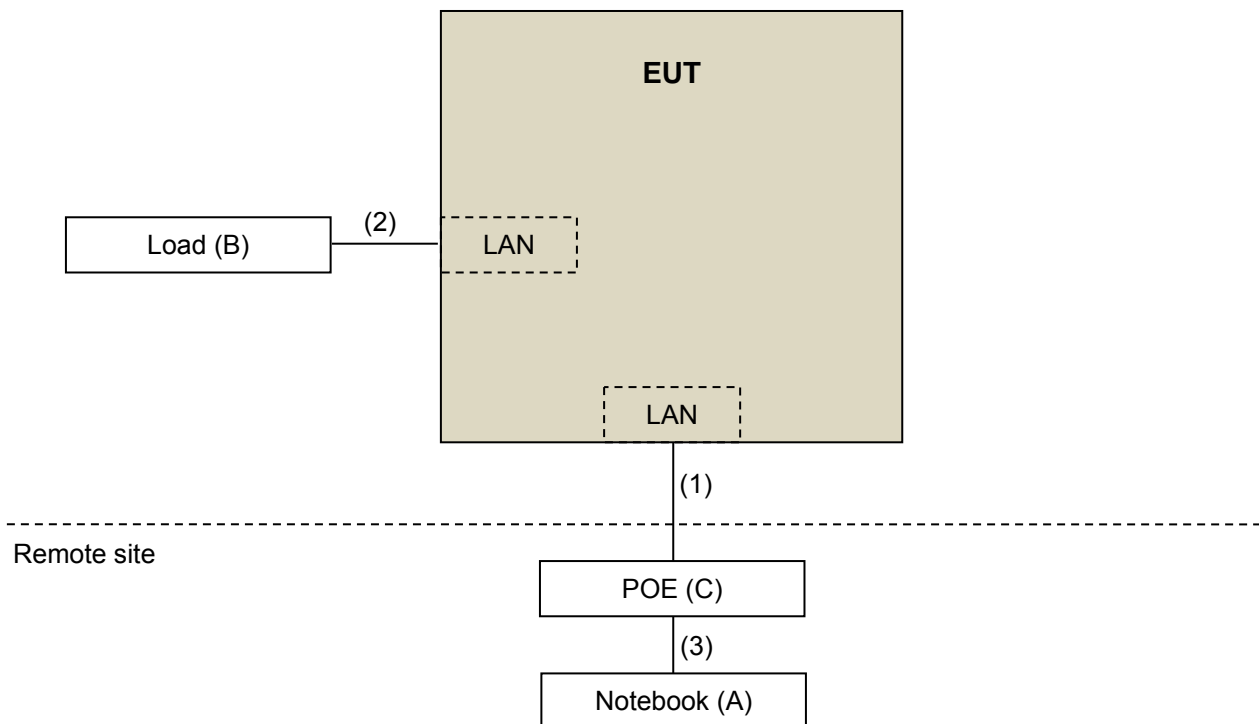

3.4 General Description of Applied Standards

The EUT is a RF Product. According to the specification of the EUT declared by the manufacturer, it must comply with the requirements of the following standards:

FCC Part 15, Subpart C (15.247)

FCC Part 15, Subpart E (15.407)

ANSI C63.10:2013

All test items have been performed and recorded as per the above standards.

4 Test Types and Results

4.1 Radiated Emission and Bandedge Measurement

4.1.1 Limits of Radiated Emission and Bandedge Measurement

Radiated emissions which fall in the restricted bands must comply with the radiated emission limits specified as below table. Other emissions shall be at least 30dB below the highest level of the desired power:

Frequencies (MHz)	Field Strength (microvolts/meter)	Measurement Distance (meters)
0.009 ~ 0.490	2400/F(kHz)	300
0.490 ~ 1.705	24000/F(kHz)	30
1.705 ~ 30.0	30	30
30 ~ 88	100	3
88 ~ 216	150	3
216 ~ 960	200	3
Above 960	500	3

Note:

1. The lower limit shall apply at the transition frequencies.
2. Emission level (dBuV/m) = 20 log Emission level (uV/m).
3. For frequencies above 1000MHz, the field strength limits are based on average detector, however, the peak field strength of any emission shall not exceed the maximum permitted average limits, specified above by more than 20dB under any condition of modulation.

Limits of unwanted emission out of the restricted bands

Applicable To		Limit	
789033 D02 General UNII Test Procedure New Rules v02r01		Field Strength at 3m	
		PK: 74 (dBµV/m)	AV: 54 (dBµV/m)
Frequency Band	Applicable To	EIRP Limit	Equivalent Field Strength at 3m
5150~5250 MHz	15.407(b)(1)	PK: -27 (dBm/MHz)	PK: 68.2(dBµV/m)
5250~5350 MHz	15.407(b)(2)		
5470~5725 MHz	15.407(b)(3)		
5725~5850 MHz	<input checked="" type="checkbox"/> 15.407(b)(4)(i)	PK: -27 (dBm/MHz) ^{*1} PK: 10 (dBm/MHz) ^{*2} PK: 15.6 (dBm/MHz) ^{*3} PK: 27 (dBm/MHz) ^{*4}	PK: 68.2(dBµV/m) ^{*1} PK: 105.2 (dBµV/m) ^{*2} PK: 110.8(dBµV/m) ^{*3} PK: 122.2 (dBµV/m) ^{*4}
	<input type="checkbox"/> 15.407(b)(4)(ii)	Emission limits in section 15.247(d)	
^{*1} beyond 75 MHz or more above of the band edge.		^{*2} below the band edge increasing linearly to 10 dBm/MHz at 25 MHz above.	
^{*3} below the band edge increasing linearly to a level of 15.6 dBm/MHz at 5 MHz above.		^{*4} from 5 MHz above or below the band edge increasing linearly to a level of 27 dBm/MHz at the band edge.	

Note: The following formula is used to convert the equipment isotropic radiated power (eirp) to field strength:

$$E = \frac{1000000\sqrt{30P}}{3} \mu\text{V/m, where P is the eirp (Watts).}$$

4.1.2 Test Instruments

Description & Manufacturer	Model No.	Serial No.	Cal. Date	Cal. Due
Test Receiver ROHDE & SCHWARZ	ESIB7	100187	May 29, 2018	May 28, 2019
Spectrum Analyzer ROHDE & SCHWARZ	FSP40	100040	Sep. 25, 2018	Sep. 24, 2019
BILOG Antenna SCHWARZBECK	VULB9168	9168-155	Nov. 21, 2018	Nov. 20, 2019
HORN Antenna SCHWARZBECK	BBHA 9120D	9120D-1170	Nov. 25, 2018	Nov. 24, 2019
HORN Antenna SCHWARZBECK	BBHA 9170	BBHA9170241	Nov. 25, 2018	Nov. 24, 2019
Loop Antenna TESEQ	HLA 6121	45745	Jun. 14, 2018	Jun. 13, 2019
Preamplifier Agilent (Below 1GHz)	8447D	2944A10631	Aug. 08, 2018	Aug. 07, 2019
Preamplifier KEYSIGHT (Above 1GHz)	83017A	MY53270295	Jul. 02, 2018	Jul. 01, 2019
RF signal cable HUBER+SUHNER	SUCOFLEX 104	MY 13380+295012/04	Aug. 08, 2018	Aug. 07, 2019
RF signal cable HUBER+SUHNER	SUCOFLEX 104	Cable-CH4-03 (250724)	Aug. 08, 2018	Aug. 07, 2019
Software BV ADT	ADT_Radiated_ V7.6.15.9.5	NA	NA	NA
Antenna Tower inn-co GmbH	MA 4000	010303	NA	NA
Antenna Tower Controller BV ADT	AT100	AT93021703	NA	NA
Turn Table BV ADT	TT100	TT93021703	NA	NA
Turn Table Controller BV ADT	SC100	SC93021703	NA	NA
Boresight Antenna Fixture	FBA-01	FBA-SIP01	NA	NA
Pre-amplifier (18GHz-40GHz) EMC	EMC184045B	980175	Nov. 14, 2018	Nov. 13, 2019

- Note: 1. The calibration interval of the above test instruments is 12 months and the calibrations are traceable to NML/ROC and NIST/USA.
2. The test was performed in HwaYa Chamber 4.
3. The FCC Designation Number is TW0003. The number will be varied with the Lab location and scope as attached.
4. The IC Site Registration No. is 7450F-4.

4.1.3 Test Procedures

For Radiated emission below 30MHz

- a. The EUT was placed on the top of a rotating table 0.8 meters above the ground at a 3 meter chamber room. The table was rotated 360 degrees to determine the position of the highest radiation.
- b. The EUT was set 3 meters away from the interference-receiving antenna, which was mounted on the top of a variable-height antenna tower.
- c. Parallel, perpendicular, and ground-parallel orientations of the antenna are set to make the measurement.
- d. For each suspected emission, the EUT was arranged to its worst case and the rotatable table was turned from 0 degrees to 360 degrees to find the maximum reading.
- e. The test-receiver system was set to Quasi-Peak Detect Function and Specified Bandwidth with Maximum Hold Mode.

Note:

1. The resolution bandwidth and video bandwidth of test receiver/spectrum analyzer is 9kHz at frequency below 30MHz.

For Radiated emission above 30MHz

- a. The EUT was placed on the top of a rotating table 0.8 meters (for 30MHz ~ 1GHz) / 1.5 meters (for above 1GHz) above the ground at 3 meter chamber room for test. The table was rotated 360 degrees to determine the position of the highest radiation.
- b. The EUT was set 3 meters away from the interference-receiving antenna, which was mounted on the top of a variable-height antenna tower.
- c. The height of antenna is varied from one meter to four meters above the ground to determine the maximum value of the field strength. Both horizontal and vertical polarizations of the antenna are set to make the measurement.
- d. For each suspected emission, the EUT was arranged to its worst case and then the antenna was tuned to heights from 1 meter to 4 meters and the rotatable table was turned from 0 degrees to 360 degrees to find the maximum reading.
- e. The test-receiver system was set to quasi-peak detect function and specified bandwidth with maximum hold mode when the test frequency is below 1 GHz.
- f. The test-receiver system was set to peak and average detect function and specified bandwidth with maximum hold mode when the test frequency is above 1 GHz. If the peak reading value also meets average limit, measurement with the average detector is unnecessary.

Note:

1. The resolution bandwidth and video bandwidth of test receiver/spectrum analyzer is 120kHz for Quasi-peak detection (QP) at frequency below 1GHz.
2. The resolution bandwidth of test receiver/spectrum analyzer is 1 MHz and the video bandwidth is 3 MHz for Peak detection (PK) at frequency above 1GHz.
3. The resolution bandwidth of test receiver/spectrum analyzer is 1MHz and the video bandwidth is $\geq 1/T$ (Duty cycle < 98%) or 10Hz (Duty cycle $\geq 98\%$) for Average detection (AV) at frequency above 1GHz.
4. All modes of operation were investigated and the worst-case emissions are reported.

4.1.4 Deviation from Test Standard

No deviation.

4.1.5 Test Setup

For Radiated emission below 30MHz

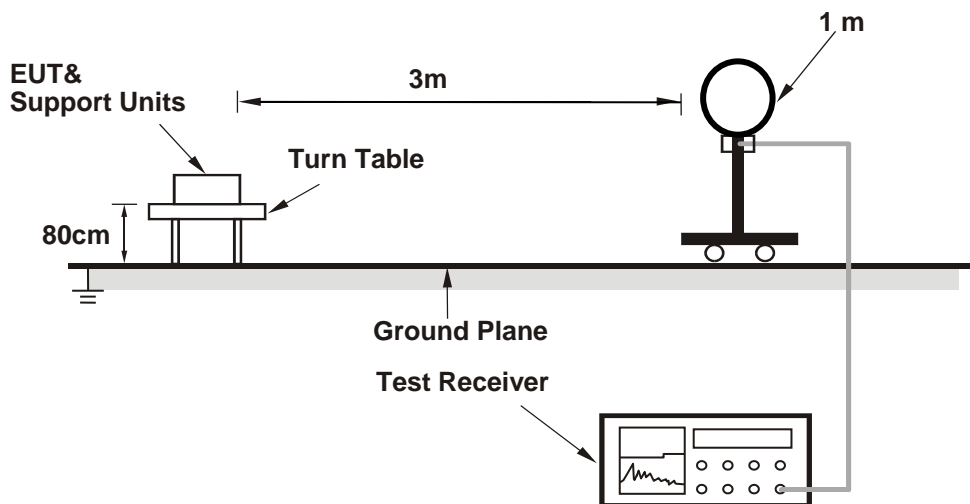

For Radiated emission 30MHz to 1GHz

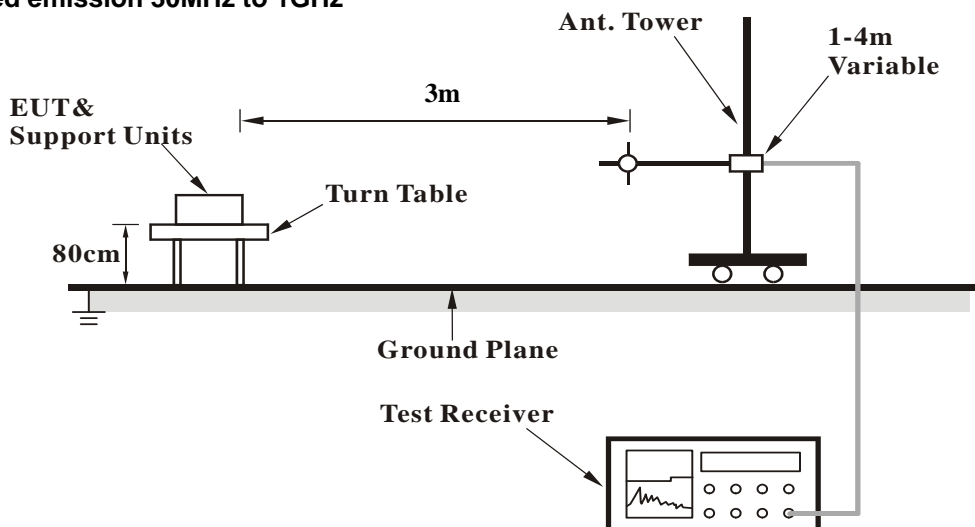

For Radiated emission above 1GHz

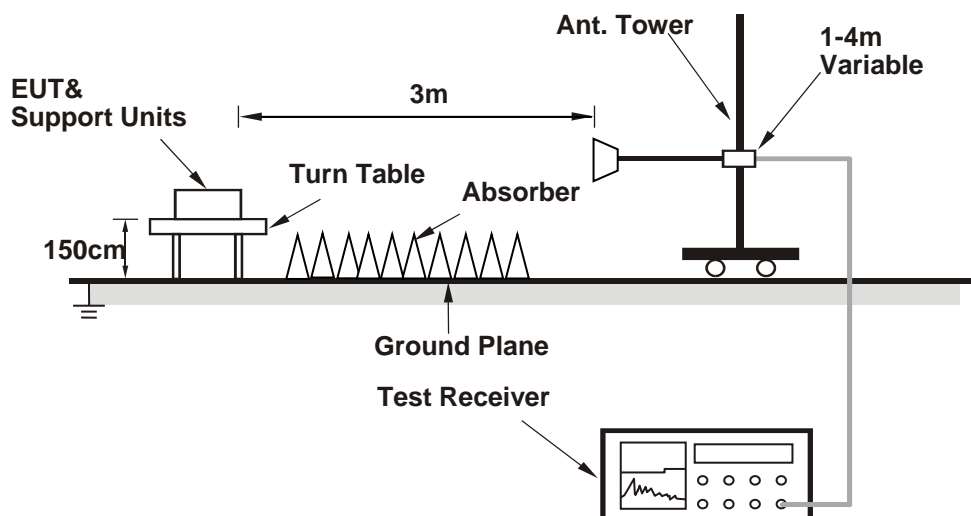

For the actual test configuration, please refer to the attached file (Test Setup Photo).

4.1.6 EUT Operating Conditions

- a. Placed the EUT on the testing table.
- b. Prepared a notebook to act as a communication partner and placed it outside of testing area.
- c. The communication partner connected with EUT via a RJ45 cable and ran a test program (provided by manufacturer) to enable EUT under transmission condition continuously at specific channel frequency.
- d. The communication partner sent data to EUT by command "PING".

4.1.7 Test Results

Above 1GHz Data:

802.11g + 802.11a + 802.11a

CHANNEL	CH 6 + CH 48 + CH 149	DETECTOR FUNCTION	Peak (PK) Average (AV)
FREQUENCY RANGE	1GHz ~ 40GHz		

ANTENNA POLARITY & TEST DISTANCE: HORIZONTAL AT 3 M								
NO.	FREQ. (MHz)	EMISSION LEVEL (dBuV/m)	LIMIT (dBuV/m)	MARGIN (dB)	ANTENNA HEIGHT (m)	TABLE ANGLE (Degree)	RAW VALUE (dBuV)	CORRECTION FACTOR (dB/m)
1	*2437.00	121.3 PK			1.56 H	18	87.5	33.8
2	*2437.00	110.7 AV			1.56 H	18	76.9	33.8
3	4874.00	51.5 PK	74.0	-22.5	1.72 H	201	38.3	13.2
4	4874.00	39.1 AV	54.0	-14.9	1.72 H	201	25.9	13.2
5	*5240.00	122.7 PK			1.52 H	93	81.5	41.2
6	*5240.00	112.0 AV			1.52 H	93	70.8	41.2
7	5350.00	61.6 PK	74.0	-12.4	1.52 H	90	49.2	12.4
8	5350.00	48.4 AV	54.0	-5.6	1.52 H	93	36.0	12.4
9	#5628.00	63.6 PK	68.2	-4.6	1.26 H	80	50.9	12.7
10	*5745.00	123.9 PK			1.26 H	80	81.4	42.5
11	*5745.00	113.5 AV			1.26 H	80	71.0	42.5
12	#5987.20	64.5 PK	68.2	-3.7	1.26 H	80	50.7	13.8
13	#10480.00	63.4 PK	68.2	-4.8	1.99 H	289	40.6	22.8
14	11490.00	63.9 PK	74.0	-10.1	2.38 H	155	39.8	24.1
15	11490.00	51.0 AV	54.0	-3.0	2.38 H	155	26.9	24.1

Remarks:

1. Emission Level(dBuV/m) = Raw Value(dBuV) + Correction Factor(dB/m)
2. Correction Factor(dB/m) = Antenna Factor(dB/m) + Cable Factor(dB) – Pre-Amplifier Factor(dB)
3. The other emission levels were very low against the limit.
4. Margin value = Emission Level – Limit value
5. " * ": Fundamental frequency.
6. " # ": The radiated frequency is out of the restricted band.

CHANNEL	CH 6 + CH 48 + CH 149	DETECTOR FUNCTION	Peak (PK) Average (AV)
FREQUENCY RANGE	1GHz ~ 40GHz		

ANTENNA POLARITY & TEST DISTANCE: VERTICAL AT 3 M								
NO.	FREQ. (MHz)	EMISSION LEVEL (dBuV/m)	LIMIT (dBuV/m)	MARGIN (dB)	ANTENNA HEIGHT (m)	TABLE ANGLE (Degree)	RAW VALUE (dBuV)	CORRECTION FACTOR (dB/m)
1	*2437.00	116.6 PK			3.32 V	102	82.8	33.8
2	*2437.00	106.5 AV			3.32 V	102	72.7	33.8
3	4874.00	51.2 PK	74.0	-22.8	2.15 V	163	38.0	13.2
4	4874.00	39.0 AV	54.0	-15.0	2.15 V	163	25.8	13.2
5	*5240.00	117.7 PK			1.23 V	150	76.5	41.2
6	*5240.00	96.7 AV			1.23 V	150	55.5	41.2
7	5350.00	61.5 PK	74.0	-12.5	1.00 V	179	49.1	12.4
8	5350.00	48.4 AV	54.0	-5.6	1.00 V	179	36.0	12.4
9	#5635.20	63.4 PK	68.2	-4.8	2.30 V	61	50.7	12.7
10	*5745.00	118.3 PK			2.30 V	61	75.8	42.5
11	*5745.00	107.5 AV			2.30 V	61	65.0	42.5
12	#5934.40	63.1 PK	68.2	-5.1	2.30 V	61	49.5	13.6
13	#10480.00	61.9 PK	68.2	-6.3	2.30 V	243	39.1	22.8
14	11490.00	63.5 PK	74.0	-10.5	1.74 V	190	39.4	24.1
15	11490.00	50.3 AV	54.0	-3.7	1.74 V	190	26.2	24.1

Remarks:

1. Emission Level(dBuV/m) = Raw Value(dBuV) + Correction Factor(dB/m)
2. Correction Factor(dB/m) = Antenna Factor(dB/m) + Cable Factor(dB) – Pre-Amplifier Factor(dB)
3. The other emission levels were very low against the limit.
4. Margin value = Emission Level – Limit value
5. " * ": Fundamental frequency.
6. " # ": The radiated frequency is out of the restricted band.

Below 1GHz data

802.11g + 802.11a + 802.11a

CHANNEL	CH 6 + CH 48 + CH 149	DETECTOR FUNCTION	Quasi-Peak (QP)
FREQUENCY RANGE	9kHz ~ 1GHz		
TEST MODE	A		

ANTENNA POLARITY & TEST DISTANCE: HORIZONTAL AT 3 M								
NO.	FREQ. (MHz)	EMISSION LEVEL (dBuV/m)	LIMIT (dBuV/m)	MARGIN (dB)	ANTENNA HEIGHT (m)	TABLE ANGLE (Degree)	RAW VALUE (dBuV)	CORRECTION FACTOR (dB/m)
1	49.30	20.0 QP	40.0	-20.0	1.50 H	124	28.9	-8.9
2	130.80	24.7 QP	43.5	-18.8	1.00 H	270	34.8	-10.1
3	161.85	25.8 QP	43.5	-17.7	1.00 H	263	34.6	-8.8
4	278.27	25.1 QP	46.0	-20.9	1.00 H	259	33.5	-8.4
5	730.38	33.2 QP	46.0	-12.8	1.00 H	10	32.8	0.4
6	932.19	33.2 QP	46.0	-12.8	2.00 H	32	29.2	4.0

Remarks:

1. Emission Level(dBuV/m) = Raw Value(dBuV) + Correction Factor(dB/m)
2. Correction Factor(dB/m) = Antenna Factor(dB/m) + Cable Factor(dB) – Pre-Amplifier Factor(dB)
3. The other emission levels were very low against the limit of frequency range 30MHz ~ 1000MHz
4. Margin value = Emission Level – Limit value
5. The emission levels were very low against the limit of frequency range 9kHz ~ 30MHz: the amplitude of spurious emissions attenuated more than 20 dB below the permissible value to be report

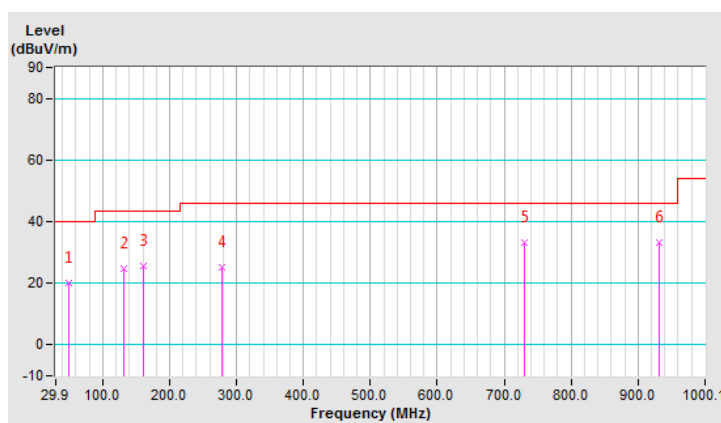

CHANNEL	CH 6 + CH 48 + CH 149	DETECTOR FUNCTION	Quasi-Peak (QP)
FREQUENCY RANGE	9kHz ~ 1GHz		
TEST MODE	A		

ANTENNA POLARITY & TEST DISTANCE: VERTICAL AT 3 M								
NO.	FREQ. (MHz)	EMISSION LEVEL (dBuV/m)	LIMIT (dBuV/m)	MARGIN (dB)	ANTENNA HEIGHT (m)	TABLE ANGLE (Degree)	RAW VALUE (dBuV)	CORRECTION FACTOR (dB/m)
1	30.00	36.8 QP	40.0	-3.2	1.00 V	36	47.9	-11.1
2	105.58	28.6 QP	43.5	-14.9	1.00 V	292	41.1	-12.5
3	154.09	27.1 QP	43.5	-16.4	1.00 V	258	35.7	-8.6
4	491.72	28.9 QP	46.0	-17.1	1.00 V	255	34.1	-5.2
5	745.91	35.4 QP	46.0	-10.6	1.99 V	7	34.6	0.8
6	939.95	37.0 QP	46.0	-9.0	1.99 V	7	33.0	4.0

Remarks:

1. Emission Level(dBuV/m) = Raw Value(dBuV) + Correction Factor(dB/m)
2. Correction Factor(dB/m) = Antenna Factor(dB/m) + Cable Factor(dB) – Pre-Amplifier Factor(dB)
3. The other emission levels were very low against the limit of frequency range 30MHz ~ 1000MHz
4. Margin value = Emission Level – Limit value
5. The emission levels were very low against the limit of frequency range 9kHz ~ 30MHz: the amplitude of spurious emissions attenuated more than 20 dB below the permissible value to be report

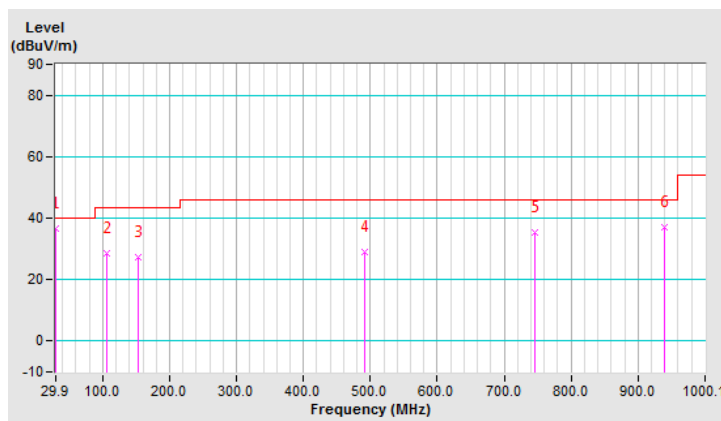

CHANNEL	CH 6 + CH 48 + CH 149	DETECTOR FUNCTION	Quasi-Peak (QP)
FREQUENCY RANGE	9kHz ~ 1GHz		
TEST MODE	B		

ANTENNA POLARITY & TEST DISTANCE: HORIZONTAL AT 3 M								
NO.	FREQ. (MHz)	EMISSION LEVEL (dBuV/m)	LIMIT (dBuV/m)	MARGIN (dB)	ANTENNA HEIGHT (m)	TABLE ANGLE (Degree)	RAW VALUE (dBuV)	CORRECTION FACTOR (dB/m)
1	60.95	22.6 QP	40.0	-17.4	1.00 H	76	32.7	-10.1
2	256.93	24.9 QP	46.0	-21.1	1.00 H	259	34.2	-9.3
3	714.86	30.4 QP	46.0	-15.6	1.00 H	159	30.6	-0.2
4	773.07	29.9 QP	46.0	-16.1	1.00 H	170	28.5	1.4
5	959.35	32.5 QP	46.0	-13.5	1.00 H	172	28.1	4.4
6	1000.00	31.9 QP	54.0	-22.1	1.00 H	145	27.4	4.5

Remarks:

1. Emission Level(dBuV/m) = Raw Value(dBuV) + Correction Factor(dB/m)
2. Correction Factor(dB/m) = Antenna Factor(dB/m) + Cable Factor(dB) – Pre-Amplifier Factor(dB)
3. The other emission levels were very low against the limit of frequency range 30MHz ~ 1000MHz
4. Margin value = Emission Level – Limit value
5. The emission levels were very low against the limit of frequency range 9kHz ~ 30MHz: the amplitude of spurious emissions attenuated more than 20 dB below the permissible value to be report

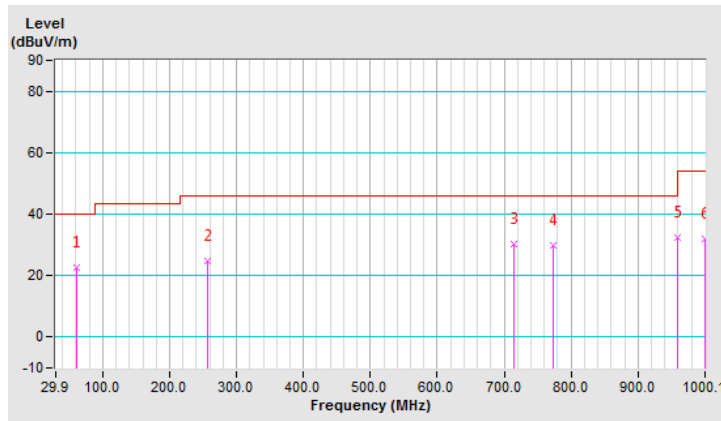

CHANNEL	CH 6 + CH 48 + CH 149	DETECTOR FUNCTION	Quasi-Peak (QP)
FREQUENCY RANGE	9kHz ~ 1GHz		
TEST MODE	B		

ANTENNA POLARITY & TEST DISTANCE: VERTICAL AT 3 M								
NO.	FREQ. (MHz)	EMISSION LEVEL (dBuV/m)	LIMIT (dBuV/m)	MARGIN (dB)	ANTENNA HEIGHT (m)	TABLE ANGLE (Degree)	RAW VALUE (dBuV)	CORRECTION FACTOR (dB/m)
1	31.84	30.3 QP	40.0	-9.7	1.00 V	9	41.3	-11.0
2	39.60	38.1 QP	40.0	-1.9	1.00 V	41	47.5	-9.4
3	59.01	26.2 QP	40.0	-13.8	1.00 V	45	35.9	-9.7
4	509.18	28.0 QP	46.0	-18.0	1.00 V	11	32.8	-4.8
5	736.21	34.1 QP	46.0	-11.9	1.00 V	63	33.6	0.5
6	945.77	32.6 QP	46.0	-13.4	1.00 V	108	28.3	4.3

Remarks:

1. Emission Level(dBuV/m) = Raw Value(dBuV) + Correction Factor(dB/m)
2. Correction Factor(dB/m) = Antenna Factor(dB/m) + Cable Factor(dB) – Pre-Amplifier Factor(dB)
3. The other emission levels were very low against the limit of frequency range 30MHz ~ 1000MHz
4. Margin value = Emission Level – Limit value
5. The emission levels were very low against the limit of frequency range 9kHz ~ 30MHz: the amplitude of spurious emissions attenuated more than 20 dB below the permissible value to be report

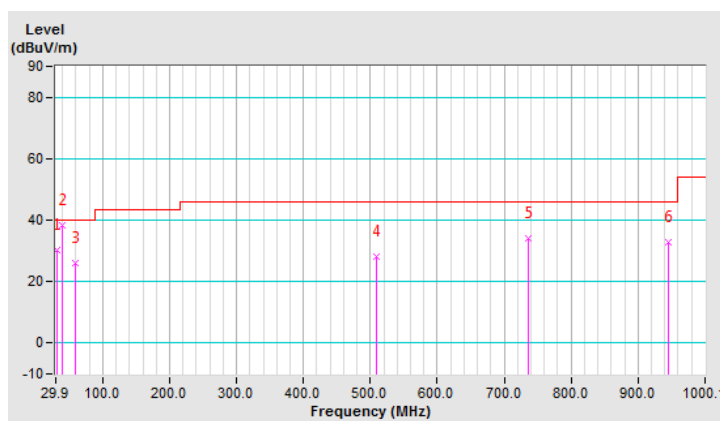

CHANNEL	CH 6 + CH 48 + CH 149	DETECTOR FUNCTION	Quasi-Peak (QP)
FREQUENCY RANGE	9kHz ~ 1GHz		
TEST MODE	C		

ANTENNA POLARITY & TEST DISTANCE: HORIZONTAL AT 3 M								
NO.	FREQ. (MHz)	EMISSION LEVEL (dBuV/m)	LIMIT (dBuV/m)	MARGIN (dB)	ANTENNA HEIGHT (m)	TABLE ANGLE (Degree)	RAW VALUE (dBuV)	CORRECTION FACTOR (dB/m)
1	31.84	23.2 QP	40.0	-16.8	1.00 H	353	34.2	-11.0
2	39.60	26.5 QP	40.0	-13.5	1.00 H	99	35.9	-9.4
3	254.99	23.3 QP	46.0	-22.7	1.00 H	267	32.6	-9.3
4	747.85	33.0 QP	46.0	-13.0	1.00 H	299	32.1	0.9
5	932.19	35.3 QP	46.0	-10.7	1.00 H	234	31.3	4.0
6	994.28	31.1 QP	54.0	-22.9	1.00 H	253	26.7	4.4

Remarks:

1. Emission Level(dBuV/m) = Raw Value(dBuV) + Correction Factor(dB/m)
2. Correction Factor(dB/m) = Antenna Factor(dB/m) + Cable Factor(dB) – Pre-Amplifier Factor(dB)
3. The other emission levels were very low against the limit of frequency range 30MHz ~ 1000MHz
4. Margin value = Emission Level – Limit value
5. The emission levels were very low against the limit of frequency range 9kHz ~ 30MHz: the amplitude of spurious emissions attenuated more than 20 dB below the permissible value to be report

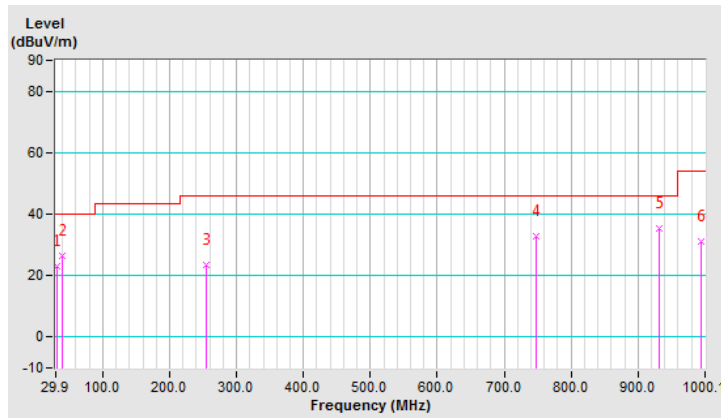

CHANNEL	CH 6 + CH 48 + CH 149	DETECTOR FUNCTION	Quasi-Peak (QP)
FREQUENCY RANGE	9kHz ~ 1GHz		
TEST MODE	C		

ANTENNA POLARITY & TEST DISTANCE: VERTICAL AT 3 M								
NO.	FREQ. (MHz)	EMISSION LEVEL (dBuV/m)	LIMIT (dBuV/m)	MARGIN (dB)	ANTENNA HEIGHT (m)	TABLE ANGLE (Degree)	RAW VALUE (dBuV)	CORRECTION FACTOR (dB/m)
1	31.84	30.9 QP	40.0	-9.1	2.00 V	330	41.9	-11.0
2	60.95	25.8 QP	40.0	-14.2	1.00 V	78	35.9	-10.1
3	485.89	27.7 QP	46.0	-18.3	1.00 V	80	33.0	-5.3
4	788.60	29.7 QP	46.0	-16.3	1.00 V	10	28.1	1.6
5	955.47	31.7 QP	46.0	-14.3	1.00 V	196	27.4	4.3
6	1000.00	31.2 QP	54.0	-22.8	1.50 V	75	26.7	4.5

Remarks:

1. Emission Level(dBuV/m) = Raw Value(dBuV) + Correction Factor(dB/m)
2. Correction Factor(dB/m) = Antenna Factor(dB/m) + Cable Factor(dB) – Pre-Amplifier Factor(dB)
3. The other emission levels were very low against the limit of frequency range 30MHz ~ 1000MHz
4. Margin value = Emission Level – Limit value
5. The emission levels were very low against the limit of frequency range 9kHz ~ 30MHz: the amplitude of spurious emissions attenuated more than 20 dB below the permissible value to be report

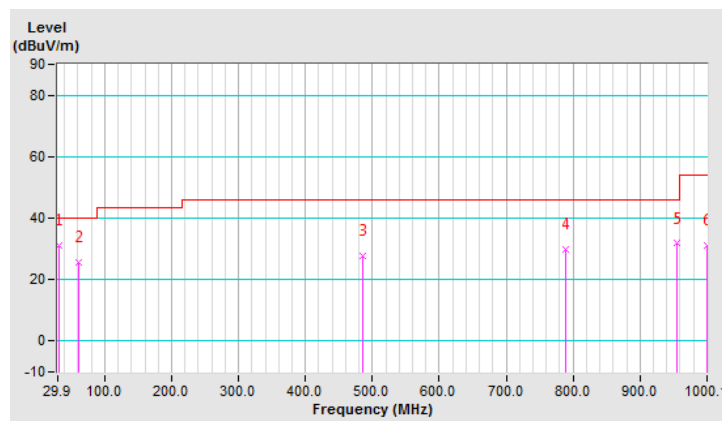

4.2 Conducted Out of Band Emission Measurement

4.2.1 Limits of Conducted Out of Band Emission Measurement

Below 30dB of the highest emission level of operating band (in 100kHz Resolution Bandwidth).

4.2.2 Test Setup

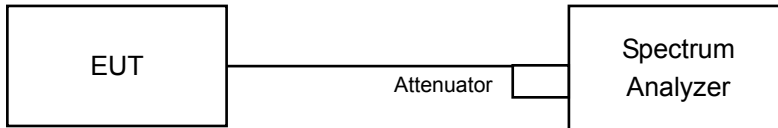

4.2.3 Test Instruments

Refer to section 4.1.2 to get information of above instrument.

4.2.4 Test Procedure

MEASUREMENT PROCEDURE REF

- Set the RBW = 100 kHz.
- Set the VBW \geq 300 kHz.
- Detector = peak.
- Sweep time = auto couple.
- Trace mode = max hold.
- Allow trace to fully stabilize.
- Use the peak marker function to determine the maximum power level in any 100 kHz band segment within the fundamental EBW.

MEASUREMENT PROCEDURE OOB

- Set RBW = 100 kHz.
- Set VBW \geq 300 kHz.
- Detector = peak.
- Sweep = auto couple.
- Trace Mode = max hold.
- Allow trace to fully stabilize.
- Use the peak marker function to determine the maximum amplitude level.

4.2.5 Deviation from Test Standard

No deviation.

4.2.6 EUT Operating Condition

The software provided by client to enable the EUT under transmission condition continuously at lowest, middle and highest channel frequencies individually.

4.2.7 Test Results

The spectrum plots are attached on the following pages. D1 line indicates the highest level, and D2 line indicates the 30dB offset below D1. It shows compliance with the requirement.

802.11g CH 6 + 802.11a CH 48

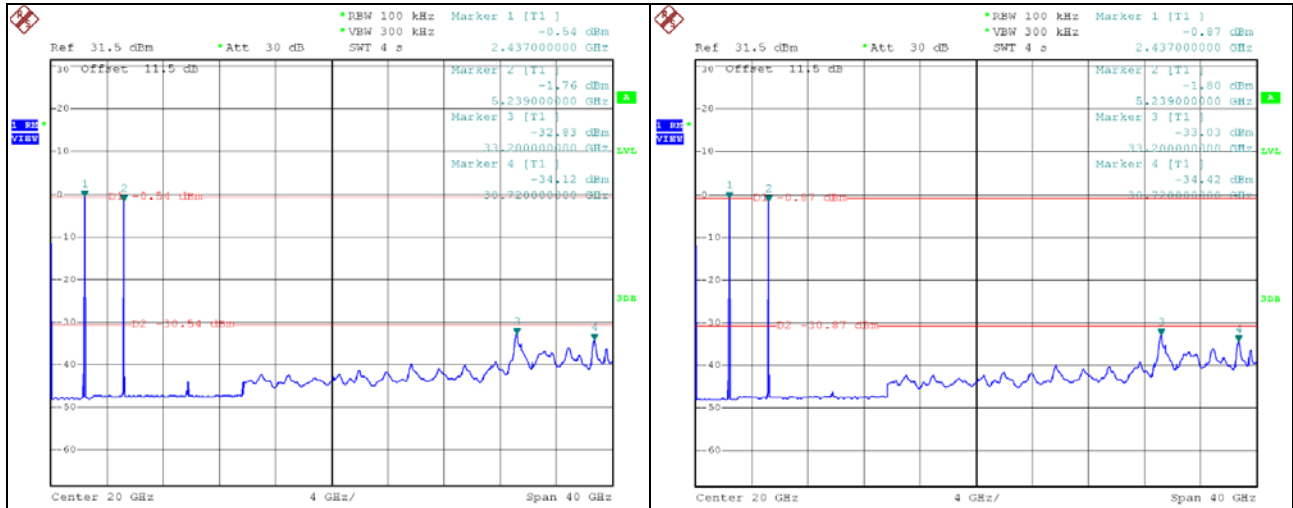

5 Pictures of Test Arrangements

Please refer to the attached file (Test Setup Photo).

Annex A- Radiated Out of Band Emission (OOBE) Measurement (For U-NII-3 band)

802.11g CH 6 + 802.11a CH 48 + 802.11a CH 149

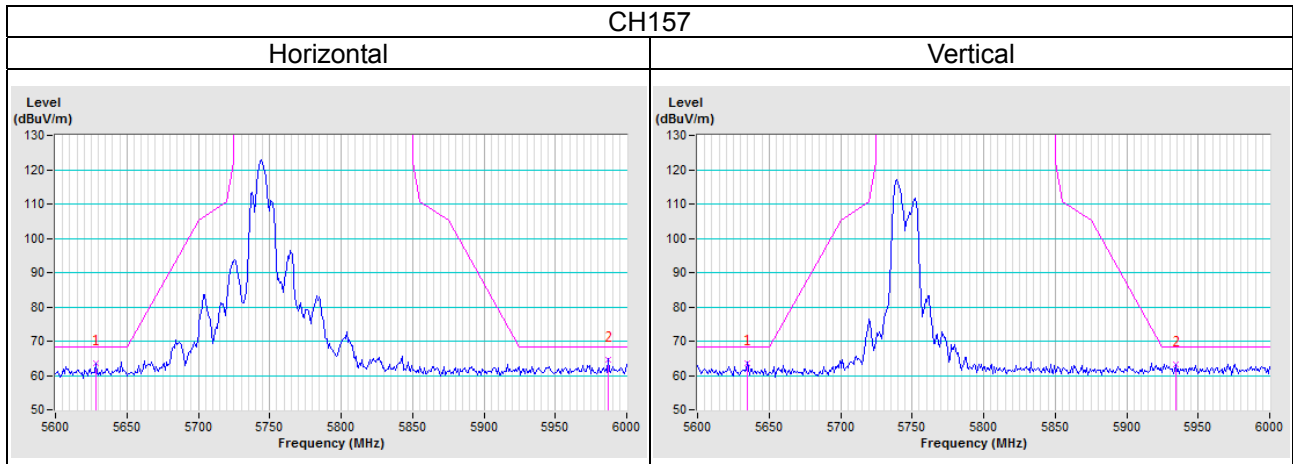

Appendix – Information of the Testing Laboratories

We, Bureau Veritas Consumer Products Services (H.K.) Ltd., Taoyuan Branch, were founded in 1988 to provide our best service in EMC, Radio, Telecom and Safety consultation. Our laboratories are FCC recognized accredited test firms and accredited and approved according to ISO/IEC 17025.

If you have any comments, please feel free to contact us at the following:

Linko EMC/RF Lab

Tel: 886-2-26052180

Fax: 886-2-26051924

Hsin Chu EMC/RF/Telecom Lab

Tel: 886-3-6668565

Fax: 886-3-6668323

Hwa Ya EMC/RF/Safety Lab

Tel: 886-3-3183232

Fax: 886-3-3270892

Email: service.adt@tw.bureauveritas.com

Web Site: www.bureauveritas-adt.com

The address and road map of all our labs can be found in our web site also.

--- END ---