

FCC Test Report

Report No.: RF170801E01

FCC ID: PY317300392

Test Model: VMC4030P

Received Date: Aug. 01, 2017

Test Date: Aug. 08 to 29, 2017

Issued Date: Sep. 07, 2017

Applicant: NETGEAR, Inc.

Address: 350 East Plumeria Drive San Jose, CA 95134

Issued By: Bureau Veritas Consumer Products Services (H.K.) Ltd., Taoyuan Branch
Hsin Chu Laboratory

Lab Address: E-2, No.1, Li Hsin 1st Road, Hsinchu Science Park, Hsinchu City 300,
Taiwan R.O.C.

Test Location: E-2, No.1, Li Hsin 1st Road, Hsinchu Science Park, Hsinchu City 300,
Taiwan R.O.C.



This report is for your exclusive use. Any copying or replication of this report to or for any other person or entity, or use of our name or trademark, is permitted only with our prior written permission. This report sets forth our findings solely with respect to the test samples identified herein. The results set forth in this report are not indicative or representative of the quality or characteristics of the lot from which a test sample was taken or any similar or identical product unless specifically and expressly noted. Our report includes all of the tests requested by you and the results thereof based upon the information that you provided to us. You have 60 days from date of issuance of this report to notify us of any material error or omission caused by our negligence, provided, however, that such notice shall be in writing and shall specifically address the issue you wish to raise. A failure to raise such issue within the prescribed time shall constitute your unqualified acceptance of the completeness of this report, the tests conducted and the correctness of the report contents. Unless specific mention, the uncertainty of measurement has been explicitly taken into account to declare the compliance or non-compliance to the specification. The report must not be used by the client to claim product certification, approval, or endorsement by TAF or any government agencies.

Table of Contents

Release Control Record	4
1 Certificate of Conformity	5
2 Summary of Test Results	6
2.1 Measurement Uncertainty	6
2.2 Modification Record	6
3 General Information	7
3.1 General Description of EUT	7
3.2 Description of Test Modes	9
3.2.1 Test Mode Applicability and Tested Channel Detail	10
3.3 Duty Cycle of Test Signal	12
3.4 Description of Support Units	13
3.4.1 Configuration of System under Test	14
3.5 General Description of Applied Standards	15
4 Test Types and Results	16
4.1 Radiated Emission and Bandedge Measurement	16
4.1.1 Limits of Radiated Emission and Bandedge Measurement	16
4.1.2 Test Instruments	17
4.1.3 Test Procedures	18
4.1.4 Deviation from Test Standard	18
4.1.5 Test Setup	19
4.1.6 EUT Operating Conditions	20
4.1.7 Test Results	21
4.2 Conducted Emission Measurement	31
4.2.1 Limits of Conducted Emission Measurement	31
4.2.2 Test Instruments	31
4.2.3 Test Procedures	32
4.2.4 Deviation from Test Standard	32
4.2.5 Test Setup	32
4.2.6 EUT Operating Conditions	32
4.2.7 Test Results (Mode 1)	33
4.2.8 Test Results (Mode 2)	35
4.2.9 Test Results (Mode 3)	37
4.3 6dB Bandwidth Measurement	39
4.3.1 Limits of 6dB Bandwidth Measurement	39
4.3.2 Test Setup	39
4.3.3 Test Instruments	39
4.3.4 Test Procedure	39
4.3.5 Deviation from Test Standard	39
4.3.6 EUT Operating Conditions	39
4.3.7 Test Result	40
4.4 Conducted Output Power Measurement	42
4.4.1 Limits of Conducted Output Power Measurement	42
4.4.2 Test Setup	42
4.4.3 Test Instruments	42
4.4.4 Test Procedures	42
4.4.5 Deviation from Test Standard	42
4.4.6 EUT Operating Conditions	42
4.4.7 Test Results	43
4.5 Power Spectral Density Measurement	45
4.5.1 Limits of Power Spectral Density Measurement	45
4.5.2 Test Setup	45
4.5.3 Test Instruments	45
4.5.4 Test Procedure	45

4.5.5	Deviation from Test Standard	45
4.5.6	EUT Operating Condition	45
4.5.7	Test Results	46
4.6	Conducted Out of Band Emission Measurement	48
4.6.1	Limits of Conducted Out of Band Emission Measurement.....	48
4.6.2	Test Setup.....	48
4.6.3	Test Instruments	48
4.6.4	Test Procedure	48
4.6.5	Deviation from Test Standard	48
4.6.6	EUT Operating Condition	48
4.6.7	Test Results	48
5	Pictures of Test Arrangements.....	52
	Appendix – Information on the Testing Laboratories	53

Release Control Record

Issue No.	Description	Date Issued
RF170801E01	Original release.	Sep. 07, 2017

1 Certificate of Conformity

Product: Arlo Pro 2

Brand: NETGEAR

Test Model: VMC4030P

Sample Status: ENGINEERING SAMPLE

Applicant: NETGEAR, Inc.

Test Date: Aug. 08 to 29, 2017

Standards: 47 CFR FCC Part 15, Subpart C (Section 15.247)
ANSI C63.10: 2013

The above equipment has been tested by **Bureau Veritas Consumer Products Services (H.K.) Ltd., Taoyuan Branch**, and found compliance with the requirement of the above standards. The test record, data evaluation & Equipment Under Test (EUT) configurations represented herein are true and accurate accounts of the measurements of the sample's EMC characteristics under the conditions specified in this report.

Prepared by : Wendy Wu , **Date:** Sep. 07, 2017
Wendy Wu / Specialist

Approved by : May Chen , **Date:** Sep. 07, 2017
May Chen / Manager

2 Summary of Test Results

47 CFR FCC Part 15, Subpart C (Section 15.247)			
FCC Clause	Test Item	Result	Remarks
15.207	AC Power Conducted Emission	PASS	Meet the requirement of limit. Minimum passing margin is -12.18dB at 3.27734MHz.
15.205 / 15.209 / 15.247(d)	Radiated Emissions and Band Edge Measurement	PASS	Meet the requirement of limit. Minimum passing margin is -0.1dB at 2390.00MHz, 2483.50MHz.
15.247(d)	Antenna Port Emission	PASS	Meet the requirement of limit.
15.247(a)(2)	6dB bandwidth	PASS	Meet the requirement of limit.
15.247(b)	Conducted power	PASS	Meet the requirement of limit.
15.247(e)	Power Spectral Density	PASS	Meet the requirement of limit.
15.203	Antenna Requirement	PASS	No antenna connector is used.

2.1 Measurement Uncertainty

Where relevant, the following measurement uncertainty levels have been estimated for tests performed on the EUT as specified in CISPR 16-4-2:

Measurement	Frequency	Expanded Uncertainty (k=2) (\pm)
Conducted Emissions at mains ports	150kHz ~ 30MHz	1.84 dB
Radiated Emissions up to 1 GHz	30MHz ~ 1GHz	5.30 dB
Radiated Emissions above 1 GHz	1GHz ~ 6GHz	5.16 dB
	6GHz ~ 18GHz	4.91 dB
	18GHz ~ 40GHz	5.30 dB

2.2 Modification Record

There were no modifications required for compliance.

3 General Information

3.1 General Description of EUT

Product	Arlo Pro 2
Brand	NETGEAR
Test Model	VMC4030P
Status of EUT	ENGINEERING SAMPLE
Power Supply Rating	5 or 9Vdc from power adapter or 7.2V from battery
Modulation Type	CCK, DQPSK, DBPSK for DSSS 64QAM, 16QAM, QPSK, BPSK for OFDM
Modulation Technology	DSSS, OFDM
Transfer Rate	802.11b: up to 11Mbps 802.11g: up to 54Mbps 802.11n: up to 72.2Mbps
Operating Frequency	2.412 ~ 2.462GHz
Number of Channel	11
Output Power	334.195mW
Antenna Type	Refer to Note
Antenna Connector	Refer to Note
Accessory Device	Adapter x 1
Data Cable Supplied	USB cable x 1 (unshielded, 2m)

Note:

- The EUT must be supplied with a power adapter or battery and following different models could be chosen as following table:

Adapter				
No	Brand Name	Model No.	P/N	Spec.
1	NETGEAR	AD2085320	332-11004-01	Input: 100-240Vac, 50/60Hz, 0.3A Output: 5 or 9Vdc, 1.8 or 1.1A
2	NETGEAR	2ADB0102 NJ	332-10981-01	Input: 100-240Vac, 50/60Hz, 0.3A Output: 5 or 9Vdc, 1.8 or 1.1A

Battery				
No	Brand Name	Model No.	P/N	Rating
1	NETGEAR	A-1	308-10029-01	7.2V, 2440mAh, 17.57Wh

Note:

- From the above adapters and battery, the radiated emissions worse case was found in Adapter 2. Therefore only the test data of the mode was recorded in this report.

- The antennas provided to the EUT, please refer to the following table:

Antenna set	Brand	Model	Antenna Gain (dBi)	Frequency range	Antenna Type	Connector Type
1	Master Wave	9 02P00197N0	2.62	2.4~2.4835GHz	PIFA	NA
	Master Wave	9 02P00196N0	1.3	2.4~2.4835GHz	PIFA	NA

3. The EUT incorporates a SISO function.

MODULATION MODE	DATA RATE (MCS)	TX & RX CONFIGURATION	
802.11b	1~11Mbps	1TX diversity	1RX diversity
802.11g	6~54Mbps	1TX diversity	1RX diversity
802.11n (HT20)	MCS 0~7	1TX diversity	1RX diversity

4. The above EUT information is declared by manufacturer and for more detailed features description, please refer to the manufacturer's specifications or user's manual.

3.2 Description of Test Modes

11 channels are provided for 802.11b, 802.11g and 802.11n (HT20):

Channel	Frequency	Channel	Frequency
1	2412MHz	7	2442MHz
2	2417MHz	8	2447MHz
3	2422MHz	9	2452MHz
4	2427MHz	10	2457MHz
5	2432MHz	11	2462MHz
6	2437MHz		

3.2.1 Test Mode Applicability and Tested Channel Detail

EUT CONFIGURE MODE	APPLICABLE TO				DESCRIPTION
	RE \geq 1G	RE<1G	PLC	APCM	
1	√	√	√	√	Power from Adapter 2
2	-	-	√	-	Power from Adapter 1
3		-	√	-	Power from Laptop

Where RE \geq 1G: Radiated Emission above 1GHz & Bandedge Measurement
 RE<1G: Radiated Emission below 1GHz
 PLC: Power Line Conducted Emission
 APCM: Antenna Port Conducted Measurement

NOTE: The EUT had been pre-tested on the positioned of each 3 axis. The worst case was found when positioned on **Y-plane**.
NOTE: “-” means no effect.

Radiated Emission Test (Above 1GHz):

- Pre-Scan has been conducted to determine the worst-case mode from all possible combinations between available modulations, data rates and antenna ports (if EUT with antenna diversity architecture).
- Following channel(s) was (were) selected for the final test as listed below.

MODE	AVAILABLE CHANNEL	TESTED CHANNEL	MODULATION TECHNOLOGY	MODULATION TYPE	DATA RATE (Mbps)
802.11b	1 to 11	1, 6, 11	DSSS	DBPSK	1
802.11g	1 to 11	1, 6, 11	OFDM	BPSK	6
802.11n (HT20)	1 to 11	1, 6, 11	OFDM	BPSK	6.5

Radiated Emission Test (Below 1GHz):

- Pre-Scan has been conducted to determine the worst-case mode from all possible combinations between available modulations, data rates and antenna ports (if EUT with antenna diversity architecture).
- Following channel(s) was (were) selected for the final test as listed below.

MODE	AVAILABLE CHANNEL	TESTED CHANNEL	MODULATION TECHNOLOGY	MODULATION TYPE	DATA RATE (Mbps)
802.11b	1 to 11	6	DSSS	DBPSK	1

Power Line Conducted Emission Test:

- Pre-Scan has been conducted to determine the worst-case mode from all possible combinations between available modulations, data rates and antenna ports (if EUT with antenna diversity architecture).
- Following channel(s) was (were) selected for the final test as listed below.

MODE	AVAILABLE CHANNEL	TESTED CHANNEL	MODULATION TECHNOLOGY	MODULATION TYPE	DATA RATE (Mbps)
802.11b	1 to 11	6	DSSS	DBPSK	1

Antenna Port Conducted Measurement:

- This item includes all test value of each mode, but only includes spectrum plot of worst value of each mode.
- Pre-Scan has been conducted to determine the worst-case mode from all possible combinations between available modulations, data rates and antenna ports (if EUT with antenna diversity architecture).
- Following channel(s) was (were) selected for the final test as listed below.

MODE	AVAILABLE CHANNEL	TESTED CHANNEL	MODULATION TECHNOLOGY	MODULATION TYPE	DATA RATE (Mbps)
802.11b	1 to 11	1, 6, 11	DSSS	DBPSK	1
802.11g	1 to 11	1, 6, 11	OFDM	BPSK	6
802.11n (HT20)	1 to 11	1, 6, 11	OFDM	BPSK	6.5

Test Condition:

APPLICABLE TO	ENVIRONMENTAL CONDITIONS	INPUT POWER	TESTED BY
RE \geq 1G	22deg. C, 67%RH	120Vac, 60Hz	Jyunchun Lin
RE $<$ 1G	24deg. C, 66%RH	120Vac, 60Hz	Jyunchun Lin
PLC	25deg. C, 75%RH	120Vac, 60Hz	Andy Ho
APCM	24deg. C, 60%RH	120Vac, 60Hz	Anderson Chen

3.3 Duty Cycle of Test Signal

If duty cycle of test signal is $\geq 98\%$, duty factor is not required.

802.11b: Duty cycle = $12.4/12.441 = 0.997$

802.11g: Duty cycle = $2.062/2.093 = 0.985$

802.11n (HT20): Duty cycle = $1.919/1.949 = 0.985$

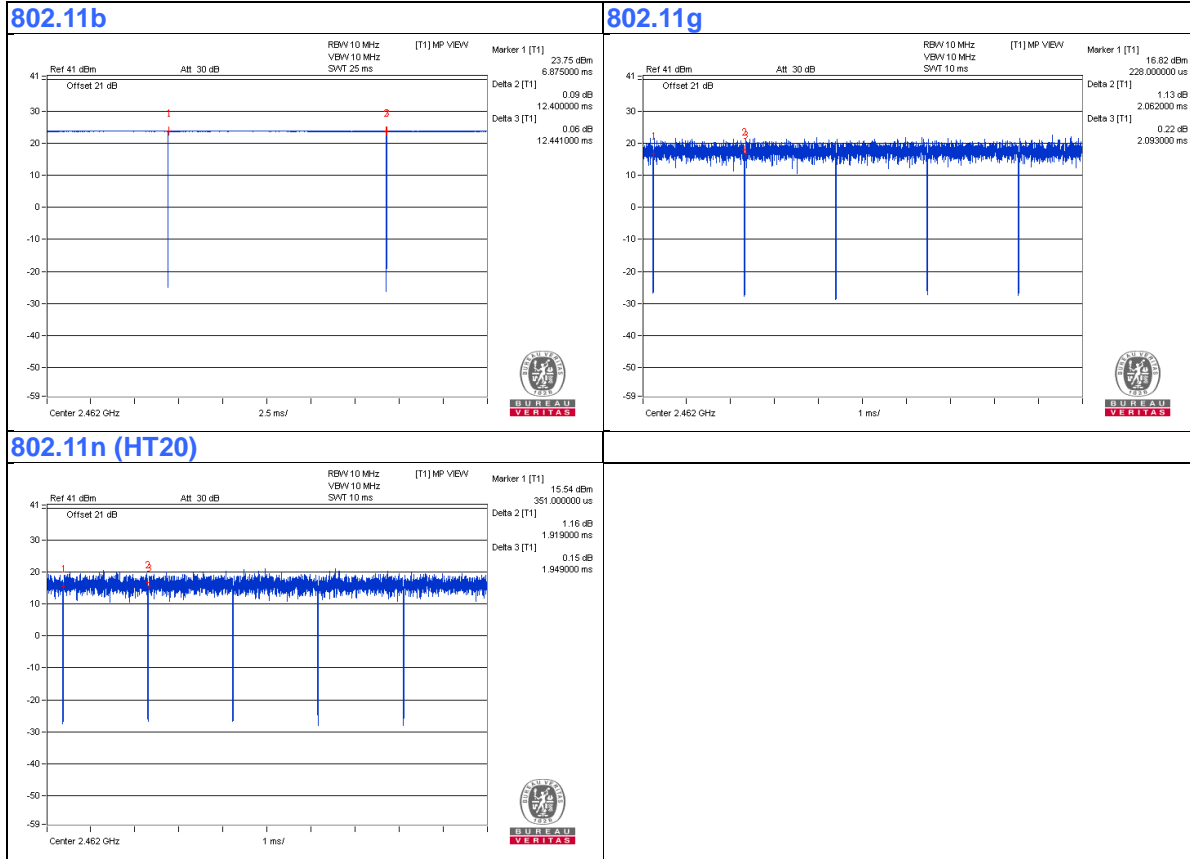

3.4 Description of Support Units

The EUT has been tested as an independent unit together with other necessary accessories or support units. The following support units or accessories were used to form a representative test configuration during the tests.

ID	Product	Brand	Model No.	Serial No.	FCC ID	Remarks
A.	Laptop	DELL	E5430	GM1SKV1	FCC DoC	Provided by Lab

Note:

1. All power cords of the above support units are non-shielded (1.8m).

ID	Descriptions	Qty.	Length (m)	Shielding (Yes/No)	Cores (Qty.)	Remarks
1.	USB Cable	1	2	Yes	0	Supplied by client

Note: The core(s) is(are) originally attached to the cable(s).

3.4.1 Configuration of System under Test

Adapter Mode:

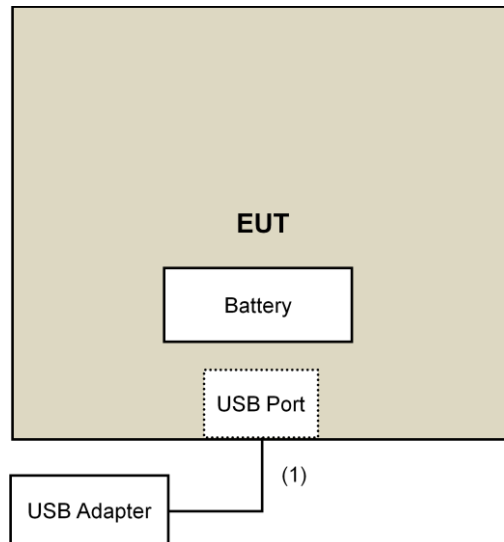

Laptop Mode:

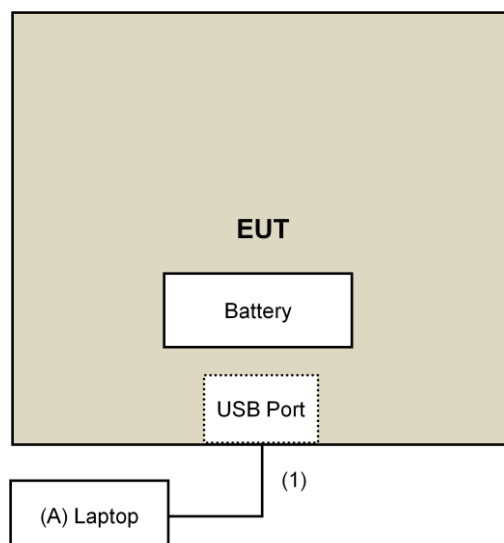

3.5 General Description of Applied Standards

The EUT is a RF Product. According to the specifications of the manufacturer, it must comply with the requirements of the following standards:

FCC Part 15, Subpart C (15.247)
KDB 558074 D01 DTS Meas Guidance v04
ANSI C63.10-2013

All test items have been performed and recorded as per the above standards.

NOTE: The EUT has been verified to comply with the requirements of FCC Part 15, Subpart B, Class B (DoC). The test report has been issued separately.

4 Test Types and Results

4.1 Radiated Emission and Bandedge Measurement

4.1.1 Limits of Radiated Emission and Bandedge Measurement

Radiated emissions which fall in the restricted bands must comply with the radiated emission limits specified as below table. Other emissions shall be at least 20dB below the highest level of the desired power:

Frequencies (MHz)	Field Strength (microvolts/meter)	Measurement Distance (meters)
0.009 ~ 0.490	2400/F(kHz)	300
0.490 ~ 1.705	24000/F(kHz)	30
1.705 ~ 30.0	30	30
30 ~ 88	100	3
88 ~ 216	150	3
216 ~ 960	200	3
Above 960	500	3

NOTE:

1. The lower limit shall apply at the transition frequencies.
2. Emission level (dBuV/m) = 20 log Emission level (uV/m).
3. For frequencies above 1000MHz, the field strength limits are based on average detector, however, the peak field strength of any emission shall not exceed the maximum permitted average limits, specified above by more than 20dB under any condition of modulation.

4.1.2 Test Instruments

DESCRIPTION & MANUFACTURER	MODEL NO.	SERIAL NO.	CALIBRATED DATE	CALIBRATED UNTIL
Test Receiver Keysight	N9038A	MY54450088	July 08, 2017	July 07, 2018
Pre-Amplifier ^(*) EMCI	EMC001340	980142	Jan. 20, 2016	Jan. 19, 2018
Loop Antenna ^(*) Electro-Metrics	EM-6879	264	Dec. 16, 2016	Dec. 15, 2018
RF Cable	NA	LOOPCAB-001 LOOPCAB-002	Jan. 17, 2017	Jan. 16, 2018
Pre-Amplifier Mini-Circuits	ZFL-1000VH2B	AMP-ZFL-01	Nov. 10, 2016	Nov. 09, 2017
Trilog Broadband Antenna SCHWARZBECK	VULB 9168	9168-406	Dec. 13, 2016	Dec. 12, 2017
RF Cable	8D	966-4-1 966-4-2 966-4-3	Apr. 01, 2017	Mar. 31, 2018
Fixed attenuator Mini-Circuits	UNAT-5+	PAD-3m-4-01	Oct. 05, 2016	Oct. 04, 2017
Horn_Antenna SCHWARZBECK	BBHA 9120D	9120D-783	Dec. 27, 2016	Dec. 26, 2017
Pre-Amplifier EMCI	EMC12630SE	980385	Feb. 02, 2017	Feb. 01, 2018
RF Cable	EMC104-SM-SM-1200 EMC104-SM-SM-2000 EMC104-SM-SM-5000	160923 150318 150321	Feb. 02, 2017 Mar. 29, 2017 Mar. 29, 2017	Feb. 01, 2018 Mar. 28, 2018 Mar. 28, 2018
Pre-Amplifier EMCI	EMC184045SE	980387	Feb. 02, 2017	Feb. 01, 2018
Horn_Antenna SCHWARZBECK	BBHA 9170	BBHA9170608	Dec. 15, 2016	Dec. 14, 2017
RF Cable	SUCOFLEX 102	36432/2 36433/2	Jan. 15, 2017	Jan. 14, 2018
Software	ADT_Radiated_V8.7.08	NA	NA	NA
Antenna Tower & Turn Table Max-Full	MF-7802	MF780208410	NA	NA
Boresight Antenna Fixture	FBA-01	FBA-SIP02	NA	NA
Spectrum Analyzer R&S	FSv40	100964	July 1, 2017	June 30, 2018
Power meter Anritsu	ML2495A	1014008	May 11, 2017	May 10, 2018
Power sensor Anritsu	MA2411B	0917122	May 11, 2017	May 10, 2018

Note:

1. The calibration interval of the above test instruments is 12 months and the calibrations are traceable to NML/ROC and NIST/USA.
2. *The calibration interval of the above test instruments is 24 months and the calibrations are traceable to NML/ROC and NIST/USA.
3. The test was performed in 966 Chamber No. 4.
4. Loop antenna was used for all emissions below 30 MHz.
5. The CANADA Site Registration No. is 20331-2
6. Tested Date: Aug. 17 to 29, 2017

4.1.3 Test Procedures

For Radiated emission below 30MHz

- a. The EUT was placed on the top of a rotating table 0.8 meters above the ground at a 3 meter chamber room. The table was rotated 360 degrees to determine the position of the highest radiation.
- b. The EUT was set 3 meters away from the interference-receiving antenna, which was mounted on the top of a variable-height antenna tower.
- c. Both X and Y axes of the antenna are set to make the measurement.
- d. For each suspected emission, the EUT was arranged to its worst case and the rotatable table was turned from 0 degrees to 360 degrees to find the maximum reading.
- e. The test-receiver system was set to Quasi-Peak Detect Function and Specified Bandwidth with Maximum Hold Mode.

NOTE:

1. The resolution bandwidth and video bandwidth of test receiver/spectrum analyzer is 9kHz at frequency below 30MHz.

For Radiated emission above 30MHz

- a. The EUT was placed on the top of a rotating table 0.8 meters (for 30MHz ~ 1GHz) / 1.5 meters (for above 1GHz) above the ground at 3 meter chamber room for test. The table was rotated 360 degrees to determine the position of the highest radiation.
- b. The EUT was set 3 meters away from the interference-receiving antenna, which was mounted on the top of a variable-height antenna tower.
- c. The height of antenna is varied from one meter to four meters above the ground to determine the maximum value of the field strength. Both horizontal and vertical polarizations of the antenna are set to make the measurement.
- d. For each suspected emission, the EUT was arranged to its worst case and then the antenna was tuned to heights from 1 meter to 4 meters and the rotatable table was turned from 0 degrees to 360 degrees to find the maximum reading.
- e. The test-receiver system was set to quasi-peak detect function and specified bandwidth with maximum hold mode when the test frequency is below 1 GHz.
- f. The test-receiver system was set to peak and average detect function and specified bandwidth with maximum hold mode when the test frequency is above 1 GHz. If the peak reading value also meets average limit, measurement with the average detector is unnecessary.

Note:

1. The resolution bandwidth and video bandwidth of test receiver/spectrum analyzer is 120kHz for Quasi-peak detection (QP) at frequency below 1GHz.
2. The resolution bandwidth of test receiver/spectrum analyzer is 1 MHz and the video bandwidth is 3 MHz for Peak detection (PK) at frequency above 1GHz.
3. The resolution bandwidth of test receiver/spectrum analyzer is 1MHz and the video bandwidth is $\geq 1/T$ (Duty cycle < 98%) or 10Hz (Duty cycle $\geq 98\%$) for Average detection (AV) at frequency above 1GHz.
4. All modes of operation were investigated and the worst-case emissions are reported.

4.1.4 Deviation from Test Standard

No deviation.

4.1.5 Test Setup

For Radiated emission below 30MHz

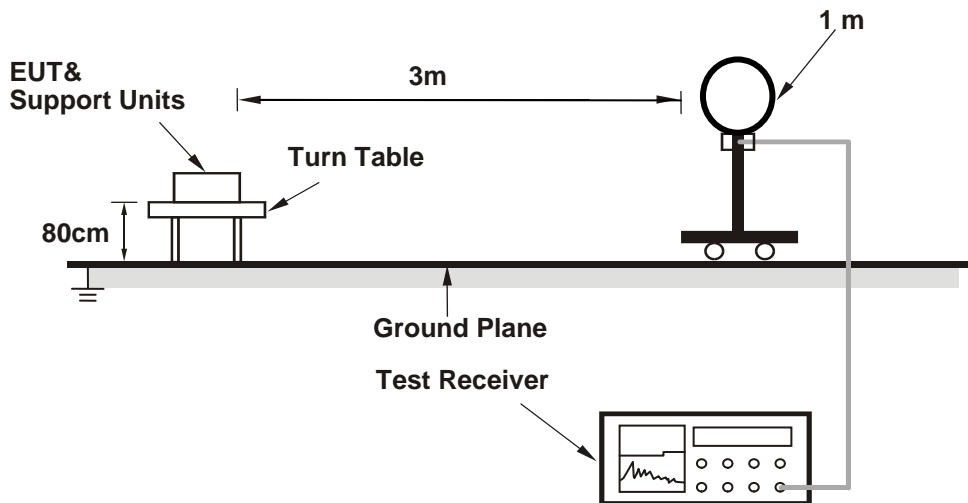

For Radiated emission 30MHz to 1GHz

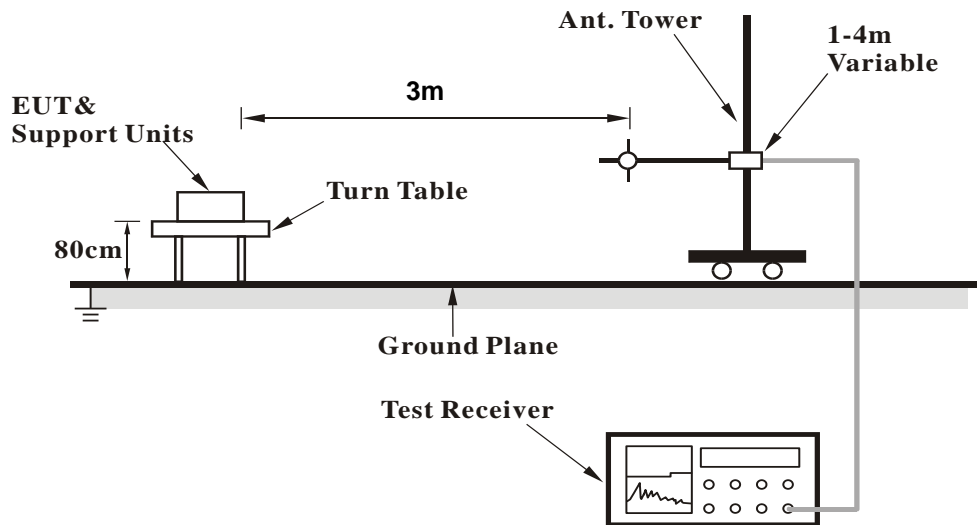

For Radiated emission above 1GHz

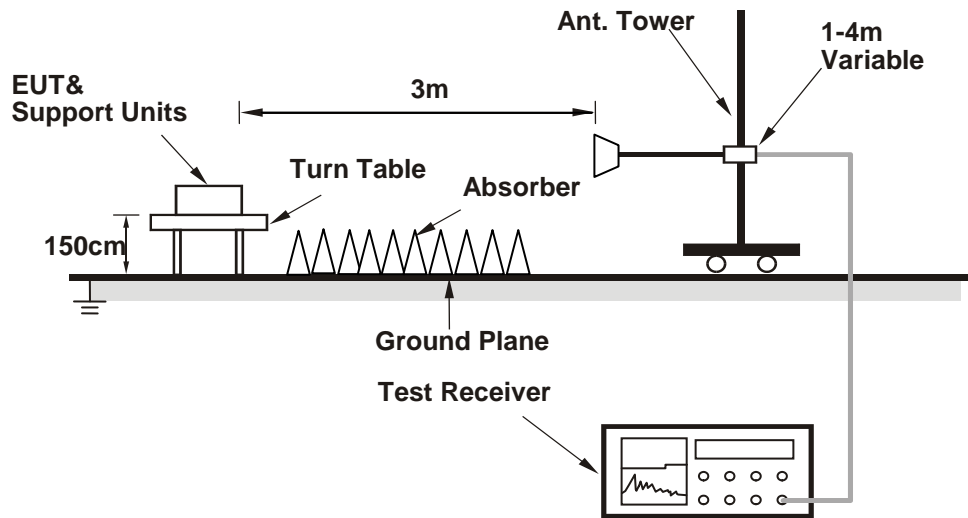

For the actual test configuration, please refer to the attached file (Test Setup Photo).

4.1.6 EUT Operating Conditions

- a. Connected the EUT with the Laptop which is placed on remote site.
- b. Contorlling software (HyperTerminal paste Txcommand.txt command) has been activated to set the EUT on specific status.

4.1.7 Test Results

Above 1GHz Data:

802.11b

CHANNEL	TX Channel 1	DETECTOR FUNCTION	Peak (PK)
FREQUENCY RANGE	1GHz ~ 25GHz		Average (AV)

ANTENNA POLARITY & TEST DISTANCE: HORIZONTAL AT 3 M

NO.	FREQ. (MHz)	EMISSION LEVEL (dBuV/m)	LIMIT (dBuV/m)	MARGIN (dB)	ANTENNA HEIGHT (m)	TABLE ANGLE (Degree)	RAW VALUE (dBuV)	CORRECTION FACTOR (dB/m)
1	2390.00	62.7 PK	74.0	-11.3	1.45 H	196	64.0	-1.3
2	2390.00	53.9 AV	54.0	-0.1	1.45 H	196	55.2	-1.3
3	*2412.00	110.6 PK			1.45 H	196	111.7	-1.1
4	*2412.00	108.4 AV			1.45 H	196	109.5	-1.1
5	4824.00	43.5 PK	74.0	-30.5	1.55 H	149	40.3	3.2
6	4824.00	38.9 AV	54.0	-15.1	1.55 H	149	35.7	3.2

ANTENNA POLARITY & TEST DISTANCE: VERTICAL AT 3 M

NO.	FREQ. (MHz)	EMISSION LEVEL (dBuV/m)	LIMIT (dBuV/m)	MARGIN (dB)	ANTENNA HEIGHT (m)	TABLE ANGLE (Degree)	RAW VALUE (dBuV)	CORRECTION FACTOR (dB/m)
1	2390.00	59.8 PK	74.0	-14.2	1.50 V	290	61.1	-1.3
2	2390.00	50.2 AV	54.0	-3.8	1.50 V	290	51.5	-1.3
3	*2412.00	107.1 PK			1.50 V	290	108.2	-1.1
4	*2412.00	104.9 AV			1.50 V	290	106.0	-1.1
5	4824.00	40.8 PK	74.0	-33.2	1.46 V	311	37.6	3.2
6	4824.00	34.7 AV	54.0	-19.3	1.46 V	311	31.5	3.2

REMARKS:

1. Emission Level(dBuV/m) = Raw Value(dBuV) + Correction Factor(dB/m)
2. Correction Factor(dB/m) = Antenna Factor(dB/m) + Cable Factor(dB) – Pre-Amplifier Factor(dB)
3. The other emission levels were very low against the limit.
4. Margin value = Emission Level – Limit value
5. " * ": Fundamental frequency.

CHANNEL	TX Channel 6	DETECTOR FUNCTION	Peak (PK)
FREQUENCY RANGE	1GHz ~ 25GHz		Average (AV)

ANTENNA POLARITY & TEST DISTANCE: HORIZONTAL AT 3 M

NO.	FREQ. (MHz)	EMISSION LEVEL (dBuV/m)	LIMIT (dBuV/m)	MARGIN (dB)	ANTENNA HEIGHT (m)	TABLE ANGLE (Degree)	RAW VALUE (dBuV)	CORRECTION FACTOR (dB/m)
1	2390.00	60.6 PK	74.0	-13.4	1.67 H	196	61.9	-1.3
2	2390.00	50.4 AV	54.0	-3.6	1.67 H	196	51.7	-1.3
3	*2437.00	112.3 PK			1.67 H	196	113.5	-1.2
4	*2437.00	110.1 AV			1.67 H	196	111.3	-1.2
5	2485.00	60.5 PK	74.0	-13.5	1.67 H	196	61.5	-1.0
6	2485.00	50.0 AV	54.0	-4.0	1.67 H	196	51.0	-1.0
7	4874.00	45.4 PK	74.0	-28.6	1.54 H	137	42.1	3.3
8	4874.00	40.7 AV	54.0	-13.3	1.54 H	137	37.4	3.3
9	7311.00	53.6 PK	74.0	-20.4	2.28 H	225	43.8	9.8
10	7311.00	49.5 AV	54.0	-4.5	2.28 H	225	39.7	9.8

ANTENNA POLARITY & TEST DISTANCE: VERTICAL AT 3 M

NO.	FREQ. (MHz)	EMISSION LEVEL (dBuV/m)	LIMIT (dBuV/m)	MARGIN (dB)	ANTENNA HEIGHT (m)	TABLE ANGLE (Degree)	RAW VALUE (dBuV)	CORRECTION FACTOR (dB/m)
1	2390.00	66.9 PK	74.0	-7.1	1.45 V	289	68.2	-1.3
2	2390.00	47.1 AV	54.0	-6.9	1.45 V	289	48.4	-1.3
3	*2437.00	108.8 PK			1.45 V	289	110.0	-1.2
4	*2437.00	106.6 AV			1.45 V	289	107.8	-1.2
5	2485.00	66.6 PK	74.0	-7.4	1.45 V	289	67.6	-1.0
6	2485.00	46.7 AV	54.0	-7.3	1.45 V	289	47.7	-1.0
7	4874.00	42.2 PK	74.0	-31.8	1.46 V	320	38.9	3.3
8	4874.00	35.8 AV	54.0	-18.2	1.46 V	320	32.5	3.3
9	7311.00	51.6 PK	74.0	-22.4	1.50 V	345	41.8	9.8
10	7311.00	46.5 AV	54.0	-7.5	1.50 V	345	36.7	9.8

REMARKS:

1. Emission Level(dBuV/m) = Raw Value(dBuV) + Correction Factor(dB/m)
2. Correction Factor(dB/m) = Antenna Factor(dB/m) + Cable Factor(dB) – Pre-Amplifier Factor(dB)
3. The other emission levels were very low against the limit.
4. Margin value = Emission Level – Limit value
5. " * ": Fundamental frequency.

CHANNEL	TX Channel 11	DETECTOR FUNCTION	Peak (PK)
FREQUENCY RANGE	1GHz ~ 25GHz		Average (AV)

ANTENNA POLARITY & TEST DISTANCE: HORIZONTAL AT 3 M

NO.	FREQ. (MHz)	EMISSION LEVEL (dBuV/m)	LIMIT (dBuV/m)	MARGIN (dB)	ANTENNA HEIGHT (m)	TABLE ANGLE (Degree)	RAW VALUE (dBuV)	CORRECTION FACTOR (dB/m)
1	*2462.00	111.6 PK			1.44 H	197	112.7	-1.1
2	*2462.00	109.4 AV			1.44 H	197	110.5	-1.1
3	2488.00	63.0 PK	74.0	-11.0	1.44 H	197	64.0	-1.0
4	2488.00	53.3 AV	54.0	-0.7	1.44 H	197	54.3	-1.0
5	4924.00	44.1 PK	74.0	-29.9	1.57 H	128	40.6	3.5
6	4924.00	39.7 AV	54.0	-14.3	1.57 H	128	36.2	3.5
7	7386.00	51.9 PK	74.0	-22.1	2.30 H	220	42.0	9.9
8	7386.00	48.0 AV	54.0	-6.0	2.30 H	220	38.1	9.9

ANTENNA POLARITY & TEST DISTANCE: VERTICAL AT 3 M

NO.	FREQ. (MHz)	EMISSION LEVEL (dBuV/m)	LIMIT (dBuV/m)	MARGIN (dB)	ANTENNA HEIGHT (m)	TABLE ANGLE (Degree)	RAW VALUE (dBuV)	CORRECTION FACTOR (dB/m)
1	*2462.00	108.1 PK			1.51 V	283	109.2	-1.1
2	*2462.00	105.9 AV			1.51 V	283	107.0	-1.1
3	2488.00	59.6 PK	74.0	-14.4	1.51 V	283	60.6	-1.0
4	2488.00	49.8 AV	54.0	-4.2	1.51 V	283	50.8	-1.0
5	4924.00	41.4 PK	74.0	-32.6	1.46 V	323	37.9	3.5
6	4924.00	35.1 AV	54.0	-18.9	1.46 V	323	31.6	3.5
7	7386.00	50.8 PK	74.0	-23.2	1.52 V	353	40.9	9.9
8	7386.00	45.9 AV	54.0	-8.1	1.52 V	353	36.0	9.9

REMARKS:

1. Emission Level(dBuV/m) = Raw Value(dBuV) + Correction Factor(dB/m)
2. Correction Factor(dB/m) = Antenna Factor(dB/m) + Cable Factor(dB) – Pre-Amplifier Factor(dB)
3. The other emission levels were very low against the limit.
4. Margin value = Emission Level – Limit value
5. " * ": Fundamental frequency.

802.11g

CHANNEL	TX Channel 1	DETECTOR FUNCTION	Peak (PK)
FREQUENCY RANGE	1GHz ~ 25GHz		Average (AV)

ANTENNA POLARITY & TEST DISTANCE: HORIZONTAL AT 3 M

NO.	FREQ. (MHz)	EMISSION LEVEL (dBuV/m)	LIMIT (dBuV/m)	MARGIN (dB)	ANTENNA HEIGHT (m)	TABLE ANGLE (Degree)	RAW VALUE (dBuV)	CORRECTION FACTOR (dB/m)
1	2390.00	73.0 PK	74.0	-1.0	1.47 H	196	74.3	-1.3
2	2390.00	53.9 AV	54.0	-0.1	1.47 H	196	55.2	-1.3
3	*2412.00	108.7 PK			1.47 H	196	109.8	-1.1
4	*2412.00	97.5 AV			1.47 H	196	98.6	-1.1
5	4824.00	40.2 PK	74.0	-33.8	1.40 H	130	37.0	3.2
6	4824.00	27.5 AV	54.0	-26.5	1.40 H	130	24.3	3.2

ANTENNA POLARITY & TEST DISTANCE: VERTICAL AT 3 M

NO.	FREQ. (MHz)	EMISSION LEVEL (dBuV/m)	LIMIT (dBuV/m)	MARGIN (dB)	ANTENNA HEIGHT (m)	TABLE ANGLE (Degree)	RAW VALUE (dBuV)	CORRECTION FACTOR (dB/m)
1	2390.00	69.8 PK	74.0	-4.2	1.48 V	293	71.1	-1.3
2	2390.00	50.3 AV	54.0	-3.7	1.48 V	293	51.6	-1.3
3	*2412.00	105.2 PK			1.48 V	293	106.3	-1.1
4	*2412.00	94.0 AV			1.48 V	293	95.1	-1.1
5	4824.00	39.0 PK	74.0	-35.0	3.55 V	329	35.8	3.2
6	4824.00	25.7 AV	54.0	-28.3	3.55 V	329	22.5	3.2

REMARKS:

1. Emission Level(dBuV/m) = Raw Value(dBuV) + Correction Factor(dB/m)
2. Correction Factor(dB/m) = Antenna Factor(dB/m) + Cable Factor(dB) – Pre-Amplifier Factor(dB)
3. The other emission levels were very low against the limit.
4. Margin value = Emission Level – Limit value
5. " * ": Fundamental frequency.

CHANNEL	TX Channel 6	DETECTOR FUNCTION	Peak (PK)
FREQUENCY RANGE	1GHz ~ 25GHz		Average (AV)

ANTENNA POLARITY & TEST DISTANCE: HORIZONTAL AT 3 M

NO.	FREQ. (MHz)	EMISSION LEVEL (dBuV/m)	LIMIT (dBuV/m)	MARGIN (dB)	ANTENNA HEIGHT (m)	TABLE ANGLE (Degree)	RAW VALUE (dBuV)	CORRECTION FACTOR (dB/m)
1	2390.00	70.3 PK	74.0	-3.7	1.51 H	196	71.6	-1.3
2	2390.00	52.5 AV	54.0	-1.5	1.51 H	196	53.8	-1.3
3	*2437.00	114.6 PK			1.51 H	196	115.8	-1.2
4	*2437.00	103.7 AV			1.51 H	196	104.9	-1.2
5	2483.50	73.9 PK	74.0	-0.1	1.51 H	196	74.9	-1.0
6	2483.50	50.2 AV	54.0	-3.8	1.51 H	196	51.2	-1.0
7	4874.00	41.2 PK	74.0	-32.8	1.40 H	140	37.9	3.3
8	4874.00	27.9 AV	54.0	-26.1	1.40 H	140	24.6	3.3
9	7311.00	52.4 PK	74.0	-21.6	2.02 H	47	42.6	9.8
10	7311.00	39.1 AV	54.0	-14.9	2.02 H	47	29.3	9.8

ANTENNA POLARITY & TEST DISTANCE: VERTICAL AT 3 M

NO.	FREQ. (MHz)	EMISSION LEVEL (dBuV/m)	LIMIT (dBuV/m)	MARGIN (dB)	ANTENNA HEIGHT (m)	TABLE ANGLE (Degree)	RAW VALUE (dBuV)	CORRECTION FACTOR (dB/m)
1	2390.00	67.1 PK	74.0	-6.9	1.49 V	298	68.4	-1.3
2	2390.00	49.2 AV	54.0	-4.8	1.49 V	298	50.5	-1.3
3	*2437.00	111.2 PK			1.49 V	298	112.4	-1.2
4	*2437.00	100.2 AV			1.49 V	298	101.4	-1.2
5	2483.50	70.2 PK	74.0	-3.8	1.49 V	298	71.2	-1.0
6	2483.50	46.8 AV	54.0	-7.2	1.49 V	298	47.8	-1.0
7	4874.00	39.0 PK	74.0	-35.0	3.50 V	340	35.7	3.3
8	4874.00	25.5 AV	54.0	-28.5	3.50 V	340	22.2	3.3
9	7311.00	51.7 PK	74.0	-22.3	3.50 V	151	41.9	9.8
10	7311.00	34.7 AV	54.0	-19.3	3.50 V	151	24.9	9.8

REMARKS:

1. Emission Level(dBuV/m) = Raw Value(dBuV) + Correction Factor(dB/m)
2. Correction Factor(dB/m) = Antenna Factor(dB/m) + Cable Factor(dB) – Pre-Amplifier Factor(dB)
3. The other emission levels were very low against the limit.
4. Margin value = Emission Level – Limit value
5. " * ": Fundamental frequency.

CHANNEL	TX Channel 11	DETECTOR FUNCTION	Peak (PK)
FREQUENCY RANGE	1GHz ~ 25GHz		Average (AV)

ANTENNA POLARITY & TEST DISTANCE: HORIZONTAL AT 3 M

NO.	FREQ. (MHz)	EMISSION LEVEL (dBuV/m)	LIMIT (dBuV/m)	MARGIN (dB)	ANTENNA HEIGHT (m)	TABLE ANGLE (Degree)	RAW VALUE (dBuV)	CORRECTION FACTOR (dB/m)
1	*2462.00	108.7 PK			1.51 H	196	109.8	-1.1
2	*2462.00	97.2 AV			1.51 H	196	98.3	-1.1
3	2483.50	73.9 PK	74.0	-0.1	1.51 H	196	74.9	-1.0
4	2483.50	52.7 AV	54.0	-1.3	1.51 H	196	53.7	-1.0
5	4924.00	39.9 PK	74.0	-34.1	1.43 H	151	36.4	3.5
6	4924.00	27.1 AV	54.0	-26.9	1.43 H	151	23.6	3.5
7	7386.00	46.2 PK	74.0	-27.8	2.01 H	42	36.3	9.9
8	7386.00	33.7 AV	54.0	-20.3	2.01 H	42	23.8	9.9

ANTENNA POLARITY & TEST DISTANCE: VERTICAL AT 3 M

NO.	FREQ. (MHz)	EMISSION LEVEL (dBuV/m)	LIMIT (dBuV/m)	MARGIN (dB)	ANTENNA HEIGHT (m)	TABLE ANGLE (Degree)	RAW VALUE (dBuV)	CORRECTION FACTOR (dB/m)
1	*2462.00	105.0 PK			1.47 V	285	106.1	-1.1
2	*2462.00	93.8 AV			1.47 V	285	94.9	-1.1
3	2483.50	70.5 PK	74.0	-3.5	1.47 V	285	71.5	-1.0
4	2483.50	49.5 AV	54.0	-4.5	1.47 V	285	50.5	-1.0
5	4924.00	39.1 PK	74.0	-34.9	3.50 V	349	35.6	3.5
6	4924.00	25.7 AV	54.0	-28.3	3.50 V	349	22.2	3.5
7	7386.00	44.8 PK	74.0	-29.2	3.52 V	167	34.9	9.9
8	7386.00	32.1 AV	54.0	-21.9	3.52 V	167	22.2	9.9

REMARKS:

1. Emission Level(dBuV/m) = Raw Value(dBuV) + Correction Factor(dB/m)
2. Correction Factor(dB/m) = Antenna Factor(dB/m) + Cable Factor(dB) – Pre-Amplifier Factor(dB)
3. The other emission levels were very low against the limit.
4. Margin value = Emission Level – Limit value
5. " * ": Fundamental frequency.

802.11n (HT20)

CHANNEL	TX Channel 1	DETECTOR FUNCTION	Peak (PK)
FREQUENCY RANGE	1GHz ~ 25GHz		Average (AV)

ANTENNA POLARITY & TEST DISTANCE: HORIZONTAL AT 3 M

NO.	FREQ. (MHz)	EMISSION LEVEL (dBuV/m)	LIMIT (dBuV/m)	MARGIN (dB)	ANTENNA HEIGHT (m)	TABLE ANGLE (Degree)	RAW VALUE (dBuV)	CORRECTION FACTOR (dB/m)
1	2390.00	73.8 PK	74.0	-0.2	1.03 H	198	75.1	-1.3
2	2390.00	53.6 AV	54.0	-0.4	1.03 H	198	54.9	-1.3
3	*2412.00	106.2 PK			1.03 H	198	107.3	-1.1
4	*2412.00	95.7 AV			1.03 H	198	96.8	-1.1
5	4824.00	40.6 PK	74.0	-33.4	1.45 H	135	37.4	3.2
6	4824.00	28.0 AV	54.0	-26.0	1.45 H	135	24.8	3.2

ANTENNA POLARITY & TEST DISTANCE: VERTICAL AT 3 M

NO.	FREQ. (MHz)	EMISSION LEVEL (dBuV/m)	LIMIT (dBuV/m)	MARGIN (dB)	ANTENNA HEIGHT (m)	TABLE ANGLE (Degree)	RAW VALUE (dBuV)	CORRECTION FACTOR (dB/m)
1	2390.00	73.2 PK	74.0	-0.8	1.43 V	284	74.5	-1.3
2	2390.00	50.1 AV	54.0	-3.9	1.43 V	284	51.4	-1.3
3	*2412.00	102.5 PK			1.43 V	284	103.6	-1.1
4	*2412.00	92.3 AV			1.43 V	284	93.4	-1.1
5	4824.00	39.0 PK	74.0	-35.0	3.57 V	345	35.8	3.2
6	4824.00	25.8 AV	54.0	-28.2	3.57 V	345	22.6	3.2

REMARKS:

1. Emission Level(dBuV/m) = Raw Value(dBuV) + Correction Factor(dB/m)
2. Correction Factor(dB/m) = Antenna Factor(dB/m) + Cable Factor(dB) – Pre-Amplifier Factor(dB)
3. The other emission levels were very low against the limit.
4. Margin value = Emission Level – Limit value
5. " * ": Fundamental frequency.

CHANNEL	TX Channel 6	DETECTOR FUNCTION	Peak (PK)
FREQUENCY RANGE	1GHz ~ 25GHz		Average (AV)

ANTENNA POLARITY & TEST DISTANCE: HORIZONTAL AT 3 M

NO.	FREQ. (MHz)	EMISSION LEVEL (dBuV/m)	LIMIT (dBuV/m)	MARGIN (dB)	ANTENNA HEIGHT (m)	TABLE ANGLE (Degree)	RAW VALUE (dBuV)	CORRECTION FACTOR (dB/m)
1	2390.00	66.8 PK	74.0	-7.2	1.00 H	242	68.1	-1.3
2	2390.00	49.4 AV	54.0	-4.6	1.00 H	242	50.7	-1.3
3	*2437.00	112.2 PK			1.00 H	242	113.4	-1.2
4	*2437.00	101.7 AV			1.00 H	242	102.9	-1.2
5	2483.50	73.7 PK	74.0	-0.3	1.00 H	242	74.7	-1.0
6	2483.50	50.1 AV	54.0	-3.9	1.00 H	242	51.1	-1.0
7	4874.00	41.6 PK	74.0	-32.4	1.41 H	137	38.3	3.3
8	4874.00	28.3 AV	54.0	-25.7	1.41 H	137	25.0	3.3
9	7311.00	52.4 PK	74.0	-21.6	2.06 H	39	42.6	9.8
10	7311.00	38.9 AV	54.0	-15.1	2.06 H	39	29.1	9.8

ANTENNA POLARITY & TEST DISTANCE: VERTICAL AT 3 M

NO.	FREQ. (MHz)	EMISSION LEVEL (dBuV/m)	LIMIT (dBuV/m)	MARGIN (dB)	ANTENNA HEIGHT (m)	TABLE ANGLE (Degree)	RAW VALUE (dBuV)	CORRECTION FACTOR (dB/m)
1	2390.00	63.2 PK	74.0	-10.8	1.44 V	282	64.5	-1.3
2	2390.00	45.9 AV	54.0	-8.1	1.44 V	282	47.2	-1.3
3	*2437.00	108.5 PK			1.44 V	282	109.7	-1.2
4	*2437.00	98.3 AV			1.44 V	282	99.5	-1.2
5	2483.50	70.3 PK	74.0	-3.7	1.44 V	282	71.3	-1.0
6	2483.50	46.7 AV	54.0	-7.3	1.44 V	282	47.7	-1.0
7	4874.00	39.3 PK	74.0	-34.7	3.47 V	335	36.0	3.3
8	4874.00	26.0 AV	54.0	-28.0	3.47 V	335	22.7	3.3
9	7311.00	51.9 PK	74.0	-22.1	3.48 V	153	42.1	9.8
10	7311.00	34.7 AV	54.0	-19.3	3.48 V	153	24.9	9.8

REMARKS:

1. Emission Level(dBuV/m) = Raw Value(dBuV) + Correction Factor(dB/m)
2. Correction Factor(dB/m) = Antenna Factor(dB/m) + Cable Factor(dB) – Pre-Amplifier Factor(dB)
3. The other emission levels were very low against the limit.
4. Margin value = Emission Level – Limit value
5. " * ": Fundamental frequency.

CHANNEL	TX Channel 11	DETECTOR FUNCTION	Peak (PK)
FREQUENCY RANGE	1GHz ~ 25GHz		Average (AV)

ANTENNA POLARITY & TEST DISTANCE: HORIZONTAL AT 3 M

NO.	FREQ. (MHz)	EMISSION LEVEL (dBuV/m)	LIMIT (dBuV/m)	MARGIN (dB)	ANTENNA HEIGHT (m)	TABLE ANGLE (Degree)	RAW VALUE (dBuV)	CORRECTION FACTOR (dB/m)
1	*2462.00	104.7 PK			1.14 H	202	105.8	-1.1
2	*2462.00	94.0 AV			1.14 H	202	95.1	-1.1
3	2483.50	73.9 PK	74.0	-0.1	1.14 H	202	74.9	-1.0
4	2483.50	51.3 AV	54.0	-2.7	1.14 H	202	52.3	-1.0
5	4924.00	39.3 PK	74.0	-34.7	1.37 H	137	35.8	3.5
6	4924.00	26.8 AV	54.0	-27.2	1.37 H	137	23.3	3.5
7	7386.00	46.0 PK	74.0	-28.0	2.06 H	43	36.1	9.9
8	7386.00	33.6 AV	54.0	-20.4	2.06 H	43	23.7	9.9

ANTENNA POLARITY & TEST DISTANCE: VERTICAL AT 3 M

NO.	FREQ. (MHz)	EMISSION LEVEL (dBuV/m)	LIMIT (dBuV/m)	MARGIN (dB)	ANTENNA HEIGHT (m)	TABLE ANGLE (Degree)	RAW VALUE (dBuV)	CORRECTION FACTOR (dB/m)
1	*2462.00	101.0 PK			1.48 V	293	102.1	-1.1
2	*2462.00	90.6 AV			1.48 V	293	91.7	-1.1
3	2483.50	70.5 PK	74.0	-3.5	1.48 V	293	71.5	-1.0
4	2483.50	48.1 AV	54.0	-5.9	1.48 V	293	49.1	-1.0
5	4924.00	38.9 PK	74.0	-35.1	3.49 V	349	35.4	3.5
6	4924.00	25.4 AV	54.0	-28.6	3.49 V	349	21.9	3.5
7	7386.00	44.7 PK	74.0	-29.3	3.58 V	154	34.8	9.9
8	7386.00	31.9 AV	54.0	-22.1	3.58 V	154	22.0	9.9

REMARKS:

1. Emission Level(dBuV/m) = Raw Value(dBuV) + Correction Factor(dB/m)
2. Correction Factor(dB/m) = Antenna Factor(dB/m) + Cable Factor(dB) – Pre-Amplifier Factor(dB)
3. The other emission levels were very low against the limit.
4. Margin value = Emission Level – Limit value
5. " * ": Fundamental frequency.

Below 1GHz Data:

802.11b

CHANNEL	TX Channel 6	DETECTOR FUNCTION	Quasi-Peak (QP)
FREQUENCY RANGE	9kHz ~ 1GHz		

ANTENNA POLARITY & TEST DISTANCE: HORIZONTAL AT 3 M

NO.	FREQ. (MHz)	EMISSION LEVEL (dBuV/m)	LIMIT (dBuV/m)	MARGIN (dB)	ANTENNA HEIGHT (m)	TABLE ANGLE (Degree)	RAW VALUE (dBuV)	CORRECTION FACTOR (dB/m)
1	116.33	22.4 QP	43.5	-21.1	3.00 H	83	32.6	-10.2
2	169.39	23.2 QP	43.5	-20.3	1.50 H	277	31.6	-8.4
3	396.01	21.6 QP	46.0	-24.4	1.00 H	244	27.0	-5.4
4	621.82	24.7 QP	46.0	-21.3	1.00 H	0	24.9	-0.2
5	765.36	27.8 QP	46.0	-18.2	1.50 H	23	25.5	2.3
6	960.04	33.3 QP	54.0	-20.7	1.50 H	360	28.6	4.7

ANTENNA POLARITY & TEST DISTANCE: VERTICAL AT 3 M

NO.	FREQ. (MHz)	EMISSION LEVEL (dBuV/m)	LIMIT (dBuV/m)	MARGIN (dB)	ANTENNA HEIGHT (m)	TABLE ANGLE (Degree)	RAW VALUE (dBuV)	CORRECTION FACTOR (dB/m)
1	109.56	23.8 QP	43.5	-19.7	1.00 V	360	34.9	-11.1
2	170.72	20.9 QP	43.5	-22.6	1.00 V	92	29.4	-8.5
3	240.03	20.2 QP	46.0	-25.8	1.00 V	87	30.2	-10.0
4	631.76	25.2 QP	46.0	-20.8	2.50 V	0	25.3	-0.1
5	825.28	28.5 QP	46.0	-17.5	2.50 V	61	25.5	3.0
6	960.04	36.8 QP	54.0	-17.2	1.00 V	358	32.1	4.7

REMARKS:

1. Emission Level(dBuV/m) = Raw Value(dBuV) + Correction Factor(dB/m)
2. Correction Factor(dB/m) = Antenna Factor(dB/m) + Cable Factor(dB) – Pre-Amplifier Factor(dB)
3. The other emission levels were very low against the limit.
4. Margin value = Emission Level – Limit value

4.2 Conducted Emission Measurement

4.2.1 Limits of Conducted Emission Measurement

Frequency (MHz)	Conducted Limit (dBuV)	
	Quasi-peak	Average
0.15 - 0.5	66 - 56	56 - 46
0.50 - 5.0	56	46
5.0 - 30.0	60	50

Note: 1. The lower limit shall apply at the transition frequencies.

2. The limit decreases in line with the logarithm of the frequency in the range of 0.15 to 0.50MHz.

4.2.2 Test Instruments

DESCRIPTION & MANUFACTURER	MODEL NO.	SERIAL NO.	CALIBRATED DATE	CALIBRATED UNTIL
Test Receiver R&S	ESCS 30	847124/029	Oct. 24, 2016	Oct. 23, 2017
Line-Impedance Stabilization Network (for EUT) R&S	ESH3-Z5	848773/004	Oct. 26, 2016	Oct. 25, 2017
Line-Impedance Stabilization Network (for Peripheral) R&S	ENV216	100072	June 03, 2017	June 02, 2018
50 ohms Terminator	N/A	EMC-02	Sep. 29, 2016	Sep. 28, 2017
RF Cable	5D-FB	COCCAB-001	Sep. 30, 2016	Sep. 29, 2017
10 dB PAD Mini-Circuits	HAT-10+	CONATT-004	June 18, 2017	June 17, 2018
Software BVADT	BVADT_Cond_ V7.3.7.4	NA	NA	NA

Note:

1. The calibration interval of the above test instruments are 12 months and the calibrations are traceable to NML/ROC and NIST/USA.
2. The test was performed in Shielded Room No. 1.
3. Tested Date: Aug. 08 to 29, 2017

4.2.3 Test Procedures

- The EUT was placed 0.4 meters from the conducting wall of the shielded room with EUT being connected to the power mains through a line impedance stabilization network (LISN). Other support units were connected to the power mains through another LISN. The two LISNs provide 50 ohm/ 50uH of coupling impedance for the measuring instrument.
- Both lines of the power mains connected to the EUT were checked for maximum conducted interference.
- The frequency range from 150kHz to 30MHz was searched. Emission levels under (Limit - 20dB) was not recorded.

NOTE: The resolution bandwidth and video bandwidth of test receiver is 9kHz for quasi-peak detection (QP) and average detection (AV) at frequency 0.15MHz-30MHz.

4.2.4 Deviation from Test Standard

No deviation.

4.2.5 Test Setup

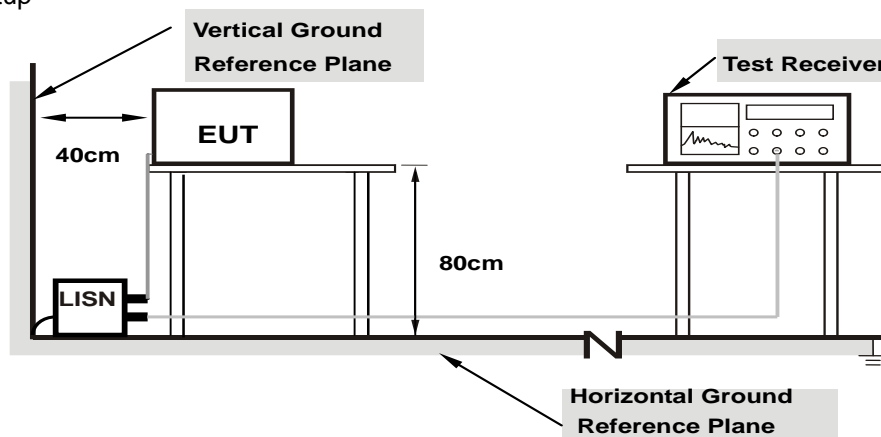

Note: 1.Support units were connected to second LISN.

For the actual test configuration, please refer to the attached file (Test Setup Photo).

4.2.6 EUT Operating Conditions

Same as 4.1.6.

4.2.7 Test Results (Mode 1)

Phase	Line (L)	Detector Function	Quasi-Peak (QP) / Average (AV)
-------	----------	-------------------	--------------------------------

No	Freq. [MHz]	Corr.	Reading Value		Emission Level		Limit		Margin	
		Factor (dB)	[dB (uV)]		[dB (uV)]		[dB (uV)]		(dB)	
		Q.P.	AV.	Q.P.	AV.	Q.P.	AV.	Q.P.	AV.	Q.P.
1	0.18516	10.32	26.66	12.72	36.98	23.04	64.25	54.25	-27.27	-31.21
2	0.38047	10.38	17.84	12.07	28.22	22.45	58.27	48.27	-30.05	-25.82
3	0.72422	10.44	16.49	12.03	26.93	22.47	56.00	46.00	-29.07	-23.53
4	4.82813	10.58	16.15	7.64	26.73	18.22	56.00	46.00	-29.27	-27.78
5	10.26953	10.86	13.15	7.40	24.01	18.26	60.00	50.00	-35.99	-31.74
6	25.23047	11.51	27.64	25.20	39.15	36.71	60.00	50.00	-20.85	-13.29

REMARKS:

1. Q.P. and AV. are abbreviations of quasi-peak and average individually.
2. The emission levels of other frequencies were very low against the limit.
3. Margin value = Emission level - Limit value
4. Correction factor = Insertion loss + Cable loss
5. Emission Level = Correction Factor + Reading Value.

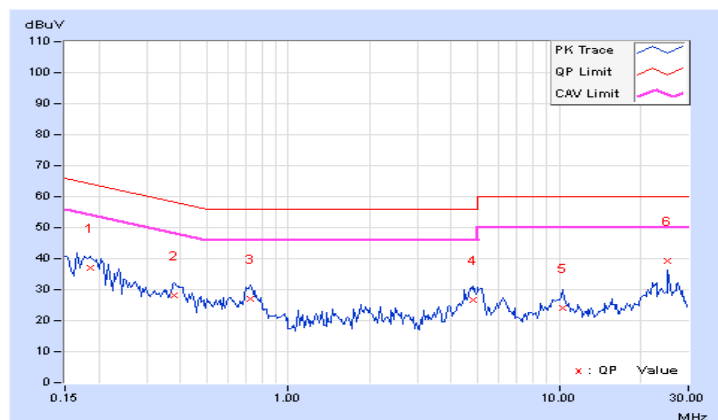

Phase	Neutral (N)	Detector Function	Quasi-Peak (QP) / Average (AV)
-------	-------------	-------------------	--------------------------------

No	Freq. [MHz]	Corr.	Reading Value		Emission Level		Limit		Margin	
		Factor (dB)	[dB (uV)]		[dB (uV)]		[dB (uV)]		(dB)	
	Q.P.	AV.	Q.P.	AV.	Q.P.	AV.	Q.P.	AV.	Q.P.	AV.
1	0.16562	10.78	27.87	10.85	38.65	21.63	65.18	55.18	-26.53	-33.55
2	0.39219	10.37	17.60	6.92	27.97	17.29	58.02	48.02	-30.05	-30.73
3	0.73203	10.43	13.24	7.49	23.67	17.92	56.00	46.00	-32.33	-28.08
4	4.69141	10.50	18.83	8.34	29.33	18.84	56.00	46.00	-26.67	-27.16
5	10.23828	10.79	14.56	7.74	25.35	18.53	60.00	50.00	-34.65	-31.47
6	25.23047	11.15	24.98	24.78	36.13	35.93	60.00	50.00	-23.87	-14.07

REMARKS:

1. Q.P. and AV. are abbreviations of quasi-peak and average individually.
2. The emission levels of other frequencies were very low against the limit.
3. Margin value = Emission level - Limit value
4. Correction factor = Insertion loss + Cable loss
5. Emission Level = Correction Factor + Reading Value.

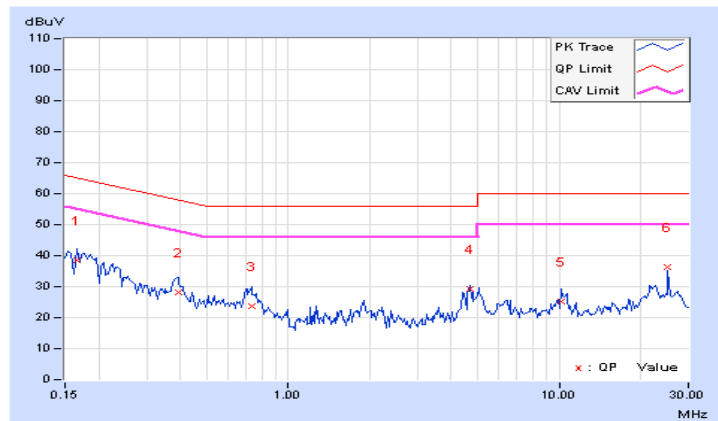

4.2.8 Test Results (Mode 2)

Phase	Line (L)	Detector Function	Quasi-Peak (QP) / Average (AV)
-------	----------	-------------------	--------------------------------

No	Freq. [MHz]	Corr.	Reading Value		Emission Level		Limit		Margin	
		Factor	[dB (uV)]		[dB (uV)]		[dB (uV)]		(dB)	
	(dB)	Q.P.	AV.	Q.P.	AV.	Q.P.	AV.	Q.P.	AV.	
1	0.15000	10.08	25.51	12.79	35.59	22.87	66.00	56.00	-30.41	-33.13
2	0.26328	10.09	19.09	10.71	29.18	20.80	61.33	51.33	-32.15	-30.53
3	0.38438	10.12	30.17	23.66	40.29	33.78	58.18	48.18	-17.89	-14.40
4	0.98594	10.16	10.52	5.93	20.68	16.09	56.00	46.00	-35.32	-29.91
5	6.37109	10.53	9.89	6.12	20.42	16.65	60.00	50.00	-39.58	-33.35
6	15.30469	11.21	4.34	2.11	15.55	13.32	60.00	50.00	-44.45	-36.68

REMARKS:

1. Q.P. and AV. are abbreviations of quasi-peak and average individually.
2. The emission levels of other frequencies were very low against the limit.
3. Margin value = Emission level - Limit value
4. Correction factor = Insertion loss + Cable loss
5. Emission Level = Correction Factor + Reading Value.

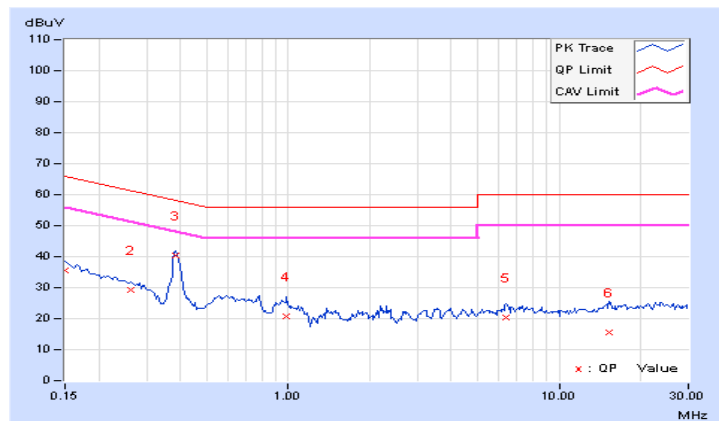

Phase	Neutral (N)	Detector Function	Quasi-Peak (QP) / Average (AV)
-------	-------------	-------------------	--------------------------------

No	Freq. [MHz]	Corr.	Reading Value		Emission Level		Limit		Margin	
		Factor (dB)	[dB (uV)]		[dB (uV)]		[dB (uV)]		(dB)	
	Q.P.	AV.	Q.P.	AV.	Q.P.	AV.	Q.P.	AV.	Q.P.	AV.
1	0.15000	10.07	25.04	11.27	35.11	21.34	66.00	56.00	-30.89	-34.66
2	0.23984	10.06	17.03	6.18	27.09	16.24	62.10	52.10	-35.01	-35.86
3	0.38438	10.11	25.07	20.70	35.18	30.81	58.18	48.18	-23.00	-17.37
4	2.27734	10.22	10.15	6.90	20.37	17.12	56.00	46.00	-35.63	-28.88
5	6.33984	10.44	10.53	7.56	20.97	18.00	60.00	50.00	-39.03	-32.00
6	19.45313	11.25	-2.87	-6.08	8.38	5.17	60.00	50.00	-51.62	-44.83

REMARKS:

1. Q.P. and AV. are abbreviations of quasi-peak and average individually.
2. The emission levels of other frequencies were very low against the limit.
3. Margin value = Emission level - Limit value
4. Correction factor = Insertion loss + Cable loss
5. Emission Level = Correction Factor + Reading Value.

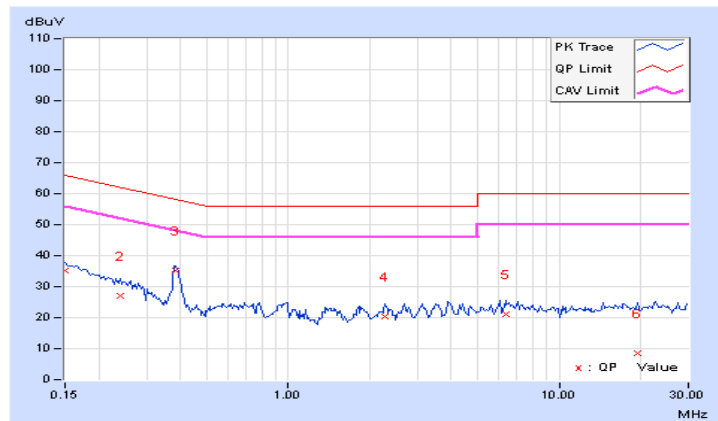

4.2.9 Test Results (Mode 3)

Phase	Line (L)	Detector Function	Quasi-Peak (QP) / Average (AV)
-------	----------	-------------------	--------------------------------

No	Freq. [MHz]	Corr. Factor	Reading Value [dB (uV)]		Emission Level [dB (uV)]		Limit [dB (uV)]		Margin (dB)	
		(dB)	Q.P.	AV.	Q.P.	AV.	Q.P.	AV.	Q.P.	AV.
	1	0.15000	10.07	34.14	28.11	44.21	38.18	66.00	56.00	-21.79
2	0.16953	10.07	33.20	23.96	43.27	34.03	64.98	54.98	-21.71	-20.95
3	0.21250	10.06	28.42	16.12	38.48	26.18	63.11	53.11	-24.63	-26.93
4	1.42969	10.14	24.25	18.23	34.39	28.37	56.00	46.00	-21.61	-17.63
5	3.27734	10.24	29.35	23.58	39.59	33.82	56.00	46.00	-16.41	-12.18
6	23.08203	11.31	25.68	19.77	36.99	31.08	60.00	50.00	-23.01	-18.92

REMARKS:

1. Q.P. and AV. are abbreviations of quasi-peak and average individually.
2. The emission levels of other frequencies were very low against the limit.
3. Margin value = Emission level - Limit value
4. Correction factor = Insertion loss + Cable loss
5. Emission Level = Correction Factor + Reading Value.

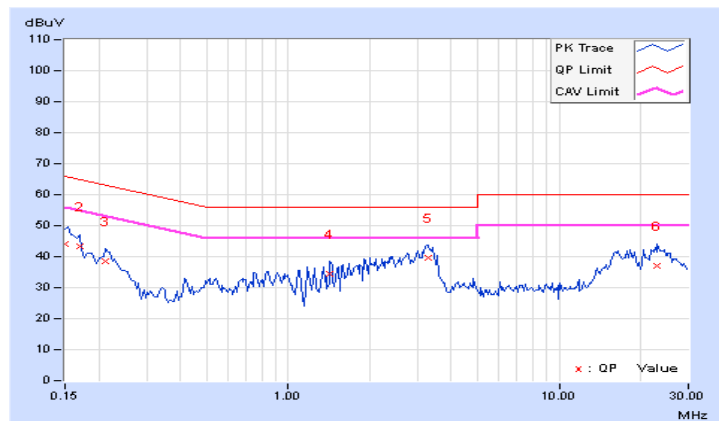

Phase	Neutral (N)	Detector Function	Quasi-Peak (QP) / Average (AV)
-------	-------------	-------------------	--------------------------------

No	Freq. [MHz]	Corr.	Reading Value		Emission Level		Limit		Margin	
		Factor	[dB (uV)]		[dB (uV)]		[dB (uV)]		(dB)	
		(dB)	Q.P.	AV.	Q.P.	AV.	Q.P.	AV.	Q.P.	AV.
1	0.15000	10.06	30.78	20.71	40.84	30.77	66.00	56.00	-25.16	-25.23
2	0.20078	10.03	24.39	19.23	34.42	29.26	63.58	53.58	-29.16	-24.32
3	0.76328	10.11	25.47	22.26	35.58	32.37	56.00	46.00	-20.42	-13.63
4	2.33203	10.19	24.51	17.61	34.70	27.80	56.00	46.00	-21.30	-18.20
5	3.19141	10.20	26.18	20.20	36.38	30.40	56.00	46.00	-19.62	-15.60
6	23.12109	10.99	26.19	19.20	37.18	30.19	60.00	50.00	-22.82	-19.81

REMARKS:

1. Q.P. and AV. are abbreviations of quasi-peak and average individually.
2. The emission levels of other frequencies were very low against the limit.
3. Margin value = Emission level - Limit value
4. Correction factor = Insertion loss + Cable loss
5. Emission Level = Correction Factor + Reading Value.

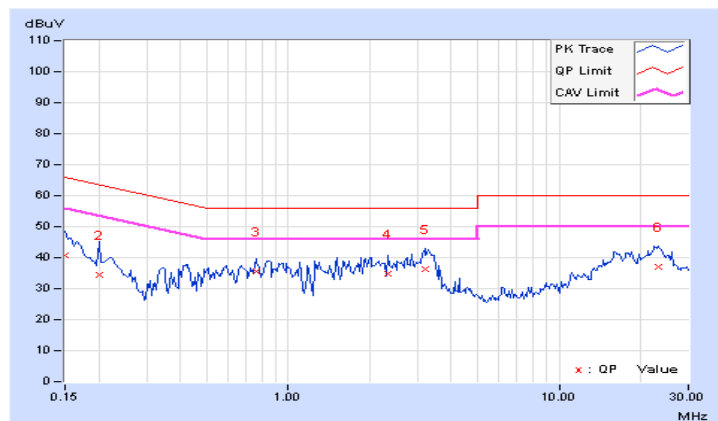

4.3 6dB Bandwidth Measurement

4.3.1 Limits of 6dB Bandwidth Measurement

The minimum of 6dB Bandwidth Measurement is 0.5 MHz.

4.3.2 Test Setup

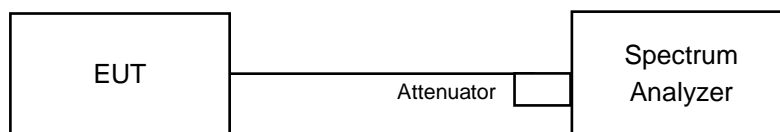

4.3.3 Test Instruments

Refer to section 4.1.2 to get information of above instrument.

4.3.4 Test Procedure

- a. Set resolution bandwidth (RBW) = 100kHz
- b. Set the video bandwidth (VBW) $\geq 3 \times$ RBW, Detector = Peak.
- c. Trace mode = max hold.
- d. Sweep = auto couple.
- e. Measure the maximum width of the emission that is constrained by the frequencies associated with the two amplitude points (upper and lower) that are attenuated by 6 dB relative to the maximum level measured in the fundamental emission

4.3.5 Deviation from Test Standard

No deviation.

4.3.6 EUT Operating Conditions

The software provided by client to enable the EUT under transmission condition continuously at lowest, middle and highest channel frequencies individually.

4.3.7 Test Result

802.11b

Channel	Frequency (MHz)	6dB Bandwidth (MHz)	Minimum Limit (MHz)	Pass / Fail
1	2412	8.08	0.5	PASS
6	2437	10.06	0.5	PASS
11	2462	8.08	0.5	PASS

802.11g

Channel	Frequency (MHz)	6dB Bandwidth (MHz)	Minimum Limit (MHz)	Pass / Fail
1	2412	16.54	0.5	PASS
6	2437	16.51	0.5	PASS
11	2462	16.47	0.5	PASS

802.11n (HT20)

Channel	Frequency (MHz)	6dB Bandwidth (MHz)	Minimum Limit (MHz)	Pass / Fail
1	2412	17.73	0.5	Pass
6	2437	17.70	0.5	Pass
11	2462	17.72	0.5	Pass

Spectrum Plot of Worst Value

802.11b / CH1

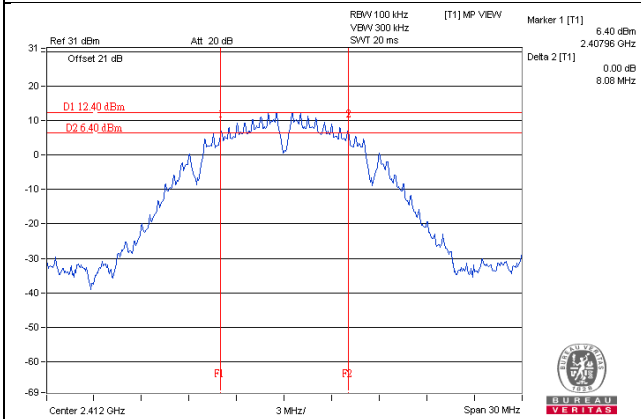

802.11g / CH11

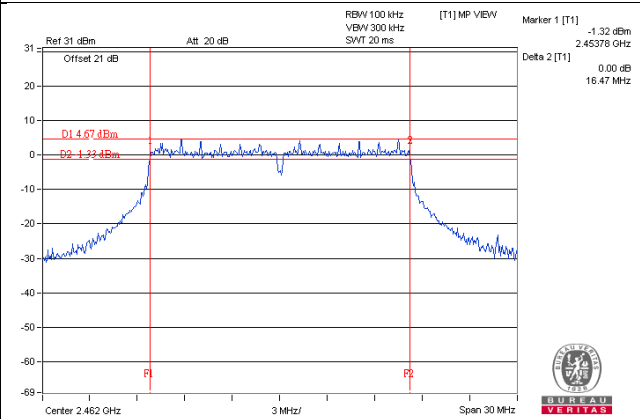

802.11n (HT20) / CH6

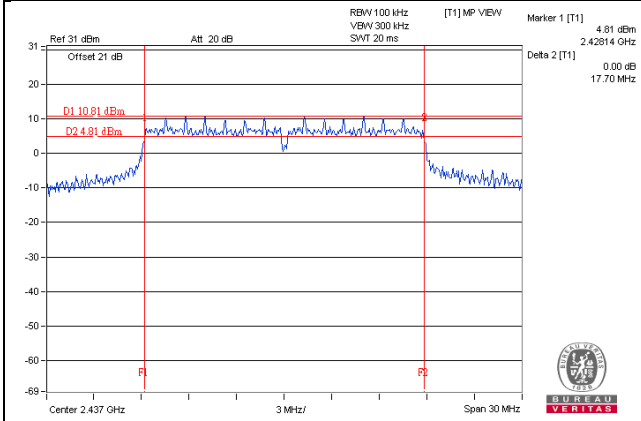

4.4 Conducted Output Power Measurement

4.4.1 Limits of Conducted Output Power Measurement

For systems using digital modulation in the 2400–2483.5 MHz bands: 1 Watt (30dBm)

4.4.2 Test Setup

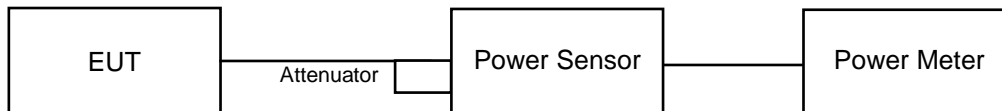

4.4.3 Test Instruments

Refer to section 4.1.2 to get information of above instrument.

4.4.4 Test Procedures

A peak / average power sensor was used on the output port of the EUT. A power meter was used to read the response of the peak / average power sensor. Record the power level.

4.4.5 Deviation from Test Standard

No deviation.

4.4.6 EUT Operating Conditions

Same as Item 4.3.6.

4.4.7 Test Results

FOR PEAK POWER

802.11b

Channel	Frequency (MHz)	Peak Power (mW)	Peak Power (dBm)	Limit (dBm)	Pass/Fail
1	2412	207.97	23.18	30	Pass
6	2437	308.319	24.89	30	Pass
11	2462	262.422	24.19	30	Pass

802.11g

Channel	Frequency (MHz)	Peak Power (mW)	Peak Power (dBm)	Limit (dBm)	Pass/Fail
1	2412	264.241	24.22	30	Pass
6	2437	334.195	25.24	30	Pass
11	2462	261.818	24.18	30	Pass

802.11n (HT20)

Channel	Frequency (MHz)	Peak Power (mW)	Peak Power (dBm)	Limit (dBm)	Pass/Fail
1	2412	274.789	24.39	30	Pass
6	2437	334.195	25.24	30	Pass
11	2462	206.063	23.14	30	Pass

FOR AVERAGE POWER

802.11b

Channel	Frequency (MHz)	Average Power (mW)	Average Power (dBm)
1	2412	117.22	20.69
6	2437	216.77	23.36
11	2462	162.181	22.10

802.11g

Channel	Frequency (MHz)	Average Power (mW)	Average Power (dBm)
1	2412	45.186	16.55
6	2437	181.552	22.59
11	2462	44.875	16.52

802.11n (HT20)

Channel	Frequency (MHz)	Average Power (mW)	Average Power (dBm)
1	2412	46.345	16.66
6	2437	166.341	22.21
11	2462	32.961	15.18

4.5 Power Spectral Density Measurement

4.5.1 Limits of Power Spectral Density Measurement

The Maximum of Power Spectral Density Measurement is 8dBm in any 3 kHz.

4.5.2 Test Setup

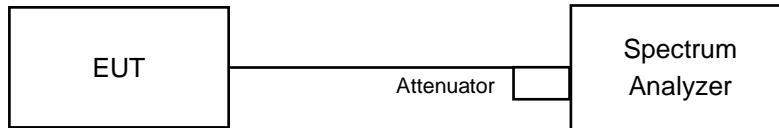

4.5.3 Test Instruments

Refer to section 4.1.2 to get information of above instrument.

4.5.4 Test Procedure

- a. Set analyzer center frequency to DTS channel center frequency.
- b. Set the span to 1.5 times the DTS bandwidth.
- c. Set the RBW to: $3 \text{ kHz} \leq \text{RBW} \leq 100 \text{ kHz}$.
- d. Set the VBW $\geq 3 \times \text{RBW}$.
- e. Detector = peak.
- f. Sweep time = auto couple.
- g. Trace mode = max hold.
- h. Allow trace to fully stabilize.
- i. Use the peak marker function to determine the maximum amplitude level within the RBW.

4.5.5 Deviation from Test Standard

No deviation.

4.5.6 EUT Operating Condition

Same as Item 4.3.6

4.5.7 Test Results

802.11b

Channel	Freq. (MHz)	PSD (dBm/3kHz)	Limit (dBm/3kHz)	Pass /Fail
1	2412	-2.24	8	Pass
6	2437	-0.96	8	Pass
11	2462	-1.29	8	Pass

802.11g

Channel	Freq. (MHz)	PSD (dBm/3kHz)	Limit (dBm/3kHz)	Pass /Fail
1	2412	-10.52	8	Pass
6	2437	-3.98	8	Pass
11	2462	-10.23	8	Pass

802.11n (HT20)

Channel	Freq. (MHz)	PSD (dBm/3kHz)	Limit (dBm/3kHz)	Pass /Fail
1	2412	-10.11	8	Pass
6	2437	-4.11	8	Pass
11	2462	-11.60	8	Pass

Spectrum Plot of Worst Value

802.11b / CH6

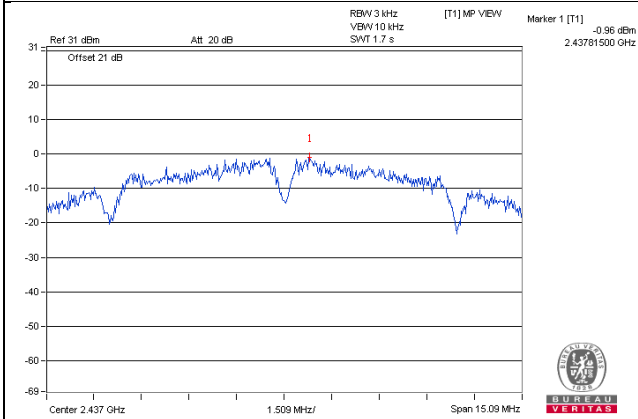

802.11g / CH6

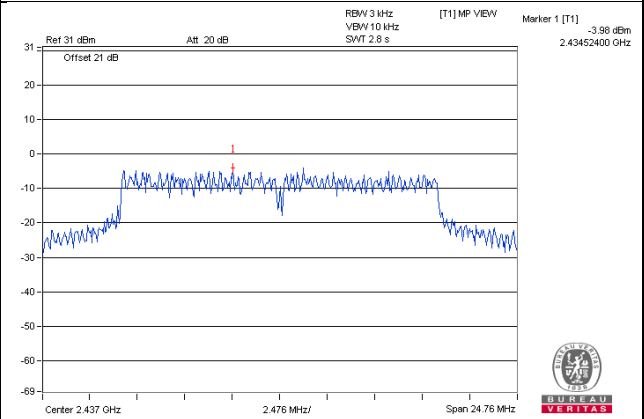

802.11n (HT20) / CH6

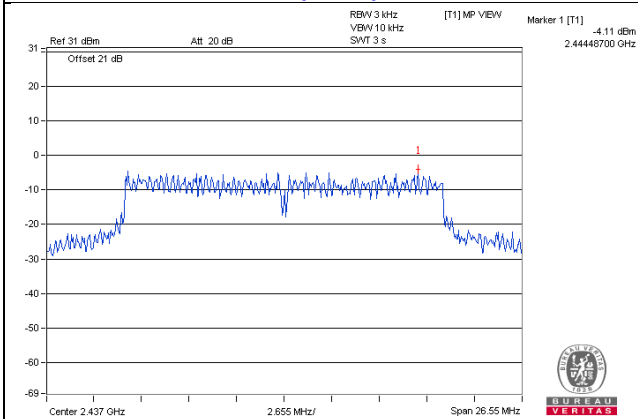

4.6 Conducted Out of Band Emission Measurement

4.6.1 Limits of Conducted Out of Band Emission Measurement

Below 20dB of the highest emission level of operating band (in 100kHz Resolution Bandwidth).

4.6.2 Test Setup

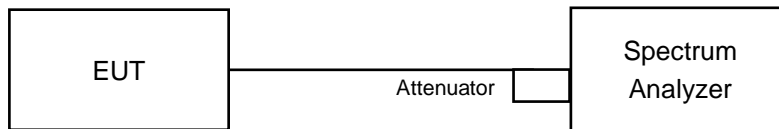

4.6.3 Test Instruments

Refer to section 4.1.2 to get information of above instrument.

4.6.4 Test Procedure

MEASUREMENT PROCEDURE REF

1. Set the RBW = 100 kHz.
2. Set the VBW \geq 300 kHz.
3. Detector = peak.
4. Sweep time = auto couple.
5. Trace mode = max hold.
6. Allow trace to fully stabilize.
7. Use the peak marker function to determine the maximum power level in any 100 kHz band segment within the fundamental EBW.

MEASUREMENT PROCEDURE OOB

1. Set RBW = 100 kHz.
2. Set VBW \geq 300 kHz.
3. Detector = peak.
4. Sweep = auto couple.
5. Trace Mode = max hold.
6. Allow trace to fully stabilize.
7. Use the peak marker function to determine the maximum amplitude level.

4.6.5 Deviation from Test Standard

No deviation.

4.6.6 EUT Operating Condition

Same as Item 4.3.6

4.6.7 Test Results

The spectrum plots are attached on the following pages. D1 line indicates the highest level, and D2 line indicates the 20dB offset below D1. It shows compliance with the requirement.

802.11b

CH 1

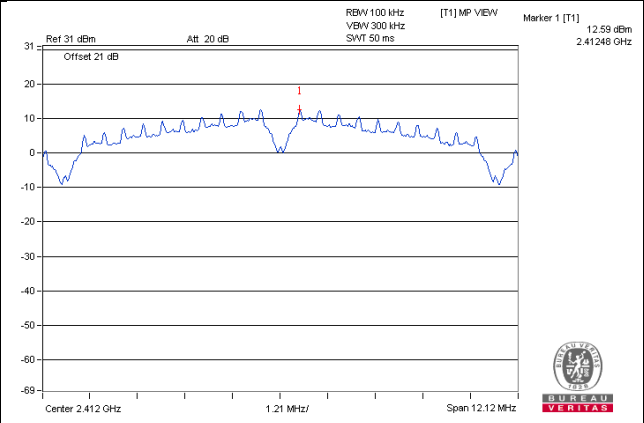
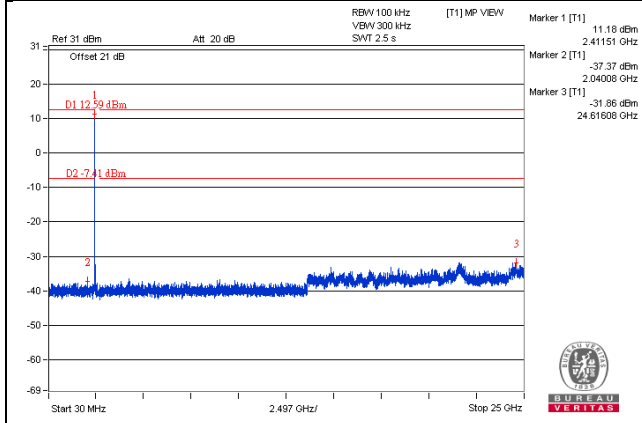

CH 6

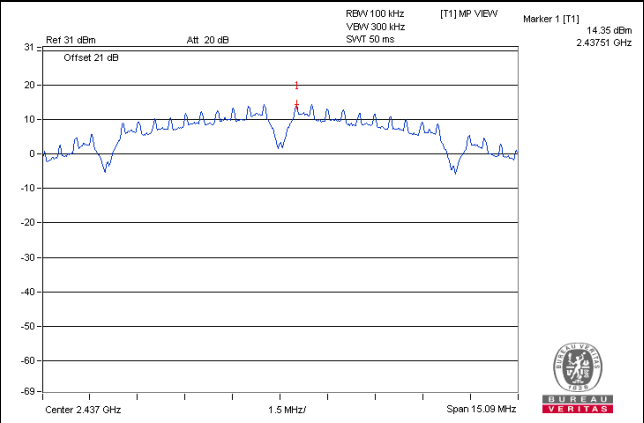
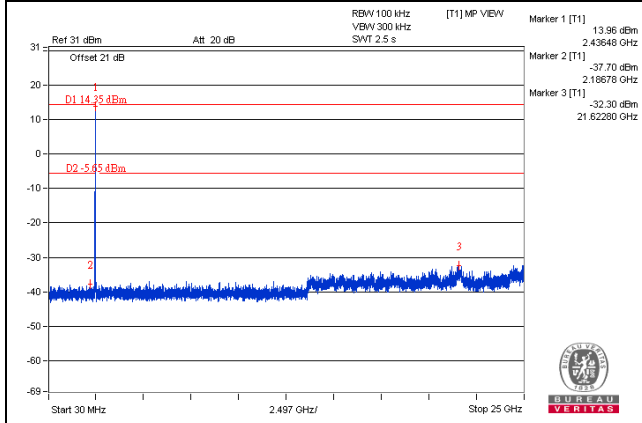

CH 11

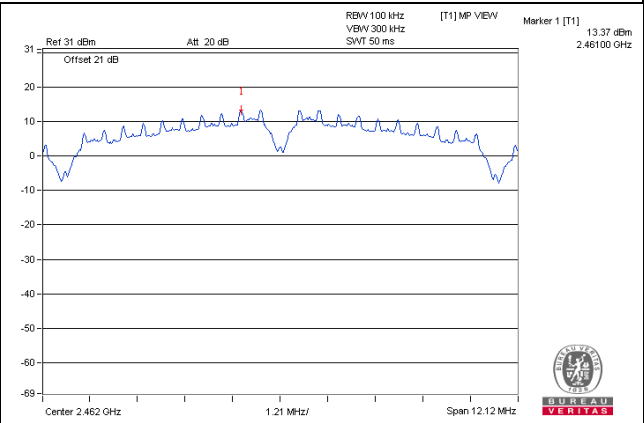
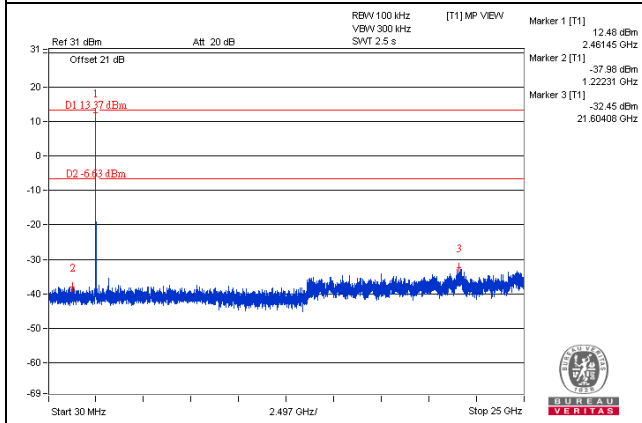

CH 1 Band edge

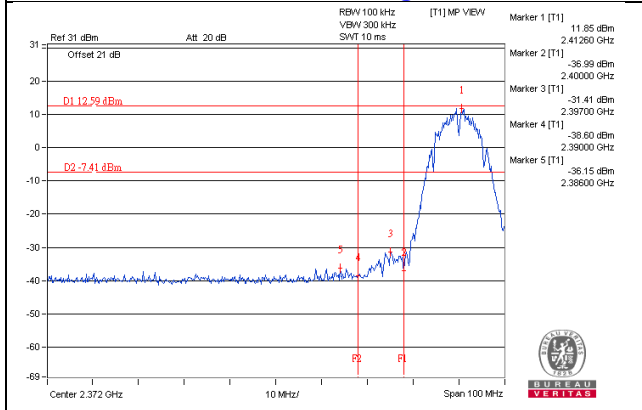

CH 11 Band edge

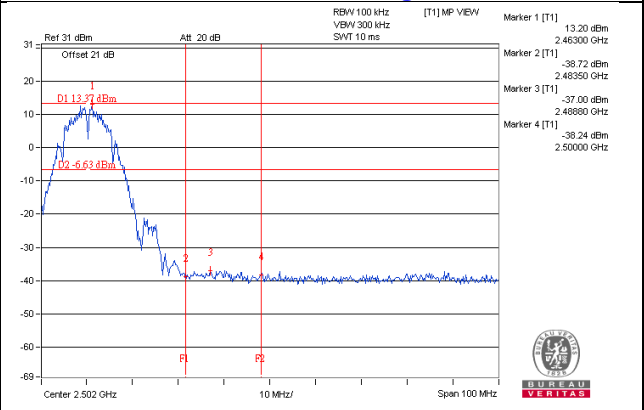

802.11g

CH 1

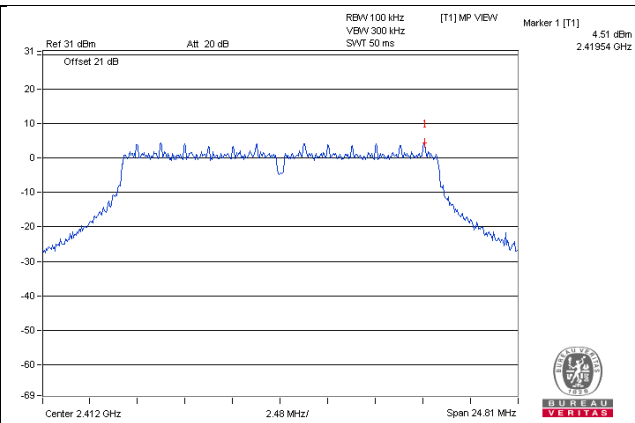
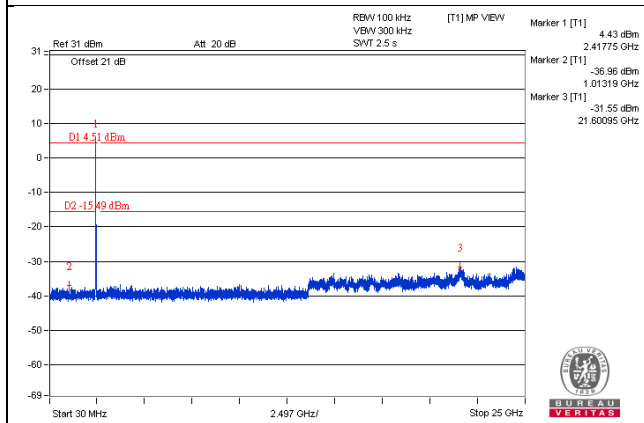

CH 6

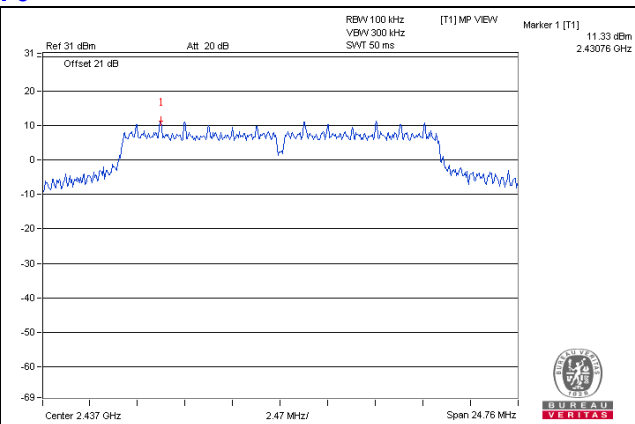
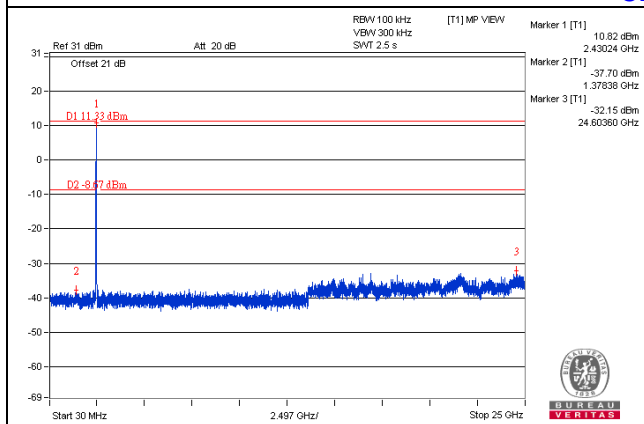

CH 11

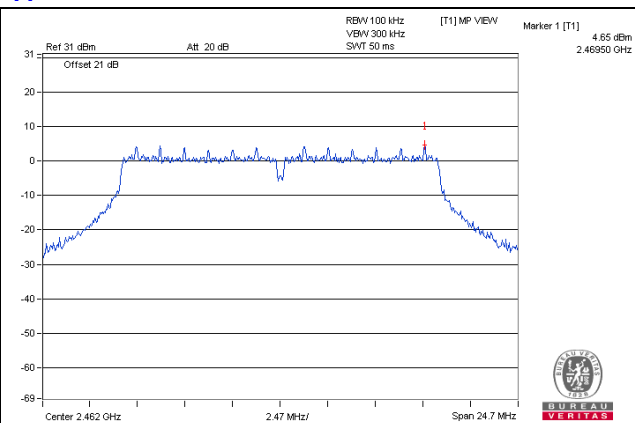
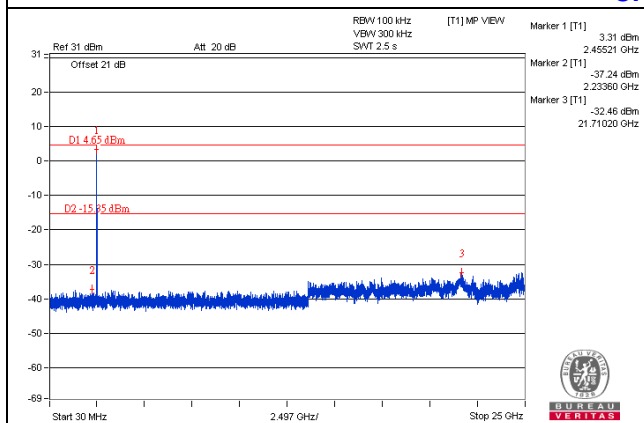

CH 1 Band edge

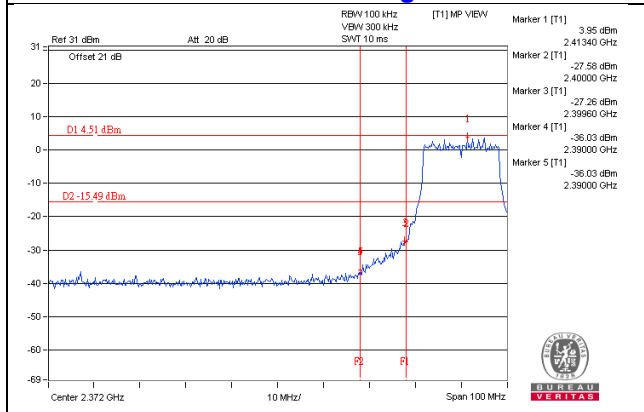

CH 11 Band edge

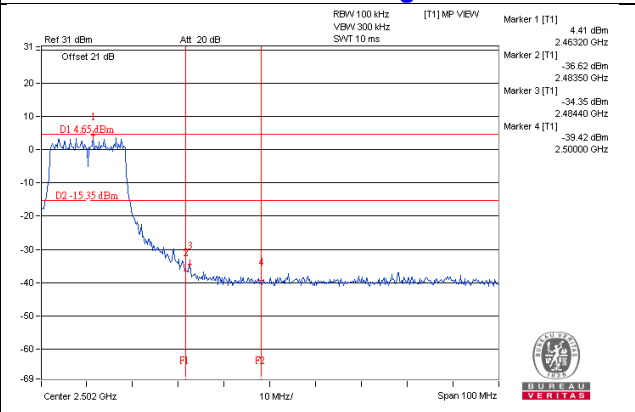

802.11n (HT20)

CH 1

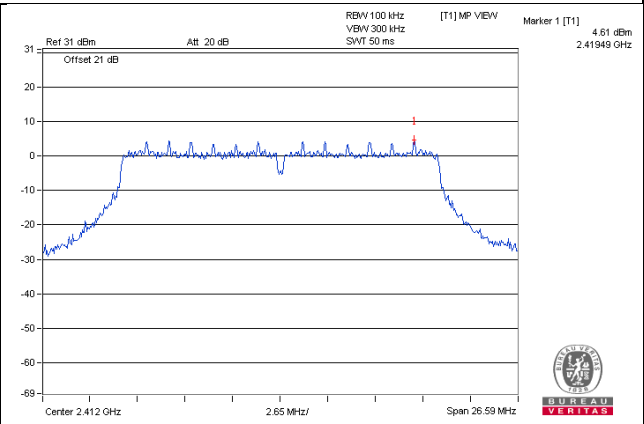
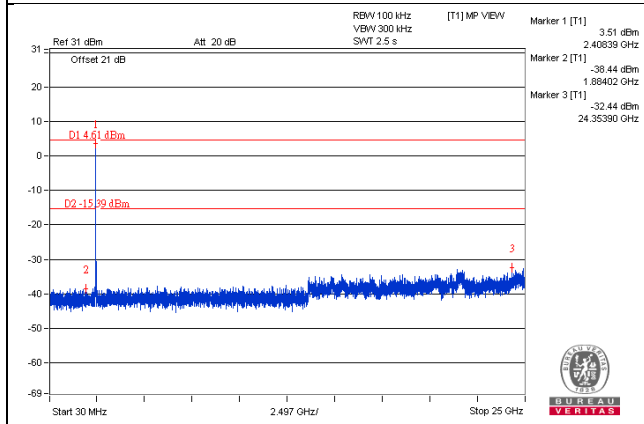

CH 6

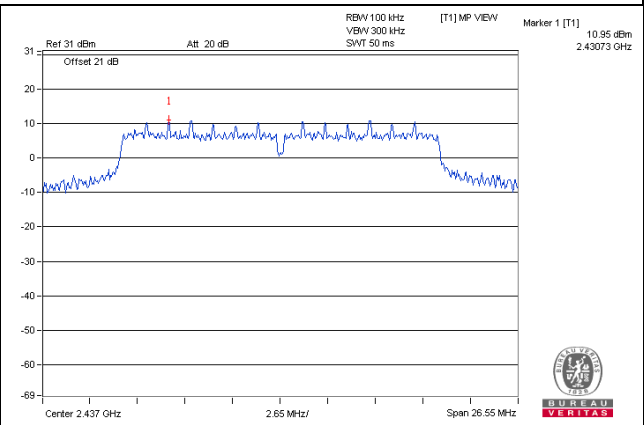
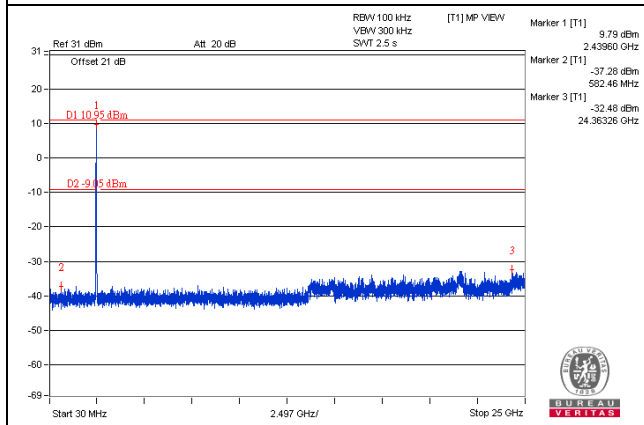

CH 11

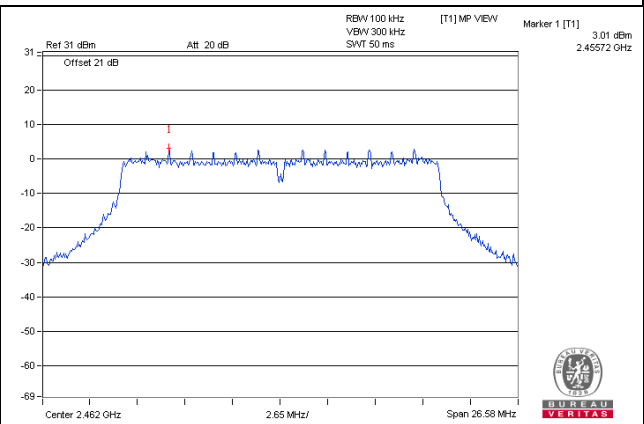
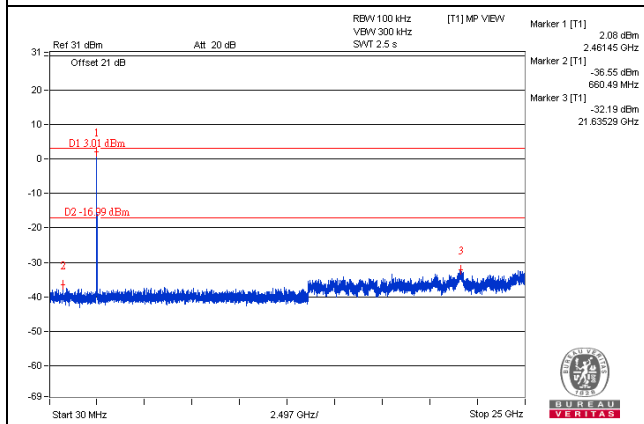

CH 1 Band edge

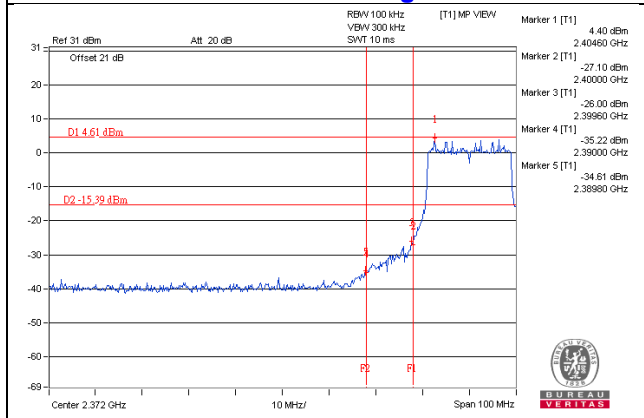

CH 11 Band edge

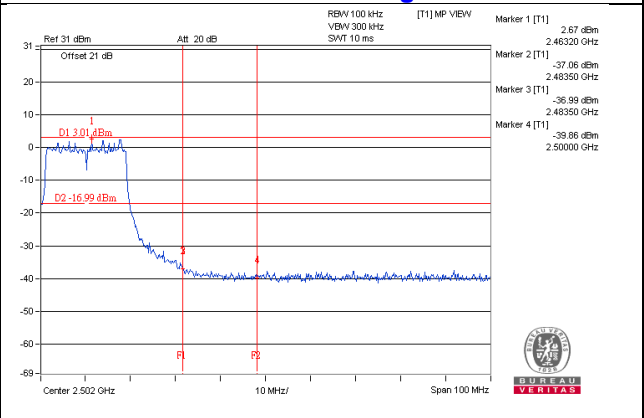

5 Pictures of Test Arrangements

Please refer to the attached file (Test Setup Photo).

Appendix – Information on the Testing Laboratories

We, Bureau Veritas Consumer Products Services (H.K.) Ltd., Taoyuan Branch, were founded in 1988 to provide our best service in EMC, Radio, Telecom and Safety consultation. Our laboratories are FCC recognized accredited test firms and accredited according to ISO/IEC 17025.

If you have any comments, please feel free to contact us at the following:

Linko EMC/RF Lab

Tel: 886-2-26052180

Fax: 886-2-26051924

Hsin Chu EMC/RF/Telecom Lab

Tel: 886-3-6668565

Fax: 886-3-6668323

Hwa Ya EMC/RF/Safety Lab

Tel: 886-3-3183232

Fax: 886-3-3270892

Email: service.adt@tw.bureauveritas.com

Web Site: www.bureauveritas-adt.com

The address and road map of all our labs can be found in our web site also.

--- END ---