

FCC Test Report

(PART 22)

Report No.: RF170515E06

FCC ID: PY317200381

Test Model: NM8207

Received Date: May 16, 2017

Test Date: May 24 to June 08, 2017

Issued Date: June 22, 2017

Applicant: NETGEAR, INC.

Address: 350 East Plumeria Drive San Jose, CA 95134

Issued By: Bureau Veritas Consumer Products Services (H.K.) Ltd., Taoyuan Branch
Hsin Chu Laboratory

Lab Address: E-2, No.1, Li Hsin 1st Road, Hsinchu Science Park, Hsinchu City 300,
Taiwan R.O.C.

Test Location (1): E-2, No.1, Li Hsin 1st Road, Hsinchu Science Park, Hsinchu City 300,
Taiwan R.O.C.

Test Location (2): No. 49, Ln. 206, Wende Rd., Shangshan Tsuen, Chiung Lin Hsiang, Hsin
Chu Hsien 307, Taiwan R.O.C.



This report is for your exclusive use. Any copying or replication of this report to or for any other person or entity, or use of our name or trademark, is permitted only with our prior written permission. This report sets forth our findings solely with respect to the test samples identified herein. The results set forth in this report are not indicative or representative of the quality or characteristics of the lot from which a test sample was taken or any similar or identical product unless specifically and expressly noted. Our report includes all of the tests requested by you and the results thereof based upon the information that you provided to us. You have 60 days from date of issuance of this report to notify us of any material error or omission caused by our negligence, provided, however, that such notice shall be in writing and shall specifically address the issue you wish to raise. A failure to raise such issue within the prescribed time shall constitute your unqualified acceptance of the completeness of this report, the tests conducted and the correctness of the report contents. Unless specific mention, the uncertainty of measurement has been explicitly taken into account to declare the compliance or non-compliance to the specification. The report must not be used by the client to claim product certification, approval, or endorsement by TAF or any government agencies. The report must not be used by the client to claim product certification, approval, or endorsement by TAF or any government agencies.

Table of Contents

Release Control Record	3
1 Certificate of Conformity	4
2 Summary of Test Results	5
2.1 Measurement Uncertainty	5
2.2 Test Site and Instruments	6
3 General Information	8
3.1 General Description of EUT	8
3.2 Configuration of System under Test	9
3.2.1 Description of Support Units	10
3.3 Test Mode Applicability and Tested Channel Detail	11
3.4 EUT Operating Conditions	12
3.5 General Description of Applied Standards	13
4 Test Types and Results	14
4.1 Output Power Measurement	14
4.1.1 Limits of Output Power Measurement	14
4.1.2 Test Procedures	14
4.1.3 Test Setup	14
4.1.4 Test Results	15
4.2 Frequency Stability Measurement	17
4.2.1 Limits of Frequency Stability Measurement	17
4.2.2 Test Procedure	17
4.2.3 Test Setup	17
4.2.4 Test Results	18
4.3 Occupied Bandwidth Measurement	19
4.3.1 Test Procedure	19
4.3.2 Test Setup	19
4.3.3 Test Result (-26dB Bandwidth)	20
4.3.4 Test Result (Occupied Bandwidth)	21
4.4 Band Edge Measurement	22
4.4.1 Limits of Band Edge Measurement	22
4.4.2 Test Setup	22
4.4.3 Test Procedures	22
4.4.4 Test Results	23
4.5 Peak to Average Ratio	24
4.5.1 Limits of Peak to Average Ratio Measurement	24
4.5.2 Test Setup	24
4.5.3 Test Procedures	24
4.5.4 Test Results	25
4.6 Conducted Spurious Emissions	26
4.6.1 Limits of Conducted Spurious Emissions Measurement	26
4.6.2 Test Setup	26
4.6.3 Test Procedure	26
4.6.4 Test Results	27
4.7 Radiated Emission Measurement	30
4.7.1 Limits of Radiated Emission Measurement	30
4.7.2 Test Procedure	30
4.7.3 Deviation from Test Standard	30
4.7.4 Test Setup	31
4.7.5 Test Results	32
5 Pictures of Test Arrangements	38
Appendix – Information on the Testing Laboratories	39

Release Control Record

Issue No.	Description	Date Issued
RF170515E06	Original release.	June 22, 2017

1 Certificate of Conformity

Product: WWAN module
Brand: Netgear
Test Model: NM8207
Sample Status: ENGINEERING SAMPLE
Applicant: NETGEAR, INC.
Test Date: May 24 to June 08, 2017
Standards: FCC Part 22

The above equipment has been tested by **Bureau Veritas Consumer Products Services (H.K.) Ltd., Taoyuan Branch**, and found compliance with the requirement of the above standards. The test record, data evaluation & Equipment Under Test (EUT) configurations represented herein are true and accurate accounts of the measurements of the sample's EMC characteristics under the conditions specified in this report.

Prepared by :  _____, **Date:** June 22, 2017
Claire Kuan / Specialist

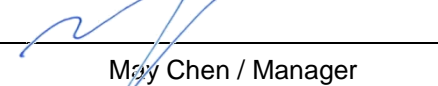
Approved by :  _____, **Date:** June 22, 2017
May Chen / Manager

2 Summary of Test Results

Applied Standard: FCC Part 22 & Part 2			
FCC Clause	Test Item	Result	Remarks
2.1046 22.913 (a)	Effective radiated power	PASS	Meet the requirement of limit.
---	Peak To Average Ratio	PASS	Meet the requirement of limit.
2.1055 22.355	Frequency Stability	PASS	Meet the requirement of limit.
2.1049	Occupied Bandwidth	PASS	Meet the requirement of limit.
22.917	Band Edge Measurements	PASS	Meet the requirement of limit.
2.1051 22.917	Conducted Spurious Emissions	PASS	Meet the requirement of limit.
2.1053 22.917	Radiated Spurious Emissions	PASS	Meet the requirement of limit. Minimum passing margin is -27.72dB at 8364MHz.

2.1 Measurement Uncertainty

Where relevant, the following measurement uncertainty levels have been estimated for tests performed on the EUT as specified in CISPR 16-4-2:

Measurement	Frequency	Expanded Uncertainty (k=2) (\pm)
Radiated Emissions up to 1 GHz	30MHz ~ 1GHz	5.32 dB
Radiated Emissions above 1 GHz	1GHz ~ 6GHz	5.14 dB
	6GHz ~ 18GHz	5.04 dB
	18GHz ~ 40GHz	5.25 dB

2.2 Test Site and Instruments

For radiated spurious emissions

DESCRIPTION & MANUFACTURER	MODEL NO.	SERIAL NO.	CALIBRATED DATE	CALIBRATED UNTIL
Test Receiver Agilent	N9038A	MY50010156	Aug. 18, 2016	Aug. 17, 2017
Pre-Amplifier ^(*) EMCI	EMC001340	980142	Jan. 20, 2016	Jan. 19, 2018
Loop Antenna ^(*) Electro-Metrics	EM-6879	264	Dec. 16, 2016	Dec. 15, 2018
RF Cable	NA	LOOPCAB-001 LOOPCAB-002	Jan. 17, 2017	Jan. 16, 2018
Pre-Amplifier Mini-Circuits	ZFL-1000VH2B	AMP-ZFL-05	May 06, 2017	May 05, 2018
Trilog Broadband Antenna SCHWARZBECK	VULB 9168	9168-361	Dec. 29, 2016	Dec. 28, 2017
RF Cable	8D	966-3-1 966-3-2 966-3-3	Apr. 01, 2017	Mar. 31, 2018
Fixed attenuator Mini-Circuits	UNAT-5+	PAD-3m-3-01	Oct. 05, 2016	Oct. 04, 2017
Horn_Antenna SCHWARZBECK	BBHA9120-D	9120D-406	Dec. 28, 2016	Dec. 27, 2017
Pre-Amplifier EMCI	EMC12630SE	980384	Feb. 02, 2017	Feb. 01, 2018
RF Cable	EMC104-SM-SM-1200 EMC104-SM-SM-2000 EMC104-SM-SM-5000	160922 150317 150322	Feb. 02, 2017 Mar. 29, 2017 Mar. 29, 2017	Feb. 01, 2018 Mar. 28, 2018 Mar. 28, 2018
Spectrum Analyzer Keysight	N9030A	MY54490520	July 29, 2016	July 28, 2017
Pre-Amplifier EMCI	EMC184045SE	980386	Feb. 02, 2017	Feb. 01, 2018
Horn_Antenna SCHWARZBECK	BBHA 9170	BBHA9170608	Dec. 15, 2016	Dec. 14, 2017
RF Cable	SUCOFLEX 102	36432/2 36433/2	Jan. 15, 2017	Jan. 14, 2018
Software	ADT_Radiated_V8.7.08	NA	NA	NA
Antenna Tower & Turn Table Max-Full	MF-7802	MF780208406	NA	NA
Boresight Antenna Fixture	FBA-01	FBA-SIP01	NA	NA

Note:

1. The calibration interval of the above test instruments is 12 months and the calibrations are traceable to NML/ROC and NIST/USA.
2. *The calibration interval of the above test instruments is 24 months and the calibrations are traceable to NML/ROC and NIST/USA.
3. The test was performed in 966 Chamber No. 3.
4. The FCC Site Registration No. is 147459
5. The CANADA Site Registration No. is 20331-1
6. Tested Date: June 04 to 06, 2017

For other test items:

DESCRIPTION & MANUFACTURER	MODEL NO.	SERIAL NO.	CALIBRATED DATE	CALIBRATED UNTIL
Spectrum Analyzer R&S	FSV40	100964	June 28, 2016	June 27, 2017
Spectrum Analyzer Keysight	N9030A	MY54490570	July 06, 2016	July 05, 2017
AC Power Source Extech Electronics	6502	1140503	NA	NA
Temperature & Humidity Chamber TERCHY	MHU-225AU	911033	Dec. 02, 2016	Dec. 01, 2017
DC Power Supply GOOD WILL INSTRUMENT CO., LTD.	GPC - 3030D	7700087	NA	NA
ESG Vector signal generator Agilent	E4438C	Y45094468/00 5 506 602 UK6 UNJ	Nov. 25, 2016	Nov. 24, 2017
Power meter Anritsu	ML2495A	1014008	May 11, 2017	May 10, 2018
Power sensor Anritsu	MA2411B	0917122	May 11, 2017	May 10, 2018
Software	ADT_RF Test Software V6.6.5.4	NA	NA	NA
Digital Multimeter FLUKE	87III	73680266	Nov. 10, 2016	Nov. 09, 2017
Band Reject Filter	WRCGV824/849-810/8 63-60/8SS	4	June 22, 2016	June 21, 2017
Band Reject Filter	WRCGV1710/1785-16 90/1805-60/12SS	SN6	May 11, 2017	May 10, 2018

- NOTE:**
1. The test was performed in Oven room 1.
 2. The calibration interval of the above test instruments is 12 months and the calibrations are traceable to NML/ROC and NIST/USA.
 3. Tested Date: May 24 to June 08, 2017

3 General Information

3.1 General Description of EUT

Product	WWAN module	
Brand	Netgear	
Test Model	NM8207	
Status of EUT	ENGINEERING SAMPLE	
Power Supply Rating	3.3Vdc from host equipment	
Modulation Type	GPRS, EDGE	GMSK
	WCDMA, HSDPA, HSUPA	8PSK
Operating Frequency	GPRS, EDGE	824.2MHz ~848.8MHz
	WCDMA, HSDPA, HSUPA	826.4MHz ~846.6MHz
Max. ERP Power	GPRS	2208.00mW
	EDGE	2187.76mW
	WCDMA	207.49mW
Emission Designator	GPRS	246KGXW
	EDGE	248KG7W
	WCDMA	4M16F9W
Antenna Type	Refer to Note	
Antenna Connector	Refer to Note	
Accessory Device	NA	
Data Cable Supplied	NA	

Note:

1. The antennas provided to the EUT, please refer to the following table:

Antenna	Antenna Gain(dBi)	Frequency range (MHz to MHz)	Antenna Type	Connector Type
1	3.4	824 to 849	PIFA	I-PEX MHF IV
	4.39	880 to 915		
2	2.62	1850 to 1915	PIFA	I-PEX MHF IV
	4.25	1710 to 1785		
	3.82	1920 to 1980		

2. The above EUT information is declared by manufacturer and for more detailed features description, please refer to the manufacturer's specifications or User's Manual.

3.2 Configuration of System under Test

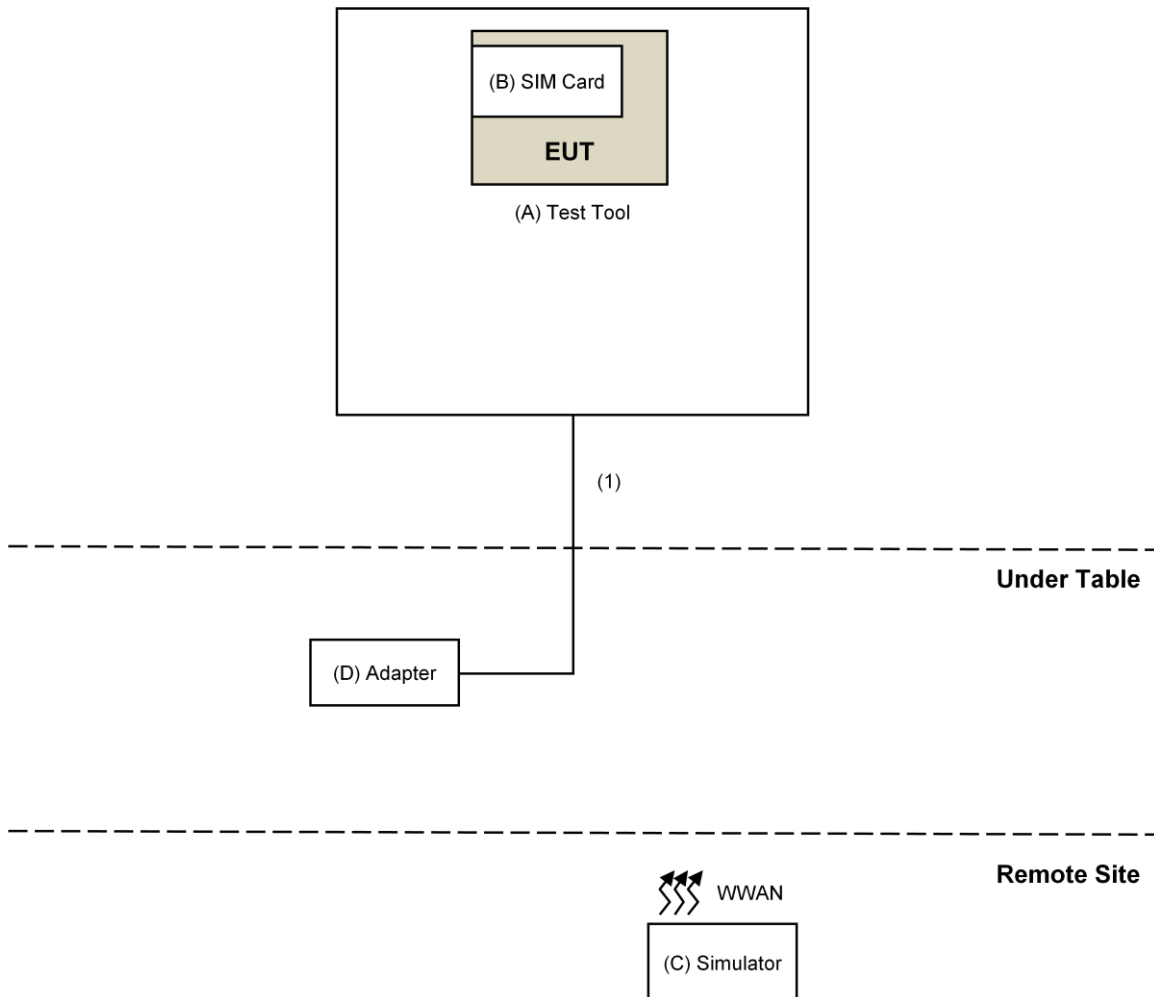

3.2.1 Description of Support Units

The EUT has been tested as an independent unit together with other necessary accessories or support units. The following support units or accessories were used to form a representative test configuration during the tests.

ID	Product	Brand	Model No.	Serial No.	FCC ID	Remarks
A.	Test Tool	WNC	NA	NA	NA	Supplied by client
B.	SIM Card	R&S	CMW-Z05	NA	NA	Provided by Lab
C.	Simulator	R&S	CMU200	121040	NA	Provided by Lab
D.	Adapter	NA	SAL012F1 NA	NA	NA	Provided by Lab

Note:

1. All power cords of the above support units are non-shielded (1.8m).

ID	Descriptions	Qty.	Length (m)	Shielding (Yes/No)	Cores (Qty.)	Remarks
1.	DC Cable	1	1.8	No	0	Provided by Lab

3.3 Test Mode Applicability and Tested Channel Detail

Pre-Scan has been conducted to determine the worst-case mode from all possible combinations between available modulations, data rates, XYZ axis and antenna ports

The worst case was found when positioned on X-plane. Following channel(s) was (were) selected for the final test as listed below:

GSM850 MODE

Test Item	Available Channel	Tested Channel	Mode
ERP	128 to 251	128, 189, 251	GPRS, EDGE
Frequency Stability	128 to 251	189	GPRS, EDGE
Occupied Bandwidth	128 to 251	128, 189, 251	GPRS, EDGE
Peak to Average Ratio	128 to 251	128, 189, 251	GPRS, EDGE
Band Edge	128 to 251	128, 251	GPRS, EDGE
Conducted Emission	128 to 251	189	GPRS, EDGE
Radiated Emission Below 1GHz	128 to 251	189	GPRS, EDGE
Radiated Emission Above 1GHz	128 to 251	189	GPRS, EDGE

WCDMA V MODE

Test Item	Available Channel	Tested Channel	Mode
ERP	4132 to 4233	4132, 4182, 4233	WCDMA
Frequency Stability	4132 to 4233	4182	WCDMA
Occupied Bandwidth	4132 to 4233	4132, 4182, 4233	WCDMA
Peak to Average Ratio	4132 to 4233	4132, 4182, 4233	WCDMA
Band Edge	4132 to 4233	4132, 4233	WCDMA
Conducted Emission	4132 to 4233	4182	WCDMA
Radiated Emission Below 1GHz	4132 to 4233	4182	WCDMA
Radiated Emission Above 1GHz	4132 to 4233	4182	WCDMA

Test Condition:

Test Item	Environmental Conditions	Input Power (System)	Tested By
ERP	25deg. C, 63%RH	120Vac, 60Hz	Robert Cheng
Frequency Stability	25deg. C, 63%RH	120Vac, 60Hz	Robert Cheng
Occupied Bandwidth	25deg. C, 63%RH	120Vac, 60Hz	Robert Cheng
Band Edge	25deg. C, 63%RH	120Vac, 60Hz	Robert Cheng
Peak to Average Ratio	25deg. C, 63%RH	120Vac, 60Hz	Robert Cheng
Conducuted Emission	25deg. C, 63%RH	120Vac, 60Hz	Robert Cheng
Radiated Emission Below 1GHz	25deg. C, 63%RH	120Vac, 60Hz	Andy Ho
Radiated Emission Above 1GHz	25deg. C, 63%RH	120Vac, 60Hz	Andy Ho

3.4 EUT Operating Conditions

The communication simulator station system controlled a EUT to export maximum output power under transmission mode and specific channel frequency

3.5 General Description of Applied Standards

The EUT is a RF Product. According to the specifications of the manufacturer, it must comply with the requirements of the following standards:

FCC 47 CFR Part 2

FCC 47 CFR Part 22

KDB 971168 D01 Power Meas License Digital Systems v02r02

ANSI/TIA/EIA-603-D 2010

NOTE: All test items have been performed and recorded as per the above standards.

4 Test Types and Results

4.1 Output Power Measurement

4.1.1 Limits of Output Power Measurement

Mobile / Portable station are limited to 7 watts e.r.p.

4.1.2 Test Procedures

Conducted Power Measurement:

The EUT was set up for the maximum power with GPRS, EDGE, &WCDMA link data modulation and link up with simulator. Set the EUT to transmit under low, middle and high channel and record the power level shown on simulator.

ERP / EIRP Measurement:

- a. $EIRP = \text{Conducted Power} + \text{Antenna gain of substitution antenna.}$
- b. ERP power can be calculated form EIRP power by subtracting the gain of dipole, $ERP \text{ power} = EIPR \text{ power} - 2.15\text{dBi.}$

4.1.3 Test Setup

CONDUCTED POWER MEASUREMENT:

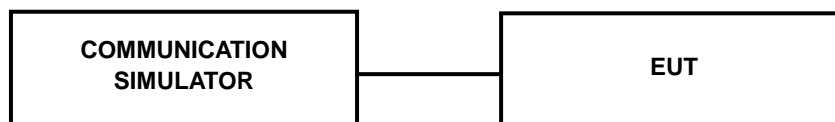

4.1.4 Test Results

CONDUCTED OUTPUT POWER (dBm)

Band	GSM850		
Channel	128	189	251
Frequency (MHz)	824.2	836.6	848.8
GSM	32.15	32.07	32.19
GPRS 8	32.14	32.05	32.17
GPRS 10	32.13	32.04	32.16
GPRS 11	32.13	32.04	32.16
GPRS 12	32.12	32.03	32.15
EDGE 8 (MCS9)	32.12	32.03	32.15
EDGE 10 (MCS9)	32.11	32.02	32.14
EDGE 11 (MCS9)	32.10	32.01	32.11
EDGE 12 (MCS9)	32.08	32.00	32.10

Band	WCDMA V		
Channel	4132	4182	4233
Frequency (MHz)	826.4	836.6	846.6
RMC	21.45	21.57	21.92
HSDPA Subtest-1	21.42	21.54	21.88
HSDPA Subtest-2	21.41	21.52	21.85
HSDPA Subtest-3	21.39	21.48	21.80
HSDPA Subtest-4	21.37	21.46	21.76
HSUPA Subtest-1	21.36	21.42	21.75
HSUPA Subtest-2	21.32	21.39	21.70
HSUPA Subtest-3	21.30	21.34	21.65
HSUPA Subtest-4	21.29	21.33	21.61
HSUPA Subtest-5	21.28	21.32	21.59

ERP POWER (dBm)

GPRS

Channel	Frequency (MHz)	Conducted average power (dBm)	Gain (dBi)	ERP(dBm)	ERP(mW)
128	824.2	32.15	3.40	33.40	2187.76
189	836.6	32.07	3.40	33.32	2147.83
251	848.8	32.19	3.40	33.44	2208.00

EDGE

Channel	Frequency (MHz)	Conducted average power (dBm)	Gain (dBi)	ERP(dBm)	ERP(mW)
128	824.2	32.12	3.40	33.37	2172.70
189	836.6	32.03	3.40	33.28	2128.14
251	848.8	32.15	3.40	33.40	2187.76

WCDMA

Channel	Frequency (MHz)	Conducted average power (dBm)	Gain (dBi)	ERP(dBm)	ERP(mW)
4132	826.4	21.45	3.40	22.70	186.21
4182	836.6	21.57	3.40	22.82	191.43
4233	846.6	21.92	3.40	23.17	207.49

4.2 Frequency Stability Measurement

4.2.1 Limits of Frequency Stability Measurement

1.5 ppm is for base and fixed station. 2.5 ppm is for mobile station.

4.2.2 Test Procedure

- Device is placed at the oven room. The oven room could control the temperatures and humidity. Power warm up is at least 15 min and power applied should perform before recording frequency error.
- EUT is connected the external power supply to control the DC input power. The test voltage range is from minimum to maximum working voltage. Each step shall be record the frequency error rate.
- The temperature range step is 10 degrees in this test items. All temperature levels shall be hold the ± 0.5 °C during the measurement testing. The each temperature step shall be at least 0.5 hours, consider the EUT could be test under the stability condition.

NOTE: The frequency error was recorded frequency error from the communication simulator.

4.2.3 Test Setup

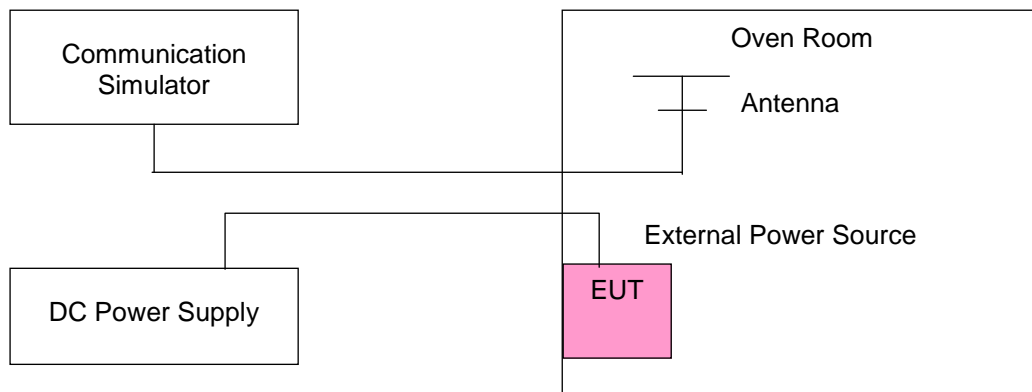

4.2.4 Test Results

Frequency Error vs. Voltage

Voltage (Volts)	Frequency Error (ppm)			Limit (ppm)
	GPRS	EDGE	WCDMA	
2.97	0.014	0.012	0.008	2.5
3.63	0.017	0.013	0.007	2.5

Frequency Error vs. Temperature.

TEMP. (°C)	Frequency Error (ppm)			Limit (ppm)
	GPRS	EDGE	WCDMA	
75	0.041	0.027	0.029	2.5
70	0.042	0.025	0.026	2.5
60	0.038	0.023	0.022	2.5
50	0.032	0.019	0.019	2.5
40	0.027	0.017	0.012	2.5
30	0.026	0.013	0.017	2.5
20	0.025	0.011	0.011	2.5
10	0.027	0.012	0.012	2.5
0	0.029	0.016	0.017	2.5
-10	0.029	0.017	0.017	2.5
-20	0.036	0.018	0.018	2.5
-30	0.035	0.019	0.020	2.5

4.3 Occupied Bandwidth Measurement

4.3.1 Test Procedure

All measurements were done at low, middle and high operational frequency range. The communication simulator station system controlled a EUT to export maximum output power under transmission mode and specific channel frequency. Use OBW measurement function of Spectrum analyzer to measure 99 % occupied bandwidth.

4.3.2 Test Setup

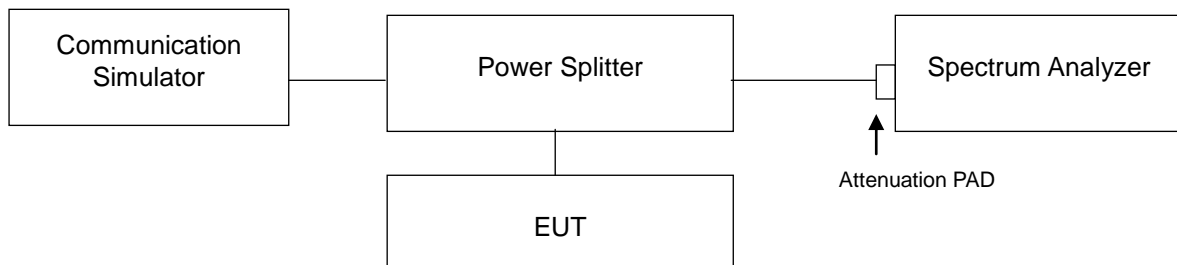

4.3.3 Test Result (-26dB Bandwidth)

Channel	Frequency (MHz)	-26dB Bandwidth (kHz)		Channel	FREQ. (MHz)	-26dB Bandwidth (MHz)
		GPRS	EDGE			WCDMA
128	824.2	321	317	4132	826.4	4.69
189	836.4	319	315	4182	836.4	4.72
251	848.8	317	318	4233	846.6	4.73

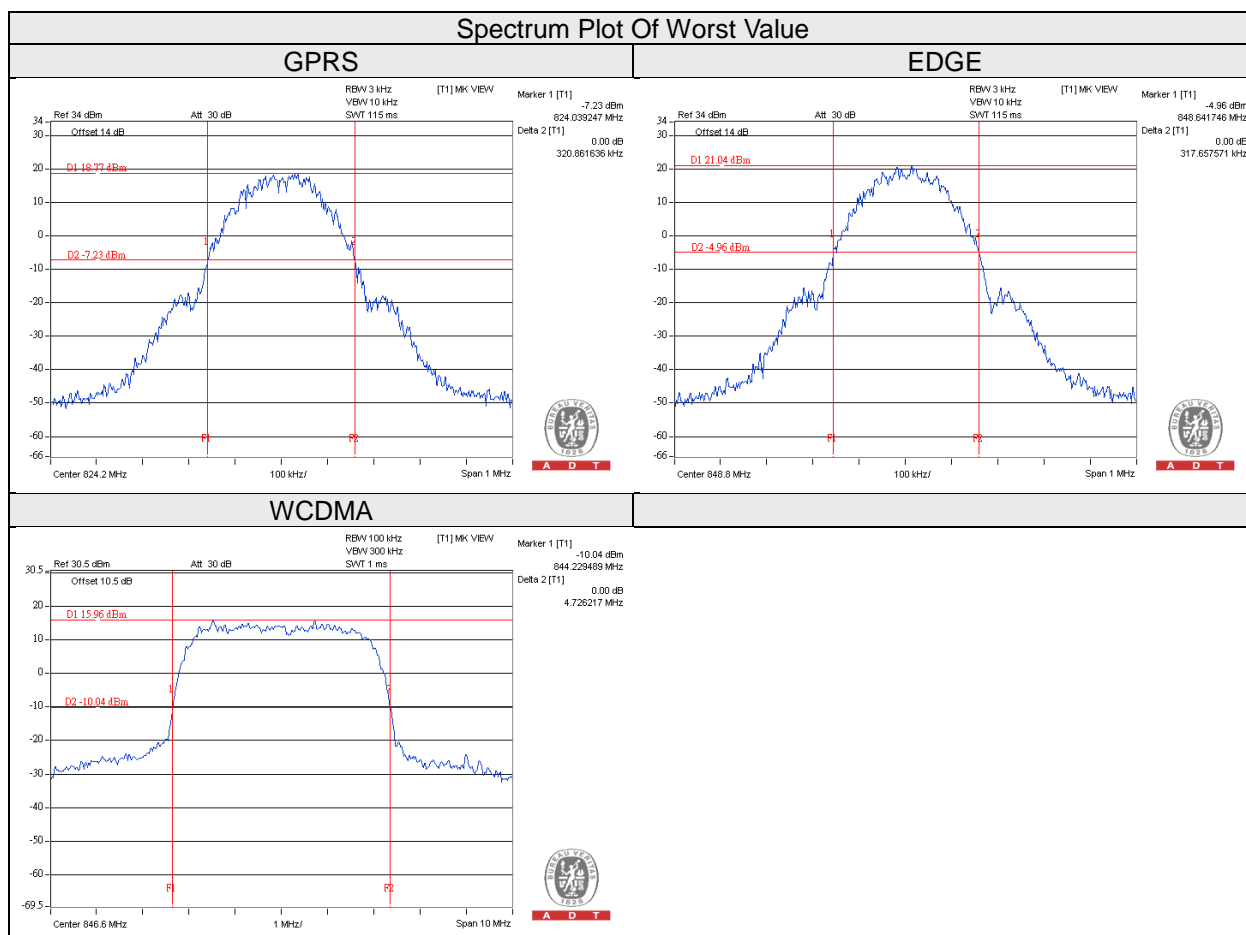

4.3.4 Test Result (Occupied Bandwidth)

Channel	Frequency (MHz)	99% Occupied Bandwidth (kHz)		Channel	FREQ. (MHz)	99% Occupied Bandwidth (MHz)
		GPRS	EDGE			WCDMA
128	824.2	246	244	4132	826.4	4.12
189	836.6	244	246	4182	836.6	4.14
251	848.8	244	248	4233	846.6	4.16

Spectrum Plot Of Worst Value

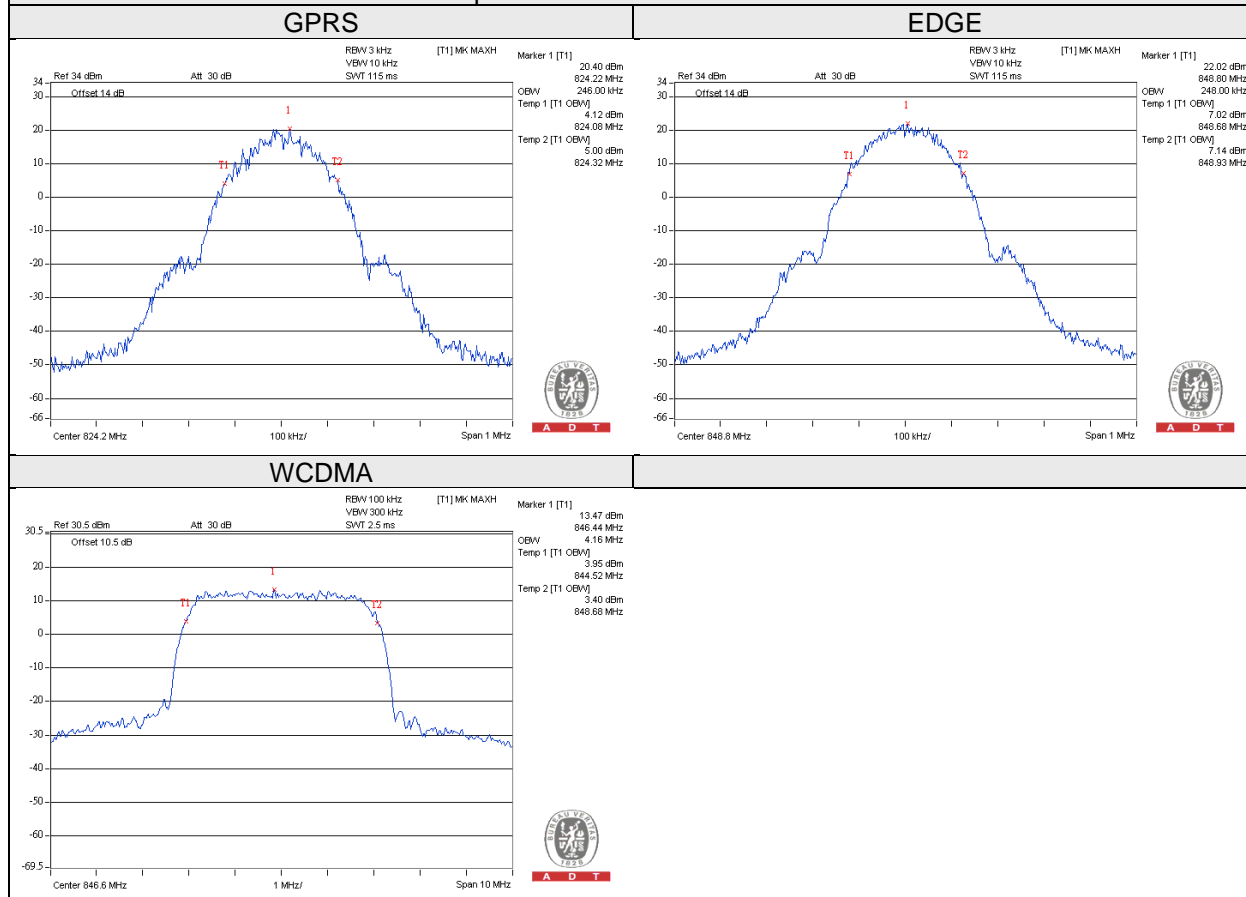

4.4 Band Edge Measurement

4.4.1 Limits of Band Edge Measurement

Power of any emission outside of the authorized operating frequency ranges must be attenuated below the transmitting power (P) by a factor of at least $43 + 10 \log(P)$ dB. In the 1 MHz bands immediately outside and adjacent to the frequency block a resolution bandwidth of at least one percent of the emission bandwidth of the fundamental emission of the transmitter may be employed.

4.4.2 Test Setup

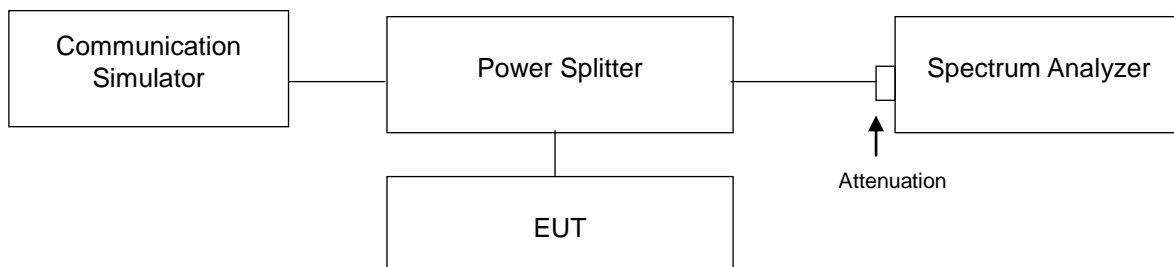

4.4.3 Test Procedures

- All measurements were done at low and high operational frequency range.
- The center frequency of spectrum is the band edge frequency and s RB of the spectrum is $>1\%$ EMISSION BANDWIDTH and VB of the spectrum is $\geq 3*RB$.
- Record the max trace plot into the test report.

4.4.4 Test Results

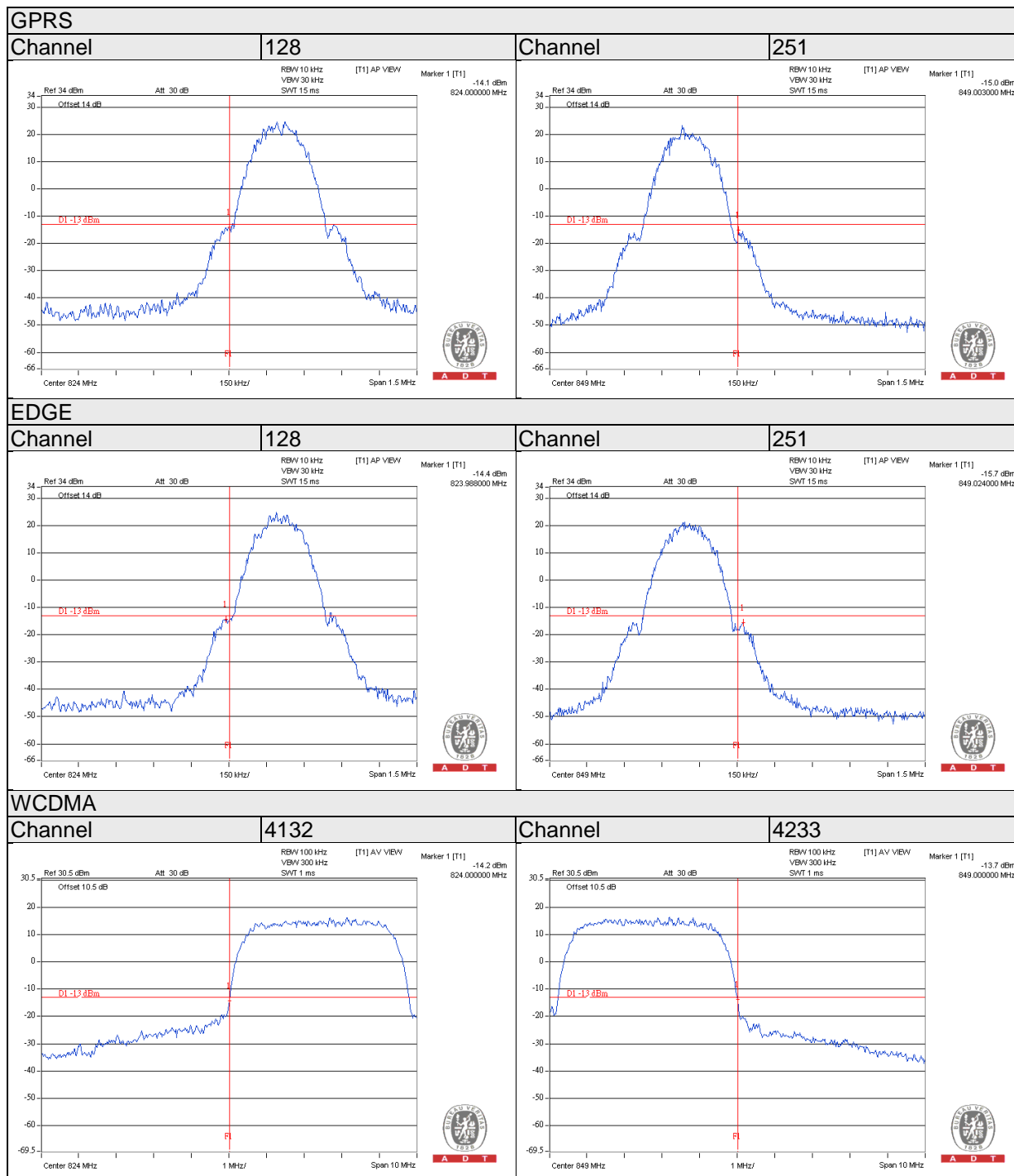

4.5 Peak to Average Ratio

4.5.1 Limits of Peak to Average Ratio Measurement

In measuring transmissions in this band using an average power technique, the peak to-average ratio (PAR) of the transmission may not exceed 13 dB

4.5.2 Test Setup

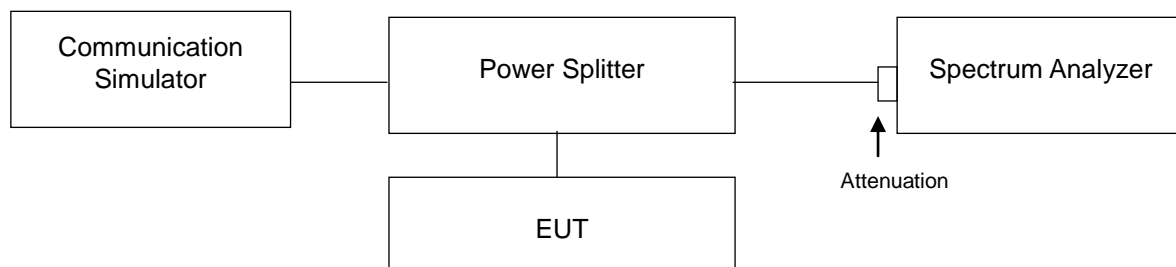

4.5.3 Test Procedures

1. Set resolution/measurement bandwidth \geq signal's occupied bandwidth;
2. Set the number of counts to a value that stabilizes the measured CCDF curve;
3. Record the maximum PAPR level associated with a probability of 0.1%.

4.5.4 Test Results

Channel	Frequency (MHz)	Peak to Average Ratio (dB)		Channel	Freq. (MHz)	Peak to Average Ratio (dB)
		GPRS	EDGE			
128	824.2	0.27	0.27	4132	826.4	3.67
190	836.6	0.27	0.26	4183	836.6	3.78
251	848.8	0.26	0.28	4233	846.6	3.78



4.6 Conducted Spurious Emissions

4.6.1 Limits of Conducted Spurious Emissions Measurement

The power of any emission outside of the authorized operating frequency ranges must be attenuated below the transmitting power (P) by a factor of at least $43 + 10 \log(P)$ dB. The emission limit equal to -13dBm .

4.6.2 Test Setup

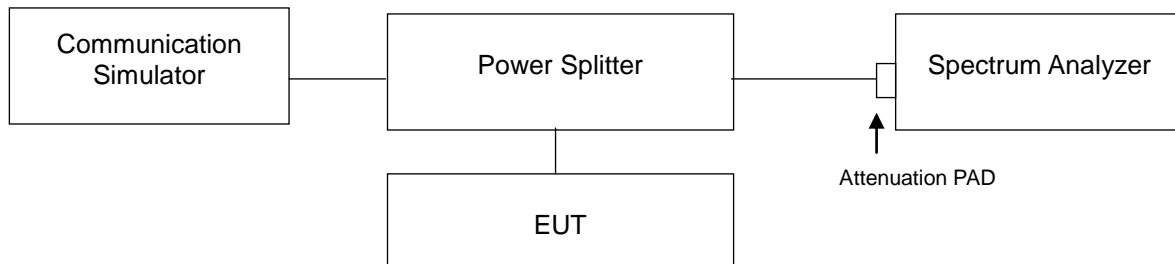

4.6.3 Test Procedure

- a. All measurements were done at middle operational frequency range.
- b. Measuring frequency range is from 9 kHz to 9GHz. RBW: 100 kHz and VBW=3*RBW is used for measurement.

4.6.4 Test Results

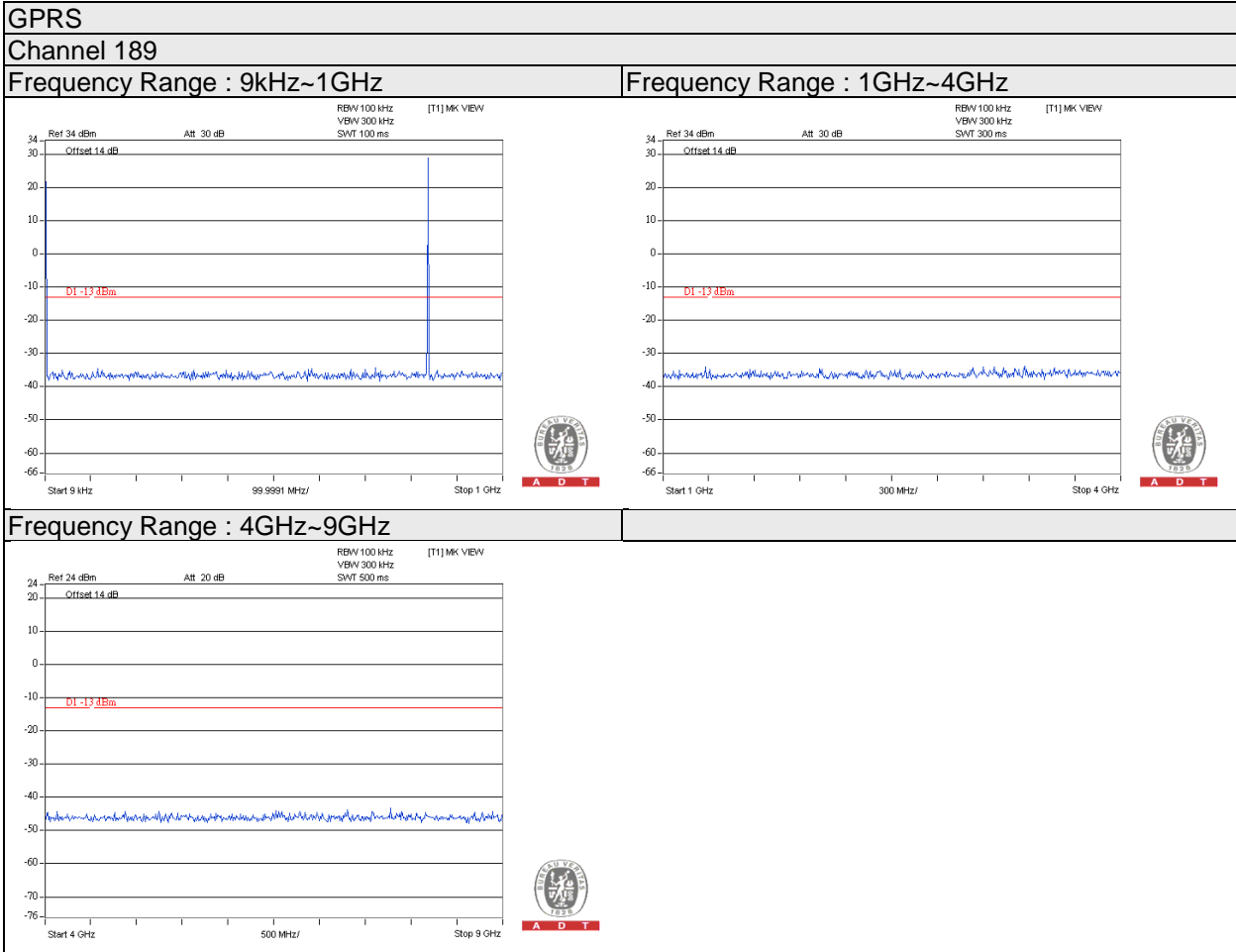

EDGE

Channel 189

Frequency Range : 9kHz~1GHz

Frequency Range : 1GHz~4GHz

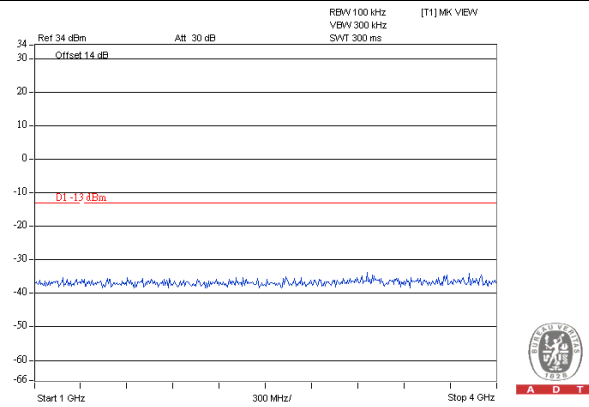
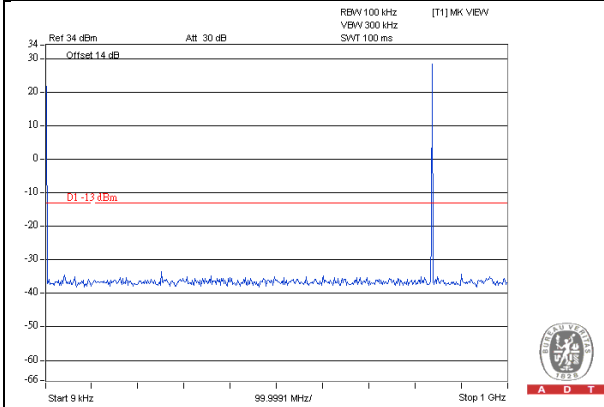

Frequency Range : 4GHz~9GHz

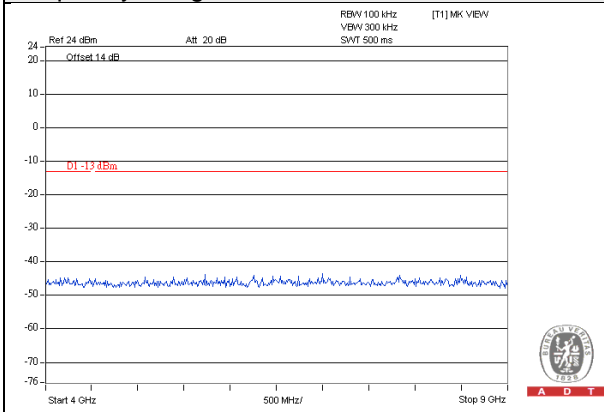

WCDMA
Channel 4181
Frequency Range : 9kHz~1GHz **Frequency Range : 1GHz~4GHz**

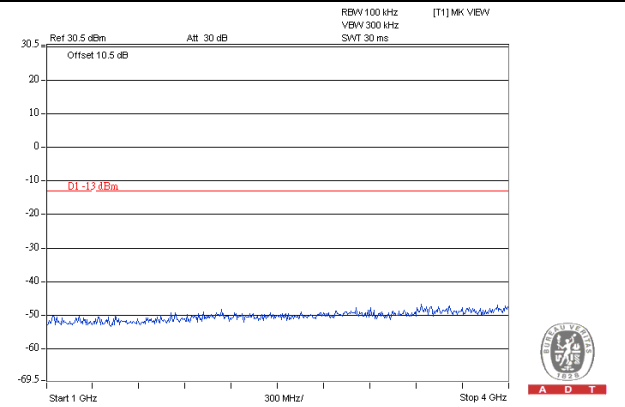
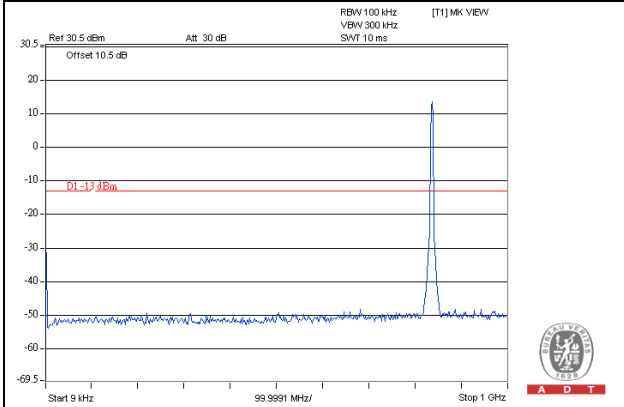

Frequency Range : 4GHz~9GHz

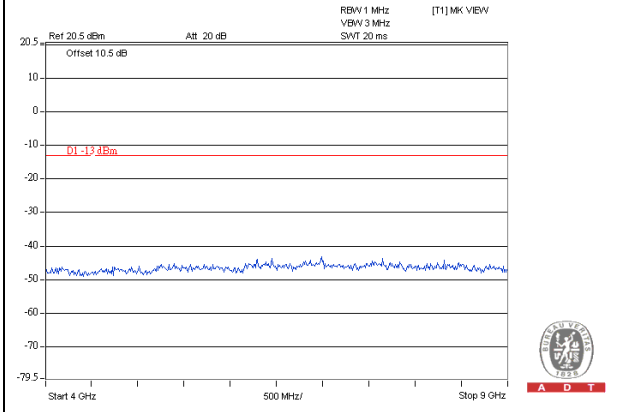

4.7 Radiated Emission Measurement

4.7.1 Limits of Radiated Emission Measurement

The power of any emission outside of the authorized operating frequency ranges must be attenuated below the transmitting power (P) by a factor of at least $43 + 10 \log(P)$ dB. The emission limit equal to -13dBm .

4.7.2 Test Procedure

- a. The power was measured with Spectrum Analyzer.
- b. Substitution method is used for EIRP measurement. In the semi-anechoic chamber, EUT placed on the 0.8m height of Turn Table, rotated the table around 360 degrees to search the maximum radiation power and receiver antenna shall be rotated vertical and horizontal polarization and moved height from 1m to 4m to find the maximum polar radiated power. The "Read Value" is the spectrum reading the maximum power value.
- c. The substitution antenna is substituted for EUT at the same position and signals generator export the CW signal to the substitution antenna via a TX cable. Rotated the Turn Table and moved receiving antenna to find the maximum radiation power. Adjust output power level of S.G to get a Value of spectrum reading equal to "Read Value " of step b. Record the power level of S.G
- d. $\text{EIRP} = \text{Output power level of S.G} - \text{TX cable loss} + \text{Antenna gain of substitution antenna}$.
- e. ERP power can be calculated form EIRP power by subtracting the gain of dipole, $\text{ERP power} = \text{EIRP power} - 2.15\text{dBi}$.

NOTE: The resolution bandwidth and video bandwidth of test receiver/spectrum analyzer is 100kHz/300kHz.

4.7.3 Deviation from Test Standard

No deviation.

**4.7.4 Test Setup
For Below 1GHz**

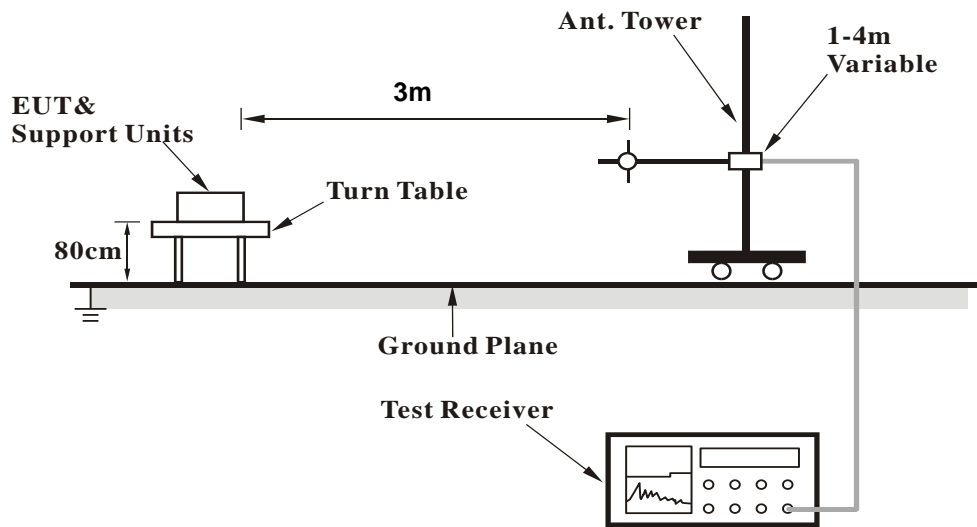

For Above 1GHz:

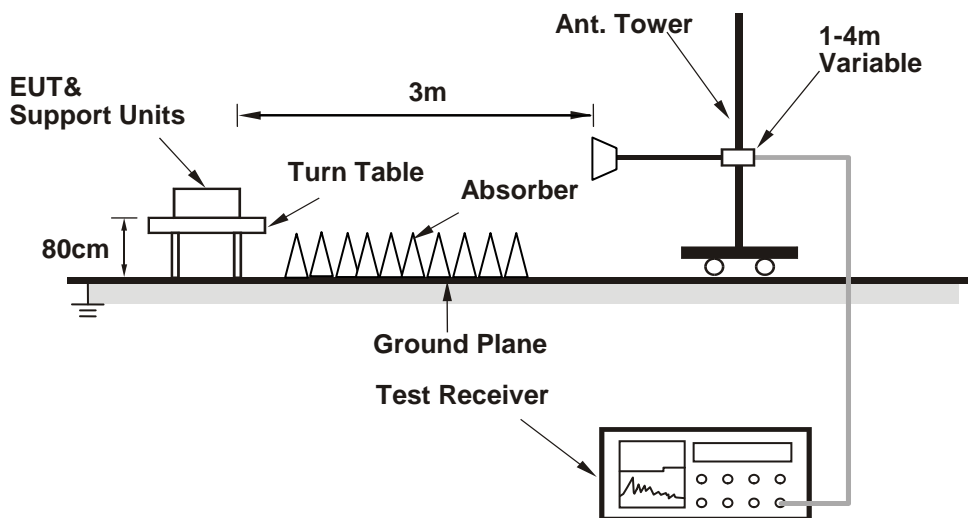

For the actual test configuration, please refer to the attached file (Test Setup Photo).

4.7.5 Test Results

BELOW 1GHz

GPRS:

Mode	TX channel 189	Frequency Range	Below 1000 MHz
------	----------------	-----------------	----------------

Antenna Polarity & Test Distance: Horizontal at 3 M

No.	Freq. (MHz)	Reading (dBm)	S.G Power Value (dBm)	Correction Factor (dB)	Emission Value (dBm)	Limit (dBm)	Margin (dB)
1	33.18	15.43	-56.98	-14.12	-71.11	-13	-58.11
2	109.86	28.33	-61.81	-0.90	-62.71	-13	-49.71
3	175.99	22.89	-70.56	1.75	-68.81	-13	-55.81
4	281.01	13.82	-81.17	3.76	-77.41	-13	-64.41
5	438.76	21.11	-77.76	2.79	-74.97	-13	-61.97
6	840.64	19.88	-74.01	1.13	-72.88	-13	-59.88

Antenna Polarity & Test Distance: Vertical at 3 M

No.	Freq. (MHz)	Reading (dBm)	S.G Power Value (dBm)	Correction Factor (dB)	Emission Value (dBm)	Limit (dBm)	Margin (dB)
1	103.56	23.72	-66.76	-0.73	-67.49	-13	-54.49
2	137.09	28.54	-66.23	-1.40	-67.63	-13	-54.63
3	349.16	23.07	-74.80	3.60	-71.20	-13	-58.20
4	441.33	23.18	-75.55	2.79	-72.76	-13	-59.76
5	840.21	20.39	-73.46	1.14	-72.33	-13	-59.33
6	983.39	23.63	-71.24	0.58	-70.66	-13	-57.66

Remarks:

1. Emission Value (dBm) = S.G Value (dBm) + Correction Factor (dB).
2. Correction Factor (dB) = Substitution Antenna Gain (dB) + Cable Loss (dB).

EDGE:

Mode	TX channel 189	Frequency Range	Below 1000 MHz
------	----------------	-----------------	----------------

Antenna Polarity & Test Distance: Horizontal at 3 M

No.	Freq. (MHz)	Reading (dBm)	S.G Power Value (dBm)	Correction Factor (dB)	Emission Value (dBm)	Limit (dBm)	Margin (dB)
1	33.1	21.67	-50.71	-14.14	-64.86	-13	-51.86
2	110.21	31.72	-55.75	-1.12	-56.87	-13	-43.87
3	177.93	24.75	-68.87	1.96	-66.91	-13	-53.91
4	279.88	17.77	-77.40	3.84	-73.56	-13	-60.56
5	439.74	24.21	-74.61	2.79	-71.82	-13	-58.82
6	840.89	24.63	-69.28	1.13	-68.15	-13	-55.15

Antenna Polarity & Test Distance: Vertical at 3 M

No.	Freq. (MHz)	Reading (dBm)	S.G Power Value (dBm)	Correction Factor (dB)	Emission Value (dBm)	Limit (dBm)	Margin (dB)
1	103.5	27.21	-63.27	-0.72	-64.00	-13	-51.00
2	139.06	32.55	-61.66	-1.34	-63.00	-13	-50.00
3	350.12	26.85	-71.01	3.59	-67.42	-13	-54.42
4	441.95	25.54	-73.16	2.79	-70.36	-13	-57.36
5	842.15	25.25	-68.76	1.12	-67.64	-13	-54.64
6	983.27	27.70	-67.16	0.58	-66.58	-13	-53.58

Remarks:

1. Emission Value (dBm) = S.G Value (dBm) + Correction Factor (dB).
2. Correction Factor (dB) = Substitution Antenna Gain (dB) + Cable Loss (dB).

WCDMA:

Mode	TX channel 4182	Frequency Range	Below 1000 MHz
------	-----------------	-----------------	----------------

Antenna Polarity & Test Distance: Horizontal at 3 M

No.	Freq. (MHz)	Reading (dBm)	S.G Power Value (dBm)	Correction Factor (dB)	Emission Value (dBm)	Limit (dBm)	Margin (dB)
1	35.27	26.40	-46.77	-13.61	-60.38	-13	-47.38
2	108.87	35.25	-54.95	-0.87	-55.82	-13	-42.82
3	179.15	30.50	-63.22	2.09	-61.13	-13	-48.13
4	279.33	22.83	-72.33	3.85	-68.48	-13	-55.48
5	439.34	27.87	-70.97	2.79	-68.18	-13	-55.18
6	839.69	30.39	-63.42	1.14	-62.28	-13	-49.28

Antenna Polarity & Test Distance: Vertical at 3 M

No.	Freq. (MHz)	Reading (dBm)	S.G Power Value (dBm)	Correction Factor (dB)	Emission Value (dBm)	Limit (dBm)	Margin (dB)
1	105.81	31.34	-59.02	-0.79	-59.81	-13	-46.81
2	139.99	35.69	-58.25	-1.31	-59.56	-13	-46.56
3	350.31	31.01	-66.85	3.59	-63.26	-13	-50.26
4	440.95	29.73	-69.02	2.79	-66.23	-13	-53.23
5	840.88	30.29	-63.62	1.13	-62.49	-13	-49.49
6	983.29	31.67	-63.19	0.58	-62.61	-13	-49.61

Remarks:

1. Emission Value (dBm) = S.G Value (dBm) + Correction Factor (dB).
2. Correction Factor (dB) = Substitution Antenna Gain (dB) + Cable Loss (dB).

ABOVE 1GHz

GPRS:

Mode	TX channel 189	Frequency Range	Above 1000MHz
------	----------------	-----------------	---------------

Antenna Polarity & Test Distance: Horizontal at 3 M

No.	Freq. (MHz)	Reading (dBm)	S.G Power Value (dBm)	Correction Factor (dB)	Emission Value (dBm)	Limit (dBm)	Margin (dB)
1	1672.8	44.31	-58.32	6.31	-52.01	-13	-39.01
2	2509.2	44.21	-54.31	6.66	-47.65	-13	-34.65
3	3345.6	48.27	-54.74	7.63	-47.11	-13	-34.11
4	4182	50.02	-54.82	7.44	-47.38	-13	-34.38
5	5018.4	48.94	-55.32	7.01	-48.31	-13	-35.31
6	5854.8	51.7	-52.68	6.87	-45.81	-13	-32.81
7	6691.2	55.12	-48.20	5.56	-42.64	-13	-29.64
8	7527.6	55.88	-46.74	4.52	-42.22	-13	-29.22
9	8364	56.26	-46.36	4.18	-42.18	-13	-29.18

Antenna Polarity & Test Distance: Vertical at 3 M

No.	Freq. (MHz)	Reading (dBm)	S.G Power Value (dBm)	Correction Factor (dB)	Emission Value (dBm)	Limit (dBm)	Margin (dB)
1	1672.8	44.56	-58.07	6.31	-51.76	-13	-38.76
2	2509.2	45.43	-53.09	6.66	-46.43	-13	-33.43
3	3345.6	44.36	-58.65	7.63	-51.02	-13	-38.02
4	4182	48.71	-56.13	7.44	-48.69	-13	-35.69
5	5018.4	48.89	-55.37	7.01	-48.36	-13	-35.36
6	5854.8	51.17	-53.21	6.87	-46.34	-13	-33.34
7	6691.2	55.58	-47.74	5.56	-42.18	-13	-29.18
8	7527.6	54.66	-47.96	4.52	-43.44	-13	-30.44
9	8364	57.72	-44.90	4.18	-40.72	-13	-27.72

Remarks:

1. Emission Value (dBm) = S.G Value (dBm) + Correction Factor (dB).
2. Correction Factor (dB) = Substitution Antenna Gain (dB) + Cable Loss (dB).

EDGE:

Mode	TX channel 189	Frequency Range	Above 1000MHz
------	----------------	-----------------	---------------

Antenna Polarity & Test Distance: Horizontal at 3 M

No.	Freq. (MHz)	Reading (dBm)	S.G Power Value (dBm)	Correction Factor (dB)	Emission Value (dBm)	Limit (dBm)	Margin (dB)
1	1672.8	44.10	-58.53	6.31	-52.22	-13	-39.22
2	2509.2	45.70	-52.82	6.66	-46.16	-13	-33.16
3	3345.6	47.20	-55.81	7.63	-48.18	-13	-35.18
4	4182	48.6	-56.24	7.44	-48.80	-13	-35.80
5	5018.4	49	-55.26	7.01	-48.25	-13	-35.25
6	5854.8	51.1	-53.28	6.87	-46.41	-13	-33.41
7	6691.2	56.1	-47.23	5.56	-41.67	-13	-28.67
8	7527.6	56.5	-46.12	4.52	-41.60	-13	-28.60
9	8364	57.3	-45.32	4.18	-41.14	-13	-28.14

Antenna Polarity & Test Distance: Vertical at 3 M

No.	Freq. (MHz)	Reading (dBm)	S.G Power Value (dBm)	Correction Factor (dB)	Emission Value (dBm)	Limit (dBm)	Margin (dB)
1	1672.8	43.8	-58.83	6.31	-52.52	-13	-39.52
2	2509.2	45.2	-53.32	6.66	-46.66	-13	-33.66
3	3345.6	46.4	-56.61	7.63	-48.98	-13	-35.98
4	4182	48.4	-56.44	7.44	-49.00	-13	-36.00
5	5018.4	48.9	-55.36	7.01	-48.35	-13	-35.35
6	5854.8	50.7	-53.68	6.87	-46.81	-13	-33.81
7	6691.2	55.4	-47.93	5.56	-42.37	-13	-29.37
8	7527.6	56.3	-46.32	4.52	-41.80	-13	-28.80
9	8364	56.9	-45.72	4.18	-41.54	-13	-28.54

Remarks:

1. Emission Value (dBm) = S.G Value (dBm) + Correction Factor (dB).
2. Correction Factor (dB) = Substitution Antenna Gain (dB) + Cable Loss (dB).

WCDMA:

Mode	TX channel 4182	Frequency Range	Above 1000MHz
------	-----------------	-----------------	---------------

Antenna Polarity & Test Distance: Horizontal at 3 M

No.	Freq. (MHz)	Reading (dBm)	S.G Power Value (dBm)	Correction Factor (dB)	Emission Value (dBm)	Limit (dBm)	Margin (dB)
1	1672.8	50.60	-52.03	6.31	-45.72	-13	-32.72
2	2509.2	39.40	-59.12	6.66	-52.46	-13	-39.46
3	3345.6	52.10	-50.91	7.63	-43.28	-13	-30.28
4	4182	42.7	-62.14	7.44	-54.70	-13	-41.70
5	5018.4	37.9	-66.36	7.01	-59.35	-13	-46.35
6	5854.8	39.2	-65.18	6.87	-58.31	-13	-45.31
7	6691.2	41.4	-61.92	5.56	-56.36	-13	-43.36
8	7527.6	43.4	-59.22	4.52	-54.70	-13	-41.70
9	8364	44.6	-58.02	4.18	-53.84	-13	-40.84

Antenna Polarity & Test Distance: Vertical at 3 M

No.	Freq. (MHz)	Reading (dBm)	S.G Power Value (dBm)	Correction Factor (dB)	Emission Value (dBm)	Limit (dBm)	Margin (dB)
1	1672.8	43.1	-59.53	6.31	-53.22	-13	-40.22
2	2509.2	37.4	-61.12	6.66	-54.46	-13	-41.46
3	3345.6	47.8	-55.21	7.63	-47.58	-13	-34.58
4	4182	38.3	-66.54	7.44	-59.10	-13	-46.10
5	5018.4	35.2	-69.06	7.01	-62.05	-13	-49.05
6	5854.8	38.1	-66.28	6.87	-59.41	-13	-46.41
7	6691.2	40.2	-63.12	5.56	-57.56	-13	-44.56
8	7527.6	42.6	-60.02	4.52	-55.50	-13	-42.50
9	8364	42.8	-59.82	4.18	-55.64	-13	-42.64

Remarks:

1. Emission Value (dBm) = S.G Value (dBm) + Correction Factor (dB).
2. Correction Factor (dB) = Substitution Antenna Gain (dB) + Cable Loss (dB).

5 Pictures of Test Arrangements

Please refer to the attached file (Test Setup Photo).

Appendix – Information on the Testing Laboratories

We, Bureau Veritas Consumer Products Services (H.K.) Ltd., Taoyuan Branch, were founded in 1988 to provide our best service in EMC, Radio, Telecom and Safety consultation. Our laboratories are accredited and approved according to ISO/IEC 17025.

If you have any comments, please feel free to contact us at the following:

Linko EMC/RF Lab

Tel: 886-2-26052180

Fax: 886-2-26051924

Hsin Chu EMC/RF/Telecom Lab

Tel: 886-3-6668565

Fax: 886-3-6668323

Hwa Ya EMC/RF/Safety Lab

Tel: 886-3-3183232

Fax: 886-3-3270892

Email: service.adt@tw.bureauveritas.com

Web Site: www.bureauveritas-adt.com

The address and road map of all our labs can be found in our web site also.

--- END ---