

FCC Test Report

Report No.: RF161125E01D

FCC ID: PY317100373

Test Model: EX7500

Received Date: Nov. 25, 2016

Test Date: Dec. 01 to 21, 2016

Issued Date: Sep. 08, 2017

Applicant: NETGEAR, Inc.

Address: 350 East Plumeria Drive San Jose, CA 95134

Issued By: Bureau Veritas Consumer Products Services (H.K.) Ltd., Taoyuan Branch
Hsin Chu Laboratory

Lab Address: E-2, No.1, Li Hsin 1st Road, Hsinchu Science Park, Hsinchu City 300,
Taiwan R.O.C.

Test Location : E-2, No.1, Li Hsin 1st Road, Hsinchu Science Park, Hsinchu City 300,
Taiwan R.O.C.

Test Location (2): No. 49, Ln. 206, Wende Rd., Shangshan Tsuen, Chiung Lin Hsiang, Hsin
Chu Hsien 307, Taiwan R.O.C.



This report is for your exclusive use. Any copying or replication of this report to or for any other person or entity, or use of our name or trademark, is permitted only with our prior written permission. This report sets forth our findings solely with respect to the test samples identified herein. The results set forth in this report are not indicative or representative of the quality or characteristics of the lot from which a test sample was taken or any similar or identical product unless specifically and expressly noted. Our report includes all of the tests requested by you and the results thereof based upon the information that you provided to us. You have 60 days from date of issuance of this report to notify us of any material error or omission caused by our negligence, provided, however, that such notice shall be in writing and shall specifically address the issue you wish to raise. A failure to raise such issue within the prescribed time shall constitute your unqualified acceptance of the completeness of this report, the tests conducted and the correctness of the report contents. Unless specific mention, the uncertainty of measurement has been explicitly taken into account to declare the compliance or non-compliance to the specification. The report must not be used by the client to claim product certification, approval, or endorsement by TAF or any government agencies.

Table of Contents

Release Control Record	4
1 Certificate of Conformity	5
2 Summary of Test Results	6
2.1 Measurement Uncertainty	6
2.2 Modification Record	6
3 General Information	7
3.1 General Description of EUT	7
3.2 Description of Test Modes	9
3.2.1 Test Mode Applicability and Tested Channel Detail	10
3.3 Duty Cycle of Test Signal	12
3.4 Description of Support Units	13
3.4.1 Configuration of System under Test	13
3.5 General Description of Applied Standards	14
4 Test Types and Results	15
4.1 Radiated Emission and Bandedge Measurement	15
4.1.1 Limits of Radiated Emission and Bandedge Measurement	15
4.1.2 Test Instruments	16
4.1.3 Test Procedures	17
4.1.4 Deviation from Test Standard	17
4.1.5 Test Setup	18
4.1.6 EUT Operating Conditions	19
4.1.7 Test Results	20
4.2 Conducted Emission Measurement	33
4.2.1 Limits of Conducted Emission Measurement	33
4.2.2 Test Instruments	33
4.2.3 Test Procedures	34
4.2.4 Deviation from Test Standard	34
4.2.5 Test Setup	34
4.2.6 EUT Operating Conditions	34
4.2.7 Test Results	35
4.3 6dB Bandwidth Measurement	37
4.3.1 Limits of 6dB Bandwidth Measurement	37
4.3.2 Test Setup	37
4.3.3 Test Instruments	37
4.3.4 Test Procedure	37
4.3.5 Deviation from Test Standard	37
4.3.6 EUT Operating Conditions	37
4.3.7 Test Result	38
4.4 Conducted Output Power Measurement	40
4.4.1 Limits of Conducted Output Power Measurement	40
4.4.2 Test Setup	40
4.4.3 Test Instruments	40
4.4.4 Test Procedures	40
4.4.5 Deviation from Test Standard	40
4.4.6 EUT Operating Conditions	40
4.4.7 Test Results	41
4.5 Power Spectral Density Measurement	43
4.5.1 Limits of Power Spectral Density Measurement	43
4.5.2 Test Setup	43
4.5.3 Test Instruments	43
4.5.4 Test Procedure	43
4.5.5 Deviation from Test Standard	43
4.5.6 EUT Operating Condition	43

4.5.7 Test Results	44
4.6 Conducted Out of Band Emission Measurement	47
4.6.1 Limits of Conducted Out of Band Emission Measurement.....	47
4.6.2 Test Setup.....	47
4.6.3 Test Instruments	47
4.6.4 Test Procedure	47
4.6.5 Deviation from Test Standard	47
4.6.6 EUT Operating Condition	47
4.6.7 Test Results	47
5 Pictures of Test Arrangements.....	56
Appendix – Information on the Testing Laboratories	57

Release Control Record

Issue No.	Description	Date Issued
RF161125E01D	Original release.	Sep. 08, 2017

1 Certificate of Conformity

Product: Nighthawk X4S AC2200 Tri-Band WiFi Range Extender

Brand: NETGEAR

Test Model: EX7500

Sample Status: ENGINEERING SAMPLE

Applicant: NETGEAR, Inc.

Test Date: Dec. 01 to 21, 2016

Standards: 47 CFR FCC Part 15, Subpart C (Section 15.247)
ANSI C63.10: 2013

The above equipment has been tested by **Bureau Veritas Consumer Products Services (H.K.) Ltd., Taoyuan Branch**, and found compliance with the requirement of the above standards. The test record, data evaluation & Equipment Under Test (EUT) configurations represented herein are true and accurate accounts of the measurements of the sample's EMC characteristics under the conditions specified in this report.

Prepared by :  _____, **Date:** _____ Sep. 08, 2017
Wendy Wu / Specialist

Approved by :  _____, **Date:** _____ Sep. 08, 2017
May Chen / Manager

2 Summary of Test Results

47 CFR FCC Part 15, Subpart C (SECTION 15.247)			
FCC Clause	Test Item	Result	Remarks
15.207	AC Power Conducted Emission	PASS	Meet the requirement of limit. Minimum passing margin is -17.08dB at 1.40625MHz.
15.205 / 15.209 / 15.247(d)	Radiated Emissions and Band Edge Measurement	PASS	Meet the requirement of limit. Minimum passing margin is -0.1dB at 2390.00MHz, 2483.50MHz.
15.247(d)	Antenna Port Emission	PASS	Meet the requirement of limit.
15.247(a)(2)	6dB bandwidth	PASS	Meet the requirement of limit.
15.247(b)	Conducted power	PASS	Meet the requirement of limit.
15.247(e)	Power Spectral Density	PASS	Meet the requirement of limit.
15.203	Antenna Requirement	PASS	No antenna connector is used.

2.1 Measurement Uncertainty

Where relevant, the following measurement uncertainty levels have been estimated for tests performed on the EUT as specified in CISPR 16-4-2:

Measurement	Frequency	Expanded Uncertainty (k=2) (\pm)
Conducted Emissions at mains ports	150kHz ~ 30MHz	1.83 dB
Radiated Emissions up to 1 GHz	30MHz ~ 1GHz	5.34 dB
Radiated Emissions above 1 GHz	1GHz ~ 6GHz	3.41 dB
	6GHz ~ 18GHz	3.49 dB
	18GHz ~ 40GHz	3.30 dB

2.2 Modification Record

There were no modifications required for compliance.

3 General Information

3.1 General Description of EUT

Product	Nighthawk X4S AC2200 Tri-Band WiFi Range Extender
Brand	NETGEAR
Test Model	EX7500
Status of EUT	ENGINEERING SAMPLE
Power Supply Rating	AC 100-240V, 60/50Hz, 0.2A
Modulation Type	CCK, DQPSK, DBPSK for DSSS 64QAM, 16QAM, QPSK, BPSK for OFDM 256QAM for OFDM in 11ac mode and VHT20/40 mode in 2.4GHz band
Modulation Technology	DSSS, OFDM
Transfer Rate	802.11b: up to 11Mbps 802.11a/g: up to 54Mbps 802.11n: up to 300Mbps 802.11ac: up to 866.7Mbps
Operating Frequency	2.4GHz: 2.412 ~ 2.462GHz 5GHz: 5.18 ~ 5.24GHz, 5.745 ~ 5.825GHz
Number of Channel	2.4GHz: 802.11b, 802.11g, 802.11n (HT20), VHT20: 11 802.11n (HT40), VHT40: 7 5GHz: 802.11a, 802.11n (HT20), 802.11ac (VHT20): 9 802.11n (HT40), 802.11ac (VHT40): 4 802.11ac (VHT80): 2
Output Power	2.4GHz: CDD Mode 798.221mW Beamforming Mode 775.412mW 5GHz: 5.18GHz ~ 5.24GHz: CDD Mode 291.67mW Beamforming Mode 309.071mW 5.745GHz ~ 5.825GHz: CDD Mode 567.608mW Beamforming Mode 566.416mW
Antenna Type	Refer to Note
Antenna Connector	Refer to Note
Accessory Device	NA
Data Cable Supplied	NA

Note:

- The EUT has two radio transceivers, radio 1 is WLAN technologies for dual band (2.4GHz & 5GHz-UNII-3) and radio 2 is WLAN technology for single band (5GHz-UNII-1).
- Simultaneously transmission condition.

Condition	Technology	
1	WLAN (Radio 1) (2.4GHz)+ (5GHz-UNII-3)	WLAN (Radio 2) (5GHz-UNII-1)

Note: The emission of the simultaneous operation has been evaluated and no non-compliance was found.

- The antennas provided to the EUT, please refer to the following table:

WLAN (Radio 1) Antenna			
Frequency range (GHz)	Directional Antenna Gain (dBi)	Antenna Type	Connector Type
2.4~2.4835	5.23	PIFA	NA
5.725~5.85	4.86		
WLAN (Radio 2) Antenna			
Frequency range (GHz)	Directional Antenna Gain (dBi)	Antenna Type	Connector Type
5.15~5.25	3.35	PIFA	NA

- The EUT incorporates a MIMO function.

2.4GHz Band			
MODULATION MODE	DATA RATE (MCS)	TX & RX CONFIGURATION	
802.11b	1 ~ 11Mbps	2TX	2RX
802.11g	6 ~ 54Mbps	2TX	2RX
802.11n (HT20)	MCS 0~7	2TX	2RX
	MCS 8~15	2TX	2RX
802.11n (HT40)	MCS 0~7	2TX	2RX
	MCS 8~15	2TX	2RX
VHT20	MCS0~8 Nss=1	2TX	2RX
	MCS0~8 Nss=2	2TX	2RX
VHT40	MCS0~9 Nss=1	2TX	2RX
	MCS0~9 Nss=2	2TX	2RX
5GHz Band			
MODULATION MODE	DATA RATE (MCS)	TX & RX CONFIGURATION	
802.11a	6 ~ 54Mbps	2TX	2RX
802.11n (HT20)	MCS 0~7	2TX	2RX
	MCS 8~15	2TX	2RX
802.11n (HT40)	MCS 0~7	2TX	2RX
	MCS 8~15	2TX	2RX
802.11ac (VHT20)	MCS0~8 Nss=1	2TX	2RX
	MCS0~8 Nss=2	2TX	2RX
802.11ac (VHT40)	MCS0~9 Nss=1	2TX	2RX
	MCS0~9 Nss=2	2TX	2RX
802.11ac (VHT80)	MCS0~9 Nss=1	2TX	2RX
	MCS0~9 Nss=2	2TX	2RX

Note:

- All of modulation mode support beamforming function except 802.11a/b/g modulation mode.
- The EUT support Beamforming and CDD mode, therefore both mode were investigated and the worst case scenario was identified. The worst case data were presented in test report.

- The above EUT information is declared by manufacturer and for more detailed features description, please refer to the manufacturer's specifications or user's manual.

3.2 Description of Test Modes

11 channels are provided for 802.11b, 802.11g and 802.11n (HT20), VHT20:

Channel	Frequency	Channel	Frequency
1	2412MHz	7	2442MHz
2	2417MHz	8	2447MHz
3	2422MHz	9	2452MHz
4	2427MHz	10	2457MHz
5	2432MHz	11	2462MHz
6	2437MHz		

7 channels are provided for 802.11n (HT40), VHT40:

Channel	Frequency	Channel	Frequency
3	2422MHz	7	2442MHz
4	2427MHz	8	2447MHz
5	2432MHz	9	2452MHz
6	2437MHz		

3.2.1 Test Mode Applicability and Tested Channel Detail

EUT CONFIGURE MODE	APPLICABLE TO				DESCRIPTION
	RE \geq 1G	RE<1G	PLC	APCM	
-	√	√	√	√	-

Where RE \geq 1G: Radiated Emission above 1GHz & Bandedge Measurement
 RE<1G: Radiated Emission below 1GHz
 PLC: Power Line Conducted Emission
 APCM: Antenna Port Conducted Measurement

NOTE: The EUT had been pre-tested on the positioned of each 3 axis. The worst case was found when positioned on **Y-plane**.

Radiated Emission Test (Above 1GHz):

- Pre-Scan has been conducted to determine the worst-case mode from all possible combinations between available modulations, data rates and antenna ports (if EUT with antenna diversity architecture).
- Following channel(s) was (were) selected for the final test as listed below.

CDD Mode					
MODE	AVAILABLE CHANNEL	TESTED CHANNEL	MODULATION TECHNOLOGY	MODULATION TYPE	DATA RATE (Mbps)
802.11b	1 to 11	1, 6, 11	DSSS	DBPSK	1
802.11g	1 to 11	1, 6, 11	OFDM	BPSK	6
Beamforming Mode					
MODE	AVAILABLE CHANNEL	TESTED CHANNEL	MODULATION TECHNOLOGY	MODULATION TYPE	DATA RATE (Mbps)
802.11n (HT20)	1 to 11	1, 6, 11	OFDM	BPSK	6.5
802.11n (HT40)	3 to 9	3, 6, 9	OFDM	BPSK	13.5

Radiated Emission Test (Below 1GHz):

- Pre-Scan has been conducted to determine the worst-case mode from all possible combinations between available modulations, data rates and antenna ports (if EUT with antenna diversity architecture).
- Following channel(s) was (were) selected for the final test as listed below.

CDD Mode					
MODE	AVAILABLE CHANNEL	TESTED CHANNEL	MODULATION TECHNOLOGY	MODULATION TYPE	DATA RATE (Mbps)
802.11g	1 to 11	6	OFDM	BPSK	6

Power Line Conducted Emission Test:

- Pre-Scan has been conducted to determine the worst-case mode from all possible combinations between available modulations, data rates and antenna ports (if EUT with antenna diversity architecture).
- Following channel(s) was (were) selected for the final test as listed below.

CDD Mode					
MODE	AVAILABLE CHANNEL	TESTED CHANNEL	MODULATION TECHNOLOGY	MODULATION TYPE	DATA RATE (Mbps)
802.11g	1 to 11	6	OFDM	BPSK	6

Antenna Port Conducted Measurement:

- This item includes all test value of each mode, but only includes spectrum plot of worst value of each mode.
- Pre-Scan has been conducted to determine the worst-case mode from all possible combinations between available modulations, data rates and antenna ports (if EUT with antenna diversity architecture).
- Following channel(s) was (were) selected for the final test as listed below.

CDD Mode					
MODE	AVAILABLE CHANNEL	TESTED CHANNEL	MODULATION TECHNOLOGY	MODULATION TYPE	DATA RATE (Mbps)
802.11b	1 to 11	1, 6, 11	DSSS	DBPSK	1
802.11g	1 to 11	1, 6, 11	OFDM	BPSK	6
Beamforming Mode					
MODE	AVAILABLE CHANNEL	TESTED CHANNEL	MODULATION TECHNOLOGY	MODULATION TYPE	DATA RATE (Mbps)
802.11n (HT20)	1 to 11	1, 6, 11	OFDM	BPSK	6.5
802.11n (HT40)	3 to 9	3, 6, 9	OFDM	BPSK	13.5

Test Condition:

APPLICABLE TO	ENVIRONMENTAL CONDITIONS	INPUT POWER	TESTED BY
RE \geq 1G	25deg. C, 71%RH	120Vac, 60Hz	Terry Huang
RE $<$ 1G	25deg. C, 68%RH	120Vac, 60Hz	Andy Ho
PLC	25deg. C, 75%RH	120Vac, 60Hz	Andy Ho
APCM	25deg. C, 60%RH	120Vac, 60Hz	Robert Cheng

3.3 Duty Cycle of Test Signal

If duty cycle of test signal is $\geq 98\%$, duty factor is not required.

If duty cycle of test signal is $< 98\%$, duty factor shall be considered.

802.11b: Duty cycle = $12.428/12.518 = 0.993$,

802.11g: Duty cycle = $2.113/2.155 = 0.981$

802.11n (HT20): Duty cycle = $4.997/5.09 = 0.982$

802.11n (HT40): Duty cycle = $2.425/2.529 = 0.959$, Duty factor = $10 * \log(1/0.959) = 0.19$

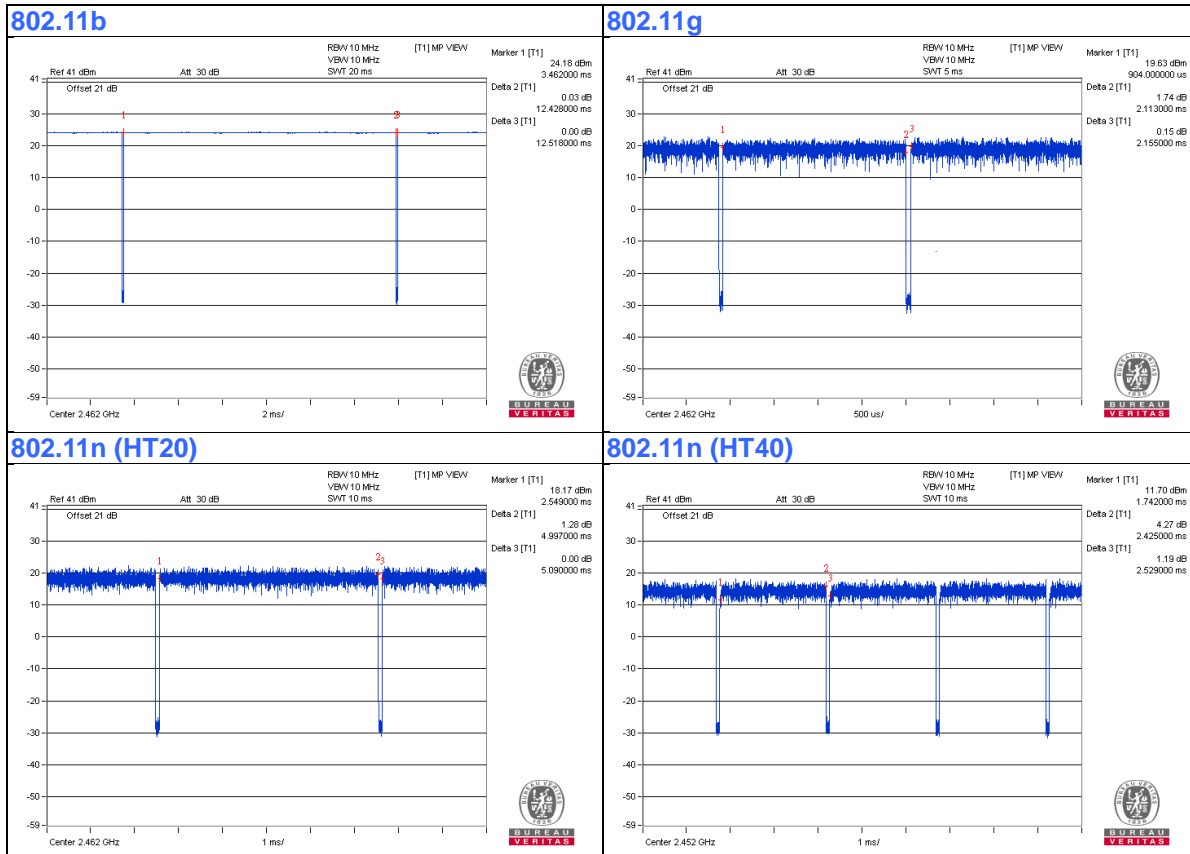

3.4 Description of Support Units

The EUT has been tested as an independent unit.

3.4.1 Configuration of System under Test



3.5 General Description of Applied Standards

The EUT is a RF Product. According to the specifications of the manufacturer, it must comply with the requirements of the following standards:

FCC Part 15, Subpart C (15.247)
KDB 558074 D01 DTS Meas Guidance v04
KDB 662911 D01 Multiple Transmitter Output v02r01
ANSI C63.10-2013

All test items have been performed and recorded as per the above standards.

NOTE: The EUT has been verified to comply with the requirements of FCC Part 15, Subpart B, Class B (DoC). The test report has been issued separately.

4 Test Types and Results

4.1 Radiated Emission and Bandedge Measurement

4.1.1 Limits of Radiated Emission and Bandedge Measurement

Radiated emissions which fall in the restricted bands must comply with the radiated emission limits specified as below table. Other emissions shall be at least 20dB below the highest level of the desired power:

Frequencies (MHz)	Field Strength (microvolts/meter)	Measurement Distance (meters)
0.009 ~ 0.490	2400/F(kHz)	300
0.490 ~ 1.705	24000/F(kHz)	30
1.705 ~ 30.0	30	30
30 ~ 88	100	3
88 ~ 216	150	3
216 ~ 960	200	3
Above 960	500	3

NOTE:

1. The lower limit shall apply at the transition frequencies.
2. Emission level (dBuV/m) = 20 log Emission level (uV/m).
3. For frequencies above 1000MHz, the field strength limits are based on average detector, however, the peak field strength of any emission shall not exceed the maximum permitted average limits, specified above by more than 20dB under any condition of modulation.

4.1.2 Test Instruments

DESCRIPTION & MANUFACTURER	MODEL NO.	SERIAL NO.	CALIBRATED DATE	CALIBRATED UNTIL
Test Receiver Keysight	N9038A	MY54450088	July 20, 2016	July 19, 2017
Pre-Amplifier ^(*) EMCI	EMC001340	980142	Jan. 20, 2016	Jan. 19, 2018
Loop Antenna ^(*) Electro-Metrics	EM-6879	264	Dec. 16, 2016	Dec. 15, 2018
RF Cable	NA	LOOPCAB-001 LOOPCAB-002	Jan. 18, 2016	Jan. 17, 2017
Pre-Amplifier Mini-Circuits	ZFL-1000VH2B	AMP-ZFL-01	Nov. 10, 2016	Nov. 09, 2017
Trilog Broadband Antenna SCHWARZBECK	VULB 9168	9168-406	Jan. 04, 2016	Jan. 03, 2017
RF Cable	8D	966-4-1 966-4-2 966-4-3	Apr. 02, 2016	Apr. 01, 2017
Fixed attenuator Mini-Circuits	UNAT-5+	PAD-3m-4-01	Oct. 05, 2016	Oct. 04, 2017
Horn_Antenna SCHWARZBECK	BBHA 9120D	9120D-783	Jan. 19, 2016	Jan. 18, 2017
Pre-Amplifier Agilent	8449B	3008A01922	Sep. 18, 2016	Sep. 17, 2017
RF Cable	EMC104-SM-SM-2000 EMC104-SM-SM-5000 EMC104-SM-SM-5000	150318 150323 150324	Mar. 30, 2016	Mar. 29, 2017
Pre-Amplifier EMCI	EMC184045	980143	Jan. 15, 2016	Jan. 14, 2017
Horn_Antenna SCHWARZBECK	BBHA 9170	BBHA9170608	Jan. 08, 2016	Jan. 07, 2017
RF Cable	SUCOFLEX 102	36432/2 36441/2	Jan. 16, 2016	Jan. 15, 2017
Software	ADT_Radiated_V8.7.08	NA	NA	NA
Antenna Tower & Turn Table Max-Full	MF-7802	MF780208410	NA	NA
Boresight Antenna Fixture	FBA-01	FBA-SIP02	NA	NA
Spectrum Analyzer R&S	FSv40	100964	June 28, 2016	June 27, 2017
Power meter Anritsu	ML2495A	1014008	May 5, 2016	May 4, 2017
Power sensor Anritsu	MA2411B	0917122	May 5, 2016	May 4, 2017

Note:

1. The calibration interval of the above test instruments is 12 months and the calibrations are traceable to NML/ROC and NIST/USA.
2. *The calibration interval of the above test instruments is 24 months and the calibrations are traceable to NML/ROC and NIST/USA.
3. The test was performed in 966 Chamber No. 4.
4. The CANADA Site Registration No. is 20331-2
- 5 Loop antenna was used for all emissions below 30 MHz.
6. Tested Date: Dec. 20 to 21, 2016

4.1.3 Test Procedures

For Radiated emission below 30MHz

- a. The EUT was placed on the top of a rotating table 0.8 meters above the ground at a 3 meter chamber room. The table was rotated 360 degrees to determine the position of the highest radiation.
- b. The EUT was set 3 meters away from the interference-receiving antenna, which was mounted on the top of a variable-height antenna tower.
- c. Both X and Y axes of the antenna are set to make the measurement.
- d. For each suspected emission, the EUT was arranged to its worst case and the rotatable table was turned from 0 degrees to 360 degrees to find the maximum reading.
- e. The test-receiver system was set to Quasi-Peak Detect Function and Specified Bandwidth with Maximum Hold Mode.

NOTE:

1. The resolution bandwidth and video bandwidth of test receiver/spectrum analyzer is 9kHz at frequency below 30MHz.

For Radiated emission above 30MHz

- a. The EUT was placed on the top of a rotating table 0.8 meters (for 30MHz ~ 1GHz) / 1.5 meters (for above 1GHz) above the ground at 3 meter chamber room for test. The table was rotated 360 degrees to determine the position of the highest radiation.
- b. The EUT was set 3 meters away from the interference-receiving antenna, which was mounted on the top of a variable-height antenna tower.
- c. The height of antenna is varied from one meter to four meters above the ground to determine the maximum value of the field strength. Both horizontal and vertical polarizations of the antenna are set to make the measurement.
- d. For each suspected emission, the EUT was arranged to its worst case and then the antenna was tuned to heights from 1 meter to 4 meters and the rotatable table was turned from 0 degrees to 360 degrees to find the maximum reading.
- e. The test-receiver system was set to quasi-peak detect function and specified bandwidth with maximum hold mode when the test frequency is below 1 GHz.
- f. The test-receiver system was set to peak and average detect function and specified bandwidth with maximum hold mode when the test frequency is above 1 GHz. If the peak reading value also meets average limit, measurement with the average detector is unnecessary.

Note:

1. The resolution bandwidth and video bandwidth of test receiver/spectrum analyzer is 120kHz for Quasi-peak detection (QP) at frequency below 1GHz.
2. The resolution bandwidth of test receiver/spectrum analyzer is 1 MHz and the video bandwidth is 3 MHz for Peak detection (PK) at frequency above 1GHz.
3. The resolution bandwidth of test receiver/spectrum analyzer is 1MHz and the video bandwidth is $\geq 1/T$ (Duty cycle < 98%) or 10Hz (Duty cycle $\geq 98\%$) for Average detection (AV) at frequency above 1GHz.
4. All modes of operation were investigated and the worst-case emissions are reported.

4.1.4 Deviation from Test Standard

No deviation.

4.1.5 Test Setup

For Radiated emission below 30MHz

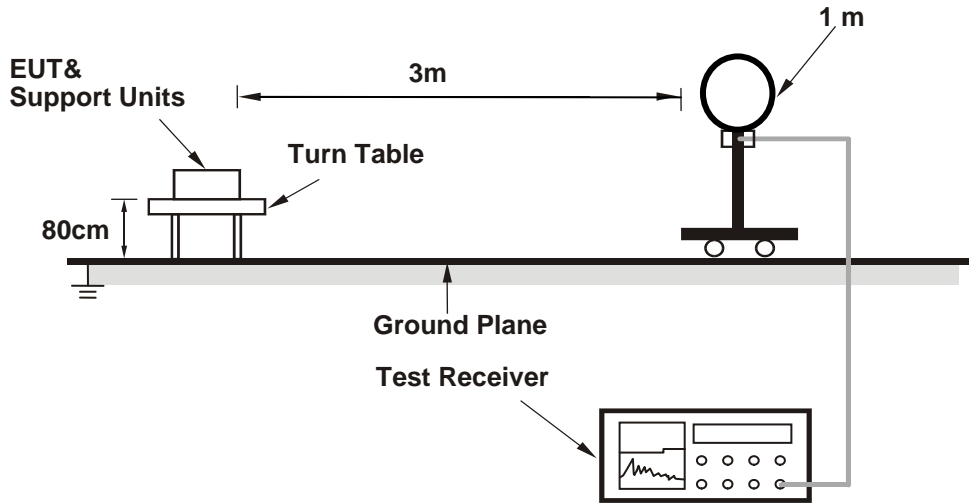

For Radiated emission 30MHz to 1GHz

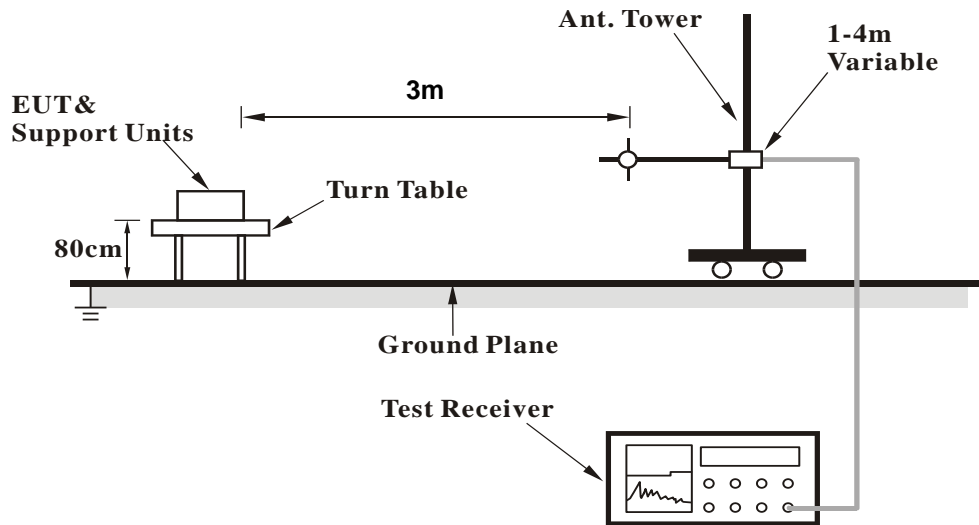

For Radiated emission above 1GHz

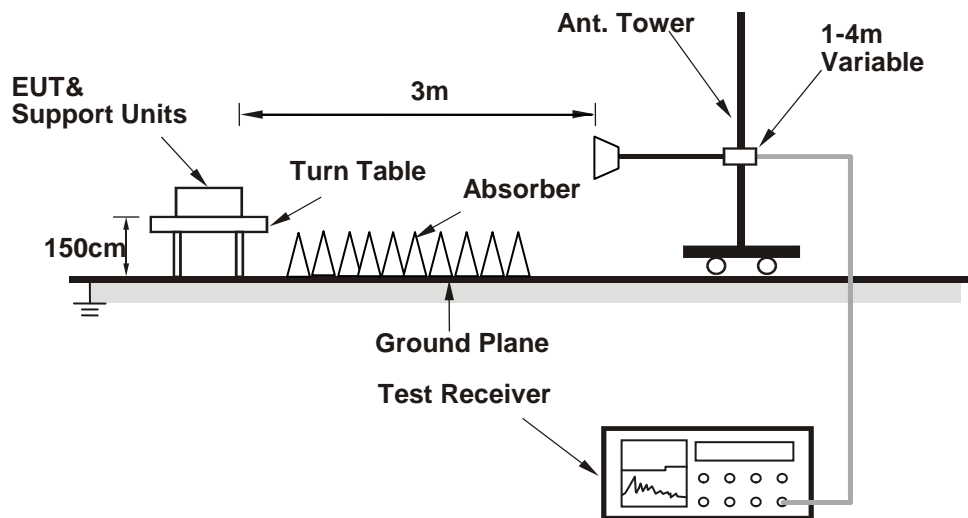

For the actual test configuration, please refer to the attached file (Test Setup Photo).

4.1.6 EUT Operating Conditions

- 1 Turn on the power of EUT.
- 2 The communication partner run test program "QRCT3.0.187.0" to enable EUT under transmission/receiving condition continuously at specific channel frequency.

4.1.7 Test Results

Above 1GHz Data:

802.11b

CHANNEL	TX Channel 1	DETECTOR FUNCTION	Peak (PK)
FREQUENCY RANGE	1GHz ~ 25GHz		Average (AV)

ANTENNA POLARITY & TEST DISTANCE: HORIZONTAL AT 3 M

NO.	FREQ. (MHz)	EMISSION LEVEL (dBuV/m)	LIMIT (dBuV/m)	MARGIN (dB)	ANTENNA HEIGHT (m)	TABLE ANGLE (Degree)	RAW VALUE (dBuV)	CORRECTION FACTOR (dB/m)
1	2387.00	49.1 PK	74.0	-24.9	1.55 H	320	52.8	-3.7
2	2387.00	42.3 AV	54.0	-11.7	1.55 H	320	46.0	-3.7
3	*2412.00	105.9 PK			1.55 H	320	109.6	-3.7
4	*2412.00	103.9 AV			1.55 H	320	107.6	-3.7
5	4824.00	43.4 PK	74.0	-30.6	1.02 H	157	41.2	2.2
6	4824.00	36.7 AV	54.0	-17.3	1.02 H	157	34.5	2.2

ANTENNA POLARITY & TEST DISTANCE: VERTICAL AT 3 M

NO.	FREQ. (MHz)	EMISSION LEVEL (dBuV/m)	LIMIT (dBuV/m)	MARGIN (dB)	ANTENNA HEIGHT (m)	TABLE ANGLE (Degree)	RAW VALUE (dBuV)	CORRECTION FACTOR (dB/m)
1	2387.00	56.5 PK	74.0	-17.5	1.45 V	339	60.2	-3.7
2	2387.00	50.5 AV	54.0	-3.5	1.45 V	339	54.2	-3.7
3	*2412.00	113.2 PK			1.45 V	339	116.9	-3.7
4	*2412.00	111.2 AV			1.45 V	339	114.9	-3.7
5	4824.00	43.9 PK	74.0	-30.1	1.03 V	23	41.7	2.2
6	4824.00	37.3 AV	54.0	-16.7	1.03 V	23	35.1	2.2

REMARKS:

1. Emission Level(dBuV/m) = Raw Value(dBuV) + Correction Factor(dB/m)
2. Correction Factor(dB/m) = Antenna Factor(dB/m) + Cable Factor(dB) – Pre-Amplifier Factor(dB)
3. The other emission levels were very low against the limit.
4. Margin value = Emission Level – Limit value
5. " * ": Fundamental frequency.

CHANNEL	TX Channel 6	DETECTOR FUNCTION	Peak (PK)
FREQUENCY RANGE	1GHz ~ 25GHz		Average (AV)

ANTENNA POLARITY & TEST DISTANCE: HORIZONTAL AT 3 M

NO.	FREQ. (MHz)	EMISSION LEVEL (dBuV/m)	LIMIT (dBuV/m)	MARGIN (dB)	ANTENNA HEIGHT (m)	TABLE ANGLE (Degree)	RAW VALUE (dBuV)	CORRECTION FACTOR (dB/m)
1	2390.00	46.9 PK	74.0	-27.1	1.57 H	331	50.6	-3.7
2	2390.00	39.2 AV	54.0	-14.8	1.57 H	331	42.9	-3.7
3	*2437.00	107.6 PK			1.57 H	331	111.2	-3.6
4	*2437.00	104.7 AV			1.57 H	331	108.3	-3.6
5	2483.50	46.1 PK	74.0	-27.9	1.57 H	331	49.7	-3.6
6	2483.50	36.4 AV	54.0	-17.6	1.57 H	331	40.0	-3.6
7	4874.00	43.5 PK	74.0	-30.5	1.02 H	141	41.1	2.4
8	4874.00	36.5 AV	54.0	-17.5	1.02 H	141	34.1	2.4
9	7311.00	53.8 PK	74.0	-20.2	4.00 H	218	45.1	8.7
10	7311.00	50.2 AV	54.0	-3.8	4.00 H	218	41.5	8.7

ANTENNA POLARITY & TEST DISTANCE: VERTICAL AT 3 M

NO.	FREQ. (MHz)	EMISSION LEVEL (dBuV/m)	LIMIT (dBuV/m)	MARGIN (dB)	ANTENNA HEIGHT (m)	TABLE ANGLE (Degree)	RAW VALUE (dBuV)	CORRECTION FACTOR (dB/m)
1	2390.00	54.3 PK	74.0	-19.7	1.51 V	341	58.0	-3.7
2	2390.00	47.7 AV	54.0	-6.3	1.51 V	341	51.4	-3.7
3	*2437.00	114.9 PK			1.51 V	341	118.5	-3.6
4	*2437.00	112.0 AV			1.51 V	341	115.6	-3.6
5	2483.50	53.5 PK	74.0	-20.5	1.51 V	341	57.1	-3.6
6	2483.50	44.6 AV	54.0	-9.4	1.51 V	341	48.2	-3.6
7	4874.00	44.5 PK	74.0	-29.5	1.00 V	18	42.1	2.4
8	4874.00	37.7 AV	54.0	-16.3	1.00 V	18	35.3	2.4
9	7311.00	52.4 PK	74.0	-21.6	1.00 V	355	43.7	8.7
10	7311.00	46.7 AV	54.0	-7.3	1.00 V	355	38.0	8.7

REMARKS:

1. Emission Level(dBuV/m) = Raw Value(dBuV) + Correction Factor(dB/m)
2. Correction Factor(dB/m) = Antenna Factor(dB/m) + Cable Factor(dB) – Pre-Amplifier Factor(dB)
3. The other emission levels were very low against the limit.
4. Margin value = Emission Level – Limit value
5. " * ": Fundamental frequency.

CHANNEL	TX Channel 11	DETECTOR FUNCTION	Peak (PK)
FREQUENCY RANGE	1GHz ~ 25GHz		Average (AV)

ANTENNA POLARITY & TEST DISTANCE: HORIZONTAL AT 3 M

NO.	FREQ. (MHz)	EMISSION LEVEL (dBuV/m)	LIMIT (dBuV/m)	MARGIN (dB)	ANTENNA HEIGHT (m)	TABLE ANGLE (Degree)	RAW VALUE (dBuV)	CORRECTION FACTOR (dB/m)
1	*2462.00	106.6 PK			1.58 H	320	110.1	-3.5
2	*2462.00	104.0 AV			1.58 H	320	107.5	-3.5
3	2483.50	52.3 PK	74.0	-21.7	1.58 H	320	55.9	-3.6
4	2483.50	45.2 AV	54.0	-8.8	1.58 H	320	48.8	-3.6
5	4924.00	43.6 PK	74.0	-30.4	1.08 H	132	41.1	2.5
6	4924.00	36.6 AV	54.0	-17.4	1.08 H	132	34.1	2.5
7	7386.00	53.5 PK	74.0	-20.5	4.00 H	228	44.4	9.1
8	7386.00	49.9 AV	54.0	-4.1	4.00 H	228	40.8	9.1

ANTENNA POLARITY & TEST DISTANCE: VERTICAL AT 3 M

NO.	FREQ. (MHz)	EMISSION LEVEL (dBuV/m)	LIMIT (dBuV/m)	MARGIN (dB)	ANTENNA HEIGHT (m)	TABLE ANGLE (Degree)	RAW VALUE (dBuV)	CORRECTION FACTOR (dB/m)
1	*2462.00	113.9 PK			1.64 V	338	117.4	-3.5
2	*2462.00	111.3 AV			1.64 V	338	114.8	-3.5
3	2483.50	60.0 PK	74.0	-14.0	1.64 V	338	63.6	-3.6
4	2483.50	53.7 AV	54.0	-0.3	1.64 V	338	57.3	-3.6
5	4924.00	43.9 PK	74.0	-30.1	1.48 V	223	41.4	2.5
6	4924.00	37.3 AV	54.0	-16.7	1.48 V	223	34.8	2.5
7	7386.00	54.4 PK	74.0	-19.6	1.67 V	329	45.3	9.1
8	7386.00	50.0 AV	54.0	-4.0	1.67 V	329	40.9	9.1

REMARKS:

1. Emission Level(dBuV/m) = Raw Value(dBuV) + Correction Factor(dB/m)
2. Correction Factor(dB/m) = Antenna Factor(dB/m) + Cable Factor(dB) – Pre-Amplifier Factor(dB)
3. The other emission levels were very low against the limit.
4. Margin value = Emission Level – Limit value
5. " * ": Fundamental frequency.

802.11g

CHANNEL	TX Channel 1	DETECTOR FUNCTION	Peak (PK)
FREQUENCY RANGE	1GHz ~ 25GHz		Average (AV)

ANTENNA POLARITY & TEST DISTANCE: HORIZONTAL AT 3 M

NO.	FREQ. (MHz)	EMISSION LEVEL (dBuV/m)	LIMIT (dBuV/m)	MARGIN (dB)	ANTENNA HEIGHT (m)	TABLE ANGLE (Degree)	RAW VALUE (dBuV)	CORRECTION FACTOR (dB/m)
1	2390.00	60.6 PK	74.0	-13.4	1.62 H	319	64.3	-3.7
2	2390.00	44.8 AV	54.0	-9.2	1.62 H	319	48.5	-3.7
3	*2412.00	104.5 PK			1.62 H	319	108.2	-3.7
4	*2412.00	92.2 AV			1.62 H	319	95.9	-3.7
5	4824.00	40.5 PK	74.0	-33.5	3.25 H	153	38.3	2.2
6	4824.00	30.2 AV	54.0	-23.8	3.25 H	153	28.0	2.2

ANTENNA POLARITY & TEST DISTANCE: VERTICAL AT 3 M

NO.	FREQ. (MHz)	EMISSION LEVEL (dBuV/m)	LIMIT (dBuV/m)	MARGIN (dB)	ANTENNA HEIGHT (m)	TABLE ANGLE (Degree)	RAW VALUE (dBuV)	CORRECTION FACTOR (dB/m)
1	2390.00	68.0 PK	74.0	-6.0	1.15 V	68	71.7	-3.7
2	2390.00	53.0 AV	54.0	-1.0	1.15 V	68	56.7	-3.7
3	*2412.00	111.8 PK			1.15 V	68	115.5	-3.7
4	*2412.00	99.5 AV			1.15 V	68	103.2	-3.7
5	4824.00	41.1 PK	74.0	-32.9	1.74 V	343	38.9	2.2
6	4824.00	31.0 AV	54.0	-23.0	1.74 V	343	28.8	2.2

REMARKS:

1. Emission Level(dBuV/m) = Raw Value(dBuV) + Correction Factor(dB/m)
2. Correction Factor(dB/m) = Antenna Factor(dB/m) + Cable Factor(dB) – Pre-Amplifier Factor(dB)
3. The other emission levels were very low against the limit.
4. Margin value = Emission Level – Limit value
5. " * ": Fundamental frequency.

CHANNEL	TX Channel 6	DETECTOR FUNCTION	Peak (PK)
FREQUENCY RANGE	1GHz ~ 25GHz		Average (AV)

ANTENNA POLARITY & TEST DISTANCE: HORIZONTAL AT 3 M

NO.	FREQ. (MHz)	EMISSION LEVEL (dBuV/m)	LIMIT (dBuV/m)	MARGIN (dB)	ANTENNA HEIGHT (m)	TABLE ANGLE (Degree)	RAW VALUE (dBuV)	CORRECTION FACTOR (dB/m)
1	2390.00	61.3 PK	74.0	-12.7	1.64 H	328	65.0	-3.7
2	2390.00	43.6 AV	54.0	-10.4	1.64 H	328	47.3	-3.7
3	*2437.00	111.3 PK			1.64 H	328	114.9	-3.6
4	*2437.00	98.7 AV			1.64 H	328	102.3	-3.6
5	2496.00	60.9 PK	74.0	-13.1	1.64 H	328	64.4	-3.5
6	2496.00	41.8 AV	54.0	-12.2	1.64 H	328	45.3	-3.5
7	4874.00	40.5 PK	74.0	-33.5	3.26 H	143	38.1	2.4
8	4874.00	30.1 AV	54.0	-23.9	3.26 H	143	27.7	2.4
9	7311.00	47.9 PK	74.0	-26.1	1.93 H	282	39.2	8.7
10	7311.00	34.8 AV	54.0	-19.2	1.93 H	282	26.1	8.7

ANTENNA POLARITY & TEST DISTANCE: VERTICAL AT 3 M

NO.	FREQ. (MHz)	EMISSION LEVEL (dBuV/m)	LIMIT (dBuV/m)	MARGIN (dB)	ANTENNA HEIGHT (m)	TABLE ANGLE (Degree)	RAW VALUE (dBuV)	CORRECTION FACTOR (dB/m)
1	2390.00	68.7 PK	74.0	-5.3	1.40 V	55	72.4	-3.7
2	2390.00	51.8 AV	54.0	-2.2	1.40 V	55	55.5	-3.7
3	*2437.00	118.6 PK			1.40 V	55	122.2	-3.6
4	*2437.00	106.0 AV			1.40 V	55	109.6	-3.6
5	2496.00	68.3 PK	74.0	-5.7	1.40 V	55	71.8	-3.5
6	2496.00	50.0 AV	54.0	-4.0	1.40 V	55	53.5	-3.5
7	4874.00	40.7 PK	74.0	-33.3	1.69 V	336	38.3	2.4
8	4874.00	30.5 AV	54.0	-23.5	1.69 V	336	28.1	2.4
9	7311.00	50.7 PK	74.0	-23.3	1.65 V	334	42.0	8.7
10	7311.00	41.2 AV	54.0	-12.8	1.65 V	334	32.5	8.7

REMARKS:

1. Emission Level(dBuV/m) = Raw Value(dBuV) + Correction Factor(dB/m)
2. Correction Factor(dB/m) = Antenna Factor(dB/m) + Cable Factor(dB) – Pre-Amplifier Factor(dB)
3. The other emission levels were very low against the limit.
4. Margin value = Emission Level – Limit value
5. " * ": Fundamental frequency.

CHANNEL	TX Channel 11	DETECTOR FUNCTION	Peak (PK)
FREQUENCY RANGE	1GHz ~ 25GHz		Average (AV)

ANTENNA POLARITY & TEST DISTANCE: HORIZONTAL AT 3 M

NO.	FREQ. (MHz)	EMISSION LEVEL (dBuV/m)	LIMIT (dBuV/m)	MARGIN (dB)	ANTENNA HEIGHT (m)	TABLE ANGLE (Degree)	RAW VALUE (dBuV)	CORRECTION FACTOR (dB/m)
1	*2462.00	105.3 PK			1.60 H	332	108.8	-3.5
2	*2462.00	93.4 AV			1.60 H	332	96.9	-3.5
3	2483.50	62.1 PK	74.0	-11.9	1.60 H	332	65.7	-3.6
4	2483.50	45.0 AV	54.0	-9.0	1.60 H	332	48.6	-3.6
5	4924.00	40.8 PK	74.0	-33.2	3.24 H	138	38.3	2.5
6	4924.00	30.1 AV	54.0	-23.9	3.24 H	138	27.6	2.5
7	7386.00	47.8 PK	74.0	-26.2	1.97 H	286	38.7	9.1
8	7386.00	34.5 AV	54.0	-19.5	1.97 H	286	25.4	9.1

ANTENNA POLARITY & TEST DISTANCE: VERTICAL AT 3 M

NO.	FREQ. (MHz)	EMISSION LEVEL (dBuV/m)	LIMIT (dBuV/m)	MARGIN (dB)	ANTENNA HEIGHT (m)	TABLE ANGLE (Degree)	RAW VALUE (dBuV)	CORRECTION FACTOR (dB/m)
1	*2462.00	112.6 PK			1.42 V	88	116.1	-3.5
2	*2462.00	100.7 AV			1.42 V	88	104.2	-3.5
3	2483.50	69.5 PK	74.0	-4.5	1.42 V	88	73.1	-3.6
4	2483.50	53.2 AV	54.0	-0.8	1.42 V	88	56.8	-3.6
5	4924.00	41.1 PK	74.0	-32.9	1.73 V	348	38.6	2.5
6	4924.00	30.8 AV	54.0	-23.2	1.73 V	348	28.3	2.5
7	7386.00	50.7 PK	74.0	-23.3	1.70 V	350	41.6	9.1
8	7386.00	41.3 AV	54.0	-12.7	1.70 V	350	32.2	9.1

REMARKS:

1. Emission Level(dBuV/m) = Raw Value(dBuV) + Correction Factor(dB/m)
2. Correction Factor(dB/m) = Antenna Factor(dB/m) + Cable Factor(dB) – Pre-Amplifier Factor(dB)
3. The other emission levels were very low against the limit.
4. Margin value = Emission Level – Limit value
5. " * ": Fundamental frequency.

802.11n (HT20)

CHANNEL	TX Channel 1	DETECTOR FUNCTION	Peak (PK)
FREQUENCY RANGE	1GHz ~ 25GHz		Average (AV)

ANTENNA POLARITY & TEST DISTANCE: HORIZONTAL AT 3 M

NO.	FREQ. (MHz)	EMISSION LEVEL (dBuV/m)	LIMIT (dBuV/m)	MARGIN (dB)	ANTENNA HEIGHT (m)	TABLE ANGLE (Degree)	RAW VALUE (dBuV)	CORRECTION FACTOR (dB/m)
1	2390.00	63.0 PK	74.0	-11.0	1.65 H	326	66.7	-3.7
2	2390.00	45.7 AV	54.0	-8.3	1.65 H	326	49.4	-3.7
3	*2412.00	104.1 PK			1.65 H	326	107.8	-3.7
4	*2412.00	92.7 AV			1.65 H	326	96.4	-3.7
5	4824.00	40.5 PK	74.0	-33.5	3.19 H	135	38.3	2.2
6	4824.00	29.6 AV	54.0	-24.4	3.19 H	135	27.4	2.2

ANTENNA POLARITY & TEST DISTANCE: VERTICAL AT 3 M

NO.	FREQ. (MHz)	EMISSION LEVEL (dBuV/m)	LIMIT (dBuV/m)	MARGIN (dB)	ANTENNA HEIGHT (m)	TABLE ANGLE (Degree)	RAW VALUE (dBuV)	CORRECTION FACTOR (dB/m)
1	2390.00	70.4 PK	74.0	-3.6	1.50 V	63	74.1	-3.7
2	2390.00	53.9 AV	54.0	-0.1	1.50 V	63	57.6	-3.7
3	*2412.00	111.4 PK			1.50 V	63	115.1	-3.7
4	*2412.00	100.0 AV			1.50 V	63	103.7	-3.7
5	4824.00	40.7 PK	74.0	-33.3	1.75 V	360	38.5	2.2
6	4824.00	30.5 AV	54.0	-23.5	1.75 V	360	28.3	2.2

REMARKS:

1. Emission Level(dBuV/m) = Raw Value(dBuV) + Correction Factor(dB/m)
2. Correction Factor(dB/m) = Antenna Factor(dB/m) + Cable Factor(dB) – Pre-Amplifier Factor(dB)
3. The other emission levels were very low against the limit.
4. Margin value = Emission Level – Limit value
5. " * ": Fundamental frequency.

CHANNEL	TX Channel 6	DETECTOR FUNCTION	Peak (PK)
FREQUENCY RANGE	1GHz ~ 25GHz		Average (AV)

ANTENNA POLARITY & TEST DISTANCE: HORIZONTAL AT 3 M

NO.	FREQ. (MHz)	EMISSION LEVEL (dBuV/m)	LIMIT (dBuV/m)	MARGIN (dB)	ANTENNA HEIGHT (m)	TABLE ANGLE (Degree)	RAW VALUE (dBuV)	CORRECTION FACTOR (dB/m)
1	2390.00	64.8 PK	74.0	-9.2	1.70 H	313	68.5	-3.7
2	2390.00	45.5 AV	54.0	-8.5	1.70 H	313	49.2	-3.7
3	*2437.00	111.2 PK			1.70 H	313	114.8	-3.6
4	*2437.00	99.5 AV			1.70 H	313	103.1	-3.6
5	2483.50	59.4 PK	74.0	-14.6	1.70 H	313	63.0	-3.6
6	2483.50	40.0 AV	54.0	-14.0	1.70 H	313	43.6	-3.6
7	4874.00	40.9 PK	74.0	-33.1	3.23 H	147	38.5	2.4
8	4874.00	30.0 AV	54.0	-24.0	3.23 H	147	27.6	2.4
9	7311.00	47.7 PK	74.0	-26.3	2.01 H	284	39.0	8.7
10	7311.00	34.7 AV	54.0	-19.3	2.01 H	284	26.0	8.7

ANTENNA POLARITY & TEST DISTANCE: VERTICAL AT 3 M

NO.	FREQ. (MHz)	EMISSION LEVEL (dBuV/m)	LIMIT (dBuV/m)	MARGIN (dB)	ANTENNA HEIGHT (m)	TABLE ANGLE (Degree)	RAW VALUE (dBuV)	CORRECTION FACTOR (dB/m)
1	2390.00	72.2 PK	74.0	-1.8	1.30 V	56	75.9	-3.7
2	2390.00	53.7 AV	54.0	-0.3	1.30 V	56	57.4	-3.7
3	*2437.00	118.5 PK			1.30 V	56	122.1	-3.6
4	*2437.00	106.8 AV			1.30 V	56	110.4	-3.6
5	2483.50	66.8 PK	74.0	-7.2	1.30 V	56	70.4	-3.6
6	2483.50	48.1 AV	54.0	-5.9	1.30 V	56	51.7	-3.6
7	4874.00	40.7 PK	74.0	-33.3	1.70 V	359	38.3	2.4
8	4874.00	30.4 AV	54.0	-23.6	1.70 V	359	28.0	2.4
9	7311.00	50.6 PK	74.0	-23.4	1.66 V	341	41.9	8.7
10	7311.00	41.1 AV	54.0	-12.9	1.66 V	341	32.4	8.7

REMARKS:

1. Emission Level(dBuV/m) = Raw Value(dBuV) + Correction Factor(dB/m)
2. Correction Factor(dB/m) = Antenna Factor(dB/m) + Cable Factor(dB) – Pre-Amplifier Factor(dB)
3. The other emission levels were very low against the limit.
4. Margin value = Emission Level – Limit value
5. " * ": Fundamental frequency.

CHANNEL	TX Channel 11	DETECTOR FUNCTION	Peak (PK)
FREQUENCY RANGE	1GHz ~ 25GHz		Average (AV)

ANTENNA POLARITY & TEST DISTANCE: HORIZONTAL AT 3 M

NO.	FREQ. (MHz)	EMISSION LEVEL (dBuV/m)	LIMIT (dBuV/m)	MARGIN (dB)	ANTENNA HEIGHT (m)	TABLE ANGLE (Degree)	RAW VALUE (dBuV)	CORRECTION FACTOR (dB/m)
1	*2462.00	104.5 PK			1.69 H	312	108.0	-3.5
2	*2462.00	93.0 AV			1.69 H	312	96.5	-3.5
3	2483.50	61.4 PK	74.0	-12.6	1.69 H	312	65.0	-3.6
4	2483.50	45.0 AV	54.0	-9.0	1.69 H	312	48.6	-3.6
5	4924.00	40.8 PK	74.0	-33.2	3.27 H	153	38.3	2.5
6	4924.00	30.2 AV	54.0	-23.8	3.27 H	153	27.7	2.5
7	7386.00	47.8 PK	74.0	-26.2	1.98 H	289	38.7	9.1
8	7386.00	34.9 AV	54.0	-19.1	1.98 H	289	25.8	9.1

ANTENNA POLARITY & TEST DISTANCE: VERTICAL AT 3 M

NO.	FREQ. (MHz)	EMISSION LEVEL (dBuV/m)	LIMIT (dBuV/m)	MARGIN (dB)	ANTENNA HEIGHT (m)	TABLE ANGLE (Degree)	RAW VALUE (dBuV)	CORRECTION FACTOR (dB/m)
1	*2462.00	111.8 PK			1.45 V	64	115.3	-3.5
2	*2462.00	100.3 AV			1.45 V	64	103.8	-3.5
3	2483.50	68.8 PK	74.0	-5.2	1.45 V	64	72.4	-3.6
4	2483.50	53.2 AV	54.0	-0.8	1.45 V	64	56.8	-3.6
5	4924.00	40.3 PK	74.0	-33.7	1.72 V	347	37.8	2.5
6	4924.00	30.2 AV	54.0	-23.8	1.72 V	347	27.7	2.5
7	7386.00	50.9 PK	74.0	-23.1	1.70 V	333	41.8	9.1
8	7386.00	41.3 AV	54.0	-12.7	1.70 V	333	32.2	9.1

REMARKS:

1. Emission Level(dBuV/m) = Raw Value(dBuV) + Correction Factor(dB/m)
2. Correction Factor(dB/m) = Antenna Factor(dB/m) + Cable Factor(dB) – Pre-Amplifier Factor(dB)
3. The other emission levels were very low against the limit.
4. Margin value = Emission Level – Limit value
5. " * ": Fundamental frequency.

802.11n (HT40)

CHANNEL	TX Channel 3	DETECTOR FUNCTION	Peak (PK)
FREQUENCY RANGE	1GHz ~ 25GHz		Average (AV)

ANTENNA POLARITY & TEST DISTANCE: HORIZONTAL AT 3 M								
NO.	FREQ. (MHz)	EMISSION LEVEL (dBuV/m)	LIMIT (dBuV/m)	MARGIN (dB)	ANTENNA HEIGHT (m)	TABLE ANGLE (Degree)	RAW VALUE (dBuV)	CORRECTION FACTOR (dB/m)
1	2390.00	61.7 PK	74.0	-12.3	1.73 H	320	65.4	-3.7
2	2390.00	45.4 AV	54.0	-8.6	1.73 H	320	49.1	-3.7
3	*2422.00	100.8 PK			1.73 H	320	104.4	-3.6
4	*2422.00	91.3 AV			1.73 H	320	94.9	-3.6
5	4844.00	40.6 PK	74.0	-33.4	3.26 H	160	38.3	2.3
6	4844.00	29.8 AV	54.0	-24.2	3.26 H	160	27.5	2.3
7	7266.00	47.8 PK	74.0	-26.2	1.99 H	277	39.0	8.8
8	7266.00	35.2 AV	54.0	-18.8	1.99 H	277	26.4	8.8

ANTENNA POLARITY & TEST DISTANCE: VERTICAL AT 3 M								
NO.	FREQ. (MHz)	EMISSION LEVEL (dBuV/m)	LIMIT (dBuV/m)	MARGIN (dB)	ANTENNA HEIGHT (m)	TABLE ANGLE (Degree)	RAW VALUE (dBuV)	CORRECTION FACTOR (dB/m)
1	2390.00	69.1 PK	74.0	-4.9	1.45 V	67	72.8	-3.7
2	2390.00	53.6 AV	54.0	-0.4	1.45 V	67	57.3	-3.7
3	*2422.00	108.1 PK			1.45 V	67	111.7	-3.6
4	*2422.00	98.6 AV			1.45 V	67	102.2	-3.6
5	4844.00	40.2 PK	74.0	-33.8	1.75 V	360	37.9	2.3
6	4844.00	29.8 AV	54.0	-24.2	1.75 V	360	27.5	2.3
7	7266.00	50.7 PK	74.0	-23.3	1.72 V	348	41.9	8.8
8	7266.00	41.1 AV	54.0	-12.9	1.72 V	348	32.3	8.8

REMARKS:

1. Emission Level(dBuV/m) = Raw Value(dBuV) + Correction Factor(dB/m)
2. Correction Factor(dB/m) = Antenna Factor(dB/m) + Cable Factor(dB) – Pre-Amplifier Factor(dB)
3. The other emission levels were very low against the limit.
4. Margin value = Emission Level – Limit value
5. " * ": Fundamental frequency.

CHANNEL	TX Channel 6	DETECTOR FUNCTION	Peak (PK)
FREQUENCY RANGE	1GHz ~ 25GHz		Average (AV)

ANTENNA POLARITY & TEST DISTANCE: HORIZONTAL AT 3 M

NO.	FREQ. (MHz)	EMISSION LEVEL (dBuV/m)	LIMIT (dBuV/m)	MARGIN (dB)	ANTENNA HEIGHT (m)	TABLE ANGLE (Degree)	RAW VALUE (dBuV)	CORRECTION FACTOR (dB/m)
1	2390.00	59.4 PK	74.0	-14.6	1.76 H	304	63.1	-3.7
2	2390.00	45.3 AV	54.0	-8.7	1.76 H	304	49.0	-3.7
3	*2437.00	103.3 PK			1.76 H	304	106.9	-3.6
4	*2437.00	93.6 AV			1.76 H	304	97.2	-3.6
5	2490.00	56.4 PK	74.0	-17.6	1.76 H	304	59.9	-3.5
6	2490.00	40.6 AV	54.0	-13.4	1.76 H	304	44.1	-3.5
7	4874.00	40.1 PK	74.0	-33.9	3.31 H	156	37.7	2.4
8	4874.00	29.3 AV	54.0	-24.7	3.31 H	156	26.9	2.4
9	7311.00	47.6 PK	74.0	-26.4	1.98 H	282	38.9	8.7
10	7311.00	35.2 AV	54.0	-18.8	1.98 H	282	26.5	8.7

ANTENNA POLARITY & TEST DISTANCE: VERTICAL AT 3 M

NO.	FREQ. (MHz)	EMISSION LEVEL (dBuV/m)	LIMIT (dBuV/m)	MARGIN (dB)	ANTENNA HEIGHT (m)	TABLE ANGLE (Degree)	RAW VALUE (dBuV)	CORRECTION FACTOR (dB/m)
1	2390.00	66.8 PK	74.0	-7.2	1.45 V	65	70.5	-3.7
2	2390.00	53.5 AV	54.0	-0.5	1.45 V	65	57.2	-3.7
3	*2437.00	110.6 PK			1.45 V	65	114.2	-3.6
4	*2437.00	100.9 AV			1.45 V	65	104.5	-3.6
5	2490.00	63.8 PK	74.0	-10.2	1.45 V	65	67.3	-3.5
6	2490.00	48.8 AV	54.0	-5.2	1.45 V	65	52.3	-3.5
7	4874.00	39.8 PK	74.0	-34.2	1.70 V	360	37.4	2.4
8	4874.00	29.4 AV	54.0	-24.6	1.70 V	360	27.0	2.4
9	7311.00	50.5 PK	74.0	-23.5	1.67 V	352	41.8	8.7
10	7311.00	41.1 AV	54.0	-12.9	1.67 V	352	32.4	8.7

REMARKS:

1. Emission Level(dBuV/m) = Raw Value(dBuV) + Correction Factor(dB/m)
2. Correction Factor(dB/m) = Antenna Factor(dB/m) + Cable Factor(dB) – Pre-Amplifier Factor(dB)
3. The other emission levels were very low against the limit.
4. Margin value = Emission Level – Limit value
5. " * ": Fundamental frequency.

CHANNEL	TX Channel 9	DETECTOR FUNCTION	Peak (PK)
FREQUENCY RANGE	1GHz ~ 25GHz		Average (AV)

ANTENNA POLARITY & TEST DISTANCE: HORIZONTAL AT 3 M

NO.	FREQ. (MHz)	EMISSION LEVEL (dBuV/m)	LIMIT (dBuV/m)	MARGIN (dB)	ANTENNA HEIGHT (m)	TABLE ANGLE (Degree)	RAW VALUE (dBuV)	CORRECTION FACTOR (dB/m)
1	*2452.00	100.2 PK			1.71 H	294	103.8	-3.6
2	*2452.00	89.3 AV			1.71 H	294	92.9	-3.6
3	2483.50	62.9 PK	74.0	-11.1	1.71 H	294	66.5	-3.6
4	2483.50	45.7 AV	54.0	-8.3	1.71 H	294	49.3	-3.6
5	4904.00	40.8 PK	74.0	-33.2	3.28 H	145	38.3	2.5
6	4904.00	29.8 AV	54.0	-24.2	3.28 H	145	27.3	2.5
7	7356.00	47.6 PK	74.0	-26.4	2.01 H	272	38.7	8.9
8	7356.00	35.2 AV	54.0	-18.8	2.01 H	272	26.3	8.9

ANTENNA POLARITY & TEST DISTANCE: VERTICAL AT 3 M

NO.	FREQ. (MHz)	EMISSION LEVEL (dBuV/m)	LIMIT (dBuV/m)	MARGIN (dB)	ANTENNA HEIGHT (m)	TABLE ANGLE (Degree)	RAW VALUE (dBuV)	CORRECTION FACTOR (dB/m)
1	*2452.00	107.5 PK			1.45 V	65	111.1	-3.6
2	*2452.00	96.6 AV			1.45 V	65	100.2	-3.6
3	2483.50	70.3 PK	74.0	-3.7	1.45 V	65	73.9	-3.6
4	2483.50	53.9 AV	54.0	-0.1	1.45 V	65	57.5	-3.6
5	4904.00	39.7 PK	74.0	-34.3	1.76 V	360	37.2	2.5
6	4904.00	29.1 AV	54.0	-24.9	1.76 V	360	26.6	2.5
7	7356.00	50.2 PK	74.0	-23.8	1.71 V	357	41.3	8.9
8	7356.00	41.0 AV	54.0	-13.0	1.71 V	357	32.1	8.9

REMARKS:

1. Emission Level(dBuV/m) = Raw Value(dBuV) + Correction Factor(dB/m)
2. Correction Factor(dB/m) = Antenna Factor(dB/m) + Cable Factor(dB) – Pre-Amplifier Factor(dB)
3. The other emission levels were very low against the limit.
4. Margin value = Emission Level – Limit value
5. " * ": Fundamental frequency.

Below 1GHz Data:

802.11g

CHANNEL	TX Channel 6	DETECTOR FUNCTION	Quasi-Peak (QP)
FREQUENCY RANGE	9kHz ~ 1GHz		

ANTENNA POLARITY & TEST DISTANCE: HORIZONTAL AT 3 M								
NO.	FREQ. (MHz)	EMISSION LEVEL (dBuV/m)	LIMIT (dBuV/m)	MARGIN (dB)	ANTENNA HEIGHT (m)	TABLE ANGLE (Degree)	RAW VALUE (dBuV)	CORRECTION FACTOR (dB/m)
1	30.07	24.6 QP	40.0	-15.4	1.50 H	262	34.2	-9.6
2	100.83	35.0 QP	43.5	-8.5	2.00 H	256	47.5	-12.5
3	236.95	24.1 QP	46.0	-21.9	1.00 H	296	34.2	-10.1
4	345.74	23.0 QP	46.0	-23.0	1.00 H	42	29.6	-6.6
5	391.28	23.0 QP	46.0	-23.0	2.00 H	327	28.3	-5.3
6	803.60	28.6 QP	46.0	-17.4	1.50 H	102	25.8	2.8

ANTENNA POLARITY & TEST DISTANCE: VERTICAL AT 3 M								
NO.	FREQ. (MHz)	EMISSION LEVEL (dBuV/m)	LIMIT (dBuV/m)	MARGIN (dB)	ANTENNA HEIGHT (m)	TABLE ANGLE (Degree)	RAW VALUE (dBuV)	CORRECTION FACTOR (dB/m)
1	100.18	26.0 QP	43.5	-17.5	2.00 V	236	38.6	-12.6
2	143.20	30.2 QP	43.5	-13.3	1.00 V	42	38.4	-8.2
3	268.79	23.3 QP	46.0	-22.7	2.00 V	360	31.9	-8.6
4	660.01	32.3 QP	46.0	-13.7	1.50 V	65	31.7	0.6
5	780.00	36.5 QP	46.0	-9.5	1.50 V	65	33.9	2.6
6	840.00	34.5 QP	46.0	-11.5	1.50 V	65	31.3	3.2

REMARKS:

1. Emission Level(dBuV/m) = Raw Value(dBuV) + Correction Factor(dB/m)
2. Correction Factor(dB/m) = Antenna Factor(dB/m) + Cable Factor(dB) – Pre-Amplifier Factor(dB)
3. The other emission levels were very low against the limit.
4. Margin value = Emission Level – Limit value

4.2 Conducted Emission Measurement

4.2.1 Limits of Conducted Emission Measurement

Frequency (MHz)	Conducted Limit (dBuV)	
	Quasi-peak	Average
0.15 - 0.5	66 - 56	56 - 46
0.50 - 5.0	56	46
5.0 - 30.0	60	50

Note: 1. The lower limit shall apply at the transition frequencies.

2. The limit decreases in line with the logarithm of the frequency in the range of 0.15 to 0.50MHz.

4.2.2 Test Instruments

DESCRIPTION & MANUFACTURER	MODEL NO.	SERIAL NO.	CALIBRATED DATE	CALIBRATED UNTIL
Test Receiver R&S	ESCS 30	847124/029	Oct. 24, 2016	Oct. 23, 2017
Line-Impedance Stabilization Network (for EUT) R&S	ESH3-Z5	848773/004	Oct. 26, 2016	Oct. 25, 2017
Line-Impedance Stabilization Network (for Peripheral) R&S	ENV216	100072	June 13, 2016	June 12, 2017
RF Cable	5D-FB	COCCAB-001	Sep. 30, 2016	Sep. 29, 2017
10 dB PAD Mini-Circuits	HAT-10+	CONATT-004	June 20, 2016	June 19, 2017
Software BVADT	BVADT_Cond_ V7.3.7.4	NA	NA	NA

Note:

1. The calibration interval of the above test instruments are 12 months and the calibrations are traceable to NML/ROC and NIST/USA.
2. The test was performed in Shielded Room No. 1.
- 3 Tested Date: Dec. 01, 2016

4.2.3 Test Procedures

- a. The EUT was placed 0.4 meters from the conducting wall of the shielded room with EUT being connected to the power mains through a line impedance stabilization network (LISN). Other support units were connected to the power mains through another LISN. The two LISNs provide 50 ohm/ 50uH of coupling impedance for the measuring instrument.
- b. Both lines of the power mains connected to the EUT were checked for maximum conducted interference.
- c. The frequency range from 150kHz to 30MHz was searched. Emission levels under (Limit - 20dB) was not recorded.

NOTE: The resolution bandwidth and video bandwidth of test receiver is 9kHz for quasi-peak detection (QP) and average detection (AV) at frequency 0.15MHz-30MHz.

4.2.4 Deviation from Test Standard

No deviation.

4.2.5 Test Setup

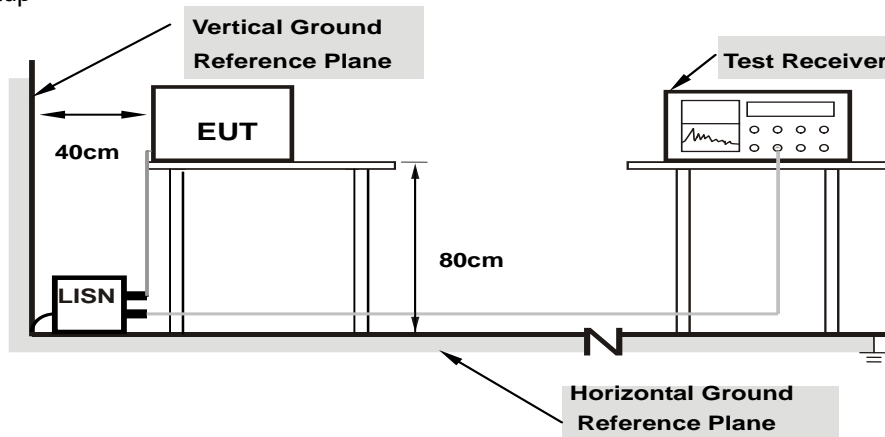

Note: 1.Support units were connected to second LISN.

For the actual test configuration, please refer to the attached file (Test Setup Photo).

4.2.6 EUT Operating Conditions

Same as 4.1.6.

4.2.7 Test Results

Phase	Line (L)	Detector Function	Quasi-Peak (QP) / Average (AV)
-------	----------	-------------------	--------------------------------

No	Freq. [MHz]	Corr.	Reading Value		Emission Level		Limit		Margin	
		Factor (dB)	[dB (uV)]		[dB (uV)]		[dB (uV)]		(dB)	
			Q.P.	AV.	Q.P.	AV.	Q.P.	AV.	Q.P.	AV.
1	0.15781	10.20	35.10	23.68	45.30	33.88	65.58	55.58	-20.28	-21.70
2	0.27500	10.22	19.29	7.05	29.51	17.27	60.97	50.97	-31.46	-33.70
3	0.53672	10.25	23.49	12.99	33.74	23.24	56.00	46.00	-22.26	-22.76
4	2.81641	10.30	24.22	14.37	34.52	24.67	56.00	46.00	-21.48	-21.33
5	7.03516	10.52	15.72	7.86	26.24	18.38	60.00	50.00	-33.76	-31.62
6	14.03125	11.19	11.05	6.29	22.24	17.48	60.00	50.00	-37.76	-32.52

REMARKS:

1. Q.P. and AV. are abbreviations of quasi-peak and average individually.
2. The emission levels of other frequencies were very low against the limit.
3. Margin value = Emission level - Limit value
4. Correction factor = Insertion loss + Cable loss
5. Emission Level = Correction Factor + Reading Value.

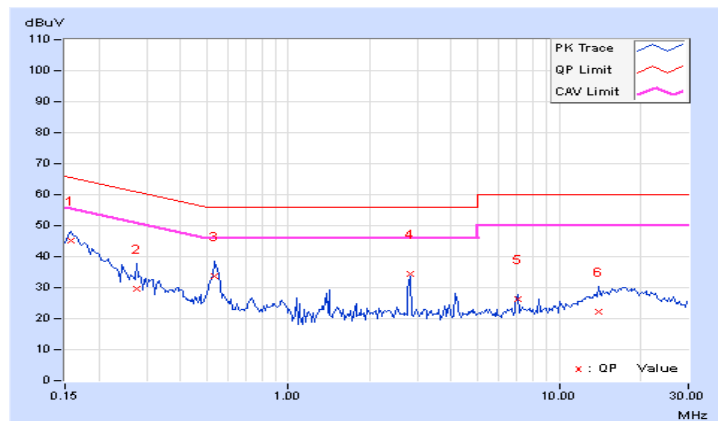

Phase	Neutral (N)	Detector Function	Quasi-Peak (QP) / Average (AV)
-------	-------------	-------------------	--------------------------------

No	Freq. [MHz]	Corr.	Reading Value		Emission Level		Limit		Margin	
		Factor	[dB (uV)]		[dB (uV)]		[dB (uV)]		(dB)	
	(dB)	Q.P.	AV.	Q.P.	AV.	Q.P.	AV.	Q.P.	AV.	
1	0.15000	10.19	32.70	16.65	42.89	26.84	66.00	56.00	-23.11	-29.16
2	0.31016	10.21	21.11	8.49	31.32	18.70	59.97	49.97	-28.65	-31.27
3	0.55234	10.25	19.04	13.59	29.29	23.84	56.00	46.00	-26.71	-22.16
4	1.40625	10.28	28.64	18.44	38.92	28.72	56.00	46.00	-17.08	-17.28
5	2.81250	10.27	23.87	14.49	34.14	24.76	56.00	46.00	-21.86	-21.24
6	5.52734	10.32	8.67	4.35	18.99	14.67	60.00	50.00	-41.01	-35.33

REMARKS:

1. Q.P. and AV. are abbreviations of quasi-peak and average individually.
2. The emission levels of other frequencies were very low against the limit.
3. Margin value = Emission level - Limit value
4. Correction factor = Insertion loss + Cable loss
5. Emission Level = Correction Factor + Reading Value.

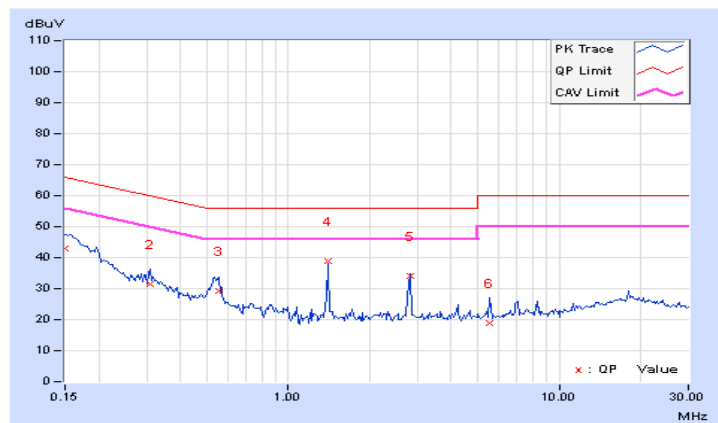

4.3 6dB Bandwidth Measurement

4.3.1 Limits of 6dB Bandwidth Measurement

The minimum of 6dB Bandwidth Measurement is 0.5 MHz.

4.3.2 Test Setup

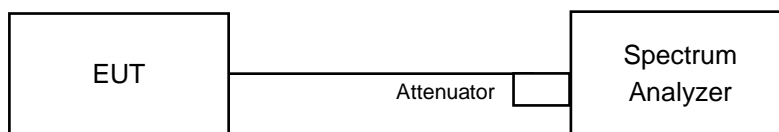

4.3.3 Test Instruments

Refer to section 4.1.2 to get information of above instrument.

4.3.4 Test Procedure

- a. Set resolution bandwidth (RBW) = 100kHz
- b. Set the video bandwidth (VBW) $\geq 3 \times$ RBW, Detector = Peak.
- c. Trace mode = max hold.
- d. Sweep = auto couple.
- e. Measure the maximum width of the emission that is constrained by the frequencies associated with the two amplitude points (upper and lower) that are attenuated by 6 dB relative to the maximum level measured in the fundamental emission

4.3.5 Deviation from Test Standard

No deviation.

4.3.6 EUT Operating Conditions

The software provided by client to enable the EUT under transmission condition continuously at lowest, middle and highest channel frequencies individually.

4.3.7 Test Result

CDD Mode

802.11b

Channel	Frequency (MHz)	6dB Bandwidth (MHz)		Minimum Limit (MHz)	Pass / Fail
		Chain 0	Chain 1		
1	2412	8.15	8.15	0.5	PASS
6	2437	9.07	10.11	0.5	PASS
11	2462	7.63	8.14	0.5	PASS

802.11g

Channel	Frequency (MHz)	6dB Bandwidth (MHz)		Minimum Limit (MHz)	Pass / Fail
		Chain 0	Chain 1		
1	2412	16.42	16.44	0.5	PASS
6	2437	16.35	16.36	0.5	PASS
11	2462	16.39	16.42	0.5	PASS

Beamforming Mode

802.11n (HT20)

Channel	Frequency (MHz)	6dB Bandwidth (MHz)		Minimum Limit (MHz)	Pass / Fail
		Chain 0	Chain 1		
1	2412	17.61	17.63	0.5	Pass
6	2437	17.60	17.66	0.5	Pass
11	2462	17.65	17.64	0.5	Pass

802.11n (HT40)

Channel	Frequency (MHz)	6dB Bandwidth (MHz)		Minimum Limit (MHz)	Pass / Fail
		Chain 0	Chain 1		
3	2422	35.17	35.20	0.5	Pass
6	2437	35.37	35.24	0.5	Pass
9	2452	35.37	35.41	0.5	Pass

Spectrum Plot of Worst Value

802.11b / Chain 0 : CH11

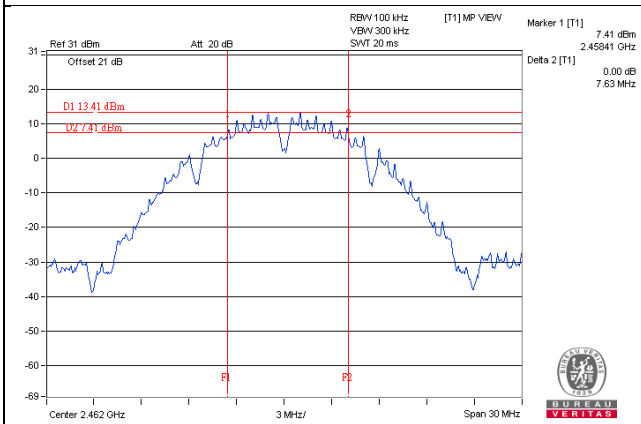

802.11g / Chain 0 : CH6

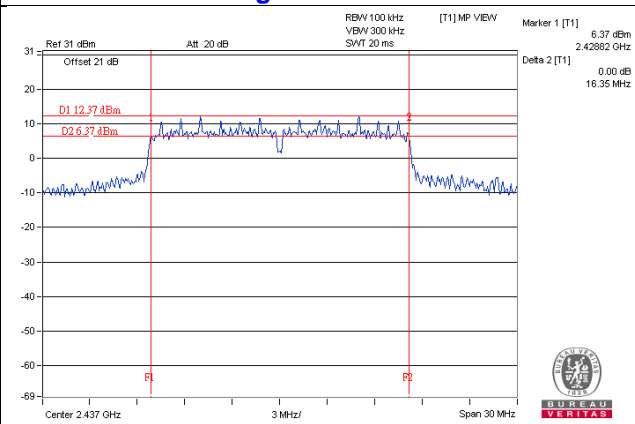

802.11n (HT20) / Chain 0 : CH6

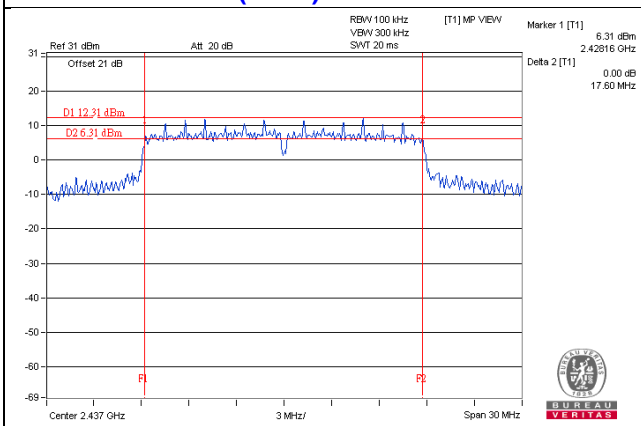

802.11n (HT40) / Chain 0 : CH3

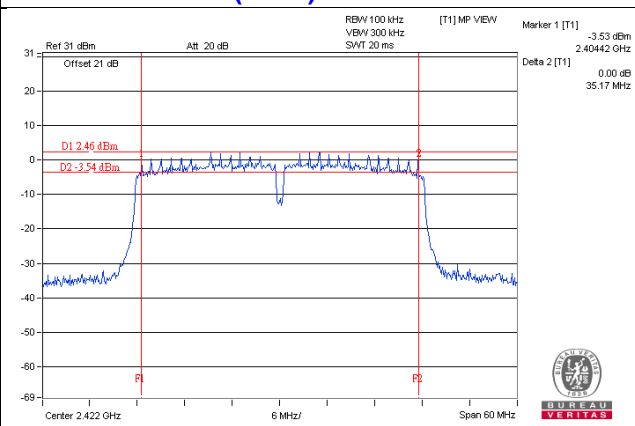

4.4 Conducted Output Power Measurement

4.4.1 Limits of Conducted Output Power Measurement

For systems using digital modulation in the 2400–2483.5 MHz bands: 1 Watt (30dBm)

Per KDB 662911 D01 Multiple Transmitter Output Method of conducted output power measurement on IEEE 802.11 devices,

Array Gain = 0 dB (i.e., no array gain) for $N_{ANT} \leq 4$;

Array Gain = 0 dB (i.e., no array gain) for channel widths ≥ 40 MHz for any N_{ANT} ;

Array Gain = $5 \log(N_{ANT}/N_{SS})$ dB or 3 dB, whichever is less for 20-MHz channel widths with $N_{ANT} \geq 5$.

For power measurements on all other devices: Array Gain = $10 \log(N_{ANT}/N_{SS})$ dB.

4.4.2 Test Setup

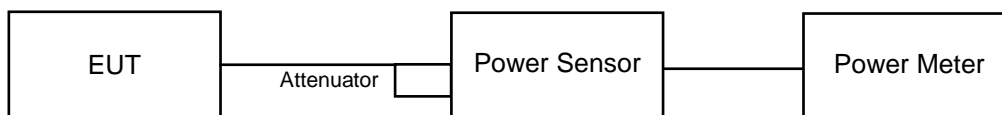

4.4.3 Test Instruments

Refer to section 4.1.2 to get information of above instrument.

4.4.4 Test Procedures

A peak / average power sensor was used on the output port of the EUT. A power meter was used to read the response of the peak / average power sensor. Record the power level.

4.4.5 Deviation from Test Standard

No deviation.

4.4.6 EUT Operating Conditions

Same as Item 4.3.6.

4.4.7 Test Results

FOR PEAK POWER

CDD Mode

802.11b

Chan.	Freq. (MHz)	Peak Power (dBm)		Total Power (mW)	Total Power (dBm)	Limit (dBm)	Pass / Fail
		Chain 0	Chain 1				
1	2412	23.47	23.32	437.114	26.41	30	Pass
6	2437	24.97	24.83	618.14	27.91	30	Pass
11	2462	23.40	23.72	454.281	26.57	30	Pass

802.11g

Chan.	Freq. (MHz)	Peak Power (dBm)		Total Power (mW)	Total Power (dBm)	Limit (dBm)	Pass / Fail
		Chain 0	Chain 1				
1	2412	24.08	24.02	508.207	27.06	30	Pass
6	2437	26.10	25.92	798.221	29.02	30	Pass
11	2462	24.55	24.71	580.903	27.64	30	Pass

Beamforming Mode

802.11n (HT20)

Chan.	Freq. (MHz)	Peak Power (dBm)		Total Power (mW)	Total Power (dBm)	Limit (dBm)	Pass / Fail
		Chain 0	Chain 1				
1	2412	24.10	24.20	520.067	27.16	30	Pass
6	2437	25.90	25.87	775.412	28.90	30	Pass
11	2462	23.71	23.96	483.849	26.85	30	Pass

802.11n (HT40)

Chan.	Freq. (MHz)	Peak Power (dBm)		Total Power (mW)	Total Power (dBm)	Limit (dBm)	Pass / Fail
		Chain 0	Chain 1				
3	2422	23.36	23.55	443.234	26.47	30	Pass
6	2437	24.23	24.21	528.483	27.23	30	Pass
9	2452	23.10	23.50	428.046	26.31	30	Pass

FOR AVERAGE POWER

CDD Mode

802.11b

Chan.	Frequency (MHz)	Avg. Power (dBm)		Total Power (mW)	Total Power (dBm)
		Chain 0	Chain 1		
1	2412	21.30	21.15	265.213	24.24
6	2437	23.16	23.03	407.923	26.11
11	2462	21.22	21.62	277.645	24.43

802.11g

Chan.	Frequency (MHz)	Avg. Power (dBm)		Total Power (mW)	Total Power (dBm)
		Chain 0	Chain 1		
1	2412	17.07	17.04	101.515	20.07
6	2437	23.97	24.06	504.142	27.03
11	2462	17.91	18.35	130.193	21.15

Beamforming Mode

802.11n (HT20)

Chan.	Frequency (MHz)	Avg. Power (dBm)		Total Power (mW)	Total Power (dBm)
		Chain 0	Chain 1		
1	2412	17.02	17.05	101.049	20.05
6	2437	23.81	24.02	492.784	26.93
11	2462	16.36	16.84	91.557	19.62

802.11n (HT40)

Chan.	Frequency (MHz)	Avg. Power (dBm)		Total Power (mW)	Total Power (dBm)
		Chain 0	Chain 1		
3	2422	16.04	16.26	82.446	19.16
6	2437	17.64	17.67	116.555	20.67
9	2452	15.55	15.87	74.529	18.72

4.5 Power Spectral Density Measurement

4.5.1 Limits of Power Spectral Density Measurement

The Maximum of Power Spectral Density Measurement is 8dBm.

4.5.2 Test Setup

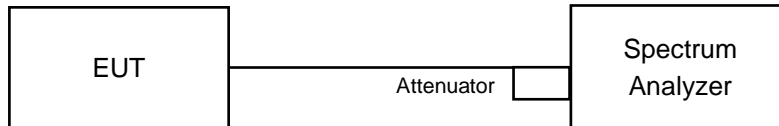

4.5.3 Test Instruments

Refer to section 4.1.2 to get information of above instrument.

4.5.4 Test Procedure

- a. Set analyzer center frequency to DTS channel center frequency.
- b. Set the span to 1.5 times the DTS bandwidth.
- c. Set the RBW to: $3 \text{ kHz} \leq \text{RBW} \leq 100 \text{ kHz}$.
- d. Set the VBW $\geq 3 \times \text{RBW}$.
- e. Detector = peak.
- f. Sweep time = auto couple.
- g. Trace mode = max hold.
- h. Allow trace to fully stabilize.
- i. Use the peak marker function to determine the maximum amplitude level within the RBW.

4.5.5 Deviation from Test Standard

No deviation.

4.5.6 EUT Operating Condition

Same as Item 4.3.6

4.5.7 Test Results

CDD Mode

802.11b

TX chain	Channel	Freq. (MHz)	PSD (dBm/3kHz)	10 log (N=2) dB	Total PSD (dBm/3kHz)	Limit (dBm/3kHz)	Pass /Fail
0	1	2412	-3.06	3.01	-0.05	6	Pass
	6	2437	-3.86	3.01	-0.85	6	Pass
	11	2462	-4.20	3.01	-1.19	6	Pass
1	1	2412	-4.19	3.01	-1.18	6	Pass
	6	2437	-2.81	3.01	0.20	6	Pass
	11	2462	-3.31	3.01	-0.30	6	Pass

NOTE: Directional gain = 5.23dBi < 6dBi, so the power limit shall not to be reduced.

802.11g

TX chain	Channel	Freq. (MHz)	PSD (dBm/3kHz)	10 log (N=2) dB	Total PSD (dBm/3kHz)	Limit (dBm/3kHz)	Pass /Fail
0	1	2412	-11.32	3.01	-8.31	6	Pass
	6	2437	-4.68	3.01	-1.67	6	Pass
	11	2462	-9.35	3.01	-6.34	6	Pass
1	1	2412	-10.98	3.01	-7.97	6	Pass
	6	2437	-5.23	3.01	-2.22	6	Pass
	11	2462	-9.39	3.01	-6.38	6	Pass

NOTE: Directional gain = 5.23dBi < 6dBi, so the power limit shall not to be reduced.

Beamforming Mode

802.11n (HT20)

TX chain	Channel	Freq. (MHz)	PSD (dBm/3kHz)	10 log (N=2) dB	Total PSD (dBm/3kHz)	Limit (dBm/3kHz)	Pass /Fail
0	1	2412	-10.17	3.01	-7.16	6	Pass
	6	2437	-5.60	3.01	-2.59	6	Pass
	11	2462	-11.31	3.01	-8.30	6	Pass
1	1	2412	-10.50	3.01	-7.49	6	Pass
	6	2437	-5.37	3.01	-2.36	6	Pass
	11	2462	-10.78	3.01	-7.77	6	Pass

NOTE: Directional gain = 5.23dBi < 6dBi, so the power limit shall not to be reduced.

802.11n (HT40)

TX chain	Channel	Freq. (MHz)	PSD (dBm/3kHz)	10 log (N=2) dB	Total PSD (dBm/3kHz)	Limit (dBm/3kHz)	Pass /Fail
0	3	2422	-12.71	3.01	-9.70	6	Pass
	6	2437	-12.09	3.01	-9.08	6	Pass
	9	2452	-14.33	3.01	-11.32	6	Pass
1	3	2422	-14.23	3.01	-11.22	6	Pass
	6	2437	-11.92	3.01	-8.91	6	Pass
	9	2452	-13.18	3.01	-10.17	6	Pass

NOTE: Directional gain = 5.23dBi < 6dBi, so the power limit shall not to be reduced.

Spectrum Plot of Worst Value

802.11b / Chain 1 : CH6

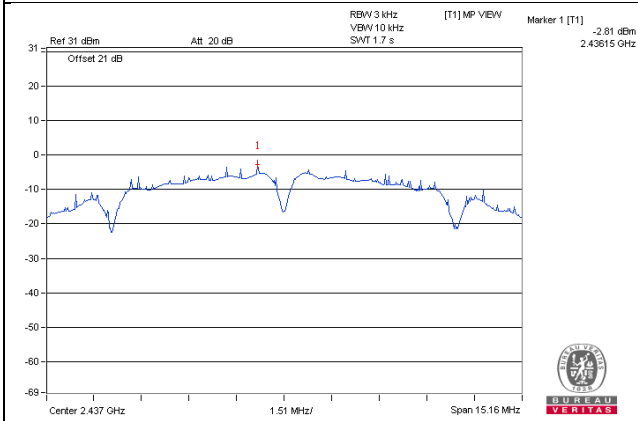

802.11g / Chain 0 : CH6

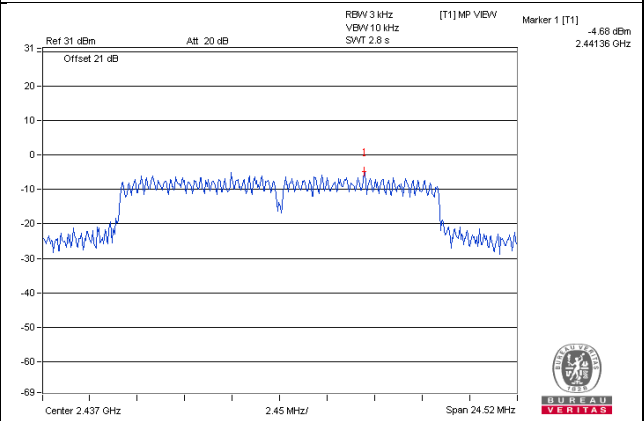

802.11n (HT20) / Chain 1 : CH6

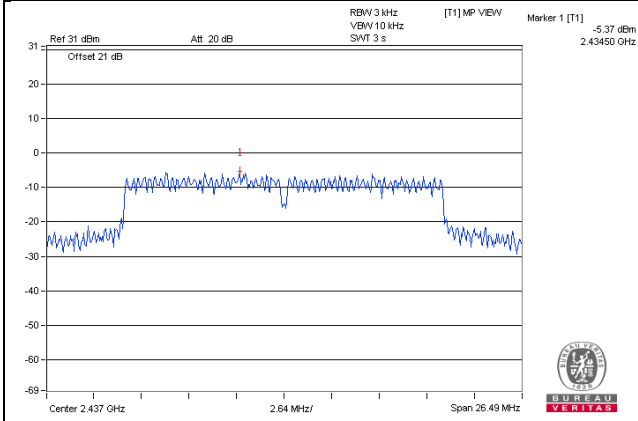

802.11n (HT40) / Chain 1 : CH6

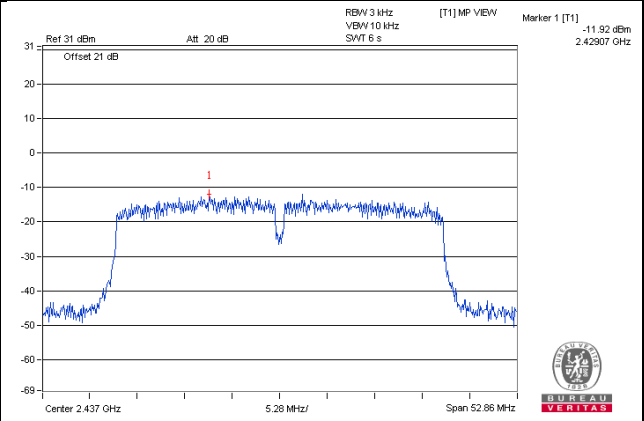

4.6 Conducted Out of Band Emission Measurement

4.6.1 Limits of Conducted Out of Band Emission Measurement

Below 20dB of the highest emission level of operating band (in 100kHz Resolution Bandwidth).

4.6.2 Test Setup

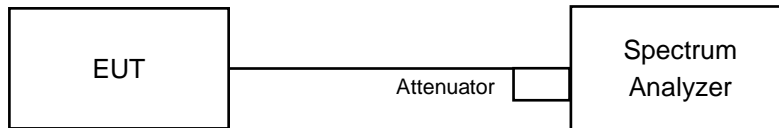

4.6.3 Test Instruments

Refer to section 4.1.2 to get information of above instrument.

4.6.4 Test Procedure

MEASUREMENT PROCEDURE REF

1. Set the RBW = 100 kHz.
2. Set the VBW \geq 300 kHz.
3. Detector = peak.
4. Sweep time = auto couple.
5. Trace mode = max hold.
6. Allow trace to fully stabilize.
7. Use the peak marker function to determine the maximum power level in any 100 kHz band segment within the fundamental EBW.

MEASUREMENT PROCEDURE OOBE

1. Set RBW = 100 kHz.
2. Set VBW \geq 300 kHz.
3. Detector = peak.
4. Sweep = auto couple.
5. Trace Mode = max hold.
6. Allow trace to fully stabilize.
7. Use the peak marker function to determine the maximum amplitude level.

4.6.5 Deviation from Test Standard

No deviation.

4.6.6 EUT Operating Condition

Same as Item 4.3.6

4.6.7 Test Results

The spectrum plots are attached on the following pages. D1 line indicates the highest level, and D2 line indicates the 20dB offset below D1. It shows compliance with the requirement.

802.11b - CHAIN 0

CH 1

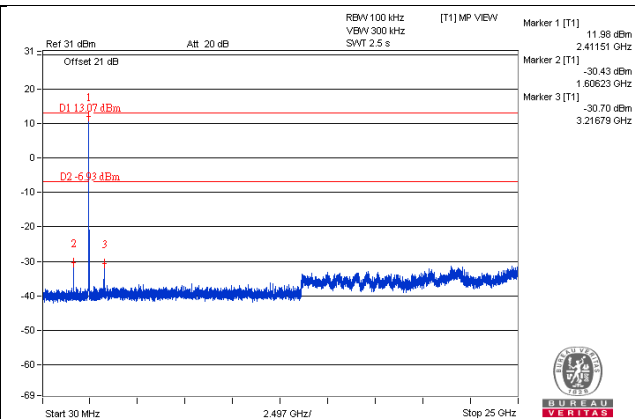
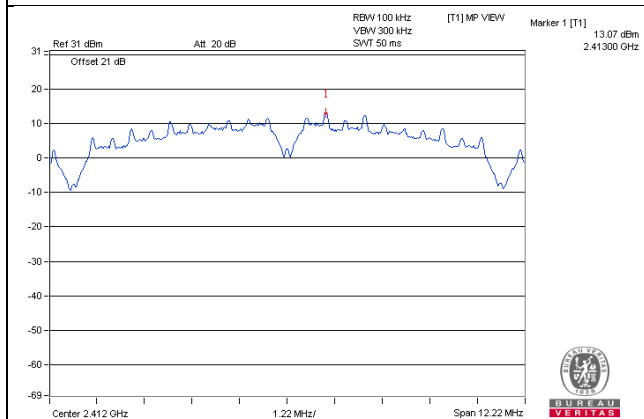

CH 6

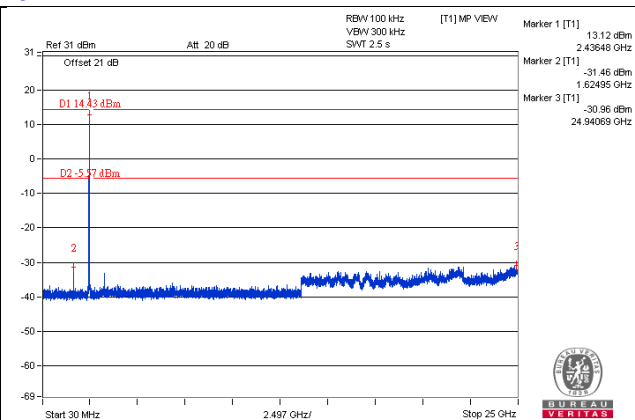
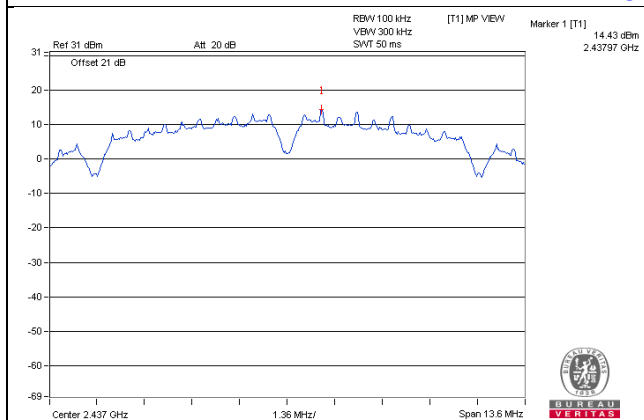

CH 11

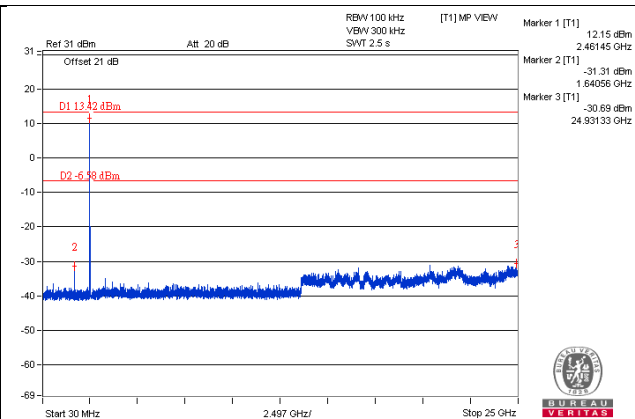
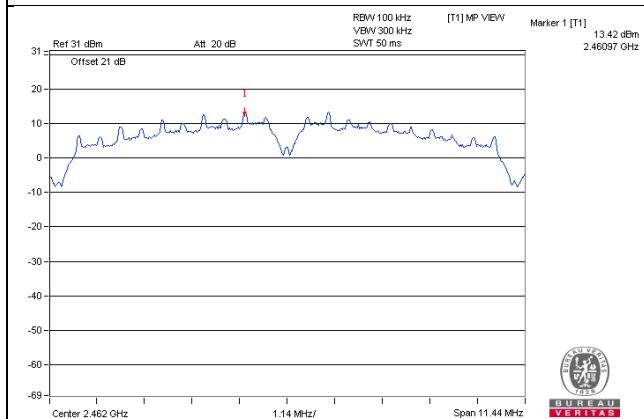

CH 1 Band edge

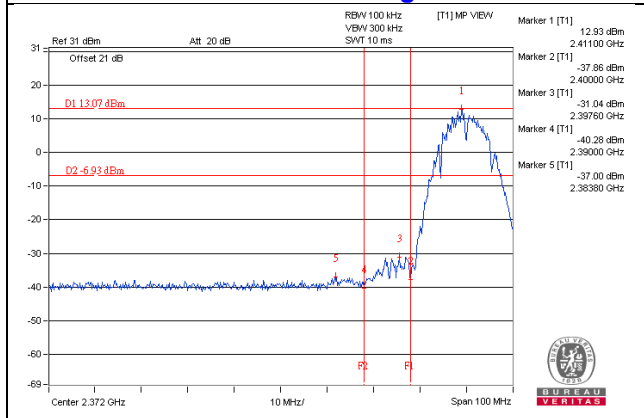

CH 11 Band edge

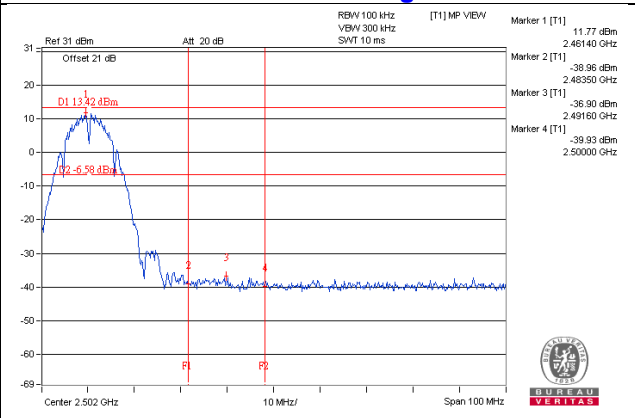

CHAIN 1

CH 1

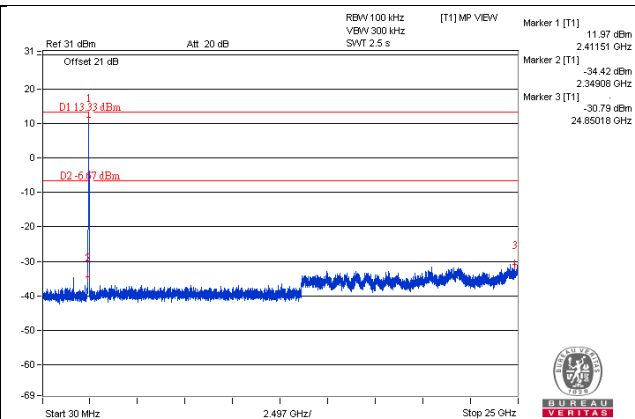
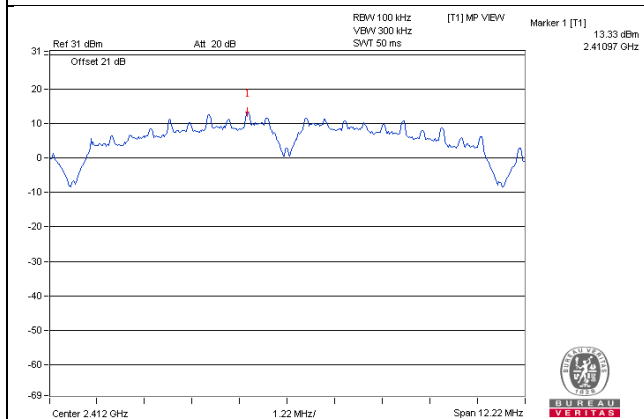

CH 6

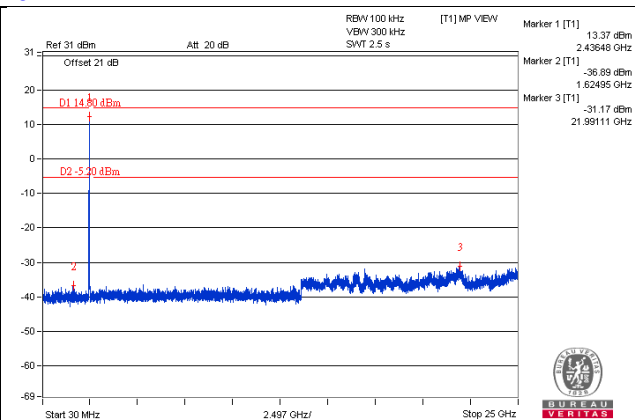
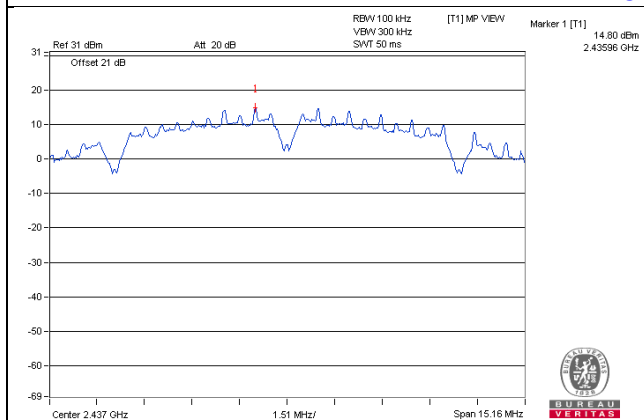

CH 11

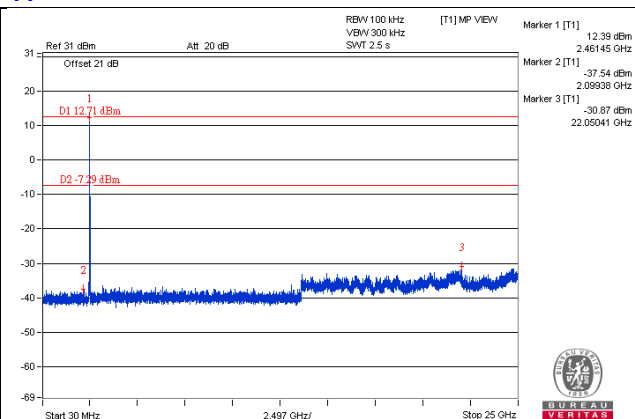
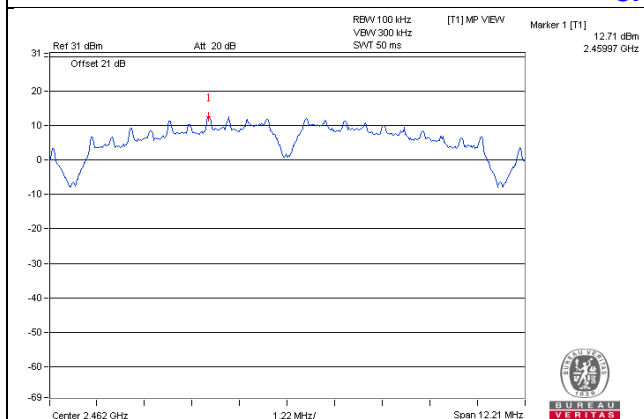

CH 1 Band edge

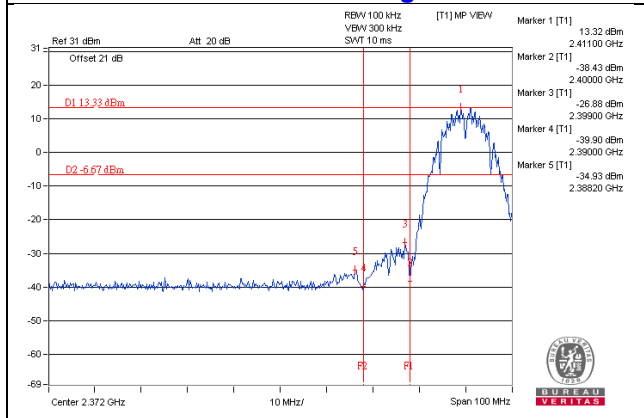

CH 11 Band edge

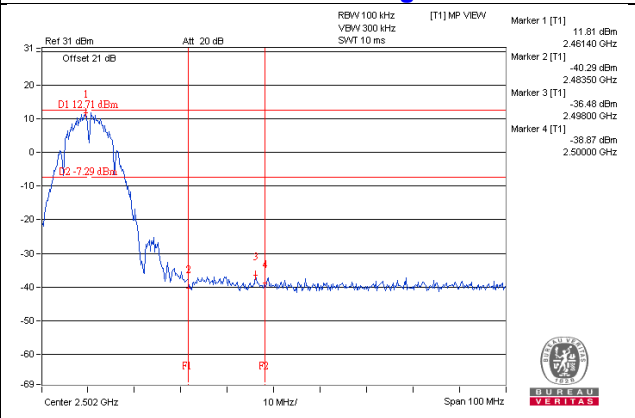

802.11g - CHAIN 0

CH 1

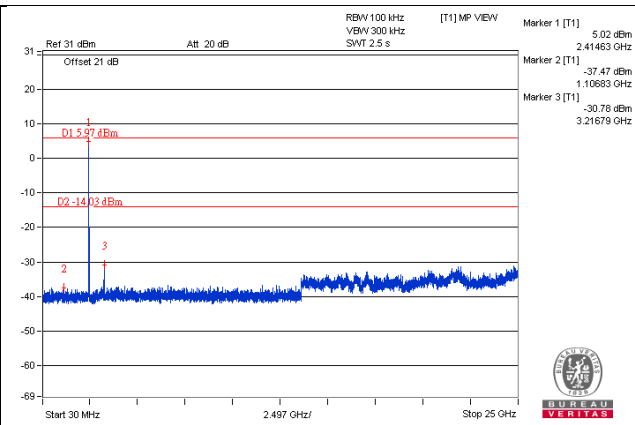
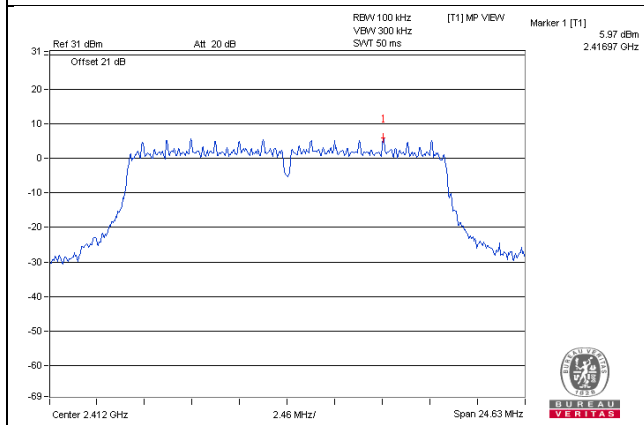

CH 6

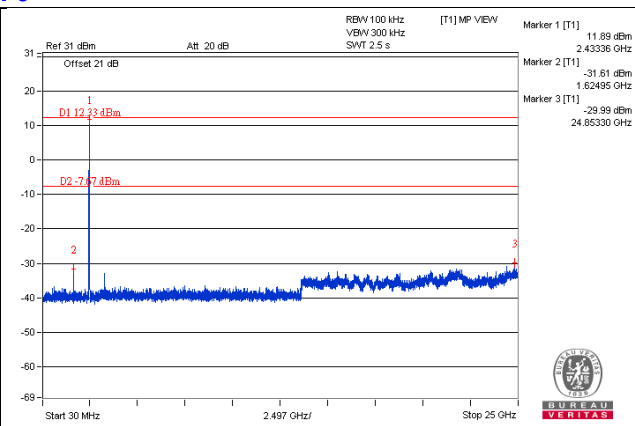
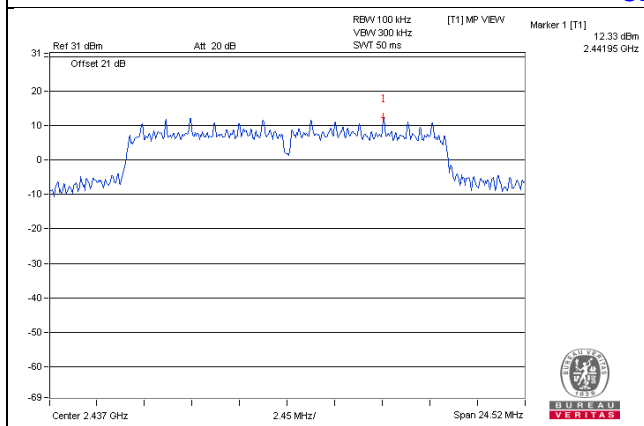

CH 11

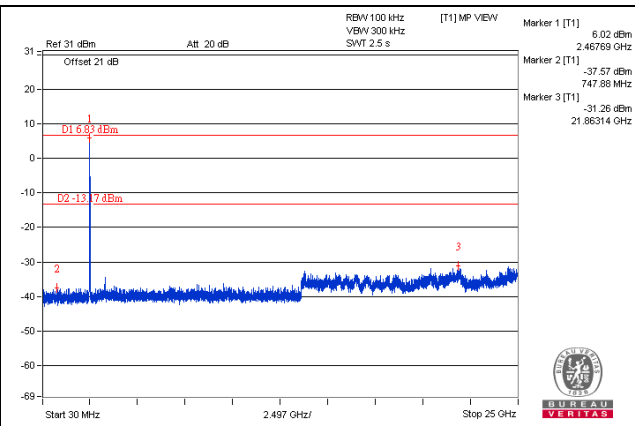
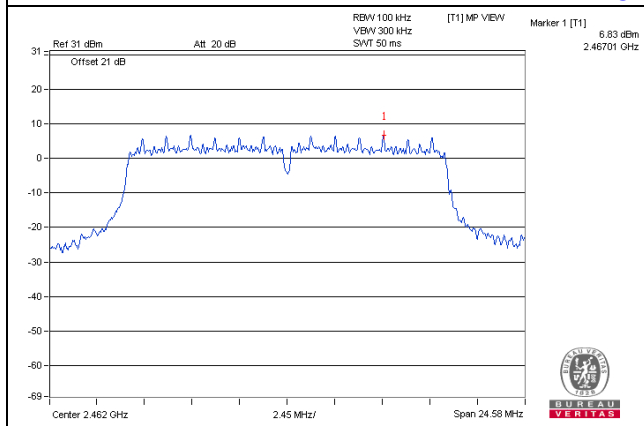

CH 1 Band edge

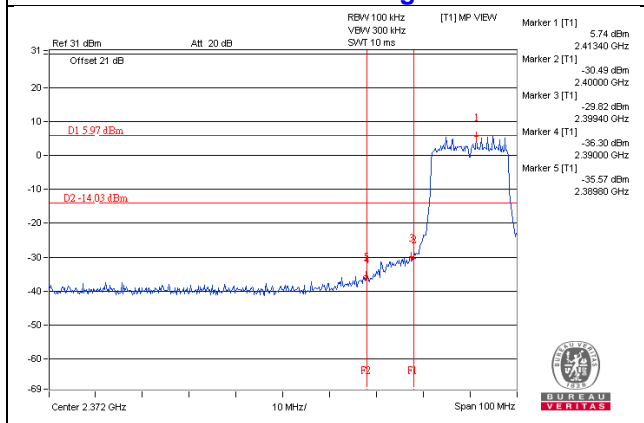

CH 11 Band edge

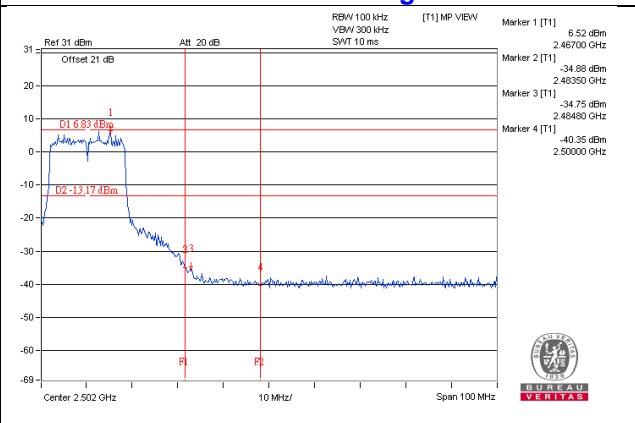

CHAIN 1

CH 1

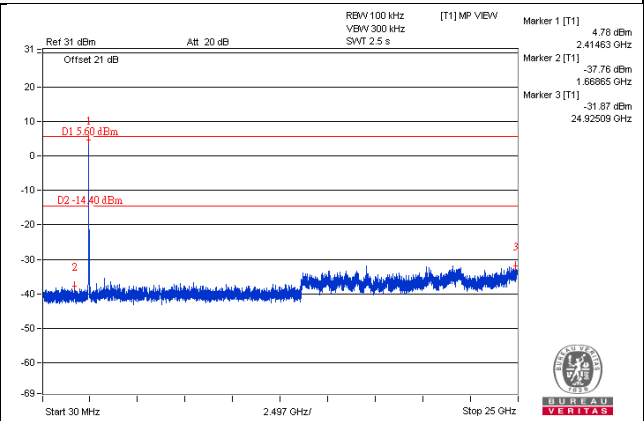
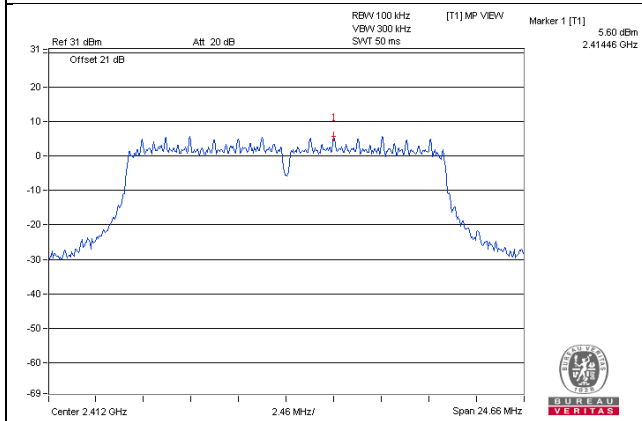

CH 6

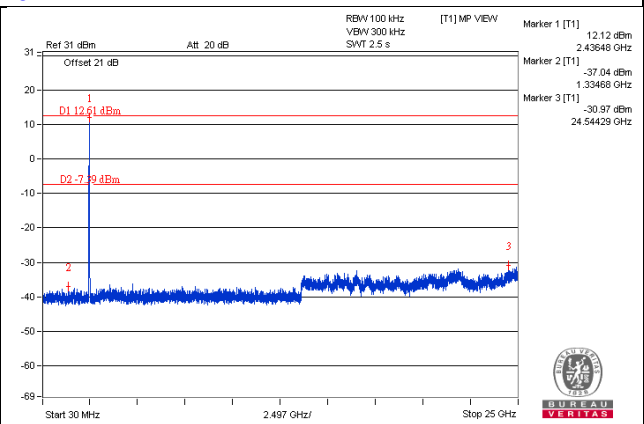
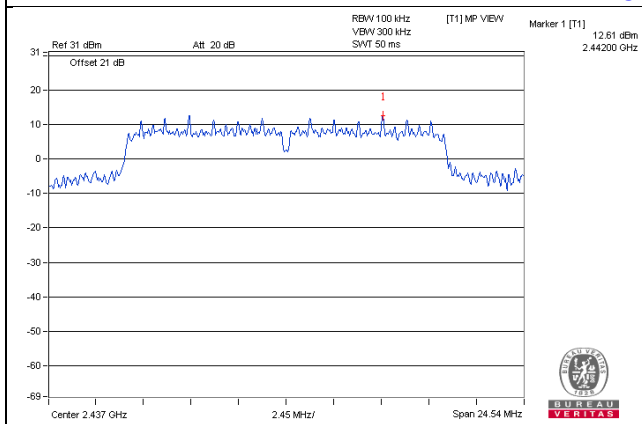

CH 11

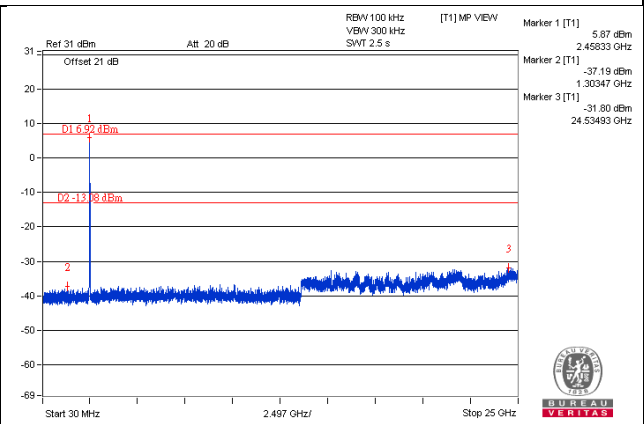
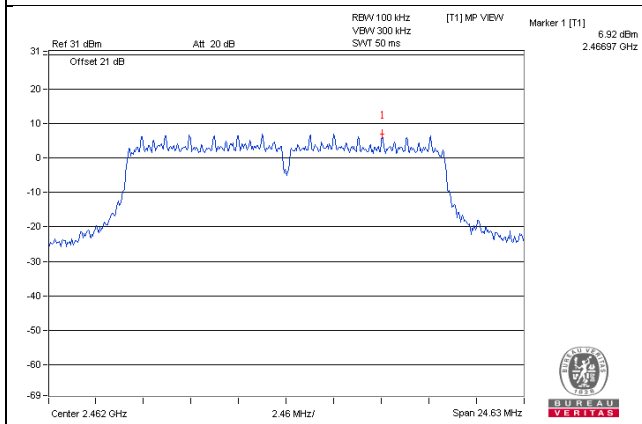

CH 1 Band edge

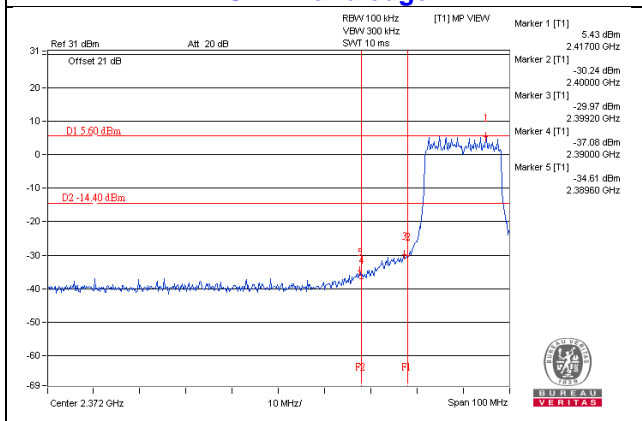

CH 11 Band edge

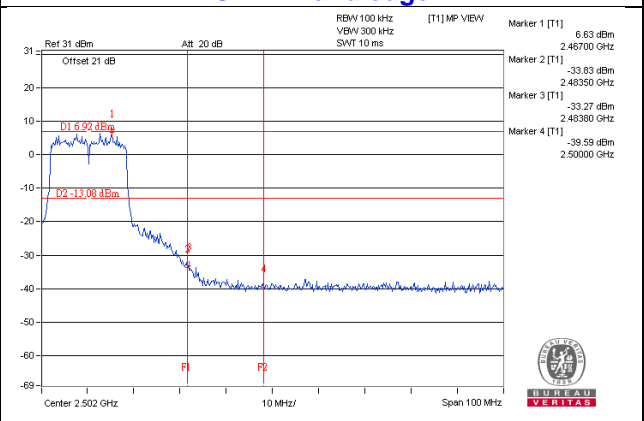

802.11n (HT20) - CHAIN 0

CH 1

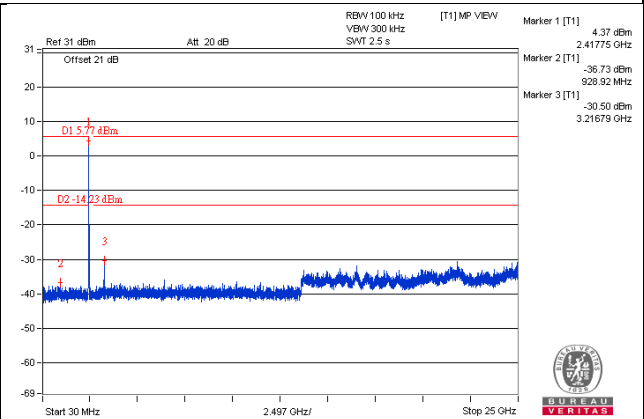
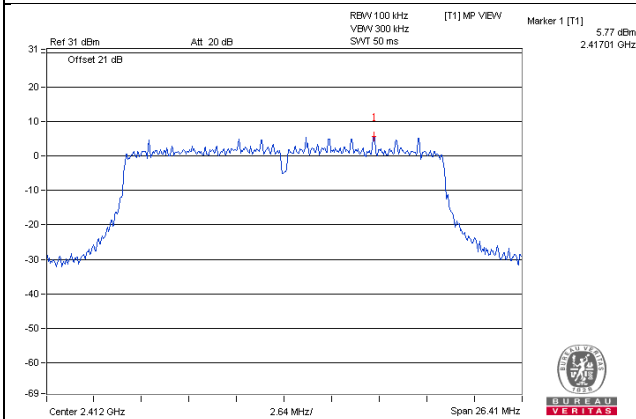

CH 6

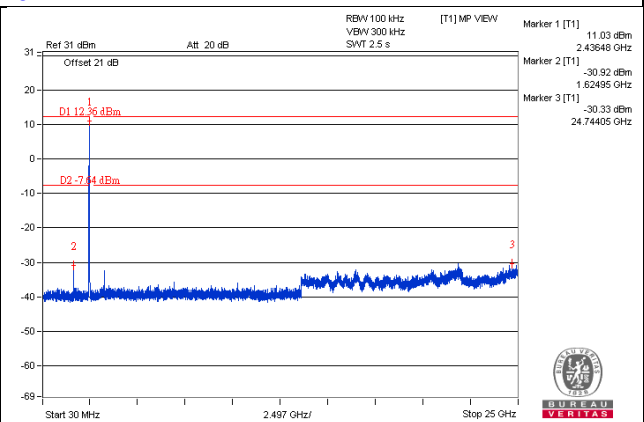
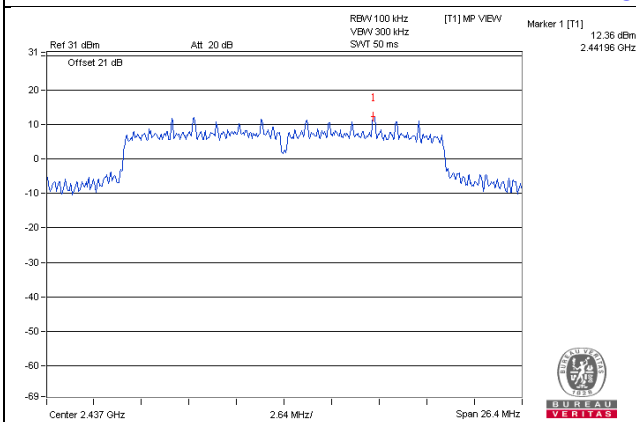

CH 11

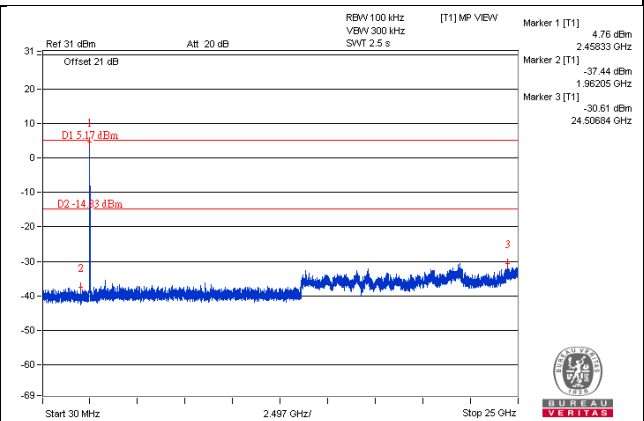
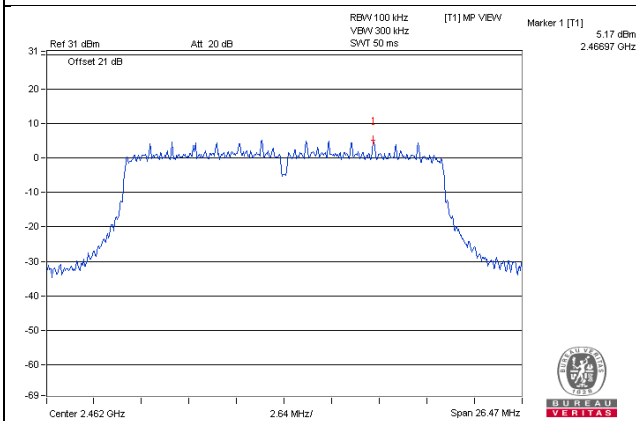

CH 1 Band edge

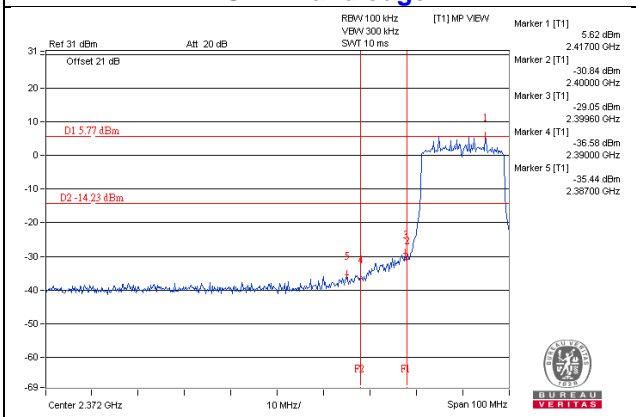

CH 11 Band edge

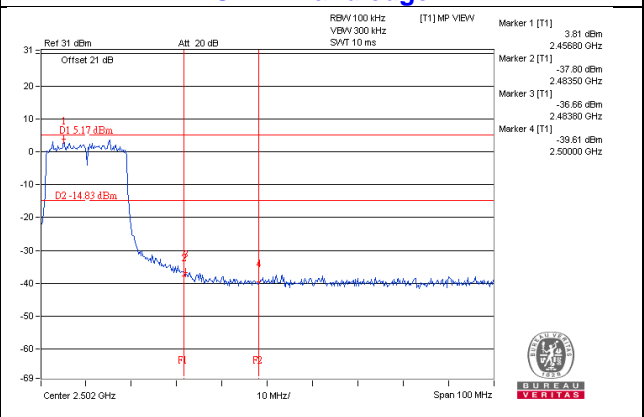

CHAIN 1

CH 1

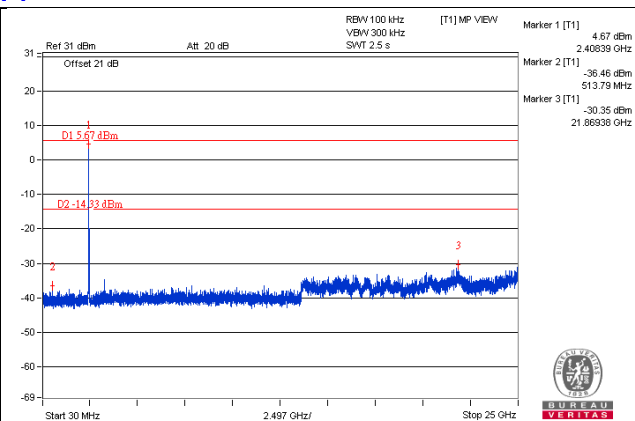
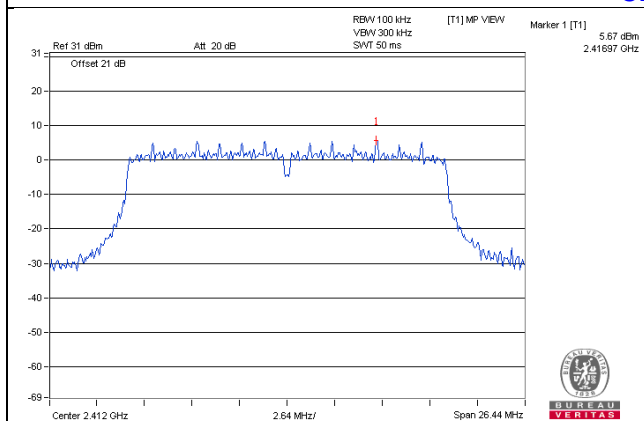

CH 6

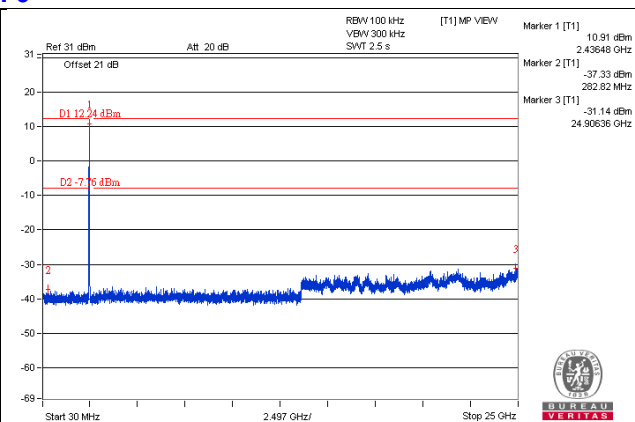
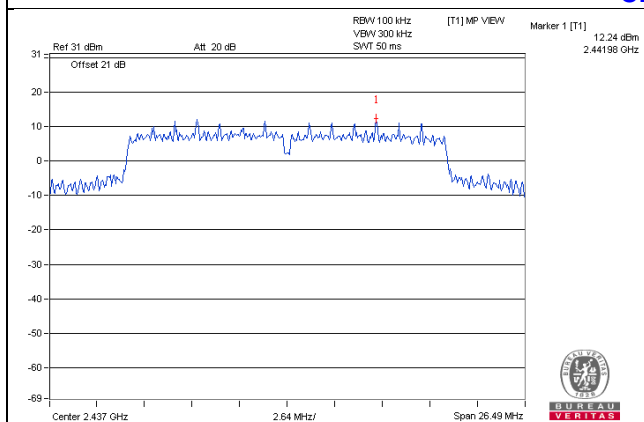

CH 11

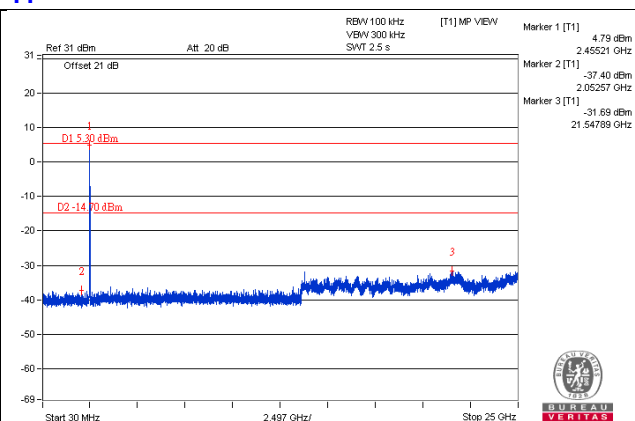
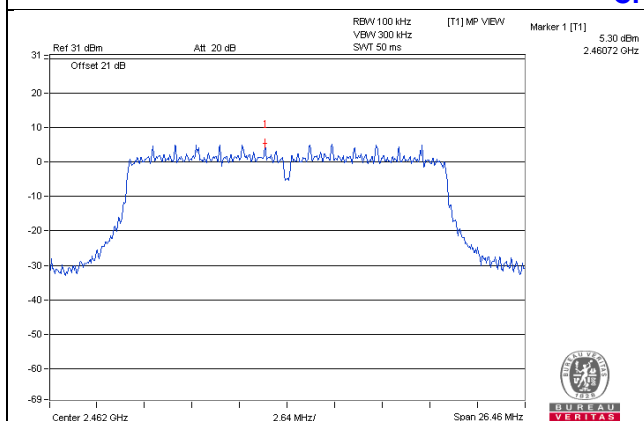

CH 1 Band edge

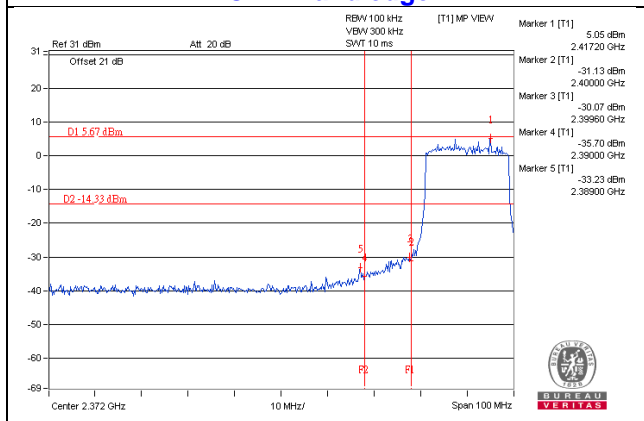

CH 11 Band edge

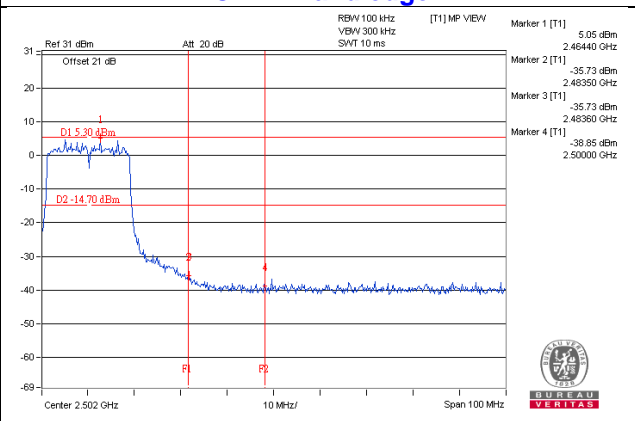

802.11n (HT40) - Chain 0

CH 3

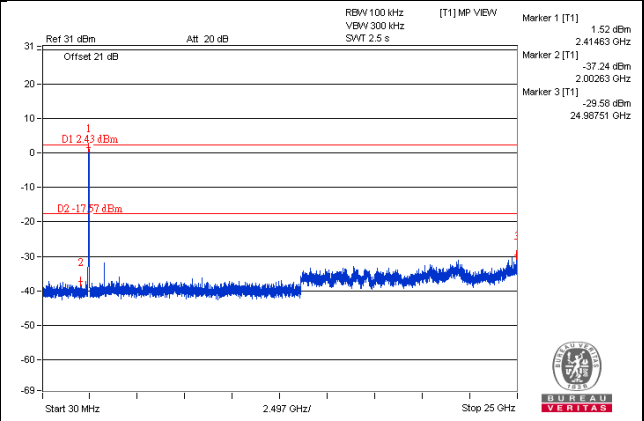
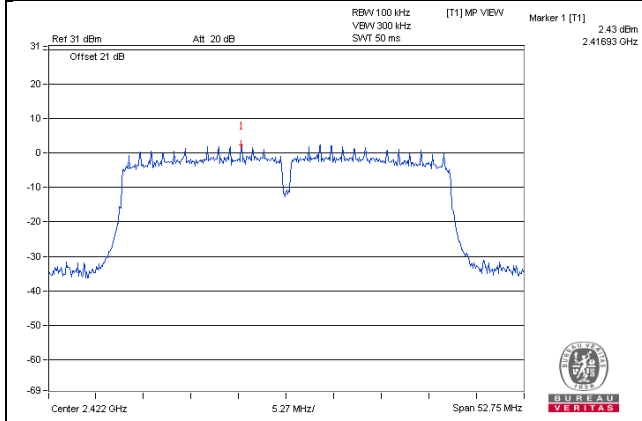

CH 6

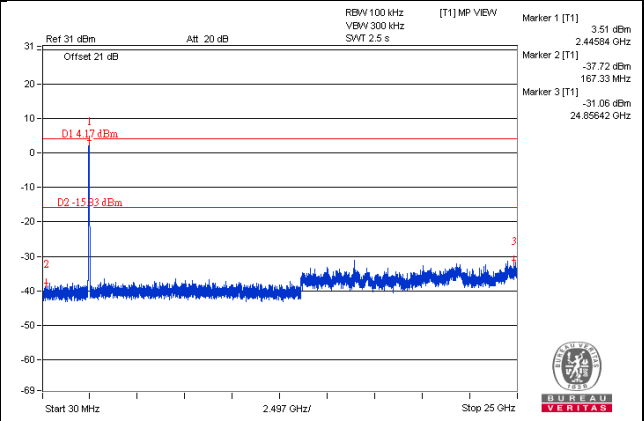
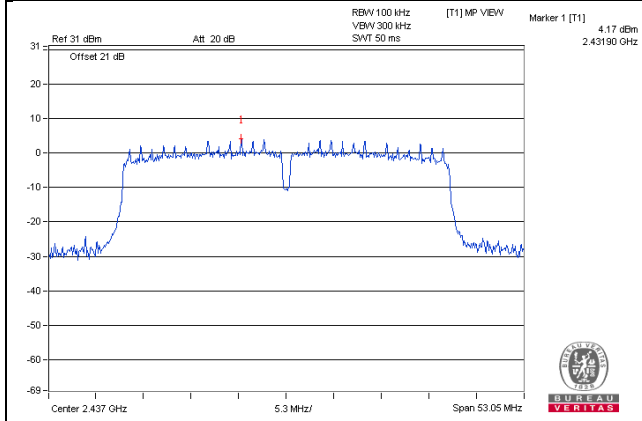

CH 9

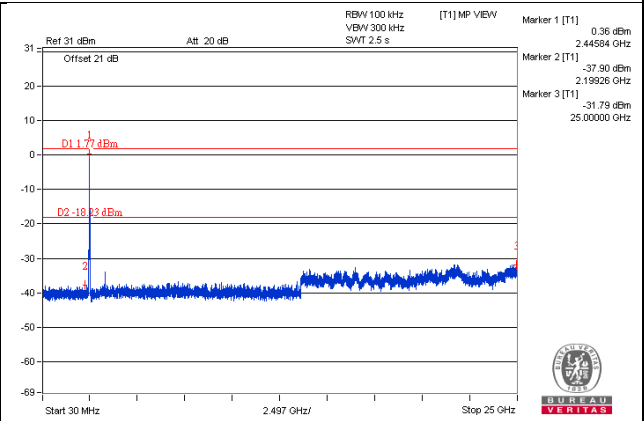
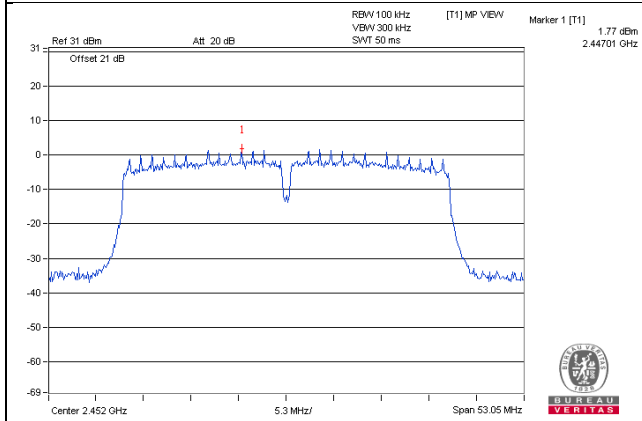

CH 3 Band edge

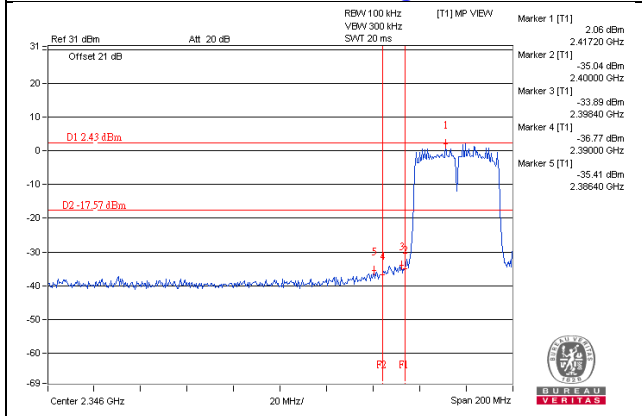

CH 9 Band edge

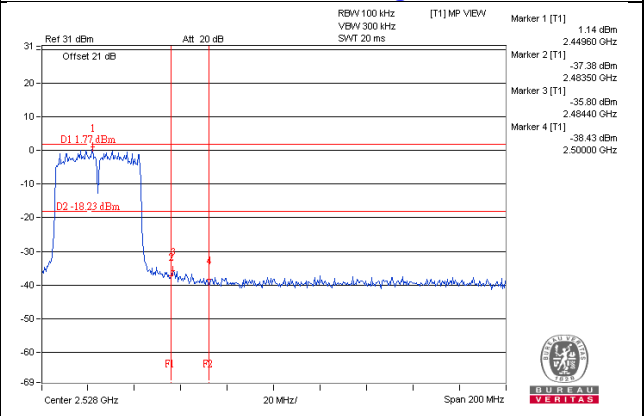

Chain 1

CH 3

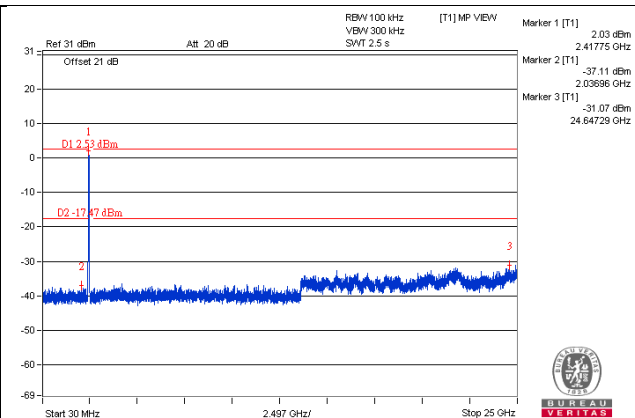
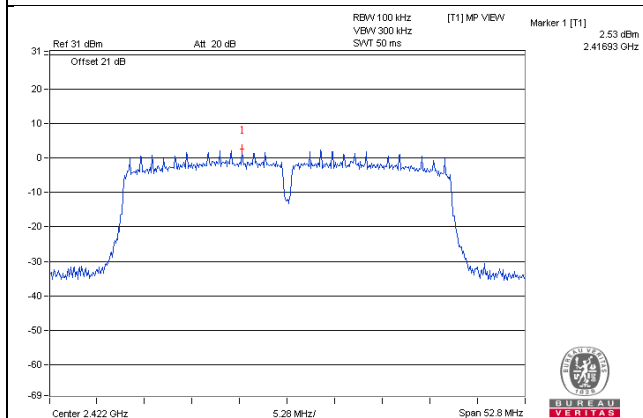

CH 6

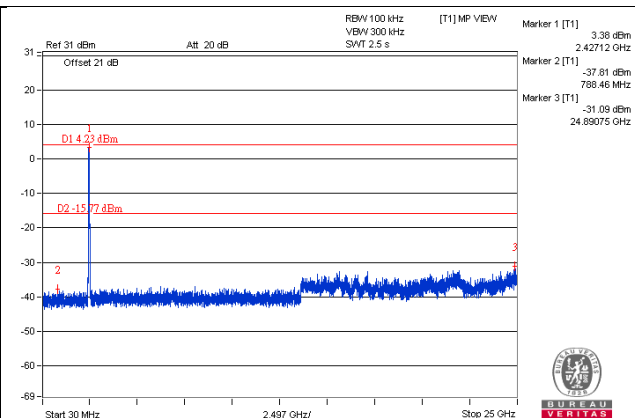
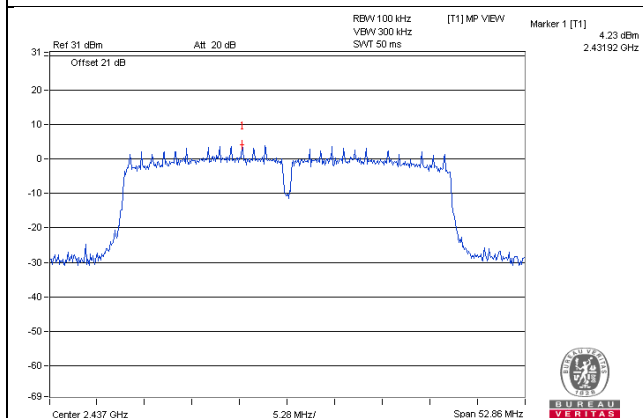

CH 9

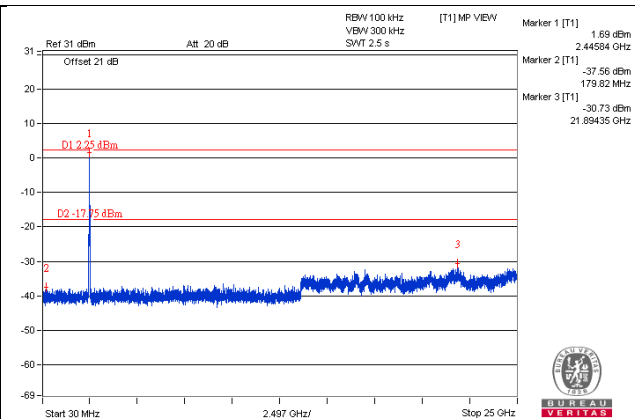
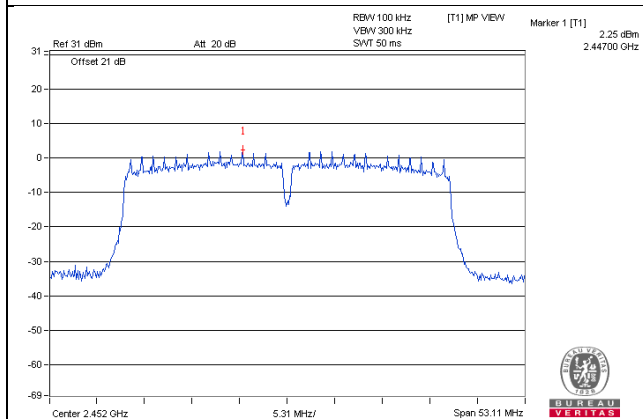

CH 3 Band edge

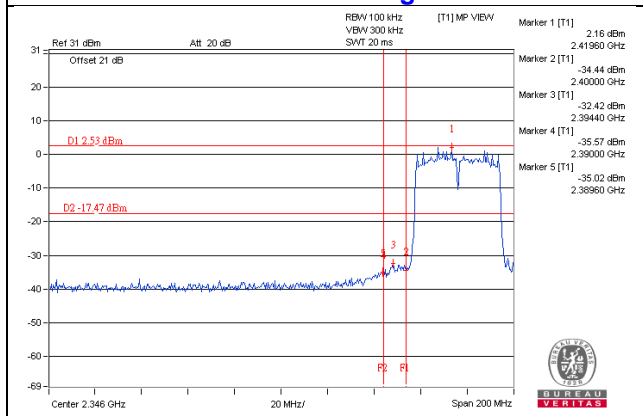

CH 9 Band edge

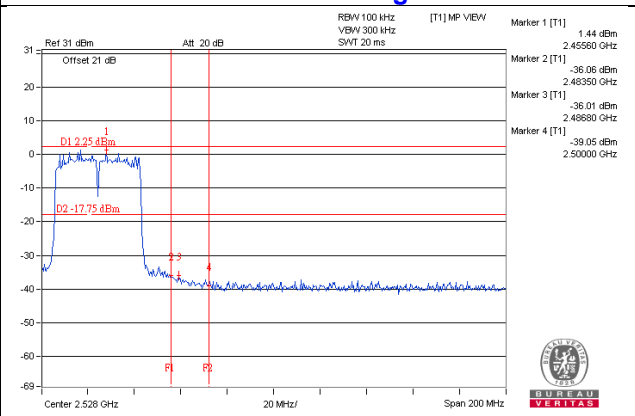

5 Pictures of Test Arrangements

Please refer to the attached file (Test Setup Photo).

Appendix – Information on the Testing Laboratories

We, Bureau Veritas Consumer Products Services (H.K.) Ltd., Taoyuan Branch, were founded in 1988 to provide our best service in EMC, Radio, Telecom and Safety consultation. Our laboratories are accredited and approved according to ISO/IEC 17025.

If you have any comments, please feel free to contact us at the following:

Linko EMC/RF Lab

Tel: 886-2-26052180

Fax: 886-2-26051924

Hsin Chu EMC/RF/Telecom Lab

Tel: 886-3-6668565

Fax: 886-3-6668323

Hwa Ya EMC/RF/Safety Lab

Tel: 886-3-3183232

Fax: 886-3-3270892

Email: service.adt@tw.bureauveritas.com

Web Site: www.bureauveritas-adt.com

The address and road map of all our labs can be found in our web site also.

--- END ---