

## FCC Test Report

**Report No.:** RF170322E05

**FCC ID:** PY317100371

**Test Model:** ABC1000

**Received Date:** Mar. 22, 2017

**Test Date:** Mar. 28 to Apr. 07, 2017

**Issued Date:** Apr. 13, 2017

**Applicant:** NETGEAR, INC

**Address:** 350 East Plumeria Drive San Jose, CA 95134

**Issued By:** Bureau Veritas Consumer Products Services (H.K.) Ltd., Taoyuan Branch  
Hsin Chu Laboratory

**Lab Address:** E-2, No.1, Li Hsin 1st Road, Hsinchu Science Park, Hsinchu City 300,  
Taiwan R.O.C.

**Test Location (1):** E-2, No.1, Li Hsin 1st Road, Hsinchu Science Park, Hsinchu City 300,  
Taiwan R.O.C.

**Test Location (2):** No. 49, Ln. 206, Wende Rd., Shangshan Tsuen, Chiung Lin Hsiang, Hsin  
Chu Hsien 307, Taiwan R.O.C.



This report is for your exclusive use. Any copying or replication of this report to or for any other person or entity, or use of our name or trademark, is permitted only with our prior written permission. This report sets forth our findings solely with respect to the test samples identified herein. The results set forth in this report are not indicative or representative of the quality or characteristics of the lot from which a test sample was taken or any similar or identical product unless specifically and expressly noted. Our report includes all of the tests requested by you and the results thereof based upon the information that you provided to us. You have 60 days from date of issuance of this report to notify us of any material error or omission caused by our negligence, provided, however, that such notice shall be in writing and shall specifically address the issue you wish to raise. A failure to raise such issue within the prescribed time shall constitute your unqualified acceptance of the completeness of this report, the tests conducted and the correctness of the report contents. Unless specific mention, the uncertainty of measurement has been explicitly taken into account to declare the compliance or non-compliance to the specification. The report must not be used by the client to claim product certification, approval, or endorsement by TAF or any government agencies.

## Table of Contents

<b>Release Control Record</b> .....	<b>4</b>
<b>1 Certificate of Conformity</b> .....	<b>5</b>
<b>2 Summary of Test Results</b> .....	<b>6</b>
2.1 Measurement Uncertainty .....	6
2.2 Modification Record .....	6
<b>3 General Information</b> .....	<b>7</b>
3.1 General Description of EUT .....	7
3.2 Description of Test Modes .....	9
3.2.1 Test Mode Applicability and Tested Channel Detail .....	10
3.3 Duty Cycle of Test Signal .....	12
3.4 Description of Support Units .....	13
3.4.1 Configuration of System under Test .....	14
3.5 General Description of Applied Standards .....	15
<b>4 Test Types and Results</b> .....	<b>16</b>
4.1 Radiated Emission and Bandedge Measurement .....	16
4.1.1 Limits of Radiated Emission and Bandedge Measurement .....	16
4.1.2 Test Instruments .....	17
4.1.3 Test Procedures .....	19
4.1.4 Deviation from Test Standard .....	19
4.1.5 Test Setup .....	20
4.1.6 EUT Operating Conditions .....	21
4.1.7 Test Results (Mode 1) .....	22
4.1.8 Test Results (Mode 3) .....	35
4.2 Conducted Emission Measurement .....	47
4.2.1 Limits of Conducted Emission Measurement .....	47
4.2.2 Test Instruments .....	47
4.2.3 Test Procedures .....	48
4.2.4 Deviation from Test Standard .....	48
4.2.5 Test Setup .....	48
4.2.6 EUT Operating Conditions .....	48
4.2.7 Test Results (Mode 1) .....	49
4.2.8 Test Results (Mode 2) .....	51
4.3 6dB Bandwidth Measurement .....	53
4.3.1 Limits of 6dB Bandwidth Measurement .....	53
4.3.2 Test Setup .....	53
4.3.3 Test Instruments .....	53
4.3.4 Test Procedure .....	53
4.3.5 Deviation from Test Standard .....	53
4.3.6 EUT Operating Conditions .....	53
4.3.7 Test Result .....	54
4.4 Conducted Output Power Measurement .....	56
4.4.1 Limits of Conducted Output Power Measurement .....	56
4.4.2 Test Setup .....	56
4.4.3 Test Instruments .....	56
4.4.4 Test Procedures .....	56
4.4.5 Deviation from Test Standard .....	56
4.4.6 EUT Operating Conditions .....	56
4.4.7 Test Results .....	57
4.5 Power Spectral Density Measurement .....	58
4.5.1 Limits of Power Spectral Density Measurement .....	58
4.5.2 Test Setup .....	58
4.5.3 Test Instruments .....	58
4.5.4 Test Procedure .....	58

4.5.5	Deviation from Test Standard .....	58
4.5.6	EUT Operating Condition .....	58
4.5.7	Test Results .....	59
4.6	Conducted Out of Band Emission Measurement .....	61
4.6.1	Limits of Conducted Out of Band Emission Measurement.....	61
4.6.2	Test Setup.....	61
4.6.3	Test Instruments .....	61
4.6.4	Test Procedure .....	61
4.6.5	Deviation from Test Standard .....	61
4.6.6	EUT Operating Condition .....	61
4.6.7	Test Results .....	61
<b>5</b>	<b>Pictures of Test Arrangements.....</b>	<b>66</b>
	<b>Appendix – Information on the Testing Laboratories .....</b>	<b>67</b>

### Release Control Record

Issue No.	Description	Date Issued
RF170322E05	Original release.	Apr. 13, 2017

## 1 Certificate of Conformity

**Product:** Alro Baby

**Brand:** NETGEAR

**Test Model:** ABC1000

**Sample Status:** ENGINEERING SAMPLE

**Applicant:** NETGEAR, INC

**Test Date:** Mar. 28 to Apr. 07, 2017

**Standards:** 47 CFR FCC Part 15, Subpart C (Section 15.247)  
ANSI C63.10: 2013

The above equipment has been tested by **Bureau Veritas Consumer Products Services (H.K.) Ltd., Taoyuan Branch**, and found compliance with the requirement of the above standards. The test record, data evaluation & Equipment Under Test (EUT) configurations represented herein are true and accurate accounts of the measurements of the sample's EMC characteristics under the conditions specified in this report.

**Prepared by :** Wendy Wu , **Date:** Apr. 13, 2017  
Wendy Wu / Specialist

**Approved by :** May Chen , **Date:** Apr. 13, 2017  
May Chen / Manager

## 2 Summary of Test Results

47 CFR FCC Part 15, Subpart C (SECTION 15.247)			
FCC Clause	Test Item	Result	Remarks
15.207	AC Power Conducted Emission	PASS	Meet the requirement of limit. Minimum passing margin is -9.51dB at 0.16953MHz.
15.205 / 15.209 / 15.247(d)	Radiated Emissions and Band Edge Measurement	PASS	Meet the requirement of limit. Minimum passing margin is -0.1dB at 2483.50MHz, 2390.00MHz.
15.247(d)	Antenna Port Emission	PASS	Meet the requirement of limit.
15.247(a)(2)	6dB bandwidth	PASS	Meet the requirement of limit.
15.247(b)	Conducted power	PASS	Meet the requirement of limit.
15.247(e)	Power Spectral Density	PASS	Meet the requirement of limit.
15.203	Antenna Requirement	PASS	No antenna connector is used.

### 2.1 Measurement Uncertainty

Where relevant, the following measurement uncertainty levels have been estimated for tests performed on the EUT as specified in CISPR 16-4-2:

Measurement	Frequency	Expanded Uncertainty (k=2) ( $\pm$ )
Conducted Emissions at mains ports	150kHz ~ 30MHz	1.84 dB
Radiated Emissions up to 1 GHz	30MHz ~ 1GHz	5.32 dB
Radiated Emissions above 1 GHz	1GHz ~ 6GHz	4.82 dB
	6GHz ~ 18GHz	4.58 dB
	18GHz ~ 40GHz	5.03 dB

### 2.2 Modification Record

There were no modifications required for compliance.

### 3 General Information

#### 3.1 General Description of EUT

Product	Alro Baby
Brand	NETGEAR
Test Model	ABC1000
Status of EUT	ENGINEERING SAMPLE
Power Supply Rating	5Vdc from power adapter or 3.6V from battery
Modulation Type	CCK, DQPSK, DBPSK for DSSS 64QAM, 16QAM, QPSK, BPSK for OFDM 256QAM for OFDM in 11ac mode only
Modulation Technology	DSSS, OFDM
Transfer Rate	802.11b: up to 11Mbps 802.11a/g: up to 54Mbps 802.11n: up to 150Mbps 802.11ac: up to 433.3Mbps
Operating Frequency	<b>2.4GHz:</b> 2.412 ~ 2.462GHz <b>5GHz:</b> 5.18 ~ 5.24GHz, 5.745 ~ 5.825GHz
Number of Channel	<b>2.4GHz:</b> 802.11b, 802.11g, 802.11n (HT20), VHT20: 11 802.11n (HT40), VHT40: 7 <b>5GHz:</b> 802.11a, 802.11n (HT20), 802.11ac (VHT20): 9 802.11n (HT40), 802.11ac (VHT40): 4 802.11ac (VHT80): 2
Output Power	<b>2.4GHz:</b> 162.555mW <b>5GHz:</b> <b>5.18 ~ 5.24GHz:</b> 75.162mW <b>5.745 ~ 5.825GH:</b> 79.799mW
Antenna Type	Refer to Note
Antenna Connector	Refer to Note
Accessory Device	Adapter x 1
Data Cable Supplied	USB cable x 1 (3m, unshielded)

Note:

- The EUT must be supplied with a power adapter or battery and following different models could be chosen as following table:

Adapter					
No	Brand Name	Model No.	P/N	Spec.	
1	NETGEAR	AD2037320	332-10924-01	Input: 100-240Vac, 50/60Hz, 0.3A Output: 5Vdc, 2A	
2	NETGEAR	AD2037520	332-10925-01	Input: 100-240Vac, 50/60Hz, 0.3A Output: 5Vdc, 2A	
Battery					
No	Brand Name	Model No.	P/N	Rating	Min. Capacity
1	NETGEAR	A-3	308-10033-01	3.6V 8.78Wh	2440mA

Note:

- The adapter 2 is as same as adapter 1; except for color is different.
- From the above adapters and battery, the radiated emissions worse case was found in Adapter 1. Therefore only the test data of the mode was recorded in this report.

2. Simultaneously transmission condition.

Condition	Technology	
1	WLAN (5GHz)	Bluetooth

**Note:** The emission of the simultaneous operation has been evaluated and no non-compliance was found.

3. The antennas provided to the EUT, please refer to the following table:

Chain No.	Ant. Gain(dBi)	Frequency range (GHz)	Antenna Type	Connecter Type
Chain 0	2.64	2.4~2.4835	PIFA	NA
	5.61	5.15~5.25		
	4.92	5.25~5.35		
	4.83	5.47~5.725		
	5.38	5.725~5.85		
Chain 1	3.18	2.4~2.4835	Monopole	NA
	4.13	5.15~5.25		
	4.23	5.25~5.35		
	3.14	5.47~5.725		
	2.82	5.725~5.85		

4. The EUT incorporates a SISO function.

For 2.4GHz Band			
MODULATION MODE	DATA RATE (MCS)	TX & RX CONFIGURATION	
802.11b	1~11Mbps	1TX diversity	1RX diversity
802.11g	6~54Mbps	1TX diversity	1RX diversity
802.11n (HT20)	MCS 0~7	1TX diversity	1RX diversity
802.11n (HT40)	MCS 0~7	1TX diversity	1RX diversity
For 5GHz Band			
MODULATION MODE	DATA RATE (MCS)	TX & RX CONFIGURATION	
802.11a	6~54Mbps	1TX diversity	1RX diversity
802.11n (HT20)	MCS 0~7	1TX diversity	1RX diversity
802.11n (HT40)	MCS 0~7	1TX diversity	1RX diversity
802.11ac (VHT20)	MCS 0~8, Nss=1	1TX diversity	1RX diversity
802.11ac (VHT40)	MCS 0~9, Nss=1	1TX diversity	1RX diversity
802.11ac (VHT80)	MCS 0~9, Nss=1	1TX diversity	1RX diversity

5. The above EUT information is declared by manufacturer and for more detailed features description, please refer to the manufacturer's specifications or user's manual.



### 3.2 Description of Test Modes

11 channels are provided for 802.11b, 802.11g and 802.11n (HT20):

Channel	Frequency	Channel	Frequency
1	2412MHz	7	2442MHz
2	2417MHz	8	2447MHz
3	2422MHz	9	2452MHz
4	2427MHz	10	2457MHz
5	2432MHz	11	2462MHz
6	2437MHz		

7 channels are provided for 802.11n (HT40):

Channel	Frequency	Channel	Frequency
3	2422MHz	7	2442MHz
4	2427MHz	8	2447MHz
5	2432MHz	9	2452MHz
6	2437MHz		

### 3.2.1 Test Mode Applicability and Tested Channel Detail

EUT CONFIGURE MODE	APPLICABLE TO				DESCRIPTION
	RE $\geq$ 1G	RE<1G	PLC	APCM	
1	√	√	√	√	EUT+ Monopole antenna (Power from Adapter)
2	-	-	√	-	EUT+ Monopole antenna (Power from Laptop)
3	√	-	-	-	EUT+ PIFA antenna (Power from Adapter)

Where RE $\geq$ 1G: Radiated Emission above 1GHz & Bandedge Measurement  
 RE<1G: Radiated Emission below 1GHz  
 PLC: Power Line Conducted Emission  
 APCM: Antenna Port Conducted Measurement

**NOTE:** The EUT had been pre-tested on the positioned of each 2 axis. The worst case was found when positioned on **Y-plane**.  
**NOTE:** “-” means no effect.

#### **Radiated Emission Test (Above 1GHz):**

- Pre-Scan has been conducted to determine the worst-case mode from all possible combinations between available modulations, data rates and antenna ports (if EUT with antenna diversity architecture).
- Following channel(s) was (were) selected for the final test as listed below.

MODE	AVAILABLE CHANNEL	TESTED CHANNEL	MODULATION TECHNOLOGY	MODULATION TYPE	DATA RATE (Mbps)
802.11b	1 to 11	1, 6, 11	DSSS	DBPSK	1
802.11g	1 to 11	1, 6, 11	OFDM	BPSK	6
802.11n (HT20)	1 to 11	1, 6, 11	OFDM	BPSK	6.5
802.11n (HT40)	3 to 9	3, 6, 9	OFDM	BPSK	13.5

#### **Radiated Emission Test (Below 1GHz):**

- Pre-Scan has been conducted to determine the worst-case mode from all possible combinations between available modulations, data rates and antenna ports (if EUT with antenna diversity architecture).
- Following channel(s) was (were) selected for the final test as listed below.

MODE	AVAILABLE CHANNEL	TESTED CHANNEL	MODULATION TECHNOLOGY	MODULATION TYPE	DATA RATE (Mbps)
802.11b	1 to 11	11	DSSS	DBPSK	1

#### **Power Line Conducted Emission Test:**

- Pre-Scan has been conducted to determine the worst-case mode from all possible combinations between available modulations, data rates and antenna ports (if EUT with antenna diversity architecture).
- Following channel(s) was (were) selected for the final test as listed below.

MODE	AVAILABLE CHANNEL	TESTED CHANNEL	MODULATION TECHNOLOGY	MODULATION TYPE	DATA RATE (Mbps)
802.11b	1 to 11	11	DSSS	DBPSK	1

**Antenna Port Conducted Measurement:**

- This item includes all test value of each mode, but only includes spectrum plot of worst value of each mode.
- Pre-Scan has been conducted to determine the worst-case mode from all possible combinations between available modulations, data rates and antenna ports (if EUT with antenna diversity architecture).
- Following channel(s) was (were) selected for the final test as listed below.

MODE	AVAILABLE CHANNEL	TESTED CHANNEL	MODULATION TECHNOLOGY	MODULATION TYPE	DATA RATE (Mbps)
802.11b	1 to 11	1, 6, 11	DSSS	DBPSK	1
802.11g	1 to 11	1, 6, 11	OFDM	BPSK	6
802.11n (HT20)	1 to 11	1, 6, 11	OFDM	BPSK	6.5
802.11n (HT40)	3 to 9	3, 6, 9	OFDM	BPSK	13.5

**Test Condition:**

APPLICABLE TO	ENVIRONMENTAL CONDITIONS	INPUT POWER	TESTED BY
RE $\geq$ 1G	24deg. C, 69%RH	120Vac, 60Hz	Chris Lin
RE $<$ 1G	25deg. C, 67%RH	120Vac, 60Hz	Rey Chen
PLC	24deg. C, 68%RH	120Vac, 60Hz	Andy Ho
APCM	23deg. C, 60%RH	120Vac, 60Hz	Anderson Chen

### 3.3 Duty Cycle of Test Signal

If duty cycle of test signal is  $\geq 98\%$ , duty factor is not required.

**802.11b:** Duty cycle =  $128.425/128.85 = 0.997$

**802.11g:** Duty cycle =  $21.506/21.6 = 0.996$

**802.11n (HT20):** Duty cycle =  $19.863/19.994 = 0.993$

**802.11n (HT40):** Duty cycle =  $9.535/9.638 = 0.989$

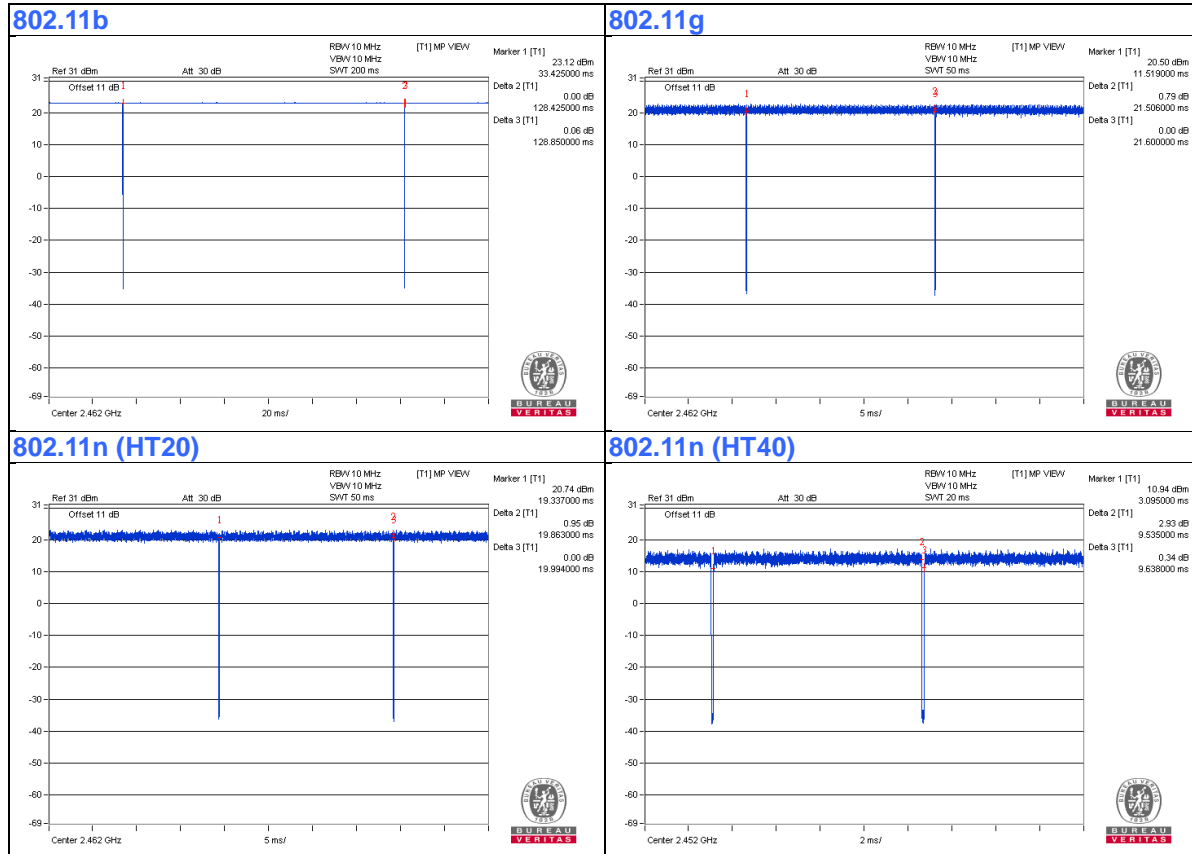

### 3.4 Description of Support Units

The EUT has been tested as an independent unit together with other necessary accessories or support units. The following support units or accessories were used to form a representative test configuration during the tests.

ID	Product	Brand	Model No.	Serial No.	FCC ID	Remarks
A.	Laptop	DELL	PP32LA	DSL32S	FCC DoC	Provided by Lab

Note:

1. All power cords of the above support units are non-shielded (1.8m).

ID	Descriptions	Qty.	Length (m)	Shielding (Yes/No)	Cores (Qty.)	Remarks
1.	Micro USB Cable	1	3	No	0	Supplied by client

### 3.4.1 Configuration of System under Test

Adapter mode

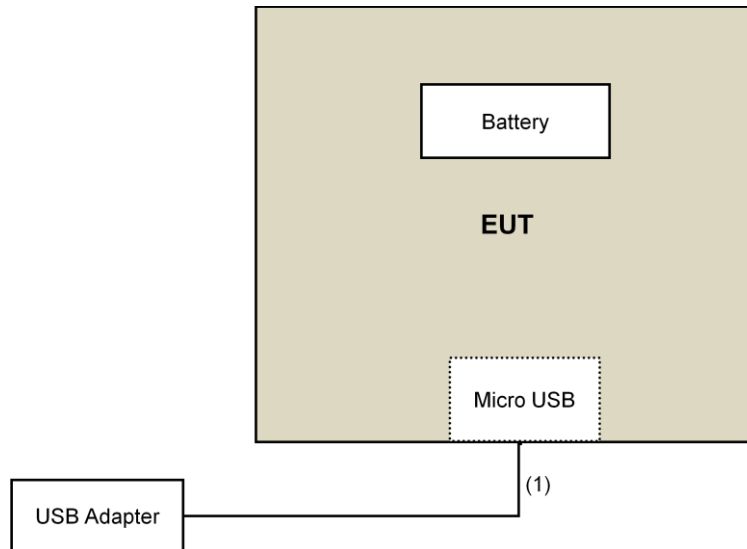

Laptop mode

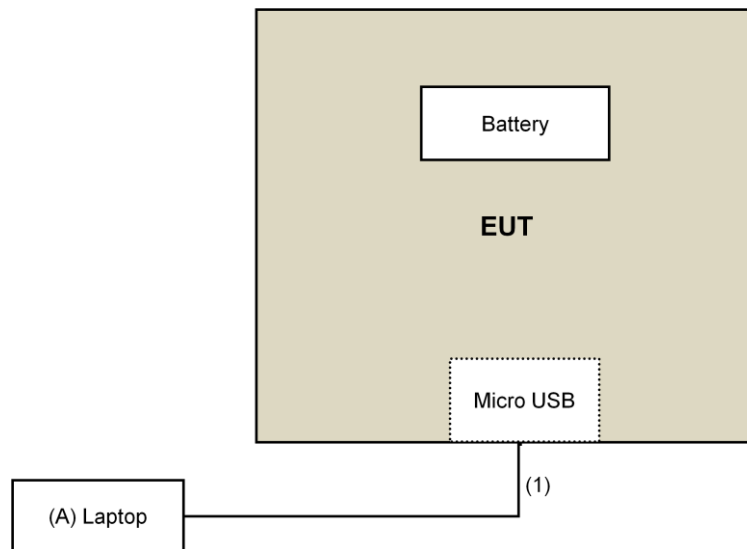

### 3.5 General Description of Applied Standards

The EUT is a RF Product. According to the specifications of the manufacturer, it must comply with the requirements of the following standards:

**FCC Part 15, Subpart C (15.247)**  
**KDB 558074 D01 DTS Meas Guidance v03r05**  
**ANSI C63.10-2013**

All test items have been performed and recorded as per the above standards.

**NOTE:** The EUT has been verified to comply with the requirements of FCC Part 15, Subpart B, Class B (DoC). The test report has been issued separately.

## 4 Test Types and Results

### 4.1 Radiated Emission and Bandedge Measurement

#### 4.1.1 Limits of Radiated Emission and Bandedge Measurement

Radiated emissions which fall in the restricted bands must comply with the radiated emission limits specified as below table. Other emissions shall be at least 30dB below the highest level of the desired power:

Frequencies (MHz)	Field Strength (microvolts/meter)	Measurement Distance (meters)
0.009 ~ 0.490	2400/F(kHz)	300
0.490 ~ 1.705	24000/F(kHz)	30
1.705 ~ 30.0	30	30
30 ~ 88	100	3
88 ~ 216	150	3
216 ~ 960	200	3
Above 960	500	3

**NOTE:**

1. The lower limit shall apply at the transition frequencies.
2. Emission level (dBuV/m) = 20 log Emission level (uV/m).
3. For frequencies above 1000MHz, the field strength limits are based on average detector, however, the peak field strength of any emission shall not exceed the maximum permitted average limits, specified above by more than 20dB under any condition of modulation.



#### 4.1.2 Test Instruments

For Below 1GHz test:

DESCRIPTION & MANUFACTURER	MODEL NO.	SERIAL NO.	CALIBRATED DATE	CALIBRATED UNTIL
Test Receiver Agilent	N9038A	MY50010156	Aug. 18, 2016	Aug. 17, 2017
Pre-Amplifier <sup>(*)</sup> EMCI	EMC001340	980142	Jan. 20, 2016	Jan. 19, 2018
Loop Antenna <sup>(*)</sup> Electro-Metrics	EM-6879	264	Dec. 16, 2016	Dec. 15, 2018
RF Cable	NA	LOOPCAB-001 LOOPCAB-002	Jan. 17, 2017	Jan. 16, 2018
Pre-Amplifier Mini-Circuits	ZFL-1000VH2 B	AMP-ZFL-05	May 07, 2016	May 06, 2017
Trilog Broadband Antenna SCHWARZBECK	VULB 9168	9168-361	Dec. 29, 2016	Dec. 28, 2017
RF Cable	8D	966-3-1 966-3-2 966-3-3	Apr. 02, 2016	Apr. 01, 2017
Fixed attenuator Mini-Circuits	UNAT-5+	PAD-3m-3-01	Oct. 05, 2016	Oct. 04, 2017
Software	ADT_Radiated _V8.7.08	NA	NA	NA
Antenna Tower & Turn Table Max-Full	MF-7802	MF780208406	NA	NA

**Note:**

1. The calibration interval of the above test instruments is 12 months and the calibrations are traceable to NML/ROC and NIST/USA.
2. \*The calibration interval of the above test instruments is 24 months and the calibrations are traceable to NML/ROC and NIST/USA.
3. The test was performed in 966 Chamber No. 3.
4. The FCC Site Registration No. is 147459
5. The CANADA Site Registration No. is 20331-1
- 6 Loop antenna was used for all emissions below 30 MHz.
7. Tested Date: Mar. 28, 2017

For other test:

DESCRIPTION & MANUFACTURER	MODEL NO.	SERIAL NO.	CALIBRATED DATE	CALIBRATED UNTIL
Test Receiver Agilent	N9038A	MY50010156	Aug. 18, 2016	Aug. 17, 2017
Horn_Antenna SCHWARZBECK	BBHA9120-D	9120D-406	Dec. 28, 2016	Dec. 27, 2017
Pre-Amplifier EMCI	EMC12630SE	980384	Feb. 02, 2017	Feb. 01, 2018
RF Cable	EMC104-SM-SM-1200 EMC104-SM-SM-2000 EMC104-SM-SM-5000	160922 150317 150322	Feb. 02, 2017 Mar. 29, 2017 Mar. 29, 2017	Feb. 01, 2018 Mar. 28, 2018 Mar. 28, 2018
Spectrum Analyzer Keysight	N9030A	MY54490520	July 29, 2016	July 28, 2017
Pre-Amplifier EMCI	EMC184045SE	980386	Feb. 02, 2017	Feb. 01, 2018
Horn_Antenna SCHWARZBECK	BBHA 9170	BBHA9170608	Dec. 15, 2016	Dec. 14, 2017
RF Cable	SUCOFLEX 102	36432/2 36433/2	Jan. 15, 2017	Jan. 14, 2018
Software	ADT_Radiated_V8.7.08	NA	NA	NA
Antenna Tower & Turn Table Max-Full	MF-7802	MF780208406	NA	NA
Boresight Antenna Fixture	FBA-01	FBA-SIP01	NA	NA
Spectrum Analyzer R&S	FSv40	100964	June 28, 2016	June 27, 2017
Power meter Anritsu	ML2495A	1014008	May 5, 2016	May 4, 2017
Power sensor Anritsu	MA2411B	0917122	May 5, 2016	May 4, 2017

**Note:**

1. The calibration interval of the above test instruments is 12 months and the calibrations are traceable to NML/ROC and NIST/USA.
2. The test was performed in 966 Chamber No. 3.
3. The FCC Site Registration No. is 147459
4. The CANADA Site Registration No. is 20331-1
5. Tested Date: Apr. 04 to 07, 2017

#### 4.1.3 Test Procedures

##### **For Radiated emission below 30MHz**

- a. The EUT was placed on the top of a rotating table 0.8 meters above the ground at a 3 meter chamber room. The table was rotated 360 degrees to determine the position of the highest radiation.
- b. The EUT was set 3 meters away from the interference-receiving antenna, which was mounted on the top of a variable-height antenna tower.
- c. Both X and Y axes of the antenna are set to make the measurement.
- d. For each suspected emission, the EUT was arranged to its worst case and the rotatable table was turned from 0 degrees to 360 degrees to find the maximum reading.
- e. The test-receiver system was set to Quasi-Peak Detect Function and Specified Bandwidth with Maximum Hold Mode.

##### **NOTE:**

1. The resolution bandwidth and video bandwidth of test receiver/spectrum analyzer is 9kHz at frequency below 30MHz.

##### **For Radiated emission above 30MHz**

- a. The EUT was placed on the top of a rotating table 0.8 meters (for 30MHz ~ 1GHz) / 1.5 meters (for above 1GHz) above the ground at 3 meter chamber room for test. The table was rotated 360 degrees to determine the position of the highest radiation.
- b. The EUT was set 3 meters away from the interference-receiving antenna, which was mounted on the top of a variable-height antenna tower.
- c. The height of antenna is varied from one meter to four meters above the ground to determine the maximum value of the field strength. Both horizontal and vertical polarizations of the antenna are set to make the measurement.
- d. For each suspected emission, the EUT was arranged to its worst case and then the antenna was tuned to heights from 1 meter to 4 meters and the rotatable table was turned from 0 degrees to 360 degrees to find the maximum reading.
- e. The test-receiver system was set to quasi-peak detect function and specified bandwidth with maximum hold mode when the test frequency is below 1 GHz.
- f. The test-receiver system was set to peak and average detect function and specified bandwidth with maximum hold mode when the test frequency is above 1 GHz. If the peak reading value also meets average limit, measurement with the average detector is unnecessary.

##### **Note:**

1. The resolution bandwidth and video bandwidth of test receiver/spectrum analyzer is 120kHz for Quasi-peak detection (QP) at frequency below 1GHz.
2. The resolution bandwidth of test receiver/spectrum analyzer is 1 MHz and the video bandwidth is 3 MHz for Peak detection (PK) at frequency above 1GHz.
3. The resolution bandwidth of test receiver/spectrum analyzer is 1MHz and the video bandwidth is  $\geq 1/T$  (Duty cycle < 98%) or 10Hz (Duty cycle  $\geq 98\%$ ) for Average detection (AV) at frequency above 1GHz.
4. All modes of operation were investigated and the worst-case emissions are reported.

#### 4.1.4 Deviation from Test Standard

No deviation.

#### 4.1.5 Test Setup

##### For Radiated emission below 30MHz

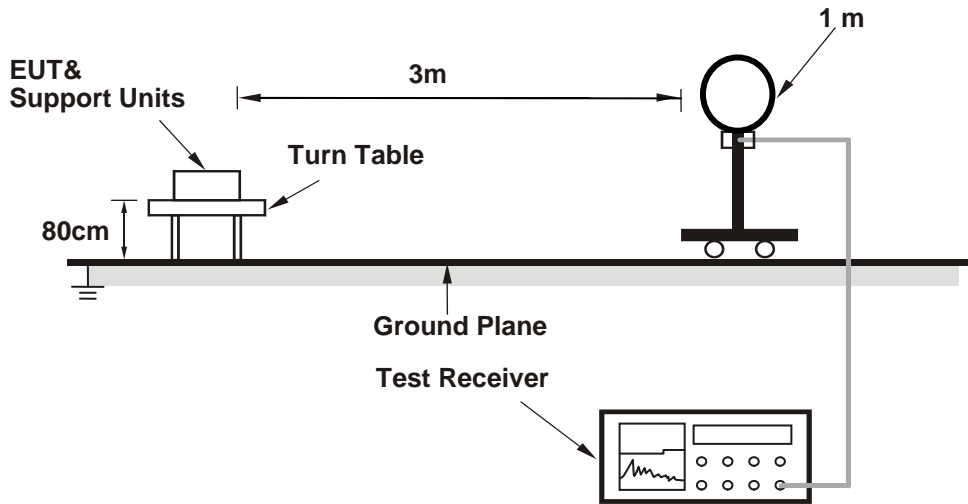

##### For Radiated emission 30MHz to 1GHz

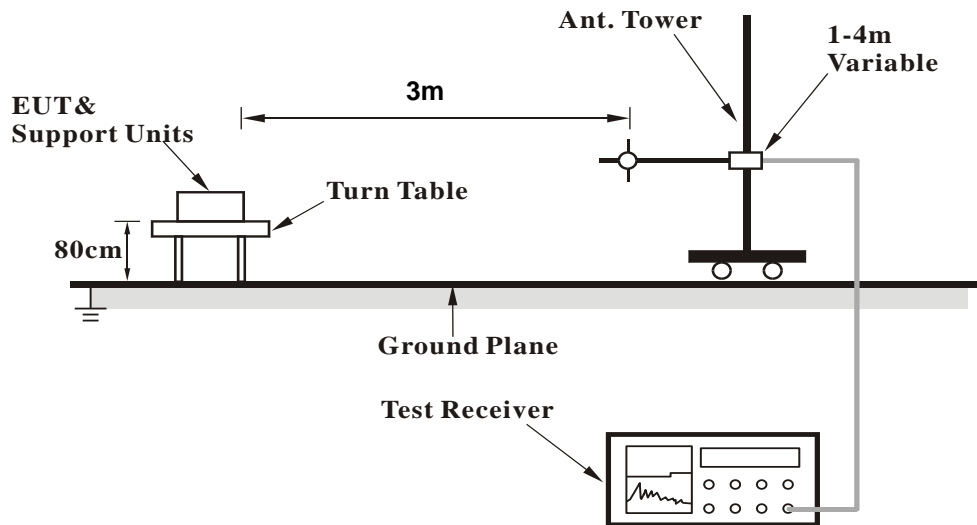

### For Radiated emission above 1GHz

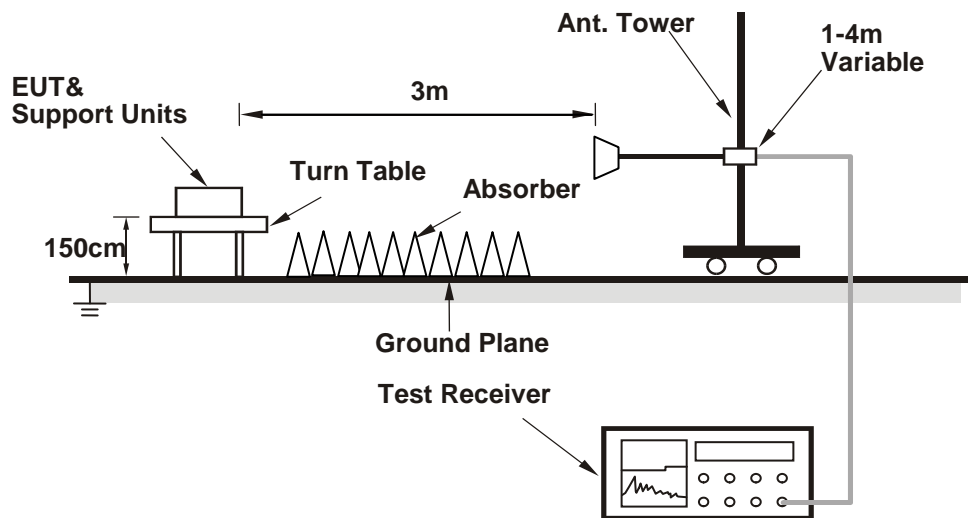

For the actual test configuration, please refer to the attached file (Test Setup Photo).

#### 4.1.6 EUT Operating Conditions

- a. Connected the EUT with the Notebook Computer which is placed on remote site.
- b. Controlling software (QRCT.EXE V3.0.219.0) has been activated to set the EUT on specific status.

## 4.1.7 Test Results (Mode 1)

## Above 1GHz Data:

## Monopole antenna

## 802.11b

<b>CHANNEL</b>	TX Channel 1	<b>DETECTOR FUNCTION</b>	Peak (PK)
<b>FREQUENCY RANGE</b>	1GHz ~ 25GHz		Average (AV)

**ANTENNA POLARITY & TEST DISTANCE: HORIZONTAL AT 3 M**

NO.	FREQ. (MHz)	EMISSION LEVEL (dBuV/m)	LIMIT (dBuV/m)	MARGIN (dB)	ANTENNA HEIGHT (m)	TABLE ANGLE (Degree)	RAW VALUE (dBuV)	CORRECTION FACTOR (dB/m)
1	2390.00	60.9 PK	74.0	-13.1	1.59 H	185	62.9	-2.0
2	2390.00	53.5 AV	54.0	-0.5	1.59 H	185	55.5	-2.0
3	*2412.00	114.7 PK			1.59 H	185	116.6	-1.9
4	*2412.00	110.9 AV			1.59 H	185	112.8	-1.9
5	4824.00	54.0 PK	74.0	-20.0	1.21 H	286	51.7	2.3
6	4824.00	48.4 AV	54.0	-5.6	1.21 H	286	46.1	2.3

**ANTENNA POLARITY & TEST DISTANCE: VERTICAL AT 3 M**

NO.	FREQ. (MHz)	EMISSION LEVEL (dBuV/m)	LIMIT (dBuV/m)	MARGIN (dB)	ANTENNA HEIGHT (m)	TABLE ANGLE (Degree)	RAW VALUE (dBuV)	CORRECTION FACTOR (dB/m)
1	2390.00	55.1 PK	74.0	-18.9	1.60 V	121	57.1	-2.0
2	2390.00	48.6 AV	54.0	-5.4	1.60 V	121	50.6	-2.0
3	*2412.00	109.2 PK			1.74 V	196	111.1	-1.9
4	*2412.00	106.3 AV			1.74 V	196	108.2	-1.9
5	4824.00	48.0 PK	74.0	-26.0	1.55 V	250	45.7	2.3
6	4824.00	43.4 AV	54.0	-10.6	1.55 V	250	41.1	2.3

**REMARKS:**

1. Emission Level(dBuV/m) = Raw Value(dBuV) + Correction Factor(dB/m)
2. Correction Factor(dB/m) = Antenna Factor(dB/m) + Cable Factor(dB) – Pre-Amplifier Factor(dB)
3. The other emission levels were very low against the limit.
4. Margin value = Emission Level – Limit value
5. " \* ": Fundamental frequency.

<b>CHANNEL</b>	TX Channel 6	<b>DETECTOR FUNCTION</b>	Peak (PK)
<b>FREQUENCY RANGE</b>	1GHz ~ 25GHz		Average (AV)

**ANTENNA POLARITY & TEST DISTANCE: HORIZONTAL AT 3 M**

NO.	FREQ. (MHz)	EMISSION LEVEL (dBuV/m)	LIMIT (dBuV/m)	MARGIN (dB)	ANTENNA HEIGHT (m)	TABLE ANGLE (Degree)	RAW VALUE (dBuV)	CORRECTION FACTOR (dB/m)
1	*2437.00	115.8 PK			1.44 H	188	117.7	-1.9
2	*2437.00	111.9 AV			1.44 H	188	113.8	-1.9
3	4874.00	53.6 PK	74.0	-20.4	1.06 H	287	51.2	2.4
4	4874.00	47.7 AV	54.0	-6.3	1.06 H	287	45.3	2.4

**ANTENNA POLARITY & TEST DISTANCE: VERTICAL AT 3 M**

NO.	FREQ. (MHz)	EMISSION LEVEL (dBuV/m)	LIMIT (dBuV/m)	MARGIN (dB)	ANTENNA HEIGHT (m)	TABLE ANGLE (Degree)	RAW VALUE (dBuV)	CORRECTION FACTOR (dB/m)
1	*2437.00	108.8 PK			1.67 V	217	110.7	-1.9
2	*2437.00	105.9 AV			1.67 V	217	107.8	-1.9
3	4874.00	47.7 PK	74.0	-26.3	1.60 V	248	45.3	2.4
4	4874.00	43.0 AV	54.0	-11.0	1.60 V	248	40.6	2.4

**REMARKS:**

1. Emission Level(dBuV/m) = Raw Value(dBuV) + Correction Factor(dB/m)
2. Correction Factor(dB/m) = Antenna Factor(dB/m) + Cable Factor(dB) – Pre-Amplifier Factor(dB)
3. The other emission levels were very low against the limit.
4. Margin value = Emission Level – Limit value
5. " \* ": Fundamental frequency.

<b>CHANNEL</b>	TX Channel 11	<b>DETECTOR FUNCTION</b>	Peak (PK)
<b>FREQUENCY RANGE</b>	1GHz ~ 25GHz		Average (AV)

**ANTENNA POLARITY & TEST DISTANCE: HORIZONTAL AT 3 M**

NO.	FREQ. (MHz)	EMISSION LEVEL (dBuV/m)	LIMIT (dBuV/m)	MARGIN (dB)	ANTENNA HEIGHT (m)	TABLE ANGLE (Degree)	RAW VALUE (dBuV)	CORRECTION FACTOR (dB/m)
1	*2462.00	114.5 PK			1.02 H	193	116.3	-1.8
2	*2462.00	110.8 AV			1.02 H	193	112.6	-1.8
3	2483.50	63.3 PK	74.0	-10.7	1.02 H	193	65.1	-1.8
4	2483.50	53.5 AV	54.0	-0.5	1.02 H	193	55.3	-1.8
5	4924.00	52.8 PK	74.0	-21.2	1.78 H	152	50.3	2.5
6	4924.00	46.7 AV	54.0	-7.3	1.78 H	152	44.2	2.5

**ANTENNA POLARITY & TEST DISTANCE: VERTICAL AT 3 M**

NO.	FREQ. (MHz)	EMISSION LEVEL (dBuV/m)	LIMIT (dBuV/m)	MARGIN (dB)	ANTENNA HEIGHT (m)	TABLE ANGLE (Degree)	RAW VALUE (dBuV)	CORRECTION FACTOR (dB/m)
1	*2462.00	108.8 PK			1.67 V	217	110.6	-1.8
2	*2462.00	105.9 AV			1.67 V	217	107.7	-1.8
3	2483.50	55.1 PK	74.0	-18.9	1.63 V	129	56.9	-1.8
4	2483.50	48.5 AV	54.0	-5.5	1.63 V	129	50.3	-1.8
5	4924.00	47.7 PK	74.0	-26.3	1.60 V	248	45.2	2.5
6	4924.00	43.0 AV	54.0	-11.0	1.60 V	248	40.5	2.5

**REMARKS:**

1. Emission Level(dBuV/m) = Raw Value(dBuV) + Correction Factor(dB/m)
2. Correction Factor(dB/m) = Antenna Factor(dB/m) + Cable Factor(dB) – Pre-Amplifier Factor(dB)
3. The other emission levels were very low against the limit.
4. Margin value = Emission Level – Limit value
5. " \* ": Fundamental frequency.



**802.11g**

<b>CHANNEL</b>	TX Channel 1	<b>DETECTOR FUNCTION</b>	Peak (PK)
<b>FREQUENCY RANGE</b>	1GHz ~ 25GHz		Average (AV)

**ANTENNA POLARITY & TEST DISTANCE: HORIZONTAL AT 3 M**

NO.	FREQ. (MHz)	EMISSION LEVEL (dBuV/m)	LIMIT (dBuV/m)	MARGIN (dB)	ANTENNA HEIGHT (m)	TABLE ANGLE (Degree)	RAW VALUE (dBuV)	CORRECTION FACTOR (dB/m)
1	2390.00	64.7 PK	74.0	-9.3	1.05 H	194	66.7	-2.0
2	2390.00	53.4 AV	54.0	-0.6	1.05 H	194	55.4	-2.0
3	*2412.00	112.9 PK			1.05 H	194	114.8	-1.9
4	*2412.00	103.9 AV			1.05 H	194	105.8	-1.9
5	4824.00	49.6 PK	74.0	-24.4	1.55 H	126	47.3	2.3
6	4824.00	37.5 AV	54.0	-16.5	1.55 H	126	35.2	2.3

**ANTENNA POLARITY & TEST DISTANCE: VERTICAL AT 3 M**

NO.	FREQ. (MHz)	EMISSION LEVEL (dBuV/m)	LIMIT (dBuV/m)	MARGIN (dB)	ANTENNA HEIGHT (m)	TABLE ANGLE (Degree)	RAW VALUE (dBuV)	CORRECTION FACTOR (dB/m)
1	2390.00	58.0 PK	74.0	-16.0	1.62 V	227	60.0	-2.0
2	2390.00	46.8 AV	54.0	-7.2	1.62 V	227	48.8	-2.0
3	*2412.00	106.2 PK			1.75 V	227	108.1	-1.9
4	*2412.00	98.8 AV			1.75 V	227	100.7	-1.9
5	4824.00	43.8 PK	74.0	-30.2	1.69 V	245	41.5	2.3
6	4824.00	32.5 AV	54.0	-21.5	1.69 V	245	30.2	2.3

**REMARKS:**

1. Emission Level(dBuV/m) = Raw Value(dBuV) + Correction Factor(dB/m)
2. Correction Factor(dB/m) = Antenna Factor(dB/m) + Cable Factor(dB) – Pre-Amplifier Factor(dB)
3. The other emission levels were very low against the limit.
4. Margin value = Emission Level – Limit value
5. " \* ": Fundamental frequency.

<b>CHANNEL</b>	TX Channel 6	<b>DETECTOR FUNCTION</b>	Peak (PK)
<b>FREQUENCY RANGE</b>	1GHz ~ 25GHz		Average (AV)

**ANTENNA POLARITY & TEST DISTANCE: HORIZONTAL AT 3 M**

NO.	FREQ. (MHz)	EMISSION LEVEL (dBuV/m)	LIMIT (dBuV/m)	MARGIN (dB)	ANTENNA HEIGHT (m)	TABLE ANGLE (Degree)	RAW VALUE (dBuV)	CORRECTION FACTOR (dB/m)
1	*2437.00	115.6 PK			2.48 H	196	117.5	-1.9
2	*2437.00	105.9 AV			2.48 H	196	107.8	-1.9
3	4874.00	49.0 PK	74.0	-25.0	1.07 H	41	46.6	2.4
4	4874.00	37.3 AV	54.0	-16.7	1.07 H	41	34.9	2.4

**ANTENNA POLARITY & TEST DISTANCE: VERTICAL AT 3 M**

NO.	FREQ. (MHz)	EMISSION LEVEL (dBuV/m)	LIMIT (dBuV/m)	MARGIN (dB)	ANTENNA HEIGHT (m)	TABLE ANGLE (Degree)	RAW VALUE (dBuV)	CORRECTION FACTOR (dB/m)
1	*2437.00	109.4 PK			1.76 V	239	111.3	-1.9
2	*2437.00	100.6 AV			1.76 V	239	102.5	-1.9
3	4874.00	43.6 PK	74.0	-30.4	1.72 V	252	41.2	2.4
4	4874.00	32.2 AV	54.0	-21.8	1.72 V	252	29.8	2.4

**REMARKS:**

1. Emission Level(dBuV/m) = Raw Value(dBuV) + Correction Factor(dB/m)
2. Correction Factor(dB/m) = Antenna Factor(dB/m) + Cable Factor(dB) – Pre-Amplifier Factor(dB)
3. The other emission levels were very low against the limit.
4. Margin value = Emission Level – Limit value
5. " \* ": Fundamental frequency.

<b>CHANNEL</b>	TX Channel 11	<b>DETECTOR FUNCTION</b>	Peak (PK)
<b>FREQUENCY RANGE</b>	1GHz ~ 25GHz		Average (AV)

**ANTENNA POLARITY & TEST DISTANCE: HORIZONTAL AT 3 M**

NO.	FREQ. (MHz)	EMISSION LEVEL (dBuV/m)	LIMIT (dBuV/m)	MARGIN (dB)	ANTENNA HEIGHT (m)	TABLE ANGLE (Degree)	RAW VALUE (dBuV)	CORRECTION FACTOR (dB/m)
1	*2462.00	112.9 PK			1.37 H	182	114.7	-1.8
2	*2462.00	102.9 AV			1.37 H	182	104.7	-1.8
3	2483.50	66.9 PK	74.0	-7.1	1.37 H	182	68.7	-1.8
4	2483.50	53.7 AV	54.0	-0.3	1.37 H	182	55.5	-1.8
5	4924.00	49.1 PK	74.0	-24.9	1.30 H	58	46.6	2.5
6	4924.00	37.3 AV	54.0	-16.7	1.30 H	58	34.8	2.5

**ANTENNA POLARITY & TEST DISTANCE: VERTICAL AT 3 M**

NO.	FREQ. (MHz)	EMISSION LEVEL (dBuV/m)	LIMIT (dBuV/m)	MARGIN (dB)	ANTENNA HEIGHT (m)	TABLE ANGLE (Degree)	RAW VALUE (dBuV)	CORRECTION FACTOR (dB/m)
1	*2462.00	106.2 PK			1.73 V	228	108.0	-1.8
2	*2462.00	98.5 AV			1.73 V	228	100.3	-1.8
3	2483.50	57.8 PK	74.0	-16.2	1.66 V	221	59.6	-1.8
4	2483.50	46.4 AV	54.0	-7.6	1.66 V	221	48.2	-1.8
5	4924.00	43.9 PK	74.0	-30.1	1.65 V	236	41.4	2.5
6	4924.00	32.5 AV	54.0	-21.5	1.65 V	236	30.0	2.5

**REMARKS:**

1. Emission Level(dBuV/m) = Raw Value(dBuV) + Correction Factor(dB/m)
2. Correction Factor(dB/m) = Antenna Factor(dB/m) + Cable Factor(dB) – Pre-Amplifier Factor(dB)
3. The other emission levels were very low against the limit.
4. Margin value = Emission Level – Limit value
5. " \* ": Fundamental frequency.

**802.11n (HT20)**

<b>CHANNEL</b>	TX Channel 1	<b>DETECTOR FUNCTION</b>	Peak (PK)
<b>FREQUENCY RANGE</b>	1GHz ~ 25GHz		Average (AV)

**ANTENNA POLARITY & TEST DISTANCE: HORIZONTAL AT 3 M**

NO.	FREQ. (MHz)	EMISSION LEVEL (dBuV/m)	LIMIT (dBuV/m)	MARGIN (dB)	ANTENNA HEIGHT (m)	TABLE ANGLE (Degree)	RAW VALUE (dBuV)	CORRECTION FACTOR (dB/m)
1	2390.00	64.7 PK	74.0	-9.3	1.29 H	187	66.7	-2.0
2	2390.00	53.5 AV	54.0	-0.5	1.29 H	187	55.5	-2.0
3	*2412.00	112.1 PK			1.29 H	187	114.0	-1.9
4	*2412.00	102.7 AV			1.29 H	187	104.6	-1.9
5	4824.00	48.8 PK	74.0	-25.2	1.07 H	44	46.5	2.3
6	4824.00	37.3 AV	54.0	-16.7	1.07 H	44	35.0	2.3

**ANTENNA POLARITY & TEST DISTANCE: VERTICAL AT 3 M**

NO.	FREQ. (MHz)	EMISSION LEVEL (dBuV/m)	LIMIT (dBuV/m)	MARGIN (dB)	ANTENNA HEIGHT (m)	TABLE ANGLE (Degree)	RAW VALUE (dBuV)	CORRECTION FACTOR (dB/m)
1	2390.00	57.9 PK	74.0	-16.1	1.64 V	216	59.9	-2.0
2	2390.00	46.7 AV	54.0	-7.3	1.64 V	216	48.7	-2.0
3	*2412.00	107.1 PK			1.78 V	230	109.0	-1.9
4	*2412.00	98.3 AV			1.78 V	230	100.2	-1.9
5	4824.00	44.0 PK	74.0	-30.0	1.66 V	234	41.7	2.3
6	4824.00	32.9 AV	54.0	-21.1	1.66 V	234	30.6	2.3

**REMARKS:**

1. Emission Level(dBuV/m) = Raw Value(dBuV) + Correction Factor(dB/m)
2. Correction Factor(dB/m) = Antenna Factor(dB/m) + Cable Factor(dB) – Pre-Amplifier Factor(dB)
3. The other emission levels were very low against the limit.
4. Margin value = Emission Level – Limit value
5. " \* ": Fundamental frequency.

<b>CHANNEL</b>	TX Channel 6	<b>DETECTOR FUNCTION</b>	Peak (PK)
<b>FREQUENCY RANGE</b>	1GHz ~ 25GHz		Average (AV)

**ANTENNA POLARITY & TEST DISTANCE: HORIZONTAL AT 3 M**

NO.	FREQ. (MHz)	EMISSION LEVEL (dBuV/m)	LIMIT (dBuV/m)	MARGIN (dB)	ANTENNA HEIGHT (m)	TABLE ANGLE (Degree)	RAW VALUE (dBuV)	CORRECTION FACTOR (dB/m)
1	*2437.00	115.9 PK			2.54 H	199	117.8	-1.9
2	*2437.00	105.8 AV			2.54 H	199	107.7	-1.9
3	4874.00	48.9 PK	74.0	-25.1	1.08 H	74	46.5	2.4
4	4874.00	37.5 AV	54.0	-16.5	1.08 H	74	35.1	2.4

**ANTENNA POLARITY & TEST DISTANCE: VERTICAL AT 3 M**

NO.	FREQ. (MHz)	EMISSION LEVEL (dBuV/m)	LIMIT (dBuV/m)	MARGIN (dB)	ANTENNA HEIGHT (m)	TABLE ANGLE (Degree)	RAW VALUE (dBuV)	CORRECTION FACTOR (dB/m)
1	*2437.00	110.5 PK			1.76 V	227	112.4	-1.9
2	*2437.00	100.8 AV			1.76 V	227	102.7	-1.9
3	4874.00	44.0 PK	74.0	-30.0	1.71 V	255	41.6	2.4
4	4874.00	32.5 AV	54.0	-21.5	1.71 V	255	30.1	2.4

**REMARKS:**

1. Emission Level(dBuV/m) = Raw Value(dBuV) + Correction Factor(dB/m)
2. Correction Factor(dB/m) = Antenna Factor(dB/m) + Cable Factor(dB) – Pre-Amplifier Factor(dB)
3. The other emission levels were very low against the limit.
4. Margin value = Emission Level – Limit value
5. " \* ": Fundamental frequency.

<b>CHANNEL</b>	TX Channel 11	<b>DETECTOR FUNCTION</b>	Peak (PK)
<b>FREQUENCY RANGE</b>	1GHz ~ 25GHz		Average (AV)

**ANTENNA POLARITY & TEST DISTANCE: HORIZONTAL AT 3 M**

NO.	FREQ. (MHz)	EMISSION LEVEL (dBuV/m)	LIMIT (dBuV/m)	MARGIN (dB)	ANTENNA HEIGHT (m)	TABLE ANGLE (Degree)	RAW VALUE (dBuV)	CORRECTION FACTOR (dB/m)
1	*2462.00	111.0 PK			1.38 H	186	112.8	-1.8
2	*2462.00	101.0 AV			1.38 H	186	102.8	-1.8
3	2483.50	67.1 PK	74.0	-6.9	1.38 H	186	68.9	-1.8
4	2483.50	53.4 AV	54.0	-0.6	1.38 H	186	55.2	-1.8
5	4924.00	49.5 PK	74.0	-24.5	1.07 H	15	47.0	2.5
6	4924.00	37.0 AV	54.0	-17.0	1.07 H	15	34.5	2.5

**ANTENNA POLARITY & TEST DISTANCE: VERTICAL AT 3 M**

NO.	FREQ. (MHz)	EMISSION LEVEL (dBuV/m)	LIMIT (dBuV/m)	MARGIN (dB)	ANTENNA HEIGHT (m)	TABLE ANGLE (Degree)	RAW VALUE (dBuV)	CORRECTION FACTOR (dB/m)
1	*2462.00	105.9 PK			1.74 V	240	107.7	-1.8
2	*2462.00	96.8 AV			1.74 V	240	98.6	-1.8
3	2483.50	57.4 PK	74.0	-16.6	1.68 V	225	59.2	-1.8
4	2483.50	46.3 AV	54.0	-7.7	1.68 V	225	48.1	-1.8
5	4924.00	43.7 PK	74.0	-30.3	1.67 V	238	41.2	2.5
6	4924.00	32.7 AV	54.0	-21.3	1.67 V	238	30.2	2.5

**REMARKS:**

1. Emission Level(dBuV/m) = Raw Value(dBuV) + Correction Factor(dB/m)
2. Correction Factor(dB/m) = Antenna Factor(dB/m) + Cable Factor(dB) – Pre-Amplifier Factor(dB)
3. The other emission levels were very low against the limit.
4. Margin value = Emission Level – Limit value
5. " \* ": Fundamental frequency.

**802.11n (HT40)**

<b>CHANNEL</b>	TX Channel 3	<b>DETECTOR FUNCTION</b>	Peak (PK)
<b>FREQUENCY RANGE</b>	1GHz ~ 25GHz		Average (AV)

**ANTENNA POLARITY & TEST DISTANCE: HORIZONTAL AT 3 M**

NO.	FREQ. (MHz)	EMISSION LEVEL (dBuV/m)	LIMIT (dBuV/m)	MARGIN (dB)	ANTENNA HEIGHT (m)	TABLE ANGLE (Degree)	RAW VALUE (dBuV)	CORRECTION FACTOR (dB/m)
1	2390.00	68.1 PK	74.0	-5.9	1.00 H	195	70.1	-2.0
2	2390.00	53.4 AV	54.0	-0.6	1.00 H	195	55.4	-2.0
3	*2422.00	106.5 PK			1.00 H	195	108.5	-2.0
4	*2422.00	97.2 AV			1.00 H	195	99.2	-2.0
5	4844.00	49.4 PK	74.0	-24.6	1.07 H	11	47.0	2.4
6	4844.00	36.3 AV	54.0	-17.7	1.07 H	11	33.9	2.4

**ANTENNA POLARITY & TEST DISTANCE: VERTICAL AT 3 M**

NO.	FREQ. (MHz)	EMISSION LEVEL (dBuV/m)	LIMIT (dBuV/m)	MARGIN (dB)	ANTENNA HEIGHT (m)	TABLE ANGLE (Degree)	RAW VALUE (dBuV)	CORRECTION FACTOR (dB/m)
1	2390.00	57.6 PK	74.0	-16.4	1.73 V	232	59.6	-2.0
2	2390.00	46.6 AV	54.0	-7.4	1.73 V	232	48.6	-2.0
3	*2422.00	102.4 PK			1.79 V	243	104.4	-2.0
4	*2422.00	93.9 AV			1.79 V	243	95.9	-2.0
5	4844.00	42.8 PK	74.0	-31.2	1.71 V	241	40.4	2.4
6	4844.00	31.7 AV	54.0	-22.3	1.71 V	241	29.3	2.4

**REMARKS:**

1. Emission Level(dBuV/m) = Raw Value(dBuV) + Correction Factor(dB/m)
2. Correction Factor(dB/m) = Antenna Factor(dB/m) + Cable Factor(dB) – Pre-Amplifier Factor(dB)
3. The other emission levels were very low against the limit.
4. Margin value = Emission Level – Limit value
5. " \* ": Fundamental frequency.

<b>CHANNEL</b>	TX Channel 6	<b>DETECTOR FUNCTION</b>	Peak (PK)
<b>FREQUENCY RANGE</b>	1GHz ~ 25GHz		Average (AV)

**ANTENNA POLARITY & TEST DISTANCE: HORIZONTAL AT 3 M**

NO.	FREQ. (MHz)	EMISSION LEVEL (dBuV/m)	LIMIT (dBuV/m)	MARGIN (dB)	ANTENNA HEIGHT (m)	TABLE ANGLE (Degree)	RAW VALUE (dBuV)	CORRECTION FACTOR (dB/m)
1	*2437.00	108.8 PK			2.51 H	197	110.7	-1.9
2	*2437.00	98.8 AV			2.51 H	197	100.7	-1.9
3	2483.50	68.0 PK	74.0	-6.0	2.51 H	197	69.8	-1.8
4	2483.50	53.8 AV	54.0	-0.2	2.51 H	197	55.6	-1.8
5	4874.00	48.9 PK	74.0	-25.1	1.06 H	55	46.5	2.4
6	4874.00	36.4 AV	54.0	-17.6	1.06 H	55	34.0	2.4

**ANTENNA POLARITY & TEST DISTANCE: VERTICAL AT 3 M**

NO.	FREQ. (MHz)	EMISSION LEVEL (dBuV/m)	LIMIT (dBuV/m)	MARGIN (dB)	ANTENNA HEIGHT (m)	TABLE ANGLE (Degree)	RAW VALUE (dBuV)	CORRECTION FACTOR (dB/m)
1	*2437.00	104.9 PK			1.72 V	229	106.8	-1.9
2	*2437.00	95.4 AV			1.72 V	229	97.3	-1.9
3	2483.50	57.3 PK	74.0	-16.7	1.75 V	248	59.1	-1.8
4	2483.50	46.3 AV	54.0	-7.7	1.75 V	248	48.1	-1.8
5	4874.00	43.9 PK	74.0	-30.1	1.68 V	230	41.5	2.4
6	4874.00	32.3 AV	54.0	-21.7	1.68 V	230	29.9	2.4

**REMARKS:**

1. Emission Level(dBuV/m) = Raw Value(dBuV) + Correction Factor(dB/m)
2. Correction Factor(dB/m) = Antenna Factor(dB/m) + Cable Factor(dB) – Pre-Amplifier Factor(dB)
3. The other emission levels were very low against the limit.
4. Margin value = Emission Level – Limit value
5. " \* ": Fundamental frequency.



<b>CHANNEL</b>	TX Channel 9	<b>DETECTOR FUNCTION</b>	Peak (PK)
<b>FREQUENCY RANGE</b>	1GHz ~ 25GHz		Average (AV)

**ANTENNA POLARITY & TEST DISTANCE: HORIZONTAL AT 3 M**

NO.	FREQ. (MHz)	EMISSION LEVEL (dBuV/m)	LIMIT (dBuV/m)	MARGIN (dB)	ANTENNA HEIGHT (m)	TABLE ANGLE (Degree)	RAW VALUE (dBuV)	CORRECTION FACTOR (dB/m)
1	*2452.00	105.9 PK			1.34 H	192	107.8	-1.9
2	*2452.00	96.9 AV			1.34 H	192	98.8	-1.9
3	2483.50	69.1 PK	74.0	-4.9	1.34 H	192	70.9	-1.8
4	<b>2483.50</b>	<b>53.9 AV</b>	<b>54.0</b>	<b>-0.1</b>	<b>1.34 H</b>	<b>192</b>	<b>55.7</b>	<b>-1.8</b>
5	4904.00	47.9 PK	74.0	-26.1	1.14 H	74	45.5	2.4
6	4904.00	36.6 AV	54.0	-17.4	1.14 H	74	34.2	2.4

**ANTENNA POLARITY & TEST DISTANCE: VERTICAL AT 3 M**

NO.	FREQ. (MHz)	EMISSION LEVEL (dBuV/m)	LIMIT (dBuV/m)	MARGIN (dB)	ANTENNA HEIGHT (m)	TABLE ANGLE (Degree)	RAW VALUE (dBuV)	CORRECTION FACTOR (dB/m)
1	*2452.00	101.8 PK			1.79 V	225	103.7	-1.9
2	*2452.00	93.4 AV			1.79 V	225	95.3	-1.9
3	2483.50	57.8 PK	74.0	-16.2	1.78 V	233	59.6	-1.8
4	2483.50	46.8 AV	54.0	-7.2	1.78 V	233	48.6	-1.8
5	4904.00	43.8 PK	74.0	-30.2	1.74 V	230	41.4	2.4
6	4904.00	32.7 AV	54.0	-21.3	1.74 V	230	30.3	2.4

**REMARKS:**

1. Emission Level(dBuV/m) = Raw Value(dBuV) + Correction Factor(dB/m)
2. Correction Factor(dB/m) = Antenna Factor(dB/m) + Cable Factor(dB) – Pre-Amplifier Factor(dB)
3. The other emission levels were very low against the limit.
4. Margin value = Emission Level – Limit value
5. " \* ": Fundamental frequency.

**Below 1GHz Data:**

**802.11b**

<b>CHANNEL</b>	TX Channel 11	<b>DETECTOR FUNCTION</b>	Quasi-Peak (QP)
<b>FREQUENCY RANGE</b>	9kHz ~ 1GHz		

**ANTENNA POLARITY & TEST DISTANCE: HORIZONTAL AT 3 M**

NO.	FREQ. (MHz)	EMISSION LEVEL (dBuV/m)	LIMIT (dBuV/m)	MARGIN (dB)	ANTENNA HEIGHT (m)	TABLE ANGLE (Degree)	RAW VALUE (dBuV)	CORRECTION FACTOR (dB/m)
1	30.00	31.7 QP	40.0	-8.3	1.00 H	360	41.3	-9.6
2	105.95	33.5 QP	43.5	-10.0	3.00 H	274	45.1	-11.6
3	228.95	43.0 QP	46.0	-3.0	1.00 H	58	53.7	-10.7
4	281.64	42.9 QP	46.0	-3.1	1.00 H	309	50.9	-8.0
5	332.30	37.5 QP	46.0	-8.5	1.00 H	306	43.9	-6.4
6	725.17	30.0 QP	46.0	-16.0	2.00 H	249	28.7	1.3

**ANTENNA POLARITY & TEST DISTANCE: VERTICAL AT 3 M**

NO.	FREQ. (MHz)	EMISSION LEVEL (dBuV/m)	LIMIT (dBuV/m)	MARGIN (dB)	ANTENNA HEIGHT (m)	TABLE ANGLE (Degree)	RAW VALUE (dBuV)	CORRECTION FACTOR (dB/m)
1	145.53	34.1 QP	43.5	-9.4	1.00 V	3	42.4	-8.3
2	230.43	39.0 QP	46.0	-7.0	2.00 V	17	49.5	-10.5
3	283.34	39.2 QP	46.0	-6.8	1.00 V	0	47.0	-7.8
4	342.44	33.1 QP	46.0	-12.9	2.00 V	76	39.4	-6.3
5	513.01	30.1 QP	46.0	-15.9	1.00 V	40	32.4	-2.3
6	645.10	25.0 QP	46.0	-21.0	3.00 V	184	24.7	0.3

**REMARKS:**

1. Emission Level(dBuV/m) = Raw Value(dBuV) + Correction Factor(dB/m)
2. Correction Factor(dB/m) = Antenna Factor(dB/m) + Cable Factor(dB) – Pre-Amplifier Factor(dB)
3. The other emission levels were very low against the limit.
4. Margin value = Emission Level – Limit value

## 4.1.8 Test Results (Mode 3)

## Above 1GHz Data:

## PIFA antenna

## 802.11b

<b>CHANNEL</b>	TX Channel 1	<b>DETECTOR FUNCTION</b>	Peak (PK)
<b>FREQUENCY RANGE</b>	1GHz ~ 25GHz		Average (AV)

**ANTENNA POLARITY & TEST DISTANCE: HORIZONTAL AT 3 M**

NO.	FREQ. (MHz)	EMISSION LEVEL (dBuV/m)	LIMIT (dBuV/m)	MARGIN (dB)	ANTENNA HEIGHT (m)	TABLE ANGLE (Degree)	RAW VALUE (dBuV)	CORRECTION FACTOR (dB/m)
1	2390.00	53.9 PK	74.0	-20.1	3.12 H	331	55.9	-2.0
2	2390.00	48.1 AV	54.0	-5.9	3.12 H	331	50.1	-2.0
3	*2412.00	108.7 PK			3.19 H	343	110.6	-1.9
4	*2412.00	104.8 AV			3.19 H	343	106.7	-1.9
5	4824.00	55.3 PK	74.0	-18.7	3.53 H	236	53.0	2.3
6	4824.00	52.3 AV	54.0	-1.7	3.53 H	236	50.0	2.3

**ANTENNA POLARITY & TEST DISTANCE: VERTICAL AT 3 M**

NO.	FREQ. (MHz)	EMISSION LEVEL (dBuV/m)	LIMIT (dBuV/m)	MARGIN (dB)	ANTENNA HEIGHT (m)	TABLE ANGLE (Degree)	RAW VALUE (dBuV)	CORRECTION FACTOR (dB/m)
1	2390.00	59.9 PK	74.0	-14.1	3.13 V	333	61.9	-2.0
2	<b>2390.00</b>	<b>53.9 AV</b>	<b>54.0</b>	<b>-0.1</b>	<b>3.13 V</b>	<b>333</b>	<b>55.9</b>	<b>-2.0</b>
3	*2412.00	109.1 PK			3.13 V	333	111.0	-1.9
4	*2412.00	105.3 AV			3.13 V	333	107.2	-1.9
5	4824.00	55.7 PK	74.0	-18.3	3.48 V	223	53.4	2.3
6	4824.00	52.8 AV	54.0	-1.2	3.48 V	223	50.5	2.3

**REMARKS:**

1. Emission Level(dBuV/m) = Raw Value(dBuV) + Correction Factor(dB/m)
2. Correction Factor(dB/m) = Antenna Factor(dB/m) + Cable Factor(dB) – Pre-Amplifier Factor(dB)
3. The other emission levels were very low against the limit.
4. Margin value = Emission Level – Limit value
5. " \* ": Fundamental frequency.

<b>CHANNEL</b>	TX Channel 6	<b>DETECTOR FUNCTION</b>	Peak (PK)
<b>FREQUENCY RANGE</b>	1GHz ~ 25GHz		Average (AV)

**ANTENNA POLARITY & TEST DISTANCE: HORIZONTAL AT 3 M**

NO.	FREQ. (MHz)	EMISSION LEVEL (dBuV/m)	LIMIT (dBuV/m)	MARGIN (dB)	ANTENNA HEIGHT (m)	TABLE ANGLE (Degree)	RAW VALUE (dBuV)	CORRECTION FACTOR (dB/m)
1	*2437.00	103.9 PK			3.13 H	318	105.8	-1.9
2	*2437.00	99.6 AV			3.13 H	318	101.5	-1.9
3	4874.00	48.4 PK	74.0	-25.6	3.19 H	317	46.0	2.4
4	4874.00	44.5 AV	54.0	-9.5	3.19 H	317	42.1	2.4

**ANTENNA POLARITY & TEST DISTANCE: VERTICAL AT 3 M**

NO.	FREQ. (MHz)	EMISSION LEVEL (dBuV/m)	LIMIT (dBuV/m)	MARGIN (dB)	ANTENNA HEIGHT (m)	TABLE ANGLE (Degree)	RAW VALUE (dBuV)	CORRECTION FACTOR (dB/m)
1	*2437.00	109.6 PK			2.90 V	357	111.5	-1.9
2	*2437.00	105.8 AV			2.90 V	357	107.7	-1.9
3	4874.00	54.7 PK	74.0	-19.3	2.50 V	359	52.3	2.4
4	4874.00	50.7 AV	54.0	-3.3	2.50 V	359	48.3	2.4

**REMARKS:**

1. Emission Level(dBuV/m) = Raw Value(dBuV) + Correction Factor(dB/m)
2. Correction Factor(dB/m) = Antenna Factor(dB/m) + Cable Factor(dB) – Pre-Amplifier Factor(dB)
3. The other emission levels were very low against the limit.
4. Margin value = Emission Level – Limit value
5. " \* ": Fundamental frequency.

<b>CHANNEL</b>	TX Channel 11	<b>DETECTOR FUNCTION</b>	Peak (PK)
<b>FREQUENCY RANGE</b>	1GHz ~ 25GHz		Average (AV)

**ANTENNA POLARITY & TEST DISTANCE: HORIZONTAL AT 3 M**

NO.	FREQ. (MHz)	EMISSION LEVEL (dBuV/m)	LIMIT (dBuV/m)	MARGIN (dB)	ANTENNA HEIGHT (m)	TABLE ANGLE (Degree)	RAW VALUE (dBuV)	CORRECTION FACTOR (dB/m)
1	*2462.00	105.2 PK			3.17 H	326	107.0	-1.8
2	*2462.00	101.1 AV			3.17 H	326	102.9	-1.8
3	2483.50	55.4 PK	74.0	-18.6	3.09 H	319	57.2	-1.8
4	2483.50	47.8 AV	54.0	-6.2	3.09 H	319	49.6	-1.8
5	4924.00	47.1 PK	74.0	-26.9	2.88 H	329	44.6	2.5
6	4924.00	43.4 AV	54.0	-10.6	2.88 H	329	40.9	2.5

**ANTENNA POLARITY & TEST DISTANCE: VERTICAL AT 3 M**

NO.	FREQ. (MHz)	EMISSION LEVEL (dBuV/m)	LIMIT (dBuV/m)	MARGIN (dB)	ANTENNA HEIGHT (m)	TABLE ANGLE (Degree)	RAW VALUE (dBuV)	CORRECTION FACTOR (dB/m)
1	*2462.00	110.4 PK			2.85 V	326	112.2	-1.8
2	*2462.00	106.7 AV			2.85 V	326	108.5	-1.8
3	2483.50	61.6 PK	74.0	-12.4	2.85 V	326	63.4	-1.8
<b>4</b>	<b>2483.50</b>	<b>53.9 AV</b>	<b>54.0</b>	<b>-0.1</b>	<b>2.85 V</b>	<b>326</b>	<b>55.7</b>	<b>-1.8</b>
5	4924.00	53.7 PK	74.0	-20.3	2.03 V	353	51.2	2.5
6	4924.00	49.2 AV	54.0	-4.8	2.03 V	353	46.7	2.5

**REMARKS:**

1. Emission Level(dBuV/m) = Raw Value(dBuV) + Correction Factor(dB/m)
2. Correction Factor(dB/m) = Antenna Factor(dB/m) + Cable Factor(dB) – Pre-Amplifier Factor(dB)
3. The other emission levels were very low against the limit.
4. Margin value = Emission Level – Limit value
5. " \* ": Fundamental frequency.

**802.11g**

<b>CHANNEL</b>	TX Channel 1	<b>DETECTOR FUNCTION</b>	Peak (PK)
<b>FREQUENCY RANGE</b>	1GHz ~ 25GHz		Average (AV)

**ANTENNA POLARITY & TEST DISTANCE: HORIZONTAL AT 3 M**

NO.	FREQ. (MHz)	EMISSION LEVEL (dBuV/m)	LIMIT (dBuV/m)	MARGIN (dB)	ANTENNA HEIGHT (m)	TABLE ANGLE (Degree)	RAW VALUE (dBuV)	CORRECTION FACTOR (dB/m)
1	2390.00	60.5 PK	74.0	-13.5	3.17 H	323	62.5	-2.0
2	2390.00	48.8 AV	54.0	-5.2	3.17 H	323	50.8	-2.0
3	*2412.00	101.9 PK			3.16 H	328	103.8	-1.9
4	*2412.00	93.0 AV			3.16 H	328	94.9	-1.9
5	4824.00	43.8 PK	74.0	-30.2	3.12 H	314	41.5	2.3
6	4824.00	31.8 AV	54.0	-22.2	3.12 H	314	29.5	2.3

**ANTENNA POLARITY & TEST DISTANCE: VERTICAL AT 3 M**

NO.	FREQ. (MHz)	EMISSION LEVEL (dBuV/m)	LIMIT (dBuV/m)	MARGIN (dB)	ANTENNA HEIGHT (m)	TABLE ANGLE (Degree)	RAW VALUE (dBuV)	CORRECTION FACTOR (dB/m)
1	2390.00	65.7 PK	74.0	-8.3	3.11 V	355	67.7	-2.0
2	2390.00	53.6 AV	54.0	-0.4	3.11 V	355	55.6	-2.0
3	*2412.00	107.6 PK			3.11 V	355	109.5	-1.9
4	*2412.00	97.8 AV			3.11 V	355	99.7	-1.9
5	4824.00	49.2 PK	74.0	-24.8	2.89 V	214	46.9	2.3
6	4824.00	36.8 AV	54.0	-17.2	2.89 V	214	34.5	2.3

**REMARKS:**

1. Emission Level(dBuV/m) = Raw Value(dBuV) + Correction Factor(dB/m)
2. Correction Factor(dB/m) = Antenna Factor(dB/m) + Cable Factor(dB) – Pre-Amplifier Factor(dB)
3. The other emission levels were very low against the limit.
4. Margin value = Emission Level – Limit value
5. " \* ": Fundamental frequency.

<b>CHANNEL</b>	TX Channel 6	<b>DETECTOR FUNCTION</b>	Peak (PK)
<b>FREQUENCY RANGE</b>	1GHz ~ 25GHz		Average (AV)

**ANTENNA POLARITY & TEST DISTANCE: HORIZONTAL AT 3 M**

NO.	FREQ. (MHz)	EMISSION LEVEL (dBuV/m)	LIMIT (dBuV/m)	MARGIN (dB)	ANTENNA HEIGHT (m)	TABLE ANGLE (Degree)	RAW VALUE (dBuV)	CORRECTION FACTOR (dB/m)
1	*2437.00	105.3 PK			3.20 H	319	107.2	-1.9
2	*2437.00	96.1 AV			3.20 H	319	98.0	-1.9
3	4874.00	43.5 PK	74.0	-30.5	3.15 H	335	41.1	2.4
4	4874.00	31.4 AV	54.0	-22.6	3.15 H	335	29.0	2.4

**ANTENNA POLARITY & TEST DISTANCE: VERTICAL AT 3 M**

NO.	FREQ. (MHz)	EMISSION LEVEL (dBuV/m)	LIMIT (dBuV/m)	MARGIN (dB)	ANTENNA HEIGHT (m)	TABLE ANGLE (Degree)	RAW VALUE (dBuV)	CORRECTION FACTOR (dB/m)
1	*2437.00	111.2 PK			2.91 V	352	113.1	-1.9
2	*2437.00	100.8 AV			2.91 V	352	102.7	-1.9
3	4874.00	50.3 PK	74.0	-23.7	2.45 V	208	47.9	2.4
4	4874.00	37.2 AV	54.0	-16.8	2.45 V	208	34.8	2.4

**REMARKS:**

1. Emission Level(dBuV/m) = Raw Value(dBuV) + Correction Factor(dB/m)
2. Correction Factor(dB/m) = Antenna Factor(dB/m) + Cable Factor(dB) – Pre-Amplifier Factor(dB)
3. The other emission levels were very low against the limit.
4. Margin value = Emission Level – Limit value
5. " \* ": Fundamental frequency.

<b>CHANNEL</b>	TX Channel 11	<b>DETECTOR FUNCTION</b>	Peak (PK)
<b>FREQUENCY RANGE</b>	1GHz ~ 25GHz		Average (AV)

**ANTENNA POLARITY & TEST DISTANCE: HORIZONTAL AT 3 M**

NO.	FREQ. (MHz)	EMISSION LEVEL (dBuV/m)	LIMIT (dBuV/m)	MARGIN (dB)	ANTENNA HEIGHT (m)	TABLE ANGLE (Degree)	RAW VALUE (dBuV)	CORRECTION FACTOR (dB/m)
1	*2462.00	104.0 PK			3.11 H	337	105.8	-1.8
2	*2462.00	94.7 AV			3.11 H	337	96.5	-1.8
3	2483.50	62.8 PK	74.0	-11.2	3.15 H	336	64.6	-1.8
4	2483.50	49.0 AV	54.0	-5.0	3.15 H	336	50.8	-1.8
5	4924.00	43.5 PK	74.0	-30.5	3.20 H	343	41.0	2.5
6	4924.00	31.7 AV	54.0	-22.3	3.20 H	343	29.2	2.5

**ANTENNA POLARITY & TEST DISTANCE: VERTICAL AT 3 M**

NO.	FREQ. (MHz)	EMISSION LEVEL (dBuV/m)	LIMIT (dBuV/m)	MARGIN (dB)	ANTENNA HEIGHT (m)	TABLE ANGLE (Degree)	RAW VALUE (dBuV)	CORRECTION FACTOR (dB/m)
1	*2462.00	108.8 PK			2.86 V	286	110.6	-1.8
2	*2462.00	98.8 AV			2.86 V	286	100.6	-1.8
3	2483.50	68.0 PK	74.0	-6.0	2.86 V	286	69.8	-1.8
4	2483.50	53.5 AV	54.0	-0.5	2.86 V	286	55.3	-1.8
5	4924.00	49.6 PK	74.0	-24.4	2.57 V	198	47.1	2.5
6	4924.00	36.9 AV	54.0	-17.1	2.57 V	198	34.4	2.5

**REMARKS:**

1. Emission Level(dBuV/m) = Raw Value(dBuV) + Correction Factor(dB/m)
2. Correction Factor(dB/m) = Antenna Factor(dB/m) + Cable Factor(dB) – Pre-Amplifier Factor(dB)
3. The other emission levels were very low against the limit.
4. Margin value = Emission Level – Limit value
5. " \* ": Fundamental frequency.



**802.11n (HT20)**

<b>CHANNEL</b>	TX Channel 1	<b>DETECTOR FUNCTION</b>	Peak (PK)
<b>FREQUENCY RANGE</b>	1GHz ~ 25GHz		Average (AV)

**ANTENNA POLARITY & TEST DISTANCE: HORIZONTAL AT 3 M**

NO.	FREQ. (MHz)	EMISSION LEVEL (dBuV/m)	LIMIT (dBuV/m)	MARGIN (dB)	ANTENNA HEIGHT (m)	TABLE ANGLE (Degree)	RAW VALUE (dBuV)	CORRECTION FACTOR (dB/m)
1	2390.00	59.2 PK	74.0	-14.8	3.14 H	345	61.2	-2.0
2	2390.00	48.9 AV	54.0	-5.1	3.14 H	345	50.9	-2.0
3	*2412.00	100.7 PK			3.08 H	335	102.6	-1.9
4	*2412.00	91.7 AV			3.08 H	335	93.6	-1.9
5	4824.00	43.1 PK	74.0	-30.9	3.18 H	337	40.8	2.3
6	4824.00	31.4 AV	54.0	-22.6	3.18 H	337	29.1	2.3

**ANTENNA POLARITY & TEST DISTANCE: VERTICAL AT 3 M**

NO.	FREQ. (MHz)	EMISSION LEVEL (dBuV/m)	LIMIT (dBuV/m)	MARGIN (dB)	ANTENNA HEIGHT (m)	TABLE ANGLE (Degree)	RAW VALUE (dBuV)	CORRECTION FACTOR (dB/m)
1	2390.00	64.6 PK	74.0	-9.4	3.77 V	319	66.6	-2.0
2	2390.00	53.5 AV	54.0	-0.5	3.77 V	319	55.5	-2.0
3	*2412.00	106.5 PK			3.77 V	319	108.4	-1.9
4	*2412.00	96.7 AV			3.77 V	319	98.6	-1.9
5	4824.00	70.4 PK	74.0	-3.6	3.13 V	159	68.1	2.3
6	4824.00	36.5 AV	54.0	-17.5	3.13 V	159	34.2	2.3

**REMARKS:**

1. Emission Level(dBuV/m) = Raw Value(dBuV) + Correction Factor(dB/m)
2. Correction Factor(dB/m) = Antenna Factor(dB/m) + Cable Factor(dB) – Pre-Amplifier Factor(dB)
3. The other emission levels were very low against the limit.
4. Margin value = Emission Level – Limit value
5. " \* ": Fundamental frequency.

<b>CHANNEL</b>	TX Channel 6	<b>DETECTOR FUNCTION</b>	Peak (PK)
<b>FREQUENCY RANGE</b>	1GHz ~ 25GHz		Average (AV)

**ANTENNA POLARITY & TEST DISTANCE: HORIZONTAL AT 3 M**

NO.	FREQ. (MHz)	EMISSION LEVEL (dBuV/m)	LIMIT (dBuV/m)	MARGIN (dB)	ANTENNA HEIGHT (m)	TABLE ANGLE (Degree)	RAW VALUE (dBuV)	CORRECTION FACTOR (dB/m)
1	*2437.00	105.6 PK			3.07 H	337	107.5	-1.9
2	*2437.00	96.2 AV			3.07 H	337	98.1	-1.9
3	4874.00	44.0 PK	74.0	-30.0	3.19 H	356	41.6	2.4
4	4874.00	31.9 AV	54.0	-22.1	3.19 H	356	29.5	2.4

**ANTENNA POLARITY & TEST DISTANCE: VERTICAL AT 3 M**

NO.	FREQ. (MHz)	EMISSION LEVEL (dBuV/m)	LIMIT (dBuV/m)	MARGIN (dB)	ANTENNA HEIGHT (m)	TABLE ANGLE (Degree)	RAW VALUE (dBuV)	CORRECTION FACTOR (dB/m)
1	*2437.00	111.2 PK			3.29 V	322	113.1	-1.9
2	*2437.00	100.9 AV			3.29 V	322	102.8	-1.9
3	4874.00	49.9 PK	74.0	-24.1	2.88 V	179	47.5	2.4
4	4874.00	37.2 AV	54.0	-16.8	2.88 V	179	34.8	2.4

**REMARKS:**

1. Emission Level(dBuV/m) = Raw Value(dBuV) + Correction Factor(dB/m)
2. Correction Factor(dB/m) = Antenna Factor(dB/m) + Cable Factor(dB) – Pre-Amplifier Factor(dB)
3. The other emission levels were very low against the limit.
4. Margin value = Emission Level – Limit value
5. " \* ": Fundamental frequency.

<b>CHANNEL</b>	TX Channel 11	<b>DETECTOR FUNCTION</b>	Peak (PK)
<b>FREQUENCY RANGE</b>	1GHz ~ 25GHz		Average (AV)

**ANTENNA POLARITY & TEST DISTANCE: HORIZONTAL AT 3 M**

NO.	FREQ. (MHz)	EMISSION LEVEL (dBuV/m)	LIMIT (dBuV/m)	MARGIN (dB)	ANTENNA HEIGHT (m)	TABLE ANGLE (Degree)	RAW VALUE (dBuV)	CORRECTION FACTOR (dB/m)
1	*2462.00	102.9 PK			3.05 H	347	104.7	-1.8
2	*2462.00	93.6 AV			3.05 H	347	95.4	-1.8
3	2483.50	50.4 PK	74.0	-23.6	3.12 H	337	52.2	-1.8
4	2483.50	49.4 AV	54.0	-4.6	3.12 H	337	51.2	-1.8
5	4924.00	44.0 PK	74.0	-30.0	3.21 H	356	41.5	2.5
6	4924.00	32.0 AV	54.0	-22.0	3.21 H	356	29.5	2.5

**ANTENNA POLARITY & TEST DISTANCE: VERTICAL AT 3 M**

NO.	FREQ. (MHz)	EMISSION LEVEL (dBuV/m)	LIMIT (dBuV/m)	MARGIN (dB)	ANTENNA HEIGHT (m)	TABLE ANGLE (Degree)	RAW VALUE (dBuV)	CORRECTION FACTOR (dB/m)
1	*2462.00	107.8 PK			3.26 V	311	109.6	-1.8
2	*2462.00	97.8 AV			3.26 V	311	99.6	-1.8
3	2483.50	66.7 PK	74.0	-7.3	3.58 V	354	68.5	-1.8
4	2483.50	53.8 AV	54.0	-0.2	3.58 V	354	55.6	-1.8
5	4924.00	49.3 PK	74.0	-24.7	2.88 V	222	46.8	2.5
6	4924.00	36.6 AV	54.0	-17.4	2.88 V	222	34.1	2.5

**REMARKS:**

1. Emission Level(dBuV/m) = Raw Value(dBuV) + Correction Factor(dB/m)
2. Correction Factor(dB/m) = Antenna Factor(dB/m) + Cable Factor(dB) – Pre-Amplifier Factor(dB)
3. The other emission levels were very low against the limit.
4. Margin value = Emission Level – Limit value
5. " \* ": Fundamental frequency.

802.11n (HT40)

<b>CHANNEL</b>	TX Channel 3	<b>DETECTOR FUNCTION</b>	Peak (PK)
<b>FREQUENCY RANGE</b>	1GHz ~ 25GHz		Average (AV)

ANTENNA POLARITY & TEST DISTANCE: HORIZONTAL AT 3 M								
NO.	FREQ. (MHz)	EMISSION LEVEL (dBUV/m)	LIMIT (dBUV/m)	MARGIN (dB)	ANTENNA HEIGHT (m)	TABLE ANGLE (Degree)	RAW VALUE (dBUV)	CORRECTION FACTOR (dB/m)
1	2390.00	61.7 PK	74.0	-12.3	3.02 H	343	63.7	-2.0
2	2390.00	48.9 AV	54.0	-5.1	3.02 H	343	50.9	-2.0
3	*2422.00	99.0 PK			3.03 H	354	101.0	-2.0
4	*2422.00	90.3 AV			3.03 H	354	92.3	-2.0
5	4844.00	43.9 PK	74.0	-30.1	3.25 H	345	41.5	2.4
6	4844.00	32.2 AV	54.0	-21.8	3.25 H	345	29.8	2.4

ANTENNA POLARITY & TEST DISTANCE: VERTICAL AT 3 M								
NO.	FREQ. (MHz)	EMISSION LEVEL (dBUV/m)	LIMIT (dBUV/m)	MARGIN (dB)	ANTENNA HEIGHT (m)	TABLE ANGLE (Degree)	RAW VALUE (dBUV)	CORRECTION FACTOR (dB/m)
1	2390.00	66.5 PK	74.0	-7.5	3.30 V	324	68.5	-2.0
2	2390.00	53.7 AV	54.0	-0.3	3.30 V	324	55.7	-2.0
3	*2422.00	103.9 PK			3.30 V	324	105.9	-2.0
4	*2422.00	94.2 AV			3.30 V	324	96.2	-2.0
5	4844.00	48.9 PK	74.0	-25.1	2.17 V	155	46.5	2.4
6	4844.00	36.2 AV	54.0	-17.8	2.17 V	155	33.8	2.4

**REMARKS:**

1. Emission Level(dBUV/m) = Raw Value(dBUV) + Correction Factor(dB/m)
2. Correction Factor(dB/m) = Antenna Factor(dB/m) + Cable Factor(dB) – Pre-Amplifier Factor(dB)
3. The other emission levels were very low against the limit.
4. Margin value = Emission Level – Limit value
5. " \* ": Fundamental frequency.

<b>CHANNEL</b>	TX Channel 6	<b>DETECTOR FUNCTION</b>	Peak (PK)
<b>FREQUENCY RANGE</b>	1GHz ~ 25GHz		Average (AV)

**ANTENNA POLARITY & TEST DISTANCE: HORIZONTAL AT 3 M**

NO.	FREQ. (MHz)	EMISSION LEVEL (dBuV/m)	LIMIT (dBuV/m)	MARGIN (dB)	ANTENNA HEIGHT (m)	TABLE ANGLE (Degree)	RAW VALUE (dBuV)	CORRECTION FACTOR (dB/m)
1	*2437.00	101.6 PK			3.09 H	347	103.5	-1.9
2	*2437.00	90.7 AV			3.09 H	347	92.6	-1.9
3	2483.50	63.1 PK	74.0	-10.9	3.02 H	334	64.9	-1.8
4	2483.50	49.5 AV	54.0	-4.5	3.02 H	334	51.3	-1.8
5	4874.00	44.4 PK	74.0	-29.6	3.20 H	341	42.0	2.4
6	4874.00	32.4 AV	54.0	-21.6	3.20 H	341	30.0	2.4

**ANTENNA POLARITY & TEST DISTANCE: VERTICAL AT 3 M**

NO.	FREQ. (MHz)	EMISSION LEVEL (dBuV/m)	LIMIT (dBuV/m)	MARGIN (dB)	ANTENNA HEIGHT (m)	TABLE ANGLE (Degree)	RAW VALUE (dBuV)	CORRECTION FACTOR (dB/m)
1	*2437.00	105.0 PK			3.29 V	321	106.9	-1.9
2	*2437.00	95.1 AV			3.29 V	321	97.0	-1.9
3	2483.50	67.0 PK	74.0	-7.0	3.29 V	321	68.8	-1.8
<b>4</b>	<b>2483.50</b>	<b>53.9 AV</b>	<b>54.0</b>	<b>-0.1</b>	<b>3.29 V</b>	<b>321</b>	<b>55.7</b>	<b>-1.8</b>
5	4874.00	49.1 PK	74.0	-24.9	3.00 V	216	46.7	2.4
6	4874.00	36.4 AV	54.0	-17.6	3.00 V	216	34.0	2.4

**REMARKS:**

- Emission Level(dBuV/m) = Raw Value(dBuV) + Correction Factor(dB/m)
- Correction Factor(dB/m) = Antenna Factor(dB/m) + Cable Factor(dB) – Pre-Amplifier Factor(dB)
- The other emission levels were very low against the limit.
- Margin value = Emission Level – Limit value
- " \* ": Fundamental frequency.

<b>CHANNEL</b>	TX Channel 9	<b>DETECTOR FUNCTION</b>	Peak (PK)
<b>FREQUENCY RANGE</b>	1GHz ~ 25GHz		Average (AV)

**ANTENNA POLARITY & TEST DISTANCE: HORIZONTAL AT 3 M**

NO.	FREQ. (MHz)	EMISSION LEVEL (dBuV/m)	LIMIT (dBuV/m)	MARGIN (dB)	ANTENNA HEIGHT (m)	TABLE ANGLE (Degree)	RAW VALUE (dBuV)	CORRECTION FACTOR (dB/m)
1	*2452.00	98.7 PK			3.09 H	358	100.6	-1.9
2	*2452.00	89.6 AV			3.09 H	358	91.5	-1.9
3	2483.50	61.7 PK	74.0	-12.3	3.10 H	347	63.5	-1.8
4	2483.50	49.1 AV	54.0	-4.9	3.10 H	347	50.9	-1.8
5	4904.00	44.8 PK	74.0	-29.2	3.22 H	360	42.4	2.4
6	4904.00	32.5 AV	54.0	-21.5	3.22 H	360	30.1	2.4

**ANTENNA POLARITY & TEST DISTANCE: VERTICAL AT 3 M**

NO.	FREQ. (MHz)	EMISSION LEVEL (dBuV/m)	LIMIT (dBuV/m)	MARGIN (dB)	ANTENNA HEIGHT (m)	TABLE ANGLE (Degree)	RAW VALUE (dBuV)	CORRECTION FACTOR (dB/m)
1	*2452.00	102.6 PK			2.87 V	326	104.5	-1.9
2	*2452.00	93.1 AV			2.87 V	326	95.0	-1.9
3	2483.50	66.7 PK	74.0	-7.3	2.87 V	326	68.5	-1.8
4	2483.50	53.6 AV	54.0	-0.4	2.87 V	326	55.4	-1.8
5	4904.00	48.7 PK	74.0	-25.3	2.23 V	197	46.3	2.4
6	4904.00	36.2 AV	54.0	-17.8	2.23 V	197	33.8	2.4

**REMARKS:**

1. Emission Level(dBuV/m) = Raw Value(dBuV) + Correction Factor(dB/m)
2. Correction Factor(dB/m) = Antenna Factor(dB/m) + Cable Factor(dB) – Pre-Amplifier Factor(dB)
3. The other emission levels were very low against the limit.
4. Margin value = Emission Level – Limit value
5. " \* ": Fundamental frequency.

## 4.2 Conducted Emission Measurement

### 4.2.1 Limits of Conducted Emission Measurement

Frequency (MHz)	Conducted Limit (dBuV)	
	Quasi-peak	Average
0.15 - 0.5	66 - 56	56 - 46
0.50 - 5.0	56	46
5.0 - 30.0	60	50

Note: 1. The lower limit shall apply at the transition frequencies.

2. The limit decreases in line with the logarithm of the frequency in the range of 0.15 to 0.50MHz.

### 4.2.2 Test Instruments

DESCRIPTION & MANUFACTURER	MODEL NO.	SERIAL NO.	CALIBRATED DATE	CALIBRATED UNTIL
Test Receiver R&S	ESCS 30	847124/029	Oct. 24, 2016	Oct. 23, 2017
Line-Impedance Stabilization Network (for EUT) R&S	ESH3-Z5	848773/004	Oct. 26, 2016	Oct. 25, 2017
Line-Impedance Stabilization Network (for Peripheral) R&S	ENV216	100072	June 13, 2016	June 12, 2017
50 ohms Terminator	N/A	EMC-02	Sep. 29, 2016	Sep. 28, 2017
RF Cable	5D-FB	COCCAB-001	Sep. 30, 2016	Sep. 29, 2017
10 dB PAD Mini-Circuits	HAT-10+	CONATT-004	June 20, 2016	June 19, 2017
Software BVADT	BVADT_Cond_ V7.3.7.4	NA	NA	NA

**Note:**

1. The calibration interval of the above test instruments are 12 months and the calibrations are traceable to NML/ROC and NIST/USA.
2. The test was performed in Shielded Room No. 1.
3. Tested Date: Mar. 30, 2017

#### 4.2.3 Test Procedures

- The EUT was placed 0.4 meters from the conducting wall of the shielded room with EUT being connected to the power mains through a line impedance stabilization network (LISN). Other support units were connected to the power mains through another LISN. The two LISNs provide 50 ohm/ 50uH of coupling impedance for the measuring instrument.
- Both lines of the power mains connected to the EUT were checked for maximum conducted interference.
- The frequency range from 150kHz to 30MHz was searched. Emission levels under (Limit - 20dB) was not recorded.

**NOTE:** The resolution bandwidth and video bandwidth of test receiver is 9kHz for quasi-peak detection (QP) and average detection (AV) at frequency 0.15MHz-30MHz.

#### 4.2.4 Deviation from Test Standard

No deviation.

#### 4.2.5 Test Setup

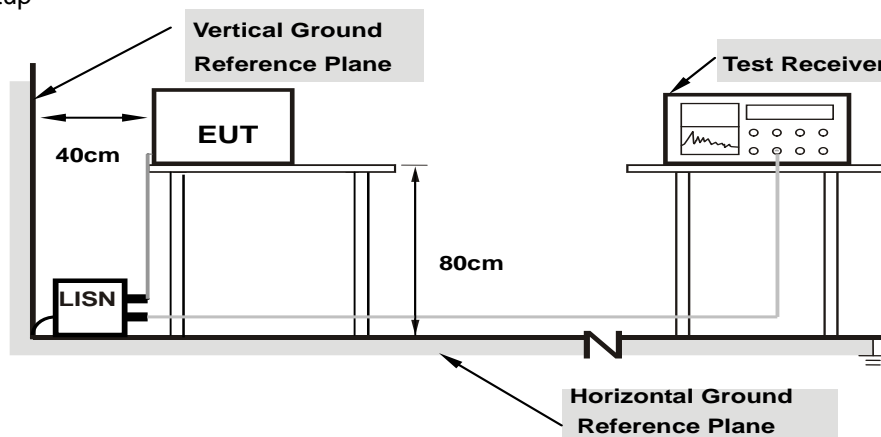

**Note:** 1.Support units were connected to second LISN.

For the actual test configuration, please refer to the attached file (Test Setup Photo).

#### 4.2.6 EUT Operating Conditions

Same as 4.1.6.



#### 4.2.7 Test Results (Mode 1)

Phase	Line (L)	Detector Function	Quasi-Peak (QP) / Average (AV)
-------	----------	-------------------	--------------------------------

No	Freq. [MHz]	Corr.	Reading Value		Emission Level		Limit		Margin	
		Factor (dB)	[dB (uV)]		[dB (uV)]		[dB (uV)]		(dB)	
		Q.P.	AV.	Q.P.	AV.	Q.P.	AV.	Q.P.	AV.	
1	0.15000	10.20	41.25	29.89	51.45	40.09	66.00	56.00	-14.55	-15.91
2	0.27891	10.22	24.14	15.35	34.36	25.57	60.85	50.85	-26.49	-25.28
3	0.52500	10.25	30.46	20.78	40.71	31.03	56.00	46.00	-15.29	-14.97
4	0.67734	10.27	24.07	12.64	34.34	22.91	56.00	46.00	-21.66	-23.09
5	9.28125	10.68	18.54	9.63	29.22	20.31	60.00	50.00	-30.78	-29.69
6	28.31641	11.82	17.32	8.13	29.14	19.95	60.00	50.00	-30.86	-30.05

#### REMARKS:

1. Q.P. and AV. are abbreviations of quasi-peak and average individually.
2. The emission levels of other frequencies were very low against the limit.
3. Margin value = Emission level - Limit value
4. Correction factor = Insertion loss + Cable loss
5. Emission Level = Correction Factor + Reading Value.

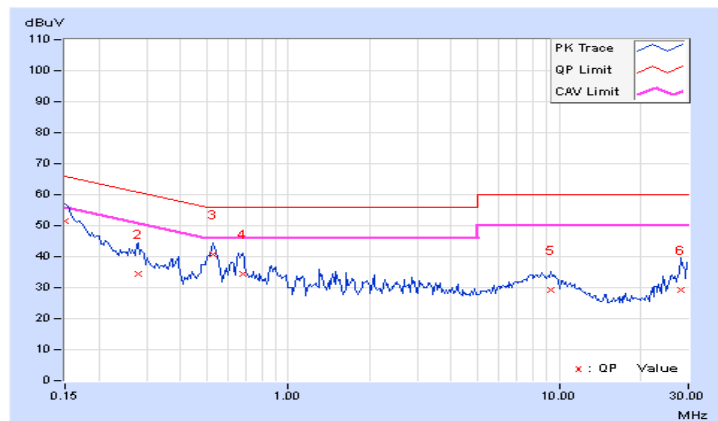

Phase	Neutral (N)	Detector Function	Quasi-Peak (QP) / Average (AV)
-------	-------------	-------------------	--------------------------------

No	Freq. [MHz]	Corr.	Reading Value		Emission Level		Limit		Margin	
		Factor (dB)	[dB (uV)]		[dB (uV)]		[dB (uV)]		(dB)	
			Q.P.	AV.	Q.P.	AV.	Q.P.	AV.	Q.P.	AV.
1	0.15000	10.19	40.00	25.95	50.19	36.14	66.00	56.00	-15.81	-19.86
2	0.29063	10.20	23.76	13.86	33.96	24.06	60.51	50.51	-26.55	-26.45
3	0.52500	10.24	24.27	18.01	34.51	28.25	56.00	46.00	-21.49	-17.75
4	0.68125	10.25	22.71	9.69	32.96	19.94	56.00	46.00	-23.04	-26.06
5	9.01172	10.56	15.90	8.93	26.46	19.49	60.00	50.00	-33.54	-30.51
6	28.50000	11.40	12.33	4.25	23.73	15.65	60.00	50.00	-36.27	-34.35

#### REMARKS:

1. Q.P. and AV. are abbreviations of quasi-peak and average individually.
2. The emission levels of other frequencies were very low against the limit.
3. Margin value = Emission level - Limit value
4. Correction factor = Insertion loss + Cable loss
5. Emission Level = Correction Factor + Reading Value.

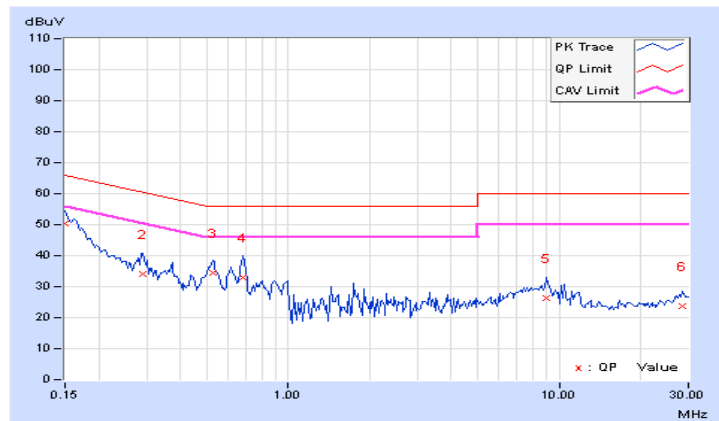

#### 4.2.8 Test Results (Mode 2)

Phase	Line (L)	Detector Function	Quasi-Peak (QP) / Average (AV)
-------	----------	-------------------	--------------------------------

No	Freq. [MHz]	Corr.	Reading Value		Emission Level		Limit		Margin	
		Factor (dB)	[dB (uV)]		[dB (uV)]		[dB (uV)]		(dB)	
			Q.P.	AV.	Q.P.	AV.	Q.P.	AV.	Q.P.	AV.
1	0.15000	10.19	31.59	11.51	41.78	21.70	66.00	56.00	-24.22	-34.30
2	0.16562	10.19	41.31	33.63	51.50	43.82	65.18	55.18	-13.68	-11.36
3	0.23203	10.19	36.91	29.97	47.10	40.16	62.38	52.38	-15.28	-12.22
4	0.28281	10.20	33.62	27.23	43.82	37.43	60.73	50.73	-16.91	-13.30
5	4.33984	10.26	26.33	11.72	36.59	21.98	56.00	46.00	-19.41	-24.02
6	20.46094	11.38	19.46	12.03	30.84	23.41	60.00	50.00	-29.16	-26.59

#### REMARKS:

1. Q.P. and AV. are abbreviations of quasi-peak and average individually.
2. The emission levels of other frequencies were very low against the limit.
3. Margin value = Emission level - Limit value
4. Correction factor = Insertion loss + Cable loss
5. Emission Level = Correction Factor + Reading Value.

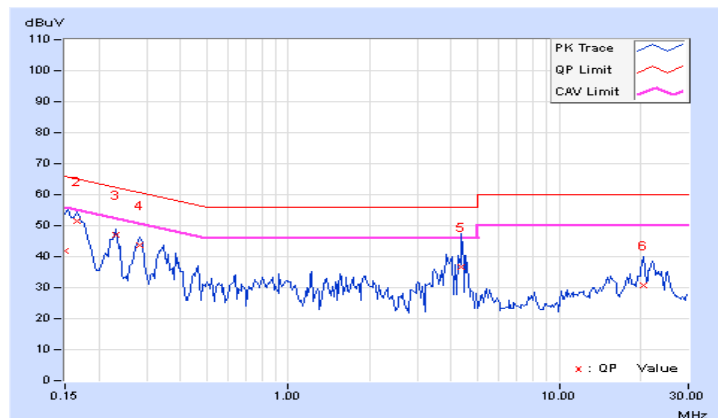

Phase	Neutral (N)	Detector Function	Quasi-Peak (QP) / Average (AV)
-------	-------------	-------------------	--------------------------------

No	Freq. [MHz]	Corr.	Reading Value		Emission Level		Limit		Margin	
		Factor (dB)	[dB (uV)]		[dB (uV)]		[dB (uV)]		(dB)	
			Q.P.	AV.	Q.P.	AV.	Q.P.	AV.	Q.P.	AV.
1	<b>0.16953</b>	<b>10.17</b>	<b>40.53</b>	<b>35.30</b>	<b>50.70</b>	<b>45.47</b>	<b>64.98</b>	<b>54.98</b>	<b>-14.28</b>	<b>-9.51</b>
2	0.23231	10.17	36.54	28.67	46.71	38.84	62.37	52.37	-15.66	-13.53
3	0.28281	10.18	33.11	28.33	43.29	38.51	60.73	50.73	-17.44	-12.22
4	2.49219	10.25	23.64	14.08	33.89	24.33	56.00	46.00	-22.11	-21.67
5	3.91406	10.17	22.83	10.39	33.00	20.56	56.00	46.00	-23.00	-25.44
6	22.98438	11.09	24.25	18.01	35.34	29.10	60.00	50.00	-24.66	-20.90

#### REMARKS:

1. Q.P. and AV. are abbreviations of quasi-peak and average individually.
2. The emission levels of other frequencies were very low against the limit.
3. Margin value = Emission level - Limit value
4. Correction factor = Insertion loss + Cable loss
5. Emission Level = Correction Factor + Reading Value.

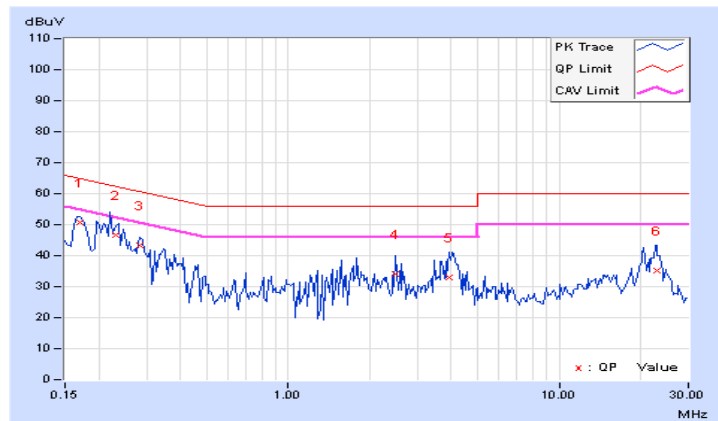

### 4.3 6dB Bandwidth Measurement

#### 4.3.1 Limits of 6dB Bandwidth Measurement

The minimum of 6dB Bandwidth Measurement is 0.5 MHz.

#### 4.3.2 Test Setup

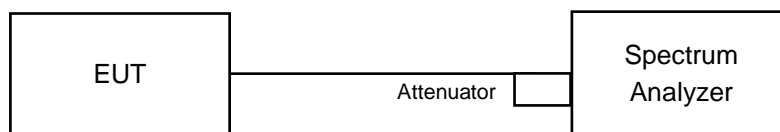

#### 4.3.3 Test Instruments

Refer to section 4.1.2 to get information of above instrument.

#### 4.3.4 Test Procedure

- a. Set resolution bandwidth (RBW) = 100kHz
- b. Set the video bandwidth (VBW)  $\geq 3 \times$  RBW, Detector = Peak.
- c. Trace mode = max hold.
- d. Sweep = auto couple.
- e. Measure the maximum width of the emission that is constrained by the frequencies associated with the two amplitude points (upper and lower) that are attenuated by 6 dB relative to the maximum level measured in the fundamental emission

#### 4.3.5 Deviation from Test Standard

No deviation.

#### 4.3.6 EUT Operating Conditions

The software provided by client to enable the EUT under transmission condition continuously at lowest, middle and highest channel frequencies individually.

#### 4.3.7 Test Result

##### 802.11b

Channel	Frequency (MHz)	6dB Bandwidth (MHz)	Minimum Limit (MHz)	Pass / Fail
1	2412	9.14	0.5	PASS
6	2437	9.15	0.5	PASS
11	2462	9.13	0.5	PASS

##### 802.11g

Channel	Frequency (MHz)	6dB Bandwidth (MHz)	Minimum Limit (MHz)	Pass / Fail
1	2412	14.48	0.5	PASS
6	2437	14.54	0.5	PASS
11	2462	15.62	0.5	PASS

##### 802.11n (HT20)

Channel	Frequency (MHz)	6dB Bandwidth (MHz)	Minimum Limit (MHz)	Pass / Fail
1	2412	15.18	0.5	Pass
6	2437	16.33	0.5	Pass
11	2462	15.19	0.5	Pass

##### 802.11n (HT40)

Channel	Frequency (MHz)	6dB Bandwidth (MHz)	Minimum Limit (MHz)	Pass / Fail
3	2422	32.63	0.5	Pass
6	2437	32.03	0.5	Pass
9	2452	35.23	0.5	Pass

### Spectrum Plot of Worst Value

#### 802.11b / CH1

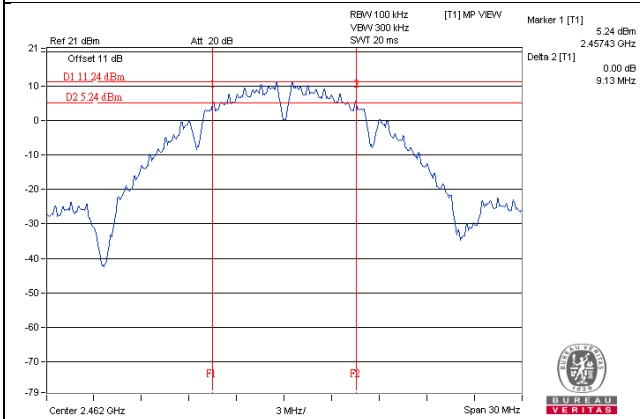

#### 802.11g / CH1

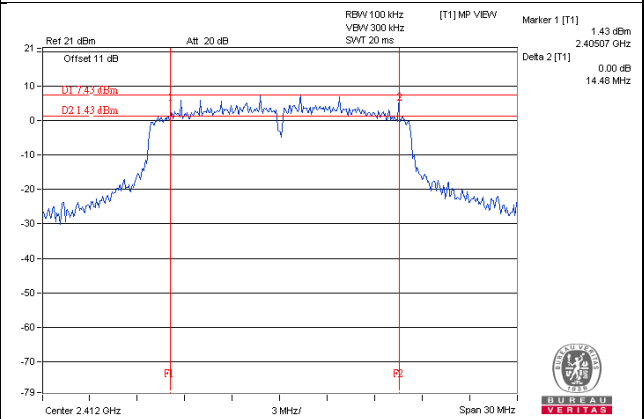

#### 802.11n (HT20) / CH1

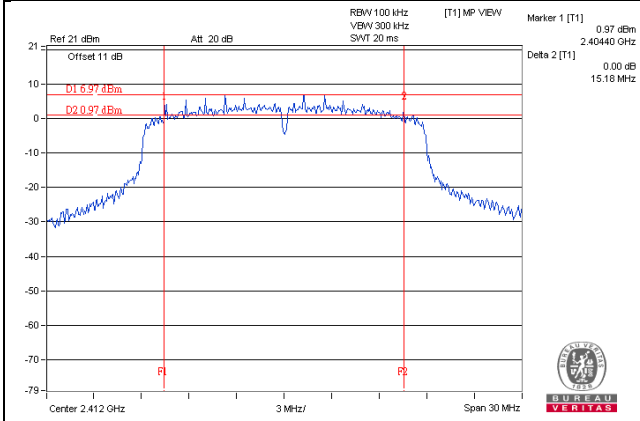

#### 802.11n (HT40) / CH6

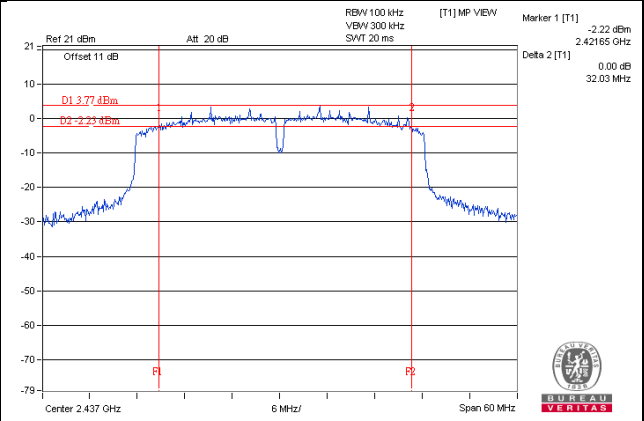

## 4.4 Conducted Output Power Measurement

### 4.4.1 Limits of Conducted Output Power Measurement

For systems using digital modulation in the 2400–2483.5 MHz bands: 1 Watt (30dBm)

### 4.4.2 Test Setup

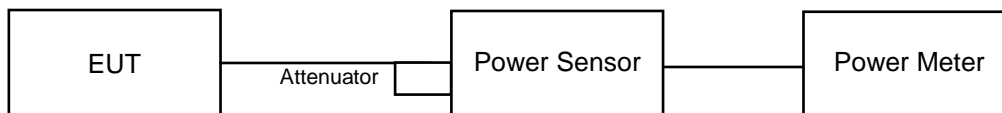

### 4.4.3 Test Instruments

Refer to section 4.1.2 to get information of above instrument.

### 4.4.4 Test Procedures

An average power sensor was used on the output port of the EUT. A power meter was used to read the response of the average power sensor. Record the power level.

### 4.4.5 Deviation from Test Standard

No deviation.

### 4.4.6 EUT Operating Conditions

Same as Item 4.3.6.



#### 4.4.7 Test Results

##### 802.11b

Channel	Frequency (MHz)	Average Power (mW)	Average Power (dBm)	Limit (dBm)	Pass/Fail
1	2412	156.675	21.95	30	Pass
6	2437	157.761	21.98	30	Pass
11	2462	162.555	22.11	30	Pass

##### 802.11g

Channel	Frequency (MHz)	Average Power (mW)	Average Power (dBm)	Limit (dBm)	Pass/Fail
1	2412	68.549	18.36	30	Pass
6	2437	144.212	21.59	30	Pass
11	2462	65.615	18.17	30	Pass

##### 802.11n (HT20)

Channel	Frequency (MHz)	Average Power (mW)	Average Power (dBm)	Limit (dBm)	Pass/Fail
1	2412	61.376	17.88	30	Pass
6	2437	135.519	21.32	30	Pass
11	2462	63.241	18.01	30	Pass

##### 802.11n (HT40)

Channel	Frequency (MHz)	Average Power (mW)	Average Power (dBm)	Limit (dBm)	Pass/Fail
3	2422	45.394	16.57	30	Pass
6	2437	61.944	17.92	30	Pass
9	2452	33.42	15.24	30	Pass

## 4.5 Power Spectral Density Measurement

### 4.5.1 Limits of Power Spectral Density Measurement

The Maximum of Power Spectral Density Measurement is 8dBm.

### 4.5.2 Test Setup

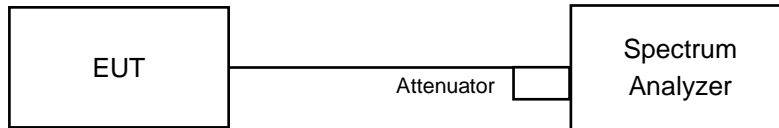

### 4.5.3 Test Instruments

Refer to section 4.1.2 to get information of above instrument.

### 4.5.4 Test Procedure

- Set instrument center frequency to DTS channel center frequency.
- Set span to at least 1.5 times the OBW.
- Set RBW to:  $3 \text{ kHz} \leq \text{RBW} \leq 100 \text{ kHz}$ .
- Set VBW  $\geq 3 \times \text{RBW}$ .
- Detector = power averaging (RMS) or sample detector (when RMS not available).
- Ensure that the number of measurement points in the sweep  $\geq 2 \times \text{span}/\text{RBW}$ .
- Sweep time = auto couple.
- Employ trace averaging (RMS) mode over a minimum of 100 traces.
- Use the peak marker function to determine the maximum amplitude level.

### 4.5.5 Deviation from Test Standard

No deviation.

### 4.5.6 EUT Operating Condition

Same as Item 4.3.6

#### 4.5.7 Test Results

##### 802.11b

Channel	Freq. (MHz)	PSD (dBm/3kHz)	Limit (dBm/3kHz)	Pass /Fail
1	2412	-7.22	8	Pass
6	2437	-7.24	8	Pass
11	2462	-7.50	8	Pass

##### 802.11g

Channel	Freq. (MHz)	PSD (dBm/3kHz)	Limit (dBm/3kHz)	Pass /Fail
1	2412	-13.84	8	Pass
6	2437	-10.67	8	Pass
11	2462	-13.30	8	Pass

##### 802.11n (HT20)

Channel	Freq. (MHz)	PSD (dBm/3kHz)	Limit (dBm/3kHz)	Pass /Fail
1	2412	-14.95	8	Pass
6	2437	-11.78	8	Pass
11	2462	-13.79	8	Pass

##### 802.11n (HT40)

Channel	Freq. (MHz)	PSD (dBm/3kHz)	Limit (dBm/3kHz)	Pass /Fail
3	2422	-18.82	8	Pass
6	2437	-17.01	8	Pass
9	2452	-20.63	8	Pass

### Spectrum Plot of Worst Value

#### 802.11b / CH1

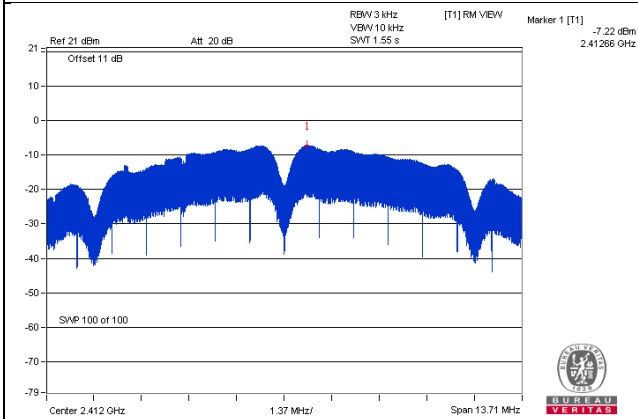

#### 802.11g / CH6

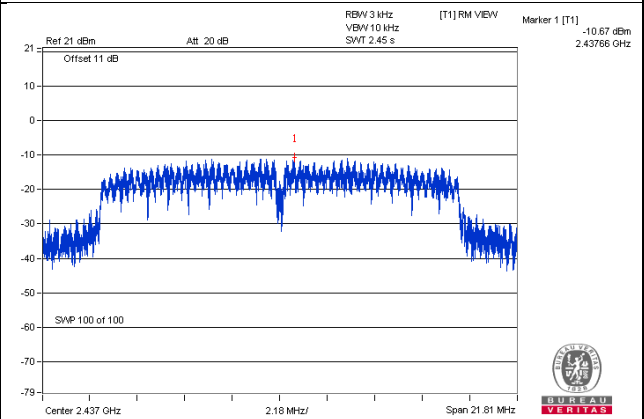

#### 802.11n (HT20) / CH6

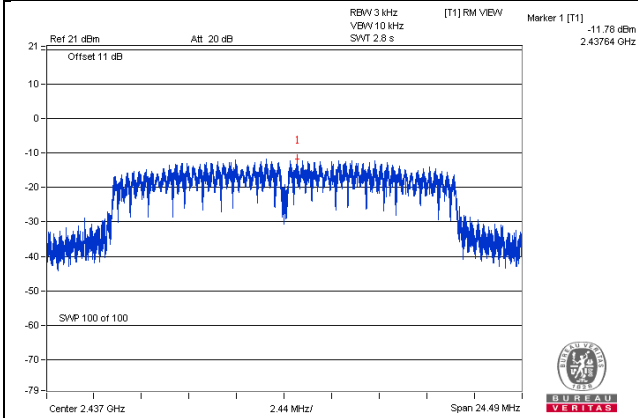

#### 802.11n (HT40) / CH6

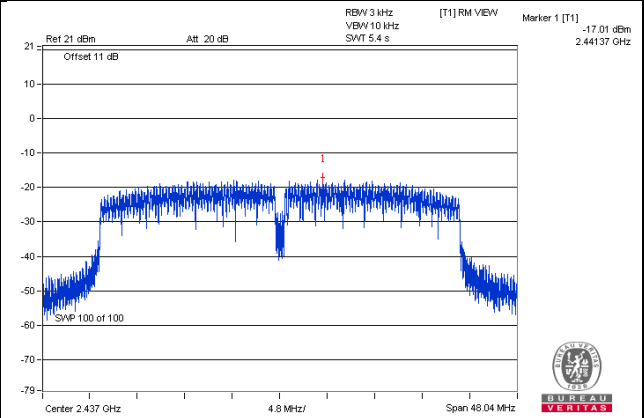

## 4.6 Conducted Out of Band Emission Measurement

### 4.6.1 Limits of Conducted Out of Band Emission Measurement

Below 30dB of the highest emission level of operating band (in 100kHz Resolution Bandwidth).

### 4.6.2 Test Setup

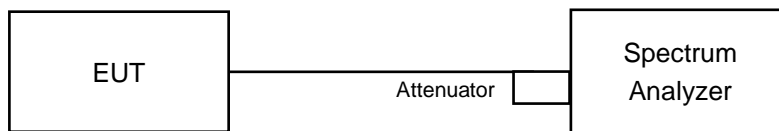

### 4.6.3 Test Instruments

Refer to section 4.1.2 to get information of above instrument.

### 4.6.4 Test Procedure

#### MEASUREMENT PROCEDURE REF

1. Set the RBW = 100 kHz.
2. Set the VBW  $\geq$  300 kHz.
3. Detector = peak.
4. Sweep time = auto couple.
5. Trace mode = max hold.
6. Allow trace to fully stabilize.
7. Use the peak marker function to determine the maximum power level in any 100 kHz band segment within the fundamental EBW.

#### MEASUREMENT PROCEDURE OOB

1. Set RBW = 100 kHz.
2. Set VBW  $\geq$  300 kHz.
3. Detector = peak.
4. Sweep = auto couple.
5. Trace Mode = max hold.
6. Allow trace to fully stabilize.
7. Use the peak marker function to determine the maximum amplitude level.

### 4.6.5 Deviation from Test Standard

No deviation.

### 4.6.6 EUT Operating Condition

Same as Item 4.3.6

### 4.6.7 Test Results

The spectrum plots are attached on the following pages. D1 line indicates the highest level, and D2 line indicates the 30dBoffset below D1. It shows compliance with the requirement.

802.11b

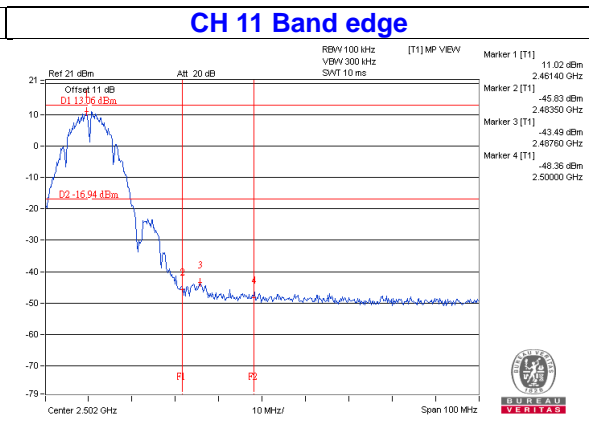
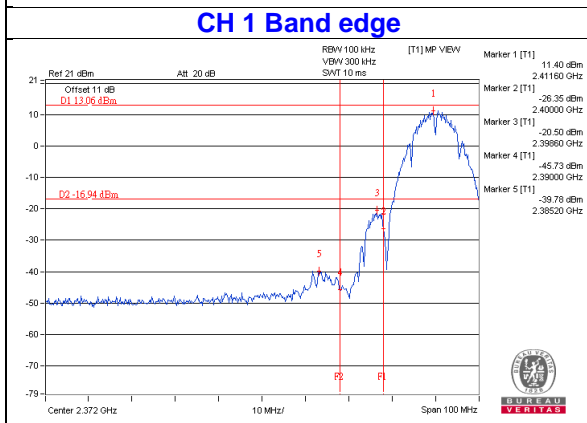
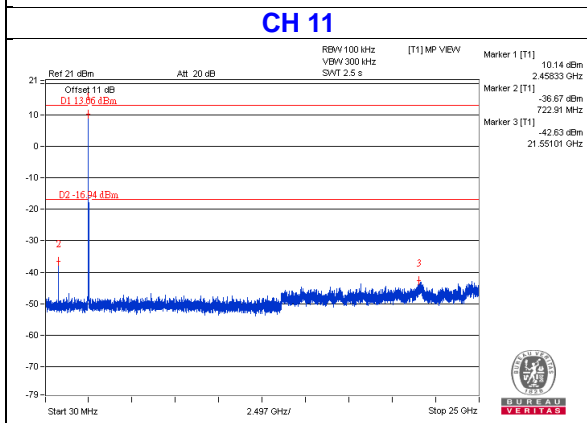
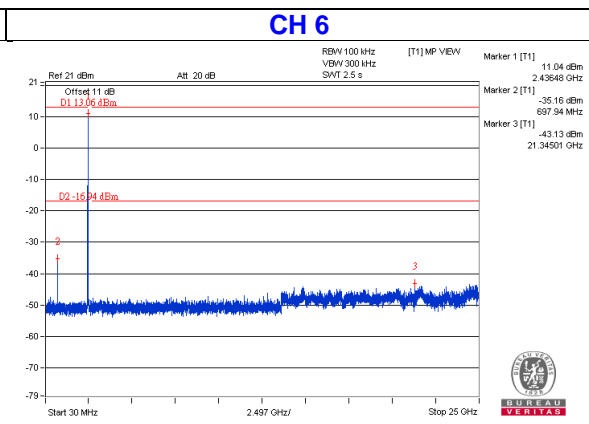
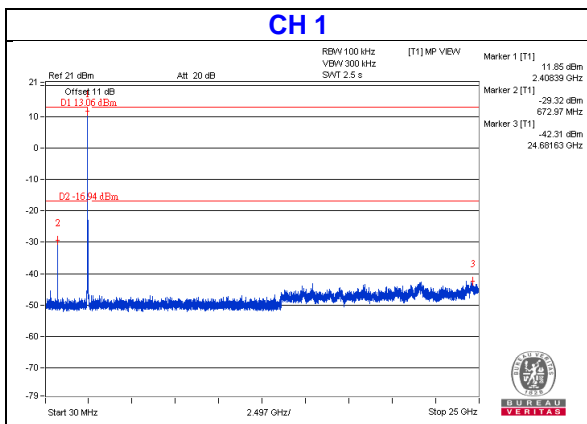
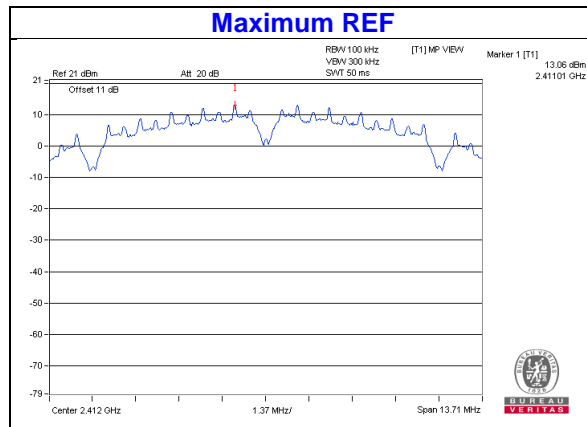

802.11g

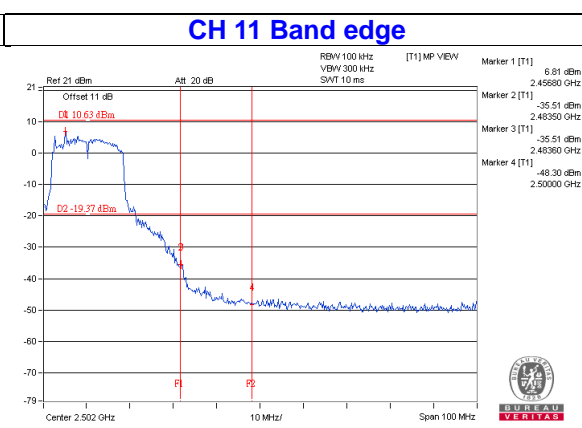
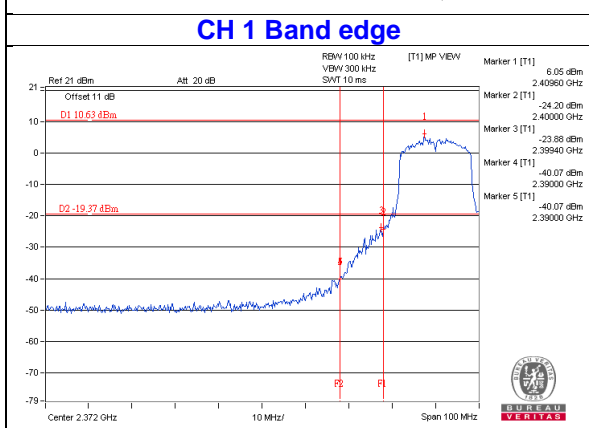
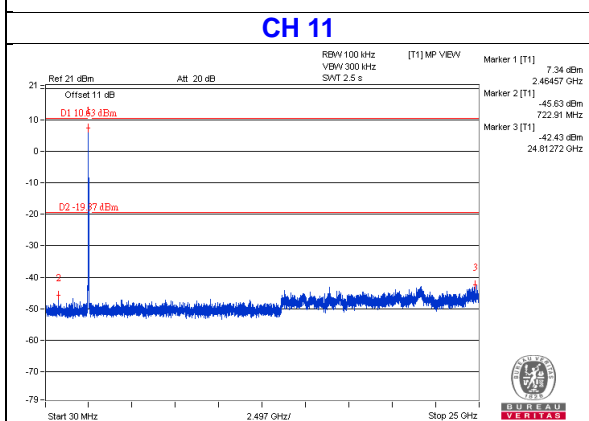
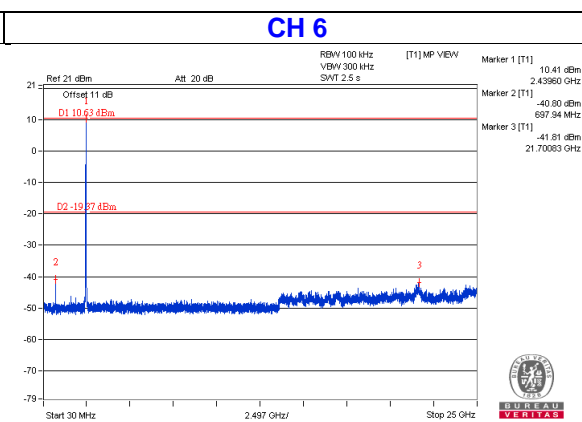
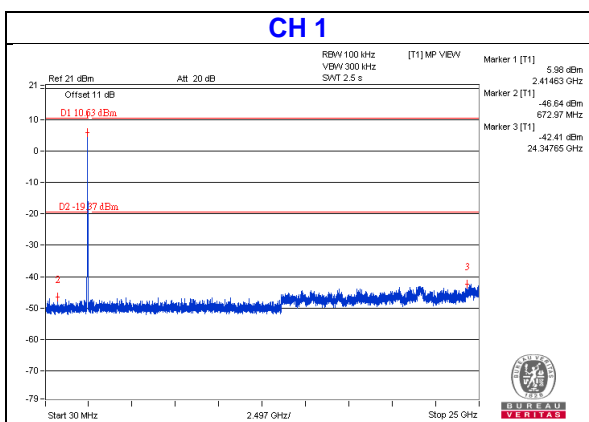
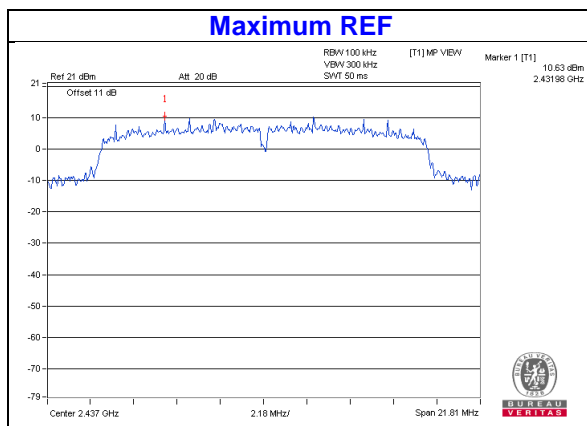

# 802.11n (HT20)

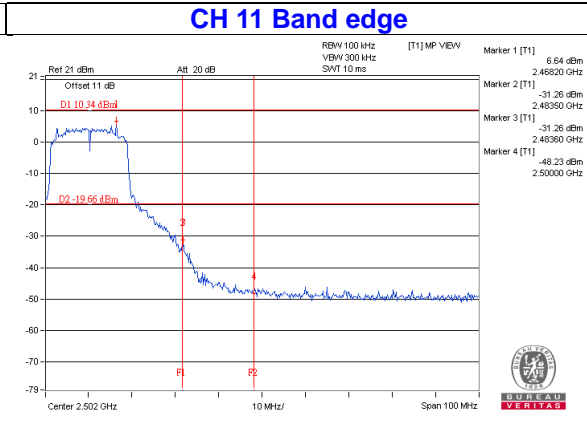
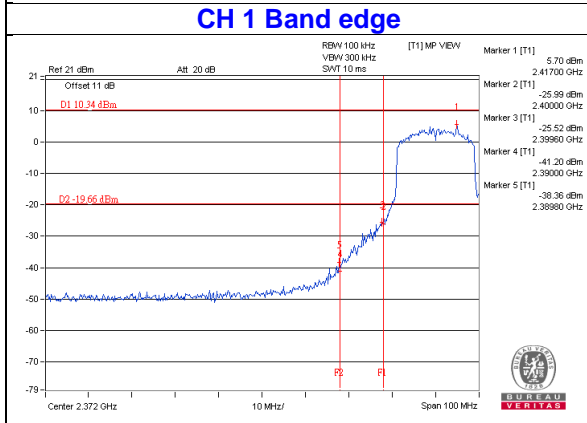
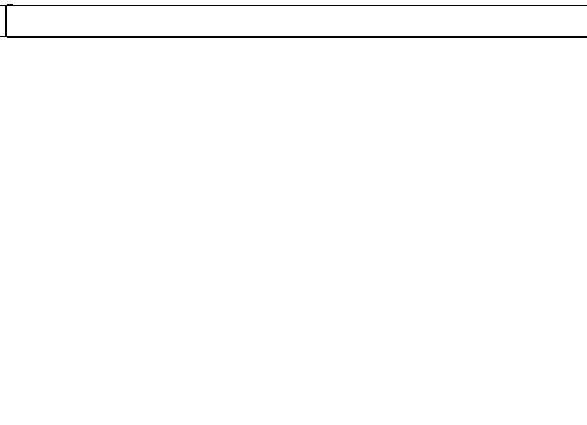
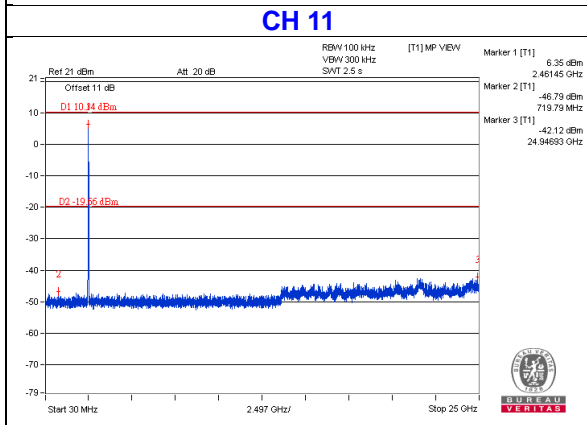
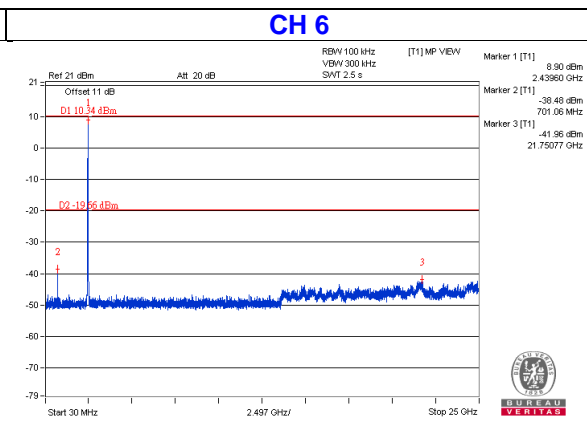
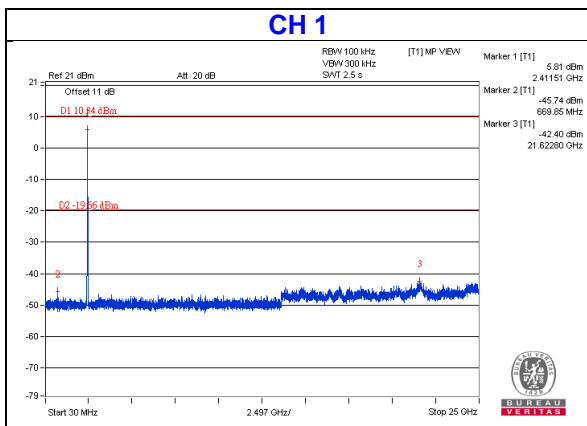
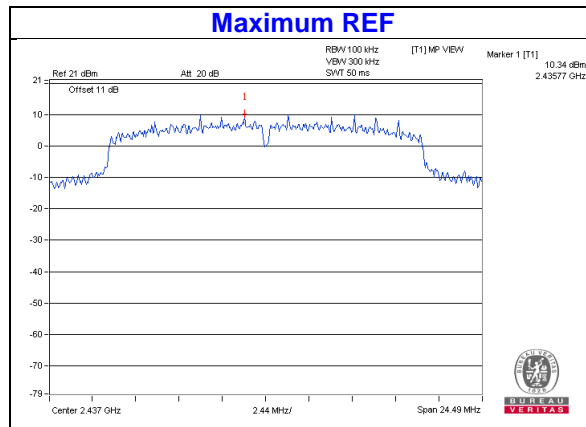



802.11n (HT40)

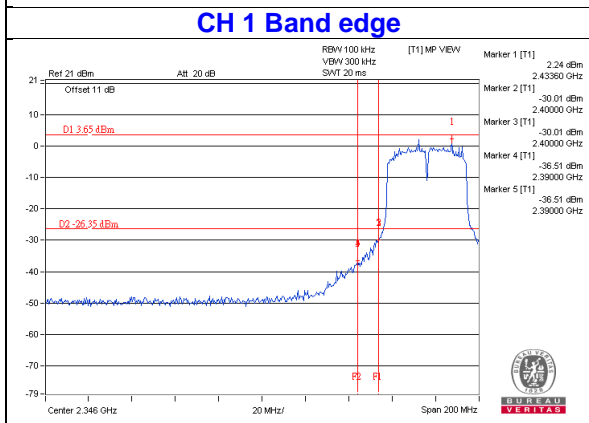
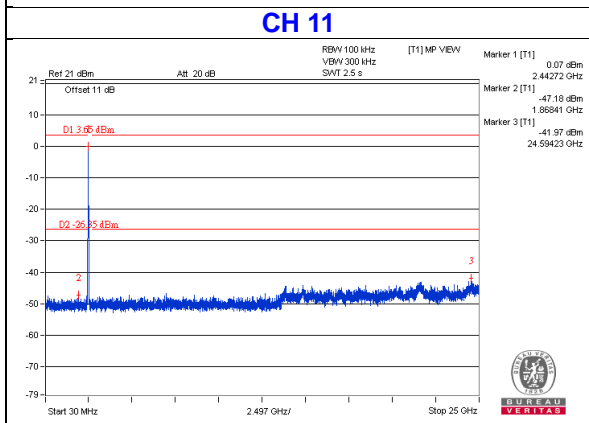
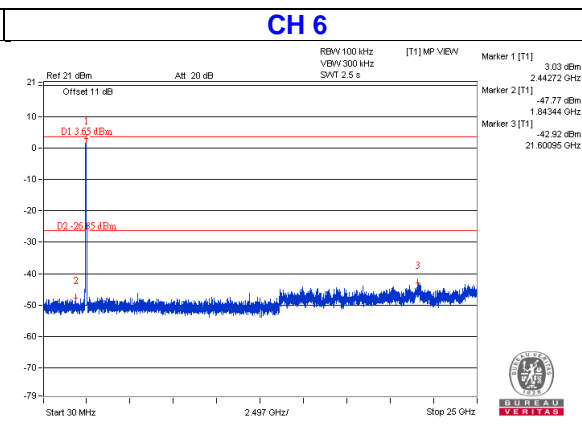
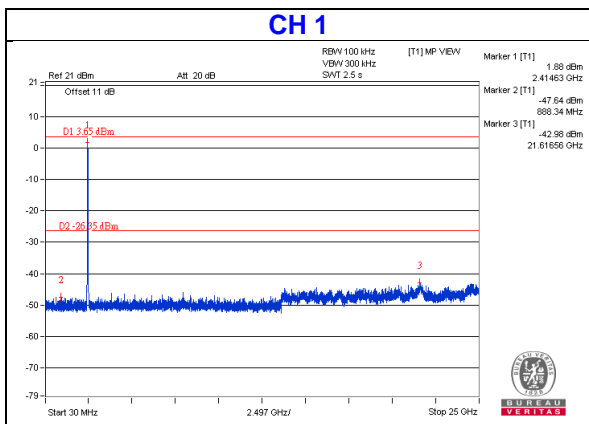
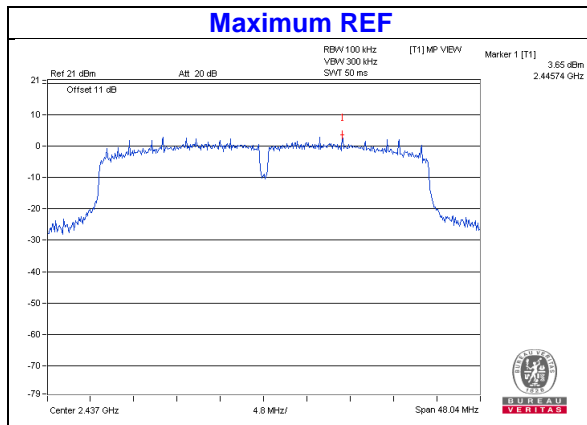

## 5 Pictures of Test Arrangements

Please refer to the attached file (Test Setup Photo).

## Appendix – Information on the Testing Laboratories

We, Bureau Veritas Consumer Products Services (H.K.) Ltd., Taoyuan Branch, were founded in 1988 to provide our best service in EMC, Radio, Telecom and Safety consultation. Our laboratories are accredited and approved according to ISO/IEC 17025.

If you have any comments, please feel free to contact us at the following:

**Linko EMC/RF Lab**

Tel: 886-2-26052180

Fax: 886-2-26051924

**Hsin Chu EMC/RF/Telecom Lab**

Tel: 886-3-6668565

Fax: 886-3-6668323

**Hwa Ya EMC/RF/Safety Lab**

Tel: 886-3-3183232

Fax: 886-3-3270892

**Email:** [service.adt@tw.bureauveritas.com](mailto:service.adt@tw.bureauveritas.com)

**Web Site:** [www.bureauveritas-adt.com](http://www.bureauveritas-adt.com)

The address and road map of all our labs can be found in our web site also.

--- END ---