

## FCC Test Report

**Report No.:** RF170322E05-1

**FCC ID:** PY317100371

**Test Model:** ABC1000

**Received Date:** Mar. 22, 2017

**Test Date:** Mar. 28 to Apr. 07, 2017

**Issued Date:** Apr. 13, 2017

**Applicant:** NETGEAR, INC

**Address:** 350 East Plumeria Drive San Jose, CA 95134

**Issued By:** Bureau Veritas Consumer Products Services (H.K.) Ltd., Taoyuan Branch  
Hsin Chu Laboratory

**Lab Address:** E-2, No.1, Li Hsin 1st Road, Hsinchu Science Park, Hsinchu City 300,  
Taiwan R.O.C.

**Test Location (1):** E-2, No.1, Li Hsin 1st Road, Hsinchu Science Park, Hsinchu City 300,  
Taiwan R.O.C.

**Test Location (2):** No. 49, Ln. 206, Wende Rd., Shangshan Tsuen, Chiung Lin Hsiang, Hsin  
Chu Hsien 307, Taiwan R.O.C.



This report is for your exclusive use. Any copying or replication of this report to or for any other person or entity, or use of our name or trademark, is permitted only with our prior written permission. This report sets forth our findings solely with respect to the test samples identified herein. The results set forth in this report are not indicative or representative of the quality or characteristics of the lot from which a test sample was taken or any similar or identical product unless specifically and expressly noted. Our report includes all of the tests requested by you and the results thereof based upon the information that you provided to us. You have 60 days from date of issuance of this report to notify us of any material error or omission caused by our negligence, provided, however, that such notice shall be in writing and shall specifically address the issue you wish to raise. A failure to raise such issue within the prescribed time shall constitute your unqualified acceptance of the completeness of this report, the tests conducted and the correctness of the report contents. Unless specific mention, the uncertainty of measurement has been explicitly taken into account to declare the compliance or non-compliance to the specification. The report must not be used by the client to claim product certification, approval, or endorsement by TAF or any government agencies.

## Table of Contents

<b>Release Control Record</b> .....	<b>4</b>
<b>1 Certificate of Conformity</b> .....	<b>5</b>
<b>2 Summary of Test Results</b> .....	<b>6</b>
2.1 Measurement Uncertainty .....	6
2.2 Modification Record .....	6
<b>3 General Information</b> .....	<b>7</b>
3.1 General Description of EUT .....	7
3.2 Description of Test Modes .....	9
3.2.1 Test Mode Applicability and Tested Channel Detail .....	10
3.3 Duty Cycle of Test Signal .....	12
3.4 Description of Support Units .....	13
3.4.1 Configuration of System under Test .....	14
3.5 General Description of Applied Standard .....	15
<b>4 Test Types and Results</b> .....	<b>16</b>
4.1 Radiated Emission and Bandedge Measurement .....	16
4.1.1 Limits of Radiated Emission and Bandedge Measurement .....	16
4.1.2 Test Instruments .....	17
4.1.3 Test Procedure .....	19
4.1.4 Deviation from Test Standard .....	19
4.1.5 Test Setup .....	20
4.1.6 EUT Operating Condition .....	21
4.1.7 Test Results (Mode 1) .....	22
4.1.8 Test Results (Mode 3) .....	41
4.2 Conducted Emission Measurement .....	59
4.2.1 Limits of Conducted Emission Measurement .....	59
4.2.2 Test Instruments .....	59
4.2.3 Test Procedure .....	60
4.2.4 Deviation from Test Standard .....	60
4.2.5 Test Setup .....	60
4.2.6 EUT Operating Condition .....	60
4.2.7 Test Results (Mode 1) .....	61
4.2.8 Test Results (Mode 2) .....	63
4.3 Transmit Power Measurement .....	65
4.3.1 Limits of Transmit Power Measurement .....	65
4.3.2 Test Setup .....	65
4.3.3 Test Instruments .....	65
4.3.4 Test Procedure .....	65
4.3.5 Deviation from Test Standard .....	65
4.3.6 EUT Operating Condition .....	65
4.3.7 Test Result .....	66
4.4 Occupied Bandwidth Measurement .....	67
4.4.1 Test Setup .....	67
4.4.2 Test Instruments .....	67
4.4.3 Test Procedure .....	67
4.4.4 Test Results .....	68
4.5 Peak Power Spectral Density Measurement .....	72
4.5.1 Limits of Peak Power Spectral Density Measurement .....	72
4.5.2 Test Setup .....	72
4.5.3 Test Instruments .....	72
4.5.4 Test Procedure .....	73
4.5.5 Deviation from Test Standard .....	73
4.5.6 EUT Operating Condition .....	73
4.5.7 Test Results .....	74

4.6	Frequency Stability Measurement.....	78
4.6.1	Limits of Frequency Stability Measurement .....	78
4.6.2	Test Setup.....	78
4.6.3	Test Instruments .....	78
4.6.4	Test Procedure .....	78
4.6.5	Deviation from Test Standard .....	78
4.6.6	EUT Operating Condition .....	78
4.6.7	Test Results .....	79
4.7	6dB Bandwidth Measurement.....	80
4.7.1	Limits of 6dB Bandwidth Measurement.....	80
4.7.2	Test Setup.....	80
4.7.3	Test Instruments .....	80
4.7.4	Test Procedure .....	80
4.7.5	Deviation from Test Standard .....	80
4.7.6	EUT Operating Condition .....	80
4.7.7	Test Results .....	81
<b>5</b>	<b>Pictures of Test Arrangements.....</b>	<b>83</b>
	<b>Annex A- Radiated Out of Band Emission (OOBE) Measurement (For U-NII-3 band).....</b>	<b>84</b>
	<b>Appendix – Information on the Testing Laboratories .....</b>	<b>90</b>

### Release Control Record

Issue No.	Description	Date Issued
RF170322E05-1	Original release.	Apr. 13, 2017

## 1 Certificate of Conformity

**Product:** Alro Baby  
**Brand:** NETGEAR  
**Test Model:** ABC1000  
**Sample Status:** ENGINEERING SAMPLE  
**Applicant:** NETGEAR, INC  
**Test Date:** Mar. 28 to Apr. 07, 2017  
**Standard:** 47 CFR FCC Part 15, Subpart E (Section 15.407)  
ANSI C63.10: 2013

The above equipment has been tested by **Bureau Veritas Consumer Products Services (H.K.) Ltd., Taoyuan Branch**, and found compliance with the requirement of the above standards. The test record, data evaluation & Equipment Under Test (EUT) configurations represented herein are true and accurate accounts of the measurements of the sample's EMC characteristics under the conditions specified in this report.

**Prepared by :** Wendy Wu , **Date:** Apr. 13, 2017  
Wendy Wu / Specialist

**Approved by :** May Chen , **Date:** Apr. 13, 2017  
May Chen / Manager

## 2 Summary of Test Results

47 CFR FCC Part 15, Subpart E (Section 15.407)			
FCC Clause	Test Item	Result	Remarks
15.407(b)(6)	AC Power Conducted Emissions	Pass	Meet the requirement of limit. Minimum passing margin is -4.07dB at 0.17500MHz.
15.407(b) (1/2/3/4(i/ii)/6)	Radiated Emissions & Band Edge Measurement*	Pass	Meet the requirement of limit. Minimum passing margin is -0.1dB at 5150.00MHz.
15.407(a)(1/2/3)	Max Average Transmit Power	Pass	Meet the requirement of limit.
---	Occupied Bandwidth Measurement	-	Reference only.
15.407(a)(1/2/3)	Peak Power Spectral Density	Pass	Meet the requirement of limit.
15.407(e)	6dB bandwidth	Pass	Meet the requirement of limit. (U-NII-3 Band only)
15.407(g)	Frequency Stability	Pass	Meet the requirement of limit.
15.203	Antenna Requirement	Pass	No antenna connector is used.

\*For U-NII-3 band compliance with rule part 15.407(b)(4)(i), the OBE test plots were recorded in Annex A.

### 2.1 Measurement Uncertainty

Where relevant, the following measurement uncertainty levels have been estimated for tests performed on the EUT as specified in CISPR 16-4-2:

Measurement	Frequency	Expanded Uncertainty (k=2) ( $\pm$ )
Conducted Emissions at mains ports	150kHz ~ 30MHz	1.84 dB
Radiated Emissions up to 1 GHz	30MHz ~ 1GHz	5.32 dB
Radiated Emissions above 1 GHz	1GHz ~ 6GHz	4.82 dB
	6GHz ~ 18GHz	4.58 dB
	18GHz ~ 40GHz	5.03 dB

### 2.2 Modification Record

There were no modifications required for compliance.

### 3 General Information

#### 3.1 General Description of EUT

Product	Alro Baby
Brand	NETGEAR
Test Model	ABC1000
Status of EUT	ENGINEERING SAMPLE
Power Supply Rating	5Vdc from power adapter or 3.6V from battery
Modulation Type	CCK, DQPSK, DBPSK for DSSS 64QAM, 16QAM, QPSK, BPSK for OFDM 256QAM for OFDM in 11ac mode only
Modulation Technology	DSSS, OFDM
Transfer Rate	802.11b: up to 11Mbps 802.11a/g: up to 54Mbps 802.11n: up to 150Mbps 802.11ac: up to 433.3Mbps
Operating Frequency	<b>2.4GHz:</b> 2.412 ~ 2.462GHz <b>5GHz:</b> 5.18 ~ 5.24GHz, 5.745 ~ 5.825GHz
Number of Channel	<b>2.4GHz:</b> 802.11b, 802.11g, 802.11n (HT20), VHT20: 11 802.11n (HT40), VHT40: 7 <b>5GHz:</b> 802.11a, 802.11n (HT20), 802.11ac (VHT20): 9 802.11n (HT40), 802.11ac (VHT40): 4 802.11ac (VHT80): 2
Output Power	<b>2.4GHz:</b> 162.555mW <b>5GHz:</b> <b>5.18 ~ 5.24GHz:</b> 75.162mW <b>5.745 ~ 5.825GH:</b> 79.799mW
Antenna Type	Refer to Note
Antenna Connector	Refer to Note
Accessory Device	Adapter x 1
Data Cable Supplied	USB cable x 1 (3m, unshielded)

Note:

- The EUT must be supplied with a power adapter or battery and following different models could be chosen as following table:

Adapter					
No	Brand Name	Model No.	P/N	Spec.	
1	NETGEAR	AD2037320	332-10924-01	Input: 100-240Vac, 50/60Hz, 0.3A Output: 5Vdc, 2A	
2	NETGEAR	AD2037520	332-10925-01	Input: 100-240Vac, 50/60Hz, 0.3A Output: 5Vdc, 2A	
Battery					
No	Brand Name	Model No.	P/N	Rating	Min. Capacity
1	NETGEAR	A-3	308-10033-01	3.6V 8.78Wh	2440mA

Note:

- The adapter 2 is as same as adapter 1; except for color is different.
- From the above adapters and battery, the radiated emissions worse case was found in Adapter 1. Therefore only the test data of the mode was recorded in this report.

2. Simultaneously transmission condition.

Condition	Technology	
1	WLAN (5GHz)	Bluetooth

**Note:** The emission of the simultaneous operation has been evaluated and no non-compliance was found.

3. The antennas provided to the EUT, please refer to the following table:

Chain No.	Ant. Gain(dBi)	Frequency range (GHz)	Antenna Type	Connecter Type
Chain 0	2.64	2.4~2.4835	PIFA	NA
	5.61	5.15~5.25		
	4.92	5.25~5.35		
	4.83	5.47~5.725		
	5.38	5.725~5.85		
Chain 1	3.18	2.4~2.4835	Monopole	NA
	4.13	5.15~5.25		
	4.23	5.25~5.35		
	3.14	5.47~5.725		
	2.82	5.725~5.85		

4. The EUT incorporates a SISO function.

For 2.4GHz Band			
MODULATION MODE	DATA RATE (MCS)	TX & RX CONFIGURATION	
802.11b	1~11Mbps	1TX diversity	1RX diversity
802.11g	6~54Mbps	1TX diversity	1RX diversity
802.11n (HT20)	MCS 0~7	1TX diversity	1RX diversity
802.11n (HT40)	MCS 0~7	1TX diversity	1RX diversity
For 5GHz Band			
MODULATION MODE	DATA RATE (MCS)	TX & RX CONFIGURATION	
802.11a	6~54Mbps	1TX diversity	1RX diversity
802.11n (HT20)	MCS 0~7	1TX diversity	1RX diversity
802.11n (HT40)	MCS 0~7	1TX diversity	1RX diversity
802.11ac (VHT20)	MCS 0~8, Nss=1	1TX diversity	1RX diversity
802.11ac (VHT40)	MCS 0~9, Nss=1	1TX diversity	1RX diversity
802.11ac (VHT80)	MCS 0~9, Nss=1	1TX diversity	1RX diversity

Note:

1. The modulation and bandwidth are similar for 802.11n mode for 20MHz (40MHz) and 802.11ac mode for 20MHz (40MHz), therefore investigated worst case to representative mode in test report. (Final test mode refer section 3.2.1)

5. The above EUT information is declared by manufacturer and for more detailed features description, please refer to the manufacturer's specifications or user's manual.



### 3.2 Description of Test Modes

#### FOR 5180 ~ 5240MHz

4 channels are provided for 802.11a, 802.11n (HT20), 802.11ac (VHT20):

Channel	Frequency	Channel	Frequency
36	5180 MHz	44	5220 MHz
40	5200 MHz	48	5240 MHz

2 channels are provided for 802.11n (HT40), 802.11ac (VHT40):

Channel	Frequency	Channel	Frequency
38	5190 MHz	46	5230 MHz

1 channel is provided for 802.11ac (VHT80):

Channel	Frequency
42	5210MHz

#### FOR 5745 ~ 5825MHz:

5 channels are provided for 802.11a, 802.11n (HT20), 802.11ac (VHT20):

Channel	Frequency	Channel	Frequency
149	5745MHz	161	5805MHz
153	5765MHz	165	5825MHz
157	5785MHz		

2 channels are provided for 802.11n (HT40), 802.11ac (VHT40):

Channel	Frequency	Channel	Frequency
151	5755MHz	159	5795MHz

1 channel is provided for 802.11ac (VHT80):

Channel	Frequency
155	5775MHz

### 3.2.1 Test Mode Applicability and Tested Channel Detail

EUT Configure Mode	Applicable To				Description
	RE $\geq$ 1G	RE $<$ 1G	PLC	APCM	
1	√	√	√	√	EUT+ PIFA antenna (Power from Adapter)
2	-	-	√	-	EUT+ PIFA antenna (Power from Laptop)
3	√	-	-	-	EUT+ Monopole antenna (Power from Adapter)

Where **RE $\geq$ 1G**: Radiated Emission above 1GHz      **RE $<$ 1G**: Radiated Emission below 1GHz  
**PLC**: Power Line Conducted Emission      **APCM**: Antenna Port Conducted Measurement

**NOTE:**

1. The EUT had been pre-tested on the positioned of each 2 axis. The worst case was found when positioned on **Y-plane**.
2. "-" means no effect.

#### **Radiated Emission Test (Above 1GHz):**

- Pre-Scan has been conducted to determine the worst-case mode from all possible combinations between available modulations, data rates and antenna ports (if EUT with antenna diversity architecture).
- Following channel(s) was (were) selected for the final test as listed below.

Mode	FREQ. Band (MHz)	Available Channel	Tested Channel	Modulation Technology	Modulation Type	Data Rate (Mbps)
802.11a	5180-5240	36 to 48	36, 40, 48	OFDM	BPSK	6
802.11ac (VHT20)		36 to 48	36, 40, 48	OFDM	BPSK	6.5
802.11ac (VHT40)		38 to 46	38, 46	OFDM	BPSK	13.5
802.11ac (VHT80)		42	42	OFDM	BPSK	29.3
802.11a	5745-5825	149 to 165	149, 157, 165	OFDM	BPSK	6
802.11ac (VHT20)		149 to 165	149, 157, 165	OFDM	BPSK	6.5
802.11ac (VHT40)		151 to 159	151, 159	OFDM	BPSK	13.5
802.11ac (VHT80)		155	155	OFDM	BPSK	29.3

#### **Radiated Emission Test (Below 1GHz):**

- Pre-Scan has been conducted to determine the worst-case mode from all possible combinations between available modulations, data rates and antenna ports (if EUT with antenna diversity architecture).
- Following channel(s) was (were) selected for the final test as listed below.

Mode	FREQ. Band (MHz)	Available Channel	Tested Channel	Modulation Technology	Modulation Type	Data Rate (Mbps)
802.11a	5180-5240 5745-5825	36 to 48 149 to 165	157	OFDM	BPSK	6

### Power Line Conducted Emission Test:

- Pre-Scan has been conducted to determine the worst-case mode from all possible combinations between available modulations, data rates and antenna ports (if EUT with antenna diversity architecture).
- Following channel(s) was (were) selected for the final test as listed below.

Mode	FREQ. Band (MHz)	Available Channel	Tested Channel	Modulation Technology	Modulation Type	Data Rate (Mbps)
802.11a	5180-5240 5745-5825	36 to 48 149 to 165	157	OFDM	BPSK	6

### Antenna Port Conducted Measurement:

- This item includes all test value of each mode, but only includes spectrum plot of worst value of each mode.
- Pre-Scan has been conducted to determine the worst-case mode from all possible combinations between available modulations, data rates and antenna ports (if EUT with antenna diversity architecture).
- Following channel(s) was (were) selected for the final test as listed below.

Mode	FREQ. Band (MHz)	Available Channel	Tested Channel	Modulation Technology	Modulation Type	Data Rate (Mbps)
802.11a	5180-5240	36 to 48	36, 40, 48	OFDM	BPSK	6
802.11ac (VHT20)		36 to 48	36, 40, 48	OFDM	BPSK	6.5
802.11ac (VHT40)		38 to 46	38, 46	OFDM	BPSK	13.5
802.11ac (VHT80)		42	42	OFDM	BPSK	29.3
802.11a	5745-5825	149 to 165	149, 157, 165	OFDM	BPSK	6
802.11ac (VHT20)		149 to 165	149, 157, 165	OFDM	BPSK	6.5
802.11ac (VHT40)		151 to 159	151, 159	OFDM	BPSK	13.5
802.11ac (VHT80)		155	155	OFDM	BPSK	29.3

### Test Condition:

Applicable To	Environmental Conditions	Input Power	Tested By
RE $\geq$ 1G	24deg. C, 69%RH	120Vac, 60Hz	Chris Lin
RE $<$ 1G	25deg. C, 67%RH	120Vac, 60Hz	Rey Chen
PLC	24deg. C, 68%RH	120Vac, 60Hz	Andy Ho
APCM	23deg. C, 60%RH	120Vac, 60Hz	Anderson Chen

### 3.3 Duty Cycle of Test Signal

If duty cycle of test signal is  $\geq 98\%$ , duty factor is not required.

If duty cycle of test signal is  $< 98\%$ , duty factor shall be considered.

**802.11a**: Duty cycle =  $21.507 \text{ ms} / 21.607 \text{ ms} = 0.995$

**802.11ac (VHT20)**: Duty cycle =  $19.875 \text{ ms} / 19.975 \text{ ms} = 0.995$

**802.11ac (VHT40)**: Duty cycle =  $9.541 \text{ ms} / 9.641 \text{ ms} = 0.99$

**802.11ac (VHT80)**: Duty cycle =  $4.427 \text{ ms} / 4.537 \text{ ms} = 0.976$ , Duty factor =  $10 * \log(1/0.976) = 0.11$

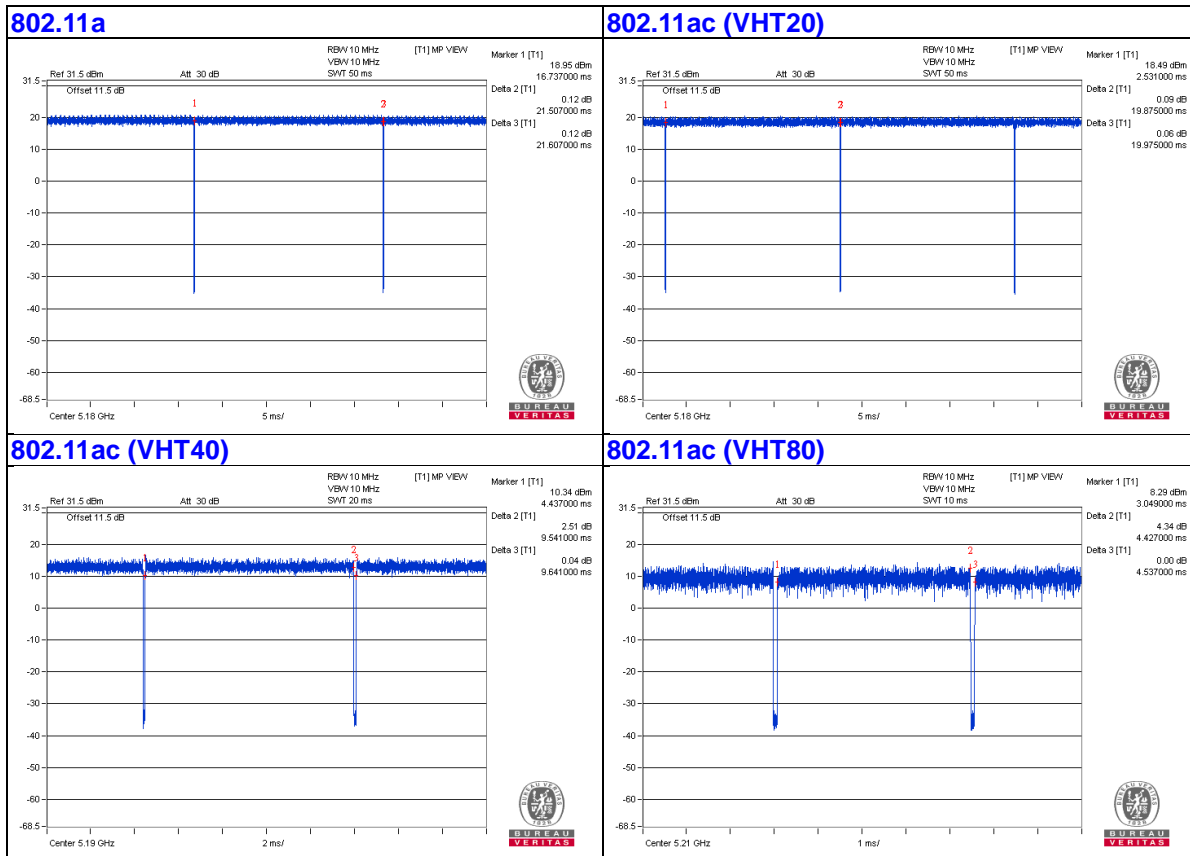

### 3.4 Description of Support Units

The EUT has been tested as an independent unit together with other necessary accessories or support units. The following support units or accessories were used to form a representative test configuration during the tests.

ID	Product	Brand	Model No.	Serial No.	FCC ID	Remarks
A.	Laptop	DELL	PP32LA	DSL32S	FCC DoC	Provided by Lab

Note:

1. All power cords of the above support units are non-shielded (1.8m).

ID	Descriptions	Qty.	Length (m)	Shielding (Yes/No)	Cores (Qty.)	Remarks
1.	Micro USB Cable	1	3	No	0	Supplied by client

### 3.4.1 Configuration of System under Test

#### Adapter mode

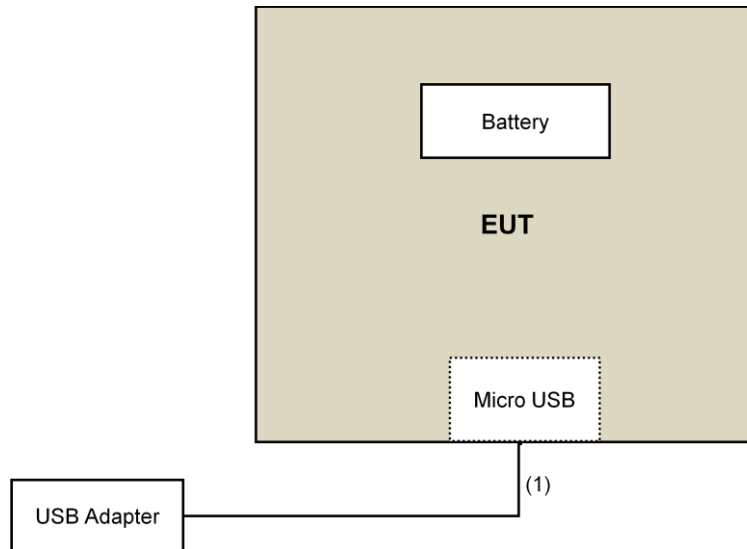

#### Laptop mode

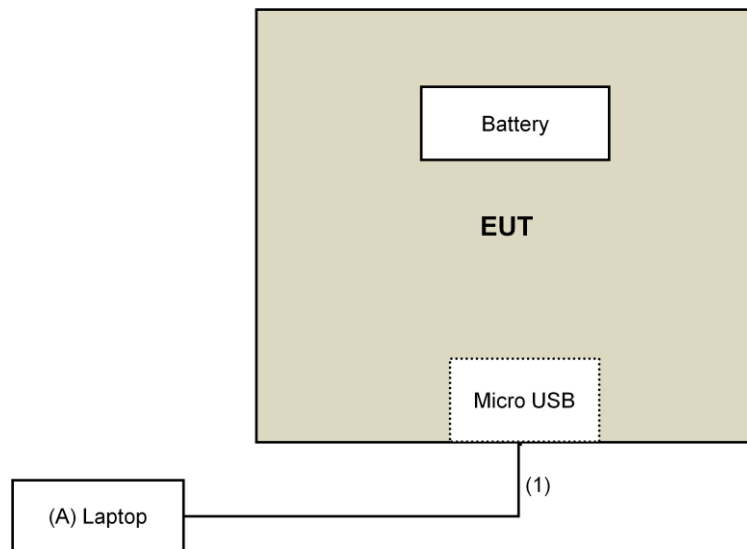

### 3.5 General Description of Applied Standard

The EUT is a RF Product. According to the specifications of the manufacturer, it must comply with the requirements of the following standards:

**FCC Part 15, Subpart E (15.407)**  
**KDB 789033 D02 General UNII Test Procedure New Rules v01r03**  
**ANSI C63.10-2013**

All test items have been performed and recorded as per the above standards.

**NOTE:** The EUT has been verified to comply with the requirements of FCC Part 15, Subpart B, Class B (DoC). The test report has been issued separately.

## 4 Test Types and Results

### 4.1 Radiated Emission and Bandedge Measurement

#### 4.1.1 Limits of Radiated Emission and Bandedge Measurement

Radiated emissions which fall in the restricted bands must comply with the radiated emission limits specified as below table.

Frequencies (MHz)	Field Strength (microvolts/meter)	Measurement Distance (meters)
0.009 ~ 0.490	2400/F(kHz)	300
0.490 ~ 1.705	24000/F(kHz)	30
1.705 ~ 30.0	30	30
30 ~ 88	100	3
88 ~ 216	150	3
216 ~ 960	200	3
Above 960	500	3

#### NOTE:

1. The lower limit shall apply at the transition frequencies.
2. Emission level (dBuV/m) = 20 log Emission level (uV/m).
3. For frequencies above 1000MHz, the field strength limits are based on average detector, however, the peak field strength of any emission shall not exceed the maximum permitted average limits, specified above by more than 20dB under any condition of modulation.

Limits of unwanted emission out of the restricted bands

Applicable To		Limit	
789033 D02 General UNII Test Procedure New Rules v01r03		Field Strength at 3m	
		PK:74 (dBuV/m)	AV:54 (dBuV/m)
Frequency Band	Applicable To	EIRP Limit	Equivalent Field Strength at 3m
5150~5250 MHz	15.407(b)(1)	PK:-27 (dBm/MHz)	PK:68.2(dBuV/m)
5250~5350 MHz	15.407(b)(2)		
5470~5725 MHz	15.407(b)(3)		
5725~5850 MHz	<input checked="" type="checkbox"/> 15.407(b)(4)(i)	PK:-27 (dBm/MHz) <sup>*1</sup> PK:10 (dBm/MHz) <sup>*2</sup> PK:15.6 (dBm/MHz) <sup>*3</sup> PK:27 (dBm/MHz) <sup>*4</sup>	PK: 68.2(dBuV/m) <sup>*1</sup> PK:105.2 (dBuV/m) <sup>*2</sup> PK: 110.8(dBuV/m) <sup>*3</sup> PK:122.2 (dBuV/m) <sup>*4</sup>
	<input type="checkbox"/> 15.407(b)(4)(ii)	Emission limits in section 15.247(d)	
<sup>*1</sup> beyond 75 MHz or more above of the band edge.		<sup>*2</sup> below the band edge increasing linearly to 10 dBm/MHz at 25 MHz above.	
<sup>*3</sup> below the band edge increasing linearly to a level of 15.6 dBm/MHz at 5 MHz above.		<sup>*4</sup> from 5 MHz above or below the band edge increasing linearly to a level of 27 dBm/MHz at the band edge.	

#### Note:

The following formula is used to convert the equipment isotropic radiated power (eirp) to field strength:

$$E = \frac{1000000\sqrt{30P}}{3} \mu\text{V/m, where P is the eirp (Watts).}$$



#### 4.1.2 Test Instruments

For Below 1GHz test:

DESCRIPTION & MANUFACTURER	MODEL NO.	SERIAL NO.	CALIBRATED DATE	CALIBRATED UNTIL
Test Receiver Agilent	N9038A	MY50010156	Aug. 18, 2016	Aug. 17, 2017
Pre-Amplifier <sup>(*)</sup> EMCI	EMC001340	980142	Jan. 20, 2016	Jan. 19, 2018
Loop Antenna <sup>(*)</sup> Electro-Metrics	EM-6879	264	Dec. 16, 2016	Dec. 15, 2018
RF Cable	NA	LOOPCAB-001 LOOPCAB-002	Jan. 17, 2017	Jan. 16, 2018
Pre-Amplifier Mini-Circuits	ZFL-1000VH2 B	AMP-ZFL-05	May 07, 2016	May 06, 2017
Trilog Broadband Antenna SCHWARZBECK	VULB 9168	9168-361	Dec. 29, 2016	Dec. 28, 2017
RF Cable	8D	966-3-1 966-3-2 966-3-3	Apr. 02, 2016	Apr. 01, 2017
Fixed attenuator Mini-Circuits	UNAT-5+	PAD-3m-3-01	Oct. 05, 2016	Oct. 04, 2017
Software	ADT_Radiated _V8.7.08	NA	NA	NA
Antenna Tower & Turn Table Max-Full	MF-7802	MF780208406	NA	NA

**Note:**

1. The calibration interval of the above test instruments is 12 months and the calibrations are traceable to NML/ROC and NIST/USA.
2. \*The calibration interval of the above test instruments is 24 months and the calibrations are traceable to NML/ROC and NIST/USA.
3. The test was performed in 966 Chamber No. 3.
4. The FCC Site Registration No. is 147459
5. The CANADA Site Registration No. is 20331-1
- 6 Loop antenna was used for all emissions below 30 MHz.
7. Tested Date: Mar. 28, 2017

For other test:

DESCRIPTION & MANUFACTURER	MODEL NO.	SERIAL NO.	CALIBRATED DATE	CALIBRATED UNTIL
Test Receiver Agilent	N9038A	MY50010156	Aug. 18, 2016	Aug. 17, 2017
Horn_Antenna SCHWARZBECK	BBHA9120-D	9120D-406	Dec. 28, 2016	Dec. 27, 2017
Pre-Amplifier EMCI	EMC12630SE	980384	Feb. 02, 2017	Feb. 01, 2018
RF Cable	EMC104-SM-SM-1200 EMC104-SM-SM-2000 EMC104-SM-SM-5000	160922 150317 150322	Feb. 02, 2017 Mar. 29, 2017 Mar. 29, 2017	Feb. 01, 2018 Mar. 28, 2018 Mar. 28, 2018
Spectrum Analyzer Keysight	N9030A	MY54490520	July 29, 2016	July 28, 2017
Pre-Amplifier EMCI	EMC184045SE	980386	Feb. 02, 2017	Feb. 01, 2018
Horn_Antenna SCHWARZBECK	BBHA 9170	BBHA9170608	Dec. 15, 2016	Dec. 14, 2017
RF Cable	SUCOFLEX 102	36432/2 36433/2	Jan. 15, 2017	Jan. 14, 2018
Software	ADT_Radiated_V8.7.08	NA	NA	NA
Antenna Tower & Turn Table Max-Full	MF-7802	MF780208406	NA	NA
Boresight Antenna Fixture	FBA-01	FBA-SIP01	NA	NA
Spectrum Analyzer R&S	FSv40	100964	June 28, 2016	June 27, 2017
Power meter Anritsu	ML2495A	1014008	May 5, 2016	May 4, 2017
Power sensor Anritsu	MA2411B	0917122	May 5, 2016	May 4, 2017
AC Power Source Extech Electronics	6205	1440452	NA	NA
Temperature & Humidity Chamber Giant Force	GTH-150-40-SP-AR	MAA0812-008	Jan. 11, 2017	Jan. 10, 2018
Digital Multimeter FLUKE	87III	73680266	Nov. 10, 2016	Nov. 09, 2017

**Note:**

1. The calibration interval of the above test instruments is 12 months and the calibrations are traceable to NML/ROC and NIST/USA.
2. The test was performed in 966 Chamber No. 3.
3. The FCC Site Registration No. is 147459
4. The CANADA Site Registration No. is 20331-1
5. Tested Date: Apr. 04 to 07, 2017

#### 4.1.3 Test Procedure

##### **For Radiated emission below 30MHz**

- a. The EUT was placed on the top of a rotating table 0.8 meters above the ground at a 3 meter chamber room. The table was rotated 360 degrees to determine the position of the highest radiation.
- b. The EUT was set 3 meters away from the interference-receiving antenna, which was mounted on the top of a variable-height antenna tower.
- c. Both X and Y axes of the antenna are set to make the measurement.
- d. For each suspected emission, the EUT was arranged to its worst case and the rotatable table was turned from 0 degrees to 360 degrees to find the maximum reading.
- e. The test-receiver system was set to Quasi-Peak Detect Function and Specified Bandwidth with Maximum Hold Mode.

##### **NOTE:**

1. The resolution bandwidth and video bandwidth of test receiver/spectrum analyzer is 9kHz at frequency below 30MHz.

##### **For Radiated emission above 30MHz**

- a. The EUT was placed on the top of a rotating table 0.8 meters (for 30MHz ~ 1GHz) / 1.5 meters (for above 1GHz) above the ground at 3 meter chamber room for test. The table was rotated 360 degrees to determine the position of the highest radiation.
- b. The EUT was set 3 meters away from the interference-receiving antenna, which was mounted on the top of a variable-height antenna tower.
- c. The height of antenna is varied from one meter to four meters above the ground to determine the maximum value of the field strength. Both horizontal and vertical polarizations of the antenna are set to make the measurement.
- d. For each suspected emission, the EUT was arranged to its worst case and then the antenna was tuned to heights from 1 meter to 4 meters and the rotatable table was turned from 0 degrees to 360 degrees to find the maximum reading.
- e. The test-receiver system was set to quasi-peak detect function and specified bandwidth with maximum hold mode when the test frequency is below 1 GHz.
- f. The test-receiver system was set to peak and average detect function and specified bandwidth with maximum hold mode when the test frequency is above 1 GHz. If the peak reading value also meets average limit, measurement with the average detector is unnecessary.

##### **Note:**

1. The resolution bandwidth and video bandwidth of test receiver/spectrum analyzer is 120kHz for Quasi-peak detection (QP) at frequency below 1GHz.
2. The resolution bandwidth of test receiver/spectrum analyzer is 1 MHz and the video bandwidth is 3 MHz for Peak detection (PK) at frequency above 1GHz.
3. The resolution bandwidth of test receiver/spectrum analyzer is 1MHz and the video bandwidth is  $\geq 1/T$  (Duty cycle < 98%) or 10Hz (Duty cycle  $\geq 98\%$ ) for Average detection (AV) at frequency above 1GHz.
4. All modes of operation were investigated and the worst-case emissions are reported.

#### 4.1.4 Deviation from Test Standard

No deviation.

#### 4.1.5 Test Setup

##### For Radiated emission below 30MHz

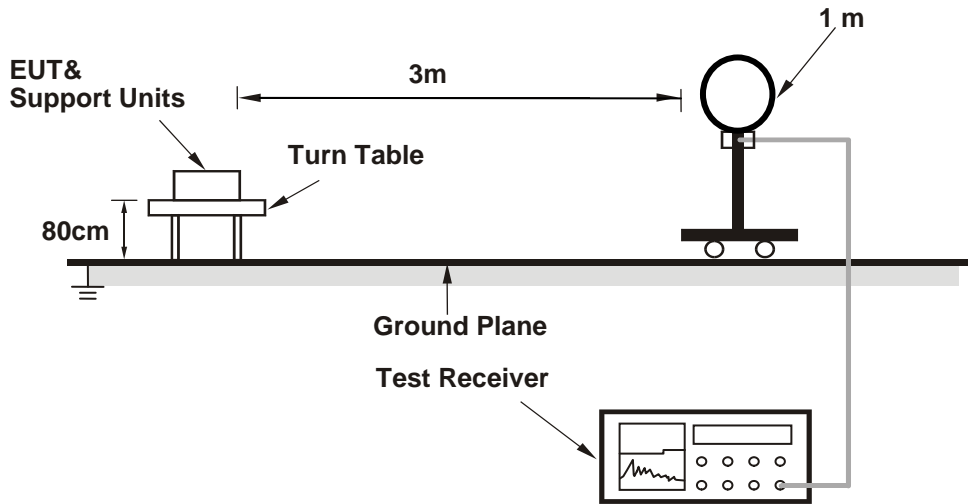

##### For Radiated emission 30MHz to 1GHz

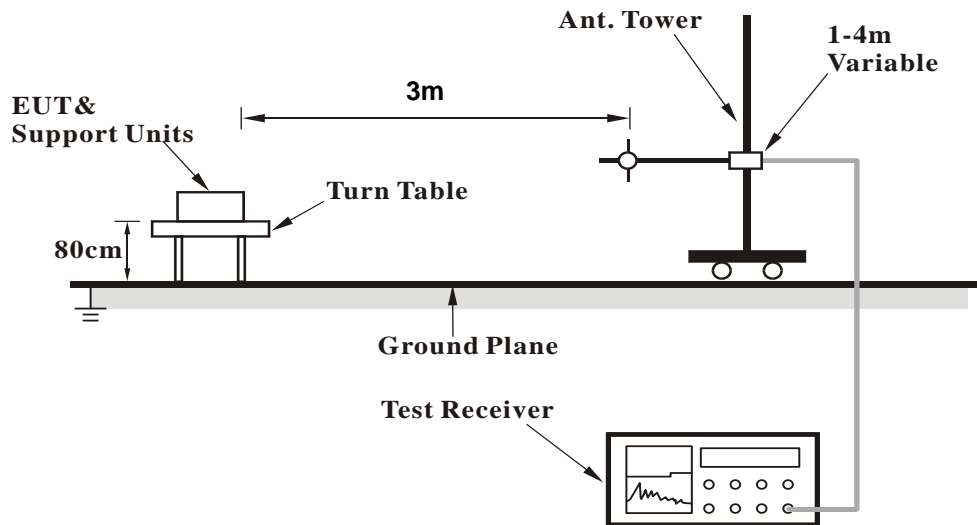

### For Radiated emission above 1GHz

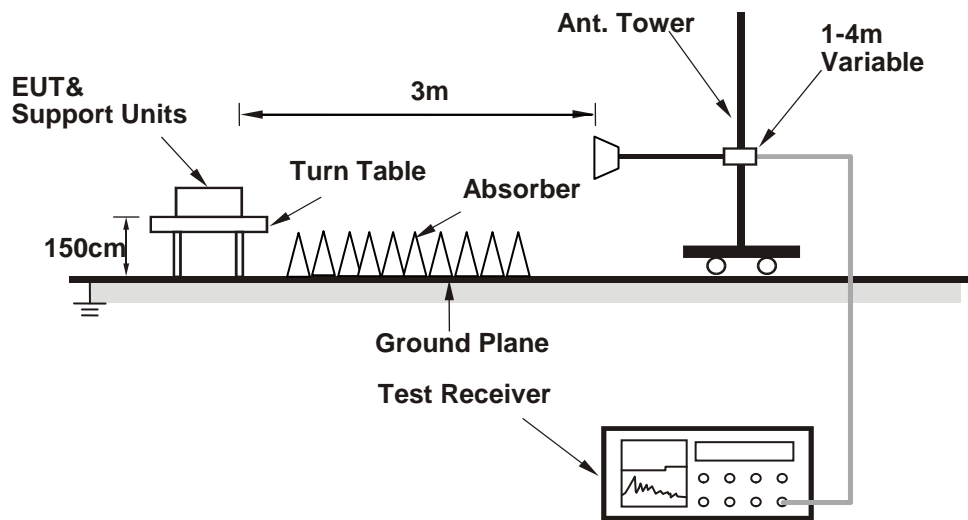

For the actual test configuration, please refer to the attached file (Test Setup Photo).

#### 4.1.6 EUT Operating Condition

- a. Connected the EUT with the Notebook Computer which is placed on remote site.
- b. Controlling software (QRCT.EXE V3.0.219.0) has been activated to set the EUT on specific status.

## 4.1.7 Test Results (Mode 1)

## Above 1GHz Data:

## PIFA antenna

## 802.11a

<b>CHANNEL</b>	TX Channel 36	<b>DETECTOR FUNCTION</b>	Peak (PK)
<b>FREQUENCY RANGE</b>	1GHz ~ 40GHz		Average (AV)

**ANTENNA POLARITY & TEST DISTANCE: HORIZONTAL AT 3 M**

NO.	FREQ. (MHz)	EMISSION LEVEL (dBuV/m)	LIMIT (dBuV/m)	MARGIN (dB)	ANTENNA HEIGHT (m)	TABLE ANGLE (Degree)	RAW VALUE (dBuV)	CORRECTION FACTOR (dB/m)
1	5150.00	70.3 PK	74.0	-3.7	3.25 H	292	67.3	3.0
2	5150.00	53.9 AV	54.0	-0.1	3.25 H	292	50.9	3.0
3	*5180.00	110.6 PK			3.25 H	292	107.6	3.0
4	*5180.00	100.4 AV			3.25 H	292	97.4	3.0
5	#10360.00	60.7 PK	74.0	-13.3	2.58 H	88	48.7	12.0
6	#10360.00	48.7 AV	54.0	-5.3	2.58 H	88	36.7	12.0

**ANTENNA POLARITY & TEST DISTANCE: VERTICAL AT 3 M**

NO.	FREQ. (MHz)	EMISSION LEVEL (dBuV/m)	LIMIT (dBuV/m)	MARGIN (dB)	ANTENNA HEIGHT (m)	TABLE ANGLE (Degree)	RAW VALUE (dBuV)	CORRECTION FACTOR (dB/m)
1	5150.00	64.5 PK	74.0	-9.5	2.23 V	302	61.5	3.0
2	5150.00	48.6 AV	54.0	-5.4	2.23 V	302	45.6	3.0
3	*5180.00	104.6 PK			2.25 V	298	101.6	3.0
4	*5180.00	94.7 AV			2.25 V	298	91.7	3.0
5	#10360.00	54.6 PK	74.0	-19.4	2.33 V	292	42.6	12.0
6	#10360.00	43.5 AV	54.0	-10.5	2.33 V	292	31.5	12.0

**REMARKS:**

1. Emission Level(dBuV/m) = Raw Value(dBuV) + Correction Factor(dB/m)
2. Correction Factor(dB/m) = Antenna Factor(dB/m) + Cable Factor(dB) – Pre-Amplifier Factor(dB)
3. The other emission levels were very low against the limit.
4. Margin value = Emission Level – Limit value
5. " \* ": Fundamental frequency.
6. " # ": The radiated frequency is out of the restricted band.

<b>CHANNEL</b>	TX Channel 40	<b>DETECTOR FUNCTION</b>	Peak (PK)
<b>FREQUENCY RANGE</b>	1GHz ~ 40GHz		Average (AV)

**ANTENNA POLARITY & TEST DISTANCE: HORIZONTAL AT 3 M**

NO.	FREQ. (MHz)	EMISSION LEVEL (dBuV/m)	LIMIT (dBuV/m)	MARGIN (dB)	ANTENNA HEIGHT (m)	TABLE ANGLE (Degree)	RAW VALUE (dBuV)	CORRECTION FACTOR (dB/m)
1	*5200.00	113.5 PK			3.17 H	281	110.5	3.0
2	*5200.00	102.9 AV			3.17 H	281	99.9	3.0
3	#10400.00	60.9 PK	74.0	-13.1	2.38 H	83	49.0	11.9
4	#10400.00	48.1 AV	54.0	-5.9	2.38 H	83	36.2	11.9

**ANTENNA POLARITY & TEST DISTANCE: VERTICAL AT 3 M**

NO.	FREQ. (MHz)	EMISSION LEVEL (dBuV/m)	LIMIT (dBuV/m)	MARGIN (dB)	ANTENNA HEIGHT (m)	TABLE ANGLE (Degree)	RAW VALUE (dBuV)	CORRECTION FACTOR (dB/m)
1	*5200.00	107.1 PK			2.24 V	301	104.1	3.0
2	*5200.00	97.2 AV			2.24 V	301	94.2	3.0
3	#10400.00	54.7 PK	74.0	-19.3	2.37 V	287	42.8	11.9
4	#10400.00	43.5 AV	54.0	-10.5	2.37 V	287	31.6	11.9

**REMARKS:**

1. Emission Level(dBuV/m) = Raw Value(dBuV) + Correction Factor(dB/m)
2. Correction Factor(dB/m) = Antenna Factor(dB/m) + Cable Factor(dB) – Pre-Amplifier Factor(dB)
3. The other emission levels were very low against the limit.
4. Margin value = Emission Level – Limit value
5. " \* ": Fundamental frequency.
6. " # ": The radiated frequency is out of the restricted band.

<b>CHANNEL</b>	TX Channel 48	<b>DETECTOR FUNCTION</b>	Peak (PK)
<b>FREQUENCY RANGE</b>	1GHz ~ 40GHz		Average (AV)

**ANTENNA POLARITY & TEST DISTANCE: HORIZONTAL AT 3 M**

NO.	FREQ. (MHz)	EMISSION LEVEL (dBuV/m)	LIMIT (dBuV/m)	MARGIN (dB)	ANTENNA HEIGHT (m)	TABLE ANGLE (Degree)	RAW VALUE (dBuV)	CORRECTION FACTOR (dB/m)
1	*5240.00	114.1 PK			3.09 H	303	111.0	3.1
2	*5240.00	103.9 AV			3.09 H	303	100.8	3.1
3	5350.00	58.1 PK	74.0	-15.9	3.09 H	303	54.8	3.3
4	5350.00	45.1 AV	54.0	-8.9	3.09 H	303	41.8	3.3
5	#10480.00	60.5 PK	74.0	-13.5	2.09 H	77	48.5	12.0
6	#10480.00	48.2 AV	54.0	-5.8	2.09 H	77	36.2	12.0

**ANTENNA POLARITY & TEST DISTANCE: VERTICAL AT 3 M**

NO.	FREQ. (MHz)	EMISSION LEVEL (dBuV/m)	LIMIT (dBuV/m)	MARGIN (dB)	ANTENNA HEIGHT (m)	TABLE ANGLE (Degree)	RAW VALUE (dBuV)	CORRECTION FACTOR (dB/m)
1	*5240.00	107.4 PK			2.25 V	298	104.3	3.1
2	*5240.00	98.5 AV			2.25 V	298	95.4	3.1
3	5350.00	52.3 PK	74.0	-21.7	2.24 V	275	49.0	3.3
4	5350.00	40.1 AV	54.0	-13.9	2.24 V	275	36.8	3.3
5	#10480.00	54.4 PK	74.0	-19.6	2.33 V	277	42.4	12.0
6	#10480.00	43.1 AV	54.0	-10.9	2.33 V	277	31.1	12.0

**REMARKS:**

1. Emission Level(dBuV/m) = Raw Value(dBuV) + Correction Factor(dB/m)
2. Correction Factor(dB/m) = Antenna Factor(dB/m) + Cable Factor(dB) – Pre-Amplifier Factor(dB)
3. The other emission levels were very low against the limit.
4. Margin value = Emission Level – Limit value
5. " \* ": Fundamental frequency.
6. " # ": The radiated frequency is out of the restricted band.



<b>CHANNEL</b>	TX Channel 149	<b>DETECTOR FUNCTION</b>	Peak (PK)
<b>FREQUENCY RANGE</b>	1GHz ~ 40GHz		Average (AV)

**ANTENNA POLARITY & TEST DISTANCE: HORIZONTAL AT 3 M**

NO.	FREQ. (MHz)	EMISSION LEVEL (dBuV/m)	LIMIT (dBuV/m)	MARGIN (dB)	ANTENNA HEIGHT (m)	TABLE ANGLE (Degree)	RAW VALUE (dBuV)	CORRECTION FACTOR (dB/m)
1	#5647.20	59.4 PK	68.2	-8.8	2.30 H	281	52.3	7.1
2	*5745.00	114.1 PK			2.30 H	281	110.4	3.7
3	*5745.00	103.4 AV			2.30 H	281	99.7	3.7
4	#5972.00	59.4 PK	68.2	-8.8	2.30 H	281	51.5	7.9
5	11490.00	61.8 PK	74.0	-12.2	1.07 H	41	49.5	12.3
6	11490.00	49.7 AV	54.0	-4.3	1.07 H	41	37.4	12.3

**ANTENNA POLARITY & TEST DISTANCE: VERTICAL AT 3 M**

NO.	FREQ. (MHz)	EMISSION LEVEL (dBuV/m)	LIMIT (dBuV/m)	MARGIN (dB)	ANTENNA HEIGHT (m)	TABLE ANGLE (Degree)	RAW VALUE (dBuV)	CORRECTION FACTOR (dB/m)
1	#5646.43	58.1 PK	68.2	-10.1	1.02 V	352	54.4	3.7
2	*5745.00	108.0 PK			1.02 V	352	104.3	3.7
3	*5745.00	97.6 AV			1.02 V	352	93.9	3.7
4	#5989.85	57.8 PK	68.2	-10.4	1.02 V	352	53.8	4.0
5	11490.00	55.6 PK	74.0	-18.4	2.19 V	290	43.3	12.3
6	11490.00	44.4 AV	54.0	-9.6	2.19 V	290	32.1	12.3

**REMARKS:**

1. Emission Level(dBuV/m) = Raw Value(dBuV) + Correction Factor(dB/m)
2. Correction Factor(dB/m) = Antenna Factor(dB/m) + Cable Factor(dB) – Pre-Amplifier Factor(dB)
3. The other emission levels were very low against the limit.
4. Margin value = Emission Level – Limit value
5. " \* ": Fundamental frequency.
6. " # ": The radiated frequency is out of the restricted band.

<b>CHANNEL</b>	TX Channel 157	<b>DETECTOR FUNCTION</b>	Peak (PK)
<b>FREQUENCY RANGE</b>	1GHz ~ 40GHz		Average (AV)

**ANTENNA POLARITY & TEST DISTANCE: HORIZONTAL AT 3 M**

NO.	FREQ. (MHz)	EMISSION LEVEL (dBuV/m)	LIMIT (dBuV/m)	MARGIN (dB)	ANTENNA HEIGHT (m)	TABLE ANGLE (Degree)	RAW VALUE (dBuV)	CORRECTION FACTOR (dB/m)
1	#5633.60	58.0 PK	68.2	-10.2	2.42 H	280	51.0	7.0
2	*5785.00	113.6 PK			2.42 H	280	109.9	3.7
3	*5785.00	102.6 AV			2.42 H	280	98.9	3.7
4	#5928.00	59.5 PK	68.2	-8.7	2.42 H	280	51.7	7.8
5	11570.00	61.3 PK	74.0	-12.7	1.25 H	74	49.1	12.2
6	11570.00	49.5 AV	54.0	-4.5	1.25 H	74	37.3	12.2

**ANTENNA POLARITY & TEST DISTANCE: VERTICAL AT 3 M**

NO.	FREQ. (MHz)	EMISSION LEVEL (dBuV/m)	LIMIT (dBuV/m)	MARGIN (dB)	ANTENNA HEIGHT (m)	TABLE ANGLE (Degree)	RAW VALUE (dBuV)	CORRECTION FACTOR (dB/m)
1	#5567.74	51.9 PK	68.2	-16.3	1.00 V	268	48.4	3.5
2	*5785.00	109.2 PK			1.00 V	268	105.5	3.7
3	*5785.00	98.2 AV			1.00 V	268	94.5	3.7
4	#5931.51	50.8 PK	68.2	-17.4	1.00 V	268	46.8	4.0
5	11570.00	55.6 PK	74.0	-18.4	2.21 V	301	43.4	12.2
6	11570.00	44.4 AV	54.0	-9.6	2.21 V	301	32.2	12.2

**REMARKS:**

- Emission Level(dBuV/m) = Raw Value(dBuV) + Correction Factor(dB/m)
- Correction Factor(dB/m) = Antenna Factor(dB/m) + Cable Factor(dB) – Pre-Amplifier Factor(dB)
- The other emission levels were very low against the limit.
- Margin value = Emission Level – Limit value
- " \* ": Fundamental frequency.
- " # ": The radiated frequency is out of the restricted band.

<b>CHANNEL</b>	TX Channel 165	<b>DETECTOR FUNCTION</b>	Peak (PK)
<b>FREQUENCY RANGE</b>	1GHz ~ 40GHz		Average (AV)

**ANTENNA POLARITY & TEST DISTANCE: HORIZONTAL AT 3 M**

NO.	FREQ. (MHz)	EMISSION LEVEL (dBuV/m)	LIMIT (dBuV/m)	MARGIN (dB)	ANTENNA HEIGHT (m)	TABLE ANGLE (Degree)	RAW VALUE (dBuV)	CORRECTION FACTOR (dB/m)
1	#5647.20	59.4 PK	68.2	-8.8	2.29 H	292	52.3	7.1
2	*5825.00	114.6 PK			2.29 H	292	110.9	3.7
3	*5825.00	103.7 AV			2.29 H	292	100.0	3.7
4	#5948.00	60.0 PK	68.2	-8.2	2.29 H	292	52.2	7.8
5	11650.00	61.0 PK	74.0	-13.0	1.05 H	74	48.6	12.4
6	11650.00	48.9 AV	54.0	-5.1	1.05 H	74	36.5	12.4

**ANTENNA POLARITY & TEST DISTANCE: VERTICAL AT 3 M**

NO.	FREQ. (MHz)	EMISSION LEVEL (dBuV/m)	LIMIT (dBuV/m)	MARGIN (dB)	ANTENNA HEIGHT (m)	TABLE ANGLE (Degree)	RAW VALUE (dBuV)	CORRECTION FACTOR (dB/m)
1	#5551.64	57.3 PK	68.2	-10.9	1.03 V	255	53.8	3.5
2	*5825.00	108.5 PK			1.03 V	252	104.8	3.7
3	*5825.00	98.2 AV			1.03 V	252	94.5	3.7
4	#5941.59	57.4 PK	68.2	-10.8	1.03 V	255	53.4	4.0
5	11650.00	55.0 PK	74.0	-19.0	2.16 V	284	42.6	12.4
6	11650.00	44.0 AV	54.0	-10.0	2.16 V	284	31.6	12.4

**REMARKS:**

1. Emission Level(dBuV/m) = Raw Value(dBuV) + Correction Factor(dB/m)
2. Correction Factor(dB/m) = Antenna Factor(dB/m) + Cable Factor(dB) – Pre-Amplifier Factor(dB)
3. The other emission levels were very low against the limit.
4. Margin value = Emission Level – Limit value
5. " \* ": Fundamental frequency.
6. " # ": The radiated frequency is out of the restricted band.

**802.11ac (VHT20)**

<b>CHANNEL</b>	TX Channel 36	<b>DETECTOR FUNCTION</b>	Peak (PK)
<b>FREQUENCY RANGE</b>	1GHz ~ 40GHz		Average (AV)

**ANTENNA POLARITY & TEST DISTANCE: HORIZONTAL AT 3 M**

NO.	FREQ. (MHz)	EMISSION LEVEL (dBuV/m)	LIMIT (dBuV/m)	MARGIN (dB)	ANTENNA HEIGHT (m)	TABLE ANGLE (Degree)	RAW VALUE (dBuV)	CORRECTION FACTOR (dB/m)
1	5150.00	67.9 PK	74.0	-6.1	2.96 H	322	64.9	3.0
2	5150.00	53.4 AV	54.0	-0.6	2.96 H	322	50.4	3.0
3	*5180.00	110.3 PK			2.96 H	322	107.3	3.0
4	*5180.00	100.1 AV			2.96 H	322	97.1	3.0
5	#10360.00	59.4 PK	74.0	-14.6	1.07 H	48	47.4	12.0
6	#10360.00	47.8 AV	54.0	-6.2	1.07 H	48	35.8	12.0

**ANTENNA POLARITY & TEST DISTANCE: VERTICAL AT 3 M**

NO.	FREQ. (MHz)	EMISSION LEVEL (dBuV/m)	LIMIT (dBuV/m)	MARGIN (dB)	ANTENNA HEIGHT (m)	TABLE ANGLE (Degree)	RAW VALUE (dBuV)	CORRECTION FACTOR (dB/m)
1	5150.00	65.0 PK	74.0	-9.0	2.20 V	318	62.0	3.0
2	5150.00	49.0 AV	54.0	-5.0	2.20 V	318	46.0	3.0
3	*5180.00	104.6 PK			2.24 V	292	101.6	3.0
4	*5180.00	95.3 AV			2.24 V	292	92.3	3.0
5	#10360.00	54.5 PK	74.0	-19.5	2.37 V	298	42.5	12.0
6	#10360.00	43.1 AV	54.0	-10.9	2.37 V	298	31.1	12.0

**REMARKS:**

1. Emission Level(dBuV/m) = Raw Value(dBuV) + Correction Factor(dB/m)
2. Correction Factor(dB/m) = Antenna Factor(dB/m) + Cable Factor(dB) – Pre-Amplifier Factor(dB)
3. The other emission levels were very low against the limit.
4. Margin value = Emission Level – Limit value
5. " \* ": Fundamental frequency.
6. " # ": The radiated frequency is out of the restricted band.

<b>CHANNEL</b>	TX Channel 40	<b>DETECTOR FUNCTION</b>	Peak (PK)
<b>FREQUENCY RANGE</b>	1GHz ~ 40GHz		Average (AV)

**ANTENNA POLARITY & TEST DISTANCE: HORIZONTAL AT 3 M**

NO.	FREQ. (MHz)	EMISSION LEVEL (dBuV/m)	LIMIT (dBuV/m)	MARGIN (dB)	ANTENNA HEIGHT (m)	TABLE ANGLE (Degree)	RAW VALUE (dBuV)	CORRECTION FACTOR (dB/m)
1	*5200.00	110.8 PK			3.31 H	335	107.8	3.0
2	*5200.00	100.3 AV			3.31 H	335	97.3	3.0
3	#10400.00	60.8 PK	74.0	-13.2	1.07 H	44	48.9	11.9
4	#10400.00	48.1 AV	54.0	-5.9	1.07 H	44	36.2	11.9

**ANTENNA POLARITY & TEST DISTANCE: VERTICAL AT 3 M**

NO.	FREQ. (MHz)	EMISSION LEVEL (dBuV/m)	LIMIT (dBuV/m)	MARGIN (dB)	ANTENNA HEIGHT (m)	TABLE ANGLE (Degree)	RAW VALUE (dBuV)	CORRECTION FACTOR (dB/m)
1	*5200.00	104.6 PK			2.19 V	275	101.6	3.0
2	*5200.00	95.2 AV			2.19 V	275	92.2	3.0
3	#10400.00	54.7 PK	74.0	-19.3	2.36 V	286	42.8	11.9
4	#10400.00	43.7 AV	54.0	-10.3	2.36 V	286	31.8	11.9

**REMARKS:**

1. Emission Level(dBuV/m) = Raw Value(dBuV) + Correction Factor(dB/m)
2. Correction Factor(dB/m) = Antenna Factor(dB/m) + Cable Factor(dB) – Pre-Amplifier Factor(dB)
3. The other emission levels were very low against the limit.
4. Margin value = Emission Level – Limit value
5. " \* ": Fundamental frequency.
6. " # ": The radiated frequency is out of the restricted band.

<b>CHANNEL</b>	TX Channel 48	<b>DETECTOR FUNCTION</b>	Peak (PK)
<b>FREQUENCY RANGE</b>	1GHz ~ 40GHz		Average (AV)

**ANTENNA POLARITY & TEST DISTANCE: HORIZONTAL AT 3 M**

NO.	FREQ. (MHz)	EMISSION LEVEL (dBuV/m)	LIMIT (dBuV/m)	MARGIN (dB)	ANTENNA HEIGHT (m)	TABLE ANGLE (Degree)	RAW VALUE (dBuV)	CORRECTION FACTOR (dB/m)
1	*5240.00	113.3 PK			3.25 H	322	110.2	3.1
2	*5240.00	101.5 AV			3.25 H	322	98.4	3.1
3	5350.00	59.4 PK	74.0	-14.6	3.25 H	322	56.1	3.3
4	5350.00	47.0 AV	54.0	-7.0	3.25 H	322	43.7	3.3
5	#10480.00	60.0 PK	74.0	-14.0	1.47 H	87	48.0	12.0
6	#10480.00	48.1 AV	54.0	-5.9	1.47 H	87	36.1	12.0

**ANTENNA POLARITY & TEST DISTANCE: VERTICAL AT 3 M**

NO.	FREQ. (MHz)	EMISSION LEVEL (dBuV/m)	LIMIT (dBuV/m)	MARGIN (dB)	ANTENNA HEIGHT (m)	TABLE ANGLE (Degree)	RAW VALUE (dBuV)	CORRECTION FACTOR (dB/m)
1	*5240.00	107.2 PK			2.20 V	298	104.1	3.1
2	*5240.00	96.4 AV			2.20 V	298	93.3	3.1
3	5350.00	51.9 PK	74.0	-22.1	2.21 V	288	48.6	3.3
4	5350.00	39.7 AV	54.0	-14.3	2.21 V	288	36.4	3.3
5	#10480.00	54.4 PK	74.0	-19.6	2.29 V	287	42.4	12.0
6	#10480.00	43.6 AV	54.0	-10.4	2.29 V	287	31.6	12.0

**REMARKS:**

1. Emission Level(dBuV/m) = Raw Value(dBuV) + Correction Factor(dB/m)
2. Correction Factor(dB/m) = Antenna Factor(dB/m) + Cable Factor(dB) – Pre-Amplifier Factor(dB)
3. The other emission levels were very low against the limit.
4. Margin value = Emission Level – Limit value
5. " \* ": Fundamental frequency.
6. " # ": The radiated frequency is out of the restricted band.

<b>CHANNEL</b>	TX Channel 149	<b>DETECTOR FUNCTION</b>	Peak (PK)
<b>FREQUENCY RANGE</b>	1GHz ~ 40GHz		Average (AV)

**ANTENNA POLARITY & TEST DISTANCE: HORIZONTAL AT 3 M**

NO.	FREQ. (MHz)	EMISSION LEVEL (dBuV/m)	LIMIT (dBuV/m)	MARGIN (dB)	ANTENNA HEIGHT (m)	TABLE ANGLE (Degree)	RAW VALUE (dBuV)	CORRECTION FACTOR (dB/m)
1	#5626.40	59.4 PK	68.2	-8.8	2.25 H	298	52.4	7.0
2	*5745.00	114.1 PK			2.25 H	298	110.4	3.7
3	*5745.00	103.3 AV			2.25 H	298	99.6	3.7
4	#5988.80	59.8 PK	68.2	-8.4	2.25 H	298	51.9	7.9
5	11490.00	62.1 PK	74.0	-11.9	1.05 H	31	49.8	12.3
6	11490.00	49.7 AV	54.0	-4.3	1.05 H	31	37.4	12.3

**ANTENNA POLARITY & TEST DISTANCE: VERTICAL AT 3 M**

NO.	FREQ. (MHz)	EMISSION LEVEL (dBuV/m)	LIMIT (dBuV/m)	MARGIN (dB)	ANTENNA HEIGHT (m)	TABLE ANGLE (Degree)	RAW VALUE (dBuV)	CORRECTION FACTOR (dB/m)
1	#5641.60	56.9 PK	68.2	-11.3	1.00 V	315	53.2	3.7
2	*5745.00	107.7 PK			1.00 V	315	104.0	3.7
3	*5745.00	97.0 AV			1.00 V	315	93.3	3.7
4	#5954.24	56.7 PK	68.2	-11.5	1.00 V	315	52.7	4.0
5	11490.00	55.7 PK	74.0	-18.3	2.13 V	301	43.4	12.3
6	11490.00	44.3 AV	54.0	-9.7	2.13 V	301	32.0	12.3

**REMARKS:**

1. Emission Level(dBuV/m) = Raw Value(dBuV) + Correction Factor(dB/m)
2. Correction Factor(dB/m) = Antenna Factor(dB/m) + Cable Factor(dB) – Pre-Amplifier Factor(dB)
3. The other emission levels were very low against the limit.
4. Margin value = Emission Level – Limit value
5. " \* ": Fundamental frequency.
6. " # ": The radiated frequency is out of the restricted band.

<b>CHANNEL</b>	TX Channel 157	<b>DETECTOR FUNCTION</b>	Peak (PK)
<b>FREQUENCY RANGE</b>	1GHz ~ 40GHz		Average (AV)

**ANTENNA POLARITY & TEST DISTANCE: HORIZONTAL AT 3 M**

NO.	FREQ. (MHz)	EMISSION LEVEL (dBuV/m)	LIMIT (dBuV/m)	MARGIN (dB)	ANTENNA HEIGHT (m)	TABLE ANGLE (Degree)	RAW VALUE (dBuV)	CORRECTION FACTOR (dB/m)
1	#5601.60	58.7 PK	68.2	-9.5	2.34 H	296	51.8	6.9
2	*5785.00	114.8 PK			2.34 H	296	111.1	3.7
3	*5785.00	104.6 AV			2.34 H	296	100.9	3.7
4	#5982.40	60.3 PK	68.2	-7.9	2.34 H	296	52.4	7.9
5	11570.00	61.6 PK	74.0	-12.4	1.05 H	74	49.4	12.2
6	11570.00	50.0 AV	54.0	-4.0	1.05 H	74	37.8	12.2

**ANTENNA POLARITY & TEST DISTANCE: VERTICAL AT 3 M**

NO.	FREQ. (MHz)	EMISSION LEVEL (dBuV/m)	LIMIT (dBuV/m)	MARGIN (dB)	ANTENNA HEIGHT (m)	TABLE ANGLE (Degree)	RAW VALUE (dBuV)	CORRECTION FACTOR (dB/m)
1	#5580.36	56.6 PK	68.2	-11.6	1.00 V	313	53.1	3.5
2	*5785.00	108.7 PK			1.00 V	313	105.0	3.7
3	*5785.00	97.7 AV			1.00 V	313	94.0	3.7
4	#5939.44	56.8 PK	68.2	-11.4	1.00 V	313	52.8	4.0
5	11570.00	56.0 PK	74.0	-18.0	2.21 V	305	43.8	12.2
6	11570.00	44.7 AV	54.0	-9.3	2.21 V	305	32.5	12.2

**REMARKS:**

1. Emission Level(dBuV/m) = Raw Value(dBuV) + Correction Factor(dB/m)
2. Correction Factor(dB/m) = Antenna Factor(dB/m) + Cable Factor(dB) – Pre-Amplifier Factor(dB)
3. The other emission levels were very low against the limit.
4. Margin value = Emission Level – Limit value
5. " \* ": Fundamental frequency.
6. " # ": The radiated frequency is out of the restricted band.



<b>CHANNEL</b>	TX Channel 165	<b>DETECTOR FUNCTION</b>	Peak (PK)
<b>FREQUENCY RANGE</b>	1GHz ~ 40GHz		Average (AV)

**ANTENNA POLARITY & TEST DISTANCE: HORIZONTAL AT 3 M**

NO.	FREQ. (MHz)	EMISSION LEVEL (dBuV/m)	LIMIT (dBuV/m)	MARGIN (dB)	ANTENNA HEIGHT (m)	TABLE ANGLE (Degree)	RAW VALUE (dBuV)	CORRECTION FACTOR (dB/m)
1	#5628.80	57.8 PK	68.2	-10.4	2.40 H	281	50.8	7.0
2	*5825.00	115.0 PK			2.40 H	281	111.3	3.7
3	*5825.00	103.9 AV			2.40 H	281	100.2	3.7
4	#5959.20	60.0 PK	68.2	-8.2	2.40 H	281	52.1	7.9
5	11650.00	60.9 PK	74.0	-13.1	1.05 H	63	48.5	12.4
6	11650.00	48.8 AV	54.0	-5.2	1.05 H	63	36.4	12.4

**ANTENNA POLARITY & TEST DISTANCE: VERTICAL AT 3 M**

NO.	FREQ. (MHz)	EMISSION LEVEL (dBuV/m)	LIMIT (dBuV/m)	MARGIN (dB)	ANTENNA HEIGHT (m)	TABLE ANGLE (Degree)	RAW VALUE (dBuV)	CORRECTION FACTOR (dB/m)
1	#5644.12	57.8 PK	68.2	-10.4	1.00 V	314	54.1	3.7
2	*5825.00	108.3 PK			1.00 V	314	104.6	3.7
3	*5825.00	97.6 AV			1.00 V	314	93.9	3.7
4	#5990.85	56.9 PK	68.2	-11.3	1.00 V	314	52.9	4.0
5	11650.00	55.9 PK	74.0	-18.1	2.15 V	286	43.5	12.4
6	11650.00	44.6 AV	54.0	-9.4	2.15 V	286	32.2	12.4

**REMARKS:**

1. Emission Level(dBuV/m) = Raw Value(dBuV) + Correction Factor(dB/m)
2. Correction Factor(dB/m) = Antenna Factor(dB/m) + Cable Factor(dB) – Pre-Amplifier Factor(dB)
3. The other emission levels were very low against the limit.
4. Margin value = Emission Level – Limit value
5. " \* ": Fundamental frequency.
6. " # ": The radiated frequency is out of the restricted band.

**802.11ac (VHT40)**

<b>CHANNEL</b>	TX Channel 38	<b>DETECTOR FUNCTION</b>	Peak (PK)
<b>FREQUENCY RANGE</b>	1GHz ~ 40GHz		Average (AV)

**ANTENNA POLARITY & TEST DISTANCE: HORIZONTAL AT 3 M**

NO.	FREQ. (MHz)	EMISSION LEVEL (dBuV/m)	LIMIT (dBuV/m)	MARGIN (dB)	ANTENNA HEIGHT (m)	TABLE ANGLE (Degree)	RAW VALUE (dBuV)	CORRECTION FACTOR (dB/m)
1	5150.00	65.6 PK	74.0	-8.4	3.28 H	322	62.6	3.0
2	5150.00	53.5 AV	54.0	-0.5	3.28 H	322	50.5	3.0
3	*5190.00	103.4 PK			3.28 H	322	100.4	3.0
4	*5190.00	93.4 AV			3.28 H	322	90.4	3.0
5	#10380.00	59.6 PK	74.0	-14.4	1.47 H	48	47.6	12.0
6	#10380.00	47.4 AV	54.0	-6.6	1.47 H	48	35.4	12.0

**ANTENNA POLARITY & TEST DISTANCE: VERTICAL AT 3 M**

NO.	FREQ. (MHz)	EMISSION LEVEL (dBuV/m)	LIMIT (dBuV/m)	MARGIN (dB)	ANTENNA HEIGHT (m)	TABLE ANGLE (Degree)	RAW VALUE (dBuV)	CORRECTION FACTOR (dB/m)
1	5150.00	65.1 PK	74.0	-8.9	2.24 V	333	62.1	3.0
2	5150.00	49.2 AV	54.0	-4.8	2.24 V	333	46.2	3.0
3	*5190.00	98.8 PK			2.24 V	333	95.8	3.0
4	*5190.00	89.3 AV			2.24 V	333	86.3	3.0
5	#10380.00	54.8 PK	74.0	-19.2	2.36 V	293	42.8	12.0
6	#10380.00	43.8 AV	54.0	-10.2	2.36 V	293	31.8	12.0

**REMARKS:**

1. Emission Level(dBuV/m) = Raw Value(dBuV) + Correction Factor(dB/m)
2. Correction Factor(dB/m) = Antenna Factor(dB/m) + Cable Factor(dB) – Pre-Amplifier Factor(dB)
3. The other emission levels were very low against the limit.
4. Margin value = Emission Level – Limit value
5. " \* ": Fundamental frequency.
6. " # ": The radiated frequency is out of the restricted band.

<b>CHANNEL</b>	TX Channel 46	<b>DETECTOR FUNCTION</b>	Peak (PK)
<b>FREQUENCY RANGE</b>	1GHz ~ 40GHz		Average (AV)

**ANTENNA POLARITY & TEST DISTANCE: HORIZONTAL AT 3 M**

NO.	FREQ. (MHz)	EMISSION LEVEL (dBuV/m)	LIMIT (dBuV/m)	MARGIN (dB)	ANTENNA HEIGHT (m)	TABLE ANGLE (Degree)	RAW VALUE (dBuV)	CORRECTION FACTOR (dB/m)
1	*5230.00	109.8 PK			3.22 H	321	106.7	3.1
2	*5230.00	99.4 AV			3.22 H	321	96.3	3.1
3	5350.00	63.5 PK	74.0	-10.5	3.22 H	321	60.2	3.3
4	5350.00	48.9 AV	54.0	-5.1	3.22 H	321	45.6	3.3
5	#10460.00	59.9 PK	74.0	-14.1	1.47 H	85	48.0	11.9
6	#10460.00	47.6 AV	54.0	-6.4	1.47 H	85	35.7	11.9

**ANTENNA POLARITY & TEST DISTANCE: VERTICAL AT 3 M**

NO.	FREQ. (MHz)	EMISSION LEVEL (dBuV/m)	LIMIT (dBuV/m)	MARGIN (dB)	ANTENNA HEIGHT (m)	TABLE ANGLE (Degree)	RAW VALUE (dBuV)	CORRECTION FACTOR (dB/m)
1	*5230.00	104.4 PK			2.24 V	303	101.3	3.1
2	*5230.00	95.3 AV			2.24 V	303	92.2	3.1
3	5350.00	52.5 PK	74.0	-21.5	2.24 V	303	49.2	3.3
4	5350.00	40.1 AV	54.0	-13.9	2.24 V	303	36.8	3.3
5	#10460.00	54.2 PK	74.0	-19.8	2.35 V	281	42.3	11.9
6	#10460.00	43.0 AV	54.0	-11.0	2.35 V	281	31.1	11.9

**REMARKS:**

1. Emission Level(dBuV/m) = Raw Value(dBuV) + Correction Factor(dB/m)
2. Correction Factor(dB/m) = Antenna Factor(dB/m) + Cable Factor(dB) – Pre-Amplifier Factor(dB)
3. The other emission levels were very low against the limit.
4. Margin value = Emission Level – Limit value
5. " \* ": Fundamental frequency.
6. " # ": The radiated frequency is out of the restricted band.

<b>CHANNEL</b>	TX Channel 151	<b>DETECTOR FUNCTION</b>	Peak (PK)
<b>FREQUENCY RANGE</b>	1GHz ~ 40GHz		Average (AV)

**ANTENNA POLARITY & TEST DISTANCE: HORIZONTAL AT 3 M**

NO.	FREQ. (MHz)	EMISSION LEVEL (dBuV/m)	LIMIT (dBuV/m)	MARGIN (dB)	ANTENNA HEIGHT (m)	TABLE ANGLE (Degree)	RAW VALUE (dBuV)	CORRECTION FACTOR (dB/m)
1	#5649.60	67.4 PK	68.2	-0.8	2.34 H	278	60.3	7.1
2	*5755.00	112.2 PK			2.34 H	278	108.5	3.7
3	*5755.00	101.5 AV			2.34 H	278	97.8	3.7
4	#5930.40	59.8 PK	68.2	-8.4	2.34 H	278	52.0	7.8
5	11510.00	61.3 PK	74.0	-12.7	1.05 H	21	49.0	12.3
6	11510.00	49.6 AV	54.0	-4.4	1.05 H	21	37.3	12.3

**ANTENNA POLARITY & TEST DISTANCE: VERTICAL AT 3 M**

NO.	FREQ. (MHz)	EMISSION LEVEL (dBuV/m)	LIMIT (dBuV/m)	MARGIN (dB)	ANTENNA HEIGHT (m)	TABLE ANGLE (Degree)	RAW VALUE (dBuV)	CORRECTION FACTOR (dB/m)
1	#5621.93	61.3 PK	68.2	-6.9	3.89 V	351	57.7	3.6
2	*5755.00	105.3 PK			3.89 V	351	101.6	3.7
3	*5755.00	95.6 AV			3.89 V	351	91.9	3.7
4	#5957.19	57.0 PK	68.2	-11.2	3.89 V	351	53.0	4.0
5	11510.00	55.4 PK	74.0	-18.6	2.18 V	290	43.1	12.3
6	11510.00	44.5 AV	54.0	-9.5	2.18 V	290	32.2	12.3

**REMARKS:**

1. Emission Level(dBuV/m) = Raw Value(dBuV) + Correction Factor(dB/m)
2. Correction Factor(dB/m) = Antenna Factor(dB/m) + Cable Factor(dB) – Pre-Amplifier Factor(dB)
3. The other emission levels were very low against the limit.
4. Margin value = Emission Level – Limit value
5. " \* ": Fundamental frequency.
6. " # ": The radiated frequency is out of the restricted band.

<b>CHANNEL</b>	TX Channel 159	<b>DETECTOR FUNCTION</b>	Peak (PK)
<b>FREQUENCY RANGE</b>	1GHz ~ 40GHz		Average (AV)

**ANTENNA POLARITY & TEST DISTANCE: HORIZONTAL AT 3 M**

NO.	FREQ. (MHz)	EMISSION LEVEL (dBuV/m)	LIMIT (dBuV/m)	MARGIN (dB)	ANTENNA HEIGHT (m)	TABLE ANGLE (Degree)	RAW VALUE (dBuV)	CORRECTION FACTOR (dB/m)
1	#5644.00	60.8 PK	68.2	-7.4	2.43 H	273	53.7	7.1
2	*5795.00	111.5 PK			2.43 H	273	107.8	3.7
3	*5795.00	101.2 AV			2.43 H	273	97.5	3.7
4	#5928.00	64.2 PK	68.2	-4.0	2.43 H	273	56.4	7.8
5	11590.00	61.7 PK	74.0	-12.3	1.25 H	87	49.5	12.2
6	11590.00	49.6 AV	54.0	-4.4	1.25 H	87	37.4	12.2

**ANTENNA POLARITY & TEST DISTANCE: VERTICAL AT 3 M**

NO.	FREQ. (MHz)	EMISSION LEVEL (dBuV/m)	LIMIT (dBuV/m)	MARGIN (dB)	ANTENNA HEIGHT (m)	TABLE ANGLE (Degree)	RAW VALUE (dBuV)	CORRECTION FACTOR (dB/m)
1	#5561.01	57.0 PK	68.2	-11.2	3.97 V	353	53.5	3.5
2	*5795.00	104.1 PK			3.97 V	353	100.4	3.7
3	*5795.00	94.9 AV			3.97 V	353	91.2	3.7
4	#5951.85	57.5 PK	68.2	-10.7	3.97 V	353	53.5	4.0
5	11590.00	56.1 PK	74.0	-17.9	2.22 V	285	43.9	12.2
6	11590.00	44.8 AV	54.0	-9.2	2.22 V	285	32.6	12.2

**REMARKS:**

1. Emission Level(dBuV/m) = Raw Value(dBuV) + Correction Factor(dB/m)
2. Correction Factor(dB/m) = Antenna Factor(dB/m) + Cable Factor(dB) – Pre-Amplifier Factor(dB)
3. The other emission levels were very low against the limit.
4. Margin value = Emission Level – Limit value
5. " \* ": Fundamental frequency.
6. " # ": The radiated frequency is out of the restricted band.

802.11ac (VHT80)

<b>CHANNEL</b>	TX Channel 42	<b>DETECTOR FUNCTION</b>	Peak (PK)
<b>FREQUENCY RANGE</b>	1GHz ~ 40GHz		Average (AV)

ANTENNA POLARITY & TEST DISTANCE: HORIZONTAL AT 3 M								
NO.	FREQ. (MHz)	EMISSION LEVEL (dBuV/m)	LIMIT (dBuV/m)	MARGIN (dB)	ANTENNA HEIGHT (m)	TABLE ANGLE (Degree)	RAW VALUE (dBuV)	CORRECTION FACTOR (dB/m)
1	5150.00	65.7 PK	74.0	-8.3	3.60 H	334	62.7	3.0
2	5150.00	53.6 AV	54.0	-0.4	3.60 H	334	50.6	3.0
3	*5210.00	99.0 PK			3.60 H	334	95.9	3.1
4	*5210.00	86.9 AV			3.60 H	334	83.8	3.1
5	#10420.00	60.2 PK	74.0	-13.8	1.33 H	205	48.2	12.0
6	#10420.00	47.5 AV	54.0	-6.5	1.33 H	205	35.5	12.0

ANTENNA POLARITY & TEST DISTANCE: VERTICAL AT 3 M								
NO.	FREQ. (MHz)	EMISSION LEVEL (dBuV/m)	LIMIT (dBuV/m)	MARGIN (dB)	ANTENNA HEIGHT (m)	TABLE ANGLE (Degree)	RAW VALUE (dBuV)	CORRECTION FACTOR (dB/m)
1	5150.00	64.6 PK	74.0	-9.4	2.28 V	337	61.6	3.0
2	5150.00	48.8 AV	54.0	-5.2	2.28 V	337	45.8	3.0
3	*5210.00	94.1 PK			2.28 V	337	91.0	3.1
4	*5210.00	82.9 AV			2.28 V	337	79.8	3.1
5	#10420.00	54.6 PK	74.0	-19.4	2.37 V	301	42.6	12.0
6	#10420.00	43.5 AV	54.0	-10.5	2.37 V	301	31.5	12.0

**REMARKS:**

1. Emission Level(dBuV/m) = Raw Value(dBuV) + Correction Factor(dB/m)
2. Correction Factor(dB/m) = Antenna Factor(dB/m) + Cable Factor(dB) – Pre-Amplifier Factor(dB)
3. The other emission levels were very low against the limit.
4. Margin value = Emission Level – Limit value
5. " \* ": Fundamental frequency.
6. " # ": The radiated frequency is out of the restricted band.

<b>CHANNEL</b>	TX Channel 155	<b>DETECTOR FUNCTION</b>	Peak (PK)
<b>FREQUENCY RANGE</b>	1GHz ~ 40GHz		Average (AV)

**ANTENNA POLARITY & TEST DISTANCE: HORIZONTAL AT 3 M**

NO.	FREQ. (MHz)	EMISSION LEVEL (dBuV/m)	LIMIT (dBuV/m)	MARGIN (dB)	ANTENNA HEIGHT (m)	TABLE ANGLE (Degree)	RAW VALUE (dBuV)	CORRECTION FACTOR (dB/m)
1	#5648.00	67.7 PK	68.2	-0.5	2.35 H	295	60.6	7.1
2	*5775.00	106.8 PK			2.35 H	295	103.1	3.7
3	*5775.00	94.8 AV			2.35 H	295	91.1	3.7
4	#5924.00	67.5 PK	68.9	-1.4	2.35 H	295	59.7	7.8
5	11550.00	61.4 PK	74.0	-12.6	1.06 H	98	49.2	12.2
6	11550.00	49.8 AV	54.0	-4.2	1.06 H	98	37.6	12.2

**ANTENNA POLARITY & TEST DISTANCE: VERTICAL AT 3 M**

NO.	FREQ. (MHz)	EMISSION LEVEL (dBuV/m)	LIMIT (dBuV/m)	MARGIN (dB)	ANTENNA HEIGHT (m)	TABLE ANGLE (Degree)	RAW VALUE (dBuV)	CORRECTION FACTOR (dB/m)
1	#5646.90	66.9 PK	68.2	-1.3	1.05 V	254	63.2	3.7
2	*5775.00	102.5 PK			1.05 V	254	98.8	3.7
3	*5775.00	93.6 AV			1.05 V	254	89.9	3.7
4	#5931.43	62.0 PK	68.2	-6.2	1.05 V	254	58.0	4.0
5	11550.00	55.4 PK	74.0	-18.6	2.23 V	295	43.2	12.2
6	11550.00	44.5 AV	54.0	-9.5	2.23 V	295	32.3	12.2

**REMARKS:**

1. Emission Level(dBuV/m) = Raw Value(dBuV) + Correction Factor(dB/m)
2. Correction Factor(dB/m) = Antenna Factor(dB/m) + Cable Factor(dB) – Pre-Amplifier Factor(dB)
3. The other emission levels were very low against the limit.
4. Margin value = Emission Level – Limit value
5. " \* ": Fundamental frequency.
6. " # ": The radiated frequency is out of the restricted band.

**Below 1GHz Data:**

**802.11a**

<b>CHANNEL</b>	TX Channel 157	<b>DETECTOR FUNCTION</b>	Quasi-Peak (QP)
<b>FREQUENCY RANGE</b>	9kHz ~ 1GHz		

**ANTENNA POLARITY & TEST DISTANCE: HORIZONTAL AT 3 M**

NO.	FREQ. (MHz)	EMISSION LEVEL (dBuV/m)	LIMIT (dBuV/m)	MARGIN (dB)	ANTENNA HEIGHT (m)	TABLE ANGLE (Degree)	RAW VALUE (dBuV)	CORRECTION FACTOR (dB/m)
1	107.65	27.5 QP	43.5	-16.0	1.00 H	214	38.7	-11.2
2	149.92	30.0 QP	43.5	-13.5	2.00 H	89	38.3	-8.3
3	230.31	42.7 QP	46.0	-3.3	1.00 H	58	53.2	-10.5
4	280.91	42.7 QP	46.0	-3.3	1.00 H	158	50.7	-8.0
5	333.85	37.8 QP	46.0	-8.2	1.00 H	213	44.1	-6.3
6	708.95	28.6 QP	46.0	-17.4	3.00 H	154	27.6	1.0

**ANTENNA POLARITY & TEST DISTANCE: VERTICAL AT 3 M**

NO.	FREQ. (MHz)	EMISSION LEVEL (dBuV/m)	LIMIT (dBuV/m)	MARGIN (dB)	ANTENNA HEIGHT (m)	TABLE ANGLE (Degree)	RAW VALUE (dBuV)	CORRECTION FACTOR (dB/m)
1	73.80	26.4 QP	40.0	-13.6	1.00 V	145	37.9	-11.5
2	147.08	34.8 QP	43.5	-8.7	1.00 V	23	43.1	-8.3
3	229.31	34.1 QP	46.0	-11.9	2.00 V	321	44.7	-10.6
4	281.98	39.5 QP	46.0	-6.5	1.00 V	360	47.5	-8.0
5	334.19	36.7 QP	46.0	-9.3	3.00 V	124	43.0	-6.3
6	503.85	29.3 QP	46.0	-16.7	2.00 V	327	31.8	-2.5

**REMARKS:**

1. Emission Level(dBuV/m) = Raw Value(dBuV) + Correction Factor(dB/m)
2. Correction Factor(dB/m) = Antenna Factor(dB/m) + Cable Factor(dB) – Pre-Amplifier Factor(dB)
3. The other emission levels were very low against the limit.
4. Margin value = Emission Level – Limit value



## 4.1.8 Test Results (Mode 3)

**Monopole antenna**
**802.11a**

<b>CHANNEL</b>	TX Channel 36	<b>DETECTOR FUNCTION</b>	Peak (PK)
<b>FREQUENCY RANGE</b>	1GHz ~ 40GHz		Average (AV)

**ANTENNA POLARITY & TEST DISTANCE: HORIZONTAL AT 3 M**

NO.	FREQ. (MHz)	EMISSION LEVEL (dBuV/m)	LIMIT (dBuV/m)	MARGIN (dB)	ANTENNA HEIGHT (m)	TABLE ANGLE (Degree)	RAW VALUE (dBuV)	CORRECTION FACTOR (dB/m)
1	5150.00	68.6 PK	74.0	-5.4	2.28 H	289	65.6	3.0
2	5150.00	53.8 AV	54.0	-0.2	2.28 H	289	50.8	3.0
3	*5180.00	108.4 PK			2.28 H	289	105.4	3.0
4	*5180.00	98.4 AV			2.28 H	289	95.4	3.0
5	#10360.00	60.5 PK	74.0	-13.5	1.07 H	87	48.5	12.0
6	#10360.00	48.5 AV	54.0	-5.5	1.07 H	87	36.5	12.0

**ANTENNA POLARITY & TEST DISTANCE: VERTICAL AT 3 M**

NO.	FREQ. (MHz)	EMISSION LEVEL (dBuV/m)	LIMIT (dBuV/m)	MARGIN (dB)	ANTENNA HEIGHT (m)	TABLE ANGLE (Degree)	RAW VALUE (dBuV)	CORRECTION FACTOR (dB/m)
1	5150.00	61.9 PK	74.0	-12.1	3.19 V	329	58.9	3.0
2	5150.00	47.8 AV	54.0	-6.2	3.19 V	329	44.8	3.0
3	*5180.00	101.7 PK			3.14 V	321	98.7	3.0
4	*5180.00	92.8 AV			3.14 V	321	89.8	3.0
5	#10360.00	54.4 PK	74.0	-19.6	1.62 V	201	42.4	12.0
6	#10360.00	42.8 AV	54.0	-11.2	1.62 V	201	30.8	12.0

**REMARKS:**

1. Emission Level(dBuV/m) = Raw Value(dBuV) + Correction Factor(dB/m)
2. Correction Factor(dB/m) = Antenna Factor(dB/m) + Cable Factor(dB) – Pre-Amplifier Factor(dB)
3. The other emission levels were very low against the limit.
4. Margin value = Emission Level – Limit value
5. " \* ": Fundamental frequency.
6. " # ": The radiated frequency is out of the restricted band.

<b>CHANNEL</b>	TX Channel 40	<b>DETECTOR FUNCTION</b>	Peak (PK)
<b>FREQUENCY RANGE</b>	1GHz ~ 40GHz		Average (AV)

**ANTENNA POLARITY & TEST DISTANCE: HORIZONTAL AT 3 M**

NO.	FREQ. (MHz)	EMISSION LEVEL (dBuV/m)	LIMIT (dBuV/m)	MARGIN (dB)	ANTENNA HEIGHT (m)	TABLE ANGLE (Degree)	RAW VALUE (dBuV)	CORRECTION FACTOR (dB/m)
1	*5200.00	108.5 PK			2.19 H	288	105.5	3.0
2	*5200.00	98.0 AV			2.19 H	288	95.0	3.0
3	#10400.00	61.1 PK	74.0	-12.9	1.32 H	58	49.2	11.9
4	#10400.00	48.1 AV	54.0	-5.9	1.32 H	58	36.2	11.9

**ANTENNA POLARITY & TEST DISTANCE: VERTICAL AT 3 M**

NO.	FREQ. (MHz)	EMISSION LEVEL (dBuV/m)	LIMIT (dBuV/m)	MARGIN (dB)	ANTENNA HEIGHT (m)	TABLE ANGLE (Degree)	RAW VALUE (dBuV)	CORRECTION FACTOR (dB/m)
1	*5200.00	102.1 PK			3.12 V	324	99.1	3.0
2	*5200.00	92.4 AV			3.12 V	324	89.4	3.0
3	#10400.00	54.1 PK	74.0	-19.9	1.60 V	195	42.2	11.9
4	#10400.00	42.8 AV	54.0	-11.2	1.60 V	195	30.9	11.9

**REMARKS:**

1. Emission Level(dBuV/m) = Raw Value(dBuV) + Correction Factor(dB/m)
2. Correction Factor(dB/m) = Antenna Factor(dB/m) + Cable Factor(dB) – Pre-Amplifier Factor(dB)
3. The other emission levels were very low against the limit.
4. Margin value = Emission Level – Limit value
5. " \* ": Fundamental frequency.
6. " # ": The radiated frequency is out of the restricted band.

<b>CHANNEL</b>	TX Channel 48	<b>DETECTOR FUNCTION</b>	Peak (PK)
<b>FREQUENCY RANGE</b>	1GHz ~ 40GHz		Average (AV)

**ANTENNA POLARITY & TEST DISTANCE: HORIZONTAL AT 3 M**

NO.	FREQ. (MHz)	EMISSION LEVEL (dBuV/m)	LIMIT (dBuV/m)	MARGIN (dB)	ANTENNA HEIGHT (m)	TABLE ANGLE (Degree)	RAW VALUE (dBuV)	CORRECTION FACTOR (dB/m)
1	*5240.00	109.6 PK			2.15 H	290	106.5	3.1
2	*5240.00	98.9 AV			2.15 H	290	95.8	3.1
3	5350.00	57.6 PK	74.0	-16.4	2.15 H	290	54.3	3.3
4	5350.00	44.7 AV	54.0	-9.3	2.15 H	290	41.4	3.3
5	#10480.00	59.9 PK	74.0	-14.1	1.03 H	22	47.9	12.0
6	#10480.00	48.0 AV	54.0	-6.0	1.03 H	22	36.0	12.0

**ANTENNA POLARITY & TEST DISTANCE: VERTICAL AT 3 M**

NO.	FREQ. (MHz)	EMISSION LEVEL (dBuV/m)	LIMIT (dBuV/m)	MARGIN (dB)	ANTENNA HEIGHT (m)	TABLE ANGLE (Degree)	RAW VALUE (dBuV)	CORRECTION FACTOR (dB/m)
1	*5240.00	104.3 PK			3.18 V	327	101.2	3.1
2	*5240.00	92.4 AV			3.18 V	327	89.3	3.1
3	5350.00	51.3 PK	74.0	-22.7	3.15 V	308	48.0	3.3
4	5350.00	39.1 AV	54.0	-14.9	3.15 V	308	35.8	3.3
5	#10480.00	54.1 PK	74.0	-19.9	1.67 V	201	42.1	12.0
6	#10480.00	42.7 AV	54.0	-11.3	1.67 V	201	30.7	12.0

**REMARKS:**

1. Emission Level(dBuV/m) = Raw Value(dBuV) + Correction Factor(dB/m)
2. Correction Factor(dB/m) = Antenna Factor(dB/m) + Cable Factor(dB) – Pre-Amplifier Factor(dB)
3. The other emission levels were very low against the limit.
4. Margin value = Emission Level – Limit value
5. " \* ": Fundamental frequency.
6. " # ": The radiated frequency is out of the restricted band.

<b>CHANNEL</b>	TX Channel 149	<b>DETECTOR FUNCTION</b>	Peak (PK)
<b>FREQUENCY RANGE</b>	1GHz ~ 40GHz		Average (AV)

**ANTENNA POLARITY & TEST DISTANCE: HORIZONTAL AT 3 M**

NO.	FREQ. (MHz)	EMISSION LEVEL (dBuV/m)	LIMIT (dBuV/m)	MARGIN (dB)	ANTENNA HEIGHT (m)	TABLE ANGLE (Degree)	RAW VALUE (dBuV)	CORRECTION FACTOR (dB/m)
1	#5620.00	59.5 PK	68.2	-8.7	2.00 H	224	52.6	6.9
2	*5745.00	112.8 PK			2.00 H	224	109.1	3.7
3	*5745.00	102.4 AV			2.00 H	224	98.7	3.7
4	#5943.20	59.8 PK	68.2	-8.4	2.00 H	224	52.0	7.8
5	11490.00	62.1 PK	74.0	-11.9	1.02 H	54	49.8	12.3
6	11490.00	49.9 AV	54.0	-4.1	1.02 H	54	37.6	12.3

**ANTENNA POLARITY & TEST DISTANCE: VERTICAL AT 3 M**

NO.	FREQ. (MHz)	EMISSION LEVEL (dBuV/m)	LIMIT (dBuV/m)	MARGIN (dB)	ANTENNA HEIGHT (m)	TABLE ANGLE (Degree)	RAW VALUE (dBuV)	CORRECTION FACTOR (dB/m)
1	#5597.98	57.1 PK	68.2	-11.1	1.75 V	267	53.5	3.6
2	*5745.00	111.0 PK			1.75 V	267	107.3	3.7
3	*5745.00	98.9 AV			1.75 V	267	95.2	3.7
4	#6011.70	57.2 PK	68.2	-11.0	1.75 V	267	53.1	4.1
5	11490.00	56.3 PK	74.0	-17.7	1.53 V	353	44.0	12.3
6	11490.00	44.3 AV	54.0	-9.7	1.53 V	353	32.0	12.3

**REMARKS:**

1. Emission Level(dBuV/m) = Raw Value(dBuV) + Correction Factor(dB/m)
2. Correction Factor(dB/m) = Antenna Factor(dB/m) + Cable Factor(dB) – Pre-Amplifier Factor(dB)
3. The other emission levels were very low against the limit.
4. Margin value = Emission Level – Limit value
5. " \* ": Fundamental frequency.
6. " # ": The radiated frequency is out of the restricted band.

<b>CHANNEL</b>	TX Channel 157	<b>DETECTOR FUNCTION</b>	Peak (PK)
<b>FREQUENCY RANGE</b>	1GHz ~ 40GHz		Average (AV)

**ANTENNA POLARITY & TEST DISTANCE: HORIZONTAL AT 3 M**

NO.	FREQ. (MHz)	EMISSION LEVEL (dBuV/m)	LIMIT (dBuV/m)	MARGIN (dB)	ANTENNA HEIGHT (m)	TABLE ANGLE (Degree)	RAW VALUE (dBuV)	CORRECTION FACTOR (dB/m)
1	#5646.40	59.4 PK	68.2	-8.8	1.97 H	228	52.3	7.1
2	*5785.00	113.3 PK			1.97 H	225	109.6	3.7
3	*5785.00	102.6 AV			1.97 H	225	98.9	3.7
4	#5993.60	61.3 PK	68.2	-6.9	1.97 H	228	53.4	7.9
5	11570.00	61.7 PK	74.0	-12.3	1.07 H	20	49.5	12.2
6	11570.00	49.8 AV	54.0	-4.2	1.07 H	20	37.6	12.2

**ANTENNA POLARITY & TEST DISTANCE: VERTICAL AT 3 M**

NO.	FREQ. (MHz)	EMISSION LEVEL (dBuV/m)	LIMIT (dBuV/m)	MARGIN (dB)	ANTENNA HEIGHT (m)	TABLE ANGLE (Degree)	RAW VALUE (dBuV)	CORRECTION FACTOR (dB/m)
1	#5589.90	57.4 PK	68.2	-10.8	1.74 V	266	53.9	3.5
2	*5785.00	110.8 PK			1.74 V	266	107.1	3.7
3	*5785.00	99.0 AV			1.74 V	266	95.3	3.7
4	#5943.30	58.2 PK	68.2	-10.0	1.74 V	266	54.2	4.0
5	11570.00	56.3 PK	74.0	-17.7	1.52 V	360	44.1	12.2
6	11570.00	44.5 AV	54.0	-9.5	1.52 V	360	32.3	12.2

**REMARKS:**

1. Emission Level(dBuV/m) = Raw Value(dBuV) + Correction Factor(dB/m)
2. Correction Factor(dB/m) = Antenna Factor(dB/m) + Cable Factor(dB) – Pre-Amplifier Factor(dB)
3. The other emission levels were very low against the limit.
4. Margin value = Emission Level – Limit value
5. " \* ": Fundamental frequency.
6. " # ": The radiated frequency is out of the restricted band.

<b>CHANNEL</b>	TX Channel 165	<b>DETECTOR FUNCTION</b>	Peak (PK)
<b>FREQUENCY RANGE</b>	1GHz ~ 40GHz		Average (AV)

**ANTENNA POLARITY & TEST DISTANCE: HORIZONTAL AT 3 M**

NO.	FREQ. (MHz)	EMISSION LEVEL (dBuV/m)	LIMIT (dBuV/m)	MARGIN (dB)	ANTENNA HEIGHT (m)	TABLE ANGLE (Degree)	RAW VALUE (dBuV)	CORRECTION FACTOR (dB/m)
1	#5608.00	59.5 PK	68.2	-8.7	2.18 H	246	52.6	6.9
2	*5825.00	112.3 PK			2.18 H	246	108.6	3.7
3	*5825.00	101.7 AV			2.18 H	246	98.0	3.7
4	#5942.40	60.7 PK	68.2	-7.5	2.48 H	246	52.9	7.8
5	11650.00	61.4 PK	74.0	-12.6	1.07 H	41	49.0	12.4
6	11650.00	49.7 AV	54.0	-4.3	1.07 H	41	37.3	12.4

**ANTENNA POLARITY & TEST DISTANCE: VERTICAL AT 3 M**

NO.	FREQ. (MHz)	EMISSION LEVEL (dBuV/m)	LIMIT (dBuV/m)	MARGIN (dB)	ANTENNA HEIGHT (m)	TABLE ANGLE (Degree)	RAW VALUE (dBuV)	CORRECTION FACTOR (dB/m)
1	#5644.52	57.3 PK	68.2	-10.9	1.76 V	257	53.6	3.7
2	*5825.00	110.5 PK			1.76 V	257	106.8	3.7
3	*5825.00	99.3 AV			1.76 V	257	95.6	3.7
4	#6011.70	58.1 PK	68.2	-10.1	1.76 V	257	54.0	4.1
5	11650.00	56.0 PK	74.0	-18.0	1.52 V	360	43.6	12.4
6	11650.00	44.2 AV	54.0	-9.8	1.52 V	360	31.8	12.4

**REMARKS:**

1. Emission Level(dBuV/m) = Raw Value(dBuV) + Correction Factor(dB/m)
2. Correction Factor(dB/m) = Antenna Factor(dB/m) + Cable Factor(dB) – Pre-Amplifier Factor(dB)
3. The other emission levels were very low against the limit.
4. Margin value = Emission Level – Limit value
5. " \* ": Fundamental frequency.
6. " # ": The radiated frequency is out of the restricted band.

**802.11ac (VHT20)**

<b>CHANNEL</b>	TX Channel 36	<b>DETECTOR FUNCTION</b>	Peak (PK)
<b>FREQUENCY RANGE</b>	1GHz ~ 40GHz		Average (AV)

**ANTENNA POLARITY & TEST DISTANCE: HORIZONTAL AT 3 M**

NO.	FREQ. (MHz)	EMISSION LEVEL (dBuV/m)	LIMIT (dBuV/m)	MARGIN (dB)	ANTENNA HEIGHT (m)	TABLE ANGLE (Degree)	RAW VALUE (dBuV)	CORRECTION FACTOR (dB/m)
1	5150.00	65.4 PK	74.0	-8.6	2.28 H	291	62.4	3.0
2	5150.00	53.6 AV	54.0	-0.4	2.28 H	291	50.6	3.0
3	*5180.00	106.6 PK			2.28 H	291	103.6	3.0
4	*5180.00	96.7 AV			2.28 H	291	93.7	3.0
5	#10360.00	59.5 PK	74.0	-14.5	1.32 H	57	47.5	12.0
6	#10360.00	47.6 AV	54.0	-6.4	1.32 H	57	35.6	12.0

**ANTENNA POLARITY & TEST DISTANCE: VERTICAL AT 3 M**

NO.	FREQ. (MHz)	EMISSION LEVEL (dBuV/m)	LIMIT (dBuV/m)	MARGIN (dB)	ANTENNA HEIGHT (m)	TABLE ANGLE (Degree)	RAW VALUE (dBuV)	CORRECTION FACTOR (dB/m)
1	5150.00	58.9 PK	74.0	-15.1	3.16 V	323	55.9	3.0
2	5150.00	48.2 AV	54.0	-5.8	3.16 V	323	45.2	3.0
3	*5180.00	99.9 PK			3.18 V	328	96.9	3.0
4	*5180.00	90.7 AV			3.18 V	328	87.7	3.0
5	#10360.00	53.6 PK	74.0	-20.4	1.70 V	212	41.6	12.0
6	#10360.00	42.4 AV	54.0	-11.6	1.70 V	212	30.4	12.0

**REMARKS:**

1. Emission Level(dBuV/m) = Raw Value(dBuV) + Correction Factor(dB/m)
2. Correction Factor(dB/m) = Antenna Factor(dB/m) + Cable Factor(dB) – Pre-Amplifier Factor(dB)
3. The other emission levels were very low against the limit.
4. Margin value = Emission Level – Limit value
5. " \* ": Fundamental frequency.
6. " # ": The radiated frequency is out of the restricted band.

<b>CHANNEL</b>	TX Channel 40	<b>DETECTOR FUNCTION</b>	Peak (PK)
<b>FREQUENCY RANGE</b>	1GHz ~ 40GHz		Average (AV)

**ANTENNA POLARITY & TEST DISTANCE: HORIZONTAL AT 3 M**

NO.	FREQ. (MHz)	EMISSION LEVEL (dBuV/m)	LIMIT (dBuV/m)	MARGIN (dB)	ANTENNA HEIGHT (m)	TABLE ANGLE (Degree)	RAW VALUE (dBuV)	CORRECTION FACTOR (dB/m)
1	*5200.00	108.7 PK			2.23 H	288	105.7	3.0
2	*5200.00	97.6 AV			2.23 H	288	94.6	3.0
3	#10400.00	60.7 PK	74.0	-13.3	1.32 H	54	48.8	11.9
4	#10400.00	47.8 AV	54.0	-6.2	1.32 H	54	35.9	11.9

**ANTENNA POLARITY & TEST DISTANCE: VERTICAL AT 3 M**

NO.	FREQ. (MHz)	EMISSION LEVEL (dBuV/m)	LIMIT (dBuV/m)	MARGIN (dB)	ANTENNA HEIGHT (m)	TABLE ANGLE (Degree)	RAW VALUE (dBuV)	CORRECTION FACTOR (dB/m)
1	*5200.00	102.6 PK			3.18 V	318	99.6	3.0
2	*5200.00	92.4 AV			3.18 V	318	89.4	3.0
3	#10400.00	54.0 PK	74.0	-20.0	1.62 V	205	42.1	11.9
4	#10400.00	42.8 AV	54.0	-11.2	1.62 V	205	30.9	11.9

**REMARKS:**

1. Emission Level(dBuV/m) = Raw Value(dBuV) + Correction Factor(dB/m)
2. Correction Factor(dB/m) = Antenna Factor(dB/m) + Cable Factor(dB) – Pre-Amplifier Factor(dB)
3. The other emission levels were very low against the limit.
4. Margin value = Emission Level – Limit value
5. " \* ": Fundamental frequency.
6. " # ": The radiated frequency is out of the restricted band.



<b>CHANNEL</b>	TX Channel 48	<b>DETECTOR FUNCTION</b>	Peak (PK)
<b>FREQUENCY RANGE</b>	1GHz ~ 40GHz		Average (AV)

**ANTENNA POLARITY & TEST DISTANCE: HORIZONTAL AT 3 M**

NO.	FREQ. (MHz)	EMISSION LEVEL (dBuV/m)	LIMIT (dBuV/m)	MARGIN (dB)	ANTENNA HEIGHT (m)	TABLE ANGLE (Degree)	RAW VALUE (dBuV)	CORRECTION FACTOR (dB/m)
1	*5240.00	109.2 PK			2.10 H	290	106.1	3.1
2	*5240.00	98.2 AV			2.10 H	290	95.1	3.1
3	5350.00	59.1 PK	74.0	-14.9	2.10 H	290	55.8	3.3
4	5350.00	48.5 AV	54.0	-5.5	2.10 H	290	45.2	3.3
5	#10480.00	60.5 PK	74.0	-13.5	1.20 H	65	48.5	12.0
6	#10480.00	47.8 AV	54.0	-6.2	1.20 H	65	35.8	12.0

**ANTENNA POLARITY & TEST DISTANCE: VERTICAL AT 3 M**

NO.	FREQ. (MHz)	EMISSION LEVEL (dBuV/m)	LIMIT (dBuV/m)	MARGIN (dB)	ANTENNA HEIGHT (m)	TABLE ANGLE (Degree)	RAW VALUE (dBuV)	CORRECTION FACTOR (dB/m)
1	*5240.00	102.4 PK			3.14 V	334	99.3	3.1
2	*5240.00	92.5 AV			3.14 V	334	89.4	3.1
3	5350.00	52.7 PK	74.0	-21.3	3.13 V	313	49.4	3.3
4	5350.00	43.3 AV	54.0	-10.7	3.13 V	313	40.0	3.3
5	#10480.00	54.1 PK	74.0	-19.9	1.69 V	206	42.1	12.0
6	#10480.00	42.9 AV	54.0	-11.1	1.69 V	206	30.9	12.0

**REMARKS:**

1. Emission Level(dBuV/m) = Raw Value(dBuV) + Correction Factor(dB/m)
2. Correction Factor(dB/m) = Antenna Factor(dB/m) + Cable Factor(dB) – Pre-Amplifier Factor(dB)
3. The other emission levels were very low against the limit.
4. Margin value = Emission Level – Limit value
5. " \* ": Fundamental frequency.
6. " # ": The radiated frequency is out of the restricted band.

<b>CHANNEL</b>	TX Channel 149	<b>DETECTOR FUNCTION</b>	Peak (PK)
<b>FREQUENCY RANGE</b>	1GHz ~ 40GHz		Average (AV)

**ANTENNA POLARITY & TEST DISTANCE: HORIZONTAL AT 3 M**

NO.	FREQ. (MHz)	EMISSION LEVEL (dBuV/m)	LIMIT (dBuV/m)	MARGIN (dB)	ANTENNA HEIGHT (m)	TABLE ANGLE (Degree)	RAW VALUE (dBuV)	CORRECTION FACTOR (dB/m)
1	#5602.40	59.5 PK	68.2	-8.7	1.90 H	228	52.6	6.9
2	*5745.00	112.7 PK			1.90 H	228	109.0	3.7
3	*5745.00	102.5 AV			1.90 H	228	98.8	3.7
4	#5924.00	60.0 PK	68.9	-8.9	1.90 H	228	52.2	7.8
5	11490.00	63.0 PK	74.0	-11.0	1.48 H	78	50.7	12.3
6	11490.00	50.8 AV	54.0	-3.2	1.48 H	78	38.5	12.3

**ANTENNA POLARITY & TEST DISTANCE: VERTICAL AT 3 M**

NO.	FREQ. (MHz)	EMISSION LEVEL (dBuV/m)	LIMIT (dBuV/m)	MARGIN (dB)	ANTENNA HEIGHT (m)	TABLE ANGLE (Degree)	RAW VALUE (dBuV)	CORRECTION FACTOR (dB/m)
1	#5587.52	57.7 PK	68.2	-10.5	1.71 V	261	54.2	3.5
2	*5745.00	110.2 PK			1.71 V	261	106.5	3.7
3	*5745.00	99.0 AV			1.71 V	261	95.3	3.7
4	#5973.70	58.0 PK	68.2	-10.2	1.71 V	261	54.0	4.0
5	11490.00	56.3 PK	74.0	-17.7	1.55 V	360	44.0	12.3
6	11490.00	44.5 AV	54.0	-9.5	1.55 V	360	32.2	12.3

**REMARKS:**

1. Emission Level(dBuV/m) = Raw Value(dBuV) + Correction Factor(dB/m)
2. Correction Factor(dB/m) = Antenna Factor(dB/m) + Cable Factor(dB) – Pre-Amplifier Factor(dB)
3. The other emission levels were very low against the limit.
4. Margin value = Emission Level – Limit value
5. " \* ": Fundamental frequency.
6. " # ": The radiated frequency is out of the restricted band.

<b>CHANNEL</b>	TX Channel 157	<b>DETECTOR FUNCTION</b>	Peak (PK)
<b>FREQUENCY RANGE</b>	1GHz ~ 40GHz		Average (AV)

**ANTENNA POLARITY & TEST DISTANCE: HORIZONTAL AT 3 M**

NO.	FREQ. (MHz)	EMISSION LEVEL (dBuV/m)	LIMIT (dBuV/m)	MARGIN (dB)	ANTENNA HEIGHT (m)	TABLE ANGLE (Degree)	RAW VALUE (dBuV)	CORRECTION FACTOR (dB/m)
1	#5612.80	58.2 PK	68.2	-10.0	1.96 H	225	51.3	6.9
2	*5785.00	113.4 PK			1.96 H	225	109.7	3.7
3	*5785.00	102.4 AV			1.96 H	225	98.7	3.7
4	#5950.40	60.0 PK	68.2	-8.2	1.96 H	225	52.2	7.8
5	11570.00	61.7 PK	74.0	-12.3	1.05 H	74	49.5	12.2
6	11570.00	49.5 AV	54.0	-4.5	1.05 H	74	37.3	12.2

**ANTENNA POLARITY & TEST DISTANCE: VERTICAL AT 3 M**

NO.	FREQ. (MHz)	EMISSION LEVEL (dBuV/m)	LIMIT (dBuV/m)	MARGIN (dB)	ANTENNA HEIGHT (m)	TABLE ANGLE (Degree)	RAW VALUE (dBuV)	CORRECTION FACTOR (dB/m)
1	#5596.55	58.7 PK	68.2	-9.5	1.73 V	260	55.2	3.5
2	*5785.00	110.1 PK			1.73 V	260	106.4	3.7
3	*5785.00	99.5 AV			1.73 V	260	95.8	3.7
4	#5958.02	58.2 PK	68.2	-10.0	1.73 V	260	54.2	4.0
5	11570.00	56.8 PK	74.0	-17.2	1.54 V	360	44.6	12.2
6	11570.00	44.6 AV	54.0	-9.4	1.54 V	360	32.4	12.2

**REMARKS:**

1. Emission Level(dBuV/m) = Raw Value(dBuV) + Correction Factor(dB/m)
2. Correction Factor(dB/m) = Antenna Factor(dB/m) + Cable Factor(dB) – Pre-Amplifier Factor(dB)
3. The other emission levels were very low against the limit.
4. Margin value = Emission Level – Limit value
5. " \* ": Fundamental frequency.
6. " # ": The radiated frequency is out of the restricted band.

<b>CHANNEL</b>	TX Channel 165	<b>DETECTOR FUNCTION</b>	Peak (PK)
<b>FREQUENCY RANGE</b>	1GHz ~ 40GHz		Average (AV)

**ANTENNA POLARITY & TEST DISTANCE: HORIZONTAL AT 3 M**

NO.	FREQ. (MHz)	EMISSION LEVEL (dBuV/m)	LIMIT (dBuV/m)	MARGIN (dB)	ANTENNA HEIGHT (m)	TABLE ANGLE (Degree)	RAW VALUE (dBuV)	CORRECTION FACTOR (dB/m)
1	#5616.00	59.5 PK	68.2	-8.7	2.15 H	245	52.6	6.9
2	*5825.00	112.5 PK			2.15 H	245	108.8	3.7
3	*5825.00	101.7 AV			2.15 H	245	98.0	3.7
4	#5977.60	59.9 PK	68.2	-8.3	2.15 H	245	52.0	7.9
5	11650.00	61.0 PK	74.0	-13.0	1.55 H	148	48.6	12.4
6	11650.00	49.2 AV	54.0	-4.8	1.55 H	148	36.8	12.4

**ANTENNA POLARITY & TEST DISTANCE: VERTICAL AT 3 M**

NO.	FREQ. (MHz)	EMISSION LEVEL (dBuV/m)	LIMIT (dBuV/m)	MARGIN (dB)	ANTENNA HEIGHT (m)	TABLE ANGLE (Degree)	RAW VALUE (dBuV)	CORRECTION FACTOR (dB/m)
1	#5608.43	59.9 PK	68.2	-8.3	1.75 V	264	56.3	3.6
2	*5825.00	110.4 PK			1.75 V	264	106.7	3.7
3	*5825.00	99.7 AV			1.75 V	264	96.0	3.7
4	#5933.80	59.0 PK	68.2	-9.2	1.75 V	264	55.0	4.0
5	11650.00	56.6 PK	74.0	-17.4	1.56 V	340	44.2	12.4
6	11650.00	44.6 AV	54.0	-9.4	1.56 V	340	32.2	12.4

**REMARKS:**

1. Emission Level(dBuV/m) = Raw Value(dBuV) + Correction Factor(dB/m)
2. Correction Factor(dB/m) = Antenna Factor(dB/m) + Cable Factor(dB) – Pre-Amplifier Factor(dB)
3. The other emission levels were very low against the limit.
4. Margin value = Emission Level – Limit value
5. " \* ": Fundamental frequency.
6. " # ": The radiated frequency is out of the restricted band.

**802.11ac (VHT40)**

<b>CHANNEL</b>	TX Channel 38	<b>DETECTOR FUNCTION</b>	Peak (PK)
<b>FREQUENCY RANGE</b>	1GHz ~ 40GHz		Average (AV)

**ANTENNA POLARITY & TEST DISTANCE: HORIZONTAL AT 3 M**

NO.	FREQ. (MHz)	EMISSION LEVEL (dBuV/m)	LIMIT (dBuV/m)	MARGIN (dB)	ANTENNA HEIGHT (m)	TABLE ANGLE (Degree)	RAW VALUE (dBuV)	CORRECTION FACTOR (dB/m)
1	5150.00	67.5 PK	74.0	-6.5	2.08 H	282	64.5	3.0
2	5150.00	53.6 AV	54.0	-0.4	2.08 H	282	50.6	3.0
3	*5190.00	102.9 PK			2.08 H	282	99.9	3.0
4	*5190.00	92.7 AV			2.08 H	282	89.7	3.0
5	#10380.00	60.1 PK	74.0	-13.9	1.05 H	24	48.1	12.0
6	#10380.00	47.4 AV	54.0	-6.6	1.05 H	24	35.4	12.0

**ANTENNA POLARITY & TEST DISTANCE: VERTICAL AT 3 M**

NO.	FREQ. (MHz)	EMISSION LEVEL (dBuV/m)	LIMIT (dBuV/m)	MARGIN (dB)	ANTENNA HEIGHT (m)	TABLE ANGLE (Degree)	RAW VALUE (dBuV)	CORRECTION FACTOR (dB/m)
1	5150.00	62.6 PK	74.0	-11.4	3.15 V	328	59.6	3.0
2	5150.00	49.2 AV	54.0	-4.8	3.15 V	328	46.2	3.0
3	*5190.00	97.7 PK			3.17 V	313	94.7	3.0
4	*5190.00	88.1 AV			3.17 V	313	85.1	3.0
5	#10380.00	54.6 PK	74.0	-19.4	1.64 V	203	42.6	12.0
6	#10380.00	42.9 AV	54.0	-11.1	1.64 V	203	30.9	12.0

**REMARKS:**

1. Emission Level(dBuV/m) = Raw Value(dBuV) + Correction Factor(dB/m)
2. Correction Factor(dB/m) = Antenna Factor(dB/m) + Cable Factor(dB) – Pre-Amplifier Factor(dB)
3. The other emission levels were very low against the limit.
4. Margin value = Emission Level – Limit value
5. " \* ": Fundamental frequency.
6. " # ": The radiated frequency is out of the restricted band.

<b>CHANNEL</b>	TX Channel 46	<b>DETECTOR FUNCTION</b>	Peak (PK)
<b>FREQUENCY RANGE</b>	1GHz ~ 40GHz		Average (AV)

**ANTENNA POLARITY & TEST DISTANCE: HORIZONTAL AT 3 M**

NO.	FREQ. (MHz)	EMISSION LEVEL (dBuV/m)	LIMIT (dBuV/m)	MARGIN (dB)	ANTENNA HEIGHT (m)	TABLE ANGLE (Degree)	RAW VALUE (dBuV)	CORRECTION FACTOR (dB/m)
1	*5230.00	106.4 PK			2.14 H	280	103.3	3.1
2	*5230.00	95.8 AV			2.14 H	280	92.7	3.1
3	5350.00	59.5 PK	74.0	-14.5	2.14 H	280	56.2	3.3
4	5350.00	48.0 AV	54.0	-6.0	2.14 H	280	44.7	3.3
5	#10460.00	59.8 PK	74.0	-14.2	1.07 H	41	47.9	11.9
6	#10460.00	47.9 AV	54.0	-6.1	1.07 H	41	36.0	11.9

**ANTENNA POLARITY & TEST DISTANCE: VERTICAL AT 3 M**

NO.	FREQ. (MHz)	EMISSION LEVEL (dBuV/m)	LIMIT (dBuV/m)	MARGIN (dB)	ANTENNA HEIGHT (m)	TABLE ANGLE (Degree)	RAW VALUE (dBuV)	CORRECTION FACTOR (dB/m)
1	*5230.00	101.1 PK			3.16 V	330	98.0	3.1
2	*5230.00	91.4 AV			3.16 V	330	88.3	3.1
3	5350.00	61.6 PK	74.0	-12.4	3.16 V	334	58.3	3.3
4	5350.00	48.7 AV	54.0	-5.3	3.16 V	334	45.4	3.3
5	#10460.00	54.5 PK	74.0	-19.5	1.61 V	210	42.6	11.9
6	#10460.00	43.0 AV	54.0	-11.0	1.61 V	210	31.1	11.9

**REMARKS:**

1. Emission Level(dBuV/m) = Raw Value(dBuV) + Correction Factor(dB/m)
2. Correction Factor(dB/m) = Antenna Factor(dB/m) + Cable Factor(dB) – Pre-Amplifier Factor(dB)
3. The other emission levels were very low against the limit.
4. Margin value = Emission Level – Limit value
5. " \* ": Fundamental frequency.
6. " # ": The radiated frequency is out of the restricted band.

<b>CHANNEL</b>	TX Channel 151	<b>DETECTOR FUNCTION</b>	Peak (PK)
<b>FREQUENCY RANGE</b>	1GHz ~ 40GHz		Average (AV)

**ANTENNA POLARITY & TEST DISTANCE: HORIZONTAL AT 3 M**

NO.	FREQ. (MHz)	EMISSION LEVEL (dBuV/m)	LIMIT (dBuV/m)	MARGIN (dB)	ANTENNA HEIGHT (m)	TABLE ANGLE (Degree)	RAW VALUE (dBuV)	CORRECTION FACTOR (dB/m)
1	#5646.40	61.2 PK	68.2	-7.0	2.19 H	279	54.1	7.1
2	*5755.00	106.4 PK			2.19 H	279	102.7	3.7
3	*5755.00	96.0 AV			2.19 H	279	92.3	3.7
4	#5970.40	59.4 PK	68.2	-8.8	2.19 H	279	51.5	7.9
5	11510.00	62.1 PK	74.0	-11.9	1.32 H	55	49.8	12.3
6	11510.00	49.6 AV	54.0	-4.4	1.32 H	55	37.3	12.3

**ANTENNA POLARITY & TEST DISTANCE: VERTICAL AT 3 M**

NO.	FREQ. (MHz)	EMISSION LEVEL (dBuV/m)	LIMIT (dBuV/m)	MARGIN (dB)	ANTENNA HEIGHT (m)	TABLE ANGLE (Degree)	RAW VALUE (dBuV)	CORRECTION FACTOR (dB/m)
1	#5627.72	58.4 PK	68.2	-9.8	1.79 V	269	54.8	3.6
2	*5755.00	105.1 PK			1.79 V	269	101.4	3.7
3	*5755.00	94.3 AV			1.79 V	269	90.6	3.7
4	#5978.73	58.3 PK	68.2	-9.9	1.79 V	269	54.3	4.0
5	11510.00	57.3 PK	74.0	-16.7	1.50 V	351	45.0	12.3
6	11510.00	45.0 AV	54.0	-9.0	1.50 V	351	32.7	12.3

**REMARKS:**

1. Emission Level(dBuV/m) = Raw Value(dBuV) + Correction Factor(dB/m)
2. Correction Factor(dB/m) = Antenna Factor(dB/m) + Cable Factor(dB) – Pre-Amplifier Factor(dB)
3. The other emission levels were very low against the limit.
4. Margin value = Emission Level – Limit value
5. " \* ": Fundamental frequency.
6. " # ": The radiated frequency is out of the restricted band.

<b>CHANNEL</b>	TX Channel 159	<b>DETECTOR FUNCTION</b>	Peak (PK)
<b>FREQUENCY RANGE</b>	1GHz ~ 40GHz		Average (AV)

**ANTENNA POLARITY & TEST DISTANCE: HORIZONTAL AT 3 M**

NO.	FREQ. (MHz)	EMISSION LEVEL (dBuV/m)	LIMIT (dBuV/m)	MARGIN (dB)	ANTENNA HEIGHT (m)	TABLE ANGLE (Degree)	RAW VALUE (dBuV)	CORRECTION FACTOR (dB/m)
1	#5645.60	59.5 PK	68.2	-8.7	2.58 H	213	52.4	7.1
2	*5795.00	108.6 PK			2.58 H	213	104.9	3.7
3	*5795.00	97.9 AV			2.58 H	213	94.2	3.7
4	#5940.00	63.7 PK	68.2	-4.5	2.58 H	213	55.9	7.8
5	11590.00	61.3 PK	74.0	-12.7	1.35 H	69	49.1	12.2
6	11590.00	49.5 AV	54.0	-4.5	1.35 H	69	37.3	12.2

**ANTENNA POLARITY & TEST DISTANCE: VERTICAL AT 3 M**

NO.	FREQ. (MHz)	EMISSION LEVEL (dBuV/m)	LIMIT (dBuV/m)	MARGIN (dB)	ANTENNA HEIGHT (m)	TABLE ANGLE (Degree)	RAW VALUE (dBuV)	CORRECTION FACTOR (dB/m)
1	#5597.37	58.1 PK	68.2	-10.1	1.81 V	266	54.5	3.6
2	*5795.00	105.0 PK			1.81 V	266	101.3	3.7
3	*5795.00	94.6 AV			1.81 V	266	90.9	3.7
4	#5933.62	58.7 PK	68.2	-9.5	1.81 V	266	54.7	4.0
5	11590.00	57.1 PK	74.0	-16.9	1.52 V	341	44.9	12.2
6	11590.00	45.0 AV	54.0	-9.0	1.52 V	341	32.8	12.2

**REMARKS:**

1. Emission Level(dBuV/m) = Raw Value(dBuV) + Correction Factor(dB/m)
2. Correction Factor(dB/m) = Antenna Factor(dB/m) + Cable Factor(dB) – Pre-Amplifier Factor(dB)
3. The other emission levels were very low against the limit.
4. Margin value = Emission Level – Limit value
5. " \* ": Fundamental frequency.
6. " # ": The radiated frequency is out of the restricted band.



802.11ac (VHT80)

<b>CHANNEL</b>	TX Channel 42	<b>DETECTOR FUNCTION</b>	Peak (PK)
<b>FREQUENCY RANGE</b>	1GHz ~ 40GHz		Average (AV)

ANTENNA POLARITY & TEST DISTANCE: HORIZONTAL AT 3 M								
NO.	FREQ. (MHz)	EMISSION LEVEL (dBuV/m)	LIMIT (dBuV/m)	MARGIN (dB)	ANTENNA HEIGHT (m)	TABLE ANGLE (Degree)	RAW VALUE (dBuV)	CORRECTION FACTOR (dB/m)
1	5150.00	67.0 PK	74.0	-7.0	2.44 H	290	64.0	3.0
2	5150.00	53.5 AV	54.0	-0.5	2.44 H	290	50.5	3.0
3	*5210.00	99.0 PK			2.44 H	290	95.9	3.1
4	*5210.00	85.2 AV			2.44 H	290	82.1	3.1
5	#10420.00	59.3 PK	74.0	-14.7	1.02 H	36	47.3	12.0
6	#10420.00	47.5 AV	54.0	-6.5	1.02 H	36	35.5	12.0

ANTENNA POLARITY & TEST DISTANCE: VERTICAL AT 3 M								
NO.	FREQ. (MHz)	EMISSION LEVEL (dBuV/m)	LIMIT (dBuV/m)	MARGIN (dB)	ANTENNA HEIGHT (m)	TABLE ANGLE (Degree)	RAW VALUE (dBuV)	CORRECTION FACTOR (dB/m)
1	5150.00	61.9 PK	74.0	-12.1	3.20 V	328	58.9	3.0
2	5150.00	48.9 AV	54.0	-5.1	3.20 V	328	45.9	3.0
3	*5210.00	95.1 PK			3.20 V	328	92.0	3.1
4	*5210.00	81.6 AV			3.20 V	328	78.5	3.1
5	#10420.00	53.9 PK	74.0	-20.1	1.63 V	195	41.9	12.0
6	#10420.00	42.6 AV	54.0	-11.4	1.63 V	195	30.6	12.0

**REMARKS:**

1. Emission Level(dBuV/m) = Raw Value(dBuV) + Correction Factor(dB/m)
2. Correction Factor(dB/m) = Antenna Factor(dB/m) + Cable Factor(dB) – Pre-Amplifier Factor(dB)
3. The other emission levels were very low against the limit.
4. Margin value = Emission Level – Limit value
5. " \* ": Fundamental frequency.
6. " # ": The radiated frequency is out of the restricted band.

<b>CHANNEL</b>	TX Channel 155	<b>DETECTOR FUNCTION</b>	Peak (PK)
<b>FREQUENCY RANGE</b>	1GHz ~ 40GHz		Average (AV)

**ANTENNA POLARITY & TEST DISTANCE: HORIZONTAL AT 3 M**

NO.	FREQ. (MHz)	EMISSION LEVEL (dBuV/m)	LIMIT (dBuV/m)	MARGIN (dB)	ANTENNA HEIGHT (m)	TABLE ANGLE (Degree)	RAW VALUE (dBuV)	CORRECTION FACTOR (dB/m)
1	#5649.60	67.7 PK	68.2	-0.5	3.05 H	280	60.6	7.1
2	*5775.00	104.3 PK			3.05 H	280	100.6	3.7
3	*5775.00	93.2 AV			3.05 H	280	89.5	3.7
4	#5928.00	67.2 PK	68.2	-1.0	3.05 H	280	59.4	7.8
5	11550.00	61.8 PK	74.0	-12.2	1.47 H	87	49.6	12.2
6	11550.00	49.6 AV	54.0	-4.4	1.47 H	87	37.4	12.2

**ANTENNA POLARITY & TEST DISTANCE: VERTICAL AT 3 M**

NO.	FREQ. (MHz)	EMISSION LEVEL (dBuV/m)	LIMIT (dBuV/m)	MARGIN (dB)	ANTENNA HEIGHT (m)	TABLE ANGLE (Degree)	RAW VALUE (dBuV)	CORRECTION FACTOR (dB/m)
1	#5649.07	61.5 PK	68.2	-6.7	1.77 V	258	57.8	3.7
2	*5775.00	102.1 PK			1.77 V	258	98.4	3.7
3	*5775.00	90.6 AV			1.77 V	258	86.9	3.7
4	#5984.27	58.5 PK	68.2	-9.7	1.77 V	258	54.5	4.0
5	11550.00	55.8 PK	74.0	-18.2	1.56 V	354	43.6	12.2
6	11550.00	44.1 AV	54.0	-9.9	1.56 V	354	31.9	12.2

**REMARKS:**

1. Emission Level(dBuV/m) = Raw Value(dBuV) + Correction Factor(dB/m)
2. Correction Factor(dB/m) = Antenna Factor(dB/m) + Cable Factor(dB) – Pre-Amplifier Factor(dB)
3. The other emission levels were very low against the limit.
4. Margin value = Emission Level – Limit value
5. " \* ": Fundamental frequency.
6. " # ": The radiated frequency is out of the restricted band.

## 4.2 Conducted Emission Measurement

### 4.2.1 Limits of Conducted Emission Measurement

Frequency (MHz)	Conducted Limit (dBuV)	
	Quasi-peak	Average
0.15 - 0.5	66 - 56	56 - 46
0.50 - 5.0	56	46
5.0 - 30.0	60	50

Note: 1. The lower limit shall apply at the transition frequencies.

2. The limit decreases in line with the logarithm of the frequency in the range of 0.15 to 0.50MHz.

### 4.2.2 Test Instruments

DESCRIPTION & MANUFACTURER	MODEL NO.	SERIAL NO.	CALIBRATED DATE	CALIBRATED UNTIL
Test Receiver R&S	ESCS 30	847124/029	Oct. 24, 2016	Oct. 23, 2017
Line-Impedance Stabilization Network (for EUT) R&S	ESH3-Z5	848773/004	Oct. 26, 2016	Oct. 25, 2017
Line-Impedance Stabilization Network (for Peripheral) R&S	ENV216	100072	June 13, 2016	June 12, 2017
50 ohms Terminator	N/A	EMC-02	Sep. 29, 2016	Sep. 28, 2017
RF Cable	5D-FB	COCCAB-001	Sep. 30, 2016	Sep. 29, 2017
10 dB PAD Mini-Circuits	HAT-10+	CONATT-004	June 20, 2016	June 19, 2017
Software BVADT	BVADT_Cond_ V7.3.7.4	NA	NA	NA

**Note:**

1. The calibration interval of the above test instruments are 12 months and the calibrations are traceable to NML/ROC and NIST/USA.
2. The test was performed in Shielded Room No. 1.
3. Tested Date: Mar. 30, 2017

#### 4.2.3 Test Procedure

- The EUT was placed 0.4 meters from the conducting wall of the shielded room with EUT being connected to the power mains through a line impedance stabilization network (LISN). Other support units were connected to the power mains through another LISN. The two LISNs provide 50 ohm/ 50uH of coupling impedance for the measuring instrument.
- Both lines of the power mains connected to the EUT were checked for maximum conducted interference.
- The frequency range from 150kHz to 30MHz was searched. Emission levels under (Limit - 20dB) was not recorded.

**NOTE:** All modes of operation were investigated and the worst-case emissions are reported.

#### 4.2.4 Deviation from Test Standard

No deviation.

#### 4.2.5 Test Setup

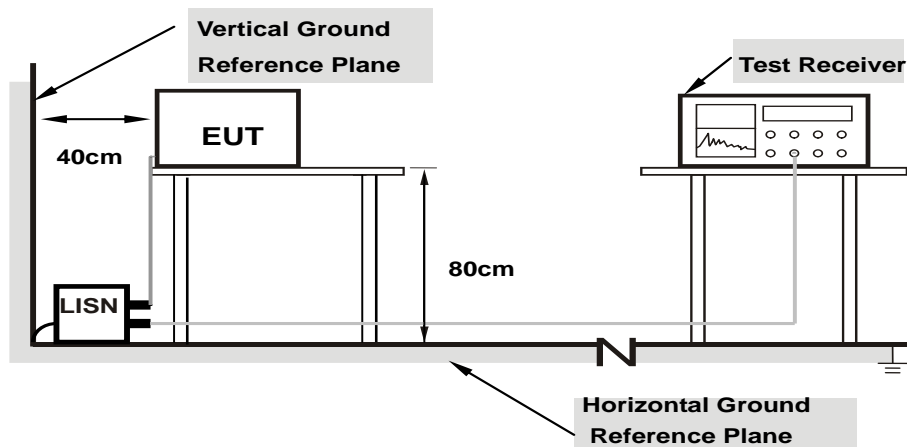

**Note: 1.Support units were connected to second LISN.**

For the actual test configuration, please refer to the attached file (Test Setup Photo).

#### 4.2.6 EUT Operating Condition

Same as 4.1.6.

#### 4.2.7 Test Results (Mode 1)

Phase	Line (L)	Detector Function	Quasi-Peak (QP) / Average (AV)
-------	----------	-------------------	--------------------------------

No	Freq. [MHz]	Corr.	Reading Value		Emission Level		Limit		Margin	
		Factor (dB)	[dB (uV)]		[dB (uV)]		[dB (uV)]		(dB)	
			Q.P.	AV.	Q.P.	AV.	Q.P.	AV.	Q.P.	AV.
1	0.15000	10.20	40.00	28.11	50.20	38.31	66.00	56.00	-15.80	-17.69
2	0.52109	10.25	28.60	20.35	38.85	30.60	56.00	46.00	-17.15	-15.40
3	0.67734	10.27	23.29	12.90	33.56	23.17	56.00	46.00	-22.44	-22.83
4	0.89219	10.29	21.82	10.38	32.11	20.67	56.00	46.00	-23.89	-25.33
5	9.12891	10.67	17.24	9.45	27.91	20.12	60.00	50.00	-32.09	-29.88
6	28.64453	11.83	16.27	5.94	28.10	17.77	60.00	50.00	-31.90	-32.23

#### REMARKS:

1. Q.P. and AV. are abbreviations of quasi-peak and average individually.
2. The emission levels of other frequencies were very low against the limit.
3. Margin value = Emission level - Limit value
4. Correction factor = Insertion loss + Cable loss
5. Emission Level = Correction Factor + Reading Value.

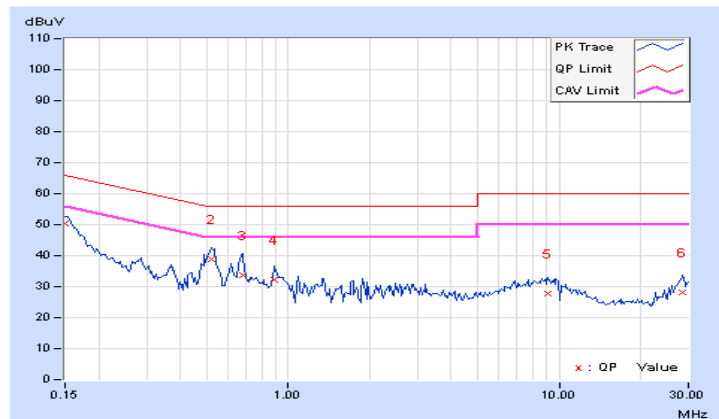

Phase	Neutral (N)	Detector Function	Quasi-Peak (QP) / Average (AV)
-------	-------------	-------------------	--------------------------------

No	Freq. [MHz]	Corr. Factor	Reading Value [dB (uV)]		Emission Level [dB (uV)]		Limit [dB (uV)]		Margin (dB)	
		(dB)	Q.P.	AV.	Q.P.	AV.	Q.P.	AV.	Q.P.	AV.
	1	0.15000	10.19	39.77	26.11	49.96	36.30	66.00	56.00	-16.04
2	0.52500	10.24	25.01	17.07	35.25	27.31	56.00	46.00	-20.75	-18.69
3	0.67344	10.25	23.75	9.75	34.00	20.00	56.00	46.00	-22.00	-26.00
4	0.90391	10.26	16.80	6.76	27.06	17.02	56.00	46.00	-28.94	-28.98
5	9.23828	10.58	15.62	9.01	26.20	19.59	60.00	50.00	-33.80	-30.41
6	28.62109	11.40	14.92	7.30	26.32	18.70	60.00	50.00	-33.68	-31.30

#### REMARKS:

1. Q.P. and AV. are abbreviations of quasi-peak and average individually.
2. The emission levels of other frequencies were very low against the limit.
3. Margin value = Emission level - Limit value
4. Correction factor = Insertion loss + Cable loss
5. Emission Level = Correction Factor + Reading Value.

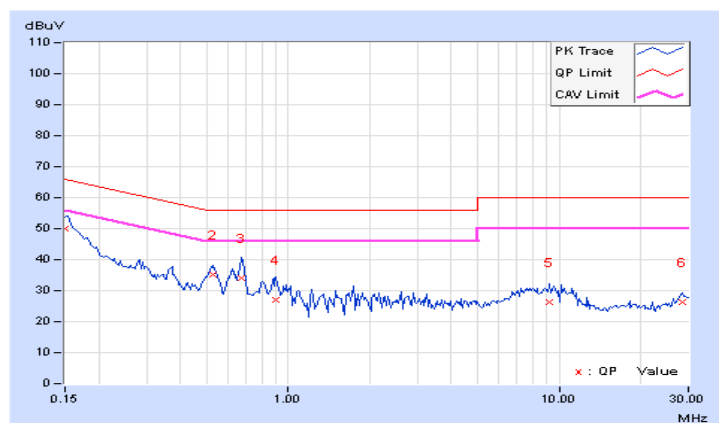

#### 4.2.8 Test Results (Mode 2)

Phase	Line (L)	Detector Function	Quasi-Peak (QP) / Average (AV)
-------	----------	-------------------	--------------------------------

No	Freq.	Corr.	Reading Value		Emission Level		Limit		Margin	
	[MHz]	Factor	[dB (uV)]		[dB (uV)]		[dB (uV)]		(dB)	
		(dB)	Q.P.	AV.	Q.P.	AV.	Q.P.	AV.	Q.P.	AV.
1	0.15000	10.19	40.32	13.39	50.51	23.58	66.00	56.00	-15.49	-32.42
<b>2</b>	<b>0.17500</b>	<b>10.19</b>	<b>45.42</b>	<b>40.46</b>	<b>55.61</b>	<b>50.65</b>	<b>64.72</b>	<b>54.72</b>	<b>-9.11</b>	<b>-4.07</b>
3	0.23594	10.20	36.34	30.97	46.54	41.17	62.24	52.24	-15.70	-11.07
4	1.91797	10.24	28.65	23.89	38.89	34.13	56.00	46.00	-17.11	-11.87
5	3.83594	10.24	32.14	17.00	42.38	27.24	56.00	46.00	-13.62	-18.76
6	22.93359	11.41	27.06	20.45	38.47	31.86	60.00	50.00	-21.53	-18.14

#### REMARKS:

1. Q.P. and AV. are abbreviations of quasi-peak and average individually.
2. The emission levels of other frequencies were very low against the limit.
3. Margin value = Emission level - Limit value
4. Correction factor = Insertion loss + Cable loss
5. Emission Level = Correction Factor + Reading Value.

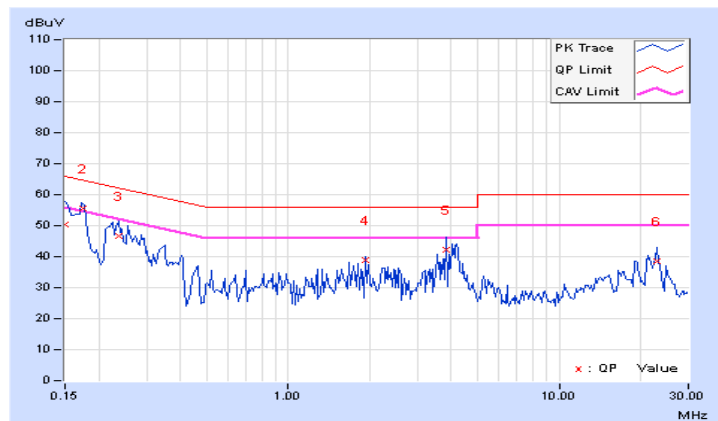

Phase	Neutral (N)	Detector Function	Quasi-Peak (QP) / Average (AV)
-------	-------------	-------------------	--------------------------------

No	Freq.	Corr.	Reading Value		Emission Level		Limit		Margin	
	[MHz]	Factor	[dB (uV)]		[dB (uV)]		[dB (uV)]		(dB)	
		(dB)	Q.P.	AV.	Q.P.	AV.	Q.P.	AV.	Q.P.	AV.
1	0.15391	10.18	34.07	12.11	44.25	22.29	65.79	55.79	-21.54	-33.50
2	0.16953	10.17	40.81	35.32	50.98	45.49	64.98	54.98	-14.00	-9.49
3	0.20078	10.16	26.65	4.62	36.81	14.78	63.58	53.58	-26.77	-38.80
4	0.28281	10.18	33.17	27.03	43.35	37.21	60.73	50.73	-17.38	-13.52
5	4.19141	10.17	25.08	11.70	35.25	21.87	56.00	46.00	-20.75	-24.13
6	20.81250	11.10	26.21	17.58	37.31	28.68	60.00	50.00	-22.69	-21.32

#### REMARKS:

1. Q.P. and AV. are abbreviations of quasi-peak and average individually.
2. The emission levels of other frequencies were very low against the limit.
3. Margin value = Emission level - Limit value
4. Correction factor = Insertion loss + Cable loss
5. Emission Level = Correction Factor + Reading Value.

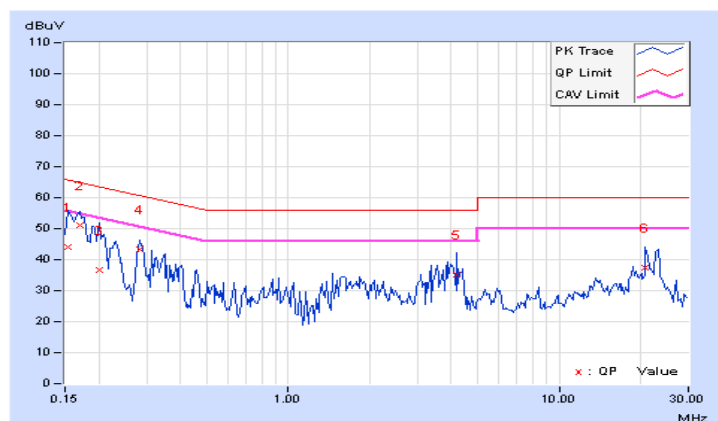



### 4.3 Transmit Power Measurement

#### 4.3.1 Limits of Transmit Power Measurement

Operation Band	EUT Category		Limit
U-NII-1		Outdoor Access Point	1 Watt (30 dBm) (Max. e.i.r.p $\leq$ 125mW(21 dBm) at any elevation angle above 30 degrees as measured from the horizon)
		Fixed point-to-point Access Point	1 Watt (30 dBm)
	√	Indoor Access Point	1 Watt (30 dBm)
		Mobile and Portable client device	250mW (24 dBm)
U-NII-2A			250mW (24 dBm) or 11 dBm+10 log B*
U-NII-2C			250mW (24 dBm) or 11 dBm+10 log B*
U-NII-3		√	1 Watt (30 dBm)

\*B is the 26 dB emission bandwidth in megahertz

#### 4.3.2 Test Setup

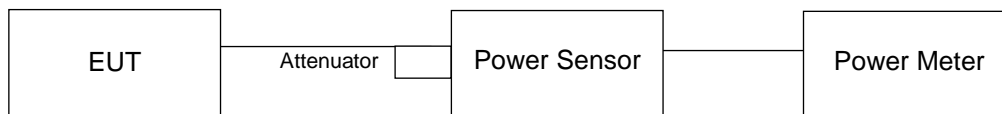

#### 4.3.3 Test Instruments

Refer to section 4.1.2 to get information of above instrument.

#### 4.3.4 Test Procedure

Method PM is used to perform output power measurement, trigger and gating function of wide band power meter is enabled to measure max output power of TX on burst. Duty factor is not added to measured value.

#### 4.3.5 Deviation from Test Standard

No deviation.

#### 4.3.6 EUT Operating Condition

The software provided by client to enable the EUT under transmission condition continuously at lowest, middle and highest channel frequencies individually.

#### 4.3.7 Test Result

##### 802.11a

Channel	Channel Frequency (MHz)	Maximum Conducted Power (mW)	Maximum Conducted Power (dBm)	Power Limit (dBm)	Pass/Fail
36	5180	40.644	16.09	30	Pass
40	5200	63.241	18.01	30	Pass
48	5240	75.162	18.76	30	Pass
149	5745	70.958	18.51	30	Pass
157	5785	79.799	19.02	30	Pass
165	5825	77.268	18.88	30	Pass

##### 802.11ac (VHT20)

Channel	Channel Frequency (MHz)	Maximum Conducted Power (mW)	Maximum Conducted Power (dBm)	Power Limit (dBm)	Pass/Fail
36	5180	39.174	15.93	30	Pass
40	5200	67.453	18.29	30	Pass
48	5240	68.707	18.37	30	Pass
149	5745	72.946	18.63	30	Pass
157	5785	71.945	18.57	30	Pass
165	5825	73.961	18.69	30	Pass

##### 802.11ac (VHT40)

Channel	Channel Frequency (MHz)	Maximum Conducted Power (mW)	Maximum Conducted Power (dBm)	Power Limit (dBm)	Pass/Fail
38	5190	20.137	13.04	30	Pass
46	5230	72.778	18.62	30	Pass
151	5755	76.736	18.85	30	Pass
159	5795	74.473	18.72	30	Pass

##### 802.11ac (VHT80)

Channel	Channel Frequency (MHz)	Maximum Conducted Power (mW)	Maximum Conducted Power (dBm)	Power Limit (dBm)	Pass/Fail
42	5210	20.324	13.08	30	Pass
155	5775	51.168	17.09	30	Pass

## 4.4 Occupied Bandwidth Measurement

### 4.4.1 Test Setup

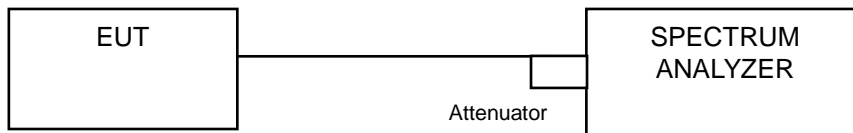

### 4.4.2 Test Instruments

Refer to section 4.1.2 to get information of above instrument.

### 4.4.3 Test Procedure

The transmitter output was connected to the spectrum analyzer through an attenuator. The bandwidth of the fundamental frequency was measured by spectrum analyzer with resolution bandwidth in the range of 1% to 5% of the anticipated emission bandwidth, and a video bandwidth at least 3x the resolution bandwidth and set the detector to SAMPLE. The width of a frequency band such that, below the lower and above the upper frequency limits, the mean powers emitted are each equal to a specified percentage 0.5 %of the total mean power of a given emission.

#### 4.4.4 Test Results

##### 802.11a

Channel	Channel Frequency (MHz)	Occupied Bandwidth (MHz)
36	5180	16.56
40	5200	22.56
48	5240	17.28
149	5745	31.08
157	5785	33.72
165	5825	32.64

##### 802.11ac (VHT20)

Channel	Channel Frequency (MHz)	Occupied Bandwidth (MHz)
36	5180	17.76
40	5200	27.24
48	5240	18.12
149	5745	31.56
157	5785	34.68
165	5825	33.72

##### 802.11ac (VHT40)

Channel	Channel Frequency (MHz)	Occupied Bandwidth (MHz)
38	5190	36.24
46	5230	37.68
151	5755	59.52
159	5795	73.44

##### 802.11ac (VHT80)

Channel	Channel Frequency (MHz)	Occupied Bandwidth (MHz)
42	5210	75.36
155	5775	77.28

### Spectrum Plot of Worst Value

**802.11a / CH157**

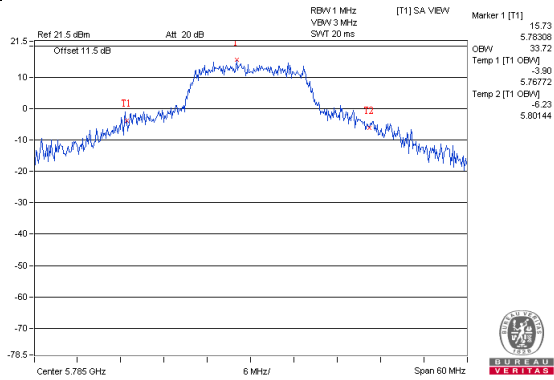

**802.11ac (VHT20) / CH157**

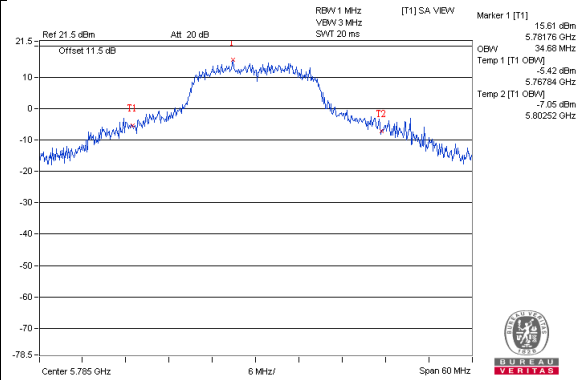

**802.11ac (VHT40) / CH159**

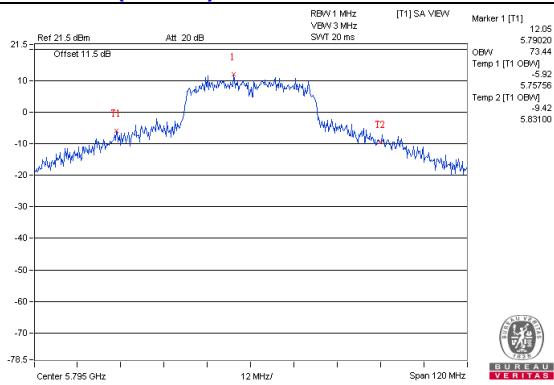

**802.11ac (VHT80) / CH155**

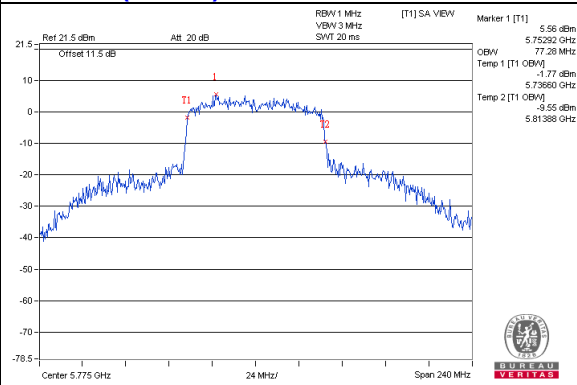

### Spectrum Plot for near by DFS band (DFS is required, if 99% OCP straddle into U-NII-2A band)

**802.11a / CH48**

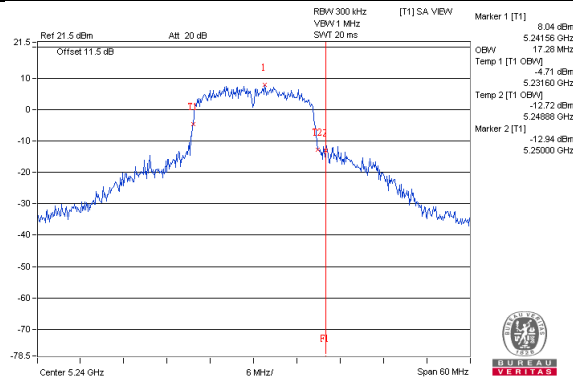

**802.11ac(VHT20) / CH48**

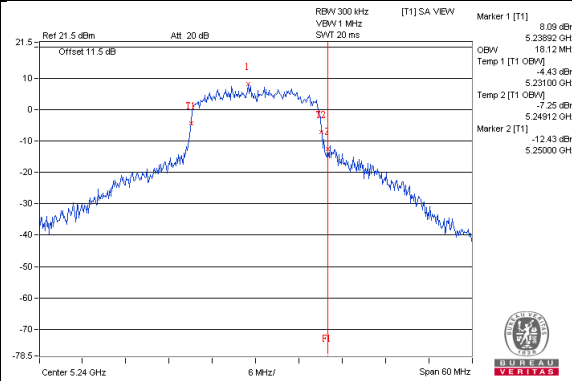

**802.11ac(VHT40) / CH46**

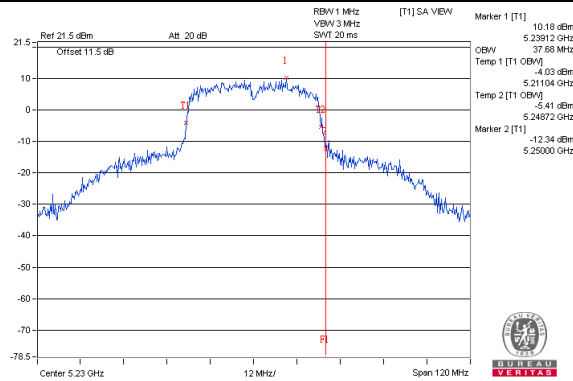

**802.11ac(VHT80) / CH42**

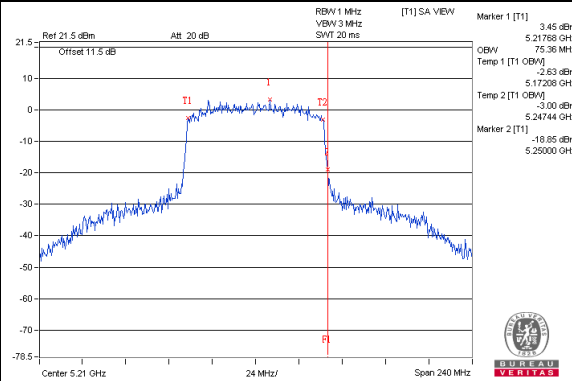

### Spectrum Plot for near by DFS band (DFS is required, if 99% OCP straddle into U-NII-2C band)

**802.11a / CH149**

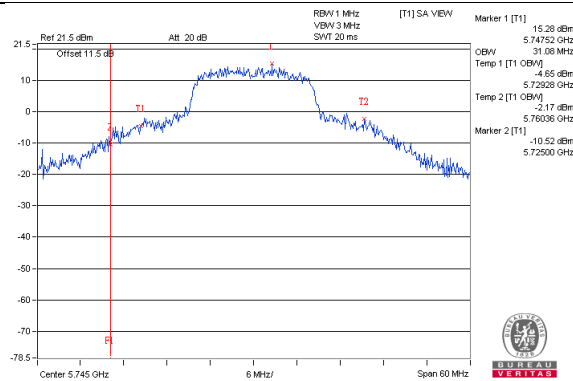

**802.11ac(VHT20 / CH149)**

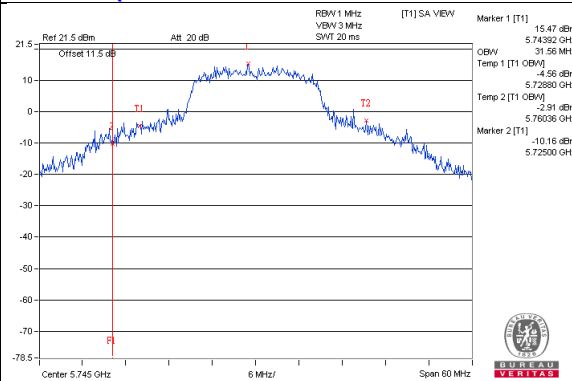

**802.11ac(VHT40) / CH151**

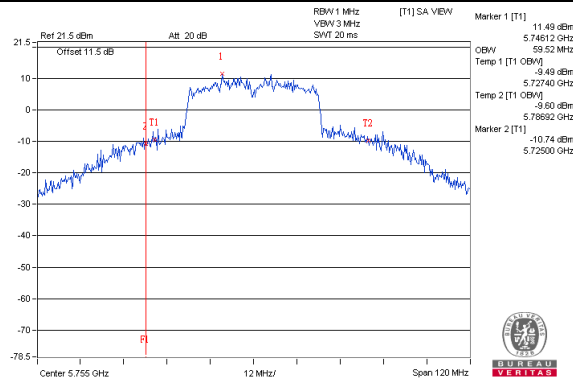

**802.11ac(VHT80) / CH155**

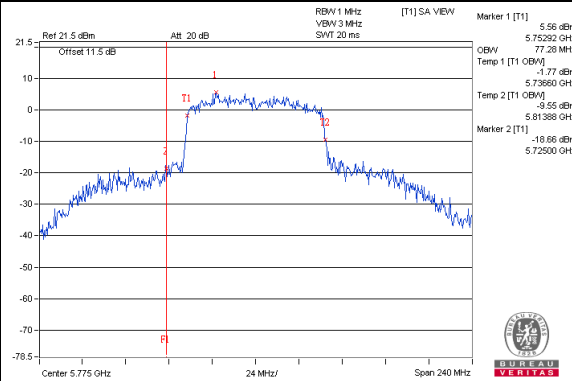

## 4.5 Peak Power Spectral Density Measurement

### 4.5.1 Limits of Peak Power Spectral Density Measurement

Operation Band	EUT Category		Limit
U-NII-1		Outdoor Access Point	17dBm/ MHz
		Fixed point-to-point Access Point	
	√	Indoor Access Point	11dBm/ MHz
		Mobile and Portable client device	
U-NII-2A			11dBm/ MHz
U-NII-2C			11dBm/ MHz
U-NII-3	√		30dBm/ 500kHz

### 4.5.2 Test Setup

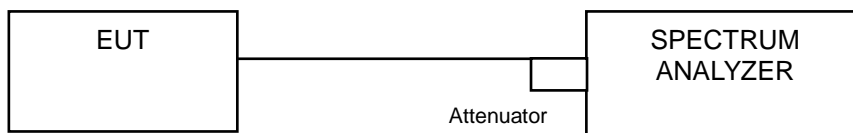

### 4.5.3 Test Instruments

Refer to section 4.1.2 to get information of above instrument.



#### 4.5.4 Test Procedure

##### **802.11a, 802.11ac (VHT20), 802.11ac (VHT40)**

###### **For U-NII-1:**

Using method SA-1

1. Set span to encompass the entire emission bandwidth (EBW) of the signal.
2. Set RBW = 1 MHz, Set VBW  $\geq$  3 MHz, Detector = RMS
3. Sweep time = auto, trigger set to "free run".
4. Trace average at least 100 traces in power averaging mode.
5. Record the max value

###### **For U-NII-3:**

1. Set span to encompass the entire emission bandwidth (EBW) of the signal.
2. Set RBW = 300 kHz, Set VBW  $\geq$  1 MHz, Detector = RMS
3. Use the peak marker function to determine the maximum power level in any 300 kHz band segment within the fundamental EBW.
4. Scale the observed power level to an equivalent value in 500 kHz by adjusting (reducing) the measured power by a bandwidth correction factor (BWCF) where  $BWCF = 10\log(500 \text{ kHz}/300\text{kHz})$
5. Sweep time = auto, trigger set to "free run".
6. Trace average at least 100 traces in power averaging mode.
7. Record the max value

##### **802.11ac (VHT80)**

###### **For U-NII-1:**

Using method SA-2

1. Set span to encompass the entire emission bandwidth (EBW) of the signal.
2. Set RBW = 1 MHz, Set VBW  $\geq$  3 MHz, Detector = RMS
3. Sweep time = auto, trigger set to "free run".
4. Trace average at least 100 traces in power averaging mode.
5. Record the max value and add  $10 \log (1/\text{duty cycle})$

###### **For U-NII-3:**

1. Set span to encompass the entire emission bandwidth (EBW) of the signal.
2. Set RBW = 300 kHz, Set VBW  $\geq$  1 MHz, Detector = RMS
3. Use the peak marker function to determine the maximum power level in any 300 kHz band segment within the fundamental EBW.
4. Scale the observed power level to an equivalent value in 500 kHz by adjusting (reducing) the measured power by a bandwidth correction factor (BWCF) where  $BWCF = 10\log(500 \text{ kHz}/300\text{kHz})$
5. Sweep time = auto, trigger set to "free run".
6. Trace average at least 100 traces in power averaging mode.
7. Record the max value and add  $10 \log (1/\text{duty cycle})$

#### 4.5.5 Deviation from Test Standard

No deviation.

#### 4.5.6 EUT Operating Condition

Same as Item 4.3.6.

#### 4.5.7 Test Results

##### For U-NII-1:

##### 802.11a

Chan.	Chan. Freq. (MHz)	PSD (dBm/MHz)	MAX. Limit (dBm/MHz)	Pass / Fail
36	5180	3.24	17.00	Pass
40	5200	4.74	17.00	Pass
48	5240	3.56	17.00	Pass

##### 802.11ac (VHT20)

Chan.	Chan. Freq. (MHz)	PSD (dBm/MHz)	MAX. Limit (dBm/MHz)	Pass / Fail
36	5180	2.44	17.00	Pass
40	5200	4.58	17.00	Pass
48	5240	3.24	17.00	Pass

##### 802.11ac (VHT40)

Chan.	Chan. Freq. (MHz)	PSD (dBm/MHz)	MAX. Limit (dBm/MHz)	Pass / Fail
38	5190	-2.80	17.00	Pass
46	5230	0.02	17.00	Pass

##### 802.11ac (VHT80)

Chan.	Chan. Freq. (MHz)	PSD W/O Duty Factor (dBm/MHz)	Duty Factor (dB)	PSD With Duty Factor (dBm/MHz)	MAX. Limit (dBm/MHz)	Pass / Fail
42	5210	-6.17	0.11	-6.06	17.00	Pass

**Note:** 1. Refer to section 3.3 for duty cycle spectrum plot.

### Spectrum Plot of Worst Value

#### 802.11a / CH40

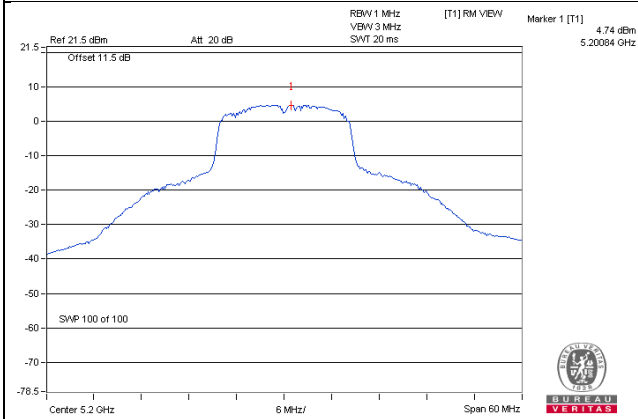

#### 802.11ac (VHT20) / CH40

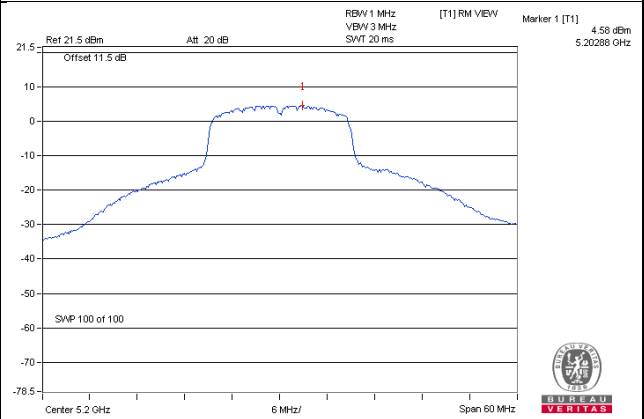

#### 802.11ac (VHT40) / CH46

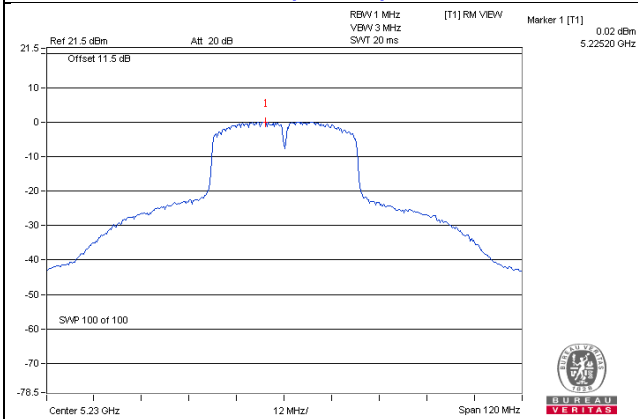

#### 802.11ac (VHT80) / CH42

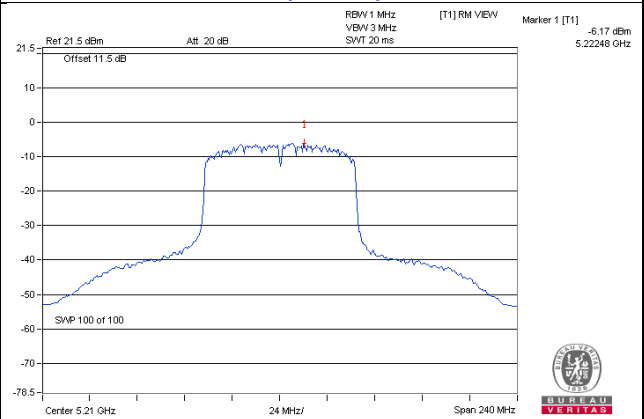

**For U-NII-3:**
**802.11a**

Chan.	Chan. Freq. (MHz)	PSD (dBm/300kHz)	PSD (dBm/500kHz)	Limit (dBm/500kHz)	Pass /Fail
149	5745	-3.17	-0.95	30	Pass
157	5785	-2.29	-0.07	30	Pass
165	5825	-2.41	-0.19	30	Pass

**802.11ac (VHT20)**

Chan.	Chan. Freq. (MHz)	PSD (dBm/300kHz)	PSD (dBm/500kHz)	Limit (dBm/500kHz)	Pass /Fail
149	5745	-3.16	-0.94	30	Pass
157	5785	-2.75	-0.53	30	Pass
165	5825	-3.25	-1.03	30	Pass

**802.11ac (VHT40)**

Chan.	Chan. Freq. (MHz)	PSD (dBm/300kHz)	PSD (dBm/500kHz)	Limit (dBm/500kHz)	Pass /Fail
151	5755	-7.13	-4.91	30	Pass
159	5795	-6.67	-4.45	30	Pass

**802.11ac (VHT80)**

Chan.	Chan. Freq. (MHz)	PSD W/O Duty Factor		Duty Factor (dB)	Total PSD With Duty Factor (dBm/500kHz)	Limit (dBm/500kHz)	Pass /Fail
		(dBm/300kHz)	(dBm/500kHz)				
155	5775	-12.29	-10.07	0.11	-9.96	30	Pass

**Note:** 1. Refer to section 3.3 for duty cycle spectrum plot.

Spectrum Plot of Worst Value

802.11a: CH 157

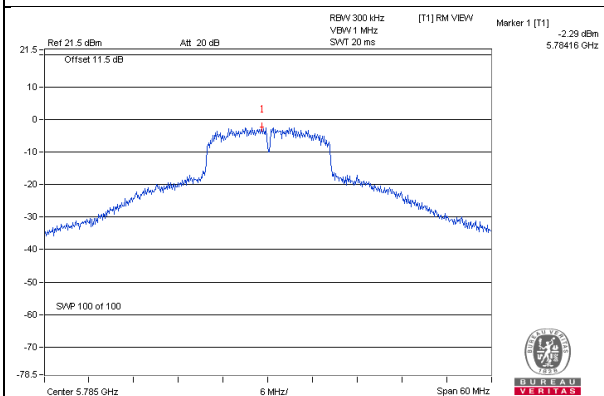

802.11ac (VHT20): CH 157

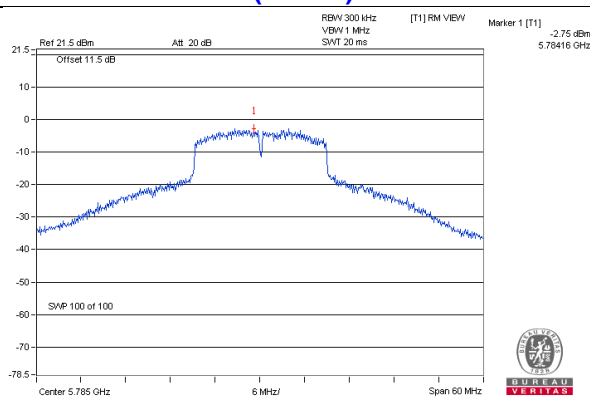

802.11ac (VHT40): CH 159

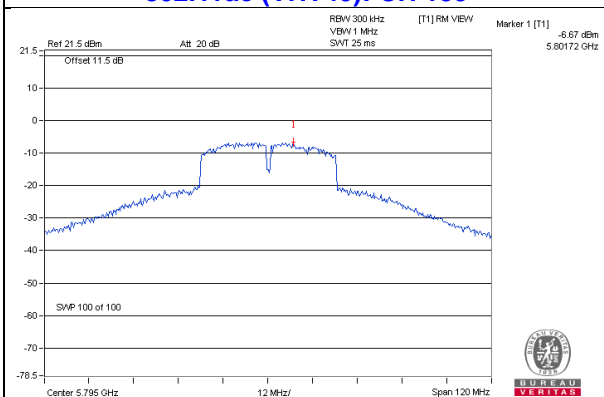

802.11ac (VHT80): CH 155

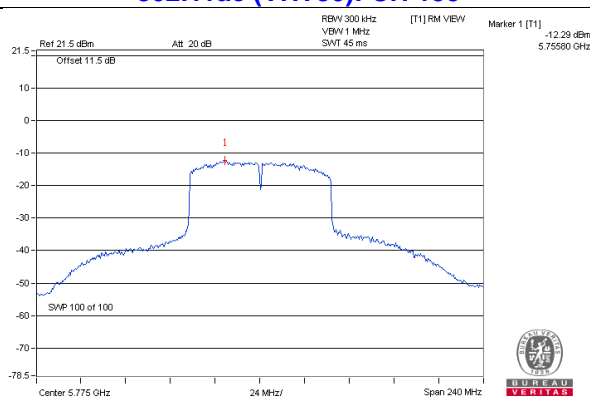

## 4.6 Frequency Stability Measurement

### 4.6.1 Limits of Frequency Stability Measurement

The frequency of the carrier signal shall be maintained within band of operation

### 4.6.2 Test Setup

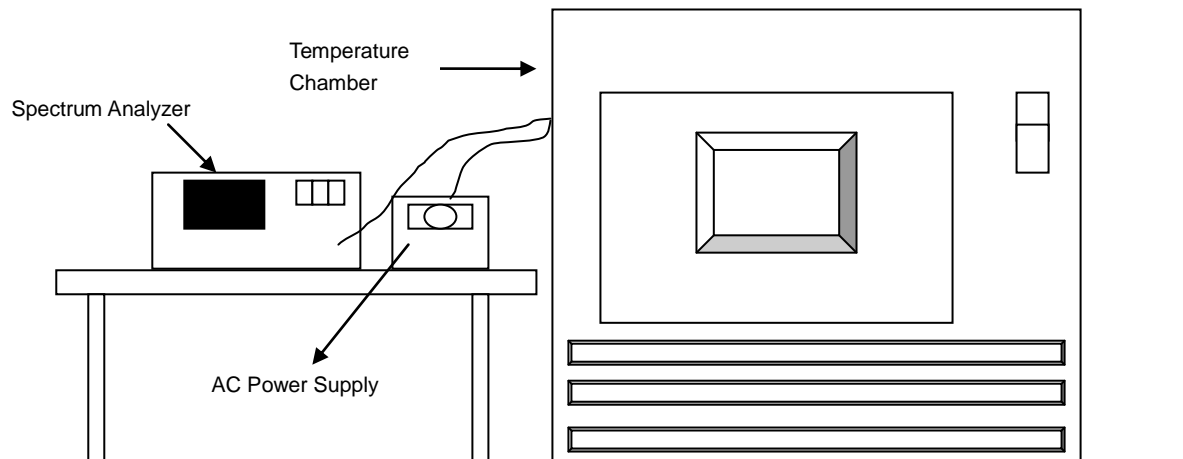

### 4.6.3 Test Instruments

Refer to section 4.1.2 to get information of above instrument.

### 4.6.4 Test Procedure

- The EUT was placed inside the environmental test chamber and powered by nominal AC voltage.
- Turn the EUT on and couple its output to a spectrum analyzer.
- Turn the EUT off and set the chamber to the highest temperature specified.
- Allow sufficient time (approximately 30 min) for the temperature of the chamber to stabilize, turn the EUT on and measure the operating frequency after 2, 5, and 10 Minutes.
- Repeat step 2 and 3 with the temperature chamber set to the lowest temperature.
- The test chamber was allowed to stabilize at +20 degree C for a minimum of 30 Minutes. The supply voltage was then adjusted on the EUT from 85% to 115% and the frequency record.

### 4.6.5 Deviation from Test Standard

No deviation.

### 4.6.6 EUT Operating Condition

Set the EUT transmit at un-modulation mode to test frequency stability.

## 4.6.7 Test Results

Frequency Stability Versus Temp.									
Operating Frequency: 5180 MHz									
TEMP. (°C)	Power Supply (Vac)	0 Minute		2 Minute		5 Minute		10 Minute	
		Measured Frequency (MHz)	Pass/Fail	Measured Frequency (MHz)	Pass/Fail	Measured Frequency (MHz)	Pass/Fail	Measured Frequency (MHz)	Pass/Fail
50	120	5180.0167	PASS	5180.0189	PASS	5180.0146	PASS	5180.0144	PASS
40	120	5180.008	PASS	5180.0117	PASS	5180.0088	PASS	5180.0078	PASS
30	120	5179.9977	PASS	5179.9997	PASS	5180.0005	PASS	5179.9991	PASS
20	120	5179.9874	PASS	5179.9901	PASS	5179.9884	PASS	5179.9919	PASS
10	120	5180.0074	PASS	5180.0097	PASS	5180.0078	PASS	5180.0072	PASS
0	120	5179.9886	PASS	5179.9882	PASS	5179.9894	PASS	5179.9905	PASS
-10	120	5179.9902	PASS	5179.9923	PASS	5179.9898	PASS	5179.9916	PASS
-20	120	5179.9839	PASS	5179.9809	PASS	5179.9842	PASS	5179.983	PASS
-30	120	5179.9839	PASS	5179.9839	PASS	5179.9835	PASS	5179.9841	PASS

Frequency Stability Versus Voltage									
Operating Frequency: 5180 MHz									
TEMP. (°C)	Power Supply (Vac)	0 Minute		2 Minute		5 Minute		10 Minute	
		Measured Frequency (MHz)	Pass/Fail	Measured Frequency (MHz)	Pass/Fail	Measured Frequency (MHz)	Pass/Fail	Measured Frequency (MHz)	Pass/Fail
20	138	5179.9875	PASS	5179.9905	PASS	5179.9889	PASS	5179.9909	PASS
	120	5179.9874	PASS	5179.9901	PASS	5179.9884	PASS	5179.9919	PASS
	102	5179.9866	PASS	5179.9908	PASS	5179.988	PASS	5179.9915	PASS

## 4.7 6dB Bandwidth Measurement

### 4.7.1 Limits of 6dB Bandwidth Measurement

The minimum of 6dB Bandwidth Measurement is 0.5MHz.

### 4.7.2 Test Setup

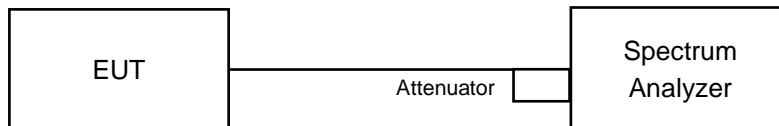

### 4.7.3 Test Instruments

Refer to section 4.1.2 to get information of above instrument.

### 4.7.4 Test Procedure

#### MEASUREMENT PROCEDURE REF

- a. Set resolution bandwidth (RBW) = 100kHz
- b. Set the video bandwidth (VBW)  $\geq 3 \times$  RBW, Detector = Peak.
- c. Trace mode = max hold.
- d. Sweep = auto couple.
- e. Measure the maximum width of the emission that is constrained by the frequencies associated with the two amplitude points (upper and lower) that are attenuated by 6 dB relative to the maximum level measured in the fundamental emission

### 4.7.5 Deviation from Test Standard

No deviation.

### 4.7.6 EUT Operating Condition

The software provided by client to enable the EUT under transmission condition continuously at lowest, middle and highest channel frequencies individually.



#### 4.7.7 Test Results

##### 802.11a

Channel	Frequency (MHz)	6dB Bandwidth (MHz)	Minimum Limit (MHz)	Pass / Fail
149	5745	15.71	0.5	PASS
157	5785	15.10	0.5	PASS
165	5825	15.08	0.5	PASS

##### 802.11ac (VHT20)

Channel	Frequency (MHz)	6dB Bandwidth (MHz)	Minimum Limit (MHz)	Pass / Fail
149	5745	16.55	0.5	PASS
157	5785	17.28	0.5	PASS
165	5825	17.57	0.5	PASS

##### 802.11ac (VHT40)

Channel	Frequency (MHz)	6dB Bandwidth (MHz)	Minimum Limit (MHz)	Pass / Fail
151	5755	35.15	0.5	PASS
159	5795	32.87	0.5	PASS

##### 802.11ac (VHT80)

Channel	Frequency (MHz)	6dB Bandwidth (MHz)	Minimum Limit (MHz)	Pass / Fail
155	5775	70.14	0.5	PASS

### Spectrum Plot of Worst Value

#### 802.11a / CH165

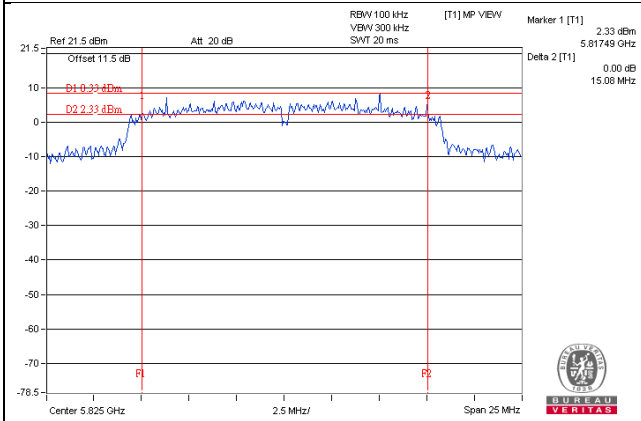

#### 802.11ac (VHT20) / CH149

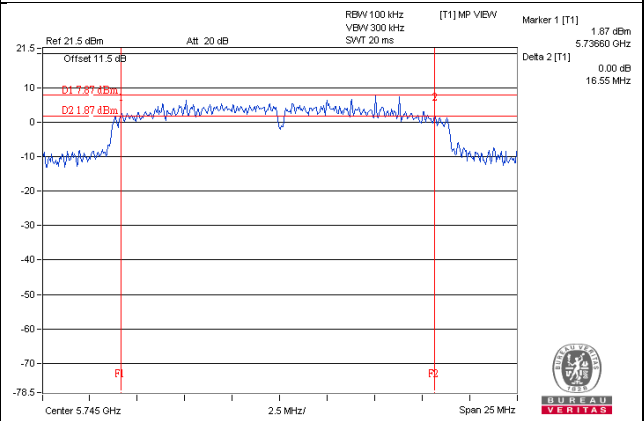

#### 802.11ac (VHT40) / CH159

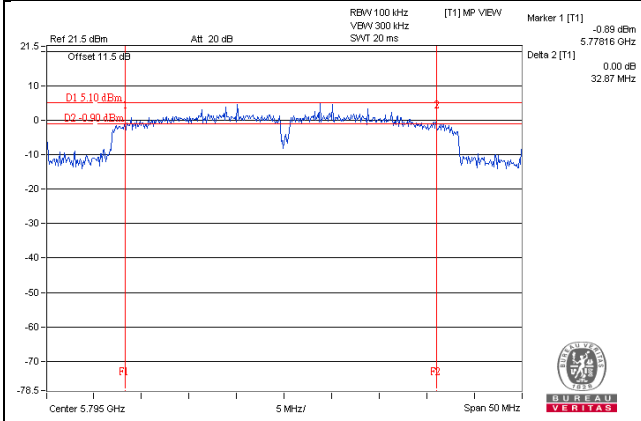

#### 802.11ac (VHT80) / CH155

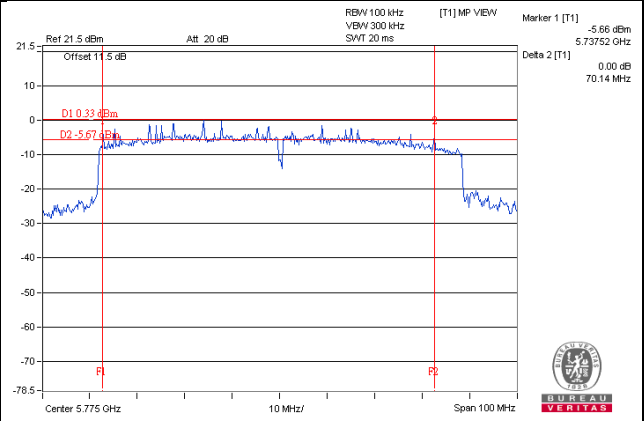

## 5 Pictures of Test Arrangements

Please refer to the attached file (Test Setup Photo).

### Annex A- Radiated Out of Band Emission (OOBE) Measurement (For U-NII-3 band)

PIFA antenna

802.11a

**CH 149 5745 MHz**

**Horizontal**

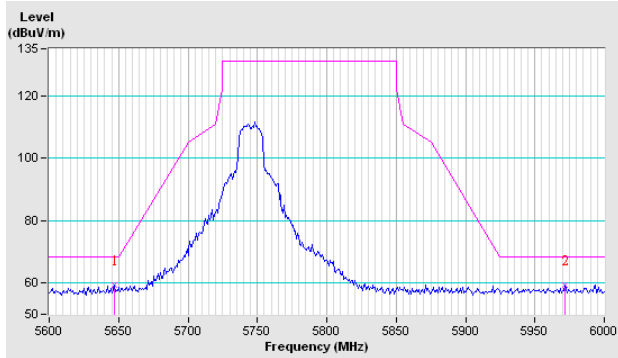

**Vertical**

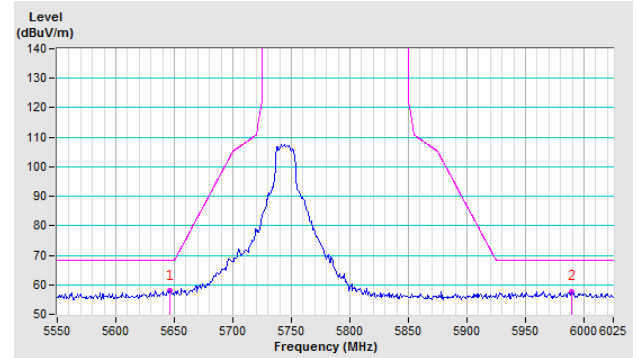

**CH 157 5785 MHz**

**Horizontal**

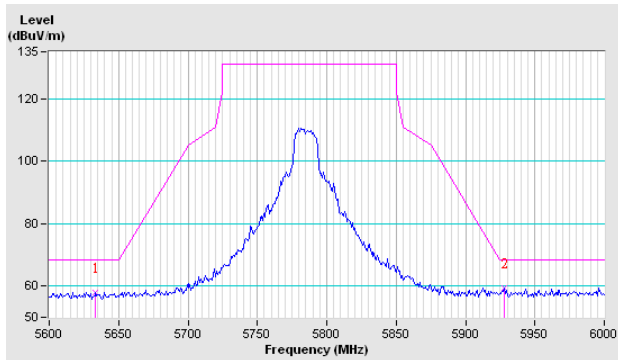

**Vertical**

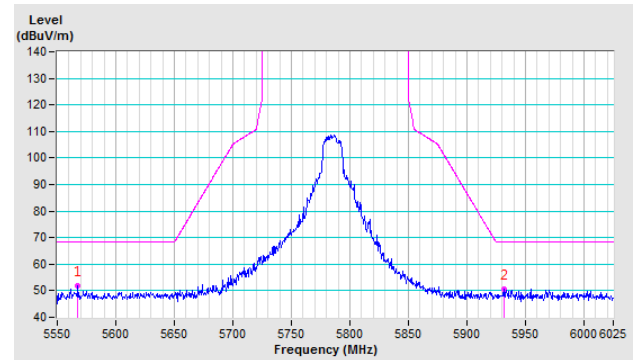

**CH 165 5825 MHz**

**Horizontal**

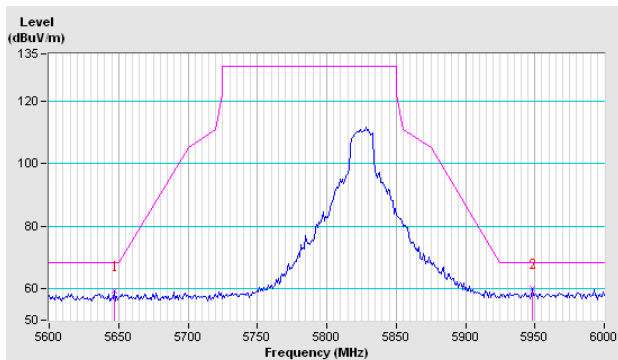

**Vertical**

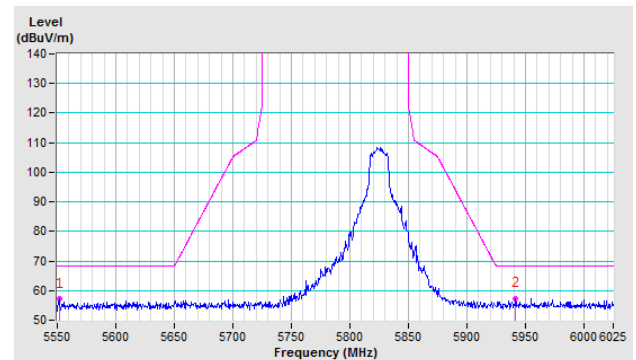

802.11ac (VHT20)

CH 149 5745 MHz

Horizontal

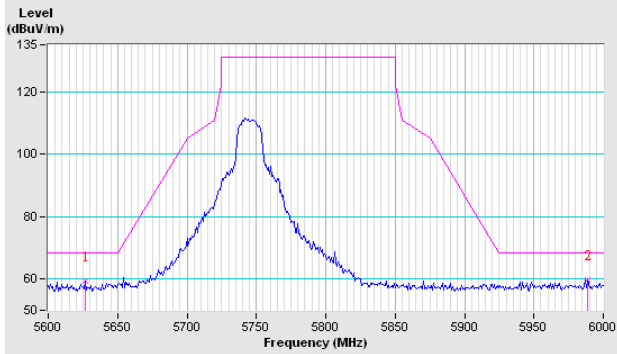

Vertical

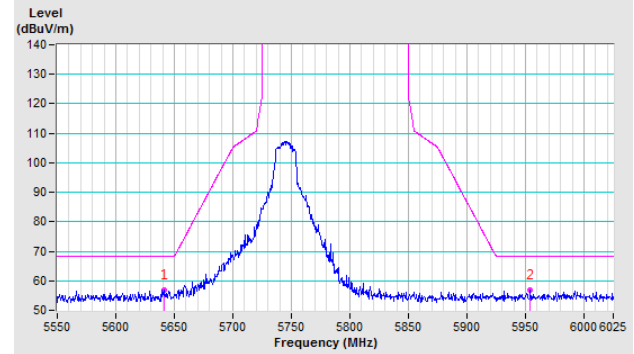

CH 157 5785 MHz

Horizontal

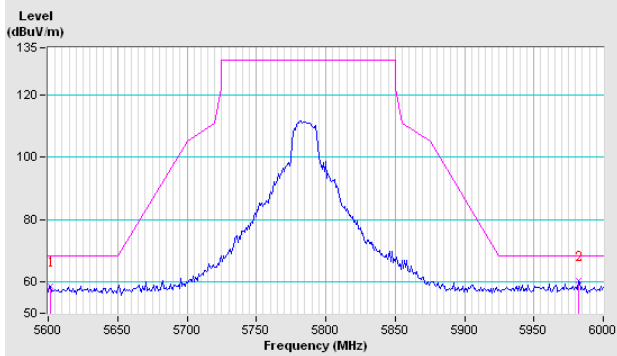

Vertical

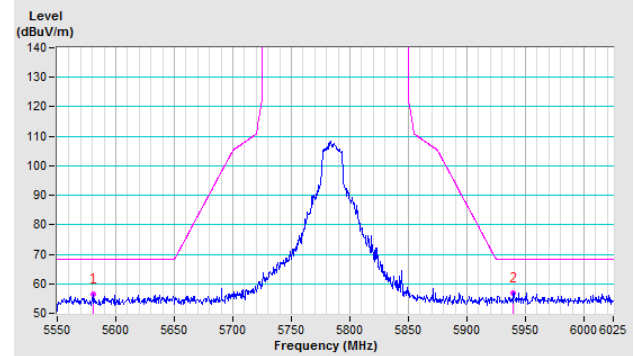

CH 165 5825 MHz

Horizontal

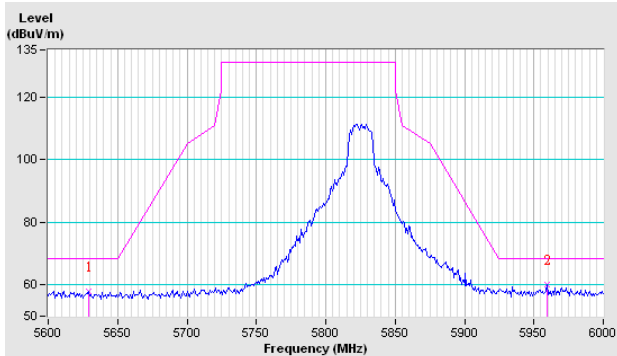

Vertical

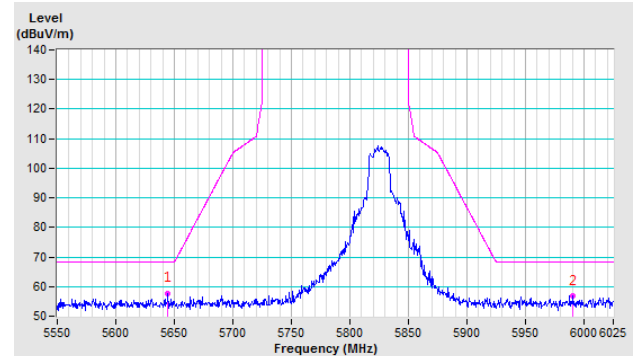

### 802.11ac (VHT40)

**CH 151 5755 MHz**

**Horizontal**

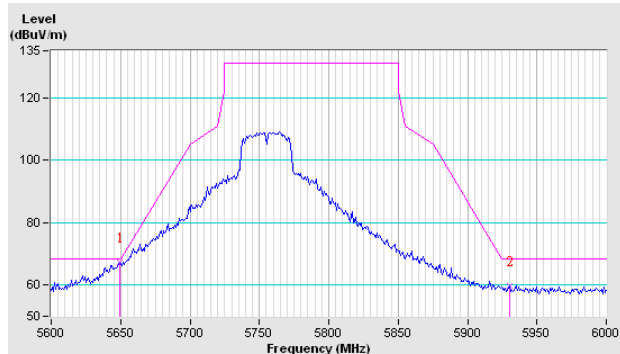

**Vertical**

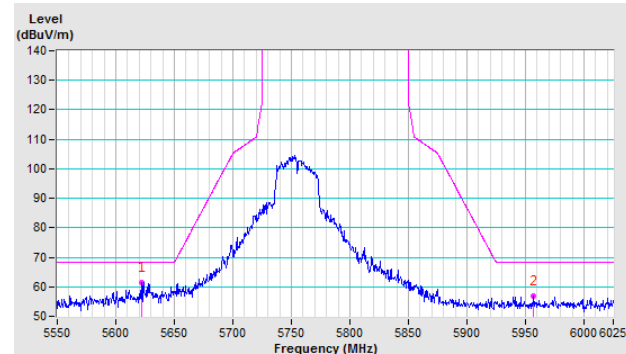

**CH 159 5795 MHz**

**Horizontal**

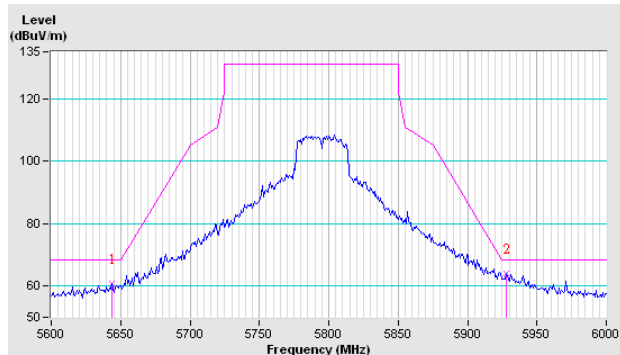

**Vertical**

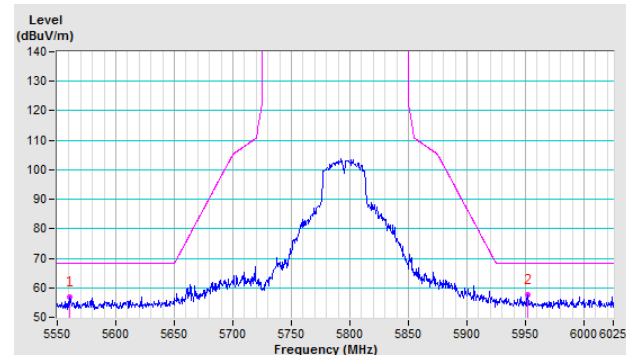

### 802.11ac (VHT80)

**CH 155 5775 MHz**

**Horizontal**

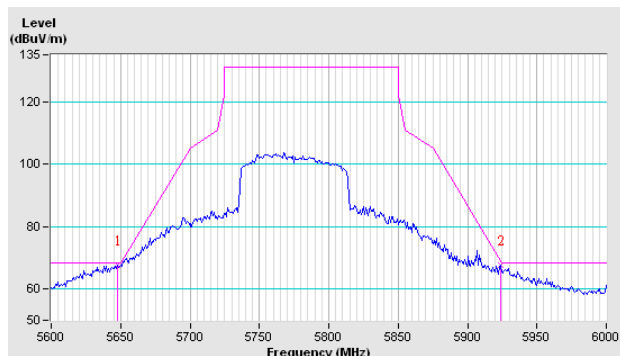

**Vertical**

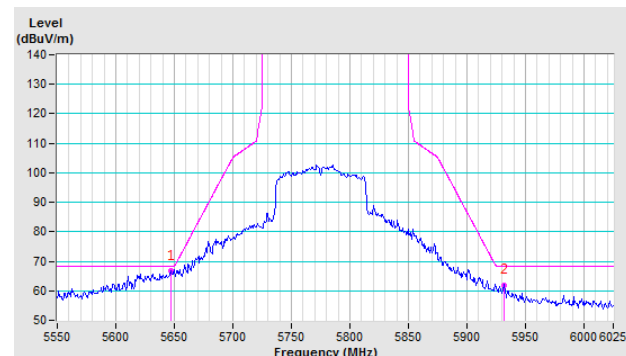

## Monopole antenna

802.11a

CH 149 5745 MHz

Horizontal

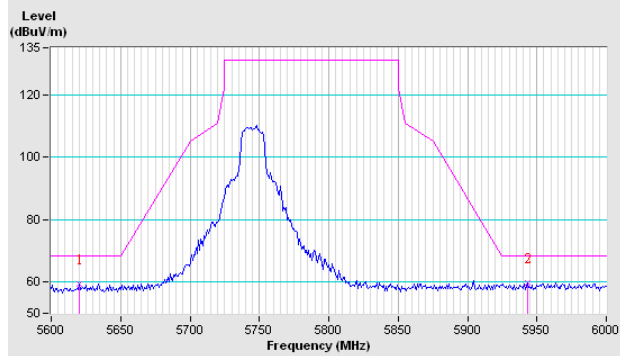

Vertical

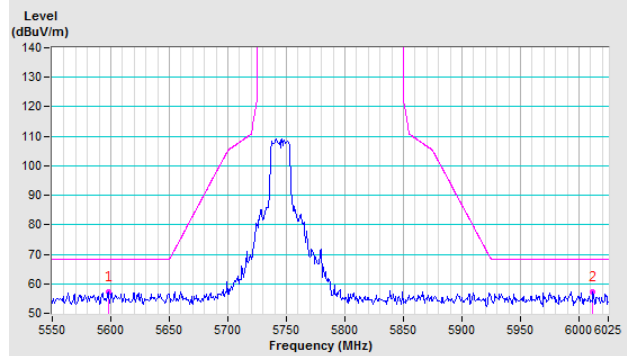

CH 157 5785 MHz

Horizontal

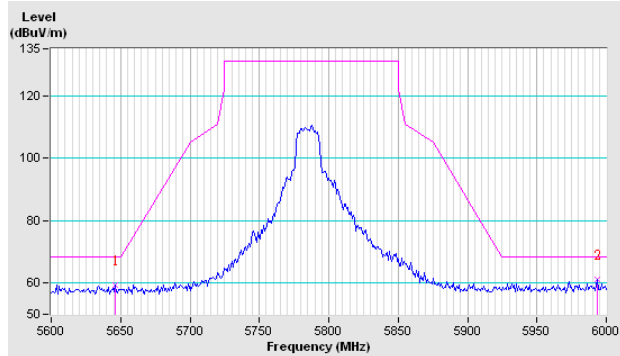

Vertical

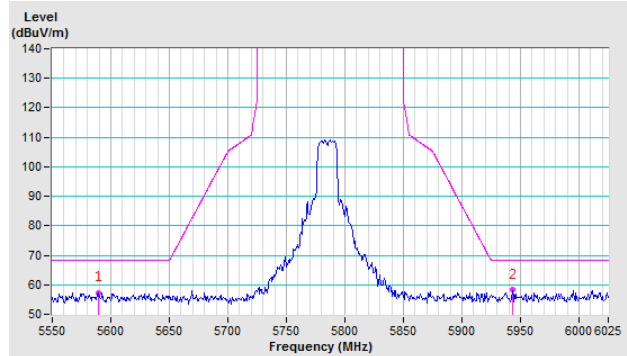

CH 165 5825 MHz

Horizontal

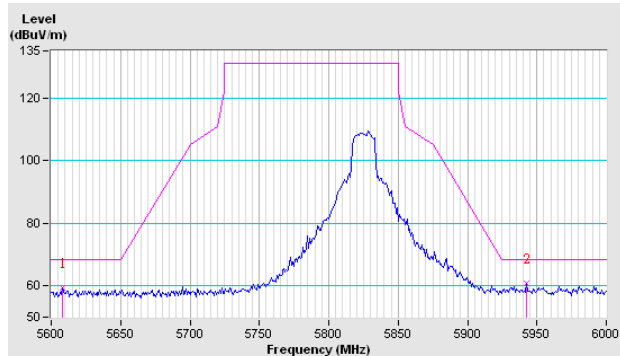

Vertical

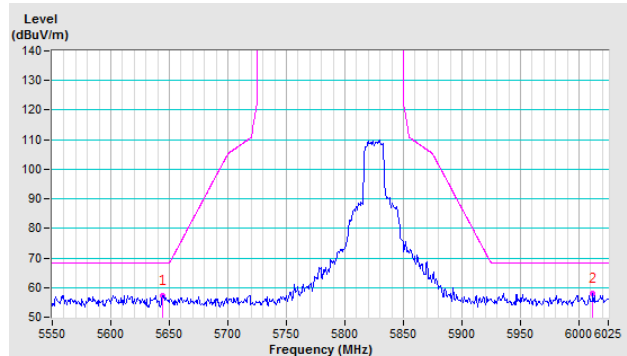

### 802.11ac (VHT20)

#### CH 149 5745 MHz

**Horizontal**

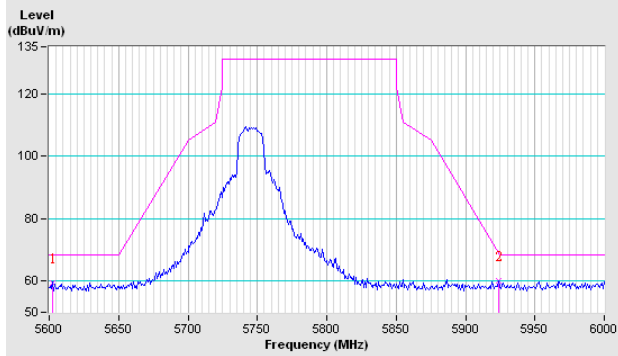

**Vertical**

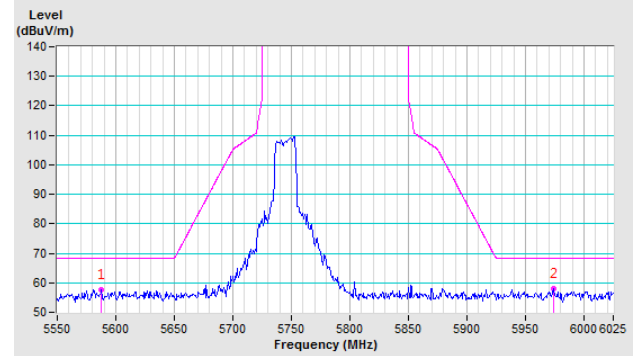

#### CH 157 5785 MHz

**Horizontal**

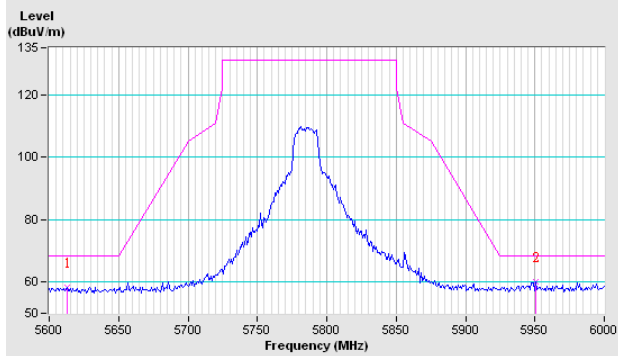

**Vertical**

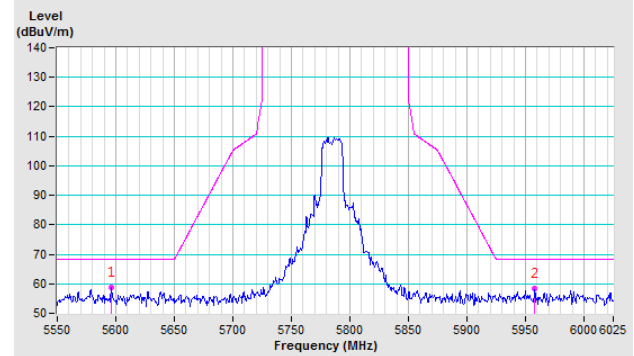

#### CH 165 5825 MHz

**Horizontal**

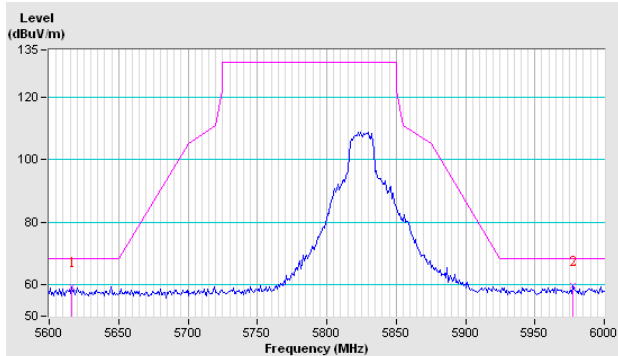

**Vertical**

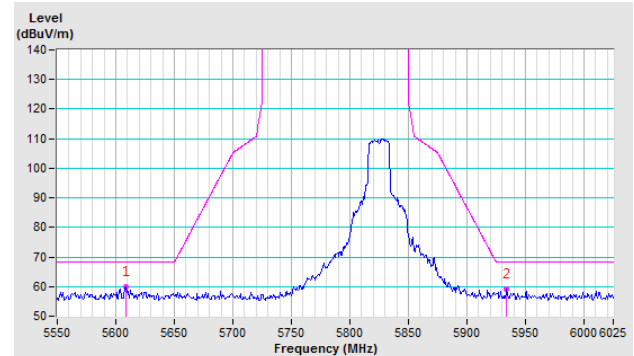



### 802.11ac (VHT40)

**CH 151 5755 MHz**

**Horizontal**

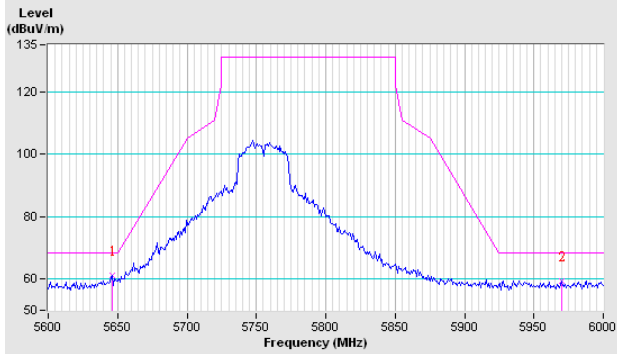

**Vertical**

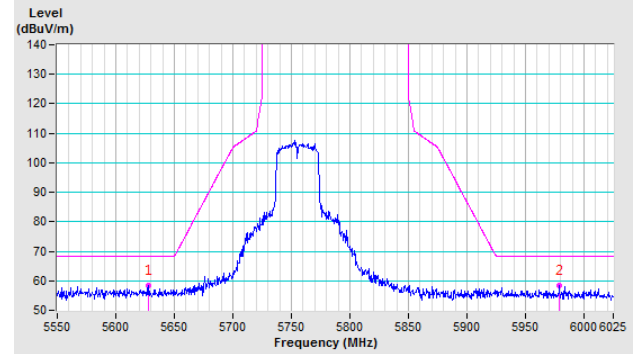

**CH 159 5795 MHz**

**Horizontal**

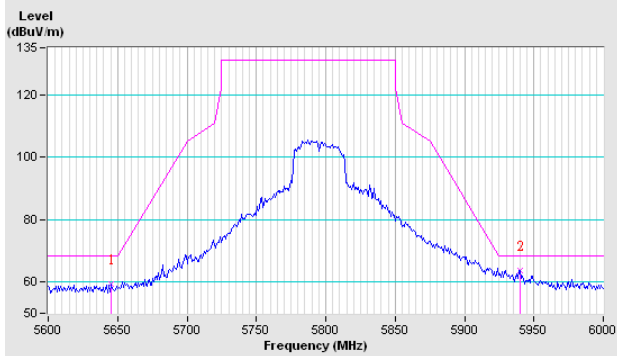

**Vertical**

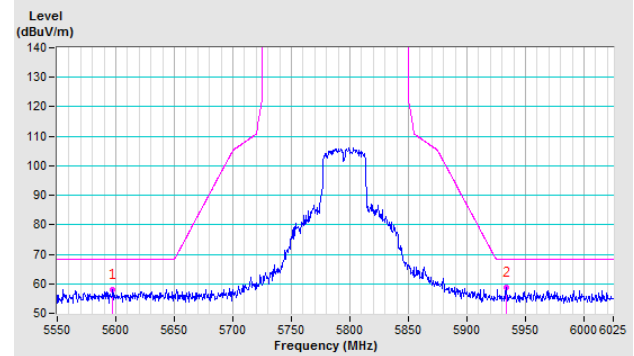

### 802.11ac (VHT80)

**CH 155 5775 MHz**

**Horizontal**

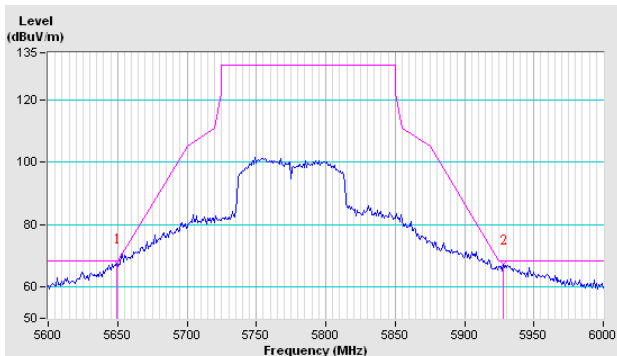

**Vertical**

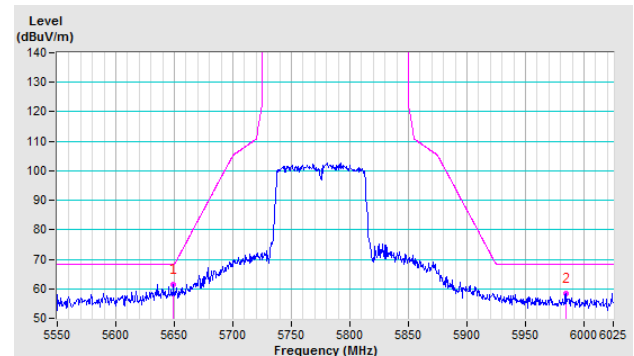

## Appendix – Information on the Testing Laboratories

We, Bureau Veritas Consumer Products Services (H.K.) Ltd., Taoyuan Branch, were founded in 1988 to provide our best service in EMC, Radio, Telecom and Safety consultation. Our laboratories are accredited and approved according to ISO/IEC 17025.

If you have any comments, please feel free to contact us at the following:

**Linko EMC/RF Lab**

Tel: 886-2-26052180

Fax: 886-2-26051924

**Hsin Chu EMC/RF/Telecom Lab**

Tel: 886-3-6668565

Fax: 886-3-6668323

**Hwa Ya EMC/RF/Safety Lab**

Tel: 886-3-3183232

Fax: 886-3-3270892

**Email:** [service.adt@tw.bureauveritas.com](mailto:service.adt@tw.bureauveritas.com)

**Web Site:** [www.bureauveritas-adt.com](http://www.bureauveritas-adt.com)

The address and road map of all our labs can be found in our web site also.

--- END ---