

DFS Test Report

Report No.: RF161229C25A-2

FCC ID: PY316400362

Test Model: RBR40

Series Model: RBS40

Received Date: Dec. 22, 2016

Test Date: Jul. 05 ~ Jul. 10, 2017

Issued Date: Jul. 13, 2017

Applicant: NETGEAR, INC.

Address: 350 East Plumeria Drive San Jose, CA 95134

Issued By: Bureau Veritas Consumer Products Services (H.K.) Ltd., Taoyuan Branch

Lab Address: No. 47-2, 14th Ling, Chia Pau Vil., Lin Kou Dist., New Taipei City, Taiwan, R.O.C.

Test Location: No. 19, Hwa Ya 2nd Rd., Wen Hwa Vil., Kwei Shan Dist., Taoyuan City 33383, TAIWAN (R.O.C.)



This report is for your exclusive use. Any copying or replication of this report to or for any other person or entity, or use of our name or trademark, is permitted only with our prior written permission. This report sets forth our findings solely with respect to the test samples identified herein. The results set forth in this report are not indicative or representative of the quality or characteristics of the lot from which a test sample was taken or any similar or identical product unless specifically and expressly noted. Our report includes all of the tests requested by you and the results thereof based upon the information that you provided to us. You have 60 days from date of issuance of this report to notify us of any material error or omission caused by our negligence, provided, however, that such notice shall be in writing and shall specifically address the issue you wish to raise. A failure to raise such issue within the prescribed time shall constitute your unqualified acceptance of the completeness of this report, the tests conducted and the correctness of the report contents. Unless specific mention, the uncertainty of measurement has been explicitly taken into account to declare the compliance or non-compliance to the specification. The report must not be used by the client to claim product certification, approval, or endorsement by TAF or any government agencies.

Table of Contents

Release Control Record	3
1 Certificate of Conformity	4
2 EUT Information	5
2.1 Operating Frequency Bands and Mode of EUT.....	5
2.2 EUT Software and Firmware Version.....	5
2.3 Description Of Available Antennas to The EUT	5
2.4 EUT Maximum Conducted Power.....	6
2.5 EUT Maximum E.I.R.P. Power	8
2.6 Transmit Power Control (TPc).....	10
2.7 Statement of Manufacturer.....	10
3. U-NII DFS Rule Requirements	11
3.1 Working Modes and Required Test Items	11
3.2 Test Limits and Radar Signal Parameters.....	12
4. Test & Support Equipment List	15
4.1 Test Instruments.....	15
4.2 Description of Support Units	15
5. Test Procedure	16
5.1 DFS Measurement System.....	16
5.2 Calibration of DFS Detection Threshold Level.....	17
5.3 Deviation from Test Standard.....	17
5.4 Radiated Test Setup Configuration	18
5.4.1 Master Mode for RBR40 & RBS40.....	18
5.4.2 Client mode for RBS40.....	18
6. Test Results	19
6.1 Summary of Test Results	19
6.2 Test Results: Master.....	20
6.2.1 Test Mode	20
6.2.2 U-NII Detection Bandwidth	30
6.2.3 Channel Availability Check Time	48
6.2.4 Channel Closing Transmission and Channel Move Time.....	52
6.2.5 Non- Occupancy Period	78
6.2.6 Uniform Spreading.....	85
6.3 Test Results: Client	86
6.3.1 Test Mode	86
6.3.2 Channel Closing Transmission and Channel Move Time.....	87
6.3.3 Non-Occupancy Period	90
6.3.4 Non-Associated Test.....	92
6.3.5 Non-Co-Channel Test.....	92
7. Information on the Testing Laboratories	93

Release Control Record

Issue No.	Description	Date Issued
RF161229C25A-2	Original release.	Jul. 13, 2017

1 Certificate of Conformity

Product: Orbi Router, Orbi Satellite

Brand: NETGEAR

Test Model: RBR40

Series Model: RBS40

Sample Status: Engineering sample

Applicant: NETGEAR, INC.

Test Date: Jul. 05 ~ Jul. 10, 2017

Standards: FCC Part 15, Subpart E (Section 15.407)

KDB 905462 D02 UNII DFS Compliance Procedures New Rules v02

The above equipment has been tested by **Bureau Veritas Consumer Products Services (H.K.) Ltd., Taoyuan Branch**, and found compliance with the requirement of the above standards. The test record, data evaluation & Equipment Under Test (EUT) configurations represented herein are true and accurate accounts of the measurements of the sample's EMC characteristics under the conditions specified in this report.

Prepared by :

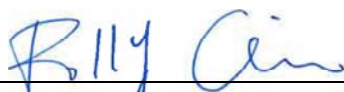

Polly Chien / Specialist

Date: Jul. 13, 2017

Approved by :



Ken Liu / Senior Manager

Date: Jul. 13, 2017

2 EUT Information

2.1 Operating Frequency Bands and Mode of EUT

Table 1: Operating Frequency Bands and Mode of EUT

RBR40

Operational Mode	Operating Frequency Range	
	5250~5350MHz	5470~5725MHz
Master	✓	✓

RBS40

Operational Mode	Operating Frequency Range	
	5250~5350MHz	5470~5725MHz
Master	✓	-
Slave Without Radar Detection	-	✓

2.2 EUT Software and Firmware Version

Table 2: The EUT Software/Firmware Version

No.	Product	Model No.	Software/Firmware Version
1	Orbi Router	RBR40	Firmware Version: V1.4.0.12-dfs-14
2	Orbi Satellite	RBS40	Firmware Version: V1.4.0.12-dfs-14

2.3 Description of Available Antennas to The EUT

Table 3: Antenna List

ANT No.	Antenna Type	Operation Frequency Range (MHz)	Gain (dBi)
1	Dipole	5250-5350	3.56
1	Dipole	5470-5725	3.49
2	Dipole	5250-5350	3.53
2	Dipole	5470-5725	3.51

For U-NII-2A: Directional gain = $10 \log\left[\frac{10^{G1/20} + 10^{G2/20} + \dots + 10^{GN/20}}{2}\right] = 6.56\text{dBi}$
 For U-NII-2C: Directional gain = $10 \log\left[\frac{10^{G1/20} + 10^{G2/20} + \dots + 10^{GN/20}}{2}\right] = 6.51\text{dBi}$

2.4 EUT Maximum Conducted Power

Table 4: The Measured Conducted Output Power

CDD Mode

802.11a

Frequency Band (MHz)	MAX. Power	
	Output Power(dBm)	Output Power(mW)
5250~5350	23.68	233.401
5470~5725	23.53	225.510

802.11n HT20

Frequency Band (MHz)	MAX. Power	
	Output Power(dBm)	Output Power(mW)
5250~5350	23.50	223.738
5470~5725	23.67	232.855

802.11n HT40

Frequency Band (MHz)	MAX. Power	
	Output Power(dBm)	Output Power(mW)
5250~5350	23.61	229.422
5470~5725	23.55	226.299

802.11ac VHT80

Frequency Band (MHz)	MAX. Power	
	Output Power(dBm)	Output Power(mW)
5250~5350	22.56	180.395
5470~5725	23.26	212.053

Beamforming Mode

802.11n HT20

Frequency Band (MHz)	MAX. Power	
	Output Power(dBm)	Output Power(mW)
5250~5350	23.42	219.786
5470~5725	23.43	220.293

802.11n HT40

Frequency Band (MHz)	MAX. Power	
	Output Power(dBm)	Output Power(mW)
5250~5350	23.37	217.270
5470~5725	23.47	222.331

802.11ac VHT80

Frequency Band (MHz)	MAX. Power	
	Output Power(dBm)	Output Power(mW)
5250~5350	22.56	180.395
5470~5725	23.26	212.053

2.5 EUT Maximum E.I.R.P. Power

Table 5: The EIRP Output Power List

CDD Mode

802.11a

Frequency Band (MHz)	MAX. Power	
	Output Power(dBm)	Output Power(mW)
5250~5350	27.24	529.663
5470~5725	27.04	505.825

802.11n HT20

Frequency Band (MHz)	MAX. Power	
	Output Power(dBm)	Output Power(mW)
5250~5350	27.90	616.595
5470~5725	29.37	864.968

802.11n HT40

Frequency Band (MHz)	MAX. Power	
	Output Power(dBm)	Output Power(mW)
5250~5350	28.01	632.412
5470~5725	29.25	841.395

802.11ac VHT80

Frequency Band (MHz)	MAX. Power	
	Output Power(dBm)	Output Power(mW)
5250~5350	26.96	496.592
5470~5725	28.96	787.046

Beamforming Mode

802.11n HT20

Frequency Band (MHz)	MAX. Power	
	Output Power(dBm)	Output Power(mW)
5250~5350	29.93	984.011
5470~5725	29.94	986.279

802.11n HT40

Frequency Band (MHz)	MAX. Power	
	Output Power(dBm)	Output Power(mW)
5250~5350	29.88	972.747
5470~5725	29.98	995.405

802.11ac VHT80

Frequency Band (MHz)	MAX. Power	
	Output Power(dBm)	Output Power(mW)
5250~5350	29.07	807.235
5470~5725	29.77	948.418

2.6 Transmit Power Control (TPC)

U-NII devices operating in the 5.25-5.35 GHz band and the 5.47-5.725 GHz band shall employ a TPC mechanism. The U-NII device is required to have the capability to operate at least 6 dB below the mean EIRP value of 30 dBm. A TPC mechanism is not required for systems with an e.i.r.p. of less than 500 mW.

Applicable	E.I.R.P	FCC 15.407 (h)(1)
√	>500mW	The TPC mechanism is required for system with an E.I.R.P of above 500mW
	<500mW	The TPC mechanism is not required for system with an E.I.R.P of less 500mW

The UUT can adjust a transmitter's output power based on the signal level present at the receiver. TPC is auto controlled by software

2.7 Statement of Manufacturer

Manufacturer statement confirming that information regarding the parameters of the detected Radar Waveforms is not available to the end user.

3. U-NII DFS Rule Requirements

3.1 Working Modes and Required Test Items

The manufacturer shall state whether the UUT is capable of operating as a Master and/or a Client. If the UUT is capable of operating in more than one operating mode then each operating mode shall be tested separately. See tables 6 and 7 for the applicability of DFS requirements for each of the operational modes.

Table 6: Applicability of DFS Requirements Prior To Use a Channel

Requirement	Operational Mode		
	Master	Client without radar detection	Client with radar detection
Non-Occupancy Period	✓	✓ <small>note</small>	✓
DFS Detection Threshold	✓	Not required	✓
Channel Availability Check Time	✓	Not required	Not required
U-NII Detection Bandwidth	✓	Not required	✓

Note: Per KDB 905462 D03 UNII Clients Without Radar Detection New Rules v01r02 section (b)(5/6), If the client moves with the master, the device is considered compliant if nothing appears in the client non-occupancy period test. For devices that shut down (rather than moving channels), no beacons should appear. An analyzer plot that contains a single 30-minute sweep on the original channel.

Table 7: Applicability of DFS Requirements During Normal Operation.

Requirement	Operational Mode	
	Master or Client with radar detection	Client without radar detection
DFS Detection Threshold	✓	Not required
Channel Closing Transmission Time	✓	✓
Channel Move Time	✓	✓
U-NII Detection Bandwidth	✓	Not required

Additional requirements for devices with multiple bandwidth modes	Master or Client with radar detection	Client without radar detection
U-NII Detection Bandwidth and Statistical Performance Check	All BW modes must be tested	Not required
Channel Move Time and Channel Closing Transmission Time	Test using widest BW mode available	Test using the widest BW mode available for the link
All other tests	Any single BW mode	Not required

Note: Frequencies selected for statistical performance check (Section 7.8.4) should include several frequencies within the radar detection bandwidth and frequencies near the edge of the radar detection bandwidth. For 802.11 devices it is suggested to select frequencies in each of the bonded 20 MHz channels and the channel center frequency.

3.2 Test Limits and Radar Signal Parameters

Detection Threshold Values

Table 8: DFS Detection Thresholds For Master Devices And Client Devices With Radar Detection

Maximum Transmit Power	Value (See Notes 1, 2, and 3)
EIRP \geq 200 milliwatt	-64 dBm
EIRP < 200 milliwatt and power spectral density < 10 dBm/MHz	-62 dBm
EIRP < 200 milliwatt that do not meet the power spectral density requirement	-64 dBm

Note 1: This is the level at the input of the receiver assuming a 0 dBi receive antenna.
 Note 2: Throughout these test procedures an additional 1 dB has been added to the amplitude of the test transmission waveforms to account for variations in measurement equipment. This will ensure that the test signal is at or above the detection threshold level to trigger a DFS response.
 Note3: EIRP is based on the highest antenna gain. For MIMO devices refer to KDB Publication 662911 D01.

Table 9: DFS Response Requirement Values

Parameter	Value
Non-occupancy period	Minimum 30 minutes
Channel Availability Check Time	60 seconds
Channel Move Time	10 seconds See Note 1.
Channel Closing Transmission Time	200 milliseconds + an aggregate of 60 milliseconds over remaining 10 second period. See Notes 1 and 2.
U-NII Detection Bandwidth	Minimum 100% of the U-NII 99% transmission power bandwidth. See Note 3

Note 1: Channel Move Time and the Channel Closing Transmission Time should be performed with Radar Type 0. The measurement timing begins at the end of the Radar Type 0 burst.
 Note 2: The Channel Closing Transmission Time is comprised of 200 milliseconds starting at the beginning of the Channel Move Time plus any additional intermittent control signals required to facilitate a Channel move (an aggregate of 60 milliseconds) during the remainder of the 10 second period. The aggregate duration of control signals will not count quiet periods in between transmissions.
 Note 3: During the U-NII Detection Bandwidth detection test, radar type 0 should be used. For each frequency step the minimum percentage of detection is 90 percent. Measurements are performed with no data traffic.

Parameters of DFS Test Signals

Step intervals of 0.1 microsecond for Pulse Width, 1 microsecond for PRI, 1 MHz for chirp width and 1 for the number of pulses will be utilized for the random determination of specific test waveforms.

Table 10: Short Pulse Radar Test Waveforms

Radar Type	Pulse Width (μsec)	PRI (μsec)	Number of Pulses	Minimum Percentage of Successful Detection	Minimum Number of Trials
0	1	1428	18	See Note 1	See Note 1
1	1	Test A: 15 unique PRI values randomly selected from the list of 23 PRI values in Table 5a	$\text{Roundup} \left\{ \left(\frac{1}{360} \right) \cdot \left(\frac{19 \cdot 10^6}{\text{PRI}_{\mu\text{sec}}} \right) \right\}$	60%	30
		Test B: 15 unique PRI values randomly selected within the range of 518-3066 μ sec, with a minimum increment of 1 μ sec, excluding PRI values selected in Test A			
2	1-5	150-230	23-29	60%	30
3	6-10	200-500	16-18	60%	30
4	11-20	200-500	12-16	60%	30
Aggregate (Radar Types 1-4)				80%	120
Note 1: Short Pulse Radar Type 0 should be used for the detection bandwidth test, channel move time, and channel closing time tests.					

Table 11: Long Pulse Radar Test Waveform

Radar Type	Pulse Width (μsec)	Chirp Width (MHz)	PRI (μsec)	Number Of Pulses Per Burst	Number Of Bursts	Minimum Percentage Of Successful Detection	Minimum Number Of Trials
5	50-100	5-20	1000-2000	1-3	8-20	80%	30

Three subsets of trials will be performed with a minimum of ten trials per subset. The subset of trials differ in where the Long Pulse Type 5 Signal is tuned in frequency.

- a) the Channel center frequency
- b) tuned frequencies such that 90% of the Long Pulse Type 5 frequency modulation is within the low edge of the UUT Occupied Bandwidth
- c) tuned frequencies such that 90% of the Long Pulse Type 5 frequency modulation is within the high edge of the UUT Occupied Bandwidth

It include 10 trails for every subset, the formula as below,

For subset case 1: the center frequency of the signal generator will remain fixed at the center of the UUT Channel.

For subset case 2: to retain 90% frequency overlap between the radar signal and the UUT Occupied Bandwidth, the center frequency of the signal generator will vary for each of the ten trials in subset case 2. The center frequency of the signal generator for each trial is calculated by:

$$FL+(0.4*Chirp\ Width\ [in\ MHz])$$

For subset case 3: to retain 90% frequency overlap between the radar signal and the UUT Occupied Bandwidth, the center frequency of the signal generator will vary for each of the ten trials in subset case 3. The center frequency of the signal generator for each trial is calculated by:

$$FH-(0.4*Chirp\ Width\ [in\ MHz])$$

Table 12: Frequency Hopping Radar Test Waveform

Radar Type	Pulse Width (μsec)	PRI (μsec)	Pulses per Hop	Hopping Rate (kHz)	Hopping Sequence Length (msec)	Minimum Percentage Of Successful Detection	Minimum Number Of Trials
6	1	333	9	0.333	300	70%	30

4. Test & Support Equipment List

4.1 Test Instruments

Table 13: Test Instruments List

Description & Manufacturer	Model No.	Brand	Date Of Calibration	Due Date Of Calibration
R&S Spectrum analyzer	ESR	R&S	2017/02/20	2018/02/19
Signal generator	8645A	Agilent	2016/08/08	2017/08/07

4.2 Description of Support Units

For 5250~5350MHz:

Table 14: Support Unit Information.

No.	Product	Brand	Model No.	FCC ID
1	WiFi USB Adapter	NETGEAR	A6210	PY313400249

NOTE: This device was functioned as a Master Slave device during the DFS test.

For 5470~5725MHz:

This EUT was functioned as a Master & Slave device during the DFS test.

5. Test Procedure

5.1 DFS Measurement System

A complete DFS Measurement System consists of two subsystems: (1) the Radar Signal Generating Subsystem and (2) the Traffic Monitoring Subsystem. The control PC is necessary for generating the Radar waveforms in Table 10, 11 and 12. The traffic monitoring subsystem is specified to the type of unit under test (UUT).

Radiated Setup Configuration of DFS Measurement System

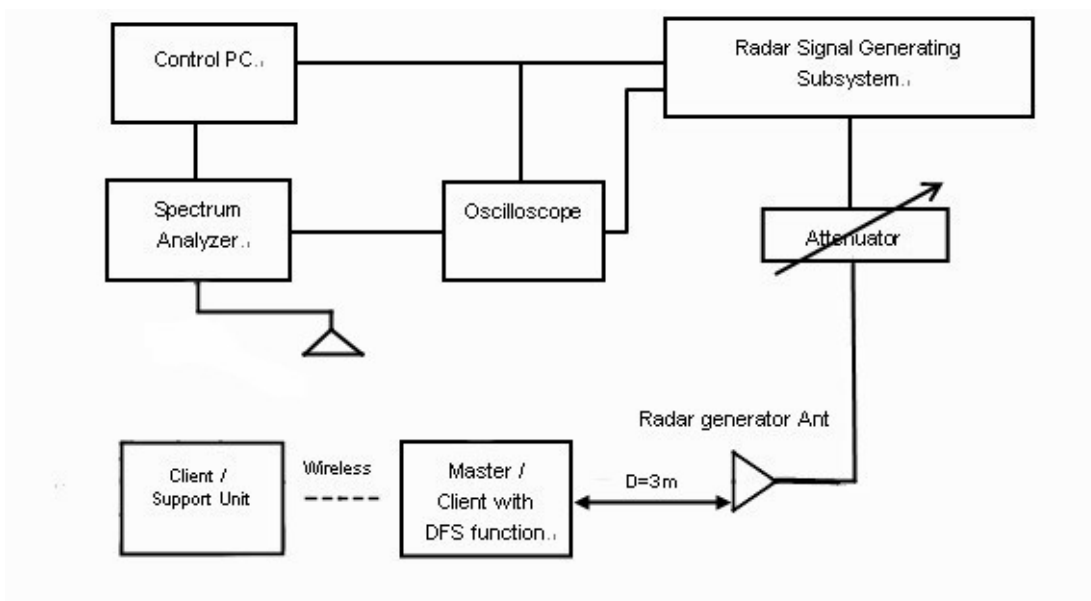

System testing will be performed with channel-loading using means appropriate to the data types that are used by the unlicensed device. The following requirements apply:

	a) The data file must be of a type that is typical for the device (i.e., MPEG-2, MPEG-4, WAV, MP3, MP4, AVI, etc.) and must generally be transmitting in a streaming mode.
	b) Software to ping the client is permitted to simulate data transfer but must have random ping intervals.
v	c) Timing plots are required with calculations demonstrating a minimum channel loading of approximately 17% or greater.
	d) Unicast or Multicast protocols are preferable but other protocols may be used. The appropriate protocol used must be described in the test procedures.

5.2 Calibration of DFS Detection Threshold Level

The measured channel is 5300MHz, 5310MHz and 5290 MHz, 5500MHz, 5510MHz and 5530MHz. The radar signal was the same as transmitted channels, and injected into the antenna of AP (master) or Client Device with Radar Detection, measured the channel closing transmission time and channel move time. The calibrated conducted detection threshold level is set to -64dBm. The tested level is lower than required level hence it provides margin to the limit.

Radiated setup configuration of Calibration of DFS Detection Threshold Level

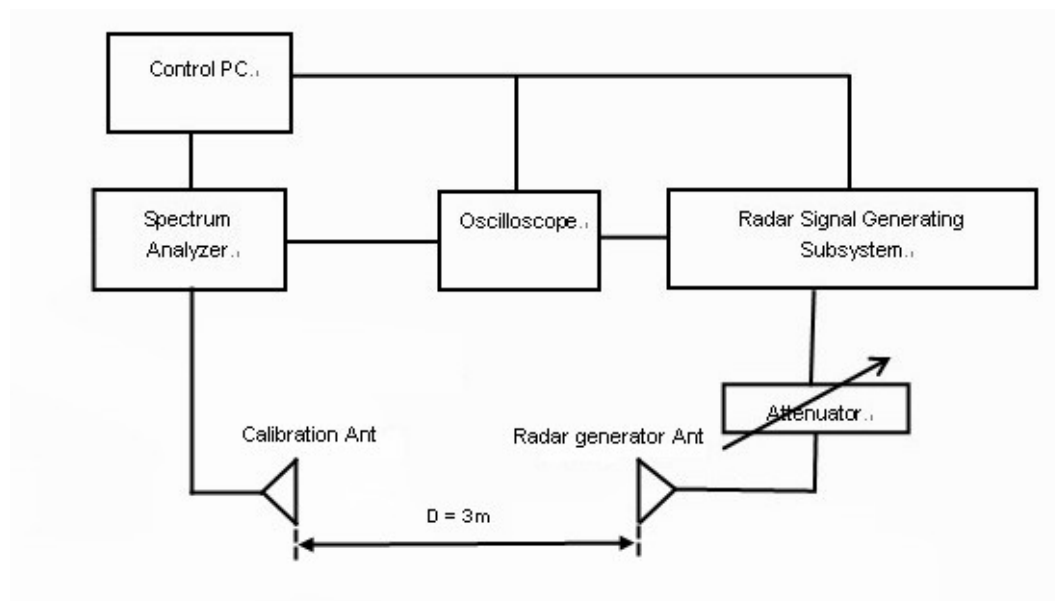

5.3 Deviation from Test Standard

No deviation.

5.4 Radiated Test Setup Configuration

5.4.1 Master Mode for RBR40 & RBS40

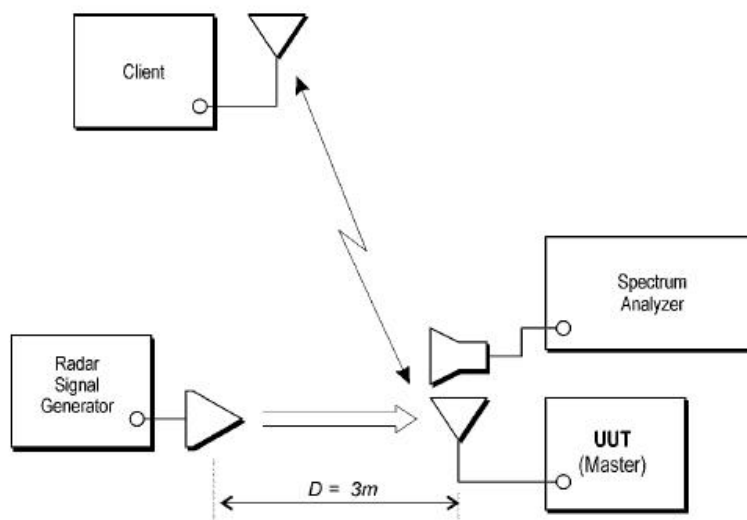

The EUT is a U-NII Device operating in Master mode. The radar test signals are injected into the Master Device.

5.4.2 Client mode for RBS40

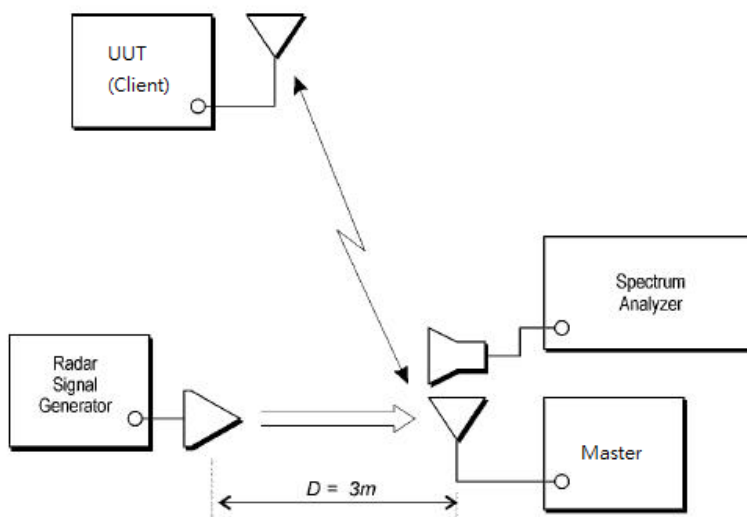

The UUT is a U-NII Device operating in Client mode without radar detection. The radar test signals are injected into the Master Device.

6. Test Results

6.1 Summary of Test Results

Master Mode

Clause	Test Parameter	Remarks	Pass/Fail
15.407	DFS Detection Threshold	Applicable	Pass
15.407	U-NII Detection Bandwidth	Applicable	Pass
15.407	Channel Availability Check Time	Applicable	Pass
15.407	Channel Move Time	Applicable	Pass
15.407	Channel Closing Transmission Time	Applicable	Pass
15.407	Non- Occupancy Period	Applicable	Pass
15.407	Uniform Spreading	Applicable	Pass

Slave without radar detection mode

Clause	Test Parameter	Remarks	Pass/Fail
15.407	DFS Detection Threshold	Not Applicable	NA
15.407	Channel Availability Check Time	Not Applicable	NA
15.407	Channel Move Time	Applicable	Pass
15.407	Channel Closing Transmission Time	Applicable	Pass
15.407	Non- Occupancy Period	Applicable	Pass
15.407	Uniform Spreading	Not Applicable	NA
15.407	U-NII Detection Bandwidth	Not Applicable	NA
15.407	Non-associated test	Applicable	Pass
15.407	Non-Co-Channel test	Applicable	Pass

6.2 Test Results: Master

6.2.1 Test Mode

Master with injection at the Master. (Radar Test Waveforms are injected into the Master.)

The modulation and bandwidth are similar for 802.11n mode for HT20 / HT40 and 802.11ac mode for VHT20 / VHT40, therefore investigated worst case for final test were chosen 802.11ac (VHT20/VHT40) and record in test report.

For 5250~5350MHz DFS Detection Threshold

For a detection threshold level of -64dBm, the required signal strength at EUT antenna location is -64 dBm. The tested level is lower than required level hence it provides margin to the limit.

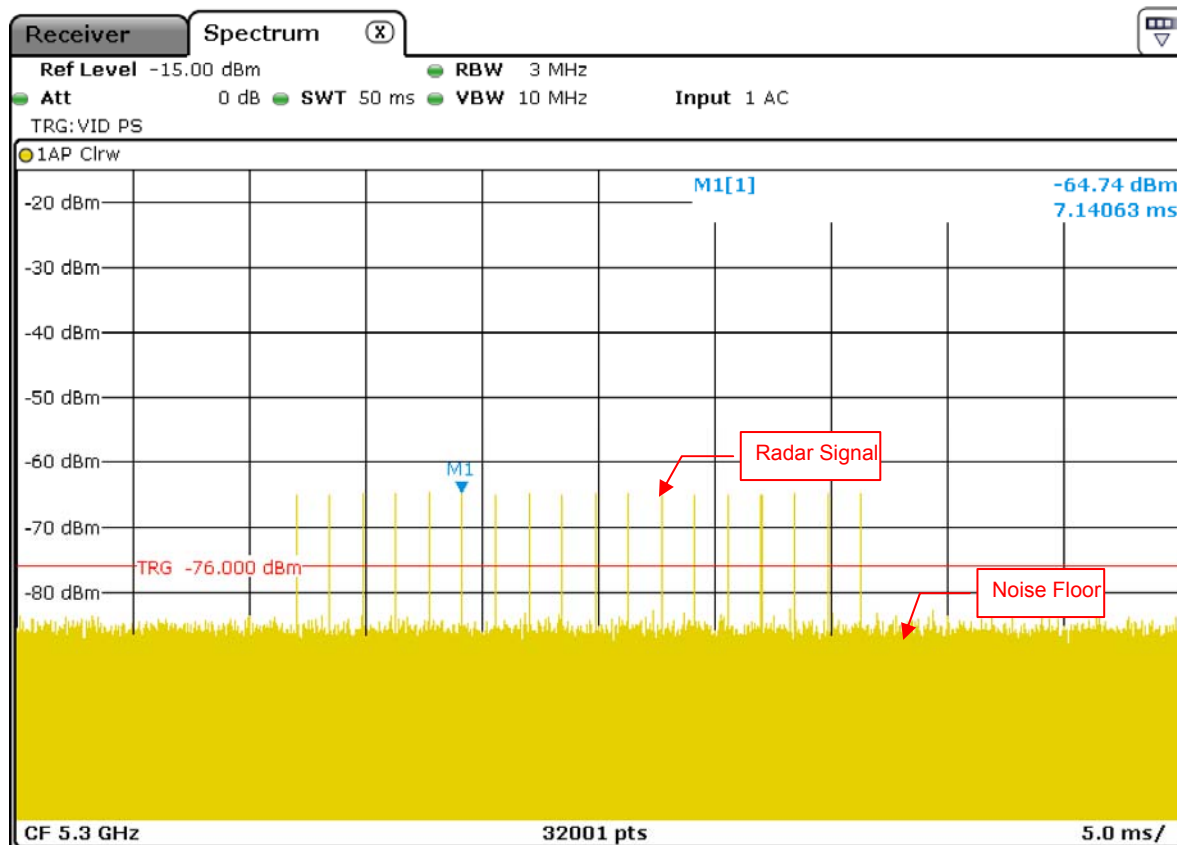

Radar Signal 0

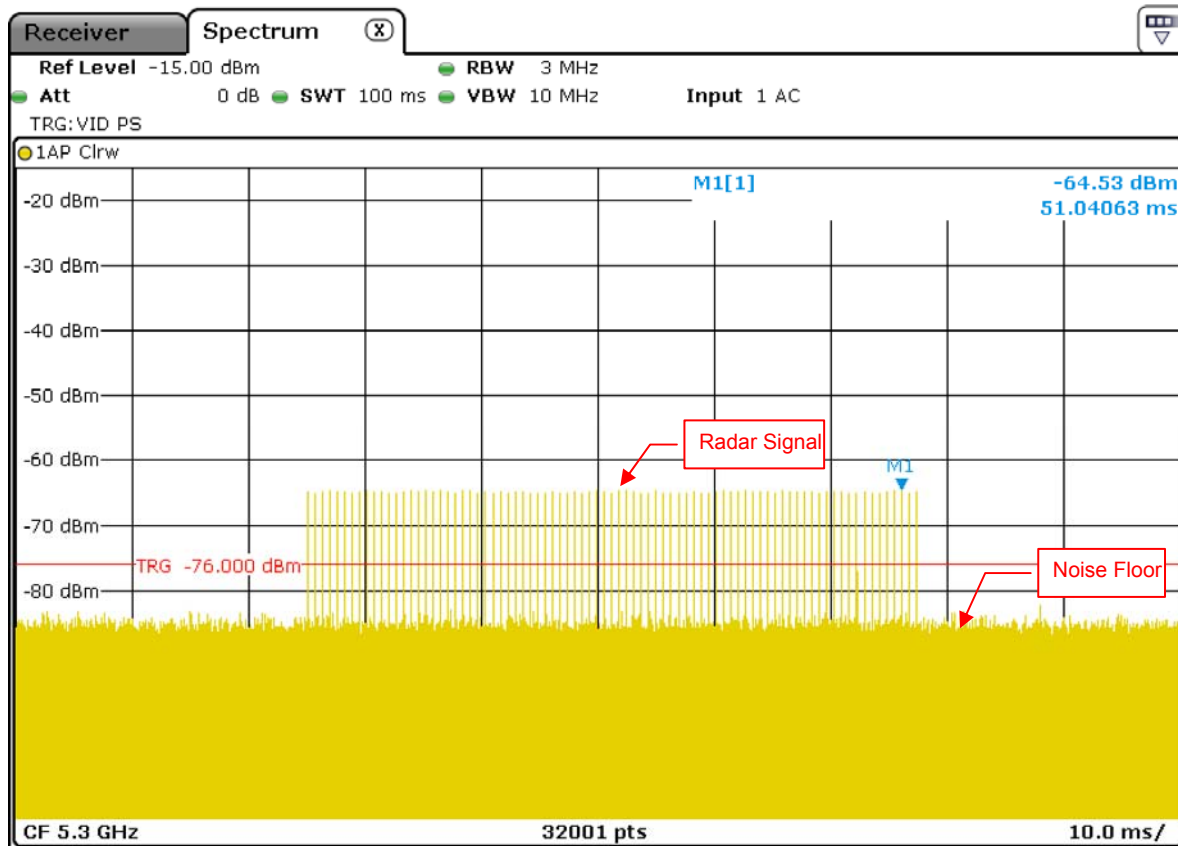

Radar Signal 1 (Test A)

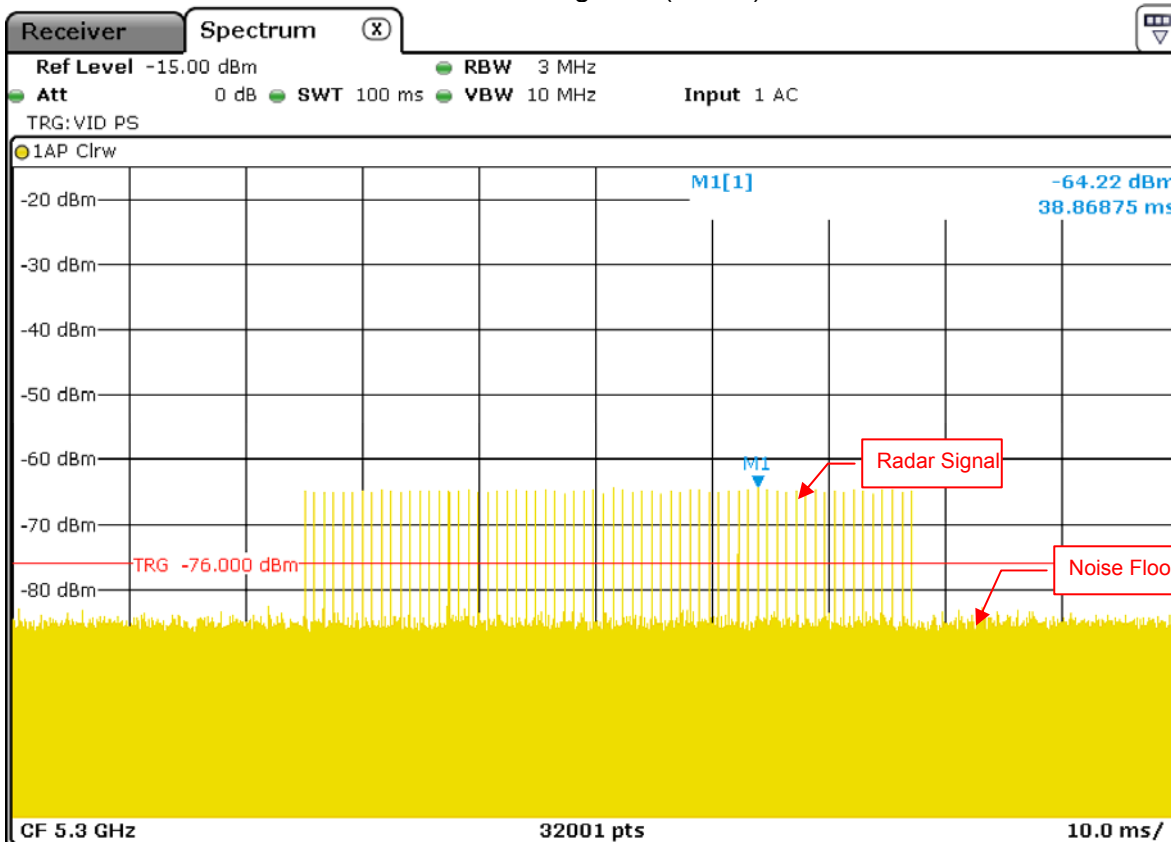

Radar Signal 1 (Test B)

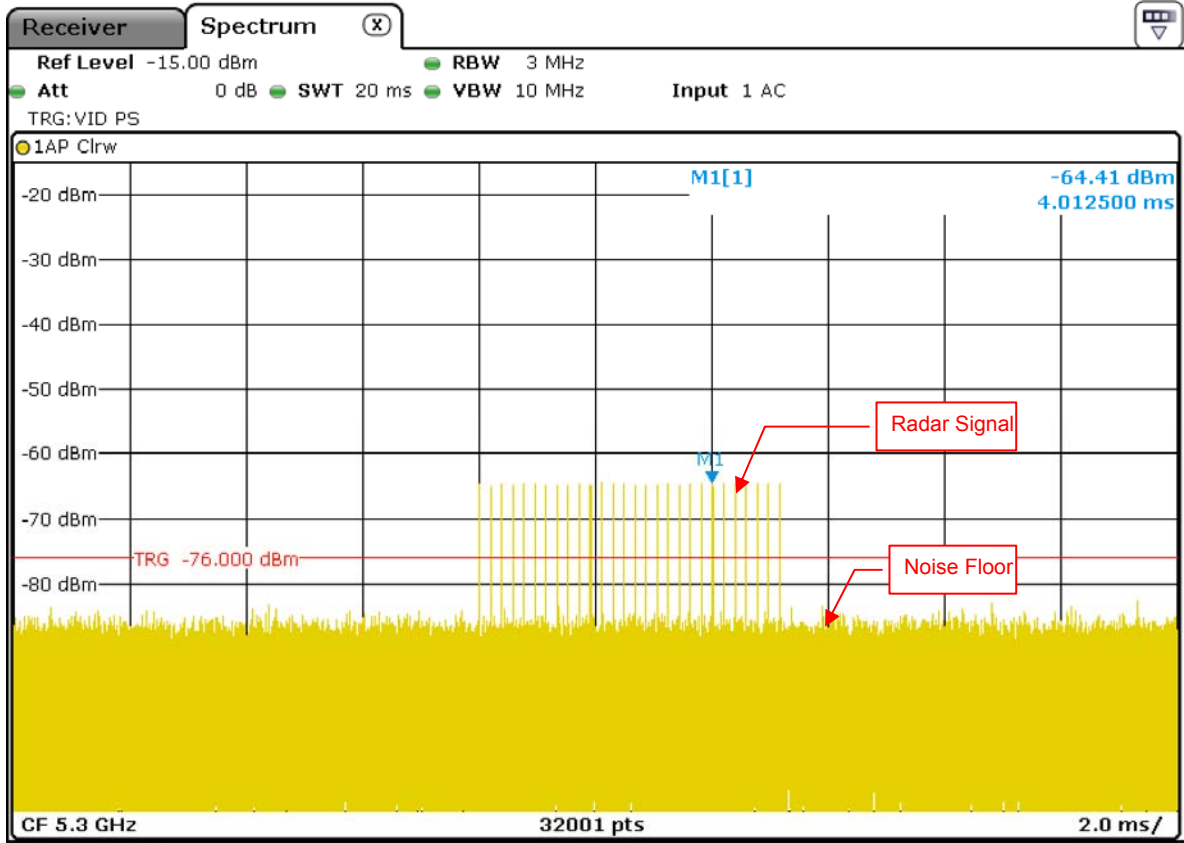

Radar Signal 2

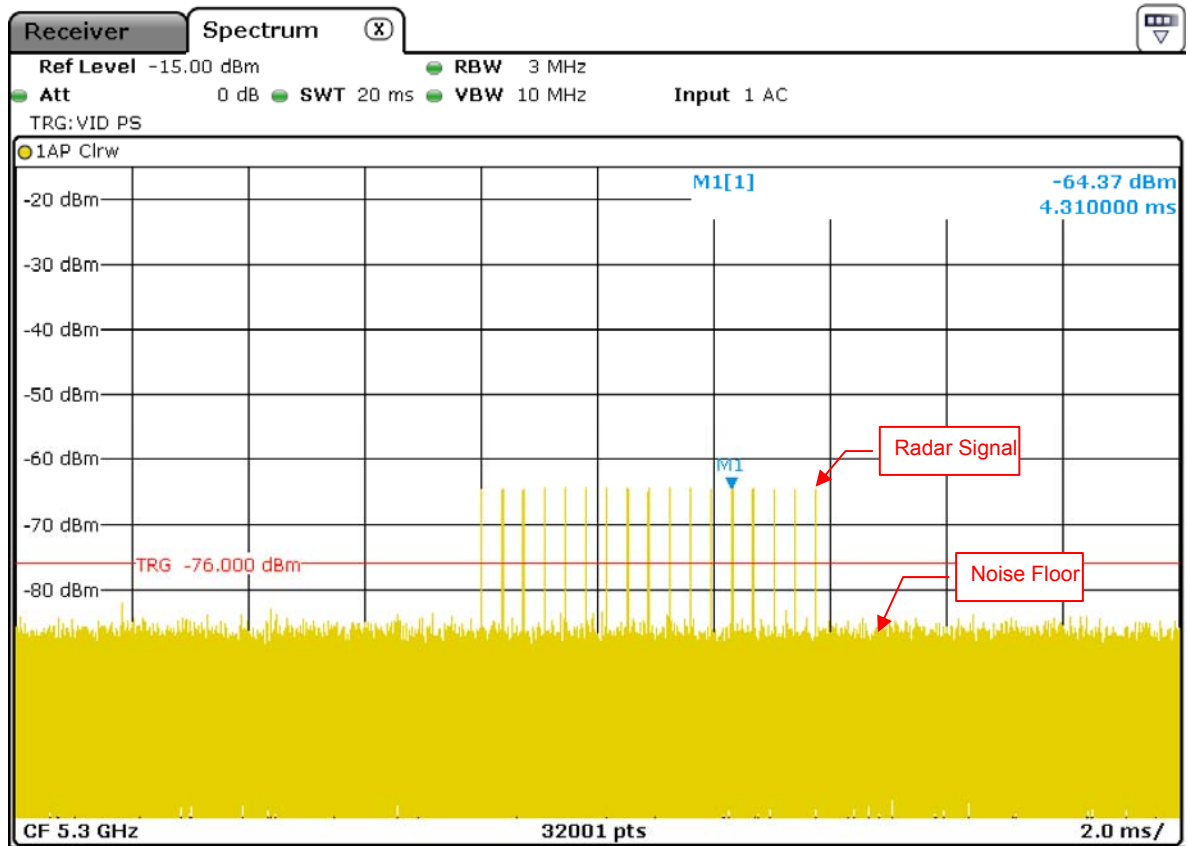

Radar Signal 3

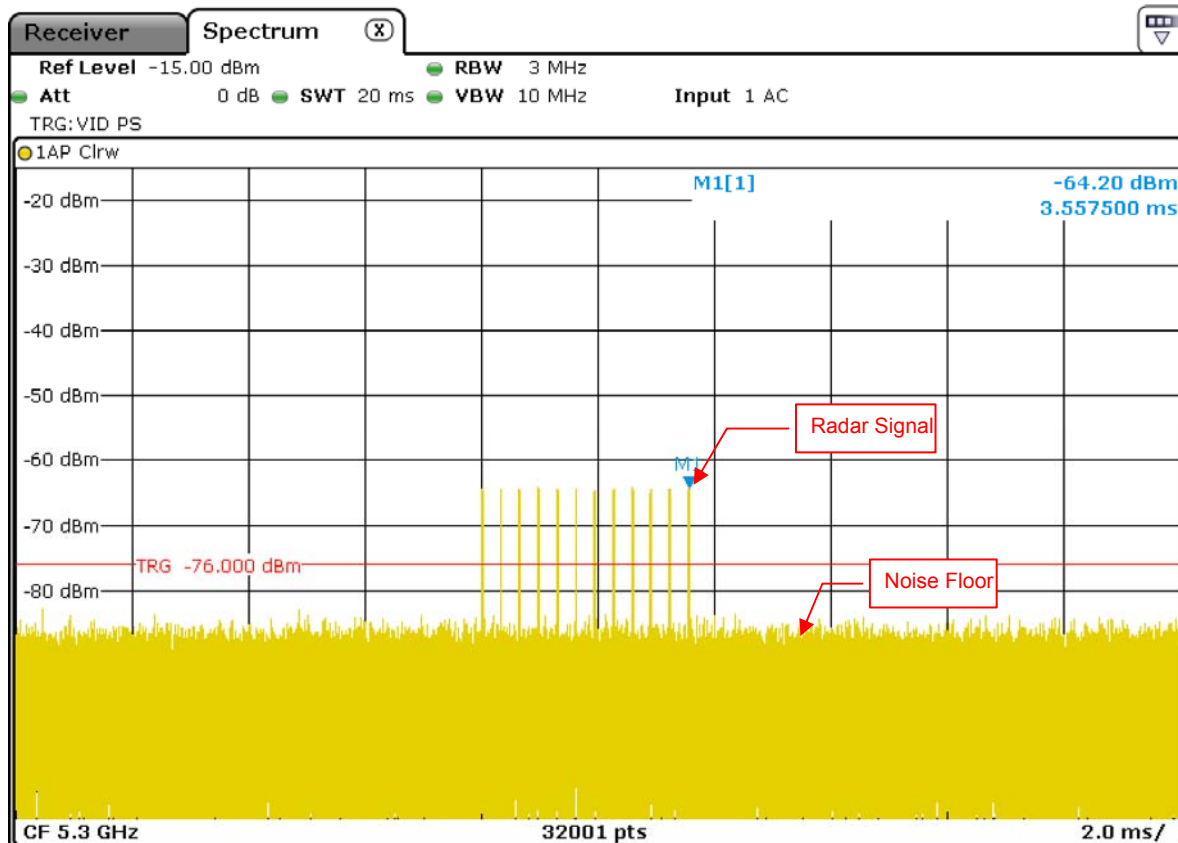

Radar Signal 4

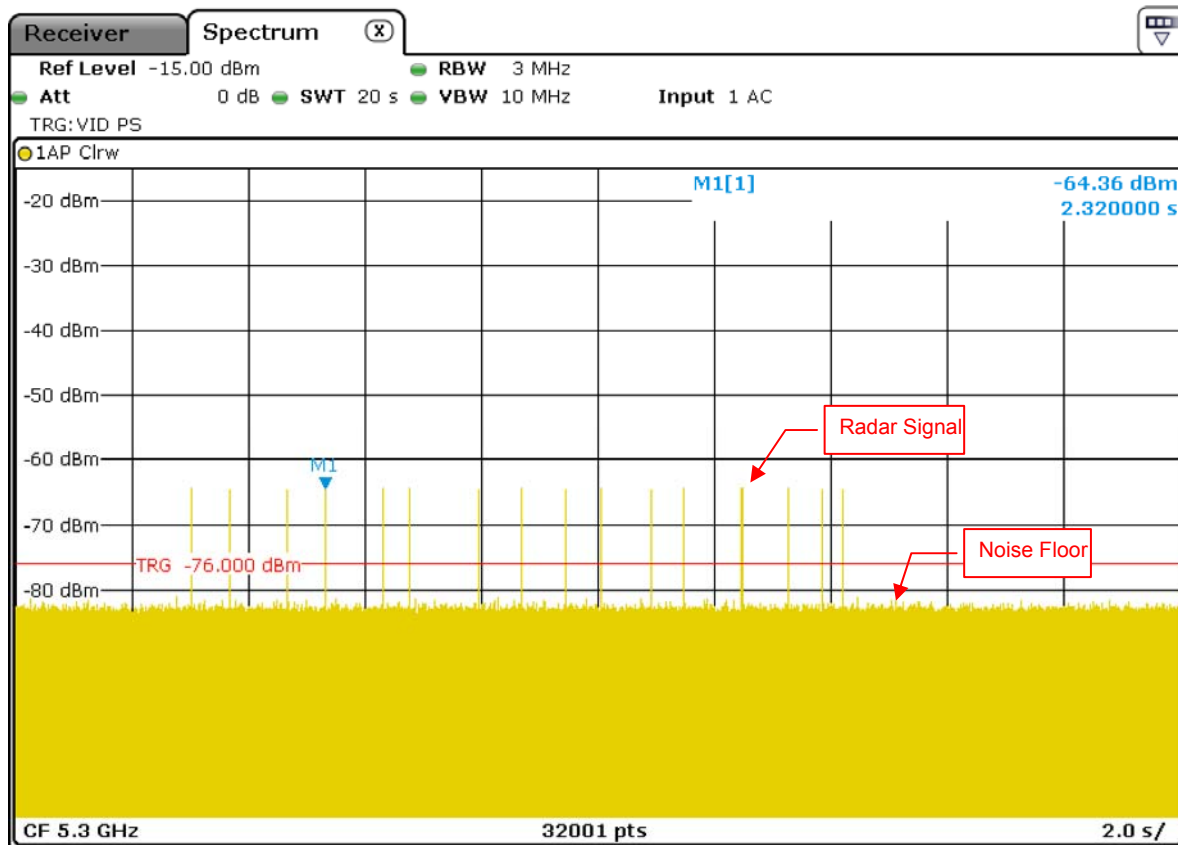

Radar Signal 5

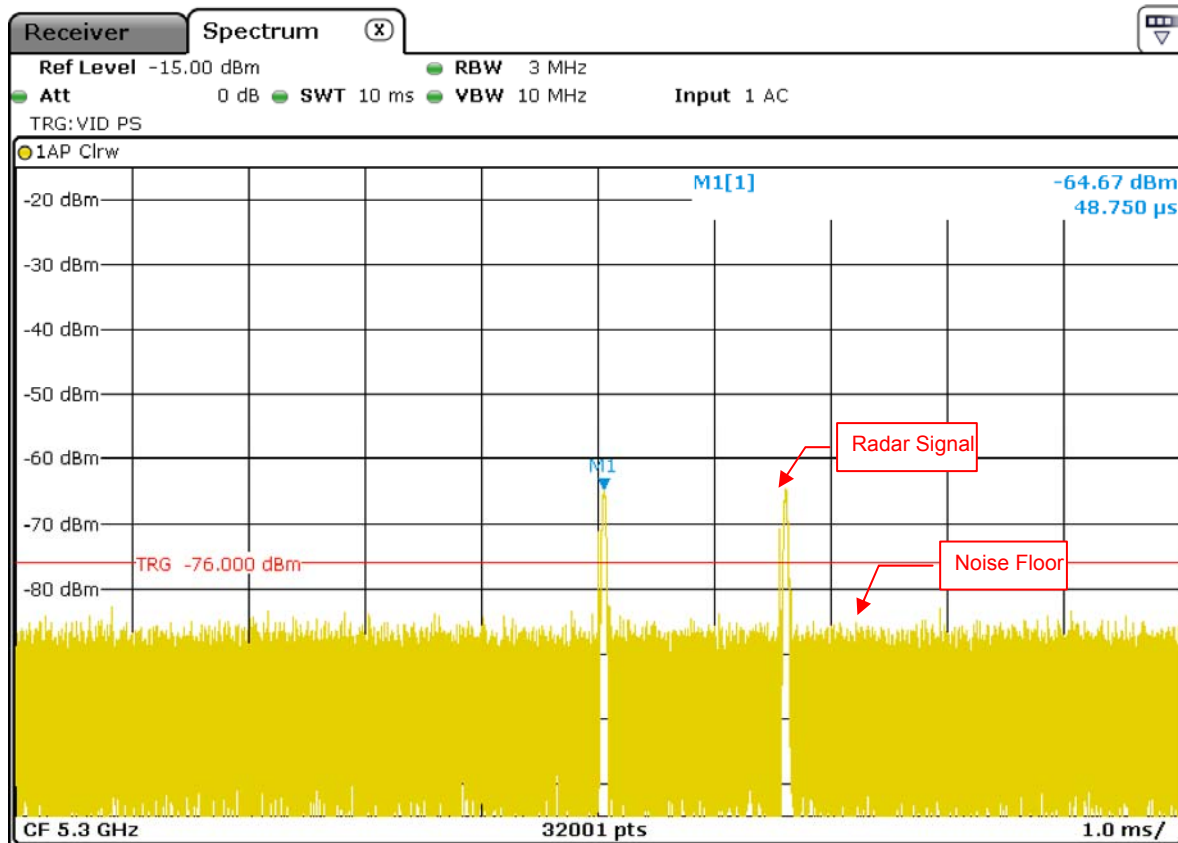

Single Burst of Radar Signal 5

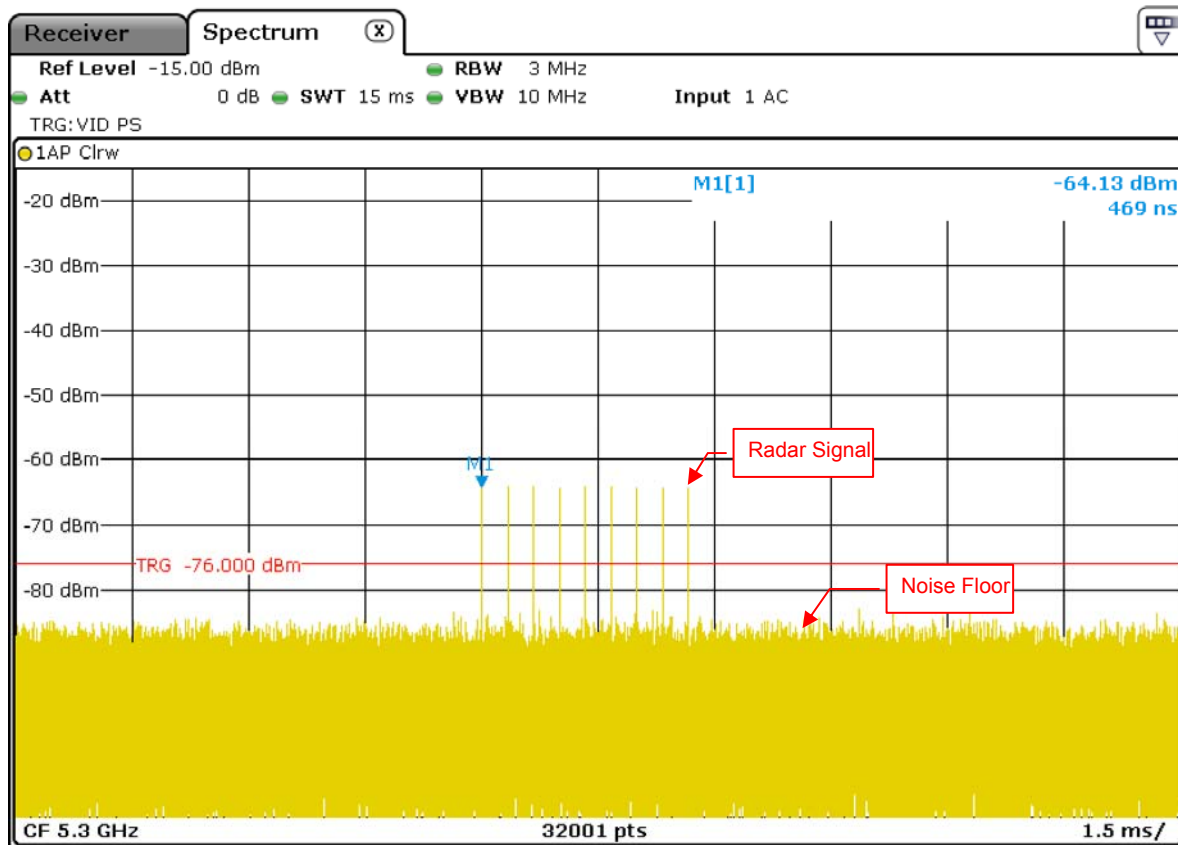

Radar Signal 6

For 5470~5725MHz
DFS Detection Threshold

For detection threshold level of -64dBm, the required Radar Signal at antenna port was set to -64dBm. The tested level is lower than required level for 1dB, hence it provides margin to the limit.

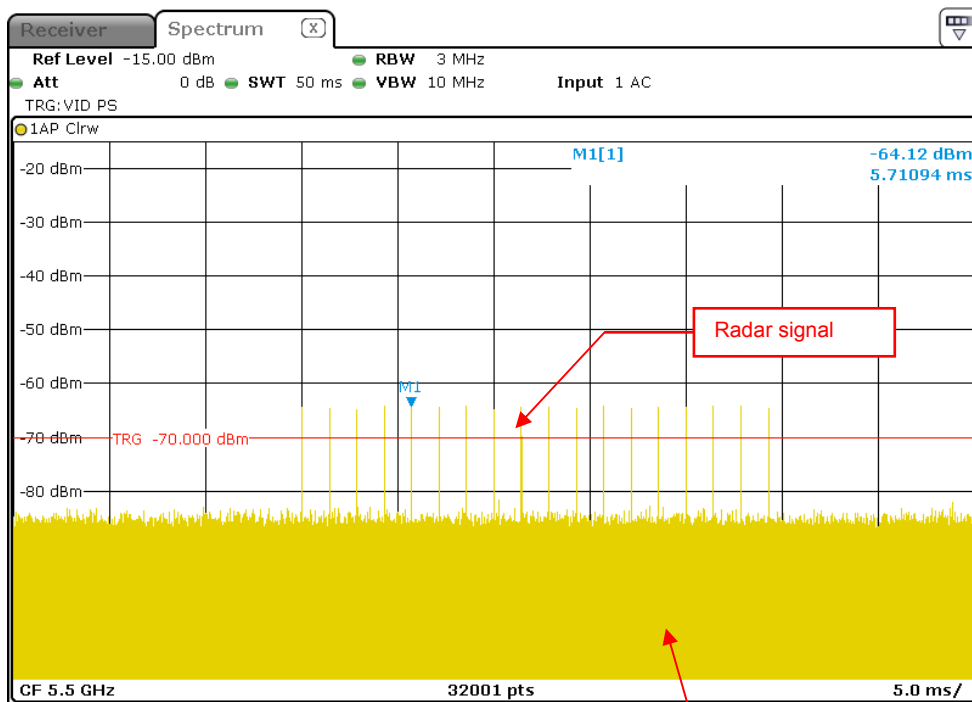

Radar Signal 0

Noise Floor

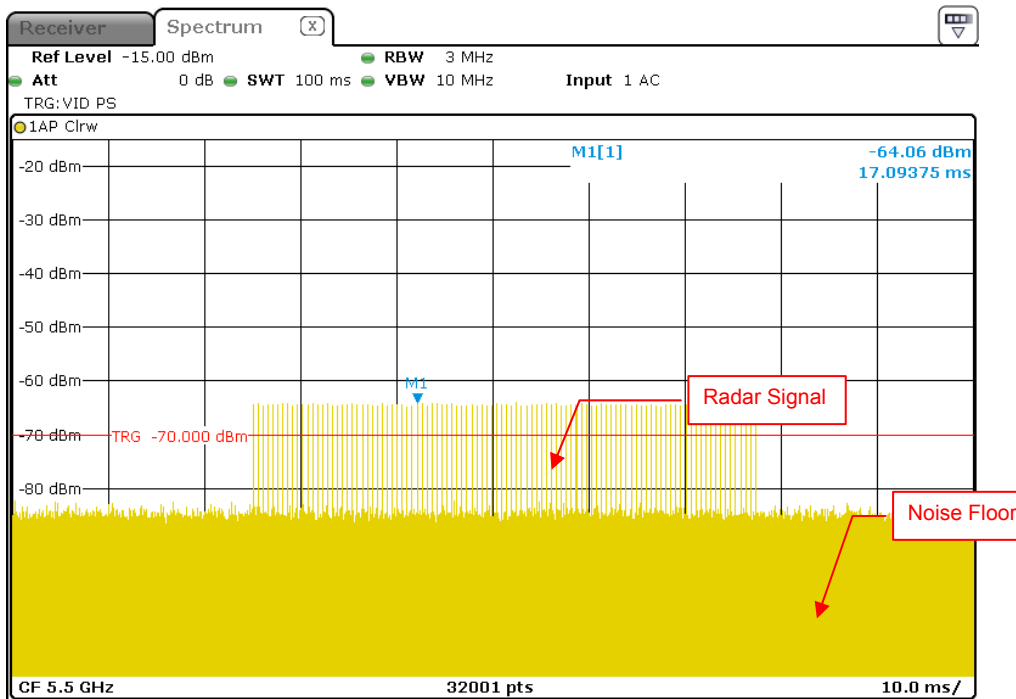

Radar Signal 1 (Test A)

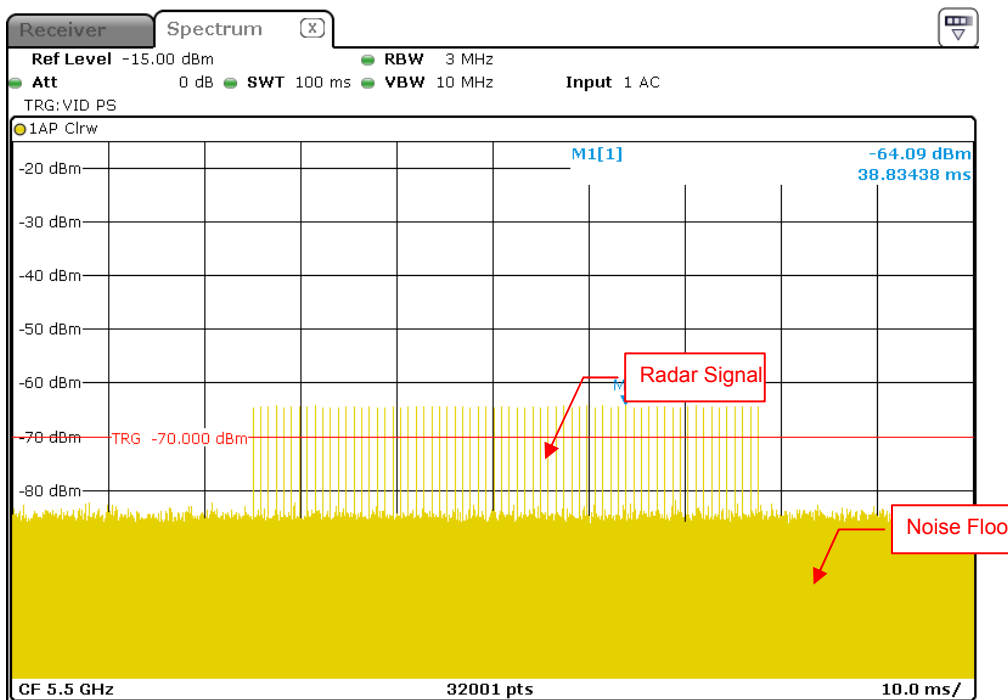

Radar Signal 1 (Test B)

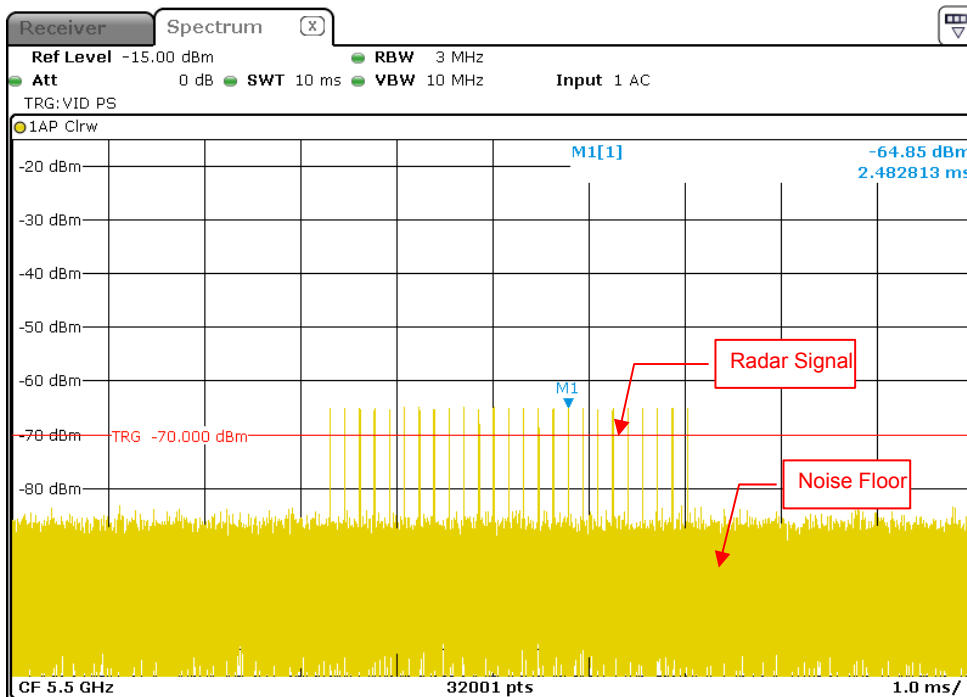

Radar Signal 2

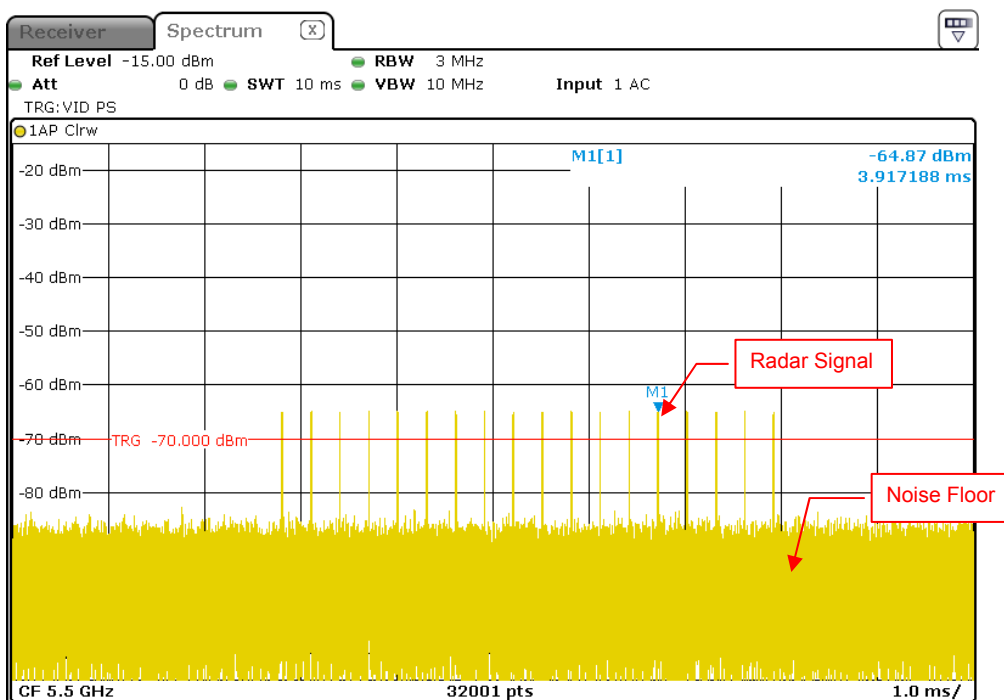

Radar Signal 3

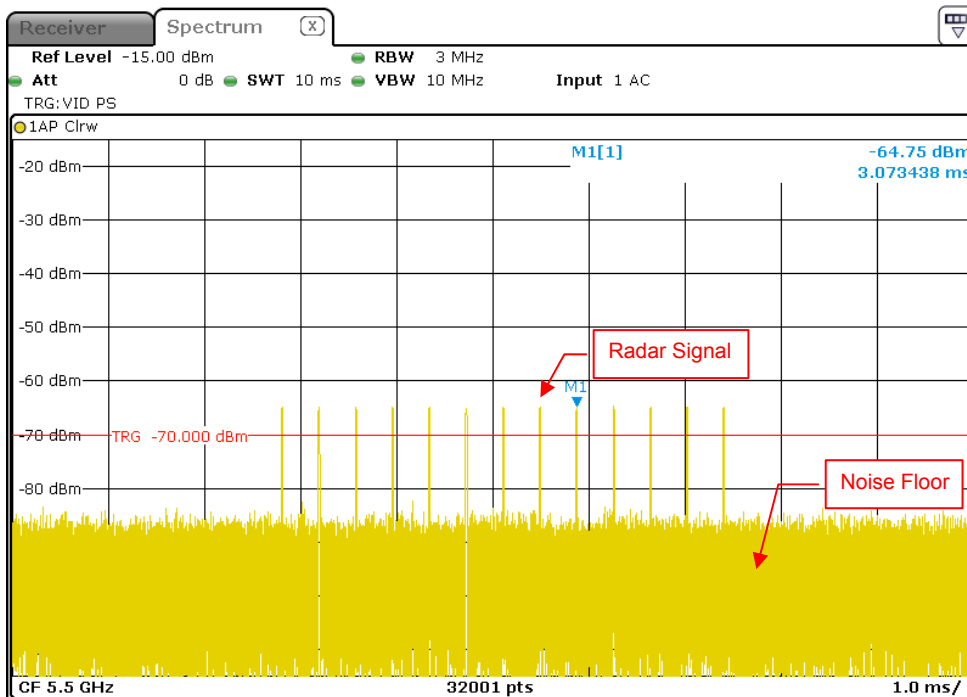

Radar Signal 4

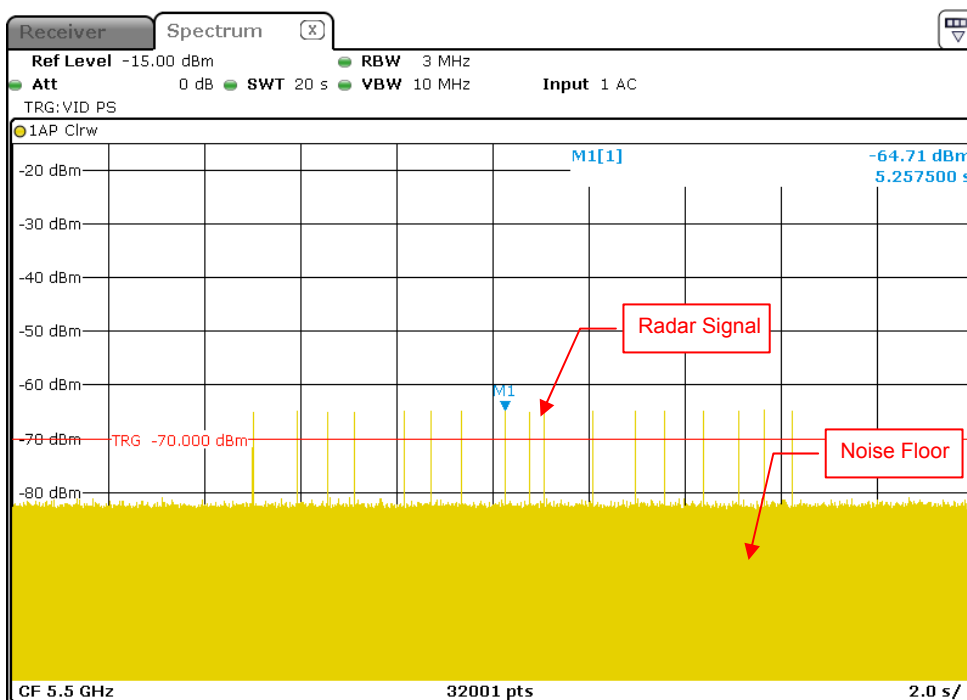

Radar Signal 5

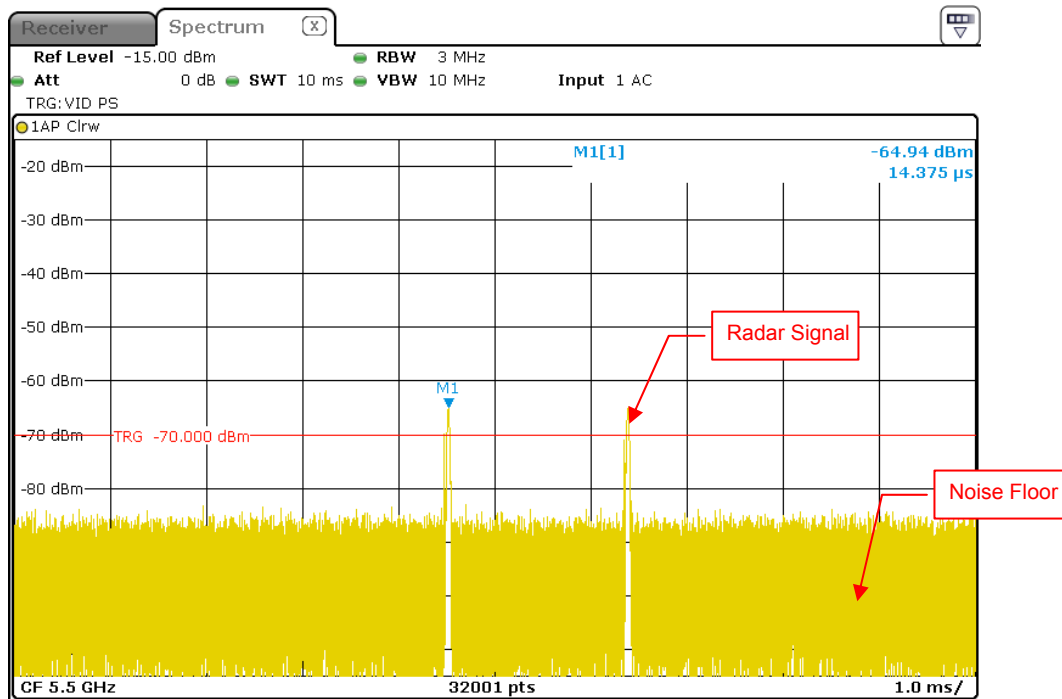

Single Burst of Radar Signal 5

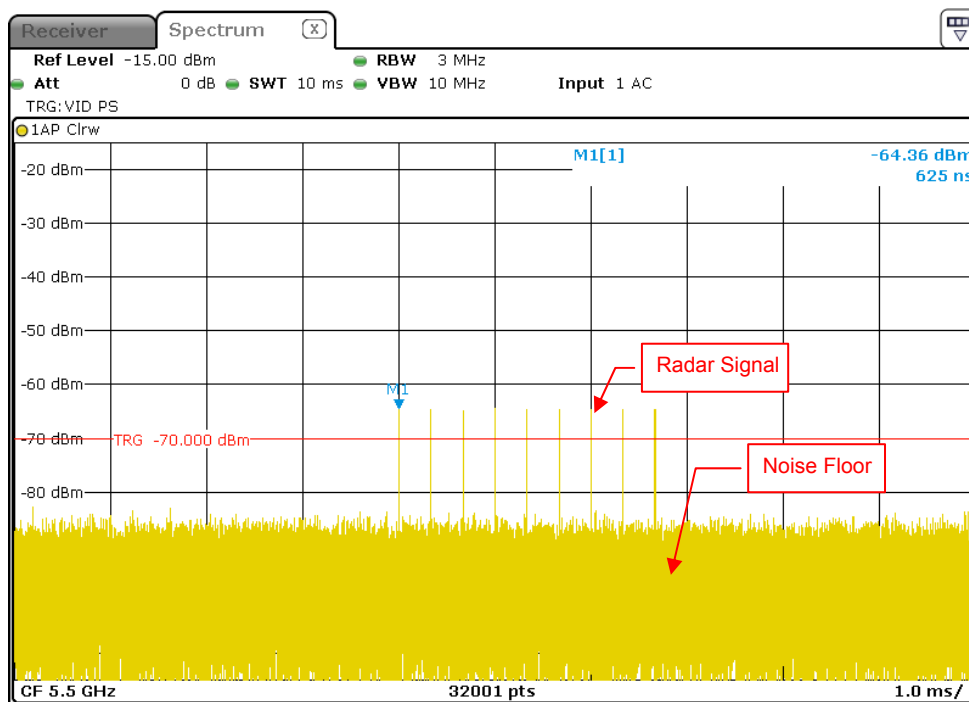

Radar Signal 6

6.2.2 U-NII Detection Bandwidth

For 5250~5350MHz
RBR40

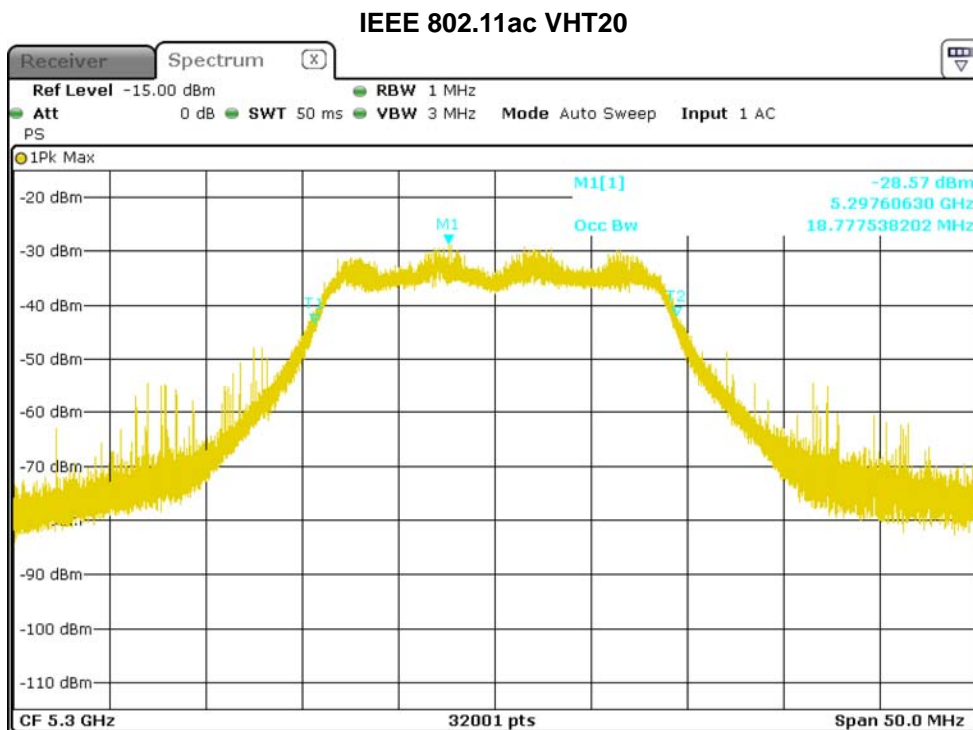

U-NII 99% Channel bandwidth

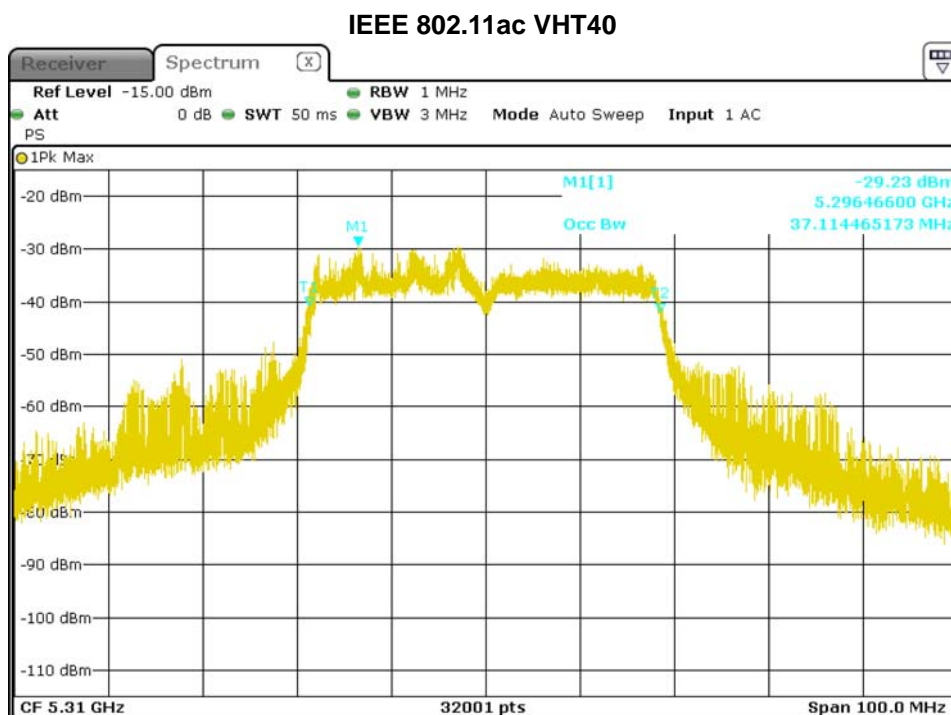

U-NII 99% Channel bandwidth

IEEE 802.11ac VHT80

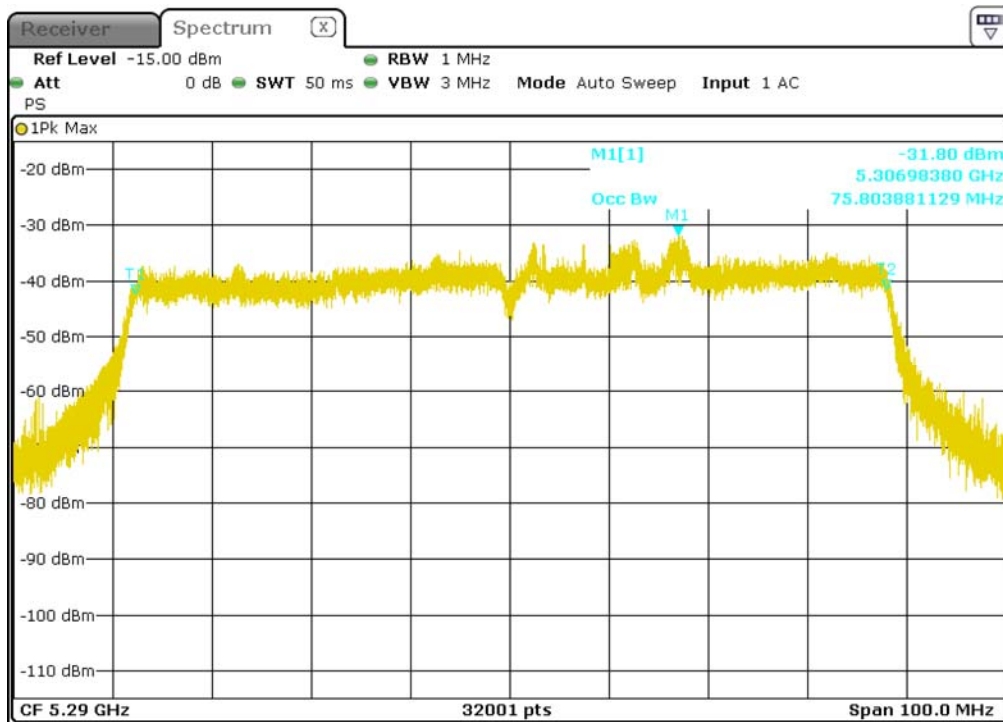

U-NII 99% Channel bandwidth

Detection Bandwidth Test - IEEE 802.11ac VHT20											
Radar Type 0											
EUT Frequency: 5300MHz											
EUT 99% Power bandwidth: 18.77MHz											
Detection bandwidth limit (100% of EUT 99% Power bandwidth): 18.77MHz											
Detection bandwidth (5310(FH) – 5290(FL)) : 20MHz											
Test Result : PASS											
Radar Frequency (MHz)	Trial Number / Detection										Detection Rate (%)
	1	2	3	4	5	6	7	8	9	10	
5289	N	N	N	N	N	N	N	N	N	N	0
5290(FL)	Y	Y	Y	Y	Y	Y	Y	Y	Y	Y	100
5291	Y	Y	Y	Y	Y	Y	Y	Y	Y	Y	100
5292	Y	Y	Y	Y	Y	Y	Y	Y	Y	Y	100
5293	Y	Y	Y	Y	Y	Y	Y	Y	Y	Y	100
5294	Y	Y	Y	Y	Y	Y	Y	Y	Y	Y	100
5295	Y	Y	Y	Y	Y	Y	Y	Y	Y	Y	100
5296	Y	Y	Y	Y	Y	Y	Y	Y	Y	Y	100
5297	Y	Y	Y	Y	Y	Y	Y	Y	Y	Y	100
5298	Y	Y	Y	Y	Y	Y	Y	Y	Y	Y	100
5299	Y	Y	Y	Y	Y	Y	Y	Y	Y	Y	100
5300	Y	Y	Y	Y	Y	Y	Y	Y	Y	Y	100
5301	Y	Y	Y	Y	Y	Y	Y	Y	Y	Y	100
5302	Y	Y	Y	Y	Y	Y	Y	Y	Y	Y	100
5303	Y	Y	Y	Y	Y	Y	Y	Y	Y	Y	100
5304	Y	Y	Y	Y	Y	Y	Y	Y	Y	Y	100
5305	Y	Y	Y	Y	Y	Y	Y	Y	Y	Y	100
5306	Y	Y	Y	Y	Y	Y	Y	Y	Y	Y	100
5307	Y	Y	Y	Y	Y	Y	Y	Y	Y	Y	100
5308	Y	Y	Y	Y	Y	Y	Y	Y	Y	Y	100
5309	Y	Y	Y	Y	Y	Y	Y	Y	Y	Y	100
5310(FH)	Y	Y	Y	Y	Y	Y	Y	Y	Y	Y	100
5311	N	N	N	N	N	N	N	N	N	N	0

Detection Bandwidth Test - IEEE 802.11ac VHT40											
Radar Type 0											
EUT Frequency: 5310MHz											
EUT 99% Power bandwidth: 37.11MHz											
Detection bandwidth limit (100% of EUT 99% Power bandwidth): 37.11MHz											
Detection bandwidth (5330(FH) – 5290(FL)) : 40MHz											
Test Result : PASS											
Radar Frequency (MHz)	Trial Number / Detection										Detection Rate (%)
	1	2	3	4	5	6	7	8	9	10	
5289	N	N	N	N	N	N	N	N	N	N	0
5290(FL)	Y	Y	Y	Y	Y	Y	Y	Y	Y	Y	100
5291	Y	Y	Y	Y	Y	Y	Y	Y	Y	Y	100
5292	Y	Y	Y	Y	Y	Y	Y	Y	Y	Y	100
5293	Y	Y	Y	Y	Y	Y	Y	Y	Y	Y	100
5294	Y	Y	Y	Y	Y	Y	Y	Y	Y	Y	100
5295	Y	Y	Y	Y	Y	Y	Y	Y	Y	Y	100
5296	Y	Y	Y	Y	Y	Y	Y	Y	Y	Y	100
5297	Y	Y	Y	Y	Y	Y	Y	Y	Y	Y	100
5298	Y	Y	Y	Y	Y	Y	Y	Y	Y	Y	100
5299	Y	Y	Y	Y	Y	Y	Y	Y	Y	Y	100
5300	Y	Y	Y	Y	Y	Y	Y	Y	Y	Y	100
5301	Y	Y	Y	Y	Y	Y	Y	Y	Y	Y	100
5302	Y	Y	Y	Y	Y	Y	Y	Y	Y	Y	100
5303	Y	Y	Y	Y	Y	Y	Y	Y	Y	Y	100
5304	Y	Y	Y	Y	Y	Y	Y	Y	Y	Y	100
5305	Y	Y	Y	Y	Y	Y	Y	Y	Y	Y	100
5306	Y	Y	Y	Y	Y	Y	Y	Y	Y	Y	100
5307	Y	Y	Y	Y	Y	Y	Y	Y	Y	Y	100
5308	Y	Y	Y	Y	Y	Y	Y	Y	Y	Y	100
5309	Y	Y	Y	Y	Y	Y	Y	Y	Y	Y	100
5310	Y	Y	Y	Y	Y	Y	Y	Y	Y	Y	100
5311	Y	Y	Y	Y	Y	Y	Y	Y	Y	Y	100
5312	Y	Y	Y	Y	Y	Y	Y	Y	Y	Y	100
5313	Y	Y	Y	Y	Y	Y	Y	Y	Y	Y	100
5314	Y	Y	Y	Y	Y	Y	Y	Y	Y	Y	100
5315	Y	Y	Y	Y	Y	Y	Y	Y	Y	Y	100
5316	Y	Y	Y	Y	Y	Y	Y	Y	Y	Y	100
5317	Y	Y	Y	Y	Y	Y	Y	Y	Y	Y	100
5318	Y	Y	Y	Y	Y	Y	Y	Y	Y	Y	100
5319	Y	Y	Y	Y	Y	Y	Y	Y	Y	Y	100
5320	Y	Y	Y	Y	Y	Y	Y	Y	Y	Y	100
5321	Y	Y	Y	Y	Y	Y	Y	Y	Y	Y	100
5322	Y	Y	Y	Y	Y	Y	Y	Y	Y	Y	100
5323	Y	Y	Y	Y	Y	Y	Y	Y	Y	Y	100
5324	Y	Y	Y	Y	Y	Y	Y	Y	Y	Y	100
5325	Y	Y	Y	Y	Y	Y	Y	Y	Y	Y	100
5326	Y	Y	Y	Y	Y	Y	Y	Y	Y	Y	100
5327	Y	Y	Y	Y	Y	Y	Y	Y	Y	Y	100
5328	Y	Y	Y	Y	Y	Y	Y	Y	Y	Y	100
5329	Y	Y	Y	Y	Y	Y	Y	Y	Y	Y	100
5330(FH)	Y	Y	Y	Y	Y	Y	Y	Y	Y	Y	100
5331	N	N	N	N	N	N	N	N	N	N	0

Detection Bandwidth Test - IEEE 802.11ac VHT80											
Radar Type 0											
EUT Frequency: 5290MHz											
EUT 99% Power bandwidth: 75.80MHz											
Detection bandwidth limit (100% of EUT 99% Power bandwidth): 75.80MHz											
Detection bandwidth (5330(FH) – 5250(FL)) : 80MHz											
Test Result : PASS											
Radar Frequency (MHz)	Trial Number / Detection										Detection Rate (%)
	1	2	3	4	5	6	7	8	9	10	
5249	N	N	N	N	N	N	N	N	N	N	0
5250(FL)	Y	Y	Y	Y	Y	Y	Y	Y	Y	Y	100
5251	Y	Y	Y	Y	Y	Y	Y	Y	Y	Y	100
5252	Y	Y	Y	Y	Y	Y	Y	Y	Y	Y	100
5253	Y	Y	Y	Y	Y	Y	Y	Y	Y	Y	100
5254	Y	Y	Y	Y	Y	Y	Y	Y	Y	Y	100
5255	Y	Y	Y	Y	Y	Y	Y	Y	Y	Y	100
5256	Y	Y	Y	Y	Y	Y	Y	Y	Y	Y	100
5257	Y	Y	Y	Y	Y	Y	Y	Y	Y	Y	100
5258	Y	Y	Y	Y	Y	Y	Y	Y	Y	Y	100
5259	Y	Y	Y	Y	Y	Y	Y	Y	Y	Y	100
5260	Y	Y	Y	Y	Y	Y	Y	Y	Y	Y	100
5261	Y	Y	Y	Y	Y	Y	Y	Y	Y	Y	100
5262	Y	Y	Y	Y	Y	Y	Y	Y	Y	Y	100
5263	Y	Y	Y	Y	Y	Y	Y	Y	Y	Y	100
5264	Y	Y	Y	Y	Y	Y	Y	Y	Y	Y	100
5265	Y	Y	Y	Y	Y	Y	Y	Y	Y	Y	100
5266	Y	Y	Y	Y	Y	Y	Y	Y	Y	Y	100
5267	Y	Y	Y	Y	Y	Y	Y	Y	Y	Y	100
5268	Y	Y	Y	Y	Y	Y	Y	Y	Y	Y	100
5269	Y	Y	Y	Y	Y	Y	Y	Y	Y	Y	100
5270	Y	Y	Y	Y	Y	Y	Y	Y	Y	Y	100
5271	Y	Y	Y	Y	Y	Y	Y	Y	Y	Y	100
5272	Y	Y	Y	Y	Y	Y	Y	Y	Y	Y	100
5273	Y	Y	Y	Y	Y	Y	Y	Y	Y	Y	100
5274	Y	Y	Y	Y	Y	Y	Y	Y	Y	Y	100
5275	Y	Y	Y	Y	Y	Y	Y	Y	Y	Y	100
5276	Y	Y	Y	Y	Y	Y	Y	Y	Y	Y	100
5277	Y	Y	Y	Y	Y	Y	Y	Y	Y	Y	100
5278	Y	Y	Y	Y	Y	Y	Y	Y	Y	Y	100
5279	Y	Y	Y	Y	Y	Y	Y	Y	Y	Y	100
5280	Y	Y	Y	Y	Y	Y	Y	Y	Y	Y	100
5281	Y	Y	Y	Y	Y	Y	Y	Y	Y	Y	100
5282	Y	Y	Y	Y	Y	Y	Y	Y	Y	Y	100
5283	Y	Y	Y	Y	Y	Y	Y	Y	Y	Y	100
5284	Y	Y	Y	Y	Y	Y	Y	Y	Y	Y	100
5285	Y	Y	Y	Y	Y	Y	Y	Y	Y	Y	100
5286	Y	Y	Y	Y	Y	Y	Y	Y	Y	Y	100
5287	Y	Y	Y	Y	Y	Y	Y	Y	Y	Y	100
5288	Y	Y	Y	Y	Y	Y	Y	Y	Y	Y	100
5289	Y	Y	Y	Y	Y	Y	Y	Y	Y	Y	100
5290	Y	Y	Y	Y	Y	Y	Y	Y	Y	Y	100
5291	Y	Y	Y	Y	Y	Y	Y	Y	Y	Y	100

5292	Y	Y	Y	Y	Y	Y	Y	Y	Y	Y	100
5293	Y	Y	Y	Y	Y	Y	Y	Y	Y	Y	100
5294	Y	Y	Y	Y	Y	Y	Y	Y	Y	Y	100
5295	Y	Y	Y	Y	Y	Y	Y	Y	Y	Y	100
5296	Y	Y	Y	Y	Y	Y	Y	Y	Y	Y	100
5297	Y	Y	Y	Y	Y	Y	Y	Y	Y	Y	100
5298	Y	Y	Y	Y	Y	Y	Y	Y	Y	Y	100
5299	Y	Y	Y	Y	Y	Y	Y	Y	Y	Y	100
5300	Y	Y	Y	Y	Y	Y	Y	Y	Y	Y	100
5301	Y	Y	Y	Y	Y	Y	Y	Y	Y	Y	100
5302	Y	Y	Y	Y	Y	Y	Y	Y	Y	Y	100
5303	Y	Y	Y	Y	Y	Y	Y	Y	Y	Y	100
5304	Y	Y	Y	Y	Y	Y	Y	Y	Y	Y	100
5305	Y	Y	Y	Y	Y	Y	Y	Y	Y	Y	100
5306	Y	Y	Y	Y	Y	Y	Y	Y	Y	Y	100
5307	Y	Y	Y	Y	Y	Y	Y	Y	Y	Y	100
5308	Y	Y	Y	Y	Y	Y	Y	Y	Y	Y	100
5309	Y	Y	Y	Y	Y	Y	Y	Y	Y	Y	100
5310	Y	Y	Y	Y	Y	Y	Y	Y	Y	Y	100
5311	Y	Y	Y	Y	Y	Y	Y	Y	Y	Y	100
5312	Y	Y	Y	Y	Y	Y	Y	Y	Y	Y	100
5313	Y	Y	Y	Y	Y	Y	Y	Y	Y	Y	100
5314	Y	Y	Y	Y	Y	Y	Y	Y	Y	Y	100
5315	Y	Y	Y	Y	Y	Y	Y	Y	Y	Y	100
5316	Y	Y	Y	Y	Y	Y	Y	Y	Y	Y	100
5317	Y	Y	Y	Y	Y	Y	Y	Y	Y	Y	100
5318	Y	Y	Y	Y	Y	Y	Y	Y	Y	Y	100
5319	Y	Y	Y	Y	Y	Y	Y	Y	Y	Y	100
5320	Y	Y	Y	Y	Y	Y	Y	Y	Y	Y	100
5321	Y	Y	Y	Y	Y	Y	Y	Y	Y	Y	100
5322	Y	Y	Y	Y	Y	Y	Y	Y	Y	Y	100
5323	Y	Y	Y	Y	Y	Y	Y	Y	Y	Y	100
5324	Y	Y	Y	Y	Y	Y	Y	Y	Y	Y	100
5325	Y	Y	Y	Y	Y	Y	Y	Y	Y	Y	100
5326	Y	Y	Y	Y	Y	Y	Y	Y	Y	Y	100
5327	Y	Y	Y	Y	Y	Y	Y	Y	Y	Y	100
5328	Y	Y	Y	Y	Y	Y	Y	Y	Y	Y	100
5329	Y	Y	Y	Y	Y	Y	Y	Y	Y	Y	100
5330(FH)	Y	Y	Y	Y	Y	Y	Y	Y	Y	Y	100
5331	N	N	N	N	N	N	N	N	N	N	0

RBS40

IEEE 802.11ac VHT20

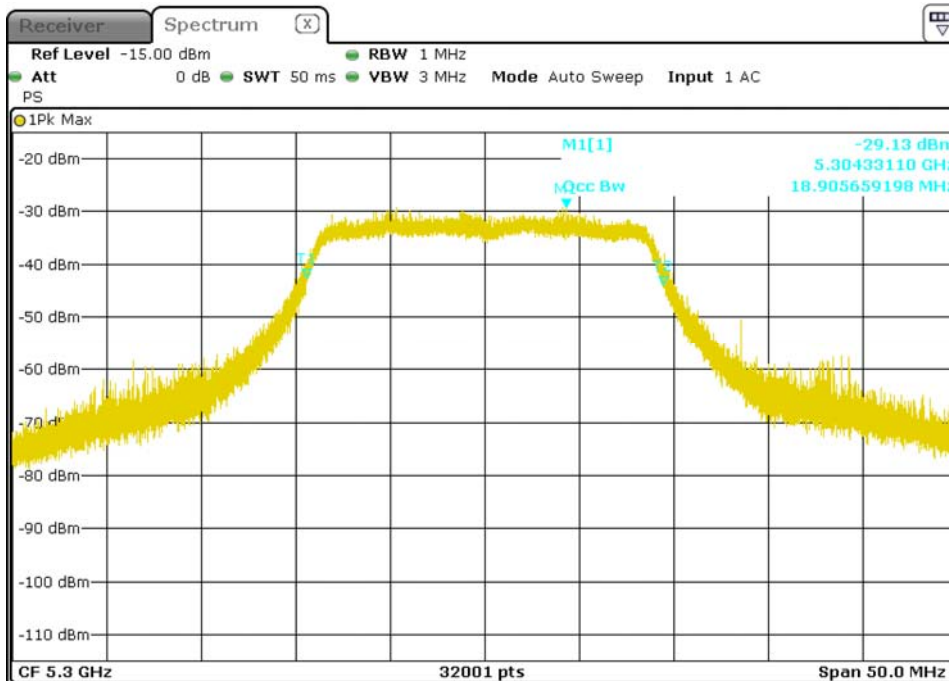

U-NII 99% Channel bandwidth

IEEE 802.11ac VHT40

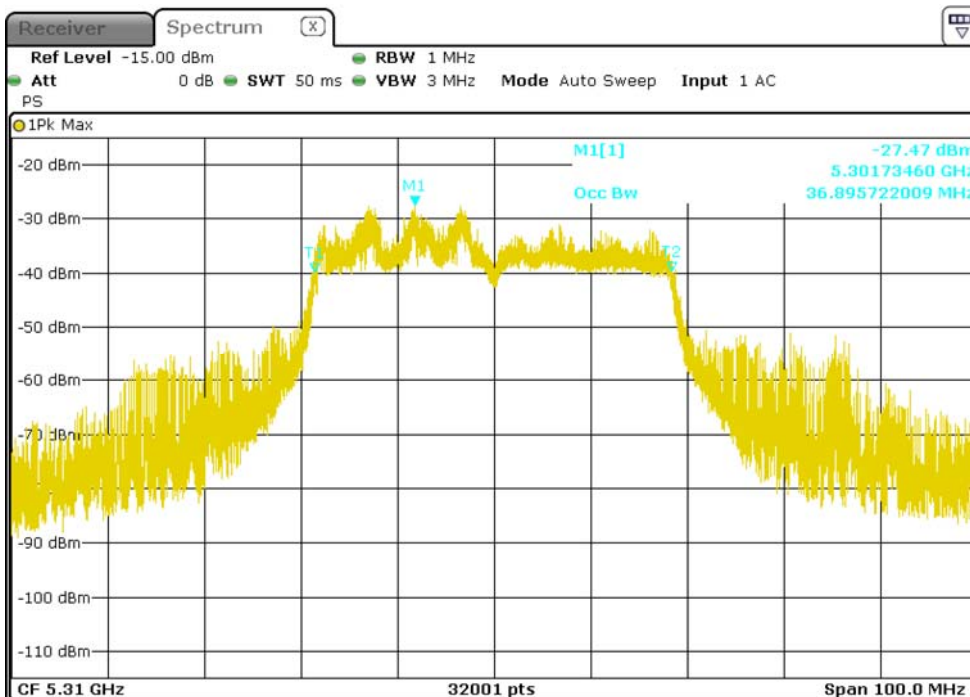

U-NII 99% Channel bandwidth

IEEE 802.11ac VHT80

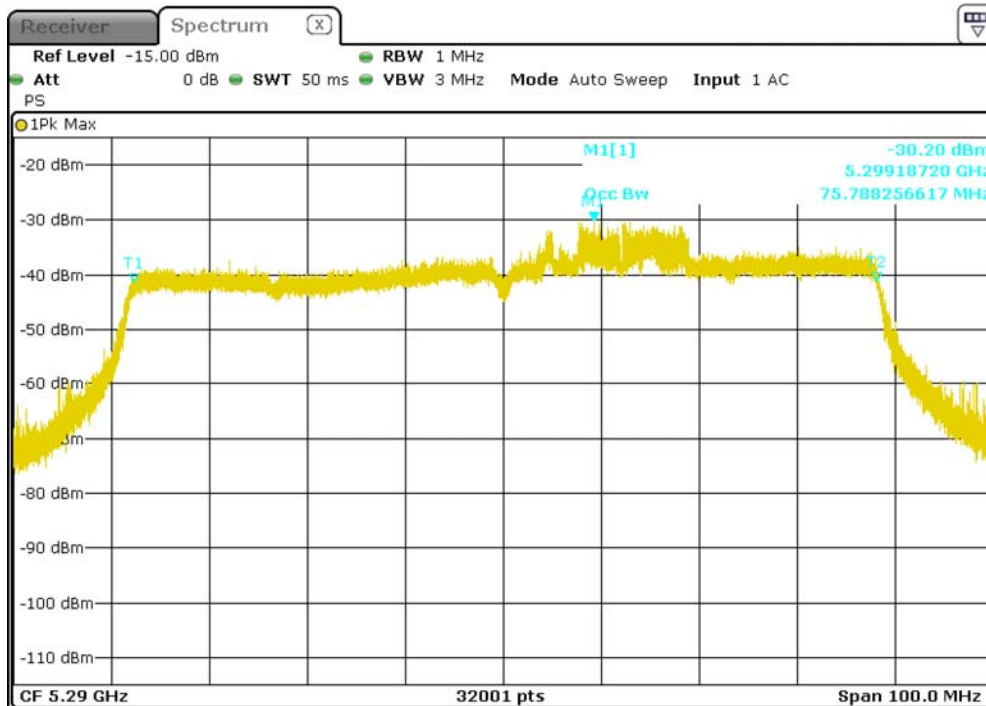

U-NII 99% Channel bandwidth

Detection Bandwidth Test - IEEE 802.11ac VHT20											
Radar Type 0											
EUT Frequency: 5300MHz											
EUT 99% Power bandwidth: 18.90MHz											
Detection bandwidth limit (100% of EUT 99% Power bandwidth): 18.90MHz											
Detection bandwidth (5310(FH) – 5290(FL)) : 20MHz											
Test Result : PASS											
Radar Frequency (MHz)	Trial Number / Detection										Detection Rate (%)
	1	2	3	4	5	6	7	8	9	10	
5289	N	N	N	N	N	N	N	N	N	N	0
5290(FL)	Y	Y	Y	Y	Y	Y	Y	Y	Y	Y	100
5291	Y	Y	Y	Y	Y	Y	Y	Y	Y	Y	100
5292	Y	Y	Y	Y	Y	Y	Y	Y	Y	Y	100
5293	Y	Y	Y	Y	Y	Y	Y	Y	Y	Y	100
5294	Y	Y	Y	Y	Y	Y	Y	Y	Y	Y	100
5295	Y	Y	Y	Y	Y	Y	Y	Y	Y	Y	100
5296	Y	Y	Y	Y	Y	Y	Y	Y	Y	Y	100
5297	Y	Y	Y	Y	Y	Y	Y	Y	Y	Y	100
5298	Y	Y	Y	Y	Y	Y	Y	Y	Y	Y	100
5299	Y	Y	Y	Y	Y	Y	Y	Y	Y	Y	100
5300	Y	Y	Y	Y	Y	Y	Y	Y	Y	Y	100
5301	Y	Y	Y	Y	Y	Y	Y	Y	Y	Y	100
5302	Y	Y	Y	Y	Y	Y	Y	Y	Y	Y	100
5303	Y	Y	Y	Y	Y	Y	Y	Y	Y	Y	100
5304	Y	Y	Y	Y	Y	Y	Y	Y	Y	Y	100
5305	Y	Y	Y	Y	Y	Y	Y	Y	Y	Y	100
5306	Y	Y	Y	Y	Y	Y	Y	Y	Y	Y	100
5307	Y	Y	Y	Y	Y	Y	Y	Y	Y	Y	100
5308	Y	Y	Y	Y	Y	Y	Y	Y	Y	Y	100
5309	Y	Y	Y	Y	Y	Y	Y	Y	Y	Y	100
5310(FH)	Y	Y	Y	Y	Y	Y	Y	Y	Y	Y	100
5311	N	N	N	N	N	N	N	N	N	N	0

Detection Bandwidth Test - IEEE 802.11ac VHT40											
Radar Type 0											
EUT Frequency: 5310MHz											
EUT 99% Power bandwidth: 36.89MHz											
Detection bandwidth limit (100% of EUT 99% Power bandwidth): 36.89MHz											
Detection bandwidth (5330(FH) – 5290(FL)) : 40MHz											
Test Result : PASS											
Radar Frequency (MHz)	Trial Number / Detection										Detection Rate (%)
	1	2	3	4	5	6	7	8	9	10	
5289	N	N	N	N	N	N	N	N	N	N	0
5290(FL)	Y	Y	Y	Y	Y	Y	Y	Y	Y	Y	100
5291	Y	Y	Y	Y	Y	Y	Y	Y	Y	Y	100
5292	Y	Y	Y	Y	Y	Y	Y	Y	Y	Y	100
5293	Y	Y	Y	Y	Y	Y	Y	Y	Y	Y	100
5294	Y	Y	Y	Y	Y	Y	Y	Y	Y	Y	100
5295	Y	Y	Y	Y	Y	Y	Y	Y	Y	Y	100
5296	Y	Y	Y	Y	Y	Y	Y	Y	Y	Y	100
5297	Y	Y	Y	Y	Y	Y	Y	Y	Y	Y	100
5298	Y	Y	Y	Y	Y	Y	Y	Y	Y	Y	100
5299	Y	Y	Y	Y	Y	Y	Y	Y	Y	Y	100
5300	Y	Y	Y	Y	Y	Y	Y	Y	Y	Y	100
5301	Y	Y	Y	Y	Y	Y	Y	Y	Y	Y	100
5302	Y	Y	Y	Y	Y	Y	Y	Y	Y	Y	100
5303	Y	Y	Y	Y	Y	Y	Y	Y	Y	Y	100
5304	Y	Y	Y	Y	Y	Y	Y	Y	Y	Y	100
5305	Y	Y	Y	Y	Y	Y	Y	Y	Y	Y	100
5306	Y	Y	Y	Y	Y	Y	Y	Y	Y	Y	100
5307	Y	Y	Y	Y	Y	Y	Y	Y	Y	Y	100
5308	Y	Y	Y	Y	Y	Y	Y	Y	Y	Y	100
5309	Y	Y	Y	Y	Y	Y	Y	Y	Y	Y	100
5310	Y	Y	Y	Y	Y	Y	Y	Y	Y	Y	100
5311	Y	Y	Y	Y	Y	Y	Y	Y	Y	Y	100
5312	Y	Y	Y	Y	Y	Y	Y	Y	Y	Y	100
5313	Y	Y	Y	Y	Y	Y	Y	Y	Y	Y	100
5314	Y	Y	Y	Y	Y	Y	Y	Y	Y	Y	100
5315	Y	Y	Y	Y	Y	Y	Y	Y	Y	Y	100
5316	Y	Y	Y	Y	Y	Y	Y	Y	Y	Y	100
5317	Y	Y	Y	Y	Y	Y	Y	Y	Y	Y	100
5318	Y	Y	Y	Y	Y	Y	Y	Y	Y	Y	100
5319	Y	Y	Y	Y	Y	Y	Y	Y	Y	Y	100
5320	Y	Y	Y	Y	Y	Y	Y	Y	Y	Y	100
5321	Y	Y	Y	Y	Y	Y	Y	Y	Y	Y	100
5322	Y	Y	Y	Y	Y	Y	Y	Y	Y	Y	100
5323	Y	Y	Y	Y	Y	Y	Y	Y	Y	Y	100
5324	Y	Y	Y	Y	Y	Y	Y	Y	Y	Y	100
5325	Y	Y	Y	Y	Y	Y	Y	Y	Y	Y	100
5326	Y	Y	Y	Y	Y	Y	Y	Y	Y	Y	100
5327	Y	Y	Y	Y	Y	Y	Y	Y	Y	Y	100
5328	Y	Y	Y	Y	Y	Y	Y	Y	Y	Y	100
5329	Y	Y	Y	Y	Y	Y	Y	Y	Y	Y	100
5330(FH)	Y	Y	Y	Y	Y	Y	Y	Y	Y	Y	100
5331	N	N	N	N	N	N	N	N	N	N	0

Detection Bandwidth Test - IEEE 802.11ac VHT80											
Radar Type 0											
EUT Frequency: 5290MHz											
EUT 99% Power bandwidth: 75.78MHz											
Detection bandwidth limit (100% of EUT 99% Power bandwidth): 75.78MHz											
Detection bandwidth (5330(FH) – 5250(FL)) : 80MHz											
Test Result : PASS											
Radar Frequency (MHz)	Trial Number / Detection										Detection Rate (%)
	1	2	3	4	5	6	7	8	9	10	
5249	N	N	N	N	N	N	N	N	N	N	0
5250(FL)	Y	Y	Y	Y	Y	Y	Y	Y	Y	Y	100
5251	Y	Y	Y	Y	Y	Y	Y	Y	Y	Y	100
5252	Y	Y	Y	Y	Y	Y	Y	Y	Y	Y	100
5253	Y	Y	Y	Y	Y	Y	Y	Y	Y	Y	100
5254	Y	Y	Y	Y	Y	Y	Y	Y	Y	Y	100
5255	Y	Y	Y	Y	Y	Y	Y	Y	Y	Y	100
5256	Y	Y	Y	Y	Y	Y	Y	Y	Y	Y	100
5257	Y	Y	Y	Y	Y	Y	Y	Y	Y	Y	100
5258	Y	Y	Y	Y	Y	Y	Y	Y	Y	Y	100
5259	Y	Y	Y	Y	Y	Y	Y	Y	Y	Y	100
5260	Y	Y	Y	Y	Y	Y	Y	Y	Y	Y	100
5261	Y	Y	Y	Y	Y	Y	Y	Y	Y	Y	100
5262	Y	Y	Y	Y	Y	Y	Y	Y	Y	Y	100
5263	Y	Y	Y	Y	Y	Y	Y	Y	Y	Y	100
5264	Y	Y	Y	Y	Y	Y	Y	Y	Y	Y	100
5265	Y	Y	Y	Y	Y	Y	Y	Y	Y	Y	100
5266	Y	Y	Y	Y	Y	Y	Y	Y	Y	Y	100
5267	Y	Y	Y	Y	Y	Y	Y	Y	Y	Y	100
5268	Y	Y	Y	Y	Y	Y	Y	Y	Y	Y	100
5269	Y	Y	Y	Y	Y	Y	Y	Y	Y	Y	100
5270	Y	Y	Y	Y	Y	Y	Y	Y	Y	Y	100
5271	Y	Y	Y	Y	Y	Y	Y	Y	Y	Y	100
5272	Y	Y	Y	Y	Y	Y	Y	Y	Y	Y	100
5273	Y	Y	Y	Y	Y	Y	Y	Y	Y	Y	100
5274	Y	Y	Y	Y	Y	Y	Y	Y	Y	Y	100
5275	Y	Y	Y	Y	Y	Y	Y	Y	Y	Y	100
5276	Y	Y	Y	Y	Y	Y	Y	Y	Y	Y	100
5277	Y	Y	Y	Y	Y	Y	Y	Y	Y	Y	100
5278	Y	Y	Y	Y	Y	Y	Y	Y	Y	Y	100
5279	Y	Y	Y	Y	Y	Y	Y	Y	Y	Y	100
5280	Y	Y	Y	Y	Y	Y	Y	Y	Y	Y	100
5281	Y	Y	Y	Y	Y	Y	Y	Y	Y	Y	100
5282	Y	Y	Y	Y	Y	Y	Y	Y	Y	Y	100
5283	Y	Y	Y	Y	Y	Y	Y	Y	Y	Y	100
5284	Y	Y	Y	Y	Y	Y	Y	Y	Y	Y	100
5285	Y	Y	Y	Y	Y	Y	Y	Y	Y	Y	100
5286	Y	Y	Y	Y	Y	Y	Y	Y	Y	Y	100
5287	Y	Y	Y	Y	Y	Y	Y	Y	Y	Y	100
5288	Y	Y	Y	Y	Y	Y	Y	Y	Y	Y	100
5289	Y	Y	Y	Y	Y	Y	Y	Y	Y	Y	100
5290	Y	Y	Y	Y	Y	Y	Y	Y	Y	Y	100
5291	Y	Y	Y	Y	Y	Y	Y	Y	Y	Y	100
5292	Y	Y	Y	Y	Y	Y	Y	Y	Y	Y	100

5293	Y	Y	Y	Y	Y	Y	Y	Y	Y	Y	100
5294	Y	Y	Y	Y	Y	Y	Y	Y	Y	Y	100
5295	Y	Y	Y	Y	Y	Y	Y	Y	Y	Y	100
5296	Y	Y	Y	Y	Y	Y	Y	Y	Y	Y	100
5297	Y	Y	Y	Y	Y	Y	Y	Y	Y	Y	100
5298	Y	Y	Y	Y	Y	Y	Y	Y	Y	Y	100
5299	Y	Y	Y	Y	Y	Y	Y	Y	Y	Y	100
5300	Y	Y	Y	Y	Y	Y	Y	Y	Y	Y	100
5301	Y	Y	Y	Y	Y	Y	Y	Y	Y	Y	100
5302	Y	Y	Y	Y	Y	Y	Y	Y	Y	Y	100
5303	Y	Y	Y	Y	Y	Y	Y	Y	Y	Y	100
5304	Y	Y	Y	Y	Y	Y	Y	Y	Y	Y	100
5305	Y	Y	Y	Y	Y	Y	Y	Y	Y	Y	100
5306	Y	Y	Y	Y	Y	Y	Y	Y	Y	Y	100
5307	Y	Y	Y	Y	Y	Y	Y	Y	Y	Y	100
5308	Y	Y	Y	Y	Y	Y	Y	Y	Y	Y	100
5309	Y	Y	Y	Y	Y	Y	Y	Y	Y	Y	100
5310	Y	Y	Y	Y	Y	Y	Y	Y	Y	Y	100
5311	Y	Y	Y	Y	Y	Y	Y	Y	Y	Y	100
5312	Y	Y	Y	Y	Y	Y	Y	Y	Y	Y	100
5313	Y	Y	Y	Y	Y	Y	Y	Y	Y	Y	100
5314	Y	Y	Y	Y	Y	Y	Y	Y	Y	Y	100
5315	Y	Y	Y	Y	Y	Y	Y	Y	Y	Y	100
5316	Y	Y	Y	Y	Y	Y	Y	Y	Y	Y	100
5317	Y	Y	Y	Y	Y	Y	Y	Y	Y	Y	100
5318	Y	Y	Y	Y	Y	Y	Y	Y	Y	Y	100
5319	Y	Y	Y	Y	Y	Y	Y	Y	Y	Y	100
5320	Y	Y	Y	Y	Y	Y	Y	Y	Y	Y	100
5321	Y	Y	Y	Y	Y	Y	Y	Y	Y	Y	100
5322	Y	Y	Y	Y	Y	Y	Y	Y	Y	Y	100
5323	Y	Y	Y	Y	Y	Y	Y	Y	Y	Y	100
5324	Y	Y	Y	Y	Y	Y	Y	Y	Y	Y	100
5325	Y	Y	Y	Y	Y	Y	Y	Y	Y	Y	100
5326	Y	Y	Y	Y	Y	Y	Y	Y	Y	Y	100
5327	Y	Y	Y	Y	Y	Y	Y	Y	Y	Y	100
5328	Y	Y	Y	Y	Y	Y	Y	Y	Y	Y	100
5329	Y	Y	Y	Y	Y	Y	Y	Y	Y	Y	100
5330(FH)	Y	Y	Y	Y	Y	Y	Y	Y	Y	Y	100
5331	N	N	N	N	N	N	N	N	N	N	0

For 5470~5725MHz

IEEE 802.11ac VHT20

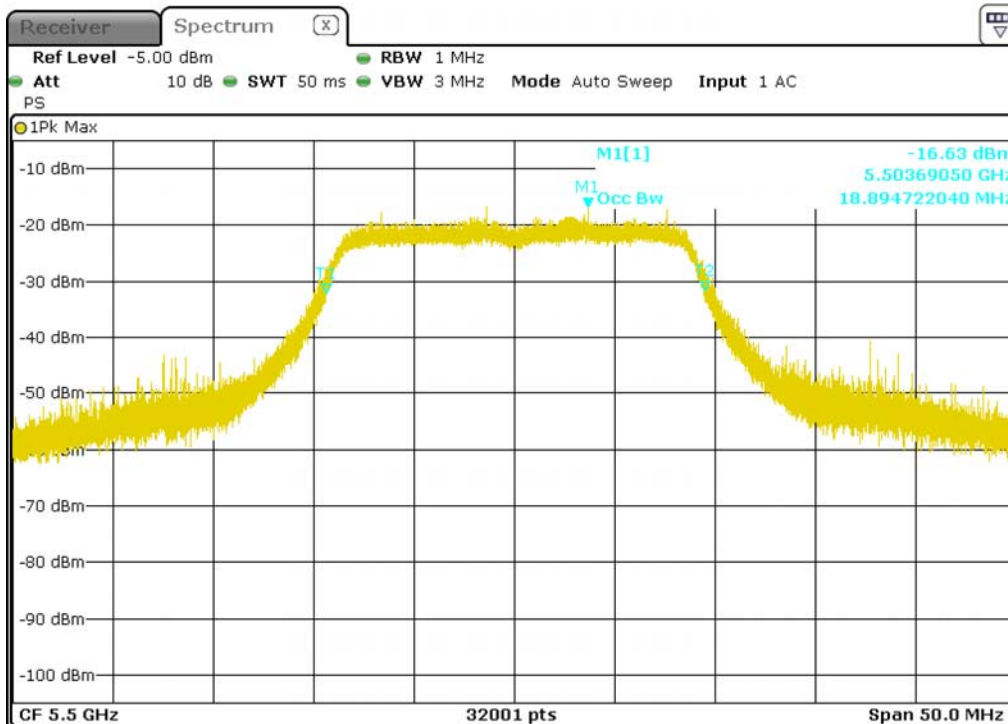

U-NII 99% Channel bandwidth

IEEE 802.11ac VHT40

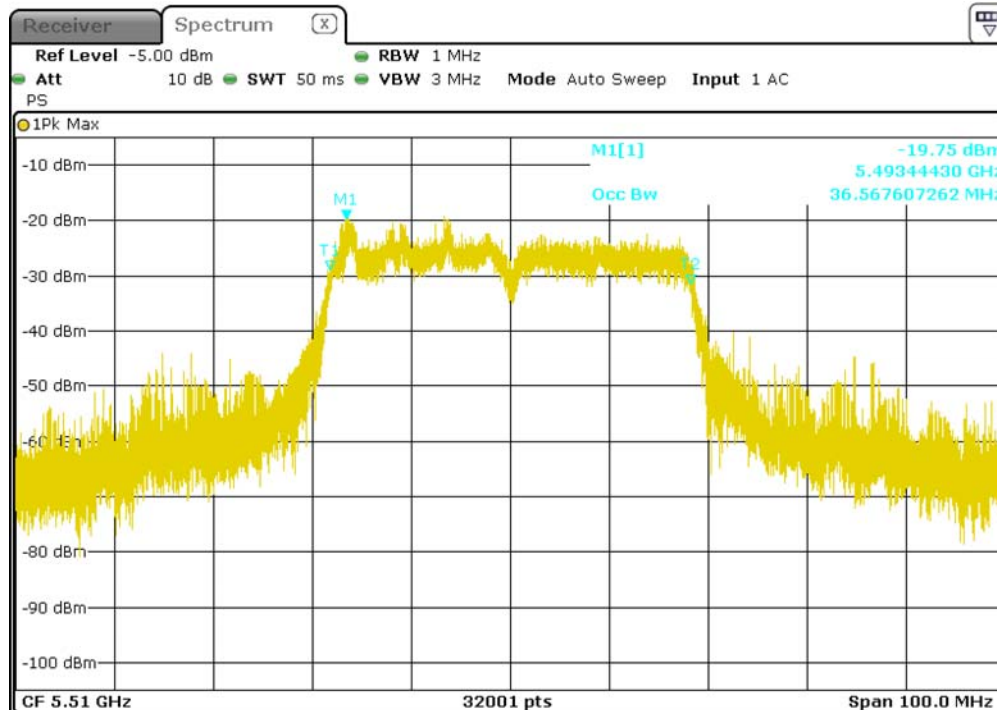

U-NII 99% Channel bandwidth

IEEE 802.11ac VHT80

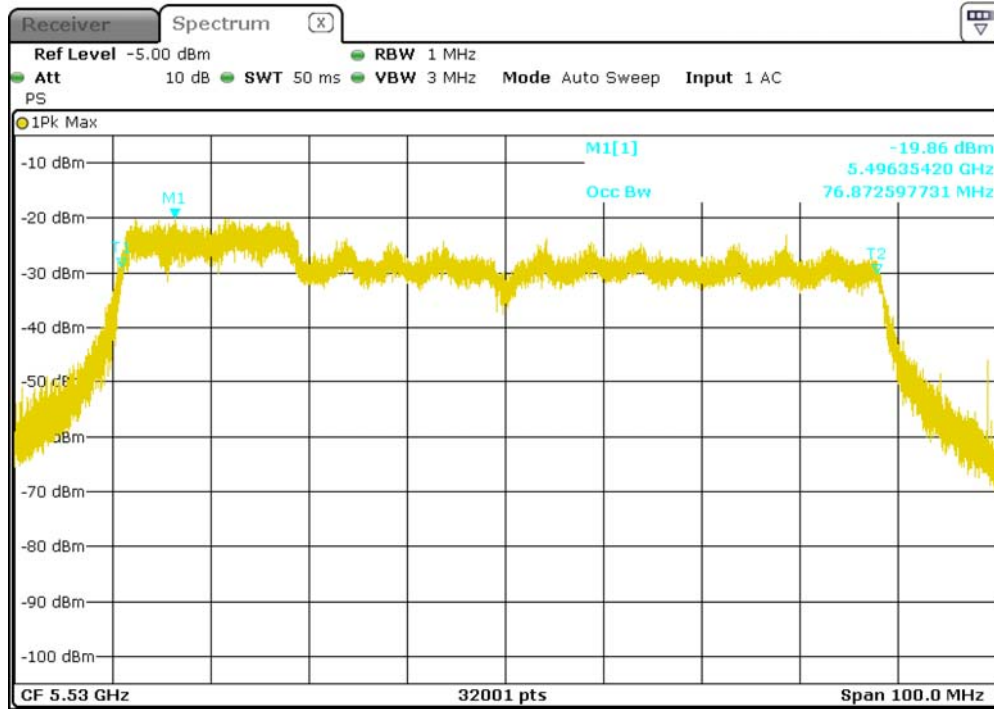

U-NII 99% Channel bandwidth

Detection Bandwidth Test - IEEE 802.11ac VHT20											
Radar Type 0											
EUT Frequency: 5500MHz											
EUT 99% Power bandwidth: 17.71MHz											
Detection bandwidth limit (100% of EUT 99% Power bandwidth): 17.71MHz											
Detection bandwidth (5510(FH) – 5490(FL)) : 20MHz											
Test Result : PASS											
Radar Frequency (MHz)	Trial Number / Detection										Detection Rate (%)
	1	2	3	4	5	6	7	8	9	10	
5489	N	N	N	N	N	N	N	N	N	N	0
5490(FL)	Y	Y	Y	Y	Y	Y	Y	Y	Y	Y	100
5491	Y	Y	Y	Y	Y	Y	Y	Y	Y	Y	100
5492	Y	Y	Y	Y	Y	Y	Y	Y	Y	Y	100
5493	Y	Y	Y	Y	Y	Y	Y	Y	Y	Y	100
5494	Y	Y	Y	Y	Y	Y	Y	Y	Y	Y	100
5495	Y	Y	Y	Y	Y	Y	Y	Y	Y	Y	100
5496	Y	Y	Y	Y	Y	Y	Y	Y	Y	Y	100
5497	Y	Y	Y	Y	Y	Y	Y	Y	Y	Y	100
5498	Y	Y	Y	Y	Y	Y	Y	Y	Y	Y	100
5499	Y	Y	Y	Y	Y	Y	Y	Y	Y	Y	100
5500	Y	Y	Y	Y	Y	Y	Y	Y	Y	Y	100
5501	Y	Y	Y	Y	Y	Y	Y	Y	Y	Y	100
5502	Y	Y	Y	Y	Y	Y	Y	Y	Y	Y	100
5503	Y	Y	Y	Y	Y	Y	Y	Y	Y	Y	100
5504	Y	Y	Y	Y	Y	Y	Y	Y	Y	Y	100
5505	Y	Y	Y	Y	Y	Y	Y	Y	Y	Y	100
5506	Y	Y	Y	Y	Y	Y	Y	Y	Y	Y	100
5507	Y	Y	Y	Y	Y	Y	Y	Y	Y	Y	100
5508	Y	Y	Y	Y	Y	Y	Y	Y	Y	Y	100
5509	Y	Y	Y	Y	Y	Y	Y	Y	Y	Y	100
5510(FH)	Y	Y	Y	Y	Y	Y	Y	Y	Y	Y	100
5511	N	N	N	N	N	N	N	N	N	N	0

Detection Bandwidth Test - IEEE 802.11ac VHT40											
Radar Type 0											
EUT Frequency: 5510MHz											
EUT 99% Power bandwidth: 37.72MHz											
Detection bandwidth limit (100% of EUT 99% Power bandwidth): 37.72MHz											
Detection bandwidth (5530(FH) – 5490(FL)) : 40MHz											
Test Result : PASS											
Radar Frequency (MHz)	Trial Number / Detection										Detection Rate (%)
	1	2	3	4	5	6	7	8	9	10	
5489	N	N	N	N	N	N	N	N	N	N	0
5490(FL)	Y	Y	Y	Y	Y	Y	Y	Y	Y	Y	100
5491	Y	Y	Y	Y	Y	Y	Y	Y	Y	Y	100
5492	Y	Y	Y	Y	Y	Y	Y	Y	Y	Y	100
5493	Y	Y	Y	Y	Y	Y	Y	Y	Y	Y	100
5494	Y	Y	Y	Y	Y	Y	Y	Y	Y	Y	100
5495	Y	Y	Y	Y	Y	Y	Y	Y	Y	Y	100
5496	Y	Y	Y	Y	Y	Y	Y	Y	Y	Y	100
5497	Y	Y	Y	Y	Y	Y	Y	Y	Y	Y	100
5498	Y	Y	Y	Y	Y	Y	Y	Y	Y	Y	100
5499	Y	Y	Y	Y	Y	Y	Y	Y	Y	Y	100
5500	Y	Y	Y	Y	Y	Y	Y	Y	Y	Y	100
5501	Y	Y	Y	Y	Y	Y	Y	Y	Y	Y	100
5502	Y	Y	Y	Y	Y	Y	Y	Y	Y	Y	100
5503	Y	Y	Y	Y	Y	Y	Y	Y	Y	Y	100
5504	Y	Y	Y	Y	Y	Y	Y	Y	Y	Y	100
5505	Y	Y	Y	Y	Y	Y	Y	Y	Y	Y	100
5506	Y	Y	Y	Y	Y	Y	Y	Y	Y	Y	100
5507	Y	Y	Y	Y	Y	Y	Y	Y	Y	Y	100
5508	Y	Y	Y	Y	Y	Y	Y	Y	Y	Y	100
5509	Y	Y	Y	Y	Y	Y	Y	Y	Y	Y	100
5510	Y	Y	Y	Y	Y	Y	Y	Y	Y	Y	100
5511	Y	Y	Y	Y	Y	Y	Y	Y	Y	Y	100
5512	Y	Y	Y	Y	Y	Y	Y	Y	Y	Y	100
5513	Y	Y	Y	Y	Y	Y	Y	Y	Y	Y	100
5514	Y	Y	Y	Y	Y	Y	Y	Y	Y	Y	100
5515	Y	Y	Y	Y	Y	Y	Y	Y	Y	Y	100
5516	Y	Y	Y	Y	Y	Y	Y	Y	Y	Y	100
5517	Y	Y	Y	Y	Y	Y	Y	Y	Y	Y	100
5518	Y	Y	Y	Y	Y	Y	Y	Y	Y	Y	100
5519	Y	Y	Y	Y	Y	Y	Y	Y	Y	Y	100
5520	Y	Y	Y	Y	Y	Y	Y	Y	Y	Y	100
5521	Y	Y	Y	Y	Y	Y	Y	Y	Y	Y	100
5522	Y	Y	Y	Y	Y	Y	Y	Y	Y	Y	100
5523	Y	Y	Y	Y	Y	Y	Y	Y	Y	Y	100
5524	Y	Y	Y	Y	Y	Y	Y	Y	Y	Y	100
5525	Y	Y	Y	Y	Y	Y	Y	Y	Y	Y	100
5526	Y	Y	Y	Y	Y	Y	Y	Y	Y	Y	100
5527	Y	Y	Y	Y	Y	Y	Y	Y	Y	Y	100
5528	Y	Y	Y	Y	Y	Y	Y	Y	Y	Y	100
5529	Y	Y	Y	Y	Y	Y	Y	Y	Y	Y	100
5530(FH)	Y	Y	Y	Y	Y	Y	Y	Y	Y	Y	100
5531	N	N	N	N	N	N	N	N	N	N	0

Detection Bandwidth Test - IEEE 802.11ac VHT80											
Radar Type 0											
EUT Frequency: 5530MHz											
EUT 99% Power bandwidth: 75.98MHz											
Detection bandwidth limit (100% of EUT 99% Power bandwidth): 75.98MHz											
Detection bandwidth (5570(FH) – 5490(FL)) : 80MHz											
Test Result : PASS											
Radar Frequency (MHz)	Trial Number / Detection										Detection Rate (%)
	1	2	3	4	5	6	7	8	9	10	
5489	N	N	N	N	N	N	N	N	N	N	0
5490(FL)	Y	Y	Y	Y	Y	Y	Y	Y	Y	Y	100
5491	Y	Y	Y	Y	Y	Y	Y	Y	Y	Y	100
5492	Y	Y	Y	Y	Y	Y	Y	Y	Y	Y	100
5493	Y	Y	Y	Y	Y	Y	Y	Y	Y	Y	100
5494	Y	Y	Y	Y	Y	Y	Y	Y	Y	Y	100
5495	Y	Y	Y	Y	Y	Y	Y	Y	Y	Y	100
5496	Y	Y	Y	Y	Y	Y	Y	Y	Y	Y	100
5497	Y	Y	Y	Y	Y	Y	Y	Y	Y	Y	100
5498	Y	Y	Y	Y	Y	Y	Y	Y	Y	Y	100
5499	Y	Y	Y	Y	Y	Y	Y	Y	Y	Y	100
5500	Y	Y	Y	Y	Y	Y	Y	Y	Y	Y	100
5501	Y	Y	Y	Y	Y	Y	Y	Y	Y	Y	100
5502	Y	Y	Y	Y	Y	Y	Y	Y	Y	Y	100
5503	Y	Y	Y	Y	Y	Y	Y	Y	Y	Y	100
5504	Y	Y	Y	Y	Y	Y	Y	Y	Y	Y	100
5505	Y	Y	Y	Y	Y	Y	Y	Y	Y	Y	100
5506	Y	Y	Y	Y	Y	Y	Y	Y	Y	Y	100
5507	Y	Y	Y	Y	Y	Y	Y	Y	Y	Y	100
5508	Y	Y	Y	Y	Y	Y	Y	Y	Y	Y	100
5509	Y	Y	Y	Y	Y	Y	Y	Y	Y	Y	100
5510	Y	Y	Y	Y	Y	Y	Y	Y	Y	Y	100
5511	Y	Y	Y	Y	Y	Y	Y	Y	Y	Y	100
5512	Y	Y	Y	Y	Y	Y	Y	Y	Y	Y	100
5513	Y	Y	Y	Y	Y	Y	Y	Y	Y	Y	100
5514	Y	Y	Y	Y	Y	Y	Y	Y	Y	Y	100
5515	Y	Y	Y	Y	Y	Y	Y	Y	Y	Y	100
5516	Y	Y	Y	Y	Y	Y	Y	Y	Y	Y	100
5517	Y	Y	Y	Y	Y	Y	Y	Y	Y	Y	100
5518	Y	Y	Y	Y	Y	Y	Y	Y	Y	Y	100
5519	Y	Y	Y	Y	Y	Y	Y	Y	Y	Y	100
5520	Y	Y	Y	Y	Y	Y	Y	Y	Y	Y	100
5521	Y	Y	Y	Y	Y	Y	Y	Y	Y	Y	100
5522	Y	Y	Y	Y	Y	Y	Y	Y	Y	Y	100
5523	Y	Y	Y	Y	Y	Y	Y	Y	Y	Y	100
5524	Y	Y	Y	Y	Y	Y	Y	Y	Y	Y	100
5525	Y	Y	Y	Y	Y	Y	Y	Y	Y	Y	100
5526	Y	Y	Y	Y	Y	Y	Y	Y	Y	Y	100
5527	Y	Y	Y	Y	Y	Y	Y	Y	Y	Y	100
5528	Y	Y	Y	Y	Y	Y	Y	Y	Y	Y	100
5529	Y	Y	Y	Y	Y	Y	Y	Y	Y	Y	100
5530	Y	Y	Y	Y	Y	Y	Y	Y	Y	Y	100
5531	Y	Y	Y	Y	Y	Y	Y	Y	Y	Y	100
5532	Y	Y	Y	Y	Y	Y	Y	Y	Y	Y	100
5533	Y	Y	Y	Y	Y	Y	Y	Y	Y	Y	100

5534	Y	Y	Y	Y	Y	Y	Y	Y	Y	Y	100
5535	Y	Y	Y	Y	Y	Y	Y	Y	Y	Y	100
5536	Y	Y	Y	Y	Y	Y	Y	Y	Y	Y	100
5537	Y	Y	Y	Y	Y	Y	Y	Y	Y	Y	100
5538	Y	Y	Y	Y	Y	Y	Y	Y	Y	Y	100
5539	Y	Y	Y	Y	Y	Y	Y	Y	Y	Y	100
5540	Y	Y	Y	Y	Y	Y	Y	Y	Y	Y	100
5541	Y	Y	Y	Y	Y	Y	Y	Y	Y	Y	100
5542	Y	Y	Y	Y	Y	Y	Y	Y	Y	Y	100
5543	Y	Y	Y	Y	Y	Y	Y	Y	Y	Y	100
5544	Y	Y	Y	Y	Y	Y	Y	Y	Y	Y	100
5545	Y	Y	Y	Y	Y	Y	Y	Y	Y	Y	100
5546	Y	Y	Y	Y	Y	Y	Y	Y	Y	Y	100
5547	Y	Y	Y	Y	Y	Y	Y	Y	Y	Y	100
5548	Y	Y	Y	Y	Y	Y	Y	Y	Y	Y	100
5549	Y	Y	Y	Y	Y	Y	Y	Y	Y	Y	100
5550	Y	Y	Y	Y	Y	Y	Y	Y	Y	Y	100
5551	Y	Y	Y	Y	Y	Y	Y	Y	Y	Y	100
5552	Y	Y	Y	Y	Y	Y	Y	Y	Y	Y	100
5553	Y	Y	Y	Y	Y	Y	Y	Y	Y	Y	100
5554	Y	Y	Y	Y	Y	Y	Y	Y	Y	Y	100
5555	Y	Y	Y	Y	Y	Y	Y	Y	Y	Y	100
5556	Y	Y	Y	Y	Y	Y	Y	Y	Y	Y	100
5557	Y	Y	Y	Y	Y	Y	Y	Y	Y	Y	100
5558	Y	Y	Y	Y	Y	Y	Y	Y	Y	Y	100
5559	Y	Y	Y	Y	Y	Y	Y	Y	Y	Y	100
5560	Y	Y	Y	Y	Y	Y	Y	Y	Y	Y	100
5561	Y	Y	Y	Y	Y	Y	Y	Y	Y	Y	100
5562	Y	Y	Y	Y	Y	Y	Y	Y	Y	Y	100
5563	Y	Y	Y	Y	Y	Y	Y	Y	Y	Y	100
5564	Y	Y	Y	Y	Y	Y	Y	Y	Y	Y	100
5565	Y	Y	Y	Y	Y	Y	Y	Y	Y	Y	100
5566	Y	Y	Y	Y	Y	Y	Y	Y	Y	Y	100
5567	Y	Y	Y	Y	Y	Y	Y	Y	Y	Y	100
5568	Y	Y	Y	Y	Y	Y	Y	Y	Y	Y	100
5569	Y	Y	Y	Y	Y	Y	Y	Y	Y	Y	100
5570(FH)	Y	Y	Y	Y	Y	Y	Y	Y	Y	Y	100
5571	N	N	N	N	N	N	N	N	N	N	0

6.2.3 Channel Availability Check Time

If the EUT successfully detected the radar burst, it should be observed as the EUT has no transmissions occurred until the EUT starts transmitting on another channel.

Timing of Radar Signal	Observation	
	EUT	Spectrum Analyzer
Within 1 to 6 second	Detected	No transmissions
Within 54 to 60 second	Detected	No transmissions

Initial Channel Availability Check Time

For 5250~5350MHz

RBR40

Channel Availability Check

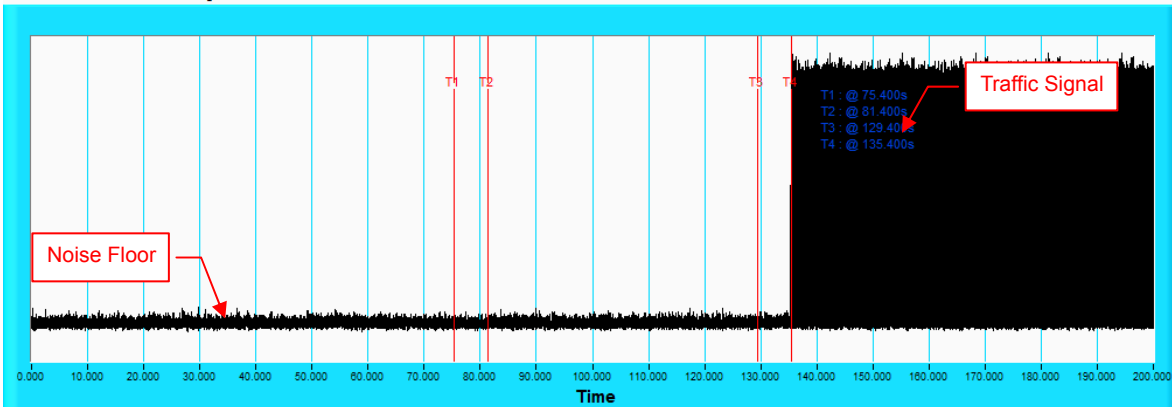

NOTE: T1 denotes the end of power-up time period is 75.4 second. T4 denotes the end of Channel Availability Check time is 135.4 second. Channel Availability Check time is equal to (T4 – T1) 60 seconds.

Radar Burst at the Beginning of the Channel Availability Check Time

Channel Availability Check

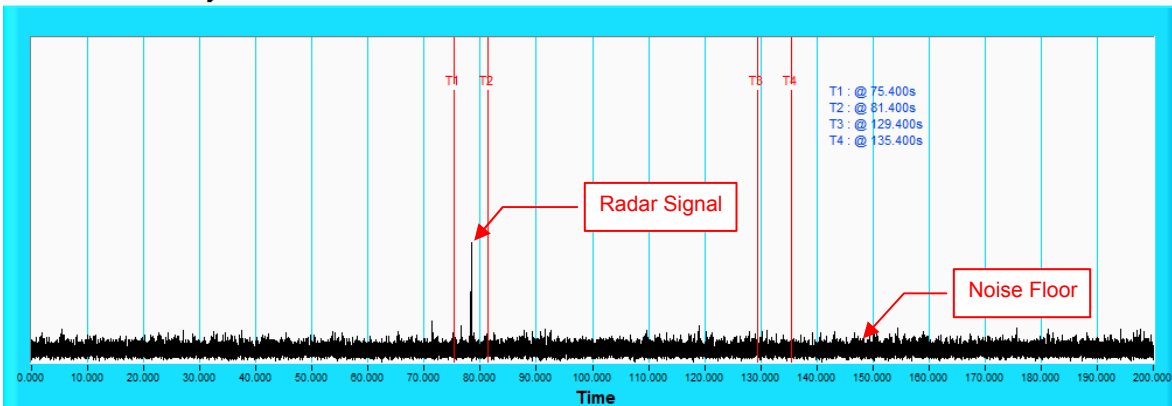

NOTE: T1 denotes the end of power up time period is 75.4 second. T2 denotes 81.4 second, the radar burst was commenced within a 6 second window starting from the end of power-up sequence. T4 denotes the 135.4 second.

Radar Burst at the End of the Channel Availability Check Time

Channel Availability Check

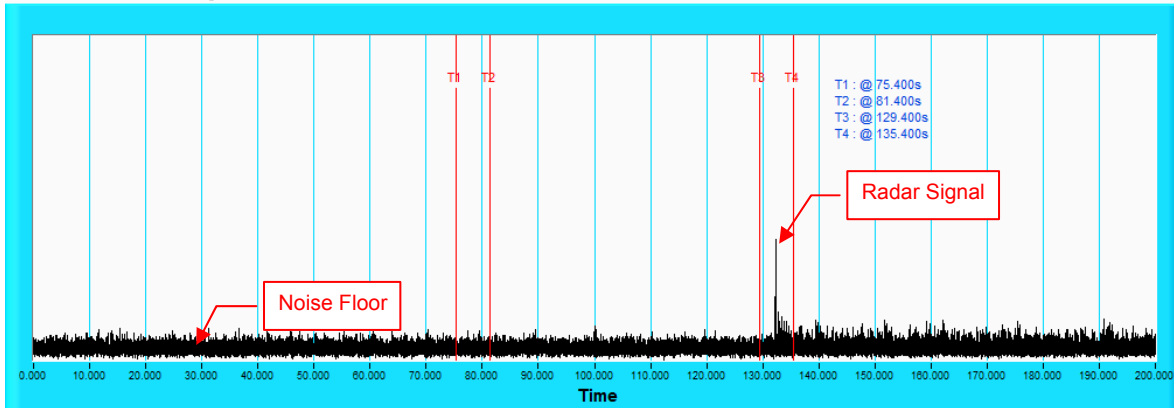

NOTE: T1 denotes the end of power up time period is 75.4 second. T3 denotes 129.4 second and radar burst was commenced within 54th second to 60th second window starting from the end of power-up sequence. T4 denotes the 135.4 second.

RBS40

Channel Availability Check

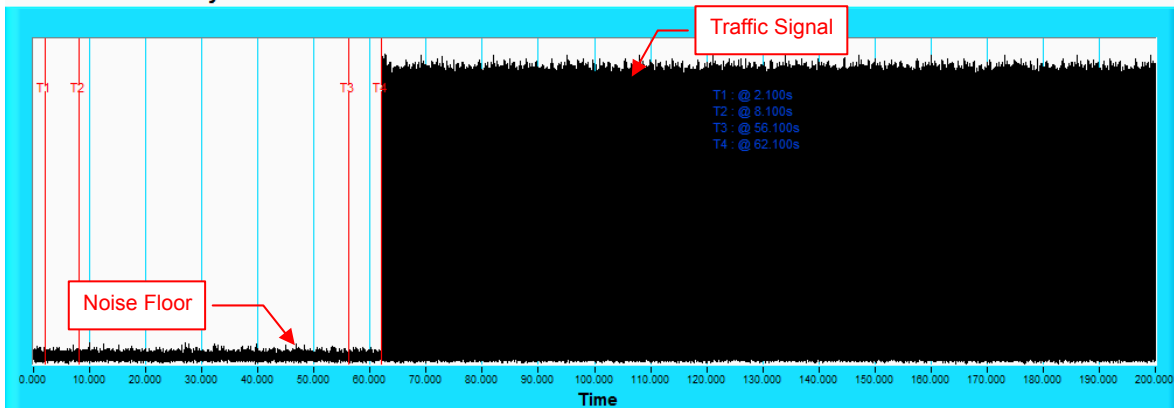

NOTE: T1 denotes the end of power-up time period is 2.1 second. T4 denotes the end of Channel Availability Check time is 62.1 second. Channel Availability Check time is equal to (T4 – T1) 60 seconds.

Radar Burst at the Beginning of the Channel Availability Check Time

Channel Availability Check

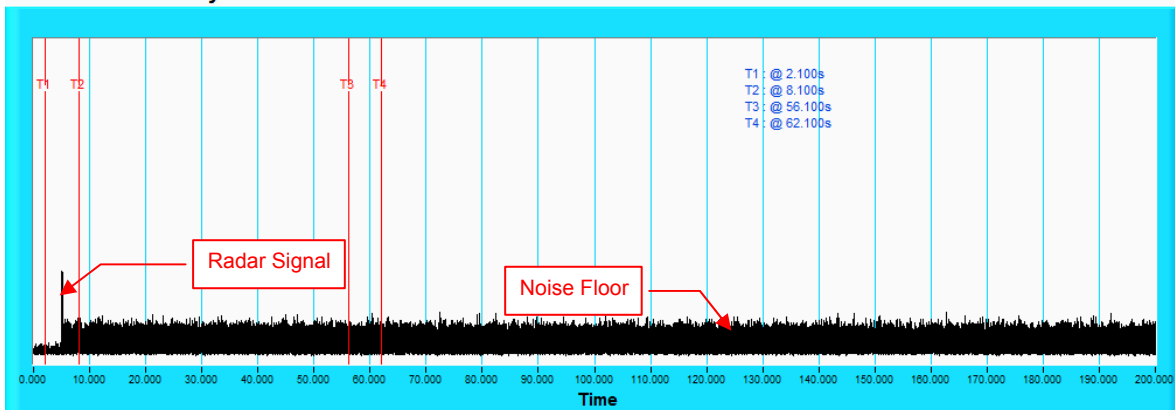

NOTE: T1 denotes the end of power up time period is 2.1 second. T2 denotes 8.1 second, the radar burst was commenced within a 6 second window starting from the end of power-up sequence. T4 denotes the 62.1 second.

Radar Burst at the End of the Channel Availability Check Time

Channel Availability Check

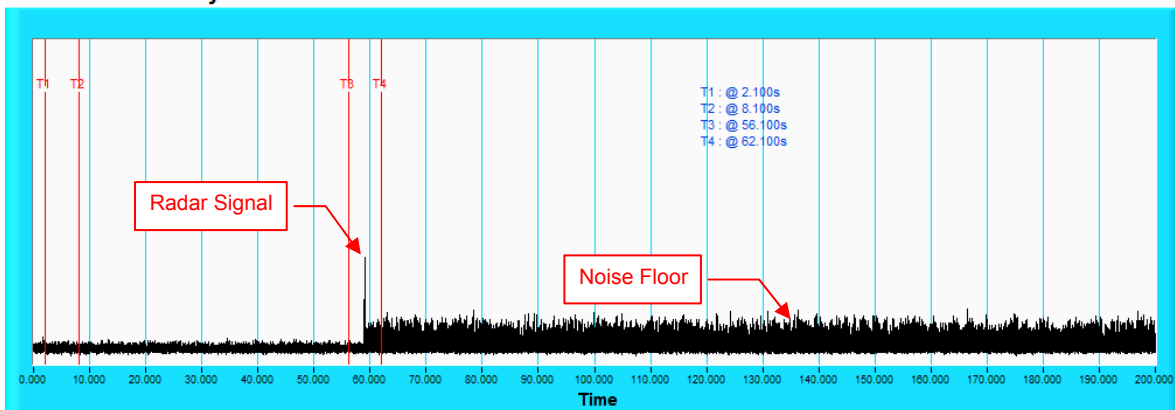

NOTE: T1 denotes the end of power up time period is 2.1 second. T3 denotes 56.1 second and radar burst was commenced within 54th second to 60th second window starting from the end of power-up sequence. T4 denotes the 62.1 second.

**For 5470~5725MHz
Channel Availability Check**

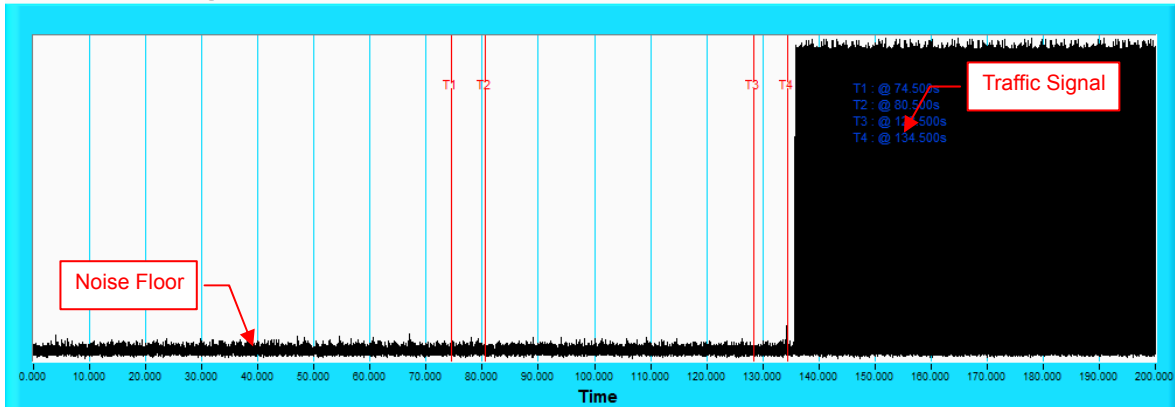

NOTE: T1 denotes the end of power-up time period is 74.5 second. T4 denotes the end of Channel Availability Check time is 134.5 second. Channel Availability Check time is equal to (T4 – T1) 60 seconds.

Radar Burst at the Beginning of the Channel Availability Check Time

Channel Availability Check

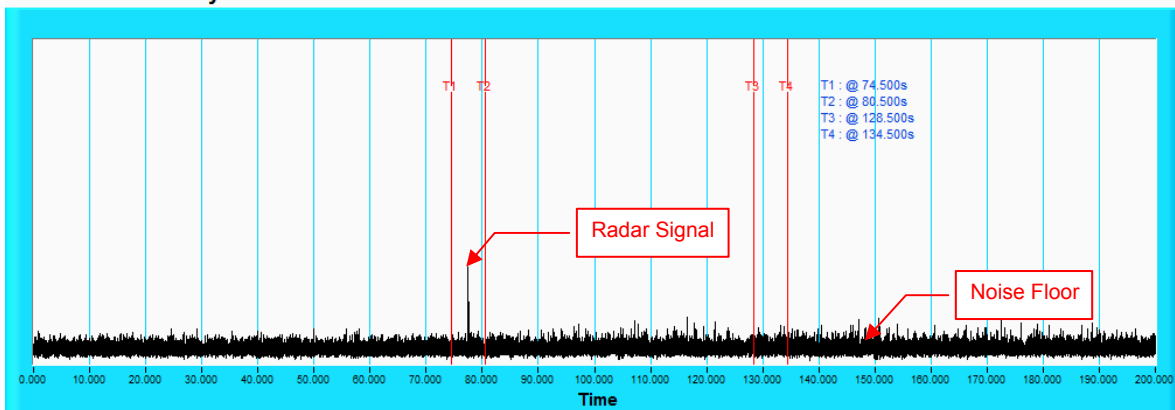

NOTE: T1 denotes the end of power up time period is 74.5 second. T2 denotes 80.5 second, the radar burst was commenced within a 6 second window starting from the end of power-up sequence. T4 denotes the 134.5 second.

Radar Burst at the End of the Channel Availability Check Time

Channel Availability Check

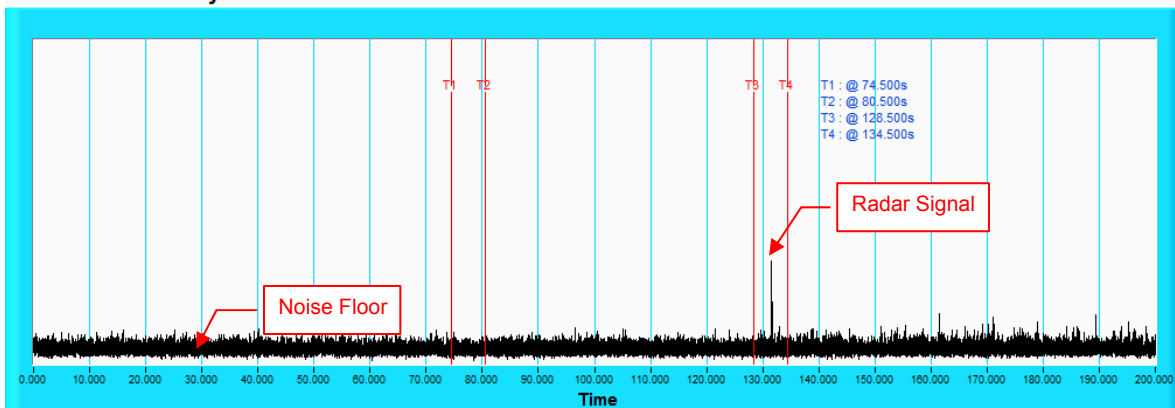

NOTE: T1 denotes the end of power up time period is 74.5 second. T3 denotes 128.5 second and radar burst was commenced within 54th second to 60th second window starting from the end of power-up sequence. T4 denotes the 134.5 second.

6.2.4 Channel Closing Transmission and Channel Move Time

For 5250~5350MHz
 Wireless Traffic Loading
 IEEE 802.11ac VHT20
 Duty Cycle

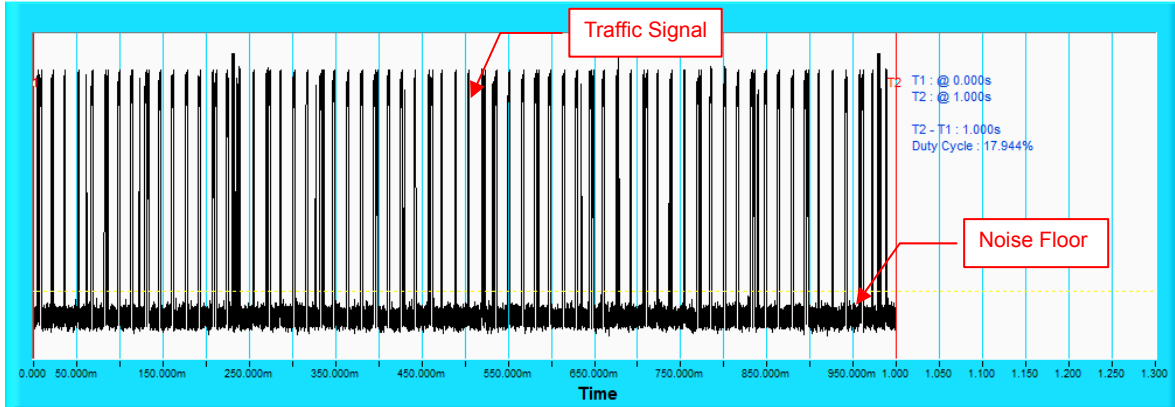

IEEE 802.11ac VHT40
 Duty Cycle

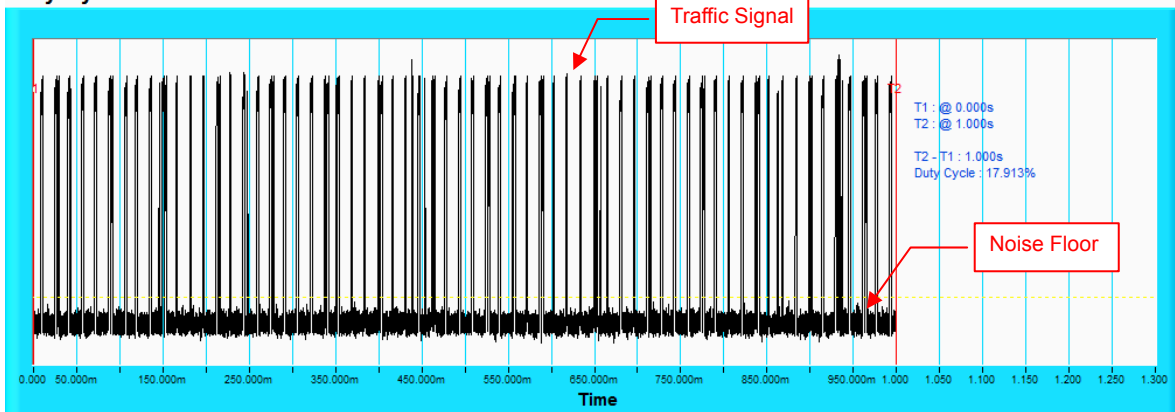

IEEE 802.11ac VHT80
 Duty Cycle

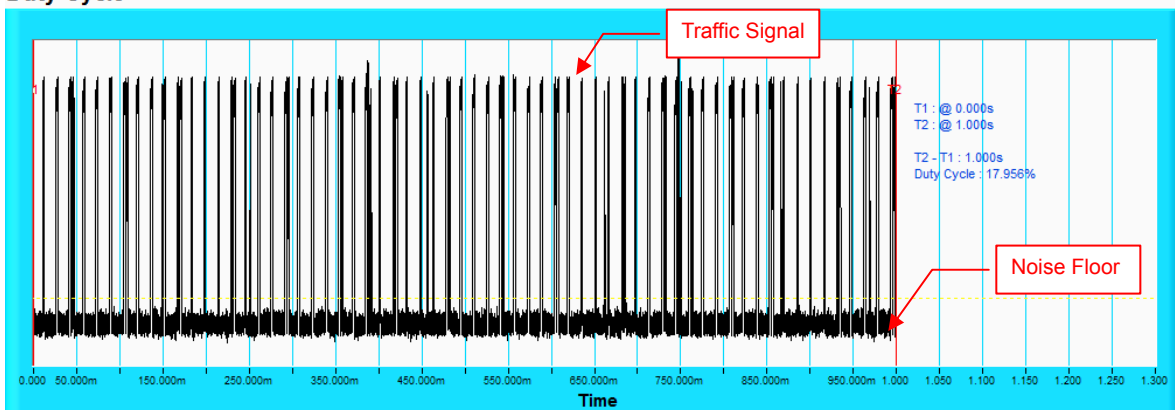

RBR40

Radar signal 0

IEEE 802.11ac VHT80

Channel Closing Transmission Time & Channel Move Time

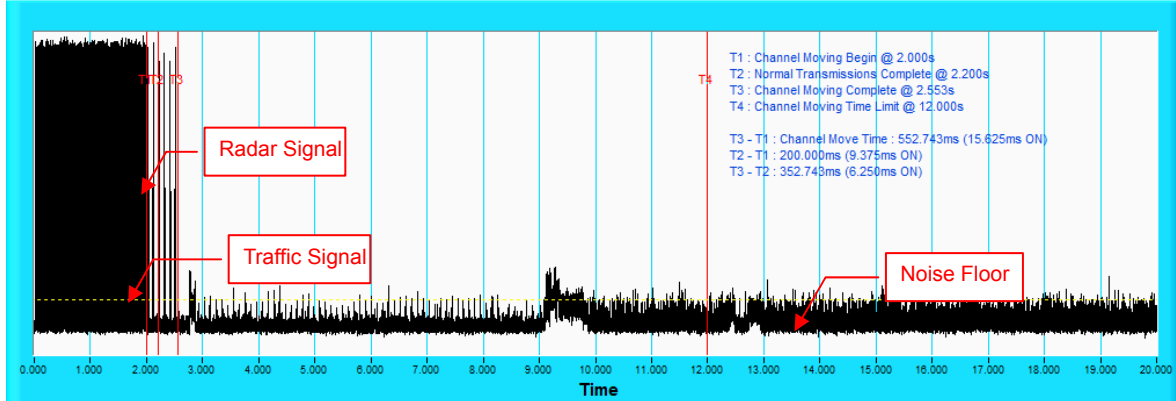

NOTE: T1 denotes the start of Channel Move Time upon the end of the last Radar burst. T2 denotes the data transmission time of 200ms from T1. T3 denotes the end of Channel Move Time. T4 denotes the 10 second from T1 to observe the aggregate duration of transmissions.

Channel Closing Transmission Time & Channel Move Time

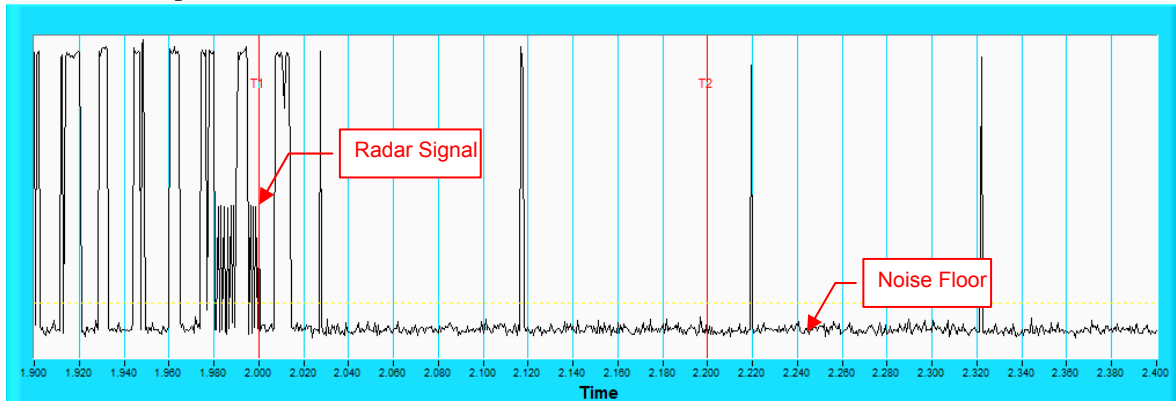

NOTE: Zoom-in of the first 500ms after radar signal applied.

Radar signal 1

IEEE 802.11ac VHT80

Channel Closing Transmission Time & Channel Move Time

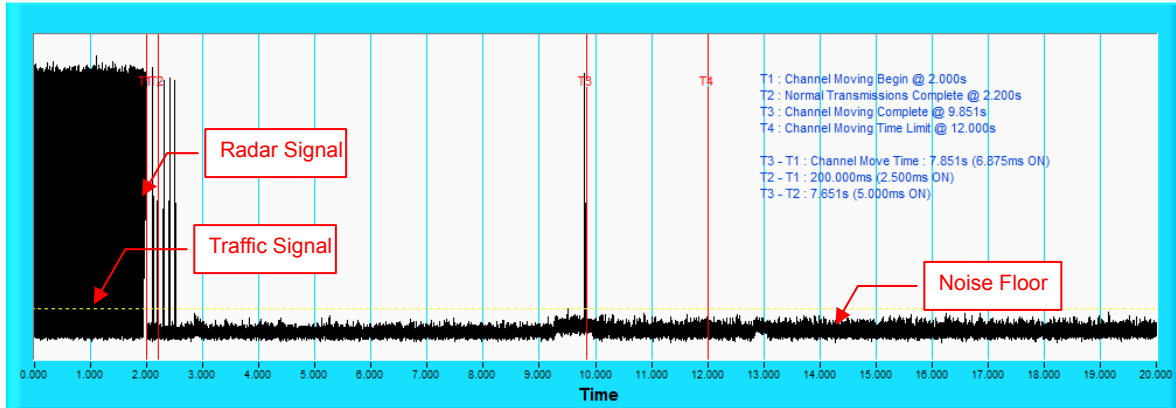

NOTE: T1 denotes the start of Channel Move Time upon the end of the last Radar burst. T2 denotes the data transmission time of 200ms from T1. T3 denotes the end of Channel Move Time. T4 denotes the 10 second from T1 to observe the aggregate duration of transmissions.

Channel Closing Transmission Time & Channel Move Time

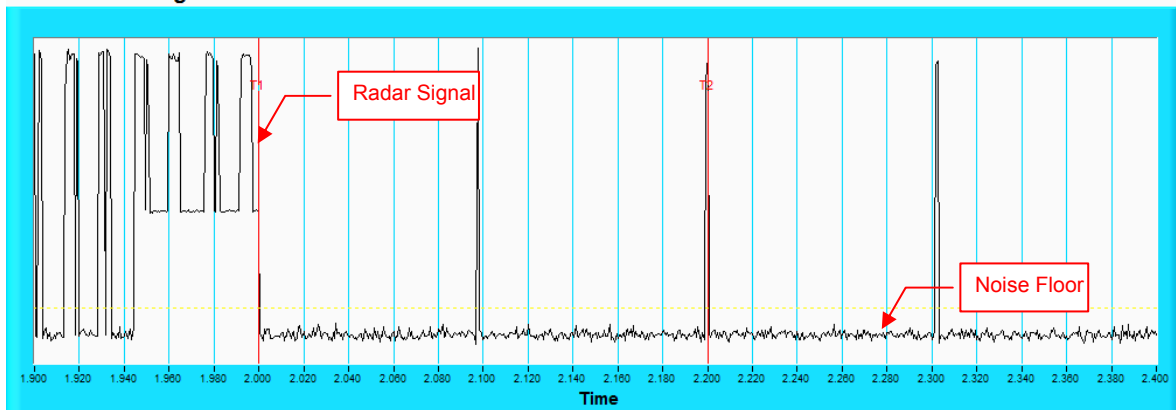

NOTE: Zoom-in of the first 500ms after radar signal applied.

Radar signal 2

IEEE 802.11ac VHT80

Channel Closing Transmission Time & Channel Move Time

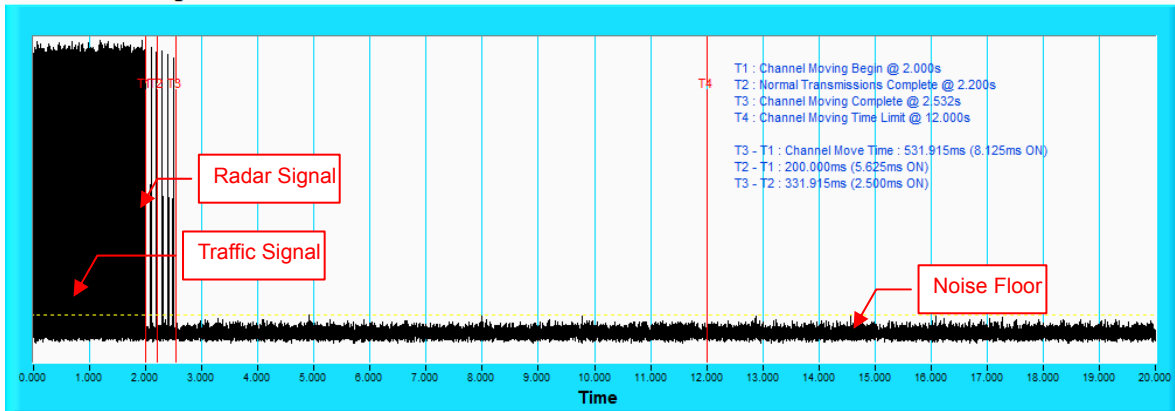

NOTE: T1 denotes the start of Channel Move Time upon the end of the last Radar burst. T2 denotes the data transmission time of 200ms from T1. T3 denotes the end of Channel Move Time. T4 denotes the 10 second from T1 to observe the aggregate duration of transmissions.

Channel Closing Transmission Time & Channel Move Time

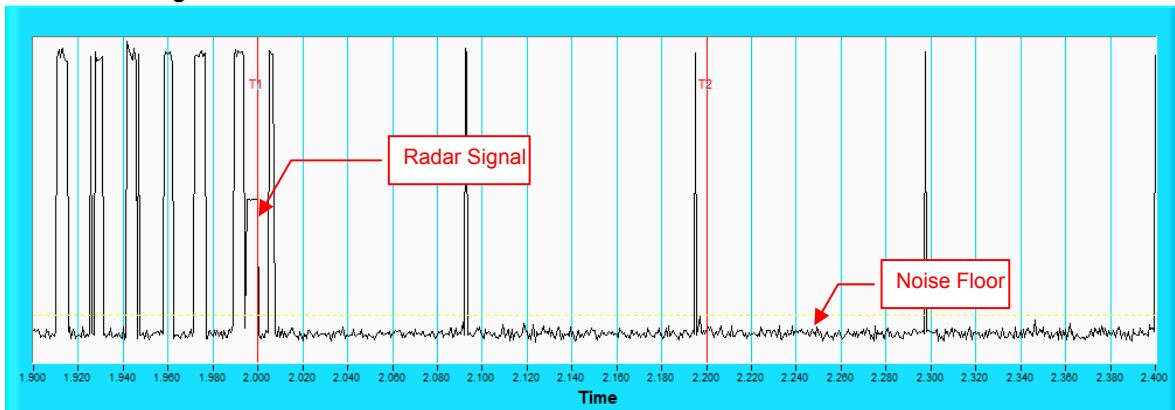

NOTE: Zoom-in of the first 500ms after radar signal applied.

Radar signal 3

IEEE 802.11ac VHT80

Channel Closing Transmission Time & Channel Move Time

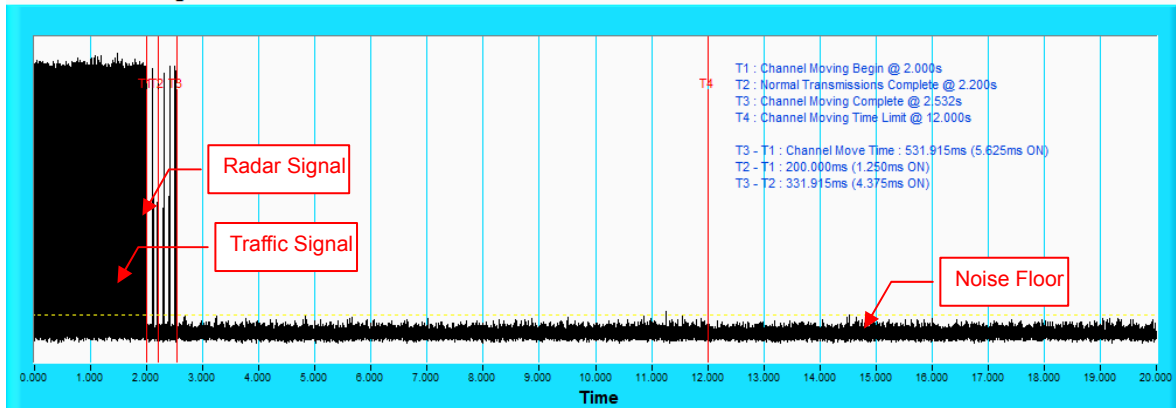

NOTE: T1 denotes the start of Channel Move Time upon the end of the last Radar burst. T2 denotes the data transmission time of 200ms from T1. T3 denotes the end of Channel Move Time. T4 denotes the 10 second from T1 to observe the aggregate duration of transmissions.

Channel Closing Transmission Time & Channel Move Time

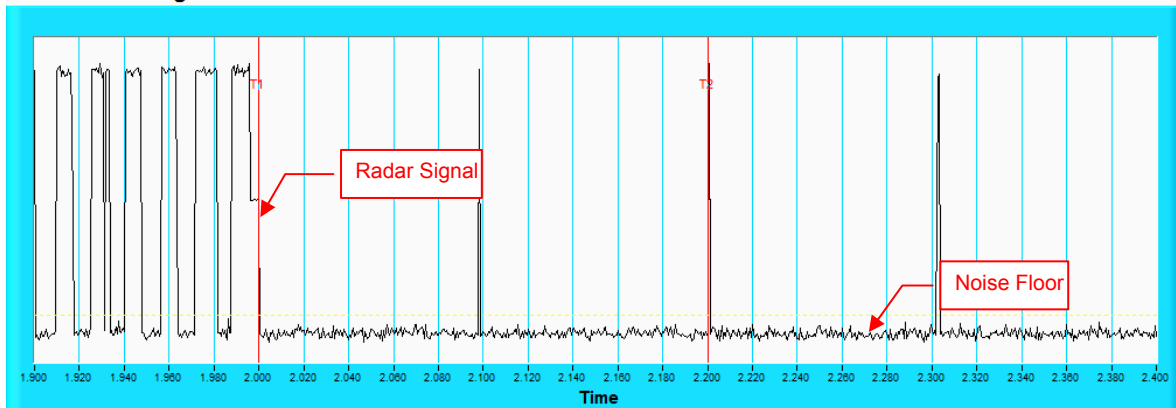

NOTE: Room-in of the first 500ms after radar signal applied.

Radar signal 4

IEEE 802.11ac VHT80

Channel Closing Transmission Time & Channel Move Time

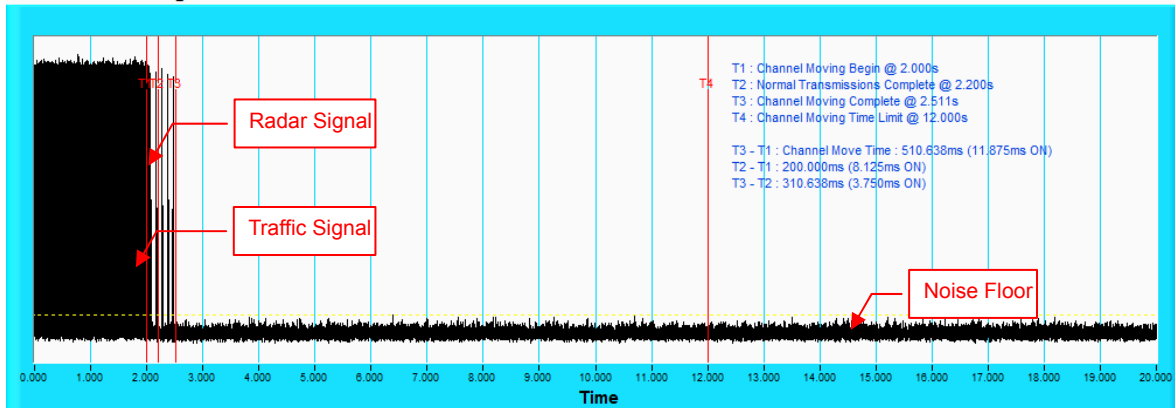

NOTE: T1 denotes the start of Channel Move Time upon the end of the last Radar burst. T2 denotes the data transmission time of 200ms from T1. T3 denotes the end of Channel Move Time. T4 denotes the 10 second from T1 to observe the aggregate duration of transmissions.

Channel Closing Transmission Time & Channel Move Time

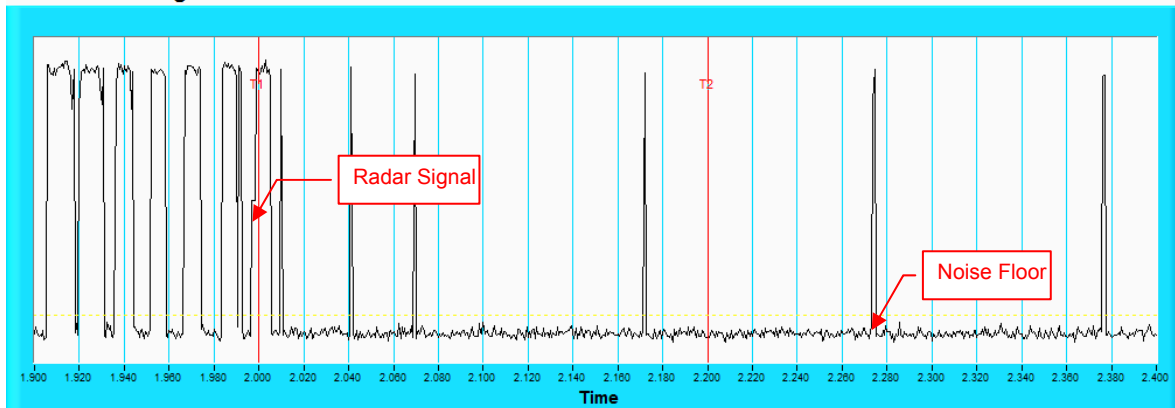

NOTE: Room-in of the first 500ms after radar signal applied.

RBS40
Radar signal 0
 IEEE 802.11ac VHT80
Channel Closing Transmission Time & Channel Move Time

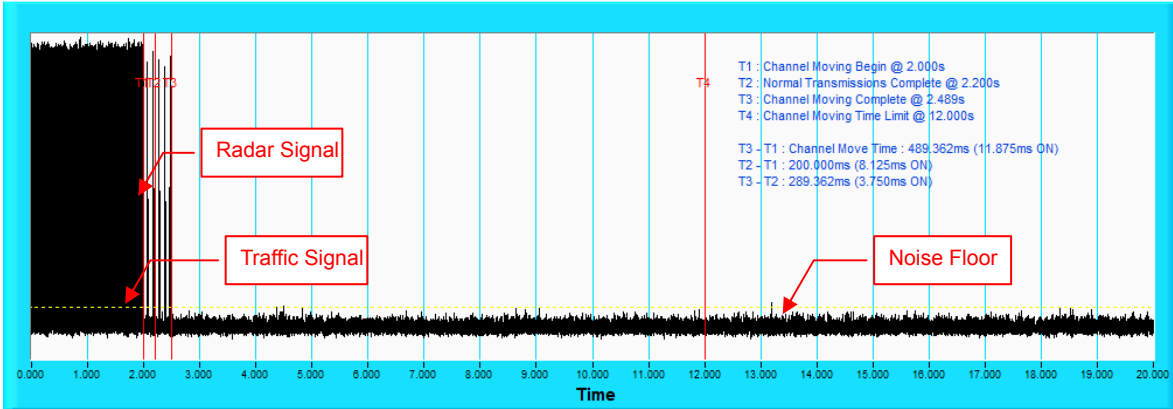

NOTE: T1 denotes the start of Channel Move Time upon the end of the last Radar burst. T2 denotes the data transmission time of 200ms from T1. T3 denotes the end of Channel Move Time. T4 denotes the 10 second from T1 to observe the aggregate duration of transmissions.

Channel Closing Transmission Time & Channel Move Time

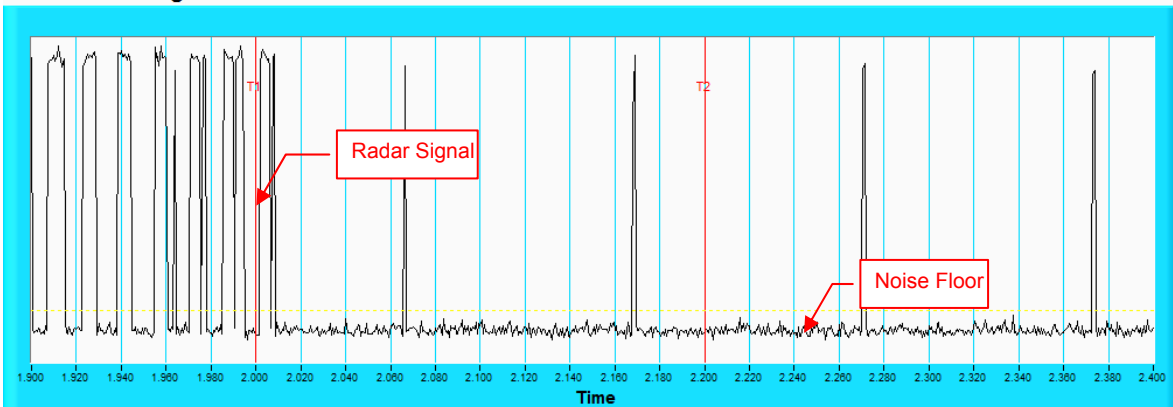

NOTE: Zoom-in of the first 500ms after radar signal applied.

Radar signal 1

IEEE 802.11ac VHT80

Channel Closing Transmission Time & Channel Move Time

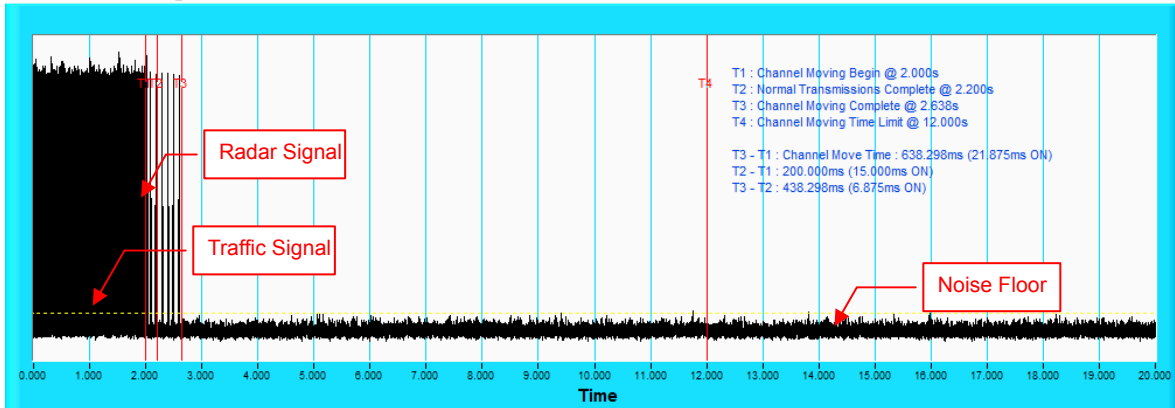

NOTE: T1 denotes the start of Channel Move Time upon the end of the last Radar burst. T2 denotes the data transmission time of 200ms from T1. T3 denotes the end of Channel Move Time. T4 denotes the 10 second from T1 to observe the aggregate duration of transmissions.

Channel Closing Transmission Time & Channel Move Time

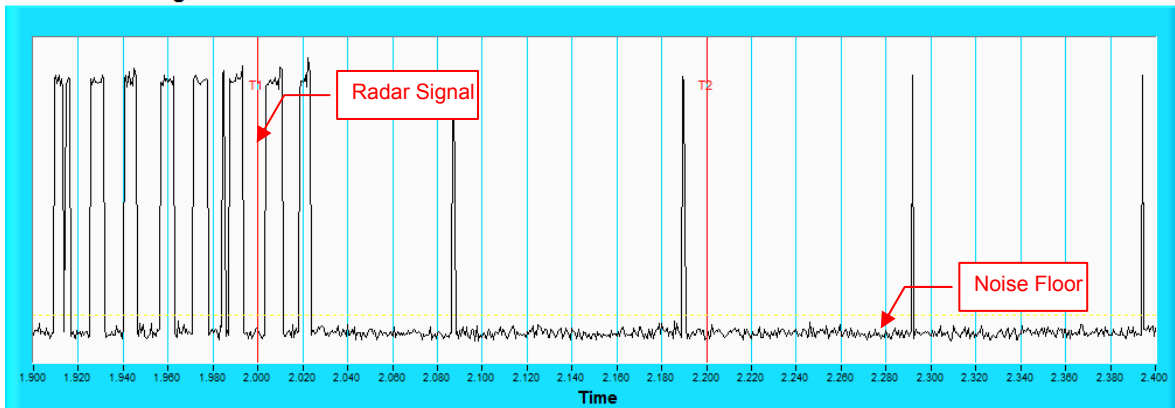

NOTE: Zoom-in of the first 500ms after radar signal applied.

Radar signal 2

IEEE 802.11ac VHT80

Channel Closing Transmission Time & Channel Move Time

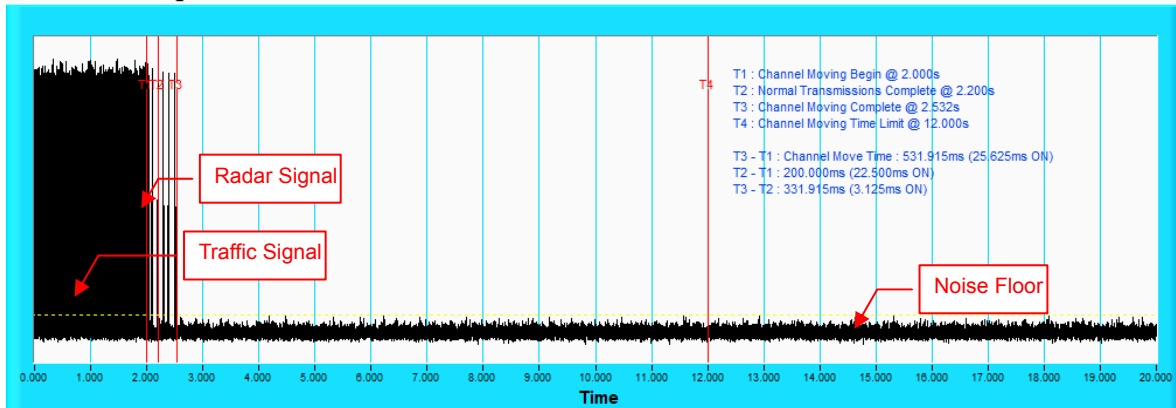

NOTE: T1 denotes the start of Channel Move Time upon the end of the last Radar burst. T2 denotes the data transmission time of 200ms from T1. T3 denotes the end of Channel Move Time. T4 denotes the 10 second from T1 to observe the aggregate duration of transmissions.

Channel Closing Transmission Time & Channel Move Time

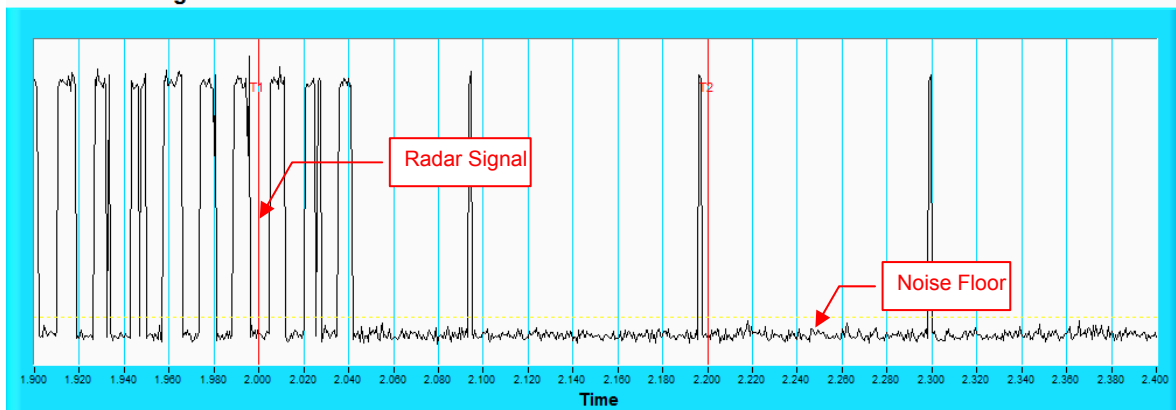

NOTE: Zoom-in of the first 500ms after radar signal applied.

Radar signal 3

IEEE 802.11ac VHT80

Channel Closing Transmission Time & Channel Move Time

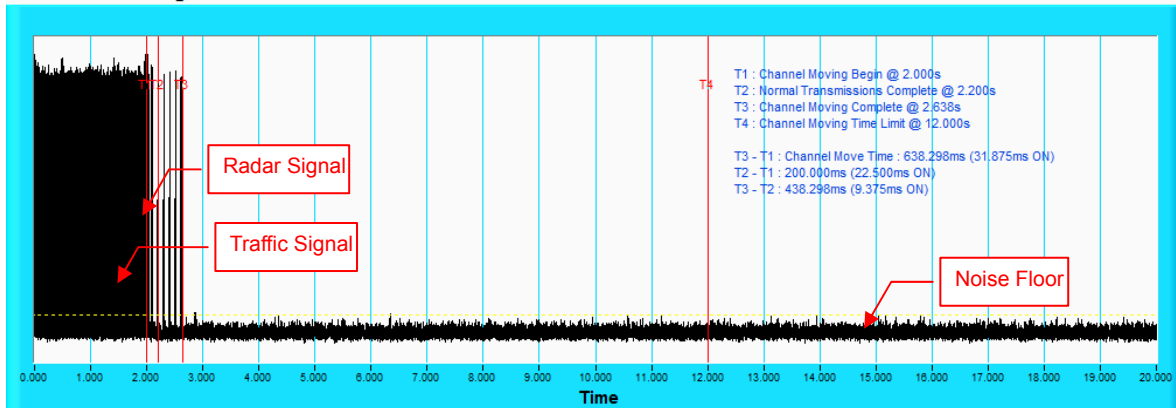

NOTE: T1 denotes the start of Channel Move Time upon the end of the last Radar burst. T2 denotes the data transmission time of 200ms from T1. T3 denotes the end of Channel Move Time. T4 denotes the 10 second from T1 to observe the aggregate duration of transmissions.

Channel Closing Transmission Time & Channel Move Time

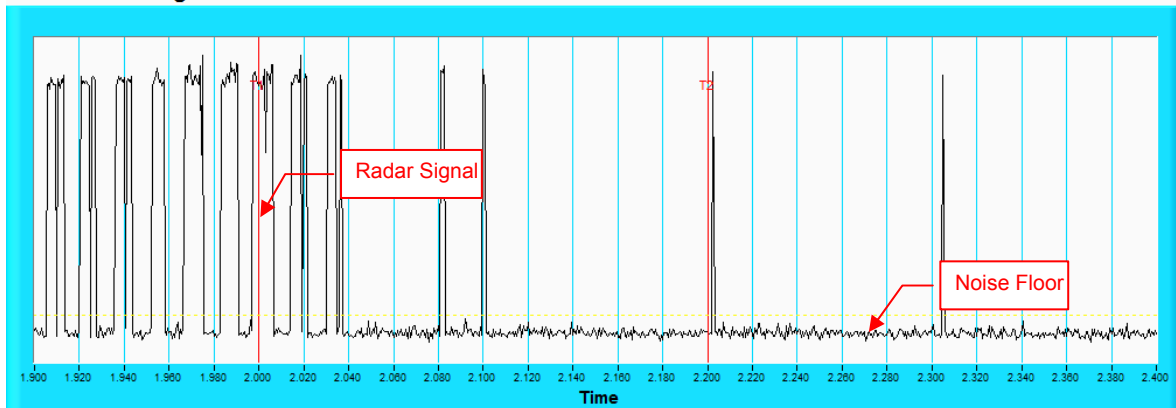

NOTE: Room-in of the first 500ms after radar signal applied.

Radar signal 4

IEEE 802.11ac VHT80

Channel Closing Transmission Time & Channel Move Time

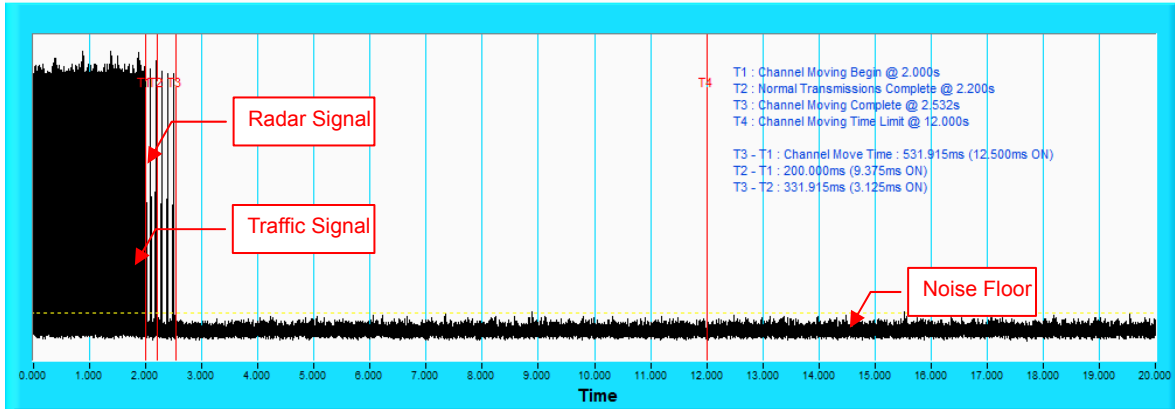

NOTE: T1 denotes the start of Channel Move Time upon the end of the last Radar burst. T2 denotes the data transmission time of 200ms from T1. T3 denotes the end of Channel Move Time. T4 denotes the 10 second from T1 to observe the aggregate duration of transmissions.

Channel Closing Transmission Time & Channel Move Time

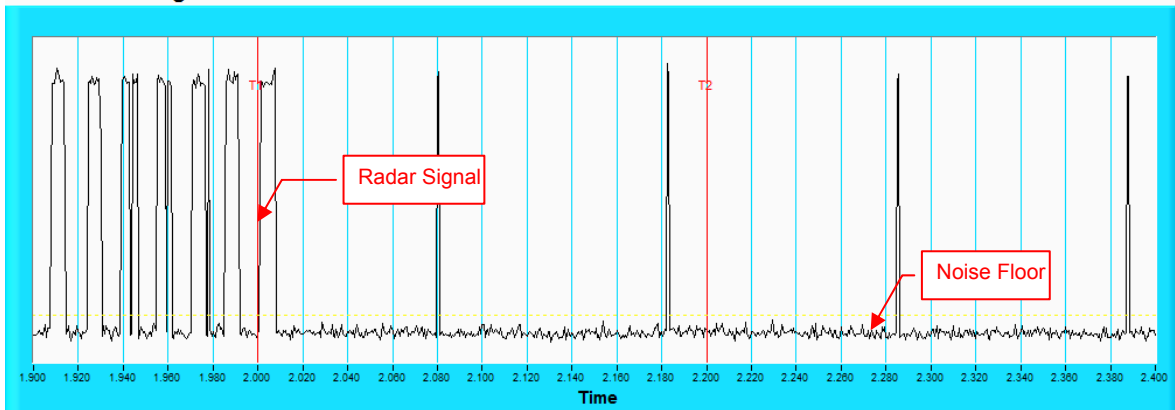

NOTE: Room-in of the first 500ms after radar signal applied.

**For 5470~5725MHz
Wireless Traffic Loading
IEEE 802.11ac VHT20
Duty Cycle**

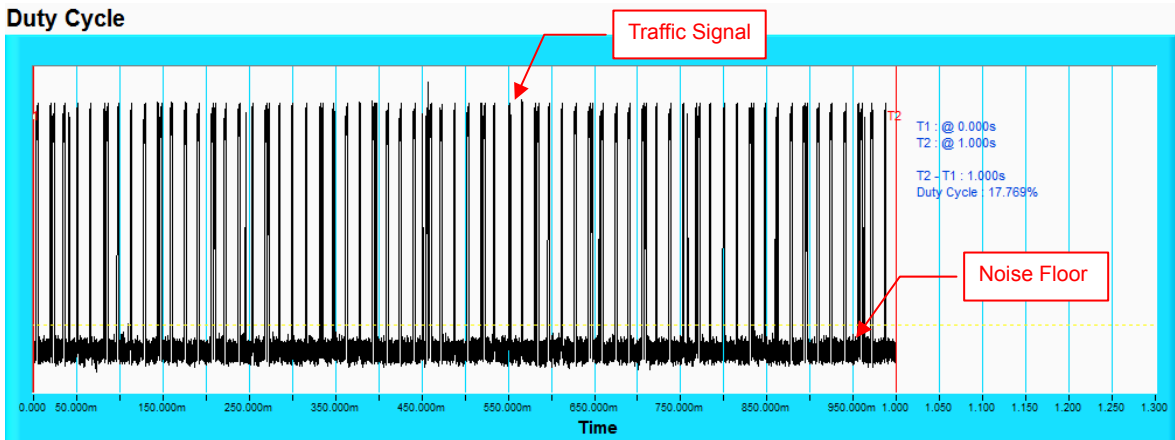

**IEEE 802.11ac VHT40
Duty Cycle**

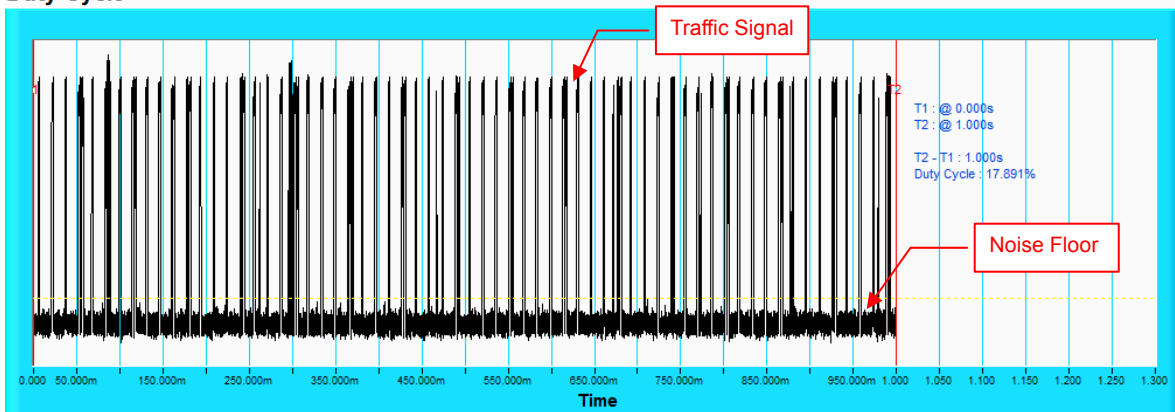

**IEEE 802.11ac VHT80
Duty Cycle**

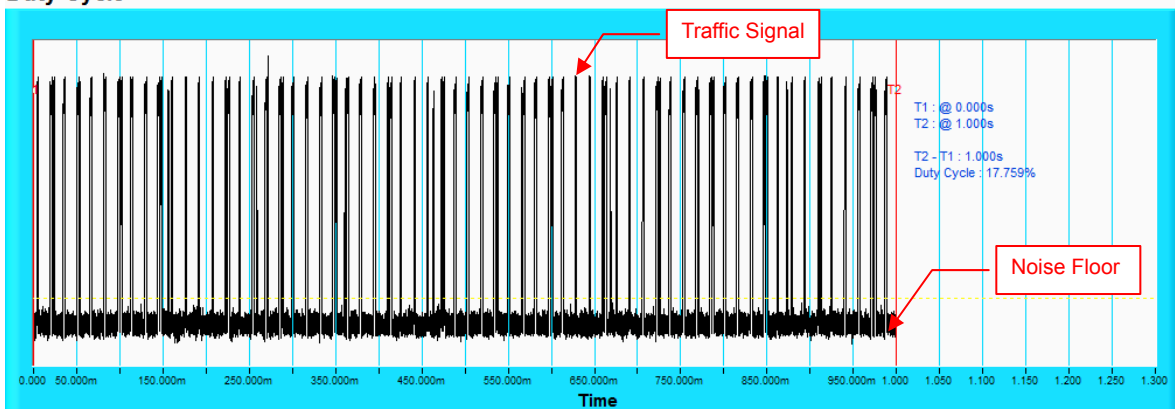

Radar signal 0

IEEE 802.11ac VHT80

Channel Closing Transmission Time & Channel Move Time

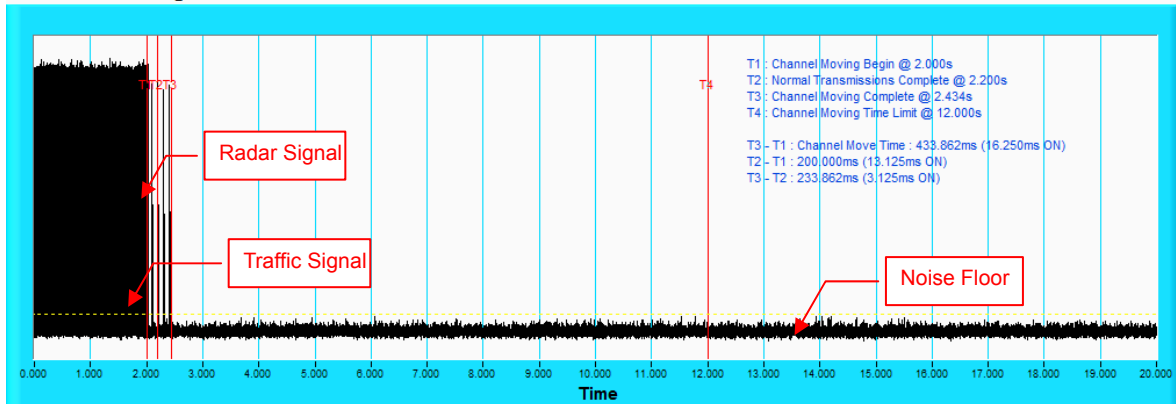

NOTE: T1 denotes the start of Channel Move Time upon the end of the last Radar burst. T2 denotes the data transmission time of 200ms from T1. T3 denotes the end of Channel Move Time. T4 denotes the 10 second from T1 to observe the aggregate duration of transmissions.

Channel Closing Transmission Time & Channel Move Time

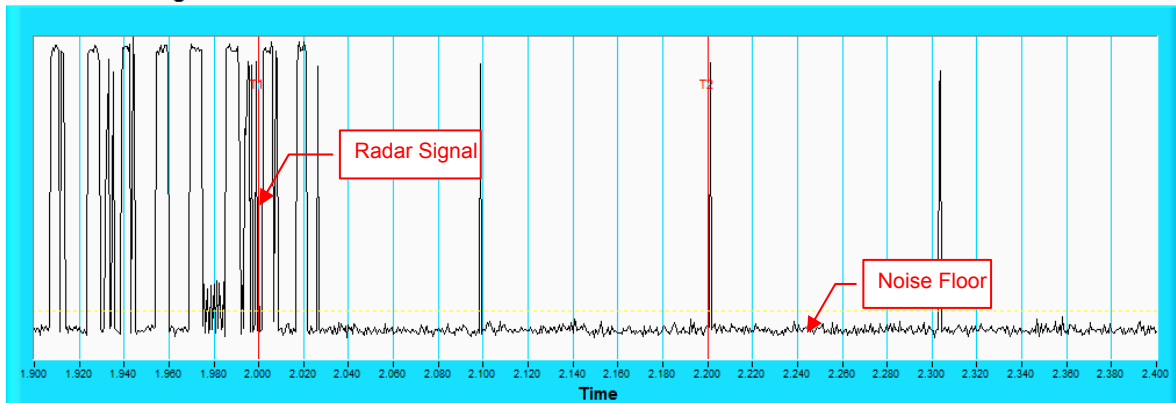

NOTE: Zoom-in of the first 500ms after radar signal applied.

Radar signal 1
 IEEE 802.11ac VHT80
 Channel Closing Transmission Time & Channel Move Time

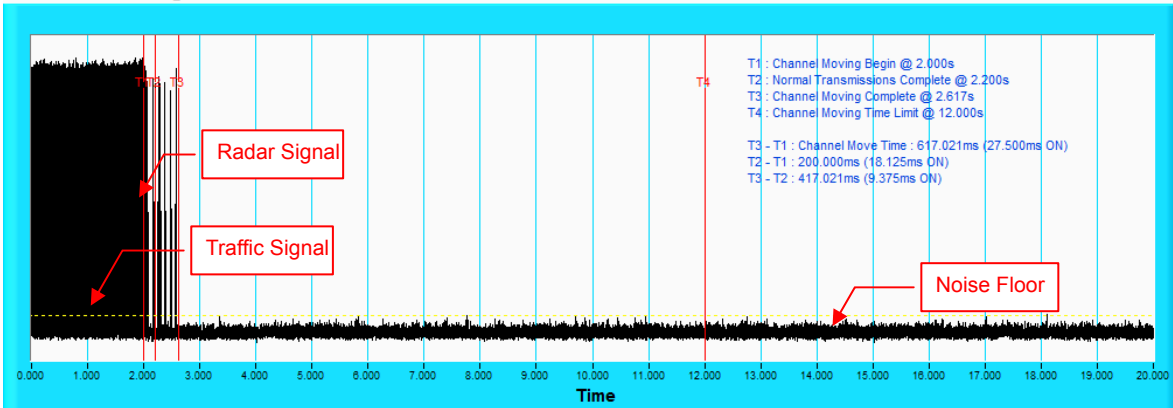

NOTE: T1 denotes the start of Channel Move Time upon the end of the last Radar burst. T2 denotes the data transmission time of 200ms from T1. T3 denotes the end of Channel Move Time. T4 denotes the 10 second from T1 to observe the aggregate duration of transmissions.

Channel Closing Transmission Time & Channel Move Time

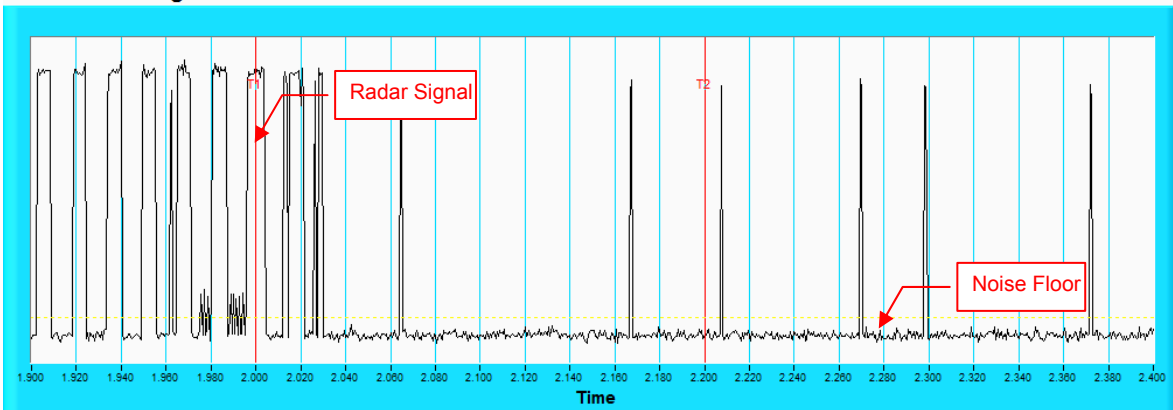

NOTE: Zoom-in of the first 500ms after radar signal applied.

Radar signal 2

IEEE 802.11ac VHT80

Channel Closing Transmission Time & Channel Move Time

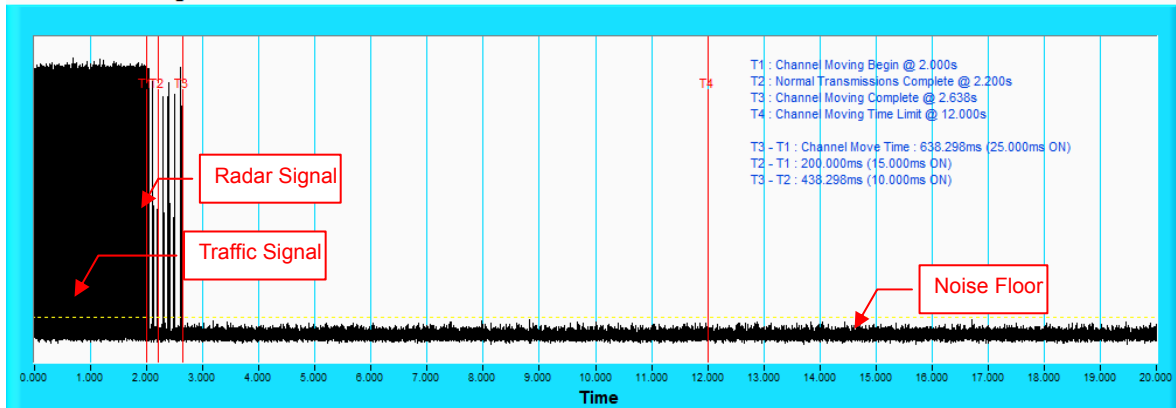

NOTE: T1 denotes the start of Channel Move Time upon the end of the last Radar burst. T2 denotes the data transmission time of 200ms from T1. T3 denotes the end of Channel Move Time. T4 denotes the 10 second from T1 to observe the aggregate duration of transmissions.

Channel Closing Transmission Time & Channel Move Time

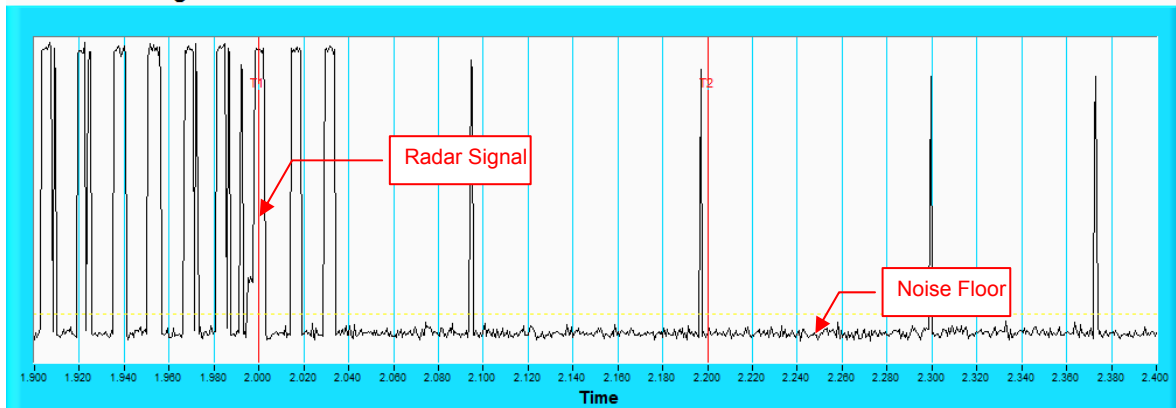

NOTE: Zoom-in of the first 500ms after radar signal applied.

Radar signal 3

IEEE 802.11ac VHT80

Channel Closing Transmission Time & Channel Move Time

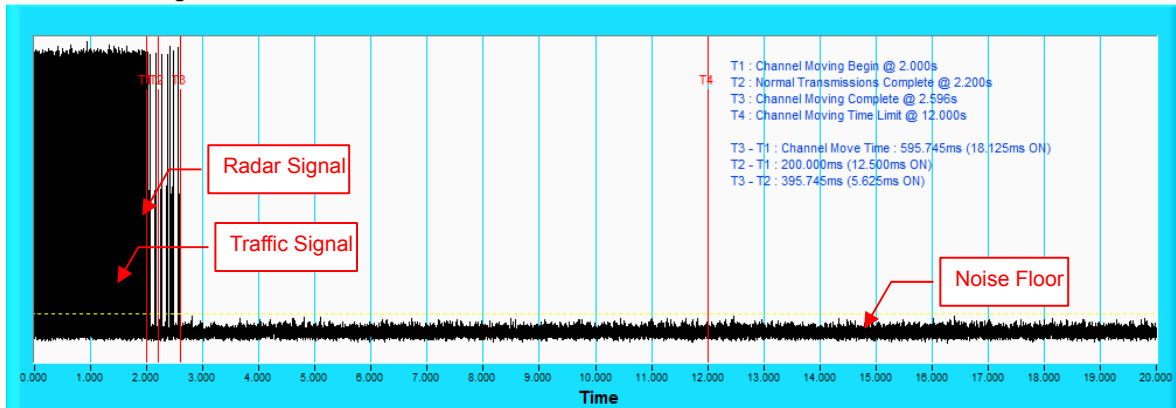

NOTE: T1 denotes the start of Channel Move Time upon the end of the last Radar burst. T2 denotes the data transmission time of 200ms from T1. T3 denotes the end of Channel Move Time. T4 denotes the 10 second from T1 to observe the aggregate duration of transmissions.

Channel Closing Transmission Time & Channel Move Time

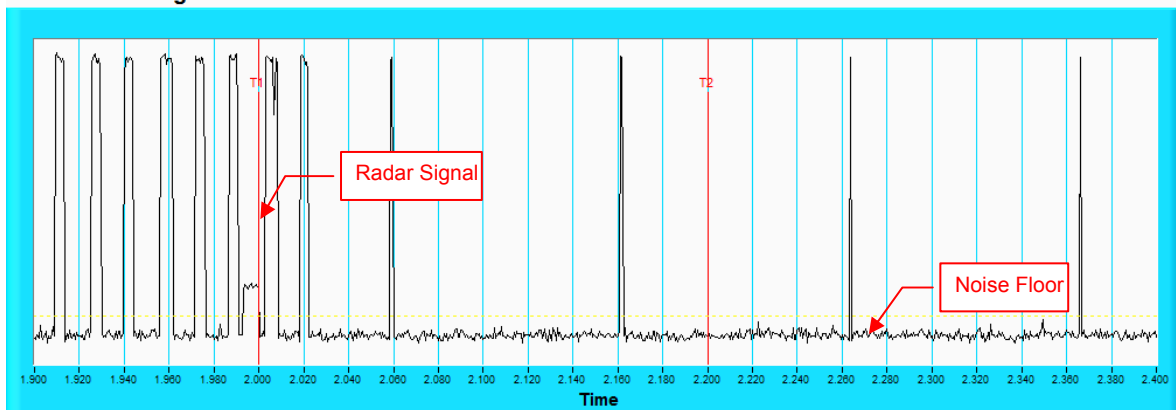

NOTE: Room-in of the first 500ms after radar signal applied.

Radar signal 4

IEEE 802.11ac VHT80

Channel Closing Transmission Time & Channel Move Time

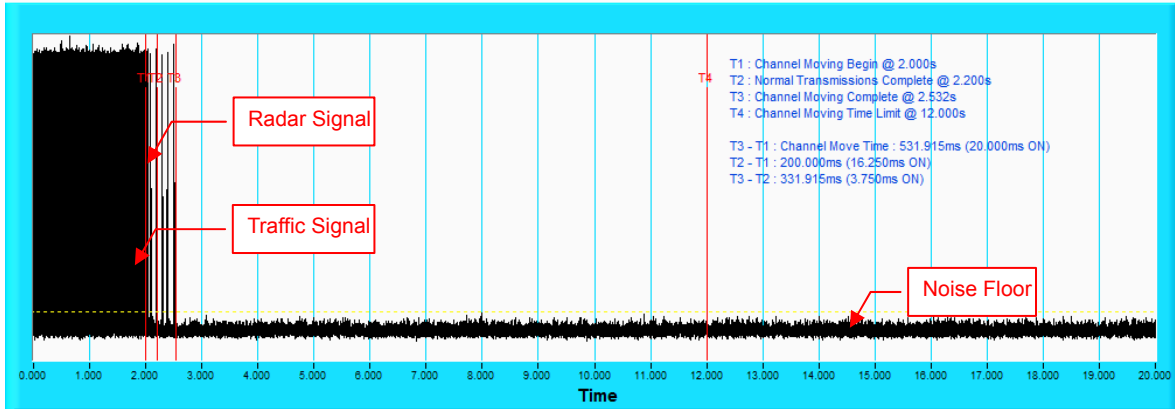

NOTE: T1 denotes the start of Channel Move Time upon the end of the last Radar burst. T2 denotes the data transmission time of 200ms from T1. T3 denotes the end of Channel Move Time. T4 denotes the 10 second from T1 to observe the aggregate duration of transmissions.

Channel Closing Transmission Time & Channel Move Time

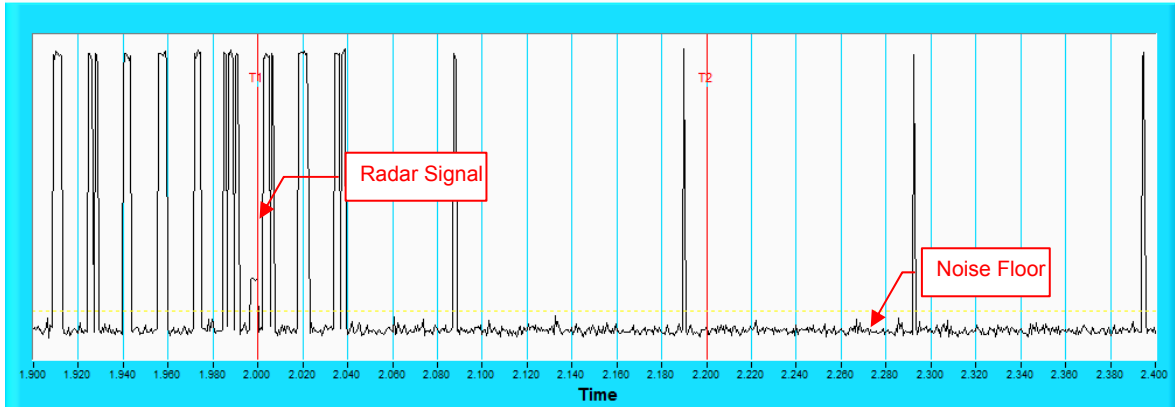

NOTE: Room-in of the first 500ms after radar signal applied.

For 5250~5350MHz
RBR40

IEEE 802.11ac VHT20

Table 1: Short Pulse Radar Test Waveforms.

Radar Type	Pulse Width (μsec)	PRI (μsec)	Number of Pulses	Number of Trials(Times)	Percentage of Successful Detection (%)
1	1	Test A: 15 unique PRI values randomly selected from the list of 23 PRI values in Table 5a	Roundup $\left\{ \begin{array}{l} \left(\frac{1}{360} \right) \cdot \\ \left(\frac{19 \cdot 10^6}{PRI_{\mu sec}} \right) \end{array} \right\}$	30	100
		Test B: 15 unique PRI values randomly selected within the range of 518-3066 μ sec, with a minimum increment of 1 μ sec, excluding PRI values selected in Test A			
2	1-5	150-230	23-29	30	76.6
3	6-10	200-500	16-18	30	86.6
4	11-20	200-500	12-16	30	93.3
Aggregate (Radar Types 1-4)				120	89.1

Table 2: Long Pulse Radar Test Waveform

Radar Type	Pulse Width (μsec)	Chirp Width (MHz)	PRI (μsec)	Number of Pulses per Burst	Number of Bursts	Number of Trials(Times)	Percentage of Successful Detection (%)
5	50-100	5-20	1000-2000	1-3	8-20	30	96.6

Table 3: Frequency Hopping Radar Test Waveform

Radar Type	Pulse Width (μsec)	PRI (μsec)	Pulses per Hop	Hopping Rate (kHz)	Hopping Sequence Length (msec)	Number of Trials(Times)	Percentage of Successful Detection (%)
6	1	333	9	0.333	300	30	96.6

The Detailed Radar pattern and Statistical Performance showed in Annex A.

IEEE 802.11ac VHT40

Table 1: Short Pulse Radar Test Waveforms.

Radar Type	Pulse Width (μsec)	PRI (μsec)	Number of Pulses	Number of Trials(Times)	Percentage of Successful Detection (%)
1	1	Test A: 15 unique PRI values randomly selected from the list of 23 PRI values in Table 5a	$\text{Roundup} \left\{ \begin{array}{l} \left(\frac{1}{360} \right) \cdot \\ \left(\frac{19 \cdot 10^6}{\text{PRI}_{\mu\text{sec}}} \right) \end{array} \right\}$	30	100
		Test B: 15 unique PRI values randomly selected within the range of 518-3066 μ sec, with a minimum increment of 1 μ sec, excluding PRI values selected in Test A			
2	1-5	150-230	23-29	30	80
3	6-10	200-500	16-18	30	93.3
4	11-20	200-500	12-16	30	76.6
Aggregate (Radar Types 1-4)				120	87.5

Table 2: Long Pulse Radar Test Waveform

Radar Type	Pulse Width (μsec)	Chirp Width (MHz)	PRI (μsec)	Number of Pulses per Burst	Number of Bursts	Number of Trials(Times)	Percentage of Successful Detection (%)
5	50-100	5-20	1000-2000	1-3	8-20	30	100

Table 3: Frequency Hopping Radar Test Waveform

Radar Type	Pulse Width (μsec)	PRI (μsec)	Pulses per Hop	Hopping Rate (kHz)	Hopping Sequence Length (msec)	Number of Trials(Times)	Percentage of Successful Detection (%)
6	1	333	9	0.333	300	30	100

The Detailed Radar pattern and Statistical Performance showed in Annex A.

IEEE 802.11ac VHT80

Table 1: Short Pulse Radar Test Waveforms.

Radar Type	Pulse Width (μsec)	PRI (μsec)	Number of Pulses	Number of Trials(Times)	Percentage of Successful Detection (%)
1	1	Test A: 15 unique PRI values randomly selected from the list of 23 PRI values in Table 5a	Roundup $\left\{ \begin{array}{l} \left(\frac{1}{360} \right) \cdot \\ \left(\frac{19 \cdot 10^6}{PRI_{\mu sec}} \right) \end{array} \right\}$	30	100
		Test B: 15 unique PRI values randomly selected within the range of 518-3066 μ sec, with a minimum increment of 1 μ sec, excluding PRI values selected in Test A			
2	1-5	150-230	23-29	30	96.6
3	6-10	200-500	16-18	30	93.3
4	11-20	200-500	12-16	30	83.3
Aggregate (Radar Types 1-4)				120	90.83

Table 2: Long Pulse Radar Test Waveform

Radar Type	Pulse Width (μsec)	Chirp Width (MHz)	PRI (μsec)	Number of Pulses per Burst	Number of Bursts	Number of Trials(Times)	Percentage of Successful Detection (%)
5	50-100	5-20	1000-2000	1-3	8-20	30	100

Table 3: Frequency Hopping Radar Test Waveform

Radar Type	Pulse Width (μsec)	PRI (μsec)	Pulses per Hop	Hopping Rate (kHz)	Hopping Sequence Length (msec)	Number of Trials(Times)	Percentage of Successful Detection (%)
6	1	333	9	0.333	300	30	93.3

The Detailed Radar pattern and Statistical Performance showed in Annex A.

RBS40

IEEE 802.11ac VHT20

Table 1: Short Pulse Radar Test Waveforms.

Radar Type	Pulse Width (μsec)	PRI (μsec)	Number of Pulses	Number of Trials(Times)	Percentage of Successful Detection (%)
1	1	Test A: 15 unique PRI values randomly selected from the list of 23 PRI values in Table 5a	Roundup $\left\{ \begin{matrix} \left(\frac{1}{360} \right) \cdot \\ \left(\frac{19 \cdot 10^6}{PRI_{\mu sec}} \right) \end{matrix} \right\}$	30	100
		Test B: 15 unique PRI values randomly selected within the range of 518-3066 μ sec, with a minimum increment of 1 μ sec, excluding PRI values selected in Test A			
2	1-5	150-230	23-29	30	96.6
3	6-10	200-500	16-18	30	93.3
4	11-20	200-500	12-16	30	83.3
Aggregate (Radar Types 1-4)				120	93.3

Table 2: Long Pulse Radar Test Waveform

Radar Type	Pulse Width (μsec)	Chirp Width (MHz)	PRI (μsec)	Number of Pulses per Burst	Number of Bursts	Number of Trials(Times)	Percentage of Successful Detection (%)
5	50-100	5-20	1000-2000	1-3	8-20	30	100

Table 3: Frequency Hopping Radar Test Waveform

Radar Type	Pulse Width (μsec)	PRI (μsec)	Pulses per Hop	Hopping Rate (kHz)	Hopping Sequence Length (msec)	Number of Trials(Times)	Percentage of Successful Detection (%)
6	1	333	9	0.333	300	30	93.3

The Detailed Radar pattern and Statistical Performance showed in Annex A.

IEEE 802.11ac VHT40

Table 1: Short Pulse Radar Test Waveforms.

Radar Type	Pulse Width (μsec)	PRI (μsec)	Number of Pulses	Number of Trials(Times)	Percentage of Successful Detection (%)
1	1	Test A: 15 unique PRI values randomly selected from the list of 23 PRI values in Table 5a	Roundup $\left\{ \begin{array}{l} \left(\frac{1}{360} \right) \cdot \\ \left(\frac{19 \cdot 10^6}{PRI_{\mu sec}} \right) \end{array} \right\}$	30	100
		Test B: 15 unique PRI values randomly selected within the range of 518-3066 μ sec, with a minimum increment of 1 μ sec, excluding PRI values selected in Test A			
2	1-5	150-230	23-29	30	96.6
3	6-10	200-500	16-18	30	93.3
4	11-20	200-500	12-16	30	73.3
Aggregate (Radar Types 1-4)				120	90.8

Table 2: Long Pulse Radar Test Waveform

Radar Type	Pulse Width (μsec)	Chirp Width (MHz)	PRI (μsec)	Number of Pulses per Burst	Number of Bursts	Number of Trials(Times)	Percentage of Successful Detection (%)
5	50-100	5-20	1000-2000	1-3	8-20	30	100

Table 3: Frequency Hopping Radar Test Waveform

Radar Type	Pulse Width (μsec)	PRI (μsec)	Pulses per Hop	Hopping Rate (kHz)	Hopping Sequence Length (msec)	Number of Trials(Times)	Percentage of Successful Detection (%)
6	1	333	9	0.333	300	30	100

The Detailed Radar pattern and Statistical Performance showed in Annex A.

IEEE 802.11ac VHT80

Table 1: Short Pulse Radar Test Waveforms.

Radar Type	Pulse Width (μsec)	PRI (μsec)	Number of Pulses	Number of Trials(Times)	Percentage of Successful Detection (%)
1	1	Test A: 15 unique PRI values randomly selected from the list of 23 PRI values in Table 5a	Roundup $\left\{ \begin{array}{l} \left(\frac{1}{360} \right) \cdot \\ \left(\frac{19 \cdot 10^6}{PRI_{\mu sec}} \right) \end{array} \right\}$	30	100
		Test B: 15 unique PRI values randomly selected within the range of 518-3066 μ sec, with a minimum increment of 1 μ sec, excluding PRI values selected in Test A			
2	1-5	150-230	23-29	30	80
3	6-10	200-500	16-18	30	80
4	11-20	200-500	12-16	30	93.3
Aggregate (Radar Types 1-4)				120	88.3

Table 2: Long Pulse Radar Test Waveform

Radar Type	Pulse Width (μsec)	Chirp Width (MHz)	PRI (μsec)	Number of Pulses per Burst	Number of Bursts	Number of Trials(Times)	Percentage of Successful Detection (%)
5	50-100	5-20	1000-2000	1-3	8-20	30	100

Table 3: Frequency Hopping Radar Test Waveform

Radar Type	Pulse Width (μsec)	PRI (μsec)	Pulses per Hop	Hopping Rate (kHz)	Hopping Sequence Length (msec)	Number of Trials(Times)	Percentage of Successful Detection (%)
6	1	333	9	0.333	300	30	100

The Detailed Radar pattern and Statistical Performance showed in Annex A.

For 5470~5725MHz

IEEE 802.11ac VHT20

Table 1: Short Pulse Radar Test Waveforms.

Radar Type	Pulse Width (μsec)	PRI (μsec)	Number of Pulses	Number of Trials(Times)	Percentage of Successful Detection (%)
1	1	Test A: 15 unique PRI values randomly selected from the list of 23 PRI values in Table 5a	Roundup $\left\{ \begin{array}{l} \left(\frac{1}{360} \right) \cdot \\ \left(\frac{19 \cdot 10^6}{PRI_{\mu sec}} \right) \end{array} \right\}$	30	96.67
		Test B: 15 unique PRI values randomly selected within the range of 518-3066 μ sec, with a minimum increment of 1 μ sec, excluding PRI values selected in Test A			
2	1-5	150-230	23-29	30	73.33
3	6-10	200-500	16-18	30	80
4	11-20	200-500	12-16	30	83.33
Aggregate (Radar Types 1-4)				120	83.33

Table 2: Long Pulse Radar Test Waveform

Radar Type	Pulse Width (μsec)	Chirp Width (MHz)	PRI (μsec)	Number of Pulses per Burst	Number of Bursts	Number of Trials(Times)	Percentage of Successful Detection (%)
5	50-100	5-20	1000-2000	1-3	8-20	30	80

Table 3: Frequency Hopping Radar Test Waveform

Radar Type	Pulse Width (μsec)	PRI (μsec)	Pulses per Hop	Hopping Rate (kHz)	Hopping Sequence Length (msec)	Number of Trials(Times)	Percentage of Successful Detection (%)
6	1	333	9	0.333	300	30	100

The Detailed Radar pattern and Statistical Performance showed in Annex A.

IEEE 802.11ac VHT40

Table 1: Short Pulse Radar Test Waveforms.

Radar Type	Pulse Width (μsec)	PRI (μsec)	Number of Pulses	Number of Trials(Times)	Percentage of Successful Detection (%)
1	1	Test A: 15 unique PRI values randomly selected from the list of 23 PRI values in Table 5a	$\text{Roundup} \left\{ \begin{array}{l} \left(\frac{1}{360} \right) \cdot \\ \left(\frac{19 \cdot 10^6}{\text{PRI}_{\mu\text{sec}}} \right) \end{array} \right\}$	30	100
		Test B: 15 unique PRI values randomly selected within the range of 518-3066 μ sec, with a minimum increment of 1 μ sec, excluding PRI values selected in Test A			
2	1-5	150-230	23-29	30	83.33
3	6-10	200-500	16-18	30	80
4	11-20	200-500	12-16	30	83.33
Aggregate (Radar Types 1-4)				120	86.67

Table 2: Long Pulse Radar Test Waveform

Radar Type	Pulse Width (μsec)	Chirp Width (MHz)	PRI (μsec)	Number of Pulses per Burst	Number of Bursts	Number of Trials(Times)	Percentage of Successful Detection (%)
5	50-100	5-20	1000-2000	1-3	8-20	30	90

Table 3: Frequency Hopping Radar Test Waveform

Radar Type	Pulse Width (μsec)	PRI (μsec)	Pulses per Hop	Hopping Rate (kHz)	Hopping Sequence Length (msec)	Number of Trials(Times)	Percentage of Successful Detection (%)
6	1	333	9	0.333	300	30	100

The Detailed Radar pattern and Statistical Performance showed in Annex A.

IEEE 802.11ac VHT80

Table 1: Short Pulse Radar Test Waveforms.

Radar Type	Pulse Width (μsec)	PRI (μsec)	Number of Pulses	Number of Trials(Times)	Percentage of Successful Detection (%)
1	1	Test A: 15 unique PRI values randomly selected from the list of 23 PRI values in Table 5a	Roundup $\left\{ \begin{array}{l} \left(\frac{1}{360} \right) \cdot \\ \left(\frac{19 \cdot 10^6}{PRI_{\mu sec}} \right) \end{array} \right\}$	30	100
		Test B: 15 unique PRI values randomly selected within the range of 518-3066 μ sec, with a minimum increment of 1 μ sec, excluding PRI values selected in Test A			
2	1-5	150-230	23-29	30	76.7
3	6-10	200-500	16-18	30	83.3
4	11-20	200-500	12-16	30	80
Aggregate (Radar Types 1-4)				120	85

Table 2: Long Pulse Radar Test Waveform

Radar Type	Pulse Width (μsec)	Chirp Width (MHz)	PRI (μsec)	Number of Pulses per Burst	Number of Bursts	Number of Trials(Times)	Percentage of Successful Detection (%)
5	50-100	5-20	1000-2000	1-3	8-20	30	100

Table 3: Frequency Hopping Radar Test Waveform

Radar Type	Pulse Width (μsec)	PRI (μsec)	Pulses per Hop	Hopping Rate (kHz)	Hopping Sequence Length (msec)	Number of Trials(Times)	Percentage of Successful Detection (%)
6	1	333	9	0.333	300	30	93.3

The Detailed Radar pattern and Statistical Performance showed in Annex A.

6.2.5 Non- Occupancy Period

Associate test:

During the 30 minutes observation time, UUT did not make any transmissions on a channel after a radar signal was detected on that channel by either the Channel Availability Check or the In-Service Monitoring.

For 5250~5350MHz

- 1) EUT (Client) links with master on 5300MHz.

Waveform of EUT links up with Master

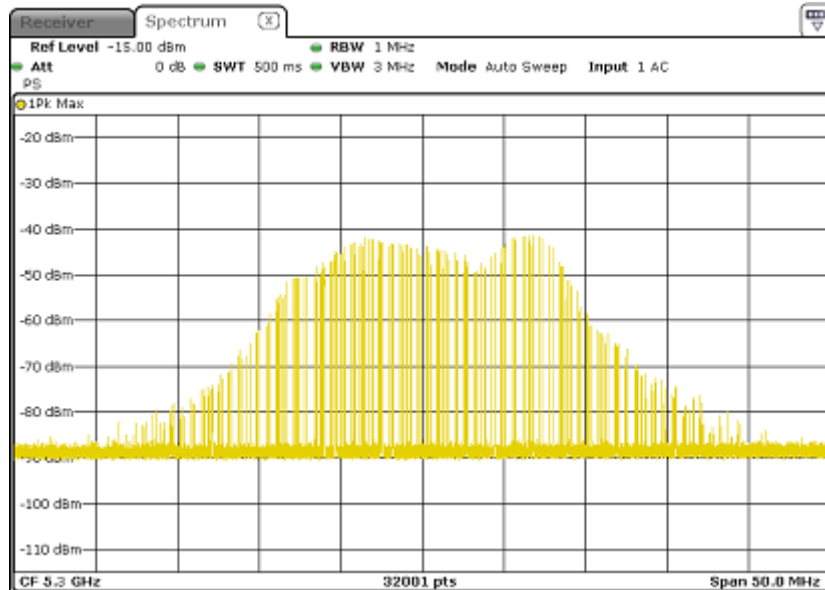

- 2) Client plays specified files via master.

Waveform of transmission



3) Radar signal is applied to the Master device and WiFi traffic signal stop immediately.

Radar 0

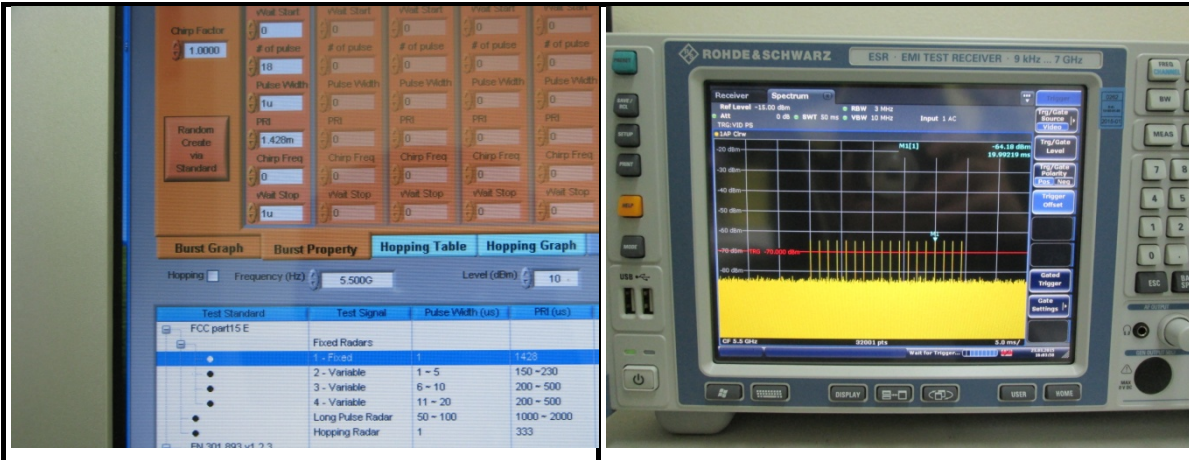

Radar 1

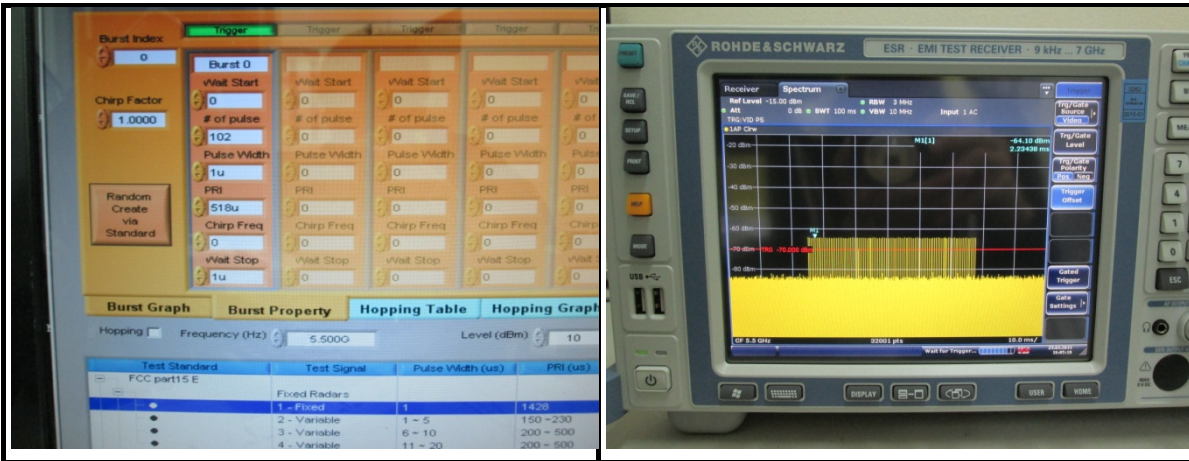

Radar 2

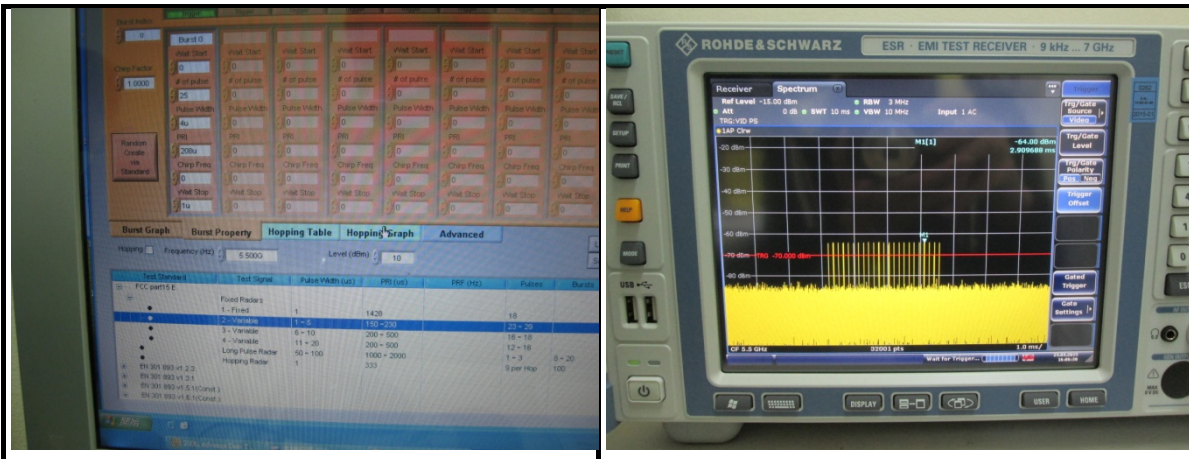

Radar 3

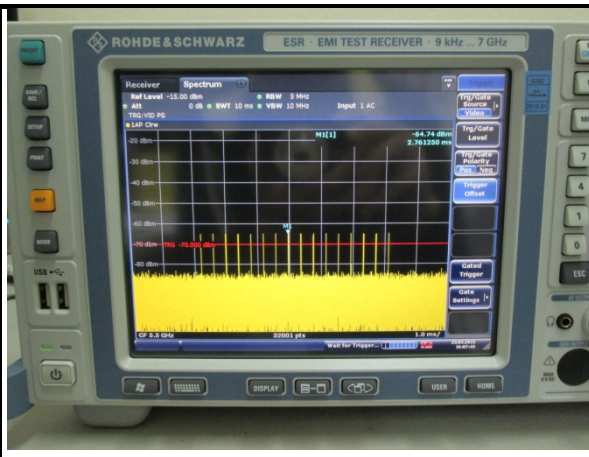

Radar 4

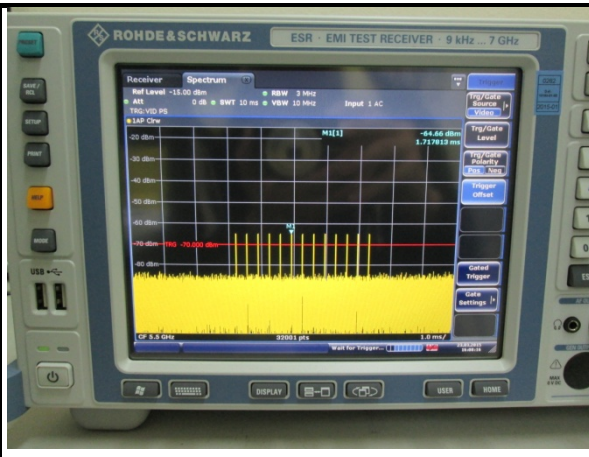
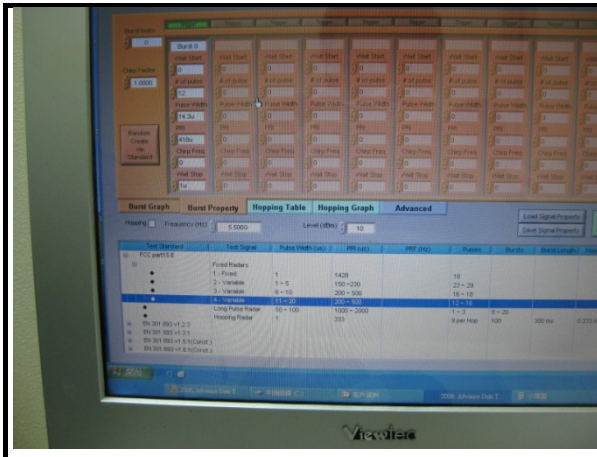

Radar 5

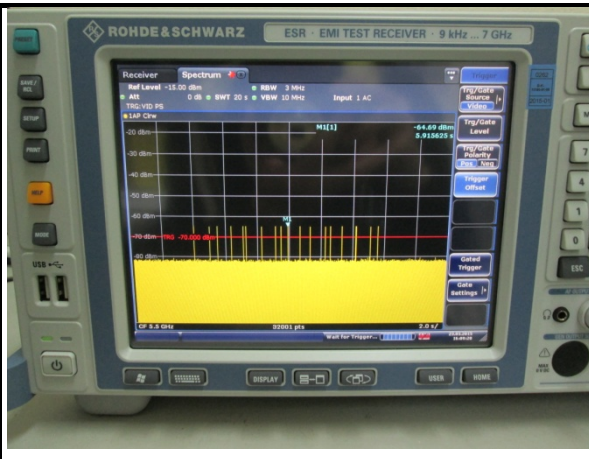
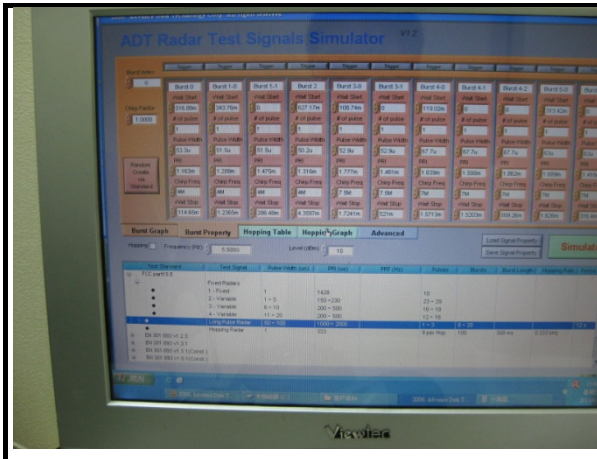

Radar 6



4) 5300MHz has been monitored in 30 minutes period. In this period, no any transmission occurs.

Plot of 30minutes period

802.11an HT20

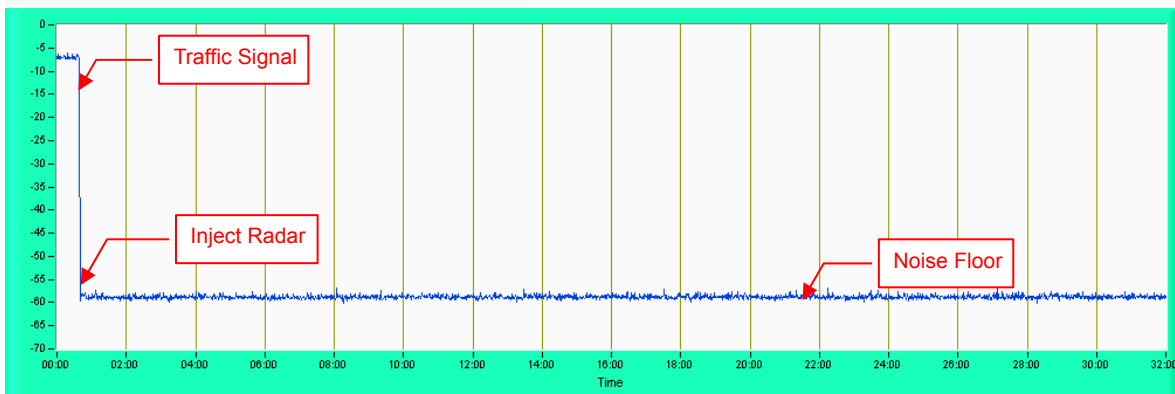

NOTE: Test setup are shown on Test setup photo.pdf

For 5470~5725MHz

1) EUT (Client) links with master on 5500MHz.

Waveform of EUT links up with Master

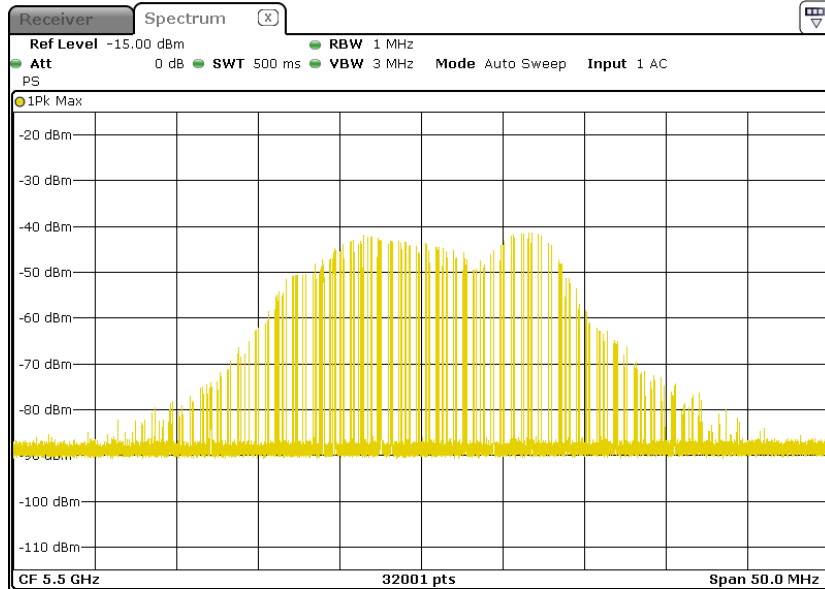

2) Client plays specified files via master.

Waveform of transmission

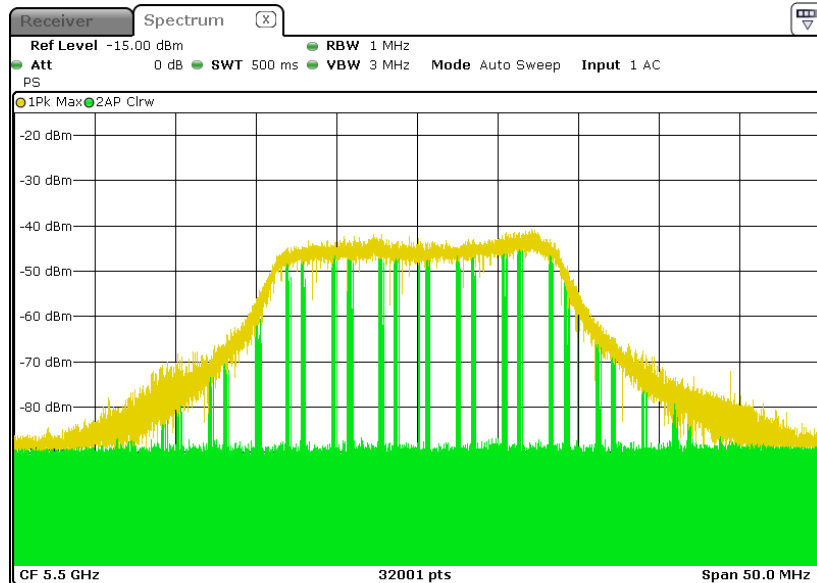

3) Radar signal is applied to the Master device and WiFi traffic signal stop immediately.

Radar 0

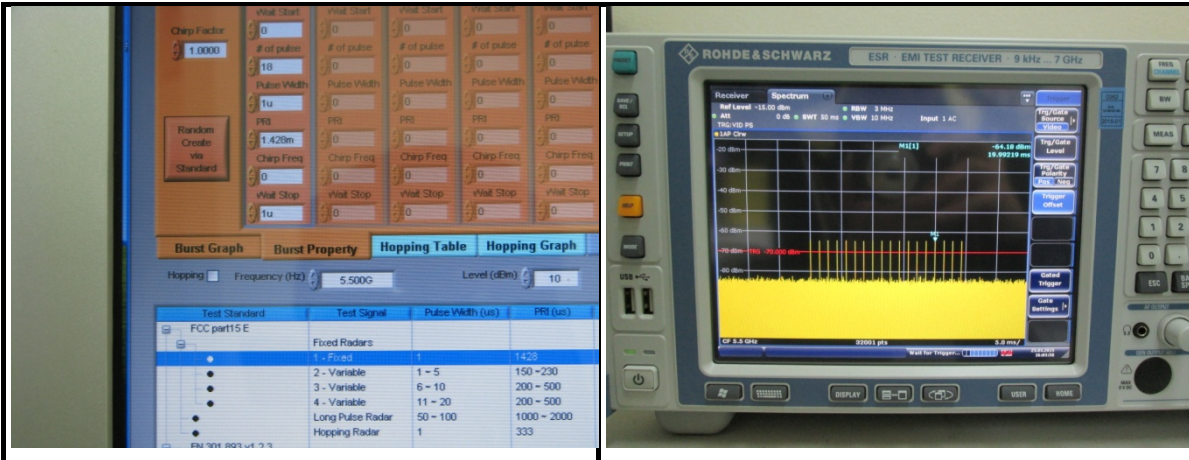

Radar 1

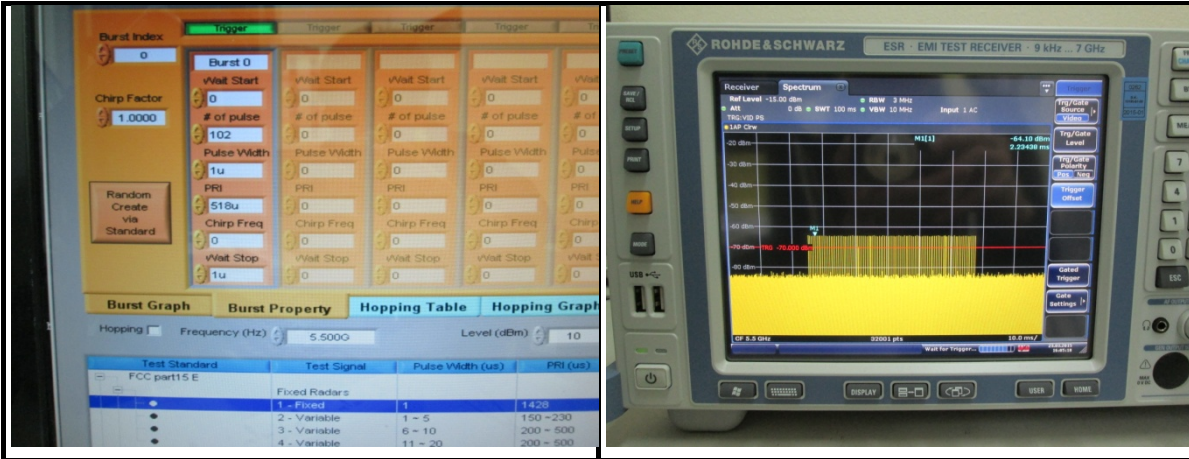

Radar 2



Radar 3

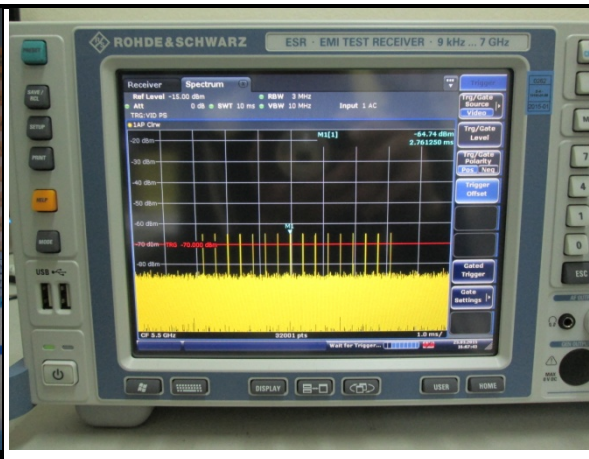

Radar 4

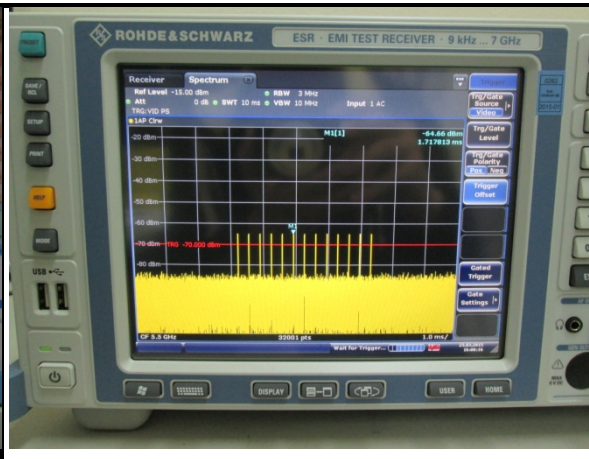
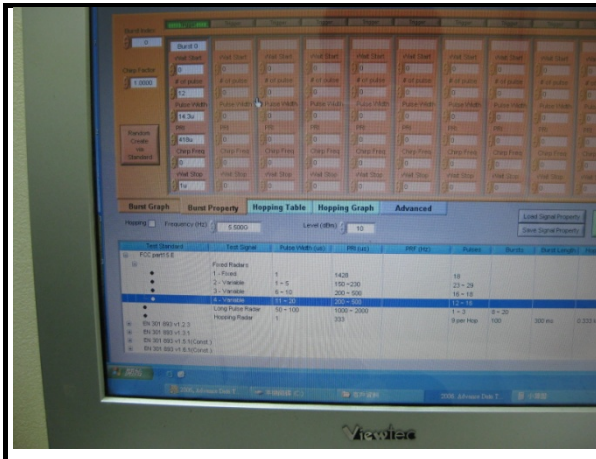

Radar 5

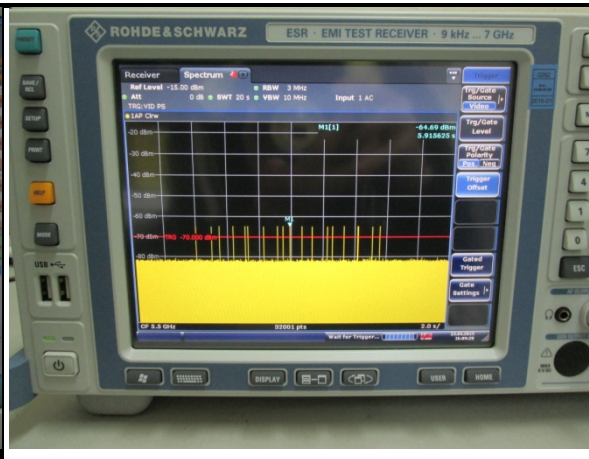

Radar 6



4) 5500MHz has been monitored in 30 minutes period. In this period, no any transmission occurs.

Plot of 30minutes period

802.11an HT20

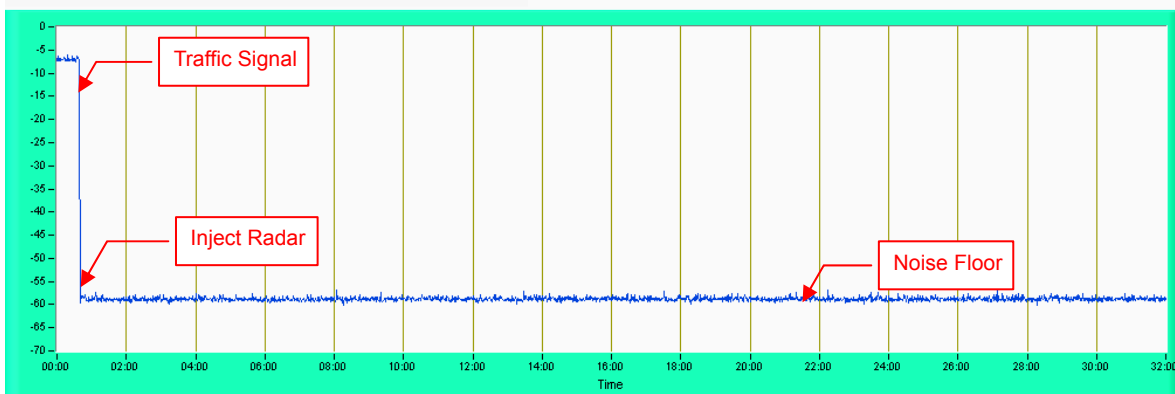

NOTE: Test setup are shown on Test setup photo.pdf

6.2.6 Uniform Spreading

The intention of the uniform spreading is to provide, on aggregate, a uniform loading of the spectrum. The EUT randomly select next output channel without any bias or fixed pattern, so that all channels in DFS bands (5250 to 5350MHz and 5470 to 5725 MHz) will be used equally.

6.3 Test Results: Client

6.3.1 Test Mode

Client with injection at the Master. (The radar test signals are injected into the Master Device.)

DFS Detection Threshold

For a detection threshold level of -64dBm, the required signal strength at EUT antenna location is -64 dBm. The tested level is lower than required level hence it provides margin to the limit.

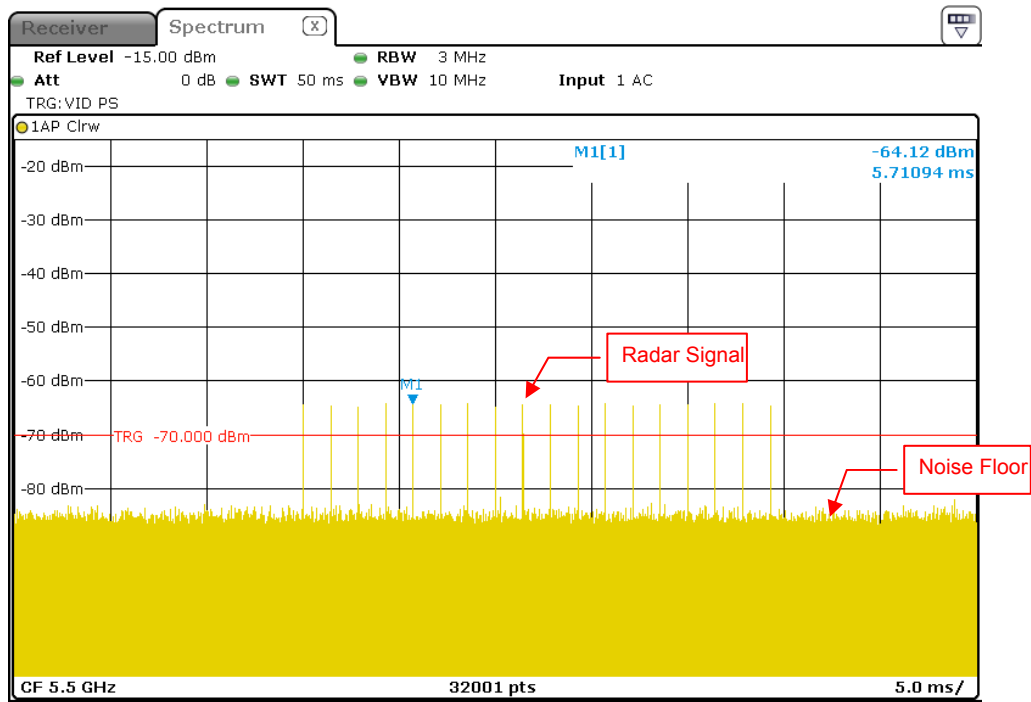

Radar Signal 0

6.3.2 Channel Closing Transmission and Channel Move Time

Radar signal 0

802.11ac (VHT20)

Channel Closing Transmission Time & Channel Move Time

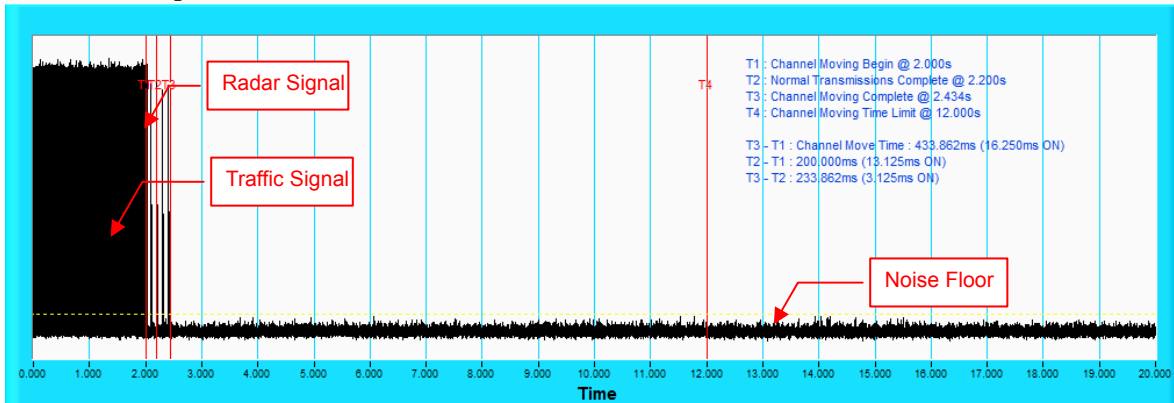

NOTE: T1 denotes the start of Channel Move Time upon the end of the last Radar burst. T2 denotes the data transmission time of 200ms from T1. T3 denotes the end of Channel Move Time. T4 denotes the 10 second from T1 to observe the aggregate duration of transmissions.

Channel Closing Transmission Time & Channel Move Time

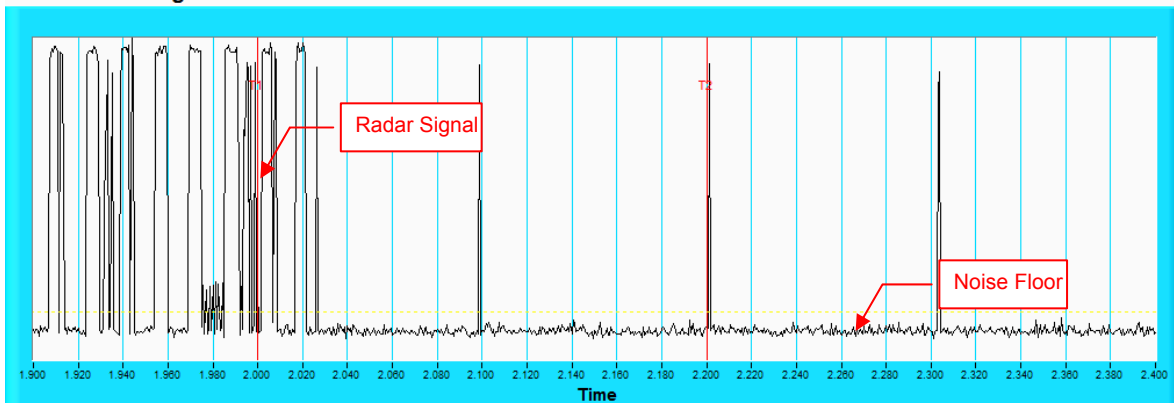

NOTE: Zoom-in of the first 500ms after radar signal applied.

Radar signal 0
802.11ac (VHT40)

Channel Closing Transmission Time & Channel Move Time

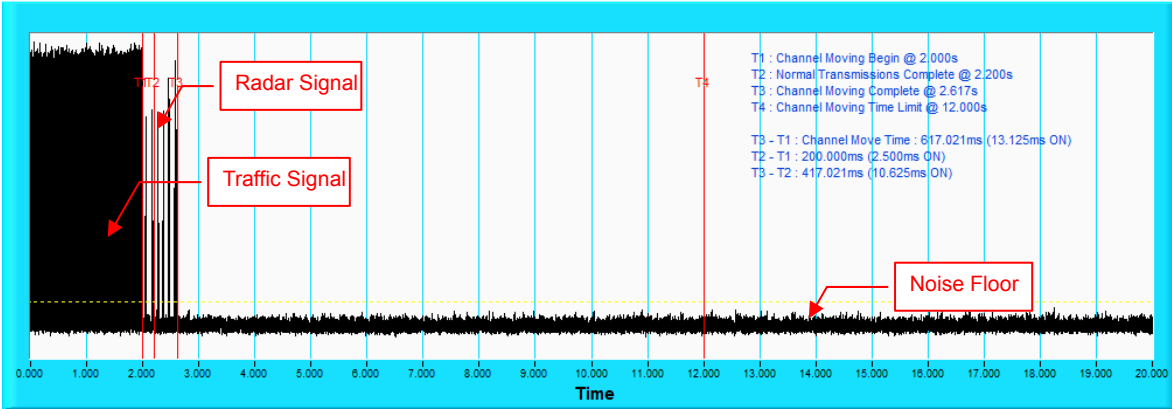

NOTE: T1 denotes the start of Channel Move Time upon the end of the last Radar burst. T2 denotes the data transmission time of 200ms from T1. T3 denotes the end of Channel Move Time. T4 denotes the 10 second from T1 to observe the aggregate duration of transmissions.

Channel Closing Transmission Time & Channel Move Time

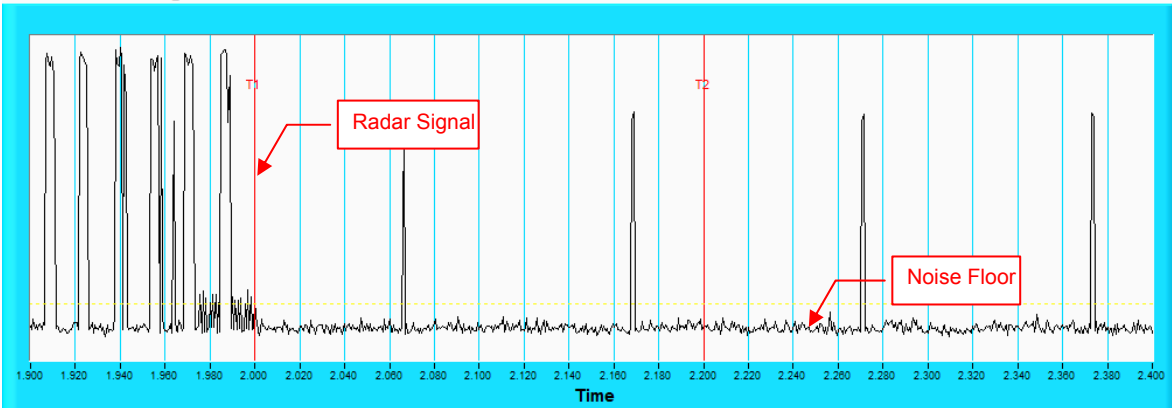

NOTE: Zoom-in of the first 500ms after radar signal applied.

Radar signal 0
802.11ac (VHT80)

Channel Closing Transmission Time & Channel Move Time

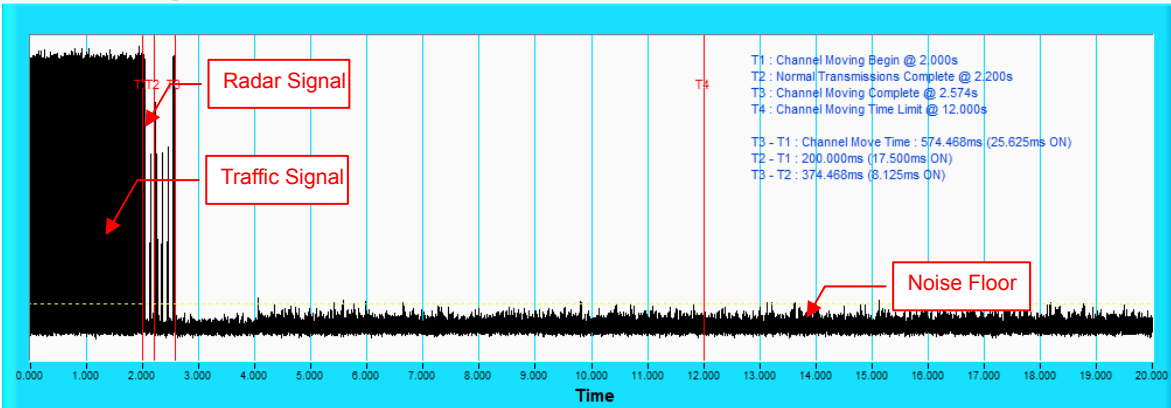

NOTE: T1 denotes the start of Channel Move Time upon the end of the last Radar burst. T2 denotes the data transmission time of 200ms from T1. T3 denotes the end of Channel Move Time. T4 denotes the 10 second from T1 to observe the aggregate duration of transmissions.

Channel Closing Transmission Time & Channel Move Time

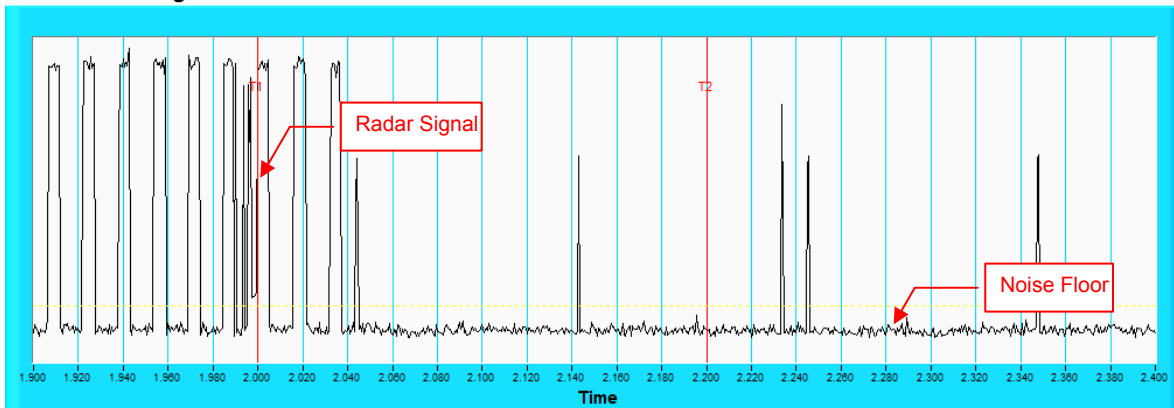

NOTE: Zoom-in of the first 500ms after radar signal applied.

6.3.3 Non-Occupancy Period

Associate test:

During the 30 minutes observation time, UUT did not make any transmissions on a channel after a radar signal was detected on that channel by either the Channel Availability Check or the In-Service Monitoring.

- 1) EUT (Client) links with master on 5500MHz.

Waveform of EUT links up with Master

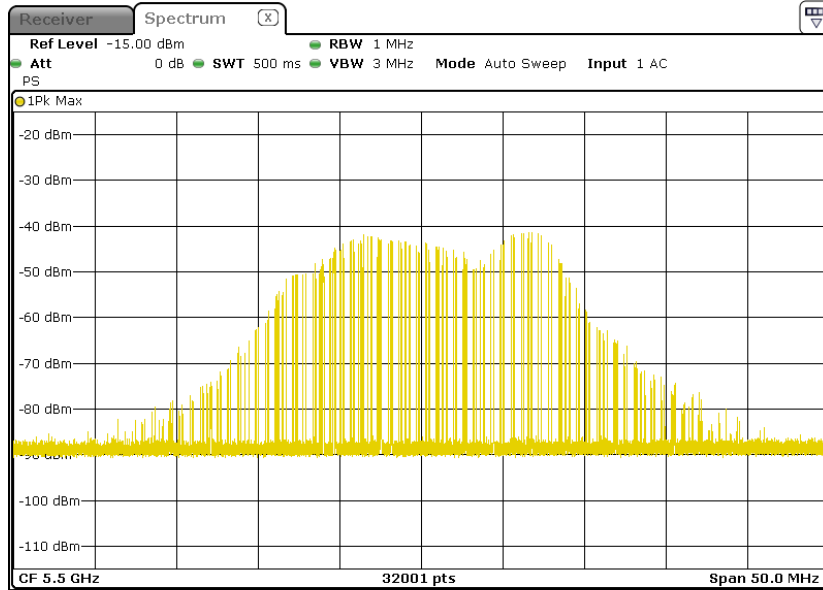

- 2) Client plays specified files via master.

Waveform of transmission

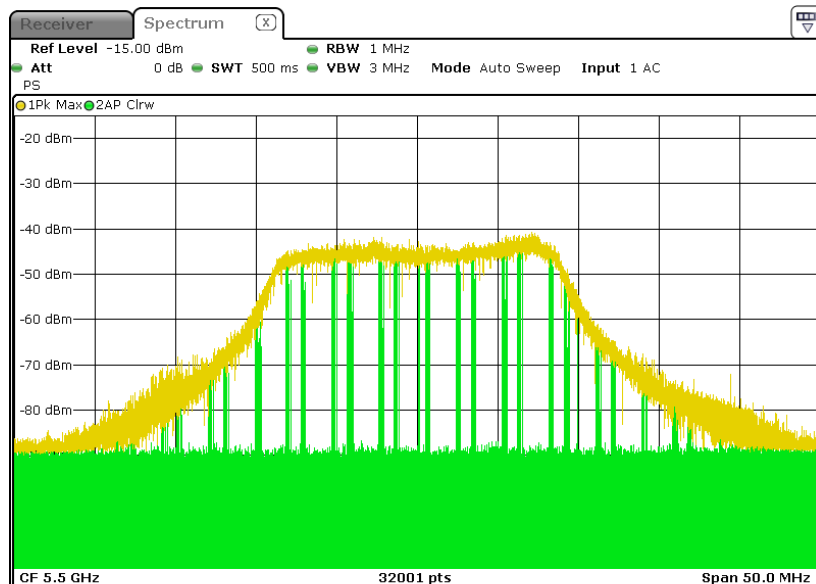

3) Radar signal 0 is applied to the Master device and WiFi traffic signal stop immediately.

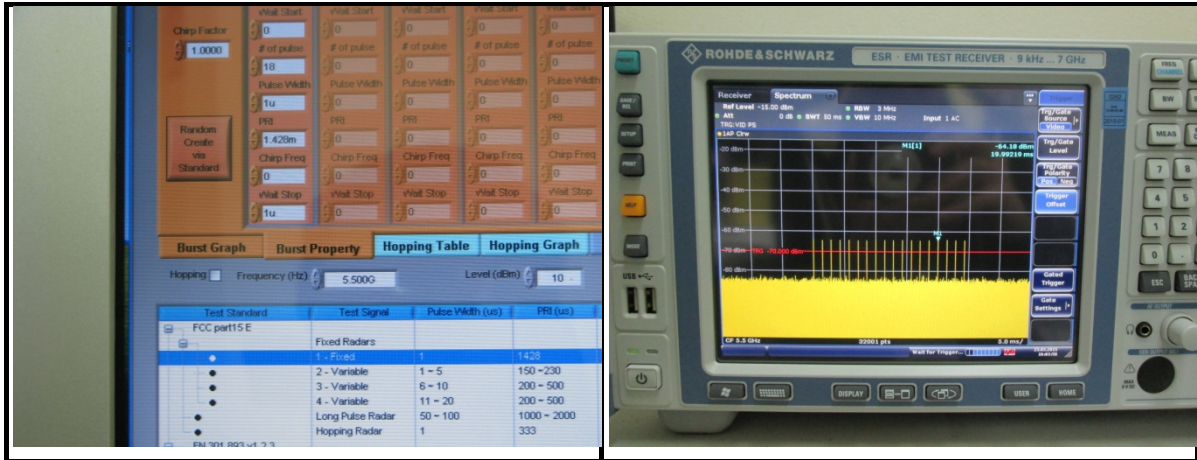

4) 5500MHz has been monitored in 30 minutes period. In this period, no any transmission occurs.

Plot of 30minutes period

802.11ac (VHT20)

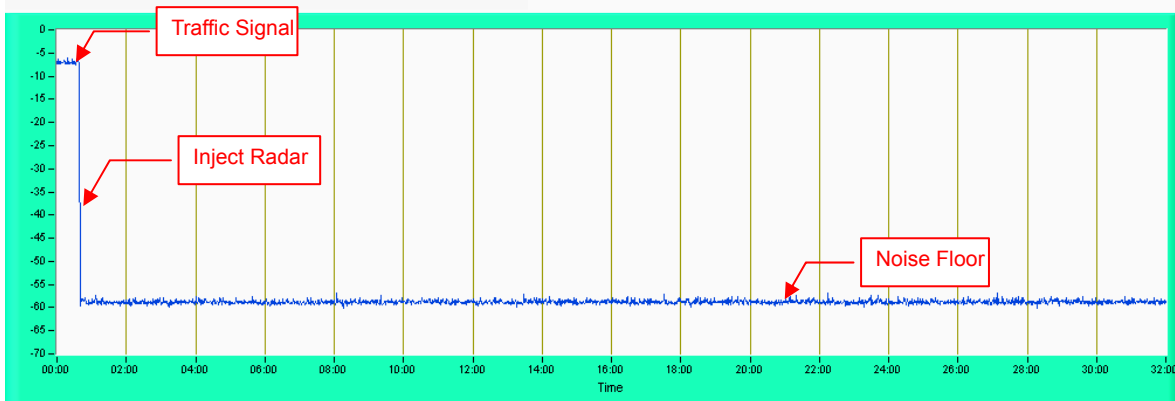

NOTE: Test setup are shown on Test setup photo.pdf

6.3.4 Non-Associated Test

Master was off.

During the 30 minutes observation time, The EUT did not make any transmissions in the DFS band after EUT power up.

802.11ac (VHT20)

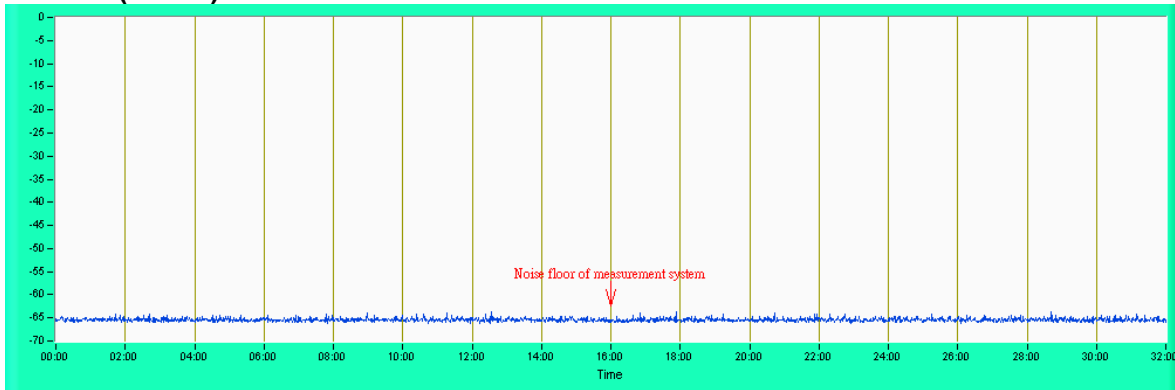

6.3.5 Non-Co-Channel Test

The EUT was investigated after radar was detected the channel and made sure no co-channel operation with radars.

7. Information on the Testing Laboratories

We, Bureau Veritas Consumer Products Services (H.K.) Ltd., Taoyuan Branch, were founded in 1988 to provide our best service in EMC, Radio, Telecom and Safety consultation. Our laboratories are accredited and approved according to ISO/IEC 17025.

If you have any comments, please feel free to contact us at the following:

Linko EMC/RF Lab
Tel: 886-2-26052180
Fax: 886-2-26051924

Hsin Chu EMC/RF/Telecom Lab
Tel: 886-3-6668565
Fax: 886-3-6668323

Hwa Ya EMC/RF/Safety Lab:
Tel: 886-3-3183232
Fax: 886-3-3270892

Email: service.adt@tw.bureauveritas.com

Web Site: www.bureauveritas-adt.com

The address and road map of all our labs can be found in our web site also.

--- END ---

Annex-A
For 5250~5350MHz
RBR40

Annex A.1: The Detailed Radar pattern and Statistical Performance
IEEE 802.11ac VHT20

Type 1 Radar Statistical Performances					
Trial #	Pulses per Burst	Pulse Width (s)	PRI (s)	Radar Frequency (MHz)	Detection
1	99	1.0u	538.0u	5291	Yes
2	95	1.0u	558.0u	5292	Yes
3	92	1.0u	578.0u	5293	Yes
4	86	1.0u	618.0u	5294	Yes
5	83	1.0u	638.0u	5295	Yes
6	81	1.0u	658.0u	5296	Yes
7	78	1.0u	678.0u	5297	Yes
8	76	1.0u	698.0u	5298	Yes
9	74	1.0u	718.0u	5299	Yes
10	67	1.0u	798.0u	5300	Yes
11	63	1.0u	838.0u	5301	Yes
12	62	1.0u	858.0u	5302	Yes
13	61	1.0u	878.0u	5303	Yes
14	59	1.0u	898.0u	5304	Yes
15	58	1.0u	918.0u	5305	Yes
16	66	1.0u	801.0u	5306	Yes
17	59	1.0u	901.0u	5307	Yes
18	63	1.0u	841.0u	5308	Yes
19	39	1.0u	1.365m	5309	Yes
20	69	1.0u	769.0u	5307	Yes
21	63	1.0u	849.0u	5305	Yes
22	57	1.0u	929.0u	5303	Yes
23	56	1.0u	949.0u	5302	Yes
24	69	1.0u	775.0u	5300	Yes
25	65	1.0u	815.0u	5298	Yes
26	61	1.0u	875.0u	5296	Yes
27	59	1.0u	895.0u	5294	Yes
28	58	1.0u	915.0u	5293	Yes
29	57	1.0u	935.0u	5292	Yes
30	19	1.0u	2.853m	5291	Yes
Detection Rate: 100.0 %					

Type 2 Radar Statistical Performances					
Trial #	Pulses per Burst	Pulse Width (s)	PRI (s)	Radar Frequency (MHz)	Detection
1	23	2.3u	222.0u	5291	Yes
2	28	1.8u	204.0u	5292	Yes
3	26	1.6u	225.0u	5293	Yes
4	27	3.8u	168.0u	5294	Yes
5	27	1.1u	227.0u	5295	Yes
6	27	2.6u	166.0u	5296	No
7	24	4.7u	161.0u	5297	No
8	28	1.9u	180.0u	5298	Yes
9	29	1.3u	176.0u	5299	Yes
10	23	1.8u	170.0u	5300	No
11	29	1.4u	195.0u	5301	Yes
12	25	3.4u	228.0u	5302	Yes
13	26	2.3u	206.0u	5303	No
14	27	4.5u	189.0u	5304	Yes
15	25	3.9u	194.0u	5302	Yes
16	25	3.0u	154.0u	5303	No
17	23	3.6u	182.0u	5304	Yes
18	26	3.4u	160.0u	5305	Yes
19	25	3.3u	229.0u	5306	No
20	23	1.9u	151.0u	5307	Yes
21	25	1.8u	184.0u	5308	Yes
22	28	2.3u	229.0u	5309	No
23	29	1.1u	210.0u	5307	Yes
24	26	2.2u	203.0u	5305	Yes
25	25	2.9u	222.0u	5303	Yes
26	28	1.4u	220.0u	5302	Yes
27	26	1.8u	155.0u	5300	Yes
28	29	3.4u	155.0u	5298	Yes
29	28	3.1u	204.0u	5296	Yes
30	26	4.4u	176.0u	5291	Yes

Detection Rate: 76.6 %

Type 3 Radar Statistical Performances					
Trial #	Pulses per Burst	Pulse Width (s)	PRI (s)	Radar Frequency (MHz)	Detection
1	18	7.8u	292.0u	5291	Yes
2	18	7.0u	366.0u	5292	Yes
3	18	9.2u	486.0u	5293	Yes
4	17	6.8u	216.0u	5294	Yes
5	18	7.3u	446.0u	5295	No
6	16	6.6u	208.0u	5296	Yes
7	17	6.8u	347.0u	5297	Yes
8	17	9.6u	232.0u	5298	Yes
9	17	6.2u	364.0u	5299	Yes
10	16	7.1u	407.0u	5300	Yes
11	18	6.6u	458.0u	5301	Yes
12	17	9.1u	226.0u	5302	Yes
13	16	6.9u	297.0u	5303	Yes
14	18	9.8u	463.0u	5304	Yes
15	17	6.1u	329.0u	5302	Yes
16	17	10.0u	333.0u	5303	Yes
17	18	8.5u	399.0u	5304	Yes
18	17	8.7u	316.0u	5305	Yes
19	16	9.9u	402.0u	5306	Yes
20	17	6.9u	446.0u	5307	Yes
21	16	6.6u	451.0u	5308	Yes
22	16	8.2u	272.0u	5296	Yes
23	17	8.5u	395.0u	5297	Yes
24	17	8.4u	379.0u	5298	No
25	16	7.4u	292.0u	5299	No
26	16	9.8u	489.0u	5300	No
27	17	7.7u	375.0u	5301	Yes
28	16	7.7u	297.0u	5302	Yes
29	18	9.2u	347.0u	5303	Yes
30	16	6.9u	415.0u	5291	Yes

Detection Rate: 86.6 %

Type 4 Radar Statistical Performances					
Trial #	Pulses per Burst	Pulse Width (s)	PRI (s)	Radar Frequency (MHz)	Detection
1	14	18.2u	402.0u	5291	Yes
2	13	14.5u	226.0u	5292	Yes
3	15	13.7u	340.0u	5293	Yes
4	16	12.2u	469.0u	5294	Yes
5	12	14.6u	220.0u	5295	Yes
6	15	17.0u	370.0u	5296	Yes
7	15	11.4u	458.0u	5297	No
8	13	11.6u	487.0u	5298	Yes
9	16	16.2u	202.0u	5299	Yes
10	15	19.8u	363.0u	5300	Yes
11	14	11.8u	424.0u	5301	Yes
12	14	18.0u	407.0u	5302	Yes
13	16	17.8u	256.0u	5303	Yes
14	16	13.1u	420.0u	5304	No
15	13	18.6u	243.0u	5302	Yes
16	14	13.4u	284.0u	5303	Yes
17	12	17.7u	410.0u	5304	Yes
18	15	19.3u	234.0u	5305	Yes
19	14	11.9u	411.0u	5306	Yes
20	16	13.4u	420.0u	5307	Yes
21	14	19.2u	235.0u	5308	Yes
22	14	15.2u	406.0u	5295	Yes
23	15	18.7u	408.0u	5296	Yes
24	13	16.1u	366.0u	5297	Yes
25	13	11.3u	369.0u	5298	Yes
26	14	17.1u	284.0u	5299	Yes
27	13	13.5u	495.0u	5300	Yes
28	15	16.8u	424.0u	5301	Yes
29	14	16.3u	322.0u	5302	Yes
30	13	13.0u	314.0u	5291	Yes

Detection Rate: 93.3 %

Type 5 Radar Statistical Performances		
Trial #	Test Signal Name	Detection
1	LP_Signal_01	Yes
2	LP_Signal_02	Yes
3	LP_Signal_03	Yes
4	LP_Signal_04	Yes
5	LP_Signal_05	Yes
6	LP_Signal_06	Yes
7	LP_Signal_07	Yes
8	LP_Signal_08	Yes
9	LP_Signal_09	Yes
10	LP_Signal_10	Yes
11	LP_Signal_11	Yes
12	LP_Signal_12	Yes
13	LP_Signal_13	Yes
14	LP_Signal_14	Yes
15	LP_Signal_15	Yes
16	LP_Signal_16	Yes
17	LP_Signal_17	Yes
18	LP_Signal_18	Yes
19	LP_Signal_19	Yes
20	LP_Signal_20	Yes
21	LP_Signal_21	Yes
22	LP_Signal_22	Yes
23	LP_Signal_23	Yes
24	LP_Signal_24	Yes
25	LP_Signal_25	Yes
26	LP_Signal_26	Yes
27	LP_Signal_27	Yes
28	LP_Signal_28	Yes
29	LP_Signal_29	Yes
30	LP_Signal_30	No
		Detection Rate: 96.6 %

Long Pulse Radar Test Signal						
Test Signal Name: LP_Signal_01						
Number of Bursts in Trial: 16						
Chrip Center Frequency: 5293MHz						
Burst	Pulses per Burst	Chrip (Hz)	Pulse Width (s)	Pulse 1 to 2 Spacing (s)	Pulse 2 to 3 Spacing (s)	Start Location (s)
1	1	5M	59.2u	-	-	243.0m
2	2	5M	94.5u	1.834m	-	299.3m
3	2	5M	95.4u	1.641m	-	566.0m
4	3	5M	59.5u	1.313m	1.332m	354.8m
5	2	5M	62.1u	1.158m	-	618.4m
6	3	5M	73.9u	1.671m	1.534m	629.7m
7	2	5M	50.4u	1.155m	-	384.7m
8	3	5M	62.7u	1.675m	1.571m	94.54m
9	1	5M	52.4u	-	-	45.93m
10	3	5M	55.9u	1.743m	1.537m	37.45m
11	2	5M	62.1u	1.725m	-	173.9m
12	3	5M	65.1u	1.567m	1.369m	549.6m
13	3	5M	80.3u	1.548m	1.117m	530.8m
14	2	5M	85.5u	1.063m	-	265.8m
15	3	5M	54.7u	1.134m	1.657m	49.43m
16	2	5M	85.8u	1.450m	-	382.0m

Long Pulse Radar Test Signal						
Test Signal Name: LP_Signal_02						
Number of Bursts in Trial: 11						
Chrip Center Frequency: 5293MHz						
Burst	Pulses per Burst	Chrip (Hz)	Pulse Width (s)	Pulse 1 to 2 Spacing (s)	Pulse 2 to 3 Spacing (s)	Start Location (s)
1	3	5M	77.4u	928.6u	1.433m	748.0m
2	2	5M	76.8u	1.792m	-	106.4m
3	2	5M	80.6u	1.265m	-	687.9m
4	3	5M	91.4u	1.357m	1.842m	327.9m
5	3	5M	90.0u	1.712m	1.217m	846.9m
6	2	5M	64.2u	1.792m	-	764.9m
7	2	5M	97.3u	1.153m	-	266.8m
8	2	5M	52.9u	952.1u	-	132.9m
9	3	5M	95.0u	1.657m	1.029m	423.4m
10	2	5M	87.7u	1.304m	-	303.7m
11	3	5M	69.8u	1.737m	1.511m	612.5m

Long Pulse Radar Test Signal						
Test Signal Name: LP_Signal_03						
Number of Bursts in Trial: 16						
Chrip Center Frequency: 5293MHz						
Burst	Pulses per Burst	Chrip (Hz)	Pulse Width (s)	Pulse 1 to 2 Spacing (s)	Pulse 2 to 3 Spacing (s)	Start Location (s)
1	3	6M	58.3u	1.169m	1.228m	212.0m
2	1	6M	67.9u	-	-	683.3m
3	2	6M	76.5u	1.176m	-	683.9m
4	2	6M	54.8u	1.298m	-	490.2m
5	3	6M	79.2u	1.024m	1.835m	160.4m
6	2	6M	89.3u	1.805m	-	653.3m
7	1	6M	77.2u	-	-	73.40m
8	3	6M	89.4u	1.249m	1.228m	589.4m
9	3	6M	97.7u	1.549m	1.052m	484.7m
10	3	6M	99.5u	1.824m	1.045m	490.8m
11	2	6M	62.4u	1.758m	-	48.28m
12	2	6M	99.1u	1.202m	-	270.9m
13	3	6M	92.6u	1.079m	1.569m	227.5m
14	2	6M	87.4u	1.359m	-	577.4m
15	1	6M	81.1u	-	-	371.3m
16	3	6M	50.5u	1.117m	996.5u	19.19m

Long Pulse Radar Test Signal						
Test Signal Name: LP_Signal_04						
Number of Bursts in Trial: 15						
Chrip Center Frequency: 5293MHz						
Burst	Pulses per Burst	Chrip (Hz)	Pulse Width (s)	Pulse 1 to 2 Spacing (s)	Pulse 2 to 3 Spacing (s)	Start Location (s)
1	1	6M	68.7u	-	-	13.44m
2	1	6M	92.8u	-	-	618.8m
3	2	6M	73.7u	1.459m	-	424.4m
4	2	6M	97.6u	1.294m	-	736.2m
5	1	6M	93.2u	-	-	795.7m
6	2	6M	97.1u	1.871m	-	787.0m
7	2	6M	89.4u	948.6u	-	601.5m
8	2	6M	92.5u	922.5u	-	499.5m
9	2	6M	94.8u	1.066m	-	562.5m
10	2	6M	78.1u	1.629m	-	68.89m
11	1	6M	88.1u	-	-	749.7m
12	3	6M	98.0u	1.708m	999.0u	541.0m
13	2	6M	74.6u	1.001m	-	9.908m
14	1	6M	80.3u	-	-	107.8m
15	1	6M	66.7u	-	-	643.2m

Long Pulse Radar Test Signal
 Test Signal Name: LP_Signal_05
 Number of Bursts in Trial: 10
 Chrip Center Frequency: 5293MHz

Burst	Pulses per Burst	Chrip (Hz)	Pulse Width (s)	Pulse 1 to 2 Spacing (s)	Pulse 2 to 3 Spacing (s)	Start Location (s)
1	2	7M	55.6u	1.308m	-	946.0m
2	2	7M	90.3u	1.109m	-	586.0m
3	3	7M	75.1u	1.179m	1.124m	427.1m
4	3	7M	86.1u	1.371m	1.270m	375.9m
5	2	7M	89.1u	1.058m	-	615.5m
6	2	7M	76.9u	1.774m	-	247.3m
7	2	7M	64.3u	1.929m	-	1.055
8	3	7M	61.7u	1.387m	1.721m	167.4m
9	2	7M	95.7u	1.831m	-	305.4m
10	3	7M	84.7u	1.764m	1.195m	294.9m

Long Pulse Radar Test Signal
 Test Signal Name: LP_Signal_06
 Number of Bursts in Trial: 14
 Chrip Center Frequency: 5293MHz

Burst	Pulses per Burst	Chrip (Hz)	Pulse Width (s)	Pulse 1 to 2 Spacing (s)	Pulse 2 to 3 Spacing (s)	Start Location (s)
1	3	7M	61.1u	1.316m	1.353m	376.4m
2	2	7M	69.8u	1.577m	-	775.8m
3	3	7M	83.7u	1.741m	1.014m	812.2m
4	3	7M	93.6u	933.4u	990.4u	456.3m
5	1	7M	88.6u	-	-	210.5m
6	1	7M	71.2u	-	-	415.3m
7	2	7M	64.3u	1.046m	-	215.6m
8	1	7M	67.5u	-	-	630.2m
9	1	7M	66.7u	-	-	332.1m
10	1	7M	73.9u	-	-	254.5m
11	2	7M	68.8u	1.006m	-	808.5m
12	2	7M	51.4u	1.834m	-	352.5m
13	2	7M	60.3u	1.317m	-	643.1m
14	1	7M	84.8u	-	-	743.2m

Long Pulse Radar Test Signal
 Test Signal Name: LP_Signal_07
 Number of Bursts in Trial: 13
 Chrip Center Frequency: 5297MHz

Burst	Pulses per Burst	Chrip (Hz)	Pulse Width (s)	Pulse 1 to 2 Spacing (s)	Pulse 2 to 3 Spacing (s)	Start Location (s)
1	1	15M	58.8u	-	-	24.59m
2	2	15M	70.7u	1.396m	-	679.2m
3	2	15M	73.6u	1.819m	-	117.6m
4	2	15M	61.6u	1.469m	-	619.5m
5	2	15M	94.1u	1.818m	-	334.8m
6	2	15M	75.1u	1.779m	-	356.5m
7	2	15M	72.8u	1.892m	-	109.8m
8	1	15M	60.6u	-	-	347.6m
9	1	15M	78.3u	-	-	296.3m
10	1	15M	92.8u	-	-	611.0m
11	2	15M	87.0u	1.901m	-	64.79m
12	2	15M	98.1u	1.888m	-	304.4m
13	2	15M	53.2u	1.031m	-	667.8m

Long Pulse Radar Test Signal						
Test Signal Name: LP_Signal_08						
Number of Bursts in Trial: 8						
Chrip Center Frequency: 5297MHz						
Burst	Pulses per Burst	Chrip (Hz)	Pulse Width (s)	Pulse 1 to 2 Spacing (s)	Pulse 2 to 3 Spacing (s)	Start Location (s)
1	3	15M	86.3u	1.743m	985.7u	297.0m
2	1	15M	66.0u	-	-	1.473
3	3	15M	67.9u	1.531m	1.717m	438.4m
4	3	15M	86.6u	1.433m	1.491m	650.2m
5	2	15M	59.3u	1.648m	-	773.9m
6	2	15M	60.7u	1.384m	-	278.3m
7	2	15M	58.5u	1.114m	-	1.321
8	2	15M	88.9u	920.1u	-	360.9m

Long Pulse Radar Test Signal						
Test Signal Name: LP_Signal_09						
Number of Bursts in Trial: 16						
Chrip Center Frequency: 5299MHz						
Burst	Pulses per Burst	Chrip (Hz)	Pulse Width (s)	Pulse 1 to 2 Spacing (s)	Pulse 2 to 3 Spacing (s)	Start Location (s)
1	2	20M	80.2u	1.739m	-	720.6m
2	3	20M	50.1u	1.816m	1.933m	558.9m
3	1	20M	96.2u	-	-	211.8m
4	3	20M	72.6u	1.275m	1.410m	628.1m
5	2	20M	92.6u	1.262m	-	295.1m
6	2	20M	70.1u	1.814m	-	404.0m
7	2	20M	96.2u	1.463m	-	89.45m
8	2	20M	78.6u	1.436m	-	275.4m
9	2	20M	85.9u	1.077m	-	726.5m
10	3	20M	86.3u	1.689m	1.395m	279.8m
11	1	20M	88.0u	-	-	142.6m
12	3	20M	58.3u	1.051m	995.7u	248.6m
13	2	20M	95.3u	1.642m	-	392.4m
14	3	20M	93.1u	1.100m	1.481m	639.1m
15	1	20M	96.7u	-	-	614.9m
16	2	20M	67.1u	1.370m	-	471.2m

Long Pulse Radar Test Signal						
Test Signal Name: LP_Signal_10						
Number of Bursts in Trial: 18						
Chrip Center Frequency: 5299MHz						
Burst	Pulses per Burst	Chrip (Hz)	Pulse Width (s)	Pulse 1 to 2 Spacing (s)	Pulse 2 to 3 Spacing (s)	Start Location (s)
1	2	20M	98.6u	1.198m	-	344.9m
2	2	20M	57.6u	961.4u	-	641.7m
3	1	20M	56.4u	-	-	308.8m
4	1	20M	81.4u	-	-	180.2m
5	1	20M	61.8u	-	-	297.7m
6	2	20M	90.4u	1.563m	-	282.9m
7	3	20M	68.8u	1.515m	1.370m	37.46m
8	1	20M	73.9u	-	-	475.8m
9	2	20M	68.4u	1.684m	-	117.5m
10	3	20M	95.4u	1.490m	1.735m	155.9m
11	1	20M	70.9u	-	-	253.8m
12	1	20M	94.7u	-	-	356.0m
13	3	20M	76.9u	1.750m	1.203m	56.37m

14	3	20M	80.6u	1.024m	1.881m	588.3m
15	2	20M	87.2u	1.015m	-	223.6m
16	2	20M	85.9u	1.898m	-	380.5m
17	1	20M	62.9u	-	-	127.1m
18	2	20M	96.3u	1.532m	-	541.3m

Long Pulse Radar Test Signal						
Test Signal Name: LP_Signal_11						
Number of Bursts in Trial: 12						
Chrip Center Frequency: 5300MHz						
Burst	Pulses per Burst	Chrip (Hz)	Pulse Width (s)	Pulse 1 to 2 Spacing (s)	Pulse 2 to 3 Spacing (s)	Start Location (s)
1	1	6M	74.4u	-	-	870.4m
2	2	6M	73.0u	1.799m	-	254.4m
3	1	6M	69.1u	-	-	695.0m
4	2	6M	80.4u	1.729m	-	818.0m
5	2	6M	80.1u	1.222m	-	775.0m
6	3	6M	61.6u	1.022m	1.568m	773.7m
7	2	6M	72.5u	1.562m	-	260.7m
8	3	6M	69.9u	1.863m	1.712m	187.4m
9	2	6M	98.9u	1.750m	-	407.2m
10	1	6M	86.5u	-	-	242.1m
11	2	6M	67.5u	1.178m	-	608.3m
12	3	6M	85.8u	1.665m	1.754m	944.7m

Long Pulse Radar Test Signal						
Test Signal Name: LP_Signal_12						
Number of Bursts in Trial: 10						
Chrip Center Frequency: 5300MHz						
Burst	Pulses per Burst	Chrip (Hz)	Pulse Width (s)	Pulse 1 to 2 Spacing (s)	Pulse 2 to 3 Spacing (s)	Start Location (s)
1	1	6M	63.2u	-	-	639.7m
2	3	6M	51.2u	1.477m	1.835m	678.8m
3	3	6M	64.0u	1.440m	1.154m	534.7m
4	2	6M	70.2u	1.135m	-	1.023
5	2	6M	82.2u	1.368m	-	565.5m
6	2	6M	90.8u	1.524m	-	59.60m
7	2	6M	61.5u	985.5u	-	1.004
8	1	6M	52.3u	-	-	775.3m
9	3	6M	75.8u	1.274m	1.399m	123.2m
10	1	6M	83.4u	-	-	1.109

Long Pulse Radar Test Signal						
Test Signal Name: LP_Signal_13						
Number of Bursts in Trial: 8						
Chrip Center Frequency: 5300MHz						
Burst	Pulses per Burst	Chrip (Hz)	Pulse Width (s)	Pulse 1 to 2 Spacing (s)	Pulse 2 to 3 Spacing (s)	Start Location (s)
1	2	11M	84.4u	1.421m	-	801.3m
2	3	11M	70.4u	1.837m	1.413m	694.8m
3	1	11M	56.8u	-	-	852.3m
4	2	11M	88.3u	1.609m	-	214.6m
5	3	11M	63.4u	1.206m	1.734m	788.8m
6	3	11M	66.9u	942.1u	1.551m	502.0m
7	3	11M	67.8u	938.2u	1.580m	404.8m
8	2	11M	68.5u	1.233m	-	191.0m

Long Pulse Radar Test Signal						
Test Signal Name: LP_Signal_14						
Number of Bursts in Trial: 19						
Chrip Center Frequency: 5300MHz						
Burst	Pulses per Burst	Chrip (Hz)	Pulse Width (s)	Pulse 1 to 2 Spacing (s)	Pulse 2 to 3 Spacing (s)	Start Location (s)
1	1	11M	83.2u	-	-	45.94m
2	2	11M	64.2u	1.124m	-	371.8m
3	2	11M	93.6u	1.066m	-	35.45m
4	2	11M	81.4u	1.900m	-	379.4m
5	2	11M	72.5u	1.373m	-	425.9m
6	2	11M	63.2u	1.827m	-	395.1m
7	3	11M	78.0u	1.366m	1.019m	157.6m
8	1	11M	70.4u	-	-	237.3m
9	3	11M	62.4u	1.269m	1.701m	582.7m
10	1	11M	85.8u	-	-	223.0m
11	3	11M	57.4u	1.075m	1.909m	626.8m
12	2	11M	66.5u	1.637m	-	578.6m
13	3	11M	52.8u	1.165m	1.623m	626.6m
14	3	11M	51.0u	1.021m	1.068m	482.0m
15	1	11M	52.0u	-	-	471.8m
16	2	11M	72.0u	1.694m	-	284.8m
17	2	11M	58.9u	1.920m	-	155.7m
18	3	11M	84.2u	1.879m	1.077m	352.7m
19	2	11M	51.5u	1.504m	-	605.5m

Long Pulse Radar Test Signal						
Test Signal Name: LP_Signal_15						
Number of Bursts in Trial: 11						
Chrip Center Frequency: 5300MHz						
Burst	Pulses per Burst	Chrip (Hz)	Pulse Width (s)	Pulse 1 to 2 Spacing (s)	Pulse 2 to 3 Spacing (s)	Start Location (s)
1	2	16M	60.9u	1.685m	-	1.030
2	2	16M	86.8u	1.363m	-	1.069
3	2	16M	95.4u	1.521m	-	296.1m
4	3	16M	73.5u	1.628m	1.226m	377.5m
5	2	16M	67.5u	1.036m	-	644.9m
6	3	16M	65.5u	1.798m	1.561m	766.1m
7	3	16M	95.9u	1.094m	1.242m	537.2m
8	2	16M	96.2u	1.578m	-	172.3m
9	2	16M	90.4u	1.274m	-	256.1m
10	2	16M	90.1u	1.319m	-	842.4m
11	2	16M	59.3u	1.600m	-	728.8m

Long Pulse Radar Test Signal						
Test Signal Name: LP_Signal_16						
Number of Bursts in Trial: 16						
Chrip Center Frequency: 5300MHz						
Burst	Pulses per Burst	Chrip (Hz)	Pulse Width (s)	Pulse 1 to 2 Spacing (s)	Pulse 2 to 3 Spacing (s)	Start Location (s)
1	1	16M	53.9u	-	-	653.0m
2	3	16M	87.4u	1.140m	1.207m	109.0m
3	2	16M	56.0u	1.104m	-	462.3m
4	2	16M	62.5u	1.625m	-	704.3m
5	2	16M	66.7u	1.202m	-	296.4m
6	2	16M	65.6u	1.571m	-	169.5m
7	2	16M	65.2u	1.889m	-	703.7m
8	1	16M	67.4u	-	-	78.58m
9	3	16M	70.1u	1.820m	1.460m	419.9m
10	2	16M	62.3u	1.636m	-	7.821m
11	3	16M	79.8u	1.442m	1.551m	384.2m
12	1	16M	81.4u	-	-	378.9m
13	2	16M	75.0u	1.336m	-	742.0m
14	2	16M	74.3u	1.487m	-	726.4m
15	3	16M	88.8u	1.772m	1.153m	168.4m
16	3	16M	67.7u	1.248m	1.211m	647.3m

Long Pulse Radar Test Signal						
Test Signal Name: LP_Signal_17						
Number of Bursts in Trial: 9						
Chrip Center Frequency: 5300MHz						
Burst	Pulses per Burst	Chrip (Hz)	Pulse Width (s)	Pulse 1 to 2 Spacing (s)	Pulse 2 to 3 Spacing (s)	Start Location (s)
1	3	18M	50.9u	1.721m	1.677m	787.1m
2	2	18M	70.9u	1.645m	-	357.8m
3	2	18M	61.2u	1.863m	-	730.2m
4	3	18M	55.6u	1.573m	1.305m	472.0m
5	2	18M	61.9u	1.421m	-	88.96m
6	1	18M	52.6u	-	-	911.3m
7	3	18M	60.7u	1.420m	1.845m	81.67m
8	2	18M	76.7u	1.616m	-	600.1m
9	1	18M	82.1u	-	-	1.017

Long Pulse Radar Test Signal						
Test Signal Name: LP_Signal_18						
Number of Bursts in Trial: 12						
Chrip Center Frequency: 5300MHz						
Burst	Pulses per Burst	Chrip (Hz)	Pulse Width (s)	Pulse 1 to 2 Spacing (s)	Pulse 2 to 3 Spacing (s)	Start Location (s)
1	3	18M	52.0u	963.0u	1.272m	607.1m
2	2	18M	94.7u	1.569m	-	970.0m
3	2	18M	81.7u	1.783m	-	405.2m
4	1	18M	79.0u	-	-	481.4m
5	3	18M	68.5u	1.228m	1.226m	689.8m
6	2	18M	54.6u	1.639m	-	657.6m
7	1	18M	68.1u	-	-	841.1m
8	1	18M	89.8u	-	-	916.7m
9	1	18M	69.1u	-	-	211.7m
10	1	18M	97.8u	-	-	374.1m
11	2	18M	96.3u	1.242m	-	457.4m
12	3	18M	95.6u	981.4u	1.107m	828.4m

Long Pulse Radar Test Signal
 Test Signal Name: LP_Signal_19
 Number of Bursts in Trial: 10
 Chrip Center Frequency: 5300MHz

Burst	Pulses per Burst	Chrip (Hz)	Pulse Width (s)	Pulse 1 to 2 Spacing (s)	Pulse 2 to 3 Spacing (s)	Start Location (s)
1	2	20M	78.6u	1.551m	-	833.2m
2	2	20M	51.6u	990.4u	-	825.2m
3	2	20M	86.8u	1.097m	-	809.6m
4	1	20M	60.5u	-	-	792.9m
5	2	20M	54.9u	1.783m	-	491.4m
6	2	20M	75.7u	1.245m	-	717.7m
7	2	20M	55.0u	1.513m	-	1.155
8	2	20M	79.2u	955.8u	-	118.6m
9	1	20M	56.4u	-	-	881.1m
10	1	20M	97.7u	-	-	978.0m

Long Pulse Radar Test Signal
 Test Signal Name: LP_Signal_20
 Number of Bursts in Trial: 20
 Chrip Center Frequency: 5300MHz

Burst	Pulses per Burst	Chrip (Hz)	Pulse Width (s)	Pulse 1 to 2 Spacing (s)	Pulse 2 to 3 Spacing (s)	Start Location (s)
1	2	20M	63.1u	1.352m	-	165.6m
2	2	20M	58.9u	1.458m	-	231.2m
3	2	20M	77.9u	1.812m	-	578.2m
4	2	20M	55.4u	1.834m	-	493.0m
5	3	20M	93.5u	1.337m	1.895m	207.5m
6	2	20M	92.8u	1.212m	-	161.6m
7	3	20M	60.2u	1.500m	1.299m	450.6m
8	3	20M	92.9u	980.1u	1.224m	70.72m
9	3	20M	68.5u	1.737m	1.169m	263.0m
10	2	20M	85.6u	967.4u	-	128.5m
11	2	20M	85.4u	1.165m	-	495.9m
12	2	20M	68.2u	1.498m	-	88.26m
13	2	20M	66.6u	1.769m	-	10.88m
14	3	20M	56.7u	1.517m	1.056m	393.2m
15	1	20M	61.9u	-	-	488.3m
16	3	20M	92.9u	1.185m	1.163m	309.7m
17	2	20M	59.6u	1.139m	-	243.6m
18	3	20M	71.4u	1.337m	1.026m	381.3m
19	3	20M	66.5u	1.886m	1.669m	75.38m
20	1	20M	99.2u	-	-	205.0m

Long Pulse Radar Test Signal
 Test Signal Name: LP_Signal_21
 Number of Bursts in Trial: 16
 Chrip Center Frequency: 5307MHz

Burst	Pulses per Burst	Chrip (Hz)	Pulse Width (s)	Pulse 1 to 2 Spacing (s)	Pulse 2 to 3 Spacing (s)	Start Location (s)
1	1	5M	59.2u	-	-	243.0m
2	2	5M	94.5u	1.834m	-	299.3m
3	2	5M	95.4u	1.641m	-	566.0m
4	3	5M	59.5u	1.313m	1.332m	354.8m
5	2	5M	62.1u	1.158m	-	618.4m
6	3	5M	73.9u	1.671m	1.534m	629.7m
7	2	5M	50.4u	1.155m	-	384.7m

8	3	5M	62.7u	1.675m	1.571m	94.54m
9	1	5M	52.4u	-	-	45.93m
10	3	5M	55.9u	1.743m	1.537m	37.45m
11	2	5M	62.1u	1.725m	-	173.9m
12	3	5M	65.1u	1.567m	1.369m	549.6m
13	3	5M	80.3u	1.548m	1.117m	530.8m
14	2	5M	85.5u	1.063m	-	265.8m
15	3	5M	54.7u	1.134m	1.657m	49.43m
16	2	5M	85.8u	1.450m	-	382.0m

Long Pulse Radar Test Signal
Test Signal Name: LP_Signal_22
Number of Bursts in Trial: 19
Chrip Center Frequency: 5307MHz

Burst	Pulses per Burst	Chrip (Hz)	Pulse Width (s)	Pulse 1 to 2 Spacing (s)	Pulse 2 to 3 Spacing (s)	Start Location (s)
1	3	5M	61.2u	1.793m	1.857m	398.8m
2	1	5M	53.7u	-	-	300.3m
3	2	5M	82.7u	1.900m	-	154.0m
4	3	5M	98.8u	1.369m	1.879m	7.212m
5	2	5M	54.9u	1.516m	-	475.2m
6	3	5M	57.2u	1.640m	1.396m	427.7m
7	2	5M	91.6u	1.507m	-	435.3m
8	2	5M	69.8u	1.897m	-	349.7m
9	2	5M	58.1u	1.668m	-	584.4m
10	2	5M	81.6u	1.380m	-	184.8m
11	2	5M	57.5u	1.242m	-	221.2m
12	3	5M	92.2u	1.227m	913.8u	353.3m
13	2	5M	81.9u	1.129m	-	486.4m
14	2	5M	66.9u	1.395m	-	235.5m
15	1	5M	67.9u	-	-	415.5m
16	3	5M	99.2u	1.884m	1.803m	462.9m
17	2	5M	71.2u	1.043m	-	214.2m
18	1	5M	70.9u	-	-	379.4m
19	2	5M	68.8u	1.209m	-	322.3m

Long Pulse Radar Test Signal
Test Signal Name: LP_Signal_23
Number of Bursts in Trial: 10
Chrip Center Frequency: 5305MHz

Burst	Pulses per Burst	Chrip (Hz)	Pulse Width (s)	Pulse 1 to 2 Spacing (s)	Pulse 2 to 3 Spacing (s)	Start Location (s)
1	2	10M	77.1u	1.267m	-	774.1m
2	3	10M	99.8u	1.558m	1.032m	769.0m
3	2	10M	73.2u	1.204m	-	760.7m
4	3	10M	74.0u	1.642m	1.403m	202.1m
5	2	10M	61.7u	982.3u	-	236.2m
6	2	10M	68.4u	1.120m	-	889.3m
7	2	10M	98.4u	1.604m	-	192.4m
8	2	10M	72.5u	1.756m	-	721.2m
9	3	10M	52.4u	1.480m	1.691m	405.5m
10	3	10M	96.6u	1.397m	1.029m	235.6m

Long Pulse Radar Test Signal						
Test Signal Name: LP_Signal_24						
Number of Bursts in Trial: 9						
Chrip Center Frequency: 5305MHz						
Burst	Pulses per Burst	Chrip (Hz)	Pulse Width (s)	Pulse 1 to 2 Spacing (s)	Pulse 2 to 3 Spacing (s)	Start Location (s)
1	3	10M	80.2u	1.716m	1.208m	458.3m
2	2	10M	99.0u	1.877m	-	80.24m
3	1	10M	70.5u	-	-	705.0m
4	1	10M	88.3u	-	-	69.65m
5	2	10M	56.4u	1.516m	-	922.0m
6	1	10M	100.0u	-	-	179.3m
7	2	10M	58.2u	994.8u	-	1.187
8	1	10M	98.0u	-	-	223.9m
9	1	10M	92.7u	-	-	927.1m

Long Pulse Radar Test Signal						
Test Signal Name: LP_Signal_25						
Number of Bursts in Trial: 10						
Chrip Center Frequency: 5303MHz						
Burst	Pulses per Burst	Chrip (Hz)	Pulse Width (s)	Pulse 1 to 2 Spacing (s)	Pulse 2 to 3 Spacing (s)	Start Location (s)
1	2	15M	94.0u	1.223m	-	602.5m
2	1	15M	72.8u	-	-	973.3m
3	1	15M	53.8u	-	-	901.9m
4	2	15M	62.4u	1.292m	-	937.5m
5	2	15M	78.8u	1.014m	-	731.3m
6	2	15M	93.5u	1.149m	-	20.15m
7	1	15M	61.8u	-	-	620.4m
8	3	15M	82.0u	1.788m	1.001m	82.34m
9	1	15M	63.6u	-	-	891.7m
10	2	15M	76.7u	1.229m	-	49.96m

Long Pulse Radar Test Signal						
Test Signal Name: LP_Signal_26						
Number of Bursts in Trial: 11						
Chrip Center Frequency: 5303MHz						
Burst	Pulses per Burst	Chrip (Hz)	Pulse Width (s)	Pulse 1 to 2 Spacing (s)	Pulse 2 to 3 Spacing (s)	Start Location (s)
1	1	15M	84.4u	-	-	558.9m
2	2	15M	74.4u	1.227m	-	40.96m
3	3	15M	59.9u	1.513m	1.461m	466.4m
4	1	15M	54.6u	-	-	934.1m
5	2	15M	56.2u	1.306m	-	791.5m
6	2	15M	80.1u	1.693m	-	378.4m
7	2	15M	50.2u	1.675m	-	844.0m
8	2	15M	89.6u	1.641m	-	762.8m
9	1	15M	81.8u	-	-	133.1m
10	1	15M	89.0u	-	-	56.12m
11	1	15M	62.1u	-	-	784.8m

Long Pulse Radar Test Signal						
Test Signal Name: LP_Signal_27						
Number of Bursts in Trial: 17						
Chrip Center Frequency: 5302MHz						
Burst	Pulses per Burst	Chrip (Hz)	Pulse Width (s)	Pulse 1 to 2 Spacing (s)	Pulse 2 to 3 Spacing (s)	Start Location (s)
1	1	18M	99.1u	-	-	365.0m
2	2	18M	80.2u	1.073m	-	218.9m
3	1	18M	98.4u	-	-	62.40m
4	2	18M	79.9u	924.1u	-	28.38m
5	3	18M	85.7u	1.729m	1.103m	59.49m
6	3	18M	83.1u	1.033m	1.823m	360.0m
7	1	18M	93.9u	-	-	207.7m
8	2	18M	92.9u	1.657m	-	307.2m
9	2	18M	93.9u	1.164m	-	269.1m
10	3	18M	71.8u	1.516m	1.207m	433.3m
11	2	18M	60.1u	1.913m	-	334.1m
12	2	18M	65.1u	1.569m	-	471.0m
13	2	18M	70.1u	1.020m	-	403.4m
14	2	18M	54.7u	1.505m	-	537.2m
15	2	18M	71.7u	1.764m	-	569.9m
16	2	18M	98.5u	1.729m	-	505.7m
17	2	18M	90.2u	1.677m	-	644.0m

Long Pulse Radar Test Signal						
Test Signal Name: LP_Signal_28						
Number of Bursts in Trial: 10						
Chrip Center Frequency: 5302MHz						
Burst	Pulses per Burst	Chrip (Hz)	Pulse Width (s)	Pulse 1 to 2 Spacing (s)	Pulse 2 to 3 Spacing (s)	Start Location (s)
1	1	18M	91.4u	-	-	1.193
2	2	18M	59.0u	1.416m	-	691.9m
3	3	18M	75.5u	1.576m	1.710m	949.0m
4	3	18M	57.2u	1.495m	1.274m	98.67m
5	2	18M	86.9u	1.499m	-	1.077
6	3	18M	59.2u	1.913m	1.856m	327.0m
7	1	18M	79.4u	-	-	681.2m
8	3	18M	98.1u	1.764m	1.499m	780.6m
9	2	18M	79.1u	1.785m	-	22.12m
10	3	18M	75.5u	1.187m	1.373m	229.5m

Long Pulse Radar Test Signal						
Test Signal Name: LP_Signal_29						
Number of Bursts in Trial: 16						
Chrip Center Frequency: 5301MHz						
Burst	Pulses per Burst	Chrip (Hz)	Pulse Width (s)	Pulse 1 to 2 Spacing (s)	Pulse 2 to 3 Spacing (s)	Start Location (s)
1	2	20M	80.2u	1.739m	-	720.6m
2	3	20M	50.1u	1.816m	1.933m	558.9m
3	1	20M	96.2u	-	-	211.8m
4	3	20M	72.6u	1.275m	1.410m	628.1m
5	2	20M	92.6u	1.262m	-	295.1m
6	2	20M	70.1u	1.814m	-	404.0m
7	2	20M	96.2u	1.463m	-	89.45m
8	2	20M	78.6u	1.436m	-	275.4m
9	2	20M	85.9u	1.077m	-	726.5m
10	3	20M	86.3u	1.689m	1.395m	279.8m
11	1	20M	88.0u	-	-	142.6m
12	3	20M	58.3u	1.051m	995.7u	248.6m
13	2	20M	95.3u	1.642m	-	392.4m
14	3	20M	93.1u	1.100m	1.481m	639.1m
15	1	20M	96.7u	-	-	614.9m
16	2	20M	67.1u	1.370m	-	471.2m

Long Pulse Radar Test Signal						
Test Signal Name: LP_Signal_30						
Number of Bursts in Trial: 16						
Chrip Center Frequency: 5301MHz						
Burst	Pulses per Burst	Chrip (Hz)	Pulse Width (s)	Pulse 1 to 2 Spacing (s)	Pulse 2 to 3 Spacing (s)	Start Location (s)
1	2	20M	98.1u	1.220m	-	507.2m
2	2	20M	73.5u	1.910m	-	227.2m
3	2	20M	98.2u	1.506m	-	631.2m
4	3	20M	97.9u	1.595m	1.851m	164.0m
5	1	20M	92.9u	-	-	45.06m
6	2	20M	76.6u	1.260m	-	601.8m
7	2	20M	68.1u	1.217m	-	342.9m
8	1	20M	53.3u	-	-	86.38m
9	2	20M	58.0u	978.0u	-	75.50m
10	1	20M	66.6u	-	-	328.5m
11	3	20M	69.0u	1.388m	1.330m	707.6m
12	2	20M	68.3u	1.450m	-	328.0m
13	3	20M	99.1u	1.752m	1.303m	426.0m
14	1	20M	94.8u	-	-	632.9m
15	1	20M	99.7u	-	-	169.8m
16	1	20M	51.5u	-	-	455.1m

Type 6 Radar Statistical Performances				
Trial #	Pulses per Burst	Pulse Width (s)	PRI (s)	Detection
1	9	1.0u	333.0u	Yes
2	9	1.0u	333.0u	Yes
3	9	1.0u	333.0u	Yes
4	9	1.0u	333.0u	Yes
5	9	1.0u	333.0u	Yes
6	9	1.0u	333.0u	Yes
7	9	1.0u	333.0u	Yes
8	9	1.0u	333.0u	Yes
9	9	1.0u	333.0u	Yes
10	9	1.0u	333.0u	Yes
11	9	1.0u	333.0u	Yes
12	9	1.0u	333.0u	Yes
13	9	1.0u	333.0u	Yes
14	9	1.0u	333.0u	Yes
15	9	1.0u	333.0u	Yes
16	9	1.0u	333.0u	Yes
17	9	1.0u	333.0u	Yes
18	9	1.0u	333.0u	Yes
19	9	1.0u	333.0u	Yes
20	9	1.0u	333.0u	No
21	9	1.0u	333.0u	Yes
22	9	1.0u	333.0u	Yes
23	9	1.0u	333.0u	Yes
24	9	1.0u	333.0u	Yes
25	9	1.0u	333.0u	Yes
26	9	1.0u	333.0u	Yes
27	9	1.0u	333.0u	Yes
28	9	1.0u	333.0u	Yes
29	9	1.0u	333.0u	Yes
30	9	1.0u	333.0u	Yes
				Detection Rate: 96.6 %

Type 6 Radar Statistical Performances		
Trial #	Hopping Frequency Sequence Name	Detection
1	HOP_FREQ_SEQ_01	Yes
2	HOP_FREQ_SEQ_02	Yes
3	HOP_FREQ_SEQ_03	Yes
4	HOP_FREQ_SEQ_04	Yes
5	HOP_FREQ_SEQ_05	Yes
6	HOP_FREQ_SEQ_06	Yes
7	HOP_FREQ_SEQ_07	Yes
8	HOP_FREQ_SEQ_08	Yes
9	HOP_FREQ_SEQ_09	Yes
10	HOP_FREQ_SEQ_10	Yes
11	HOP_FREQ_SEQ_11	Yes
12	HOP_FREQ_SEQ_12	Yes
13	HOP_FREQ_SEQ_13	Yes
14	HOP_FREQ_SEQ_14	Yes
15	HOP_FREQ_SEQ_15	Yes
16	HOP_FREQ_SEQ_16	Yes
17	HOP_FREQ_SEQ_17	Yes
18	HOP_FREQ_SEQ_18	Yes
19	HOP_FREQ_SEQ_19	Yes
20	HOP_FREQ_SEQ_20	No
21	HOP_FREQ_SEQ_21	Yes
22	HOP_FREQ_SEQ_22	Yes
23	HOP_FREQ_SEQ_23	Yes
24	HOP_FREQ_SEQ_24	Yes
25	HOP_FREQ_SEQ_25	Yes
26	HOP_FREQ_SEQ_26	Yes
27	HOP_FREQ_SEQ_27	Yes
28	HOP_FREQ_SEQ_28	Yes
29	HOP_FREQ_SEQ_29	Yes
30	HOP_FREQ_SEQ_30	Yes
		Detection Rate: 96.6 %

Hopping Frequency Sequence Name: HOP_FREQ_SEQ_01							
SEQ#	Frequency (Hz)	SEQ#	Frequency (Hz)	SEQ#	Frequency (Hz)	SEQ#	Frequency (Hz)
1	5.505G	2	5.674G	3	5.257G	4	5.690G
5	5.520G	6	5.262G	7	5.356G	8	5.439G
9	5.685G	10	5.332G	11	5.720G	12	5.579G
13	5.313G	14	5.383G	15	5.697G	16	5.318G
17	5.695G	18	5.461G	19	5.719G	20	5.606G
21	5.533G	22	5.287G	23	5.675G	24	5.540G
25	5.604G	26	5.591G	27	5.564G	28	5.612G
29	5.399G	30	5.593G	31	5.600G	32	5.478G
33	5.667G	34	5.434G	35	5.299G	36	5.387G
37	5.319G	38	5.376G	39	5.710G	40	5.581G
41	5.624G	42	5.302G	43	5.406G	44	5.272G
45	5.531G	46	5.298G	47	5.303G	48	5.265G
49	5.688G	50	5.372G	51	5.699G	52	5.550G
53	5.336G	54	5.308G	55	5.565G	56	5.269G
57	5.635G	58	5.650G	59	5.357G	60	5.462G
61	5.389G	62	5.626G	63	5.411G	64	5.386G
65	5.665G	66	5.481G	67	5.354G	68	5.267G
69	5.279G	70	5.558G	71	5.578G	72	5.647G
73	5.717G	74	5.382G	75	5.297G	76	5.601G
77	5.630G	78	5.603G	79	5.676G	80	5.657G
81	5.608G	82	5.329G	83	5.388G	84	5.602G
85	5.549G	86	5.451G	87	5.709G	88	5.716G
89	5.643G	90	5.285G	91	5.377G	92	5.443G
93	5.535G	94	5.584G	95	5.506G	96	5.723G
97	5.507G	98	5.712G	99	5.680G	100	5.724G

Hopping Frequency Sequence Name: HOP_FREQ_SEQ_02							
SEQ#	Frequency (Hz)	SEQ#	Frequency (Hz)	SEQ#	Frequency (Hz)	SEQ#	Frequency (Hz)
1	5.350G	2	5.673G	3	5.251G	4	5.286G
5	5.699G	6	5.714G	7	5.500G	8	5.265G
9	5.299G	10	5.455G	11	5.359G	12	5.611G
13	5.487G	14	5.448G	15	5.663G	16	5.373G
17	5.269G	18	5.614G	19	5.439G	20	5.385G
21	5.680G	22	5.603G	23	5.363G	24	5.341G
25	5.303G	26	5.504G	27	5.576G	28	5.584G
29	5.632G	30	5.535G	31	5.402G	32	5.597G
33	5.308G	34	5.566G	35	5.689G	36	5.301G
37	5.494G	38	5.400G	39	5.513G	40	5.691G
41	5.553G	42	5.343G	43	5.532G	44	5.520G
45	5.664G	46	5.718G	47	5.612G	48	5.444G
49	5.452G	50	5.588G	51	5.307G	52	5.422G
53	5.662G	54	5.275G	55	5.583G	56	5.578G
57	5.595G	58	5.479G	59	5.410G	60	5.693G
61	5.465G	62	5.312G	63	5.268G	64	5.629G
65	5.671G	66	5.284G	67	5.406G	68	5.624G
69	5.300G	70	5.568G	71	5.318G	72	5.711G
73	5.330G	74	5.399G	75	5.694G	76	5.631G
77	5.416G	78	5.723G	79	5.637G	80	5.339G
81	5.252G	82	5.703G	83	5.654G	84	5.538G
85	5.478G	86	5.482G	87	5.474G	88	5.407G
89	5.279G	90	5.316G	91	5.592G	92	5.627G
93	5.594G	94	5.633G	95	5.380G	96	5.598G
97	5.533G	98	5.446G	99	5.526G	100	5.555G

Hopping Frequency Sequence Name: HOP_FREQ_SEQ_03							
SEQ#	Frequency (Hz)	SEQ#	Frequency (Hz)	SEQ#	Frequency (Hz)	SEQ#	Frequency (Hz)
1	5.501G	2	5.592G	3	5.263G	4	5.484G
5	5.549G	6	5.346G	7	5.361G	8	5.576G
9	5.264G	10	5.700G	11	5.623G	12	5.324G
13	5.640G	14	5.669G	15	5.344G	16	5.579G
17	5.703G	18	5.585G	19	5.382G	20	5.601G
21	5.364G	22	5.296G	23	5.524G	24	5.532G
25	5.546G	26	5.555G	27	5.710G	28	5.644G
29	5.465G	30	5.456G	31	5.526G	32	5.627G
33	5.621G	34	5.717G	35	5.667G	36	5.652G
37	5.659G	38	5.498G	39	5.478G	40	5.386G
41	5.654G	42	5.508G	43	5.716G	44	5.599G
45	5.408G	46	5.427G	47	5.306G	48	5.402G
49	5.337G	50	5.464G	51	5.712G	52	5.358G
53	5.278G	54	5.680G	55	5.365G	56	5.442G
57	5.432G	58	5.538G	59	5.315G	60	5.587G
61	5.342G	62	5.615G	63	5.674G	64	5.563G
65	5.668G	66	5.460G	67	5.590G	68	5.542G
69	5.685G	70	5.469G	71	5.453G	72	5.429G
73	5.504G	74	5.660G	75	5.353G	76	5.616G
77	5.417G	78	5.672G	79	5.331G	80	5.393G
81	5.449G	82	5.347G	83	5.610G	84	5.706G
85	5.314G	86	5.321G	87	5.415G	88	5.724G
89	5.392G	90	5.437G	91	5.691G	92	5.407G
93	5.625G	94	5.463G	95	5.582G	96	5.646G
97	5.622G	98	5.688G	99	5.266G	100	5.428G

Hopping Frequency Sequence Name: HOP_FREQ_SEQ_04							
SEQ#	Frequency (Hz)	SEQ#	Frequency (Hz)	SEQ#	Frequency (Hz)	SEQ#	Frequency (Hz)
1	5.487G	2	5.498G	3	5.707G	4	5.277G
5	5.312G	6	5.447G	7	5.259G	8	5.548G
9	5.492G	10	5.699G	11	5.308G	12	5.677G
13	5.328G	14	5.520G	15	5.318G	16	5.433G
17	5.440G	18	5.294G	19	5.486G	20	5.258G
21	5.370G	22	5.405G	23	5.266G	24	5.380G
25	5.292G	26	5.590G	27	5.459G	28	5.495G
29	5.541G	30	5.564G	31	5.472G	32	5.680G
33	5.558G	34	5.319G	35	5.645G	36	5.475G
37	5.591G	38	5.375G	39	5.678G	40	5.649G
41	5.437G	42	5.674G	43	5.706G	44	5.460G
45	5.316G	46	5.636G	47	5.301G	48	5.660G
49	5.416G	50	5.284G	51	5.321G	52	5.545G
53	5.260G	54	5.353G	55	5.489G	56	5.334G
57	5.256G	58	5.600G	59	5.307G	60	5.683G
61	5.288G	62	5.637G	63	5.631G	64	5.253G
65	5.604G	66	5.709G	67	5.568G	68	5.697G
69	5.404G	70	5.508G	71	5.681G	72	5.345G
73	5.300G	74	5.497G	75	5.633G	76	5.655G
77	5.415G	78	5.333G	79	5.251G	80	5.374G
81	5.451G	82	5.443G	83	5.625G	84	5.473G
85	5.584G	86	5.338G	87	5.647G	88	5.304G
89	5.525G	90	5.542G	91	5.361G	92	5.650G
93	5.482G	94	5.666G	95	5.608G	96	5.589G
97	5.427G	98	5.384G	99	5.457G	100	5.355G

Hopping Frequency Sequence Name: HOP_FREQ_SEQ_05							
SEQ#	Frequency (Hz)	SEQ#	Frequency (Hz)	SEQ#	Frequency (Hz)	SEQ#	Frequency (Hz)
1	5.583G	2	5.381G	3	5.662G	4	5.649G
5	5.275G	6	5.678G	7	5.287G	8	5.452G
9	5.461G	10	5.670G	11	5.279G	12	5.702G
13	5.399G	14	5.420G	15	5.479G	16	5.278G
17	5.487G	18	5.484G	19	5.320G	20	5.433G
21	5.550G	22	5.333G	23	5.573G	24	5.456G
25	5.299G	26	5.261G	27	5.263G	28	5.614G
29	5.321G	30	5.300G	31	5.391G	32	5.551G
33	5.600G	34	5.509G	35	5.718G	36	5.522G
37	5.396G	38	5.713G	39	5.457G	40	5.717G
41	5.659G	42	5.607G	43	5.536G	44	5.370G
45	5.329G	46	5.708G	47	5.534G	48	5.429G
49	5.492G	50	5.379G	51	5.653G	52	5.545G
53	5.620G	54	5.681G	55	5.546G	56	5.715G
57	5.616G	58	5.591G	59	5.508G	60	5.375G
61	5.271G	62	5.596G	63	5.500G	64	5.455G
65	5.318G	66	5.585G	67	5.336G	68	5.657G
69	5.598G	70	5.251G	71	5.512G	72	5.668G
73	5.665G	74	5.667G	75	5.682G	76	5.407G
77	5.489G	78	5.309G	79	5.490G	80	5.418G
81	5.257G	82	5.697G	83	5.719G	84	5.341G
85	5.689G	86	5.647G	87	5.568G	88	5.699G
89	5.674G	90	5.572G	91	5.619G	92	5.408G
93	5.664G	94	5.706G	95	5.360G	96	5.439G
97	5.284G	98	5.312G	99	5.367G	100	5.478G

Hopping Frequency Sequence Name: HOP_FREQ_SEQ_06							
SEQ#	Frequency (Hz)	SEQ#	Frequency (Hz)	SEQ#	Frequency (Hz)	SEQ#	Frequency (Hz)
1	5.493G	2	5.665G	3	5.291G	4	5.553G
5	5.367G	6	5.518G	7	5.444G	8	5.350G
9	5.338G	10	5.467G	11	5.262G	12	5.629G
13	5.439G	14	5.406G	15	5.267G	16	5.293G
17	5.384G	18	5.447G	19	5.647G	20	5.716G
21	5.583G	22	5.697G	23	5.260G	24	5.609G
25	5.465G	26	5.632G	27	5.268G	28	5.593G
29	5.611G	30	5.546G	31	5.466G	32	5.478G
33	5.653G	34	5.660G	35	5.357G	36	5.454G
37	5.605G	38	5.502G	39	5.604G	40	5.703G
41	5.637G	42	5.519G	43	5.258G	44	5.601G
45	5.516G	46	5.346G	47	5.645G	48	5.638G
49	5.418G	50	5.354G	51	5.644G	52	5.456G
53	5.682G	54	5.702G	55	5.607G	56	5.503G
57	5.396G	58	5.441G	59	5.273G	60	5.548G
61	5.314G	62	5.371G	63	5.306G	64	5.360G
65	5.691G	66	5.413G	67	5.551G	68	5.485G
69	5.495G	70	5.419G	71	5.531G	72	5.492G
73	5.499G	74	5.392G	75	5.347G	76	5.497G
77	5.692G	78	5.342G	79	5.723G	80	5.356G
81	5.484G	82	5.491G	83	5.705G	84	5.563G
85	5.394G	86	5.397G	87	5.534G	88	5.269G
89	5.471G	90	5.514G	91	5.339G	92	5.640G
93	5.332G	94	5.680G	95	5.482G	96	5.488G
97	5.429G	98	5.430G	99	5.464G	100	5.295G

Hopping Frequency Sequence Name: HOP_FREQ_SEQ_07							
SEQ#	Frequency (Hz)	SEQ#	Frequency (Hz)	SEQ#	Frequency (Hz)	SEQ#	Frequency (Hz)
1	5.320G	2	5.390G	3	5.286G	4	5.418G
5	5.603G	6	5.488G	7	5.457G	8	5.410G
9	5.299G	10	5.545G	11	5.358G	12	5.355G
13	5.454G	14	5.277G	15	5.687G	16	5.582G
17	5.434G	18	5.475G	19	5.619G	20	5.627G
21	5.307G	22	5.317G	23	5.319G	24	5.421G
25	5.556G	26	5.541G	27	5.623G	28	5.546G
29	5.336G	30	5.578G	31	5.304G	32	5.325G
33	5.574G	34	5.382G	35	5.570G	36	5.544G
37	5.700G	38	5.571G	39	5.491G	40	5.465G
41	5.272G	42	5.536G	43	5.279G	44	5.402G
45	5.628G	46	5.595G	47	5.479G	48	5.401G
49	5.451G	50	5.356G	51	5.309G	52	5.561G
53	5.539G	54	5.685G	55	5.648G	56	5.693G
57	5.414G	58	5.679G	59	5.362G	60	5.695G
61	5.256G	62	5.283G	63	5.376G	64	5.706G
65	5.504G	66	5.441G	67	5.284G	68	5.449G
69	5.476G	70	5.462G	71	5.381G	72	5.343G
73	5.638G	74	5.689G	75	5.357G	76	5.389G
77	5.255G	78	5.303G	79	5.592G	80	5.675G
81	5.450G	82	5.611G	83	5.566G	84	5.265G
85	5.510G	86	5.724G	87	5.680G	88	5.392G
89	5.296G	90	5.605G	91	5.490G	92	5.631G
93	5.560G	94	5.612G	95	5.555G	96	5.487G
97	5.530G	98	5.327G	99	5.573G	100	5.704G

Hopping Frequency Sequence Name: HOP_FREQ_SEQ_08							
SEQ#	Frequency (Hz)	SEQ#	Frequency (Hz)	SEQ#	Frequency (Hz)	SEQ#	Frequency (Hz)
1	5.537G	2	5.669G	3	5.683G	4	5.517G
5	5.583G	6	5.304G	7	5.607G	8	5.656G
9	5.424G	10	5.441G	11	5.256G	12	5.552G
13	5.599G	14	5.277G	15	5.349G	16	5.707G
17	5.521G	18	5.478G	19	5.612G	20	5.302G
21	5.677G	22	5.581G	23	5.300G	24	5.412G
25	5.381G	26	5.259G	27	5.637G	28	5.251G
29	5.296G	30	5.565G	31	5.306G	32	5.285G
33	5.648G	34	5.563G	35	5.452G	36	5.555G
37	5.650G	38	5.495G	39	5.503G	40	5.594G
41	5.469G	42	5.582G	43	5.307G	44	5.255G
45	5.253G	46	5.323G	47	5.676G	48	5.709G
49	5.720G	50	5.712G	51	5.679G	52	5.482G
53	5.438G	54	5.415G	55	5.268G	56	5.636G
57	5.593G	58	5.427G	59	5.383G	60	5.661G
61	5.560G	62	5.697G	63	5.675G	64	5.468G
65	5.649G	66	5.298G	67	5.651G	68	5.400G
69	5.647G	70	5.467G	71	5.329G	72	5.652G
73	5.589G	74	5.347G	75	5.628G	76	5.500G
77	5.689G	78	5.368G	79	5.611G	80	5.387G
81	5.608G	82	5.473G	83	5.575G	84	5.278G
85	5.704G	86	5.662G	87	5.342G	88	5.592G
89	5.686G	90	5.702G	91	5.624G	92	5.434G
93	5.416G	94	5.553G	95	5.576G	96	5.477G
97	5.464G	98	5.396G	99	5.386G	100	5.432G

Hopping Frequency Sequence Name: HOP_FREQ_SEQ_09							
SEQ#	Frequency (Hz)	SEQ#	Frequency (Hz)	SEQ#	Frequency (Hz)	SEQ#	Frequency (Hz)
1	5.349G	2	5.590G	3	5.466G	4	5.546G
5	5.530G	6	5.355G	7	5.575G	8	5.709G
9	5.350G	10	5.724G	11	5.456G	12	5.682G
13	5.625G	14	5.554G	15	5.713G	16	5.477G
17	5.432G	18	5.412G	19	5.454G	20	5.402G
21	5.357G	22	5.389G	23	5.626G	24	5.717G
25	5.282G	26	5.524G	27	5.697G	28	5.264G
29	5.467G	30	5.720G	31	5.459G	32	5.313G
33	5.640G	34	5.329G	35	5.605G	36	5.427G
37	5.295G	38	5.567G	39	5.302G	40	5.635G
41	5.278G	42	5.578G	43	5.461G	44	5.700G
45	5.455G	46	5.327G	47	5.592G	48	5.275G
49	5.632G	50	5.453G	51	5.422G	52	5.300G
53	5.721G	54	5.650G	55	5.704G	56	5.380G
57	5.403G	58	5.373G	59	5.367G	60	5.372G
61	5.492G	62	5.690G	63	5.618G	64	5.540G
65	5.508G	66	5.485G	67	5.496G	68	5.548G
69	5.512G	70	5.687G	71	5.296G	72	5.676G
73	5.499G	74	5.440G	75	5.579G	76	5.604G
77	5.608G	78	5.723G	79	5.576G	80	5.703G
81	5.433G	82	5.612G	83	5.482G	84	5.583G
85	5.633G	86	5.582G	87	5.437G	88	5.521G
89	5.601G	90	5.391G	91	5.647G	92	5.393G
93	5.419G	94	5.598G	95	5.434G	96	5.597G
97	5.446G	98	5.478G	99	5.551G	100	5.621G

Hopping Frequency Sequence Name: HOP_FREQ_SEQ_10							
SEQ#	Frequency (Hz)	SEQ#	Frequency (Hz)	SEQ#	Frequency (Hz)	SEQ#	Frequency (Hz)
1	5.550G	2	5.265G	3	5.435G	4	5.470G
5	5.657G	6	5.490G	7	5.566G	8	5.303G
9	5.400G	10	5.263G	11	5.271G	12	5.372G
13	5.448G	14	5.659G	15	5.549G	16	5.571G
17	5.381G	18	5.398G	19	5.278G	20	5.511G
21	5.583G	22	5.333G	23	5.482G	24	5.494G
25	5.353G	26	5.668G	27	5.460G	28	5.563G
29	5.706G	30	5.421G	31	5.283G	32	5.703G
33	5.554G	34	5.503G	35	5.513G	36	5.461G
37	5.355G	38	5.341G	39	5.532G	40	5.528G
41	5.380G	42	5.698G	43	5.392G	44	5.582G
45	5.285G	46	5.425G	47	5.454G	48	5.617G
49	5.323G	50	5.281G	51	5.544G	52	5.466G
53	5.447G	54	5.420G	55	5.600G	56	5.676G
57	5.422G	58	5.638G	59	5.324G	60	5.295G
61	5.359G	62	5.483G	63	5.628G	64	5.350G
65	5.690G	66	5.389G	67	5.495G	68	5.252G
69	5.603G	70	5.688G	71	5.266G	72	5.696G
73	5.713G	74	5.649G	75	5.465G	76	5.413G
77	5.551G	78	5.615G	79	5.620G	80	5.358G
81	5.567G	82	5.442G	83	5.524G	84	5.506G
85	5.296G	86	5.597G	87	5.360G	88	5.484G
89	5.430G	90	5.407G	91	5.612G	92	5.619G
93	5.488G	94	5.631G	95	5.375G	96	5.432G
97	5.641G	98	5.342G	99	5.443G	100	5.590G

Hopping Frequency Sequence Name: HOP_FREQ_SEQ_11							
SEQ#	Frequency (Hz)	SEQ#	Frequency (Hz)	SEQ#	Frequency (Hz)	SEQ#	Frequency (Hz)
1	5.408G	2	5.306G	3	5.263G	4	5.393G
5	5.321G	6	5.559G	7	5.525G	8	5.427G
9	5.723G	10	5.451G	11	5.696G	12	5.626G
13	5.709G	14	5.553G	15	5.257G	16	5.474G
17	5.261G	18	5.669G	19	5.462G	20	5.348G
21	5.487G	22	5.589G	23	5.625G	24	5.294G
25	5.262G	26	5.711G	27	5.362G	28	5.623G
29	5.568G	30	5.564G	31	5.666G	32	5.413G
33	5.538G	34	5.484G	35	5.641G	36	5.520G
37	5.721G	38	5.483G	39	5.659G	40	5.339G
41	5.300G	42	5.478G	43	5.563G	44	5.269G
45	5.684G	46	5.663G	47	5.252G	48	5.254G
49	5.480G	50	5.655G	51	5.521G	52	5.377G
53	5.603G	54	5.627G	55	5.314G	56	5.364G
57	5.629G	58	5.365G	59	5.351G	60	5.528G
61	5.657G	62	5.447G	63	5.270G	64	5.477G
65	5.515G	66	5.295G	67	5.268G	68	5.383G
69	5.251G	70	5.458G	71	5.320G	72	5.374G
73	5.492G	74	5.358G	75	5.357G	76	5.410G
77	5.676G	78	5.588G	79	5.414G	80	5.399G
81	5.498G	82	5.491G	83	5.604G	84	5.658G
85	5.330G	86	5.613G	87	5.317G	88	5.539G
89	5.652G	90	5.403G	91	5.675G	92	5.642G
93	5.551G	94	5.343G	95	5.460G	96	5.543G
97	5.369G	98	5.276G	99	5.532G	100	5.708G

Hopping Frequency Sequence Name: HOP_FREQ_SEQ_12							
SEQ#	Frequency (Hz)	SEQ#	Frequency (Hz)	SEQ#	Frequency (Hz)	SEQ#	Frequency (Hz)
1	5.603G	2	5.666G	3	5.522G	4	5.502G
5	5.678G	6	5.480G	7	5.479G	8	5.281G
9	5.364G	10	5.297G	11	5.713G	12	5.316G
13	5.476G	14	5.662G	15	5.437G	16	5.710G
17	5.561G	18	5.306G	19	5.416G	20	5.463G
21	5.268G	22	5.498G	23	5.674G	24	5.313G
25	5.549G	26	5.294G	27	5.558G	28	5.637G
29	5.583G	30	5.462G	31	5.291G	32	5.492G
33	5.452G	34	5.260G	35	5.497G	36	5.535G
37	5.586G	38	5.577G	39	5.658G	40	5.470G
41	5.424G	42	5.264G	43	5.680G	44	5.347G
45	5.619G	46	5.500G	47	5.266G	48	5.411G
49	5.272G	50	5.353G	51	5.661G	52	5.317G
53	5.696G	54	5.576G	55	5.391G	56	5.376G
57	5.442G	58	5.432G	59	5.305G	60	5.461G
61	5.398G	62	5.394G	63	5.368G	64	5.283G
65	5.624G	66	5.414G	67	5.483G	68	5.458G
69	5.329G	70	5.634G	71	5.578G	72	5.718G
73	5.387G	74	5.596G	75	5.650G	76	5.517G
77	5.690G	78	5.453G	79	5.613G	80	5.653G
81	5.628G	82	5.451G	83	5.478G	84	5.356G
85	5.441G	86	5.381G	87	5.552G	88	5.395G
89	5.341G	90	5.496G	91	5.455G	92	5.469G
93	5.573G	94	5.365G	95	5.642G	96	5.505G
97	5.309G	98	5.397G	99	5.568G	100	5.639G

Hopping Frequency Sequence Name: HOP_FREQ_SEQ_13							
SEQ#	Frequency (Hz)	SEQ#	Frequency (Hz)	SEQ#	Frequency (Hz)	SEQ#	Frequency (Hz)
1	5.375G	2	5.264G	3	5.273G	4	5.293G
5	5.612G	6	5.436G	7	5.695G	8	5.549G
9	5.422G	10	5.631G	11	5.262G	12	5.490G
13	5.589G	14	5.506G	15	5.326G	16	5.282G
17	5.657G	18	5.497G	19	5.509G	20	5.660G
21	5.474G	22	5.629G	23	5.272G	24	5.314G
25	5.433G	26	5.560G	27	5.399G	28	5.357G
29	5.668G	30	5.484G	31	5.408G	32	5.325G
33	5.434G	34	5.356G	35	5.563G	36	5.285G
37	5.401G	38	5.426G	39	5.393G	40	5.621G
41	5.277G	42	5.567G	43	5.593G	44	5.559G
45	5.496G	46	5.675G	47	5.419G	48	5.319G
49	5.690G	50	5.694G	51	5.373G	52	5.661G
53	5.367G	54	5.522G	55	5.674G	56	5.265G
57	5.300G	58	5.468G	59	5.596G	60	5.324G
61	5.528G	62	5.526G	63	5.537G	64	5.669G
65	5.599G	66	5.358G	67	5.303G	68	5.648G
69	5.378G	70	5.478G	71	5.469G	72	5.407G
73	5.513G	74	5.263G	75	5.586G	76	5.360G
77	5.571G	78	5.604G	79	5.446G	80	5.479G
81	5.482G	82	5.366G	83	5.394G	84	5.693G
85	5.288G	86	5.512G	87	5.551G	88	5.585G
89	5.723G	90	5.705G	91	5.412G	92	5.711G
93	5.345G	94	5.486G	95	5.678G	96	5.361G
97	5.390G	98	5.352G	99	5.649G	100	5.647G

Hopping Frequency Sequence Name: HOP_FREQ_SEQ_14							
SEQ#	Frequency (Hz)	SEQ#	Frequency (Hz)	SEQ#	Frequency (Hz)	SEQ#	Frequency (Hz)
1	5.507G	2	5.709G	3	5.352G	4	5.516G
5	5.503G	6	5.594G	7	5.415G	8	5.255G
9	5.475G	10	5.275G	11	5.657G	12	5.344G
13	5.534G	14	5.406G	15	5.612G	16	5.671G
17	5.389G	18	5.314G	19	5.323G	20	5.544G
21	5.277G	22	5.302G	23	5.545G	24	5.577G
25	5.388G	26	5.258G	27	5.386G	28	5.434G
29	5.312G	30	5.595G	31	5.689G	32	5.420G
33	5.287G	34	5.408G	35	5.464G	36	5.511G
37	5.443G	38	5.427G	39	5.416G	40	5.365G
41	5.500G	42	5.587G	43	5.457G	44	5.395G
45	5.621G	46	5.588G	47	5.442G	48	5.411G
49	5.390G	50	5.539G	51	5.425G	52	5.521G
53	5.722G	54	5.696G	55	5.413G	56	5.529G
57	5.355G	58	5.656G	59	5.704G	60	5.316G
61	5.480G	62	5.581G	63	5.632G	64	5.676G
65	5.482G	66	5.432G	67	5.259G	68	5.438G
69	5.694G	70	5.580G	71	5.536G	72	5.663G
73	5.495G	74	5.674G	75	5.347G	76	5.400G
77	5.465G	78	5.330G	79	5.589G	80	5.519G
81	5.699G	82	5.645G	83	5.380G	84	5.672G
85	5.635G	86	5.548G	87	5.563G	88	5.710G
89	5.348G	90	5.629G	91	5.641G	92	5.509G
93	5.317G	94	5.384G	95	5.562G	96	5.666G
97	5.332G	98	5.456G	99	5.262G	100	5.701G

Hopping Frequency Sequence Name: HOP_FREQ_SEQ_15							
SEQ#	Frequency (Hz)	SEQ#	Frequency (Hz)	SEQ#	Frequency (Hz)	SEQ#	Frequency (Hz)
1	5.332G	2	5.253G	3	5.256G	4	5.368G
5	5.366G	6	5.427G	7	5.495G	8	5.322G
9	5.496G	10	5.474G	11	5.448G	12	5.678G
13	5.410G	14	5.687G	15	5.686G	16	5.533G
17	5.269G	18	5.385G	19	5.429G	20	5.261G
21	5.585G	22	5.509G	23	5.255G	24	5.478G
25	5.360G	26	5.339G	27	5.335G	28	5.512G
29	5.604G	30	5.462G	31	5.479G	32	5.562G
33	5.693G	34	5.337G	35	5.671G	36	5.260G
37	5.382G	38	5.556G	39	5.523G	40	5.292G
41	5.273G	42	5.313G	43	5.586G	44	5.668G
45	5.317G	46	5.324G	47	5.505G	48	5.486G
49	5.358G	50	5.493G	51	5.456G	52	5.610G
53	5.528G	54	5.590G	55	5.506G	56	5.517G
57	5.530G	58	5.640G	59	5.318G	60	5.274G
61	5.381G	62	5.579G	63	5.667G	64	5.661G
65	5.415G	66	5.442G	67	5.621G	68	5.552G
69	5.455G	70	5.300G	71	5.441G	72	5.491G
73	5.722G	74	5.305G	75	5.331G	76	5.365G
77	5.390G	78	5.637G	79	5.266G	80	5.591G
81	5.563G	82	5.607G	83	5.461G	84	5.262G
85	5.605G	86	5.617G	87	5.403G	88	5.600G
89	5.492G	90	5.294G	91	5.706G	92	5.507G
93	5.284G	94	5.298G	95	5.564G	96	5.650G
97	5.537G	98	5.611G	99	5.645G	100	5.413G

Hopping Frequency Sequence Name: HOP_FREQ_SEQ_16							
SEQ#	Frequency (Hz)	SEQ#	Frequency (Hz)	SEQ#	Frequency (Hz)	SEQ#	Frequency (Hz)
1	5.469G	2	5.426G	3	5.347G	4	5.449G
5	5.330G	6	5.537G	7	5.391G	8	5.687G
9	5.666G	10	5.332G	11	5.651G	12	5.341G
13	5.352G	14	5.457G	15	5.686G	16	5.531G
17	5.693G	18	5.631G	19	5.269G	20	5.525G
21	5.702G	22	5.403G	23	5.536G	24	5.363G
25	5.516G	26	5.538G	27	5.490G	28	5.511G
29	5.724G	30	5.704G	31	5.442G	32	5.441G
33	5.411G	34	5.717G	35	5.571G	36	5.647G
37	5.649G	38	5.606G	39	5.319G	40	5.448G
41	5.504G	42	5.472G	43	5.609G	44	5.438G
45	5.545G	46	5.480G	47	5.256G	48	5.679G
49	5.382G	50	5.284G	51	5.543G	52	5.424G
53	5.317G	54	5.520G	55	5.604G	56	5.397G
57	5.505G	58	5.463G	59	5.685G	60	5.602G
61	5.270G	62	5.618G	63	5.662G	64	5.273G
65	5.707G	66	5.664G	67	5.552G	68	5.294G
69	5.320G	70	5.464G	71	5.641G	72	5.476G
73	5.661G	74	5.566G	75	5.299G	76	5.584G
77	5.619G	78	5.420G	79	5.488G	80	5.593G
81	5.654G	82	5.714G	83	5.287G	84	5.657G
85	5.337G	86	5.644G	87	5.648G	88	5.659G
89	5.251G	90	5.265G	91	5.279G	92	5.359G
93	5.460G	94	5.413G	95	5.308G	96	5.544G
97	5.640G	98	5.394G	99	5.348G	100	5.613G

Hopping Frequency Sequence Name: HOP_FREQ_SEQ_17							
SEQ#	Frequency (Hz)	SEQ#	Frequency (Hz)	SEQ#	Frequency (Hz)	SEQ#	Frequency (Hz)
1	5.421G	2	5.498G	3	5.713G	4	5.660G
5	5.583G	6	5.662G	7	5.657G	8	5.641G
9	5.268G	10	5.654G	11	5.517G	12	5.259G
13	5.485G	14	5.419G	15	5.276G	16	5.649G
17	5.467G	18	5.646G	19	5.359G	20	5.642G
21	5.659G	22	5.620G	23	5.345G	24	5.257G
25	5.288G	26	5.478G	27	5.637G	28	5.252G
29	5.489G	30	5.274G	31	5.703G	32	5.534G
33	5.376G	34	5.719G	35	5.682G	36	5.413G
37	5.614G	38	5.448G	39	5.256G	40	5.365G
41	5.587G	42	5.350G	43	5.605G	44	5.447G
45	5.328G	46	5.710G	47	5.330G	48	5.679G
49	5.557G	50	5.674G	51	5.437G	52	5.668G
53	5.714G	54	5.353G	55	5.488G	56	5.427G
57	5.577G	58	5.482G	59	5.700G	60	5.626G
61	5.307G	62	5.464G	63	5.423G	64	5.336G
65	5.617G	66	5.608G	67	5.562G	68	5.443G
69	5.446G	70	5.561G	71	5.493G	72	5.560G
73	5.304G	74	5.354G	75	5.495G	76	5.680G
77	5.397G	78	5.344G	79	5.426G	80	5.425G
81	5.599G	82	5.567G	83	5.510G	84	5.555G
85	5.625G	86	5.324G	87	5.707G	88	5.262G
89	5.501G	90	5.651G	91	5.292G	92	5.424G
93	5.573G	94	5.411G	95	5.597G	96	5.691G
97	5.435G	98	5.459G	99	5.282G	100	5.600G

Hopping Frequency Sequence Name: HOP_FREQ_SEQ_18							
SEQ#	Frequency (Hz)	SEQ#	Frequency (Hz)	SEQ#	Frequency (Hz)	SEQ#	Frequency (Hz)
1	5.471G	2	5.678G	3	5.410G	4	5.537G
5	5.446G	6	5.666G	7	5.563G	8	5.355G
9	5.484G	10	5.489G	11	5.556G	12	5.596G
13	5.454G	14	5.682G	15	5.554G	16	5.595G
17	5.270G	18	5.610G	19	5.586G	20	5.549G
21	5.264G	22	5.415G	23	5.266G	24	5.339G
25	5.662G	26	5.697G	27	5.379G	28	5.392G
29	5.301G	30	5.334G	31	5.573G	32	5.643G
33	5.253G	34	5.439G	35	5.300G	36	5.519G
37	5.267G	38	5.689G	39	5.539G	40	5.455G
41	5.468G	42	5.613G	43	5.496G	44	5.665G
45	5.381G	46	5.250G	47	5.298G	48	5.272G
49	5.592G	50	5.360G	51	5.532G	52	5.324G
53	5.710G	54	5.409G	55	5.517G	56	5.467G
57	5.647G	58	5.668G	59	5.309G	60	5.548G
61	5.317G	62	5.428G	63	5.597G	64	5.314G
65	5.481G	66	5.308G	67	5.584G	68	5.622G
69	5.358G	70	5.466G	71	5.616G	72	5.295G
73	5.364G	74	5.261G	75	5.655G	76	5.660G
77	5.457G	78	5.672G	79	5.565G	80	5.652G
81	5.260G	82	5.683G	83	5.343G	84	5.401G
85	5.325G	86	5.686G	87	5.353G	88	5.315G
89	5.373G	90	5.402G	91	5.352G	92	5.599G
93	5.626G	94	5.702G	95	5.258G	96	5.460G
97	5.724G	98	5.670G	99	5.444G	100	5.388G

Hopping Frequency Sequence Name: HOP_FREQ_SEQ_19							
SEQ#	Frequency (Hz)	SEQ#	Frequency (Hz)	SEQ#	Frequency (Hz)	SEQ#	Frequency (Hz)
1	5.550G	2	5.672G	3	5.305G	4	5.508G
5	5.713G	6	5.500G	7	5.312G	8	5.704G
9	5.291G	10	5.288G	11	5.664G	12	5.468G
13	5.405G	14	5.558G	15	5.313G	16	5.308G
17	5.390G	18	5.685G	19	5.526G	20	5.394G
21	5.616G	22	5.333G	23	5.419G	24	5.461G
25	5.417G	26	5.393G	27	5.427G	28	5.650G
29	5.376G	30	5.351G	31	5.656G	32	5.494G
33	5.700G	34	5.365G	35	5.624G	36	5.551G
37	5.259G	38	5.657G	39	5.470G	40	5.666G
41	5.250G	42	5.501G	43	5.681G	44	5.496G
45	5.370G	46	5.689G	47	5.535G	48	5.271G
49	5.444G	50	5.696G	51	5.337G	52	5.621G
53	5.265G	54	5.399G	55	5.609G	56	5.722G
57	5.401G	58	5.667G	59	5.473G	60	5.511G
61	5.350G	62	5.614G	63	5.516G	64	5.409G
65	5.260G	66	5.709G	67	5.677G	68	5.590G
69	5.671G	70	5.418G	71	5.297G	72	5.623G
73	5.539G	74	5.371G	75	5.280G	76	5.422G
77	5.607G	78	5.407G	79	5.533G	80	5.316G
81	5.301G	82	5.640G	83	5.610G	84	5.454G
85	5.413G	86	5.512G	87	5.577G	88	5.557G
89	5.471G	90	5.622G	91	5.439G	92	5.361G
93	5.582G	94	5.360G	95	5.440G	96	5.537G
97	5.406G	98	5.585G	99	5.342G	100	5.462G

Hopping Frequency Sequence Name: HOP_FREQ_SEQ_20							
SEQ#	Frequency (Hz)	SEQ#	Frequency (Hz)	SEQ#	Frequency (Hz)	SEQ#	Frequency (Hz)
1	5.664G	2	5.377G	3	5.595G	4	5.701G
5	5.596G	6	5.490G	7	5.573G	8	5.706G
9	5.594G	10	5.393G	11	5.581G	12	5.592G
13	5.403G	14	5.547G	15	5.428G	16	5.314G
17	5.643G	18	5.585G	19	5.444G	20	5.405G
21	5.279G	22	5.294G	23	5.477G	24	5.277G
25	5.543G	26	5.338G	27	5.720G	28	5.613G
29	5.323G	30	5.541G	31	5.496G	32	5.270G
33	5.499G	34	5.410G	35	5.530G	36	5.339G
37	5.452G	38	5.287G	39	5.423G	40	5.375G
41	5.328G	42	5.644G	43	5.620G	44	5.333G
45	5.635G	46	5.566G	47	5.645G	48	5.497G
49	5.325G	50	5.417G	51	5.523G	52	5.562G
53	5.605G	54	5.495G	55	5.271G	56	5.693G
57	5.442G	58	5.524G	59	5.637G	60	5.407G
61	5.421G	62	5.342G	63	5.435G	64	5.590G
65	5.636G	66	5.711G	67	5.468G	68	5.288G
69	5.488G	70	5.719G	71	5.699G	72	5.400G
73	5.343G	74	5.589G	75	5.379G	76	5.408G
77	5.406G	78	5.712G	79	5.370G	80	5.268G
81	5.299G	82	5.576G	83	5.619G	84	5.332G
85	5.361G	86	5.465G	87	5.517G	88	5.485G
89	5.724G	90	5.557G	91	5.297G	92	5.586G
93	5.321G	94	5.368G	95	5.683G	96	5.526G
97	5.649G	98	5.587G	99	5.582G	100	5.681G

Hopping Frequency Sequence Name: HOP_FREQ_SEQ_21							
SEQ#	Frequency (Hz)	SEQ#	Frequency (Hz)	SEQ#	Frequency (Hz)	SEQ#	Frequency (Hz)
1	5.265G	2	5.645G	3	5.335G	4	5.680G
5	5.551G	6	5.661G	7	5.669G	8	5.387G
9	5.352G	10	5.635G	11	5.451G	12	5.534G
13	5.511G	14	5.708G	15	5.721G	16	5.644G
17	5.524G	18	5.634G	19	5.453G	20	5.698G
21	5.631G	22	5.445G	23	5.279G	24	5.582G
25	5.488G	26	5.687G	27	5.292G	28	5.673G
29	5.361G	30	5.256G	31	5.471G	32	5.523G
33	5.464G	34	5.330G	35	5.555G	36	5.499G
37	5.700G	38	5.613G	39	5.695G	40	5.672G
41	5.591G	42	5.399G	43	5.432G	44	5.664G
45	5.578G	46	5.571G	47	5.478G	48	5.463G
49	5.431G	50	5.516G	51	5.371G	52	5.652G
53	5.709G	54	5.692G	55	5.421G	56	5.480G
57	5.425G	58	5.293G	59	5.285G	60	5.693G
61	5.666G	62	5.609G	63	5.377G	64	5.338G
65	5.597G	66	5.430G	67	5.568G	68	5.489G
69	5.495G	70	5.479G	71	5.304G	72	5.527G
73	5.473G	74	5.397G	75	5.643G	76	5.626G
77	5.411G	78	5.702G	79	5.409G	80	5.512G
81	5.599G	82	5.497G	83	5.393G	84	5.351G
85	5.706G	86	5.327G	87	5.660G	88	5.437G
89	5.322G	90	5.566G	91	5.553G	92	5.501G
93	5.315G	94	5.590G	95	5.385G	96	5.650G
97	5.614G	98	5.705G	99	5.276G	100	5.469G

Hopping Frequency Sequence Name: HOP_FREQ_SEQ_22							
SEQ#	Frequency (Hz)	SEQ#	Frequency (Hz)	SEQ#	Frequency (Hz)	SEQ#	Frequency (Hz)
1	5.609G	2	5.255G	3	5.447G	4	5.276G
5	5.345G	6	5.385G	7	5.526G	8	5.623G
9	5.601G	10	5.535G	11	5.657G	12	5.300G
13	5.306G	14	5.708G	15	5.495G	16	5.422G
17	5.658G	18	5.379G	19	5.692G	20	5.502G
21	5.253G	22	5.498G	23	5.380G	24	5.670G
25	5.460G	26	5.514G	27	5.545G	28	5.319G
29	5.252G	30	5.457G	31	5.478G	32	5.707G
33	5.722G	34	5.681G	35	5.329G	36	5.390G
37	5.367G	38	5.622G	39	5.286G	40	5.472G
41	5.435G	42	5.427G	43	5.458G	44	5.715G
45	5.537G	46	5.312G	47	5.671G	48	5.521G
49	5.322G	50	5.655G	51	5.308G	52	5.484G
53	5.361G	54	5.304G	55	5.259G	56	5.418G
57	5.360G	58	5.724G	59	5.594G	60	5.420G
61	5.549G	62	5.454G	63	5.314G	64	5.569G
65	5.467G	66	5.450G	67	5.519G	68	5.444G
69	5.268G	70	5.663G	71	5.709G	72	5.610G
73	5.621G	74	5.647G	75	5.648G	76	5.557G
77	5.529G	78	5.483G	79	5.589G	80	5.377G
81	5.338G	82	5.698G	83	5.433G	84	5.446G
85	5.618G	86	5.597G	87	5.393G	88	5.554G
89	5.477G	90	5.403G	91	5.280G	92	5.719G
93	5.263G	94	5.465G	95	5.305G	96	5.646G
97	5.550G	98	5.396G	99	5.637G	100	5.716G

Hopping Frequency Sequence Name: HOP_FREQ_SEQ_23							
SEQ#	Frequency (Hz)	SEQ#	Frequency (Hz)	SEQ#	Frequency (Hz)	SEQ#	Frequency (Hz)
1	5.401G	2	5.459G	3	5.412G	4	5.639G
5	5.383G	6	5.630G	7	5.689G	8	5.673G
9	5.441G	10	5.384G	11	5.432G	12	5.451G
13	5.608G	14	5.440G	15	5.593G	16	5.398G
17	5.590G	18	5.280G	19	5.339G	20	5.257G
21	5.702G	22	5.422G	23	5.648G	24	5.683G
25	5.642G	26	5.479G	27	5.354G	28	5.718G
29	5.633G	30	5.620G	31	5.562G	32	5.334G
33	5.515G	34	5.546G	35	5.585G	36	5.486G
37	5.366G	38	5.409G	39	5.375G	40	5.392G
41	5.482G	42	5.313G	43	5.660G	44	5.279G
45	5.563G	46	5.617G	47	5.694G	48	5.307G
49	5.314G	50	5.376G	51	5.447G	52	5.697G
53	5.393G	54	5.698G	55	5.335G	56	5.358G
57	5.503G	58	5.605G	59	5.712G	60	5.413G
61	5.285G	62	5.662G	63	5.576G	64	5.429G
65	5.365G	66	5.653G	67	5.284G	68	5.687G
69	5.415G	70	5.315G	71	5.347G	72	5.722G
73	5.613G	74	5.372G	75	5.425G	76	5.504G
77	5.723G	78	5.330G	79	5.672G	80	5.473G
81	5.423G	82	5.618G	83	5.526G	84	5.452G
85	5.301G	86	5.460G	87	5.652G	88	5.592G
89	5.547G	90	5.286G	91	5.614G	92	5.603G
93	5.696G	94	5.484G	95	5.721G	96	5.343G
97	5.519G	98	5.667G	99	5.407G	100	5.489G

Hopping Frequency Sequence Name: HOP_FREQ_SEQ_24							
SEQ#	Frequency (Hz)	SEQ#	Frequency (Hz)	SEQ#	Frequency (Hz)	SEQ#	Frequency (Hz)
1	5.338G	2	5.690G	3	5.513G	4	5.614G
5	5.452G	6	5.451G	7	5.357G	8	5.646G
9	5.375G	10	5.403G	11	5.400G	12	5.341G
13	5.469G	14	5.723G	15	5.707G	16	5.314G
17	5.708G	18	5.474G	19	5.336G	20	5.416G
21	5.427G	22	5.521G	23	5.593G	24	5.611G
25	5.598G	26	5.558G	27	5.652G	28	5.581G
29	5.383G	30	5.642G	31	5.313G	32	5.649G
33	5.722G	34	5.664G	35	5.561G	36	5.594G
37	5.266G	38	5.334G	39	5.685G	40	5.701G
41	5.437G	42	5.544G	43	5.332G	44	5.603G
45	5.465G	46	5.379G	47	5.579G	48	5.262G
49	5.250G	50	5.724G	51	5.283G	52	5.291G
53	5.587G	54	5.391G	55	5.329G	56	5.382G
57	5.372G	58	5.645G	59	5.455G	60	5.596G
61	5.422G	62	5.251G	63	5.609G	64	5.559G
65	5.497G	66	5.253G	67	5.545G	68	5.438G
69	5.488G	70	5.697G	71	5.503G	72	5.348G
73	5.583G	74	5.390G	75	5.647G	76	5.377G
77	5.535G	78	5.298G	79	5.556G	80	5.571G
81	5.644G	82	5.625G	83	5.490G	84	5.610G
85	5.592G	86	5.426G	87	5.280G	88	5.591G
89	5.305G	90	5.564G	91	5.721G	92	5.285G
93	5.526G	94	5.315G	95	5.698G	96	5.624G
97	5.258G	98	5.505G	99	5.606G	100	5.516G

Hopping Frequency Sequence Name: HOP_FREQ_SEQ_25							
SEQ#	Frequency (Hz)	SEQ#	Frequency (Hz)	SEQ#	Frequency (Hz)	SEQ#	Frequency (Hz)
1	5.337G	2	5.639G	3	5.406G	4	5.583G
5	5.403G	6	5.551G	7	5.705G	8	5.571G
9	5.488G	10	5.253G	11	5.519G	12	5.369G
13	5.575G	14	5.445G	15	5.511G	16	5.419G
17	5.619G	18	5.261G	19	5.473G	20	5.710G
21	5.580G	22	5.657G	23	5.446G	24	5.508G
25	5.355G	26	5.634G	27	5.334G	28	5.460G
29	5.648G	30	5.546G	31	5.608G	32	5.674G
33	5.534G	34	5.723G	35	5.256G	36	5.629G
37	5.459G	38	5.352G	39	5.293G	40	5.517G
41	5.322G	42	5.467G	43	5.557G	44	5.672G
45	5.703G	46	5.415G	47	5.296G	48	5.547G
49	5.435G	50	5.465G	51	5.260G	52	5.282G
53	5.374G	54	5.430G	55	5.494G	56	5.640G
57	5.268G	58	5.432G	59	5.392G	60	5.307G
61	5.393G	62	5.344G	63	5.416G	64	5.285G
65	5.638G	66	5.597G	67	5.516G	68	5.690G
69	5.449G	70	5.504G	71	5.572G	72	5.669G
73	5.594G	74	5.532G	75	5.628G	76	5.673G
77	5.448G	78	5.537G	79	5.326G	80	5.266G
81	5.697G	82	5.522G	83	5.678G	84	5.655G
85	5.422G	86	5.317G	87	5.602G	88	5.264G
89	5.589G	90	5.627G	91	5.491G	92	5.701G
93	5.436G	94	5.680G	95	5.478G	96	5.558G
97	5.320G	98	5.662G	99	5.525G	100	5.434G

Hopping Frequency Sequence Name: HOP_FREQ_SEQ_26							
SEQ#	Frequency (Hz)	SEQ#	Frequency (Hz)	SEQ#	Frequency (Hz)	SEQ#	Frequency (Hz)
1	5.518G	2	5.489G	3	5.280G	4	5.598G
5	5.417G	6	5.447G	7	5.418G	8	5.400G
9	5.674G	10	5.631G	11	5.668G	12	5.577G
13	5.654G	14	5.251G	15	5.570G	16	5.649G
17	5.318G	18	5.373G	19	5.558G	20	5.544G
21	5.331G	22	5.695G	23	5.395G	24	5.628G
25	5.551G	26	5.338G	27	5.678G	28	5.375G
29	5.448G	30	5.254G	31	5.693G	32	5.273G
33	5.501G	34	5.596G	35	5.406G	36	5.295G
37	5.253G	38	5.430G	39	5.315G	40	5.650G
41	5.565G	42	5.504G	43	5.533G	44	5.664G
45	5.547G	46	5.307G	47	5.385G	48	5.561G
49	5.521G	50	5.303G	51	5.383G	52	5.525G
53	5.300G	54	5.641G	55	5.613G	56	5.291G
57	5.614G	58	5.588G	59	5.365G	60	5.294G
61	5.600G	62	5.445G	63	5.387G	64	5.468G
65	5.405G	66	5.429G	67	5.450G	68	5.288G
69	5.462G	70	5.464G	71	5.443G	72	5.659G
73	5.344G	74	5.636G	75	5.611G	76	5.432G
77	5.341G	78	5.532G	79	5.420G	80	5.449G
81	5.284G	82	5.414G	83	5.724G	84	5.440G
85	5.556G	86	5.455G	87	5.499G	88	5.474G
89	5.481G	90	5.363G	91	5.478G	92	5.456G
93	5.264G	94	5.633G	95	5.589G	96	5.686G
97	5.538G	98	5.569G	99	5.524G	100	5.578G

Hopping Frequency Sequence Name: HOP_FREQ_SEQ_27							
SEQ#	Frequency (Hz)	SEQ#	Frequency (Hz)	SEQ#	Frequency (Hz)	SEQ#	Frequency (Hz)
1	5.368G	2	5.583G	3	5.564G	4	5.520G
5	5.428G	6	5.366G	7	5.611G	8	5.390G
9	5.616G	10	5.556G	11	5.539G	12	5.485G
13	5.360G	14	5.302G	15	5.581G	16	5.614G
17	5.353G	18	5.358G	19	5.582G	20	5.325G
21	5.348G	22	5.292G	23	5.287G	24	5.567G
25	5.615G	26	5.346G	27	5.531G	28	5.263G
29	5.272G	30	5.282G	31	5.657G	32	5.554G
33	5.618G	34	5.580G	35	5.525G	36	5.291G
37	5.715G	38	5.343G	39	5.534G	40	5.312G
41	5.275G	42	5.270G	43	5.718G	44	5.696G
45	5.671G	46	5.307G	47	5.332G	48	5.721G
49	5.462G	50	5.714G	51	5.451G	52	5.679G
53	5.422G	54	5.317G	55	5.640G	56	5.695G
57	5.722G	58	5.598G	59	5.607G	60	5.648G
61	5.547G	62	5.396G	63	5.523G	64	5.659G
65	5.624G	66	5.584G	67	5.660G	68	5.452G
69	5.550G	70	5.440G	71	5.683G	72	5.382G
73	5.562G	74	5.578G	75	5.513G	76	5.393G
77	5.379G	78	5.409G	79	5.362G	80	5.297G
81	5.597G	82	5.337G	83	5.711G	84	5.460G
85	5.576G	86	5.605G	87	5.645G	88	5.591G
89	5.667G	90	5.398G	91	5.456G	92	5.380G
93	5.710G	94	5.636G	95	5.315G	96	5.277G
97	5.441G	98	5.676G	99	5.593G	100	5.394G

Hopping Frequency Sequence Name: HOP_FREQ_SEQ_28							
SEQ#	Frequency (Hz)	SEQ#	Frequency (Hz)	SEQ#	Frequency (Hz)	SEQ#	Frequency (Hz)
1	5.336G	2	5.506G	3	5.514G	4	5.286G
5	5.715G	6	5.452G	7	5.408G	8	5.722G
9	5.332G	10	5.606G	11	5.608G	12	5.630G
13	5.676G	14	5.547G	15	5.568G	16	5.436G
17	5.503G	18	5.344G	19	5.723G	20	5.331G
21	5.637G	22	5.454G	23	5.589G	24	5.517G
25	5.586G	26	5.474G	27	5.267G	28	5.686G
29	5.333G	30	5.540G	31	5.585G	32	5.678G
33	5.482G	34	5.549G	35	5.473G	36	5.695G
37	5.412G	38	5.600G	39	5.620G	40	5.272G
41	5.499G	42	5.424G	43	5.366G	44	5.594G
45	5.526G	46	5.625G	47	5.632G	48	5.572G
49	5.260G	50	5.463G	51	5.679G	52	5.444G
53	5.716G	54	5.388G	55	5.587G	56	5.592G
57	5.399G	58	5.327G	59	5.607G	60	5.529G
61	5.455G	62	5.554G	63	5.688G	64	5.534G
65	5.250G	66	5.295G	67	5.541G	68	5.402G
69	5.551G	70	5.595G	71	5.459G	72	5.516G
73	5.467G	74	5.544G	75	5.358G	76	5.393G
77	5.490G	78	5.656G	79	5.493G	80	5.639G
81	5.410G	82	5.494G	83	5.346G	84	5.304G
85	5.357G	86	5.616G	87	5.339G	88	5.316G
89	5.318G	90	5.510G	91	5.405G	92	5.697G
93	5.483G	94	5.535G	95	5.672G	96	5.645G
97	5.558G	98	5.284G	99	5.460G	100	5.519G

Hopping Frequency Sequence Name: HOP_FREQ_SEQ_29							
SEQ#	Frequency (Hz)	SEQ#	Frequency (Hz)	SEQ#	Frequency (Hz)	SEQ#	Frequency (Hz)
1	5.666G	2	5.685G	3	5.395G	4	5.370G
5	5.611G	6	5.291G	7	5.687G	8	5.327G
9	5.307G	10	5.486G	11	5.389G	12	5.604G
13	5.319G	14	5.463G	15	5.445G	16	5.357G
17	5.415G	18	5.721G	19	5.587G	20	5.585G
21	5.558G	22	5.574G	23	5.675G	24	5.566G
25	5.679G	26	5.570G	27	5.488G	28	5.640G
29	5.406G	30	5.617G	31	5.386G	32	5.592G
33	5.382G	34	5.448G	35	5.479G	36	5.461G
37	5.273G	38	5.671G	39	5.458G	40	5.432G
41	5.544G	42	5.271G	43	5.628G	44	5.343G
45	5.689G	46	5.709G	47	5.691G	48	5.529G
49	5.540G	50	5.633G	51	5.623G	52	5.667G
53	5.536G	54	5.277G	55	5.577G	56	5.625G
57	5.454G	58	5.595G	59	5.660G	60	5.564G
61	5.673G	62	5.362G	63	5.692G	64	5.252G
65	5.680G	66	5.304G	67	5.459G	68	5.436G
69	5.314G	70	5.723G	71	5.423G	72	5.651G
73	5.435G	74	5.553G	75	5.562G	76	5.602G
77	5.368G	78	5.646G	79	5.441G	80	5.412G
81	5.718G	82	5.552G	83	5.430G	84	5.607G
85	5.404G	86	5.393G	87	5.420G	88	5.672G
89	5.669G	90	5.596G	91	5.384G	92	5.428G
93	5.495G	94	5.268G	95	5.606G	96	5.551G
97	5.377G	98	5.588G	99	5.352G	100	5.477G

Hopping Frequency Sequence Name: HOP_FREQ_SEQ_30							
SEQ#	Frequency (Hz)	SEQ#	Frequency (Hz)	SEQ#	Frequency (Hz)	SEQ#	Frequency (Hz)
1	5.458G	2	5.613G	3	5.717G	4	5.475G
5	5.607G	6	5.589G	7	5.417G	8	5.406G
9	5.298G	10	5.318G	11	5.710G	12	5.667G
13	5.351G	14	5.347G	15	5.300G	16	5.619G
17	5.309G	18	5.502G	19	5.578G	20	5.639G
21	5.573G	22	5.448G	23	5.462G	24	5.721G
25	5.389G	26	5.509G	27	5.414G	28	5.443G
29	5.262G	30	5.571G	31	5.558G	32	5.285G
33	5.529G	34	5.606G	35	5.419G	36	5.352G
37	5.566G	38	5.459G	39	5.304G	40	5.398G
41	5.339G	42	5.408G	43	5.281G	44	5.663G
45	5.690G	46	5.405G	47	5.335G	48	5.577G
49	5.491G	50	5.424G	51	5.411G	52	5.581G
53	5.715G	54	5.686G	55	5.267G	56	5.594G
57	5.277G	58	5.596G	59	5.457G	60	5.554G
61	5.388G	62	5.669G	63	5.474G	64	5.720G
65	5.453G	66	5.658G	67	5.500G	68	5.677G
69	5.358G	70	5.287G	71	5.338G	72	5.394G
73	5.609G	74	5.676G	75	5.353G	76	5.379G
77	5.616G	78	5.625G	79	5.257G	80	5.595G
81	5.588G	82	5.426G	83	5.556G	84	5.680G
85	5.373G	86	5.674G	87	5.350G	88	5.628G
89	5.423G	90	5.418G	91	5.260G	92	5.590G
93	5.392G	94	5.532G	95	5.478G	96	5.582G
97	5.562G	98	5.326G	99	5.548G	100	5.286G

IEEE 802.11ac VHT40

Type 1 Radar Statistical Performances

Trial #	Pulses per Burst	Pulse Width (s)	PRI (s)	Radar Frequency (MHz)	Detection
1	102	1.0u	518.0u	5291	Yes
2	95	1.0u	558.0u	5293	Yes
3	89	1.0u	598.0u	5294	Yes
4	83	1.0u	638.0u	5295	Yes
5	78	1.0u	678.0u	5297	Yes
6	76	1.0u	698.0u	5299	Yes
7	74	1.0u	718.0u	5300	Yes
8	72	1.0u	738.0u	5301	Yes
9	68	1.0u	778.0u	5303	Yes
10	67	1.0u	798.0u	5305	Yes
11	63	1.0u	838.0u	5306	Yes
12	62	1.0u	858.0u	5307	Yes
13	59	1.0u	898.0u	5308	Yes
14	58	1.0u	918.0u	5309	Yes
15	57	1.0u	938.0u	5310	Yes
16	66	1.0u	805.0u	5312	Yes
17	63	1.0u	845.0u	5313	Yes
18	60	1.0u	885.0u	5314	Yes
19	59	1.0u	905.0u	5316	Yes
20	69	1.0u	771.0u	5317	Yes
21	66	1.0u	811.0u	5319	Yes
22	63	1.0u	851.0u	5320	Yes
23	60	1.0u	891.0u	5322	Yes
24	58	1.0u	911.0u	5323	Yes
25	92	1.0u	577.0u	5324	Yes
26	86	1.0u	617.0u	5325	Yes
27	78	1.0u	677.0u	5326	Yes
28	74	1.0u	717.0u	5327	Yes
29	68	1.0u	777.0u	5328	Yes
30	58	1.0u	917.0u	5329	Yes

Detection Rate: 100.0 %

Type 2 Radar Statistical Performances					
Trial #	Pulses per Burst	Pulse Width (s)	PRI (s)	Radar Frequency (MHz)	Detection
1	25	4.6u	200.0u	5291	Yes
2	27	2.8u	200.0u	5293	Yes
3	27	1.7u	161.0u	5294	Yes
4	28	2.6u	220.0u	5295	Yes
5	27	2.6u	218.0u	5297	No
6	27	1.7u	172.0u	5299	No
7	26	1.6u	191.0u	5300	No
8	25	3.7u	158.0u	5301	Yes
9	28	1.5u	228.0u	5303	Yes
10	26	4.9u	198.0u	5305	Yes
11	28	1.3u	205.0u	5306	Yes
12	29	2.6u	155.0u	5307	No
13	28	4.9u	224.0u	5308	No
14	24	2.9u	169.0u	5309	Yes
15	28	4.1u	183.0u	5310	Yes
16	27	1.7u	192.0u	5312	Yes
17	24	2.6u	191.0u	5313	Yes
18	27	4.6u	173.0u	5314	Yes
19	28	3.4u	187.0u	5316	Yes
20	27	4.3u	214.0u	5317	Yes
21	29	1.2u	179.0u	5319	Yes
22	25	1.1u	154.0u	5320	Yes
23	25	4.1u	159.0u	5322	Yes
24	28	2.9u	158.0u	5323	Yes
25	25	2.8u	215.0u	5324	Yes
26	27	4.0u	196.0u	5325	Yes
27	27	4.5u	215.0u	5326	No
28	27	2.9u	180.0u	5327	Yes
29	27	1.5u	177.0u	5328	Yes
30	28	1.6u	186.0u	5329	Yes

Detection Rate: 80.0 %

Type 3 Radar Statistical Performances					
Trial #	Pulses per Burst	Pulse Width (s)	PRI (s)	Radar Frequency (MHz)	Detection
1	17	9.6u	218.0u	5291	Yes
2	18	8.4u	494.0u	5293	Yes
3	17	8.7u	375.0u	5294	Yes
4	18	7.0u	379.0u	5295	Yes
5	17	8.9u	401.0u	5297	Yes
6	17	8.3u	348.0u	5299	No
7	16	6.2u	454.0u	5300	Yes
8	18	9.2u	299.0u	5301	Yes
9	16	9.6u	347.0u	5303	Yes
10	16	7.0u	293.0u	5305	Yes
11	17	9.7u	434.0u	5306	Yes
12	16	9.5u	405.0u	5307	Yes
13	17	9.0u	459.0u	5308	Yes
14	18	6.2u	349.0u	5309	Yes
15	17	7.9u	225.0u	5310	Yes
16	18	8.0u	384.0u	5312	Yes
17	17	6.5u	220.0u	5313	Yes
18	16	8.4u	225.0u	5314	Yes
19	17	6.1u	210.0u	5316	Yes
20	16	6.0u	260.0u	5317	Yes
21	18	9.1u	470.0u	5319	Yes
22	16	7.1u	474.0u	5320	Yes
23	18	9.1u	433.0u	5322	Yes
24	18	9.1u	296.0u	5323	No
25	16	8.5u	368.0u	5324	Yes
26	16	6.4u	315.0u	5325	Yes
27	17	6.9u	204.0u	5326	Yes
28	18	6.8u	309.0u	5327	Yes
29	17	9.2u	351.0u	5328	Yes
30	17	9.0u	201.0u	5329	Yes

Detection Rate: 93.3 %

Type 4 Radar Statistical Performances					
Trial #	Pulses per Burst	Pulse Width (s)	PRI (s)	Radar Frequency (MHz)	Detection
1	14	14.3u	312.0u	5291	Yes
2	13	18.3u	368.0u	5293	No
3	13	18.4u	392.0u	5294	Yes
4	16	14.9u	457.0u	5295	Yes
5	13	15.9u	337.0u	5297	Yes
6	14	13.7u	413.0u	5299	Yes
7	13	13.6u	263.0u	5300	Yes
8	14	11.2u	484.0u	5301	Yes
9	12	11.6u	341.0u	5303	Yes
10	14	18.2u	448.0u	5305	No
11	14	14.2u	423.0u	5306	Yes
12	14	12.4u	470.0u	5307	Yes
13	13	18.0u	336.0u	5308	Yes
14	15	17.8u	213.0u	5309	Yes
15	14	11.8u	297.0u	5310	No
16	15	16.6u	436.0u	5312	No
17	15	16.8u	298.0u	5313	Yes
18	13	14.9u	459.0u	5314	No
19	14	19.5u	286.0u	5316	Yes
20	16	18.4u	462.0u	5317	Yes
21	15	19.0u	314.0u	5319	No
22	15	16.2u	284.0u	5320	Yes
23	13	16.9u	396.0u	5322	Yes
24	15	14.9u	202.0u	5323	Yes
25	14	17.8u	492.0u	5324	Yes
26	12	14.2u	451.0u	5325	Yes
27	12	18.2u	350.0u	5326	Yes
28	15	14.7u	204.0u	5327	Yes
29	12	16.6u	418.0u	5328	Yes
30	13	14.1u	218.0u	5329	No

Detection Rate: 76.6 %

Type 5 Radar Statistical Performances		
Trial #	Test Signal Name	Detection
1	LP_Signal_01	Yes
2	LP_Signal_02	Yes
3	LP_Signal_03	Yes
4	LP_Signal_04	Yes
5	LP_Signal_05	Yes
6	LP_Signal_06	Yes
7	LP_Signal_07	Yes
8	LP_Signal_08	Yes
9	LP_Signal_09	Yes
10	LP_Signal_10	Yes
11	LP_Signal_11	Yes
12	LP_Signal_12	Yes
13	LP_Signal_13	Yes
14	LP_Signal_14	Yes
15	LP_Signal_15	Yes
16	LP_Signal_16	Yes
17	LP_Signal_17	Yes
18	LP_Signal_18	Yes
19	LP_Signal_19	Yes
20	LP_Signal_20	Yes
21	LP_Signal_21	Yes
22	LP_Signal_22	Yes
23	LP_Signal_23	Yes
24	LP_Signal_24	Yes
25	LP_Signal_25	Yes
26	LP_Signal_26	Yes
27	LP_Signal_27	Yes
28	LP_Signal_28	Yes
29	LP_Signal_29	Yes
30	LP_Signal_30	Yes
		Detection Rate: 100.0 %

Long Pulse Radar Test Signal						
Test Signal Name: LP_Signal_01						
Number of Bursts in Trial: 19						
Chrip Center Frequency: 5294MHz						
Burst	Pulses per Burst	Chrip (Hz)	Pulse Width (s)	Pulse 1 to 2 Spacing (s)	Pulse 2 to 3 Spacing (s)	Start Location (s)
1	2	5M	50.4u	1.916m	-	334.6m
2	2	5M	54.2u	1.760m	-	40.17m
3	2	5M	66.7u	1.591m	-	375.0m
4	1	5M	81.8u	-	-	224.8m
5	3	5M	85.3u	1.562m	1.550m	598.5m
6	2	5M	50.9u	1.097m	-	247.8m
7	3	5M	71.5u	1.403m	1.250m	384.9m
8	1	5M	57.3u	-	-	545.1m
9	1	5M	99.4u	-	-	327.7m
10	2	5M	81.7u	1.762m	-	346.5m
11	3	5M	87.0u	1.625m	1.683m	237.2m
12	2	5M	94.9u	1.522m	-	585.4m
13	2	5M	83.5u	1.529m	-	480.1m
14	2	5M	66.1u	1.677m	-	545.9m
15	2	5M	52.9u	1.709m	-	563.8m
16	3	5M	51.5u	1.865m	1.887m	433.2m
17	1	5M	82.8u	-	-	4.846m
18	2	5M	84.6u	957.4u	-	397.1m
19	3	5M	70.6u	1.247m	1.791m	432.2m

Long Pulse Radar Test Signal						
Test Signal Name: LP_Signal_02						
Number of Bursts in Trial: 13						
Chrip Center Frequency: 5294MHz						
Burst	Pulses per Burst	Chrip (Hz)	Pulse Width (s)	Pulse 1 to 2 Spacing (s)	Pulse 2 to 3 Spacing (s)	Start Location (s)
1	2	5M	64.2u	1.510m	-	171.7m
2	2	5M	85.7u	1.457m	-	23.95m
3	3	5M	93.8u	1.348m	1.769m	685.0m
4	3	5M	85.1u	1.065m	1.624m	112.8m
5	1	5M	84.7u	-	-	797.2m
6	2	5M	80.4u	1.702m	-	14.43m
7	1	5M	98.4u	-	-	314.4m
8	2	5M	71.1u	1.369m	-	529.1m
9	1	5M	98.6u	-	-	667.9m
10	2	5M	91.7u	1.176m	-	571.6m
11	2	5M	69.1u	1.770m	-	615.7m
12	2	5M	90.9u	1.511m	-	676.8m
13	2	5M	89.6u	1.199m	-	683.8m

Long Pulse Radar Test Signal
 Test Signal Name: LP_Signal_03
 Number of Bursts in Trial: 9
 Chrip Center Frequency: 5295MHz

Burst	Pulses per Burst	Chrip (Hz)	Pulse Width (s)	Pulse 1 to 2 Spacing (s)	Pulse 2 to 3 Spacing (s)	Start Location (s)
1	3	8M	71.1u	1.222m	1.413m	444.6m
2	2	8M	59.0u	1.893m	-	289.7m
3	2	8M	60.7u	1.211m	-	933.9m
4	3	8M	68.6u	1.430m	1.751m	827.1m
5	3	8M	78.0u	1.707m	1.351m	65.79m
6	3	8M	95.0u	1.577m	1.175m	1.235
7	2	8M	94.0u	1.043m	-	1.170
8	2	8M	82.2u	1.181m	-	463.7m
9	1	8M	55.8u	-	-	543.3m

Long Pulse Radar Test Signal
 Test Signal Name: LP_Signal_04
 Number of Bursts in Trial: 11
 Chrip Center Frequency: 5295MHz

Burst	Pulses per Burst	Chrip (Hz)	Pulse Width (s)	Pulse 1 to 2 Spacing (s)	Pulse 2 to 3 Spacing (s)	Start Location (s)
1	3	8M	77.4u	1.030m	976.6u	796.6m
2	1	8M	67.0u	-	-	626.7m
3	2	8M	66.8u	1.592m	-	230.3m
4	2	8M	96.2u	1.786m	-	706.5m
5	1	8M	73.5u	-	-	809.0m
6	3	8M	64.8u	1.909m	1.249m	95.29m
7	3	8M	69.4u	1.248m	1.386m	601.9m
8	2	8M	98.4u	1.041m	-	333.4m
9	1	8M	86.7u	-	-	201.6m
10	2	8M	76.0u	1.466m	-	691.6m
11	3	8M	64.9u	1.673m	1.042m	635.0m

Long Pulse Radar Test Signal
 Test Signal Name: LP_Signal_05
 Number of Bursts in Trial: 12
 Chrip Center Frequency: 5297MHz

Burst	Pulses per Burst	Chrip (Hz)	Pulse Width (s)	Pulse 1 to 2 Spacing (s)	Pulse 2 to 3 Spacing (s)	Start Location (s)
1	2	13M	71.5u	982.5u	-	86.36m
2	1	13M	89.8u	-	-	993.6m
3	1	13M	83.2u	-	-	30.83m
4	1	13M	59.2u	-	-	837.0m
5	1	13M	68.7u	-	-	229.0m
6	2	13M	96.4u	1.547m	-	543.5m
7	2	13M	84.2u	1.813m	-	108.2m
8	1	13M	61.5u	-	-	194.1m
9	2	13M	87.9u	1.451m	-	603.2m
10	1	13M	94.3u	-	-	285.9m
11	2	13M	61.6u	1.018m	-	423.4m
12	2	13M	55.8u	1.245m	-	287.7m

Long Pulse Radar Test Signal						
Test Signal Name: LP_Signal_06						
Number of Bursts in Trial: 10						
Chrip Center Frequency: 5297MHz						
Burst	Pulses per Burst	Chrip (Hz)	Pulse Width (s)	Pulse 1 to 2 Spacing (s)	Pulse 2 to 3 Spacing (s)	Start Location (s)
1	1	13M	67.5u	-	-	502.0m
2	1	13M	88.4u	-	-	240.1m
3	1	13M	65.8u	-	-	262.9m
4	2	13M	62.4u	1.503m	-	341.2m
5	1	13M	95.6u	-	-	958.2m
6	3	13M	62.0u	1.724m	1.096m	947.7m
7	1	13M	52.1u	-	-	612.1m
8	2	13M	50.7u	1.853m	-	1.171
9	2	13M	88.5u	1.693m	-	992.4m
10	2	13M	51.3u	1.595m	-	447.5m

Long Pulse Radar Test Signal						
Test Signal Name: LP_Signal_07						
Number of Bursts in Trial: 17						
Chrip Center Frequency: 5298MHz						
Burst	Pulses per Burst	Chrip (Hz)	Pulse Width (s)	Pulse 1 to 2 Spacing (s)	Pulse 2 to 3 Spacing (s)	Start Location (s)
1	2	15M	73.3u	1.117m	-	263.9m
2	3	15M	77.1u	1.610m	1.018m	283.7m
3	2	15M	70.2u	1.453m	-	47.73m
4	2	15M	84.6u	1.444m	-	566.8m
5	3	15M	82.8u	1.477m	1.433m	572.1m
6	2	15M	95.2u	987.8u	-	614.1m
7	3	15M	95.3u	1.243m	1.697m	22.08m
8	3	15M	59.7u	1.441m	1.343m	23.27m
9	3	15M	69.3u	1.787m	1.428m	620.8m
10	2	15M	75.3u	1.838m	-	693.6m
11	3	15M	91.2u	1.427m	1.347m	498.9m
12	3	15M	91.2u	1.212m	1.579m	309.3m
13	2	15M	94.7u	1.191m	-	266.5m
14	3	15M	98.4u	1.552m	1.534m	614.4m
15	3	15M	54.0u	1.482m	990.0u	449.2m
16	2	15M	74.1u	1.675m	-	613.7m
17	2	15M	83.4u	1.632m	-	699.8m

Long Pulse Radar Test Signal
 Test Signal Name: LP_Signal_08
 Number of Bursts in Trial: 9
 Chrip Center Frequency: 5298MHz

Burst	Pulses per Burst	Chrip (Hz)	Pulse Width (s)	Pulse 1 to 2 Spacing (s)	Pulse 2 to 3 Spacing (s)	Start Location (s)
1	1	15M	97.5u	-	-	471.5m
2	3	15M	52.7u	1.940m	1.267m	85.10m
3	2	15M	85.6u	1.832m	-	606.7m
4	3	15M	93.9u	1.311m	1.757m	129.9m
5	2	15M	77.8u	1.140m	-	697.6m
6	2	15M	55.9u	1.283m	-	587.3m
7	3	15M	77.8u	1.001m	1.712m	269.7m
8	2	15M	54.8u	1.560m	-	1.196
9	2	15M	54.1u	1.552m	-	817.5m

Long Pulse Radar Test Signal
 Test Signal Name: LP_Signal_09
 Number of Bursts in Trial: 13
 Chrip Center Frequency: 5300MHz

Burst	Pulses per Burst	Chrip (Hz)	Pulse Width (s)	Pulse 1 to 2 Spacing (s)	Pulse 2 to 3 Spacing (s)	Start Location (s)
1	3	20M	99.7u	1.511m	1.864m	57.55m
2	2	20M	62.6u	1.651m	-	208.8m
3	2	20M	78.6u	1.897m	-	188.5m
4	3	20M	92.7u	1.075m	1.701m	713.1m
5	2	20M	84.2u	1.551m	-	875.0m
6	2	20M	71.6u	1.165m	-	311.7m
7	1	20M	67.9u	-	-	735.6m
8	3	20M	54.0u	1.098m	1.873m	138.9m
9	1	20M	82.3u	-	-	262.2m
10	2	20M	63.4u	1.368m	-	14.73m
11	2	20M	64.4u	1.845m	-	637.0m
12	2	20M	90.9u	1.294m	-	356.2m
13	1	20M	96.9u	-	-	536.0m

Long Pulse Radar Test Signal
 Test Signal Name: LP_Signal_10
 Number of Bursts in Trial: 18
 Chrip Center Frequency: 5300MHz

Burst	Pulses per Burst	Chrip (Hz)	Pulse Width (s)	Pulse 1 to 2 Spacing (s)	Pulse 2 to 3 Spacing (s)	Start Location (s)
1	2	20M	98.6u	1.198m	-	344.9m
2	2	20M	57.6u	961.4u	-	641.7m
3	1	20M	56.4u	-	-	308.8m
4	1	20M	81.4u	-	-	180.2m
5	1	20M	61.8u	-	-	297.7m
6	2	20M	90.4u	1.563m	-	282.9m
7	3	20M	68.8u	1.515m	1.370m	37.46m
8	1	20M	73.9u	-	-	475.8m
9	2	20M	68.4u	1.684m	-	117.5m
10	3	20M	95.4u	1.490m	1.735m	155.9m
11	1	20M	70.9u	-	-	253.8m
12	1	20M	94.7u	-	-	356.0m
13	3	20M	76.9u	1.750m	1.203m	56.37m
14	3	20M	80.6u	1.024m	1.881m	588.3m
15	2	20M	87.2u	1.015m	-	223.6m

16	2	20M	85.9u	1.898m	-	380.5m
17	1	20M	62.9u	-	-	127.1m
18	2	20M	96.3u	1.532m	-	541.3m

Long Pulse Radar Test Signal						
Test Signal Name: LP_Signal_11						
Number of Bursts in Trial: 13						
Chrip Center Frequency: 5310MHz						
Burst	Pulses per Burst	Chrip (Hz)	Pulse Width (s)	Pulse 1 to 2 Spacing (s)	Pulse 2 to 3 Spacing (s)	Start Location (s)
1	2	5M	64.2u	1.510m	-	171.7m
2	2	5M	85.7u	1.457m	-	23.95m
3	3	5M	93.8u	1.348m	1.769m	685.0m
4	3	5M	85.1u	1.065m	1.624m	112.8m
5	1	5M	84.7u	-	-	797.2m
6	2	5M	80.4u	1.702m	-	14.43m
7	1	5M	98.4u	-	-	314.4m
8	2	5M	71.1u	1.369m	-	529.1m
9	1	5M	98.6u	-	-	667.9m
10	2	5M	91.7u	1.176m	-	571.6m
11	2	5M	69.1u	1.770m	-	615.7m
12	2	5M	90.9u	1.511m	-	676.8m
13	2	5M	89.6u	1.199m	-	683.8m

Long Pulse Radar Test Signal						
Test Signal Name: LP_Signal_12						
Number of Bursts in Trial: 19						
Chrip Center Frequency: 5310MHz						
Burst	Pulses per Burst	Chrip (Hz)	Pulse Width (s)	Pulse 1 to 2 Spacing (s)	Pulse 2 to 3 Spacing (s)	Start Location (s)
1	3	5M	61.2u	1.793m	1.857m	398.8m
2	1	5M	53.7u	-	-	300.3m
3	2	5M	82.7u	1.900m	-	154.0m
4	3	5M	98.8u	1.369m	1.879m	7.212m
5	2	5M	54.9u	1.516m	-	475.2m
6	3	5M	57.2u	1.640m	1.396m	427.7m
7	2	5M	91.6u	1.507m	-	435.3m
8	2	5M	69.8u	1.897m	-	349.7m
9	2	5M	58.1u	1.668m	-	584.4m
10	2	5M	81.6u	1.380m	-	184.8m
11	2	5M	57.5u	1.242m	-	221.2m
12	3	5M	92.2u	1.227m	913.8u	353.3m
13	2	5M	81.9u	1.129m	-	486.4m
14	2	5M	66.9u	1.395m	-	235.5m
15	1	5M	67.9u	-	-	415.5m
16	3	5M	99.2u	1.884m	1.803m	462.9m
17	2	5M	71.2u	1.043m	-	214.2m
18	1	5M	70.9u	-	-	379.4m
19	2	5M	68.8u	1.209m	-	322.3m

Long Pulse Radar Test Signal
 Test Signal Name: LP_Signal_13
 Number of Bursts in Trial: 12
 Chrip Center Frequency: 5310MHz

Burst	Pulses per Burst	Chrip (Hz)	Pulse Width (s)	Pulse 1 to 2 Spacing (s)	Pulse 2 to 3 Spacing (s)	Start Location (s)
1	2	9M	83.6u	1.774m	-	467.4m
2	2	9M	97.1u	1.796m	-	328.2m
3	1	9M	84.9u	-	-	712.5m
4	1	9M	85.6u	-	-	456.6m
5	2	9M	97.8u	917.2u	-	642.0m
6	2	9M	95.4u	1.079m	-	800.8m
7	1	9M	71.2u	-	-	898.6m
8	3	9M	82.0u	1.666m	1.468m	784.5m
9	3	9M	86.6u	1.322m	1.519m	535.5m
10	1	9M	71.4u	-	-	43.23m
11	2	9M	62.2u	1.268m	-	268.5m
12	2	9M	96.1u	1.888m	-	253.4m

Long Pulse Radar Test Signal
 Test Signal Name: LP_Signal_14
 Number of Bursts in Trial: 13
 Chrip Center Frequency: 5310MHz

Burst	Pulses per Burst	Chrip (Hz)	Pulse Width (s)	Pulse 1 to 2 Spacing (s)	Pulse 2 to 3 Spacing (s)	Start Location (s)
1	2	9M	61.5u	955.5u	-	640.4m
2	1	9M	92.5u	-	-	393.8m
3	3	9M	71.1u	1.724m	1.483m	227.5m
4	2	9M	79.5u	1.035m	-	625.6m
5	2	9M	75.3u	1.324m	-	302.7m
6	3	9M	71.1u	1.201m	1.880m	210.6m
7	2	9M	83.2u	1.845m	-	576.6m
8	2	9M	81.1u	1.333m	-	524.0m
9	2	9M	97.7u	1.050m	-	855.4m
10	2	9M	95.7u	1.224m	-	597.8m
11	2	9M	53.5u	1.334m	-	874.0m
12	3	9M	70.8u	1.735m	1.020m	510.2m
13	2	9M	95.7u	1.535m	-	870.2m

Long Pulse Radar Test Signal
 Test Signal Name: LP_Signal_15
 Number of Bursts in Trial: 17
 Chrip Center Frequency: 5310MHz

Burst	Pulses per Burst	Chrip (Hz)	Pulse Width (s)	Pulse 1 to 2 Spacing (s)	Pulse 2 to 3 Spacing (s)	Start Location (s)
1	2	15M	73.3u	1.117m	-	263.9m
2	3	15M	77.1u	1.610m	1.018m	283.7m
3	2	15M	70.2u	1.453m	-	47.73m
4	2	15M	84.6u	1.444m	-	566.8m
5	3	15M	82.8u	1.477m	1.433m	572.1m
6	2	15M	95.2u	987.8u	-	614.1m
7	3	15M	95.3u	1.243m	1.697m	22.08m
8	3	15M	59.7u	1.441m	1.343m	23.27m
9	3	15M	69.3u	1.787m	1.428m	620.8m
10	2	15M	75.3u	1.838m	-	693.6m
11	3	15M	91.2u	1.427m	1.347m	498.9m
12	3	15M	91.2u	1.212m	1.579m	309.3m

13	2	15M	94.7u	1.191m	-	266.5m
14	3	15M	98.4u	1.552m	1.534m	614.4m
15	3	15M	54.0u	1.482m	990.0u	449.2m
16	2	15M	74.1u	1.675m	-	613.7m
17	2	15M	83.4u	1.632m	-	699.8m

Long Pulse Radar Test Signal						
Test Signal Name: LP_Signal_16						
Number of Bursts in Trial: 8						
Chrip Center Frequency: 5310MHz						
Burst	Pulses per Burst	Chrip (Hz)	Pulse Width (s)	Pulse 1 to 2 Spacing (s)	Pulse 2 to 3 Spacing (s)	Start Location (s)
1	3	15M	86.3u	1.743m	985.7u	297.0m
2	1	15M	66.0u	-	-	1.473
3	3	15M	67.9u	1.531m	1.717m	438.4m
4	3	15M	86.6u	1.433m	1.491m	650.2m
5	2	15M	59.3u	1.648m	-	773.9m
6	2	15M	60.7u	1.384m	-	278.3m
7	2	15M	58.5u	1.114m	-	1.321
8	2	15M	88.9u	920.1u	-	360.9m

Long Pulse Radar Test Signal						
Test Signal Name: LP_Signal_17						
Number of Bursts in Trial: 19						
Chrip Center Frequency: 5310MHz						
Burst	Pulses per Burst	Chrip (Hz)	Pulse Width (s)	Pulse 1 to 2 Spacing (s)	Pulse 2 to 3 Spacing (s)	Start Location (s)
1	3	17M	56.6u	1.081m	1.442m	264.5m
2	2	17M	77.0u	1.479m	-	411.6m
3	1	17M	64.7u	-	-	502.4m
4	2	17M	66.3u	1.533m	-	128.2m
5	2	17M	66.5u	1.654m	-	32.33m
6	2	17M	53.9u	1.723m	-	368.5m
7	2	17M	95.4u	1.678m	-	502.6m
8	2	17M	79.6u	1.481m	-	375.6m
9	2	17M	94.7u	1.774m	-	335.2m
10	3	17M	86.7u	1.256m	1.147m	567.5m
11	2	17M	65.2u	1.373m	-	55.52m
12	3	17M	53.6u	1.336m	1.086m	350.4m
13	1	17M	93.6u	-	-	549.5m
14	3	17M	99.9u	1.866m	961.1u	222.0m
15	2	17M	98.7u	1.242m	-	603.9m
16	3	17M	99.5u	992.5u	1.138m	514.9m
17	2	17M	88.7u	1.906m	-	388.1m
18	2	17M	98.4u	1.185m	-	429.7m
19	2	17M	84.8u	1.718m	-	344.7m

Long Pulse Radar Test Signal						
Test Signal Name: LP_Signal_18						
Number of Bursts in Trial: 15						
Chrip Center Frequency: 5310MHz						
Burst	Pulses per Burst	Chrip (Hz)	Pulse Width (s)	Pulse 1 to 2 Spacing (s)	Pulse 2 to 3 Spacing (s)	Start Location (s)
1	2	17M	74.4u	1.078m	-	405.4m
2	2	17M	64.5u	1.652m	-	642.9m
3	2	17M	60.9u	1.407m	-	702.7m
4	1	17M	93.7u	-	-	738.4m
5	3	17M	73.4u	1.274m	1.171m	600.8m
6	2	17M	65.8u	1.640m	-	566.8m
7	2	17M	67.9u	1.038m	-	561.0m
8	2	17M	75.2u	970.8u	-	25.08m
9	1	17M	58.5u	-	-	667.7m
10	1	17M	97.9u	-	-	176.6m
11	3	17M	87.6u	1.679m	1.187m	730.3m
12	1	17M	94.5u	-	-	720.4m
13	3	17M	56.4u	1.013m	1.776m	274.4m
14	2	17M	84.2u	1.338m	-	186.8m
15	1	17M	67.2u	-	-	223.4m

Long Pulse Radar Test Signal						
Test Signal Name: LP_Signal_19						
Number of Bursts in Trial: 15						
Chrip Center Frequency: 5310MHz						
Burst	Pulses per Burst	Chrip (Hz)	Pulse Width (s)	Pulse 1 to 2 Spacing (s)	Pulse 2 to 3 Spacing (s)	Start Location (s)
1	1	20M	63.9u	-	-	77.33m
2	2	20M	94.7u	1.807m	-	47.69m
3	2	20M	55.2u	1.653m	-	235.8m
4	1	20M	88.6u	-	-	734.4m
5	3	20M	58.9u	1.448m	1.576m	594.5m
6	3	20M	80.2u	1.051m	1.328m	738.1m
7	2	20M	51.8u	1.771m	-	610.0m
8	1	20M	58.2u	-	-	187.6m
9	3	20M	51.5u	1.442m	1.642m	91.17m
10	2	20M	54.6u	1.066m	-	128.0m
11	3	20M	92.5u	1.718m	1.207m	337.4m
12	3	20M	88.1u	1.794m	1.583m	438.5m
13	2	20M	63.5u	1.643m	-	214.3m
14	2	20M	73.1u	959.9u	-	235.5m
15	1	20M	71.4u	-	-	509.1m

Long Pulse Radar Test Signal						
Test Signal Name: LP_Signal_20						
Number of Bursts in Trial: 18						
Chrip Center Frequency: 5310MHz						
Burst	Pulses per Burst	Chrip (Hz)	Pulse Width (s)	Pulse 1 to 2 Spacing (s)	Pulse 2 to 3 Spacing (s)	Start Location (s)
1	1	20M	58.6u	-	-	36.12m
2	2	20M	92.0u	1.831m	-	301.7m
3	2	20M	97.4u	1.173m	-	286.9m
4	2	20M	57.0u	979.0u	-	55.23m
5	1	20M	66.5u	-	-	376.4m
6	2	20M	78.9u	1.100m	-	434.4m
7	2	20M	70.2u	1.681m	-	626.6m
8	3	20M	72.3u	1.233m	1.537m	438.6m
9	2	20M	59.1u	1.565m	-	429.8m
10	1	20M	50.4u	-	-	446.6m
11	2	20M	88.1u	1.050m	-	371.0m
12	2	20M	52.9u	1.220m	-	91.61m
13	1	20M	95.1u	-	-	395.7m
14	1	20M	82.4u	-	-	374.5m
15	2	20M	96.3u	992.7u	-	595.6m
16	2	20M	91.4u	1.793m	-	121.7m
17	2	20M	97.6u	1.191m	-	331.3m
18	2	20M	61.0u	1.695m	-	56.15m

Long Pulse Radar Test Signal						
Test Signal Name: LP_Signal_21						
Number of Bursts in Trial: 19						
Chrip Center Frequency: 5326MHz						
Burst	Pulses per Burst	Chrip (Hz)	Pulse Width (s)	Pulse 1 to 2 Spacing (s)	Pulse 2 to 3 Spacing (s)	Start Location (s)
1	3	5M	61.2u	1.793m	1.857m	398.8m
2	1	5M	53.7u	-	-	300.3m
3	2	5M	82.7u	1.900m	-	154.0m
4	3	5M	98.8u	1.369m	1.879m	7.212m
5	2	5M	54.9u	1.516m	-	475.2m
6	3	5M	57.2u	1.640m	1.396m	427.7m
7	2	5M	91.6u	1.507m	-	435.3m
8	2	5M	69.8u	1.897m	-	349.7m
9	2	5M	58.1u	1.668m	-	584.4m
10	2	5M	81.6u	1.380m	-	184.8m
11	2	5M	57.5u	1.242m	-	221.2m
12	3	5M	92.2u	1.227m	913.8u	353.3m
13	2	5M	81.9u	1.129m	-	486.4m
14	2	5M	66.9u	1.395m	-	235.5m
15	1	5M	67.9u	-	-	415.5m
16	3	5M	99.2u	1.884m	1.803m	462.9m
17	2	5M	71.2u	1.043m	-	214.2m
18	1	5M	70.9u	-	-	379.4m
19	2	5M	68.8u	1.209m	-	322.3m

Long Pulse Radar Test Signal						
Test Signal Name: LP_Signal_22						
Number of Bursts in Trial: 18						
Chrip Center Frequency: 5326MHz						
Burst	Pulses per Burst	Chrip (Hz)	Pulse Width (s)	Pulse 1 to 2 Spacing (s)	Pulse 2 to 3 Spacing (s)	Start Location (s)
1	2	5M	64.8u	1.186m	-	75.79m
2	3	5M	95.3u	1.039m	1.151m	354.7m
3	1	5M	58.2u	-	-	145.6m
4	2	5M	96.2u	1.328m	-	408.6m
5	1	5M	70.0u	-	-	571.7m
6	1	5M	97.0u	-	-	4.469m
7	2	5M	74.8u	1.904m	-	112.1m
8	2	5M	86.3u	1.847m	-	19.29m
9	1	5M	56.7u	-	-	317.3m
10	2	5M	61.0u	956.0u	-	142.0m
11	2	5M	71.0u	935.0u	-	251.8m
12	1	5M	54.2u	-	-	150.7m
13	3	5M	90.1u	1.385m	1.143m	630.6m
14	2	5M	99.6u	1.522m	-	405.1m
15	2	5M	67.1u	1.741m	-	9.165m
16	2	5M	50.8u	1.064m	-	487.1m
17	2	5M	78.9u	1.002m	-	226.8m
18	3	5M	87.7u	1.409m	1.017m	595.7m

Long Pulse Radar Test Signal						
Test Signal Name: LP_Signal_23						
Number of Bursts in Trial: 11						
Chrip Center Frequency: 5326MHz						
Burst	Pulses per Burst	Chrip (Hz)	Pulse Width (s)	Pulse 1 to 2 Spacing (s)	Pulse 2 to 3 Spacing (s)	Start Location (s)
1	3	6M	51.6u	1.534m	1.356m	923.6m
2	3	6M	71.6u	1.079m	1.587m	287.7m
3	2	6M	74.5u	1.832m	-	980.6m
4	2	6M	78.9u	1.266m	-	281.6m
5	2	6M	50.0u	1.076m	-	519.7m
6	1	6M	58.3u	-	-	189.4m
7	2	6M	63.9u	1.193m	-	701.3m
8	2	6M	88.1u	1.462m	-	107.5m
9	3	6M	62.4u	1.328m	971.6u	153.5m
10	1	6M	65.5u	-	-	1.012
11	1	6M	95.5u	-	-	359.5m

Long Pulse Radar Test Signal
 Test Signal Name: LP_Signal_24
 Number of Bursts in Trial: 10
 Chrip Center Frequency: 5326MHz

Burst	Pulses per Burst	Chrip (Hz)	Pulse Width (s)	Pulse 1 to 2 Spacing (s)	Pulse 2 to 3 Spacing (s)	Start Location (s)
1	1	6M	63.2u	-	-	639.7m
2	3	6M	51.2u	1.477m	1.835m	678.8m
3	3	6M	64.0u	1.440m	1.154m	534.7m
4	2	6M	70.2u	1.135m	-	1.023
5	2	6M	82.2u	1.368m	-	565.5m
6	2	6M	90.8u	1.524m	-	59.60m
7	2	6M	61.5u	985.5u	-	1.004
8	1	6M	52.3u	-	-	775.3m
9	3	6M	75.8u	1.274m	1.399m	123.2m
10	1	6M	83.4u	-	-	1.109

Long Pulse Radar Test Signal
 Test Signal Name: LP_Signal_25
 Number of Bursts in Trial: 8
 Chrip Center Frequency: 5324MHz

Burst	Pulses per Burst	Chrip (Hz)	Pulse Width (s)	Pulse 1 to 2 Spacing (s)	Pulse 2 to 3 Spacing (s)	Start Location (s)
1	2	11M	84.4u	1.421m	-	801.3m
2	3	11M	70.4u	1.837m	1.413m	694.8m
3	1	11M	56.8u	-	-	852.3m
4	2	11M	88.3u	1.609m	-	214.6m
5	3	11M	63.4u	1.206m	1.734m	788.8m
6	3	11M	66.9u	942.1u	1.551m	502.0m
7	3	11M	67.8u	938.2u	1.580m	404.8m
8	2	11M	68.5u	1.233m	-	191.0m

Long Pulse Radar Test Signal
 Test Signal Name: LP_Signal_26
 Number of Bursts in Trial: 19
 Chrip Center Frequency: 5324MHz

Burst	Pulses per Burst	Chrip (Hz)	Pulse Width (s)	Pulse 1 to 2 Spacing (s)	Pulse 2 to 3 Spacing (s)	Start Location (s)
1	1	11M	83.2u	-	-	45.94m
2	2	11M	64.2u	1.124m	-	371.8m
3	2	11M	93.6u	1.066m	-	35.45m
4	2	11M	81.4u	1.900m	-	379.4m
5	2	11M	72.5u	1.373m	-	425.9m
6	2	11M	63.2u	1.827m	-	395.1m
7	3	11M	78.0u	1.366m	1.019m	157.6m
8	1	11M	70.4u	-	-	237.3m
9	3	11M	62.4u	1.269m	1.701m	582.7m
10	1	11M	85.8u	-	-	223.0m
11	3	11M	57.4u	1.075m	1.909m	626.8m
12	2	11M	66.5u	1.637m	-	578.6m
13	3	11M	52.8u	1.165m	1.623m	626.6m
14	3	11M	51.0u	1.021m	1.068m	482.0m
15	1	11M	52.0u	-	-	471.8m
16	2	11M	72.0u	1.694m	-	284.8m
17	2	11M	58.9u	1.920m	-	155.7m
18	3	11M	84.2u	1.879m	1.077m	352.7m
19	2	11M	51.5u	1.504m	-	605.5m

Long Pulse Radar Test Signal						
Test Signal Name: LP_Signal_27						
Number of Bursts in Trial: 9						
Chrip Center Frequency: 5321MHz						
Burst	Pulses per Burst	Chrip (Hz)	Pulse Width (s)	Pulse 1 to 2 Spacing (s)	Pulse 2 to 3 Spacing (s)	Start Location (s)
1	1	19M	86.6u	-	-	1.233
2	2	19M	75.4u	1.787m	-	1.316
3	3	19M	50.2u	1.838m	1.148m	902.0m
4	1	19M	58.8u	-	-	953.0m
5	2	19M	54.0u	1.432m	-	424.4m
6	2	19M	51.1u	1.395m	-	265.3m
7	1	19M	63.0u	-	-	502.3m
8	1	19M	67.6u	-	-	1.070
9	2	19M	91.3u	1.439m	-	517.4m

Long Pulse Radar Test Signal						
Test Signal Name: LP_Signal_28						
Number of Bursts in Trial: 17						
Chrip Center Frequency: 5321MHz						
Burst	Pulses per Burst	Chrip (Hz)	Pulse Width (s)	Pulse 1 to 2 Spacing (s)	Pulse 2 to 3 Spacing (s)	Start Location (s)
1	2	19M	78.0u	1.167m	-	269.8m
2	3	19M	82.8u	1.545m	1.544m	640.4m
3	2	19M	73.0u	1.679m	-	88.41m
4	2	19M	67.7u	1.793m	-	557.7m
5	2	19M	55.9u	1.359m	-	651.0m
6	2	19M	92.9u	1.029m	-	485.5m
7	3	19M	70.2u	1.756m	1.342m	179.1m
8	1	19M	55.1u	-	-	407.5m
9	3	19M	67.9u	1.910m	1.250m	285.0m
10	1	19M	50.3u	-	-	147.8m
11	3	19M	50.3u	1.543m	1.185m	550.6m
12	3	19M	93.9u	1.670m	1.112m	207.5m
13	3	19M	54.3u	1.260m	1.333m	689.3m
14	1	19M	73.3u	-	-	595.0m
15	2	19M	86.5u	1.506m	-	78.29m
16	3	19M	53.8u	1.088m	1.261m	105.6m
17	2	19M	89.3u	1.368m	-	145.9m

Long Pulse Radar Test Signal						
Test Signal Name: LP_Signal_29						
Number of Bursts in Trial: 10						
Chrip Center Frequency: 5320MHz						
Burst	Pulses per Burst	Chrip (Hz)	Pulse Width (s)	Pulse 1 to 2 Spacing (s)	Pulse 2 to 3 Spacing (s)	Start Location (s)
1	2	20M	78.6u	1.551m	-	833.2m
2	2	20M	51.6u	990.4u	-	825.2m
3	2	20M	86.8u	1.097m	-	809.6m
4	1	20M	60.5u	-	-	792.9m
5	2	20M	54.9u	1.783m	-	491.4m
6	2	20M	75.7u	1.245m	-	717.7m
7	2	20M	55.0u	1.513m	-	1.155
8	2	20M	79.2u	955.8u	-	118.6m
9	1	20M	56.4u	-	-	881.1m
10	1	20M	97.7u	-	-	978.0m

Long Pulse Radar Test Signal						
Test Signal Name: LP_Signal_30						
Number of Bursts in Trial: 18						
Chrip Center Frequency: 5320MHz						
Burst	Pulses per Burst	Chrip (Hz)	Pulse Width (s)	Pulse 1 to 2 Spacing (s)	Pulse 2 to 3 Spacing (s)	Start Location (s)
1	1	20M	58.6u	-	-	36.12m
2	2	20M	92.0u	1.831m	-	301.7m
3	2	20M	97.4u	1.173m	-	286.9m
4	2	20M	57.0u	979.0u	-	55.23m
5	1	20M	66.5u	-	-	376.4m
6	2	20M	78.9u	1.100m	-	434.4m
7	2	20M	70.2u	1.681m	-	626.6m
8	3	20M	72.3u	1.233m	1.537m	438.6m
9	2	20M	59.1u	1.565m	-	429.8m
10	1	20M	50.4u	-	-	446.6m
11	2	20M	88.1u	1.050m	-	371.0m
12	2	20M	52.9u	1.220m	-	91.61m
13	1	20M	95.1u	-	-	395.7m
14	1	20M	82.4u	-	-	374.5m
15	2	20M	96.3u	992.7u	-	595.6m
16	2	20M	91.4u	1.793m	-	121.7m
17	2	20M	97.6u	1.191m	-	331.3m
18	2	20M	61.0u	1.695m	-	56.15m

Type 6 Radar Statistical Performances				
Trial #	Pulses per Burst	Pulse Width (s)	PRI (s)	Detection
1	9	1.0u	333.0u	Yes
2	9	1.0u	333.0u	Yes
3	9	1.0u	333.0u	Yes
4	9	1.0u	333.0u	Yes
5	9	1.0u	333.0u	Yes
6	9	1.0u	333.0u	Yes
7	9	1.0u	333.0u	Yes
8	9	1.0u	333.0u	Yes
9	9	1.0u	333.0u	Yes
10	9	1.0u	333.0u	Yes
11	9	1.0u	333.0u	Yes
12	9	1.0u	333.0u	Yes
13	9	1.0u	333.0u	Yes
14	9	1.0u	333.0u	Yes
15	9	1.0u	333.0u	Yes
16	9	1.0u	333.0u	Yes
17	9	1.0u	333.0u	Yes
18	9	1.0u	333.0u	Yes
19	9	1.0u	333.0u	Yes
20	9	1.0u	333.0u	Yes
21	9	1.0u	333.0u	Yes
22	9	1.0u	333.0u	Yes
23	9	1.0u	333.0u	Yes
24	9	1.0u	333.0u	Yes
25	9	1.0u	333.0u	Yes
26	9	1.0u	333.0u	Yes
27	9	1.0u	333.0u	Yes
28	9	1.0u	333.0u	Yes
29	9	1.0u	333.0u	Yes
30	9	1.0u	333.0u	Yes
				Detection Rate: 100.0 %

Type 6 Radar Statistical Performances		
Trial #	Hopping Frequency Sequence Name	Detection
1	HOP_FREQ_SEQ_01	Yes
2	HOP_FREQ_SEQ_02	Yes
3	HOP_FREQ_SEQ_03	Yes
4	HOP_FREQ_SEQ_04	Yes
5	HOP_FREQ_SEQ_05	Yes
6	HOP_FREQ_SEQ_06	Yes
7	HOP_FREQ_SEQ_07	Yes
8	HOP_FREQ_SEQ_08	Yes
9	HOP_FREQ_SEQ_09	Yes
10	HOP_FREQ_SEQ_10	Yes
11	HOP_FREQ_SEQ_11	Yes
12	HOP_FREQ_SEQ_12	Yes
13	HOP_FREQ_SEQ_13	Yes
14	HOP_FREQ_SEQ_14	Yes
15	HOP_FREQ_SEQ_15	Yes
16	HOP_FREQ_SEQ_16	Yes
17	HOP_FREQ_SEQ_17	Yes
18	HOP_FREQ_SEQ_18	Yes
19	HOP_FREQ_SEQ_19	Yes
20	HOP_FREQ_SEQ_20	Yes
21	HOP_FREQ_SEQ_21	Yes
22	HOP_FREQ_SEQ_22	Yes
23	HOP_FREQ_SEQ_23	Yes
24	HOP_FREQ_SEQ_24	Yes
25	HOP_FREQ_SEQ_25	Yes
26	HOP_FREQ_SEQ_26	Yes
27	HOP_FREQ_SEQ_27	Yes
28	HOP_FREQ_SEQ_28	Yes
29	HOP_FREQ_SEQ_29	Yes
30	HOP_FREQ_SEQ_30	Yes
		Detection Rate: 100.0 %

Hopping Frequency Sequence Name: HOP_FREQ_SEQ_01							
SEQ#	Frequency (Hz)	SEQ#	Frequency (Hz)	SEQ#	Frequency (Hz)	SEQ#	Frequency (Hz)
1	5.603G	2	5.405G	3	5.498G	4	5.670G
5	5.630G	6	5.712G	7	5.653G	8	5.285G
9	5.399G	10	5.541G	11	5.704G	12	5.323G
13	5.532G	14	5.366G	15	5.410G	16	5.581G
17	5.612G	18	5.467G	19	5.312G	20	5.554G
21	5.520G	22	5.551G	23	5.575G	24	5.448G
25	5.414G	26	5.598G	27	5.354G	28	5.708G
29	5.332G	30	5.288G	31	5.310G	32	5.456G
33	5.397G	34	5.361G	35	5.390G	36	5.380G
37	5.620G	38	5.652G	39	5.666G	40	5.457G
41	5.296G	42	5.631G	43	5.411G	44	5.470G
45	5.526G	46	5.472G	47	5.628G	48	5.375G
49	5.649G	50	5.656G	51	5.408G	52	5.393G
53	5.514G	54	5.348G	55	5.523G	56	5.709G
57	5.311G	58	5.284G	59	5.552G	60	5.427G
61	5.255G	62	5.395G	63	5.536G	64	5.626G
65	5.389G	66	5.297G	67	5.679G	68	5.545G
69	5.496G	70	5.617G	71	5.283G	72	5.508G
73	5.299G	74	5.319G	75	5.624G	76	5.440G
77	5.677G	78	5.643G	79	5.558G	80	5.252G
81	5.671G	82	5.378G	83	5.680G	84	5.547G
85	5.683G	86	5.453G	87	5.466G	88	5.471G
89	5.548G	90	5.356G	91	5.486G	92	5.684G
93	5.669G	94	5.349G	95	5.504G	96	5.641G
97	5.495G	98	5.578G	99	5.702G	100	5.706G

Hopping Frequency Sequence Name: HOP_FREQ_SEQ_02							
SEQ#	Frequency (Hz)	SEQ#	Frequency (Hz)	SEQ#	Frequency (Hz)	SEQ#	Frequency (Hz)
1	5.328G	2	5.655G	3	5.570G	4	5.291G
5	5.485G	6	5.342G	7	5.365G	8	5.720G
9	5.647G	10	5.264G	11	5.362G	12	5.403G
13	5.392G	14	5.284G	15	5.363G	16	5.461G
17	5.346G	18	5.381G	19	5.598G	20	5.528G
21	5.640G	22	5.315G	23	5.500G	24	5.539G
25	5.531G	26	5.459G	27	5.603G	28	5.372G
29	5.499G	30	5.263G	31	5.329G	32	5.366G
33	5.431G	34	5.586G	35	5.536G	36	5.266G
37	5.376G	38	5.654G	39	5.701G	40	5.285G
41	5.699G	42	5.327G	43	5.450G	44	5.567G
45	5.680G	46	5.581G	47	5.270G	48	5.633G
49	5.676G	50	5.353G	51	5.456G	52	5.454G
53	5.446G	54	5.532G	55	5.665G	56	5.443G
57	5.432G	58	5.371G	59	5.269G	60	5.559G
61	5.386G	62	5.535G	63	5.308G	64	5.451G
65	5.276G	66	5.718G	67	5.719G	68	5.287G
69	5.636G	70	5.292G	71	5.490G	72	5.700G
73	5.303G	74	5.569G	75	5.489G	76	5.364G
77	5.564G	78	5.335G	79	5.340G	80	5.326G
81	5.677G	82	5.375G	83	5.664G	84	5.427G
85	5.538G	86	5.509G	87	5.420G	88	5.344G
89	5.462G	90	5.682G	91	5.565G	92	5.691G
93	5.355G	94	5.687G	95	5.652G	96	5.352G
97	5.416G	98	5.286G	99	5.684G	100	5.425G

Hopping Frequency Sequence Name: HOP_FREQ_SEQ_03							
SEQ#	Frequency (Hz)	SEQ#	Frequency (Hz)	SEQ#	Frequency (Hz)	SEQ#	Frequency (Hz)
1	5.715G	2	5.431G	3	5.262G	4	5.608G
5	5.436G	6	5.354G	7	5.555G	8	5.545G
9	5.322G	10	5.379G	11	5.513G	12	5.254G
13	5.468G	14	5.449G	15	5.470G	16	5.616G
17	5.287G	18	5.393G	19	5.560G	20	5.256G
21	5.689G	22	5.647G	23	5.707G	24	5.413G
25	5.364G	26	5.445G	27	5.485G	28	5.615G
29	5.566G	30	5.610G	31	5.359G	32	5.723G
33	5.629G	34	5.312G	35	5.296G	36	5.341G
37	5.400G	38	5.611G	39	5.475G	40	5.463G
41	5.625G	42	5.412G	43	5.573G	44	5.434G
45	5.457G	46	5.540G	47	5.264G	48	5.496G
49	5.706G	50	5.724G	51	5.597G	52	5.299G
53	5.324G	54	5.539G	55	5.455G	56	5.547G
57	5.542G	58	5.631G	59	5.367G	60	5.363G
61	5.601G	62	5.714G	63	5.590G	64	5.365G
65	5.578G	66	5.453G	67	5.416G	68	5.471G
69	5.698G	70	5.323G	71	5.605G	72	5.635G
73	5.537G	74	5.352G	75	5.339G	76	5.378G
77	5.317G	78	5.257G	79	5.717G	80	5.637G
81	5.654G	82	5.361G	83	5.511G	84	5.510G
85	5.380G	86	5.594G	87	5.699G	88	5.600G
89	5.648G	90	5.683G	91	5.671G	92	5.283G
93	5.684G	94	5.508G	95	5.337G	96	5.342G
97	5.617G	98	5.278G	99	5.398G	100	5.497G

Hopping Frequency Sequence Name: HOP_FREQ_SEQ_04							
SEQ#	Frequency (Hz)	SEQ#	Frequency (Hz)	SEQ#	Frequency (Hz)	SEQ#	Frequency (Hz)
1	5.267G	2	5.612G	3	5.554G	4	5.569G
5	5.698G	6	5.718G	7	5.288G	8	5.716G
9	5.621G	10	5.723G	11	5.322G	12	5.511G
13	5.570G	14	5.683G	15	5.721G	16	5.530G
17	5.508G	18	5.451G	19	5.416G	20	5.521G
21	5.501G	22	5.460G	23	5.527G	24	5.699G
25	5.363G	26	5.470G	27	5.304G	28	5.623G
29	5.453G	30	5.426G	31	5.441G	32	5.579G
33	5.398G	34	5.669G	35	5.333G	36	5.468G
37	5.557G	38	5.517G	39	5.665G	40	5.610G
41	5.448G	42	5.629G	43	5.380G	44	5.262G
45	5.597G	46	5.285G	47	5.318G	48	5.266G
49	5.270G	50	5.381G	51	5.315G	52	5.401G
53	5.463G	54	5.298G	55	5.607G	56	5.700G
57	5.711G	58	5.417G	59	5.717G	60	5.360G
61	5.429G	62	5.654G	63	5.524G	64	5.496G
65	5.445G	66	5.499G	67	5.280G	68	5.386G
69	5.351G	70	5.687G	71	5.584G	72	5.356G
73	5.661G	74	5.589G	75	5.663G	76	5.657G
77	5.478G	78	5.659G	79	5.389G	80	5.513G
81	5.555G	82	5.458G	83	5.502G	84	5.420G
85	5.549G	86	5.690G	87	5.641G	88	5.648G
89	5.452G	90	5.473G	91	5.542G	92	5.588G
93	5.632G	94	5.439G	95	5.250G	96	5.348G
97	5.466G	98	5.541G	99	5.481G	100	5.562G

Hopping Frequency Sequence Name: HOP_FREQ_SEQ_05							
SEQ#	Frequency (Hz)	SEQ#	Frequency (Hz)	SEQ#	Frequency (Hz)	SEQ#	Frequency (Hz)
1	5.538G	2	5.423G	3	5.481G	4	5.307G
5	5.357G	6	5.593G	7	5.615G	8	5.404G
9	5.711G	10	5.490G	11	5.550G	12	5.416G
13	5.519G	14	5.541G	15	5.339G	16	5.612G
17	5.699G	18	5.653G	19	5.350G	20	5.369G
21	5.373G	22	5.656G	23	5.672G	24	5.688G
25	5.403G	26	5.522G	27	5.665G	28	5.675G
29	5.297G	30	5.402G	31	5.588G	32	5.673G
33	5.421G	34	5.512G	35	5.537G	36	5.715G
37	5.299G	38	5.686G	39	5.263G	40	5.679G
41	5.391G	42	5.313G	43	5.480G	44	5.561G
45	5.523G	46	5.389G	47	5.692G	48	5.569G
49	5.556G	50	5.578G	51	5.425G	52	5.517G
53	5.475G	54	5.532G	55	5.255G	56	5.375G
57	5.349G	58	5.436G	59	5.424G	60	5.271G
61	5.390G	62	5.585G	63	5.652G	64	5.486G
65	5.722G	66	5.280G	67	5.554G	68	5.514G
69	5.587G	70	5.683G	71	5.321G	72	5.547G
73	5.590G	74	5.432G	75	5.548G	76	5.657G
77	5.279G	78	5.693G	79	5.671G	80	5.539G
81	5.438G	82	5.301G	83	5.544G	84	5.670G
85	5.346G	86	5.463G	87	5.394G	88	5.567G
89	5.526G	90	5.434G	91	5.467G	92	5.611G
93	5.295G	94	5.647G	95	5.602G	96	5.318G
97	5.714G	98	5.649G	99	5.695G	100	5.630G

Hopping Frequency Sequence Name: HOP_FREQ_SEQ_06							
SEQ#	Frequency (Hz)	SEQ#	Frequency (Hz)	SEQ#	Frequency (Hz)	SEQ#	Frequency (Hz)
1	5.527G	2	5.604G	3	5.380G	4	5.393G
5	5.280G	6	5.665G	7	5.273G	8	5.473G
9	5.566G	10	5.647G	11	5.694G	12	5.645G
13	5.528G	14	5.359G	15	5.369G	16	5.564G
17	5.497G	18	5.669G	19	5.508G	20	5.459G
21	5.342G	22	5.563G	23	5.531G	24	5.605G
25	5.322G	26	5.436G	27	5.394G	28	5.611G
29	5.295G	30	5.441G	31	5.622G	32	5.469G
33	5.652G	34	5.638G	35	5.308G	36	5.375G
37	5.374G	38	5.309G	39	5.439G	40	5.626G
41	5.688G	42	5.345G	43	5.514G	44	5.646G
45	5.602G	46	5.666G	47	5.254G	48	5.271G
49	5.347G	50	5.470G	51	5.408G	52	5.700G
53	5.467G	54	5.480G	55	5.337G	56	5.673G
57	5.506G	58	5.417G	59	5.512G	60	5.348G
61	5.317G	62	5.621G	63	5.368G	64	5.557G
65	5.722G	66	5.266G	67	5.363G	68	5.678G
69	5.305G	70	5.485G	71	5.352G	72	5.668G
73	5.720G	74	5.509G	75	5.403G	76	5.460G
77	5.351G	78	5.556G	79	5.259G	80	5.629G
81	5.454G	82	5.723G	83	5.291G	84	5.356G
85	5.496G	86	5.681G	87	5.376G	88	5.689G
89	5.461G	90	5.711G	91	5.381G	92	5.279G
93	5.267G	94	5.533G	95	5.367G	96	5.361G
97	5.468G	98	5.389G	99	5.261G	100	5.357G

Hopping Frequency Sequence Name: HOP_FREQ_SEQ_07							
SEQ#	Frequency (Hz)	SEQ#	Frequency (Hz)	SEQ#	Frequency (Hz)	SEQ#	Frequency (Hz)
1	5.273G	2	5.275G	3	5.630G	4	5.277G
5	5.532G	6	5.396G	7	5.342G	8	5.379G
9	5.283G	10	5.475G	11	5.423G	12	5.571G
13	5.516G	14	5.382G	15	5.467G	16	5.429G
17	5.537G	18	5.386G	19	5.678G	20	5.544G
21	5.657G	22	5.527G	23	5.340G	24	5.470G
25	5.440G	26	5.332G	27	5.406G	28	5.373G
29	5.299G	30	5.385G	31	5.314G	32	5.255G
33	5.503G	34	5.507G	35	5.335G	36	5.476G
37	5.310G	38	5.383G	39	5.337G	40	5.518G
41	5.464G	42	5.674G	43	5.560G	44	5.322G
45	5.631G	46	5.446G	47	5.270G	48	5.708G
49	5.590G	50	5.365G	51	5.591G	52	5.706G
53	5.318G	54	5.402G	55	5.703G	56	5.662G
57	5.457G	58	5.414G	59	5.278G	60	5.308G
61	5.569G	62	5.407G	63	5.426G	64	5.376G
65	5.321G	66	5.384G	67	5.381G	68	5.542G
69	5.558G	70	5.472G	71	5.684G	72	5.553G
73	5.306G	74	5.401G	75	5.715G	76	5.458G
77	5.575G	78	5.654G	79	5.352G	80	5.671G
81	5.710G	82	5.479G	83	5.690G	84	5.297G
85	5.528G	86	5.276G	87	5.368G	88	5.585G
89	5.596G	90	5.353G	91	5.681G	92	5.442G
93	5.266G	94	5.268G	95	5.291G	96	5.615G
97	5.416G	98	5.699G	99	5.663G	100	5.293G

Hopping Frequency Sequence Name: HOP_FREQ_SEQ_08							
SEQ#	Frequency (Hz)	SEQ#	Frequency (Hz)	SEQ#	Frequency (Hz)	SEQ#	Frequency (Hz)
1	5.706G	2	5.662G	3	5.360G	4	5.585G
5	5.609G	6	5.471G	7	5.569G	8	5.485G
9	5.292G	10	5.673G	11	5.486G	12	5.626G
13	5.430G	14	5.563G	15	5.659G	16	5.287G
17	5.687G	18	5.719G	19	5.616G	20	5.668G
21	5.621G	22	5.591G	23	5.329G	24	5.558G
25	5.540G	26	5.623G	27	5.393G	28	5.712G
29	5.689G	30	5.370G	31	5.451G	32	5.545G
33	5.448G	34	5.394G	35	5.588G	36	5.633G
37	5.561G	38	5.418G	39	5.522G	40	5.707G
41	5.480G	42	5.414G	43	5.491G	44	5.312G
45	5.704G	46	5.317G	47	5.291G	48	5.319G
49	5.321G	50	5.681G	51	5.273G	52	5.473G
53	5.547G	54	5.457G	55	5.404G	56	5.456G
57	5.296G	58	5.299G	59	5.358G	60	5.684G
61	5.705G	62	5.581G	63	5.355G	64	5.592G
65	5.575G	66	5.436G	67	5.284G	68	5.381G
69	5.542G	70	5.388G	71	5.267G	72	5.254G
73	5.643G	74	5.257G	75	5.618G	76	5.332G
77	5.560G	78	5.647G	79	5.362G	80	5.677G
81	5.670G	82	5.651G	83	5.656G	84	5.425G
85	5.584G	86	5.612G	87	5.379G	88	5.368G
89	5.600G	90	5.489G	91	5.657G	92	5.357G
93	5.263G	94	5.277G	95	5.583G	96	5.555G
97	5.307G	98	5.658G	99	5.286G	100	5.487G

Hopping Frequency Sequence Name: HOP_FREQ_SEQ_09							
SEQ#	Frequency (Hz)	SEQ#	Frequency (Hz)	SEQ#	Frequency (Hz)	SEQ#	Frequency (Hz)
1	5.358G	2	5.423G	3	5.255G	4	5.380G
5	5.477G	6	5.387G	7	5.724G	8	5.629G
9	5.466G	10	5.254G	11	5.611G	12	5.379G
13	5.395G	14	5.702G	15	5.508G	16	5.543G
17	5.261G	18	5.360G	19	5.696G	20	5.411G
21	5.394G	22	5.460G	23	5.592G	24	5.528G
25	5.692G	26	5.449G	27	5.281G	28	5.285G
29	5.279G	30	5.558G	31	5.348G	32	5.496G
33	5.418G	34	5.647G	35	5.661G	36	5.517G
37	5.607G	38	5.359G	39	5.636G	40	5.650G
41	5.559G	42	5.642G	43	5.713G	44	5.274G
45	5.322G	46	5.604G	47	5.667G	48	5.674G
49	5.564G	50	5.414G	51	5.627G	52	5.489G
53	5.431G	54	5.298G	55	5.439G	56	5.353G
57	5.339G	58	5.398G	59	5.457G	60	5.497G
61	5.511G	62	5.390G	63	5.710G	64	5.407G
65	5.334G	66	5.609G	67	5.665G	68	5.263G
69	5.706G	70	5.259G	71	5.484G	72	5.479G
73	5.381G	74	5.693G	75	5.341G	76	5.351G
77	5.614G	78	5.566G	79	5.422G	80	5.475G
81	5.467G	82	5.386G	83	5.492G	84	5.705G
85	5.504G	86	5.399G	87	5.286G	88	5.610G
89	5.267G	90	5.670G	91	5.646G	92	5.265G
93	5.486G	94	5.635G	95	5.615G	96	5.608G
97	5.633G	98	5.514G	99	5.723G	100	5.372G

Hopping Frequency Sequence Name: HOP_FREQ_SEQ_10							
SEQ#	Frequency (Hz)	SEQ#	Frequency (Hz)	SEQ#	Frequency (Hz)	SEQ#	Frequency (Hz)
1	5.597G	2	5.266G	3	5.337G	4	5.578G
5	5.512G	6	5.712G	7	5.553G	8	5.671G
9	5.628G	10	5.713G	11	5.392G	12	5.346G
13	5.681G	14	5.520G	15	5.356G	16	5.488G
17	5.257G	18	5.393G	19	5.458G	20	5.605G
21	5.297G	22	5.287G	23	5.637G	24	5.710G
25	5.505G	26	5.549G	27	5.455G	28	5.385G
29	5.344G	30	5.402G	31	5.534G	32	5.452G
33	5.404G	34	5.461G	35	5.363G	36	5.322G
37	5.309G	38	5.638G	39	5.299G	40	5.445G
41	5.368G	42	5.288G	43	5.624G	44	5.516G
45	5.298G	46	5.548G	47	5.694G	48	5.685G
49	5.716G	50	5.500G	51	5.618G	52	5.431G
53	5.286G	54	5.547G	55	5.328G	56	5.351G
57	5.595G	58	5.253G	59	5.723G	60	5.350G
61	5.613G	62	5.542G	63	5.325G	64	5.255G
65	5.433G	66	5.469G	67	5.539G	68	5.420G
69	5.487G	70	5.345G	71	5.634G	72	5.483G
73	5.606G	74	5.722G	75	5.399G	76	5.386G
77	5.342G	78	5.459G	79	5.689G	80	5.658G
81	5.599G	82	5.557G	83	5.478G	84	5.477G
85	5.603G	86	5.473G	87	5.410G	88	5.540G
89	5.446G	90	5.443G	91	5.623G	92	5.550G
93	5.616G	94	5.670G	95	5.376G	96	5.341G
97	5.412G	98	5.596G	99	5.693G	100	5.347G

Hopping Frequency Sequence Name: HOP_FREQ_SEQ_11							
SEQ#	Frequency (Hz)	SEQ#	Frequency (Hz)	SEQ#	Frequency (Hz)	SEQ#	Frequency (Hz)
1	5.481G	2	5.267G	3	5.677G	4	5.358G
5	5.424G	6	5.457G	7	5.486G	8	5.285G
9	5.455G	10	5.632G	11	5.637G	12	5.679G
13	5.534G	14	5.651G	15	5.341G	16	5.376G
17	5.580G	18	5.705G	19	5.505G	20	5.438G
21	5.610G	22	5.606G	23	5.682G	24	5.578G
25	5.627G	26	5.674G	27	5.410G	28	5.370G
29	5.631G	30	5.475G	31	5.514G	32	5.694G
33	5.405G	34	5.555G	35	5.659G	36	5.420G
37	5.533G	38	5.575G	39	5.508G	40	5.266G
41	5.471G	42	5.657G	43	5.392G	44	5.339G
45	5.562G	46	5.348G	47	5.497G	48	5.278G
49	5.628G	50	5.643G	51	5.292G	52	5.528G
53	5.595G	54	5.450G	55	5.461G	56	5.387G
57	5.665G	58	5.257G	59	5.454G	60	5.301G
61	5.540G	62	5.571G	63	5.391G	64	5.568G
65	5.343G	66	5.347G	67	5.565G	68	5.718G
69	5.646G	70	5.488G	71	5.608G	72	5.710G
73	5.569G	74	5.377G	75	5.408G	76	5.572G
77	5.626G	78	5.666G	79	5.412G	80	5.284G
81	5.473G	82	5.459G	83	5.402G	84	5.416G
85	5.480G	86	5.525G	87	5.413G	88	5.519G
89	5.375G	90	5.602G	91	5.640G	92	5.478G
93	5.418G	94	5.653G	95	5.681G	96	5.421G
97	5.638G	98	5.714G	99	5.536G	100	5.673G

Hopping Frequency Sequence Name: HOP_FREQ_SEQ_12							
SEQ#	Frequency (Hz)	SEQ#	Frequency (Hz)	SEQ#	Frequency (Hz)	SEQ#	Frequency (Hz)
1	5.585G	2	5.257G	3	5.621G	4	5.720G
5	5.611G	6	5.538G	7	5.556G	8	5.427G
9	5.657G	10	5.628G	11	5.508G	12	5.367G
13	5.291G	14	5.341G	15	5.300G	16	5.485G
17	5.630G	18	5.648G	19	5.697G	20	5.378G
21	5.386G	22	5.711G	23	5.584G	24	5.350G
25	5.365G	26	5.337G	27	5.501G	28	5.272G
29	5.463G	30	5.420G	31	5.668G	32	5.283G
33	5.323G	34	5.640G	35	5.629G	36	5.502G
37	5.612G	38	5.329G	39	5.469G	40	5.701G
41	5.588G	42	5.295G	43	5.418G	44	5.683G
45	5.315G	46	5.573G	47	5.517G	48	5.592G
49	5.387G	50	5.311G	51	5.595G	52	5.580G
53	5.445G	54	5.381G	55	5.318G	56	5.523G
57	5.271G	58	5.705G	59	5.712G	60	5.669G
61	5.715G	62	5.507G	63	5.623G	64	5.491G
65	5.515G	66	5.604G	67	5.267G	68	5.368G
69	5.625G	70	5.714G	71	5.581G	72	5.407G
73	5.665G	74	5.475G	75	5.616G	76	5.276G
77	5.474G	78	5.716G	79	5.423G	80	5.302G
81	5.410G	82	5.496G	83	5.471G	84	5.413G
85	5.339G	86	5.565G	87	5.266G	88	5.352G
89	5.521G	90	5.275G	91	5.652G	92	5.653G
93	5.601G	94	5.593G	95	5.681G	96	5.656G
97	5.476G	98	5.498G	99	5.348G	100	5.446G

Hopping Frequency Sequence Name: HOP_FREQ_SEQ_13							
SEQ#	Frequency (Hz)	SEQ#	Frequency (Hz)	SEQ#	Frequency (Hz)	SEQ#	Frequency (Hz)
1	5.303G	2	5.525G	3	5.524G	4	5.392G
5	5.396G	6	5.518G	7	5.534G	8	5.685G
9	5.573G	10	5.406G	11	5.468G	12	5.389G
13	5.492G	14	5.341G	15	5.585G	16	5.540G
17	5.323G	18	5.653G	19	5.652G	20	5.269G
21	5.460G	22	5.387G	23	5.443G	24	5.424G
25	5.643G	26	5.678G	27	5.312G	28	5.526G
29	5.675G	30	5.626G	31	5.515G	32	5.668G
33	5.495G	34	5.611G	35	5.633G	36	5.408G
37	5.344G	38	5.305G	39	5.493G	40	5.623G
41	5.717G	42	5.411G	43	5.569G	44	5.516G
45	5.478G	46	5.538G	47	5.673G	48	5.255G
49	5.566G	50	5.340G	51	5.512G	52	5.463G
53	5.561G	54	5.661G	55	5.624G	56	5.713G
57	5.256G	58	5.533G	59	5.322G	60	5.503G
61	5.487G	62	5.394G	63	5.638G	64	5.436G
65	5.311G	66	5.635G	67	5.298G	68	5.284G
69	5.375G	70	5.336G	71	5.694G	72	5.456G
73	5.295G	74	5.577G	75	5.605G	76	5.625G
77	5.417G	78	5.592G	79	5.437G	80	5.627G
81	5.629G	82	5.388G	83	5.414G	84	5.264G
85	5.572G	86	5.701G	87	5.360G	88	5.508G
89	5.689G	90	5.266G	91	5.707G	92	5.543G
93	5.671G	94	5.632G	95	5.596G	96	5.407G
97	5.510G	98	5.612G	99	5.337G	100	5.576G

Hopping Frequency Sequence Name: HOP_FREQ_SEQ_14							
SEQ#	Frequency (Hz)	SEQ#	Frequency (Hz)	SEQ#	Frequency (Hz)	SEQ#	Frequency (Hz)
1	5.320G	2	5.569G	3	5.430G	4	5.515G
5	5.378G	6	5.686G	7	5.418G	8	5.682G
9	5.367G	10	5.715G	11	5.444G	12	5.405G
13	5.695G	14	5.421G	15	5.574G	16	5.293G
17	5.266G	18	5.450G	19	5.462G	20	5.524G
21	5.499G	22	5.520G	23	5.455G	24	5.270G
25	5.345G	26	5.560G	27	5.466G	28	5.491G
29	5.498G	30	5.602G	31	5.274G	32	5.550G
33	5.393G	34	5.454G	35	5.268G	36	5.590G
37	5.608G	38	5.424G	39	5.600G	40	5.276G
41	5.305G	42	5.374G	43	5.588G	44	5.662G
45	5.541G	46	5.516G	47	5.463G	48	5.677G
49	5.555G	50	5.540G	51	5.649G	52	5.484G
53	5.639G	54	5.641G	55	5.655G	56	5.316G
57	5.678G	58	5.357G	59	5.547G	60	5.269G
61	5.397G	62	5.318G	63	5.302G	64	5.596G
65	5.411G	66	5.538G	67	5.568G	68	5.626G
69	5.694G	70	5.671G	71	5.323G	72	5.267G
73	5.693G	74	5.643G	75	5.443G	76	5.598G
77	5.502G	78	5.528G	79	5.341G	80	5.445G
81	5.691G	82	5.353G	83	5.368G	84	5.575G
85	5.344G	86	5.440G	87	5.489G	88	5.501G
89	5.292G	90	5.355G	91	5.534G	92	5.642G
93	5.423G	94	5.545G	95	5.470G	96	5.409G
97	5.425G	98	5.612G	99	5.651G	100	5.688G

Hopping Frequency Sequence Name: HOP_FREQ_SEQ_15							
SEQ#	Frequency (Hz)	SEQ#	Frequency (Hz)	SEQ#	Frequency (Hz)	SEQ#	Frequency (Hz)
1	5.679G	2	5.438G	3	5.375G	4	5.447G
5	5.698G	6	5.642G	7	5.366G	8	5.662G
9	5.653G	10	5.250G	11	5.299G	12	5.427G
13	5.303G	14	5.277G	15	5.283G	16	5.574G
17	5.720G	18	5.279G	19	5.455G	20	5.470G
21	5.638G	22	5.639G	23	5.323G	24	5.643G
25	5.619G	26	5.575G	27	5.633G	28	5.710G
29	5.411G	30	5.645G	31	5.712G	32	5.510G
33	5.604G	34	5.680G	35	5.284G	36	5.357G
37	5.397G	38	5.322G	39	5.294G	40	5.681G
41	5.555G	42	5.523G	43	5.591G	44	5.593G
45	5.392G	46	5.342G	47	5.401G	48	5.255G
49	5.363G	50	5.345G	51	5.348G	52	5.281G
53	5.449G	54	5.319G	55	5.671G	56	5.498G
57	5.558G	58	5.350G	59	5.464G	60	5.405G
61	5.717G	62	5.317G	63	5.669G	64	5.526G
65	5.530G	66	5.597G	67	5.329G	68	5.508G
69	5.270G	70	5.552G	71	5.634G	72	5.355G
73	5.646G	74	5.461G	75	5.516G	76	5.380G
77	5.263G	78	5.387G	79	5.306G	80	5.341G
81	5.605G	82	5.606G	83	5.687G	84	5.637G
85	5.362G	86	5.325G	87	5.305G	88	5.326G
89	5.688G	90	5.390G	91	5.477G	92	5.567G
93	5.320G	94	5.651G	95	5.499G	96	5.721G
97	5.296G	98	5.410G	99	5.673G	100	5.586G

Hopping Frequency Sequence Name: HOP_FREQ_SEQ_16							
SEQ#	Frequency (Hz)	SEQ#	Frequency (Hz)	SEQ#	Frequency (Hz)	SEQ#	Frequency (Hz)
1	5.426G	2	5.604G	3	5.396G	4	5.259G
5	5.410G	6	5.543G	7	5.666G	8	5.395G
9	5.569G	10	5.340G	11	5.348G	12	5.690G
13	5.679G	14	5.628G	15	5.515G	16	5.588G
17	5.436G	18	5.547G	19	5.555G	20	5.385G
21	5.456G	22	5.563G	23	5.499G	24	5.573G
25	5.526G	26	5.264G	27	5.521G	28	5.528G
29	5.334G	30	5.363G	31	5.470G	32	5.386G
33	5.275G	34	5.693G	35	5.493G	36	5.427G
37	5.665G	38	5.446G	39	5.681G	40	5.382G
41	5.336G	42	5.416G	43	5.447G	44	5.390G
45	5.278G	46	5.685G	47	5.263G	48	5.342G
49	5.345G	50	5.343G	51	5.497G	52	5.653G
53	5.417G	54	5.309G	55	5.509G	56	5.579G
57	5.441G	58	5.684G	59	5.397G	60	5.341G
61	5.372G	62	5.315G	63	5.554G	64	5.540G
65	5.546G	66	5.268G	67	5.299G	68	5.561G
69	5.317G	70	5.656G	71	5.318G	72	5.703G
73	5.516G	74	5.544G	75	5.454G	76	5.414G
77	5.273G	78	5.574G	79	5.535G	80	5.380G
81	5.457G	82	5.595G	83	5.548G	84	5.466G
85	5.672G	86	5.271G	87	5.486G	88	5.650G
89	5.490G	90	5.699G	91	5.381G	92	5.581G
93	5.276G	94	5.550G	95	5.487G	96	5.402G
97	5.257G	98	5.406G	99	5.323G	100	5.371G

Hopping Frequency Sequence Name: HOP_FREQ_SEQ_17							
SEQ#	Frequency (Hz)	SEQ#	Frequency (Hz)	SEQ#	Frequency (Hz)	SEQ#	Frequency (Hz)
1	5.421G	2	5.452G	3	5.547G	4	5.598G
5	5.335G	6	5.378G	7	5.572G	8	5.279G
9	5.419G	10	5.605G	11	5.553G	12	5.461G
13	5.406G	14	5.397G	15	5.293G	16	5.401G
17	5.435G	18	5.596G	19	5.683G	20	5.352G
21	5.480G	22	5.416G	23	5.575G	24	5.543G
25	5.708G	26	5.449G	27	5.652G	28	5.372G
29	5.661G	30	5.483G	31	5.588G	32	5.315G
33	5.251G	34	5.611G	35	5.667G	36	5.264G
37	5.283G	38	5.339G	39	5.592G	40	5.363G
41	5.629G	42	5.594G	43	5.518G	44	5.674G
45	5.573G	46	5.531G	47	5.323G	48	5.405G
49	5.353G	50	5.617G	51	5.468G	52	5.671G
53	5.695G	54	5.269G	55	5.515G	56	5.580G
57	5.649G	58	5.673G	59	5.299G	60	5.644G
61	5.509G	62	5.650G	63	5.500G	64	5.467G
65	5.344G	66	5.614G	67	5.538G	68	5.622G
69	5.645G	70	5.721G	71	5.368G	72	5.627G
73	5.260G	74	5.620G	75	5.601G	76	5.356G
77	5.413G	78	5.340G	79	5.451G	80	5.697G
81	5.643G	82	5.519G	83	5.444G	84	5.578G
85	5.624G	86	5.556G	87	5.551G	88	5.355G
89	5.677G	90	5.439G	91	5.548G	92	5.338G
93	5.277G	94	5.387G	95	5.252G	96	5.311G
97	5.651G	98	5.599G	99	5.574G	100	5.600G

Hopping Frequency Sequence Name: HOP_FREQ_SEQ_18							
SEQ#	Frequency (Hz)	SEQ#	Frequency (Hz)	SEQ#	Frequency (Hz)	SEQ#	Frequency (Hz)
1	5.487G	2	5.444G	3	5.562G	4	5.715G
5	5.662G	6	5.308G	7	5.379G	8	5.453G
9	5.368G	10	5.629G	11	5.514G	12	5.329G
13	5.538G	14	5.356G	15	5.588G	16	5.391G
17	5.413G	18	5.700G	19	5.381G	20	5.618G
21	5.455G	22	5.558G	23	5.352G	24	5.582G
25	5.283G	26	5.709G	27	5.542G	28	5.394G
29	5.663G	30	5.689G	31	5.288G	32	5.262G
33	5.370G	34	5.371G	35	5.577G	36	5.702G
37	5.299G	38	5.465G	39	5.325G	40	5.503G
41	5.312G	42	5.549G	43	5.451G	44	5.314G
45	5.319G	46	5.274G	47	5.682G	48	5.388G
49	5.546G	50	5.513G	51	5.474G	52	5.713G
53	5.260G	54	5.251G	55	5.722G	56	5.408G
57	5.625G	58	5.392G	59	5.418G	60	5.389G
61	5.492G	62	5.668G	63	5.697G	64	5.482G
65	5.300G	66	5.647G	67	5.599G	68	5.494G
69	5.571G	70	5.348G	71	5.460G	72	5.716G
73	5.551G	74	5.327G	75	5.366G	76	5.509G
77	5.600G	78	5.406G	79	5.622G	80	5.495G
81	5.712G	82	5.404G	83	5.421G	84	5.464G
85	5.393G	86	5.470G	87	5.676G	88	5.617G
89	5.594G	90	5.637G	91	5.425G	92	5.691G
93	5.278G	94	5.410G	95	5.486G	96	5.632G
97	5.653G	98	5.400G	99	5.572G	100	5.426G

Hopping Frequency Sequence Name: HOP_FREQ_SEQ_19							
SEQ#	Frequency (Hz)	SEQ#	Frequency (Hz)	SEQ#	Frequency (Hz)	SEQ#	Frequency (Hz)
1	5.329G	2	5.351G	3	5.639G	4	5.713G
5	5.256G	6	5.715G	7	5.672G	8	5.430G
9	5.291G	10	5.665G	11	5.459G	12	5.427G
13	5.693G	14	5.462G	15	5.571G	16	5.573G
17	5.474G	18	5.262G	19	5.596G	20	5.287G
21	5.327G	22	5.341G	23	5.326G	24	5.701G
25	5.457G	26	5.576G	27	5.681G	28	5.620G
29	5.325G	30	5.671G	31	5.543G	32	5.720G
33	5.521G	34	5.360G	35	5.485G	36	5.509G
37	5.408G	38	5.334G	39	5.555G	40	5.315G
41	5.417G	42	5.694G	43	5.623G	44	5.654G
45	5.253G	46	5.499G	47	5.544G	48	5.293G
49	5.708G	50	5.372G	51	5.366G	52	5.520G
53	5.302G	54	5.711G	55	5.590G	56	5.477G
57	5.349G	58	5.712G	59	5.305G	60	5.281G
61	5.383G	62	5.467G	63	5.397G	64	5.388G
65	5.527G	66	5.540G	67	5.651G	68	5.511G
69	5.386G	70	5.370G	71	5.580G	72	5.517G
73	5.684G	74	5.519G	75	5.435G	76	5.444G
77	5.535G	78	5.298G	79	5.699G	80	5.554G
81	5.514G	82	5.319G	83	5.473G	84	5.348G
85	5.705G	86	5.594G	87	5.323G	88	5.484G
89	5.506G	90	5.714G	91	5.411G	92	5.359G
93	5.421G	94	5.487G	95	5.258G	96	5.312G
97	5.491G	98	5.269G	99	5.320G	100	5.641G

Hopping Frequency Sequence Name: HOP_FREQ_SEQ_20							
SEQ#	Frequency (Hz)	SEQ#	Frequency (Hz)	SEQ#	Frequency (Hz)	SEQ#	Frequency (Hz)
1	5.288G	2	5.291G	3	5.457G	4	5.252G
5	5.596G	6	5.598G	7	5.306G	8	5.434G
9	5.633G	10	5.625G	11	5.374G	12	5.477G
13	5.684G	14	5.272G	15	5.664G	16	5.441G
17	5.399G	18	5.586G	19	5.261G	20	5.656G
21	5.621G	22	5.373G	23	5.280G	24	5.376G
25	5.349G	26	5.530G	27	5.632G	28	5.348G
29	5.333G	30	5.618G	31	5.391G	32	5.283G
33	5.265G	34	5.273G	35	5.594G	36	5.440G
37	5.548G	38	5.651G	39	5.724G	40	5.584G
41	5.676G	42	5.682G	43	5.506G	44	5.294G
45	5.679G	46	5.323G	47	5.649G	48	5.497G
49	5.361G	50	5.337G	51	5.286G	52	5.268G
53	5.524G	54	5.513G	55	5.257G	56	5.300G
57	5.697G	58	5.504G	59	5.492G	60	5.607G
61	5.525G	62	5.377G	63	5.432G	64	5.310G
65	5.320G	66	5.661G	67	5.250G	68	5.493G
69	5.593G	70	5.346G	71	5.456G	72	5.307G
73	5.368G	74	5.281G	75	5.636G	76	5.382G
77	5.540G	78	5.538G	79	5.502G	80	5.573G
81	5.692G	82	5.445G	83	5.590G	84	5.370G
85	5.570G	86	5.439G	87	5.654G	88	5.443G
89	5.352G	90	5.581G	91	5.295G	92	5.681G
93	5.322G	94	5.680G	95	5.327G	96	5.561G
97	5.345G	98	5.550G	99	5.356G	100	5.609G

Hopping Frequency Sequence Name: HOP_FREQ_SEQ_21							
SEQ#	Frequency (Hz)	SEQ#	Frequency (Hz)	SEQ#	Frequency (Hz)	SEQ#	Frequency (Hz)
1	5.269G	2	5.285G	3	5.400G	4	5.637G
5	5.564G	6	5.523G	7	5.255G	8	5.461G
9	5.563G	10	5.552G	11	5.625G	12	5.421G
13	5.531G	14	5.695G	15	5.271G	16	5.590G
17	5.484G	18	5.456G	19	5.352G	20	5.409G
21	5.672G	22	5.459G	23	5.292G	24	5.359G
25	5.486G	26	5.422G	27	5.650G	28	5.407G
29	5.633G	30	5.532G	31	5.720G	32	5.493G
33	5.357G	34	5.439G	35	5.472G	36	5.628G
37	5.442G	38	5.668G	39	5.343G	40	5.638G
41	5.466G	42	5.470G	43	5.585G	44	5.611G
45	5.471G	46	5.524G	47	5.307G	48	5.441G
49	5.398G	50	5.529G	51	5.545G	52	5.325G
53	5.641G	54	5.688G	55	5.657G	56	5.429G
57	5.302G	58	5.719G	59	5.687G	60	5.494G
61	5.328G	62	5.397G	63	5.475G	64	5.626G
65	5.693G	66	5.265G	67	5.608G	68	5.337G
69	5.485G	70	5.703G	71	5.554G	72	5.294G
73	5.505G	74	5.314G	75	5.324G	76	5.405G
77	5.355G	78	5.389G	79	5.649G	80	5.620G
81	5.259G	82	5.566G	83	5.645G	84	5.701G
85	5.510G	86	5.370G	87	5.539G	88	5.423G
89	5.342G	90	5.609G	91	5.384G	92	5.629G
93	5.369G	94	5.613G	95	5.718G	96	5.381G
97	5.424G	98	5.578G	99	5.568G	100	5.427G

Hopping Frequency Sequence Name: HOP_FREQ_SEQ_22							
SEQ#	Frequency (Hz)	SEQ#	Frequency (Hz)	SEQ#	Frequency (Hz)	SEQ#	Frequency (Hz)
1	5.576G	2	5.614G	3	5.255G	4	5.381G
5	5.450G	6	5.715G	7	5.545G	8	5.517G
9	5.647G	10	5.317G	11	5.546G	12	5.375G
13	5.530G	14	5.439G	15	5.344G	16	5.541G
17	5.323G	18	5.513G	19	5.480G	20	5.586G
21	5.300G	22	5.565G	23	5.341G	24	5.472G
25	5.283G	26	5.524G	27	5.307G	28	5.284G
29	5.388G	30	5.583G	31	5.663G	32	5.332G
33	5.484G	34	5.362G	35	5.658G	36	5.295G
37	5.446G	38	5.491G	39	5.441G	40	5.570G
41	5.351G	42	5.533G	43	5.349G	44	5.655G
45	5.563G	46	5.638G	47	5.613G	48	5.646G
49	5.285G	50	5.696G	51	5.417G	52	5.358G
53	5.703G	54	5.669G	55	5.662G	56	5.713G
57	5.335G	58	5.321G	59	5.438G	60	5.355G
61	5.628G	62	5.412G	63	5.700G	64	5.674G
65	5.536G	66	5.334G	67	5.626G	68	5.465G
69	5.310G	70	5.518G	71	5.282G	72	5.551G
73	5.585G	74	5.548G	75	5.680G	76	5.376G
77	5.338G	78	5.440G	79	5.266G	80	5.648G
81	5.516G	82	5.468G	83	5.644G	84	5.414G
85	5.579G	86	5.393G	87	5.643G	88	5.537G
89	5.487G	90	5.592G	91	5.590G	92	5.423G
93	5.430G	94	5.288G	95	5.387G	96	5.636G
97	5.456G	98	5.508G	99	5.359G	100	5.425G

Hopping Frequency Sequence Name: HOP_FREQ_SEQ_23							
SEQ#	Frequency (Hz)	SEQ#	Frequency (Hz)	SEQ#	Frequency (Hz)	SEQ#	Frequency (Hz)
1	5.650G	2	5.457G	3	5.366G	4	5.672G
5	5.654G	6	5.255G	7	5.381G	8	5.432G
9	5.701G	10	5.639G	11	5.310G	12	5.598G
13	5.405G	14	5.576G	15	5.464G	16	5.529G
17	5.659G	18	5.278G	19	5.251G	20	5.525G
21	5.530G	22	5.528G	23	5.567G	24	5.486G
25	5.394G	26	5.690G	27	5.713G	28	5.315G
29	5.533G	30	5.614G	31	5.623G	32	5.395G
33	5.620G	34	5.308G	35	5.379G	36	5.281G
37	5.677G	38	5.304G	39	5.537G	40	5.364G
41	5.352G	42	5.339G	43	5.284G	44	5.456G
45	5.626G	46	5.632G	47	5.287G	48	5.592G
49	5.452G	50	5.470G	51	5.329G	52	5.388G
53	5.356G	54	5.585G	55	5.593G	56	5.283G
57	5.603G	58	5.361G	59	5.408G	60	5.717G
61	5.404G	62	5.298G	63	5.347G	64	5.332G
65	5.412G	66	5.697G	67	5.674G	68	5.263G
69	5.499G	70	5.372G	71	5.676G	72	5.609G
73	5.619G	74	5.468G	75	5.692G	76	5.577G
77	5.578G	78	5.268G	79	5.428G	80	5.552G
81	5.413G	82	5.482G	83	5.579G	84	5.662G
85	5.621G	86	5.572G	87	5.682G	88	5.625G
89	5.644G	90	5.279G	91	5.253G	92	5.652G
93	5.678G	94	5.360G	95	5.627G	96	5.270G
97	5.721G	98	5.261G	99	5.497G	100	5.441G

Hopping Frequency Sequence Name: HOP_FREQ_SEQ_24							
SEQ#	Frequency (Hz)	SEQ#	Frequency (Hz)	SEQ#	Frequency (Hz)	SEQ#	Frequency (Hz)
1	5.564G	2	5.702G	3	5.585G	4	5.465G
5	5.407G	6	5.670G	7	5.522G	8	5.466G
9	5.628G	10	5.659G	11	5.485G	12	5.704G
13	5.640G	14	5.367G	15	5.510G	16	5.722G
17	5.412G	18	5.355G	19	5.430G	20	5.549G
21	5.361G	22	5.329G	23	5.389G	24	5.587G
25	5.621G	26	5.720G	27	5.451G	28	5.320G
29	5.321G	30	5.424G	31	5.508G	32	5.618G
33	5.278G	34	5.556G	35	5.387G	36	5.374G
37	5.562G	38	5.553G	39	5.470G	40	5.276G
41	5.457G	42	5.439G	43	5.711G	44	5.518G
45	5.458G	46	5.513G	47	5.500G	48	5.376G
49	5.402G	50	5.447G	51	5.669G	52	5.524G
53	5.400G	54	5.515G	55	5.625G	56	5.652G
57	5.449G	58	5.301G	59	5.484G	60	5.529G
61	5.541G	62	5.333G	63	5.255G	64	5.354G
65	5.695G	66	5.365G	67	5.701G	68	5.494G
69	5.646G	70	5.454G	71	5.613G	72	5.721G
73	5.595G	74	5.688G	75	5.690G	76	5.487G
77	5.415G	78	5.428G	79	5.548G	80	5.591G
81	5.277G	82	5.496G	83	5.323G	84	5.302G
85	5.719G	86	5.298G	87	5.299G	88	5.614G
89	5.405G	90	5.497G	91	5.563G	92	5.291G
93	5.724G	94	5.483G	95	5.271G	96	5.297G
97	5.559G	98	5.311G	99	5.426G	100	5.360G

Hopping Frequency Sequence Name: HOP_FREQ_SEQ_25							
SEQ#	Frequency (Hz)	SEQ#	Frequency (Hz)	SEQ#	Frequency (Hz)	SEQ#	Frequency (Hz)
1	5.336G	2	5.277G	3	5.619G	4	5.303G
5	5.685G	6	5.545G	7	5.356G	8	5.341G
9	5.471G	10	5.533G	11	5.724G	12	5.716G
13	5.267G	14	5.495G	15	5.253G	16	5.460G
17	5.600G	18	5.279G	19	5.333G	20	5.335G
21	5.566G	22	5.384G	23	5.718G	24	5.616G
25	5.598G	26	5.588G	27	5.722G	28	5.591G
29	5.621G	30	5.475G	31	5.366G	32	5.692G
33	5.681G	34	5.306G	35	5.595G	36	5.594G
37	5.673G	38	5.291G	39	5.400G	40	5.269G
41	5.426G	42	5.491G	43	5.281G	44	5.395G
45	5.515G	46	5.288G	47	5.519G	48	5.334G
49	5.711G	50	5.550G	51	5.464G	52	5.525G
53	5.377G	54	5.265G	55	5.452G	56	5.596G
57	5.297G	58	5.305G	59	5.565G	60	5.579G
61	5.345G	62	5.703G	63	5.719G	64	5.298G
65	5.541G	66	5.456G	67	5.282G	68	5.645G
69	5.421G	70	5.357G	71	5.351G	72	5.431G
73	5.674G	74	5.449G	75	5.576G	76	5.539G
77	5.264G	78	5.257G	79	5.439G	80	5.562G
81	5.493G	82	5.642G	83	5.668G	84	5.477G
85	5.450G	86	5.311G	87	5.544G	88	5.707G
89	5.402G	90	5.567G	91	5.442G	92	5.343G
93	5.720G	94	5.397G	95	5.665G	96	5.582G
97	5.405G	98	5.467G	99	5.444G	100	5.693G

Hopping Frequency Sequence Name: HOP_FREQ_SEQ_26							
SEQ#	Frequency (Hz)	SEQ#	Frequency (Hz)	SEQ#	Frequency (Hz)	SEQ#	Frequency (Hz)
1	5.474G	2	5.271G	3	5.495G	4	5.592G
5	5.560G	6	5.447G	7	5.713G	8	5.561G
9	5.389G	10	5.526G	11	5.400G	12	5.715G
13	5.672G	14	5.388G	15	5.450G	16	5.325G
17	5.706G	18	5.556G	19	5.621G	20	5.522G
21	5.532G	22	5.357G	23	5.587G	24	5.258G
25	5.435G	26	5.329G	27	5.716G	28	5.571G
29	5.344G	30	5.250G	31	5.649G	32	5.639G
33	5.611G	34	5.466G	35	5.612G	36	5.274G
37	5.263G	38	5.539G	39	5.434G	40	5.645G
41	5.615G	42	5.572G	43	5.574G	44	5.549G
45	5.420G	46	5.646G	47	5.501G	48	5.402G
49	5.453G	50	5.320G	51	5.674G	52	5.491G
53	5.683G	54	5.700G	55	5.607G	56	5.441G
57	5.625G	58	5.464G	59	5.699G	60	5.490G
61	5.265G	62	5.719G	63	5.470G	64	5.494G
65	5.302G	66	5.391G	67	5.541G	68	5.641G
69	5.338G	70	5.722G	71	5.475G	72	5.295G
73	5.352G	74	5.692G	75	5.583G	76	5.529G
77	5.665G	78	5.603G	79	5.423G	80	5.465G
81	5.487G	82	5.415G	83	5.381G	84	5.354G
85	5.624G	86	5.502G	87	5.533G	88	5.688G
89	5.375G	90	5.272G	91	5.622G	92	5.437G
93	5.499G	94	5.714G	95	5.578G	96	5.576G
97	5.278G	98	5.513G	99	5.419G	100	5.383G

Hopping Frequency Sequence Name: HOP_FREQ_SEQ_27							
SEQ#	Frequency (Hz)	SEQ#	Frequency (Hz)	SEQ#	Frequency (Hz)	SEQ#	Frequency (Hz)
1	5.668G	2	5.412G	3	5.577G	4	5.421G
5	5.372G	6	5.376G	7	5.363G	8	5.645G
9	5.696G	10	5.596G	11	5.650G	12	5.587G
13	5.306G	14	5.691G	15	5.341G	16	5.256G
17	5.399G	18	5.429G	19	5.392G	20	5.632G
21	5.263G	22	5.466G	23	5.567G	24	5.265G
25	5.522G	26	5.661G	27	5.700G	28	5.511G
29	5.536G	30	5.326G	31	5.709G	32	5.695G
33	5.669G	34	5.523G	35	5.582G	36	5.580G
37	5.550G	38	5.277G	39	5.285G	40	5.557G
41	5.574G	42	5.461G	43	5.425G	44	5.551G
45	5.608G	46	5.261G	47	5.317G	48	5.260G
49	5.439G	50	5.562G	51	5.324G	52	5.414G
53	5.527G	54	5.497G	55	5.686G	56	5.259G
57	5.664G	58	5.590G	59	5.478G	60	5.404G
61	5.589G	62	5.607G	63	5.481G	64	5.689G
65	5.389G	66	5.640G	67	5.720G	68	5.697G
69	5.402G	70	5.452G	71	5.313G	72	5.717G
73	5.257G	74	5.287G	75	5.534G	76	5.553G
77	5.304G	78	5.684G	79	5.374G	80	5.390G
81	5.441G	82	5.506G	83	5.444G	84	5.329G
85	5.250G	86	5.503G	87	5.588G	88	5.442G
89	5.611G	90	5.561G	91	5.406G	92	5.663G
93	5.297G	94	5.619G	95	5.405G	96	5.677G
97	5.501G	98	5.508G	99	5.262G	100	5.474G

Hopping Frequency Sequence Name: HOP_FREQ_SEQ_28							
SEQ#	Frequency (Hz)	SEQ#	Frequency (Hz)	SEQ#	Frequency (Hz)	SEQ#	Frequency (Hz)
1	5.307G	2	5.649G	3	5.482G	4	5.315G
5	5.443G	6	5.285G	7	5.390G	8	5.326G
9	5.654G	10	5.581G	11	5.263G	12	5.687G
13	5.679G	14	5.486G	15	5.279G	16	5.680G
17	5.387G	18	5.608G	19	5.487G	20	5.724G
21	5.683G	22	5.430G	23	5.436G	24	5.320G
25	5.281G	26	5.257G	27	5.539G	28	5.255G
29	5.622G	30	5.359G	31	5.251G	32	5.418G
33	5.456G	34	5.569G	35	5.628G	36	5.643G
37	5.301G	38	5.488G	39	5.338G	40	5.584G
41	5.685G	42	5.503G	43	5.411G	44	5.697G
45	5.574G	46	5.558G	47	5.468G	48	5.355G
49	5.478G	50	5.549G	51	5.283G	52	5.648G
53	5.695G	54	5.371G	55	5.304G	56	5.705G
57	5.722G	58	5.349G	59	5.453G	60	5.591G
61	5.678G	62	5.401G	63	5.284G	64	5.481G
65	5.381G	66	5.644G	67	5.422G	68	5.590G
69	5.547G	70	5.458G	71	5.274G	72	5.446G
73	5.523G	74	5.391G	75	5.719G	76	5.296G
77	5.521G	78	5.286G	79	5.435G	80	5.336G
81	5.619G	82	5.668G	83	5.565G	84	5.343G
85	5.434G	86	5.356G	87	5.374G	88	5.278G
89	5.449G	90	5.660G	91	5.544G	92	5.363G
93	5.604G	94	5.314G	95	5.499G	96	5.531G
97	5.322G	98	5.347G	99	5.675G	100	5.273G

Hopping Frequency Sequence Name: HOP_FREQ_SEQ_29							
SEQ#	Frequency (Hz)	SEQ#	Frequency (Hz)	SEQ#	Frequency (Hz)	SEQ#	Frequency (Hz)
1	5.587G	2	5.271G	3	5.622G	4	5.676G
5	5.627G	6	5.604G	7	5.309G	8	5.666G
9	5.449G	10	5.613G	11	5.340G	12	5.579G
13	5.372G	14	5.263G	15	5.252G	16	5.665G
17	5.568G	18	5.386G	19	5.639G	20	5.480G
21	5.251G	22	5.270G	23	5.614G	24	5.698G
25	5.549G	26	5.451G	27	5.335G	28	5.685G
29	5.464G	30	5.424G	31	5.291G	32	5.400G
33	5.555G	34	5.530G	35	5.510G	36	5.278G
37	5.257G	38	5.595G	39	5.724G	40	5.645G
41	5.675G	42	5.317G	43	5.695G	44	5.722G
45	5.277G	46	5.522G	47	5.686G	48	5.597G
49	5.588G	50	5.517G	51	5.518G	52	5.707G
53	5.431G	54	5.364G	55	5.542G	56	5.513G
57	5.322G	58	5.405G	59	5.402G	60	5.560G
61	5.677G	62	5.492G	63	5.446G	64	5.268G
65	5.717G	66	5.459G	67	5.357G	68	5.655G
69	5.650G	70	5.314G	71	5.688G	72	5.528G
73	5.535G	74	5.715G	75	5.380G	76	5.648G
77	5.556G	78	5.531G	79	5.616G	80	5.586G
81	5.612G	82	5.435G	83	5.656G	84	5.659G
85	5.546G	86	5.407G	87	5.346G	88	5.516G
89	5.623G	90	5.634G	91	5.325G	92	5.420G
93	5.720G	94	5.558G	95	5.478G	96	5.644G
97	5.311G	98	5.607G	99	5.273G	100	5.444G

Hopping Frequency Sequence Name: HOP_FREQ_SEQ_30							
SEQ#	Frequency (Hz)	SEQ#	Frequency (Hz)	SEQ#	Frequency (Hz)	SEQ#	Frequency (Hz)
1	5.490G	2	5.296G	3	5.458G	4	5.553G
5	5.430G	6	5.516G	7	5.414G	8	5.618G
9	5.521G	10	5.544G	11	5.721G	12	5.438G
13	5.311G	14	5.677G	15	5.386G	16	5.382G
17	5.600G	18	5.446G	19	5.549G	20	5.422G
21	5.291G	22	5.581G	23	5.316G	24	5.359G
25	5.637G	26	5.588G	27	5.612G	28	5.288G
29	5.455G	30	5.541G	31	5.385G	32	5.557G
33	5.413G	34	5.701G	35	5.515G	36	5.254G
37	5.459G	38	5.714G	39	5.502G	40	5.528G
41	5.536G	42	5.260G	43	5.614G	44	5.451G
45	5.663G	46	5.532G	47	5.273G	48	5.482G
49	5.689G	50	5.326G	51	5.578G	52	5.537G
53	5.266G	54	5.387G	55	5.299G	56	5.513G
57	5.355G	58	5.297G	59	5.569G	60	5.262G
61	5.699G	62	5.551G	63	5.648G	64	5.679G
65	5.389G	66	5.607G	67	5.450G	68	5.421G
69	5.571G	70	5.629G	71	5.345G	72	5.623G
73	5.380G	74	5.643G	75	5.656G	76	5.500G
77	5.664G	78	5.550G	79	5.554G	80	5.269G
81	5.435G	82	5.442G	83	5.715G	84	5.284G
85	5.277G	86	5.582G	87	5.460G	88	5.412G
89	5.638G	90	5.354G	91	5.265G	92	5.323G
93	5.585G	94	5.539G	95	5.711G	96	5.390G
97	5.697G	98	5.619G	99	5.552G	100	5.650G

IEEE 802.11ac VHT80

Type 1 Radar Statistical Performances

Trial #	Pulses per Burst	Pulse Width (s)	PRI (s)	Radar Frequency (MHz)	Detection
1	89	1.0u	598.0u	5252	Yes
2	81	1.0u	658.0u	5255	Yes
3	86	1.0u	618.0u	5257	Yes
4	78	1.0u	678.0u	5258	Yes
5	76	1.0u	698.0u	5260	Yes
6	72	1.0u	738.0u	5261	Yes
7	70	1.0u	758.0u	5263	Yes
8	68	1.0u	778.0u	5265	Yes
9	65	1.0u	818.0u	5267	Yes
10	63	1.0u	838.0u	5269	Yes
11	62	1.0u	858.0u	5271	Yes
12	61	1.0u	878.0u	5273	Yes
13	59	1.0u	898.0u	5275	Yes
14	58	1.0u	918.0u	5277	Yes
15	57	1.0u	938.0u	5280	Yes
16	68	1.0u	781.0u	5284	Yes
17	60	1.0u	881.0u	5287	Yes
18	59	1.0u	907.0u	5290	Yes
19	59	1.0u	931.0u	5292	Yes
20	63	1.0u	851.0u	5296	Yes
21	71	1.0u	751.0u	5300	Yes
22	67	1.0u	793.0u	5304	Yes
23	64	1.0u	833.0u	5306	Yes
24	60	1.0u	893.0u	5310	Yes
25	86	1.0u	617.0u	5312	Yes
26	76	1.0u	697.0u	5315	Yes
27	68	1.0u	777.0u	5317	Yes
28	67	1.0u	797.0u	5320	Yes
29	64	1.0u	837.0u	5325	Yes
30	58	1.0u	917.0u	5328	Yes

Detection Rate: 100 %

Type 2 Radar Statistical Performances					
Trial #	Pulses per Burst	Pulse Width (s)	PRI (s)	Radar Frequency (MHz)	Detection
1	26	3.3u	225.0u	5252	Yes
2	27	3.6u	171.0u	5255	Yes
3	24	2.9u	155.0u	5257	Yes
4	28	1.1u	174.0u	5258	Yes
5	24	3.8u	179.0u	5260	Yes
6	24	3.7u	217.0u	5261	Yes
7	23	2.9u	153.0u	5263	Yes
8	26	4.8u	169.0u	5265	No
9	25	1.2u	152.0u	5267	Yes
10	28	2.6u	228.0u	5269	Yes
11	26	1.6u	151.0u	5271	Yes
12	24	2.0u	152.0u	5273	Yes
13	26	1.7u	176.0u	5275	Yes
14	29	4.4u	229.0u	5277	Yes
15	25	3.2u	169.0u	5280	Yes
16	24	4.5u	226.0u	5284	Yes
17	27	3.1u	156.0u	5287	Yes
18	23	1.5u	176.0u	5290	Yes
19	28	3.5u	225.0u	5292	Yes
20	28	1.8u	182.0u	5296	Yes
21	27	1.2u	180.0u	5300	Yes
22	28	3.5u	213.0u	5304	Yes
23	24	2.5u	175.0u	5306	Yes
24	27	3.1u	164.0u	5310	Yes
25	26	1.8u	151.0u	5312	Yes
26	26	1.7u	217.0u	5315	Yes
27	25	3.1u	183.0u	5317	Yes
28	23	1.3u	185.0u	5320	Yes
29	26	1.4u	219.0u	5325	Yes
30	24	3.5u	183.0u	5328	Yes

Detection Rate: 96.6 %

Type 3 Radar Statistical Performances					
Trial #	Pulses per Burst	Pulse Width (s)	PRI (s)	Radar Frequency (MHz)	Detection
1	16	8.8u	280.0u	5252	Yes
2	16	8.8u	462.0u	5255	Yes
3	18	6.0u	378.0u	5257	No
4	16	8.8u	413.0u	5258	Yes
5	17	8.7u	385.0u	5260	Yes
6	17	8.5u	447.0u	5261	Yes
7	16	7.5u	284.0u	5263	No
8	16	9.9u	276.0u	5265	Yes
9	17	9.9u	461.0u	5267	Yes
10	16	8.4u	446.0u	5269	Yes
11	16	8.9u	314.0u	5271	No
12	18	6.3u	387.0u	5273	Yes
13	17	8.5u	273.0u	5275	Yes
14	18	8.6u	322.0u	5277	Yes
15	17	7.0u	286.0u	5280	Yes
16	18	9.2u	305.0u	5284	No
17	17	9.2u	316.0u	5287	Yes
18	16	7.4u	214.0u	5290	Yes
19	18	9.3u	255.0u	5292	Yes
20	17	9.6u	240.0u	5296	Yes
21	17	6.0u	205.0u	5300	Yes
22	16	6.9u	202.0u	5304	Yes
23	17	7.9u	405.0u	5306	Yes
24	17	9.1u	397.0u	5310	Yes
25	16	8.2u	485.0u	5312	Yes
26	16	9.9u	428.0u	5315	Yes
27	17	7.2u	247.0u	5317	Yes
28	17	8.7u	457.0u	5320	Yes
29	17	8.1u	327.0u	5325	No
30	17	7.0u	429.0u	5328	Yes

Detection Rate: 83.3 %

Type 4 Radar Statistical Performances					
Trial #	Pulses per Burst	Pulse Width (s)	PRI (s)	Radar Frequency (MHz)	Detection
1	14	16.1u	359.0u	5252	Yes
2	12	19.9u	419.0u	5255	Yes
3	15	19.1u	300.0u	5257	Yes
4	12	16.5u	497.0u	5258	Yes
5	16	11.5u	347.0u	5260	Yes
6	15	13.0u	396.0u	5261	Yes
7	16	12.4u	326.0u	5263	Yes
8	14	17.7u	309.0u	5265	Yes
9	14	17.9u	416.0u	5267	Yes
10	14	14.4u	441.0u	5269	No
11	14	11.4u	305.0u	5271	Yes
12	15	17.7u	333.0u	5273	Yes
13	13	17.2u	203.0u	5275	Yes
14	16	16.1u	371.0u	5277	Yes
15	15	19.9u	204.0u	5280	Yes
16	12	12.8u	444.0u	5284	Yes
17	15	15.6u	415.0u	5287	Yes
18	14	19.7u	321.0u	5290	No
19	14	19.9u	499.0u	5292	No
20	13	13.1u	438.0u	5296	Yes
21	15	16.6u	432.0u	5300	Yes
22	13	18.1u	351.0u	5304	Yes
23	16	18.6u	382.0u	5306	No
24	15	19.2u	484.0u	5310	Yes
25	16	15.7u	496.0u	5312	Yes
26	15	13.7u	368.0u	5315	Yes
27	13	17.7u	311.0u	5317	Yes
28	13	13.8u	368.0u	5320	Yes
29	13	19.1u	404.0u	5325	No
30	13	15.2u	226.0u	5328	Yes

Detection Rate: 83.3 %

Type 5 Radar Statistical Performances

Trial #	Test Signal Name	Detection
1	LP_Signal_01	Yes
2	LP_Signal_02	Yes
3	LP_Signal_03	Yes
4	LP_Signal_04	Yes
5	LP_Signal_05	Yes
6	LP_Signal_06	Yes
7	LP_Signal_07	Yes
8	LP_Signal_08	Yes
9	LP_Signal_09	Yes
10	LP_Signal_10	Yes
11	LP_Signal_11	Yes
12	LP_Signal_12	Yes
13	LP_Signal_13	Yes
14	LP_Signal_14	Yes
15	LP_Signal_15	Yes
16	LP_Signal_16	Yes
17	LP_Signal_17	Yes
18	LP_Signal_18	Yes
19	LP_Signal_19	Yes
20	LP_Signal_20	Yes
21	LP_Signal_21	Yes
22	LP_Signal_22	Yes
23	LP_Signal_23	Yes
24	LP_Signal_24	Yes
25	LP_Signal_25	Yes
26	LP_Signal_26	Yes
27	LP_Signal_27	Yes
28	LP_Signal_28	Yes
29	LP_Signal_29	Yes
30	LP_Signal_30	Yes

Detection Rate: 100.0 %

Long Pulse Radar Test Signal

Test Signal Name: LP_Signal_01

Number of Bursts in Trial: 12

Chrip Center Frequency: 5254MHz

Burst	Pulses per Burst	Chrip (Hz)	Pulse Width (s)	Pulse 1 to 2 Spacing (s)	Pulse 2 to 3 Spacing (s)	Start Location (s)
1	1	5M	96.5u	-	-	857.4m
2	2	5M	53.0u	1.173m	-	643.5m
3	1	5M	84.3u	-	-	871.6m
4	3	5M	99.1u	1.140m	1.778m	521.9m
5	3	5M	67.5u	1.487m	1.636m	314.7m
6	2	5M	60.2u	1.210m	-	877.7m
7	1	5M	98.6u	-	-	340.6m
8	3	5M	90.3u	1.747m	1.331m	243.1m
9	2	5M	52.8u	1.060m	-	767.7m
10	2	5M	76.4u	1.115m	-	481.2m
11	3	5M	98.3u	1.759m	1.414m	449.9m
12	1	5M	66.6u	-	-	887.3m

Long Pulse Radar Test Signal						
Test Signal Name: LP_Signal_02						
Number of Bursts in Trial: 18						
Chrip Center Frequency: 5254MHz						
Burst	Pulses per Burst	Chrip (Hz)	Pulse Width (s)	Pulse 1 to 2 Spacing (s)	Pulse 2 to 3 Spacing (s)	Start Location (s)
1	1	5M	53.6u	-	-	504.6m
2	3	5M	97.1u	1.798m	1.565m	441.5m
3	3	5M	53.5u	1.548m	1.068m	291.7m
4	2	5M	52.2u	1.395m	-	212.8m
5	2	5M	95.3u	1.226m	-	96.33m
6	2	5M	92.6u	1.470m	-	303.7m
7	1	5M	82.6u	-	-	516.6m
8	1	5M	53.5u	-	-	141.6m
9	2	5M	57.4u	999.6u	-	95.05m
10	2	5M	96.4u	1.888m	-	567.5m
11	2	5M	66.0u	1.443m	-	271.3m
12	1	5M	98.5u	-	-	442.6m
13	2	5M	68.3u	1.114m	-	512.5m
14	2	5M	85.3u	1.613m	-	105.4m
15	3	5M	99.4u	1.752m	1.843m	647.8m
16	2	5M	97.8u	1.644m	-	259.0m
17	1	5M	77.1u	-	-	649.5m
18	1	5M	58.2u	-	-	539.5m

Long Pulse Radar Test Signal						
Test Signal Name: LP_Signal_03						
Number of Bursts in Trial: 14						
Chrip Center Frequency: 5254MHz						
Burst	Pulses per Burst	Chrip (Hz)	Pulse Width (s)	Pulse 1 to 2 Spacing (s)	Pulse 2 to 3 Spacing (s)	Start Location (s)
1	3	7M	62.7u	1.678m	1.717m	280.1m
2	2	7M	77.5u	1.567m	-	308.4m
3	1	7M	98.3u	-	-	380.5m
4	2	7M	85.2u	1.831m	-	205.0m
5	3	7M	91.8u	1.520m	947.2u	688.8m
6	1	7M	91.4u	-	-	69.25m
7	2	7M	76.1u	1.384m	-	699.5m
8	2	7M	68.2u	1.336m	-	142.5m
9	1	7M	87.0u	-	-	439.3m
10	2	7M	85.3u	1.230m	-	171.5m
11	2	7M	75.6u	1.213m	-	309.9m
12	3	7M	82.8u	1.743m	1.125m	450.3m
13	2	7M	74.3u	1.667m	-	190.8m
14	1	7M	77.4u	-	-	385.5m

Long Pulse Radar Test Signal						
Test Signal Name: LP_Signal_04						
Number of Bursts in Trial: 19						
Chrip Center Frequency: 5254MHz						
Burst	Pulses per Burst	Chrip (Hz)	Pulse Width (s)	Pulse 1 to 2 Spacing (s)	Pulse 2 to 3 Spacing (s)	Start Location (s)
1	1	7M	88.9u	-	-	400.9m
2	2	7M	87.7u	1.749m	-	609.2m
3	2	7M	50.6u	1.085m	-	105.0m
4	3	7M	91.1u	1.614m	1.318m	577.2m
5	2	7M	74.9u	973.1u	-	357.6m
6	3	7M	73.2u	1.725m	1.906m	367.0m
7	3	7M	80.3u	945.7u	1.860m	150.4m
8	2	7M	95.3u	1.286m	-	625.2m
9	2	7M	84.7u	1.685m	-	954.0u
10	2	7M	59.4u	1.472m	-	547.2m
11	2	7M	86.9u	1.657m	-	488.3m
12	2	7M	58.6u	1.575m	-	148.0m
13	1	7M	97.1u	-	-	448.7m
14	1	7M	75.6u	-	-	601.2m
15	3	7M	66.8u	1.457m	1.366m	239.7m
16	2	7M	79.2u	1.394m	-	127.7m
17	2	7M	50.1u	1.763m	-	55.41m
18	1	7M	73.1u	-	-	132.9m
19	1	7M	51.8u	-	-	601.6m

Long Pulse Radar Test Signal						
Test Signal Name: LP_Signal_05						
Number of Bursts in Trial: 19						
Chrip Center Frequency: 5257MHz						
Burst	Pulses per Burst	Chrip (Hz)	Pulse Width (s)	Pulse 1 to 2 Spacing (s)	Pulse 2 to 3 Spacing (s)	Start Location (s)
1	2	13M	98.5u	1.185m	-	281.2m
2	2	13M	66.9u	1.351m	-	601.3m
3	3	13M	55.6u	1.069m	1.564m	386.6m
4	1	13M	63.9u	-	-	70.85m
5	2	13M	88.1u	1.499m	-	486.4m
6	2	13M	77.3u	1.188m	-	445.4m
7	2	13M	51.2u	1.501m	-	39.21m
8	2	13M	84.1u	1.309m	-	348.6m
9	3	13M	62.5u	1.360m	1.020m	537.1m
10	2	13M	96.3u	1.862m	-	172.3m
11	1	13M	51.7u	-	-	207.5m
12	2	13M	91.0u	1.645m	-	337.1m
13	2	13M	56.6u	1.739m	-	566.0m
14	3	13M	66.1u	1.150m	1.775m	563.4m
15	2	13M	84.0u	1.515m	-	378.1m
16	1	13M	76.1u	-	-	565.0m
17	2	13M	79.4u	1.295m	-	628.4m
18	2	13M	75.4u	1.198m	-	128.5m
19	2	13M	61.5u	949.5u	-	582.9m

Long Pulse Radar Test Signal						
Test Signal Name: LP_Signal_06						
Number of Bursts in Trial: 12						
Chirp Center Frequency: 5257MHz						
Burst	Pulses per Burst	Chirp (Hz)	Pulse Width (s)	Pulse 1 to 2 Spacing (s)	Pulse 2 to 3 Spacing (s)	Start Location (s)
1	1	13M	98.7u	-	-	633.0m
2	1	13M	57.3u	-	-	438.3m
3	3	13M	68.6u	1.493m	1.610m	875.1m
4	2	13M	97.5u	1.612m	-	685.6m
5	1	13M	55.5u	-	-	747.3m
6	2	13M	62.8u	967.2u	-	788.4m
7	2	13M	80.7u	1.417m	-	652.7m
8	1	13M	65.9u	-	-	782.6m
9	3	13M	79.9u	1.732m	1.557m	410.0m
10	2	13M	76.4u	1.761m	-	78.51m
11	1	13M	58.1u	-	-	580.4m
12	2	13M	78.0u	961.0u	-	162.0m

Long Pulse Radar Test Signal						
Test Signal Name: LP_Signal_07						
Number of Bursts in Trial: 11						
Chirp Center Frequency: 5258MHz						
Burst	Pulses per Burst	Chirp (Hz)	Pulse Width (s)	Pulse 1 to 2 Spacing (s)	Pulse 2 to 3 Spacing (s)	Start Location (s)
1	2	16M	60.9u	1.685m	-	1.030
2	2	16M	86.8u	1.363m	-	1.069
3	2	16M	95.4u	1.521m	-	296.1m
4	3	16M	73.5u	1.628m	1.226m	377.5m
5	2	16M	67.5u	1.036m	-	644.9m
6	3	16M	65.5u	1.798m	1.561m	766.1m
7	3	16M	95.9u	1.094m	1.242m	537.2m
8	2	16M	96.2u	1.578m	-	172.3m
9	2	16M	90.4u	1.274m	-	256.1m
10	2	16M	90.1u	1.319m	-	842.4m
11	2	16M	59.3u	1.600m	-	728.8m

Long Pulse Radar Test Signal						
Test Signal Name: LP_Signal_08						
Number of Bursts in Trial: 16						
Chrip Center Frequency: 5258MHz						
Burst	Pulses per Burst	Chrip (Hz)	Pulse Width (s)	Pulse 1 to 2 Spacing (s)	Pulse 2 to 3 Spacing (s)	Start Location (s)
1	1	16M	53.9u	-	-	653.0m
2	3	16M	87.4u	1.140m	1.207m	109.0m
3	2	16M	56.0u	1.104m	-	462.3m
4	2	16M	62.5u	1.625m	-	704.3m
5	2	16M	66.7u	1.202m	-	296.4m
6	2	16M	65.6u	1.571m	-	169.5m
7	2	16M	65.2u	1.889m	-	703.7m
8	1	16M	67.4u	-	-	78.58m
9	3	16M	70.1u	1.820m	1.460m	419.9m
10	2	16M	62.3u	1.636m	-	7.821m
11	3	16M	79.8u	1.442m	1.551m	384.2m
12	1	16M	81.4u	-	-	378.9m
13	2	16M	75.0u	1.336m	-	742.0m
14	2	16M	74.3u	1.487m	-	726.4m
15	3	16M	88.8u	1.772m	1.153m	168.4m
16	3	16M	67.7u	1.248m	1.211m	647.3m

Long Pulse Radar Test Signal						
Test Signal Name: LP_Signal_09						
Number of Bursts in Trial: 16						
Chrip Center Frequency: 5260MHz						
Burst	Pulses per Burst	Chrip (Hz)	Pulse Width (s)	Pulse 1 to 2 Spacing (s)	Pulse 2 to 3 Spacing (s)	Start Location (s)
1	2	20M	80.2u	1.739m	-	720.6m
2	3	20M	50.1u	1.816m	1.933m	558.9m
3	1	20M	96.2u	-	-	211.8m
4	3	20M	72.6u	1.275m	1.410m	628.1m
5	2	20M	92.6u	1.262m	-	295.1m
6	2	20M	70.1u	1.814m	-	404.0m
7	2	20M	96.2u	1.463m	-	89.45m
8	2	20M	78.6u	1.436m	-	275.4m
9	2	20M	85.9u	1.077m	-	726.5m
10	3	20M	86.3u	1.689m	1.395m	279.8m
11	1	20M	88.0u	-	-	142.6m
12	3	20M	58.3u	1.051m	995.7u	248.6m
13	2	20M	95.3u	1.642m	-	392.4m
14	3	20M	93.1u	1.100m	1.481m	639.1m
15	1	20M	96.7u	-	-	614.9m
16	2	20M	67.1u	1.370m	-	471.2m

Long Pulse Radar Test Signal						
Test Signal Name: LP_Signal_10						
Number of Bursts in Trial: 18						
Chrip Center Frequency: 5260MHz						
Burst	Pulses per Burst	Chrip (Hz)	Pulse Width (s)	Pulse 1 to 2 Spacing (s)	Pulse 2 to 3 Spacing (s)	Start Location (s)
1	2	20M	98.6u	1.198m	-	344.9m
2	2	20M	57.6u	961.4u	-	641.7m
3	1	20M	56.4u	-	-	308.8m
4	1	20M	81.4u	-	-	180.2m
5	1	20M	61.8u	-	-	297.7m
6	2	20M	90.4u	1.563m	-	282.9m
7	3	20M	68.8u	1.515m	1.370m	37.46m
8	1	20M	73.9u	-	-	475.8m
9	2	20M	68.4u	1.684m	-	117.5m
10	3	20M	95.4u	1.490m	1.735m	155.9m
11	1	20M	70.9u	-	-	253.8m
12	1	20M	94.7u	-	-	356.0m
13	3	20M	76.9u	1.750m	1.203m	56.37m
14	3	20M	80.6u	1.024m	1.881m	588.3m
15	2	20M	87.2u	1.015m	-	223.6m
16	2	20M	85.9u	1.898m	-	380.5m
17	1	20M	62.9u	-	-	127.1m
18	2	20M	96.3u	1.532m	-	541.3m

Long Pulse Radar Test Signal						
Test Signal Name: LP_Signal_11						
Number of Bursts in Trial: 13						
Chrip Center Frequency: 5290MHz						
Burst	Pulses per Burst	Chrip (Hz)	Pulse Width (s)	Pulse 1 to 2 Spacing (s)	Pulse 2 to 3 Spacing (s)	Start Location (s)
1	2	5M	64.2u	1.510m	-	171.7m
2	2	5M	85.7u	1.457m	-	23.95m
3	3	5M	93.8u	1.348m	1.769m	685.0m
4	3	5M	85.1u	1.065m	1.624m	112.8m
5	1	5M	84.7u	-	-	797.2m
6	2	5M	80.4u	1.702m	-	14.43m
7	1	5M	98.4u	-	-	314.4m
8	2	5M	71.1u	1.369m	-	529.1m
9	1	5M	98.6u	-	-	667.9m
10	2	5M	91.7u	1.176m	-	571.6m
11	2	5M	69.1u	1.770m	-	615.7m
12	2	5M	90.9u	1.511m	-	676.8m
13	2	5M	89.6u	1.199m	-	683.8m

Long Pulse Radar Test Signal						
Test Signal Name: LP_Signal_12						
Number of Bursts in Trial: 12						
Chrip Center Frequency: 5290MHz						
Burst	Pulses per Burst	Chrip (Hz)	Pulse Width (s)	Pulse 1 to 2 Spacing (s)	Pulse 2 to 3 Spacing (s)	Start Location (s)
1	1	5M	96.5u	-	-	857.4m
2	2	5M	53.0u	1.173m	-	643.5m
3	1	5M	84.3u	-	-	871.6m
4	3	5M	99.1u	1.140m	1.778m	521.9m
5	3	5M	67.5u	1.487m	1.636m	314.7m
6	2	5M	60.2u	1.210m	-	877.7m
7	1	5M	98.6u	-	-	340.6m
8	3	5M	90.3u	1.747m	1.331m	243.1m
9	2	5M	52.8u	1.060m	-	767.7m
10	2	5M	76.4u	1.115m	-	481.2m
11	3	5M	98.3u	1.759m	1.414m	449.9m
12	1	5M	66.6u	-	-	887.3m

Long Pulse Radar Test Signal						
Test Signal Name: LP_Signal_13						
Number of Bursts in Trial: 12						
Chrip Center Frequency: 5290MHz						
Burst	Pulses per Burst	Chrip (Hz)	Pulse Width (s)	Pulse 1 to 2 Spacing (s)	Pulse 2 to 3 Spacing (s)	Start Location (s)
1	2	9M	83.6u	1.774m	-	467.4m
2	2	9M	97.1u	1.796m	-	328.2m
3	1	9M	84.9u	-	-	712.5m
4	1	9M	85.6u	-	-	456.6m
5	2	9M	97.8u	917.2u	-	642.0m
6	2	9M	95.4u	1.079m	-	800.8m
7	1	9M	71.2u	-	-	898.6m
8	3	9M	82.0u	1.666m	1.468m	784.5m
9	3	9M	86.6u	1.322m	1.519m	535.5m
10	1	9M	71.4u	-	-	43.23m
11	2	9M	62.2u	1.268m	-	268.5m
12	2	9M	96.1u	1.888m	-	253.4m

Long Pulse Radar Test Signal						
Test Signal Name: LP_Signal_14						
Number of Bursts in Trial: 18						
Chrip Center Frequency: 5290MHz						
Burst	Pulses per Burst	Chrip (Hz)	Pulse Width (s)	Pulse 1 to 2 Spacing (s)	Pulse 2 to 3 Spacing (s)	Start Location (s)
1	1	9M	92.6u	-	-	574.7m
2	3	9M	67.9u	1.272m	1.316m	302.6m
3	1	9M	85.3u	-	-	195.7m
4	2	9M	87.8u	1.863m	-	517.8m
5	2	9M	73.7u	1.364m	-	350.7m
6	1	9M	55.8u	-	-	569.5m
7	3	9M	99.1u	936.9u	1.756m	652.9m
8	2	9M	94.5u	1.889m	-	175.3m
9	2	9M	69.1u	1.741m	-	186.8m
10	2	9M	60.2u	1.826m	-	144.5m
11	2	9M	90.0u	1.419m	-	500.0m
12	2	9M	98.3u	1.336m	-	157.3m
13	2	9M	94.4u	1.660m	-	479.9m
14	3	9M	91.0u	1.788m	1.474m	137.2m
15	1	9M	74.3u	-	-	351.9m
16	2	9M	55.0u	1.665m	-	89.03m
17	3	9M	85.5u	981.5u	1.182m	444.9m
18	2	9M	86.1u	1.623m	-	259.0m

Long Pulse Radar Test Signal						
Test Signal Name: LP_Signal_15						
Number of Bursts in Trial: 8						
Chrip Center Frequency: 5290MHz						
Burst	Pulses per Burst	Chrip (Hz)	Pulse Width (s)	Pulse 1 to 2 Spacing (s)	Pulse 2 to 3 Spacing (s)	Start Location (s)
1	2	14M	100.0u	1.316m	-	574.2m
2	2	14M	67.5u	1.529m	-	280.0m
3	3	14M	52.4u	1.833m	955.6u	312.3m
4	3	14M	74.3u	1.451m	1.391m	1.205
5	2	14M	82.0u	1.489m	-	1.470
6	2	14M	65.4u	1.871m	-	1.159
7	2	14M	56.9u	1.758m	-	300.0m
8	1	14M	67.1u	-	-	431.5m

Long Pulse Radar Test Signal						
Test Signal Name: LP_Signal_16						
Number of Bursts in Trial: 9						
Chrip Center Frequency: 5290MHz						
Burst	Pulses per Burst	Chrip (Hz)	Pulse Width (s)	Pulse 1 to 2 Spacing (s)	Pulse 2 to 3 Spacing (s)	Start Location (s)
1	2	14M	89.0u	1.663m	-	435.6m
2	1	14M	50.5u	-	-	582.4m
3	2	14M	58.5u	1.078m	-	681.0m
4	3	14M	59.6u	1.582m	1.397m	730.4m
5	2	14M	92.9u	1.695m	-	227.2m
6	2	14M	69.6u	1.367m	-	963.5m
7	2	14M	65.4u	1.684m	-	1.200
8	2	14M	95.7u	1.419m	-	601.2m
9	2	14M	88.7u	1.095m	-	712.2m

Long Pulse Radar Test Signal						
Test Signal Name: LP_Signal_17						
Number of Bursts in Trial: 16						
Chrip Center Frequency: 5290MHz						
Burst	Pulses per Burst	Chrip (Hz)	Pulse Width (s)	Pulse 1 to 2 Spacing (s)	Pulse 2 to 3 Spacing (s)	Start Location (s)
1	1	16M	95.3u	-	-	108.6m
2	2	16M	53.1u	1.606m	-	65.83m
3	3	16M	96.8u	1.488m	1.352m	2.636m
4	2	16M	67.5u	1.301m	-	327.5m
5	3	16M	55.6u	1.122m	1.431m	138.8m
6	1	16M	50.8u	-	-	12.03m
7	2	16M	53.4u	1.503m	-	456.4m
8	3	16M	54.8u	1.412m	1.710m	520.5m
9	3	16M	53.7u	1.685m	1.762m	465.8m
10	2	16M	60.3u	1.837m	-	679.9m
11	2	16M	91.2u	1.027m	-	500.3m
12	2	16M	95.7u	1.804m	-	154.5m
13	2	16M	70.0u	1.808m	-	89.20m
14	2	16M	72.9u	1.045m	-	617.0m
15	2	16M	94.5u	1.540m	-	399.1m
16	3	16M	67.8u	1.932m	1.398m	689.5m

Long Pulse Radar Test Signal						
Test Signal Name: LP_Signal_18						
Number of Bursts in Trial: 12						
Chrip Center Frequency: 5290MHz						
Burst	Pulses per Burst	Chrip (Hz)	Pulse Width (s)	Pulse 1 to 2 Spacing (s)	Pulse 2 to 3 Spacing (s)	Start Location (s)
1	3	16M	81.9u	1.713m	1.130m	406.8m
2	3	16M	94.1u	1.182m	1.311m	673.2m
3	3	16M	88.8u	1.272m	1.897m	962.9m
4	2	16M	85.5u	1.256m	-	689.2m
5	3	16M	91.6u	1.325m	1.053m	396.5m
6	3	16M	58.7u	1.613m	1.768m	692.7m
7	2	16M	89.9u	1.182m	-	988.1m
8	3	16M	74.7u	1.139m	1.384m	783.9m
9	2	16M	74.8u	1.849m	-	722.0m
10	2	16M	55.6u	967.4u	-	325.4m
11	2	16M	74.6u	1.876m	-	549.7m
12	3	16M	97.6u	1.660m	1.245m	109.6m

Long Pulse Radar Test Signal						
Test Signal Name: LP_Signal_19						
Number of Bursts in Trial: 10						
Chrip Center Frequency: 5290MHz						
Burst	Pulses per Burst	Chrip (Hz)	Pulse Width (s)	Pulse 1 to 2 Spacing (s)	Pulse 2 to 3 Spacing (s)	Start Location (s)
1	2	20M	78.6u	1.551m	-	833.2m
2	2	20M	51.6u	990.4u	-	825.2m
3	2	20M	86.8u	1.097m	-	809.6m
4	1	20M	60.5u	-	-	792.9m
5	2	20M	54.9u	1.783m	-	491.4m
6	2	20M	75.7u	1.245m	-	717.7m
7	2	20M	55.0u	1.513m	-	1.155
8	2	20M	79.2u	955.8u	-	118.6m
9	1	20M	56.4u	-	-	881.1m

10	1	20M	97.7u	-	-	978.0m
----	---	-----	-------	---	---	--------

Long Pulse Radar Test Signal						
Test Signal Name: LP_Signal_20						
Number of Bursts in Trial: 16						
Chrip Center Frequency: 5290MHz						
Burst	Pulses per Burst	Chrip (Hz)	Pulse Width (s)	Pulse 1 to 2 Spacing (s)	Pulse 2 to 3 Spacing (s)	Start Location (s)
1	2	20M	98.1u	1.220m	-	507.2m
2	2	20M	73.5u	1.910m	-	227.2m
3	2	20M	98.2u	1.506m	-	631.2m
4	3	20M	97.9u	1.595m	1.851m	164.0m
5	1	20M	92.9u	-	-	45.06m
6	2	20M	76.6u	1.260m	-	601.8m
7	2	20M	68.1u	1.217m	-	342.9m
8	1	20M	53.3u	-	-	86.38m
9	2	20M	58.0u	978.0u	-	75.50m
10	1	20M	66.6u	-	-	328.5m
11	3	20M	69.0u	1.388m	1.330m	707.6m
12	2	20M	68.3u	1.450m	-	328.0m
13	3	20M	99.1u	1.752m	1.303m	426.0m
14	1	20M	94.8u	-	-	632.9m
15	1	20M	99.7u	-	-	169.8m
16	1	20M	51.5u	-	-	455.1m

Long Pulse Radar Test Signal						
Test Signal Name: LP_Signal_21						
Number of Bursts in Trial: 13						
Chrip Center Frequency: 5326MHz						
Burst	Pulses per Burst	Chrip (Hz)	Pulse Width (s)	Pulse 1 to 2 Spacing (s)	Pulse 2 to 3 Spacing (s)	Start Location (s)
1	2	5M	64.2u	1.510m	-	171.7m
2	2	5M	85.7u	1.457m	-	23.95m
3	3	5M	93.8u	1.348m	1.769m	685.0m
4	3	5M	85.1u	1.065m	1.624m	112.8m
5	1	5M	84.7u	-	-	797.2m
6	2	5M	80.4u	1.702m	-	14.43m
7	1	5M	98.4u	-	-	314.4m
8	2	5M	71.1u	1.369m	-	529.1m
9	1	5M	98.6u	-	-	667.9m
10	2	5M	91.7u	1.176m	-	571.6m
11	2	5M	69.1u	1.770m	-	615.7m
12	2	5M	90.9u	1.511m	-	676.8m
13	2	5M	89.6u	1.199m	-	683.8m

Long Pulse Radar Test Signal						
Test Signal Name: LP_Signal_22						
Number of Bursts in Trial: 16						
Chrip Center Frequency: 5326MHz						
Burst	Pulses per Burst	Chrip (Hz)	Pulse Width (s)	Pulse 1 to 2 Spacing (s)	Pulse 2 to 3 Spacing (s)	Start Location (s)
1	1	5M	59.2u	-	-	243.0m
2	2	5M	94.5u	1.834m	-	299.3m
3	2	5M	95.4u	1.641m	-	566.0m
4	3	5M	59.5u	1.313m	1.332m	354.8m
5	2	5M	62.1u	1.158m	-	618.4m
6	3	5M	73.9u	1.671m	1.534m	629.7m
7	2	5M	50.4u	1.155m	-	384.7m
8	3	5M	62.7u	1.675m	1.571m	94.54m
9	1	5M	52.4u	-	-	45.93m
10	3	5M	55.9u	1.743m	1.537m	37.45m
11	2	5M	62.1u	1.725m	-	173.9m
12	3	5M	65.1u	1.567m	1.369m	549.6m
13	3	5M	80.3u	1.548m	1.117m	530.8m
14	2	5M	85.5u	1.063m	-	265.8m
15	3	5M	54.7u	1.134m	1.657m	49.43m
16	2	5M	85.8u	1.450m	-	382.0m

Long Pulse Radar Test Signal						
Test Signal Name: LP_Signal_23						
Number of Bursts in Trial: 12						
Chrip Center Frequency: 5324MHz						
Burst	Pulses per Burst	Chrip (Hz)	Pulse Width (s)	Pulse 1 to 2 Spacing (s)	Pulse 2 to 3 Spacing (s)	Start Location (s)
1	2	10M	95.2u	1.690m	-	993.9m
2	2	10M	82.3u	1.520m	-	555.8m
3	3	10M	95.0u	1.392m	1.015m	566.4m
4	1	10M	52.8u	-	-	362.2m
5	1	10M	53.1u	-	-	102.8m
6	2	10M	96.4u	1.454m	-	714.3m
7	2	10M	56.0u	1.235m	-	252.4m
8	2	10M	64.8u	1.410m	-	466.8m
9	2	10M	51.9u	1.473m	-	878.3m
10	1	10M	81.5u	-	-	856.4m
11	2	10M	97.8u	1.480m	-	699.6m
12	3	10M	61.7u	1.069m	1.910m	663.4m

Long Pulse Radar Test Signal						
Test Signal Name: LP_Signal_24						
Number of Bursts in Trial: 9						
Chrip Center Frequency: 5324MHz						
Burst	Pulses per Burst	Chrip (Hz)	Pulse Width (s)	Pulse 1 to 2 Spacing (s)	Pulse 2 to 3 Spacing (s)	Start Location (s)
1	3	10M	80.2u	1.716m	1.208m	458.3m
2	2	10M	99.0u	1.877m	-	80.24m
3	1	10M	70.5u	-	-	705.0m
4	1	10M	88.3u	-	-	69.65m
5	2	10M	56.4u	1.516m	-	922.0m
6	1	10M	100.0u	-	-	179.3m
7	2	10M	58.2u	994.8u	-	1.187
8	1	10M	98.0u	-	-	223.9m
9	1	10M	92.7u	-	-	927.1m

Long Pulse Radar Test Signal
 Test Signal Name: LP_Signal_25
 Number of Bursts in Trial: 9
 Chrip Center Frequency: 5323MHz

Burst	Pulses per Burst	Chrip (Hz)	Pulse Width (s)	Pulse 1 to 2 Spacing (s)	Pulse 2 to 3 Spacing (s)	Start Location (s)
1	2	13M	81.8u	959.2u	-	874.4m
2	1	13M	80.9u	-	-	1.030
3	3	13M	56.3u	999.7u	1.916m	930.7m
4	2	13M	63.6u	1.070m	-	903.9m
5	2	13M	65.0u	1.382m	-	89.36m
6	3	13M	83.5u	1.311m	979.5u	725.0m
7	3	13M	83.8u	918.2u	1.113m	1.114
8	2	13M	51.9u	1.314m	-	1.096
9	2	13M	72.3u	1.174m	-	658.1m

Long Pulse Radar Test Signal
 Test Signal Name: LP_Signal_26
 Number of Bursts in Trial: 12
 Chrip Center Frequency: 5323MHz

Burst	Pulses per Burst	Chrip (Hz)	Pulse Width (s)	Pulse 1 to 2 Spacing (s)	Pulse 2 to 3 Spacing (s)	Start Location (s)
1	1	13M	98.7u	-	-	633.0m
2	1	13M	57.3u	-	-	438.3m
3	3	13M	68.6u	1.493m	1.610m	875.1m
4	2	13M	97.5u	1.612m	-	685.6m
5	1	13M	55.5u	-	-	747.3m
6	2	13M	62.8u	967.2u	-	788.4m
7	2	13M	80.7u	1.417m	-	652.7m
8	1	13M	65.9u	-	-	782.6m
9	3	13M	79.9u	1.732m	1.557m	410.0m
10	2	13M	76.4u	1.761m	-	78.51m
11	1	13M	58.1u	-	-	580.4m
12	2	13M	78.0u	961.0u	-	162.0m

Long Pulse Radar Test Signal
 Test Signal Name: LP_Signal_27
 Number of Bursts in Trial: 19
 Chrip Center Frequency: 5322MHz

Burst	Pulses per Burst	Chrip (Hz)	Pulse Width (s)	Pulse 1 to 2 Spacing (s)	Pulse 2 to 3 Spacing (s)	Start Location (s)
1	3	16M	57.4u	1.310m	1.063m	263.4m
2	3	16M	53.6u	1.063m	1.123m	239.3m
3	3	16M	82.4u	1.425m	1.371m	434.0m
4	2	16M	83.1u	1.514m	-	308.5m
5	3	16M	89.8u	1.210m	1.455m	259.5m
6	2	16M	95.6u	1.397m	-	66.09m
7	2	16M	70.5u	1.045m	-	558.6m
8	2	16M	89.0u	1.309m	-	92.83m
9	1	16M	83.7u	-	-	524.2m
10	3	16M	93.5u	1.004m	1.611m	438.4m
11	2	16M	54.3u	1.632m	-	338.8m
12	1	16M	72.4u	-	-	84.23m
13	3	16M	72.1u	1.064m	1.337m	270.5m
14	2	16M	77.9u	1.844m	-	230.5m
15	2	16M	89.1u	1.282m	-	173.5m
16	2	16M	70.0u	1.089m	-	189.6m

17	3	16M	87.1u	1.138m	1.322m	348.7m
18	1	16M	56.9u	-	-	486.2m
19	3	16M	79.4u	1.267m	1.580m	285.8m

Long Pulse Radar Test Signal						
Test Signal Name: LP_Signal_28						
Number of Bursts in Trial: 12						
Chrip Center Frequency: 5322MHz						
Burst	Pulses per Burst	Chrip (Hz)	Pulse Width (s)	Pulse 1 to 2 Spacing (s)	Pulse 2 to 3 Spacing (s)	Start Location (s)
1	3	16M	81.9u	1.713m	1.130m	406.8m
2	3	16M	94.1u	1.182m	1.311m	673.2m
3	3	16M	88.8u	1.272m	1.897m	962.9m
4	2	16M	85.5u	1.256m	-	689.2m
5	3	16M	91.6u	1.325m	1.053m	396.5m
6	3	16M	58.7u	1.613m	1.768m	692.7m
7	2	16M	89.9u	1.182m	-	988.1m
8	3	16M	74.7u	1.139m	1.384m	783.9m
9	2	16M	74.8u	1.849m	-	722.0m
10	2	16M	55.6u	967.4u	-	325.4m
11	2	16M	74.6u	1.876m	-	549.7m
12	3	16M	97.6u	1.660m	1.245m	109.6m

Long Pulse Radar Test Signal						
Test Signal Name: LP_Signal_29						
Number of Bursts in Trial: 10						
Chrip Center Frequency: 5320MHz						
Burst	Pulses per Burst	Chrip (Hz)	Pulse Width (s)	Pulse 1 to 2 Spacing (s)	Pulse 2 to 3 Spacing (s)	Start Location (s)
1	2	20M	78.6u	1.551m	-	833.2m
2	2	20M	51.6u	990.4u	-	825.2m
3	2	20M	86.8u	1.097m	-	809.6m
4	1	20M	60.5u	-	-	792.9m
5	2	20M	54.9u	1.783m	-	491.4m
6	2	20M	75.7u	1.245m	-	717.7m
7	2	20M	55.0u	1.513m	-	1.155
8	2	20M	79.2u	955.8u	-	118.6m
9	1	20M	56.4u	-	-	881.1m
10	1	20M	97.7u	-	-	978.0m

Long Pulse Radar Test Signal						
Test Signal Name: LP_Signal_30						
Number of Bursts in Trial: 16						
Chirp Center Frequency: 5320MHz						
Burst	Pulses per Burst	Chirp (Hz)	Pulse Width (s)	Pulse 1 to 2 Spacing (s)	Pulse 2 to 3 Spacing (s)	Start Location (s)
1	2	20M	98.1u	1.220m	-	507.2m
2	2	20M	73.5u	1.910m	-	227.2m
3	2	20M	98.2u	1.506m	-	631.2m
4	3	20M	97.9u	1.595m	1.851m	164.0m
5	1	20M	92.9u	-	-	45.06m
6	2	20M	76.6u	1.260m	-	601.8m
7	2	20M	68.1u	1.217m	-	342.9m
8	1	20M	53.3u	-	-	86.38m
9	2	20M	58.0u	978.0u	-	75.50m
10	1	20M	66.6u	-	-	328.5m
11	3	20M	69.0u	1.388m	1.330m	707.6m
12	2	20M	68.3u	1.450m	-	328.0m
13	3	20M	99.1u	1.752m	1.303m	426.0m
14	1	20M	94.8u	-	-	632.9m
15	1	20M	99.7u	-	-	169.8m
16	1	20M	51.5u	-	-	455.1m

Type 6 Radar Statistical Performances				
Trial #	Pulses per Burst	Pulse Width (s)	PRI (s)	Detection
1	9	1.0u	333.0u	Yes
2	9	1.0u	333.0u	Yes
3	9	1.0u	333.0u	Yes
4	9	1.0u	333.0u	Yes
5	9	1.0u	333.0u	Yes
6	9	1.0u	333.0u	Yes
7	9	1.0u	333.0u	Yes
8	9	1.0u	333.0u	Yes
9	9	1.0u	333.0u	Yes
10	9	1.0u	333.0u	Yes
11	9	1.0u	333.0u	Yes
12	9	1.0u	333.0u	Yes
13	9	1.0u	333.0u	Yes
14	9	1.0u	333.0u	Yes
15	9	1.0u	333.0u	Yes
16	9	1.0u	333.0u	Yes
17	9	1.0u	333.0u	Yes
18	9	1.0u	333.0u	Yes
19	9	1.0u	333.0u	Yes
20	9	1.0u	333.0u	Yes
21	9	1.0u	333.0u	Yes
22	9	1.0u	333.0u	Yes
23	9	1.0u	333.0u	Yes
24	9	1.0u	333.0u	Yes
25	9	1.0u	333.0u	Yes
26	9	1.0u	333.0u	Yes
27	9	1.0u	333.0u	Yes
28	9	1.0u	333.0u	Yes
29	9	1.0u	333.0u	Yes
30	9	1.0u	333.0u	Yes
				Detection Rate: 100.0 %

Type 6 Radar Statistical Performances		
Trial #	Hopping Frequency Sequence Name	Detection
1	HOP_FREQ_SEQ_01	Yes
2	HOP_FREQ_SEQ_02	Yes
3	HOP_FREQ_SEQ_03	Yes
4	HOP_FREQ_SEQ_04	Yes
5	HOP_FREQ_SEQ_05	Yes
6	HOP_FREQ_SEQ_06	Yes
7	HOP_FREQ_SEQ_07	Yes
8	HOP_FREQ_SEQ_08	Yes
9	HOP_FREQ_SEQ_09	Yes
10	HOP_FREQ_SEQ_10	Yes
11	HOP_FREQ_SEQ_11	Yes
12	HOP_FREQ_SEQ_12	Yes
13	HOP_FREQ_SEQ_13	Yes
14	HOP_FREQ_SEQ_14	Yes
15	HOP_FREQ_SEQ_15	Yes
16	HOP_FREQ_SEQ_16	Yes
17	HOP_FREQ_SEQ_17	Yes
18	HOP_FREQ_SEQ_18	Yes
19	HOP_FREQ_SEQ_19	Yes
20	HOP_FREQ_SEQ_20	Yes
21	HOP_FREQ_SEQ_21	Yes
22	HOP_FREQ_SEQ_22	Yes
23	HOP_FREQ_SEQ_23	Yes
24	HOP_FREQ_SEQ_24	Yes
25	HOP_FREQ_SEQ_25	Yes
26	HOP_FREQ_SEQ_26	Yes
27	HOP_FREQ_SEQ_27	Yes
28	HOP_FREQ_SEQ_28	Yes
29	HOP_FREQ_SEQ_29	Yes
30	HOP_FREQ_SEQ_30	Yes
		Detection Rate: 100.0 %

Hopping Frequency Sequence Name: HOP_FREQ_SEQ_01							
SEQ#	Frequency (Hz)	SEQ#	Frequency (Hz)	SEQ#	Frequency (Hz)	SEQ#	Frequency (Hz)
1	5.540G	2	5.513G	3	5.526G	4	5.574G
5	5.501G	6	5.717G	7	5.590G	8	5.373G
9	5.338G	10	5.534G	11	5.388G	12	5.493G
13	5.447G	14	5.554G	15	5.593G	16	5.566G
17	5.688G	18	5.715G	19	5.350G	20	5.713G
21	5.404G	22	5.374G	23	5.571G	24	5.420G
25	5.588G	26	5.277G	27	5.407G	28	5.610G
29	5.278G	30	5.710G	31	5.366G	32	5.301G
33	5.666G	34	5.551G	35	5.531G	36	5.339G
37	5.410G	38	5.303G	39	5.267G	40	5.538G
41	5.327G	42	5.701G	43	5.358G	44	5.581G
45	5.408G	46	5.584G	47	5.477G	48	5.357G
49	5.703G	50	5.376G	51	5.683G	52	5.413G
53	5.662G	54	5.423G	55	5.632G	56	5.668G
57	5.619G	58	5.281G	59	5.429G	60	5.289G
61	5.306G	62	5.337G	63	5.596G	64	5.286G
65	5.592G	66	5.379G	67	5.362G	68	5.351G
69	5.433G	70	5.271G	71	5.384G	72	5.614G
73	5.504G	74	5.296G	75	5.712G	76	5.452G
77	5.687G	78	5.533G	79	5.599G	80	5.561G
81	5.293G	82	5.300G	83	5.302G	84	5.718G
85	5.291G	86	5.456G	87	5.505G	88	5.636G
89	5.367G	90	5.348G	91	5.527G	92	5.558G
93	5.640G	94	5.559G	95	5.436G	96	5.613G
97	5.472G	98	5.707G	99	5.607G	100	5.680G

Hopping Frequency Sequence Name: HOP_FREQ_SEQ_02							
SEQ#	Frequency (Hz)	SEQ#	Frequency (Hz)	SEQ#	Frequency (Hz)	SEQ#	Frequency (Hz)
1	5.641G	2	5.581G	3	5.679G	4	5.580G
5	5.429G	6	5.315G	7	5.582G	8	5.604G
9	5.353G	10	5.255G	11	5.260G	12	5.425G
13	5.366G	14	5.343G	15	5.478G	16	5.310G
17	5.367G	18	5.288G	19	5.595G	20	5.719G
21	5.514G	22	5.630G	23	5.327G	24	5.606G
25	5.424G	26	5.662G	27	5.482G	28	5.683G
29	5.528G	30	5.289G	31	5.700G	32	5.541G
33	5.356G	34	5.585G	35	5.506G	36	5.297G
37	5.391G	38	5.505G	39	5.511G	40	5.333G
41	5.292G	42	5.572G	43	5.329G	44	5.553G
45	5.408G	46	5.612G	47	5.532G	48	5.423G
49	5.594G	50	5.495G	51	5.499G	52	5.607G
53	5.706G	54	5.525G	55	5.692G	56	5.390G
57	5.576G	58	5.270G	59	5.549G	60	5.468G
61	5.407G	62	5.455G	63	5.448G	64	5.565G
65	5.687G	66	5.656G	67	5.335G	68	5.649G
69	5.360G	70	5.349G	71	5.504G	72	5.661G
73	5.422G	74	5.328G	75	5.311G	76	5.307G
77	5.669G	78	5.561G	79	5.521G	80	5.342G
81	5.337G	82	5.518G	83	5.441G	84	5.436G
85	5.682G	86	5.562G	87	5.466G	88	5.539G
89	5.372G	90	5.534G	91	5.284G	92	5.537G
93	5.701G	94	5.384G	95	5.251G	96	5.445G
97	5.473G	98	5.388G	99	5.280G	100	5.285G

Hopping Frequency Sequence Name: HOP_FREQ_SEQ_03							
SEQ#	Frequency (Hz)	SEQ#	Frequency (Hz)	SEQ#	Frequency (Hz)	SEQ#	Frequency (Hz)
1	5.284G	2	5.304G	3	5.456G	4	5.489G
5	5.670G	6	5.409G	7	5.574G	8	5.448G
9	5.581G	10	5.467G	11	5.637G	12	5.651G
13	5.641G	14	5.407G	15	5.281G	16	5.321G
17	5.428G	18	5.355G	19	5.260G	20	5.276G
21	5.435G	22	5.640G	23	5.683G	24	5.333G
25	5.382G	26	5.712G	27	5.391G	28	5.401G
29	5.554G	30	5.383G	31	5.261G	32	5.315G
33	5.563G	34	5.326G	35	5.652G	36	5.393G
37	5.280G	38	5.352G	39	5.588G	40	5.595G
41	5.498G	42	5.618G	43	5.596G	44	5.307G
45	5.720G	46	5.495G	47	5.542G	48	5.469G
49	5.617G	50	5.623G	51	5.723G	52	5.440G
53	5.350G	54	5.338G	55	5.332G	56	5.602G
57	5.277G	58	5.367G	59	5.572G	60	5.611G
61	5.294G	62	5.584G	63	5.529G	64	5.678G
65	5.501G	66	5.267G	67	5.536G	68	5.301G
69	5.516G	70	5.650G	71	5.664G	72	5.662G
73	5.263G	74	5.458G	75	5.528G	76	5.707G
77	5.717G	78	5.418G	79	5.560G	80	5.604G
81	5.644G	82	5.396G	83	5.416G	84	5.514G
85	5.526G	86	5.699G	87	5.443G	88	5.674G
89	5.411G	90	5.671G	91	5.510G	92	5.257G
93	5.436G	94	5.424G	95	5.459G	96	5.273G
97	5.685G	98	5.463G	99	5.288G	100	5.275G

Hopping Frequency Sequence Name: HOP_FREQ_SEQ_04							
SEQ#	Frequency (Hz)	SEQ#	Frequency (Hz)	SEQ#	Frequency (Hz)	SEQ#	Frequency (Hz)
1	5.278G	2	5.505G	3	5.563G	4	5.422G
5	5.685G	6	5.270G	7	5.545G	8	5.321G
9	5.641G	10	5.680G	11	5.568G	12	5.284G
13	5.675G	14	5.542G	15	5.406G	16	5.426G
17	5.346G	18	5.327G	19	5.558G	20	5.423G
21	5.285G	22	5.434G	23	5.720G	24	5.538G
25	5.357G	26	5.286G	27	5.362G	28	5.522G
29	5.520G	30	5.438G	31	5.418G	32	5.448G
33	5.605G	34	5.451G	35	5.516G	36	5.319G
37	5.694G	38	5.671G	39	5.518G	40	5.553G
41	5.252G	42	5.395G	43	5.482G	44	5.419G
45	5.397G	46	5.716G	47	5.349G	48	5.661G
49	5.296G	50	5.693G	51	5.414G	52	5.670G
53	5.356G	54	5.527G	55	5.704G	56	5.566G
57	5.429G	58	5.592G	59	5.353G	60	5.361G
61	5.475G	62	5.636G	63	5.508G	64	5.718G
65	5.484G	66	5.405G	67	5.348G	68	5.650G
69	5.412G	70	5.607G	71	5.294G	72	5.721G
73	5.565G	74	5.379G	75	5.279G	76	5.433G
77	5.578G	78	5.610G	79	5.477G	80	5.571G
81	5.276G	82	5.495G	83	5.308G	84	5.698G
85	5.572G	86	5.398G	87	5.387G	88	5.597G
89	5.688G	90	5.590G	91	5.485G	92	5.497G
93	5.253G	94	5.617G	95	5.632G	96	5.363G
97	5.628G	98	5.376G	99	5.282G	100	5.490G

Hopping Frequency Sequence Name: HOP_FREQ_SEQ_05							
SEQ#	Frequency (Hz)	SEQ#	Frequency (Hz)	SEQ#	Frequency (Hz)	SEQ#	Frequency (Hz)
1	5.535G	2	5.444G	3	5.468G	4	5.719G
5	5.264G	6	5.349G	7	5.554G	8	5.387G
9	5.462G	10	5.632G	11	5.490G	12	5.478G
13	5.340G	14	5.494G	15	5.323G	16	5.320G
17	5.560G	18	5.435G	19	5.367G	20	5.544G
21	5.519G	22	5.401G	23	5.616G	24	5.485G
25	5.477G	26	5.482G	27	5.669G	28	5.553G
29	5.682G	30	5.308G	31	5.293G	32	5.496G
33	5.480G	34	5.593G	35	5.268G	36	5.324G
37	5.657G	38	5.587G	39	5.712G	40	5.635G
41	5.473G	42	5.441G	43	5.442G	44	5.649G
45	5.597G	46	5.517G	47	5.279G	48	5.454G
49	5.689G	50	5.456G	51	5.529G	52	5.391G
53	5.515G	54	5.350G	55	5.434G	56	5.505G
57	5.539G	58	5.582G	59	5.604G	60	5.370G
61	5.413G	62	5.414G	63	5.285G	64	5.605G
65	5.648G	66	5.345G	67	5.489G	68	5.671G
69	5.540G	70	5.289G	71	5.598G	72	5.542G
73	5.636G	74	5.381G	75	5.347G	76	5.522G
77	5.711G	78	5.693G	79	5.319G	80	5.431G
81	5.501G	82	5.486G	83	5.280G	84	5.647G
85	5.398G	86	5.259G	87	5.570G	88	5.504G
89	5.558G	90	5.426G	91	5.706G	92	5.291G
93	5.253G	94	5.662G	95	5.362G	96	5.667G
97	5.590G	98	5.569G	99	5.531G	100	5.405G

Hopping Frequency Sequence Name: HOP_FREQ_SEQ_06							
SEQ#	Frequency (Hz)	SEQ#	Frequency (Hz)	SEQ#	Frequency (Hz)	SEQ#	Frequency (Hz)
1	5.642G	2	5.685G	3	5.613G	4	5.701G
5	5.526G	6	5.604G	7	5.329G	8	5.551G
9	5.624G	10	5.389G	11	5.696G	12	5.599G
13	5.323G	14	5.274G	15	5.293G	16	5.416G
17	5.720G	18	5.453G	19	5.655G	20	5.608G
21	5.344G	22	5.349G	23	5.399G	24	5.605G
25	5.326G	26	5.693G	27	5.674G	28	5.255G
29	5.370G	30	5.285G	31	5.666G	32	5.578G
33	5.260G	34	5.275G	35	5.409G	36	5.715G
37	5.660G	38	5.460G	39	5.324G	40	5.509G
41	5.712G	42	5.312G	43	5.480G	44	5.375G
45	5.681G	46	5.631G	47	5.714G	48	5.512G
49	5.445G	50	5.514G	51	5.354G	52	5.483G
53	5.490G	54	5.654G	55	5.386G	56	5.291G
57	5.476G	58	5.716G	59	5.362G	60	5.265G
61	5.680G	62	5.439G	63	5.541G	64	5.573G
65	5.682G	66	5.644G	67	5.414G	68	5.422G
69	5.668G	70	5.677G	71	5.609G	72	5.705G
73	5.473G	74	5.517G	75	5.482G	76	5.549G
77	5.360G	78	5.485G	79	5.684G	80	5.317G
81	5.264G	82	5.711G	83	5.355G	84	5.596G
85	5.300G	86	5.592G	87	5.303G	88	5.594G
89	5.579G	90	5.649G	91	5.340G	92	5.667G
93	5.643G	94	5.575G	95	5.396G	96	5.436G
97	5.437G	98	5.408G	99	5.561G	100	5.421G

Hopping Frequency Sequence Name: HOP_FREQ_SEQ_07							
SEQ#	Frequency (Hz)	SEQ#	Frequency (Hz)	SEQ#	Frequency (Hz)	SEQ#	Frequency (Hz)
1	5.597G	2	5.360G	3	5.666G	4	5.431G
5	5.587G	6	5.521G	7	5.471G	8	5.553G
9	5.676G	10	5.338G	11	5.722G	12	5.347G
13	5.458G	14	5.498G	15	5.620G	16	5.641G
17	5.596G	18	5.295G	19	5.317G	20	5.605G
21	5.532G	22	5.650G	23	5.558G	24	5.700G
25	5.495G	26	5.481G	27	5.485G	28	5.390G
29	5.656G	30	5.648G	31	5.365G	32	5.708G
33	5.371G	34	5.441G	35	5.702G	36	5.504G
37	5.261G	38	5.398G	39	5.392G	40	5.572G
41	5.683G	42	5.567G	43	5.585G	44	5.623G
45	5.569G	46	5.256G	47	5.505G	48	5.649G
49	5.426G	50	5.264G	51	5.640G	52	5.690G
53	5.520G	54	5.466G	55	5.593G	56	5.568G
57	5.325G	58	5.383G	59	5.300G	60	5.389G
61	5.469G	62	5.253G	63	5.285G	64	5.724G
65	5.538G	66	5.467G	67	5.519G	68	5.686G
69	5.539G	70	5.313G	71	5.713G	72	5.312G
73	5.654G	74	5.299G	75	5.446G	76	5.366G
77	5.320G	78	5.479G	79	5.492G	80	5.340G
81	5.548G	82	5.671G	83	5.698G	84	5.674G
85	5.343G	86	5.710G	87	5.443G	88	5.503G
89	5.599G	90	5.474G	91	5.502G	92	5.437G
93	5.263G	94	5.604G	95	5.393G	96	5.372G
97	5.369G	98	5.262G	99	5.711G	100	5.527G

Hopping Frequency Sequence Name: HOP_FREQ_SEQ_08							
SEQ#	Frequency (Hz)	SEQ#	Frequency (Hz)	SEQ#	Frequency (Hz)	SEQ#	Frequency (Hz)
1	5.667G	2	5.626G	3	5.314G	4	5.440G
5	5.527G	6	5.365G	7	5.653G	8	5.652G
9	5.469G	10	5.694G	11	5.496G	12	5.634G
13	5.517G	14	5.354G	15	5.481G	16	5.505G
17	5.292G	18	5.254G	19	5.569G	20	5.649G
21	5.433G	22	5.604G	23	5.404G	24	5.349G
25	5.416G	26	5.551G	27	5.603G	28	5.561G
29	5.386G	30	5.648G	31	5.369G	32	5.252G
33	5.635G	34	5.605G	35	5.399G	36	5.485G
37	5.391G	38	5.641G	39	5.518G	40	5.607G
41	5.529G	42	5.590G	43	5.520G	44	5.514G
45	5.409G	46	5.336G	47	5.567G	48	5.679G
49	5.698G	50	5.594G	51	5.564G	52	5.419G
53	5.657G	54	5.668G	55	5.689G	56	5.306G
57	5.385G	58	5.278G	59	5.688G	60	5.423G
61	5.674G	62	5.536G	63	5.544G	64	5.435G
65	5.251G	66	5.601G	67	5.438G	68	5.280G
69	5.260G	70	5.288G	71	5.711G	72	5.389G
73	5.640G	74	5.556G	75	5.664G	76	5.718G
77	5.677G	78	5.651G	79	5.277G	80	5.420G
81	5.300G	82	5.683G	83	5.573G	84	5.702G
85	5.256G	86	5.684G	87	5.533G	88	5.362G
89	5.443G	90	5.712G	91	5.612G	92	5.606G
93	5.491G	94	5.364G	95	5.338G	96	5.417G
97	5.428G	98	5.553G	99	5.595G	100	5.583G

Hopping Frequency Sequence Name: HOP_FREQ_SEQ_09							
SEQ#	Frequency (Hz)	SEQ#	Frequency (Hz)	SEQ#	Frequency (Hz)	SEQ#	Frequency (Hz)
1	5.652G	2	5.260G	3	5.508G	4	5.643G
5	5.653G	6	5.659G	7	5.381G	8	5.683G
9	5.724G	10	5.711G	11	5.577G	12	5.333G
13	5.682G	14	5.307G	15	5.258G	16	5.603G
17	5.605G	18	5.534G	19	5.520G	20	5.491G
21	5.367G	22	5.672G	23	5.355G	24	5.372G
25	5.651G	26	5.541G	27	5.274G	28	5.666G
29	5.498G	30	5.336G	31	5.420G	32	5.701G
33	5.496G	34	5.707G	35	5.361G	36	5.608G
37	5.582G	38	5.631G	39	5.289G	40	5.386G
41	5.568G	42	5.671G	43	5.455G	44	5.279G
45	5.558G	46	5.595G	47	5.363G	48	5.352G
49	5.549G	50	5.434G	51	5.602G	52	5.362G
53	5.379G	54	5.419G	55	5.554G	56	5.686G
57	5.366G	58	5.516G	59	5.285G	60	5.405G
61	5.319G	62	5.596G	63	5.394G	64	5.385G
65	5.356G	66	5.300G	67	5.641G	68	5.280G
69	5.332G	70	5.626G	71	5.674G	72	5.295G
73	5.664G	74	5.600G	75	5.523G	76	5.440G
77	5.286G	78	5.490G	79	5.259G	80	5.593G
81	5.531G	82	5.634G	83	5.489G	84	5.559G
85	5.527G	86	5.578G	87	5.322G	88	5.589G
89	5.709G	90	5.525G	91	5.535G	92	5.537G
93	5.636G	94	5.521G	95	5.323G	96	5.716G
97	5.611G	98	5.632G	99	5.282G	100	5.598G

Hopping Frequency Sequence Name: HOP_FREQ_SEQ_10							
SEQ#	Frequency (Hz)	SEQ#	Frequency (Hz)	SEQ#	Frequency (Hz)	SEQ#	Frequency (Hz)
1	5.448G	2	5.353G	3	5.542G	4	5.384G
5	5.676G	6	5.609G	7	5.518G	8	5.454G
9	5.662G	10	5.516G	11	5.357G	12	5.406G
13	5.491G	14	5.438G	15	5.408G	16	5.263G
17	5.625G	18	5.559G	19	5.652G	20	5.280G
21	5.577G	22	5.254G	23	5.556G	24	5.472G
25	5.672G	26	5.282G	27	5.639G	28	5.527G
29	5.612G	30	5.569G	31	5.555G	32	5.630G
33	5.347G	34	5.607G	35	5.647G	36	5.425G
37	5.422G	38	5.329G	39	5.501G	40	5.704G
41	5.364G	42	5.374G	43	5.702G	44	5.554G
45	5.644G	46	5.277G	47	5.626G	48	5.418G
49	5.587G	50	5.604G	51	5.677G	52	5.558G
53	5.568G	54	5.534G	55	5.497G	56	5.401G
57	5.252G	58	5.466G	59	5.571G	60	5.584G
61	5.714G	62	5.682G	63	5.552G	64	5.610G
65	5.597G	66	5.392G	67	5.370G	68	5.456G
69	5.316G	70	5.274G	71	5.506G	72	5.523G
73	5.537G	74	5.533G	75	5.546G	76	5.645G
77	5.276G	78	5.505G	79	5.484G	80	5.684G
81	5.679G	82	5.259G	83	5.285G	84	5.668G
85	5.723G	86	5.656G	87	5.673G	88	5.255G
89	5.594G	90	5.339G	91	5.268G	92	5.502G
93	5.496G	94	5.503G	95	5.323G	96	5.273G
97	5.342G	98	5.711G	99	5.410G	100	5.661G

Hopping Frequency Sequence Name: HOP_FREQ_SEQ_11							
SEQ#	Frequency (Hz)	SEQ#	Frequency (Hz)	SEQ#	Frequency (Hz)	SEQ#	Frequency (Hz)
1	5.407G	2	5.441G	3	5.498G	4	5.515G
5	5.358G	6	5.316G	7	5.659G	8	5.695G
9	5.542G	10	5.393G	11	5.592G	12	5.682G
13	5.332G	14	5.675G	15	5.608G	16	5.588G
17	5.578G	18	5.291G	19	5.614G	20	5.282G
21	5.648G	22	5.476G	23	5.273G	24	5.312G
25	5.697G	26	5.658G	27	5.349G	28	5.600G
29	5.279G	30	5.431G	31	5.484G	32	5.372G
33	5.283G	34	5.378G	35	5.401G	36	5.505G
37	5.471G	38	5.295G	39	5.470G	40	5.341G
41	5.669G	42	5.366G	43	5.290G	44	5.475G
45	5.549G	46	5.633G	47	5.430G	48	5.539G
49	5.425G	50	5.387G	51	5.511G	52	5.373G
53	5.514G	54	5.634G	55	5.297G	56	5.461G
57	5.392G	58	5.516G	59	5.270G	60	5.280G
61	5.427G	62	5.570G	63	5.289G	64	5.310G
65	5.411G	66	5.412G	67	5.711G	68	5.568G
69	5.386G	70	5.655G	71	5.409G	72	5.374G
73	5.437G	74	5.302G	75	5.617G	76	5.572G
77	5.370G	78	5.667G	79	5.601G	80	5.447G
81	5.551G	82	5.525G	83	5.292G	84	5.481G
85	5.571G	86	5.605G	87	5.395G	88	5.496G
89	5.402G	90	5.644G	91	5.631G	92	5.432G
93	5.694G	94	5.662G	95	5.540G	96	5.489G
97	5.463G	98	5.521G	99	5.486G	100	5.616G

Hopping Frequency Sequence Name: HOP_FREQ_SEQ_12							
SEQ#	Frequency (Hz)	SEQ#	Frequency (Hz)	SEQ#	Frequency (Hz)	SEQ#	Frequency (Hz)
1	5.544G	2	5.339G	3	5.529G	4	5.472G
5	5.508G	6	5.431G	7	5.596G	8	5.270G
9	5.327G	10	5.379G	11	5.662G	12	5.462G
13	5.273G	14	5.617G	15	5.651G	16	5.377G
17	5.686G	18	5.415G	19	5.488G	20	5.380G
21	5.351G	22	5.688G	23	5.260G	24	5.530G
25	5.589G	26	5.703G	27	5.632G	28	5.609G
29	5.333G	30	5.286G	31	5.507G	32	5.693G
33	5.664G	34	5.582G	35	5.461G	36	5.358G
37	5.667G	38	5.555G	39	5.367G	40	5.570G
41	5.711G	42	5.372G	43	5.537G	44	5.267G
45	5.301G	46	5.585G	47	5.288G	48	5.583G
49	5.398G	50	5.421G	51	5.291G	52	5.445G
53	5.541G	54	5.504G	55	5.384G	56	5.299G
57	5.543G	58	5.556G	59	5.496G	60	5.477G
61	5.423G	62	5.678G	63	5.624G	64	5.353G
65	5.413G	66	5.296G	67	5.706G	68	5.685G
69	5.473G	70	5.722G	71	5.424G	72	5.525G
73	5.674G	74	5.359G	75	5.325G	76	5.489G
77	5.614G	78	5.622G	79	5.294G	80	5.573G
81	5.494G	82	5.326G	83	5.394G	84	5.482G
85	5.650G	86	5.435G	87	5.659G	88	5.400G
89	5.637G	90	5.355G	91	5.258G	92	5.449G
93	5.718G	94	5.676G	95	5.447G	96	5.549G
97	5.640G	98	5.645G	99	5.276G	100	5.533G

Hopping Frequency Sequence Name: HOP_FREQ_SEQ_13							
SEQ#	Frequency (Hz)	SEQ#	Frequency (Hz)	SEQ#	Frequency (Hz)	SEQ#	Frequency (Hz)
1	5.358G	2	5.430G	3	5.615G	4	5.653G
5	5.439G	6	5.310G	7	5.399G	8	5.722G
9	5.721G	10	5.494G	11	5.352G	12	5.449G
13	5.538G	14	5.337G	15	5.438G	16	5.262G
17	5.307G	18	5.409G	19	5.503G	20	5.419G
21	5.487G	22	5.282G	23	5.417G	24	5.295G
25	5.644G	26	5.622G	27	5.383G	28	5.334G
29	5.692G	30	5.658G	31	5.598G	32	5.372G
33	5.573G	34	5.576G	35	5.491G	36	5.621G
37	5.380G	38	5.586G	39	5.527G	40	5.698G
41	5.342G	42	5.275G	43	5.492G	44	5.630G
45	5.529G	46	5.724G	47	5.269G	48	5.411G
49	5.474G	50	5.608G	51	5.553G	52	5.602G
53	5.429G	54	5.478G	55	5.312G	56	5.318G
57	5.673G	58	5.297G	59	5.369G	60	5.377G
61	5.375G	62	5.285G	63	5.558G	64	5.260G
65	5.390G	66	5.268G	67	5.656G	68	5.370G
69	5.596G	70	5.605G	71	5.591G	72	5.629G
73	5.506G	74	5.351G	75	5.281G	76	5.336G
77	5.524G	78	5.521G	79	5.461G	80	5.367G
81	5.296G	82	5.347G	83	5.435G	84	5.329G
85	5.340G	86	5.299G	87	5.680G	88	5.448G
89	5.261G	90	5.510G	91	5.265G	92	5.555G
93	5.595G	94	5.457G	95	5.280G	96	5.359G
97	5.410G	98	5.509G	99	5.379G	100	5.447G

Hopping Frequency Sequence Name: HOP_FREQ_SEQ_14							
SEQ#	Frequency (Hz)	SEQ#	Frequency (Hz)	SEQ#	Frequency (Hz)	SEQ#	Frequency (Hz)
1	5.393G	2	5.673G	3	5.362G	4	5.390G
5	5.528G	6	5.625G	7	5.315G	8	5.383G
9	5.653G	10	5.342G	11	5.572G	12	5.613G
13	5.252G	14	5.520G	15	5.685G	16	5.292G
17	5.268G	18	5.450G	19	5.259G	20	5.674G
21	5.321G	22	5.371G	23	5.531G	24	5.381G
25	5.284G	26	5.403G	27	5.599G	28	5.549G
29	5.400G	30	5.482G	31	5.281G	32	5.454G
33	5.689G	34	5.290G	35	5.481G	36	5.540G
37	5.571G	38	5.368G	39	5.440G	40	5.555G
41	5.607G	42	5.399G	43	5.713G	44	5.301G
45	5.423G	46	5.369G	47	5.445G	48	5.566G
49	5.574G	50	5.724G	51	5.639G	52	5.406G
53	5.407G	54	5.543G	55	5.476G	56	5.660G
57	5.633G	58	5.700G	59	5.417G	60	5.439G
61	5.589G	62	5.585G	63	5.435G	64	5.500G
65	5.715G	66	5.280G	67	5.697G	68	5.366G
69	5.442G	70	5.558G	71	5.286G	72	5.448G
73	5.716G	74	5.508G	75	5.634G	76	5.488G
77	5.657G	78	5.554G	79	5.461G	80	5.721G
81	5.517G	82	5.269G	83	5.584G	84	5.693G
85	5.587G	86	5.502G	87	5.431G	88	5.405G
89	5.272G	90	5.707G	91	5.667G	92	5.418G
93	5.662G	94	5.387G	95	5.610G	96	5.536G
97	5.485G	98	5.605G	99	5.526G	100	5.279G

Hopping Frequency Sequence Name: HOP_FREQ_SEQ_15							
SEQ#	Frequency (Hz)	SEQ#	Frequency (Hz)	SEQ#	Frequency (Hz)	SEQ#	Frequency (Hz)
1	5.293G	2	5.401G	3	5.260G	4	5.640G
5	5.308G	6	5.684G	7	5.527G	8	5.417G
9	5.419G	10	5.660G	11	5.495G	12	5.628G
13	5.363G	14	5.470G	15	5.517G	16	5.412G
17	5.446G	18	5.302G	19	5.567G	20	5.712G
21	5.272G	22	5.335G	23	5.582G	24	5.500G
25	5.311G	26	5.550G	27	5.378G	28	5.601G
29	5.671G	30	5.667G	31	5.452G	32	5.271G
33	5.283G	34	5.719G	35	5.536G	36	5.652G
37	5.526G	38	5.481G	39	5.657G	40	5.254G
41	5.343G	42	5.505G	43	5.542G	44	5.483G
45	5.342G	46	5.259G	47	5.710G	48	5.545G
49	5.410G	50	5.516G	51	5.489G	52	5.696G
53	5.512G	54	5.554G	55	5.571G	56	5.433G
57	5.445G	58	5.634G	59	5.345G	60	5.434G
61	5.716G	62	5.613G	63	5.541G	64	5.268G
65	5.282G	66	5.252G	67	5.442G	68	5.488G
69	5.703G	70	5.586G	71	5.349G	72	5.544G
73	5.325G	74	5.514G	75	5.456G	76	5.508G
77	5.403G	78	5.387G	79	5.406G	80	5.653G
81	5.497G	82	5.454G	83	5.307G	84	5.430G
85	5.377G	86	5.431G	87	5.382G	88	5.539G
89	5.251G	90	5.420G	91	5.638G	92	5.676G
93	5.592G	94	5.579G	95	5.463G	96	5.678G
97	5.262G	98	5.364G	99	5.388G	100	5.261G

Hopping Frequency Sequence Name: HOP_FREQ_SEQ_16							
SEQ#	Frequency (Hz)	SEQ#	Frequency (Hz)	SEQ#	Frequency (Hz)	SEQ#	Frequency (Hz)
1	5.700G	2	5.350G	3	5.410G	4	5.401G
5	5.669G	6	5.409G	7	5.462G	8	5.338G
9	5.266G	10	5.526G	11	5.681G	12	5.337G
13	5.420G	14	5.267G	15	5.516G	16	5.629G
17	5.389G	18	5.299G	19	5.490G	20	5.398G
21	5.380G	22	5.418G	23	5.523G	24	5.655G
25	5.360G	26	5.328G	27	5.397G	28	5.639G
29	5.417G	30	5.423G	31	5.540G	32	5.342G
33	5.656G	34	5.296G	35	5.491G	36	5.635G
37	5.395G	38	5.255G	39	5.556G	40	5.254G
41	5.278G	42	5.648G	43	5.295G	44	5.576G
45	5.686G	46	5.569G	47	5.439G	48	5.476G
49	5.614G	50	5.422G	51	5.336G	52	5.367G
53	5.259G	54	5.461G	55	5.566G	56	5.702G
57	5.345G	58	5.307G	59	5.319G	60	5.289G
61	5.517G	62	5.281G	63	5.581G	64	5.673G
65	5.489G	66	5.339G	67	5.436G	68	5.352G
69	5.440G	70	5.634G	71	5.504G	72	5.411G
73	5.407G	74	5.625G	75	5.601G	76	5.678G
77	5.671G	78	5.282G	79	5.710G	80	5.324G
81	5.264G	82	5.536G	83	5.633G	84	5.499G
85	5.271G	86	5.568G	87	5.559G	88	5.644G
89	5.514G	90	5.664G	91	5.326G	92	5.294G
93	5.646G	94	5.315G	95	5.340G	96	5.408G
97	5.638G	98	5.599G	99	5.670G	100	5.561G

Hopping Frequency Sequence Name: HOP_FREQ_SEQ_17							
SEQ#	Frequency (Hz)	SEQ#	Frequency (Hz)	SEQ#	Frequency (Hz)	SEQ#	Frequency (Hz)
1	5.563G	2	5.478G	3	5.723G	4	5.319G
5	5.374G	6	5.492G	7	5.469G	8	5.292G
9	5.525G	10	5.252G	11	5.350G	12	5.608G
13	5.323G	14	5.681G	15	5.388G	16	5.545G
17	5.291G	18	5.517G	19	5.253G	20	5.383G
21	5.489G	22	5.654G	23	5.704G	24	5.616G
25	5.621G	26	5.593G	27	5.435G	28	5.332G
29	5.420G	30	5.375G	31	5.587G	32	5.610G
33	5.498G	34	5.376G	35	5.661G	36	5.596G
37	5.413G	38	5.269G	39	5.701G	40	5.510G
41	5.266G	42	5.626G	43	5.516G	44	5.483G
45	5.467G	46	5.518G	47	5.586G	48	5.255G
49	5.512G	50	5.315G	51	5.639G	52	5.316G
53	5.667G	54	5.625G	55	5.495G	56	5.560G
57	5.455G	58	5.286G	59	5.324G	60	5.678G
61	5.555G	62	5.594G	63	5.662G	64	5.505G
65	5.320G	66	5.685G	67	5.282G	68	5.335G
69	5.677G	70	5.585G	71	5.526G	72	5.670G
73	5.400G	74	5.541G	75	5.488G	76	5.477G
77	5.480G	78	5.507G	79	5.449G	80	5.385G
81	5.473G	82	5.412G	83	5.714G	84	5.549G
85	5.690G	86	5.295G	87	5.619G	88	5.683G
89	5.411G	90	5.343G	91	5.664G	92	5.637G
93	5.351G	94	5.285G	95	5.691G	96	5.554G
97	5.415G	98	5.530G	99	5.692G	100	5.452G

Hopping Frequency Sequence Name: HOP_FREQ_SEQ_18							
SEQ#	Frequency (Hz)	SEQ#	Frequency (Hz)	SEQ#	Frequency (Hz)	SEQ#	Frequency (Hz)
1	5.497G	2	5.599G	3	5.670G	4	5.665G
5	5.351G	6	5.278G	7	5.388G	8	5.600G
9	5.263G	10	5.572G	11	5.364G	12	5.532G
13	5.643G	14	5.487G	15	5.486G	16	5.631G
17	5.515G	18	5.492G	19	5.373G	20	5.442G
21	5.358G	22	5.293G	23	5.562G	24	5.355G
25	5.496G	26	5.467G	27	5.679G	28	5.707G
29	5.607G	30	5.513G	31	5.489G	32	5.485G
33	5.320G	34	5.418G	35	5.621G	36	5.416G
37	5.522G	38	5.407G	39	5.303G	40	5.357G
41	5.378G	42	5.542G	43	5.678G	44	5.452G
45	5.574G	46	5.449G	47	5.546G	48	5.610G
49	5.434G	50	5.613G	51	5.650G	52	5.469G
53	5.281G	54	5.608G	55	5.524G	56	5.529G
57	5.428G	58	5.661G	59	5.544G	60	5.512G
61	5.393G	62	5.411G	63	5.471G	64	5.462G
65	5.504G	66	5.399G	67	5.638G	68	5.298G
69	5.395G	70	5.553G	71	5.273G	72	5.578G
73	5.463G	74	5.423G	75	5.307G	76	5.516G
77	5.507G	78	5.480G	79	5.360G	80	5.721G
81	5.598G	82	5.376G	83	5.494G	84	5.398G
85	5.595G	86	5.521G	87	5.305G	88	5.446G
89	5.275G	90	5.443G	91	5.316G	92	5.437G
93	5.549G	94	5.693G	95	5.269G	96	5.295G
97	5.668G	98	5.586G	99	5.719G	100	5.615G

Hopping Frequency Sequence Name: HOP_FREQ_SEQ_19							
SEQ#	Frequency (Hz)	SEQ#	Frequency (Hz)	SEQ#	Frequency (Hz)	SEQ#	Frequency (Hz)
1	5.691G	2	5.551G	3	5.579G	4	5.350G
5	5.688G	6	5.622G	7	5.294G	8	5.547G
9	5.460G	10	5.446G	11	5.270G	12	5.541G
13	5.620G	14	5.571G	15	5.384G	16	5.633G
17	5.477G	18	5.503G	19	5.553G	20	5.629G
21	5.472G	22	5.542G	23	5.528G	24	5.544G
25	5.613G	26	5.700G	27	5.434G	28	5.358G
29	5.525G	30	5.305G	31	5.644G	32	5.516G
33	5.648G	34	5.684G	35	5.488G	36	5.478G
37	5.498G	38	5.335G	39	5.441G	40	5.361G
41	5.411G	42	5.420G	43	5.396G	44	5.515G
45	5.353G	46	5.266G	47	5.451G	48	5.386G
49	5.617G	50	5.588G	51	5.374G	52	5.532G
53	5.666G	54	5.669G	55	5.314G	56	5.431G
57	5.520G	58	5.306G	59	5.272G	60	5.279G
61	5.634G	62	5.654G	63	5.619G	64	5.504G
65	5.334G	66	5.685G	67	5.690G	68	5.646G
69	5.575G	70	5.641G	71	5.297G	72	5.282G
73	5.713G	74	5.479G	75	5.663G	76	5.695G
77	5.492G	78	5.493G	79	5.668G	80	5.327G
81	5.288G	82	5.296G	83	5.413G	84	5.511G
85	5.486G	86	5.597G	87	5.286G	88	5.661G
89	5.421G	90	5.405G	91	5.536G	92	5.719G
93	5.518G	94	5.590G	95	5.608G	96	5.408G
97	5.582G	98	5.303G	99	5.449G	100	5.414G

Hopping Frequency Sequence Name: HOP_FREQ_SEQ_20							
SEQ#	Frequency (Hz)	SEQ#	Frequency (Hz)	SEQ#	Frequency (Hz)	SEQ#	Frequency (Hz)
1	5.680G	2	5.483G	3	5.416G	4	5.549G
5	5.475G	6	5.321G	7	5.633G	8	5.278G
9	5.311G	10	5.524G	11	5.678G	12	5.521G
13	5.605G	14	5.367G	15	5.691G	16	5.672G
17	5.370G	18	5.504G	19	5.488G	20	5.433G
21	5.465G	22	5.282G	23	5.266G	24	5.701G
25	5.709G	26	5.267G	27	5.445G	28	5.385G
29	5.623G	30	5.299G	31	5.419G	32	5.707G
33	5.617G	34	5.322G	35	5.498G	36	5.632G
37	5.649G	38	5.546G	39	5.446G	40	5.541G
41	5.599G	42	5.630G	43	5.256G	44	5.568G
45	5.566G	46	5.537G	47	5.534G	48	5.277G
49	5.618G	50	5.374G	51	5.455G	52	5.283G
53	5.564G	54	5.312G	55	5.693G	56	5.436G
57	5.338G	58	5.372G	59	5.272G	60	5.369G
61	5.696G	62	5.507G	63	5.695G	64	5.529G
65	5.317G	66	5.384G	67	5.297G	68	5.494G
69	5.366G	70	5.705G	71	5.300G	72	5.715G
73	5.481G	74	5.287G	75	5.698G	76	5.301G
77	5.655G	78	5.670G	79	5.264G	80	5.420G
81	5.262G	82	5.676G	83	5.683G	84	5.394G
85	5.540G	86	5.337G	87	5.326G	88	5.431G
89	5.381G	90	5.505G	91	5.515G	92	5.275G
93	5.408G	94	5.690G	95	5.306G	96	5.359G
97	5.427G	98	5.342G	99	5.356G	100	5.462G

Hopping Frequency Sequence Name: HOP_FREQ_SEQ_21							
SEQ#	Frequency (Hz)	SEQ#	Frequency (Hz)	SEQ#	Frequency (Hz)	SEQ#	Frequency (Hz)
1	5.600G	2	5.680G	3	5.444G	4	5.459G
5	5.718G	6	5.298G	7	5.441G	8	5.605G
9	5.622G	10	5.505G	11	5.286G	12	5.634G
13	5.683G	14	5.583G	15	5.428G	16	5.667G
17	5.570G	18	5.549G	19	5.553G	20	5.353G
21	5.602G	22	5.544G	23	5.377G	24	5.341G
25	5.677G	26	5.713G	27	5.629G	28	5.321G
29	5.483G	30	5.363G	31	5.636G	32	5.504G
33	5.595G	34	5.384G	35	5.474G	36	5.625G
37	5.269G	38	5.624G	39	5.665G	40	5.375G
41	5.712G	42	5.345G	43	5.418G	44	5.457G
45	5.311G	46	5.656G	47	5.507G	48	5.429G
49	5.440G	50	5.320G	51	5.540G	52	5.477G
53	5.411G	54	5.561G	55	5.352G	56	5.317G
57	5.497G	58	5.423G	59	5.576G	60	5.367G
61	5.509G	62	5.472G	63	5.641G	64	5.597G
65	5.559G	66	5.585G	67	5.626G	68	5.336G
69	5.271G	70	5.313G	71	5.420G	72	5.448G
73	5.443G	74	5.381G	75	5.647G	76	5.431G
77	5.370G	78	5.580G	79	5.323G	80	5.548G
81	5.430G	82	5.596G	83	5.523G	84	5.530G
85	5.560G	86	5.592G	87	5.314G	88	5.422G
89	5.607G	90	5.385G	91	5.628G	92	5.421G
93	5.463G	94	5.437G	95	5.646G	96	5.648G
97	5.536G	98	5.296G	99	5.312G	100	5.409G

Hopping Frequency Sequence Name: HOP_FREQ_SEQ_22							
SEQ#	Frequency (Hz)	SEQ#	Frequency (Hz)	SEQ#	Frequency (Hz)	SEQ#	Frequency (Hz)
1	5.290G	2	5.317G	3	5.630G	4	5.724G
5	5.411G	6	5.700G	7	5.507G	8	5.263G
9	5.308G	10	5.568G	11	5.400G	12	5.252G
13	5.499G	14	5.570G	15	5.528G	16	5.461G
17	5.638G	18	5.399G	19	5.398G	20	5.254G
21	5.684G	22	5.616G	23	5.659G	24	5.285G
25	5.640G	26	5.647G	27	5.357G	28	5.279G
29	5.324G	30	5.323G	31	5.327G	32	5.626G
33	5.722G	34	5.345G	35	5.302G	36	5.483G
37	5.702G	38	5.384G	39	5.305G	40	5.651G
41	5.498G	42	5.693G	43	5.255G	44	5.564G
45	5.299G	46	5.482G	47	5.446G	48	5.704G
49	5.459G	50	5.582G	51	5.288G	52	5.720G
53	5.335G	54	5.286G	55	5.541G	56	5.457G
57	5.272G	58	5.365G	59	5.529G	60	5.618G
61	5.441G	62	5.581G	63	5.386G	64	5.650G
65	5.580G	66	5.612G	67	5.601G	68	5.557G
69	5.486G	70	5.608G	71	5.511G	72	5.664G
73	5.675G	74	5.525G	75	5.567G	76	5.678G
77	5.586G	78	5.336G	79	5.291G	80	5.387G
81	5.625G	82	5.356G	83	5.412G	84	5.706G
85	5.591G	86	5.688G	87	5.374G	88	5.401G
89	5.510G	90	5.624G	91	5.321G	92	5.339G
93	5.466G	94	5.475G	95	5.655G	96	5.328G
97	5.513G	98	5.686G	99	5.352G	100	5.261G

Hopping Frequency Sequence Name: HOP_FREQ_SEQ_23							
SEQ#	Frequency (Hz)	SEQ#	Frequency (Hz)	SEQ#	Frequency (Hz)	SEQ#	Frequency (Hz)
1	5.367G	2	5.276G	3	5.659G	4	5.686G
5	5.388G	6	5.552G	7	5.452G	8	5.285G
9	5.475G	10	5.441G	11	5.514G	12	5.266G
13	5.432G	14	5.462G	15	5.545G	16	5.348G
17	5.442G	18	5.489G	19	5.271G	20	5.277G
21	5.542G	22	5.594G	23	5.411G	24	5.517G
25	5.613G	26	5.275G	27	5.426G	28	5.661G
29	5.286G	30	5.595G	31	5.645G	32	5.688G
33	5.357G	34	5.690G	35	5.543G	36	5.364G
37	5.497G	38	5.393G	39	5.435G	40	5.345G
41	5.482G	42	5.344G	43	5.570G	44	5.593G
45	5.715G	46	5.602G	47	5.548G	48	5.451G
49	5.633G	50	5.471G	51	5.605G	52	5.324G
53	5.550G	54	5.526G	55	5.445G	56	5.651G
57	5.289G	58	5.582G	59	5.535G	60	5.251G
61	5.549G	62	5.362G	63	5.527G	64	5.294G
65	5.539G	66	5.423G	67	5.268G	68	5.400G
69	5.368G	70	5.684G	71	5.553G	72	5.703G
73	5.460G	74	5.436G	75	5.448G	76	5.309G
77	5.290G	78	5.260G	79	5.444G	80	5.588G
81	5.530G	82	5.682G	83	5.418G	84	5.560G
85	5.320G	86	5.486G	87	5.404G	88	5.428G
89	5.663G	90	5.401G	91	5.580G	92	5.484G
93	5.495G	94	5.319G	95	5.267G	96	5.618G
97	5.431G	98	5.327G	99	5.252G	100	5.547G

Hopping Frequency Sequence Name: HOP_FREQ_SEQ_24							
SEQ#	Frequency (Hz)	SEQ#	Frequency (Hz)	SEQ#	Frequency (Hz)	SEQ#	Frequency (Hz)
1	5.280G	2	5.283G	3	5.409G	4	5.651G
5	5.340G	6	5.620G	7	5.366G	8	5.353G
9	5.501G	10	5.456G	11	5.573G	12	5.583G
13	5.375G	14	5.630G	15	5.291G	16	5.333G
17	5.477G	18	5.453G	19	5.513G	20	5.510G
21	5.445G	22	5.407G	23	5.401G	24	5.671G
25	5.523G	26	5.428G	27	5.655G	28	5.603G
29	5.650G	30	5.270G	31	5.348G	32	5.367G
33	5.564G	34	5.673G	35	5.362G	36	5.378G
37	5.528G	38	5.334G	39	5.365G	40	5.568G
41	5.341G	42	5.636G	43	5.411G	44	5.549G
45	5.394G	46	5.271G	47	5.420G	48	5.724G
49	5.467G	50	5.423G	51	5.427G	52	5.580G
53	5.611G	54	5.313G	55	5.584G	56	5.553G
57	5.396G	58	5.688G	59	5.516G	60	5.433G
61	5.487G	62	5.308G	63	5.296G	64	5.338G
65	5.666G	66	5.464G	67	5.389G	68	5.421G
69	5.721G	70	5.605G	71	5.555G	72	5.447G
73	5.455G	74	5.567G	75	5.585G	76	5.656G
77	5.469G	78	5.640G	79	5.629G	80	5.424G
81	5.481G	82	5.329G	83	5.342G	84	5.610G
85	5.710G	86	5.489G	87	5.343G	88	5.442G
89	5.692G	90	5.292G	91	5.702G	92	5.601G
93	5.491G	94	5.626G	95	5.644G	96	5.641G
97	5.406G	98	5.450G	99	5.569G	100	5.690G

Hopping Frequency Sequence Name: HOP_FREQ_SEQ_25							
SEQ#	Frequency (Hz)	SEQ#	Frequency (Hz)	SEQ#	Frequency (Hz)	SEQ#	Frequency (Hz)
1	5.615G	2	5.657G	3	5.676G	4	5.592G
5	5.327G	6	5.300G	7	5.337G	8	5.680G
9	5.448G	10	5.690G	11	5.417G	12	5.567G
13	5.604G	14	5.694G	15	5.516G	16	5.503G
17	5.312G	18	5.598G	19	5.696G	20	5.383G
21	5.718G	22	5.475G	23	5.603G	24	5.464G
25	5.425G	26	5.677G	27	5.320G	28	5.367G
29	5.313G	30	5.436G	31	5.463G	32	5.699G
33	5.565G	34	5.371G	35	5.411G	36	5.659G
37	5.661G	38	5.649G	39	5.391G	40	5.589G
41	5.452G	42	5.410G	43	5.484G	44	5.302G
45	5.692G	46	5.270G	47	5.386G	48	5.279G
49	5.601G	50	5.513G	51	5.602G	52	5.673G
53	5.501G	54	5.557G	55	5.494G	56	5.254G
57	5.571G	58	5.264G	59	5.573G	60	5.440G
61	5.281G	62	5.423G	63	5.358G	64	5.500G
65	5.701G	66	5.525G	67	5.446G	68	5.369G
69	5.499G	70	5.582G	71	5.717G	72	5.664G
73	5.515G	74	5.514G	75	5.461G	76	5.631G
77	5.719G	78	5.606G	79	5.483G	80	5.449G
81	5.458G	82	5.447G	83	5.616G	84	5.482G
85	5.453G	86	5.263G	87	5.542G	88	5.399G
89	5.469G	90	5.275G	91	5.295G	92	5.291G
93	5.416G	94	5.444G	95	5.599G	96	5.522G
97	5.640G	98	5.632G	99	5.472G	100	5.583G

Hopping Frequency Sequence Name: HOP_FREQ_SEQ_26							
SEQ#	Frequency (Hz)	SEQ#	Frequency (Hz)	SEQ#	Frequency (Hz)	SEQ#	Frequency (Hz)
1	5.339G	2	5.672G	3	5.594G	4	5.694G
5	5.660G	6	5.647G	7	5.656G	8	5.705G
9	5.551G	10	5.542G	11	5.295G	12	5.316G
13	5.454G	14	5.592G	15	5.582G	16	5.303G
17	5.465G	18	5.417G	19	5.512G	20	5.710G
21	5.289G	22	5.286G	23	5.277G	24	5.440G
25	5.584G	26	5.518G	27	5.505G	28	5.597G
29	5.326G	30	5.371G	31	5.374G	32	5.639G
33	5.355G	34	5.609G	35	5.618G	36	5.463G
37	5.425G	38	5.404G	39	5.711G	40	5.506G
41	5.394G	42	5.431G	43	5.703G	44	5.489G
45	5.596G	46	5.575G	47	5.515G	48	5.655G
49	5.652G	50	5.494G	51	5.358G	52	5.648G
53	5.376G	54	5.457G	55	5.279G	56	5.707G
57	5.412G	58	5.396G	59	5.319G	60	5.430G
61	5.363G	62	5.379G	63	5.544G	64	5.364G
65	5.499G	66	5.622G	67	5.476G	68	5.536G
69	5.487G	70	5.587G	71	5.452G	72	5.418G
73	5.333G	74	5.321G	75	5.528G	76	5.574G
77	5.619G	78	5.386G	79	5.633G	80	5.467G
81	5.600G	82	5.500G	83	5.504G	84	5.265G
85	5.625G	86	5.359G	87	5.485G	88	5.372G
89	5.569G	90	5.456G	91	5.573G	92	5.581G
93	5.281G	94	5.314G	95	5.721G	96	5.650G
97	5.713G	98	5.275G	99	5.686G	100	5.708G

Hopping Frequency Sequence Name: HOP_FREQ_SEQ_27							
SEQ#	Frequency (Hz)	SEQ#	Frequency (Hz)	SEQ#	Frequency (Hz)	SEQ#	Frequency (Hz)
1	5.452G	2	5.650G	3	5.373G	4	5.568G
5	5.602G	6	5.448G	7	5.593G	8	5.367G
9	5.529G	10	5.515G	11	5.598G	12	5.338G
13	5.380G	14	5.524G	15	5.371G	16	5.401G
17	5.522G	18	5.411G	19	5.715G	20	5.590G
21	5.300G	22	5.691G	23	5.433G	24	5.430G
25	5.670G	26	5.318G	27	5.319G	28	5.333G
29	5.260G	30	5.425G	31	5.530G	32	5.708G
33	5.722G	34	5.712G	35	5.501G	36	5.654G
37	5.485G	38	5.424G	39	5.638G	40	5.445G
41	5.564G	42	5.439G	43	5.376G	44	5.442G
45	5.619G	46	5.552G	47	5.347G	48	5.408G
49	5.316G	50	5.643G	51	5.269G	52	5.484G
53	5.687G	54	5.419G	55	5.573G	56	5.473G
57	5.327G	58	5.293G	59	5.611G	60	5.475G
61	5.537G	62	5.583G	63	5.444G	64	5.661G
65	5.551G	66	5.255G	67	5.364G	68	5.349G
69	5.574G	70	5.588G	71	5.680G	72	5.497G
73	5.585G	74	5.534G	75	5.365G	76	5.721G
77	5.469G	78	5.488G	79	5.406G	80	5.348G
81	5.504G	82	5.671G	83	5.651G	84	5.375G
85	5.286G	86	5.507G	87	5.414G	88	5.519G
89	5.684G	90	5.438G	91	5.520G	92	5.265G
93	5.404G	94	5.711G	95	5.586G	96	5.657G
97	5.302G	98	5.575G	99	5.490G	100	5.464G

Hopping Frequency Sequence Name: HOP_FREQ_SEQ_28							
SEQ#	Frequency (Hz)	SEQ#	Frequency (Hz)	SEQ#	Frequency (Hz)	SEQ#	Frequency (Hz)
1	5.434G	2	5.680G	3	5.335G	4	5.560G
5	5.369G	6	5.305G	7	5.710G	8	5.275G
9	5.315G	10	5.475G	11	5.269G	12	5.460G
13	5.533G	14	5.627G	15	5.702G	16	5.661G
17	5.707G	18	5.356G	19	5.687G	20	5.328G
21	5.656G	22	5.563G	23	5.581G	24	5.361G
25	5.694G	26	5.468G	27	5.456G	28	5.304G
29	5.499G	30	5.255G	31	5.391G	32	5.647G
33	5.320G	34	5.653G	35	5.298G	36	5.536G
37	5.665G	38	5.268G	39	5.623G	40	5.721G
41	5.620G	42	5.611G	43	5.313G	44	5.570G
45	5.545G	46	5.716G	47	5.524G	48	5.628G
49	5.698G	50	5.558G	51	5.278G	52	5.723G
53	5.420G	54	5.359G	55	5.722G	56	5.492G
57	5.446G	58	5.354G	59	5.474G	60	5.638G
61	5.720G	62	5.618G	63	5.582G	64	5.326G
65	5.398G	66	5.410G	67	5.634G	68	5.344G
69	5.697G	70	5.253G	71	5.519G	72	5.424G
73	5.594G	74	5.286G	75	5.599G	76	5.264G
77	5.718G	78	5.576G	79	5.682G	80	5.432G
81	5.584G	82	5.462G	83	5.525G	84	5.336G
85	5.577G	86	5.459G	87	5.714G	88	5.449G
89	5.483G	90	5.490G	91	5.347G	92	5.277G
93	5.478G	94	5.292G	95	5.274G	96	5.377G
97	5.617G	98	5.367G	99	5.472G	100	5.337G

Hopping Frequency Sequence Name: HOP_FREQ_SEQ_29							
SEQ#	Frequency (Hz)	SEQ#	Frequency (Hz)	SEQ#	Frequency (Hz)	SEQ#	Frequency (Hz)
1	5.410G	2	5.585G	3	5.609G	4	5.523G
5	5.304G	6	5.466G	7	5.262G	8	5.617G
9	5.311G	10	5.677G	11	5.590G	12	5.283G
13	5.305G	14	5.601G	15	5.404G	16	5.690G
17	5.302G	18	5.655G	19	5.668G	20	5.389G
21	5.412G	22	5.709G	23	5.286G	24	5.631G
25	5.626G	26	5.487G	27	5.257G	28	5.491G
29	5.328G	30	5.345G	31	5.651G	32	5.275G
33	5.605G	34	5.430G	35	5.588G	36	5.705G
37	5.289G	38	5.694G	39	5.365G	40	5.307G
41	5.673G	42	5.288G	43	5.458G	44	5.363G
45	5.573G	46	5.424G	47	5.654G	48	5.354G
49	5.548G	50	5.696G	51	5.440G	52	5.701G
53	5.629G	54	5.390G	55	5.334G	56	5.507G
57	5.434G	58	5.724G	59	5.485G	60	5.444G
61	5.527G	62	5.428G	63	5.360G	64	5.377G
65	5.542G	66	5.641G	67	5.423G	68	5.446G
69	5.483G	70	5.478G	71	5.537G	72	5.293G
73	5.612G	74	5.476G	75	5.445G	76	5.702G
77	5.596G	78	5.388G	79	5.544G	80	5.499G
81	5.621G	82	5.353G	83	5.402G	84	5.603G
85	5.650G	86	5.469G	87	5.327G	88	5.313G
89	5.721G	90	5.432G	91	5.646G	92	5.680G
93	5.640G	94	5.295G	95	5.606G	96	5.604G
97	5.539G	98	5.325G	99	5.468G	100	5.484G

Hopping Frequency Sequence Name: HOP_FREQ_SEQ_30							
SEQ#	Frequency (Hz)	SEQ#	Frequency (Hz)	SEQ#	Frequency (Hz)	SEQ#	Frequency (Hz)
1	5.631G	2	5.628G	3	5.645G	4	5.347G
5	5.591G	6	5.427G	7	5.333G	8	5.692G
9	5.441G	10	5.504G	11	5.600G	12	5.551G
13	5.271G	14	5.647G	15	5.646G	16	5.406G
17	5.613G	18	5.291G	19	5.362G	20	5.394G
21	5.470G	22	5.458G	23	5.546G	24	5.563G
25	5.318G	26	5.397G	27	5.260G	28	5.636G
29	5.576G	30	5.430G	31	5.391G	32	5.460G
33	5.361G	34	5.708G	35	5.698G	36	5.544G
37	5.258G	38	5.474G	39	5.703G	40	5.416G
41	5.657G	42	5.328G	43	5.277G	44	5.617G
45	5.449G	46	5.489G	47	5.575G	48	5.268G
49	5.294G	50	5.723G	51	5.644G	52	5.590G
53	5.256G	54	5.721G	55	5.261G	56	5.259G
57	5.514G	58	5.476G	59	5.345G	60	5.459G
61	5.462G	62	5.266G	63	5.407G	64	5.488G
65	5.286G	66	5.371G	67	5.571G	68	5.556G
69	5.588G	70	5.654G	71	5.678G	72	5.354G
73	5.472G	74	5.526G	75	5.487G	76	5.468G
77	5.508G	78	5.388G	79	5.446G	80	5.520G
81	5.418G	82	5.390G	83	5.550G	84	5.482G
85	5.337G	86	5.404G	87	5.664G	88	5.465G
89	5.598G	90	5.257G	91	5.392G	92	5.516G
93	5.448G	94	5.327G	95	5.614G	96	5.594G
97	5.633G	98	5.637G	99	5.715G	100	5.329G

RBS40**Annex A.1 : The Detailed Radar pattern and Statistical Performance****IEEE 802.11ac VHT20**

Type 1 Radar Statistical Performances					
Trial #	Pulses per Burst	Pulse Width (s)	PRI (s)	Radar Frequency (MHz)	Detection
1	99	1.0u	538.0u	5291	Yes
2	95	1.0u	558.0u	5292	Yes
3	92	1.0u	578.0u	5293	Yes
4	86	1.0u	618.0u	5294	Yes
5	83	1.0u	638.0u	5295	Yes
6	81	1.0u	658.0u	5296	Yes
7	78	1.0u	678.0u	5297	Yes
8	76	1.0u	698.0u	5298	Yes
9	74	1.0u	718.0u	5299	Yes
10	67	1.0u	798.0u	5300	Yes
11	63	1.0u	838.0u	5301	Yes
12	62	1.0u	858.0u	5302	Yes
13	61	1.0u	878.0u	5303	Yes
14	59	1.0u	898.0u	5304	Yes
15	58	1.0u	918.0u	5305	Yes
16	66	1.0u	801.0u	5306	Yes
17	59	1.0u	901.0u	5307	Yes
18	63	1.0u	841.0u	5308	Yes
19	39	1.0u	1.365m	5309	Yes
20	69	1.0u	769.0u	5307	Yes
21	63	1.0u	849.0u	5305	Yes
22	57	1.0u	929.0u	5303	Yes
23	56	1.0u	949.0u	5302	Yes
24	69	1.0u	775.0u	5300	Yes
25	65	1.0u	815.0u	5298	Yes
26	61	1.0u	875.0u	5296	Yes
27	59	1.0u	895.0u	5294	Yes
28	58	1.0u	915.0u	5293	Yes
29	57	1.0u	935.0u	5292	Yes
30	19	1.0u	2.853m	5291	Yes

Detection Rate: 100.0 %

Type 2 Radar Statistical Performances					
Trial #	Pulses per Burst	Pulse Width (s)	PRI (s)	Radar Frequency (MHz)	Detection
1	23	2.3u	222.0u	5291	Yes
2	28	1.8u	204.0u	5292	Yes
3	26	1.6u	225.0u	5293	Yes
4	27	3.8u	168.0u	5294	Yes
5	27	1.1u	227.0u	5295	Yes
6	27	2.6u	166.0u	5296	Yes
7	24	4.7u	161.0u	5297	Yes
8	28	1.9u	180.0u	5298	Yes
9	29	1.3u	176.0u	5299	Yes
10	23	1.8u	170.0u	5300	Yes
11	29	1.4u	195.0u	5301	Yes
12	25	3.4u	228.0u	5302	Yes
13	26	2.3u	206.0u	5303	Yes
14	27	4.5u	189.0u	5304	Yes
15	25	3.9u	194.0u	5302	Yes
16	25	3.0u	154.0u	5303	Yes
17	23	3.6u	182.0u	5304	Yes
18	26	3.4u	160.0u	5305	Yes
19	25	3.3u	229.0u	5306	No
20	23	1.9u	151.0u	5307	Yes
21	25	1.8u	184.0u	5308	Yes
22	28	2.3u	229.0u	5309	Yes
23	29	1.1u	210.0u	5307	Yes
24	26	2.2u	203.0u	5305	Yes
25	25	2.9u	222.0u	5303	Yes
26	28	1.4u	220.0u	5302	Yes
27	26	1.8u	155.0u	5300	Yes
28	29	3.4u	155.0u	5298	Yes
29	28	3.1u	204.0u	5296	Yes
30	26	4.4u	176.0u	5291	Yes

Detection Rate: 96.6 %

Type 3 Radar Statistical Performances					
Trial #	Pulses per Burst	Pulse Width (s)	PRI (s)	Radar Frequency (MHz)	Detection
1	18	7.8u	292.0u	5291	Yes
2	18	7.0u	366.0u	5292	Yes
3	18	9.2u	486.0u	5293	Yes
4	17	6.8u	216.0u	5294	No
5	18	7.3u	446.0u	5295	No
6	16	6.6u	208.0u	5296	Yes
7	17	6.8u	347.0u	5297	Yes
8	17	9.6u	232.0u	5298	Yes
9	17	6.2u	364.0u	5299	Yes
10	16	7.1u	407.0u	5300	Yes
11	18	6.6u	458.0u	5301	Yes
12	17	9.1u	226.0u	5302	Yes
13	16	6.9u	297.0u	5303	Yes
14	18	9.8u	463.0u	5304	Yes
15	17	6.1u	329.0u	5302	Yes
16	17	10.0u	333.0u	5303	Yes
17	18	8.5u	399.0u	5304	Yes
18	17	8.7u	316.0u	5305	Yes
19	16	9.9u	402.0u	5306	Yes
20	17	6.9u	446.0u	5307	Yes
21	16	6.6u	451.0u	5308	Yes
22	16	8.2u	272.0u	5296	Yes
23	17	8.5u	395.0u	5297	Yes
24	17	8.4u	379.0u	5298	Yes
25	16	7.4u	292.0u	5299	Yes
26	16	9.8u	489.0u	5300	Yes
27	17	7.7u	375.0u	5301	Yes
28	16	7.7u	297.0u	5302	Yes
29	18	9.2u	347.0u	5303	Yes
30	16	6.9u	415.0u	5291	Yes

Detection Rate: 93.3 %

Type 4 Radar Statistical Performances					
Trial #	Pulses per Burst	Pulse Width (s)	PRI (s)	Radar Frequency (MHz)	Detection
1	14	18.2u	402.0u	5291	Yes
2	13	14.5u	226.0u	5292	Yes
3	15	13.7u	340.0u	5293	Yes
4	16	12.2u	469.0u	5294	No
5	12	14.6u	220.0u	5295	Yes
6	15	17.0u	370.0u	5296	Yes
7	15	11.4u	458.0u	5297	Yes
8	13	11.6u	487.0u	5298	No
9	16	16.2u	202.0u	5299	No
10	15	19.8u	363.0u	5300	Yes
11	14	11.8u	424.0u	5301	No
12	14	18.0u	407.0u	5302	Yes
13	16	17.8u	256.0u	5303	Yes
14	16	13.1u	420.0u	5304	Yes
15	13	18.6u	243.0u	5302	Yes
16	14	13.4u	284.0u	5303	Yes
17	12	17.7u	410.0u	5304	Yes
18	15	19.3u	234.0u	5305	Yes
19	14	11.9u	411.0u	5306	Yes
20	16	13.4u	420.0u	5307	Yes
21	14	19.2u	235.0u	5308	Yes
22	14	15.2u	406.0u	5295	Yes
23	15	18.7u	408.0u	5296	Yes
24	13	16.1u	366.0u	5297	Yes
25	13	11.3u	369.0u	5298	Yes
26	14	17.1u	284.0u	5299	Yes
27	13	13.5u	495.0u	5300	No
28	15	16.8u	424.0u	5301	Yes
29	14	16.3u	322.0u	5302	Yes
30	13	13.0u	314.0u	5291	Yes

Detection Rate: 83.3 %

Type 5 Radar Statistical Performances		
Trial #	Test Signal Name	Detection
1	LP_Signal_01	Yes
2	LP_Signal_02	Yes
3	LP_Signal_03	Yes
4	LP_Signal_04	Yes
5	LP_Signal_05	Yes
6	LP_Signal_06	Yes
7	LP_Signal_07	Yes
8	LP_Signal_08	Yes
9	LP_Signal_09	Yes
10	LP_Signal_10	Yes
11	LP_Signal_11	Yes
12	LP_Signal_12	Yes
13	LP_Signal_13	Yes
14	LP_Signal_14	Yes
15	LP_Signal_15	Yes
16	LP_Signal_16	Yes
17	LP_Signal_17	Yes
18	LP_Signal_18	Yes
19	LP_Signal_19	Yes
20	LP_Signal_20	Yes
21	LP_Signal_21	Yes
22	LP_Signal_22	Yes
23	LP_Signal_23	Yes
24	LP_Signal_24	Yes
25	LP_Signal_25	Yes
26	LP_Signal_26	Yes
27	LP_Signal_27	Yes
28	LP_Signal_28	Yes
29	LP_Signal_29	Yes
30	LP_Signal_30	Yes
		Detection Rate: 100.0 %

Long Pulse Radar Test Signal						
Test Signal Name: LP_Signal_01						
Number of Bursts in Trial: 16						
Chrip Center Frequency: 5293MHz						
Burst	Pulses per Burst	Chrip (Hz)	Pulse Width (s)	Pulse 1 to 2 Spacing (s)	Pulse 2 to 3 Spacing (s)	Start Location (s)
1	1	5M	59.2u	-	-	243.0m
2	2	5M	94.5u	1.834m	-	299.3m
3	2	5M	95.4u	1.641m	-	566.0m
4	3	5M	59.5u	1.313m	1.332m	354.8m
5	2	5M	62.1u	1.158m	-	618.4m
6	3	5M	73.9u	1.671m	1.534m	629.7m
7	2	5M	50.4u	1.155m	-	384.7m
8	3	5M	62.7u	1.675m	1.571m	94.54m
9	1	5M	52.4u	-	-	45.93m
10	3	5M	55.9u	1.743m	1.537m	37.45m
11	2	5M	62.1u	1.725m	-	173.9m
12	3	5M	65.1u	1.567m	1.369m	549.6m
13	3	5M	80.3u	1.548m	1.117m	530.8m
14	2	5M	85.5u	1.063m	-	265.8m
15	3	5M	54.7u	1.134m	1.657m	49.43m
16	2	5M	85.8u	1.450m	-	382.0m

Long Pulse Radar Test Signal						
Test Signal Name: LP_Signal_02						
Number of Bursts in Trial: 11						
Chrip Center Frequency: 5293MHz						
Burst	Pulses per Burst	Chrip (Hz)	Pulse Width (s)	Pulse 1 to 2 Spacing (s)	Pulse 2 to 3 Spacing (s)	Start Location (s)
1	3	5M	77.4u	928.6u	1.433m	748.0m
2	2	5M	76.8u	1.792m	-	106.4m
3	2	5M	80.6u	1.265m	-	687.9m
4	3	5M	91.4u	1.357m	1.842m	327.9m
5	3	5M	90.0u	1.712m	1.217m	846.9m
6	2	5M	64.2u	1.792m	-	764.9m
7	2	5M	97.3u	1.153m	-	266.8m
8	2	5M	52.9u	952.1u	-	132.9m
9	3	5M	95.0u	1.657m	1.029m	423.4m
10	2	5M	87.7u	1.304m	-	303.7m
11	3	5M	69.8u	1.737m	1.511m	612.5m

Long Pulse Radar Test Signal						
Test Signal Name: LP_Signal_03						
Number of Bursts in Trial: 16						
Chrip Center Frequency: 5293MHz						
Burst	Pulses per Burst	Chrip (Hz)	Pulse Width (s)	Pulse 1 to 2 Spacing (s)	Pulse 2 to 3 Spacing (s)	Start Location (s)
1	3	6M	58.3u	1.169m	1.228m	212.0m
2	1	6M	67.9u	-	-	683.3m
3	2	6M	76.5u	1.176m	-	683.9m
4	2	6M	54.8u	1.298m	-	490.2m
5	3	6M	79.2u	1.024m	1.835m	160.4m
6	2	6M	89.3u	1.805m	-	653.3m
7	1	6M	77.2u	-	-	73.40m
8	3	6M	89.4u	1.249m	1.228m	589.4m
9	3	6M	97.7u	1.549m	1.052m	484.7m
10	3	6M	99.5u	1.824m	1.045m	490.8m
11	2	6M	62.4u	1.758m	-	48.28m
12	2	6M	99.1u	1.202m	-	270.9m
13	3	6M	92.6u	1.079m	1.569m	227.5m
14	2	6M	87.4u	1.359m	-	577.4m
15	1	6M	81.1u	-	-	371.3m
16	3	6M	50.5u	1.117m	996.5u	19.19m

Long Pulse Radar Test Signal						
Test Signal Name: LP_Signal_04						
Number of Bursts in Trial: 15						
Chrip Center Frequency: 5293MHz						
Burst	Pulses per Burst	Chrip (Hz)	Pulse Width (s)	Pulse 1 to 2 Spacing (s)	Pulse 2 to 3 Spacing (s)	Start Location (s)
1	1	6M	68.7u	-	-	13.44m
2	1	6M	92.8u	-	-	618.8m
3	2	6M	73.7u	1.459m	-	424.4m
4	2	6M	97.6u	1.294m	-	736.2m
5	1	6M	93.2u	-	-	795.7m
6	2	6M	97.1u	1.871m	-	787.0m
7	2	6M	89.4u	948.6u	-	601.5m
8	2	6M	92.5u	922.5u	-	499.5m
9	2	6M	94.8u	1.066m	-	562.5m
10	2	6M	78.1u	1.629m	-	68.89m
11	1	6M	88.1u	-	-	749.7m
12	3	6M	98.0u	1.708m	999.0u	541.0m
13	2	6M	74.6u	1.001m	-	9.908m
14	1	6M	80.3u	-	-	107.8m
15	1	6M	66.7u	-	-	643.2m

Long Pulse Radar Test Signal
 Test Signal Name: LP_Signal_05
 Number of Bursts in Trial: 10
 Chrip Center Frequency: 5293MHz

Burst	Pulses per Burst	Chrip (Hz)	Pulse Width (s)	Pulse 1 to 2 Spacing (s)	Pulse 2 to 3 Spacing (s)	Start Location (s)
1	2	7M	55.6u	1.308m	-	946.0m
2	2	7M	90.3u	1.109m	-	586.0m
3	3	7M	75.1u	1.179m	1.124m	427.1m
4	3	7M	86.1u	1.371m	1.270m	375.9m
5	2	7M	89.1u	1.058m	-	615.5m
6	2	7M	76.9u	1.774m	-	247.3m
7	2	7M	64.3u	1.929m	-	1.055
8	3	7M	61.7u	1.387m	1.721m	167.4m
9	2	7M	95.7u	1.831m	-	305.4m
10	3	7M	84.7u	1.764m	1.195m	294.9m

Long Pulse Radar Test Signal
 Test Signal Name: LP_Signal_06
 Number of Bursts in Trial: 14
 Chrip Center Frequency: 5293MHz

Burst	Pulses per Burst	Chrip (Hz)	Pulse Width (s)	Pulse 1 to 2 Spacing (s)	Pulse 2 to 3 Spacing (s)	Start Location (s)
1	3	7M	61.1u	1.316m	1.353m	376.4m
2	2	7M	69.8u	1.577m	-	775.8m
3	3	7M	83.7u	1.741m	1.014m	812.2m
4	3	7M	93.6u	933.4u	990.4u	456.3m
5	1	7M	88.6u	-	-	210.5m
6	1	7M	71.2u	-	-	415.3m
7	2	7M	64.3u	1.046m	-	215.6m
8	1	7M	67.5u	-	-	630.2m
9	1	7M	66.7u	-	-	332.1m
10	1	7M	73.9u	-	-	254.5m
11	2	7M	68.8u	1.006m	-	808.5m
12	2	7M	51.4u	1.834m	-	352.5m
13	2	7M	60.3u	1.317m	-	643.1m
14	1	7M	84.8u	-	-	743.2m

Long Pulse Radar Test Signal
 Test Signal Name: LP_Signal_07
 Number of Bursts in Trial: 13
 Chrip Center Frequency: 5297MHz

Burst	Pulses per Burst	Chrip (Hz)	Pulse Width (s)	Pulse 1 to 2 Spacing (s)	Pulse 2 to 3 Spacing (s)	Start Location (s)
1	1	15M	58.8u	-	-	24.59m
2	2	15M	70.7u	1.396m	-	679.2m
3	2	15M	73.6u	1.819m	-	117.6m
4	2	15M	61.6u	1.469m	-	619.5m
5	2	15M	94.1u	1.818m	-	334.8m
6	2	15M	75.1u	1.779m	-	356.5m
7	2	15M	72.8u	1.892m	-	109.8m
8	1	15M	60.6u	-	-	347.6m
9	1	15M	78.3u	-	-	296.3m
10	1	15M	92.8u	-	-	611.0m
11	2	15M	87.0u	1.901m	-	64.79m
12	2	15M	98.1u	1.888m	-	304.4m
13	2	15M	53.2u	1.031m	-	667.8m

Long Pulse Radar Test Signal						
Test Signal Name: LP_Signal_08						
Number of Bursts in Trial: 8						
Chrip Center Frequency: 5297MHz						
Burst	Pulses per Burst	Chrip (Hz)	Pulse Width (s)	Pulse 1 to 2 Spacing (s)	Pulse 2 to 3 Spacing (s)	Start Location (s)
1	3	15M	86.3u	1.743m	985.7u	297.0m
2	1	15M	66.0u	-	-	1.473
3	3	15M	67.9u	1.531m	1.717m	438.4m
4	3	15M	86.6u	1.433m	1.491m	650.2m
5	2	15M	59.3u	1.648m	-	773.9m
6	2	15M	60.7u	1.384m	-	278.3m
7	2	15M	58.5u	1.114m	-	1.321
8	2	15M	88.9u	920.1u	-	360.9m

Long Pulse Radar Test Signal						
Test Signal Name: LP_Signal_09						
Number of Bursts in Trial: 16						
Chrip Center Frequency: 5299MHz						
Burst	Pulses per Burst	Chrip (Hz)	Pulse Width (s)	Pulse 1 to 2 Spacing (s)	Pulse 2 to 3 Spacing (s)	Start Location (s)
1	2	20M	80.2u	1.739m	-	720.6m
2	3	20M	50.1u	1.816m	1.933m	558.9m
3	1	20M	96.2u	-	-	211.8m
4	3	20M	72.6u	1.275m	1.410m	628.1m
5	2	20M	92.6u	1.262m	-	295.1m
6	2	20M	70.1u	1.814m	-	404.0m
7	2	20M	96.2u	1.463m	-	89.45m
8	2	20M	78.6u	1.436m	-	275.4m
9	2	20M	85.9u	1.077m	-	726.5m
10	3	20M	86.3u	1.689m	1.395m	279.8m
11	1	20M	88.0u	-	-	142.6m
12	3	20M	58.3u	1.051m	995.7u	248.6m
13	2	20M	95.3u	1.642m	-	392.4m
14	3	20M	93.1u	1.100m	1.481m	639.1m
15	1	20M	96.7u	-	-	614.9m
16	2	20M	67.1u	1.370m	-	471.2m

Long Pulse Radar Test Signal						
Test Signal Name: LP_Signal_10						
Number of Bursts in Trial: 18						
Chrip Center Frequency: 5299MHz						
Burst	Pulses per Burst	Chrip (Hz)	Pulse Width (s)	Pulse 1 to 2 Spacing (s)	Pulse 2 to 3 Spacing (s)	Start Location (s)
1	2	20M	98.6u	1.198m	-	344.9m
2	2	20M	57.6u	961.4u	-	641.7m
3	1	20M	56.4u	-	-	308.8m
4	1	20M	81.4u	-	-	180.2m
5	1	20M	61.8u	-	-	297.7m
6	2	20M	90.4u	1.563m	-	282.9m
7	3	20M	68.8u	1.515m	1.370m	37.46m
8	1	20M	73.9u	-	-	475.8m
9	2	20M	68.4u	1.684m	-	117.5m
10	3	20M	95.4u	1.490m	1.735m	155.9m
11	1	20M	70.9u	-	-	253.8m
12	1	20M	94.7u	-	-	356.0m
13	3	20M	76.9u	1.750m	1.203m	56.37m

14	3	20M	80.6u	1.024m	1.881m	588.3m
15	2	20M	87.2u	1.015m	-	223.6m
16	2	20M	85.9u	1.898m	-	380.5m
17	1	20M	62.9u	-	-	127.1m
18	2	20M	96.3u	1.532m	-	541.3m

Long Pulse Radar Test Signal						
Test Signal Name: LP_Signal_11						
Number of Bursts in Trial: 12						
Chrip Center Frequency: 5300MHz						
Burst	Pulses per Burst	Chrip (Hz)	Pulse Width (s)	Pulse 1 to 2 Spacing (s)	Pulse 2 to 3 Spacing (s)	Start Location (s)
1	1	6M	74.4u	-	-	870.4m
2	2	6M	73.0u	1.799m	-	254.4m
3	1	6M	69.1u	-	-	695.0m
4	2	6M	80.4u	1.729m	-	818.0m
5	2	6M	80.1u	1.222m	-	775.0m
6	3	6M	61.6u	1.022m	1.568m	773.7m
7	2	6M	72.5u	1.562m	-	260.7m
8	3	6M	69.9u	1.863m	1.712m	187.4m
9	2	6M	98.9u	1.750m	-	407.2m
10	1	6M	86.5u	-	-	242.1m
11	2	6M	67.5u	1.178m	-	608.3m
12	3	6M	85.8u	1.665m	1.754m	944.7m

Long Pulse Radar Test Signal						
Test Signal Name: LP_Signal_12						
Number of Bursts in Trial: 10						
Chrip Center Frequency: 5300MHz						
Burst	Pulses per Burst	Chrip (Hz)	Pulse Width (s)	Pulse 1 to 2 Spacing (s)	Pulse 2 to 3 Spacing (s)	Start Location (s)
1	1	6M	63.2u	-	-	639.7m
2	3	6M	51.2u	1.477m	1.835m	678.8m
3	3	6M	64.0u	1.440m	1.154m	534.7m
4	2	6M	70.2u	1.135m	-	1.023
5	2	6M	82.2u	1.368m	-	565.5m
6	2	6M	90.8u	1.524m	-	59.60m
7	2	6M	61.5u	985.5u	-	1.004
8	1	6M	52.3u	-	-	775.3m
9	3	6M	75.8u	1.274m	1.399m	123.2m
10	1	6M	83.4u	-	-	1.109

Long Pulse Radar Test Signal						
Test Signal Name: LP_Signal_13						
Number of Bursts in Trial: 8						
Chrip Center Frequency: 5300MHz						
Burst	Pulses per Burst	Chrip (Hz)	Pulse Width (s)	Pulse 1 to 2 Spacing (s)	Pulse 2 to 3 Spacing (s)	Start Location (s)
1	2	11M	84.4u	1.421m	-	801.3m
2	3	11M	70.4u	1.837m	1.413m	694.8m
3	1	11M	56.8u	-	-	852.3m
4	2	11M	88.3u	1.609m	-	214.6m
5	3	11M	63.4u	1.206m	1.734m	788.8m
6	3	11M	66.9u	942.1u	1.551m	502.0m
7	3	11M	67.8u	938.2u	1.580m	404.8m
8	2	11M	68.5u	1.233m	-	191.0m

Long Pulse Radar Test Signal						
Test Signal Name: LP_Signal_14						
Number of Bursts in Trial: 19						
Chrip Center Frequency: 5300MHz						
Burst	Pulses per Burst	Chrip (Hz)	Pulse Width (s)	Pulse 1 to 2 Spacing (s)	Pulse 2 to 3 Spacing (s)	Start Location (s)
1	1	11M	83.2u	-	-	45.94m
2	2	11M	64.2u	1.124m	-	371.8m
3	2	11M	93.6u	1.066m	-	35.45m
4	2	11M	81.4u	1.900m	-	379.4m
5	2	11M	72.5u	1.373m	-	425.9m
6	2	11M	63.2u	1.827m	-	395.1m
7	3	11M	78.0u	1.366m	1.019m	157.6m
8	1	11M	70.4u	-	-	237.3m
9	3	11M	62.4u	1.269m	1.701m	582.7m
10	1	11M	85.8u	-	-	223.0m
11	3	11M	57.4u	1.075m	1.909m	626.8m
12	2	11M	66.5u	1.637m	-	578.6m
13	3	11M	52.8u	1.165m	1.623m	626.6m
14	3	11M	51.0u	1.021m	1.068m	482.0m
15	1	11M	52.0u	-	-	471.8m
16	2	11M	72.0u	1.694m	-	284.8m
17	2	11M	58.9u	1.920m	-	155.7m
18	3	11M	84.2u	1.879m	1.077m	352.7m
19	2	11M	51.5u	1.504m	-	605.5m

Long Pulse Radar Test Signal						
Test Signal Name: LP_Signal_15						
Number of Bursts in Trial: 11						
Chrip Center Frequency: 5300MHz						
Burst	Pulses per Burst	Chrip (Hz)	Pulse Width (s)	Pulse 1 to 2 Spacing (s)	Pulse 2 to 3 Spacing (s)	Start Location (s)
1	2	16M	60.9u	1.685m	-	1.030
2	2	16M	86.8u	1.363m	-	1.069
3	2	16M	95.4u	1.521m	-	296.1m
4	3	16M	73.5u	1.628m	1.226m	377.5m
5	2	16M	67.5u	1.036m	-	644.9m
6	3	16M	65.5u	1.798m	1.561m	766.1m
7	3	16M	95.9u	1.094m	1.242m	537.2m
8	2	16M	96.2u	1.578m	-	172.3m
9	2	16M	90.4u	1.274m	-	256.1m
10	2	16M	90.1u	1.319m	-	842.4m
11	2	16M	59.3u	1.600m	-	728.8m

Long Pulse Radar Test Signal						
Test Signal Name: LP_Signal_16						
Number of Bursts in Trial: 16						
Chrip Center Frequency: 5300MHz						
Burst	Pulses per Burst	Chrip (Hz)	Pulse Width (s)	Pulse 1 to 2 Spacing (s)	Pulse 2 to 3 Spacing (s)	Start Location (s)
1	1	16M	53.9u	-	-	653.0m
2	3	16M	87.4u	1.140m	1.207m	109.0m
3	2	16M	56.0u	1.104m	-	462.3m
4	2	16M	62.5u	1.625m	-	704.3m
5	2	16M	66.7u	1.202m	-	296.4m
6	2	16M	65.6u	1.571m	-	169.5m
7	2	16M	65.2u	1.889m	-	703.7m
8	1	16M	67.4u	-	-	78.58m
9	3	16M	70.1u	1.820m	1.460m	419.9m
10	2	16M	62.3u	1.636m	-	7.821m
11	3	16M	79.8u	1.442m	1.551m	384.2m
12	1	16M	81.4u	-	-	378.9m
13	2	16M	75.0u	1.336m	-	742.0m
14	2	16M	74.3u	1.487m	-	726.4m
15	3	16M	88.8u	1.772m	1.153m	168.4m
16	3	16M	67.7u	1.248m	1.211m	647.3m

Long Pulse Radar Test Signal						
Test Signal Name: LP_Signal_17						
Number of Bursts in Trial: 9						
Chrip Center Frequency: 5300MHz						
Burst	Pulses per Burst	Chrip (Hz)	Pulse Width (s)	Pulse 1 to 2 Spacing (s)	Pulse 2 to 3 Spacing (s)	Start Location (s)
1	3	18M	50.9u	1.721m	1.677m	787.1m
2	2	18M	70.9u	1.645m	-	357.8m
3	2	18M	61.2u	1.863m	-	730.2m
4	3	18M	55.6u	1.573m	1.305m	472.0m
5	2	18M	61.9u	1.421m	-	88.96m
6	1	18M	52.6u	-	-	911.3m
7	3	18M	60.7u	1.420m	1.845m	81.67m
8	2	18M	76.7u	1.616m	-	600.1m
9	1	18M	82.1u	-	-	1.017

Long Pulse Radar Test Signal						
Test Signal Name: LP_Signal_18						
Number of Bursts in Trial: 12						
Chrip Center Frequency: 5300MHz						
Burst	Pulses per Burst	Chrip (Hz)	Pulse Width (s)	Pulse 1 to 2 Spacing (s)	Pulse 2 to 3 Spacing (s)	Start Location (s)
1	3	18M	52.0u	963.0u	1.272m	607.1m
2	2	18M	94.7u	1.569m	-	970.0m
3	2	18M	81.7u	1.783m	-	405.2m
4	1	18M	79.0u	-	-	481.4m
5	3	18M	68.5u	1.228m	1.226m	689.8m
6	2	18M	54.6u	1.639m	-	657.6m
7	1	18M	68.1u	-	-	841.1m
8	1	18M	89.8u	-	-	916.7m
9	1	18M	69.1u	-	-	211.7m
10	1	18M	97.8u	-	-	374.1m
11	2	18M	96.3u	1.242m	-	457.4m
12	3	18M	95.6u	981.4u	1.107m	828.4m

Long Pulse Radar Test Signal						
Test Signal Name: LP_Signal_19						
Number of Bursts in Trial: 10						
Chrip Center Frequency: 5300MHz						
Burst	Pulses per Burst	Chrip (Hz)	Pulse Width (s)	Pulse 1 to 2 Spacing (s)	Pulse 2 to 3 Spacing (s)	Start Location (s)
1	2	20M	78.6u	1.551m	-	833.2m
2	2	20M	51.6u	990.4u	-	825.2m
3	2	20M	86.8u	1.097m	-	809.6m
4	1	20M	60.5u	-	-	792.9m
5	2	20M	54.9u	1.783m	-	491.4m
6	2	20M	75.7u	1.245m	-	717.7m
7	2	20M	55.0u	1.513m	-	1.155
8	2	20M	79.2u	955.8u	-	118.6m
9	1	20M	56.4u	-	-	881.1m
10	1	20M	97.7u	-	-	978.0m

Long Pulse Radar Test Signal						
Test Signal Name: LP_Signal_20						
Number of Bursts in Trial: 20						
Chrip Center Frequency: 5300MHz						
Burst	Pulses per Burst	Chrip (Hz)	Pulse Width (s)	Pulse 1 to 2 Spacing (s)	Pulse 2 to 3 Spacing (s)	Start Location (s)
1	2	20M	63.1u	1.352m	-	165.6m
2	2	20M	58.9u	1.458m	-	231.2m
3	2	20M	77.9u	1.812m	-	578.2m
4	2	20M	55.4u	1.834m	-	493.0m
5	3	20M	93.5u	1.337m	1.895m	207.5m
6	2	20M	92.8u	1.212m	-	161.6m
7	3	20M	60.2u	1.500m	1.299m	450.6m
8	3	20M	92.9u	980.1u	1.224m	70.72m
9	3	20M	68.5u	1.737m	1.169m	263.0m
10	2	20M	85.6u	967.4u	-	128.5m
11	2	20M	85.4u	1.165m	-	495.9m
12	2	20M	68.2u	1.498m	-	88.26m
13	2	20M	66.6u	1.769m	-	10.88m
14	3	20M	56.7u	1.517m	1.056m	393.2m
15	1	20M	61.9u	-	-	488.3m
16	3	20M	92.9u	1.185m	1.163m	309.7m
17	2	20M	59.6u	1.139m	-	243.6m
18	3	20M	71.4u	1.337m	1.026m	381.3m
19	3	20M	66.5u	1.886m	1.669m	75.38m
20	1	20M	99.2u	-	-	205.0m

Long Pulse Radar Test Signal						
Test Signal Name: LP_Signal_21						
Number of Bursts in Trial: 16						
Chrip Center Frequency: 5307MHz						
Burst	Pulses per Burst	Chrip (Hz)	Pulse Width (s)	Pulse 1 to 2 Spacing (s)	Pulse 2 to 3 Spacing (s)	Start Location (s)
1	1	5M	59.2u	-	-	243.0m
2	2	5M	94.5u	1.834m	-	299.3m
3	2	5M	95.4u	1.641m	-	566.0m
4	3	5M	59.5u	1.313m	1.332m	354.8m
5	2	5M	62.1u	1.158m	-	618.4m
6	3	5M	73.9u	1.671m	1.534m	629.7m
7	2	5M	50.4u	1.155m	-	384.7m
8	3	5M	62.7u	1.675m	1.571m	94.54m
9	1	5M	52.4u	-	-	45.93m
10	3	5M	55.9u	1.743m	1.537m	37.45m
11	2	5M	62.1u	1.725m	-	173.9m
12	3	5M	65.1u	1.567m	1.369m	549.6m
13	3	5M	80.3u	1.548m	1.117m	530.8m
14	2	5M	85.5u	1.063m	-	265.8m
15	3	5M	54.7u	1.134m	1.657m	49.43m
16	2	5M	85.8u	1.450m	-	382.0m

Long Pulse Radar Test Signal						
Test Signal Name: LP_Signal_22						
Number of Bursts in Trial: 19						
Chrip Center Frequency: 5307MHz						
Burst	Pulses per Burst	Chrip (Hz)	Pulse Width (s)	Pulse 1 to 2 Spacing (s)	Pulse 2 to 3 Spacing (s)	Start Location (s)
1	3	5M	61.2u	1.793m	1.857m	398.8m
2	1	5M	53.7u	-	-	300.3m
3	2	5M	82.7u	1.900m	-	154.0m
4	3	5M	98.8u	1.369m	1.879m	7.212m
5	2	5M	54.9u	1.516m	-	475.2m
6	3	5M	57.2u	1.640m	1.396m	427.7m
7	2	5M	91.6u	1.507m	-	435.3m
8	2	5M	69.8u	1.897m	-	349.7m
9	2	5M	58.1u	1.668m	-	584.4m
10	2	5M	81.6u	1.380m	-	184.8m
11	2	5M	57.5u	1.242m	-	221.2m
12	3	5M	92.2u	1.227m	913.8u	353.3m
13	2	5M	81.9u	1.129m	-	486.4m
14	2	5M	66.9u	1.395m	-	235.5m
15	1	5M	67.9u	-	-	415.5m
16	3	5M	99.2u	1.884m	1.803m	462.9m
17	2	5M	71.2u	1.043m	-	214.2m
18	1	5M	70.9u	-	-	379.4m
19	2	5M	68.8u	1.209m	-	322.3m

Long Pulse Radar Test Signal
 Test Signal Name: LP_Signal_23
 Number of Bursts in Trial: 10
 Chrip Center Frequency: 5305MHz

Burst	Pulses per Burst	Chrip (Hz)	Pulse Width (s)	Pulse 1 to 2 Spacing (s)	Pulse 2 to 3 Spacing (s)	Start Location (s)
1	2	10M	77.1u	1.267m	-	774.1m
2	3	10M	99.8u	1.558m	1.032m	769.0m
3	2	10M	73.2u	1.204m	-	760.7m
4	3	10M	74.0u	1.642m	1.403m	202.1m
5	2	10M	61.7u	982.3u	-	236.2m
6	2	10M	68.4u	1.120m	-	889.3m
7	2	10M	98.4u	1.604m	-	192.4m
8	2	10M	72.5u	1.756m	-	721.2m
9	3	10M	52.4u	1.480m	1.691m	405.5m
10	3	10M	96.6u	1.397m	1.029m	235.6m

Long Pulse Radar Test Signal
 Test Signal Name: LP_Signal_24
 Number of Bursts in Trial: 9
 Chrip Center Frequency: 5305MHz

Burst	Pulses per Burst	Chrip (Hz)	Pulse Width (s)	Pulse 1 to 2 Spacing (s)	Pulse 2 to 3 Spacing (s)	Start Location (s)
1	3	10M	80.2u	1.716m	1.208m	458.3m
2	2	10M	99.0u	1.877m	-	80.24m
3	1	10M	70.5u	-	-	705.0m
4	1	10M	88.3u	-	-	69.65m
5	2	10M	56.4u	1.516m	-	922.0m
6	1	10M	100.0u	-	-	179.3m
7	2	10M	58.2u	994.8u	-	1.187
8	1	10M	98.0u	-	-	223.9m
9	1	10M	92.7u	-	-	927.1m

Long Pulse Radar Test Signal
 Test Signal Name: LP_Signal_25
 Number of Bursts in Trial: 10
 Chrip Center Frequency: 5303MHz

Burst	Pulses per Burst	Chrip (Hz)	Pulse Width (s)	Pulse 1 to 2 Spacing (s)	Pulse 2 to 3 Spacing (s)	Start Location (s)
1	2	15M	94.0u	1.223m	-	602.5m
2	1	15M	72.8u	-	-	973.3m
3	1	15M	53.8u	-	-	901.9m
4	2	15M	62.4u	1.292m	-	937.5m
5	2	15M	78.8u	1.014m	-	731.3m
6	2	15M	93.5u	1.149m	-	20.15m
7	1	15M	61.8u	-	-	620.4m
8	3	15M	82.0u	1.788m	1.001m	82.34m
9	1	15M	63.6u	-	-	891.7m
10	2	15M	76.7u	1.229m	-	49.96m

Long Pulse Radar Test Signal						
Test Signal Name: LP_Signal_26						
Number of Bursts in Trial: 11						
Chrip Center Frequency: 5303MHz						
Burst	Pulses per Burst	Chrip (Hz)	Pulse Width (s)	Pulse 1 to 2 Spacing (s)	Pulse 2 to 3 Spacing (s)	Start Location (s)
1	1	15M	84.4u	-	-	558.9m
2	2	15M	74.4u	1.227m	-	40.96m
3	3	15M	59.9u	1.513m	1.461m	466.4m
4	1	15M	54.6u	-	-	934.1m
5	2	15M	56.2u	1.306m	-	791.5m
6	2	15M	80.1u	1.693m	-	378.4m
7	2	15M	50.2u	1.675m	-	844.0m
8	2	15M	89.6u	1.641m	-	762.8m
9	1	15M	81.8u	-	-	133.1m
10	1	15M	89.0u	-	-	56.12m
11	1	15M	62.1u	-	-	784.8m

Long Pulse Radar Test Signal						
Test Signal Name: LP_Signal_27						
Number of Bursts in Trial: 17						
Chrip Center Frequency: 5302MHz						
Burst	Pulses per Burst	Chrip (Hz)	Pulse Width (s)	Pulse 1 to 2 Spacing (s)	Pulse 2 to 3 Spacing (s)	Start Location (s)
1	1	18M	99.1u	-	-	365.0m
2	2	18M	80.2u	1.073m	-	218.9m
3	1	18M	98.4u	-	-	62.40m
4	2	18M	79.9u	924.1u	-	28.38m
5	3	18M	85.7u	1.729m	1.103m	59.49m
6	3	18M	83.1u	1.033m	1.823m	360.0m
7	1	18M	93.9u	-	-	207.7m
8	2	18M	92.9u	1.657m	-	307.2m
9	2	18M	93.9u	1.164m	-	269.1m
10	3	18M	71.8u	1.516m	1.207m	433.3m
11	2	18M	60.1u	1.913m	-	334.1m
12	2	18M	65.1u	1.569m	-	471.0m
13	2	18M	70.1u	1.020m	-	403.4m
14	2	18M	54.7u	1.505m	-	537.2m
15	2	18M	71.7u	1.764m	-	569.9m
16	2	18M	98.5u	1.729m	-	505.7m
17	2	18M	90.2u	1.677m	-	644.0m

Long Pulse Radar Test Signal						
Test Signal Name: LP_Signal_28						
Number of Bursts in Trial: 10						
Chrip Center Frequency: 5302MHz						
Burst	Pulses per Burst	Chrip (Hz)	Pulse Width (s)	Pulse 1 to 2 Spacing (s)	Pulse 2 to 3 Spacing (s)	Start Location (s)
1	1	18M	91.4u	-	-	1.193
2	2	18M	59.0u	1.416m	-	691.9m
3	3	18M	75.5u	1.576m	1.710m	949.0m
4	3	18M	57.2u	1.495m	1.274m	98.67m
5	2	18M	86.9u	1.499m	-	1.077
6	3	18M	59.2u	1.913m	1.856m	327.0m
7	1	18M	79.4u	-	-	681.2m
8	3	18M	98.1u	1.764m	1.499m	780.6m
9	2	18M	79.1u	1.785m	-	22.12m
10	3	18M	75.5u	1.187m	1.373m	229.5m

Long Pulse Radar Test Signal						
Test Signal Name: LP_Signal_29						
Number of Bursts in Trial: 16						
Chrip Center Frequency: 5301MHz						
Burst	Pulses per Burst	Chrip (Hz)	Pulse Width (s)	Pulse 1 to 2 Spacing (s)	Pulse 2 to 3 Spacing (s)	Start Location (s)
1	2	20M	80.2u	1.739m	-	720.6m
2	3	20M	50.1u	1.816m	1.933m	558.9m
3	1	20M	96.2u	-	-	211.8m
4	3	20M	72.6u	1.275m	1.410m	628.1m
5	2	20M	92.6u	1.262m	-	295.1m
6	2	20M	70.1u	1.814m	-	404.0m
7	2	20M	96.2u	1.463m	-	89.45m
8	2	20M	78.6u	1.436m	-	275.4m
9	2	20M	85.9u	1.077m	-	726.5m
10	3	20M	86.3u	1.689m	1.395m	279.8m
11	1	20M	88.0u	-	-	142.6m
12	3	20M	58.3u	1.051m	995.7u	248.6m
13	2	20M	95.3u	1.642m	-	392.4m
14	3	20M	93.1u	1.100m	1.481m	639.1m
15	1	20M	96.7u	-	-	614.9m
16	2	20M	67.1u	1.370m	-	471.2m

Long Pulse Radar Test Signal						
Test Signal Name: LP_Signal_30						
Number of Bursts in Trial: 16						
Chirp Center Frequency: 5301MHz						
Burst	Pulses per Burst	Chirp (Hz)	Pulse Width (s)	Pulse 1 to 2 Spacing (s)	Pulse 2 to 3 Spacing (s)	Start Location (s)
1	2	20M	98.1u	1.220m	-	507.2m
2	2	20M	73.5u	1.910m	-	227.2m
3	2	20M	98.2u	1.506m	-	631.2m
4	3	20M	97.9u	1.595m	1.851m	164.0m
5	1	20M	92.9u	-	-	45.06m
6	2	20M	76.6u	1.260m	-	601.8m
7	2	20M	68.1u	1.217m	-	342.9m
8	1	20M	53.3u	-	-	86.38m
9	2	20M	58.0u	978.0u	-	75.50m
10	1	20M	66.6u	-	-	328.5m
11	3	20M	69.0u	1.388m	1.330m	707.6m
12	2	20M	68.3u	1.450m	-	328.0m
13	3	20M	99.1u	1.752m	1.303m	426.0m
14	1	20M	94.8u	-	-	632.9m
15	1	20M	99.7u	-	-	169.8m
16	1	20M	51.5u	-	-	455.1m

Type 6 Radar Statistical Performances				
Trial #	Pulses per Burst	Pulse Width (s)	PRI (s)	Detection
1	9	1.0u	333.0u	Yes
2	9	1.0u	333.0u	Yes
3	9	1.0u	333.0u	Yes
4	9	1.0u	333.0u	Yes
5	9	1.0u	333.0u	Yes
6	9	1.0u	333.0u	Yes
7	9	1.0u	333.0u	Yes
8	9	1.0u	333.0u	Yes
9	9	1.0u	333.0u	Yes
10	9	1.0u	333.0u	Yes
11	9	1.0u	333.0u	Yes
12	9	1.0u	333.0u	Yes
13	9	1.0u	333.0u	Yes
14	9	1.0u	333.0u	Yes
15	9	1.0u	333.0u	Yes
16	9	1.0u	333.0u	No
17	9	1.0u	333.0u	Yes
18	9	1.0u	333.0u	Yes
19	9	1.0u	333.0u	Yes
20	9	1.0u	333.0u	No
21	9	1.0u	333.0u	Yes
22	9	1.0u	333.0u	Yes
23	9	1.0u	333.0u	Yes
24	9	1.0u	333.0u	Yes
25	9	1.0u	333.0u	Yes
26	9	1.0u	333.0u	Yes
27	9	1.0u	333.0u	Yes
28	9	1.0u	333.0u	Yes
29	9	1.0u	333.0u	Yes
30	9	1.0u	333.0u	Yes
				Detection Rate: 93.3 %

Type 6 Radar Statistical Performances		
Trial #	Hopping Frequency Sequence Name	Detection
1	HOP_FREQ_SEQ_01	Yes
2	HOP_FREQ_SEQ_02	Yes
3	HOP_FREQ_SEQ_03	Yes
4	HOP_FREQ_SEQ_04	Yes
5	HOP_FREQ_SEQ_05	Yes
6	HOP_FREQ_SEQ_06	Yes
7	HOP_FREQ_SEQ_07	Yes
8	HOP_FREQ_SEQ_08	Yes
9	HOP_FREQ_SEQ_09	Yes
10	HOP_FREQ_SEQ_10	Yes
11	HOP_FREQ_SEQ_11	Yes
12	HOP_FREQ_SEQ_12	Yes
13	HOP_FREQ_SEQ_13	Yes
14	HOP_FREQ_SEQ_14	Yes
15	HOP_FREQ_SEQ_15	Yes
16	HOP_FREQ_SEQ_16	No
17	HOP_FREQ_SEQ_17	Yes
18	HOP_FREQ_SEQ_18	Yes
19	HOP_FREQ_SEQ_19	Yes
20	HOP_FREQ_SEQ_20	No
21	HOP_FREQ_SEQ_21	Yes
22	HOP_FREQ_SEQ_22	Yes
23	HOP_FREQ_SEQ_23	Yes
24	HOP_FREQ_SEQ_24	Yes
25	HOP_FREQ_SEQ_25	Yes
26	HOP_FREQ_SEQ_26	Yes
27	HOP_FREQ_SEQ_27	Yes
28	HOP_FREQ_SEQ_28	Yes
29	HOP_FREQ_SEQ_29	Yes
30	HOP_FREQ_SEQ_30	Yes
		Detection Rate: 93.3 %

Hopping Frequency Sequence Name: HOP_FREQ_SEQ_01							
SEQ#	Frequency (Hz)	SEQ#	Frequency (Hz)	SEQ#	Frequency (Hz)	SEQ#	Frequency (Hz)
1	5.505G	2	5.674G	3	5.257G	4	5.690G
5	5.520G	6	5.262G	7	5.356G	8	5.439G
9	5.685G	10	5.332G	11	5.720G	12	5.579G
13	5.313G	14	5.383G	15	5.697G	16	5.318G
17	5.695G	18	5.461G	19	5.719G	20	5.606G
21	5.533G	22	5.287G	23	5.675G	24	5.540G
25	5.604G	26	5.591G	27	5.564G	28	5.612G
29	5.399G	30	5.593G	31	5.600G	32	5.478G
33	5.667G	34	5.434G	35	5.299G	36	5.387G
37	5.319G	38	5.376G	39	5.710G	40	5.581G
41	5.624G	42	5.302G	43	5.406G	44	5.272G
45	5.531G	46	5.298G	47	5.303G	48	5.265G
49	5.688G	50	5.372G	51	5.699G	52	5.550G
53	5.336G	54	5.308G	55	5.565G	56	5.269G
57	5.635G	58	5.650G	59	5.357G	60	5.462G
61	5.389G	62	5.626G	63	5.411G	64	5.386G
65	5.665G	66	5.481G	67	5.354G	68	5.267G
69	5.279G	70	5.558G	71	5.578G	72	5.647G
73	5.717G	74	5.382G	75	5.297G	76	5.601G
77	5.630G	78	5.603G	79	5.676G	80	5.657G
81	5.608G	82	5.329G	83	5.388G	84	5.602G
85	5.549G	86	5.451G	87	5.709G	88	5.716G
89	5.643G	90	5.285G	91	5.377G	92	5.443G
93	5.535G	94	5.584G	95	5.506G	96	5.723G
97	5.507G	98	5.712G	99	5.680G	100	5.724G

Hopping Frequency Sequence Name: HOP_FREQ_SEQ_02							
SEQ#	Frequency (Hz)	SEQ#	Frequency (Hz)	SEQ#	Frequency (Hz)	SEQ#	Frequency (Hz)
1	5.350G	2	5.673G	3	5.251G	4	5.286G
5	5.699G	6	5.714G	7	5.500G	8	5.265G
9	5.299G	10	5.455G	11	5.359G	12	5.611G
13	5.487G	14	5.448G	15	5.663G	16	5.373G
17	5.269G	18	5.614G	19	5.439G	20	5.385G
21	5.680G	22	5.603G	23	5.363G	24	5.341G
25	5.303G	26	5.504G	27	5.576G	28	5.584G
29	5.632G	30	5.535G	31	5.402G	32	5.597G
33	5.308G	34	5.566G	35	5.689G	36	5.301G
37	5.494G	38	5.400G	39	5.513G	40	5.691G
41	5.553G	42	5.343G	43	5.532G	44	5.520G
45	5.664G	46	5.718G	47	5.612G	48	5.444G
49	5.452G	50	5.588G	51	5.307G	52	5.422G
53	5.662G	54	5.275G	55	5.583G	56	5.578G
57	5.595G	58	5.479G	59	5.410G	60	5.693G
61	5.465G	62	5.312G	63	5.268G	64	5.629G
65	5.671G	66	5.284G	67	5.406G	68	5.624G
69	5.300G	70	5.568G	71	5.318G	72	5.711G
73	5.330G	74	5.399G	75	5.694G	76	5.631G
77	5.416G	78	5.723G	79	5.637G	80	5.339G
81	5.252G	82	5.703G	83	5.654G	84	5.538G
85	5.478G	86	5.482G	87	5.474G	88	5.407G
89	5.279G	90	5.316G	91	5.592G	92	5.627G
93	5.594G	94	5.633G	95	5.380G	96	5.598G
97	5.533G	98	5.446G	99	5.526G	100	5.555G

Hopping Frequency Sequence Name: HOP_FREQ_SEQ_03							
SEQ#	Frequency (Hz)	SEQ#	Frequency (Hz)	SEQ#	Frequency (Hz)	SEQ#	Frequency (Hz)
1	5.501G	2	5.592G	3	5.263G	4	5.484G
5	5.549G	6	5.346G	7	5.361G	8	5.576G
9	5.264G	10	5.700G	11	5.623G	12	5.324G
13	5.640G	14	5.669G	15	5.344G	16	5.579G
17	5.703G	18	5.585G	19	5.382G	20	5.601G
21	5.364G	22	5.296G	23	5.524G	24	5.532G
25	5.546G	26	5.555G	27	5.710G	28	5.644G
29	5.465G	30	5.456G	31	5.526G	32	5.627G
33	5.621G	34	5.717G	35	5.667G	36	5.652G
37	5.659G	38	5.498G	39	5.478G	40	5.386G
41	5.654G	42	5.508G	43	5.716G	44	5.599G
45	5.408G	46	5.427G	47	5.306G	48	5.402G
49	5.337G	50	5.464G	51	5.712G	52	5.358G
53	5.278G	54	5.680G	55	5.365G	56	5.442G
57	5.432G	58	5.538G	59	5.315G	60	5.587G
61	5.342G	62	5.615G	63	5.674G	64	5.563G
65	5.668G	66	5.460G	67	5.590G	68	5.542G
69	5.685G	70	5.469G	71	5.453G	72	5.429G
73	5.504G	74	5.660G	75	5.353G	76	5.616G
77	5.417G	78	5.672G	79	5.331G	80	5.393G
81	5.449G	82	5.347G	83	5.610G	84	5.706G
85	5.314G	86	5.321G	87	5.415G	88	5.724G
89	5.392G	90	5.437G	91	5.691G	92	5.407G
93	5.625G	94	5.463G	95	5.582G	96	5.646G
97	5.622G	98	5.688G	99	5.266G	100	5.428G

Hopping Frequency Sequence Name: HOP_FREQ_SEQ_04							
SEQ#	Frequency (Hz)	SEQ#	Frequency (Hz)	SEQ#	Frequency (Hz)	SEQ#	Frequency (Hz)
1	5.487G	2	5.498G	3	5.707G	4	5.277G
5	5.312G	6	5.447G	7	5.259G	8	5.548G
9	5.492G	10	5.699G	11	5.308G	12	5.677G
13	5.328G	14	5.520G	15	5.318G	16	5.433G
17	5.440G	18	5.294G	19	5.486G	20	5.258G
21	5.370G	22	5.405G	23	5.266G	24	5.380G
25	5.292G	26	5.590G	27	5.459G	28	5.495G
29	5.541G	30	5.564G	31	5.472G	32	5.680G
33	5.558G	34	5.319G	35	5.645G	36	5.475G
37	5.591G	38	5.375G	39	5.678G	40	5.649G
41	5.437G	42	5.674G	43	5.706G	44	5.460G
45	5.316G	46	5.636G	47	5.301G	48	5.660G
49	5.416G	50	5.284G	51	5.321G	52	5.545G
53	5.260G	54	5.353G	55	5.489G	56	5.334G
57	5.256G	58	5.600G	59	5.307G	60	5.683G
61	5.288G	62	5.637G	63	5.631G	64	5.253G
65	5.604G	66	5.709G	67	5.568G	68	5.697G
69	5.404G	70	5.508G	71	5.681G	72	5.345G
73	5.300G	74	5.497G	75	5.633G	76	5.655G
77	5.415G	78	5.333G	79	5.251G	80	5.374G
81	5.451G	82	5.443G	83	5.625G	84	5.473G
85	5.584G	86	5.338G	87	5.647G	88	5.304G
89	5.525G	90	5.542G	91	5.361G	92	5.650G
93	5.482G	94	5.666G	95	5.608G	96	5.589G
97	5.427G	98	5.384G	99	5.457G	100	5.355G

Hopping Frequency Sequence Name: HOP_FREQ_SEQ_05							
SEQ#	Frequency (Hz)	SEQ#	Frequency (Hz)	SEQ#	Frequency (Hz)	SEQ#	Frequency (Hz)
1	5.583G	2	5.381G	3	5.662G	4	5.649G
5	5.275G	6	5.678G	7	5.287G	8	5.452G
9	5.461G	10	5.670G	11	5.279G	12	5.702G
13	5.399G	14	5.420G	15	5.479G	16	5.278G
17	5.487G	18	5.484G	19	5.320G	20	5.433G
21	5.550G	22	5.333G	23	5.573G	24	5.456G
25	5.299G	26	5.261G	27	5.263G	28	5.614G
29	5.321G	30	5.300G	31	5.391G	32	5.551G
33	5.600G	34	5.509G	35	5.718G	36	5.522G
37	5.396G	38	5.713G	39	5.457G	40	5.717G
41	5.659G	42	5.607G	43	5.536G	44	5.370G
45	5.329G	46	5.708G	47	5.534G	48	5.429G
49	5.492G	50	5.379G	51	5.653G	52	5.545G
53	5.620G	54	5.681G	55	5.546G	56	5.715G
57	5.616G	58	5.591G	59	5.508G	60	5.375G
61	5.271G	62	5.596G	63	5.500G	64	5.455G
65	5.318G	66	5.585G	67	5.336G	68	5.657G
69	5.598G	70	5.251G	71	5.512G	72	5.668G
73	5.665G	74	5.667G	75	5.682G	76	5.407G
77	5.489G	78	5.309G	79	5.490G	80	5.418G
81	5.257G	82	5.697G	83	5.719G	84	5.341G
85	5.689G	86	5.647G	87	5.568G	88	5.699G
89	5.674G	90	5.572G	91	5.619G	92	5.408G
93	5.664G	94	5.706G	95	5.360G	96	5.439G
97	5.284G	98	5.312G	99	5.367G	100	5.478G

Hopping Frequency Sequence Name: HOP_FREQ_SEQ_06							
SEQ#	Frequency (Hz)	SEQ#	Frequency (Hz)	SEQ#	Frequency (Hz)	SEQ#	Frequency (Hz)
1	5.493G	2	5.665G	3	5.291G	4	5.553G
5	5.367G	6	5.518G	7	5.444G	8	5.350G
9	5.338G	10	5.467G	11	5.262G	12	5.629G
13	5.439G	14	5.406G	15	5.267G	16	5.293G
17	5.384G	18	5.447G	19	5.647G	20	5.716G
21	5.583G	22	5.697G	23	5.260G	24	5.609G
25	5.465G	26	5.632G	27	5.268G	28	5.593G
29	5.611G	30	5.546G	31	5.466G	32	5.478G
33	5.653G	34	5.660G	35	5.357G	36	5.454G
37	5.605G	38	5.502G	39	5.604G	40	5.703G
41	5.637G	42	5.519G	43	5.258G	44	5.601G
45	5.516G	46	5.346G	47	5.645G	48	5.638G
49	5.418G	50	5.354G	51	5.644G	52	5.456G
53	5.682G	54	5.702G	55	5.607G	56	5.503G
57	5.396G	58	5.441G	59	5.273G	60	5.548G
61	5.314G	62	5.371G	63	5.306G	64	5.360G
65	5.691G	66	5.413G	67	5.551G	68	5.485G
69	5.495G	70	5.419G	71	5.531G	72	5.492G
73	5.499G	74	5.392G	75	5.347G	76	5.497G
77	5.692G	78	5.342G	79	5.723G	80	5.356G
81	5.484G	82	5.491G	83	5.705G	84	5.563G
85	5.394G	86	5.397G	87	5.534G	88	5.269G
89	5.471G	90	5.514G	91	5.339G	92	5.640G
93	5.332G	94	5.680G	95	5.482G	96	5.488G
97	5.429G	98	5.430G	99	5.464G	100	5.295G

Hopping Frequency Sequence Name: HOP_FREQ_SEQ_07							
SEQ#	Frequency (Hz)	SEQ#	Frequency (Hz)	SEQ#	Frequency (Hz)	SEQ#	Frequency (Hz)
1	5.320G	2	5.390G	3	5.286G	4	5.418G
5	5.603G	6	5.488G	7	5.457G	8	5.410G
9	5.299G	10	5.545G	11	5.358G	12	5.355G
13	5.454G	14	5.277G	15	5.687G	16	5.582G
17	5.434G	18	5.475G	19	5.619G	20	5.627G
21	5.307G	22	5.317G	23	5.319G	24	5.421G
25	5.556G	26	5.541G	27	5.623G	28	5.546G
29	5.336G	30	5.578G	31	5.304G	32	5.325G
33	5.574G	34	5.382G	35	5.570G	36	5.544G
37	5.700G	38	5.571G	39	5.491G	40	5.465G
41	5.272G	42	5.536G	43	5.279G	44	5.402G
45	5.628G	46	5.595G	47	5.479G	48	5.401G
49	5.451G	50	5.356G	51	5.309G	52	5.561G
53	5.539G	54	5.685G	55	5.648G	56	5.693G
57	5.414G	58	5.679G	59	5.362G	60	5.695G
61	5.256G	62	5.283G	63	5.376G	64	5.706G
65	5.504G	66	5.441G	67	5.284G	68	5.449G
69	5.476G	70	5.462G	71	5.381G	72	5.343G
73	5.638G	74	5.689G	75	5.357G	76	5.389G
77	5.255G	78	5.303G	79	5.592G	80	5.675G
81	5.450G	82	5.611G	83	5.566G	84	5.265G
85	5.510G	86	5.724G	87	5.680G	88	5.392G
89	5.296G	90	5.605G	91	5.490G	92	5.631G
93	5.560G	94	5.612G	95	5.555G	96	5.487G
97	5.530G	98	5.327G	99	5.573G	100	5.704G

Hopping Frequency Sequence Name: HOP_FREQ_SEQ_08							
SEQ#	Frequency (Hz)	SEQ#	Frequency (Hz)	SEQ#	Frequency (Hz)	SEQ#	Frequency (Hz)
1	5.537G	2	5.669G	3	5.683G	4	5.517G
5	5.583G	6	5.304G	7	5.607G	8	5.656G
9	5.424G	10	5.441G	11	5.256G	12	5.552G
13	5.599G	14	5.277G	15	5.349G	16	5.707G
17	5.521G	18	5.478G	19	5.612G	20	5.302G
21	5.677G	22	5.581G	23	5.300G	24	5.412G
25	5.381G	26	5.259G	27	5.637G	28	5.251G
29	5.296G	30	5.565G	31	5.306G	32	5.285G
33	5.648G	34	5.563G	35	5.452G	36	5.555G
37	5.650G	38	5.495G	39	5.503G	40	5.594G
41	5.469G	42	5.582G	43	5.307G	44	5.255G
45	5.253G	46	5.323G	47	5.676G	48	5.709G
49	5.720G	50	5.712G	51	5.679G	52	5.482G
53	5.438G	54	5.415G	55	5.268G	56	5.636G
57	5.593G	58	5.427G	59	5.383G	60	5.661G
61	5.560G	62	5.697G	63	5.675G	64	5.468G
65	5.649G	66	5.298G	67	5.651G	68	5.400G
69	5.647G	70	5.467G	71	5.329G	72	5.652G
73	5.589G	74	5.347G	75	5.628G	76	5.500G
77	5.689G	78	5.368G	79	5.611G	80	5.387G
81	5.608G	82	5.473G	83	5.575G	84	5.278G
85	5.704G	86	5.662G	87	5.342G	88	5.592G
89	5.686G	90	5.702G	91	5.624G	92	5.434G
93	5.416G	94	5.553G	95	5.576G	96	5.477G
97	5.464G	98	5.396G	99	5.386G	100	5.432G

Hopping Frequency Sequence Name: HOP_FREQ_SEQ_09							
SEQ#	Frequency (Hz)	SEQ#	Frequency (Hz)	SEQ#	Frequency (Hz)	SEQ#	Frequency (Hz)
1	5.349G	2	5.590G	3	5.466G	4	5.546G
5	5.530G	6	5.355G	7	5.575G	8	5.709G
9	5.350G	10	5.724G	11	5.456G	12	5.682G
13	5.625G	14	5.554G	15	5.713G	16	5.477G
17	5.432G	18	5.412G	19	5.454G	20	5.402G
21	5.357G	22	5.389G	23	5.626G	24	5.717G
25	5.282G	26	5.524G	27	5.697G	28	5.264G
29	5.467G	30	5.720G	31	5.459G	32	5.313G
33	5.640G	34	5.329G	35	5.605G	36	5.427G
37	5.295G	38	5.567G	39	5.302G	40	5.635G
41	5.278G	42	5.578G	43	5.461G	44	5.700G
45	5.455G	46	5.327G	47	5.592G	48	5.275G
49	5.632G	50	5.453G	51	5.422G	52	5.300G
53	5.721G	54	5.650G	55	5.704G	56	5.380G
57	5.403G	58	5.373G	59	5.367G	60	5.372G
61	5.492G	62	5.690G	63	5.618G	64	5.540G
65	5.508G	66	5.485G	67	5.496G	68	5.548G
69	5.512G	70	5.687G	71	5.296G	72	5.676G
73	5.499G	74	5.440G	75	5.579G	76	5.604G
77	5.608G	78	5.723G	79	5.576G	80	5.703G
81	5.433G	82	5.612G	83	5.482G	84	5.583G
85	5.633G	86	5.582G	87	5.437G	88	5.521G
89	5.601G	90	5.391G	91	5.647G	92	5.393G
93	5.419G	94	5.598G	95	5.434G	96	5.597G
97	5.446G	98	5.478G	99	5.551G	100	5.621G

Hopping Frequency Sequence Name: HOP_FREQ_SEQ_10							
SEQ#	Frequency (Hz)	SEQ#	Frequency (Hz)	SEQ#	Frequency (Hz)	SEQ#	Frequency (Hz)
1	5.550G	2	5.265G	3	5.435G	4	5.470G
5	5.657G	6	5.490G	7	5.566G	8	5.303G
9	5.400G	10	5.263G	11	5.271G	12	5.372G
13	5.448G	14	5.659G	15	5.549G	16	5.571G
17	5.381G	18	5.398G	19	5.278G	20	5.511G
21	5.583G	22	5.333G	23	5.482G	24	5.494G
25	5.353G	26	5.668G	27	5.460G	28	5.563G
29	5.706G	30	5.421G	31	5.283G	32	5.703G
33	5.554G	34	5.503G	35	5.513G	36	5.461G
37	5.355G	38	5.341G	39	5.532G	40	5.528G
41	5.380G	42	5.698G	43	5.392G	44	5.582G
45	5.285G	46	5.425G	47	5.454G	48	5.617G
49	5.323G	50	5.281G	51	5.544G	52	5.466G
53	5.447G	54	5.420G	55	5.600G	56	5.676G
57	5.422G	58	5.638G	59	5.324G	60	5.295G
61	5.359G	62	5.483G	63	5.628G	64	5.350G
65	5.690G	66	5.389G	67	5.495G	68	5.252G
69	5.603G	70	5.688G	71	5.266G	72	5.696G
73	5.713G	74	5.649G	75	5.465G	76	5.413G
77	5.551G	78	5.615G	79	5.620G	80	5.358G
81	5.567G	82	5.442G	83	5.524G	84	5.506G
85	5.296G	86	5.597G	87	5.360G	88	5.484G
89	5.430G	90	5.407G	91	5.612G	92	5.619G
93	5.488G	94	5.631G	95	5.375G	96	5.432G
97	5.641G	98	5.342G	99	5.443G	100	5.590G

Hopping Frequency Sequence Name: HOP_FREQ_SEQ_11							
SEQ#	Frequency (Hz)	SEQ#	Frequency (Hz)	SEQ#	Frequency (Hz)	SEQ#	Frequency (Hz)
1	5.408G	2	5.306G	3	5.263G	4	5.393G
5	5.321G	6	5.559G	7	5.525G	8	5.427G
9	5.723G	10	5.451G	11	5.696G	12	5.626G
13	5.709G	14	5.553G	15	5.257G	16	5.474G
17	5.261G	18	5.669G	19	5.462G	20	5.348G
21	5.487G	22	5.589G	23	5.625G	24	5.294G
25	5.262G	26	5.711G	27	5.362G	28	5.623G
29	5.568G	30	5.564G	31	5.666G	32	5.413G
33	5.538G	34	5.484G	35	5.641G	36	5.520G
37	5.721G	38	5.483G	39	5.659G	40	5.339G
41	5.300G	42	5.478G	43	5.563G	44	5.269G
45	5.684G	46	5.663G	47	5.252G	48	5.254G
49	5.480G	50	5.655G	51	5.521G	52	5.377G
53	5.603G	54	5.627G	55	5.314G	56	5.364G
57	5.629G	58	5.365G	59	5.351G	60	5.528G
61	5.657G	62	5.447G	63	5.270G	64	5.477G
65	5.515G	66	5.295G	67	5.268G	68	5.383G
69	5.251G	70	5.458G	71	5.320G	72	5.374G
73	5.492G	74	5.358G	75	5.357G	76	5.410G
77	5.676G	78	5.588G	79	5.414G	80	5.399G
81	5.498G	82	5.491G	83	5.604G	84	5.658G
85	5.330G	86	5.613G	87	5.317G	88	5.539G
89	5.652G	90	5.403G	91	5.675G	92	5.642G
93	5.551G	94	5.343G	95	5.460G	96	5.543G
97	5.369G	98	5.276G	99	5.532G	100	5.708G

Hopping Frequency Sequence Name: HOP_FREQ_SEQ_12							
SEQ#	Frequency (Hz)	SEQ#	Frequency (Hz)	SEQ#	Frequency (Hz)	SEQ#	Frequency (Hz)
1	5.603G	2	5.666G	3	5.522G	4	5.502G
5	5.678G	6	5.480G	7	5.479G	8	5.281G
9	5.364G	10	5.297G	11	5.713G	12	5.316G
13	5.476G	14	5.662G	15	5.437G	16	5.710G
17	5.561G	18	5.306G	19	5.416G	20	5.463G
21	5.268G	22	5.498G	23	5.674G	24	5.313G
25	5.549G	26	5.294G	27	5.558G	28	5.637G
29	5.583G	30	5.462G	31	5.291G	32	5.492G
33	5.452G	34	5.260G	35	5.497G	36	5.535G
37	5.586G	38	5.577G	39	5.658G	40	5.470G
41	5.424G	42	5.264G	43	5.680G	44	5.347G
45	5.619G	46	5.500G	47	5.266G	48	5.411G
49	5.272G	50	5.353G	51	5.661G	52	5.317G
53	5.696G	54	5.576G	55	5.391G	56	5.376G
57	5.442G	58	5.432G	59	5.305G	60	5.461G
61	5.398G	62	5.394G	63	5.368G	64	5.283G
65	5.624G	66	5.414G	67	5.483G	68	5.458G
69	5.329G	70	5.634G	71	5.578G	72	5.718G
73	5.387G	74	5.596G	75	5.650G	76	5.517G
77	5.690G	78	5.453G	79	5.613G	80	5.653G
81	5.628G	82	5.451G	83	5.478G	84	5.356G
85	5.441G	86	5.381G	87	5.552G	88	5.395G
89	5.341G	90	5.496G	91	5.455G	92	5.469G
93	5.573G	94	5.365G	95	5.642G	96	5.505G
97	5.309G	98	5.397G	99	5.568G	100	5.639G

Hopping Frequency Sequence Name: HOP_FREQ_SEQ_13							
SEQ#	Frequency (Hz)	SEQ#	Frequency (Hz)	SEQ#	Frequency (Hz)	SEQ#	Frequency (Hz)
1	5.375G	2	5.264G	3	5.273G	4	5.293G
5	5.612G	6	5.436G	7	5.695G	8	5.549G
9	5.422G	10	5.631G	11	5.262G	12	5.490G
13	5.589G	14	5.506G	15	5.326G	16	5.282G
17	5.657G	18	5.497G	19	5.509G	20	5.660G
21	5.474G	22	5.629G	23	5.272G	24	5.314G
25	5.433G	26	5.560G	27	5.399G	28	5.357G
29	5.668G	30	5.484G	31	5.408G	32	5.325G
33	5.434G	34	5.356G	35	5.563G	36	5.285G
37	5.401G	38	5.426G	39	5.393G	40	5.621G
41	5.277G	42	5.567G	43	5.593G	44	5.559G
45	5.496G	46	5.675G	47	5.419G	48	5.319G
49	5.690G	50	5.694G	51	5.373G	52	5.661G
53	5.367G	54	5.522G	55	5.674G	56	5.265G
57	5.300G	58	5.468G	59	5.596G	60	5.324G
61	5.528G	62	5.526G	63	5.537G	64	5.669G
65	5.599G	66	5.358G	67	5.303G	68	5.648G
69	5.378G	70	5.478G	71	5.469G	72	5.407G
73	5.513G	74	5.263G	75	5.586G	76	5.360G
77	5.571G	78	5.604G	79	5.446G	80	5.479G
81	5.482G	82	5.366G	83	5.394G	84	5.693G
85	5.288G	86	5.512G	87	5.551G	88	5.585G
89	5.723G	90	5.705G	91	5.412G	92	5.711G
93	5.345G	94	5.486G	95	5.678G	96	5.361G
97	5.390G	98	5.352G	99	5.649G	100	5.647G

Hopping Frequency Sequence Name: HOP_FREQ_SEQ_14							
SEQ#	Frequency (Hz)	SEQ#	Frequency (Hz)	SEQ#	Frequency (Hz)	SEQ#	Frequency (Hz)
1	5.507G	2	5.709G	3	5.352G	4	5.516G
5	5.503G	6	5.594G	7	5.415G	8	5.255G
9	5.475G	10	5.275G	11	5.657G	12	5.344G
13	5.534G	14	5.406G	15	5.612G	16	5.671G
17	5.389G	18	5.314G	19	5.323G	20	5.544G
21	5.277G	22	5.302G	23	5.545G	24	5.577G
25	5.388G	26	5.258G	27	5.386G	28	5.434G
29	5.312G	30	5.595G	31	5.689G	32	5.420G
33	5.287G	34	5.408G	35	5.464G	36	5.511G
37	5.443G	38	5.427G	39	5.416G	40	5.365G
41	5.500G	42	5.587G	43	5.457G	44	5.395G
45	5.621G	46	5.588G	47	5.442G	48	5.411G
49	5.390G	50	5.539G	51	5.425G	52	5.521G
53	5.722G	54	5.696G	55	5.413G	56	5.529G
57	5.355G	58	5.656G	59	5.704G	60	5.316G
61	5.480G	62	5.581G	63	5.632G	64	5.676G
65	5.482G	66	5.432G	67	5.259G	68	5.438G
69	5.694G	70	5.580G	71	5.536G	72	5.663G
73	5.495G	74	5.674G	75	5.347G	76	5.400G
77	5.465G	78	5.330G	79	5.589G	80	5.519G
81	5.699G	82	5.645G	83	5.380G	84	5.672G
85	5.635G	86	5.548G	87	5.563G	88	5.710G
89	5.348G	90	5.629G	91	5.641G	92	5.509G
93	5.317G	94	5.384G	95	5.562G	96	5.666G
97	5.332G	98	5.456G	99	5.262G	100	5.701G

Hopping Frequency Sequence Name: HOP_FREQ_SEQ_15							
SEQ#	Frequency (Hz)	SEQ#	Frequency (Hz)	SEQ#	Frequency (Hz)	SEQ#	Frequency (Hz)
1	5.332G	2	5.253G	3	5.256G	4	5.368G
5	5.366G	6	5.427G	7	5.495G	8	5.322G
9	5.496G	10	5.474G	11	5.448G	12	5.678G
13	5.410G	14	5.687G	15	5.686G	16	5.533G
17	5.269G	18	5.385G	19	5.429G	20	5.261G
21	5.585G	22	5.509G	23	5.255G	24	5.478G
25	5.360G	26	5.339G	27	5.335G	28	5.512G
29	5.604G	30	5.462G	31	5.479G	32	5.562G
33	5.693G	34	5.337G	35	5.671G	36	5.260G
37	5.382G	38	5.556G	39	5.523G	40	5.292G
41	5.273G	42	5.313G	43	5.586G	44	5.668G
45	5.317G	46	5.324G	47	5.505G	48	5.486G
49	5.358G	50	5.493G	51	5.456G	52	5.610G
53	5.528G	54	5.590G	55	5.506G	56	5.517G
57	5.530G	58	5.640G	59	5.318G	60	5.274G
61	5.381G	62	5.579G	63	5.667G	64	5.661G
65	5.415G	66	5.442G	67	5.621G	68	5.552G
69	5.455G	70	5.300G	71	5.441G	72	5.491G
73	5.722G	74	5.305G	75	5.331G	76	5.365G
77	5.390G	78	5.637G	79	5.266G	80	5.591G
81	5.563G	82	5.607G	83	5.461G	84	5.262G
85	5.605G	86	5.617G	87	5.403G	88	5.600G
89	5.492G	90	5.294G	91	5.706G	92	5.507G
93	5.284G	94	5.298G	95	5.564G	96	5.650G
97	5.537G	98	5.611G	99	5.645G	100	5.413G

Hopping Frequency Sequence Name: HOP_FREQ_SEQ_16							
SEQ#	Frequency (Hz)	SEQ#	Frequency (Hz)	SEQ#	Frequency (Hz)	SEQ#	Frequency (Hz)
1	5.469G	2	5.426G	3	5.347G	4	5.449G
5	5.330G	6	5.537G	7	5.391G	8	5.687G
9	5.666G	10	5.332G	11	5.651G	12	5.341G
13	5.352G	14	5.457G	15	5.686G	16	5.531G
17	5.693G	18	5.631G	19	5.269G	20	5.525G
21	5.702G	22	5.403G	23	5.536G	24	5.363G
25	5.516G	26	5.538G	27	5.490G	28	5.511G
29	5.724G	30	5.704G	31	5.442G	32	5.441G
33	5.411G	34	5.717G	35	5.571G	36	5.647G
37	5.649G	38	5.606G	39	5.319G	40	5.448G
41	5.504G	42	5.472G	43	5.609G	44	5.438G
45	5.545G	46	5.480G	47	5.256G	48	5.679G
49	5.382G	50	5.284G	51	5.543G	52	5.424G
53	5.317G	54	5.520G	55	5.604G	56	5.397G
57	5.505G	58	5.463G	59	5.685G	60	5.602G
61	5.270G	62	5.618G	63	5.662G	64	5.273G
65	5.707G	66	5.664G	67	5.552G	68	5.294G
69	5.320G	70	5.464G	71	5.641G	72	5.476G
73	5.661G	74	5.566G	75	5.299G	76	5.584G
77	5.619G	78	5.420G	79	5.488G	80	5.593G
81	5.654G	82	5.714G	83	5.287G	84	5.657G
85	5.337G	86	5.644G	87	5.648G	88	5.659G
89	5.251G	90	5.265G	91	5.279G	92	5.359G
93	5.460G	94	5.413G	95	5.308G	96	5.544G
97	5.640G	98	5.394G	99	5.348G	100	5.613G

Hopping Frequency Sequence Name: HOP_FREQ_SEQ_17							
SEQ#	Frequency (Hz)	SEQ#	Frequency (Hz)	SEQ#	Frequency (Hz)	SEQ#	Frequency (Hz)
1	5.421G	2	5.498G	3	5.713G	4	5.660G
5	5.583G	6	5.662G	7	5.657G	8	5.641G
9	5.268G	10	5.654G	11	5.517G	12	5.259G
13	5.485G	14	5.419G	15	5.276G	16	5.649G
17	5.467G	18	5.646G	19	5.359G	20	5.642G
21	5.659G	22	5.620G	23	5.345G	24	5.257G
25	5.288G	26	5.478G	27	5.637G	28	5.252G
29	5.489G	30	5.274G	31	5.703G	32	5.534G
33	5.376G	34	5.719G	35	5.682G	36	5.413G
37	5.614G	38	5.448G	39	5.256G	40	5.365G
41	5.587G	42	5.350G	43	5.605G	44	5.447G
45	5.328G	46	5.710G	47	5.330G	48	5.679G
49	5.557G	50	5.674G	51	5.437G	52	5.668G
53	5.714G	54	5.353G	55	5.488G	56	5.427G
57	5.577G	58	5.482G	59	5.700G	60	5.626G
61	5.307G	62	5.464G	63	5.423G	64	5.336G
65	5.617G	66	5.608G	67	5.562G	68	5.443G
69	5.446G	70	5.561G	71	5.493G	72	5.560G
73	5.304G	74	5.354G	75	5.495G	76	5.680G
77	5.397G	78	5.344G	79	5.426G	80	5.425G
81	5.599G	82	5.567G	83	5.510G	84	5.555G
85	5.625G	86	5.324G	87	5.707G	88	5.262G
89	5.501G	90	5.651G	91	5.292G	92	5.424G
93	5.573G	94	5.411G	95	5.597G	96	5.691G
97	5.435G	98	5.459G	99	5.282G	100	5.600G

Hopping Frequency Sequence Name: HOP_FREQ_SEQ_18							
SEQ#	Frequency (Hz)	SEQ#	Frequency (Hz)	SEQ#	Frequency (Hz)	SEQ#	Frequency (Hz)
1	5.471G	2	5.678G	3	5.410G	4	5.537G
5	5.446G	6	5.666G	7	5.563G	8	5.355G
9	5.484G	10	5.489G	11	5.556G	12	5.596G
13	5.454G	14	5.682G	15	5.554G	16	5.595G
17	5.270G	18	5.610G	19	5.586G	20	5.549G
21	5.264G	22	5.415G	23	5.266G	24	5.339G
25	5.662G	26	5.697G	27	5.379G	28	5.392G
29	5.301G	30	5.334G	31	5.573G	32	5.643G
33	5.253G	34	5.439G	35	5.300G	36	5.519G
37	5.267G	38	5.689G	39	5.539G	40	5.455G
41	5.468G	42	5.613G	43	5.496G	44	5.665G
45	5.381G	46	5.250G	47	5.298G	48	5.272G
49	5.592G	50	5.360G	51	5.532G	52	5.324G
53	5.710G	54	5.409G	55	5.517G	56	5.467G
57	5.647G	58	5.668G	59	5.309G	60	5.548G
61	5.317G	62	5.428G	63	5.597G	64	5.314G
65	5.481G	66	5.308G	67	5.584G	68	5.622G
69	5.358G	70	5.466G	71	5.616G	72	5.295G
73	5.364G	74	5.261G	75	5.655G	76	5.660G
77	5.457G	78	5.672G	79	5.565G	80	5.652G
81	5.260G	82	5.683G	83	5.343G	84	5.401G
85	5.325G	86	5.686G	87	5.353G	88	5.315G
89	5.373G	90	5.402G	91	5.352G	92	5.599G
93	5.626G	94	5.702G	95	5.258G	96	5.460G
97	5.724G	98	5.670G	99	5.444G	100	5.388G

Hopping Frequency Sequence Name: HOP_FREQ_SEQ_19							
SEQ#	Frequency (Hz)	SEQ#	Frequency (Hz)	SEQ#	Frequency (Hz)	SEQ#	Frequency (Hz)
1	5.550G	2	5.672G	3	5.305G	4	5.508G
5	5.713G	6	5.500G	7	5.312G	8	5.704G
9	5.291G	10	5.288G	11	5.664G	12	5.468G
13	5.405G	14	5.558G	15	5.313G	16	5.308G
17	5.390G	18	5.685G	19	5.526G	20	5.394G
21	5.616G	22	5.333G	23	5.419G	24	5.461G
25	5.417G	26	5.393G	27	5.427G	28	5.650G
29	5.376G	30	5.351G	31	5.656G	32	5.494G
33	5.700G	34	5.365G	35	5.624G	36	5.551G
37	5.259G	38	5.657G	39	5.470G	40	5.666G
41	5.250G	42	5.501G	43	5.681G	44	5.496G
45	5.370G	46	5.689G	47	5.535G	48	5.271G
49	5.444G	50	5.696G	51	5.337G	52	5.621G
53	5.265G	54	5.399G	55	5.609G	56	5.722G
57	5.401G	58	5.667G	59	5.473G	60	5.511G
61	5.350G	62	5.614G	63	5.516G	64	5.409G
65	5.260G	66	5.709G	67	5.677G	68	5.590G
69	5.671G	70	5.418G	71	5.297G	72	5.623G
73	5.539G	74	5.371G	75	5.280G	76	5.422G
77	5.607G	78	5.407G	79	5.533G	80	5.316G
81	5.301G	82	5.640G	83	5.610G	84	5.454G
85	5.413G	86	5.512G	87	5.577G	88	5.557G
89	5.471G	90	5.622G	91	5.439G	92	5.361G
93	5.582G	94	5.360G	95	5.440G	96	5.537G
97	5.406G	98	5.585G	99	5.342G	100	5.462G

Hopping Frequency Sequence Name: HOP_FREQ_SEQ_20							
SEQ#	Frequency (Hz)	SEQ#	Frequency (Hz)	SEQ#	Frequency (Hz)	SEQ#	Frequency (Hz)
1	5.664G	2	5.377G	3	5.595G	4	5.701G
5	5.596G	6	5.490G	7	5.573G	8	5.706G
9	5.594G	10	5.393G	11	5.581G	12	5.592G
13	5.403G	14	5.547G	15	5.428G	16	5.314G
17	5.643G	18	5.585G	19	5.444G	20	5.405G
21	5.279G	22	5.294G	23	5.477G	24	5.277G
25	5.543G	26	5.338G	27	5.720G	28	5.613G
29	5.323G	30	5.541G	31	5.496G	32	5.270G
33	5.499G	34	5.410G	35	5.530G	36	5.339G
37	5.452G	38	5.287G	39	5.423G	40	5.375G
41	5.328G	42	5.644G	43	5.620G	44	5.333G
45	5.635G	46	5.566G	47	5.645G	48	5.497G
49	5.325G	50	5.417G	51	5.523G	52	5.562G
53	5.605G	54	5.495G	55	5.271G	56	5.693G
57	5.442G	58	5.524G	59	5.637G	60	5.407G
61	5.421G	62	5.342G	63	5.435G	64	5.590G
65	5.636G	66	5.711G	67	5.468G	68	5.288G
69	5.488G	70	5.719G	71	5.699G	72	5.400G
73	5.343G	74	5.589G	75	5.379G	76	5.408G
77	5.406G	78	5.712G	79	5.370G	80	5.268G
81	5.299G	82	5.576G	83	5.619G	84	5.332G
85	5.361G	86	5.465G	87	5.517G	88	5.485G
89	5.724G	90	5.557G	91	5.297G	92	5.586G
93	5.321G	94	5.368G	95	5.683G	96	5.526G
97	5.649G	98	5.587G	99	5.582G	100	5.681G

Hopping Frequency Sequence Name: HOP_FREQ_SEQ_21							
SEQ#	Frequency (Hz)	SEQ#	Frequency (Hz)	SEQ#	Frequency (Hz)	SEQ#	Frequency (Hz)
1	5.265G	2	5.645G	3	5.335G	4	5.680G
5	5.551G	6	5.661G	7	5.669G	8	5.387G
9	5.352G	10	5.635G	11	5.451G	12	5.534G
13	5.511G	14	5.708G	15	5.721G	16	5.644G
17	5.524G	18	5.634G	19	5.453G	20	5.698G
21	5.631G	22	5.445G	23	5.279G	24	5.582G
25	5.488G	26	5.687G	27	5.292G	28	5.673G
29	5.361G	30	5.256G	31	5.471G	32	5.523G
33	5.464G	34	5.330G	35	5.555G	36	5.499G
37	5.700G	38	5.613G	39	5.695G	40	5.672G
41	5.591G	42	5.399G	43	5.432G	44	5.664G
45	5.578G	46	5.571G	47	5.478G	48	5.463G
49	5.431G	50	5.516G	51	5.371G	52	5.652G
53	5.709G	54	5.692G	55	5.421G	56	5.480G
57	5.425G	58	5.293G	59	5.285G	60	5.693G
61	5.666G	62	5.609G	63	5.377G	64	5.338G
65	5.597G	66	5.430G	67	5.568G	68	5.489G
69	5.495G	70	5.479G	71	5.304G	72	5.527G
73	5.473G	74	5.397G	75	5.643G	76	5.626G
77	5.411G	78	5.702G	79	5.409G	80	5.512G
81	5.599G	82	5.497G	83	5.393G	84	5.351G
85	5.706G	86	5.327G	87	5.660G	88	5.437G
89	5.322G	90	5.566G	91	5.553G	92	5.501G
93	5.315G	94	5.590G	95	5.385G	96	5.650G
97	5.614G	98	5.705G	99	5.276G	100	5.469G

Hopping Frequency Sequence Name: HOP_FREQ_SEQ_22							
SEQ#	Frequency (Hz)	SEQ#	Frequency (Hz)	SEQ#	Frequency (Hz)	SEQ#	Frequency (Hz)
1	5.609G	2	5.255G	3	5.447G	4	5.276G
5	5.345G	6	5.385G	7	5.526G	8	5.623G
9	5.601G	10	5.535G	11	5.657G	12	5.300G
13	5.306G	14	5.708G	15	5.495G	16	5.422G
17	5.658G	18	5.379G	19	5.692G	20	5.502G
21	5.253G	22	5.498G	23	5.380G	24	5.670G
25	5.460G	26	5.514G	27	5.545G	28	5.319G
29	5.252G	30	5.457G	31	5.478G	32	5.707G
33	5.722G	34	5.681G	35	5.329G	36	5.390G
37	5.367G	38	5.622G	39	5.286G	40	5.472G
41	5.435G	42	5.427G	43	5.458G	44	5.715G
45	5.537G	46	5.312G	47	5.671G	48	5.521G
49	5.322G	50	5.655G	51	5.308G	52	5.484G
53	5.361G	54	5.304G	55	5.259G	56	5.418G
57	5.360G	58	5.724G	59	5.594G	60	5.420G
61	5.549G	62	5.454G	63	5.314G	64	5.569G
65	5.467G	66	5.450G	67	5.519G	68	5.444G
69	5.268G	70	5.663G	71	5.709G	72	5.610G
73	5.621G	74	5.647G	75	5.648G	76	5.557G
77	5.529G	78	5.483G	79	5.589G	80	5.377G
81	5.338G	82	5.698G	83	5.433G	84	5.446G
85	5.618G	86	5.597G	87	5.393G	88	5.554G
89	5.477G	90	5.403G	91	5.280G	92	5.719G
93	5.263G	94	5.465G	95	5.305G	96	5.646G
97	5.550G	98	5.396G	99	5.637G	100	5.716G

Hopping Frequency Sequence Name: HOP_FREQ_SEQ_23							
SEQ#	Frequency (Hz)	SEQ#	Frequency (Hz)	SEQ#	Frequency (Hz)	SEQ#	Frequency (Hz)
1	5.401G	2	5.459G	3	5.412G	4	5.639G
5	5.383G	6	5.630G	7	5.689G	8	5.673G
9	5.441G	10	5.384G	11	5.432G	12	5.451G
13	5.608G	14	5.440G	15	5.593G	16	5.398G
17	5.590G	18	5.280G	19	5.339G	20	5.257G
21	5.702G	22	5.422G	23	5.648G	24	5.683G
25	5.642G	26	5.479G	27	5.354G	28	5.718G
29	5.633G	30	5.620G	31	5.562G	32	5.334G
33	5.515G	34	5.546G	35	5.585G	36	5.486G
37	5.366G	38	5.409G	39	5.375G	40	5.392G
41	5.482G	42	5.313G	43	5.660G	44	5.279G
45	5.563G	46	5.617G	47	5.694G	48	5.307G
49	5.314G	50	5.376G	51	5.447G	52	5.697G
53	5.393G	54	5.698G	55	5.335G	56	5.358G
57	5.503G	58	5.605G	59	5.712G	60	5.413G
61	5.285G	62	5.662G	63	5.576G	64	5.429G
65	5.365G	66	5.653G	67	5.284G	68	5.687G
69	5.415G	70	5.315G	71	5.347G	72	5.722G
73	5.613G	74	5.372G	75	5.425G	76	5.504G
77	5.723G	78	5.330G	79	5.672G	80	5.473G
81	5.423G	82	5.618G	83	5.526G	84	5.452G
85	5.301G	86	5.460G	87	5.652G	88	5.592G
89	5.547G	90	5.286G	91	5.614G	92	5.603G
93	5.696G	94	5.484G	95	5.721G	96	5.343G
97	5.519G	98	5.667G	99	5.407G	100	5.489G

Hopping Frequency Sequence Name: HOP_FREQ_SEQ_24							
SEQ#	Frequency (Hz)	SEQ#	Frequency (Hz)	SEQ#	Frequency (Hz)	SEQ#	Frequency (Hz)
1	5.338G	2	5.690G	3	5.513G	4	5.614G
5	5.452G	6	5.451G	7	5.357G	8	5.646G
9	5.375G	10	5.403G	11	5.400G	12	5.341G
13	5.469G	14	5.723G	15	5.707G	16	5.314G
17	5.708G	18	5.474G	19	5.336G	20	5.416G
21	5.427G	22	5.521G	23	5.593G	24	5.611G
25	5.598G	26	5.558G	27	5.652G	28	5.581G
29	5.383G	30	5.642G	31	5.313G	32	5.649G
33	5.722G	34	5.664G	35	5.561G	36	5.594G
37	5.266G	38	5.334G	39	5.685G	40	5.701G
41	5.437G	42	5.544G	43	5.332G	44	5.603G
45	5.465G	46	5.379G	47	5.579G	48	5.262G
49	5.250G	50	5.724G	51	5.283G	52	5.291G
53	5.587G	54	5.391G	55	5.329G	56	5.382G
57	5.372G	58	5.645G	59	5.455G	60	5.596G
61	5.422G	62	5.251G	63	5.609G	64	5.559G
65	5.497G	66	5.253G	67	5.545G	68	5.438G
69	5.488G	70	5.697G	71	5.503G	72	5.348G
73	5.583G	74	5.390G	75	5.647G	76	5.377G
77	5.535G	78	5.298G	79	5.556G	80	5.571G
81	5.644G	82	5.625G	83	5.490G	84	5.610G
85	5.592G	86	5.426G	87	5.280G	88	5.591G
89	5.305G	90	5.564G	91	5.721G	92	5.285G
93	5.526G	94	5.315G	95	5.698G	96	5.624G
97	5.258G	98	5.505G	99	5.606G	100	5.516G

Hopping Frequency Sequence Name: HOP_FREQ_SEQ_25							
SEQ#	Frequency (Hz)	SEQ#	Frequency (Hz)	SEQ#	Frequency (Hz)	SEQ#	Frequency (Hz)
1	5.337G	2	5.639G	3	5.406G	4	5.583G
5	5.403G	6	5.551G	7	5.705G	8	5.571G
9	5.488G	10	5.253G	11	5.519G	12	5.369G
13	5.575G	14	5.445G	15	5.511G	16	5.419G
17	5.619G	18	5.261G	19	5.473G	20	5.710G
21	5.580G	22	5.657G	23	5.446G	24	5.508G
25	5.355G	26	5.634G	27	5.334G	28	5.460G
29	5.648G	30	5.546G	31	5.608G	32	5.674G
33	5.534G	34	5.723G	35	5.256G	36	5.629G
37	5.459G	38	5.352G	39	5.293G	40	5.517G
41	5.322G	42	5.467G	43	5.557G	44	5.672G
45	5.703G	46	5.415G	47	5.296G	48	5.547G
49	5.435G	50	5.465G	51	5.260G	52	5.282G
53	5.374G	54	5.430G	55	5.494G	56	5.640G
57	5.268G	58	5.432G	59	5.392G	60	5.307G
61	5.393G	62	5.344G	63	5.416G	64	5.285G
65	5.638G	66	5.597G	67	5.516G	68	5.690G
69	5.449G	70	5.504G	71	5.572G	72	5.669G
73	5.594G	74	5.532G	75	5.628G	76	5.673G
77	5.448G	78	5.537G	79	5.326G	80	5.266G
81	5.697G	82	5.522G	83	5.678G	84	5.655G
85	5.422G	86	5.317G	87	5.602G	88	5.264G
89	5.589G	90	5.627G	91	5.491G	92	5.701G
93	5.436G	94	5.680G	95	5.478G	96	5.558G
97	5.320G	98	5.662G	99	5.525G	100	5.434G

Hopping Frequency Sequence Name: HOP_FREQ_SEQ_26							
SEQ#	Frequency (Hz)	SEQ#	Frequency (Hz)	SEQ#	Frequency (Hz)	SEQ#	Frequency (Hz)
1	5.518G	2	5.489G	3	5.280G	4	5.598G
5	5.417G	6	5.447G	7	5.418G	8	5.400G
9	5.674G	10	5.631G	11	5.668G	12	5.577G
13	5.654G	14	5.251G	15	5.570G	16	5.649G
17	5.318G	18	5.373G	19	5.558G	20	5.544G
21	5.331G	22	5.695G	23	5.395G	24	5.628G
25	5.551G	26	5.338G	27	5.678G	28	5.375G
29	5.448G	30	5.254G	31	5.693G	32	5.273G
33	5.501G	34	5.596G	35	5.406G	36	5.295G
37	5.253G	38	5.430G	39	5.315G	40	5.650G
41	5.565G	42	5.504G	43	5.533G	44	5.664G
45	5.547G	46	5.307G	47	5.385G	48	5.561G
49	5.521G	50	5.303G	51	5.383G	52	5.525G
53	5.300G	54	5.641G	55	5.613G	56	5.291G
57	5.614G	58	5.588G	59	5.365G	60	5.294G
61	5.600G	62	5.445G	63	5.387G	64	5.468G
65	5.405G	66	5.429G	67	5.450G	68	5.288G
69	5.462G	70	5.464G	71	5.443G	72	5.659G
73	5.344G	74	5.636G	75	5.611G	76	5.432G
77	5.341G	78	5.532G	79	5.420G	80	5.449G
81	5.284G	82	5.414G	83	5.724G	84	5.440G
85	5.556G	86	5.455G	87	5.499G	88	5.474G
89	5.481G	90	5.363G	91	5.478G	92	5.456G
93	5.264G	94	5.633G	95	5.589G	96	5.686G
97	5.538G	98	5.569G	99	5.524G	100	5.578G

Hopping Frequency Sequence Name: HOP_FREQ_SEQ_27							
SEQ#	Frequency (Hz)	SEQ#	Frequency (Hz)	SEQ#	Frequency (Hz)	SEQ#	Frequency (Hz)
1	5.368G	2	5.583G	3	5.564G	4	5.520G
5	5.428G	6	5.366G	7	5.611G	8	5.390G
9	5.616G	10	5.556G	11	5.539G	12	5.485G
13	5.360G	14	5.302G	15	5.581G	16	5.614G
17	5.353G	18	5.358G	19	5.582G	20	5.325G
21	5.348G	22	5.292G	23	5.287G	24	5.567G
25	5.615G	26	5.346G	27	5.531G	28	5.263G
29	5.272G	30	5.282G	31	5.657G	32	5.554G
33	5.618G	34	5.580G	35	5.525G	36	5.291G
37	5.715G	38	5.343G	39	5.534G	40	5.312G
41	5.275G	42	5.270G	43	5.718G	44	5.696G
45	5.671G	46	5.307G	47	5.332G	48	5.721G
49	5.462G	50	5.714G	51	5.451G	52	5.679G
53	5.422G	54	5.317G	55	5.640G	56	5.695G
57	5.722G	58	5.598G	59	5.607G	60	5.648G
61	5.547G	62	5.396G	63	5.523G	64	5.659G
65	5.624G	66	5.584G	67	5.660G	68	5.452G
69	5.550G	70	5.440G	71	5.683G	72	5.382G
73	5.562G	74	5.578G	75	5.513G	76	5.393G
77	5.379G	78	5.409G	79	5.362G	80	5.297G
81	5.597G	82	5.337G	83	5.711G	84	5.460G
85	5.576G	86	5.605G	87	5.645G	88	5.591G
89	5.667G	90	5.398G	91	5.456G	92	5.380G
93	5.710G	94	5.636G	95	5.315G	96	5.277G
97	5.441G	98	5.676G	99	5.593G	100	5.394G

Hopping Frequency Sequence Name: HOP_FREQ_SEQ_28							
SEQ#	Frequency (Hz)	SEQ#	Frequency (Hz)	SEQ#	Frequency (Hz)	SEQ#	Frequency (Hz)
1	5.336G	2	5.506G	3	5.514G	4	5.286G
5	5.715G	6	5.452G	7	5.408G	8	5.722G
9	5.332G	10	5.606G	11	5.608G	12	5.630G
13	5.676G	14	5.547G	15	5.568G	16	5.436G
17	5.503G	18	5.344G	19	5.723G	20	5.331G
21	5.637G	22	5.454G	23	5.589G	24	5.517G
25	5.586G	26	5.474G	27	5.267G	28	5.686G
29	5.333G	30	5.540G	31	5.585G	32	5.678G
33	5.482G	34	5.549G	35	5.473G	36	5.695G
37	5.412G	38	5.600G	39	5.620G	40	5.272G
41	5.499G	42	5.424G	43	5.366G	44	5.594G
45	5.526G	46	5.625G	47	5.632G	48	5.572G
49	5.260G	50	5.463G	51	5.679G	52	5.444G
53	5.716G	54	5.388G	55	5.587G	56	5.592G
57	5.399G	58	5.327G	59	5.607G	60	5.529G
61	5.455G	62	5.554G	63	5.688G	64	5.534G
65	5.250G	66	5.295G	67	5.541G	68	5.402G
69	5.551G	70	5.595G	71	5.459G	72	5.516G
73	5.467G	74	5.544G	75	5.358G	76	5.393G
77	5.490G	78	5.656G	79	5.493G	80	5.639G
81	5.410G	82	5.494G	83	5.346G	84	5.304G
85	5.357G	86	5.616G	87	5.339G	88	5.316G
89	5.318G	90	5.510G	91	5.405G	92	5.697G
93	5.483G	94	5.535G	95	5.672G	96	5.645G
97	5.558G	98	5.284G	99	5.460G	100	5.519G

Hopping Frequency Sequence Name: HOP_FREQ_SEQ_29							
SEQ#	Frequency (Hz)	SEQ#	Frequency (Hz)	SEQ#	Frequency (Hz)	SEQ#	Frequency (Hz)
1	5.666G	2	5.685G	3	5.395G	4	5.370G
5	5.611G	6	5.291G	7	5.687G	8	5.327G
9	5.307G	10	5.486G	11	5.389G	12	5.604G
13	5.319G	14	5.463G	15	5.445G	16	5.357G
17	5.415G	18	5.721G	19	5.587G	20	5.585G
21	5.558G	22	5.574G	23	5.675G	24	5.566G
25	5.679G	26	5.570G	27	5.488G	28	5.640G
29	5.406G	30	5.617G	31	5.386G	32	5.592G
33	5.382G	34	5.448G	35	5.479G	36	5.461G
37	5.273G	38	5.671G	39	5.458G	40	5.432G
41	5.544G	42	5.271G	43	5.628G	44	5.343G
45	5.689G	46	5.709G	47	5.691G	48	5.529G
49	5.540G	50	5.633G	51	5.623G	52	5.667G
53	5.536G	54	5.277G	55	5.577G	56	5.625G
57	5.454G	58	5.595G	59	5.660G	60	5.564G
61	5.673G	62	5.362G	63	5.692G	64	5.252G
65	5.680G	66	5.304G	67	5.459G	68	5.436G
69	5.314G	70	5.723G	71	5.423G	72	5.651G
73	5.435G	74	5.553G	75	5.562G	76	5.602G
77	5.368G	78	5.646G	79	5.441G	80	5.412G
81	5.718G	82	5.552G	83	5.430G	84	5.607G
85	5.404G	86	5.393G	87	5.420G	88	5.672G
89	5.669G	90	5.596G	91	5.384G	92	5.428G
93	5.495G	94	5.268G	95	5.606G	96	5.551G
97	5.377G	98	5.588G	99	5.352G	100	5.477G

Hopping Frequency Sequence Name: HOP_FREQ_SEQ_30							
SEQ#	Frequency (Hz)	SEQ#	Frequency (Hz)	SEQ#	Frequency (Hz)	SEQ#	Frequency (Hz)
1	5.458G	2	5.613G	3	5.717G	4	5.475G
5	5.607G	6	5.589G	7	5.417G	8	5.406G
9	5.298G	10	5.318G	11	5.710G	12	5.667G
13	5.351G	14	5.347G	15	5.300G	16	5.619G
17	5.309G	18	5.502G	19	5.578G	20	5.639G
21	5.573G	22	5.448G	23	5.462G	24	5.721G
25	5.389G	26	5.509G	27	5.414G	28	5.443G
29	5.262G	30	5.571G	31	5.558G	32	5.285G
33	5.529G	34	5.606G	35	5.419G	36	5.352G
37	5.566G	38	5.459G	39	5.304G	40	5.398G
41	5.339G	42	5.408G	43	5.281G	44	5.663G
45	5.690G	46	5.405G	47	5.335G	48	5.577G
49	5.491G	50	5.424G	51	5.411G	52	5.581G
53	5.715G	54	5.686G	55	5.267G	56	5.594G
57	5.277G	58	5.596G	59	5.457G	60	5.554G
61	5.388G	62	5.669G	63	5.474G	64	5.720G
65	5.453G	66	5.658G	67	5.500G	68	5.677G
69	5.358G	70	5.287G	71	5.338G	72	5.394G
73	5.609G	74	5.676G	75	5.353G	76	5.379G
77	5.616G	78	5.625G	79	5.257G	80	5.595G
81	5.588G	82	5.426G	83	5.556G	84	5.680G
85	5.373G	86	5.674G	87	5.350G	88	5.628G
89	5.423G	90	5.418G	91	5.260G	92	5.590G
93	5.392G	94	5.532G	95	5.478G	96	5.582G
97	5.562G	98	5.326G	99	5.548G	100	5.286G

IEEE 802.11ac VHT40

Type 1 Radar Statistical Performances

Trial #	Pulses per Burst	Pulse Width (s)	PRI (s)	Radar Frequency (MHz)	Detection
1	102	1.0u	518.0u	5291	Yes
2	95	1.0u	558.0u	5293	Yes
3	89	1.0u	598.0u	5294	Yes
4	83	1.0u	638.0u	5295	Yes
5	78	1.0u	678.0u	5297	Yes
6	76	1.0u	698.0u	5299	Yes
7	74	1.0u	718.0u	5300	Yes
8	72	1.0u	738.0u	5301	Yes
9	68	1.0u	778.0u	5303	Yes
10	67	1.0u	798.0u	5305	Yes
11	63	1.0u	838.0u	5306	Yes
12	62	1.0u	858.0u	5307	Yes
13	59	1.0u	898.0u	5308	Yes
14	58	1.0u	918.0u	5309	Yes
15	57	1.0u	938.0u	5310	Yes
16	66	1.0u	805.0u	5312	Yes
17	63	1.0u	845.0u	5313	Yes
18	60	1.0u	885.0u	5314	Yes
19	59	1.0u	905.0u	5316	Yes
20	69	1.0u	771.0u	5317	Yes
21	66	1.0u	811.0u	5319	Yes
22	63	1.0u	851.0u	5320	Yes
23	60	1.0u	891.0u	5322	Yes
24	58	1.0u	911.0u	5323	Yes
25	92	1.0u	577.0u	5324	Yes
26	86	1.0u	617.0u	5325	Yes
27	78	1.0u	677.0u	5326	Yes
28	74	1.0u	717.0u	5327	Yes
29	68	1.0u	777.0u	5328	Yes
30	58	1.0u	917.0u	5329	Yes

Detection Rate: 100.0 %

Type 2 Radar Statistical Performances					
Trial #	Pulses per Burst	Pulse Width (s)	PRI (s)	Radar Frequency (MHz)	Detection
1	25	4.6u	200.0u	5291	Yes
2	27	2.8u	200.0u	5293	Yes
3	27	1.7u	161.0u	5294	Yes
4	28	2.6u	220.0u	5295	Yes
5	27	2.6u	218.0u	5297	Yes
6	27	1.7u	172.0u	5299	Yes
7	26	1.6u	191.0u	5300	Yes
8	25	3.7u	158.0u	5301	Yes
9	28	1.5u	228.0u	5303	Yes
10	26	4.9u	198.0u	5305	Yes
11	28	1.3u	205.0u	5306	Yes
12	29	2.6u	155.0u	5307	Yes
13	28	4.9u	224.0u	5308	Yes
14	24	2.9u	169.0u	5309	Yes
15	28	4.1u	183.0u	5310	Yes
16	27	1.7u	192.0u	5312	Yes
17	24	2.6u	191.0u	5313	Yes
18	27	4.6u	173.0u	5314	Yes
19	28	3.4u	187.0u	5316	Yes
20	27	4.3u	214.0u	5317	No
21	29	1.2u	179.0u	5319	Yes
22	25	1.1u	154.0u	5320	Yes
23	25	4.1u	159.0u	5322	Yes
24	28	2.9u	158.0u	5323	Yes
25	25	2.8u	215.0u	5324	Yes
26	27	4.0u	196.0u	5325	Yes
27	27	4.5u	215.0u	5326	Yes
28	27	2.9u	180.0u	5327	Yes
29	27	1.5u	177.0u	5328	Yes
30	28	1.6u	186.0u	5329	Yes

Detection Rate: 96.6 %

Type 3 Radar Statistical Performances					
Trial #	Pulses per Burst	Pulse Width (s)	PRI (s)	Radar Frequency (MHz)	Detection
1	17	9.6u	218.0u	5291	Yes
2	18	8.4u	494.0u	5293	No
3	17	8.7u	375.0u	5294	Yes
4	18	7.0u	379.0u	5295	Yes
5	17	8.9u	401.0u	5297	Yes
6	17	8.3u	348.0u	5299	Yes
7	16	6.2u	454.0u	5300	Yes
8	18	9.2u	299.0u	5301	Yes
9	16	9.6u	347.0u	5303	Yes
10	16	7.0u	293.0u	5305	Yes
11	17	9.7u	434.0u	5306	Yes
12	16	9.5u	405.0u	5307	Yes
13	17	9.0u	459.0u	5308	Yes
14	18	6.2u	349.0u	5309	Yes
15	17	7.9u	225.0u	5310	Yes
16	18	8.0u	384.0u	5312	Yes
17	17	6.5u	220.0u	5313	Yes
18	16	8.4u	225.0u	5314	Yes
19	17	6.1u	210.0u	5316	Yes
20	16	6.0u	260.0u	5317	Yes
21	18	9.1u	470.0u	5319	Yes
22	16	7.1u	474.0u	5320	Yes
23	18	9.1u	433.0u	5322	No
24	18	9.1u	296.0u	5323	Yes
25	16	8.5u	368.0u	5324	Yes
26	16	6.4u	315.0u	5325	Yes
27	17	6.9u	204.0u	5326	Yes
28	18	6.8u	309.0u	5327	Yes
29	17	9.2u	351.0u	5328	Yes
30	17	9.0u	201.0u	5329	Yes

Detection Rate: 93.3 %

Type 4 Radar Statistical Performances					
Trial #	Pulses per Burst	Pulse Width (s)	PRI (s)	Radar Frequency (MHz)	Detection
1	14	14.3u	312.0u	5291	Yes
2	13	18.3u	368.0u	5293	No
3	13	18.4u	392.0u	5294	Yes
4	16	14.9u	457.0u	5295	No
5	13	15.9u	337.0u	5297	Yes
6	14	13.7u	413.0u	5299	Yes
7	13	13.6u	263.0u	5300	No
8	14	11.2u	484.0u	5301	No
9	12	11.6u	341.0u	5303	No
10	14	18.2u	448.0u	5305	Yes
11	14	14.2u	423.0u	5306	Yes
12	14	12.4u	470.0u	5307	No
13	13	18.0u	336.0u	5308	Yes
14	15	17.8u	213.0u	5309	Yes
15	14	11.8u	297.0u	5310	Yes
16	15	16.6u	436.0u	5312	Yes
17	15	16.8u	298.0u	5313	No
18	13	14.9u	459.0u	5314	Yes
19	14	19.5u	286.0u	5316	No
20	16	18.4u	462.0u	5317	Yes
21	15	19.0u	314.0u	5319	Yes
22	15	16.2u	284.0u	5320	Yes
23	13	16.9u	396.0u	5322	Yes
24	15	14.9u	202.0u	5323	Yes
25	14	17.8u	492.0u	5324	Yes
26	12	14.2u	451.0u	5325	Yes
27	12	18.2u	350.0u	5326	Yes
28	15	14.7u	204.0u	5327	Yes
29	12	16.6u	418.0u	5328	Yes
30	13	14.1u	218.0u	5329	Yes
					Detection Rate: 73.3 %

Type 5 Radar Statistical Performances		
Trial #	Test Signal Name	Detection
1	LP_Signal_01	Yes
2	LP_Signal_02	Yes
3	LP_Signal_03	Yes
4	LP_Signal_04	Yes
5	LP_Signal_05	Yes
6	LP_Signal_06	Yes
7	LP_Signal_07	Yes
8	LP_Signal_08	Yes
9	LP_Signal_09	Yes
10	LP_Signal_10	Yes
11	LP_Signal_11	Yes
12	LP_Signal_12	Yes
13	LP_Signal_13	Yes
14	LP_Signal_14	Yes
15	LP_Signal_15	Yes
16	LP_Signal_16	Yes
17	LP_Signal_17	Yes
18	LP_Signal_18	Yes
19	LP_Signal_19	Yes
20	LP_Signal_20	Yes
21	LP_Signal_21	Yes
22	LP_Signal_22	Yes
23	LP_Signal_23	Yes
24	LP_Signal_24	Yes
25	LP_Signal_25	Yes
26	LP_Signal_26	Yes
27	LP_Signal_27	Yes
28	LP_Signal_28	Yes
29	LP_Signal_29	Yes
30	LP_Signal_30	Yes
		Detection Rate: 100.0 %

Long Pulse Radar Test Signal						
Test Signal Name: LP_Signal_01						
Number of Bursts in Trial: 19						
Chrip Center Frequency: 5294MHz						
Burst	Pulses per Burst	Chrip (Hz)	Pulse Width (s)	Pulse 1 to 2 Spacing (s)	Pulse 2 to 3 Spacing (s)	Start Location (s)
1	2	5M	50.4u	1.916m	-	334.6m
2	2	5M	54.2u	1.760m	-	40.17m
3	2	5M	66.7u	1.591m	-	375.0m
4	1	5M	81.8u	-	-	224.8m
5	3	5M	85.3u	1.562m	1.550m	598.5m
6	2	5M	50.9u	1.097m	-	247.8m
7	3	5M	71.5u	1.403m	1.250m	384.9m
8	1	5M	57.3u	-	-	545.1m
9	1	5M	99.4u	-	-	327.7m
10	2	5M	81.7u	1.762m	-	346.5m
11	3	5M	87.0u	1.625m	1.683m	237.2m
12	2	5M	94.9u	1.522m	-	585.4m
13	2	5M	83.5u	1.529m	-	480.1m
14	2	5M	66.1u	1.677m	-	545.9m
15	2	5M	52.9u	1.709m	-	563.8m
16	3	5M	51.5u	1.865m	1.887m	433.2m
17	1	5M	82.8u	-	-	4.846m
18	2	5M	84.6u	957.4u	-	397.1m
19	3	5M	70.6u	1.247m	1.791m	432.2m

Long Pulse Radar Test Signal						
Test Signal Name: LP_Signal_02						
Number of Bursts in Trial: 13						
Chrip Center Frequency: 5294MHz						
Burst	Pulses per Burst	Chrip (Hz)	Pulse Width (s)	Pulse 1 to 2 Spacing (s)	Pulse 2 to 3 Spacing (s)	Start Location (s)
1	2	5M	64.2u	1.510m	-	171.7m
2	2	5M	85.7u	1.457m	-	23.95m
3	3	5M	93.8u	1.348m	1.769m	685.0m
4	3	5M	85.1u	1.065m	1.624m	112.8m
5	1	5M	84.7u	-	-	797.2m
6	2	5M	80.4u	1.702m	-	14.43m
7	1	5M	98.4u	-	-	314.4m
8	2	5M	71.1u	1.369m	-	529.1m
9	1	5M	98.6u	-	-	667.9m
10	2	5M	91.7u	1.176m	-	571.6m
11	2	5M	69.1u	1.770m	-	615.7m
12	2	5M	90.9u	1.511m	-	676.8m
13	2	5M	89.6u	1.199m	-	683.8m

Long Pulse Radar Test Signal
 Test Signal Name: LP_Signal_03
 Number of Bursts in Trial: 9
 Chrip Center Frequency: 5295MHz

Burst	Pulses per Burst	Chrip (Hz)	Pulse Width (s)	Pulse 1 to 2 Spacing (s)	Pulse 2 to 3 Spacing (s)	Start Location (s)
1	3	8M	71.1u	1.222m	1.413m	444.6m
2	2	8M	59.0u	1.893m	-	289.7m
3	2	8M	60.7u	1.211m	-	933.9m
4	3	8M	68.6u	1.430m	1.751m	827.1m
5	3	8M	78.0u	1.707m	1.351m	65.79m
6	3	8M	95.0u	1.577m	1.175m	1.235
7	2	8M	94.0u	1.043m	-	1.170
8	2	8M	82.2u	1.181m	-	463.7m
9	1	8M	55.8u	-	-	543.3m

Long Pulse Radar Test Signal
 Test Signal Name: LP_Signal_04
 Number of Bursts in Trial: 11
 Chrip Center Frequency: 5295MHz

Burst	Pulses per Burst	Chrip (Hz)	Pulse Width (s)	Pulse 1 to 2 Spacing (s)	Pulse 2 to 3 Spacing (s)	Start Location (s)
1	3	8M	77.4u	1.030m	976.6u	796.6m
2	1	8M	67.0u	-	-	626.7m
3	2	8M	66.8u	1.592m	-	230.3m
4	2	8M	96.2u	1.786m	-	706.5m
5	1	8M	73.5u	-	-	809.0m
6	3	8M	64.8u	1.909m	1.249m	95.29m
7	3	8M	69.4u	1.248m	1.386m	601.9m
8	2	8M	98.4u	1.041m	-	333.4m
9	1	8M	86.7u	-	-	201.6m
10	2	8M	76.0u	1.466m	-	691.6m
11	3	8M	64.9u	1.673m	1.042m	635.0m

Long Pulse Radar Test Signal
 Test Signal Name: LP_Signal_05
 Number of Bursts in Trial: 12
 Chrip Center Frequency: 5297MHz

Burst	Pulses per Burst	Chrip (Hz)	Pulse Width (s)	Pulse 1 to 2 Spacing (s)	Pulse 2 to 3 Spacing (s)	Start Location (s)
1	2	13M	71.5u	982.5u	-	86.36m
2	1	13M	89.8u	-	-	993.6m
3	1	13M	83.2u	-	-	30.83m
4	1	13M	59.2u	-	-	837.0m
5	1	13M	68.7u	-	-	229.0m
6	2	13M	96.4u	1.547m	-	543.5m
7	2	13M	84.2u	1.813m	-	108.2m
8	1	13M	61.5u	-	-	194.1m
9	2	13M	87.9u	1.451m	-	603.2m
10	1	13M	94.3u	-	-	285.9m
11	2	13M	61.6u	1.018m	-	423.4m
12	2	13M	55.8u	1.245m	-	287.7m

Long Pulse Radar Test Signal
 Test Signal Name: LP_Signal_06
 Number of Bursts in Trial: 10
 Chrip Center Frequency: 5297MHz

Burst	Pulses per Burst	Chrip (Hz)	Pulse Width (s)	Pulse 1 to 2 Spacing (s)	Pulse 2 to 3 Spacing (s)	Start Location (s)
1	1	13M	67.5u	-	-	502.0m
2	1	13M	88.4u	-	-	240.1m
3	1	13M	65.8u	-	-	262.9m
4	2	13M	62.4u	1.503m	-	341.2m
5	1	13M	95.6u	-	-	958.2m
6	3	13M	62.0u	1.724m	1.096m	947.7m
7	1	13M	52.1u	-	-	612.1m
8	2	13M	50.7u	1.853m	-	1.171
9	2	13M	88.5u	1.693m	-	992.4m
10	2	13M	51.3u	1.595m	-	447.5m

Long Pulse Radar Test Signal
 Test Signal Name: LP_Signal_07
 Number of Bursts in Trial: 17
 Chrip Center Frequency: 5298MHz

Burst	Pulses per Burst	Chrip (Hz)	Pulse Width (s)	Pulse 1 to 2 Spacing (s)	Pulse 2 to 3 Spacing (s)	Start Location (s)
1	2	15M	73.3u	1.117m	-	263.9m
2	3	15M	77.1u	1.610m	1.018m	283.7m
3	2	15M	70.2u	1.453m	-	47.73m
4	2	15M	84.6u	1.444m	-	566.8m
5	3	15M	82.8u	1.477m	1.433m	572.1m
6	2	15M	95.2u	987.8u	-	614.1m
7	3	15M	95.3u	1.243m	1.697m	22.08m
8	3	15M	59.7u	1.441m	1.343m	23.27m
9	3	15M	69.3u	1.787m	1.428m	620.8m
10	2	15M	75.3u	1.838m	-	693.6m
11	3	15M	91.2u	1.427m	1.347m	498.9m
12	3	15M	91.2u	1.212m	1.579m	309.3m
13	2	15M	94.7u	1.191m	-	266.5m
14	3	15M	98.4u	1.552m	1.534m	614.4m
15	3	15M	54.0u	1.482m	990.0u	449.2m
16	2	15M	74.1u	1.675m	-	613.7m
17	2	15M	83.4u	1.632m	-	699.8m

Long Pulse Radar Test Signal
 Test Signal Name: LP_Signal_08
 Number of Bursts in Trial: 9
 Chrip Center Frequency: 5298MHz

Burst	Pulses per Burst	Chrip (Hz)	Pulse Width (s)	Pulse 1 to 2 Spacing (s)	Pulse 2 to 3 Spacing (s)	Start Location (s)
1	1	15M	97.5u	-	-	471.5m
2	3	15M	52.7u	1.940m	1.267m	85.10m
3	2	15M	85.6u	1.832m	-	606.7m
4	3	15M	93.9u	1.311m	1.757m	129.9m
5	2	15M	77.8u	1.140m	-	697.6m
6	2	15M	55.9u	1.283m	-	587.3m
7	3	15M	77.8u	1.001m	1.712m	269.7m
8	2	15M	54.8u	1.560m	-	1.196
9	2	15M	54.1u	1.552m	-	817.5m

Long Pulse Radar Test Signal						
Test Signal Name: LP_Signal_09						
Number of Bursts in Trial: 13						
Chrip Center Frequency: 5300MHz						
Burst	Pulses per Burst	Chrip (Hz)	Pulse Width (s)	Pulse 1 to 2 Spacing (s)	Pulse 2 to 3 Spacing (s)	Start Location (s)
1	3	20M	99.7u	1.511m	1.864m	57.55m
2	2	20M	62.6u	1.651m	-	208.8m
3	2	20M	78.6u	1.897m	-	188.5m
4	3	20M	92.7u	1.075m	1.701m	713.1m
5	2	20M	84.2u	1.551m	-	875.0m
6	2	20M	71.6u	1.165m	-	311.7m
7	1	20M	67.9u	-	-	735.6m
8	3	20M	54.0u	1.098m	1.873m	138.9m
9	1	20M	82.3u	-	-	262.2m
10	2	20M	63.4u	1.368m	-	14.73m
11	2	20M	64.4u	1.845m	-	637.0m
12	2	20M	90.9u	1.294m	-	356.2m
13	1	20M	96.9u	-	-	536.0m

Long Pulse Radar Test Signal						
Test Signal Name: LP_Signal_10						
Number of Bursts in Trial: 18						
Chrip Center Frequency: 5300MHz						
Burst	Pulses per Burst	Chrip (Hz)	Pulse Width (s)	Pulse 1 to 2 Spacing (s)	Pulse 2 to 3 Spacing (s)	Start Location (s)
1	2	20M	98.6u	1.198m	-	344.9m
2	2	20M	57.6u	961.4u	-	641.7m
3	1	20M	56.4u	-	-	308.8m
4	1	20M	81.4u	-	-	180.2m
5	1	20M	61.8u	-	-	297.7m
6	2	20M	90.4u	1.563m	-	282.9m
7	3	20M	68.8u	1.515m	1.370m	37.46m
8	1	20M	73.9u	-	-	475.8m
9	2	20M	68.4u	1.684m	-	117.5m
10	3	20M	95.4u	1.490m	1.735m	155.9m
11	1	20M	70.9u	-	-	253.8m
12	1	20M	94.7u	-	-	356.0m
13	3	20M	76.9u	1.750m	1.203m	56.37m
14	3	20M	80.6u	1.024m	1.881m	588.3m
15	2	20M	87.2u	1.015m	-	223.6m
16	2	20M	85.9u	1.898m	-	380.5m
17	1	20M	62.9u	-	-	127.1m
18	2	20M	96.3u	1.532m	-	541.3m

Long Pulse Radar Test Signal
 Test Signal Name: LP_Signal_11
 Number of Bursts in Trial: 13
 Chrip Center Frequency: 5310MHz

Burst	Pulses per Burst	Chrip (Hz)	Pulse Width (s)	Pulse 1 to 2 Spacing (s)	Pulse 2 to 3 Spacing (s)	Start Location (s)
1	2	5M	64.2u	1.510m	-	171.7m
2	2	5M	85.7u	1.457m	-	23.95m
3	3	5M	93.8u	1.348m	1.769m	685.0m
4	3	5M	85.1u	1.065m	1.624m	112.8m
5	1	5M	84.7u	-	-	797.2m
6	2	5M	80.4u	1.702m	-	14.43m
7	1	5M	98.4u	-	-	314.4m
8	2	5M	71.1u	1.369m	-	529.1m
9	1	5M	98.6u	-	-	667.9m
10	2	5M	91.7u	1.176m	-	571.6m
11	2	5M	69.1u	1.770m	-	615.7m
12	2	5M	90.9u	1.511m	-	676.8m
13	2	5M	89.6u	1.199m	-	683.8m

Long Pulse Radar Test Signal
 Test Signal Name: LP_Signal_12
 Number of Bursts in Trial: 19
 Chrip Center Frequency: 5310MHz

Burst	Pulses per Burst	Chrip (Hz)	Pulse Width (s)	Pulse 1 to 2 Spacing (s)	Pulse 2 to 3 Spacing (s)	Start Location (s)
1	3	5M	61.2u	1.793m	1.857m	398.8m
2	1	5M	53.7u	-	-	300.3m
3	2	5M	82.7u	1.900m	-	154.0m
4	3	5M	98.8u	1.369m	1.879m	7.212m
5	2	5M	54.9u	1.516m	-	475.2m
6	3	5M	57.2u	1.640m	1.396m	427.7m
7	2	5M	91.6u	1.507m	-	435.3m
8	2	5M	69.8u	1.897m	-	349.7m
9	2	5M	58.1u	1.668m	-	584.4m
10	2	5M	81.6u	1.380m	-	184.8m
11	2	5M	57.5u	1.242m	-	221.2m
12	3	5M	92.2u	1.227m	913.8u	353.3m
13	2	5M	81.9u	1.129m	-	486.4m
14	2	5M	66.9u	1.395m	-	235.5m
15	1	5M	67.9u	-	-	415.5m
16	3	5M	99.2u	1.884m	1.803m	462.9m
17	2	5M	71.2u	1.043m	-	214.2m
18	1	5M	70.9u	-	-	379.4m
19	2	5M	68.8u	1.209m	-	322.3m

Long Pulse Radar Test Signal						
Test Signal Name: LP_Signal_13						
Number of Bursts in Trial: 12						
Chrip Center Frequency: 5310MHz						
Burst	Pulses per Burst	Chrip (Hz)	Pulse Width (s)	Pulse 1 to 2 Spacing (s)	Pulse 2 to 3 Spacing (s)	Start Location (s)
1	2	9M	83.6u	1.774m	-	467.4m
2	2	9M	97.1u	1.796m	-	328.2m
3	1	9M	84.9u	-	-	712.5m
4	1	9M	85.6u	-	-	456.6m
5	2	9M	97.8u	917.2u	-	642.0m
6	2	9M	95.4u	1.079m	-	800.8m
7	1	9M	71.2u	-	-	898.6m
8	3	9M	82.0u	1.666m	1.468m	784.5m
9	3	9M	86.6u	1.322m	1.519m	535.5m
10	1	9M	71.4u	-	-	43.23m
11	2	9M	62.2u	1.268m	-	268.5m
12	2	9M	96.1u	1.888m	-	253.4m

Long Pulse Radar Test Signal						
Test Signal Name: LP_Signal_14						
Number of Bursts in Trial: 13						
Chrip Center Frequency: 5310MHz						
Burst	Pulses per Burst	Chrip (Hz)	Pulse Width (s)	Pulse 1 to 2 Spacing (s)	Pulse 2 to 3 Spacing (s)	Start Location (s)
1	2	9M	61.5u	955.5u	-	640.4m
2	1	9M	92.5u	-	-	393.8m
3	3	9M	71.1u	1.724m	1.483m	227.5m
4	2	9M	79.5u	1.035m	-	625.6m
5	2	9M	75.3u	1.324m	-	302.7m
6	3	9M	71.1u	1.201m	1.880m	210.6m
7	2	9M	83.2u	1.845m	-	576.6m
8	2	9M	81.1u	1.333m	-	524.0m
9	2	9M	97.7u	1.050m	-	855.4m
10	2	9M	95.7u	1.224m	-	597.8m
11	2	9M	53.5u	1.334m	-	874.0m
12	3	9M	70.8u	1.735m	1.020m	510.2m
13	2	9M	95.7u	1.535m	-	870.2m

Long Pulse Radar Test Signal						
Test Signal Name: LP_Signal_15						
Number of Bursts in Trial: 17						
Chrip Center Frequency: 5310MHz						
Burst	Pulses per Burst	Chrip (Hz)	Pulse Width (s)	Pulse 1 to 2 Spacing (s)	Pulse 2 to 3 Spacing (s)	Start Location (s)
1	2	15M	73.3u	1.117m	-	263.9m
2	3	15M	77.1u	1.610m	1.018m	283.7m
3	2	15M	70.2u	1.453m	-	47.73m
4	2	15M	84.6u	1.444m	-	566.8m
5	3	15M	82.8u	1.477m	1.433m	572.1m
6	2	15M	95.2u	987.8u	-	614.1m
7	3	15M	95.3u	1.243m	1.697m	22.08m
8	3	15M	59.7u	1.441m	1.343m	23.27m
9	3	15M	69.3u	1.787m	1.428m	620.8m
10	2	15M	75.3u	1.838m	-	693.6m
11	3	15M	91.2u	1.427m	1.347m	498.9m
12	3	15M	91.2u	1.212m	1.579m	309.3m
13	2	15M	94.7u	1.191m	-	266.5m
14	3	15M	98.4u	1.552m	1.534m	614.4m
15	3	15M	54.0u	1.482m	990.0u	449.2m
16	2	15M	74.1u	1.675m	-	613.7m
17	2	15M	83.4u	1.632m	-	699.8m

Long Pulse Radar Test Signal						
Test Signal Name: LP_Signal_16						
Number of Bursts in Trial: 8						
Chrip Center Frequency: 5310MHz						
Burst	Pulses per Burst	Chrip (Hz)	Pulse Width (s)	Pulse 1 to 2 Spacing (s)	Pulse 2 to 3 Spacing (s)	Start Location (s)
1	3	15M	86.3u	1.743m	985.7u	297.0m
2	1	15M	66.0u	-	-	1.473
3	3	15M	67.9u	1.531m	1.717m	438.4m
4	3	15M	86.6u	1.433m	1.491m	650.2m
5	2	15M	59.3u	1.648m	-	773.9m
6	2	15M	60.7u	1.384m	-	278.3m
7	2	15M	58.5u	1.114m	-	1.321
8	2	15M	88.9u	920.1u	-	360.9m

Long Pulse Radar Test Signal						
Test Signal Name: LP_Signal_17						
Number of Bursts in Trial: 19						
Chrip Center Frequency: 5310MHz						
Burst	Pulses per Burst	Chrip (Hz)	Pulse Width (s)	Pulse 1 to 2 Spacing (s)	Pulse 2 to 3 Spacing (s)	Start Location (s)
1	3	17M	56.6u	1.081m	1.442m	264.5m
2	2	17M	77.0u	1.479m	-	411.6m
3	1	17M	64.7u	-	-	502.4m
4	2	17M	66.3u	1.533m	-	128.2m
5	2	17M	66.5u	1.654m	-	32.33m
6	2	17M	53.9u	1.723m	-	368.5m
7	2	17M	95.4u	1.678m	-	502.6m
8	2	17M	79.6u	1.481m	-	375.6m
9	2	17M	94.7u	1.774m	-	335.2m
10	3	17M	86.7u	1.256m	1.147m	567.5m
11	2	17M	65.2u	1.373m	-	55.52m
12	3	17M	53.6u	1.336m	1.086m	350.4m
13	1	17M	93.6u	-	-	549.5m
14	3	17M	99.9u	1.866m	961.1u	222.0m
15	2	17M	98.7u	1.242m	-	603.9m
16	3	17M	99.5u	992.5u	1.138m	514.9m
17	2	17M	88.7u	1.906m	-	388.1m
18	2	17M	98.4u	1.185m	-	429.7m
19	2	17M	84.8u	1.718m	-	344.7m

Long Pulse Radar Test Signal						
Test Signal Name: LP_Signal_18						
Number of Bursts in Trial: 15						
Chrip Center Frequency: 5310MHz						
Burst	Pulses per Burst	Chrip (Hz)	Pulse Width (s)	Pulse 1 to 2 Spacing (s)	Pulse 2 to 3 Spacing (s)	Start Location (s)
1	2	17M	74.4u	1.078m	-	405.4m
2	2	17M	64.5u	1.652m	-	642.9m
3	2	17M	60.9u	1.407m	-	702.7m
4	1	17M	93.7u	-	-	738.4m
5	3	17M	73.4u	1.274m	1.171m	600.8m
6	2	17M	65.8u	1.640m	-	566.8m
7	2	17M	67.9u	1.038m	-	561.0m
8	2	17M	75.2u	970.8u	-	25.08m
9	1	17M	58.5u	-	-	667.7m
10	1	17M	97.9u	-	-	176.6m
11	3	17M	87.6u	1.679m	1.187m	730.3m
12	1	17M	94.5u	-	-	720.4m
13	3	17M	56.4u	1.013m	1.776m	274.4m
14	2	17M	84.2u	1.338m	-	186.8m
15	1	17M	67.2u	-	-	223.4m

Long Pulse Radar Test Signal						
Test Signal Name: LP_Signal_19						
Number of Bursts in Trial: 15						
Chrip Center Frequency: 5310MHz						
Burst	Pulses per Burst	Chrip (Hz)	Pulse Width (s)	Pulse 1 to 2 Spacing (s)	Pulse 2 to 3 Spacing (s)	Start Location (s)
1	1	20M	63.9u	-	-	77.33m
2	2	20M	94.7u	1.807m	-	47.69m
3	2	20M	55.2u	1.653m	-	235.8m
4	1	20M	88.6u	-	-	734.4m
5	3	20M	58.9u	1.448m	1.576m	594.5m
6	3	20M	80.2u	1.051m	1.328m	738.1m
7	2	20M	51.8u	1.771m	-	610.0m
8	1	20M	58.2u	-	-	187.6m
9	3	20M	51.5u	1.442m	1.642m	91.17m
10	2	20M	54.6u	1.066m	-	128.0m
11	3	20M	92.5u	1.718m	1.207m	337.4m
12	3	20M	88.1u	1.794m	1.583m	438.5m
13	2	20M	63.5u	1.643m	-	214.3m
14	2	20M	73.1u	959.9u	-	235.5m
15	1	20M	71.4u	-	-	509.1m

Long Pulse Radar Test Signal						
Test Signal Name: LP_Signal_20						
Number of Bursts in Trial: 18						
Chrip Center Frequency: 5310MHz						
Burst	Pulses per Burst	Chrip (Hz)	Pulse Width (s)	Pulse 1 to 2 Spacing (s)	Pulse 2 to 3 Spacing (s)	Start Location (s)
1	1	20M	58.6u	-	-	36.12m
2	2	20M	92.0u	1.831m	-	301.7m
3	2	20M	97.4u	1.173m	-	286.9m
4	2	20M	57.0u	979.0u	-	55.23m
5	1	20M	66.5u	-	-	376.4m
6	2	20M	78.9u	1.100m	-	434.4m
7	2	20M	70.2u	1.681m	-	626.6m
8	3	20M	72.3u	1.233m	1.537m	438.6m
9	2	20M	59.1u	1.565m	-	429.8m
10	1	20M	50.4u	-	-	446.6m
11	2	20M	88.1u	1.050m	-	371.0m
12	2	20M	52.9u	1.220m	-	91.61m
13	1	20M	95.1u	-	-	395.7m
14	1	20M	82.4u	-	-	374.5m
15	2	20M	96.3u	992.7u	-	595.6m
16	2	20M	91.4u	1.793m	-	121.7m
17	2	20M	97.6u	1.191m	-	331.3m
18	2	20M	61.0u	1.695m	-	56.15m

Long Pulse Radar Test Signal						
Test Signal Name: LP_Signal_21						
Number of Bursts in Trial: 19						
Chrip Center Frequency: 5326MHz						
Burst	Pulses per Burst	Chrip (Hz)	Pulse Width (s)	Pulse 1 to 2 Spacing (s)	Pulse 2 to 3 Spacing (s)	Start Location (s)
1	3	5M	61.2u	1.793m	1.857m	398.8m
2	1	5M	53.7u	-	-	300.3m
3	2	5M	82.7u	1.900m	-	154.0m
4	3	5M	98.8u	1.369m	1.879m	7.212m
5	2	5M	54.9u	1.516m	-	475.2m
6	3	5M	57.2u	1.640m	1.396m	427.7m
7	2	5M	91.6u	1.507m	-	435.3m
8	2	5M	69.8u	1.897m	-	349.7m
9	2	5M	58.1u	1.668m	-	584.4m
10	2	5M	81.6u	1.380m	-	184.8m
11	2	5M	57.5u	1.242m	-	221.2m
12	3	5M	92.2u	1.227m	913.8u	353.3m
13	2	5M	81.9u	1.129m	-	486.4m
14	2	5M	66.9u	1.395m	-	235.5m
15	1	5M	67.9u	-	-	415.5m
16	3	5M	99.2u	1.884m	1.803m	462.9m
17	2	5M	71.2u	1.043m	-	214.2m
18	1	5M	70.9u	-	-	379.4m
19	2	5M	68.8u	1.209m	-	322.3m

Long Pulse Radar Test Signal						
Test Signal Name: LP_Signal_22						
Number of Bursts in Trial: 18						
Chrip Center Frequency: 5326MHz						
Burst	Pulses per Burst	Chrip (Hz)	Pulse Width (s)	Pulse 1 to 2 Spacing (s)	Pulse 2 to 3 Spacing (s)	Start Location (s)
1	2	5M	64.8u	1.186m	-	75.79m
2	3	5M	95.3u	1.039m	1.151m	354.7m
3	1	5M	58.2u	-	-	145.6m
4	2	5M	96.2u	1.328m	-	408.6m
5	1	5M	70.0u	-	-	571.7m
6	1	5M	97.0u	-	-	4.469m
7	2	5M	74.8u	1.904m	-	112.1m
8	2	5M	86.3u	1.847m	-	19.29m
9	1	5M	56.7u	-	-	317.3m
10	2	5M	61.0u	956.0u	-	142.0m
11	2	5M	71.0u	935.0u	-	251.8m
12	1	5M	54.2u	-	-	150.7m
13	3	5M	90.1u	1.385m	1.143m	630.6m
14	2	5M	99.6u	1.522m	-	405.1m
15	2	5M	67.1u	1.741m	-	9.165m
16	2	5M	50.8u	1.064m	-	487.1m
17	2	5M	78.9u	1.002m	-	226.8m
18	3	5M	87.7u	1.409m	1.017m	595.7m

Long Pulse Radar Test Signal
 Test Signal Name: LP_Signal_23
 Number of Bursts in Trial: 11
 Chrip Center Frequency: 5326MHz

Burst	Pulses per Burst	Chrip (Hz)	Pulse Width (s)	Pulse 1 to 2 Spacing (s)	Pulse 2 to 3 Spacing (s)	Start Location (s)
1	3	6M	51.6u	1.534m	1.356m	923.6m
2	3	6M	71.6u	1.079m	1.587m	287.7m
3	2	6M	74.5u	1.832m	-	980.6m
4	2	6M	78.9u	1.266m	-	281.6m
5	2	6M	50.0u	1.076m	-	519.7m
6	1	6M	58.3u	-	-	189.4m
7	2	6M	63.9u	1.193m	-	701.3m
8	2	6M	88.1u	1.462m	-	107.5m
9	3	6M	62.4u	1.328m	971.6u	153.5m
10	1	6M	65.5u	-	-	1.012
11	1	6M	95.5u	-	-	359.5m

Long Pulse Radar Test Signal
 Test Signal Name: LP_Signal_24
 Number of Bursts in Trial: 10
 Chrip Center Frequency: 5326MHz

Burst	Pulses per Burst	Chrip (Hz)	Pulse Width (s)	Pulse 1 to 2 Spacing (s)	Pulse 2 to 3 Spacing (s)	Start Location (s)
1	1	6M	63.2u	-	-	639.7m
2	3	6M	51.2u	1.477m	1.835m	678.8m
3	3	6M	64.0u	1.440m	1.154m	534.7m
4	2	6M	70.2u	1.135m	-	1.023
5	2	6M	82.2u	1.368m	-	565.5m
6	2	6M	90.8u	1.524m	-	59.60m
7	2	6M	61.5u	985.5u	-	1.004
8	1	6M	52.3u	-	-	775.3m
9	3	6M	75.8u	1.274m	1.399m	123.2m
10	1	6M	83.4u	-	-	1.109

Long Pulse Radar Test Signal
 Test Signal Name: LP_Signal_25
 Number of Bursts in Trial: 8
 Chrip Center Frequency: 5324MHz

Burst	Pulses per Burst	Chrip (Hz)	Pulse Width (s)	Pulse 1 to 2 Spacing (s)	Pulse 2 to 3 Spacing (s)	Start Location (s)
1	2	11M	84.4u	1.421m	-	801.3m
2	3	11M	70.4u	1.837m	1.413m	694.8m
3	1	11M	56.8u	-	-	852.3m
4	2	11M	88.3u	1.609m	-	214.6m
5	3	11M	63.4u	1.206m	1.734m	788.8m
6	3	11M	66.9u	942.1u	1.551m	502.0m
7	3	11M	67.8u	938.2u	1.580m	404.8m
8	2	11M	68.5u	1.233m	-	191.0m

Long Pulse Radar Test Signal						
Test Signal Name: LP_Signal_26						
Number of Bursts in Trial: 19						
Chrip Center Frequency: 5324MHz						
Burst	Pulses per Burst	Chrip (Hz)	Pulse Width (s)	Pulse 1 to 2 Spacing (s)	Pulse 2 to 3 Spacing (s)	Start Location (s)
1	1	11M	83.2u	-	-	45.94m
2	2	11M	64.2u	1.124m	-	371.8m
3	2	11M	93.6u	1.066m	-	35.45m
4	2	11M	81.4u	1.900m	-	379.4m
5	2	11M	72.5u	1.373m	-	425.9m
6	2	11M	63.2u	1.827m	-	395.1m
7	3	11M	78.0u	1.366m	1.019m	157.6m
8	1	11M	70.4u	-	-	237.3m
9	3	11M	62.4u	1.269m	1.701m	582.7m
10	1	11M	85.8u	-	-	223.0m
11	3	11M	57.4u	1.075m	1.909m	626.8m
12	2	11M	66.5u	1.637m	-	578.6m
13	3	11M	52.8u	1.165m	1.623m	626.6m
14	3	11M	51.0u	1.021m	1.068m	482.0m
15	1	11M	52.0u	-	-	471.8m
16	2	11M	72.0u	1.694m	-	284.8m
17	2	11M	58.9u	1.920m	-	155.7m
18	3	11M	84.2u	1.879m	1.077m	352.7m
19	2	11M	51.5u	1.504m	-	605.5m

Long Pulse Radar Test Signal						
Test Signal Name: LP_Signal_27						
Number of Bursts in Trial: 9						
Chrip Center Frequency: 5321MHz						
Burst	Pulses per Burst	Chrip (Hz)	Pulse Width (s)	Pulse 1 to 2 Spacing (s)	Pulse 2 to 3 Spacing (s)	Start Location (s)
1	1	19M	86.6u	-	-	1.233
2	2	19M	75.4u	1.787m	-	1.316
3	3	19M	50.2u	1.838m	1.148m	902.0m
4	1	19M	58.8u	-	-	953.0m
5	2	19M	54.0u	1.432m	-	424.4m
6	2	19M	51.1u	1.395m	-	265.3m
7	1	19M	63.0u	-	-	502.3m
8	1	19M	67.6u	-	-	1.070
9	2	19M	91.3u	1.439m	-	517.4m

Long Pulse Radar Test Signal						
Test Signal Name: LP_Signal_28						
Number of Bursts in Trial: 17						
Chrip Center Frequency: 5321MHz						
Burst	Pulses per Burst	Chrip (Hz)	Pulse Width (s)	Pulse 1 to 2 Spacing (s)	Pulse 2 to 3 Spacing (s)	Start Location (s)
1	2	19M	78.0u	1.167m	-	269.8m
2	3	19M	82.8u	1.545m	1.544m	640.4m
3	2	19M	73.0u	1.679m	-	88.41m
4	2	19M	67.7u	1.793m	-	557.7m
5	2	19M	55.9u	1.359m	-	651.0m
6	2	19M	92.9u	1.029m	-	485.5m
7	3	19M	70.2u	1.756m	1.342m	179.1m
8	1	19M	55.1u	-	-	407.5m
9	3	19M	67.9u	1.910m	1.250m	285.0m
10	1	19M	50.3u	-	-	147.8m
11	3	19M	50.3u	1.543m	1.185m	550.6m
12	3	19M	93.9u	1.670m	1.112m	207.5m
13	3	19M	54.3u	1.260m	1.333m	689.3m
14	1	19M	73.3u	-	-	595.0m
15	2	19M	86.5u	1.506m	-	78.29m
16	3	19M	53.8u	1.088m	1.261m	105.6m
17	2	19M	89.3u	1.368m	-	145.9m

Long Pulse Radar Test Signal						
Test Signal Name: LP_Signal_29						
Number of Bursts in Trial: 10						
Chrip Center Frequency: 5320MHz						
Burst	Pulses per Burst	Chrip (Hz)	Pulse Width (s)	Pulse 1 to 2 Spacing (s)	Pulse 2 to 3 Spacing (s)	Start Location (s)
1	2	20M	78.6u	1.551m	-	833.2m
2	2	20M	51.6u	990.4u	-	825.2m
3	2	20M	86.8u	1.097m	-	809.6m
4	1	20M	60.5u	-	-	792.9m
5	2	20M	54.9u	1.783m	-	491.4m
6	2	20M	75.7u	1.245m	-	717.7m
7	2	20M	55.0u	1.513m	-	1.155
8	2	20M	79.2u	955.8u	-	118.6m
9	1	20M	56.4u	-	-	881.1m
10	1	20M	97.7u	-	-	978.0m

Long Pulse Radar Test Signal						
Test Signal Name: LP_Signal_30						
Number of Bursts in Trial: 18						
Chirp Center Frequency: 5320MHz						
Burst	Pulses per Burst	Chirp (Hz)	Pulse Width (s)	Pulse 1 to 2 Spacing (s)	Pulse 2 to 3 Spacing (s)	Start Location (s)
1	1	20M	58.6u	-	-	36.12m
2	2	20M	92.0u	1.831m	-	301.7m
3	2	20M	97.4u	1.173m	-	286.9m
4	2	20M	57.0u	979.0u	-	55.23m
5	1	20M	66.5u	-	-	376.4m
6	2	20M	78.9u	1.100m	-	434.4m
7	2	20M	70.2u	1.681m	-	626.6m
8	3	20M	72.3u	1.233m	1.537m	438.6m
9	2	20M	59.1u	1.565m	-	429.8m
10	1	20M	50.4u	-	-	446.6m
11	2	20M	88.1u	1.050m	-	371.0m
12	2	20M	52.9u	1.220m	-	91.61m
13	1	20M	95.1u	-	-	395.7m
14	1	20M	82.4u	-	-	374.5m
15	2	20M	96.3u	992.7u	-	595.6m
16	2	20M	91.4u	1.793m	-	121.7m
17	2	20M	97.6u	1.191m	-	331.3m
18	2	20M	61.0u	1.695m	-	56.15m

Type 6 Radar Statistical Performances				
Trial #	Pulses per Burst	Pulse Width (s)	PRI (s)	Detection
1	9	1.0u	333.0u	Yes
2	9	1.0u	333.0u	Yes
3	9	1.0u	333.0u	Yes
4	9	1.0u	333.0u	Yes
5	9	1.0u	333.0u	Yes
6	9	1.0u	333.0u	Yes
7	9	1.0u	333.0u	Yes
8	9	1.0u	333.0u	Yes
9	9	1.0u	333.0u	Yes
10	9	1.0u	333.0u	Yes
11	9	1.0u	333.0u	Yes
12	9	1.0u	333.0u	Yes
13	9	1.0u	333.0u	Yes
14	9	1.0u	333.0u	Yes
15	9	1.0u	333.0u	Yes
16	9	1.0u	333.0u	Yes
17	9	1.0u	333.0u	Yes
18	9	1.0u	333.0u	Yes
19	9	1.0u	333.0u	Yes
20	9	1.0u	333.0u	Yes
21	9	1.0u	333.0u	Yes
22	9	1.0u	333.0u	Yes
23	9	1.0u	333.0u	Yes
24	9	1.0u	333.0u	Yes
25	9	1.0u	333.0u	Yes
26	9	1.0u	333.0u	Yes
27	9	1.0u	333.0u	Yes
28	9	1.0u	333.0u	Yes
29	9	1.0u	333.0u	Yes
30	9	1.0u	333.0u	Yes
				Detection Rate: 100.0 %

Type 6 Radar Statistical Performances		
Trial #	Hopping Frequency Sequence Name	Detection
1	HOP_FREQ_SEQ_01	Yes
2	HOP_FREQ_SEQ_02	Yes
3	HOP_FREQ_SEQ_03	Yes
4	HOP_FREQ_SEQ_04	Yes
5	HOP_FREQ_SEQ_05	Yes
6	HOP_FREQ_SEQ_06	Yes
7	HOP_FREQ_SEQ_07	Yes
8	HOP_FREQ_SEQ_08	Yes
9	HOP_FREQ_SEQ_09	Yes
10	HOP_FREQ_SEQ_10	Yes
11	HOP_FREQ_SEQ_11	Yes
12	HOP_FREQ_SEQ_12	Yes
13	HOP_FREQ_SEQ_13	Yes
14	HOP_FREQ_SEQ_14	Yes
15	HOP_FREQ_SEQ_15	Yes
16	HOP_FREQ_SEQ_16	Yes
17	HOP_FREQ_SEQ_17	Yes
18	HOP_FREQ_SEQ_18	Yes
19	HOP_FREQ_SEQ_19	Yes
20	HOP_FREQ_SEQ_20	Yes
21	HOP_FREQ_SEQ_21	Yes
22	HOP_FREQ_SEQ_22	Yes
23	HOP_FREQ_SEQ_23	Yes
24	HOP_FREQ_SEQ_24	Yes
25	HOP_FREQ_SEQ_25	Yes
26	HOP_FREQ_SEQ_26	Yes
27	HOP_FREQ_SEQ_27	Yes
28	HOP_FREQ_SEQ_28	Yes
29	HOP_FREQ_SEQ_29	Yes
30	HOP_FREQ_SEQ_30	Yes
		Detection Rate: 100.0 %

Hopping Frequency Sequence Name: HOP_FREQ_SEQ_01							
SEQ#	Frequency (Hz)	SEQ#	Frequency (Hz)	SEQ#	Frequency (Hz)	SEQ#	Frequency (Hz)
1	5.603G	2	5.405G	3	5.498G	4	5.670G
5	5.630G	6	5.712G	7	5.653G	8	5.285G
9	5.399G	10	5.541G	11	5.704G	12	5.323G
13	5.532G	14	5.366G	15	5.410G	16	5.581G
17	5.612G	18	5.467G	19	5.312G	20	5.554G
21	5.520G	22	5.551G	23	5.575G	24	5.448G
25	5.414G	26	5.598G	27	5.354G	28	5.708G
29	5.332G	30	5.288G	31	5.310G	32	5.456G
33	5.397G	34	5.361G	35	5.390G	36	5.380G
37	5.620G	38	5.652G	39	5.666G	40	5.457G
41	5.296G	42	5.631G	43	5.411G	44	5.470G
45	5.526G	46	5.472G	47	5.628G	48	5.375G
49	5.649G	50	5.656G	51	5.408G	52	5.393G
53	5.514G	54	5.348G	55	5.523G	56	5.709G
57	5.311G	58	5.284G	59	5.552G	60	5.427G
61	5.255G	62	5.395G	63	5.536G	64	5.626G
65	5.389G	66	5.297G	67	5.679G	68	5.545G
69	5.496G	70	5.617G	71	5.283G	72	5.508G
73	5.299G	74	5.319G	75	5.624G	76	5.440G
77	5.677G	78	5.643G	79	5.558G	80	5.252G
81	5.671G	82	5.378G	83	5.680G	84	5.547G
85	5.683G	86	5.453G	87	5.466G	88	5.471G
89	5.548G	90	5.356G	91	5.486G	92	5.684G
93	5.669G	94	5.349G	95	5.504G	96	5.641G
97	5.495G	98	5.578G	99	5.702G	100	5.706G

Hopping Frequency Sequence Name: HOP_FREQ_SEQ_02							
SEQ#	Frequency (Hz)	SEQ#	Frequency (Hz)	SEQ#	Frequency (Hz)	SEQ#	Frequency (Hz)
1	5.328G	2	5.655G	3	5.570G	4	5.291G
5	5.485G	6	5.342G	7	5.365G	8	5.720G
9	5.647G	10	5.264G	11	5.362G	12	5.403G
13	5.392G	14	5.284G	15	5.363G	16	5.461G
17	5.346G	18	5.381G	19	5.598G	20	5.528G
21	5.640G	22	5.315G	23	5.500G	24	5.539G
25	5.531G	26	5.459G	27	5.603G	28	5.372G
29	5.499G	30	5.263G	31	5.329G	32	5.366G
33	5.431G	34	5.586G	35	5.536G	36	5.266G
37	5.376G	38	5.654G	39	5.701G	40	5.285G
41	5.699G	42	5.327G	43	5.450G	44	5.567G
45	5.680G	46	5.581G	47	5.270G	48	5.633G
49	5.676G	50	5.353G	51	5.456G	52	5.454G
53	5.446G	54	5.532G	55	5.665G	56	5.443G
57	5.432G	58	5.371G	59	5.269G	60	5.559G
61	5.386G	62	5.535G	63	5.308G	64	5.451G
65	5.276G	66	5.718G	67	5.719G	68	5.287G
69	5.636G	70	5.292G	71	5.490G	72	5.700G
73	5.303G	74	5.569G	75	5.489G	76	5.364G
77	5.564G	78	5.335G	79	5.340G	80	5.326G
81	5.677G	82	5.375G	83	5.664G	84	5.427G
85	5.538G	86	5.509G	87	5.420G	88	5.344G
89	5.462G	90	5.682G	91	5.565G	92	5.691G
93	5.355G	94	5.687G	95	5.652G	96	5.352G
97	5.416G	98	5.286G	99	5.684G	100	5.425G

Hopping Frequency Sequence Name: HOP_FREQ_SEQ_03							
SEQ#	Frequency (Hz)	SEQ#	Frequency (Hz)	SEQ#	Frequency (Hz)	SEQ#	Frequency (Hz)
1	5.715G	2	5.431G	3	5.262G	4	5.608G
5	5.436G	6	5.354G	7	5.555G	8	5.545G
9	5.322G	10	5.379G	11	5.513G	12	5.254G
13	5.468G	14	5.449G	15	5.470G	16	5.616G
17	5.287G	18	5.393G	19	5.560G	20	5.256G
21	5.689G	22	5.647G	23	5.707G	24	5.413G
25	5.364G	26	5.445G	27	5.485G	28	5.615G
29	5.566G	30	5.610G	31	5.359G	32	5.723G
33	5.629G	34	5.312G	35	5.296G	36	5.341G
37	5.400G	38	5.611G	39	5.475G	40	5.463G
41	5.625G	42	5.412G	43	5.573G	44	5.434G
45	5.457G	46	5.540G	47	5.264G	48	5.496G
49	5.706G	50	5.724G	51	5.597G	52	5.299G
53	5.324G	54	5.539G	55	5.455G	56	5.547G
57	5.542G	58	5.631G	59	5.367G	60	5.363G
61	5.601G	62	5.714G	63	5.590G	64	5.365G
65	5.578G	66	5.453G	67	5.416G	68	5.471G
69	5.698G	70	5.323G	71	5.605G	72	5.635G
73	5.537G	74	5.352G	75	5.339G	76	5.378G
77	5.317G	78	5.257G	79	5.717G	80	5.637G
81	5.654G	82	5.361G	83	5.511G	84	5.510G
85	5.380G	86	5.594G	87	5.699G	88	5.600G
89	5.648G	90	5.683G	91	5.671G	92	5.283G
93	5.684G	94	5.508G	95	5.337G	96	5.342G
97	5.617G	98	5.278G	99	5.398G	100	5.497G

Hopping Frequency Sequence Name: HOP_FREQ_SEQ_04							
SEQ#	Frequency (Hz)	SEQ#	Frequency (Hz)	SEQ#	Frequency (Hz)	SEQ#	Frequency (Hz)
1	5.267G	2	5.612G	3	5.554G	4	5.569G
5	5.698G	6	5.718G	7	5.288G	8	5.716G
9	5.621G	10	5.723G	11	5.322G	12	5.511G
13	5.570G	14	5.683G	15	5.721G	16	5.530G
17	5.508G	18	5.451G	19	5.416G	20	5.521G
21	5.501G	22	5.460G	23	5.527G	24	5.699G
25	5.363G	26	5.470G	27	5.304G	28	5.623G
29	5.453G	30	5.426G	31	5.441G	32	5.579G
33	5.398G	34	5.669G	35	5.333G	36	5.468G
37	5.557G	38	5.517G	39	5.665G	40	5.610G
41	5.448G	42	5.629G	43	5.380G	44	5.262G
45	5.597G	46	5.285G	47	5.318G	48	5.266G
49	5.270G	50	5.381G	51	5.315G	52	5.401G
53	5.463G	54	5.298G	55	5.607G	56	5.700G
57	5.711G	58	5.417G	59	5.717G	60	5.360G
61	5.429G	62	5.654G	63	5.524G	64	5.496G
65	5.445G	66	5.499G	67	5.280G	68	5.386G
69	5.351G	70	5.687G	71	5.584G	72	5.356G
73	5.661G	74	5.589G	75	5.663G	76	5.657G
77	5.478G	78	5.659G	79	5.389G	80	5.513G
81	5.555G	82	5.458G	83	5.502G	84	5.420G
85	5.549G	86	5.690G	87	5.641G	88	5.648G
89	5.452G	90	5.473G	91	5.542G	92	5.588G
93	5.632G	94	5.439G	95	5.250G	96	5.348G
97	5.466G	98	5.541G	99	5.481G	100	5.562G

Hopping Frequency Sequence Name: HOP_FREQ_SEQ_05							
SEQ#	Frequency (Hz)	SEQ#	Frequency (Hz)	SEQ#	Frequency (Hz)	SEQ#	Frequency (Hz)
1	5.538G	2	5.423G	3	5.481G	4	5.307G
5	5.357G	6	5.593G	7	5.615G	8	5.404G
9	5.711G	10	5.490G	11	5.550G	12	5.416G
13	5.519G	14	5.541G	15	5.339G	16	5.612G
17	5.699G	18	5.653G	19	5.350G	20	5.369G
21	5.373G	22	5.656G	23	5.672G	24	5.688G
25	5.403G	26	5.522G	27	5.665G	28	5.675G
29	5.297G	30	5.402G	31	5.588G	32	5.673G
33	5.421G	34	5.512G	35	5.537G	36	5.715G
37	5.299G	38	5.686G	39	5.263G	40	5.679G
41	5.391G	42	5.313G	43	5.480G	44	5.561G
45	5.523G	46	5.389G	47	5.692G	48	5.569G
49	5.556G	50	5.578G	51	5.425G	52	5.517G
53	5.475G	54	5.532G	55	5.255G	56	5.375G
57	5.349G	58	5.436G	59	5.424G	60	5.271G
61	5.390G	62	5.585G	63	5.652G	64	5.486G
65	5.722G	66	5.280G	67	5.554G	68	5.514G
69	5.587G	70	5.683G	71	5.321G	72	5.547G
73	5.590G	74	5.432G	75	5.548G	76	5.657G
77	5.279G	78	5.693G	79	5.671G	80	5.539G
81	5.438G	82	5.301G	83	5.544G	84	5.670G
85	5.346G	86	5.463G	87	5.394G	88	5.567G
89	5.526G	90	5.434G	91	5.467G	92	5.611G
93	5.295G	94	5.647G	95	5.602G	96	5.318G
97	5.714G	98	5.649G	99	5.695G	100	5.630G

Hopping Frequency Sequence Name: HOP_FREQ_SEQ_06							
SEQ#	Frequency (Hz)	SEQ#	Frequency (Hz)	SEQ#	Frequency (Hz)	SEQ#	Frequency (Hz)
1	5.527G	2	5.604G	3	5.380G	4	5.393G
5	5.280G	6	5.665G	7	5.273G	8	5.473G
9	5.566G	10	5.647G	11	5.694G	12	5.645G
13	5.528G	14	5.359G	15	5.369G	16	5.564G
17	5.497G	18	5.669G	19	5.508G	20	5.459G
21	5.342G	22	5.563G	23	5.531G	24	5.605G
25	5.322G	26	5.436G	27	5.394G	28	5.611G
29	5.295G	30	5.441G	31	5.622G	32	5.469G
33	5.652G	34	5.638G	35	5.308G	36	5.375G
37	5.374G	38	5.309G	39	5.439G	40	5.626G
41	5.688G	42	5.345G	43	5.514G	44	5.646G
45	5.602G	46	5.666G	47	5.254G	48	5.271G
49	5.347G	50	5.470G	51	5.408G	52	5.700G
53	5.467G	54	5.480G	55	5.337G	56	5.673G
57	5.506G	58	5.417G	59	5.512G	60	5.348G
61	5.317G	62	5.621G	63	5.368G	64	5.557G
65	5.722G	66	5.266G	67	5.363G	68	5.678G
69	5.305G	70	5.485G	71	5.352G	72	5.668G
73	5.720G	74	5.509G	75	5.403G	76	5.460G
77	5.351G	78	5.556G	79	5.259G	80	5.629G
81	5.454G	82	5.723G	83	5.291G	84	5.356G
85	5.496G	86	5.681G	87	5.376G	88	5.689G
89	5.461G	90	5.711G	91	5.381G	92	5.279G
93	5.267G	94	5.533G	95	5.367G	96	5.361G
97	5.468G	98	5.389G	99	5.261G	100	5.357G

Hopping Frequency Sequence Name: HOP_FREQ_SEQ_07							
SEQ#	Frequency (Hz)	SEQ#	Frequency (Hz)	SEQ#	Frequency (Hz)	SEQ#	Frequency (Hz)
1	5.273G	2	5.275G	3	5.630G	4	5.277G
5	5.532G	6	5.396G	7	5.342G	8	5.379G
9	5.283G	10	5.475G	11	5.423G	12	5.571G
13	5.516G	14	5.382G	15	5.467G	16	5.429G
17	5.537G	18	5.386G	19	5.678G	20	5.544G
21	5.657G	22	5.527G	23	5.340G	24	5.470G
25	5.440G	26	5.332G	27	5.406G	28	5.373G
29	5.299G	30	5.385G	31	5.314G	32	5.255G
33	5.503G	34	5.507G	35	5.335G	36	5.476G
37	5.310G	38	5.383G	39	5.337G	40	5.518G
41	5.464G	42	5.674G	43	5.560G	44	5.322G
45	5.631G	46	5.446G	47	5.270G	48	5.708G
49	5.590G	50	5.365G	51	5.591G	52	5.706G
53	5.318G	54	5.402G	55	5.703G	56	5.662G
57	5.457G	58	5.414G	59	5.278G	60	5.308G
61	5.569G	62	5.407G	63	5.426G	64	5.376G
65	5.321G	66	5.384G	67	5.381G	68	5.542G
69	5.558G	70	5.472G	71	5.684G	72	5.553G
73	5.306G	74	5.401G	75	5.715G	76	5.458G
77	5.575G	78	5.654G	79	5.352G	80	5.671G
81	5.710G	82	5.479G	83	5.690G	84	5.297G
85	5.528G	86	5.276G	87	5.368G	88	5.585G
89	5.596G	90	5.353G	91	5.681G	92	5.442G
93	5.266G	94	5.268G	95	5.291G	96	5.615G
97	5.416G	98	5.699G	99	5.663G	100	5.293G

Hopping Frequency Sequence Name: HOP_FREQ_SEQ_08							
SEQ#	Frequency (Hz)	SEQ#	Frequency (Hz)	SEQ#	Frequency (Hz)	SEQ#	Frequency (Hz)
1	5.706G	2	5.662G	3	5.360G	4	5.585G
5	5.609G	6	5.471G	7	5.569G	8	5.485G
9	5.292G	10	5.673G	11	5.486G	12	5.626G
13	5.430G	14	5.563G	15	5.659G	16	5.287G
17	5.687G	18	5.719G	19	5.616G	20	5.668G
21	5.621G	22	5.591G	23	5.329G	24	5.558G
25	5.540G	26	5.623G	27	5.393G	28	5.712G
29	5.689G	30	5.370G	31	5.451G	32	5.545G
33	5.448G	34	5.394G	35	5.588G	36	5.633G
37	5.561G	38	5.418G	39	5.522G	40	5.707G
41	5.480G	42	5.414G	43	5.491G	44	5.312G
45	5.704G	46	5.317G	47	5.291G	48	5.319G
49	5.321G	50	5.681G	51	5.273G	52	5.473G
53	5.547G	54	5.457G	55	5.404G	56	5.456G
57	5.296G	58	5.299G	59	5.358G	60	5.684G
61	5.705G	62	5.581G	63	5.355G	64	5.592G
65	5.575G	66	5.436G	67	5.284G	68	5.381G
69	5.542G	70	5.388G	71	5.267G	72	5.254G
73	5.643G	74	5.257G	75	5.618G	76	5.332G
77	5.560G	78	5.647G	79	5.362G	80	5.677G
81	5.670G	82	5.651G	83	5.656G	84	5.425G
85	5.584G	86	5.612G	87	5.379G	88	5.368G
89	5.600G	90	5.489G	91	5.657G	92	5.357G
93	5.263G	94	5.277G	95	5.583G	96	5.555G
97	5.307G	98	5.658G	99	5.286G	100	5.487G

Hopping Frequency Sequence Name: HOP_FREQ_SEQ_09							
SEQ#	Frequency (Hz)	SEQ#	Frequency (Hz)	SEQ#	Frequency (Hz)	SEQ#	Frequency (Hz)
1	5.358G	2	5.423G	3	5.255G	4	5.380G
5	5.477G	6	5.387G	7	5.724G	8	5.629G
9	5.466G	10	5.254G	11	5.611G	12	5.379G
13	5.395G	14	5.702G	15	5.508G	16	5.543G
17	5.261G	18	5.360G	19	5.696G	20	5.411G
21	5.394G	22	5.460G	23	5.592G	24	5.528G
25	5.692G	26	5.449G	27	5.281G	28	5.285G
29	5.279G	30	5.558G	31	5.348G	32	5.496G
33	5.418G	34	5.647G	35	5.661G	36	5.517G
37	5.607G	38	5.359G	39	5.636G	40	5.650G
41	5.559G	42	5.642G	43	5.713G	44	5.274G
45	5.322G	46	5.604G	47	5.667G	48	5.674G
49	5.564G	50	5.414G	51	5.627G	52	5.489G
53	5.431G	54	5.298G	55	5.439G	56	5.353G
57	5.339G	58	5.398G	59	5.457G	60	5.497G
61	5.511G	62	5.390G	63	5.710G	64	5.407G
65	5.334G	66	5.609G	67	5.665G	68	5.263G
69	5.706G	70	5.259G	71	5.484G	72	5.479G
73	5.381G	74	5.693G	75	5.341G	76	5.351G
77	5.614G	78	5.566G	79	5.422G	80	5.475G
81	5.467G	82	5.386G	83	5.492G	84	5.705G
85	5.504G	86	5.399G	87	5.286G	88	5.610G
89	5.267G	90	5.670G	91	5.646G	92	5.265G
93	5.486G	94	5.635G	95	5.615G	96	5.608G
97	5.633G	98	5.514G	99	5.723G	100	5.372G

Hopping Frequency Sequence Name: HOP_FREQ_SEQ_10							
SEQ#	Frequency (Hz)	SEQ#	Frequency (Hz)	SEQ#	Frequency (Hz)	SEQ#	Frequency (Hz)
1	5.597G	2	5.266G	3	5.337G	4	5.578G
5	5.512G	6	5.712G	7	5.553G	8	5.671G
9	5.628G	10	5.713G	11	5.392G	12	5.346G
13	5.681G	14	5.520G	15	5.356G	16	5.488G
17	5.257G	18	5.393G	19	5.458G	20	5.605G
21	5.297G	22	5.287G	23	5.637G	24	5.710G
25	5.505G	26	5.549G	27	5.455G	28	5.385G
29	5.344G	30	5.402G	31	5.534G	32	5.452G
33	5.404G	34	5.461G	35	5.363G	36	5.322G
37	5.309G	38	5.638G	39	5.299G	40	5.445G
41	5.368G	42	5.288G	43	5.624G	44	5.516G
45	5.298G	46	5.548G	47	5.694G	48	5.685G
49	5.716G	50	5.500G	51	5.618G	52	5.431G
53	5.286G	54	5.547G	55	5.328G	56	5.351G
57	5.595G	58	5.253G	59	5.723G	60	5.350G
61	5.613G	62	5.542G	63	5.325G	64	5.255G
65	5.433G	66	5.469G	67	5.539G	68	5.420G
69	5.487G	70	5.345G	71	5.634G	72	5.483G
73	5.606G	74	5.722G	75	5.399G	76	5.386G
77	5.342G	78	5.459G	79	5.689G	80	5.658G
81	5.599G	82	5.557G	83	5.478G	84	5.477G
85	5.603G	86	5.473G	87	5.410G	88	5.540G
89	5.446G	90	5.443G	91	5.623G	92	5.550G
93	5.616G	94	5.670G	95	5.376G	96	5.341G
97	5.412G	98	5.596G	99	5.693G	100	5.347G

Hopping Frequency Sequence Name: HOP_FREQ_SEQ_11							
SEQ#	Frequency (Hz)	SEQ#	Frequency (Hz)	SEQ#	Frequency (Hz)	SEQ#	Frequency (Hz)
1	5.481G	2	5.267G	3	5.677G	4	5.358G
5	5.424G	6	5.457G	7	5.486G	8	5.285G
9	5.455G	10	5.632G	11	5.637G	12	5.679G
13	5.534G	14	5.651G	15	5.341G	16	5.376G
17	5.580G	18	5.705G	19	5.505G	20	5.438G
21	5.610G	22	5.606G	23	5.682G	24	5.578G
25	5.627G	26	5.674G	27	5.410G	28	5.370G
29	5.631G	30	5.475G	31	5.514G	32	5.694G
33	5.405G	34	5.555G	35	5.659G	36	5.420G
37	5.533G	38	5.575G	39	5.508G	40	5.266G
41	5.471G	42	5.657G	43	5.392G	44	5.339G
45	5.562G	46	5.348G	47	5.497G	48	5.278G
49	5.628G	50	5.643G	51	5.292G	52	5.528G
53	5.595G	54	5.450G	55	5.461G	56	5.387G
57	5.665G	58	5.257G	59	5.454G	60	5.301G
61	5.540G	62	5.571G	63	5.391G	64	5.568G
65	5.343G	66	5.347G	67	5.565G	68	5.718G
69	5.646G	70	5.488G	71	5.608G	72	5.710G
73	5.569G	74	5.377G	75	5.408G	76	5.572G
77	5.626G	78	5.666G	79	5.412G	80	5.284G
81	5.473G	82	5.459G	83	5.402G	84	5.416G
85	5.480G	86	5.525G	87	5.413G	88	5.519G
89	5.375G	90	5.602G	91	5.640G	92	5.478G
93	5.418G	94	5.653G	95	5.681G	96	5.421G
97	5.638G	98	5.714G	99	5.536G	100	5.673G

Hopping Frequency Sequence Name: HOP_FREQ_SEQ_12							
SEQ#	Frequency (Hz)	SEQ#	Frequency (Hz)	SEQ#	Frequency (Hz)	SEQ#	Frequency (Hz)
1	5.585G	2	5.257G	3	5.621G	4	5.720G
5	5.611G	6	5.538G	7	5.556G	8	5.427G
9	5.657G	10	5.628G	11	5.508G	12	5.367G
13	5.291G	14	5.341G	15	5.300G	16	5.485G
17	5.630G	18	5.648G	19	5.697G	20	5.378G
21	5.386G	22	5.711G	23	5.584G	24	5.350G
25	5.365G	26	5.337G	27	5.501G	28	5.272G
29	5.463G	30	5.420G	31	5.668G	32	5.283G
33	5.323G	34	5.640G	35	5.629G	36	5.502G
37	5.612G	38	5.329G	39	5.469G	40	5.701G
41	5.588G	42	5.295G	43	5.418G	44	5.683G
45	5.315G	46	5.573G	47	5.517G	48	5.592G
49	5.387G	50	5.311G	51	5.595G	52	5.580G
53	5.445G	54	5.381G	55	5.318G	56	5.523G
57	5.271G	58	5.705G	59	5.712G	60	5.669G
61	5.715G	62	5.507G	63	5.623G	64	5.491G
65	5.515G	66	5.604G	67	5.267G	68	5.368G
69	5.625G	70	5.714G	71	5.581G	72	5.407G
73	5.665G	74	5.475G	75	5.616G	76	5.276G
77	5.474G	78	5.716G	79	5.423G	80	5.302G
81	5.410G	82	5.496G	83	5.471G	84	5.413G
85	5.339G	86	5.565G	87	5.266G	88	5.352G
89	5.521G	90	5.275G	91	5.652G	92	5.653G
93	5.601G	94	5.593G	95	5.681G	96	5.656G
97	5.476G	98	5.498G	99	5.348G	100	5.446G

Hopping Frequency Sequence Name: HOP_FREQ_SEQ_13							
SEQ#	Frequency (Hz)	SEQ#	Frequency (Hz)	SEQ#	Frequency (Hz)	SEQ#	Frequency (Hz)
1	5.303G	2	5.525G	3	5.524G	4	5.392G
5	5.396G	6	5.518G	7	5.534G	8	5.685G
9	5.573G	10	5.406G	11	5.468G	12	5.389G
13	5.492G	14	5.341G	15	5.585G	16	5.540G
17	5.323G	18	5.653G	19	5.652G	20	5.269G
21	5.460G	22	5.387G	23	5.443G	24	5.424G
25	5.643G	26	5.678G	27	5.312G	28	5.526G
29	5.675G	30	5.626G	31	5.515G	32	5.668G
33	5.495G	34	5.611G	35	5.633G	36	5.408G
37	5.344G	38	5.305G	39	5.493G	40	5.623G
41	5.717G	42	5.411G	43	5.569G	44	5.516G
45	5.478G	46	5.538G	47	5.673G	48	5.255G
49	5.566G	50	5.340G	51	5.512G	52	5.463G
53	5.561G	54	5.661G	55	5.624G	56	5.713G
57	5.256G	58	5.533G	59	5.322G	60	5.503G
61	5.487G	62	5.394G	63	5.638G	64	5.436G
65	5.311G	66	5.635G	67	5.298G	68	5.284G
69	5.375G	70	5.336G	71	5.694G	72	5.456G
73	5.295G	74	5.577G	75	5.605G	76	5.625G
77	5.417G	78	5.592G	79	5.437G	80	5.627G
81	5.629G	82	5.388G	83	5.414G	84	5.264G
85	5.572G	86	5.701G	87	5.360G	88	5.508G
89	5.689G	90	5.266G	91	5.707G	92	5.543G
93	5.671G	94	5.632G	95	5.596G	96	5.407G
97	5.510G	98	5.612G	99	5.337G	100	5.576G

Hopping Frequency Sequence Name: HOP_FREQ_SEQ_14							
SEQ#	Frequency (Hz)	SEQ#	Frequency (Hz)	SEQ#	Frequency (Hz)	SEQ#	Frequency (Hz)
1	5.320G	2	5.569G	3	5.430G	4	5.515G
5	5.378G	6	5.686G	7	5.418G	8	5.682G
9	5.367G	10	5.715G	11	5.444G	12	5.405G
13	5.695G	14	5.421G	15	5.574G	16	5.293G
17	5.266G	18	5.450G	19	5.462G	20	5.524G
21	5.499G	22	5.520G	23	5.455G	24	5.270G
25	5.345G	26	5.560G	27	5.466G	28	5.491G
29	5.498G	30	5.602G	31	5.274G	32	5.550G
33	5.393G	34	5.454G	35	5.268G	36	5.590G
37	5.608G	38	5.424G	39	5.600G	40	5.276G
41	5.305G	42	5.374G	43	5.588G	44	5.662G
45	5.541G	46	5.516G	47	5.463G	48	5.677G
49	5.555G	50	5.540G	51	5.649G	52	5.484G
53	5.639G	54	5.641G	55	5.655G	56	5.316G
57	5.678G	58	5.357G	59	5.547G	60	5.269G
61	5.397G	62	5.318G	63	5.302G	64	5.596G
65	5.411G	66	5.538G	67	5.568G	68	5.626G
69	5.694G	70	5.671G	71	5.323G	72	5.267G
73	5.693G	74	5.643G	75	5.443G	76	5.598G
77	5.502G	78	5.528G	79	5.341G	80	5.445G
81	5.691G	82	5.353G	83	5.368G	84	5.575G
85	5.344G	86	5.440G	87	5.489G	88	5.501G
89	5.292G	90	5.355G	91	5.534G	92	5.642G
93	5.423G	94	5.545G	95	5.470G	96	5.409G
97	5.425G	98	5.612G	99	5.651G	100	5.688G

Hopping Frequency Sequence Name: HOP_FREQ_SEQ_15							
SEQ#	Frequency (Hz)	SEQ#	Frequency (Hz)	SEQ#	Frequency (Hz)	SEQ#	Frequency (Hz)
1	5.679G	2	5.438G	3	5.375G	4	5.447G
5	5.698G	6	5.642G	7	5.366G	8	5.662G
9	5.653G	10	5.250G	11	5.299G	12	5.427G
13	5.303G	14	5.277G	15	5.283G	16	5.574G
17	5.720G	18	5.279G	19	5.455G	20	5.470G
21	5.638G	22	5.639G	23	5.323G	24	5.643G
25	5.619G	26	5.575G	27	5.633G	28	5.710G
29	5.411G	30	5.645G	31	5.712G	32	5.510G
33	5.604G	34	5.680G	35	5.284G	36	5.357G
37	5.397G	38	5.322G	39	5.294G	40	5.681G
41	5.555G	42	5.523G	43	5.591G	44	5.593G
45	5.392G	46	5.342G	47	5.401G	48	5.255G
49	5.363G	50	5.345G	51	5.348G	52	5.281G
53	5.449G	54	5.319G	55	5.671G	56	5.498G
57	5.558G	58	5.350G	59	5.464G	60	5.405G
61	5.717G	62	5.317G	63	5.669G	64	5.526G
65	5.530G	66	5.597G	67	5.329G	68	5.508G
69	5.270G	70	5.552G	71	5.634G	72	5.355G
73	5.646G	74	5.461G	75	5.516G	76	5.380G
77	5.263G	78	5.387G	79	5.306G	80	5.341G
81	5.605G	82	5.606G	83	5.687G	84	5.637G
85	5.362G	86	5.325G	87	5.305G	88	5.326G
89	5.688G	90	5.390G	91	5.477G	92	5.567G
93	5.320G	94	5.651G	95	5.499G	96	5.721G
97	5.296G	98	5.410G	99	5.673G	100	5.586G

Hopping Frequency Sequence Name: HOP_FREQ_SEQ_16							
SEQ#	Frequency (Hz)	SEQ#	Frequency (Hz)	SEQ#	Frequency (Hz)	SEQ#	Frequency (Hz)
1	5.426G	2	5.604G	3	5.396G	4	5.259G
5	5.410G	6	5.543G	7	5.666G	8	5.395G
9	5.569G	10	5.340G	11	5.348G	12	5.690G
13	5.679G	14	5.628G	15	5.515G	16	5.588G
17	5.436G	18	5.547G	19	5.555G	20	5.385G
21	5.456G	22	5.563G	23	5.499G	24	5.573G
25	5.526G	26	5.264G	27	5.521G	28	5.528G
29	5.334G	30	5.363G	31	5.470G	32	5.386G
33	5.275G	34	5.693G	35	5.493G	36	5.427G
37	5.665G	38	5.446G	39	5.681G	40	5.382G
41	5.336G	42	5.416G	43	5.447G	44	5.390G
45	5.278G	46	5.685G	47	5.263G	48	5.342G
49	5.345G	50	5.343G	51	5.497G	52	5.653G
53	5.417G	54	5.309G	55	5.509G	56	5.579G
57	5.441G	58	5.684G	59	5.397G	60	5.341G
61	5.372G	62	5.315G	63	5.554G	64	5.540G
65	5.546G	66	5.268G	67	5.299G	68	5.561G
69	5.317G	70	5.656G	71	5.318G	72	5.703G
73	5.516G	74	5.544G	75	5.454G	76	5.414G
77	5.273G	78	5.574G	79	5.535G	80	5.380G
81	5.457G	82	5.595G	83	5.548G	84	5.466G
85	5.672G	86	5.271G	87	5.486G	88	5.650G
89	5.490G	90	5.699G	91	5.381G	92	5.581G
93	5.276G	94	5.550G	95	5.487G	96	5.402G
97	5.257G	98	5.406G	99	5.323G	100	5.371G

Hopping Frequency Sequence Name: HOP_FREQ_SEQ_17							
SEQ#	Frequency (Hz)	SEQ#	Frequency (Hz)	SEQ#	Frequency (Hz)	SEQ#	Frequency (Hz)
1	5.421G	2	5.452G	3	5.547G	4	5.598G
5	5.335G	6	5.378G	7	5.572G	8	5.279G
9	5.419G	10	5.605G	11	5.553G	12	5.461G
13	5.406G	14	5.397G	15	5.293G	16	5.401G
17	5.435G	18	5.596G	19	5.683G	20	5.352G
21	5.480G	22	5.416G	23	5.575G	24	5.543G
25	5.708G	26	5.449G	27	5.652G	28	5.372G
29	5.661G	30	5.483G	31	5.588G	32	5.315G
33	5.251G	34	5.611G	35	5.667G	36	5.264G
37	5.283G	38	5.339G	39	5.592G	40	5.363G
41	5.629G	42	5.594G	43	5.518G	44	5.674G
45	5.573G	46	5.531G	47	5.323G	48	5.405G
49	5.353G	50	5.617G	51	5.468G	52	5.671G
53	5.695G	54	5.269G	55	5.515G	56	5.580G
57	5.649G	58	5.673G	59	5.299G	60	5.644G
61	5.509G	62	5.650G	63	5.500G	64	5.467G
65	5.344G	66	5.614G	67	5.538G	68	5.622G
69	5.645G	70	5.721G	71	5.368G	72	5.627G
73	5.260G	74	5.620G	75	5.601G	76	5.356G
77	5.413G	78	5.340G	79	5.451G	80	5.697G
81	5.643G	82	5.519G	83	5.444G	84	5.578G
85	5.624G	86	5.556G	87	5.551G	88	5.355G
89	5.677G	90	5.439G	91	5.548G	92	5.338G
93	5.277G	94	5.387G	95	5.252G	96	5.311G
97	5.651G	98	5.599G	99	5.574G	100	5.600G

Hopping Frequency Sequence Name: HOP_FREQ_SEQ_18							
SEQ#	Frequency (Hz)	SEQ#	Frequency (Hz)	SEQ#	Frequency (Hz)	SEQ#	Frequency (Hz)
1	5.487G	2	5.444G	3	5.562G	4	5.715G
5	5.662G	6	5.308G	7	5.379G	8	5.453G
9	5.368G	10	5.629G	11	5.514G	12	5.329G
13	5.538G	14	5.356G	15	5.588G	16	5.391G
17	5.413G	18	5.700G	19	5.381G	20	5.618G
21	5.455G	22	5.558G	23	5.352G	24	5.582G
25	5.283G	26	5.709G	27	5.542G	28	5.394G
29	5.663G	30	5.689G	31	5.288G	32	5.262G
33	5.370G	34	5.371G	35	5.577G	36	5.702G
37	5.299G	38	5.465G	39	5.325G	40	5.503G
41	5.312G	42	5.549G	43	5.451G	44	5.314G
45	5.319G	46	5.274G	47	5.682G	48	5.388G
49	5.546G	50	5.513G	51	5.474G	52	5.713G
53	5.260G	54	5.251G	55	5.722G	56	5.408G
57	5.625G	58	5.392G	59	5.418G	60	5.389G
61	5.492G	62	5.668G	63	5.697G	64	5.482G
65	5.300G	66	5.647G	67	5.599G	68	5.494G
69	5.571G	70	5.348G	71	5.460G	72	5.716G
73	5.551G	74	5.327G	75	5.366G	76	5.509G
77	5.600G	78	5.406G	79	5.622G	80	5.495G
81	5.712G	82	5.404G	83	5.421G	84	5.464G
85	5.393G	86	5.470G	87	5.676G	88	5.617G
89	5.594G	90	5.637G	91	5.425G	92	5.691G
93	5.278G	94	5.410G	95	5.486G	96	5.632G
97	5.653G	98	5.400G	99	5.572G	100	5.426G

Hopping Frequency Sequence Name: HOP_FREQ_SEQ_19							
SEQ#	Frequency (Hz)	SEQ#	Frequency (Hz)	SEQ#	Frequency (Hz)	SEQ#	Frequency (Hz)
1	5.329G	2	5.351G	3	5.639G	4	5.713G
5	5.256G	6	5.715G	7	5.672G	8	5.430G
9	5.291G	10	5.665G	11	5.459G	12	5.427G
13	5.693G	14	5.462G	15	5.571G	16	5.573G
17	5.474G	18	5.262G	19	5.596G	20	5.287G
21	5.327G	22	5.341G	23	5.326G	24	5.701G
25	5.457G	26	5.576G	27	5.681G	28	5.620G
29	5.325G	30	5.671G	31	5.543G	32	5.720G
33	5.521G	34	5.360G	35	5.485G	36	5.509G
37	5.408G	38	5.334G	39	5.555G	40	5.315G
41	5.417G	42	5.694G	43	5.623G	44	5.654G
45	5.253G	46	5.499G	47	5.544G	48	5.293G
49	5.708G	50	5.372G	51	5.366G	52	5.520G
53	5.302G	54	5.711G	55	5.590G	56	5.477G
57	5.349G	58	5.712G	59	5.305G	60	5.281G
61	5.383G	62	5.467G	63	5.397G	64	5.388G
65	5.527G	66	5.540G	67	5.651G	68	5.511G
69	5.386G	70	5.370G	71	5.580G	72	5.517G
73	5.684G	74	5.519G	75	5.435G	76	5.444G
77	5.535G	78	5.298G	79	5.699G	80	5.554G
81	5.514G	82	5.319G	83	5.473G	84	5.348G
85	5.705G	86	5.594G	87	5.323G	88	5.484G
89	5.506G	90	5.714G	91	5.411G	92	5.359G
93	5.421G	94	5.487G	95	5.258G	96	5.312G
97	5.491G	98	5.269G	99	5.320G	100	5.641G

Hopping Frequency Sequence Name: HOP_FREQ_SEQ_20							
SEQ#	Frequency (Hz)	SEQ#	Frequency (Hz)	SEQ#	Frequency (Hz)	SEQ#	Frequency (Hz)
1	5.288G	2	5.291G	3	5.457G	4	5.252G
5	5.596G	6	5.598G	7	5.306G	8	5.434G
9	5.633G	10	5.625G	11	5.374G	12	5.477G
13	5.684G	14	5.272G	15	5.664G	16	5.441G
17	5.399G	18	5.586G	19	5.261G	20	5.656G
21	5.621G	22	5.373G	23	5.280G	24	5.376G
25	5.349G	26	5.530G	27	5.632G	28	5.348G
29	5.333G	30	5.618G	31	5.391G	32	5.283G
33	5.265G	34	5.273G	35	5.594G	36	5.440G
37	5.548G	38	5.651G	39	5.724G	40	5.584G
41	5.676G	42	5.682G	43	5.506G	44	5.294G
45	5.679G	46	5.323G	47	5.649G	48	5.497G
49	5.361G	50	5.337G	51	5.286G	52	5.268G
53	5.524G	54	5.513G	55	5.257G	56	5.300G
57	5.697G	58	5.504G	59	5.492G	60	5.607G
61	5.525G	62	5.377G	63	5.432G	64	5.310G
65	5.320G	66	5.661G	67	5.250G	68	5.493G
69	5.593G	70	5.346G	71	5.456G	72	5.307G
73	5.368G	74	5.281G	75	5.636G	76	5.382G
77	5.540G	78	5.538G	79	5.502G	80	5.573G
81	5.692G	82	5.445G	83	5.590G	84	5.370G
85	5.570G	86	5.439G	87	5.654G	88	5.443G
89	5.352G	90	5.581G	91	5.295G	92	5.681G
93	5.322G	94	5.680G	95	5.327G	96	5.561G
97	5.345G	98	5.550G	99	5.356G	100	5.609G

Hopping Frequency Sequence Name: HOP_FREQ_SEQ_21							
SEQ#	Frequency (Hz)	SEQ#	Frequency (Hz)	SEQ#	Frequency (Hz)	SEQ#	Frequency (Hz)
1	5.269G	2	5.285G	3	5.400G	4	5.637G
5	5.564G	6	5.523G	7	5.255G	8	5.461G
9	5.563G	10	5.552G	11	5.625G	12	5.421G
13	5.531G	14	5.695G	15	5.271G	16	5.590G
17	5.484G	18	5.456G	19	5.352G	20	5.409G
21	5.672G	22	5.459G	23	5.292G	24	5.359G
25	5.486G	26	5.422G	27	5.650G	28	5.407G
29	5.633G	30	5.532G	31	5.720G	32	5.493G
33	5.357G	34	5.439G	35	5.472G	36	5.628G
37	5.442G	38	5.668G	39	5.343G	40	5.638G
41	5.466G	42	5.470G	43	5.585G	44	5.611G
45	5.471G	46	5.524G	47	5.307G	48	5.441G
49	5.398G	50	5.529G	51	5.545G	52	5.325G
53	5.641G	54	5.688G	55	5.657G	56	5.429G
57	5.302G	58	5.719G	59	5.687G	60	5.494G
61	5.328G	62	5.397G	63	5.475G	64	5.626G
65	5.693G	66	5.265G	67	5.608G	68	5.337G
69	5.485G	70	5.703G	71	5.554G	72	5.294G
73	5.505G	74	5.314G	75	5.324G	76	5.405G
77	5.355G	78	5.389G	79	5.649G	80	5.620G
81	5.259G	82	5.566G	83	5.645G	84	5.701G
85	5.510G	86	5.370G	87	5.539G	88	5.423G
89	5.342G	90	5.609G	91	5.384G	92	5.629G
93	5.369G	94	5.613G	95	5.718G	96	5.381G
97	5.424G	98	5.578G	99	5.568G	100	5.427G

Hopping Frequency Sequence Name: HOP_FREQ_SEQ_22							
SEQ#	Frequency (Hz)	SEQ#	Frequency (Hz)	SEQ#	Frequency (Hz)	SEQ#	Frequency (Hz)
1	5.576G	2	5.614G	3	5.255G	4	5.381G
5	5.450G	6	5.715G	7	5.545G	8	5.517G
9	5.647G	10	5.317G	11	5.546G	12	5.375G
13	5.530G	14	5.439G	15	5.344G	16	5.541G
17	5.323G	18	5.513G	19	5.480G	20	5.586G
21	5.300G	22	5.565G	23	5.341G	24	5.472G
25	5.283G	26	5.524G	27	5.307G	28	5.284G
29	5.388G	30	5.583G	31	5.663G	32	5.332G
33	5.484G	34	5.362G	35	5.658G	36	5.295G
37	5.446G	38	5.491G	39	5.441G	40	5.570G
41	5.351G	42	5.533G	43	5.349G	44	5.655G
45	5.563G	46	5.638G	47	5.613G	48	5.646G
49	5.285G	50	5.696G	51	5.417G	52	5.358G
53	5.703G	54	5.669G	55	5.662G	56	5.713G
57	5.335G	58	5.321G	59	5.438G	60	5.355G
61	5.628G	62	5.412G	63	5.700G	64	5.674G
65	5.536G	66	5.334G	67	5.626G	68	5.465G
69	5.310G	70	5.518G	71	5.282G	72	5.551G
73	5.585G	74	5.548G	75	5.680G	76	5.376G
77	5.338G	78	5.440G	79	5.266G	80	5.648G
81	5.516G	82	5.468G	83	5.644G	84	5.414G
85	5.579G	86	5.393G	87	5.643G	88	5.537G
89	5.487G	90	5.592G	91	5.590G	92	5.423G
93	5.430G	94	5.288G	95	5.387G	96	5.636G
97	5.456G	98	5.508G	99	5.359G	100	5.425G

Hopping Frequency Sequence Name: HOP_FREQ_SEQ_23							
SEQ#	Frequency (Hz)	SEQ#	Frequency (Hz)	SEQ#	Frequency (Hz)	SEQ#	Frequency (Hz)
1	5.650G	2	5.457G	3	5.366G	4	5.672G
5	5.654G	6	5.255G	7	5.381G	8	5.432G
9	5.701G	10	5.639G	11	5.310G	12	5.598G
13	5.405G	14	5.576G	15	5.464G	16	5.529G
17	5.659G	18	5.278G	19	5.251G	20	5.525G
21	5.530G	22	5.528G	23	5.567G	24	5.486G
25	5.394G	26	5.690G	27	5.713G	28	5.315G
29	5.533G	30	5.614G	31	5.623G	32	5.395G
33	5.620G	34	5.308G	35	5.379G	36	5.281G
37	5.677G	38	5.304G	39	5.537G	40	5.364G
41	5.352G	42	5.339G	43	5.284G	44	5.456G
45	5.626G	46	5.632G	47	5.287G	48	5.592G
49	5.452G	50	5.470G	51	5.329G	52	5.388G
53	5.356G	54	5.585G	55	5.593G	56	5.283G
57	5.603G	58	5.361G	59	5.408G	60	5.717G
61	5.404G	62	5.298G	63	5.347G	64	5.332G
65	5.412G	66	5.697G	67	5.674G	68	5.263G
69	5.499G	70	5.372G	71	5.676G	72	5.609G
73	5.619G	74	5.468G	75	5.692G	76	5.577G
77	5.578G	78	5.268G	79	5.428G	80	5.552G
81	5.413G	82	5.482G	83	5.579G	84	5.662G
85	5.621G	86	5.572G	87	5.682G	88	5.625G
89	5.644G	90	5.279G	91	5.253G	92	5.652G
93	5.678G	94	5.360G	95	5.627G	96	5.270G
97	5.721G	98	5.261G	99	5.497G	100	5.441G

Hopping Frequency Sequence Name: HOP_FREQ_SEQ_24							
SEQ#	Frequency (Hz)	SEQ#	Frequency (Hz)	SEQ#	Frequency (Hz)	SEQ#	Frequency (Hz)
1	5.564G	2	5.702G	3	5.585G	4	5.465G
5	5.407G	6	5.670G	7	5.522G	8	5.466G
9	5.628G	10	5.659G	11	5.485G	12	5.704G
13	5.640G	14	5.367G	15	5.510G	16	5.722G
17	5.412G	18	5.355G	19	5.430G	20	5.549G
21	5.361G	22	5.329G	23	5.389G	24	5.587G
25	5.621G	26	5.720G	27	5.451G	28	5.320G
29	5.321G	30	5.424G	31	5.508G	32	5.618G
33	5.278G	34	5.556G	35	5.387G	36	5.374G
37	5.562G	38	5.553G	39	5.470G	40	5.276G
41	5.457G	42	5.439G	43	5.711G	44	5.518G
45	5.458G	46	5.513G	47	5.500G	48	5.376G
49	5.402G	50	5.447G	51	5.669G	52	5.524G
53	5.400G	54	5.515G	55	5.625G	56	5.652G
57	5.449G	58	5.301G	59	5.484G	60	5.529G
61	5.541G	62	5.333G	63	5.255G	64	5.354G
65	5.695G	66	5.365G	67	5.701G	68	5.494G
69	5.646G	70	5.454G	71	5.613G	72	5.721G
73	5.595G	74	5.688G	75	5.690G	76	5.487G
77	5.415G	78	5.428G	79	5.548G	80	5.591G
81	5.277G	82	5.496G	83	5.323G	84	5.302G
85	5.719G	86	5.298G	87	5.299G	88	5.614G
89	5.405G	90	5.497G	91	5.563G	92	5.291G
93	5.724G	94	5.483G	95	5.271G	96	5.297G
97	5.559G	98	5.311G	99	5.426G	100	5.360G

Hopping Frequency Sequence Name: HOP_FREQ_SEQ_25							
SEQ#	Frequency (Hz)	SEQ#	Frequency (Hz)	SEQ#	Frequency (Hz)	SEQ#	Frequency (Hz)
1	5.336G	2	5.277G	3	5.619G	4	5.303G
5	5.685G	6	5.545G	7	5.356G	8	5.341G
9	5.471G	10	5.533G	11	5.724G	12	5.716G
13	5.267G	14	5.495G	15	5.253G	16	5.460G
17	5.600G	18	5.279G	19	5.333G	20	5.335G
21	5.566G	22	5.384G	23	5.718G	24	5.616G
25	5.598G	26	5.588G	27	5.722G	28	5.591G
29	5.621G	30	5.475G	31	5.366G	32	5.692G
33	5.681G	34	5.306G	35	5.595G	36	5.594G
37	5.673G	38	5.291G	39	5.400G	40	5.269G
41	5.426G	42	5.491G	43	5.281G	44	5.395G
45	5.515G	46	5.288G	47	5.519G	48	5.334G
49	5.711G	50	5.550G	51	5.464G	52	5.525G
53	5.377G	54	5.265G	55	5.452G	56	5.596G
57	5.297G	58	5.305G	59	5.565G	60	5.579G
61	5.345G	62	5.703G	63	5.719G	64	5.298G
65	5.541G	66	5.456G	67	5.282G	68	5.645G
69	5.421G	70	5.357G	71	5.351G	72	5.431G
73	5.674G	74	5.449G	75	5.576G	76	5.539G
77	5.264G	78	5.257G	79	5.439G	80	5.562G
81	5.493G	82	5.642G	83	5.668G	84	5.477G
85	5.450G	86	5.311G	87	5.544G	88	5.707G
89	5.402G	90	5.567G	91	5.442G	92	5.343G
93	5.720G	94	5.397G	95	5.665G	96	5.582G
97	5.405G	98	5.467G	99	5.444G	100	5.693G

Hopping Frequency Sequence Name: HOP_FREQ_SEQ_26							
SEQ#	Frequency (Hz)	SEQ#	Frequency (Hz)	SEQ#	Frequency (Hz)	SEQ#	Frequency (Hz)
1	5.474G	2	5.271G	3	5.495G	4	5.592G
5	5.560G	6	5.447G	7	5.713G	8	5.561G
9	5.389G	10	5.526G	11	5.400G	12	5.715G
13	5.672G	14	5.388G	15	5.450G	16	5.325G
17	5.706G	18	5.556G	19	5.621G	20	5.522G
21	5.532G	22	5.357G	23	5.587G	24	5.258G
25	5.435G	26	5.329G	27	5.716G	28	5.571G
29	5.344G	30	5.250G	31	5.649G	32	5.639G
33	5.611G	34	5.466G	35	5.612G	36	5.274G
37	5.263G	38	5.539G	39	5.434G	40	5.645G
41	5.615G	42	5.572G	43	5.574G	44	5.549G
45	5.420G	46	5.646G	47	5.501G	48	5.402G
49	5.453G	50	5.320G	51	5.674G	52	5.491G
53	5.683G	54	5.700G	55	5.607G	56	5.441G
57	5.625G	58	5.464G	59	5.699G	60	5.490G
61	5.265G	62	5.719G	63	5.470G	64	5.494G
65	5.302G	66	5.391G	67	5.541G	68	5.641G
69	5.338G	70	5.722G	71	5.475G	72	5.295G
73	5.352G	74	5.692G	75	5.583G	76	5.529G
77	5.665G	78	5.603G	79	5.423G	80	5.465G
81	5.487G	82	5.415G	83	5.381G	84	5.354G
85	5.624G	86	5.502G	87	5.533G	88	5.688G
89	5.375G	90	5.272G	91	5.622G	92	5.437G
93	5.499G	94	5.714G	95	5.578G	96	5.576G
97	5.278G	98	5.513G	99	5.419G	100	5.383G

Hopping Frequency Sequence Name: HOP_FREQ_SEQ_27							
SEQ#	Frequency (Hz)	SEQ#	Frequency (Hz)	SEQ#	Frequency (Hz)	SEQ#	Frequency (Hz)
1	5.668G	2	5.412G	3	5.577G	4	5.421G
5	5.372G	6	5.376G	7	5.363G	8	5.645G
9	5.696G	10	5.596G	11	5.650G	12	5.587G
13	5.306G	14	5.691G	15	5.341G	16	5.256G
17	5.399G	18	5.429G	19	5.392G	20	5.632G
21	5.263G	22	5.466G	23	5.567G	24	5.265G
25	5.522G	26	5.661G	27	5.700G	28	5.511G
29	5.536G	30	5.326G	31	5.709G	32	5.695G
33	5.669G	34	5.523G	35	5.582G	36	5.580G
37	5.550G	38	5.277G	39	5.285G	40	5.557G
41	5.574G	42	5.461G	43	5.425G	44	5.551G
45	5.608G	46	5.261G	47	5.317G	48	5.260G
49	5.439G	50	5.562G	51	5.324G	52	5.414G
53	5.527G	54	5.497G	55	5.686G	56	5.259G
57	5.664G	58	5.590G	59	5.478G	60	5.404G
61	5.589G	62	5.607G	63	5.481G	64	5.689G
65	5.389G	66	5.640G	67	5.720G	68	5.697G
69	5.402G	70	5.452G	71	5.313G	72	5.717G
73	5.257G	74	5.287G	75	5.534G	76	5.553G
77	5.304G	78	5.684G	79	5.374G	80	5.390G
81	5.441G	82	5.506G	83	5.444G	84	5.329G
85	5.250G	86	5.503G	87	5.588G	88	5.442G
89	5.611G	90	5.561G	91	5.406G	92	5.663G
93	5.297G	94	5.619G	95	5.405G	96	5.677G
97	5.501G	98	5.508G	99	5.262G	100	5.474G

Hopping Frequency Sequence Name: HOP_FREQ_SEQ_28							
SEQ#	Frequency (Hz)	SEQ#	Frequency (Hz)	SEQ#	Frequency (Hz)	SEQ#	Frequency (Hz)
1	5.307G	2	5.649G	3	5.482G	4	5.315G
5	5.443G	6	5.285G	7	5.390G	8	5.326G
9	5.654G	10	5.581G	11	5.263G	12	5.687G
13	5.679G	14	5.486G	15	5.279G	16	5.680G
17	5.387G	18	5.608G	19	5.487G	20	5.724G
21	5.683G	22	5.430G	23	5.436G	24	5.320G
25	5.281G	26	5.257G	27	5.539G	28	5.255G
29	5.622G	30	5.359G	31	5.251G	32	5.418G
33	5.456G	34	5.569G	35	5.628G	36	5.643G
37	5.301G	38	5.488G	39	5.338G	40	5.584G
41	5.685G	42	5.503G	43	5.411G	44	5.697G
45	5.574G	46	5.558G	47	5.468G	48	5.355G
49	5.478G	50	5.549G	51	5.283G	52	5.648G
53	5.695G	54	5.371G	55	5.304G	56	5.705G
57	5.722G	58	5.349G	59	5.453G	60	5.591G
61	5.678G	62	5.401G	63	5.284G	64	5.481G
65	5.381G	66	5.644G	67	5.422G	68	5.590G
69	5.547G	70	5.458G	71	5.274G	72	5.446G
73	5.523G	74	5.391G	75	5.719G	76	5.296G
77	5.521G	78	5.286G	79	5.435G	80	5.336G
81	5.619G	82	5.668G	83	5.565G	84	5.343G
85	5.434G	86	5.356G	87	5.374G	88	5.278G
89	5.449G	90	5.660G	91	5.544G	92	5.363G
93	5.604G	94	5.314G	95	5.499G	96	5.531G
97	5.322G	98	5.347G	99	5.675G	100	5.273G

Hopping Frequency Sequence Name: HOP_FREQ_SEQ_29							
SEQ#	Frequency (Hz)	SEQ#	Frequency (Hz)	SEQ#	Frequency (Hz)	SEQ#	Frequency (Hz)
1	5.587G	2	5.271G	3	5.622G	4	5.676G
5	5.627G	6	5.604G	7	5.309G	8	5.666G
9	5.449G	10	5.613G	11	5.340G	12	5.579G
13	5.372G	14	5.263G	15	5.252G	16	5.665G
17	5.568G	18	5.386G	19	5.639G	20	5.480G
21	5.251G	22	5.270G	23	5.614G	24	5.698G
25	5.549G	26	5.451G	27	5.335G	28	5.685G
29	5.464G	30	5.424G	31	5.291G	32	5.400G
33	5.555G	34	5.530G	35	5.510G	36	5.278G
37	5.257G	38	5.595G	39	5.724G	40	5.645G
41	5.675G	42	5.317G	43	5.695G	44	5.722G
45	5.277G	46	5.522G	47	5.686G	48	5.597G
49	5.588G	50	5.517G	51	5.518G	52	5.707G
53	5.431G	54	5.364G	55	5.542G	56	5.513G
57	5.322G	58	5.405G	59	5.402G	60	5.560G
61	5.677G	62	5.492G	63	5.446G	64	5.268G
65	5.717G	66	5.459G	67	5.357G	68	5.655G
69	5.650G	70	5.314G	71	5.688G	72	5.528G
73	5.535G	74	5.715G	75	5.380G	76	5.648G
77	5.556G	78	5.531G	79	5.616G	80	5.586G
81	5.612G	82	5.435G	83	5.656G	84	5.659G
85	5.546G	86	5.407G	87	5.346G	88	5.516G
89	5.623G	90	5.634G	91	5.325G	92	5.420G
93	5.720G	94	5.558G	95	5.478G	96	5.644G
97	5.311G	98	5.607G	99	5.273G	100	5.444G

Hopping Frequency Sequence Name: HOP_FREQ_SEQ_30							
SEQ#	Frequency (Hz)	SEQ#	Frequency (Hz)	SEQ#	Frequency (Hz)	SEQ#	Frequency (Hz)
1	5.490G	2	5.296G	3	5.458G	4	5.553G
5	5.430G	6	5.516G	7	5.414G	8	5.618G
9	5.521G	10	5.544G	11	5.721G	12	5.438G
13	5.311G	14	5.677G	15	5.386G	16	5.382G
17	5.600G	18	5.446G	19	5.549G	20	5.422G
21	5.291G	22	5.581G	23	5.316G	24	5.359G
25	5.637G	26	5.588G	27	5.612G	28	5.288G
29	5.455G	30	5.541G	31	5.385G	32	5.557G
33	5.413G	34	5.701G	35	5.515G	36	5.254G
37	5.459G	38	5.714G	39	5.502G	40	5.528G
41	5.536G	42	5.260G	43	5.614G	44	5.451G
45	5.663G	46	5.532G	47	5.273G	48	5.482G
49	5.689G	50	5.326G	51	5.578G	52	5.537G
53	5.266G	54	5.387G	55	5.299G	56	5.513G
57	5.355G	58	5.297G	59	5.569G	60	5.262G
61	5.699G	62	5.551G	63	5.648G	64	5.679G
65	5.389G	66	5.607G	67	5.450G	68	5.421G
69	5.571G	70	5.629G	71	5.345G	72	5.623G
73	5.380G	74	5.643G	75	5.656G	76	5.500G
77	5.664G	78	5.550G	79	5.554G	80	5.269G
81	5.435G	82	5.442G	83	5.715G	84	5.284G
85	5.277G	86	5.582G	87	5.460G	88	5.412G
89	5.638G	90	5.354G	91	5.265G	92	5.323G
93	5.585G	94	5.539G	95	5.711G	96	5.390G
97	5.697G	98	5.619G	99	5.552G	100	5.650G

IEEE 802.11ac VHT80

Type 1 Radar Statistical Performances

Trial #	Pulses per Burst	Pulse Width (s)	PRI (s)	Radar Frequency (MHz)	Detection
1	89	1.0u	598.0u	5252	Yes
2	81	1.0u	658.0u	5255	Yes
3	86	1.0u	618.0u	5257	Yes
4	78	1.0u	678.0u	5258	Yes
5	76	1.0u	698.0u	5260	Yes
6	72	1.0u	738.0u	5261	Yes
7	70	1.0u	758.0u	5263	Yes
8	68	1.0u	778.0u	5265	Yes
9	65	1.0u	818.0u	5267	Yes
10	63	1.0u	838.0u	5269	Yes
11	62	1.0u	858.0u	5271	Yes
12	61	1.0u	878.0u	5273	Yes
13	59	1.0u	898.0u	5275	Yes
14	58	1.0u	918.0u	5277	Yes
15	57	1.0u	938.0u	5280	Yes
16	68	1.0u	781.0u	5284	Yes
17	60	1.0u	881.0u	5287	Yes
18	59	1.0u	907.0u	5290	Yes
19	59	1.0u	931.0u	5292	Yes
20	63	1.0u	851.0u	5296	Yes
21	71	1.0u	751.0u	5300	Yes
22	67	1.0u	793.0u	5304	Yes
23	64	1.0u	833.0u	5306	Yes
24	60	1.0u	893.0u	5310	Yes
25	86	1.0u	617.0u	5312	Yes
26	76	1.0u	697.0u	5315	Yes
27	68	1.0u	777.0u	5317	Yes
28	67	1.0u	797.0u	5320	Yes
29	64	1.0u	837.0u	5325	Yes
30	58	1.0u	917.0u	5328	Yes

Detection Rate: 100 %

Type 2 Radar Statistical Performances					
Trial #	Pulses per Burst	Pulse Width (s)	PRI (s)	Radar Frequency (MHz)	Detection
1	26	3.3u	225.0u	5252	No
2	27	3.6u	171.0u	5255	Yes
3	24	2.9u	155.0u	5257	Yes
4	28	1.1u	174.0u	5258	Yes
5	24	3.8u	179.0u	5260	Yes
6	24	3.7u	217.0u	5261	Yes
7	23	2.9u	153.0u	5263	Yes
8	26	4.8u	169.0u	5265	Yes
9	25	1.2u	152.0u	5267	Yes
10	28	2.6u	228.0u	5269	Yes
11	26	1.6u	151.0u	5271	Yes
12	24	2.0u	152.0u	5273	Yes
13	26	1.7u	176.0u	5275	Yes
14	29	4.4u	229.0u	5277	No
15	25	3.2u	169.0u	5280	Yes
16	24	4.5u	226.0u	5284	Yes
17	27	3.1u	156.0u	5287	Yes
18	23	1.5u	176.0u	5290	Yes
19	28	3.5u	225.0u	5292	Yes
20	28	1.8u	182.0u	5296	Yes
21	27	1.2u	180.0u	5300	No
22	28	3.5u	213.0u	5304	No
23	24	2.5u	175.0u	5306	Yes
24	27	3.1u	164.0u	5310	Yes
25	26	1.8u	151.0u	5312	Yes
26	26	1.7u	217.0u	5315	No
27	25	3.1u	183.0u	5317	Yes
28	23	1.3u	185.0u	5320	Yes
29	26	1.4u	219.0u	5325	Yes
30	24	3.5u	183.0u	5328	No

Detection Rate: 80.0 %

Type 3 Radar Statistical Performances					
Trial #	Pulses per Burst	Pulse Width (s)	PRI (s)	Radar Frequency (MHz)	Detection
1	16	8.8u	280.0u	5252	Yes
2	16	8.8u	462.0u	5255	No
3	18	6.0u	378.0u	5257	Yes
4	16	8.8u	413.0u	5258	Yes
5	17	8.7u	385.0u	5260	Yes
6	17	8.5u	447.0u	5261	Yes
7	16	7.5u	284.0u	5263	No
8	16	9.9u	276.0u	5265	Yes
9	17	9.9u	461.0u	5267	Yes
10	16	8.4u	446.0u	5269	Yes
11	16	8.9u	314.0u	5271	Yes
12	18	6.3u	387.0u	5273	No
13	17	8.5u	273.0u	5275	Yes
14	18	8.6u	322.0u	5277	Yes
15	17	7.0u	286.0u	5280	No
16	18	9.2u	305.0u	5284	Yes
17	17	9.2u	316.0u	5287	Yes
18	16	7.4u	214.0u	5290	Yes
19	18	9.3u	255.0u	5292	Yes
20	17	9.6u	240.0u	5296	No
21	17	6.0u	205.0u	5300	Yes
22	16	6.9u	202.0u	5304	No
23	17	7.9u	405.0u	5306	Yes
24	17	9.1u	397.0u	5310	Yes
25	16	8.2u	485.0u	5312	Yes
26	16	9.9u	428.0u	5315	Yes
27	17	7.2u	247.0u	5317	Yes
28	17	8.7u	457.0u	5320	Yes
29	17	8.1u	327.0u	5325	Yes
30	17	7.0u	429.0u	5328	Yes

Detection Rate: 80.0 %

Type 4 Radar Statistical Performances					
Trial #	Pulses per Burst	Pulse Width (s)	PRI (s)	Radar Frequency (MHz)	Detection
1	14	16.1u	359.0u	5252	Yes
2	12	19.9u	419.0u	5255	Yes
3	15	19.1u	300.0u	5257	Yes
4	12	16.5u	497.0u	5258	Yes
5	16	11.5u	347.0u	5260	Yes
6	15	13.0u	396.0u	5261	Yes
7	16	12.4u	326.0u	5263	Yes
8	14	17.7u	309.0u	5265	Yes
9	14	17.9u	416.0u	5267	Yes
10	14	14.4u	441.0u	5269	Yes
11	14	11.4u	305.0u	5271	Yes
12	15	17.7u	333.0u	5273	Yes
13	13	17.2u	203.0u	5275	No
14	16	16.1u	371.0u	5277	Yes
15	15	19.9u	204.0u	5280	Yes
16	12	12.8u	444.0u	5284	Yes
17	15	15.6u	415.0u	5287	Yes
18	14	19.7u	321.0u	5290	Yes
19	14	19.9u	499.0u	5292	Yes
20	13	13.1u	438.0u	5296	Yes
21	15	16.6u	432.0u	5300	No
22	13	18.1u	351.0u	5304	Yes
23	16	18.6u	382.0u	5306	Yes
24	15	19.2u	484.0u	5310	Yes
25	16	15.7u	496.0u	5312	Yes
26	15	13.7u	368.0u	5315	Yes
27	13	17.7u	311.0u	5317	Yes
28	13	13.8u	368.0u	5320	Yes
29	13	19.1u	404.0u	5325	Yes
30	13	15.2u	226.0u	5328	Yes

Detection Rate: 93.3 %

Type 5 Radar Statistical Performances		
Trial #	Test Signal Name	Detection
1	LP_Signal_01	Yes
2	LP_Signal_02	Yes
3	LP_Signal_03	Yes
4	LP_Signal_04	Yes
5	LP_Signal_05	Yes
6	LP_Signal_06	Yes
7	LP_Signal_07	Yes
8	LP_Signal_08	Yes
9	LP_Signal_09	Yes
10	LP_Signal_10	Yes
11	LP_Signal_11	Yes
12	LP_Signal_12	Yes
13	LP_Signal_13	Yes
14	LP_Signal_14	Yes
15	LP_Signal_15	Yes
16	LP_Signal_16	Yes
17	LP_Signal_17	Yes
18	LP_Signal_18	Yes
19	LP_Signal_19	Yes
20	LP_Signal_20	Yes
21	LP_Signal_21	Yes
22	LP_Signal_22	Yes
23	LP_Signal_23	Yes
24	LP_Signal_24	Yes
25	LP_Signal_25	Yes
26	LP_Signal_26	Yes
27	LP_Signal_27	Yes
28	LP_Signal_28	Yes
29	LP_Signal_29	Yes
30	LP_Signal_30	Yes
		Detection Rate: 100.0 %

Long Pulse Radar Test Signal						
Test Signal Name: LP_Signal_01						
Number of Bursts in Trial: 12						
Chrip Center Frequency: 5254MHz						
Burst	Pulses per Burst	Chrip (Hz)	Pulse Width (s)	Pulse 1 to 2 Spacing (s)	Pulse 2 to 3 Spacing (s)	Start Location (s)
1	1	5M	96.5u	-	-	857.4m
2	2	5M	53.0u	1.173m	-	643.5m
3	1	5M	84.3u	-	-	871.6m
4	3	5M	99.1u	1.140m	1.778m	521.9m
5	3	5M	67.5u	1.487m	1.636m	314.7m
6	2	5M	60.2u	1.210m	-	877.7m
7	1	5M	98.6u	-	-	340.6m
8	3	5M	90.3u	1.747m	1.331m	243.1m
9	2	5M	52.8u	1.060m	-	767.7m
10	2	5M	76.4u	1.115m	-	481.2m
11	3	5M	98.3u	1.759m	1.414m	449.9m
12	1	5M	66.6u	-	-	887.3m

Long Pulse Radar Test Signal						
Test Signal Name: LP_Signal_02						
Number of Bursts in Trial: 18						
Chrip Center Frequency: 5254MHz						
Burst	Pulses per Burst	Chrip (Hz)	Pulse Width (s)	Pulse 1 to 2 Spacing (s)	Pulse 2 to 3 Spacing (s)	Start Location (s)
1	1	5M	53.6u	-	-	504.6m
2	3	5M	97.1u	1.798m	1.565m	441.5m
3	3	5M	53.5u	1.548m	1.068m	291.7m
4	2	5M	52.2u	1.395m	-	212.8m
5	2	5M	95.3u	1.226m	-	96.33m
6	2	5M	92.6u	1.470m	-	303.7m
7	1	5M	82.6u	-	-	516.6m
8	1	5M	53.5u	-	-	141.6m
9	2	5M	57.4u	999.6u	-	95.05m
10	2	5M	96.4u	1.888m	-	567.5m
11	2	5M	66.0u	1.443m	-	271.3m
12	1	5M	98.5u	-	-	442.6m
13	2	5M	68.3u	1.114m	-	512.5m
14	2	5M	85.3u	1.613m	-	105.4m
15	3	5M	99.4u	1.752m	1.843m	647.8m
16	2	5M	97.8u	1.644m	-	259.0m
17	1	5M	77.1u	-	-	649.5m
18	1	5M	58.2u	-	-	539.5m

Long Pulse Radar Test Signal						
Test Signal Name: LP_Signal_03						
Number of Bursts in Trial: 14						
Chrip Center Frequency: 5254MHz						
Burst	Pulses per Burst	Chrip (Hz)	Pulse Width (s)	Pulse 1 to 2 Spacing (s)	Pulse 2 to 3 Spacing (s)	Start Location (s)
1	3	7M	62.7u	1.678m	1.717m	280.1m
2	2	7M	77.5u	1.567m	-	308.4m
3	1	7M	98.3u	-	-	380.5m
4	2	7M	85.2u	1.831m	-	205.0m
5	3	7M	91.8u	1.520m	947.2u	688.8m
6	1	7M	91.4u	-	-	69.25m
7	2	7M	76.1u	1.384m	-	699.5m
8	2	7M	68.2u	1.336m	-	142.5m
9	1	7M	87.0u	-	-	439.3m
10	2	7M	85.3u	1.230m	-	171.5m
11	2	7M	75.6u	1.213m	-	309.9m
12	3	7M	82.8u	1.743m	1.125m	450.3m
13	2	7M	74.3u	1.667m	-	190.8m
14	1	7M	77.4u	-	-	385.5m

Long Pulse Radar Test Signal						
Test Signal Name: LP_Signal_04						
Number of Bursts in Trial: 19						
Chrip Center Frequency: 5254MHz						
Burst	Pulses per Burst	Chrip (Hz)	Pulse Width (s)	Pulse 1 to 2 Spacing (s)	Pulse 2 to 3 Spacing (s)	Start Location (s)
1	1	7M	88.9u	-	-	400.9m
2	2	7M	87.7u	1.749m	-	609.2m
3	2	7M	50.6u	1.085m	-	105.0m
4	3	7M	91.1u	1.614m	1.318m	577.2m
5	2	7M	74.9u	973.1u	-	357.6m
6	3	7M	73.2u	1.725m	1.906m	367.0m
7	3	7M	80.3u	945.7u	1.860m	150.4m
8	2	7M	95.3u	1.286m	-	625.2m
9	2	7M	84.7u	1.685m	-	954.0u
10	2	7M	59.4u	1.472m	-	547.2m
11	2	7M	86.9u	1.657m	-	488.3m
12	2	7M	58.6u	1.575m	-	148.0m
13	1	7M	97.1u	-	-	448.7m
14	1	7M	75.6u	-	-	601.2m
15	3	7M	66.8u	1.457m	1.366m	239.7m
16	2	7M	79.2u	1.394m	-	127.7m
17	2	7M	50.1u	1.763m	-	55.41m
18	1	7M	73.1u	-	-	132.9m
19	1	7M	51.8u	-	-	601.6m

Long Pulse Radar Test Signal						
Test Signal Name: LP_Signal_05						
Number of Bursts in Trial: 19						
Chrip Center Frequency: 5257MHz						
Burst	Pulses per Burst	Chrip (Hz)	Pulse Width (s)	Pulse 1 to 2 Spacing (s)	Pulse 2 to 3 Spacing (s)	Start Location (s)
1	2	13M	98.5u	1.185m	-	281.2m
2	2	13M	66.9u	1.351m	-	601.3m
3	3	13M	55.6u	1.069m	1.564m	386.6m
4	1	13M	63.9u	-	-	70.85m
5	2	13M	88.1u	1.499m	-	486.4m
6	2	13M	77.3u	1.188m	-	445.4m
7	2	13M	51.2u	1.501m	-	39.21m
8	2	13M	84.1u	1.309m	-	348.6m
9	3	13M	62.5u	1.360m	1.020m	537.1m
10	2	13M	96.3u	1.862m	-	172.3m
11	1	13M	51.7u	-	-	207.5m
12	2	13M	91.0u	1.645m	-	337.1m
13	2	13M	56.6u	1.739m	-	566.0m
14	3	13M	66.1u	1.150m	1.775m	563.4m
15	2	13M	84.0u	1.515m	-	378.1m
16	1	13M	76.1u	-	-	565.0m
17	2	13M	79.4u	1.295m	-	628.4m
18	2	13M	75.4u	1.198m	-	128.5m
19	2	13M	61.5u	949.5u	-	582.9m

Long Pulse Radar Test Signal						
Test Signal Name: LP_Signal_06						
Number of Bursts in Trial: 12						
Chrip Center Frequency: 5257MHz						
Burst	Pulses per Burst	Chrip (Hz)	Pulse Width (s)	Pulse 1 to 2 Spacing (s)	Pulse 2 to 3 Spacing (s)	Start Location (s)
1	1	13M	98.7u	-	-	633.0m
2	1	13M	57.3u	-	-	438.3m
3	3	13M	68.6u	1.493m	1.610m	875.1m
4	2	13M	97.5u	1.612m	-	685.6m
5	1	13M	55.5u	-	-	747.3m
6	2	13M	62.8u	967.2u	-	788.4m
7	2	13M	80.7u	1.417m	-	652.7m
8	1	13M	65.9u	-	-	782.6m
9	3	13M	79.9u	1.732m	1.557m	410.0m
10	2	13M	76.4u	1.761m	-	78.51m
11	1	13M	58.1u	-	-	580.4m
12	2	13M	78.0u	961.0u	-	162.0m

Long Pulse Radar Test Signal
 Test Signal Name: LP_Signal_07
 Number of Bursts in Trial: 11
 Chrip Center Frequency: 5258MHz

Burst	Pulses per Burst	Chrip (Hz)	Pulse Width (s)	Pulse 1 to 2 Spacing (s)	Pulse 2 to 3 Spacing (s)	Start Location (s)
1	2	16M	60.9u	1.685m	-	1.030
2	2	16M	86.8u	1.363m	-	1.069
3	2	16M	95.4u	1.521m	-	296.1m
4	3	16M	73.5u	1.628m	1.226m	377.5m
5	2	16M	67.5u	1.036m	-	644.9m
6	3	16M	65.5u	1.798m	1.561m	766.1m
7	3	16M	95.9u	1.094m	1.242m	537.2m
8	2	16M	96.2u	1.578m	-	172.3m
9	2	16M	90.4u	1.274m	-	256.1m
10	2	16M	90.1u	1.319m	-	842.4m
11	2	16M	59.3u	1.600m	-	728.8m

Long Pulse Radar Test Signal
 Test Signal Name: LP_Signal_08
 Number of Bursts in Trial: 16
 Chrip Center Frequency: 5258MHz

Burst	Pulses per Burst	Chrip (Hz)	Pulse Width (s)	Pulse 1 to 2 Spacing (s)	Pulse 2 to 3 Spacing (s)	Start Location (s)
1	1	16M	53.9u	-	-	653.0m
2	3	16M	87.4u	1.140m	1.207m	109.0m
3	2	16M	56.0u	1.104m	-	462.3m
4	2	16M	62.5u	1.625m	-	704.3m
5	2	16M	66.7u	1.202m	-	296.4m
6	2	16M	65.6u	1.571m	-	169.5m
7	2	16M	65.2u	1.889m	-	703.7m
8	1	16M	67.4u	-	-	78.58m
9	3	16M	70.1u	1.820m	1.460m	419.9m
10	2	16M	62.3u	1.636m	-	7.821m
11	3	16M	79.8u	1.442m	1.551m	384.2m
12	1	16M	81.4u	-	-	378.9m
13	2	16M	75.0u	1.336m	-	742.0m
14	2	16M	74.3u	1.487m	-	726.4m
15	3	16M	88.8u	1.772m	1.153m	168.4m
16	3	16M	67.7u	1.248m	1.211m	647.3m

Long Pulse Radar Test Signal						
Test Signal Name: LP_Signal_09						
Number of Bursts in Trial: 16						
Chrip Center Frequency: 5260MHz						
Burst	Pulses per Burst	Chrip (Hz)	Pulse Width (s)	Pulse 1 to 2 Spacing (s)	Pulse 2 to 3 Spacing (s)	Start Location (s)
1	2	20M	80.2u	1.739m	-	720.6m
2	3	20M	50.1u	1.816m	1.933m	558.9m
3	1	20M	96.2u	-	-	211.8m
4	3	20M	72.6u	1.275m	1.410m	628.1m
5	2	20M	92.6u	1.262m	-	295.1m
6	2	20M	70.1u	1.814m	-	404.0m
7	2	20M	96.2u	1.463m	-	89.45m
8	2	20M	78.6u	1.436m	-	275.4m
9	2	20M	85.9u	1.077m	-	726.5m
10	3	20M	86.3u	1.689m	1.395m	279.8m
11	1	20M	88.0u	-	-	142.6m
12	3	20M	58.3u	1.051m	995.7u	248.6m
13	2	20M	95.3u	1.642m	-	392.4m
14	3	20M	93.1u	1.100m	1.481m	639.1m
15	1	20M	96.7u	-	-	614.9m
16	2	20M	67.1u	1.370m	-	471.2m

Long Pulse Radar Test Signal						
Test Signal Name: LP_Signal_10						
Number of Bursts in Trial: 18						
Chrip Center Frequency: 5260MHz						
Burst	Pulses per Burst	Chrip (Hz)	Pulse Width (s)	Pulse 1 to 2 Spacing (s)	Pulse 2 to 3 Spacing (s)	Start Location (s)
1	2	20M	98.6u	1.198m	-	344.9m
2	2	20M	57.6u	961.4u	-	641.7m
3	1	20M	56.4u	-	-	308.8m
4	1	20M	81.4u	-	-	180.2m
5	1	20M	61.8u	-	-	297.7m
6	2	20M	90.4u	1.563m	-	282.9m
7	3	20M	68.8u	1.515m	1.370m	37.46m
8	1	20M	73.9u	-	-	475.8m
9	2	20M	68.4u	1.684m	-	117.5m
10	3	20M	95.4u	1.490m	1.735m	155.9m
11	1	20M	70.9u	-	-	253.8m
12	1	20M	94.7u	-	-	356.0m
13	3	20M	76.9u	1.750m	1.203m	56.37m
14	3	20M	80.6u	1.024m	1.881m	588.3m
15	2	20M	87.2u	1.015m	-	223.6m
16	2	20M	85.9u	1.898m	-	380.5m
17	1	20M	62.9u	-	-	127.1m
18	2	20M	96.3u	1.532m	-	541.3m

Long Pulse Radar Test Signal						
Test Signal Name: LP_Signal_11						
Number of Bursts in Trial: 13						
Chrip Center Frequency: 5290MHz						
Burst	Pulses per Burst	Chrip (Hz)	Pulse Width (s)	Pulse 1 to 2 Spacing (s)	Pulse 2 to 3 Spacing (s)	Start Location (s)
1	2	5M	64.2u	1.510m	-	171.7m
2	2	5M	85.7u	1.457m	-	23.95m
3	3	5M	93.8u	1.348m	1.769m	685.0m
4	3	5M	85.1u	1.065m	1.624m	112.8m
5	1	5M	84.7u	-	-	797.2m
6	2	5M	80.4u	1.702m	-	14.43m
7	1	5M	98.4u	-	-	314.4m
8	2	5M	71.1u	1.369m	-	529.1m
9	1	5M	98.6u	-	-	667.9m
10	2	5M	91.7u	1.176m	-	571.6m
11	2	5M	69.1u	1.770m	-	615.7m
12	2	5M	90.9u	1.511m	-	676.8m
13	2	5M	89.6u	1.199m	-	683.8m

Long Pulse Radar Test Signal						
Test Signal Name: LP_Signal_12						
Number of Bursts in Trial: 12						
Chrip Center Frequency: 5290MHz						
Burst	Pulses per Burst	Chrip (Hz)	Pulse Width (s)	Pulse 1 to 2 Spacing (s)	Pulse 2 to 3 Spacing (s)	Start Location (s)
1	1	5M	96.5u	-	-	857.4m
2	2	5M	53.0u	1.173m	-	643.5m
3	1	5M	84.3u	-	-	871.6m
4	3	5M	99.1u	1.140m	1.778m	521.9m
5	3	5M	67.5u	1.487m	1.636m	314.7m
6	2	5M	60.2u	1.210m	-	877.7m
7	1	5M	98.6u	-	-	340.6m
8	3	5M	90.3u	1.747m	1.331m	243.1m
9	2	5M	52.8u	1.060m	-	767.7m
10	2	5M	76.4u	1.115m	-	481.2m
11	3	5M	98.3u	1.759m	1.414m	449.9m
12	1	5M	66.6u	-	-	887.3m

Long Pulse Radar Test Signal						
Test Signal Name: LP_Signal_13						
Number of Bursts in Trial: 12						
Chrip Center Frequency: 5290MHz						
Burst	Pulses per Burst	Chrip (Hz)	Pulse Width (s)	Pulse 1 to 2 Spacing (s)	Pulse 2 to 3 Spacing (s)	Start Location (s)
1	2	9M	83.6u	1.774m	-	467.4m
2	2	9M	97.1u	1.796m	-	328.2m
3	1	9M	84.9u	-	-	712.5m
4	1	9M	85.6u	-	-	456.6m
5	2	9M	97.8u	917.2u	-	642.0m
6	2	9M	95.4u	1.079m	-	800.8m
7	1	9M	71.2u	-	-	898.6m
8	3	9M	82.0u	1.666m	1.468m	784.5m
9	3	9M	86.6u	1.322m	1.519m	535.5m
10	1	9M	71.4u	-	-	43.23m
11	2	9M	62.2u	1.268m	-	268.5m
12	2	9M	96.1u	1.888m	-	253.4m

Long Pulse Radar Test Signal
 Test Signal Name: LP_Signal_14
 Number of Bursts in Trial: 18
 Chrip Center Frequency: 5290MHz

Burst	Pulses per Burst	Chrip (Hz)	Pulse Width (s)	Pulse 1 to 2 Spacing (s)	Pulse 2 to 3 Spacing (s)	Start Location (s)
1	1	9M	92.6u	-	-	574.7m
2	3	9M	67.9u	1.272m	1.316m	302.6m
3	1	9M	85.3u	-	-	195.7m
4	2	9M	87.8u	1.863m	-	517.8m
5	2	9M	73.7u	1.364m	-	350.7m
6	1	9M	55.8u	-	-	569.5m
7	3	9M	99.1u	936.9u	1.756m	652.9m
8	2	9M	94.5u	1.889m	-	175.3m
9	2	9M	69.1u	1.741m	-	186.8m
10	2	9M	60.2u	1.826m	-	144.5m
11	2	9M	90.0u	1.419m	-	500.0m
12	2	9M	98.3u	1.336m	-	157.3m
13	2	9M	94.4u	1.660m	-	479.9m
14	3	9M	91.0u	1.788m	1.474m	137.2m
15	1	9M	74.3u	-	-	351.9m
16	2	9M	55.0u	1.665m	-	89.03m
17	3	9M	85.5u	981.5u	1.182m	444.9m
18	2	9M	86.1u	1.623m	-	259.0m

Long Pulse Radar Test Signal
 Test Signal Name: LP_Signal_15
 Number of Bursts in Trial: 8
 Chrip Center Frequency: 5290MHz

Burst	Pulses per Burst	Chrip (Hz)	Pulse Width (s)	Pulse 1 to 2 Spacing (s)	Pulse 2 to 3 Spacing (s)	Start Location (s)
1	2	14M	100.0u	1.316m	-	574.2m
2	2	14M	67.5u	1.529m	-	280.0m
3	3	14M	52.4u	1.833m	955.6u	312.3m
4	3	14M	74.3u	1.451m	1.391m	1.205
5	2	14M	82.0u	1.489m	-	1.470
6	2	14M	65.4u	1.871m	-	1.159
7	2	14M	56.9u	1.758m	-	300.0m
8	1	14M	67.1u	-	-	431.5m

Long Pulse Radar Test Signal
 Test Signal Name: LP_Signal_16
 Number of Bursts in Trial: 9
 Chrip Center Frequency: 5290MHz

Burst	Pulses per Burst	Chrip (Hz)	Pulse Width (s)	Pulse 1 to 2 Spacing (s)	Pulse 2 to 3 Spacing (s)	Start Location (s)
1	2	14M	89.0u	1.663m	-	435.6m
2	1	14M	50.5u	-	-	582.4m
3	2	14M	58.5u	1.078m	-	681.0m
4	3	14M	59.6u	1.582m	1.397m	730.4m
5	2	14M	92.9u	1.695m	-	227.2m
6	2	14M	69.6u	1.367m	-	963.5m
7	2	14M	65.4u	1.684m	-	1.200
8	2	14M	95.7u	1.419m	-	601.2m
9	2	14M	88.7u	1.095m	-	712.2m

Long Pulse Radar Test Signal						
Test Signal Name: LP_Signal_17						
Number of Bursts in Trial: 16						
Chrip Center Frequency: 5290MHz						
Burst	Pulses per Burst	Chrip (Hz)	Pulse Width (s)	Pulse 1 to 2 Spacing (s)	Pulse 2 to 3 Spacing (s)	Start Location (s)
1	1	16M	95.3u	-	-	108.6m
2	2	16M	53.1u	1.606m	-	65.83m
3	3	16M	96.8u	1.488m	1.352m	2.636m
4	2	16M	67.5u	1.301m	-	327.5m
5	3	16M	55.6u	1.122m	1.431m	138.8m
6	1	16M	50.8u	-	-	12.03m
7	2	16M	53.4u	1.503m	-	456.4m
8	3	16M	54.8u	1.412m	1.710m	520.5m
9	3	16M	53.7u	1.685m	1.762m	465.8m
10	2	16M	60.3u	1.837m	-	679.9m
11	2	16M	91.2u	1.027m	-	500.3m
12	2	16M	95.7u	1.804m	-	154.5m
13	2	16M	70.0u	1.808m	-	89.20m
14	2	16M	72.9u	1.045m	-	617.0m
15	2	16M	94.5u	1.540m	-	399.1m
16	3	16M	67.8u	1.932m	1.398m	689.5m

Long Pulse Radar Test Signal						
Test Signal Name: LP_Signal_18						
Number of Bursts in Trial: 12						
Chrip Center Frequency: 5290MHz						
Burst	Pulses per Burst	Chrip (Hz)	Pulse Width (s)	Pulse 1 to 2 Spacing (s)	Pulse 2 to 3 Spacing (s)	Start Location (s)
1	3	16M	81.9u	1.713m	1.130m	406.8m
2	3	16M	94.1u	1.182m	1.311m	673.2m
3	3	16M	88.8u	1.272m	1.897m	962.9m
4	2	16M	85.5u	1.256m	-	689.2m
5	3	16M	91.6u	1.325m	1.053m	396.5m
6	3	16M	58.7u	1.613m	1.768m	692.7m
7	2	16M	89.9u	1.182m	-	988.1m
8	3	16M	74.7u	1.139m	1.384m	783.9m
9	2	16M	74.8u	1.849m	-	722.0m
10	2	16M	55.6u	967.4u	-	325.4m
11	2	16M	74.6u	1.876m	-	549.7m
12	3	16M	97.6u	1.660m	1.245m	109.6m

Long Pulse Radar Test Signal						
Test Signal Name: LP_Signal_19						
Number of Bursts in Trial: 10						
Chrip Center Frequency: 5290MHz						
Burst	Pulses per Burst	Chrip (Hz)	Pulse Width (s)	Pulse 1 to 2 Spacing (s)	Pulse 2 to 3 Spacing (s)	Start Location (s)
1	2	20M	78.6u	1.551m	-	833.2m
2	2	20M	51.6u	990.4u	-	825.2m
3	2	20M	86.8u	1.097m	-	809.6m
4	1	20M	60.5u	-	-	792.9m
5	2	20M	54.9u	1.783m	-	491.4m
6	2	20M	75.7u	1.245m	-	717.7m
7	2	20M	55.0u	1.513m	-	1.155
8	2	20M	79.2u	955.8u	-	118.6m
9	1	20M	56.4u	-	-	881.1m
10	1	20M	97.7u	-	-	978.0m

Long Pulse Radar Test Signal						
Test Signal Name: LP_Signal_20						
Number of Bursts in Trial: 16						
Chrip Center Frequency: 5290MHz						
Burst	Pulses per Burst	Chrip (Hz)	Pulse Width (s)	Pulse 1 to 2 Spacing (s)	Pulse 2 to 3 Spacing (s)	Start Location (s)
1	2	20M	98.1u	1.220m	-	507.2m
2	2	20M	73.5u	1.910m	-	227.2m
3	2	20M	98.2u	1.506m	-	631.2m
4	3	20M	97.9u	1.595m	1.851m	164.0m
5	1	20M	92.9u	-	-	45.06m
6	2	20M	76.6u	1.260m	-	601.8m
7	2	20M	68.1u	1.217m	-	342.9m
8	1	20M	53.3u	-	-	86.38m
9	2	20M	58.0u	978.0u	-	75.50m
10	1	20M	66.6u	-	-	328.5m
11	3	20M	69.0u	1.388m	1.330m	707.6m
12	2	20M	68.3u	1.450m	-	328.0m
13	3	20M	99.1u	1.752m	1.303m	426.0m
14	1	20M	94.8u	-	-	632.9m
15	1	20M	99.7u	-	-	169.8m
16	1	20M	51.5u	-	-	455.1m

Long Pulse Radar Test Signal						
Test Signal Name: LP_Signal_21						
Number of Bursts in Trial: 13						
Chrip Center Frequency: 5326MHz						
Burst	Pulses per Burst	Chrip (Hz)	Pulse Width (s)	Pulse 1 to 2 Spacing (s)	Pulse 2 to 3 Spacing (s)	Start Location (s)
1	2	5M	64.2u	1.510m	-	171.7m
2	2	5M	85.7u	1.457m	-	23.95m
3	3	5M	93.8u	1.348m	1.769m	685.0m
4	3	5M	85.1u	1.065m	1.624m	112.8m
5	1	5M	84.7u	-	-	797.2m
6	2	5M	80.4u	1.702m	-	14.43m
7	1	5M	98.4u	-	-	314.4m
8	2	5M	71.1u	1.369m	-	529.1m
9	1	5M	98.6u	-	-	667.9m
10	2	5M	91.7u	1.176m	-	571.6m
11	2	5M	69.1u	1.770m	-	615.7m
12	2	5M	90.9u	1.511m	-	676.8m
13	2	5M	89.6u	1.199m	-	683.8m

Long Pulse Radar Test Signal						
Test Signal Name: LP_Signal_22						
Number of Bursts in Trial: 16						
Chrip Center Frequency: 5326MHz						
Burst	Pulses per Burst	Chrip (Hz)	Pulse Width (s)	Pulse 1 to 2 Spacing (s)	Pulse 2 to 3 Spacing (s)	Start Location (s)
1	1	5M	59.2u	-	-	243.0m
2	2	5M	94.5u	1.834m	-	299.3m
3	2	5M	95.4u	1.641m	-	566.0m
4	3	5M	59.5u	1.313m	1.332m	354.8m
5	2	5M	62.1u	1.158m	-	618.4m
6	3	5M	73.9u	1.671m	1.534m	629.7m
7	2	5M	50.4u	1.155m	-	384.7m
8	3	5M	62.7u	1.675m	1.571m	94.54m
9	1	5M	52.4u	-	-	45.93m
10	3	5M	55.9u	1.743m	1.537m	37.45m
11	2	5M	62.1u	1.725m	-	173.9m
12	3	5M	65.1u	1.567m	1.369m	549.6m
13	3	5M	80.3u	1.548m	1.117m	530.8m
14	2	5M	85.5u	1.063m	-	265.8m
15	3	5M	54.7u	1.134m	1.657m	49.43m
16	2	5M	85.8u	1.450m	-	382.0m

Long Pulse Radar Test Signal						
Test Signal Name: LP_Signal_23						
Number of Bursts in Trial: 12						
Chrip Center Frequency: 5324MHz						
Burst	Pulses per Burst	Chrip (Hz)	Pulse Width (s)	Pulse 1 to 2 Spacing (s)	Pulse 2 to 3 Spacing (s)	Start Location (s)
1	2	10M	95.2u	1.690m	-	993.9m
2	2	10M	82.3u	1.520m	-	555.8m
3	3	10M	95.0u	1.392m	1.015m	566.4m
4	1	10M	52.8u	-	-	362.2m
5	1	10M	53.1u	-	-	102.8m
6	2	10M	96.4u	1.454m	-	714.3m
7	2	10M	56.0u	1.235m	-	252.4m
8	2	10M	64.8u	1.410m	-	466.8m
9	2	10M	51.9u	1.473m	-	878.3m
10	1	10M	81.5u	-	-	856.4m
11	2	10M	97.8u	1.480m	-	699.6m
12	3	10M	61.7u	1.069m	1.910m	663.4m

Long Pulse Radar Test Signal						
Test Signal Name: LP_Signal_24						
Number of Bursts in Trial: 9						
Chrip Center Frequency: 5324MHz						
Burst	Pulses per Burst	Chrip (Hz)	Pulse Width (s)	Pulse 1 to 2 Spacing (s)	Pulse 2 to 3 Spacing (s)	Start Location (s)
1	3	10M	80.2u	1.716m	1.208m	458.3m
2	2	10M	99.0u	1.877m	-	80.24m
3	1	10M	70.5u	-	-	705.0m
4	1	10M	88.3u	-	-	69.65m
5	2	10M	56.4u	1.516m	-	922.0m
6	1	10M	100.0u	-	-	179.3m
7	2	10M	58.2u	994.8u	-	1.187
8	1	10M	98.0u	-	-	223.9m
9	1	10M	92.7u	-	-	927.1m

Long Pulse Radar Test Signal						
Test Signal Name: LP_Signal_25						
Number of Bursts in Trial: 9						
Chrip Center Frequency: 5323MHz						
Burst	Pulses per Burst	Chrip (Hz)	Pulse Width (s)	Pulse 1 to 2 Spacing (s)	Pulse 2 to 3 Spacing (s)	Start Location (s)
1	2	13M	81.8u	959.2u	-	874.4m
2	1	13M	80.9u	-	-	1.030
3	3	13M	56.3u	999.7u	1.916m	930.7m
4	2	13M	63.6u	1.070m	-	903.9m
5	2	13M	65.0u	1.382m	-	89.36m
6	3	13M	83.5u	1.311m	979.5u	725.0m
7	3	13M	83.8u	918.2u	1.113m	1.114
8	2	13M	51.9u	1.314m	-	1.096
9	2	13M	72.3u	1.174m	-	658.1m

Long Pulse Radar Test Signal						
Test Signal Name: LP_Signal_26						
Number of Bursts in Trial: 12						
Chrip Center Frequency: 5323MHz						
Burst	Pulses per Burst	Chrip (Hz)	Pulse Width (s)	Pulse 1 to 2 Spacing (s)	Pulse 2 to 3 Spacing (s)	Start Location (s)
1	1	13M	98.7u	-	-	633.0m
2	1	13M	57.3u	-	-	438.3m
3	3	13M	68.6u	1.493m	1.610m	875.1m
4	2	13M	97.5u	1.612m	-	685.6m
5	1	13M	55.5u	-	-	747.3m
6	2	13M	62.8u	967.2u	-	788.4m
7	2	13M	80.7u	1.417m	-	652.7m
8	1	13M	65.9u	-	-	782.6m
9	3	13M	79.9u	1.732m	1.557m	410.0m
10	2	13M	76.4u	1.761m	-	78.51m
11	1	13M	58.1u	-	-	580.4m
12	2	13M	78.0u	961.0u	-	162.0m

Long Pulse Radar Test Signal						
Test Signal Name: LP_Signal_27						
Number of Bursts in Trial: 19						
Chrip Center Frequency: 5322MHz						
Burst	Pulses per Burst	Chrip (Hz)	Pulse Width (s)	Pulse 1 to 2 Spacing (s)	Pulse 2 to 3 Spacing (s)	Start Location (s)
1	3	16M	57.4u	1.310m	1.063m	263.4m
2	3	16M	53.6u	1.063m	1.123m	239.3m
3	3	16M	82.4u	1.425m	1.371m	434.0m
4	2	16M	83.1u	1.514m	-	308.5m
5	3	16M	89.8u	1.210m	1.455m	259.5m
6	2	16M	95.6u	1.397m	-	66.09m
7	2	16M	70.5u	1.045m	-	558.6m
8	2	16M	89.0u	1.309m	-	92.83m
9	1	16M	83.7u	-	-	524.2m
10	3	16M	93.5u	1.004m	1.611m	438.4m
11	2	16M	54.3u	1.632m	-	338.8m
12	1	16M	72.4u	-	-	84.23m
13	3	16M	72.1u	1.064m	1.337m	270.5m
14	2	16M	77.9u	1.844m	-	230.5m
15	2	16M	89.1u	1.282m	-	173.5m
16	2	16M	70.0u	1.089m	-	189.6m
17	3	16M	87.1u	1.138m	1.322m	348.7m
18	1	16M	56.9u	-	-	486.2m
19	3	16M	79.4u	1.267m	1.580m	285.8m

Long Pulse Radar Test Signal						
Test Signal Name: LP_Signal_28						
Number of Bursts in Trial: 12						
Chrip Center Frequency: 5322MHz						
Burst	Pulses per Burst	Chrip (Hz)	Pulse Width (s)	Pulse 1 to 2 Spacing (s)	Pulse 2 to 3 Spacing (s)	Start Location (s)
1	3	16M	81.9u	1.713m	1.130m	406.8m
2	3	16M	94.1u	1.182m	1.311m	673.2m
3	3	16M	88.8u	1.272m	1.897m	962.9m
4	2	16M	85.5u	1.256m	-	689.2m
5	3	16M	91.6u	1.325m	1.053m	396.5m
6	3	16M	58.7u	1.613m	1.768m	692.7m
7	2	16M	89.9u	1.182m	-	988.1m
8	3	16M	74.7u	1.139m	1.384m	783.9m
9	2	16M	74.8u	1.849m	-	722.0m
10	2	16M	55.6u	967.4u	-	325.4m
11	2	16M	74.6u	1.876m	-	549.7m
12	3	16M	97.6u	1.660m	1.245m	109.6m

Long Pulse Radar Test Signal						
Test Signal Name: LP_Signal_29						
Number of Bursts in Trial: 10						
Chrip Center Frequency: 5320MHz						
Burst	Pulses per Burst	Chrip (Hz)	Pulse Width (s)	Pulse 1 to 2 Spacing (s)	Pulse 2 to 3 Spacing (s)	Start Location (s)
1	2	20M	78.6u	1.551m	-	833.2m
2	2	20M	51.6u	990.4u	-	825.2m
3	2	20M	86.8u	1.097m	-	809.6m
4	1	20M	60.5u	-	-	792.9m
5	2	20M	54.9u	1.783m	-	491.4m
6	2	20M	75.7u	1.245m	-	717.7m
7	2	20M	55.0u	1.513m	-	1.155
8	2	20M	79.2u	955.8u	-	118.6m
9	1	20M	56.4u	-	-	881.1m
10	1	20M	97.7u	-	-	978.0m

Long Pulse Radar Test Signal						
Test Signal Name: LP_Signal_30						
Number of Bursts in Trial: 16						
Chirp Center Frequency: 5320MHz						
Burst	Pulses per Burst	Chirp (Hz)	Pulse Width (s)	Pulse 1 to 2 Spacing (s)	Pulse 2 to 3 Spacing (s)	Start Location (s)
1	2	20M	98.1u	1.220m	-	507.2m
2	2	20M	73.5u	1.910m	-	227.2m
3	2	20M	98.2u	1.506m	-	631.2m
4	3	20M	97.9u	1.595m	1.851m	164.0m
5	1	20M	92.9u	-	-	45.06m
6	2	20M	76.6u	1.260m	-	601.8m
7	2	20M	68.1u	1.217m	-	342.9m
8	1	20M	53.3u	-	-	86.38m
9	2	20M	58.0u	978.0u	-	75.50m
10	1	20M	66.6u	-	-	328.5m
11	3	20M	69.0u	1.388m	1.330m	707.6m
12	2	20M	68.3u	1.450m	-	328.0m
13	3	20M	99.1u	1.752m	1.303m	426.0m
14	1	20M	94.8u	-	-	632.9m
15	1	20M	99.7u	-	-	169.8m
16	1	20M	51.5u	-	-	455.1m

Type 6 Radar Statistical Performances				
Trial #	Pulses per Burst	Pulse Width (s)	PRI (s)	Detection
1	9	1.0u	333.0u	Yes
2	9	1.0u	333.0u	Yes
3	9	1.0u	333.0u	Yes
4	9	1.0u	333.0u	Yes
5	9	1.0u	333.0u	Yes
6	9	1.0u	333.0u	Yes
7	9	1.0u	333.0u	Yes
8	9	1.0u	333.0u	Yes
9	9	1.0u	333.0u	Yes
10	9	1.0u	333.0u	Yes
11	9	1.0u	333.0u	Yes
12	9	1.0u	333.0u	Yes
13	9	1.0u	333.0u	Yes
14	9	1.0u	333.0u	Yes
15	9	1.0u	333.0u	Yes
16	9	1.0u	333.0u	Yes
17	9	1.0u	333.0u	Yes
18	9	1.0u	333.0u	Yes
19	9	1.0u	333.0u	Yes
20	9	1.0u	333.0u	Yes
21	9	1.0u	333.0u	Yes
22	9	1.0u	333.0u	Yes
23	9	1.0u	333.0u	Yes
24	9	1.0u	333.0u	Yes
25	9	1.0u	333.0u	Yes
26	9	1.0u	333.0u	Yes
27	9	1.0u	333.0u	Yes
28	9	1.0u	333.0u	Yes
29	9	1.0u	333.0u	Yes
30	9	1.0u	333.0u	Yes
				Detection Rate: 100.0 %

Type 6 Radar Statistical Performances		
Trial #	Hopping Frequency Sequence Name	Detection
1	HOP_FREQ_SEQ_01	Yes
2	HOP_FREQ_SEQ_02	Yes
3	HOP_FREQ_SEQ_03	Yes
4	HOP_FREQ_SEQ_04	Yes
5	HOP_FREQ_SEQ_05	Yes
6	HOP_FREQ_SEQ_06	Yes
7	HOP_FREQ_SEQ_07	Yes
8	HOP_FREQ_SEQ_08	Yes
9	HOP_FREQ_SEQ_09	Yes
10	HOP_FREQ_SEQ_10	Yes
11	HOP_FREQ_SEQ_11	Yes
12	HOP_FREQ_SEQ_12	Yes
13	HOP_FREQ_SEQ_13	Yes
14	HOP_FREQ_SEQ_14	Yes
15	HOP_FREQ_SEQ_15	Yes
16	HOP_FREQ_SEQ_16	Yes
17	HOP_FREQ_SEQ_17	Yes
18	HOP_FREQ_SEQ_18	Yes
19	HOP_FREQ_SEQ_19	Yes
20	HOP_FREQ_SEQ_20	Yes
21	HOP_FREQ_SEQ_21	Yes
22	HOP_FREQ_SEQ_22	Yes
23	HOP_FREQ_SEQ_23	Yes
24	HOP_FREQ_SEQ_24	Yes
25	HOP_FREQ_SEQ_25	Yes
26	HOP_FREQ_SEQ_26	Yes
27	HOP_FREQ_SEQ_27	Yes
28	HOP_FREQ_SEQ_28	Yes
29	HOP_FREQ_SEQ_29	Yes
30	HOP_FREQ_SEQ_30	Yes
		Detection Rate: 100.0 %

Hopping Frequency Sequence Name: HOP_FREQ_SEQ_01							
SEQ#	Frequency (Hz)	SEQ#	Frequency (Hz)	SEQ#	Frequency (Hz)	SEQ#	Frequency (Hz)
1	5.540G	2	5.513G	3	5.526G	4	5.574G
5	5.501G	6	5.717G	7	5.590G	8	5.373G
9	5.338G	10	5.534G	11	5.388G	12	5.493G
13	5.447G	14	5.554G	15	5.593G	16	5.566G
17	5.688G	18	5.715G	19	5.350G	20	5.713G
21	5.404G	22	5.374G	23	5.571G	24	5.420G
25	5.588G	26	5.277G	27	5.407G	28	5.610G
29	5.278G	30	5.710G	31	5.366G	32	5.301G
33	5.666G	34	5.551G	35	5.531G	36	5.339G
37	5.410G	38	5.303G	39	5.267G	40	5.538G
41	5.327G	42	5.701G	43	5.358G	44	5.581G
45	5.408G	46	5.584G	47	5.477G	48	5.357G
49	5.703G	50	5.376G	51	5.683G	52	5.413G
53	5.662G	54	5.423G	55	5.632G	56	5.668G
57	5.619G	58	5.281G	59	5.429G	60	5.289G
61	5.306G	62	5.337G	63	5.596G	64	5.286G
65	5.592G	66	5.379G	67	5.362G	68	5.351G
69	5.433G	70	5.271G	71	5.384G	72	5.614G
73	5.504G	74	5.296G	75	5.712G	76	5.452G
77	5.687G	78	5.533G	79	5.599G	80	5.561G
81	5.293G	82	5.300G	83	5.302G	84	5.718G
85	5.291G	86	5.456G	87	5.505G	88	5.636G
89	5.367G	90	5.348G	91	5.527G	92	5.558G
93	5.640G	94	5.559G	95	5.436G	96	5.613G
97	5.472G	98	5.707G	99	5.607G	100	5.680G

Hopping Frequency Sequence Name: HOP_FREQ_SEQ_02							
SEQ#	Frequency (Hz)	SEQ#	Frequency (Hz)	SEQ#	Frequency (Hz)	SEQ#	Frequency (Hz)
1	5.641G	2	5.581G	3	5.679G	4	5.580G
5	5.429G	6	5.315G	7	5.582G	8	5.604G
9	5.353G	10	5.255G	11	5.260G	12	5.425G
13	5.366G	14	5.343G	15	5.478G	16	5.310G
17	5.367G	18	5.288G	19	5.595G	20	5.719G
21	5.514G	22	5.630G	23	5.327G	24	5.606G
25	5.424G	26	5.662G	27	5.482G	28	5.683G
29	5.528G	30	5.289G	31	5.700G	32	5.541G
33	5.356G	34	5.585G	35	5.506G	36	5.297G
37	5.391G	38	5.505G	39	5.511G	40	5.333G
41	5.292G	42	5.572G	43	5.329G	44	5.553G
45	5.408G	46	5.612G	47	5.532G	48	5.423G
49	5.594G	50	5.495G	51	5.499G	52	5.607G
53	5.706G	54	5.525G	55	5.692G	56	5.390G
57	5.576G	58	5.270G	59	5.549G	60	5.468G
61	5.407G	62	5.455G	63	5.448G	64	5.565G
65	5.687G	66	5.656G	67	5.335G	68	5.649G
69	5.360G	70	5.349G	71	5.504G	72	5.661G
73	5.422G	74	5.328G	75	5.311G	76	5.307G
77	5.669G	78	5.561G	79	5.521G	80	5.342G
81	5.337G	82	5.518G	83	5.441G	84	5.436G
85	5.682G	86	5.562G	87	5.466G	88	5.539G
89	5.372G	90	5.534G	91	5.284G	92	5.537G
93	5.701G	94	5.384G	95	5.251G	96	5.445G
97	5.473G	98	5.388G	99	5.280G	100	5.285G

Hopping Frequency Sequence Name: HOP_FREQ_SEQ_03							
SEQ#	Frequency (Hz)	SEQ#	Frequency (Hz)	SEQ#	Frequency (Hz)	SEQ#	Frequency (Hz)
1	5.284G	2	5.304G	3	5.456G	4	5.489G
5	5.670G	6	5.409G	7	5.574G	8	5.448G
9	5.581G	10	5.467G	11	5.637G	12	5.651G
13	5.641G	14	5.407G	15	5.281G	16	5.321G
17	5.428G	18	5.355G	19	5.260G	20	5.276G
21	5.435G	22	5.640G	23	5.683G	24	5.333G
25	5.382G	26	5.712G	27	5.391G	28	5.401G
29	5.554G	30	5.383G	31	5.261G	32	5.315G
33	5.563G	34	5.326G	35	5.652G	36	5.393G
37	5.280G	38	5.352G	39	5.588G	40	5.595G
41	5.498G	42	5.618G	43	5.596G	44	5.307G
45	5.720G	46	5.495G	47	5.542G	48	5.469G
49	5.617G	50	5.623G	51	5.723G	52	5.440G
53	5.350G	54	5.338G	55	5.332G	56	5.602G
57	5.277G	58	5.367G	59	5.572G	60	5.611G
61	5.294G	62	5.584G	63	5.529G	64	5.678G
65	5.501G	66	5.267G	67	5.536G	68	5.301G
69	5.516G	70	5.650G	71	5.664G	72	5.662G
73	5.263G	74	5.458G	75	5.528G	76	5.707G
77	5.717G	78	5.418G	79	5.560G	80	5.604G
81	5.644G	82	5.396G	83	5.416G	84	5.514G
85	5.526G	86	5.699G	87	5.443G	88	5.674G
89	5.411G	90	5.671G	91	5.510G	92	5.257G
93	5.436G	94	5.424G	95	5.459G	96	5.273G
97	5.685G	98	5.463G	99	5.288G	100	5.275G

Hopping Frequency Sequence Name: HOP_FREQ_SEQ_04							
SEQ#	Frequency (Hz)	SEQ#	Frequency (Hz)	SEQ#	Frequency (Hz)	SEQ#	Frequency (Hz)
1	5.278G	2	5.505G	3	5.563G	4	5.422G
5	5.685G	6	5.270G	7	5.545G	8	5.321G
9	5.641G	10	5.680G	11	5.568G	12	5.284G
13	5.675G	14	5.542G	15	5.406G	16	5.426G
17	5.346G	18	5.327G	19	5.558G	20	5.423G
21	5.285G	22	5.434G	23	5.720G	24	5.538G
25	5.357G	26	5.286G	27	5.362G	28	5.522G
29	5.520G	30	5.438G	31	5.418G	32	5.448G
33	5.605G	34	5.451G	35	5.516G	36	5.319G
37	5.694G	38	5.671G	39	5.518G	40	5.553G
41	5.252G	42	5.395G	43	5.482G	44	5.419G
45	5.397G	46	5.716G	47	5.349G	48	5.661G
49	5.296G	50	5.693G	51	5.414G	52	5.670G
53	5.356G	54	5.527G	55	5.704G	56	5.566G
57	5.429G	58	5.592G	59	5.353G	60	5.361G
61	5.475G	62	5.636G	63	5.508G	64	5.718G
65	5.484G	66	5.405G	67	5.348G	68	5.650G
69	5.412G	70	5.607G	71	5.294G	72	5.721G
73	5.565G	74	5.379G	75	5.279G	76	5.433G
77	5.578G	78	5.610G	79	5.477G	80	5.571G
81	5.276G	82	5.495G	83	5.308G	84	5.698G
85	5.572G	86	5.398G	87	5.387G	88	5.597G
89	5.688G	90	5.590G	91	5.485G	92	5.497G
93	5.253G	94	5.617G	95	5.632G	96	5.363G
97	5.628G	98	5.376G	99	5.282G	100	5.490G

Hopping Frequency Sequence Name: HOP_FREQ_SEQ_05							
SEQ#	Frequency (Hz)	SEQ#	Frequency (Hz)	SEQ#	Frequency (Hz)	SEQ#	Frequency (Hz)
1	5.535G	2	5.444G	3	5.468G	4	5.719G
5	5.264G	6	5.349G	7	5.554G	8	5.387G
9	5.462G	10	5.632G	11	5.490G	12	5.478G
13	5.340G	14	5.494G	15	5.323G	16	5.320G
17	5.560G	18	5.435G	19	5.367G	20	5.544G
21	5.519G	22	5.401G	23	5.616G	24	5.485G
25	5.477G	26	5.482G	27	5.669G	28	5.553G
29	5.682G	30	5.308G	31	5.293G	32	5.496G
33	5.480G	34	5.593G	35	5.268G	36	5.324G
37	5.657G	38	5.587G	39	5.712G	40	5.635G
41	5.473G	42	5.441G	43	5.442G	44	5.649G
45	5.597G	46	5.517G	47	5.279G	48	5.454G
49	5.689G	50	5.456G	51	5.529G	52	5.391G
53	5.515G	54	5.350G	55	5.434G	56	5.505G
57	5.539G	58	5.582G	59	5.604G	60	5.370G
61	5.413G	62	5.414G	63	5.285G	64	5.605G
65	5.648G	66	5.345G	67	5.489G	68	5.671G
69	5.540G	70	5.289G	71	5.598G	72	5.542G
73	5.636G	74	5.381G	75	5.347G	76	5.522G
77	5.711G	78	5.693G	79	5.319G	80	5.431G
81	5.501G	82	5.486G	83	5.280G	84	5.647G
85	5.398G	86	5.259G	87	5.570G	88	5.504G
89	5.558G	90	5.426G	91	5.706G	92	5.291G
93	5.253G	94	5.662G	95	5.362G	96	5.667G
97	5.590G	98	5.569G	99	5.531G	100	5.405G

Hopping Frequency Sequence Name: HOP_FREQ_SEQ_06							
SEQ#	Frequency (Hz)	SEQ#	Frequency (Hz)	SEQ#	Frequency (Hz)	SEQ#	Frequency (Hz)
1	5.642G	2	5.685G	3	5.613G	4	5.701G
5	5.526G	6	5.604G	7	5.329G	8	5.551G
9	5.624G	10	5.389G	11	5.696G	12	5.599G
13	5.323G	14	5.274G	15	5.293G	16	5.416G
17	5.720G	18	5.453G	19	5.655G	20	5.608G
21	5.344G	22	5.349G	23	5.399G	24	5.605G
25	5.326G	26	5.693G	27	5.674G	28	5.255G
29	5.370G	30	5.285G	31	5.666G	32	5.578G
33	5.260G	34	5.275G	35	5.409G	36	5.715G
37	5.660G	38	5.460G	39	5.324G	40	5.509G
41	5.712G	42	5.312G	43	5.480G	44	5.375G
45	5.681G	46	5.631G	47	5.714G	48	5.512G
49	5.445G	50	5.514G	51	5.354G	52	5.483G
53	5.490G	54	5.654G	55	5.386G	56	5.291G
57	5.476G	58	5.716G	59	5.362G	60	5.265G
61	5.680G	62	5.439G	63	5.541G	64	5.573G
65	5.682G	66	5.644G	67	5.414G	68	5.422G
69	5.668G	70	5.677G	71	5.609G	72	5.705G
73	5.473G	74	5.517G	75	5.482G	76	5.549G
77	5.360G	78	5.485G	79	5.684G	80	5.317G
81	5.264G	82	5.711G	83	5.355G	84	5.596G
85	5.300G	86	5.592G	87	5.303G	88	5.594G
89	5.579G	90	5.649G	91	5.340G	92	5.667G
93	5.643G	94	5.575G	95	5.396G	96	5.436G
97	5.437G	98	5.408G	99	5.561G	100	5.421G

Hopping Frequency Sequence Name: HOP_FREQ_SEQ_07							
SEQ#	Frequency (Hz)	SEQ#	Frequency (Hz)	SEQ#	Frequency (Hz)	SEQ#	Frequency (Hz)
1	5.597G	2	5.360G	3	5.666G	4	5.431G
5	5.587G	6	5.521G	7	5.471G	8	5.553G
9	5.676G	10	5.338G	11	5.722G	12	5.347G
13	5.458G	14	5.498G	15	5.620G	16	5.641G
17	5.596G	18	5.295G	19	5.317G	20	5.605G
21	5.532G	22	5.650G	23	5.558G	24	5.700G
25	5.495G	26	5.481G	27	5.485G	28	5.390G
29	5.656G	30	5.648G	31	5.365G	32	5.708G
33	5.371G	34	5.441G	35	5.702G	36	5.504G
37	5.261G	38	5.398G	39	5.392G	40	5.572G
41	5.683G	42	5.567G	43	5.585G	44	5.623G
45	5.569G	46	5.256G	47	5.505G	48	5.649G
49	5.426G	50	5.264G	51	5.640G	52	5.690G
53	5.520G	54	5.466G	55	5.593G	56	5.568G
57	5.325G	58	5.383G	59	5.300G	60	5.389G
61	5.469G	62	5.253G	63	5.285G	64	5.724G
65	5.538G	66	5.467G	67	5.519G	68	5.686G
69	5.539G	70	5.313G	71	5.713G	72	5.312G
73	5.654G	74	5.299G	75	5.446G	76	5.366G
77	5.320G	78	5.479G	79	5.492G	80	5.340G
81	5.548G	82	5.671G	83	5.698G	84	5.674G
85	5.343G	86	5.710G	87	5.443G	88	5.503G
89	5.599G	90	5.474G	91	5.502G	92	5.437G
93	5.263G	94	5.604G	95	5.393G	96	5.372G
97	5.369G	98	5.262G	99	5.711G	100	5.527G

Hopping Frequency Sequence Name: HOP_FREQ_SEQ_08							
SEQ#	Frequency (Hz)	SEQ#	Frequency (Hz)	SEQ#	Frequency (Hz)	SEQ#	Frequency (Hz)
1	5.667G	2	5.626G	3	5.314G	4	5.440G
5	5.527G	6	5.365G	7	5.653G	8	5.652G
9	5.469G	10	5.694G	11	5.496G	12	5.634G
13	5.517G	14	5.354G	15	5.481G	16	5.505G
17	5.292G	18	5.254G	19	5.569G	20	5.649G
21	5.433G	22	5.604G	23	5.404G	24	5.349G
25	5.416G	26	5.551G	27	5.603G	28	5.561G
29	5.386G	30	5.648G	31	5.369G	32	5.252G
33	5.635G	34	5.605G	35	5.399G	36	5.485G
37	5.391G	38	5.641G	39	5.518G	40	5.607G
41	5.529G	42	5.590G	43	5.520G	44	5.514G
45	5.409G	46	5.336G	47	5.567G	48	5.679G
49	5.698G	50	5.594G	51	5.564G	52	5.419G
53	5.657G	54	5.668G	55	5.689G	56	5.306G
57	5.385G	58	5.278G	59	5.688G	60	5.423G
61	5.674G	62	5.536G	63	5.544G	64	5.435G
65	5.251G	66	5.601G	67	5.438G	68	5.280G
69	5.260G	70	5.288G	71	5.711G	72	5.389G
73	5.640G	74	5.556G	75	5.664G	76	5.718G
77	5.677G	78	5.651G	79	5.277G	80	5.420G
81	5.300G	82	5.683G	83	5.573G	84	5.702G
85	5.256G	86	5.684G	87	5.533G	88	5.362G
89	5.443G	90	5.712G	91	5.612G	92	5.606G
93	5.491G	94	5.364G	95	5.338G	96	5.417G
97	5.428G	98	5.553G	99	5.595G	100	5.583G

Hopping Frequency Sequence Name: HOP_FREQ_SEQ_09							
SEQ#	Frequency (Hz)	SEQ#	Frequency (Hz)	SEQ#	Frequency (Hz)	SEQ#	Frequency (Hz)
1	5.652G	2	5.260G	3	5.508G	4	5.643G
5	5.653G	6	5.659G	7	5.381G	8	5.683G
9	5.724G	10	5.711G	11	5.577G	12	5.333G
13	5.682G	14	5.307G	15	5.258G	16	5.603G
17	5.605G	18	5.534G	19	5.520G	20	5.491G
21	5.367G	22	5.672G	23	5.355G	24	5.372G
25	5.651G	26	5.541G	27	5.274G	28	5.666G
29	5.498G	30	5.336G	31	5.420G	32	5.701G
33	5.496G	34	5.707G	35	5.361G	36	5.608G
37	5.582G	38	5.631G	39	5.289G	40	5.386G
41	5.568G	42	5.671G	43	5.455G	44	5.279G
45	5.558G	46	5.595G	47	5.363G	48	5.352G
49	5.549G	50	5.434G	51	5.602G	52	5.362G
53	5.379G	54	5.419G	55	5.554G	56	5.686G
57	5.366G	58	5.516G	59	5.285G	60	5.405G
61	5.319G	62	5.596G	63	5.394G	64	5.385G
65	5.356G	66	5.300G	67	5.641G	68	5.280G
69	5.332G	70	5.626G	71	5.674G	72	5.295G
73	5.664G	74	5.600G	75	5.523G	76	5.440G
77	5.286G	78	5.490G	79	5.259G	80	5.593G
81	5.531G	82	5.634G	83	5.489G	84	5.559G
85	5.527G	86	5.578G	87	5.322G	88	5.589G
89	5.709G	90	5.525G	91	5.535G	92	5.537G
93	5.636G	94	5.521G	95	5.323G	96	5.716G
97	5.611G	98	5.632G	99	5.282G	100	5.598G

Hopping Frequency Sequence Name: HOP_FREQ_SEQ_10							
SEQ#	Frequency (Hz)	SEQ#	Frequency (Hz)	SEQ#	Frequency (Hz)	SEQ#	Frequency (Hz)
1	5.448G	2	5.353G	3	5.542G	4	5.384G
5	5.676G	6	5.609G	7	5.518G	8	5.454G
9	5.662G	10	5.516G	11	5.357G	12	5.406G
13	5.491G	14	5.438G	15	5.408G	16	5.263G
17	5.625G	18	5.559G	19	5.652G	20	5.280G
21	5.577G	22	5.254G	23	5.556G	24	5.472G
25	5.672G	26	5.282G	27	5.639G	28	5.527G
29	5.612G	30	5.569G	31	5.555G	32	5.630G
33	5.347G	34	5.607G	35	5.647G	36	5.425G
37	5.422G	38	5.329G	39	5.501G	40	5.704G
41	5.364G	42	5.374G	43	5.702G	44	5.554G
45	5.644G	46	5.277G	47	5.626G	48	5.418G
49	5.587G	50	5.604G	51	5.677G	52	5.558G
53	5.568G	54	5.534G	55	5.497G	56	5.401G
57	5.252G	58	5.466G	59	5.571G	60	5.584G
61	5.714G	62	5.682G	63	5.552G	64	5.610G
65	5.597G	66	5.392G	67	5.370G	68	5.456G
69	5.316G	70	5.274G	71	5.506G	72	5.523G
73	5.537G	74	5.533G	75	5.546G	76	5.645G
77	5.276G	78	5.505G	79	5.484G	80	5.684G
81	5.679G	82	5.259G	83	5.285G	84	5.668G
85	5.723G	86	5.656G	87	5.673G	88	5.255G
89	5.594G	90	5.339G	91	5.268G	92	5.502G
93	5.496G	94	5.503G	95	5.323G	96	5.273G
97	5.342G	98	5.711G	99	5.410G	100	5.661G

Hopping Frequency Sequence Name: HOP_FREQ_SEQ_11							
SEQ#	Frequency (Hz)	SEQ#	Frequency (Hz)	SEQ#	Frequency (Hz)	SEQ#	Frequency (Hz)
1	5.407G	2	5.441G	3	5.498G	4	5.515G
5	5.358G	6	5.316G	7	5.659G	8	5.695G
9	5.542G	10	5.393G	11	5.592G	12	5.682G
13	5.332G	14	5.675G	15	5.608G	16	5.588G
17	5.578G	18	5.291G	19	5.614G	20	5.282G
21	5.648G	22	5.476G	23	5.273G	24	5.312G
25	5.697G	26	5.658G	27	5.349G	28	5.600G
29	5.279G	30	5.431G	31	5.484G	32	5.372G
33	5.283G	34	5.378G	35	5.401G	36	5.505G
37	5.471G	38	5.295G	39	5.470G	40	5.341G
41	5.669G	42	5.366G	43	5.290G	44	5.475G
45	5.549G	46	5.633G	47	5.430G	48	5.539G
49	5.425G	50	5.387G	51	5.511G	52	5.373G
53	5.514G	54	5.634G	55	5.297G	56	5.461G
57	5.392G	58	5.516G	59	5.270G	60	5.280G
61	5.427G	62	5.570G	63	5.289G	64	5.310G
65	5.411G	66	5.412G	67	5.711G	68	5.568G
69	5.386G	70	5.655G	71	5.409G	72	5.374G
73	5.437G	74	5.302G	75	5.617G	76	5.572G
77	5.370G	78	5.667G	79	5.601G	80	5.447G
81	5.551G	82	5.525G	83	5.292G	84	5.481G
85	5.571G	86	5.605G	87	5.395G	88	5.496G
89	5.402G	90	5.644G	91	5.631G	92	5.432G
93	5.694G	94	5.662G	95	5.540G	96	5.489G
97	5.463G	98	5.521G	99	5.486G	100	5.616G

Hopping Frequency Sequence Name: HOP_FREQ_SEQ_12							
SEQ#	Frequency (Hz)	SEQ#	Frequency (Hz)	SEQ#	Frequency (Hz)	SEQ#	Frequency (Hz)
1	5.544G	2	5.339G	3	5.529G	4	5.472G
5	5.508G	6	5.431G	7	5.596G	8	5.270G
9	5.327G	10	5.379G	11	5.662G	12	5.462G
13	5.273G	14	5.617G	15	5.651G	16	5.377G
17	5.686G	18	5.415G	19	5.488G	20	5.380G
21	5.351G	22	5.688G	23	5.260G	24	5.530G
25	5.589G	26	5.703G	27	5.632G	28	5.609G
29	5.333G	30	5.286G	31	5.507G	32	5.693G
33	5.664G	34	5.582G	35	5.461G	36	5.358G
37	5.667G	38	5.555G	39	5.367G	40	5.570G
41	5.711G	42	5.372G	43	5.537G	44	5.267G
45	5.301G	46	5.585G	47	5.288G	48	5.583G
49	5.398G	50	5.421G	51	5.291G	52	5.445G
53	5.541G	54	5.504G	55	5.384G	56	5.299G
57	5.543G	58	5.556G	59	5.496G	60	5.477G
61	5.423G	62	5.678G	63	5.624G	64	5.353G
65	5.413G	66	5.296G	67	5.706G	68	5.685G
69	5.473G	70	5.722G	71	5.424G	72	5.525G
73	5.674G	74	5.359G	75	5.325G	76	5.489G
77	5.614G	78	5.622G	79	5.294G	80	5.573G
81	5.494G	82	5.326G	83	5.394G	84	5.482G
85	5.650G	86	5.435G	87	5.659G	88	5.400G
89	5.637G	90	5.355G	91	5.258G	92	5.449G
93	5.718G	94	5.676G	95	5.447G	96	5.549G
97	5.640G	98	5.645G	99	5.276G	100	5.533G

Hopping Frequency Sequence Name: HOP_FREQ_SEQ_13							
SEQ#	Frequency (Hz)	SEQ#	Frequency (Hz)	SEQ#	Frequency (Hz)	SEQ#	Frequency (Hz)
1	5.358G	2	5.430G	3	5.615G	4	5.653G
5	5.439G	6	5.310G	7	5.399G	8	5.722G
9	5.721G	10	5.494G	11	5.352G	12	5.449G
13	5.538G	14	5.337G	15	5.438G	16	5.262G
17	5.307G	18	5.409G	19	5.503G	20	5.419G
21	5.487G	22	5.282G	23	5.417G	24	5.295G
25	5.644G	26	5.622G	27	5.383G	28	5.334G
29	5.692G	30	5.658G	31	5.598G	32	5.372G
33	5.573G	34	5.576G	35	5.491G	36	5.621G
37	5.380G	38	5.586G	39	5.527G	40	5.698G
41	5.342G	42	5.275G	43	5.492G	44	5.630G
45	5.529G	46	5.724G	47	5.269G	48	5.411G
49	5.474G	50	5.608G	51	5.553G	52	5.602G
53	5.429G	54	5.478G	55	5.312G	56	5.318G
57	5.673G	58	5.297G	59	5.369G	60	5.377G
61	5.375G	62	5.285G	63	5.558G	64	5.260G
65	5.390G	66	5.268G	67	5.656G	68	5.370G
69	5.596G	70	5.605G	71	5.591G	72	5.629G
73	5.506G	74	5.351G	75	5.281G	76	5.336G
77	5.524G	78	5.521G	79	5.461G	80	5.367G
81	5.296G	82	5.347G	83	5.435G	84	5.329G
85	5.340G	86	5.299G	87	5.680G	88	5.448G
89	5.261G	90	5.510G	91	5.265G	92	5.555G
93	5.595G	94	5.457G	95	5.280G	96	5.359G
97	5.410G	98	5.509G	99	5.379G	100	5.447G

Hopping Frequency Sequence Name: HOP_FREQ_SEQ_14							
SEQ#	Frequency (Hz)	SEQ#	Frequency (Hz)	SEQ#	Frequency (Hz)	SEQ#	Frequency (Hz)
1	5.393G	2	5.673G	3	5.362G	4	5.390G
5	5.528G	6	5.625G	7	5.315G	8	5.383G
9	5.653G	10	5.342G	11	5.572G	12	5.613G
13	5.252G	14	5.520G	15	5.685G	16	5.292G
17	5.268G	18	5.450G	19	5.259G	20	5.674G
21	5.321G	22	5.371G	23	5.531G	24	5.381G
25	5.284G	26	5.403G	27	5.599G	28	5.549G
29	5.400G	30	5.482G	31	5.281G	32	5.454G
33	5.689G	34	5.290G	35	5.481G	36	5.540G
37	5.571G	38	5.368G	39	5.440G	40	5.555G
41	5.607G	42	5.399G	43	5.713G	44	5.301G
45	5.423G	46	5.369G	47	5.445G	48	5.566G
49	5.574G	50	5.724G	51	5.639G	52	5.406G
53	5.407G	54	5.543G	55	5.476G	56	5.660G
57	5.633G	58	5.700G	59	5.417G	60	5.439G
61	5.589G	62	5.585G	63	5.435G	64	5.500G
65	5.715G	66	5.280G	67	5.697G	68	5.366G
69	5.442G	70	5.558G	71	5.286G	72	5.448G
73	5.716G	74	5.508G	75	5.634G	76	5.488G
77	5.657G	78	5.554G	79	5.461G	80	5.721G
81	5.517G	82	5.269G	83	5.584G	84	5.693G
85	5.587G	86	5.502G	87	5.431G	88	5.405G
89	5.272G	90	5.707G	91	5.667G	92	5.418G
93	5.662G	94	5.387G	95	5.610G	96	5.536G
97	5.485G	98	5.605G	99	5.526G	100	5.279G

Hopping Frequency Sequence Name: HOP_FREQ_SEQ_15							
SEQ#	Frequency (Hz)	SEQ#	Frequency (Hz)	SEQ#	Frequency (Hz)	SEQ#	Frequency (Hz)
1	5.293G	2	5.401G	3	5.260G	4	5.640G
5	5.308G	6	5.684G	7	5.527G	8	5.417G
9	5.419G	10	5.660G	11	5.495G	12	5.628G
13	5.363G	14	5.470G	15	5.517G	16	5.412G
17	5.446G	18	5.302G	19	5.567G	20	5.712G
21	5.272G	22	5.335G	23	5.582G	24	5.500G
25	5.311G	26	5.550G	27	5.378G	28	5.601G
29	5.671G	30	5.667G	31	5.452G	32	5.271G
33	5.283G	34	5.719G	35	5.536G	36	5.652G
37	5.526G	38	5.481G	39	5.657G	40	5.254G
41	5.343G	42	5.505G	43	5.542G	44	5.483G
45	5.342G	46	5.259G	47	5.710G	48	5.545G
49	5.410G	50	5.516G	51	5.489G	52	5.696G
53	5.512G	54	5.554G	55	5.571G	56	5.433G
57	5.445G	58	5.634G	59	5.345G	60	5.434G
61	5.716G	62	5.613G	63	5.541G	64	5.268G
65	5.282G	66	5.252G	67	5.442G	68	5.488G
69	5.703G	70	5.586G	71	5.349G	72	5.544G
73	5.325G	74	5.514G	75	5.456G	76	5.508G
77	5.403G	78	5.387G	79	5.406G	80	5.653G
81	5.497G	82	5.454G	83	5.307G	84	5.430G
85	5.377G	86	5.431G	87	5.382G	88	5.539G
89	5.251G	90	5.420G	91	5.638G	92	5.676G
93	5.592G	94	5.579G	95	5.463G	96	5.678G
97	5.262G	98	5.364G	99	5.388G	100	5.261G

Hopping Frequency Sequence Name: HOP_FREQ_SEQ_16							
SEQ#	Frequency (Hz)	SEQ#	Frequency (Hz)	SEQ#	Frequency (Hz)	SEQ#	Frequency (Hz)
1	5.700G	2	5.350G	3	5.410G	4	5.401G
5	5.669G	6	5.409G	7	5.462G	8	5.338G
9	5.266G	10	5.526G	11	5.681G	12	5.337G
13	5.420G	14	5.267G	15	5.516G	16	5.629G
17	5.389G	18	5.299G	19	5.490G	20	5.398G
21	5.380G	22	5.418G	23	5.523G	24	5.655G
25	5.360G	26	5.328G	27	5.397G	28	5.639G
29	5.417G	30	5.423G	31	5.540G	32	5.342G
33	5.656G	34	5.296G	35	5.491G	36	5.635G
37	5.395G	38	5.255G	39	5.556G	40	5.254G
41	5.278G	42	5.648G	43	5.295G	44	5.576G
45	5.686G	46	5.569G	47	5.439G	48	5.476G
49	5.614G	50	5.422G	51	5.336G	52	5.367G
53	5.259G	54	5.461G	55	5.566G	56	5.702G
57	5.345G	58	5.307G	59	5.319G	60	5.289G
61	5.517G	62	5.281G	63	5.581G	64	5.673G
65	5.489G	66	5.339G	67	5.436G	68	5.352G
69	5.440G	70	5.634G	71	5.504G	72	5.411G
73	5.407G	74	5.625G	75	5.601G	76	5.678G
77	5.671G	78	5.282G	79	5.710G	80	5.324G
81	5.264G	82	5.536G	83	5.633G	84	5.499G
85	5.271G	86	5.568G	87	5.559G	88	5.644G
89	5.514G	90	5.664G	91	5.326G	92	5.294G
93	5.646G	94	5.315G	95	5.340G	96	5.408G
97	5.638G	98	5.599G	99	5.670G	100	5.561G

Hopping Frequency Sequence Name: HOP_FREQ_SEQ_17							
SEQ#	Frequency (Hz)	SEQ#	Frequency (Hz)	SEQ#	Frequency (Hz)	SEQ#	Frequency (Hz)
1	5.563G	2	5.478G	3	5.723G	4	5.319G
5	5.374G	6	5.492G	7	5.469G	8	5.292G
9	5.525G	10	5.252G	11	5.350G	12	5.608G
13	5.323G	14	5.681G	15	5.388G	16	5.545G
17	5.291G	18	5.517G	19	5.253G	20	5.383G
21	5.489G	22	5.654G	23	5.704G	24	5.616G
25	5.621G	26	5.593G	27	5.435G	28	5.332G
29	5.420G	30	5.375G	31	5.587G	32	5.610G
33	5.498G	34	5.376G	35	5.661G	36	5.596G
37	5.413G	38	5.269G	39	5.701G	40	5.510G
41	5.266G	42	5.626G	43	5.516G	44	5.483G
45	5.467G	46	5.518G	47	5.586G	48	5.255G
49	5.512G	50	5.315G	51	5.639G	52	5.316G
53	5.667G	54	5.625G	55	5.495G	56	5.560G
57	5.455G	58	5.286G	59	5.324G	60	5.678G
61	5.555G	62	5.594G	63	5.662G	64	5.505G
65	5.320G	66	5.685G	67	5.282G	68	5.335G
69	5.677G	70	5.585G	71	5.526G	72	5.670G
73	5.400G	74	5.541G	75	5.488G	76	5.477G
77	5.480G	78	5.507G	79	5.449G	80	5.385G
81	5.473G	82	5.412G	83	5.714G	84	5.549G
85	5.690G	86	5.295G	87	5.619G	88	5.683G
89	5.411G	90	5.343G	91	5.664G	92	5.637G
93	5.351G	94	5.285G	95	5.691G	96	5.554G
97	5.415G	98	5.530G	99	5.692G	100	5.452G

Hopping Frequency Sequence Name: HOP_FREQ_SEQ_18							
SEQ#	Frequency (Hz)	SEQ#	Frequency (Hz)	SEQ#	Frequency (Hz)	SEQ#	Frequency (Hz)
1	5.497G	2	5.599G	3	5.670G	4	5.665G
5	5.351G	6	5.278G	7	5.388G	8	5.600G
9	5.263G	10	5.572G	11	5.364G	12	5.532G
13	5.643G	14	5.487G	15	5.486G	16	5.631G
17	5.515G	18	5.492G	19	5.373G	20	5.442G
21	5.358G	22	5.293G	23	5.562G	24	5.355G
25	5.496G	26	5.467G	27	5.679G	28	5.707G
29	5.607G	30	5.513G	31	5.489G	32	5.485G
33	5.320G	34	5.418G	35	5.621G	36	5.416G
37	5.522G	38	5.407G	39	5.303G	40	5.357G
41	5.378G	42	5.542G	43	5.678G	44	5.452G
45	5.574G	46	5.449G	47	5.546G	48	5.610G
49	5.434G	50	5.613G	51	5.650G	52	5.469G
53	5.281G	54	5.608G	55	5.524G	56	5.529G
57	5.428G	58	5.661G	59	5.544G	60	5.512G
61	5.393G	62	5.411G	63	5.471G	64	5.462G
65	5.504G	66	5.399G	67	5.638G	68	5.298G
69	5.395G	70	5.553G	71	5.273G	72	5.578G
73	5.463G	74	5.423G	75	5.307G	76	5.516G
77	5.507G	78	5.480G	79	5.360G	80	5.721G
81	5.598G	82	5.376G	83	5.494G	84	5.398G
85	5.595G	86	5.521G	87	5.305G	88	5.446G
89	5.275G	90	5.443G	91	5.316G	92	5.437G
93	5.549G	94	5.693G	95	5.269G	96	5.295G
97	5.668G	98	5.586G	99	5.719G	100	5.615G

Hopping Frequency Sequence Name: HOP_FREQ_SEQ_19							
SEQ#	Frequency (Hz)	SEQ#	Frequency (Hz)	SEQ#	Frequency (Hz)	SEQ#	Frequency (Hz)
1	5.691G	2	5.551G	3	5.579G	4	5.350G
5	5.688G	6	5.622G	7	5.294G	8	5.547G
9	5.460G	10	5.446G	11	5.270G	12	5.541G
13	5.620G	14	5.571G	15	5.384G	16	5.633G
17	5.477G	18	5.503G	19	5.553G	20	5.629G
21	5.472G	22	5.542G	23	5.528G	24	5.544G
25	5.613G	26	5.700G	27	5.434G	28	5.358G
29	5.525G	30	5.305G	31	5.644G	32	5.516G
33	5.648G	34	5.684G	35	5.488G	36	5.478G
37	5.498G	38	5.335G	39	5.441G	40	5.361G
41	5.411G	42	5.420G	43	5.396G	44	5.515G
45	5.353G	46	5.266G	47	5.451G	48	5.386G
49	5.617G	50	5.588G	51	5.374G	52	5.532G
53	5.666G	54	5.669G	55	5.314G	56	5.431G
57	5.520G	58	5.306G	59	5.272G	60	5.279G
61	5.634G	62	5.654G	63	5.619G	64	5.504G
65	5.334G	66	5.685G	67	5.690G	68	5.646G
69	5.575G	70	5.641G	71	5.297G	72	5.282G
73	5.713G	74	5.479G	75	5.663G	76	5.695G
77	5.492G	78	5.493G	79	5.668G	80	5.327G
81	5.288G	82	5.296G	83	5.413G	84	5.511G
85	5.486G	86	5.597G	87	5.286G	88	5.661G
89	5.421G	90	5.405G	91	5.536G	92	5.719G
93	5.518G	94	5.590G	95	5.608G	96	5.408G
97	5.582G	98	5.303G	99	5.449G	100	5.414G

Hopping Frequency Sequence Name: HOP_FREQ_SEQ_20							
SEQ#	Frequency (Hz)	SEQ#	Frequency (Hz)	SEQ#	Frequency (Hz)	SEQ#	Frequency (Hz)
1	5.680G	2	5.483G	3	5.416G	4	5.549G
5	5.475G	6	5.321G	7	5.633G	8	5.278G
9	5.311G	10	5.524G	11	5.678G	12	5.521G
13	5.605G	14	5.367G	15	5.691G	16	5.672G
17	5.370G	18	5.504G	19	5.488G	20	5.433G
21	5.465G	22	5.282G	23	5.266G	24	5.701G
25	5.709G	26	5.267G	27	5.445G	28	5.385G
29	5.623G	30	5.299G	31	5.419G	32	5.707G
33	5.617G	34	5.322G	35	5.498G	36	5.632G
37	5.649G	38	5.546G	39	5.446G	40	5.541G
41	5.599G	42	5.630G	43	5.256G	44	5.568G
45	5.566G	46	5.537G	47	5.534G	48	5.277G
49	5.618G	50	5.374G	51	5.455G	52	5.283G
53	5.564G	54	5.312G	55	5.693G	56	5.436G
57	5.338G	58	5.372G	59	5.272G	60	5.369G
61	5.696G	62	5.507G	63	5.695G	64	5.529G
65	5.317G	66	5.384G	67	5.297G	68	5.494G
69	5.366G	70	5.705G	71	5.300G	72	5.715G
73	5.481G	74	5.287G	75	5.698G	76	5.301G
77	5.655G	78	5.670G	79	5.264G	80	5.420G
81	5.262G	82	5.676G	83	5.683G	84	5.394G
85	5.540G	86	5.337G	87	5.326G	88	5.431G
89	5.381G	90	5.505G	91	5.515G	92	5.275G
93	5.408G	94	5.690G	95	5.306G	96	5.359G
97	5.427G	98	5.342G	99	5.356G	100	5.462G

Hopping Frequency Sequence Name: HOP_FREQ_SEQ_21							
SEQ#	Frequency (Hz)	SEQ#	Frequency (Hz)	SEQ#	Frequency (Hz)	SEQ#	Frequency (Hz)
1	5.600G	2	5.680G	3	5.444G	4	5.459G
5	5.718G	6	5.298G	7	5.441G	8	5.605G
9	5.622G	10	5.505G	11	5.286G	12	5.634G
13	5.683G	14	5.583G	15	5.428G	16	5.667G
17	5.570G	18	5.549G	19	5.553G	20	5.353G
21	5.602G	22	5.544G	23	5.377G	24	5.341G
25	5.677G	26	5.713G	27	5.629G	28	5.321G
29	5.483G	30	5.363G	31	5.636G	32	5.504G
33	5.595G	34	5.384G	35	5.474G	36	5.625G
37	5.269G	38	5.624G	39	5.665G	40	5.375G
41	5.712G	42	5.345G	43	5.418G	44	5.457G
45	5.311G	46	5.656G	47	5.507G	48	5.429G
49	5.440G	50	5.320G	51	5.540G	52	5.477G
53	5.411G	54	5.561G	55	5.352G	56	5.317G
57	5.497G	58	5.423G	59	5.576G	60	5.367G
61	5.509G	62	5.472G	63	5.641G	64	5.597G
65	5.559G	66	5.585G	67	5.626G	68	5.336G
69	5.271G	70	5.313G	71	5.420G	72	5.448G
73	5.443G	74	5.381G	75	5.647G	76	5.431G
77	5.370G	78	5.580G	79	5.323G	80	5.548G
81	5.430G	82	5.596G	83	5.523G	84	5.530G
85	5.560G	86	5.592G	87	5.314G	88	5.422G
89	5.607G	90	5.385G	91	5.628G	92	5.421G
93	5.463G	94	5.437G	95	5.646G	96	5.648G
97	5.536G	98	5.296G	99	5.312G	100	5.409G

Hopping Frequency Sequence Name: HOP_FREQ_SEQ_22							
SEQ#	Frequency (Hz)	SEQ#	Frequency (Hz)	SEQ#	Frequency (Hz)	SEQ#	Frequency (Hz)
1	5.290G	2	5.317G	3	5.630G	4	5.724G
5	5.411G	6	5.700G	7	5.507G	8	5.263G
9	5.308G	10	5.568G	11	5.400G	12	5.252G
13	5.499G	14	5.570G	15	5.528G	16	5.461G
17	5.638G	18	5.399G	19	5.398G	20	5.254G
21	5.684G	22	5.616G	23	5.659G	24	5.285G
25	5.640G	26	5.647G	27	5.357G	28	5.279G
29	5.324G	30	5.323G	31	5.327G	32	5.626G
33	5.722G	34	5.345G	35	5.302G	36	5.483G
37	5.702G	38	5.384G	39	5.305G	40	5.651G
41	5.498G	42	5.693G	43	5.255G	44	5.564G
45	5.299G	46	5.482G	47	5.446G	48	5.704G
49	5.459G	50	5.582G	51	5.288G	52	5.720G
53	5.335G	54	5.286G	55	5.541G	56	5.457G
57	5.272G	58	5.365G	59	5.529G	60	5.618G
61	5.441G	62	5.581G	63	5.386G	64	5.650G
65	5.580G	66	5.612G	67	5.601G	68	5.557G
69	5.486G	70	5.608G	71	5.511G	72	5.664G
73	5.675G	74	5.525G	75	5.567G	76	5.678G
77	5.586G	78	5.336G	79	5.291G	80	5.387G
81	5.625G	82	5.356G	83	5.412G	84	5.706G
85	5.591G	86	5.688G	87	5.374G	88	5.401G
89	5.510G	90	5.624G	91	5.321G	92	5.339G
93	5.466G	94	5.475G	95	5.655G	96	5.328G
97	5.513G	98	5.686G	99	5.352G	100	5.261G

Hopping Frequency Sequence Name: HOP_FREQ_SEQ_23							
SEQ#	Frequency (Hz)	SEQ#	Frequency (Hz)	SEQ#	Frequency (Hz)	SEQ#	Frequency (Hz)
1	5.367G	2	5.276G	3	5.659G	4	5.686G
5	5.388G	6	5.552G	7	5.452G	8	5.285G
9	5.475G	10	5.441G	11	5.514G	12	5.266G
13	5.432G	14	5.462G	15	5.545G	16	5.348G
17	5.442G	18	5.489G	19	5.271G	20	5.277G
21	5.542G	22	5.594G	23	5.411G	24	5.517G
25	5.613G	26	5.275G	27	5.426G	28	5.661G
29	5.286G	30	5.595G	31	5.645G	32	5.688G
33	5.357G	34	5.690G	35	5.543G	36	5.364G
37	5.497G	38	5.393G	39	5.435G	40	5.345G
41	5.482G	42	5.344G	43	5.570G	44	5.593G
45	5.715G	46	5.602G	47	5.548G	48	5.451G
49	5.633G	50	5.471G	51	5.605G	52	5.324G
53	5.550G	54	5.526G	55	5.445G	56	5.651G
57	5.289G	58	5.582G	59	5.535G	60	5.251G
61	5.549G	62	5.362G	63	5.527G	64	5.294G
65	5.539G	66	5.423G	67	5.268G	68	5.400G
69	5.368G	70	5.684G	71	5.553G	72	5.703G
73	5.460G	74	5.436G	75	5.448G	76	5.309G
77	5.290G	78	5.260G	79	5.444G	80	5.588G
81	5.530G	82	5.682G	83	5.418G	84	5.560G
85	5.320G	86	5.486G	87	5.404G	88	5.428G
89	5.663G	90	5.401G	91	5.580G	92	5.484G
93	5.495G	94	5.319G	95	5.267G	96	5.618G
97	5.431G	98	5.327G	99	5.252G	100	5.547G

Hopping Frequency Sequence Name: HOP_FREQ_SEQ_24							
SEQ#	Frequency (Hz)	SEQ#	Frequency (Hz)	SEQ#	Frequency (Hz)	SEQ#	Frequency (Hz)
1	5.280G	2	5.283G	3	5.409G	4	5.651G
5	5.340G	6	5.620G	7	5.366G	8	5.353G
9	5.501G	10	5.456G	11	5.573G	12	5.583G
13	5.375G	14	5.630G	15	5.291G	16	5.333G
17	5.477G	18	5.453G	19	5.513G	20	5.510G
21	5.445G	22	5.407G	23	5.401G	24	5.671G
25	5.523G	26	5.428G	27	5.655G	28	5.603G
29	5.650G	30	5.270G	31	5.348G	32	5.367G
33	5.564G	34	5.673G	35	5.362G	36	5.378G
37	5.528G	38	5.334G	39	5.365G	40	5.568G
41	5.341G	42	5.636G	43	5.411G	44	5.549G
45	5.394G	46	5.271G	47	5.420G	48	5.724G
49	5.467G	50	5.423G	51	5.427G	52	5.580G
53	5.611G	54	5.313G	55	5.584G	56	5.553G
57	5.396G	58	5.688G	59	5.516G	60	5.433G
61	5.487G	62	5.308G	63	5.296G	64	5.338G
65	5.666G	66	5.464G	67	5.389G	68	5.421G
69	5.721G	70	5.605G	71	5.555G	72	5.447G
73	5.455G	74	5.567G	75	5.585G	76	5.656G
77	5.469G	78	5.640G	79	5.629G	80	5.424G
81	5.481G	82	5.329G	83	5.342G	84	5.610G
85	5.710G	86	5.489G	87	5.343G	88	5.442G
89	5.692G	90	5.292G	91	5.702G	92	5.601G
93	5.491G	94	5.626G	95	5.644G	96	5.641G
97	5.406G	98	5.450G	99	5.569G	100	5.690G

Hopping Frequency Sequence Name: HOP_FREQ_SEQ_25							
SEQ#	Frequency (Hz)	SEQ#	Frequency (Hz)	SEQ#	Frequency (Hz)	SEQ#	Frequency (Hz)
1	5.615G	2	5.657G	3	5.676G	4	5.592G
5	5.327G	6	5.300G	7	5.337G	8	5.680G
9	5.448G	10	5.690G	11	5.417G	12	5.567G
13	5.604G	14	5.694G	15	5.516G	16	5.503G
17	5.312G	18	5.598G	19	5.696G	20	5.383G
21	5.718G	22	5.475G	23	5.603G	24	5.464G
25	5.425G	26	5.677G	27	5.320G	28	5.367G
29	5.313G	30	5.436G	31	5.463G	32	5.699G
33	5.565G	34	5.371G	35	5.411G	36	5.659G
37	5.661G	38	5.649G	39	5.391G	40	5.589G
41	5.452G	42	5.410G	43	5.484G	44	5.302G
45	5.692G	46	5.270G	47	5.386G	48	5.279G
49	5.601G	50	5.513G	51	5.602G	52	5.673G
53	5.501G	54	5.557G	55	5.494G	56	5.254G
57	5.571G	58	5.264G	59	5.573G	60	5.440G
61	5.281G	62	5.423G	63	5.358G	64	5.500G
65	5.701G	66	5.525G	67	5.446G	68	5.369G
69	5.499G	70	5.582G	71	5.717G	72	5.664G
73	5.515G	74	5.514G	75	5.461G	76	5.631G
77	5.719G	78	5.606G	79	5.483G	80	5.449G
81	5.458G	82	5.447G	83	5.616G	84	5.482G
85	5.453G	86	5.263G	87	5.542G	88	5.399G
89	5.469G	90	5.275G	91	5.295G	92	5.291G
93	5.416G	94	5.444G	95	5.599G	96	5.522G
97	5.640G	98	5.632G	99	5.472G	100	5.583G

Hopping Frequency Sequence Name: HOP_FREQ_SEQ_26							
SEQ#	Frequency (Hz)	SEQ#	Frequency (Hz)	SEQ#	Frequency (Hz)	SEQ#	Frequency (Hz)
1	5.339G	2	5.672G	3	5.594G	4	5.694G
5	5.660G	6	5.647G	7	5.656G	8	5.705G
9	5.551G	10	5.542G	11	5.295G	12	5.316G
13	5.454G	14	5.592G	15	5.582G	16	5.303G
17	5.465G	18	5.417G	19	5.512G	20	5.710G
21	5.289G	22	5.286G	23	5.277G	24	5.440G
25	5.584G	26	5.518G	27	5.505G	28	5.597G
29	5.326G	30	5.371G	31	5.374G	32	5.639G
33	5.355G	34	5.609G	35	5.618G	36	5.463G
37	5.425G	38	5.404G	39	5.711G	40	5.506G
41	5.394G	42	5.431G	43	5.703G	44	5.489G
45	5.596G	46	5.575G	47	5.515G	48	5.655G
49	5.652G	50	5.494G	51	5.358G	52	5.648G
53	5.376G	54	5.457G	55	5.279G	56	5.707G
57	5.412G	58	5.396G	59	5.319G	60	5.430G
61	5.363G	62	5.379G	63	5.544G	64	5.364G
65	5.499G	66	5.622G	67	5.476G	68	5.536G
69	5.487G	70	5.587G	71	5.452G	72	5.418G
73	5.333G	74	5.321G	75	5.528G	76	5.574G
77	5.619G	78	5.386G	79	5.633G	80	5.467G
81	5.600G	82	5.500G	83	5.504G	84	5.265G
85	5.625G	86	5.359G	87	5.485G	88	5.372G
89	5.569G	90	5.456G	91	5.573G	92	5.581G
93	5.281G	94	5.314G	95	5.721G	96	5.650G
97	5.713G	98	5.275G	99	5.686G	100	5.708G

Hopping Frequency Sequence Name: HOP_FREQ_SEQ_27							
SEQ#	Frequency (Hz)	SEQ#	Frequency (Hz)	SEQ#	Frequency (Hz)	SEQ#	Frequency (Hz)
1	5.452G	2	5.650G	3	5.373G	4	5.568G
5	5.602G	6	5.448G	7	5.593G	8	5.367G
9	5.529G	10	5.515G	11	5.598G	12	5.338G
13	5.380G	14	5.524G	15	5.371G	16	5.401G
17	5.522G	18	5.411G	19	5.715G	20	5.590G
21	5.300G	22	5.691G	23	5.433G	24	5.430G
25	5.670G	26	5.318G	27	5.319G	28	5.333G
29	5.260G	30	5.425G	31	5.530G	32	5.708G
33	5.722G	34	5.712G	35	5.501G	36	5.654G
37	5.485G	38	5.424G	39	5.638G	40	5.445G
41	5.564G	42	5.439G	43	5.376G	44	5.442G
45	5.619G	46	5.552G	47	5.347G	48	5.408G
49	5.316G	50	5.643G	51	5.269G	52	5.484G
53	5.687G	54	5.419G	55	5.573G	56	5.473G
57	5.327G	58	5.293G	59	5.611G	60	5.475G
61	5.537G	62	5.583G	63	5.444G	64	5.661G
65	5.551G	66	5.255G	67	5.364G	68	5.349G
69	5.574G	70	5.588G	71	5.680G	72	5.497G
73	5.585G	74	5.534G	75	5.365G	76	5.721G
77	5.469G	78	5.488G	79	5.406G	80	5.348G
81	5.504G	82	5.671G	83	5.651G	84	5.375G
85	5.286G	86	5.507G	87	5.414G	88	5.519G
89	5.684G	90	5.438G	91	5.520G	92	5.265G
93	5.404G	94	5.711G	95	5.586G	96	5.657G
97	5.302G	98	5.575G	99	5.490G	100	5.464G

Hopping Frequency Sequence Name: HOP_FREQ_SEQ_28							
SEQ#	Frequency (Hz)	SEQ#	Frequency (Hz)	SEQ#	Frequency (Hz)	SEQ#	Frequency (Hz)
1	5.434G	2	5.680G	3	5.335G	4	5.560G
5	5.369G	6	5.305G	7	5.710G	8	5.275G
9	5.315G	10	5.475G	11	5.269G	12	5.460G
13	5.533G	14	5.627G	15	5.702G	16	5.661G
17	5.707G	18	5.356G	19	5.687G	20	5.328G
21	5.656G	22	5.563G	23	5.581G	24	5.361G
25	5.694G	26	5.468G	27	5.456G	28	5.304G
29	5.499G	30	5.255G	31	5.391G	32	5.647G
33	5.320G	34	5.653G	35	5.298G	36	5.536G
37	5.665G	38	5.268G	39	5.623G	40	5.721G
41	5.620G	42	5.611G	43	5.313G	44	5.570G
45	5.545G	46	5.716G	47	5.524G	48	5.628G
49	5.698G	50	5.558G	51	5.278G	52	5.723G
53	5.420G	54	5.359G	55	5.722G	56	5.492G
57	5.446G	58	5.354G	59	5.474G	60	5.638G
61	5.720G	62	5.618G	63	5.582G	64	5.326G
65	5.398G	66	5.410G	67	5.634G	68	5.344G
69	5.697G	70	5.253G	71	5.519G	72	5.424G
73	5.594G	74	5.286G	75	5.599G	76	5.264G
77	5.718G	78	5.576G	79	5.682G	80	5.432G
81	5.584G	82	5.462G	83	5.525G	84	5.336G
85	5.577G	86	5.459G	87	5.714G	88	5.449G
89	5.483G	90	5.490G	91	5.347G	92	5.277G
93	5.478G	94	5.292G	95	5.274G	96	5.377G
97	5.617G	98	5.367G	99	5.472G	100	5.337G

Hopping Frequency Sequence Name: HOP_FREQ_SEQ_29							
SEQ#	Frequency (Hz)	SEQ#	Frequency (Hz)	SEQ#	Frequency (Hz)	SEQ#	Frequency (Hz)
1	5.410G	2	5.585G	3	5.609G	4	5.523G
5	5.304G	6	5.466G	7	5.262G	8	5.617G
9	5.311G	10	5.677G	11	5.590G	12	5.283G
13	5.305G	14	5.601G	15	5.404G	16	5.690G
17	5.302G	18	5.655G	19	5.668G	20	5.389G
21	5.412G	22	5.709G	23	5.286G	24	5.631G
25	5.626G	26	5.487G	27	5.257G	28	5.491G
29	5.328G	30	5.345G	31	5.651G	32	5.275G
33	5.605G	34	5.430G	35	5.588G	36	5.705G
37	5.289G	38	5.694G	39	5.365G	40	5.307G
41	5.673G	42	5.288G	43	5.458G	44	5.363G
45	5.573G	46	5.424G	47	5.654G	48	5.354G
49	5.548G	50	5.696G	51	5.440G	52	5.701G
53	5.629G	54	5.390G	55	5.334G	56	5.507G
57	5.434G	58	5.724G	59	5.485G	60	5.444G
61	5.527G	62	5.428G	63	5.360G	64	5.377G
65	5.542G	66	5.641G	67	5.423G	68	5.446G
69	5.483G	70	5.478G	71	5.537G	72	5.293G
73	5.612G	74	5.476G	75	5.445G	76	5.702G
77	5.596G	78	5.388G	79	5.544G	80	5.499G
81	5.621G	82	5.353G	83	5.402G	84	5.603G
85	5.650G	86	5.469G	87	5.327G	88	5.313G
89	5.721G	90	5.432G	91	5.646G	92	5.680G
93	5.640G	94	5.295G	95	5.606G	96	5.604G
97	5.539G	98	5.325G	99	5.468G	100	5.484G

Hopping Frequency Sequence Name: HOP_FREQ_SEQ_30							
SEQ#	Frequency (Hz)	SEQ#	Frequency (Hz)	SEQ#	Frequency (Hz)	SEQ#	Frequency (Hz)
1	5.631G	2	5.628G	3	5.645G	4	5.347G
5	5.591G	6	5.427G	7	5.333G	8	5.692G
9	5.441G	10	5.504G	11	5.600G	12	5.551G
13	5.271G	14	5.647G	15	5.646G	16	5.406G
17	5.613G	18	5.291G	19	5.362G	20	5.394G
21	5.470G	22	5.458G	23	5.546G	24	5.563G
25	5.318G	26	5.397G	27	5.260G	28	5.636G
29	5.576G	30	5.430G	31	5.391G	32	5.460G
33	5.361G	34	5.708G	35	5.698G	36	5.544G
37	5.258G	38	5.474G	39	5.703G	40	5.416G
41	5.657G	42	5.328G	43	5.277G	44	5.617G
45	5.449G	46	5.489G	47	5.575G	48	5.268G
49	5.294G	50	5.723G	51	5.644G	52	5.590G
53	5.256G	54	5.721G	55	5.261G	56	5.259G
57	5.514G	58	5.476G	59	5.345G	60	5.459G
61	5.462G	62	5.266G	63	5.407G	64	5.488G
65	5.286G	66	5.371G	67	5.571G	68	5.556G
69	5.588G	70	5.654G	71	5.678G	72	5.354G
73	5.472G	74	5.526G	75	5.487G	76	5.468G
77	5.508G	78	5.388G	79	5.446G	80	5.520G
81	5.418G	82	5.390G	83	5.550G	84	5.482G
85	5.337G	86	5.404G	87	5.664G	88	5.465G
89	5.598G	90	5.257G	91	5.392G	92	5.516G
93	5.448G	94	5.327G	95	5.614G	96	5.594G
97	5.633G	98	5.637G	99	5.715G	100	5.329G

For 5470~5725MHz

Annex A.1: The Detailed Radar pattern and Statistical Performance

IEEE 802.11ac VHT20

Type 1 Radar Statistical Performances					
Trial #	Pulses per Burst	Pulse Width (s)	PRI (s)	Radar Frequency (MHz)	Detection
1	99	1.0u	538.0u	5491	Yes
2	95	1.0u	558.0u	5492	Yes
3	92	1.0u	578.0u	5493	Yes
4	86	1.0u	618.0u	5494	Yes
5	83	1.0u	638.0u	5495	Yes
6	81	1.0u	658.0u	5496	Yes
7	78	1.0u	678.0u	5497	Yes
8	76	1.0u	698.0u	5498	Yes
9	74	1.0u	718.0u	5499	Yes
10	67	1.0u	798.0u	5500	Yes
11	63	1.0u	838.0u	5501	Yes
12	62	1.0u	858.0u	5502	Yes
13	61	1.0u	878.0u	5503	Yes
14	59	1.0u	898.0u	5504	Yes
15	58	1.0u	918.0u	5505	Yes
16	66	1.0u	801.0u	5506	Yes
17	59	1.0u	901.0u	5507	Yes
18	63	1.0u	841.0u	5508	Yes
19	39	1.0u	1.365m	5509	Yes
20	69	1.0u	769.0u	5507	Yes
21	63	1.0u	849.0u	5505	Yes
22	57	1.0u	929.0u	5503	Yes
23	56	1.0u	949.0u	5502	Yes
24	69	1.0u	775.0u	5500	Yes
25	65	1.0u	815.0u	5498	No
26	61	1.0u	875.0u	5496	Yes
27	59	1.0u	895.0u	5494	Yes
28	58	1.0u	915.0u	5493	Yes
29	57	1.0u	935.0u	5492	Yes
30	19	1.0u	2.853m	5491	Yes
					Detection Rate: 96.6 %

Type 2 Radar Statistical Performances					
Trial #	Pulses per Burst	Pulse Width (s)	PRI (s)	Radar Frequency (MHz)	Detection
1	23	2.3u	222.0u	5491	Yes
2	28	1.8u	204.0u	5492	Yes
3	26	1.6u	225.0u	5493	Yes
4	27	3.8u	168.0u	5494	Yes
5	27	1.1u	227.0u	5495	No
6	27	2.6u	166.0u	5496	Yes
7	24	4.7u	161.0u	5497	Yes
8	28	1.9u	180.0u	5498	No
9	29	1.3u	176.0u	5499	Yes
10	23	1.8u	170.0u	5500	Yes
11	29	1.4u	195.0u	5501	No
12	25	3.4u	228.0u	5502	Yes
13	26	2.3u	206.0u	5503	No
14	27	4.5u	189.0u	5504	Yes
15	25	3.9u	194.0u	5505	Yes
16	25	3.0u	154.0u	5506	Yes
17	23	3.6u	182.0u	5507	Yes
18	26	3.4u	160.0u	5508	Yes
19	25	3.3u	229.0u	5509	Yes
20	23	1.9u	151.0u	5507	No
21	25	1.8u	184.0u	5505	Yes
22	28	2.3u	229.0u	5503	Yes
23	29	1.1u	210.0u	5502	No
24	26	2.2u	203.0u	5500	Yes
25	25	2.9u	222.0u	5498	No
26	28	1.4u	220.0u	5496	No
27	26	1.8u	155.0u	5494	Yes
28	29	3.4u	155.0u	5493	Yes
29	28	3.1u	204.0u	5492	Yes
30	26	4.4u	176.0u	5491	Yes

Detection Rate: 73.3 %

Type 3 Radar Statistical Performances					
Trial #	Pulses per Burst	Pulse Width (s)	PRI (s)	Radar Frequency (MHz)	Detection
1	18	7.8u	292.0u	5491	Yes
2	18	7.0u	366.0u	5492	Yes
3	18	9.2u	486.0u	5493	Yes
4	17	6.8u	216.0u	5494	No
5	18	7.3u	446.0u	5495	No
6	16	6.6u	208.0u	5496	Yes
7	17	6.8u	347.0u	5497	Yes
8	17	9.6u	232.0u	5498	Yes
9	17	6.2u	364.0u	5499	Yes
10	16	7.1u	407.0u	5500	No
11	18	6.6u	458.0u	5501	Yes
12	17	9.1u	226.0u	5502	Yes
13	16	6.9u	297.0u	5503	Yes
14	18	9.8u	463.0u	5504	No
15	17	6.1u	329.0u	5505	Yes
16	17	10.0u	333.0u	5506	Yes
17	18	8.5u	399.0u	5507	Yes
18	17	8.7u	316.0u	5508	No
19	16	9.9u	402.0u	5509	Yes
20	17	6.9u	446.0u	5507	Yes
21	16	6.6u	451.0u	5505	Yes
22	16	8.2u	272.0u	5503	Yes
23	17	8.5u	395.0u	5502	Yes
24	17	8.4u	379.0u	5500	Yes
25	16	7.4u	292.0u	5498	Yes
26	16	9.8u	489.0u	5496	No
27	17	7.7u	375.0u	5494	Yes
28	16	7.7u	297.0u	5493	Yes
29	18	9.2u	347.0u	5492	Yes
30	16	6.9u	415.0u	5491	Yes

Detection Rate: 80.0 %

Type 4 Radar Statistical Performances					
Trial #	Pulses per Burst	Pulse Width (s)	PRI (s)	Radar Frequency (MHz)	Detection
1	14	18.2u	402.0u	5491	Yes
2	13	14.5u	226.0u	5492	Yes
3	15	13.7u	340.0u	5493	Yes
4	16	12.2u	469.0u	5494	Yes
5	12	14.6u	220.0u	5495	No
6	15	17.0u	370.0u	5496	Yes
7	15	11.4u	458.0u	5497	Yes
8	13	11.6u	487.0u	5498	Yes
9	16	16.2u	202.0u	5499	Yes
10	15	19.8u	363.0u	5500	Yes
11	14	11.8u	424.0u	5501	Yes
12	14	18.0u	407.0u	5502	Yes
13	16	17.8u	256.0u	5503	Yes
14	16	13.1u	420.0u	5504	Yes
15	13	18.6u	243.0u	5505	No
16	14	13.4u	284.0u	5506	Yes
17	12	17.7u	410.0u	5507	Yes
18	15	19.3u	234.0u	5508	No
19	14	11.9u	411.0u	5509	Yes
20	16	13.4u	420.0u	5507	Yes
21	14	19.2u	235.0u	5505	Yes
22	14	15.2u	406.0u	5503	Yes
23	15	18.7u	408.0u	5502	Yes
24	13	16.1u	366.0u	5500	No
25	13	11.3u	369.0u	5498	Yes
26	14	17.1u	284.0u	5496	No
27	13	13.5u	495.0u	5494	Yes
28	15	16.8u	424.0u	5493	Yes
29	14	16.3u	322.0u	5492	Yes
30	13	13.0u	314.0u	5491	Yes

Detection Rate: 83.3 %

Type 5 Radar Statistical Performances		
Trial #	Test Signal Name	Detection
1	LP_Signal_01	Yes
2	LP_Signal_02	Yes
3	LP_Signal_03	Yes
4	LP_Signal_04	Yes
5	LP_Signal_05	Yes
6	LP_Signal_06	Yes
7	LP_Signal_07	Yes
8	LP_Signal_08	Yes
9	LP_Signal_09	Yes
10	LP_Signal_10	Yes
11	LP_Signal_11	Yes
12	LP_Signal_12	No
13	LP_Signal_13	No
14	LP_Signal_14	No
15	LP_Signal_15	Yes
16	LP_Signal_16	Yes
17	LP_Signal_17	No
18	LP_Signal_18	Yes
19	LP_Signal_19	No
20	LP_Signal_20	No
21	LP_Signal_21	Yes
22	LP_Signal_22	Yes
23	LP_Signal_23	Yes
24	LP_Signal_24	Yes
25	LP_Signal_25	Yes
26	LP_Signal_26	Yes
27	LP_Signal_27	Yes
28	LP_Signal_28	Yes
29	LP_Signal_29	Yes
30	LP_Signal_30	Yes
		Detection Rate: 80.0 %

Long Pulse Radar Test Signal						
Test Signal Name: LP_Signal_01						
Number of Bursts in Trial: 16						
Chrip Center Frequency: 5491MHz						
Burst	Pulses per Burst	Chrip (Hz)	Pulse Width (s)	Pulse 1 to 2 Spacing (s)	Pulse 2 to 3 Spacing (s)	Start Location (s)
1	1	5M	59.2u	-	-	243.0m
2	2	5M	94.5u	1.834m	-	299.3m
3	2	5M	95.4u	1.641m	-	566.0m
4	3	5M	59.5u	1.313m	1.332m	354.8m
5	2	5M	62.1u	1.158m	-	618.4m
6	3	5M	73.9u	1.671m	1.534m	629.7m
7	2	5M	50.4u	1.155m	-	384.7m
8	3	5M	62.7u	1.675m	1.571m	94.54m
9	1	5M	52.4u	-	-	45.93m
10	3	5M	55.9u	1.743m	1.537m	37.45m
11	2	5M	62.1u	1.725m	-	173.9m
12	3	5M	65.1u	1.567m	1.369m	549.6m
13	3	5M	80.3u	1.548m	1.117m	530.8m
14	2	5M	85.5u	1.063m	-	265.8m
15	3	5M	54.7u	1.134m	1.657m	49.43m
16	2	5M	85.8u	1.450m	-	382.0m

Long Pulse Radar Test Signal						
Test Signal Name: LP_Signal_02						
Number of Bursts in Trial: 11						
Chrip Center Frequency: 5491MHz						
Burst	Pulses per Burst	Chrip (Hz)	Pulse Width (s)	Pulse 1 to 2 Spacing (s)	Pulse 2 to 3 Spacing (s)	Start Location (s)
1	3	5M	77.4u	928.6u	1.433m	748.0m
2	2	5M	76.8u	1.792m	-	106.4m
3	2	5M	80.6u	1.265m	-	687.9m
4	3	5M	91.4u	1.357m	1.842m	327.9m
5	3	5M	90.0u	1.712m	1.217m	846.9m
6	2	5M	64.2u	1.792m	-	764.9m
7	2	5M	97.3u	1.153m	-	266.8m
8	2	5M	52.9u	952.1u	-	132.9m
9	3	5M	95.0u	1.657m	1.029m	423.4m
10	2	5M	87.7u	1.304m	-	303.7m
11	3	5M	69.8u	1.737m	1.511m	612.5m

Long Pulse Radar Test Signal						
Test Signal Name: LP_Signal_03						
Number of Bursts in Trial: 16						
Chrip Center Frequency: 5491MHz						
Burst	Pulses per Burst	Chrip (Hz)	Pulse Width (s)	Pulse 1 to 2 Spacing (s)	Pulse 2 to 3 Spacing (s)	Start Location (s)
1	3	6M	58.3u	1.169m	1.228m	212.0m
2	1	6M	67.9u	-	-	683.3m
3	2	6M	76.5u	1.176m	-	683.9m
4	2	6M	54.8u	1.298m	-	490.2m
5	3	6M	79.2u	1.024m	1.835m	160.4m
6	2	6M	89.3u	1.805m	-	653.3m
7	1	6M	77.2u	-	-	73.40m
8	3	6M	89.4u	1.249m	1.228m	589.4m
9	3	6M	97.7u	1.549m	1.052m	484.7m
10	3	6M	99.5u	1.824m	1.045m	490.8m
11	2	6M	62.4u	1.758m	-	48.28m
12	2	6M	99.1u	1.202m	-	270.9m
13	3	6M	92.6u	1.079m	1.569m	227.5m
14	2	6M	87.4u	1.359m	-	577.4m
15	1	6M	81.1u	-	-	371.3m
16	3	6M	50.5u	1.117m	996.5u	19.19m

Long Pulse Radar Test Signal						
Test Signal Name: LP_Signal_04						
Number of Bursts in Trial: 15						
Chrip Center Frequency: 5491MHz						
Burst	Pulses per Burst	Chrip (Hz)	Pulse Width (s)	Pulse 1 to 2 Spacing (s)	Pulse 2 to 3 Spacing (s)	Start Location (s)
1	1	6M	68.7u	-	-	13.44m
2	1	6M	92.8u	-	-	618.8m
3	2	6M	73.7u	1.459m	-	424.4m
4	2	6M	97.6u	1.294m	-	736.2m
5	1	6M	93.2u	-	-	795.7m
6	2	6M	97.1u	1.871m	-	787.0m
7	2	6M	89.4u	948.6u	-	601.5m
8	2	6M	92.5u	922.5u	-	499.5m
9	2	6M	94.8u	1.066m	-	562.5m
10	2	6M	78.1u	1.629m	-	68.89m
11	1	6M	88.1u	-	-	749.7m
12	3	6M	98.0u	1.708m	999.0u	541.0m
13	2	6M	74.6u	1.001m	-	9.908m
14	1	6M	80.3u	-	-	107.8m
15	1	6M	66.7u	-	-	643.2m

Long Pulse Radar Test Signal
 Test Signal Name: LP_Signal_05
 Number of Bursts in Trial: 10
 Chrip Center Frequency: 5492MHz

Burst	Pulses per Burst	Chrip (Hz)	Pulse Width (s)	Pulse 1 to 2 Spacing (s)	Pulse 2 to 3 Spacing (s)	Start Location (s)
1	2	7M	55.6u	1.308m	-	946.0m
2	2	7M	90.3u	1.109m	-	586.0m
3	3	7M	75.1u	1.179m	1.124m	427.1m
4	3	7M	86.1u	1.371m	1.270m	375.9m
5	2	7M	89.1u	1.058m	-	615.5m
6	2	7M	76.9u	1.774m	-	247.3m
7	2	7M	64.3u	1.929m	-	1.055
8	3	7M	61.7u	1.387m	1.721m	167.4m
9	2	7M	95.7u	1.831m	-	305.4m
10	3	7M	84.7u	1.764m	1.195m	294.9m

Long Pulse Radar Test Signal
 Test Signal Name: LP_Signal_06
 Number of Bursts in Trial: 14
 Chrip Center Frequency: 5492MHz

Burst	Pulses per Burst	Chrip (Hz)	Pulse Width (s)	Pulse 1 to 2 Spacing (s)	Pulse 2 to 3 Spacing (s)	Start Location (s)
1	3	7M	61.1u	1.316m	1.353m	376.4m
2	2	7M	69.8u	1.577m	-	775.8m
3	3	7M	83.7u	1.741m	1.014m	812.2m
4	3	7M	93.6u	933.4u	990.4u	456.3m
5	1	7M	88.6u	-	-	210.5m
6	1	7M	71.2u	-	-	415.3m
7	2	7M	64.3u	1.046m	-	215.6m
8	1	7M	67.5u	-	-	630.2m
9	1	7M	66.7u	-	-	332.1m
10	1	7M	73.9u	-	-	254.5m
11	2	7M	68.8u	1.006m	-	808.5m
12	2	7M	51.4u	1.834m	-	352.5m
13	2	7M	60.3u	1.317m	-	643.1m
14	1	7M	84.8u	-	-	743.2m

Long Pulse Radar Test Signal
 Test Signal Name: LP_Signal_07
 Number of Bursts in Trial: 13
 Chrip Center Frequency: 5495MHz

Burst	Pulses per Burst	Chrip (Hz)	Pulse Width (s)	Pulse 1 to 2 Spacing (s)	Pulse 2 to 3 Spacing (s)	Start Location (s)
1	1	15M	58.8u	-	-	24.59m
2	2	15M	70.7u	1.396m	-	679.2m
3	2	15M	73.6u	1.819m	-	117.6m
4	2	15M	61.6u	1.469m	-	619.5m
5	2	15M	94.1u	1.818m	-	334.8m
6	2	15M	75.1u	1.779m	-	356.5m
7	2	15M	72.8u	1.892m	-	109.8m
8	1	15M	60.6u	-	-	347.6m
9	1	15M	78.3u	-	-	296.3m
10	1	15M	92.8u	-	-	611.0m
11	2	15M	87.0u	1.901m	-	64.79m
12	2	15M	98.1u	1.888m	-	304.4m
13	2	15M	53.2u	1.031m	-	667.8m

Long Pulse Radar Test Signal						
Test Signal Name: LP_Signal_08						
Number of Bursts in Trial: 8						
Chrip Center Frequency: 5495MHz						
Burst	Pulses per Burst	Chrip (Hz)	Pulse Width (s)	Pulse 1 to 2 Spacing (s)	Pulse 2 to 3 Spacing (s)	Start Location (s)
1	3	15M	86.3u	1.743m	985.7u	297.0m
2	1	15M	66.0u	-	-	1.473
3	3	15M	67.9u	1.531m	1.717m	438.4m
4	3	15M	86.6u	1.433m	1.491m	650.2m
5	2	15M	59.3u	1.648m	-	773.9m
6	2	15M	60.7u	1.384m	-	278.3m
7	2	15M	58.5u	1.114m	-	1.321
8	2	15M	88.9u	920.1u	-	360.9m

Long Pulse Radar Test Signal						
Test Signal Name: LP_Signal_09						
Number of Bursts in Trial: 16						
Chrip Center Frequency: 5497MHz						
Burst	Pulses per Burst	Chrip (Hz)	Pulse Width (s)	Pulse 1 to 2 Spacing (s)	Pulse 2 to 3 Spacing (s)	Start Location (s)
1	2	20M	80.2u	1.739m	-	720.6m
2	3	20M	50.1u	1.816m	1.933m	558.9m
3	1	20M	96.2u	-	-	211.8m
4	3	20M	72.6u	1.275m	1.410m	628.1m
5	2	20M	92.6u	1.262m	-	295.1m
6	2	20M	70.1u	1.814m	-	404.0m
7	2	20M	96.2u	1.463m	-	89.45m
8	2	20M	78.6u	1.436m	-	275.4m
9	2	20M	85.9u	1.077m	-	726.5m
10	3	20M	86.3u	1.689m	1.395m	279.8m
11	1	20M	88.0u	-	-	142.6m
12	3	20M	58.3u	1.051m	995.7u	248.6m
13	2	20M	95.3u	1.642m	-	392.4m
14	3	20M	93.1u	1.100m	1.481m	639.1m
15	1	20M	96.7u	-	-	614.9m
16	2	20M	67.1u	1.370m	-	471.2m

Long Pulse Radar Test Signal						
Test Signal Name: LP_Signal_10						
Number of Bursts in Trial: 18						
Chrip Center Frequency: 5497MHz						
Burst	Pulses per Burst	Chrip (Hz)	Pulse Width (s)	Pulse 1 to 2 Spacing (s)	Pulse 2 to 3 Spacing (s)	Start Location (s)
1	2	20M	98.6u	1.198m	-	344.9m
2	2	20M	57.6u	961.4u	-	641.7m
3	1	20M	56.4u	-	-	308.8m
4	1	20M	81.4u	-	-	180.2m
5	1	20M	61.8u	-	-	297.7m
6	2	20M	90.4u	1.563m	-	282.9m
7	3	20M	68.8u	1.515m	1.370m	37.46m
8	1	20M	73.9u	-	-	475.8m
9	2	20M	68.4u	1.684m	-	117.5m
10	3	20M	95.4u	1.490m	1.735m	155.9m
11	1	20M	70.9u	-	-	253.8m
12	1	20M	94.7u	-	-	356.0m
13	3	20M	76.9u	1.750m	1.203m	56.37m
14	3	20M	80.6u	1.024m	1.881m	588.3m
15	2	20M	87.2u	1.015m	-	223.6m
16	2	20M	85.9u	1.898m	-	380.5m
17	1	20M	62.9u	-	-	127.1m
18	2	20M	96.3u	1.532m	-	541.3m

Long Pulse Radar Test Signal						
Test Signal Name: LP_Signal_11						
Number of Bursts in Trial: 12						
Chrip Center Frequency: 5500MHz						
Burst	Pulses per Burst	Chrip (Hz)	Pulse Width (s)	Pulse 1 to 2 Spacing (s)	Pulse 2 to 3 Spacing (s)	Start Location (s)
1	1	6M	74.4u	-	-	870.4m
2	2	6M	73.0u	1.799m	-	254.4m
3	1	6M	69.1u	-	-	695.0m
4	2	6M	80.4u	1.729m	-	818.0m
5	2	6M	80.1u	1.222m	-	775.0m
6	3	6M	61.6u	1.022m	1.568m	773.7m
7	2	6M	72.5u	1.562m	-	260.7m
8	3	6M	69.9u	1.863m	1.712m	187.4m
9	2	6M	98.9u	1.750m	-	407.2m
10	1	6M	86.5u	-	-	242.1m
11	2	6M	67.5u	1.178m	-	608.3m
12	3	6M	85.8u	1.665m	1.754m	944.7m

Long Pulse Radar Test Signal
 Test Signal Name: LP_Signal_12
 Number of Bursts in Trial: 10
 Chrip Center Frequency: 5500MHz

Burst	Pulses per Burst	Chrip (Hz)	Pulse Width (s)	Pulse 1 to 2 Spacing (s)	Pulse 2 to 3 Spacing (s)	Start Location (s)
1	1	6M	63.2u	-	-	639.7m
2	3	6M	51.2u	1.477m	1.835m	678.8m
3	3	6M	64.0u	1.440m	1.154m	534.7m
4	2	6M	70.2u	1.135m	-	1.023
5	2	6M	82.2u	1.368m	-	565.5m
6	2	6M	90.8u	1.524m	-	59.60m
7	2	6M	61.5u	985.5u	-	1.004
8	1	6M	52.3u	-	-	775.3m
9	3	6M	75.8u	1.274m	1.399m	123.2m
10	1	6M	83.4u	-	-	1.109

Long Pulse Radar Test Signal
 Test Signal Name: LP_Signal_13
 Number of Bursts in Trial: 8
 Chrip Center Frequency: 5500MHz

Burst	Pulses per Burst	Chrip (Hz)	Pulse Width (s)	Pulse 1 to 2 Spacing (s)	Pulse 2 to 3 Spacing (s)	Start Location (s)
1	2	11M	84.4u	1.421m	-	801.3m
2	3	11M	70.4u	1.837m	1.413m	694.8m
3	1	11M	56.8u	-	-	852.3m
4	2	11M	88.3u	1.609m	-	214.6m
5	3	11M	63.4u	1.206m	1.734m	788.8m
6	3	11M	66.9u	942.1u	1.551m	502.0m
7	3	11M	67.8u	938.2u	1.580m	404.8m
8	2	11M	68.5u	1.233m	-	191.0m

Long Pulse Radar Test Signal
 Test Signal Name: LP_Signal_14
 Number of Bursts in Trial: 19
 Chrip Center Frequency: 5500MHz

Burst	Pulses per Burst	Chrip (Hz)	Pulse Width (s)	Pulse 1 to 2 Spacing (s)	Pulse 2 to 3 Spacing (s)	Start Location (s)
1	1	11M	83.2u	-	-	45.94m
2	2	11M	64.2u	1.124m	-	371.8m
3	2	11M	93.6u	1.066m	-	35.45m
4	2	11M	81.4u	1.900m	-	379.4m
5	2	11M	72.5u	1.373m	-	425.9m
6	2	11M	63.2u	1.827m	-	395.1m
7	3	11M	78.0u	1.366m	1.019m	157.6m
8	1	11M	70.4u	-	-	237.3m
9	3	11M	62.4u	1.269m	1.701m	582.7m
10	1	11M	85.8u	-	-	223.0m
11	3	11M	57.4u	1.075m	1.909m	626.8m
12	2	11M	66.5u	1.637m	-	578.6m
13	3	11M	52.8u	1.165m	1.623m	626.6m
14	3	11M	51.0u	1.021m	1.068m	482.0m
15	1	11M	52.0u	-	-	471.8m
16	2	11M	72.0u	1.694m	-	284.8m
17	2	11M	58.9u	1.920m	-	155.7m
18	3	11M	84.2u	1.879m	1.077m	352.7m
19	2	11M	51.5u	1.504m	-	605.5m

Long Pulse Radar Test Signal
 Test Signal Name: LP_Signal_15
 Number of Bursts in Trial: 11
 Chrip Center Frequency: 5500MHz

Burst	Pulses per Burst	Chrip (Hz)	Pulse Width (s)	Pulse 1 to 2 Spacing (s)	Pulse 2 to 3 Spacing (s)	Start Location (s)
1	2	16M	60.9u	1.685m	-	1.030
2	2	16M	86.8u	1.363m	-	1.069
3	2	16M	95.4u	1.521m	-	296.1m
4	3	16M	73.5u	1.628m	1.226m	377.5m
5	2	16M	67.5u	1.036m	-	644.9m
6	3	16M	65.5u	1.798m	1.561m	766.1m
7	3	16M	95.9u	1.094m	1.242m	537.2m
8	2	16M	96.2u	1.578m	-	172.3m
9	2	16M	90.4u	1.274m	-	256.1m
10	2	16M	90.1u	1.319m	-	842.4m
11	2	16M	59.3u	1.600m	-	728.8m

Long Pulse Radar Test Signal
 Test Signal Name: LP_Signal_16
 Number of Bursts in Trial: 16
 Chrip Center Frequency: 5500MHz

Burst	Pulses per Burst	Chrip (Hz)	Pulse Width (s)	Pulse 1 to 2 Spacing (s)	Pulse 2 to 3 Spacing (s)	Start Location (s)
1	1	16M	53.9u	-	-	653.0m
2	3	16M	87.4u	1.140m	1.207m	109.0m
3	2	16M	56.0u	1.104m	-	462.3m
4	2	16M	62.5u	1.625m	-	704.3m
5	2	16M	66.7u	1.202m	-	296.4m
6	2	16M	65.6u	1.571m	-	169.5m
7	2	16M	65.2u	1.889m	-	703.7m
8	1	16M	67.4u	-	-	78.58m
9	3	16M	70.1u	1.820m	1.460m	419.9m
10	2	16M	62.3u	1.636m	-	7.821m
11	3	16M	79.8u	1.442m	1.551m	384.2m
12	1	16M	81.4u	-	-	378.9m
13	2	16M	75.0u	1.336m	-	742.0m
14	2	16M	74.3u	1.487m	-	726.4m
15	3	16M	88.8u	1.772m	1.153m	168.4m
16	3	16M	67.7u	1.248m	1.211m	647.3m

Long Pulse Radar Test Signal
 Test Signal Name: LP_Signal_17
 Number of Bursts in Trial: 9
 Chrip Center Frequency: 5500MHz

Burst	Pulses per Burst	Chrip (Hz)	Pulse Width (s)	Pulse 1 to 2 Spacing (s)	Pulse 2 to 3 Spacing (s)	Start Location (s)
1	3	18M	50.9u	1.721m	1.677m	787.1m
2	2	18M	70.9u	1.645m	-	357.8m
3	2	18M	61.2u	1.863m	-	730.2m
4	3	18M	55.6u	1.573m	1.305m	472.0m
5	2	18M	61.9u	1.421m	-	88.96m
6	1	18M	52.6u	-	-	911.3m
7	3	18M	60.7u	1.420m	1.845m	81.67m
8	2	18M	76.7u	1.616m	-	600.1m
9	1	18M	82.1u	-	-	1.017

Long Pulse Radar Test Signal						
Test Signal Name: LP_Signal_18						
Number of Bursts in Trial: 12						
Chrip Center Frequency: 5500MHz						
Burst	Pulses per Burst	Chrip (Hz)	Pulse Width (s)	Pulse 1 to 2 Spacing (s)	Pulse 2 to 3 Spacing (s)	Start Location (s)
1	3	18M	52.0u	963.0u	1.272m	607.1m
2	2	18M	94.7u	1.569m	-	970.0m
3	2	18M	81.7u	1.783m	-	405.2m
4	1	18M	79.0u	-	-	481.4m
5	3	18M	68.5u	1.228m	1.226m	689.8m
6	2	18M	54.6u	1.639m	-	657.6m
7	1	18M	68.1u	-	-	841.1m
8	1	18M	89.8u	-	-	916.7m
9	1	18M	69.1u	-	-	211.7m
10	1	18M	97.8u	-	-	374.1m
11	2	18M	96.3u	1.242m	-	457.4m
12	3	18M	95.6u	981.4u	1.107m	828.4m

Long Pulse Radar Test Signal						
Test Signal Name: LP_Signal_19						
Number of Bursts in Trial: 10						
Chrip Center Frequency: 5500MHz						
Burst	Pulses per Burst	Chrip (Hz)	Pulse Width (s)	Pulse 1 to 2 Spacing (s)	Pulse 2 to 3 Spacing (s)	Start Location (s)
1	2	20M	78.6u	1.551m	-	833.2m
2	2	20M	51.6u	990.4u	-	825.2m
3	2	20M	86.8u	1.097m	-	809.6m
4	1	20M	60.5u	-	-	792.9m
5	2	20M	54.9u	1.783m	-	491.4m
6	2	20M	75.7u	1.245m	-	717.7m
7	2	20M	55.0u	1.513m	-	1.155
8	2	20M	79.2u	955.8u	-	118.6m
9	1	20M	56.4u	-	-	881.1m
10	1	20M	97.7u	-	-	978.0m

Long Pulse Radar Test Signal						
Test Signal Name: LP_Signal_20						
Number of Bursts in Trial: 20						
Chrip Center Frequency: 5500MHz						
Burst	Pulses per Burst	Chrip (Hz)	Pulse Width (s)	Pulse 1 to 2 Spacing (s)	Pulse 2 to 3 Spacing (s)	Start Location (s)
1	2	20M	63.1u	1.352m	-	165.6m
2	2	20M	58.9u	1.458m	-	231.2m
3	2	20M	77.9u	1.812m	-	578.2m
4	2	20M	55.4u	1.834m	-	493.0m
5	3	20M	93.5u	1.337m	1.895m	207.5m
6	2	20M	92.8u	1.212m	-	161.6m
7	3	20M	60.2u	1.500m	1.299m	450.6m
8	3	20M	92.9u	980.1u	1.224m	70.72m
9	3	20M	68.5u	1.737m	1.169m	263.0m
10	2	20M	85.6u	967.4u	-	128.5m
11	2	20M	85.4u	1.165m	-	495.9m
12	2	20M	68.2u	1.498m	-	88.26m
13	2	20M	66.6u	1.769m	-	10.88m
14	3	20M	56.7u	1.517m	1.056m	393.2m
15	1	20M	61.9u	-	-	488.3m
16	3	20M	92.9u	1.185m	1.163m	309.7m
17	2	20M	59.6u	1.139m	-	243.6m
18	3	20M	71.4u	1.337m	1.026m	381.3m
19	3	20M	66.5u	1.886m	1.669m	75.38m
20	1	20M	99.2u	-	-	205.0m

Long Pulse Radar Test Signal						
Test Signal Name: LP_Signal_21						
Number of Bursts in Trial: 16						
Chrip Center Frequency: 5509MHz						
Burst	Pulses per Burst	Chrip (Hz)	Pulse Width (s)	Pulse 1 to 2 Spacing (s)	Pulse 2 to 3 Spacing (s)	Start Location (s)
1	1	5M	59.2u	-	-	243.0m
2	2	5M	94.5u	1.834m	-	299.3m
3	2	5M	95.4u	1.641m	-	566.0m
4	3	5M	59.5u	1.313m	1.332m	354.8m
5	2	5M	62.1u	1.158m	-	618.4m
6	3	5M	73.9u	1.671m	1.534m	629.7m
7	2	5M	50.4u	1.155m	-	384.7m
8	3	5M	62.7u	1.675m	1.571m	94.54m
9	1	5M	52.4u	-	-	45.93m
10	3	5M	55.9u	1.743m	1.537m	37.45m
11	2	5M	62.1u	1.725m	-	173.9m
12	3	5M	65.1u	1.567m	1.369m	549.6m
13	3	5M	80.3u	1.548m	1.117m	530.8m
14	2	5M	85.5u	1.063m	-	265.8m
15	3	5M	54.7u	1.134m	1.657m	49.43m
16	2	5M	85.8u	1.450m	-	382.0m

Long Pulse Radar Test Signal						
Test Signal Name: LP_Signal_22						
Number of Bursts in Trial: 19						
Chrip Center Frequency: 5509MHz						
Burst	Pulses per Burst	Chrip (Hz)	Pulse Width (s)	Pulse 1 to 2 Spacing (s)	Pulse 2 to 3 Spacing (s)	Start Location (s)
1	3	5M	61.2u	1.793m	1.857m	398.8m
2	1	5M	53.7u	-	-	300.3m
3	2	5M	82.7u	1.900m	-	154.0m
4	3	5M	98.8u	1.369m	1.879m	7.212m
5	2	5M	54.9u	1.516m	-	475.2m
6	3	5M	57.2u	1.640m	1.396m	427.7m
7	2	5M	91.6u	1.507m	-	435.3m
8	2	5M	69.8u	1.897m	-	349.7m
9	2	5M	58.1u	1.668m	-	584.4m
10	2	5M	81.6u	1.380m	-	184.8m
11	2	5M	57.5u	1.242m	-	221.2m
12	3	5M	92.2u	1.227m	913.8u	353.3m
13	2	5M	81.9u	1.129m	-	486.4m
14	2	5M	66.9u	1.395m	-	235.5m
15	1	5M	67.9u	-	-	415.5m
16	3	5M	99.2u	1.884m	1.803m	462.9m
17	2	5M	71.2u	1.043m	-	214.2m
18	1	5M	70.9u	-	-	379.4m
19	2	5M	68.8u	1.209m	-	322.3m

Long Pulse Radar Test Signal						
Test Signal Name: LP_Signal_23						
Number of Bursts in Trial: 10						
Chrip Center Frequency: 5507MHz						
Burst	Pulses per Burst	Chrip (Hz)	Pulse Width (s)	Pulse 1 to 2 Spacing (s)	Pulse 2 to 3 Spacing (s)	Start Location (s)
1	2	10M	77.1u	1.267m	-	774.1m
2	3	10M	99.8u	1.558m	1.032m	769.0m
3	2	10M	73.2u	1.204m	-	760.7m
4	3	10M	74.0u	1.642m	1.403m	202.1m
5	2	10M	61.7u	982.3u	-	236.2m
6	2	10M	68.4u	1.120m	-	889.3m
7	2	10M	98.4u	1.604m	-	192.4m
8	2	10M	72.5u	1.756m	-	721.2m
9	3	10M	52.4u	1.480m	1.691m	405.5m
10	3	10M	96.6u	1.397m	1.029m	235.6m

Long Pulse Radar Test Signal
 Test Signal Name: LP_Signal_24
 Number of Bursts in Trial: 9
 Chrip Center Frequency: 5507MHz

Burst	Pulses per Burst	Chrip (Hz)	Pulse Width (s)	Pulse 1 to 2 Spacing (s)	Pulse 2 to 3 Spacing (s)	Start Location (s)
1	3	10M	80.2u	1.716m	1.208m	458.3m
2	2	10M	99.0u	1.877m	-	80.24m
3	1	10M	70.5u	-	-	705.0m
4	1	10M	88.3u	-	-	69.65m
5	2	10M	56.4u	1.516m	-	922.0m
6	1	10M	100.0u	-	-	179.3m
7	2	10M	58.2u	994.8u	-	1.187
8	1	10M	98.0u	-	-	223.9m
9	1	10M	92.7u	-	-	927.1m

Long Pulse Radar Test Signal
 Test Signal Name: LP_Signal_25
 Number of Bursts in Trial: 10
 Chrip Center Frequency: 5505MHz

Burst	Pulses per Burst	Chrip (Hz)	Pulse Width (s)	Pulse 1 to 2 Spacing (s)	Pulse 2 to 3 Spacing (s)	Start Location (s)
1	2	15M	94.0u	1.223m	-	602.5m
2	1	15M	72.8u	-	-	973.3m
3	1	15M	53.8u	-	-	901.9m
4	2	15M	62.4u	1.292m	-	937.5m
5	2	15M	78.8u	1.014m	-	731.3m
6	2	15M	93.5u	1.149m	-	20.15m
7	1	15M	61.8u	-	-	620.4m
8	3	15M	82.0u	1.788m	1.001m	82.34m
9	1	15M	63.6u	-	-	891.7m
10	2	15M	76.7u	1.229m	-	49.96m

Long Pulse Radar Test Signal
 Test Signal Name: LP_Signal_26
 Number of Bursts in Trial: 11
 Chrip Center Frequency: 5505MHz

Burst	Pulses per Burst	Chrip (Hz)	Pulse Width (s)	Pulse 1 to 2 Spacing (s)	Pulse 2 to 3 Spacing (s)	Start Location (s)
1	1	15M	84.4u	-	-	558.9m
2	2	15M	74.4u	1.227m	-	40.96m
3	3	15M	59.9u	1.513m	1.461m	466.4m
4	1	15M	54.6u	-	-	934.1m
5	2	15M	56.2u	1.306m	-	791.5m
6	2	15M	80.1u	1.693m	-	378.4m
7	2	15M	50.2u	1.675m	-	844.0m
8	2	15M	89.6u	1.641m	-	762.8m
9	1	15M	81.8u	-	-	133.1m
10	1	15M	89.0u	-	-	56.12m
11	1	15M	62.1u	-	-	784.8m

Long Pulse Radar Test Signal						
Test Signal Name: LP_Signal_27						
Number of Bursts in Trial: 17						
Chrip Center Frequency: 5505MHz						
Burst	Pulses per Burst	Chrip (Hz)	Pulse Width (s)	Pulse 1 to 2 Spacing (s)	Pulse 2 to 3 Spacing (s)	Start Location (s)
1	1	18M	99.1u	-	-	365.0m
2	2	18M	80.2u	1.073m	-	218.9m
3	1	18M	98.4u	-	-	62.40m
4	2	18M	79.9u	924.1u	-	28.38m
5	3	18M	85.7u	1.729m	1.103m	59.49m
6	3	18M	83.1u	1.033m	1.823m	360.0m
7	1	18M	93.9u	-	-	207.7m
8	2	18M	92.9u	1.657m	-	307.2m
9	2	18M	93.9u	1.164m	-	269.1m
10	3	18M	71.8u	1.516m	1.207m	433.3m
11	2	18M	60.1u	1.913m	-	334.1m
12	2	18M	65.1u	1.569m	-	471.0m
13	2	18M	70.1u	1.020m	-	403.4m
14	2	18M	54.7u	1.505m	-	537.2m
15	2	18M	71.7u	1.764m	-	569.9m
16	2	18M	98.5u	1.729m	-	505.7m
17	2	18M	90.2u	1.677m	-	644.0m

Long Pulse Radar Test Signal						
Test Signal Name: LP_Signal_28						
Number of Bursts in Trial: 10						
Chrip Center Frequency: 5505MHz						
Burst	Pulses per Burst	Chrip (Hz)	Pulse Width (s)	Pulse 1 to 2 Spacing (s)	Pulse 2 to 3 Spacing (s)	Start Location (s)
1	1	18M	91.4u	-	-	1.193
2	2	18M	59.0u	1.416m	-	691.9m
3	3	18M	75.5u	1.576m	1.710m	949.0m
4	3	18M	57.2u	1.495m	1.274m	98.67m
5	2	18M	86.9u	1.499m	-	1.077
6	3	18M	59.2u	1.913m	1.856m	327.0m
7	1	18M	79.4u	-	-	681.2m
8	3	18M	98.1u	1.764m	1.499m	780.6m
9	2	18M	79.1u	1.785m	-	22.12m
10	3	18M	75.5u	1.187m	1.373m	229.5m

Long Pulse Radar Test Signal						
Test Signal Name: LP_Signal_29						
Number of Bursts in Trial: 16						
Chrip Center Frequency: 5503MHz						
Burst	Pulses per Burst	Chrip (Hz)	Pulse Width (s)	Pulse 1 to 2 Spacing (s)	Pulse 2 to 3 Spacing (s)	Start Location (s)
1	2	20M	80.2u	1.739m	-	720.6m
2	3	20M	50.1u	1.816m	1.933m	558.9m
3	1	20M	96.2u	-	-	211.8m
4	3	20M	72.6u	1.275m	1.410m	628.1m
5	2	20M	92.6u	1.262m	-	295.1m
6	2	20M	70.1u	1.814m	-	404.0m
7	2	20M	96.2u	1.463m	-	89.45m
8	2	20M	78.6u	1.436m	-	275.4m
9	2	20M	85.9u	1.077m	-	726.5m
10	3	20M	86.3u	1.689m	1.395m	279.8m
11	1	20M	88.0u	-	-	142.6m
12	3	20M	58.3u	1.051m	995.7u	248.6m
13	2	20M	95.3u	1.642m	-	392.4m
14	3	20M	93.1u	1.100m	1.481m	639.1m
15	1	20M	96.7u	-	-	614.9m
16	2	20M	67.1u	1.370m	-	471.2m

Long Pulse Radar Test Signal						
Test Signal Name: LP_Signal_30						
Number of Bursts in Trial: 16						
Chrip Center Frequency: 5503MHz						
Burst	Pulses per Burst	Chrip (Hz)	Pulse Width (s)	Pulse 1 to 2 Spacing (s)	Pulse 2 to 3 Spacing (s)	Start Location (s)
1	2	20M	98.1u	1.220m	-	507.2m
2	2	20M	73.5u	1.910m	-	227.2m
3	2	20M	98.2u	1.506m	-	631.2m
4	3	20M	97.9u	1.595m	1.851m	164.0m
5	1	20M	92.9u	-	-	45.06m
6	2	20M	76.6u	1.260m	-	601.8m
7	2	20M	68.1u	1.217m	-	342.9m
8	1	20M	53.3u	-	-	86.38m
9	2	20M	58.0u	978.0u	-	75.50m
10	1	20M	66.6u	-	-	328.5m
11	3	20M	69.0u	1.388m	1.330m	707.6m
12	2	20M	68.3u	1.450m	-	328.0m
13	3	20M	99.1u	1.752m	1.303m	426.0m
14	1	20M	94.8u	-	-	632.9m
15	1	20M	99.7u	-	-	169.8m
16	1	20M	51.5u	-	-	455.1m

Type 6 Radar Statistical Performances				
Trial #	Pulses per Burst	Pulse Width (s)	PRI (s)	Detection
1	9	1.0u	333.0u	Yes
2	9	1.0u	333.0u	Yes
3	9	1.0u	333.0u	Yes
4	9	1.0u	333.0u	Yes
5	9	1.0u	333.0u	Yes
6	9	1.0u	333.0u	Yes
7	9	1.0u	333.0u	Yes
8	9	1.0u	333.0u	Yes
9	9	1.0u	333.0u	Yes
10	9	1.0u	333.0u	Yes
11	9	1.0u	333.0u	Yes
12	9	1.0u	333.0u	Yes
13	9	1.0u	333.0u	Yes
14	9	1.0u	333.0u	Yes
15	9	1.0u	333.0u	Yes
16	9	1.0u	333.0u	Yes
17	9	1.0u	333.0u	Yes
18	9	1.0u	333.0u	Yes
19	9	1.0u	333.0u	Yes
20	9	1.0u	333.0u	Yes
21	9	1.0u	333.0u	Yes
22	9	1.0u	333.0u	Yes
23	9	1.0u	333.0u	Yes
24	9	1.0u	333.0u	Yes
25	9	1.0u	333.0u	Yes
26	9	1.0u	333.0u	Yes
27	9	1.0u	333.0u	Yes
28	9	1.0u	333.0u	Yes
29	9	1.0u	333.0u	Yes
30	9	1.0u	333.0u	Yes
				Detection Rate: 100.0 %

Type 6 Radar Statistical Performances		
Trial #	Hopping Frequency Sequence Name	Detection
1	HOP_FREQ_SEQ_01	Yes
2	HOP_FREQ_SEQ_02	Yes
3	HOP_FREQ_SEQ_03	Yes
4	HOP_FREQ_SEQ_04	Yes
5	HOP_FREQ_SEQ_05	Yes
6	HOP_FREQ_SEQ_06	Yes
7	HOP_FREQ_SEQ_07	Yes
8	HOP_FREQ_SEQ_08	Yes
9	HOP_FREQ_SEQ_09	Yes
10	HOP_FREQ_SEQ_10	Yes
11	HOP_FREQ_SEQ_11	Yes
12	HOP_FREQ_SEQ_12	Yes
13	HOP_FREQ_SEQ_13	Yes
14	HOP_FREQ_SEQ_14	Yes
15	HOP_FREQ_SEQ_15	Yes
16	HOP_FREQ_SEQ_16	Yes
17	HOP_FREQ_SEQ_17	Yes
18	HOP_FREQ_SEQ_18	Yes
19	HOP_FREQ_SEQ_19	Yes
20	HOP_FREQ_SEQ_20	Yes
21	HOP_FREQ_SEQ_21	Yes
22	HOP_FREQ_SEQ_22	Yes
23	HOP_FREQ_SEQ_23	Yes
24	HOP_FREQ_SEQ_24	Yes
25	HOP_FREQ_SEQ_25	Yes
26	HOP_FREQ_SEQ_26	Yes
27	HOP_FREQ_SEQ_27	Yes
28	HOP_FREQ_SEQ_28	Yes
29	HOP_FREQ_SEQ_29	Yes
30	HOP_FREQ_SEQ_30	Yes
		Detection Rate: 100.0 %

Hopping Frequency Sequence Name: HOP_FREQ_SEQ_01							
SEQ#	Frequency (Hz)	SEQ#	Frequency (Hz)	SEQ#	Frequency (Hz)	SEQ#	Frequency (Hz)
1	5.510G	2	5.494G	3	5.424G	4	5.274G
5	5.671G	6	5.351G	7	5.371G	8	5.616G
9	5.595G	10	5.625G	11	5.483G	12	5.676G
13	5.522G	14	5.400G	15	5.539G	16	5.543G
17	5.465G	18	5.537G	19	5.481G	20	5.325G
21	5.647G	22	5.724G	23	5.436G	24	5.322G
25	5.544G	26	5.476G	27	5.695G	28	5.608G
29	5.634G	30	5.601G	31	5.618G	32	5.433G
33	5.711G	34	5.596G	35	5.485G	36	5.262G
37	5.675G	38	5.570G	39	5.644G	40	5.688G
41	5.300G	42	5.331G	43	5.609G	44	5.637G
45	5.398G	46	5.484G	47	5.366G	48	5.620G
49	5.606G	50	5.604G	51	5.320G	52	5.495G
53	5.552G	54	5.702G	55	5.692G	56	5.673G
57	5.526G	58	5.517G	59	5.698G	60	5.651G
61	5.689G	62	5.343G	63	5.294G	64	5.301G
65	5.271G	66	5.619G	67	5.557G	68	5.615G
69	5.406G	70	5.629G	71	5.653G	72	5.521G
73	5.286G	74	5.461G	75	5.423G	76	5.304G
77	5.460G	78	5.605G	79	5.263G	80	5.643G
81	5.646G	82	5.602G	83	5.431G	84	5.652G
85	5.678G	86	5.452G	87	5.364G	88	5.299G
89	5.356G	90	5.363G	91	5.470G	92	5.359G
93	5.478G	94	5.296G	95	5.257G	96	5.353G
97	5.603G	98	5.697G	99	5.610G	100	5.425G

Hopping Frequency Sequence Name: HOP_FREQ_SEQ_02							
SEQ#	Frequency (Hz)	SEQ#	Frequency (Hz)	SEQ#	Frequency (Hz)	SEQ#	Frequency (Hz)
1	5.588G	2	5.570G	3	5.328G	4	5.311G
5	5.526G	6	5.339G	7	5.264G	8	5.463G
9	5.573G	10	5.527G	11	5.323G	12	5.421G
13	5.543G	14	5.638G	15	5.600G	16	5.404G
17	5.420G	18	5.255G	19	5.278G	20	5.563G
21	5.284G	22	5.713G	23	5.530G	24	5.710G
25	5.385G	26	5.446G	27	5.292G	28	5.510G
29	5.400G	30	5.376G	31	5.590G	32	5.486G
33	5.349G	34	5.585G	35	5.684G	36	5.315G
37	5.361G	38	5.677G	39	5.576G	40	5.412G
41	5.550G	42	5.350G	43	5.580G	44	5.549G
45	5.615G	46	5.341G	47	5.326G	48	5.374G
49	5.279G	50	5.605G	51	5.523G	52	5.724G
53	5.419G	54	5.402G	55	5.534G	56	5.505G
57	5.367G	58	5.720G	59	5.623G	60	5.552G
61	5.274G	62	5.454G	63	5.547G	64	5.397G
65	5.603G	66	5.673G	67	5.475G	68	5.625G
69	5.442G	70	5.307G	71	5.681G	72	5.340G
73	5.618G	74	5.579G	75	5.322G	76	5.662G
77	5.672G	78	5.403G	79	5.539G	80	5.703G
81	5.413G	82	5.501G	83	5.697G	84	5.698G
85	5.608G	86	5.448G	87	5.621G	88	5.572G
89	5.262G	90	5.300G	91	5.405G	92	5.686G
93	5.348G	94	5.515G	95	5.674G	96	5.275G
97	5.619G	98	5.701G	99	5.583G	100	5.496G

Hopping Frequency Sequence Name: HOP_FREQ_SEQ_03							
SEQ#	Frequency (Hz)	SEQ#	Frequency (Hz)	SEQ#	Frequency (Hz)	SEQ#	Frequency (Hz)
1	5.407G	2	5.504G	3	5.568G	4	5.256G
5	5.605G	6	5.317G	7	5.496G	8	5.717G
9	5.267G	10	5.354G	11	5.513G	12	5.373G
13	5.619G	14	5.355G	15	5.696G	16	5.713G
17	5.430G	18	5.506G	19	5.396G	20	5.447G
21	5.632G	22	5.615G	23	5.379G	24	5.663G
25	5.685G	26	5.400G	27	5.287G	28	5.490G
29	5.363G	30	5.654G	31	5.424G	32	5.311G
33	5.581G	34	5.498G	35	5.440G	36	5.329G
37	5.305G	38	5.345G	39	5.252G	40	5.427G
41	5.708G	42	5.607G	43	5.480G	44	5.423G
45	5.375G	46	5.507G	47	5.519G	48	5.408G
49	5.280G	50	5.413G	51	5.380G	52	5.324G
53	5.431G	54	5.399G	55	5.548G	56	5.611G
57	5.319G	58	5.617G	59	5.351G	60	5.658G
61	5.670G	62	5.646G	63	5.524G	64	5.483G
65	5.269G	66	5.320G	67	5.420G	68	5.710G
69	5.718G	70	5.669G	71	5.391G	72	5.641G
73	5.591G	74	5.518G	75	5.692G	76	5.369G
77	5.362G	78	5.636G	79	5.455G	80	5.590G
81	5.462G	82	5.579G	83	5.627G	84	5.676G
85	5.540G	86	5.441G	87	5.262G	88	5.720G
89	5.495G	90	5.494G	91	5.528G	92	5.682G
93	5.628G	94	5.383G	95	5.446G	96	5.390G
97	5.642G	98	5.478G	99	5.545G	100	5.666G

Hopping Frequency Sequence Name: HOP_FREQ_SEQ_04							
SEQ#	Frequency (Hz)	SEQ#	Frequency (Hz)	SEQ#	Frequency (Hz)	SEQ#	Frequency (Hz)
1	5.453G	2	5.369G	3	5.322G	4	5.609G
5	5.685G	6	5.393G	7	5.673G	8	5.362G
9	5.269G	10	5.455G	11	5.551G	12	5.427G
13	5.266G	14	5.510G	15	5.503G	16	5.293G
17	5.374G	18	5.373G	19	5.361G	20	5.283G
21	5.291G	22	5.548G	23	5.454G	24	5.606G
25	5.365G	26	5.445G	27	5.593G	28	5.632G
29	5.535G	30	5.334G	31	5.306G	32	5.693G
33	5.517G	34	5.253G	35	5.642G	36	5.459G
37	5.452G	38	5.653G	39	5.338G	40	5.385G
41	5.325G	42	5.647G	43	5.422G	44	5.313G
45	5.424G	46	5.595G	47	5.368G	48	5.690G
49	5.695G	50	5.371G	51	5.597G	52	5.396G
53	5.522G	54	5.665G	55	5.624G	56	5.442G
57	5.256G	58	5.482G	59	5.608G	60	5.350G
61	5.433G	62	5.678G	63	5.657G	64	5.397G
65	5.528G	66	5.414G	67	5.303G	68	5.315G
69	5.512G	70	5.655G	71	5.611G	72	5.555G
73	5.666G	74	5.530G	75	5.360G	76	5.476G
77	5.618G	78	5.557G	79	5.472G	80	5.500G
81	5.724G	82	5.461G	83	5.447G	84	5.680G
85	5.292G	86	5.316G	87	5.710G	88	5.426G
89	5.570G	90	5.694G	91	5.621G	92	5.536G
93	5.363G	94	5.357G	95	5.501G	96	5.328G
97	5.417G	98	5.504G	99	5.282G	100	5.488G

Hopping Frequency Sequence Name: HOP_FREQ_SEQ_05							
SEQ#	Frequency (Hz)	SEQ#	Frequency (Hz)	SEQ#	Frequency (Hz)	SEQ#	Frequency (Hz)
1	5.631G	2	5.281G	3	5.564G	4	5.645G
5	5.624G	6	5.429G	7	5.618G	8	5.394G
9	5.610G	10	5.558G	11	5.659G	12	5.531G
13	5.521G	14	5.290G	15	5.399G	16	5.609G
17	5.426G	18	5.425G	19	5.299G	20	5.407G
21	5.560G	22	5.438G	23	5.640G	24	5.644G
25	5.415G	26	5.503G	27	5.361G	28	5.572G
29	5.252G	30	5.316G	31	5.402G	32	5.650G
33	5.304G	34	5.646G	35	5.676G	36	5.536G
37	5.614G	38	5.497G	39	5.469G	40	5.571G
41	5.483G	42	5.265G	43	5.439G	44	5.551G
45	5.675G	46	5.620G	47	5.420G	48	5.493G
49	5.414G	50	5.693G	51	5.325G	52	5.616G
53	5.721G	54	5.674G	55	5.528G	56	5.322G
57	5.720G	58	5.334G	59	5.516G	60	5.549G
61	5.627G	62	5.389G	63	5.294G	64	5.641G
65	5.412G	66	5.368G	67	5.345G	68	5.666G
69	5.685G	70	5.583G	71	5.347G	72	5.615G
73	5.251G	74	5.556G	75	5.581G	76	5.502G
77	5.496G	78	5.365G	79	5.340G	80	5.335G
81	5.453G	82	5.459G	83	5.291G	84	5.696G
85	5.348G	86	5.680G	87	5.266G	88	5.655G
89	5.465G	90	5.270G	91	5.449G	92	5.445G
93	5.700G	94	5.452G	95	5.359G	96	5.263G
97	5.704G	98	5.490G	99	5.454G	100	5.603G

Hopping Frequency Sequence Name: HOP_FREQ_SEQ_06							
SEQ#	Frequency (Hz)	SEQ#	Frequency (Hz)	SEQ#	Frequency (Hz)	SEQ#	Frequency (Hz)
1	5.550G	2	5.353G	3	5.409G	4	5.369G
5	5.552G	6	5.715G	7	5.580G	8	5.398G
9	5.253G	10	5.599G	11	5.393G	12	5.634G
13	5.384G	14	5.671G	15	5.507G	16	5.636G
17	5.301G	18	5.525G	19	5.678G	20	5.474G
21	5.260G	22	5.604G	23	5.417G	24	5.401G
25	5.713G	26	5.381G	27	5.378G	28	5.412G
29	5.641G	30	5.421G	31	5.495G	32	5.540G
33	5.511G	34	5.330G	35	5.323G	36	5.305G
37	5.529G	38	5.490G	39	5.710G	40	5.374G
41	5.722G	42	5.592G	43	5.699G	44	5.575G
45	5.723G	46	5.681G	47	5.262G	48	5.716G
49	5.267G	50	5.394G	51	5.586G	52	5.652G
53	5.291G	54	5.344G	55	5.457G	56	5.392G
57	5.689G	58	5.536G	59	5.255G	60	5.288G
61	5.676G	62	5.535G	63	5.461G	64	5.328G
65	5.506G	66	5.403G	67	5.700G	68	5.612G
69	5.555G	70	5.427G	71	5.705G	72	5.402G
73	5.591G	74	5.521G	75	5.597G	76	5.396G
77	5.548G	78	5.579G	79	5.481G	80	5.707G
81	5.542G	82	5.607G	83	5.628G	84	5.355G
85	5.470G	86	5.500G	87	5.547G	88	5.368G
89	5.358G	90	5.711G	91	5.311G	92	5.265G
93	5.303G	94	5.632G	95	5.679G	96	5.589G
97	5.429G	98	5.539G	99	5.364G	100	5.287G

Hopping Frequency Sequence Name: HOP_FREQ_SEQ_07							
SEQ#	Frequency (Hz)	SEQ#	Frequency (Hz)	SEQ#	Frequency (Hz)	SEQ#	Frequency (Hz)
1	5.318G	2	5.264G	3	5.277G	4	5.489G
5	5.577G	6	5.671G	7	5.535G	8	5.372G
9	5.418G	10	5.591G	11	5.285G	12	5.696G
13	5.506G	14	5.360G	15	5.551G	16	5.362G
17	5.536G	18	5.453G	19	5.378G	20	5.279G
21	5.507G	22	5.713G	23	5.662G	24	5.625G
25	5.583G	26	5.705G	27	5.678G	28	5.332G
29	5.553G	30	5.402G	31	5.382G	32	5.533G
33	5.639G	34	5.367G	35	5.364G	36	5.463G
37	5.594G	38	5.425G	39	5.429G	40	5.287G
41	5.373G	42	5.431G	43	5.319G	44	5.628G
45	5.375G	46	5.658G	47	5.430G	48	5.688G
49	5.619G	50	5.697G	51	5.457G	52	5.613G
53	5.647G	54	5.574G	55	5.337G	56	5.304G
57	5.720G	58	5.715G	59	5.603G	60	5.272G
61	5.284G	62	5.602G	63	5.334G	64	5.660G
65	5.683G	66	5.701G	67	5.359G	68	5.470G
69	5.326G	70	5.297G	71	5.673G	72	5.684G
73	5.497G	74	5.548G	75	5.555G	76	5.666G
77	5.379G	78	5.306G	79	5.523G	80	5.575G
81	5.294G	82	5.627G	83	5.623G	84	5.335G
85	5.685G	86	5.472G	87	5.271G	88	5.343G
89	5.442G	90	5.681G	91	5.646G	92	5.710G
93	5.482G	94	5.288G	95	5.394G	96	5.377G
97	5.525G	98	5.629G	99	5.280G	100	5.473G

Hopping Frequency Sequence Name: HOP_FREQ_SEQ_08							
SEQ#	Frequency (Hz)	SEQ#	Frequency (Hz)	SEQ#	Frequency (Hz)	SEQ#	Frequency (Hz)
1	5.511G	2	5.600G	3	5.304G	4	5.459G
5	5.303G	6	5.310G	7	5.514G	8	5.618G
9	5.620G	10	5.405G	11	5.587G	12	5.585G
13	5.294G	14	5.493G	15	5.687G	16	5.460G
17	5.426G	18	5.356G	19	5.584G	20	5.490G
21	5.629G	22	5.453G	23	5.720G	24	5.512G
25	5.575G	26	5.261G	27	5.379G	28	5.311G
29	5.408G	30	5.700G	31	5.409G	32	5.299G
33	5.650G	34	5.422G	35	5.444G	36	5.344G
37	5.393G	38	5.305G	39	5.515G	40	5.383G
41	5.604G	42	5.395G	43	5.588G	44	5.592G
45	5.545G	46	5.293G	47	5.646G	48	5.378G
49	5.266G	50	5.255G	51	5.546G	52	5.342G
53	5.267G	54	5.680G	55	5.702G	56	5.639G
57	5.517G	58	5.323G	59	5.382G	60	5.396G
61	5.335G	62	5.256G	63	5.686G	64	5.614G
65	5.465G	66	5.628G	67	5.276G	68	5.306G
69	5.315G	70	5.627G	71	5.573G	72	5.537G
73	5.704G	74	5.369G	75	5.536G	76	5.653G
77	5.718G	78	5.542G	79	5.318G	80	5.454G
81	5.257G	82	5.504G	83	5.710G	84	5.452G
85	5.486G	86	5.656G	87	5.717G	88	5.282G
89	5.569G	90	5.429G	91	5.494G	92	5.442G
93	5.271G	94	5.624G	95	5.420G	96	5.397G
97	5.562G	98	5.560G	99	5.477G	100	5.470G

Hopping Frequency Sequence Name: HOP_FREQ_SEQ_09							
SEQ#	Frequency (Hz)	SEQ#	Frequency (Hz)	SEQ#	Frequency (Hz)	SEQ#	Frequency (Hz)
1	5.592G	2	5.412G	3	5.677G	4	5.253G
5	5.401G	6	5.529G	7	5.264G	8	5.348G
9	5.312G	10	5.486G	11	5.281G	12	5.420G
13	5.501G	14	5.415G	15	5.651G	16	5.279G
17	5.395G	18	5.434G	19	5.435G	20	5.441G
21	5.670G	22	5.575G	23	5.406G	24	5.616G
25	5.674G	26	5.373G	27	5.596G	28	5.683G
29	5.291G	30	5.469G	31	5.603G	32	5.715G
33	5.477G	34	5.251G	35	5.634G	36	5.484G
37	5.321G	38	5.545G	39	5.490G	40	5.268G
41	5.450G	42	5.513G	43	5.619G	44	5.482G
45	5.571G	46	5.254G	47	5.456G	48	5.717G
49	5.518G	50	5.527G	51	5.495G	52	5.543G
53	5.694G	54	5.578G	55	5.541G	56	5.645G
57	5.639G	58	5.293G	59	5.270G	60	5.337G
61	5.565G	62	5.675G	63	5.389G	64	5.614G
65	5.330G	66	5.414G	67	5.563G	68	5.503G
69	5.442G	70	5.536G	71	5.687G	72	5.390G
73	5.470G	74	5.328G	75	5.704G	76	5.342G
77	5.551G	78	5.252G	79	5.673G	80	5.326G
81	5.534G	82	5.566G	83	5.275G	84	5.340G
85	5.366G	86	5.573G	87	5.399G	88	5.632G
89	5.463G	90	5.402G	91	5.548G	92	5.304G
93	5.341G	94	5.615G	95	5.665G	96	5.471G
97	5.699G	98	5.598G	99	5.445G	100	5.659G

Hopping Frequency Sequence Name: HOP_FREQ_SEQ_10							
SEQ#	Frequency (Hz)	SEQ#	Frequency (Hz)	SEQ#	Frequency (Hz)	SEQ#	Frequency (Hz)
1	5.518G	2	5.496G	3	5.700G	4	5.625G
5	5.534G	6	5.444G	7	5.548G	8	5.501G
9	5.392G	10	5.541G	11	5.450G	12	5.445G
13	5.284G	14	5.722G	15	5.316G	16	5.506G
17	5.660G	18	5.583G	19	5.421G	20	5.338G
21	5.268G	22	5.632G	23	5.591G	24	5.558G
25	5.658G	26	5.547G	27	5.470G	28	5.620G
29	5.261G	30	5.485G	31	5.462G	32	5.554G
33	5.270G	34	5.286G	35	5.640G	36	5.498G
37	5.709G	38	5.606G	39	5.343G	40	5.645G
41	5.653G	42	5.420G	43	5.564G	44	5.277G
45	5.460G	46	5.290G	47	5.358G	48	5.440G
49	5.371G	50	5.276G	51	5.292G	52	5.575G
53	5.577G	54	5.376G	55	5.359G	56	5.517G
57	5.361G	58	5.519G	59	5.447G	60	5.602G
61	5.561G	62	5.335G	63	5.526G	64	5.711G
65	5.366G	66	5.252G	67	5.287G	68	5.585G
69	5.425G	70	5.300G	71	5.663G	72	5.406G
73	5.469G	74	5.555G	75	5.672G	76	5.415G
77	5.638G	78	5.563G	79	5.639G	80	5.368G
81	5.584G	82	5.458G	83	5.278G	84	5.717G
85	5.272G	86	5.308G	87	5.689G	88	5.542G
89	5.253G	90	5.623G	91	5.412G	92	5.313G
93	5.642G	94	5.511G	95	5.677G	96	5.691G
97	5.687G	98	5.516G	99	5.340G	100	5.294G

Hopping Frequency Sequence Name: HOP_FREQ_SEQ_11							
SEQ#	Frequency (Hz)	SEQ#	Frequency (Hz)	SEQ#	Frequency (Hz)	SEQ#	Frequency (Hz)
1	5.437G	2	5.523G	3	5.399G	4	5.597G
5	5.447G	6	5.420G	7	5.524G	8	5.269G
9	5.327G	10	5.314G	11	5.505G	12	5.525G
13	5.574G	14	5.548G	15	5.328G	16	5.588G
17	5.337G	18	5.299G	19	5.501G	20	5.260G
21	5.461G	22	5.662G	23	5.510G	24	5.498G
25	5.427G	26	5.379G	27	5.714G	28	5.626G
29	5.432G	30	5.416G	31	5.497G	32	5.352G
33	5.333G	34	5.603G	35	5.346G	36	5.578G
37	5.568G	38	5.450G	39	5.536G	40	5.264G
41	5.283G	42	5.595G	43	5.385G	44	5.443G
45	5.585G	46	5.694G	47	5.466G	48	5.604G
49	5.451G	50	5.394G	51	5.429G	52	5.359G
53	5.560G	54	5.602G	55	5.567G	56	5.422G
57	5.512G	58	5.477G	59	5.693G	60	5.251G
61	5.607G	62	5.338G	63	5.331G	64	5.355G
65	5.321G	66	5.709G	67	5.290G	68	5.308G
69	5.409G	70	5.468G	71	5.553G	72	5.713G
73	5.669G	74	5.350G	75	5.634G	76	5.423G
77	5.721G	78	5.457G	79	5.596G	80	5.435G
81	5.544G	82	5.672G	83	5.601G	84	5.517G
85	5.638G	86	5.460G	87	5.540G	88	5.258G
89	5.707G	90	5.616G	91	5.388G	92	5.654G
93	5.256G	94	5.459G	95	5.391G	96	5.646G
97	5.452G	98	5.557G	99	5.637G	100	5.504G

Hopping Frequency Sequence Name: HOP_FREQ_SEQ_12							
SEQ#	Frequency (Hz)	SEQ#	Frequency (Hz)	SEQ#	Frequency (Hz)	SEQ#	Frequency (Hz)
1	5.576G	2	5.677G	3	5.261G	4	5.699G
5	5.436G	6	5.457G	7	5.694G	8	5.655G
9	5.348G	10	5.446G	11	5.412G	12	5.562G
13	5.712G	14	5.524G	15	5.701G	16	5.397G
17	5.507G	18	5.419G	19	5.483G	20	5.422G
21	5.351G	22	5.641G	23	5.623G	24	5.709G
25	5.642G	26	5.583G	27	5.566G	28	5.715G
29	5.269G	30	5.453G	31	5.697G	32	5.533G
33	5.579G	34	5.251G	35	5.361G	36	5.643G
37	5.716G	38	5.674G	39	5.449G	40	5.286G
41	5.360G	42	5.259G	43	5.644G	44	5.455G
45	5.567G	46	5.668G	47	5.696G	48	5.607G
49	5.423G	50	5.413G	51	5.705G	52	5.326G
53	5.646G	54	5.329G	55	5.384G	56	5.450G
57	5.680G	58	5.634G	59	5.411G	60	5.632G
61	5.497G	62	5.345G	63	5.647G	64	5.603G
65	5.570G	66	5.266G	67	5.420G	68	5.722G
69	5.353G	70	5.417G	71	5.577G	72	5.618G
73	5.556G	74	5.563G	75	5.297G	76	5.368G
77	5.282G	78	5.529G	79	5.481G	80	5.356G
81	5.530G	82	5.336G	83	5.462G	84	5.302G
85	5.719G	86	5.611G	87	5.506G	88	5.367G
89	5.675G	90	5.586G	91	5.580G	92	5.434G
93	5.541G	94	5.468G	95	5.301G	96	5.593G
97	5.409G	98	5.493G	99	5.723G	100	5.437G

Hopping Frequency Sequence Name: HOP_FREQ_SEQ_13							
SEQ#	Frequency (Hz)	SEQ#	Frequency (Hz)	SEQ#	Frequency (Hz)	SEQ#	Frequency (Hz)
1	5.349G	2	5.395G	3	5.493G	4	5.408G
5	5.322G	6	5.293G	7	5.389G	8	5.563G
9	5.387G	10	5.534G	11	5.704G	12	5.441G
13	5.490G	14	5.366G	15	5.344G	16	5.697G
17	5.450G	18	5.590G	19	5.657G	20	5.410G
21	5.405G	22	5.719G	23	5.423G	24	5.290G
25	5.527G	26	5.304G	27	5.270G	28	5.373G
29	5.267G	30	5.361G	31	5.318G	32	5.331G
33	5.342G	34	5.687G	35	5.391G	36	5.494G
37	5.659G	38	5.313G	39	5.624G	40	5.268G
41	5.487G	42	5.258G	43	5.272G	44	5.406G
45	5.632G	46	5.633G	47	5.443G	48	5.691G
49	5.394G	50	5.345G	51	5.312G	52	5.588G
53	5.418G	54	5.292G	55	5.696G	56	5.428G
57	5.507G	58	5.525G	59	5.380G	60	5.553G
61	5.655G	62	5.481G	63	5.651G	64	5.596G
65	5.512G	66	5.409G	67	5.707G	68	5.397G
69	5.545G	70	5.365G	71	5.375G	72	5.591G
73	5.635G	74	5.445G	75	5.364G	76	5.252G
77	5.629G	78	5.340G	79	5.326G	80	5.502G
81	5.269G	82	5.547G	83	5.336G	84	5.575G
85	5.500G	86	5.585G	87	5.448G	88	5.564G
89	5.653G	90	5.540G	91	5.504G	92	5.539G
93	5.333G	94	5.532G	95	5.438G	96	5.464G
97	5.356G	98	5.666G	99	5.262G	100	5.642G

Hopping Frequency Sequence Name: HOP_FREQ_SEQ_14							
SEQ#	Frequency (Hz)	SEQ#	Frequency (Hz)	SEQ#	Frequency (Hz)	SEQ#	Frequency (Hz)
1	5.563G	2	5.501G	3	5.390G	4	5.261G
5	5.695G	6	5.603G	7	5.335G	8	5.446G
9	5.409G	10	5.419G	11	5.608G	12	5.308G
13	5.337G	14	5.658G	15	5.483G	16	5.510G
17	5.585G	18	5.303G	19	5.605G	20	5.442G
21	5.598G	22	5.254G	23	5.268G	24	5.584G
25	5.666G	26	5.465G	27	5.568G	28	5.629G
29	5.674G	30	5.353G	31	5.488G	32	5.457G
33	5.703G	34	5.467G	35	5.448G	36	5.657G
37	5.413G	38	5.375G	39	5.400G	40	5.429G
41	5.538G	42	5.580G	43	5.265G	44	5.309G
45	5.253G	46	5.562G	47	5.692G	48	5.496G
49	5.489G	50	5.263G	51	5.557G	52	5.315G
53	5.472G	54	5.329G	55	5.545G	56	5.407G
57	5.521G	58	5.357G	59	5.721G	60	5.471G
61	5.717G	62	5.526G	63	5.661G	64	5.259G
65	5.592G	66	5.264G	67	5.513G	68	5.498G
69	5.348G	70	5.522G	71	5.476G	72	5.290G
73	5.461G	74	5.530G	75	5.571G	76	5.543G
77	5.401G	78	5.619G	79	5.597G	80	5.399G
81	5.706G	82	5.275G	83	5.678G	84	5.647G
85	5.367G	86	5.673G	87	5.434G	88	5.338G
89	5.255G	90	5.464G	91	5.553G	92	5.537G
93	5.459G	94	5.428G	95	5.298G	96	5.403G
97	5.424G	98	5.556G	99	5.339G	100	5.506G

Hopping Frequency Sequence Name: HOP_FREQ_SEQ_15							
SEQ#	Frequency (Hz)	SEQ#	Frequency (Hz)	SEQ#	Frequency (Hz)	SEQ#	Frequency (Hz)
1	5.412G	2	5.285G	3	5.358G	4	5.394G
5	5.431G	6	5.710G	7	5.611G	8	5.258G
9	5.455G	10	5.598G	11	5.426G	12	5.364G
13	5.582G	14	5.525G	15	5.299G	16	5.644G
17	5.628G	18	5.337G	19	5.639G	20	5.257G
21	5.390G	22	5.385G	23	5.319G	24	5.633G
25	5.440G	26	5.464G	27	5.403G	28	5.691G
29	5.327G	30	5.372G	31	5.675G	32	5.435G
33	5.532G	34	5.414G	35	5.510G	36	5.667G
37	5.542G	38	5.254G	39	5.678G	40	5.608G
41	5.567G	42	5.459G	43	5.451G	44	5.427G
45	5.622G	46	5.462G	47	5.356G	48	5.297G
49	5.500G	50	5.261G	51	5.555G	52	5.612G
53	5.338G	54	5.590G	55	5.530G	56	5.513G
57	5.569G	58	5.487G	59	5.506G	60	5.404G
61	5.496G	62	5.361G	63	5.328G	64	5.552G
65	5.714G	66	5.528G	67	5.354G	68	5.672G
69	5.368G	70	5.370G	71	5.653G	72	5.686G
73	5.694G	74	5.442G	75	5.682G	76	5.472G
77	5.700G	78	5.556G	79	5.527G	80	5.359G
81	5.267G	82	5.518G	83	5.689G	84	5.519G
85	5.437G	86	5.434G	87	5.419G	88	5.365G
89	5.517G	90	5.709G	91	5.610G	92	5.409G
93	5.671G	94	5.557G	95	5.304G	96	5.585G
97	5.646G	98	5.617G	99	5.563G	100	5.534G

Hopping Frequency Sequence Name: HOP_FREQ_SEQ_16							
SEQ#	Frequency (Hz)	SEQ#	Frequency (Hz)	SEQ#	Frequency (Hz)	SEQ#	Frequency (Hz)
1	5.369G	2	5.288G	3	5.646G	4	5.430G
5	5.671G	6	5.682G	7	5.584G	8	5.541G
9	5.455G	10	5.581G	11	5.478G	12	5.263G
13	5.317G	14	5.287G	15	5.512G	16	5.529G
17	5.395G	18	5.596G	19	5.428G	20	5.459G
21	5.413G	22	5.397G	23	5.567G	24	5.451G
25	5.600G	26	5.664G	27	5.688G	28	5.383G
29	5.468G	30	5.338G	31	5.598G	32	5.416G
33	5.607G	34	5.253G	35	5.448G	36	5.659G
37	5.580G	38	5.382G	39	5.342G	40	5.367G
41	5.466G	42	5.314G	43	5.437G	44	5.546G
45	5.360G	46	5.381G	47	5.573G	48	5.349G
49	5.635G	50	5.294G	51	5.588G	52	5.696G
53	5.669G	54	5.687G	55	5.533G	56	5.434G
57	5.627G	58	5.398G	59	5.605G	60	5.304G
61	5.711G	62	5.553G	63	5.672G	64	5.595G
65	5.524G	66	5.653G	67	5.648G	68	5.623G
69	5.502G	70	5.608G	71	5.707G	72	5.599G
73	5.439G	74	5.632G	75	5.457G	76	5.385G
77	5.668G	78	5.423G	79	5.587G	80	5.561G
81	5.251G	82	5.339G	83	5.436G	84	5.384G
85	5.351G	86	5.638G	87	5.568G	88	5.334G
89	5.261G	90	5.654G	91	5.355G	92	5.673G
93	5.371G	94	5.266G	95	5.556G	96	5.716G
97	5.303G	98	5.391G	99	5.386G	100	5.578G

Hopping Frequency Sequence Name: HOP_FREQ_SEQ_17							
SEQ#	Frequency (Hz)	SEQ#	Frequency (Hz)	SEQ#	Frequency (Hz)	SEQ#	Frequency (Hz)
1	5.397G	2	5.541G	3	5.530G	4	5.288G
5	5.436G	6	5.519G	7	5.627G	8	5.631G
9	5.456G	10	5.452G	11	5.419G	12	5.636G
13	5.327G	14	5.650G	15	5.673G	16	5.396G
17	5.554G	18	5.705G	19	5.328G	20	5.442G
21	5.355G	22	5.475G	23	5.569G	24	5.381G
25	5.365G	26	5.445G	27	5.362G	28	5.719G
29	5.330G	30	5.493G	31	5.459G	32	5.324G
33	5.497G	34	5.722G	35	5.372G	36	5.645G
37	5.581G	38	5.495G	39	5.711G	40	5.678G
41	5.521G	42	5.539G	43	5.298G	44	5.500G
45	5.556G	46	5.542G	47	5.640G	48	5.608G
49	5.523G	50	5.306G	51	5.538G	52	5.723G
53	5.392G	54	5.618G	55	5.462G	56	5.696G
57	5.479G	58	5.574G	59	5.279G	60	5.307G
61	5.375G	62	5.690G	63	5.634G	64	5.384G
65	5.566G	66	5.433G	67	5.363G	68	5.350G
69	5.661G	70	5.265G	71	5.715G	72	5.465G
73	5.582G	74	5.354G	75	5.551G	76	5.287G
77	5.338G	78	5.441G	79	5.273G	80	5.598G
81	5.534G	82	5.468G	83	5.579G	84	5.502G
85	5.257G	86	5.543G	87	5.639G	88	5.577G
89	5.254G	90	5.552G	91	5.425G	92	5.404G
93	5.361G	94	5.352G	95	5.585G	96	5.578G
97	5.376G	98	5.536G	99	5.691G	100	5.432G

Hopping Frequency Sequence Name: HOP_FREQ_SEQ_18							
SEQ#	Frequency (Hz)	SEQ#	Frequency (Hz)	SEQ#	Frequency (Hz)	SEQ#	Frequency (Hz)
1	5.632G	2	5.429G	3	5.484G	4	5.565G
5	5.691G	6	5.560G	7	5.699G	8	5.402G
9	5.313G	10	5.534G	11	5.260G	12	5.389G
13	5.711G	14	5.409G	15	5.496G	16	5.290G
17	5.713G	18	5.487G	19	5.514G	20	5.472G
21	5.468G	22	5.680G	23	5.354G	24	5.312G
25	5.645G	26	5.693G	27	5.536G	28	5.499G
29	5.592G	30	5.380G	31	5.529G	32	5.572G
33	5.304G	34	5.408G	35	5.681G	36	5.308G
37	5.511G	38	5.374G	39	5.515G	40	5.590G
41	5.471G	42	5.294G	43	5.458G	44	5.655G
45	5.270G	46	5.269G	47	5.672G	48	5.498G
49	5.352G	50	5.721G	51	5.422G	52	5.598G
53	5.276G	54	5.390G	55	5.489G	56	5.555G
57	5.651G	58	5.591G	59	5.597G	60	5.442G
61	5.329G	62	5.671G	63	5.634G	64	5.454G
65	5.462G	66	5.355G	67	5.309G	68	5.475G
69	5.559G	70	5.662G	71	5.701G	72	5.459G
73	5.252G	74	5.543G	75	5.395G	76	5.350G
77	5.465G	78	5.463G	79	5.336G	80	5.470G
81	5.426G	82	5.401G	83	5.411G	84	5.452G
85	5.676G	86	5.524G	87	5.719G	88	5.646G
89	5.324G	90	5.626G	91	5.568G	92	5.334G
93	5.385G	94	5.717G	95	5.332G	96	5.694G
97	5.317G	98	5.495G	99	5.523G	100	5.420G

Hopping Frequency Sequence Name: HOP_FREQ_SEQ_19							
SEQ#	Frequency (Hz)	SEQ#	Frequency (Hz)	SEQ#	Frequency (Hz)	SEQ#	Frequency (Hz)
1	5.535G	2	5.336G	3	5.400G	4	5.605G
5	5.563G	6	5.428G	7	5.499G	8	5.602G
9	5.672G	10	5.537G	11	5.714G	12	5.334G
13	5.538G	14	5.633G	15	5.266G	16	5.553G
17	5.707G	18	5.261G	19	5.582G	20	5.667G
21	5.379G	22	5.702G	23	5.573G	24	5.457G
25	5.481G	26	5.510G	27	5.357G	28	5.575G
29	5.618G	30	5.622G	31	5.356G	32	5.596G
33	5.253G	34	5.384G	35	5.314G	36	5.616G
37	5.669G	38	5.340G	39	5.374G	40	5.632G
41	5.686G	42	5.718G	43	5.412G	44	5.506G
45	5.375G	46	5.272G	47	5.611G	48	5.293G
49	5.496G	50	5.305G	51	5.512G	52	5.699G
53	5.401G	54	5.395G	55	5.586G	56	5.373G
57	5.565G	58	5.525G	59	5.694G	60	5.426G
61	5.678G	62	5.579G	63	5.446G	64	5.592G
65	5.474G	66	5.677G	67	5.328G	68	5.556G
69	5.275G	70	5.486G	71	5.561G	72	5.635G
73	5.270G	74	5.703G	75	5.723G	76	5.327G
77	5.668G	78	5.546G	79	5.654G	80	5.560G
81	5.344G	82	5.313G	83	5.378G	84	5.567G
85	5.511G	86	5.629G	87	5.394G	88	5.468G
89	5.488G	90	5.436G	91	5.645G	92	5.465G
93	5.265G	94	5.578G	95	5.442G	96	5.559G
97	5.717G	98	5.441G	99	5.454G	100	5.393G

Hopping Frequency Sequence Name: HOP_FREQ_SEQ_20							
SEQ#	Frequency (Hz)	SEQ#	Frequency (Hz)	SEQ#	Frequency (Hz)	SEQ#	Frequency (Hz)
1	5.659G	2	5.646G	3	5.553G	4	5.544G
5	5.533G	6	5.658G	7	5.667G	8	5.696G
9	5.283G	10	5.574G	11	5.531G	12	5.607G
13	5.430G	14	5.623G	15	5.470G	16	5.385G
17	5.614G	18	5.423G	19	5.411G	20	5.501G
21	5.632G	22	5.536G	23	5.485G	24	5.576G
25	5.449G	26	5.397G	27	5.401G	28	5.606G
29	5.603G	30	5.580G	31	5.629G	32	5.638G
33	5.507G	34	5.688G	35	5.404G	36	5.627G
37	5.316G	38	5.717G	39	5.654G	40	5.384G
41	5.280G	42	5.434G	43	5.513G	44	5.302G
45	5.395G	46	5.613G	47	5.711G	48	5.472G
49	5.566G	50	5.274G	51	5.346G	52	5.388G
53	5.497G	54	5.672G	55	5.657G	56	5.537G
57	5.573G	58	5.479G	59	5.630G	60	5.693G
61	5.292G	62	5.289G	63	5.597G	64	5.315G
65	5.569G	66	5.545G	67	5.321G	68	5.443G
69	5.489G	70	5.429G	71	5.676G	72	5.555G
73	5.275G	74	5.417G	75	5.628G	76	5.565G
77	5.666G	78	5.294G	79	5.298G	80	5.295G
81	5.296G	82	5.557G	83	5.297G	84	5.564G
85	5.530G	86	5.352G	87	5.637G	88	5.377G
89	5.694G	90	5.382G	91	5.350G	92	5.282G
93	5.543G	94	5.550G	95	5.512G	96	5.568G
97	5.323G	98	5.330G	99	5.488G	100	5.490G

Hopping Frequency Sequence Name: HOP_FREQ_SEQ_21							
SEQ#	Frequency (Hz)	SEQ#	Frequency (Hz)	SEQ#	Frequency (Hz)	SEQ#	Frequency (Hz)
1	5.440G	2	5.482G	3	5.715G	4	5.408G
5	5.448G	6	5.512G	7	5.450G	8	5.352G
9	5.329G	10	5.463G	11	5.250G	12	5.293G
13	5.707G	14	5.341G	15	5.467G	16	5.343G
17	5.564G	18	5.444G	19	5.465G	20	5.308G
21	5.711G	22	5.670G	23	5.339G	24	5.709G
25	5.599G	26	5.405G	27	5.334G	28	5.674G
29	5.669G	30	5.671G	31	5.297G	32	5.328G
33	5.652G	34	5.270G	35	5.486G	36	5.396G
37	5.277G	38	5.479G	39	5.407G	40	5.649G
41	5.495G	42	5.611G	43	5.355G	44	5.386G
45	5.399G	46	5.462G	47	5.484G	48	5.310G
49	5.500G	50	5.718G	51	5.472G	52	5.443G
53	5.340G	54	5.503G	55	5.415G	56	5.608G
57	5.342G	58	5.419G	59	5.299G	60	5.547G
61	5.485G	62	5.687G	63	5.321G	64	5.410G
65	5.420G	66	5.376G	67	5.417G	68	5.686G
69	5.523G	70	5.700G	71	5.594G	72	5.557G
73	5.369G	74	5.704G	75	5.385G	76	5.581G
77	5.701G	78	5.453G	79	5.536G	80	5.580G
81	5.717G	82	5.452G	83	5.344G	84	5.251G
85	5.712G	86	5.555G	87	5.632G	88	5.429G
89	5.268G	90	5.604G	91	5.543G	92	5.641G
93	5.647G	94	5.562G	95	5.521G	96	5.446G
97	5.359G	98	5.637G	99	5.576G	100	5.705G

Hopping Frequency Sequence Name: HOP_FREQ_SEQ_22							
SEQ#	Frequency (Hz)	SEQ#	Frequency (Hz)	SEQ#	Frequency (Hz)	SEQ#	Frequency (Hz)
1	5.481G	2	5.623G	3	5.346G	4	5.289G
5	5.487G	6	5.683G	7	5.692G	8	5.649G
9	5.396G	10	5.276G	11	5.592G	12	5.542G
13	5.398G	14	5.682G	15	5.489G	16	5.611G
17	5.624G	18	5.337G	19	5.378G	20	5.695G
21	5.670G	22	5.583G	23	5.502G	24	5.462G
25	5.406G	26	5.700G	27	5.408G	28	5.657G
29	5.540G	30	5.532G	31	5.719G	32	5.299G
33	5.371G	34	5.323G	35	5.418G	36	5.705G
37	5.693G	38	5.524G	39	5.598G	40	5.591G
41	5.669G	42	5.541G	43	5.324G	44	5.426G
45	5.368G	46	5.571G	47	5.668G	48	5.325G
49	5.260G	50	5.416G	51	5.333G	52	5.676G
53	5.383G	54	5.513G	55	5.525G	56	5.255G
57	5.466G	58	5.625G	59	5.400G	60	5.348G
61	5.572G	62	5.638G	63	5.266G	64	5.559G
65	5.468G	66	5.621G	67	5.251G	68	5.265G
69	5.444G	70	5.254G	71	5.622G	72	5.561G
73	5.459G	74	5.717G	75	5.417G	76	5.687G
77	5.551G	78	5.706G	79	5.718G	80	5.336G
81	5.522G	82	5.651G	83	5.671G	84	5.305G
85	5.685G	86	5.640G	87	5.617G	88	5.708G
89	5.347G	90	5.450G	91	5.369G	92	5.318G
93	5.461G	94	5.303G	95	5.660G	96	5.330G
97	5.288G	98	5.379G	99	5.608G	100	5.449G

Hopping Frequency Sequence Name: HOP_FREQ_SEQ_23							
SEQ#	Frequency (Hz)	SEQ#	Frequency (Hz)	SEQ#	Frequency (Hz)	SEQ#	Frequency (Hz)
1	5.716G	2	5.412G	3	5.724G	4	5.649G
5	5.531G	6	5.618G	7	5.534G	8	5.699G
9	5.701G	10	5.525G	11	5.590G	12	5.720G
13	5.340G	14	5.440G	15	5.372G	16	5.461G
17	5.389G	18	5.275G	19	5.452G	20	5.451G
21	5.658G	22	5.483G	23	5.533G	24	5.393G
25	5.642G	26	5.516G	27	5.630G	28	5.471G
29	5.322G	30	5.410G	31	5.485G	32	5.604G
33	5.467G	34	5.304G	35	5.650G	36	5.327G
37	5.586G	38	5.648G	39	5.268G	40	5.257G
41	5.564G	42	5.346G	43	5.593G	44	5.592G
45	5.442G	46	5.626G	47	5.610G	48	5.625G
49	5.373G	50	5.594G	51	5.601G	52	5.441G
53	5.654G	54	5.383G	55	5.271G	56	5.694G
57	5.678G	58	5.405G	59	5.709G	60	5.714G
61	5.526G	62	5.295G	63	5.687G	64	5.579G
65	5.609G	66	5.632G	67	5.319G	68	5.400G
69	5.599G	70	5.547G	71	5.431G	72	5.572G
73	5.598G	74	5.392G	75	5.450G	76	5.365G
77	5.299G	78	5.514G	79	5.635G	80	5.505G
81	5.321G	82	5.426G	83	5.256G	84	5.263G
85	5.634G	86	5.345G	87	5.342G	88	5.669G
89	5.476G	90	5.646G	91	5.251G	92	5.333G
93	5.611G	94	5.445G	95	5.510G	96	5.307G
97	5.448G	98	5.513G	99	5.376G	100	5.464G

Hopping Frequency Sequence Name: HOP_FREQ_SEQ_24							
SEQ#	Frequency (Hz)	SEQ#	Frequency (Hz)	SEQ#	Frequency (Hz)	SEQ#	Frequency (Hz)
1	5.632G	2	5.617G	3	5.551G	4	5.529G
5	5.436G	6	5.571G	7	5.416G	8	5.669G
9	5.506G	10	5.389G	11	5.719G	12	5.679G
13	5.609G	14	5.295G	15	5.367G	16	5.255G
17	5.310G	18	5.531G	19	5.717G	20	5.314G
21	5.655G	22	5.414G	23	5.612G	24	5.479G
25	5.377G	26	5.404G	27	5.336G	28	5.692G
29	5.561G	30	5.319G	31	5.656G	32	5.712G
33	5.549G	34	5.449G	35	5.610G	36	5.579G
37	5.665G	38	5.628G	39	5.553G	40	5.627G
41	5.372G	42	5.587G	43	5.483G	44	5.538G
45	5.433G	46	5.275G	47	5.453G	48	5.671G
49	5.478G	50	5.437G	51	5.370G	52	5.334G
53	5.289G	54	5.403G	55	5.324G	56	5.474G
57	5.535G	58	5.663G	59	5.658G	60	5.446G
61	5.484G	62	5.311G	63	5.591G	64	5.564G
65	5.708G	66	5.526G	67	5.439G	68	5.351G
69	5.357G	70	5.664G	71	5.510G	72	5.567G
73	5.696G	74	5.605G	75	5.557G	76	5.323G
77	5.274G	78	5.555G	79	5.624G	80	5.659G
81	5.384G	82	5.283G	83	5.554G	84	5.445G
85	5.674G	86	5.423G	87	5.651G	88	5.298G
89	5.320G	90	5.316G	91	5.381G	92	5.430G
93	5.566G	94	5.465G	95	5.616G	96	5.405G
97	5.299G	98	5.662G	99	5.512G	100	5.643G

Hopping Frequency Sequence Name: HOP_FREQ_SEQ_25							
SEQ#	Frequency (Hz)	SEQ#	Frequency (Hz)	SEQ#	Frequency (Hz)	SEQ#	Frequency (Hz)
1	5.639G	2	5.344G	3	5.621G	4	5.542G
5	5.525G	6	5.461G	7	5.695G	8	5.358G
9	5.627G	10	5.582G	11	5.449G	12	5.281G
13	5.479G	14	5.357G	15	5.285G	16	5.567G
17	5.484G	18	5.271G	19	5.445G	20	5.571G
21	5.453G	22	5.391G	23	5.341G	24	5.499G
25	5.708G	26	5.361G	27	5.685G	28	5.634G
29	5.383G	30	5.570G	31	5.631G	32	5.515G
33	5.558G	34	5.276G	35	5.526G	36	5.265G
37	5.661G	38	5.687G	39	5.435G	40	5.697G
41	5.296G	42	5.284G	43	5.368G	44	5.309G
45	5.495G	46	5.682G	47	5.345G	48	5.434G
49	5.642G	50	5.275G	51	5.716G	52	5.596G
53	5.707G	54	5.307G	55	5.351G	56	5.295G
57	5.478G	58	5.630G	59	5.269G	60	5.660G
61	5.282G	62	5.486G	63	5.662G	64	5.417G
65	5.444G	66	5.557G	67	5.603G	68	5.333G
69	5.619G	70	5.601G	71	5.314G	72	5.510G
73	5.279G	74	5.645G	75	5.396G	76	5.420G
77	5.584G	78	5.326G	79	5.260G	80	5.659G
81	5.532G	82	5.379G	83	5.431G	84	5.507G
85	5.518G	86	5.467G	87	5.412G	88	5.580G
89	5.372G	90	5.308G	91	5.401G	92	5.537G
93	5.455G	94	5.604G	95	5.393G	96	5.672G
97	5.541G	98	5.643G	99	5.365G	100	5.463G

Hopping Frequency Sequence Name: HOP_FREQ_SEQ_26							
SEQ#	Frequency (Hz)	SEQ#	Frequency (Hz)	SEQ#	Frequency (Hz)	SEQ#	Frequency (Hz)
1	5.428G	2	5.637G	3	5.611G	4	5.704G
5	5.718G	6	5.287G	7	5.644G	8	5.411G
9	5.709G	10	5.493G	11	5.350G	12	5.614G
13	5.257G	14	5.447G	15	5.299G	16	5.294G
17	5.377G	18	5.457G	19	5.609G	20	5.703G
21	5.448G	22	5.417G	23	5.389G	24	5.385G
25	5.357G	26	5.450G	27	5.528G	28	5.536G
29	5.489G	30	5.358G	31	5.712G	32	5.271G
33	5.529G	34	5.264G	35	5.329G	36	5.361G
37	5.320G	38	5.713G	39	5.514G	40	5.583G
41	5.253G	42	5.443G	43	5.484G	44	5.362G
45	5.680G	46	5.283G	47	5.664G	48	5.424G
49	5.569G	50	5.656G	51	5.300G	52	5.373G
53	5.636G	54	5.596G	55	5.434G	56	5.557G
57	5.354G	58	5.627G	59	5.587G	60	5.376G
61	5.655G	62	5.251G	63	5.585G	64	5.695G
65	5.293G	66	5.710G	67	5.367G	68	5.446G
69	5.334G	70	5.435G	71	5.595G	72	5.379G
73	5.398G	74	5.551G	75	5.653G	76	5.401G
77	5.423G	78	5.275G	79	5.510G	80	5.488G
81	5.553G	82	5.254G	83	5.699G	84	5.708G
85	5.280G	86	5.292G	87	5.286G	88	5.544G
89	5.395G	90	5.459G	91	5.487G	92	5.455G
93	5.547G	94	5.391G	95	5.560G	96	5.625G
97	5.501G	98	5.612G	99	5.512G	100	5.556G

Hopping Frequency Sequence Name: HOP_FREQ_SEQ_27							
SEQ#	Frequency (Hz)	SEQ#	Frequency (Hz)	SEQ#	Frequency (Hz)	SEQ#	Frequency (Hz)
1	5.291G	2	5.612G	3	5.548G	4	5.673G
5	5.268G	6	5.410G	7	5.699G	8	5.668G
9	5.600G	10	5.288G	11	5.431G	12	5.470G
13	5.714G	14	5.391G	15	5.651G	16	5.377G
17	5.539G	18	5.253G	19	5.645G	20	5.501G
21	5.684G	22	5.423G	23	5.565G	24	5.561G
25	5.724G	26	5.426G	27	5.681G	28	5.608G
29	5.683G	30	5.328G	31	5.283G	32	5.558G
33	5.589G	34	5.461G	35	5.368G	36	5.659G
37	5.256G	38	5.710G	39	5.322G	40	5.617G
41	5.555G	42	5.522G	43	5.424G	44	5.705G
45	5.304G	46	5.415G	47	5.356G	48	5.469G
49	5.582G	50	5.496G	51	5.513G	52	5.642G
53	5.401G	54	5.272G	55	5.579G	56	5.455G
57	5.385G	58	5.489G	59	5.662G	60	5.716G
61	5.605G	62	5.528G	63	5.347G	64	5.483G
65	5.281G	66	5.263G	67	5.601G	68	5.613G
69	5.417G	70	5.620G	71	5.587G	72	5.351G
73	5.367G	74	5.441G	75	5.418G	76	5.721G
77	5.359G	78	5.557G	79	5.687G	80	5.619G
81	5.708G	82	5.676G	83	5.350G	84	5.704G
85	5.429G	86	5.664G	87	5.419G	88	5.498G
89	5.262G	90	5.698G	91	5.310G	92	5.433G
93	5.422G	94	5.656G	95	5.652G	96	5.494G
97	5.428G	98	5.543G	99	5.518G	100	5.615G

Hopping Frequency Sequence Name: HOP_FREQ_SEQ_28							
SEQ#	Frequency (Hz)	SEQ#	Frequency (Hz)	SEQ#	Frequency (Hz)	SEQ#	Frequency (Hz)
1	5.369G	2	5.605G	3	5.405G	4	5.277G
5	5.613G	6	5.500G	7	5.427G	8	5.490G
9	5.279G	10	5.353G	11	5.579G	12	5.581G
13	5.691G	14	5.377G	15	5.635G	16	5.723G
17	5.662G	18	5.672G	19	5.638G	20	5.435G
21	5.271G	22	5.310G	23	5.325G	24	5.455G
25	5.562G	26	5.419G	27	5.495G	28	5.483G
29	5.504G	30	5.697G	31	5.713G	32	5.587G
33	5.529G	34	5.503G	35	5.481G	36	5.505G
37	5.716G	38	5.453G	39	5.698G	40	5.602G
41	5.364G	42	5.614G	43	5.521G	44	5.418G
45	5.376G	46	5.689G	47	5.251G	48	5.619G
49	5.286G	50	5.686G	51	5.485G	52	5.650G
53	5.415G	54	5.475G	55	5.340G	56	5.371G
57	5.295G	58	5.299G	59	5.688G	60	5.578G
61	5.706G	62	5.551G	63	5.520G	64	5.724G
65	5.588G	66	5.622G	67	5.438G	68	5.319G
69	5.400G	70	5.454G	71	5.265G	72	5.282G
73	5.573G	74	5.432G	75	5.327G	76	5.306G
77	5.667G	78	5.668G	79	5.679G	80	5.300G
81	5.443G	82	5.386G	83	5.368G	84	5.705G
85	5.291G	86	5.555G	87	5.502G	88	5.423G
89	5.701G	90	5.592G	91	5.634G	92	5.285G
93	5.558G	94	5.488G	95	5.337G	96	5.480G
97	5.426G	98	5.390G	99	5.526G	100	5.700G

Hopping Frequency Sequence Name: HOP_FREQ_SEQ_29							
SEQ#	Frequency (Hz)	SEQ#	Frequency (Hz)	SEQ#	Frequency (Hz)	SEQ#	Frequency (Hz)
1	5.276G	2	5.446G	3	5.404G	4	5.334G
5	5.339G	6	5.338G	7	5.693G	8	5.522G
9	5.295G	10	5.653G	11	5.528G	12	5.541G
13	5.464G	14	5.676G	15	5.360G	16	5.629G
17	5.468G	18	5.636G	19	5.624G	20	5.298G
21	5.316G	22	5.651G	23	5.657G	24	5.390G
25	5.521G	26	5.387G	27	5.280G	28	5.534G
29	5.302G	30	5.341G	31	5.342G	32	5.413G
33	5.654G	34	5.275G	35	5.489G	36	5.554G
37	5.459G	38	5.496G	39	5.437G	40	5.444G
41	5.538G	42	5.591G	43	5.304G	44	5.520G
45	5.283G	46	5.325G	47	5.660G	48	5.707G
49	5.677G	50	5.259G	51	5.559G	52	5.386G
53	5.501G	54	5.410G	55	5.441G	56	5.384G
57	5.447G	58	5.337G	59	5.273G	60	5.645G
61	5.429G	62	5.398G	63	5.504G	64	5.291G
65	5.419G	66	5.564G	67	5.354G	68	5.597G
69	5.530G	70	5.411G	71	5.445G	72	5.336G
73	5.627G	74	5.409G	75	5.535G	76	5.292G
77	5.599G	78	5.583G	79	5.359G	80	5.277G
81	5.639G	82	5.697G	83	5.266G	84	5.555G
85	5.422G	86	5.290G	87	5.498G	88	5.692G
89	5.402G	90	5.670G	91	5.718G	92	5.281G
93	5.561G	94	5.366G	95	5.592G	96	5.250G
97	5.450G	98	5.423G	99	5.395G	100	5.678G

Hopping Frequency Sequence Name: HOP_FREQ_SEQ_30							
SEQ#	Frequency (Hz)	SEQ#	Frequency (Hz)	SEQ#	Frequency (Hz)	SEQ#	Frequency (Hz)
1	5.608G	2	5.566G	3	5.636G	4	5.493G
5	5.556G	6	5.536G	7	5.540G	8	5.537G
9	5.391G	10	5.456G	11	5.459G	12	5.597G
13	5.412G	14	5.708G	15	5.702G	16	5.594G
17	5.642G	18	5.612G	19	5.290G	20	5.582G
21	5.294G	22	5.467G	23	5.437G	24	5.285G
25	5.295G	26	5.532G	27	5.541G	28	5.516G
29	5.476G	30	5.505G	31	5.639G	32	5.515G
33	5.551G	34	5.587G	35	5.429G	36	5.514G
37	5.338G	38	5.694G	39	5.458G	40	5.323G
41	5.403G	42	5.625G	43	5.640G	44	5.324G
45	5.469G	46	5.662G	47	5.638G	48	5.308G
49	5.428G	50	5.620G	51	5.377G	52	5.374G
53	5.615G	54	5.670G	55	5.457G	56	5.419G
57	5.682G	58	5.534G	59	5.496G	60	5.663G
61	5.557G	62	5.438G	63	5.288G	64	5.355G
65	5.649G	66	5.253G	67	5.710G	68	5.443G
69	5.721G	70	5.510G	71	5.650G	72	5.359G
73	5.569G	74	5.372G	75	5.574G	76	5.423G
77	5.466G	78	5.688G	79	5.382G	80	5.337G
81	5.533G	82	5.463G	83	5.448G	84	5.401G
85	5.341G	86	5.431G	87	5.722G	88	5.656G
89	5.455G	90	5.538G	91	5.489G	92	5.546G
93	5.585G	94	5.611G	95	5.554G	96	5.309G
97	5.672G	98	5.512G	99	5.396G	100	5.420G

IEEE 802.11ac VHT40

Type 1 Radar Statistical Performances

Trial #	Pulses per Burst	Pulse Width (s)	PRI (s)	Radar Frequency (MHz)	Detection
1	102	1.0u	518.0u	5491	Yes
2	95	1.0u	558.0u	5493	Yes
3	89	1.0u	598.0u	5494	Yes
4	83	1.0u	638.0u	5495	Yes
5	78	1.0u	678.0u	5497	Yes
6	76	1.0u	698.0u	5499	Yes
7	74	1.0u	718.0u	5500	Yes
8	72	1.0u	738.0u	5501	Yes
9	68	1.0u	778.0u	5503	Yes
10	67	1.0u	798.0u	5505	Yes
11	63	1.0u	838.0u	5506	Yes
12	62	1.0u	858.0u	5507	Yes
13	59	1.0u	898.0u	5508	Yes
14	58	1.0u	918.0u	5509	Yes
15	57	1.0u	938.0u	5510	Yes
16	66	1.0u	805.0u	5512	Yes
17	63	1.0u	845.0u	5513	Yes
18	60	1.0u	885.0u	5514	Yes
19	59	1.0u	905.0u	5516	Yes
20	69	1.0u	771.0u	5517	Yes
21	66	1.0u	811.0u	5519	Yes
22	63	1.0u	851.0u	5520	Yes
23	60	1.0u	891.0u	5522	Yes
24	58	1.0u	911.0u	5523	Yes
25	92	1.0u	577.0u	5524	Yes
26	86	1.0u	617.0u	5525	Yes
27	78	1.0u	677.0u	5526	Yes
28	74	1.0u	717.0u	5527	Yes
29	68	1.0u	777.0u	5528	Yes
30	58	1.0u	917.0u	5529	Yes

Detection Rate: 100.0 %

Type 2 Radar Statistical Performances					
Trial #	Pulses per Burst	Pulse Width (s)	PRI (s)	Radar Frequency (MHz)	Detection
1	25	4.6u	200.0u	5491	Yes
2	27	2.8u	200.0u	5493	Yes
3	27	1.7u	161.0u	5494	Yes
4	28	2.6u	220.0u	5495	Yes
5	27	2.6u	218.0u	5497	No
6	27	1.7u	172.0u	5499	Yes
7	26	1.6u	191.0u	5500	No
8	25	3.7u	158.0u	5501	Yes
9	28	1.5u	228.0u	5503	Yes
10	26	4.9u	198.0u	5505	Yes
11	28	1.3u	205.0u	5506	Yes
12	29	2.6u	155.0u	5507	Yes
13	28	4.9u	224.0u	5508	Yes
14	24	2.9u	169.0u	5509	Yes
15	28	4.1u	183.0u	5510	No
16	27	1.7u	192.0u	5512	Yes
17	24	2.6u	191.0u	5513	Yes
18	27	4.6u	173.0u	5514	Yes
19	28	3.4u	187.0u	5516	No
20	27	4.3u	214.0u	5517	Yes
21	29	1.2u	179.0u	5519	Yes
22	25	1.1u	154.0u	5520	Yes
23	25	4.1u	159.0u	5522	Yes
24	28	2.9u	158.0u	5523	Yes
25	25	2.8u	215.0u	5524	Yes
26	27	4.0u	196.0u	5525	Yes
27	27	4.5u	215.0u	5526	Yes
28	27	2.9u	180.0u	5527	Yes
29	27	1.5u	177.0u	5528	No
30	28	1.6u	186.0u	5529	Yes

Detection Rate: 83.3 %

Type 3 Radar Statistical Performances					
Trial #	Pulses per Burst	Pulse Width (s)	PRI (s)	Radar Frequency (MHz)	Detection
1	17	9.6u	218.0u	5491	Yes
2	18	8.4u	494.0u	5493	Yes
3	17	8.7u	375.0u	5494	No
4	18	7.0u	379.0u	5495	Yes
5	17	8.9u	401.0u	5497	Yes
6	17	8.3u	348.0u	5499	Yes
7	16	6.2u	454.0u	5500	Yes
8	18	9.2u	299.0u	5501	Yes
9	16	9.6u	347.0u	5503	No
10	16	7.0u	293.0u	5505	Yes
11	17	9.7u	434.0u	5506	Yes
12	16	9.5u	405.0u	5507	Yes
13	17	9.0u	459.0u	5508	Yes
14	18	6.2u	349.0u	5509	Yes
15	17	7.9u	225.0u	5510	Yes
16	18	8.0u	384.0u	5512	Yes
17	17	6.5u	220.0u	5513	No
18	16	8.4u	225.0u	5514	Yes
19	17	6.1u	210.0u	5516	Yes
20	16	6.0u	260.0u	5517	No
21	18	9.1u	470.0u	5519	Yes
22	16	7.1u	474.0u	5520	Yes
23	18	9.1u	433.0u	5522	Yes
24	18	9.1u	296.0u	5523	Yes
25	16	8.5u	368.0u	5524	Yes
26	16	6.4u	315.0u	5525	No
27	17	6.9u	204.0u	5526	Yes
28	18	6.8u	309.0u	5527	Yes
29	17	9.2u	351.0u	5528	Yes
30	17	9.0u	201.0u	5529	No

Detection Rate: 80.0 %

Type 4 Radar Statistical Performances					
Trial #	Pulses per Burst	Pulse Width (s)	PRI (s)	Radar Frequency (MHz)	Detection
1	14	14.3u	312.0u	5491	Yes
2	13	18.3u	368.0u	5493	No
3	13	18.4u	392.0u	5494	No
4	16	14.9u	457.0u	5495	Yes
5	13	15.9u	337.0u	5497	Yes
6	14	13.7u	413.0u	5499	Yes
7	13	13.6u	263.0u	5500	Yes
8	14	11.2u	484.0u	5501	No
9	12	11.6u	341.0u	5503	Yes
10	14	18.2u	448.0u	5505	Yes
11	14	14.2u	423.0u	5506	Yes
12	14	12.4u	470.0u	5507	Yes
13	13	18.0u	336.0u	5508	Yes
14	15	17.8u	213.0u	5509	Yes
15	14	11.8u	297.0u	5510	Yes
16	15	16.6u	436.0u	5512	Yes
17	15	16.8u	298.0u	5513	Yes
18	13	14.9u	459.0u	5514	No
19	14	19.5u	286.0u	5516	Yes
20	16	18.4u	462.0u	5517	Yes
21	15	19.0u	314.0u	5519	Yes
22	15	16.2u	284.0u	5520	Yes
23	13	16.9u	396.0u	5522	Yes
24	15	14.9u	202.0u	5523	Yes
25	14	17.8u	492.0u	5524	Yes
26	12	14.2u	451.0u	5525	Yes
27	12	18.2u	350.0u	5526	Yes
28	15	14.7u	204.0u	5527	No
29	12	16.6u	418.0u	5528	Yes
30	13	14.1u	218.0u	5529	Yes

Detection Rate: 83.3 %

Type 5 Radar Statistical Performances		
Trial #	Test Signal Name	Detection
1	LP_Signal_01	Yes
2	LP_Signal_02	Yes
3	LP_Signal_03	Yes
4	LP_Signal_04	Yes
5	LP_Signal_05	Yes
6	LP_Signal_06	Yes
7	LP_Signal_07	Yes
8	LP_Signal_08	Yes
9	LP_Signal_09	Yes
10	LP_Signal_10	Yes
11	LP_Signal_11	Yes
12	LP_Signal_12	No
13	LP_Signal_13	Yes
14	LP_Signal_14	No
15	LP_Signal_15	No
16	LP_Signal_16	Yes
17	LP_Signal_17	Yes
18	LP_Signal_18	Yes
19	LP_Signal_19	Yes
20	LP_Signal_20	Yes
21	LP_Signal_21	Yes
22	LP_Signal_22	Yes
23	LP_Signal_23	Yes
24	LP_Signal_24	Yes
25	LP_Signal_25	Yes
26	LP_Signal_26	Yes
27	LP_Signal_27	Yes
28	LP_Signal_28	Yes
29	LP_Signal_29	Yes
30	LP_Signal_30	Yes
		Detection Rate: 90.0 %

Long Pulse Radar Test Signal						
Test Signal Name: LP_Signal_01						
Number of Bursts in Trial: 19						
Chrip Center Frequency: 5493MHz						
Burst	Pulses per Burst	Chrip (Hz)	Pulse Width (s)	Pulse 1 to 2 Spacing (s)	Pulse 2 to 3 Spacing (s)	Start Location (s)
1	2	5M	50.4u	1.916m	-	334.6m
2	2	5M	54.2u	1.760m	-	40.17m
3	2	5M	66.7u	1.591m	-	375.0m
4	1	5M	81.8u	-	-	224.8m
5	3	5M	85.3u	1.562m	1.550m	598.5m
6	2	5M	50.9u	1.097m	-	247.8m
7	3	5M	71.5u	1.403m	1.250m	384.9m
8	1	5M	57.3u	-	-	545.1m
9	1	5M	99.4u	-	-	327.7m
10	2	5M	81.7u	1.762m	-	346.5m
11	3	5M	87.0u	1.625m	1.683m	237.2m
12	2	5M	94.9u	1.522m	-	585.4m
13	2	5M	83.5u	1.529m	-	480.1m
14	2	5M	66.1u	1.677m	-	545.9m
15	2	5M	52.9u	1.709m	-	563.8m
16	3	5M	51.5u	1.865m	1.887m	433.2m
17	1	5M	82.8u	-	-	4.846m
18	2	5M	84.6u	957.4u	-	397.1m
19	3	5M	70.6u	1.247m	1.791m	432.2m

Long Pulse Radar Test Signal						
Test Signal Name: LP_Signal_02						
Number of Bursts in Trial: 13						
Chrip Center Frequency: 5493MHz						
Burst	Pulses per Burst	Chrip (Hz)	Pulse Width (s)	Pulse 1 to 2 Spacing (s)	Pulse 2 to 3 Spacing (s)	Start Location (s)
1	2	5M	64.2u	1.510m	-	171.7m
2	2	5M	85.7u	1.457m	-	23.95m
3	3	5M	93.8u	1.348m	1.769m	685.0m
4	3	5M	85.1u	1.065m	1.624m	112.8m
5	1	5M	84.7u	-	-	797.2m
6	2	5M	80.4u	1.702m	-	14.43m
7	1	5M	98.4u	-	-	314.4m
8	2	5M	71.1u	1.369m	-	529.1m
9	1	5M	98.6u	-	-	667.9m
10	2	5M	91.7u	1.176m	-	571.6m
11	2	5M	69.1u	1.770m	-	615.7m
12	2	5M	90.9u	1.511m	-	676.8m
13	2	5M	89.6u	1.199m	-	683.8m

Long Pulse Radar Test Signal
 Test Signal Name: LP_Signal_03
 Number of Bursts in Trial: 9
 Chrip Center Frequency: 5494MHz

Burst	Pulses per Burst	Chrip (Hz)	Pulse Width (s)	Pulse 1 to 2 Spacing (s)	Pulse 2 to 3 Spacing (s)	Start Location (s)
1	3	8M	71.1u	1.222m	1.413m	444.6m
2	2	8M	59.0u	1.893m	-	289.7m
3	2	8M	60.7u	1.211m	-	933.9m
4	3	8M	68.6u	1.430m	1.751m	827.1m
5	3	8M	78.0u	1.707m	1.351m	65.79m
6	3	8M	95.0u	1.577m	1.175m	1.235
7	2	8M	94.0u	1.043m	-	1.170
8	2	8M	82.2u	1.181m	-	463.7m
9	1	8M	55.8u	-	-	543.3m

Long Pulse Radar Test Signal
 Test Signal Name: LP_Signal_04
 Number of Bursts in Trial: 11
 Chrip Center Frequency: 5494MHz

Burst	Pulses per Burst	Chrip (Hz)	Pulse Width (s)	Pulse 1 to 2 Spacing (s)	Pulse 2 to 3 Spacing (s)	Start Location (s)
1	3	8M	77.4u	1.030m	976.6u	796.6m
2	1	8M	67.0u	-	-	626.7m
3	2	8M	66.8u	1.592m	-	230.3m
4	2	8M	96.2u	1.786m	-	706.5m
5	1	8M	73.5u	-	-	809.0m
6	3	8M	64.8u	1.909m	1.249m	95.29m
7	3	8M	69.4u	1.248m	1.386m	601.9m
8	2	8M	98.4u	1.041m	-	333.4m
9	1	8M	86.7u	-	-	201.6m
10	2	8M	76.0u	1.466m	-	691.6m
11	3	8M	64.9u	1.673m	1.042m	635.0m

Long Pulse Radar Test Signal
 Test Signal Name: LP_Signal_05
 Number of Bursts in Trial: 12
 Chrip Center Frequency: 5496MHz

Burst	Pulses per Burst	Chrip (Hz)	Pulse Width (s)	Pulse 1 to 2 Spacing (s)	Pulse 2 to 3 Spacing (s)	Start Location (s)
1	2	13M	71.5u	982.5u	-	86.36m
2	1	13M	89.8u	-	-	993.6m
3	1	13M	83.2u	-	-	30.83m
4	1	13M	59.2u	-	-	837.0m
5	1	13M	68.7u	-	-	229.0m
6	2	13M	96.4u	1.547m	-	543.5m
7	2	13M	84.2u	1.813m	-	108.2m
8	1	13M	61.5u	-	-	194.1m
9	2	13M	87.9u	1.451m	-	603.2m
10	1	13M	94.3u	-	-	285.9m
11	2	13M	61.6u	1.018m	-	423.4m
12	2	13M	55.8u	1.245m	-	287.7m

Long Pulse Radar Test Signal						
Test Signal Name: LP_Signal_06						
Number of Bursts in Trial: 10						
Chrip Center Frequency: 5496MHz						
Burst	Pulses per Burst	Chrip (Hz)	Pulse Width (s)	Pulse 1 to 2 Spacing (s)	Pulse 2 to 3 Spacing (s)	Start Location (s)
1	1	13M	67.5u	-	-	502.0m
2	1	13M	88.4u	-	-	240.1m
3	1	13M	65.8u	-	-	262.9m
4	2	13M	62.4u	1.503m	-	341.2m
5	1	13M	95.6u	-	-	958.2m
6	3	13M	62.0u	1.724m	1.096m	947.7m
7	1	13M	52.1u	-	-	612.1m
8	2	13M	50.7u	1.853m	-	1.171
9	2	13M	88.5u	1.693m	-	992.4m
10	2	13M	51.3u	1.595m	-	447.5m

Long Pulse Radar Test Signal						
Test Signal Name: LP_Signal_07						
Number of Bursts in Trial: 17						
Chrip Center Frequency: 5497MHz						
Burst	Pulses per Burst	Chrip (Hz)	Pulse Width (s)	Pulse 1 to 2 Spacing (s)	Pulse 2 to 3 Spacing (s)	Start Location (s)
1	2	15M	73.3u	1.117m	-	263.9m
2	3	15M	77.1u	1.610m	1.018m	283.7m
3	2	15M	70.2u	1.453m	-	47.73m
4	2	15M	84.6u	1.444m	-	566.8m
5	3	15M	82.8u	1.477m	1.433m	572.1m
6	2	15M	95.2u	987.8u	-	614.1m
7	3	15M	95.3u	1.243m	1.697m	22.08m
8	3	15M	59.7u	1.441m	1.343m	23.27m
9	3	15M	69.3u	1.787m	1.428m	620.8m
10	2	15M	75.3u	1.838m	-	693.6m
11	3	15M	91.2u	1.427m	1.347m	498.9m
12	3	15M	91.2u	1.212m	1.579m	309.3m
13	2	15M	94.7u	1.191m	-	266.5m
14	3	15M	98.4u	1.552m	1.534m	614.4m
15	3	15M	54.0u	1.482m	990.0u	449.2m
16	2	15M	74.1u	1.675m	-	613.7m
17	2	15M	83.4u	1.632m	-	699.8m

Long Pulse Radar Test Signal						
Test Signal Name: LP_Signal_08						
Number of Bursts in Trial: 9						
Chrip Center Frequency: 5497MHz						
Burst	Pulses per Burst	Chrip (Hz)	Pulse Width (s)	Pulse 1 to 2 Spacing (s)	Pulse 2 to 3 Spacing (s)	Start Location (s)
1	1	15M	97.5u	-	-	471.5m
2	3	15M	52.7u	1.940m	1.267m	85.10m
3	2	15M	85.6u	1.832m	-	606.7m
4	3	15M	93.9u	1.311m	1.757m	129.9m
5	2	15M	77.8u	1.140m	-	697.6m
6	2	15M	55.9u	1.283m	-	587.3m
7	3	15M	77.8u	1.001m	1.712m	269.7m
8	2	15M	54.8u	1.560m	-	1.196
9	2	15M	54.1u	1.552m	-	817.5m

Long Pulse Radar Test Signal						
Test Signal Name: LP_Signal_09						
Number of Bursts in Trial: 13						
Chrip Center Frequency: 5499MHz						
Burst	Pulses per Burst	Chrip (Hz)	Pulse Width (s)	Pulse 1 to 2 Spacing (s)	Pulse 2 to 3 Spacing (s)	Start Location (s)
1	3	20M	99.7u	1.511m	1.864m	57.55m
2	2	20M	62.6u	1.651m	-	208.8m
3	2	20M	78.6u	1.897m	-	188.5m
4	3	20M	92.7u	1.075m	1.701m	713.1m
5	2	20M	84.2u	1.551m	-	875.0m
6	2	20M	71.6u	1.165m	-	311.7m
7	1	20M	67.9u	-	-	735.6m
8	3	20M	54.0u	1.098m	1.873m	138.9m
9	1	20M	82.3u	-	-	262.2m
10	2	20M	63.4u	1.368m	-	14.73m
11	2	20M	64.4u	1.845m	-	637.0m
12	2	20M	90.9u	1.294m	-	356.2m
13	1	20M	96.9u	-	-	536.0m

Long Pulse Radar Test Signal						
Test Signal Name: LP_Signal_10						
Number of Bursts in Trial: 18						
Chrip Center Frequency: 5499MHz						
Burst	Pulses per Burst	Chrip (Hz)	Pulse Width (s)	Pulse 1 to 2 Spacing (s)	Pulse 2 to 3 Spacing (s)	Start Location (s)
1	2	20M	98.6u	1.198m	-	344.9m
2	2	20M	57.6u	961.4u	-	641.7m
3	1	20M	56.4u	-	-	308.8m
4	1	20M	81.4u	-	-	180.2m
5	1	20M	61.8u	-	-	297.7m
6	2	20M	90.4u	1.563m	-	282.9m
7	3	20M	68.8u	1.515m	1.370m	37.46m
8	1	20M	73.9u	-	-	475.8m
9	2	20M	68.4u	1.684m	-	117.5m
10	3	20M	95.4u	1.490m	1.735m	155.9m
11	1	20M	70.9u	-	-	253.8m
12	1	20M	94.7u	-	-	356.0m
13	3	20M	76.9u	1.750m	1.203m	56.37m
14	3	20M	80.6u	1.024m	1.881m	588.3m
15	2	20M	87.2u	1.015m	-	223.6m
16	2	20M	85.9u	1.898m	-	380.5m
17	1	20M	62.9u	-	-	127.1m
18	2	20M	96.3u	1.532m	-	541.3m

Long Pulse Radar Test Signal						
Test Signal Name: LP_Signal_11						
Number of Bursts in Trial: 13						
Chrip Center Frequency: 5510MHz						
Burst	Pulses per Burst	Chrip (Hz)	Pulse Width (s)	Pulse 1 to 2 Spacing (s)	Pulse 2 to 3 Spacing (s)	Start Location (s)
1	2	5M	64.2u	1.510m	-	171.7m
2	2	5M	85.7u	1.457m	-	23.95m
3	3	5M	93.8u	1.348m	1.769m	685.0m
4	3	5M	85.1u	1.065m	1.624m	112.8m
5	1	5M	84.7u	-	-	797.2m
6	2	5M	80.4u	1.702m	-	14.43m
7	1	5M	98.4u	-	-	314.4m
8	2	5M	71.1u	1.369m	-	529.1m
9	1	5M	98.6u	-	-	667.9m
10	2	5M	91.7u	1.176m	-	571.6m
11	2	5M	69.1u	1.770m	-	615.7m
12	2	5M	90.9u	1.511m	-	676.8m
13	2	5M	89.6u	1.199m	-	683.8m

Long Pulse Radar Test Signal						
Test Signal Name: LP_Signal_12						
Number of Bursts in Trial: 19						
Chrip Center Frequency: 5510MHz						
Burst	Pulses per Burst	Chrip (Hz)	Pulse Width (s)	Pulse 1 to 2 Spacing (s)	Pulse 2 to 3 Spacing (s)	Start Location (s)
1	3	5M	61.2u	1.793m	1.857m	398.8m
2	1	5M	53.7u	-	-	300.3m
3	2	5M	82.7u	1.900m	-	154.0m
4	3	5M	98.8u	1.369m	1.879m	7.212m
5	2	5M	54.9u	1.516m	-	475.2m
6	3	5M	57.2u	1.640m	1.396m	427.7m
7	2	5M	91.6u	1.507m	-	435.3m
8	2	5M	69.8u	1.897m	-	349.7m
9	2	5M	58.1u	1.668m	-	584.4m
10	2	5M	81.6u	1.380m	-	184.8m
11	2	5M	57.5u	1.242m	-	221.2m
12	3	5M	92.2u	1.227m	913.8u	353.3m
13	2	5M	81.9u	1.129m	-	486.4m
14	2	5M	66.9u	1.395m	-	235.5m
15	1	5M	67.9u	-	-	415.5m
16	3	5M	99.2u	1.884m	1.803m	462.9m
17	2	5M	71.2u	1.043m	-	214.2m
18	1	5M	70.9u	-	-	379.4m
19	2	5M	68.8u	1.209m	-	322.3m

Long Pulse Radar Test Signal						
Test Signal Name: LP_Signal_13						
Number of Bursts in Trial: 12						
Chrip Center Frequency: 5510MHz						
Burst	Pulses per Burst	Chrip (Hz)	Pulse Width (s)	Pulse 1 to 2 Spacing (s)	Pulse 2 to 3 Spacing (s)	Start Location (s)
1	2	9M	83.6u	1.774m	-	467.4m
2	2	9M	97.1u	1.796m	-	328.2m
3	1	9M	84.9u	-	-	712.5m
4	1	9M	85.6u	-	-	456.6m
5	2	9M	97.8u	917.2u	-	642.0m
6	2	9M	95.4u	1.079m	-	800.8m
7	1	9M	71.2u	-	-	898.6m
8	3	9M	82.0u	1.666m	1.468m	784.5m
9	3	9M	86.6u	1.322m	1.519m	535.5m
10	1	9M	71.4u	-	-	43.23m
11	2	9M	62.2u	1.268m	-	268.5m
12	2	9M	96.1u	1.888m	-	253.4m

Long Pulse Radar Test Signal						
Test Signal Name: LP_Signal_14						
Number of Bursts in Trial: 13						
Chrip Center Frequency: 5510MHz						
Burst	Pulses per Burst	Chrip (Hz)	Pulse Width (s)	Pulse 1 to 2 Spacing (s)	Pulse 2 to 3 Spacing (s)	Start Location (s)
1	2	9M	61.5u	955.5u	-	640.4m
2	1	9M	92.5u	-	-	393.8m
3	3	9M	71.1u	1.724m	1.483m	227.5m
4	2	9M	79.5u	1.035m	-	625.6m
5	2	9M	75.3u	1.324m	-	302.7m
6	3	9M	71.1u	1.201m	1.880m	210.6m
7	2	9M	83.2u	1.845m	-	576.6m
8	2	9M	81.1u	1.333m	-	524.0m
9	2	9M	97.7u	1.050m	-	855.4m
10	2	9M	95.7u	1.224m	-	597.8m
11	2	9M	53.5u	1.334m	-	874.0m
12	3	9M	70.8u	1.735m	1.020m	510.2m
13	2	9M	95.7u	1.535m	-	870.2m

Long Pulse Radar Test Signal						
Test Signal Name: LP_Signal_15						
Number of Bursts in Trial: 17						
Chrip Center Frequency: 5510MHz						
Burst	Pulses per Burst	Chrip (Hz)	Pulse Width (s)	Pulse 1 to 2 Spacing (s)	Pulse 2 to 3 Spacing (s)	Start Location (s)
1	2	15M	73.3u	1.117m	-	263.9m
2	3	15M	77.1u	1.610m	1.018m	283.7m
3	2	15M	70.2u	1.453m	-	47.73m
4	2	15M	84.6u	1.444m	-	566.8m
5	3	15M	82.8u	1.477m	1.433m	572.1m
6	2	15M	95.2u	987.8u	-	614.1m
7	3	15M	95.3u	1.243m	1.697m	22.08m
8	3	15M	59.7u	1.441m	1.343m	23.27m
9	3	15M	69.3u	1.787m	1.428m	620.8m
10	2	15M	75.3u	1.838m	-	693.6m
11	3	15M	91.2u	1.427m	1.347m	498.9m
12	3	15M	91.2u	1.212m	1.579m	309.3m
13	2	15M	94.7u	1.191m	-	266.5m
14	3	15M	98.4u	1.552m	1.534m	614.4m
15	3	15M	54.0u	1.482m	990.0u	449.2m
16	2	15M	74.1u	1.675m	-	613.7m
17	2	15M	83.4u	1.632m	-	699.8m

Long Pulse Radar Test Signal						
Test Signal Name: LP_Signal_16						
Number of Bursts in Trial: 8						
Chrip Center Frequency: 5510MHz						
Burst	Pulses per Burst	Chrip (Hz)	Pulse Width (s)	Pulse 1 to 2 Spacing (s)	Pulse 2 to 3 Spacing (s)	Start Location (s)
1	3	15M	86.3u	1.743m	985.7u	297.0m
2	1	15M	66.0u	-	-	1.473
3	3	15M	67.9u	1.531m	1.717m	438.4m
4	3	15M	86.6u	1.433m	1.491m	650.2m
5	2	15M	59.3u	1.648m	-	773.9m
6	2	15M	60.7u	1.384m	-	278.3m
7	2	15M	58.5u	1.114m	-	1.321
8	2	15M	88.9u	920.1u	-	360.9m

Long Pulse Radar Test Signal						
Test Signal Name: LP_Signal_17						
Number of Bursts in Trial: 19						
Chrip Center Frequency: 5510MHz						
Burst	Pulses per Burst	Chrip (Hz)	Pulse Width (s)	Pulse 1 to 2 Spacing (s)	Pulse 2 to 3 Spacing (s)	Start Location (s)
1	3	17M	56.6u	1.081m	1.442m	264.5m
2	2	17M	77.0u	1.479m	-	411.6m
3	1	17M	64.7u	-	-	502.4m
4	2	17M	66.3u	1.533m	-	128.2m
5	2	17M	66.5u	1.654m	-	32.33m
6	2	17M	53.9u	1.723m	-	368.5m
7	2	17M	95.4u	1.678m	-	502.6m
8	2	17M	79.6u	1.481m	-	375.6m
9	2	17M	94.7u	1.774m	-	335.2m
10	3	17M	86.7u	1.256m	1.147m	567.5m
11	2	17M	65.2u	1.373m	-	55.52m
12	3	17M	53.6u	1.336m	1.086m	350.4m
13	1	17M	93.6u	-	-	549.5m
14	3	17M	99.9u	1.866m	961.1u	222.0m
15	2	17M	98.7u	1.242m	-	603.9m
16	3	17M	99.5u	992.5u	1.138m	514.9m
17	2	17M	88.7u	1.906m	-	388.1m
18	2	17M	98.4u	1.185m	-	429.7m
19	2	17M	84.8u	1.718m	-	344.7m

Long Pulse Radar Test Signal						
Test Signal Name: LP_Signal_18						
Number of Bursts in Trial: 15						
Chrip Center Frequency: 5510MHz						
Burst	Pulses per Burst	Chrip (Hz)	Pulse Width (s)	Pulse 1 to 2 Spacing (s)	Pulse 2 to 3 Spacing (s)	Start Location (s)
1	2	17M	74.4u	1.078m	-	405.4m
2	2	17M	64.5u	1.652m	-	642.9m
3	2	17M	60.9u	1.407m	-	702.7m
4	1	17M	93.7u	-	-	738.4m
5	3	17M	73.4u	1.274m	1.171m	600.8m
6	2	17M	65.8u	1.640m	-	566.8m
7	2	17M	67.9u	1.038m	-	561.0m
8	2	17M	75.2u	970.8u	-	25.08m
9	1	17M	58.5u	-	-	667.7m
10	1	17M	97.9u	-	-	176.6m
11	3	17M	87.6u	1.679m	1.187m	730.3m
12	1	17M	94.5u	-	-	720.4m
13	3	17M	56.4u	1.013m	1.776m	274.4m
14	2	17M	84.2u	1.338m	-	186.8m
15	1	17M	67.2u	-	-	223.4m

Long Pulse Radar Test Signal						
Test Signal Name: LP_Signal_19						
Number of Bursts in Trial: 15						
Chrip Center Frequency: 5510MHz						
Burst	Pulses per Burst	Chrip (Hz)	Pulse Width (s)	Pulse 1 to 2 Spacing (s)	Pulse 2 to 3 Spacing (s)	Start Location (s)
1	1	20M	63.9u	-	-	77.33m
2	2	20M	94.7u	1.807m	-	47.69m
3	2	20M	55.2u	1.653m	-	235.8m
4	1	20M	88.6u	-	-	734.4m
5	3	20M	58.9u	1.448m	1.576m	594.5m
6	3	20M	80.2u	1.051m	1.328m	738.1m
7	2	20M	51.8u	1.771m	-	610.0m
8	1	20M	58.2u	-	-	187.6m
9	3	20M	51.5u	1.442m	1.642m	91.17m
10	2	20M	54.6u	1.066m	-	128.0m
11	3	20M	92.5u	1.718m	1.207m	337.4m
12	3	20M	88.1u	1.794m	1.583m	438.5m
13	2	20M	63.5u	1.643m	-	214.3m
14	2	20M	73.1u	959.9u	-	235.5m
15	1	20M	71.4u	-	-	509.1m

Long Pulse Radar Test Signal						
Test Signal Name: LP_Signal_20						
Number of Bursts in Trial: 18						
Chrip Center Frequency: 5510MHz						
Burst	Pulses per Burst	Chrip (Hz)	Pulse Width (s)	Pulse 1 to 2 Spacing (s)	Pulse 2 to 3 Spacing (s)	Start Location (s)
1	1	20M	58.6u	-	-	36.12m
2	2	20M	92.0u	1.831m	-	301.7m
3	2	20M	97.4u	1.173m	-	286.9m
4	2	20M	57.0u	979.0u	-	55.23m
5	1	20M	66.5u	-	-	376.4m
6	2	20M	78.9u	1.100m	-	434.4m
7	2	20M	70.2u	1.681m	-	626.6m
8	3	20M	72.3u	1.233m	1.537m	438.6m
9	2	20M	59.1u	1.565m	-	429.8m
10	1	20M	50.4u	-	-	446.6m
11	2	20M	88.1u	1.050m	-	371.0m
12	2	20M	52.9u	1.220m	-	91.61m
13	1	20M	95.1u	-	-	395.7m
14	1	20M	82.4u	-	-	374.5m
15	2	20M	96.3u	992.7u	-	595.6m
16	2	20M	91.4u	1.793m	-	121.7m
17	2	20M	97.6u	1.191m	-	331.3m
18	2	20M	61.0u	1.695m	-	56.15m

Long Pulse Radar Test Signal						
Test Signal Name: LP_Signal_21						
Number of Bursts in Trial: 19						
Chrip Center Frequency: 5527MHz						
Burst	Pulses per Burst	Chrip (Hz)	Pulse Width (s)	Pulse 1 to 2 Spacing (s)	Pulse 2 to 3 Spacing (s)	Start Location (s)
1	3	5M	61.2u	1.793m	1.857m	398.8m
2	1	5M	53.7u	-	-	300.3m
3	2	5M	82.7u	1.900m	-	154.0m
4	3	5M	98.8u	1.369m	1.879m	7.212m
5	2	5M	54.9u	1.516m	-	475.2m
6	3	5M	57.2u	1.640m	1.396m	427.7m
7	2	5M	91.6u	1.507m	-	435.3m
8	2	5M	69.8u	1.897m	-	349.7m
9	2	5M	58.1u	1.668m	-	584.4m
10	2	5M	81.6u	1.380m	-	184.8m
11	2	5M	57.5u	1.242m	-	221.2m
12	3	5M	92.2u	1.227m	913.8u	353.3m
13	2	5M	81.9u	1.129m	-	486.4m
14	2	5M	66.9u	1.395m	-	235.5m
15	1	5M	67.9u	-	-	415.5m
16	3	5M	99.2u	1.884m	1.803m	462.9m
17	2	5M	71.2u	1.043m	-	214.2m
18	1	5M	70.9u	-	-	379.4m
19	2	5M	68.8u	1.209m	-	322.3m

Long Pulse Radar Test Signal						
Test Signal Name: LP_Signal_22						
Number of Bursts in Trial: 18						
Chrip Center Frequency: 5527MHz						
Burst	Pulses per Burst	Chrip (Hz)	Pulse Width (s)	Pulse 1 to 2 Spacing (s)	Pulse 2 to 3 Spacing (s)	Start Location (s)
1	2	5M	64.8u	1.186m	-	75.79m
2	3	5M	95.3u	1.039m	1.151m	354.7m
3	1	5M	58.2u	-	-	145.6m
4	2	5M	96.2u	1.328m	-	408.6m
5	1	5M	70.0u	-	-	571.7m
6	1	5M	97.0u	-	-	4.469m
7	2	5M	74.8u	1.904m	-	112.1m
8	2	5M	86.3u	1.847m	-	19.29m
9	1	5M	56.7u	-	-	317.3m
10	2	5M	61.0u	956.0u	-	142.0m
11	2	5M	71.0u	935.0u	-	251.8m
12	1	5M	54.2u	-	-	150.7m
13	3	5M	90.1u	1.385m	1.143m	630.6m
14	2	5M	99.6u	1.522m	-	405.1m
15	2	5M	67.1u	1.741m	-	9.165m
16	2	5M	50.8u	1.064m	-	487.1m
17	2	5M	78.9u	1.002m	-	226.8m
18	3	5M	87.7u	1.409m	1.017m	595.7m

Long Pulse Radar Test Signal						
Test Signal Name: LP_Signal_23						
Number of Bursts in Trial: 11						
Chrip Center Frequency: 5527MHz						
Burst	Pulses per Burst	Chrip (Hz)	Pulse Width (s)	Pulse 1 to 2 Spacing (s)	Pulse 2 to 3 Spacing (s)	Start Location (s)
1	3	6M	51.6u	1.534m	1.356m	923.6m
2	3	6M	71.6u	1.079m	1.587m	287.7m
3	2	6M	74.5u	1.832m	-	980.6m
4	2	6M	78.9u	1.266m	-	281.6m
5	2	6M	50.0u	1.076m	-	519.7m
6	1	6M	58.3u	-	-	189.4m
7	2	6M	63.9u	1.193m	-	701.3m
8	2	6M	88.1u	1.462m	-	107.5m
9	3	6M	62.4u	1.328m	971.6u	153.5m
10	1	6M	65.5u	-	-	1.012
11	1	6M	95.5u	-	-	359.5m

Long Pulse Radar Test Signal						
Test Signal Name: LP_Signal_24						
Number of Bursts in Trial: 10						
Chrip Center Frequency: 5527MHz						
Burst	Pulses per Burst	Chrip (Hz)	Pulse Width (s)	Pulse 1 to 2 Spacing (s)	Pulse 2 to 3 Spacing (s)	Start Location (s)
1	1	6M	63.2u	-	-	639.7m
2	3	6M	51.2u	1.477m	1.835m	678.8m
3	3	6M	64.0u	1.440m	1.154m	534.7m
4	2	6M	70.2u	1.135m	-	1.023
5	2	6M	82.2u	1.368m	-	565.5m
6	2	6M	90.8u	1.524m	-	59.60m
7	2	6M	61.5u	985.5u	-	1.004
8	1	6M	52.3u	-	-	775.3m
9	3	6M	75.8u	1.274m	1.399m	123.2m
10	1	6M	83.4u	-	-	1.109

Long Pulse Radar Test Signal						
Test Signal Name: LP_Signal_25						
Number of Bursts in Trial: 8						
Chrip Center Frequency: 5525MHz						
Burst	Pulses per Burst	Chrip (Hz)	Pulse Width (s)	Pulse 1 to 2 Spacing (s)	Pulse 2 to 3 Spacing (s)	Start Location (s)
1	2	11M	84.4u	1.421m	-	801.3m
2	3	11M	70.4u	1.837m	1.413m	694.8m
3	1	11M	56.8u	-	-	852.3m
4	2	11M	88.3u	1.609m	-	214.6m
5	3	11M	63.4u	1.206m	1.734m	788.8m
6	3	11M	66.9u	942.1u	1.551m	502.0m
7	3	11M	67.8u	938.2u	1.580m	404.8m
8	2	11M	68.5u	1.233m	-	191.0m

Long Pulse Radar Test Signal						
Test Signal Name: LP_Signal_26						
Number of Bursts in Trial: 19						
Chrip Center Frequency: 5525MHz						
Burst	Pulses per Burst	Chrip (Hz)	Pulse Width (s)	Pulse 1 to 2 Spacing (s)	Pulse 2 to 3 Spacing (s)	Start Location (s)
1	1	11M	83.2u	-	-	45.94m
2	2	11M	64.2u	1.124m	-	371.8m
3	2	11M	93.6u	1.066m	-	35.45m
4	2	11M	81.4u	1.900m	-	379.4m
5	2	11M	72.5u	1.373m	-	425.9m
6	2	11M	63.2u	1.827m	-	395.1m
7	3	11M	78.0u	1.366m	1.019m	157.6m
8	1	11M	70.4u	-	-	237.3m
9	3	11M	62.4u	1.269m	1.701m	582.7m
10	1	11M	85.8u	-	-	223.0m
11	3	11M	57.4u	1.075m	1.909m	626.8m
12	2	11M	66.5u	1.637m	-	578.6m
13	3	11M	52.8u	1.165m	1.623m	626.6m
14	3	11M	51.0u	1.021m	1.068m	482.0m
15	1	11M	52.0u	-	-	471.8m
16	2	11M	72.0u	1.694m	-	284.8m
17	2	11M	58.9u	1.920m	-	155.7m
18	3	11M	84.2u	1.879m	1.077m	352.7m
19	2	11M	51.5u	1.504m	-	605.5m

Long Pulse Radar Test Signal						
Test Signal Name: LP_Signal_27						
Number of Bursts in Trial: 9						
Chrip Center Frequency: 5521MHz						
Burst	Pulses per Burst	Chrip (Hz)	Pulse Width (s)	Pulse 1 to 2 Spacing (s)	Pulse 2 to 3 Spacing (s)	Start Location (s)
1	1	19M	86.6u	-	-	1.233
2	2	19M	75.4u	1.787m	-	1.316
3	3	19M	50.2u	1.838m	1.148m	902.0m
4	1	19M	58.8u	-	-	953.0m
5	2	19M	54.0u	1.432m	-	424.4m
6	2	19M	51.1u	1.395m	-	265.3m
7	1	19M	63.0u	-	-	502.3m
8	1	19M	67.6u	-	-	1.070
9	2	19M	91.3u	1.439m	-	517.4m

Long Pulse Radar Test Signal						
Test Signal Name: LP_Signal_28						
Number of Bursts in Trial: 17						
Chrip Center Frequency: 5521MHz						
Burst	Pulses per Burst	Chrip (Hz)	Pulse Width (s)	Pulse 1 to 2 Spacing (s)	Pulse 2 to 3 Spacing (s)	Start Location (s)
1	2	19M	78.0u	1.167m	-	269.8m
2	3	19M	82.8u	1.545m	1.544m	640.4m
3	2	19M	73.0u	1.679m	-	88.41m
4	2	19M	67.7u	1.793m	-	557.7m
5	2	19M	55.9u	1.359m	-	651.0m
6	2	19M	92.9u	1.029m	-	485.5m
7	3	19M	70.2u	1.756m	1.342m	179.1m
8	1	19M	55.1u	-	-	407.5m
9	3	19M	67.9u	1.910m	1.250m	285.0m
10	1	19M	50.3u	-	-	147.8m
11	3	19M	50.3u	1.543m	1.185m	550.6m
12	3	19M	93.9u	1.670m	1.112m	207.5m
13	3	19M	54.3u	1.260m	1.333m	689.3m
14	1	19M	73.3u	-	-	595.0m
15	2	19M	86.5u	1.506m	-	78.29m
16	3	19M	53.8u	1.088m	1.261m	105.6m
17	2	19M	89.3u	1.368m	-	145.9m

Long Pulse Radar Test Signal						
Test Signal Name: LP_Signal_29						
Number of Bursts in Trial: 10						
Chrip Center Frequency: 5521MHz						
Burst	Pulses per Burst	Chrip (Hz)	Pulse Width (s)	Pulse 1 to 2 Spacing (s)	Pulse 2 to 3 Spacing (s)	Start Location (s)
1	2	20M	78.6u	1.551m	-	833.2m
2	2	20M	51.6u	990.4u	-	825.2m
3	2	20M	86.8u	1.097m	-	809.6m
4	1	20M	60.5u	-	-	792.9m
5	2	20M	54.9u	1.783m	-	491.4m
6	2	20M	75.7u	1.245m	-	717.7m
7	2	20M	55.0u	1.513m	-	1.155
8	2	20M	79.2u	955.8u	-	118.6m
9	1	20M	56.4u	-	-	881.1m
10	1	20M	97.7u	-	-	978.0m

Long Pulse Radar Test Signal						
Test Signal Name: LP_Signal_30						
Number of Bursts in Trial: 18						
Chirp Center Frequency: 5521MHz						
Burst	Pulses per Burst	Chirp (Hz)	Pulse Width (s)	Pulse 1 to 2 Spacing (s)	Pulse 2 to 3 Spacing (s)	Start Location (s)
1	1	20M	58.6u	-	-	36.12m
2	2	20M	92.0u	1.831m	-	301.7m
3	2	20M	97.4u	1.173m	-	286.9m
4	2	20M	57.0u	979.0u	-	55.23m
5	1	20M	66.5u	-	-	376.4m
6	2	20M	78.9u	1.100m	-	434.4m
7	2	20M	70.2u	1.681m	-	626.6m
8	3	20M	72.3u	1.233m	1.537m	438.6m
9	2	20M	59.1u	1.565m	-	429.8m
10	1	20M	50.4u	-	-	446.6m
11	2	20M	88.1u	1.050m	-	371.0m
12	2	20M	52.9u	1.220m	-	91.61m
13	1	20M	95.1u	-	-	395.7m
14	1	20M	82.4u	-	-	374.5m
15	2	20M	96.3u	992.7u	-	595.6m
16	2	20M	91.4u	1.793m	-	121.7m
17	2	20M	97.6u	1.191m	-	331.3m
18	2	20M	61.0u	1.695m	-	56.15m

Type 6 Radar Statistical Performances				
Trial #	Pulses per Burst	Pulse Width (s)	PRI (s)	Detection
1	9	1.0u	333.0u	Yes
2	9	1.0u	333.0u	Yes
3	9	1.0u	333.0u	Yes
4	9	1.0u	333.0u	Yes
5	9	1.0u	333.0u	Yes
6	9	1.0u	333.0u	Yes
7	9	1.0u	333.0u	Yes
8	9	1.0u	333.0u	Yes
9	9	1.0u	333.0u	Yes
10	9	1.0u	333.0u	Yes
11	9	1.0u	333.0u	Yes
12	9	1.0u	333.0u	Yes
13	9	1.0u	333.0u	Yes
14	9	1.0u	333.0u	Yes
15	9	1.0u	333.0u	Yes
16	9	1.0u	333.0u	Yes
17	9	1.0u	333.0u	Yes
18	9	1.0u	333.0u	Yes
19	9	1.0u	333.0u	Yes
20	9	1.0u	333.0u	Yes
21	9	1.0u	333.0u	Yes
22	9	1.0u	333.0u	Yes
23	9	1.0u	333.0u	Yes
24	9	1.0u	333.0u	Yes
25	9	1.0u	333.0u	Yes
26	9	1.0u	333.0u	Yes
27	9	1.0u	333.0u	Yes
28	9	1.0u	333.0u	Yes
29	9	1.0u	333.0u	Yes
30	9	1.0u	333.0u	Yes
				Detection Rate: 100.0 %

Type 6 Radar Statistical Performances		
Trial #	Hopping Frequency Sequence Name	Detection
1	HOP_FREQ_SEQ_01	Yes
2	HOP_FREQ_SEQ_02	Yes
3	HOP_FREQ_SEQ_03	Yes
4	HOP_FREQ_SEQ_04	Yes
5	HOP_FREQ_SEQ_05	Yes
6	HOP_FREQ_SEQ_06	Yes
7	HOP_FREQ_SEQ_07	Yes
8	HOP_FREQ_SEQ_08	Yes
9	HOP_FREQ_SEQ_09	Yes
10	HOP_FREQ_SEQ_10	Yes
11	HOP_FREQ_SEQ_11	Yes
12	HOP_FREQ_SEQ_12	Yes
13	HOP_FREQ_SEQ_13	Yes
14	HOP_FREQ_SEQ_14	Yes
15	HOP_FREQ_SEQ_15	Yes
16	HOP_FREQ_SEQ_16	Yes
17	HOP_FREQ_SEQ_17	Yes
18	HOP_FREQ_SEQ_18	Yes
19	HOP_FREQ_SEQ_19	Yes
20	HOP_FREQ_SEQ_20	Yes
21	HOP_FREQ_SEQ_21	Yes
22	HOP_FREQ_SEQ_22	Yes
23	HOP_FREQ_SEQ_23	Yes
24	HOP_FREQ_SEQ_24	Yes
25	HOP_FREQ_SEQ_25	Yes
26	HOP_FREQ_SEQ_26	Yes
27	HOP_FREQ_SEQ_27	Yes
28	HOP_FREQ_SEQ_28	Yes
29	HOP_FREQ_SEQ_29	Yes
30	HOP_FREQ_SEQ_30	Yes
		Detection Rate: 100.0 %

Hopping Frequency Sequence Name: HOP_FREQ_SEQ_01							
SEQ#	Frequency (Hz)	SEQ#	Frequency (Hz)	SEQ#	Frequency (Hz)	SEQ#	Frequency (Hz)
1	5.419G	2	5.701G	3	5.392G	4	5.709G
5	5.506G	6	5.313G	7	5.613G	8	5.415G
9	5.537G	10	5.299G	11	5.283G	12	5.520G
13	5.609G	14	5.422G	15	5.569G	16	5.681G
17	5.480G	18	5.265G	19	5.411G	20	5.587G
21	5.309G	22	5.495G	23	5.530G	24	5.683G
25	5.418G	26	5.654G	27	5.635G	28	5.631G
29	5.524G	30	5.426G	31	5.452G	32	5.294G
33	5.573G	34	5.461G	35	5.267G	36	5.376G
37	5.471G	38	5.685G	39	5.363G	40	5.256G
41	5.278G	42	5.518G	43	5.393G	44	5.396G
45	5.305G	46	5.385G	47	5.272G	48	5.269G
49	5.444G	50	5.712G	51	5.532G	52	5.646G
53	5.623G	54	5.514G	55	5.508G	56	5.328G
57	5.650G	58	5.317G	59	5.581G	60	5.714G
61	5.647G	62	5.534G	63	5.304G	64	5.403G
65	5.715G	66	5.274G	67	5.724G	68	5.673G
69	5.355G	70	5.374G	71	5.507G	72	5.639G
73	5.335G	74	5.442G	75	5.406G	76	5.509G
77	5.590G	78	5.655G	79	5.303G	80	5.459G
81	5.511G	82	5.296G	83	5.572G	84	5.499G
85	5.580G	86	5.548G	87	5.453G	88	5.466G
89	5.567G	90	5.614G	91	5.648G	92	5.323G
93	5.491G	94	5.481G	95	5.318G	96	5.705G
97	5.554G	98	5.372G	99	5.400G	100	5.621G

Hopping Frequency Sequence Name: HOP_FREQ_SEQ_02							
SEQ#	Frequency (Hz)	SEQ#	Frequency (Hz)	SEQ#	Frequency (Hz)	SEQ#	Frequency (Hz)
1	5.509G	2	5.630G	3	5.452G	4	5.692G
5	5.447G	6	5.312G	7	5.566G	8	5.306G
9	5.635G	10	5.674G	11	5.365G	12	5.424G
13	5.594G	14	5.668G	15	5.458G	16	5.676G
17	5.505G	18	5.444G	19	5.706G	20	5.704G
21	5.422G	22	5.528G	23	5.639G	24	5.294G
25	5.552G	26	5.570G	27	5.521G	28	5.545G
29	5.286G	30	5.636G	31	5.687G	32	5.432G
33	5.694G	34	5.641G	35	5.679G	36	5.673G
37	5.323G	38	5.571G	39	5.476G	40	5.722G
41	5.333G	42	5.307G	43	5.279G	44	5.592G
45	5.695G	46	5.638G	47	5.474G	48	5.684G
49	5.622G	50	5.648G	51	5.624G	52	5.559G
53	5.273G	54	5.462G	55	5.518G	56	5.470G
57	5.659G	58	5.669G	59	5.439G	60	5.547G
61	5.328G	62	5.420G	63	5.258G	64	5.602G
65	5.348G	66	5.703G	67	5.361G	68	5.256G
69	5.284G	70	5.723G	71	5.535G	72	5.599G
73	5.608G	74	5.714G	75	5.657G	76	5.561G
77	5.513G	78	5.393G	79	5.554G	80	5.681G
81	5.666G	82	5.285G	83	5.584G	84	5.485G
85	5.301G	86	5.585G	87	5.310G	88	5.555G
89	5.690G	90	5.434G	91	5.421G	92	5.385G
93	5.568G	94	5.548G	95	5.363G	96	5.330G
97	5.386G	98	5.262G	99	5.475G	100	5.562G

Hopping Frequency Sequence Name: HOP_FREQ_SEQ_03							
SEQ#	Frequency (Hz)	SEQ#	Frequency (Hz)	SEQ#	Frequency (Hz)	SEQ#	Frequency (Hz)
1	5.425G	2	5.296G	3	5.541G	4	5.485G
5	5.609G	6	5.550G	7	5.565G	8	5.505G
9	5.270G	10	5.439G	11	5.597G	12	5.632G
13	5.599G	14	5.305G	15	5.454G	16	5.489G
17	5.299G	18	5.272G	19	5.428G	20	5.634G
21	5.562G	22	5.482G	23	5.623G	24	5.620G
25	5.645G	26	5.637G	27	5.646G	28	5.576G
29	5.359G	30	5.386G	31	5.472G	32	5.376G
33	5.548G	34	5.554G	35	5.606G	36	5.508G
37	5.529G	38	5.481G	39	5.350G	40	5.578G
41	5.630G	42	5.354G	43	5.512G	44	5.362G
45	5.448G	46	5.335G	47	5.273G	48	5.311G
49	5.251G	50	5.365G	51	5.266G	52	5.467G
53	5.542G	54	5.569G	55	5.723G	56	5.666G
57	5.414G	58	5.709G	59	5.268G	60	5.547G
61	5.331G	62	5.430G	63	5.461G	64	5.551G
65	5.338G	66	5.343G	67	5.337G	68	5.557G
69	5.644G	70	5.347G	71	5.440G	72	5.378G
73	5.451G	74	5.294G	75	5.342G	76	5.295G
77	5.667G	78	5.699G	79	5.492G	80	5.260G
81	5.465G	82	5.290G	83	5.591G	84	5.250G
85	5.560G	86	5.607G	87	5.507G	88	5.391G
89	5.714G	90	5.476G	91	5.462G	92	5.681G
93	5.544G	94	5.657G	95	5.671G	96	5.315G
97	5.438G	98	5.594G	99	5.694G	100	5.446G

Hopping Frequency Sequence Name: HOP_FREQ_SEQ_04							
SEQ#	Frequency (Hz)	SEQ#	Frequency (Hz)	SEQ#	Frequency (Hz)	SEQ#	Frequency (Hz)
1	5.656G	2	5.317G	3	5.710G	4	5.659G
5	5.320G	6	5.553G	7	5.341G	8	5.424G
9	5.346G	10	5.700G	11	5.295G	12	5.688G
13	5.508G	14	5.433G	15	5.363G	16	5.614G
17	5.357G	18	5.293G	19	5.567G	20	5.489G
21	5.271G	22	5.343G	23	5.380G	24	5.570G
25	5.379G	26	5.305G	27	5.267G	28	5.288G
29	5.371G	30	5.683G	31	5.446G	32	5.311G
33	5.259G	34	5.352G	35	5.270G	36	5.699G
37	5.462G	38	5.501G	39	5.602G	40	5.289G
41	5.684G	42	5.434G	43	5.629G	44	5.715G
45	5.313G	46	5.429G	47	5.253G	48	5.260G
49	5.539G	50	5.717G	51	5.547G	52	5.419G
53	5.596G	54	5.251G	55	5.377G	56	5.531G
57	5.612G	58	5.476G	59	5.403G	60	5.442G
61	5.580G	62	5.663G	63	5.706G	64	5.453G
65	5.461G	66	5.677G	67	5.427G	68	5.518G
69	5.438G	70	5.721G	71	5.587G	72	5.359G
73	5.397G	74	5.304G	75	5.641G	76	5.474G
77	5.537G	78	5.650G	79	5.485G	80	5.696G
81	5.675G	82	5.588G	83	5.389G	84	5.600G
85	5.323G	86	5.516G	87	5.458G	88	5.571G
89	5.319G	90	5.354G	91	5.477G	92	5.291G
93	5.692G	94	5.422G	95	5.425G	96	5.671G
97	5.393G	98	5.497G	99	5.407G	100	5.413G

Hopping Frequency Sequence Name: HOP_FREQ_SEQ_05							
SEQ#	Frequency (Hz)	SEQ#	Frequency (Hz)	SEQ#	Frequency (Hz)	SEQ#	Frequency (Hz)
1	5.433G	2	5.522G	3	5.546G	4	5.617G
5	5.350G	6	5.599G	7	5.588G	8	5.385G
9	5.605G	10	5.484G	11	5.670G	12	5.694G
13	5.352G	14	5.544G	15	5.489G	16	5.677G
17	5.337G	18	5.394G	19	5.625G	20	5.285G
21	5.566G	22	5.435G	23	5.581G	24	5.331G
25	5.474G	26	5.280G	27	5.381G	28	5.400G
29	5.348G	30	5.446G	31	5.282G	32	5.398G
33	5.693G	34	5.336G	35	5.276G	36	5.448G
37	5.638G	38	5.371G	39	5.417G	40	5.587G
41	5.696G	42	5.574G	43	5.314G	44	5.536G
45	5.437G	46	5.405G	47	5.289G	48	5.675G
49	5.553G	50	5.298G	51	5.479G	52	5.263G
53	5.613G	54	5.295G	55	5.712G	56	5.653G
57	5.302G	58	5.538G	59	5.500G	60	5.353G
61	5.368G	62	5.416G	63	5.534G	64	5.711G
65	5.384G	66	5.632G	67	5.426G	68	5.283G
69	5.469G	70	5.418G	71	5.253G	72	5.430G
73	5.572G	74	5.620G	75	5.481G	76	5.668G
77	5.424G	78	5.559G	79	5.511G	80	5.335G
81	5.499G	82	5.319G	83	5.698G	84	5.709G
85	5.649G	86	5.376G	87	5.655G	88	5.383G
89	5.305G	90	5.614G	91	5.718G	92	5.357G
93	5.691G	94	5.409G	95	5.676G	96	5.429G
97	5.505G	98	5.703G	99	5.466G	100	5.389G

Hopping Frequency Sequence Name: HOP_FREQ_SEQ_06							
SEQ#	Frequency (Hz)	SEQ#	Frequency (Hz)	SEQ#	Frequency (Hz)	SEQ#	Frequency (Hz)
1	5.389G	2	5.339G	3	5.605G	4	5.388G
5	5.462G	6	5.676G	7	5.319G	8	5.322G
9	5.639G	10	5.379G	11	5.521G	12	5.371G
13	5.311G	14	5.414G	15	5.252G	16	5.398G
17	5.364G	18	5.723G	19	5.530G	20	5.348G
21	5.474G	22	5.509G	23	5.589G	24	5.574G
25	5.316G	26	5.279G	27	5.271G	28	5.257G
29	5.563G	30	5.699G	31	5.366G	32	5.611G
33	5.384G	34	5.643G	35	5.479G	36	5.579G
37	5.353G	38	5.487G	39	5.571G	40	5.272G
41	5.432G	42	5.422G	43	5.302G	44	5.260G
45	5.508G	46	5.281G	47	5.515G	48	5.400G
49	5.645G	50	5.291G	51	5.706G	52	5.282G
53	5.288G	54	5.453G	55	5.259G	56	5.406G
57	5.674G	58	5.687G	59	5.554G	60	5.710G
61	5.629G	62	5.654G	63	5.449G	64	5.557G
65	5.440G	66	5.323G	67	5.267G	68	5.624G
69	5.256G	70	5.516G	71	5.410G	72	5.581G
73	5.619G	74	5.341G	75	5.627G	76	5.346G
77	5.418G	78	5.625G	79	5.304G	80	5.338G
81	5.481G	82	5.454G	83	5.600G	84	5.365G
85	5.497G	86	5.667G	87	5.537G	88	5.568G
89	5.606G	90	5.287G	91	5.385G	92	5.693G
93	5.548G	94	5.702G	95	5.421G	96	5.513G
97	5.357G	98	5.675G	99	5.583G	100	5.598G

Hopping Frequency Sequence Name: HOP_FREQ_SEQ_07							
SEQ#	Frequency (Hz)	SEQ#	Frequency (Hz)	SEQ#	Frequency (Hz)	SEQ#	Frequency (Hz)
1	5.321G	2	5.701G	3	5.598G	4	5.530G
5	5.459G	6	5.522G	7	5.542G	8	5.543G
9	5.623G	10	5.463G	11	5.326G	12	5.711G
13	5.347G	14	5.674G	15	5.427G	16	5.571G
17	5.639G	18	5.669G	19	5.298G	20	5.304G
21	5.470G	22	5.315G	23	5.709G	24	5.556G
25	5.641G	26	5.299G	27	5.567G	28	5.564G
29	5.405G	30	5.291G	31	5.544G	32	5.262G
33	5.670G	34	5.577G	35	5.314G	36	5.679G
37	5.539G	38	5.387G	39	5.392G	40	5.699G
41	5.562G	42	5.478G	43	5.633G	44	5.502G
45	5.609G	46	5.305G	47	5.710G	48	5.451G
49	5.379G	50	5.707G	51	5.434G	52	5.296G
53	5.651G	54	5.700G	55	5.632G	56	5.663G
57	5.681G	58	5.369G	59	5.320G	60	5.561G
61	5.391G	62	5.307G	63	5.557G	64	5.295G
65	5.510G	66	5.273G	67	5.414G	68	5.662G
69	5.394G	70	5.489G	71	5.403G	72	5.390G
73	5.368G	74	5.601G	75	5.443G	76	5.383G
77	5.688G	78	5.704G	79	5.269G	80	5.327G
81	5.381G	82	5.409G	83	5.480G	84	5.565G
85	5.288G	86	5.250G	87	5.566G	88	5.366G
89	5.724G	90	5.361G	91	5.393G	92	5.375G
93	5.482G	94	5.647G	95	5.666G	96	5.549G
97	5.495G	98	5.593G	99	5.294G	100	5.572G

Hopping Frequency Sequence Name: HOP_FREQ_SEQ_08							
SEQ#	Frequency (Hz)	SEQ#	Frequency (Hz)	SEQ#	Frequency (Hz)	SEQ#	Frequency (Hz)
1	5.291G	2	5.486G	3	5.278G	4	5.310G
5	5.391G	6	5.386G	7	5.669G	8	5.530G
9	5.641G	10	5.490G	11	5.704G	12	5.263G
13	5.687G	14	5.475G	15	5.533G	16	5.538G
17	5.268G	18	5.593G	19	5.438G	20	5.517G
21	5.332G	22	5.683G	23	5.376G	24	5.305G
25	5.539G	26	5.544G	27	5.510G	28	5.255G
29	5.321G	30	5.274G	31	5.442G	32	5.322G
33	5.629G	34	5.661G	35	5.709G	36	5.439G
37	5.648G	38	5.571G	39	5.393G	40	5.257G
41	5.444G	42	5.532G	43	5.498G	44	5.576G
45	5.520G	46	5.597G	47	5.276G	48	5.636G
49	5.330G	50	5.684G	51	5.359G	52	5.483G
53	5.529G	54	5.525G	55	5.504G	56	5.368G
57	5.425G	58	5.303G	59	5.372G	60	5.711G
61	5.329G	62	5.463G	63	5.616G	64	5.289G
65	5.692G	66	5.723G	67	5.551G	68	5.296G
69	5.622G	70	5.251G	71	5.264G	72	5.719G
73	5.561G	74	5.695G	75	5.508G	76	5.375G
77	5.407G	78	5.428G	79	5.344G	80	5.598G
81	5.479G	82	5.617G	83	5.354G	84	5.574G
85	5.286G	86	5.534G	87	5.499G	88	5.547G
89	5.473G	90	5.714G	91	5.706G	92	5.663G
93	5.639G	94	5.273G	95	5.608G	96	5.474G
97	5.720G	98	5.456G	99	5.647G	100	5.250G

Hopping Frequency Sequence Name: HOP_FREQ_SEQ_09							
SEQ#	Frequency (Hz)	SEQ#	Frequency (Hz)	SEQ#	Frequency (Hz)	SEQ#	Frequency (Hz)
1	5.637G	2	5.540G	3	5.619G	4	5.273G
5	5.262G	6	5.537G	7	5.565G	8	5.710G
9	5.510G	10	5.713G	11	5.652G	12	5.549G
13	5.403G	14	5.708G	15	5.469G	16	5.491G
17	5.506G	18	5.444G	19	5.709G	20	5.339G
21	5.640G	22	5.426G	23	5.475G	24	5.482G
25	5.371G	26	5.503G	27	5.282G	28	5.568G
29	5.591G	30	5.563G	31	5.670G	32	5.408G
33	5.451G	34	5.374G	35	5.642G	36	5.586G
37	5.684G	38	5.377G	39	5.553G	40	5.564G
41	5.443G	42	5.466G	43	5.442G	44	5.316G
45	5.301G	46	5.501G	47	5.380G	48	5.257G
49	5.404G	50	5.386G	51	5.327G	52	5.417G
53	5.474G	54	5.416G	55	5.655G	56	5.291G
57	5.434G	58	5.518G	59	5.604G	60	5.592G
61	5.465G	62	5.541G	63	5.322G	64	5.718G
65	5.468G	66	5.588G	67	5.269G	68	5.289G
69	5.346G	70	5.632G	71	5.410G	72	5.362G
73	5.392G	74	5.283G	75	5.561G	76	5.516G
77	5.528G	78	5.650G	79	5.439G	80	5.615G
81	5.486G	82	5.310G	83	5.543G	84	5.626G
85	5.280G	86	5.266G	87	5.368G	88	5.252G
89	5.460G	90	5.400G	91	5.298G	92	5.405G
93	5.420G	94	5.302G	95	5.587G	96	5.329G
97	5.569G	98	5.472G	99	5.263G	100	5.665G

Hopping Frequency Sequence Name: HOP_FREQ_SEQ_10							
SEQ#	Frequency (Hz)	SEQ#	Frequency (Hz)	SEQ#	Frequency (Hz)	SEQ#	Frequency (Hz)
1	5.631G	2	5.465G	3	5.433G	4	5.478G
5	5.398G	6	5.603G	7	5.394G	8	5.490G
9	5.318G	10	5.372G	11	5.646G	12	5.491G
13	5.517G	14	5.384G	15	5.271G	16	5.451G
17	5.685G	18	5.415G	19	5.336G	20	5.470G
21	5.587G	22	5.520G	23	5.508G	24	5.484G
25	5.509G	26	5.629G	27	5.279G	28	5.393G
29	5.266G	30	5.571G	31	5.388G	32	5.298G
33	5.659G	34	5.482G	35	5.467G	36	5.680G
37	5.414G	38	5.281G	39	5.636G	40	5.359G
41	5.427G	42	5.501G	43	5.447G	44	5.573G
45	5.432G	46	5.278G	47	5.689G	48	5.658G
49	5.688G	50	5.519G	51	5.515G	52	5.641G
53	5.309G	54	5.475G	55	5.457G	56	5.317G
57	5.670G	58	5.346G	59	5.581G	60	5.329G
61	5.536G	62	5.604G	63	5.690G	64	5.557G
65	5.331G	66	5.399G	67	5.316G	68	5.650G
69	5.370G	70	5.651G	71	5.322G	72	5.469G
73	5.251G	74	5.714G	75	5.314G	76	5.485G
77	5.489G	78	5.411G	79	5.498G	80	5.376G
81	5.561G	82	5.321G	83	5.453G	84	5.363G
85	5.367G	86	5.455G	87	5.600G	88	5.431G
89	5.459G	90	5.634G	91	5.656G	92	5.254G
93	5.409G	94	5.550G	95	5.313G	96	5.695G
97	5.562G	98	5.534G	99	5.288G	100	5.291G

Hopping Frequency Sequence Name: HOP_FREQ_SEQ_11							
SEQ#	Frequency (Hz)	SEQ#	Frequency (Hz)	SEQ#	Frequency (Hz)	SEQ#	Frequency (Hz)
1	5.377G	2	5.523G	3	5.294G	4	5.434G
5	5.430G	6	5.438G	7	5.625G	8	5.541G
9	5.350G	10	5.311G	11	5.267G	12	5.694G
13	5.537G	14	5.280G	15	5.603G	16	5.315G
17	5.285G	18	5.577G	19	5.333G	20	5.457G
21	5.283G	22	5.633G	23	5.455G	24	5.502G
25	5.668G	26	5.706G	27	5.339G	28	5.321G
29	5.717G	30	5.566G	31	5.604G	32	5.570G
33	5.608G	34	5.270G	35	5.722G	36	5.379G
37	5.391G	38	5.671G	39	5.279G	40	5.378G
41	5.647G	42	5.649G	43	5.677G	44	5.612G
45	5.396G	46	5.300G	47	5.297G	48	5.591G
49	5.319G	50	5.558G	51	5.299G	52	5.495G
53	5.424G	54	5.611G	55	5.351G	56	5.529G
57	5.334G	58	5.629G	59	5.303G	60	5.710G
61	5.641G	62	5.423G	63	5.460G	64	5.593G
65	5.648G	66	5.251G	67	5.583G	68	5.667G
69	5.256G	70	5.621G	71	5.554G	72	5.473G
73	5.341G	74	5.390G	75	5.307G	76	5.400G
77	5.394G	78	5.601G	79	5.492G	80	5.521G
81	5.491G	82	5.560G	83	5.638G	84	5.687G
85	5.620G	86	5.506G	87	5.346G	88	5.269G
89	5.498G	90	5.719G	91	5.622G	92	5.659G
93	5.600G	94	5.695G	95	5.301G	96	5.259G
97	5.658G	98	5.661G	99	5.331G	100	5.553G

Hopping Frequency Sequence Name: HOP_FREQ_SEQ_12							
SEQ#	Frequency (Hz)	SEQ#	Frequency (Hz)	SEQ#	Frequency (Hz)	SEQ#	Frequency (Hz)
1	5.286G	2	5.333G	3	5.361G	4	5.336G
5	5.607G	6	5.500G	7	5.307G	8	5.459G
9	5.544G	10	5.564G	11	5.505G	12	5.400G
13	5.377G	14	5.546G	15	5.589G	16	5.320G
17	5.528G	18	5.387G	19	5.550G	20	5.721G
21	5.557G	22	5.616G	23	5.419G	24	5.502G
25	5.645G	26	5.611G	27	5.629G	28	5.363G
29	5.585G	30	5.474G	31	5.277G	32	5.393G
33	5.430G	34	5.283G	35	5.349G	36	5.327G
37	5.599G	38	5.582G	39	5.624G	40	5.405G
41	5.603G	42	5.296G	43	5.391G	44	5.677G
45	5.347G	46	5.298G	47	5.295G	48	5.406G
49	5.426G	50	5.686G	51	5.492G	52	5.465G
53	5.643G	54	5.628G	55	5.515G	56	5.447G
57	5.511G	58	5.388G	59	5.389G	60	5.495G
61	5.671G	62	5.529G	63	5.415G	64	5.683G
65	5.341G	66	5.446G	67	5.556G	68	5.306G
69	5.670G	70	5.651G	71	5.630G	72	5.707G
73	5.482G	74	5.262G	75	5.655G	76	5.698G
77	5.448G	78	5.553G	79	5.496G	80	5.572G
81	5.609G	82	5.692G	83	5.700G	84	5.463G
85	5.647G	86	5.445G	87	5.576G	88	5.719G
89	5.297G	90	5.650G	91	5.352G	92	5.696G
93	5.408G	94	5.407G	95	5.543G	96	5.704G
97	5.290G	98	5.548G	99	5.285G	100	5.517G

Hopping Frequency Sequence Name: HOP_FREQ_SEQ_13							
SEQ#	Frequency (Hz)	SEQ#	Frequency (Hz)	SEQ#	Frequency (Hz)	SEQ#	Frequency (Hz)
1	5.517G	2	5.619G	3	5.714G	4	5.399G
5	5.516G	6	5.573G	7	5.446G	8	5.341G
9	5.372G	10	5.342G	11	5.507G	12	5.395G
13	5.296G	14	5.256G	15	5.479G	16	5.574G
17	5.599G	18	5.480G	19	5.521G	20	5.321G
21	5.648G	22	5.427G	23	5.269G	24	5.566G
25	5.669G	26	5.358G	27	5.311G	28	5.292G
29	5.605G	30	5.712G	31	5.524G	32	5.400G
33	5.724G	34	5.501G	35	5.609G	36	5.513G
37	5.695G	38	5.649G	39	5.709G	40	5.432G
41	5.646G	42	5.383G	43	5.376G	44	5.684G
45	5.590G	46	5.430G	47	5.413G	48	5.384G
49	5.635G	50	5.716G	51	5.352G	52	5.356G
53	5.487G	54	5.601G	55	5.441G	56	5.622G
57	5.465G	58	5.528G	59	5.417G	60	5.390G
61	5.283G	62	5.674G	63	5.522G	64	5.431G
65	5.401G	66	5.705G	67	5.692G	68	5.408G
69	5.466G	70	5.381G	71	5.488G	72	5.509G
73	5.267G	74	5.661G	75	5.581G	76	5.405G
77	5.469G	78	5.656G	79	5.305G	80	5.549G
81	5.582G	82	5.456G	83	5.259G	84	5.377G
85	5.554G	86	5.319G	87	5.523G	88	5.302G
89	5.594G	90	5.293G	91	5.722G	92	5.641G
93	5.644G	94	5.453G	95	5.470G	96	5.503G
97	5.659G	98	5.330G	99	5.397G	100	5.557G

Hopping Frequency Sequence Name: HOP_FREQ_SEQ_14							
SEQ#	Frequency (Hz)	SEQ#	Frequency (Hz)	SEQ#	Frequency (Hz)	SEQ#	Frequency (Hz)
1	5.293G	2	5.445G	3	5.287G	4	5.497G
5	5.660G	6	5.352G	7	5.637G	8	5.709G
9	5.333G	10	5.427G	11	5.367G	12	5.469G
13	5.577G	14	5.613G	15	5.459G	16	5.372G
17	5.284G	18	5.252G	19	5.521G	20	5.619G
21	5.487G	22	5.379G	23	5.353G	24	5.382G
25	5.433G	26	5.271G	27	5.563G	28	5.695G
29	5.506G	30	5.686G	31	5.565G	32	5.300G
33	5.569G	34	5.568G	35	5.345G	36	5.708G
37	5.283G	38	5.502G	39	5.662G	40	5.260G
41	5.404G	42	5.710G	43	5.674G	44	5.648G
45	5.281G	46	5.610G	47	5.299G	48	5.551G
49	5.474G	50	5.622G	51	5.529G	52	5.458G
53	5.553G	54	5.416G	55	5.638G	56	5.307G
57	5.524G	58	5.491G	59	5.492G	60	5.696G
61	5.693G	62	5.251G	63	5.517G	64	5.470G
65	5.477G	66	5.523G	67	5.667G	68	5.360G
69	5.418G	70	5.533G	71	5.588G	72	5.426G
73	5.349G	74	5.682G	75	5.626G	76	5.324G
77	5.454G	78	5.485G	79	5.348G	80	5.280G
81	5.436G	82	5.659G	83	5.567G	84	5.365G
85	5.268G	86	5.482G	87	5.664G	88	5.376G
89	5.576G	90	5.630G	91	5.699G	92	5.289G
93	5.496G	94	5.547G	95	5.413G	96	5.559G
97	5.311G	98	5.480G	99	5.440G	100	5.295G

Hopping Frequency Sequence Name: HOP_FREQ_SEQ_15							
SEQ#	Frequency (Hz)	SEQ#	Frequency (Hz)	SEQ#	Frequency (Hz)	SEQ#	Frequency (Hz)
1	5.696G	2	5.616G	3	5.724G	4	5.580G
5	5.491G	6	5.647G	7	5.555G	8	5.607G
9	5.489G	10	5.306G	11	5.570G	12	5.255G
13	5.656G	14	5.291G	15	5.664G	16	5.705G
17	5.537G	18	5.376G	19	5.406G	20	5.413G
21	5.550G	22	5.501G	23	5.441G	24	5.443G
25	5.707G	26	5.509G	27	5.366G	28	5.260G
29	5.613G	30	5.536G	31	5.547G	32	5.373G
33	5.637G	34	5.294G	35	5.578G	36	5.556G
37	5.287G	38	5.485G	39	5.602G	40	5.657G
41	5.519G	42	5.606G	43	5.393G	44	5.632G
45	5.381G	46	5.293G	47	5.506G	48	5.722G
49	5.588G	50	5.652G	51	5.292G	52	5.716G
53	5.544G	54	5.363G	55	5.524G	56	5.513G
57	5.454G	58	5.462G	59	5.412G	60	5.521G
61	5.620G	62	5.370G	63	5.511G	64	5.693G
65	5.641G	66	5.666G	67	5.433G	68	5.562G
69	5.690G	70	5.375G	71	5.589G	72	5.688G
73	5.532G	74	5.480G	75	5.364G	76	5.683G
77	5.568G	78	5.402G	79	5.309G	80	5.704G
81	5.259G	82	5.539G	83	5.408G	84	5.540G
85	5.430G	86	5.386G	87	5.391G	88	5.507G
89	5.627G	90	5.416G	91	5.446G	92	5.298G
93	5.551G	94	5.350G	95	5.336G	96	5.362G
97	5.700G	98	5.590G	99	5.343G	100	5.667G

Hopping Frequency Sequence Name: HOP_FREQ_SEQ_16							
SEQ#	Frequency (Hz)	SEQ#	Frequency (Hz)	SEQ#	Frequency (Hz)	SEQ#	Frequency (Hz)
1	5.368G	2	5.373G	3	5.380G	4	5.441G
5	5.322G	6	5.572G	7	5.561G	8	5.281G
9	5.326G	10	5.676G	11	5.674G	12	5.453G
13	5.500G	14	5.485G	15	5.460G	16	5.641G
17	5.617G	18	5.722G	19	5.473G	20	5.423G
21	5.602G	22	5.483G	23	5.635G	24	5.338G
25	5.656G	26	5.298G	27	5.466G	28	5.420G
29	5.411G	30	5.481G	31	5.271G	32	5.402G
33	5.591G	34	5.306G	35	5.666G	36	5.636G
37	5.458G	38	5.261G	39	5.341G	40	5.702G
41	5.324G	42	5.251G	43	5.396G	44	5.518G
45	5.645G	46	5.701G	47	5.550G	48	5.408G
49	5.465G	50	5.643G	51	5.331G	52	5.442G
53	5.625G	54	5.325G	55	5.681G	56	5.355G
57	5.436G	58	5.668G	59	5.434G	60	5.563G
61	5.422G	62	5.557G	63	5.292G	64	5.573G
65	5.496G	66	5.566G	67	5.429G	68	5.445G
69	5.578G	70	5.269G	71	5.686G	72	5.646G
73	5.319G	74	5.632G	75	5.312G	76	5.601G
77	5.377G	78	5.268G	79	5.615G	80	5.477G
81	5.697G	82	5.608G	83	5.502G	84	5.595G
85	5.315G	86	5.522G	87	5.314G	88	5.403G
89	5.535G	90	5.363G	91	5.470G	92	5.538G
93	5.419G	94	5.590G	95	5.447G	96	5.547G
97	5.541G	98	5.564G	99	5.435G	100	5.510G

Hopping Frequency Sequence Name: HOP_FREQ_SEQ_17							
SEQ#	Frequency (Hz)	SEQ#	Frequency (Hz)	SEQ#	Frequency (Hz)	SEQ#	Frequency (Hz)
1	5.712G	2	5.390G	3	5.338G	4	5.702G
5	5.623G	6	5.566G	7	5.531G	8	5.660G
9	5.550G	10	5.264G	11	5.339G	12	5.663G
13	5.533G	14	5.540G	15	5.557G	16	5.475G
17	5.604G	18	5.611G	19	5.593G	20	5.351G
21	5.622G	22	5.386G	23	5.569G	24	5.427G
25	5.689G	26	5.645G	27	5.469G	28	5.654G
29	5.532G	30	5.317G	31	5.587G	32	5.501G
33	5.389G	34	5.643G	35	5.687G	36	5.350G
37	5.251G	38	5.614G	39	5.278G	40	5.268G
41	5.465G	42	5.620G	43	5.497G	44	5.312G
45	5.556G	46	5.592G	47	5.415G	48	5.461G
49	5.254G	50	5.579G	51	5.492G	52	5.496G
53	5.394G	54	5.273G	55	5.699G	56	5.256G
57	5.698G	58	5.286G	59	5.562G	60	5.455G
61	5.537G	62	5.688G	63	5.572G	64	5.674G
65	5.635G	66	5.507G	67	5.709G	68	5.684G
69	5.330G	70	5.680G	71	5.559G	72	5.551G
73	5.505G	74	5.414G	75	5.320G	76	5.483G
77	5.391G	78	5.319G	79	5.411G	80	5.491G
81	5.661G	82	5.677G	83	5.464G	84	5.607G
85	5.334G	86	5.280G	87	5.348G	88	5.650G
89	5.425G	90	5.721G	91	5.573G	92	5.275G
93	5.451G	94	5.499G	95	5.416G	96	5.696G
97	5.715G	98	5.541G	99	5.638G	100	5.681G

Hopping Frequency Sequence Name: HOP_FREQ_SEQ_18							
SEQ#	Frequency (Hz)	SEQ#	Frequency (Hz)	SEQ#	Frequency (Hz)	SEQ#	Frequency (Hz)
1	5.674G	2	5.592G	3	5.699G	4	5.417G
5	5.694G	6	5.256G	7	5.613G	8	5.607G
9	5.313G	10	5.267G	11	5.268G	12	5.655G
13	5.715G	14	5.593G	15	5.326G	16	5.632G
17	5.308G	18	5.711G	19	5.516G	20	5.605G
21	5.393G	22	5.464G	23	5.557G	24	5.587G
25	5.282G	26	5.262G	27	5.333G	28	5.672G
29	5.351G	30	5.582G	31	5.496G	32	5.497G
33	5.665G	34	5.571G	35	5.390G	36	5.271G
37	5.558G	38	5.429G	39	5.590G	40	5.509G
41	5.618G	42	5.514G	43	5.260G	44	5.296G
45	5.611G	46	5.386G	47	5.426G	48	5.483G
49	5.601G	50	5.594G	51	5.329G	52	5.673G
53	5.576G	54	5.336G	55	5.666G	56	5.652G
57	5.690G	58	5.482G	59	5.657G	60	5.722G
61	5.255G	62	5.685G	63	5.395G	64	5.600G
65	5.548G	66	5.498G	67	5.305G	68	5.315G
69	5.658G	70	5.499G	71	5.689G	72	5.476G
73	5.408G	74	5.465G	75	5.595G	76	5.278G
77	5.502G	78	5.444G	79	5.366G	80	5.331G
81	5.653G	82	5.564G	83	5.561G	84	5.347G
85	5.481G	86	5.449G	87	5.705G	88	5.619G
89	5.677G	90	5.570G	91	5.532G	92	5.382G
93	5.602G	94	5.629G	95	5.660G	96	5.698G
97	5.349G	98	5.283G	99	5.562G	100	5.578G

Hopping Frequency Sequence Name: HOP_FREQ_SEQ_19							
SEQ#	Frequency (Hz)	SEQ#	Frequency (Hz)	SEQ#	Frequency (Hz)	SEQ#	Frequency (Hz)
1	5.361G	2	5.418G	3	5.376G	4	5.603G
5	5.346G	6	5.513G	7	5.252G	8	5.397G
9	5.428G	10	5.474G	11	5.465G	12	5.541G
13	5.685G	14	5.681G	15	5.272G	16	5.324G
17	5.521G	18	5.481G	19	5.508G	20	5.472G
21	5.259G	22	5.690G	23	5.548G	24	5.478G
25	5.251G	26	5.682G	27	5.680G	28	5.447G
29	5.488G	30	5.380G	31	5.684G	32	5.514G
33	5.665G	34	5.643G	35	5.565G	36	5.302G
37	5.567G	38	5.381G	39	5.458G	40	5.316G
41	5.419G	42	5.661G	43	5.266G	44	5.285G
45	5.335G	46	5.504G	47	5.559G	48	5.562G
49	5.556G	50	5.612G	51	5.686G	52	5.435G
53	5.271G	54	5.699G	55	5.366G	56	5.384G
57	5.456G	58	5.442G	59	5.515G	60	5.678G
61	5.609G	62	5.640G	63	5.279G	64	5.708G
65	5.572G	66	5.638G	67	5.283G	68	5.590G
69	5.555G	70	5.356G	71	5.579G	72	5.294G
73	5.317G	74	5.278G	75	5.581G	76	5.322G
77	5.352G	78	5.660G	79	5.689G	80	5.360G
81	5.538G	82	5.319G	83	5.427G	84	5.455G
85	5.717G	86	5.657G	87	5.371G	88	5.321G
89	5.280G	90	5.402G	91	5.598G	92	5.483G
93	5.449G	94	5.476G	95	5.518G	96	5.692G
97	5.460G	98	5.524G	99	5.507G	100	5.705G

Hopping Frequency Sequence Name: HOP_FREQ_SEQ_20							
SEQ#	Frequency (Hz)	SEQ#	Frequency (Hz)	SEQ#	Frequency (Hz)	SEQ#	Frequency (Hz)
1	5.316G	2	5.553G	3	5.265G	4	5.389G
5	5.401G	6	5.407G	7	5.357G	8	5.691G
9	5.415G	10	5.416G	11	5.538G	12	5.372G
13	5.539G	14	5.327G	15	5.629G	16	5.605G
17	5.334G	18	5.465G	19	5.380G	20	5.328G
21	5.623G	22	5.491G	23	5.624G	24	5.625G
25	5.523G	26	5.514G	27	5.654G	28	5.584G
29	5.270G	30	5.511G	31	5.681G	32	5.306G
33	5.366G	34	5.703G	35	5.608G	36	5.503G
37	5.458G	38	5.633G	39	5.272G	40	5.345G
41	5.311G	42	5.483G	43	5.405G	44	5.496G
45	5.386G	46	5.643G	47	5.542G	48	5.600G
49	5.300G	50	5.290G	51	5.578G	52	5.268G
53	5.262G	54	5.572G	55	5.370G	56	5.369G
57	5.267G	58	5.621G	59	5.348G	60	5.396G
61	5.392G	62	5.540G	63	5.289G	64	5.517G
65	5.704G	66	5.617G	67	5.448G	68	5.606G
69	5.497G	70	5.495G	71	5.602G	72	5.378G
73	5.417G	74	5.335G	75	5.355G	76	5.271G
77	5.277G	78	5.611G	79	5.414G	80	5.630G
81	5.260G	82	5.699G	83	5.552G	84	5.307G
85	5.663G	86	5.439G	87	5.323G	88	5.471G
89	5.477G	90	5.720G	91	5.648G	92	5.436G
93	5.682G	94	5.604G	95	5.558G	96	5.634G
97	5.567G	98	5.356G	99	5.708G	100	5.652G

Hopping Frequency Sequence Name: HOP_FREQ_SEQ_21							
SEQ#	Frequency (Hz)	SEQ#	Frequency (Hz)	SEQ#	Frequency (Hz)	SEQ#	Frequency (Hz)
1	5.695G	2	5.392G	3	5.546G	4	5.452G
5	5.537G	6	5.523G	7	5.429G	8	5.522G
9	5.454G	10	5.492G	11	5.292G	12	5.328G
13	5.314G	14	5.321G	15	5.538G	16	5.330G
17	5.280G	18	5.533G	19	5.518G	20	5.384G
21	5.263G	22	5.436G	23	5.525G	24	5.590G
25	5.306G	26	5.285G	27	5.605G	28	5.653G
29	5.610G	30	5.458G	31	5.644G	32	5.694G
33	5.723G	34	5.374G	35	5.368G	36	5.565G
37	5.614G	38	5.270G	39	5.683G	40	5.255G
41	5.648G	42	5.634G	43	5.664G	44	5.484G
45	5.548G	46	5.419G	47	5.344G	48	5.371G
49	5.380G	50	5.607G	51	5.573G	52	5.293G
53	5.420G	54	5.567G	55	5.579G	56	5.503G
57	5.445G	58	5.296G	59	5.603G	60	5.414G
61	5.709G	62	5.516G	63	5.651G	64	5.411G
65	5.515G	66	5.432G	67	5.252G	68	5.604G
69	5.589G	70	5.323G	71	5.509G	72	5.671G
73	5.449G	74	5.491G	75	5.710G	76	5.588G
77	5.266G	78	5.622G	79	5.536G	80	5.372G
81	5.615G	82	5.268G	83	5.336G	84	5.471G
85	5.582G	86	5.382G	87	5.381G	88	5.387G
89	5.279G	90	5.264G	91	5.308G	92	5.278G
93	5.496G	94	5.404G	95	5.262G	96	5.322G
97	5.624G	98	5.534G	99	5.399G	100	5.506G

Hopping Frequency Sequence Name: HOP_FREQ_SEQ_22							
SEQ#	Frequency (Hz)	SEQ#	Frequency (Hz)	SEQ#	Frequency (Hz)	SEQ#	Frequency (Hz)
1	5.274G	2	5.442G	3	5.557G	4	5.352G
5	5.424G	6	5.359G	7	5.448G	8	5.518G
9	5.576G	10	5.374G	11	5.313G	12	5.621G
13	5.651G	14	5.574G	15	5.304G	16	5.335G
17	5.549G	18	5.280G	19	5.612G	20	5.567G
21	5.388G	22	5.646G	23	5.472G	24	5.586G
25	5.650G	26	5.553G	27	5.413G	28	5.721G
29	5.287G	30	5.373G	31	5.634G	32	5.435G
33	5.601G	34	5.266G	35	5.316G	36	5.578G
37	5.571G	38	5.301G	39	5.264G	40	5.688G
41	5.581G	42	5.370G	43	5.420G	44	5.291G
45	5.415G	46	5.329G	47	5.332G	48	5.398G
49	5.609G	50	5.295G	51	5.458G	52	5.535G
53	5.632G	54	5.286G	55	5.258G	56	5.391G
57	5.250G	58	5.368G	59	5.643G	60	5.283G
61	5.503G	62	5.540G	63	5.599G	64	5.459G
65	5.439G	66	5.523G	67	5.659G	68	5.319G
69	5.252G	70	5.408G	71	5.440G	72	5.684G
73	5.642G	74	5.666G	75	5.447G	76	5.718G
77	5.454G	78	5.452G	79	5.671G	80	5.279G
81	5.308G	82	5.346G	83	5.284G	84	5.508G
85	5.501G	86	5.560G	87	5.520G	88	5.265G
89	5.652G	90	5.689G	91	5.697G	92	5.479G
93	5.397G	94	5.656G	95	5.685G	96	5.356G
97	5.500G	98	5.660G	99	5.515G	100	5.453G

Hopping Frequency Sequence Name: HOP_FREQ_SEQ_23							
SEQ#	Frequency (Hz)	SEQ#	Frequency (Hz)	SEQ#	Frequency (Hz)	SEQ#	Frequency (Hz)
1	5.536G	2	5.300G	3	5.286G	4	5.432G
5	5.456G	6	5.499G	7	5.486G	8	5.563G
9	5.548G	10	5.703G	11	5.393G	12	5.638G
13	5.713G	14	5.608G	15	5.384G	16	5.711G
17	5.274G	18	5.516G	19	5.335G	20	5.690G
21	5.611G	22	5.424G	23	5.305G	24	5.577G
25	5.594G	26	5.289G	27	5.546G	28	5.592G
29	5.380G	30	5.565G	31	5.629G	32	5.423G
33	5.470G	34	5.372G	35	5.717G	36	5.293G
37	5.451G	38	5.722G	39	5.390G	40	5.588G
41	5.418G	42	5.460G	43	5.463G	44	5.710G
45	5.310G	46	5.675G	47	5.363G	48	5.640G
49	5.630G	50	5.457G	51	5.543G	52	5.537G
53	5.329G	54	5.518G	55	5.567G	56	5.322G
57	5.617G	58	5.450G	59	5.515G	60	5.522G
61	5.323G	62	5.512G	63	5.336G	64	5.263G
65	5.691G	66	5.287G	67	5.441G	68	5.503G
69	5.309G	70	5.283G	71	5.250G	72	5.339G
73	5.487G	74	5.321G	75	5.290G	76	5.381G
77	5.253G	78	5.599G	79	5.268G	80	5.582G
81	5.328G	82	5.532G	83	5.679G	84	5.666G
85	5.539G	86	5.469G	87	5.655G	88	5.443G
89	5.511G	90	5.643G	91	5.285G	92	5.431G
93	5.656G	94	5.535G	95	5.627G	96	5.701G
97	5.438G	98	5.495G	99	5.449G	100	5.591G

Hopping Frequency Sequence Name: HOP_FREQ_SEQ_24							
SEQ#	Frequency (Hz)	SEQ#	Frequency (Hz)	SEQ#	Frequency (Hz)	SEQ#	Frequency (Hz)
1	5.408G	2	5.464G	3	5.693G	4	5.422G
5	5.360G	6	5.659G	7	5.485G	8	5.611G
9	5.317G	10	5.273G	11	5.594G	12	5.661G
13	5.359G	14	5.696G	15	5.518G	16	5.452G
17	5.400G	18	5.324G	19	5.677G	20	5.532G
21	5.407G	22	5.569G	23	5.372G	24	5.723G
25	5.309G	26	5.275G	27	5.637G	28	5.393G
29	5.251G	30	5.614G	31	5.484G	32	5.421G
33	5.262G	34	5.325G	35	5.454G	36	5.612G
37	5.351G	38	5.702G	39	5.604G	40	5.339G
41	5.520G	42	5.314G	43	5.283G	44	5.439G
45	5.682G	46	5.449G	47	5.342G	48	5.334G
49	5.304G	50	5.459G	51	5.675G	52	5.546G
53	5.302G	54	5.419G	55	5.326G	56	5.667G
57	5.411G	58	5.432G	59	5.705G	60	5.433G
61	5.349G	62	5.361G	63	5.668G	64	5.413G
65	5.552G	66	5.328G	67	5.338G	68	5.288G
69	5.694G	70	5.467G	71	5.620G	72	5.250G
73	5.628G	74	5.560G	75	5.582G	76	5.680G
77	5.347G	78	5.298G	79	5.426G	80	5.692G
81	5.458G	82	5.548G	83	5.337G	84	5.265G
85	5.386G	86	5.343G	87	5.424G	88	5.292G
89	5.563G	90	5.539G	91	5.724G	92	5.255G
93	5.365G	94	5.469G	95	5.389G	96	5.492G
97	5.268G	98	5.610G	99	5.438G	100	5.382G

Hopping Frequency Sequence Name: HOP_FREQ_SEQ_25							
SEQ#	Frequency (Hz)	SEQ#	Frequency (Hz)	SEQ#	Frequency (Hz)	SEQ#	Frequency (Hz)
1	5.391G	2	5.724G	3	5.502G	4	5.548G
5	5.703G	6	5.544G	7	5.385G	8	5.676G
9	5.301G	10	5.271G	11	5.665G	12	5.298G
13	5.308G	14	5.504G	15	5.413G	16	5.446G
17	5.401G	18	5.365G	19	5.414G	20	5.430G
21	5.509G	22	5.332G	23	5.389G	24	5.545G
25	5.705G	26	5.624G	27	5.658G	28	5.263G
29	5.568G	30	5.422G	31	5.497G	32	5.341G
33	5.486G	34	5.395G	35	5.329G	36	5.660G
37	5.325G	38	5.477G	39	5.619G	40	5.525G
41	5.297G	42	5.559G	43	5.580G	44	5.590G
45	5.423G	46	5.285G	47	5.720G	48	5.267G
49	5.350G	50	5.706G	51	5.340G	52	5.649G
53	5.338G	54	5.543G	55	5.562G	56	5.687G
57	5.362G	58	5.266G	59	5.524G	60	5.520G
61	5.560G	62	5.355G	63	5.715G	64	5.542G
65	5.487G	66	5.584G	67	5.718G	68	5.269G
69	5.599G	70	5.374G	71	5.260G	72	5.587G
73	5.574G	74	5.384G	75	5.552G	76	5.403G
77	5.351G	78	5.484G	79	5.281G	80	5.259G
81	5.460G	82	5.319G	83	5.330G	84	5.533G
85	5.277G	86	5.626G	87	5.490G	88	5.439G
89	5.613G	90	5.565G	91	5.553G	92	5.561G
93	5.453G	94	5.555G	95	5.608G	96	5.505G
97	5.287G	98	5.506G	99	5.376G	100	5.284G

Hopping Frequency Sequence Name: HOP_FREQ_SEQ_26							
SEQ#	Frequency (Hz)	SEQ#	Frequency (Hz)	SEQ#	Frequency (Hz)	SEQ#	Frequency (Hz)
1	5.518G	2	5.476G	3	5.593G	4	5.256G
5	5.688G	6	5.624G	7	5.579G	8	5.270G
9	5.450G	10	5.639G	11	5.529G	12	5.292G
13	5.607G	14	5.447G	15	5.627G	16	5.544G
17	5.410G	18	5.574G	19	5.671G	20	5.426G
21	5.681G	22	5.595G	23	5.538G	24	5.340G
25	5.708G	26	5.351G	27	5.552G	28	5.380G
29	5.543G	30	5.460G	31	5.568G	32	5.531G
33	5.284G	34	5.492G	35	5.322G	36	5.290G
37	5.375G	38	5.656G	39	5.541G	40	5.516G
41	5.573G	42	5.553G	43	5.417G	44	5.365G
45	5.522G	46	5.327G	47	5.637G	48	5.372G
49	5.266G	50	5.388G	51	5.338G	52	5.514G
53	5.662G	54	5.448G	55	5.703G	56	5.577G
57	5.361G	58	5.261G	59	5.303G	60	5.659G
61	5.696G	62	5.601G	63	5.721G	64	5.524G
65	5.378G	66	5.641G	67	5.480G	68	5.556G
69	5.420G	70	5.615G	71	5.407G	72	5.291G
73	5.631G	74	5.483G	75	5.680G	76	5.720G
77	5.557G	78	5.283G	79	5.633G	80	5.339G
81	5.438G	82	5.623G	83	5.495G	84	5.391G
85	5.702G	86	5.310G	87	5.349G	88	5.602G
89	5.353G	90	5.698G	91	5.473G	92	5.618G
93	5.506G	94	5.486G	95	5.718G	96	5.677G
97	5.534G	98	5.376G	99	5.300G	100	5.487G

Hopping Frequency Sequence Name: HOP_FREQ_SEQ_27							
SEQ#	Frequency (Hz)	SEQ#	Frequency (Hz)	SEQ#	Frequency (Hz)	SEQ#	Frequency (Hz)
1	5.337G	2	5.631G	3	5.477G	4	5.383G
5	5.506G	6	5.710G	7	5.590G	8	5.379G
9	5.455G	10	5.562G	11	5.572G	12	5.411G
13	5.529G	14	5.630G	15	5.671G	16	5.275G
17	5.584G	18	5.441G	19	5.639G	20	5.717G
21	5.452G	22	5.609G	23	5.370G	24	5.286G
25	5.658G	26	5.303G	27	5.610G	28	5.579G
29	5.470G	30	5.660G	31	5.407G	32	5.641G
33	5.560G	34	5.338G	35	5.637G	36	5.667G
37	5.359G	38	5.520G	39	5.306G	40	5.267G
41	5.698G	42	5.277G	43	5.521G	44	5.720G
45	5.665G	46	5.647G	47	5.578G	48	5.668G
49	5.479G	50	5.342G	51	5.372G	52	5.445G
53	5.417G	54	5.487G	55	5.534G	56	5.636G
57	5.376G	58	5.702G	59	5.435G	60	5.516G
61	5.276G	62	5.343G	63	5.393G	64	5.531G
65	5.657G	66	5.567G	67	5.363G	68	5.499G
69	5.361G	70	5.654G	71	5.661G	72	5.282G
73	5.510G	74	5.290G	75	5.335G	76	5.353G
77	5.469G	78	5.349G	79	5.712G	80	5.711G
81	5.524G	82	5.569G	83	5.563G	84	5.389G
85	5.450G	86	5.645G	87	5.608G	88	5.638G
89	5.298G	90	5.691G	91	5.542G	92	5.345G
93	5.308G	94	5.256G	95	5.297G	96	5.623G
97	5.302G	98	5.536G	99	5.440G	100	5.475G

Hopping Frequency Sequence Name: HOP_FREQ_SEQ_28							
SEQ#	Frequency (Hz)	SEQ#	Frequency (Hz)	SEQ#	Frequency (Hz)	SEQ#	Frequency (Hz)
1	5.362G	2	5.677G	3	5.297G	4	5.457G
5	5.421G	6	5.286G	7	5.537G	8	5.697G
9	5.427G	10	5.690G	11	5.436G	12	5.413G
13	5.443G	14	5.492G	15	5.614G	16	5.431G
17	5.558G	18	5.633G	19	5.582G	20	5.477G
21	5.547G	22	5.505G	23	5.433G	24	5.498G
25	5.276G	26	5.630G	27	5.591G	28	5.544G
29	5.356G	30	5.454G	31	5.689G	32	5.639G
33	5.482G	34	5.627G	35	5.308G	36	5.366G
37	5.337G	38	5.523G	39	5.721G	40	5.464G
41	5.682G	42	5.426G	43	5.528G	44	5.719G
45	5.414G	46	5.488G	47	5.535G	48	5.408G
49	5.576G	50	5.456G	51	5.311G	52	5.541G
53	5.476G	54	5.302G	55	5.644G	56	5.376G
57	5.596G	58	5.306G	59	5.471G	60	5.384G
61	5.641G	62	5.461G	63	5.373G	64	5.273G
65	5.536G	66	5.507G	67	5.405G	68	5.266G
69	5.694G	70	5.524G	71	5.466G	72	5.623G
73	5.610G	74	5.451G	75	5.709G	76	5.676G
77	5.365G	78	5.617G	79	5.670G	80	5.696G
81	5.271G	82	5.319G	83	5.636G	84	5.515G
85	5.684G	86	5.517G	87	5.387G	88	5.710G
89	5.314G	90	5.674G	91	5.336G	92	5.317G
93	5.626G	94	5.688G	95	5.521G	96	5.359G
97	5.411G	98	5.574G	99	5.318G	100	5.573G

Hopping Frequency Sequence Name: HOP_FREQ_SEQ_29							
SEQ#	Frequency (Hz)	SEQ#	Frequency (Hz)	SEQ#	Frequency (Hz)	SEQ#	Frequency (Hz)
1	5.609G	2	5.264G	3	5.406G	4	5.637G
5	5.444G	6	5.301G	7	5.708G	8	5.627G
9	5.701G	10	5.420G	11	5.327G	12	5.350G
13	5.586G	14	5.504G	15	5.712G	16	5.439G
17	5.719G	18	5.338G	19	5.345G	20	5.405G
21	5.462G	22	5.260G	23	5.302G	24	5.452G
25	5.544G	26	5.416G	27	5.325G	28	5.470G
29	5.600G	30	5.604G	31	5.455G	32	5.337G
33	5.351G	34	5.402G	35	5.357G	36	5.482G
37	5.537G	38	5.436G	39	5.313G	40	5.318G
41	5.531G	42	5.410G	43	5.511G	44	5.479G
45	5.680G	46	5.709G	47	5.323G	48	5.684G
49	5.415G	50	5.272G	51	5.466G	52	5.581G
53	5.320G	54	5.311G	55	5.542G	56	5.651G
57	5.566G	58	5.317G	59	5.309G	60	5.474G
61	5.477G	62	5.385G	63	5.374G	64	5.268G
65	5.682G	66	5.661G	67	5.567G	68	5.258G
69	5.266G	70	5.534G	71	5.497G	72	5.296G
73	5.557G	74	5.283G	75	5.615G	76	5.450G
77	5.253G	78	5.570G	79	5.471G	80	5.618G
81	5.448G	82	5.549G	83	5.394G	84	5.383G
85	5.523G	86	5.644G	87	5.312G	88	5.691G
89	5.495G	90	5.629G	91	5.306G	92	5.587G
93	5.688G	94	5.356G	95	5.275G	96	5.565G
97	5.365G	98	5.424G	99	5.624G	100	5.395G

Hopping Frequency Sequence Name: HOP_FREQ_SEQ_30							
SEQ#	Frequency (Hz)	SEQ#	Frequency (Hz)	SEQ#	Frequency (Hz)	SEQ#	Frequency (Hz)
1	5.491G	2	5.450G	3	5.454G	4	5.513G
5	5.520G	6	5.308G	7	5.290G	8	5.620G
9	5.275G	10	5.407G	11	5.477G	12	5.637G
13	5.396G	14	5.452G	15	5.686G	16	5.292G
17	5.574G	18	5.553G	19	5.317G	20	5.312G
21	5.457G	22	5.547G	23	5.250G	24	5.435G
25	5.649G	26	5.523G	27	5.682G	28	5.644G
29	5.409G	30	5.595G	31	5.504G	32	5.270G
33	5.286G	34	5.283G	35	5.403G	36	5.583G
37	5.506G	38	5.543G	39	5.360G	40	5.310G
41	5.608G	42	5.387G	43	5.254G	44	5.707G
45	5.269G	46	5.665G	47	5.256G	48	5.341G
49	5.584G	50	5.692G	51	5.560G	52	5.582G
53	5.662G	54	5.324G	55	5.530G	56	5.576G
57	5.712G	58	5.552G	59	5.284G	60	5.388G
61	5.670G	62	5.507G	63	5.279G	64	5.661G
65	5.521G	66	5.402G	67	5.253G	68	5.332G
69	5.510G	70	5.428G	71	5.401G	72	5.624G
73	5.335G	74	5.377G	75	5.695G	76	5.445G
77	5.313G	78	5.531G	79	5.647G	80	5.468G
81	5.316G	82	5.395G	83	5.655G	84	5.404G
85	5.528G	86	5.581G	87	5.307G	88	5.713G
89	5.381G	90	5.328G	91	5.706G	92	5.306G
93	5.674G	94	5.676G	95	5.590G	96	5.366G
97	5.533G	98	5.684G	99	5.463G	100	5.556G

IEEE 802.11ac VHT80

Type 1 Radar Statistical Performances

Trial #	Pulses per Burst	Pulse Width (s)	PRI (s)	Radar Frequency (MHz)	Detection
1	89	1.0u	598.0u	5492	Yes
2	81	1.0u	658.0u	5495	Yes
3	86	1.0u	618.0u	5497	Yes
4	78	1.0u	678.0u	5500	Yes
5	76	1.0u	698.0u	5503	Yes
6	72	1.0u	738.0u	5506	Yes
7	70	1.0u	758.0u	5508	Yes
8	68	1.0u	778.0u	5510	Yes
9	65	1.0u	818.0u	5513	Yes
10	63	1.0u	838.0u	5516	Yes
11	62	1.0u	858.0u	5518	Yes
12	61	1.0u	878.0u	5521	Yes
13	59	1.0u	898.0u	5524	Yes
14	58	1.0u	918.0u	5527	Yes
15	57	1.0u	938.0u	5530	Yes
16	68	1.0u	781.0u	5533	Yes
17	60	1.0u	881.0u	5536	Yes
18	59	1.0u	907.0u	5539	Yes
19	59	1.0u	931.0u	5542	Yes
20	63	1.0u	851.0u	5545	Yes
21	71	1.0u	751.0u	5550	Yes
22	67	1.0u	793.0u	5552	Yes
23	64	1.0u	833.0u	5554	Yes
24	60	1.0u	893.0u	5556	Yes
25	86	1.0u	617.0u	5558	Yes
26	76	1.0u	697.0u	5560	Yes
27	68	1.0u	777.0u	5562	Yes
28	67	1.0u	797.0u	5564	Yes
29	64	1.0u	837.0u	5566	Yes
30	58	1.0u	917.0u	5568	Yes

Detection Rate: 100.0 %

Type 2 Radar Statistical Performances					
Trial #	Pulses per Burst	Pulse Width (s)	PRI (s)	Radar Frequency (MHz)	Detection
1	26	3.3u	225.0u	5492	Yes
2	27	3.6u	171.0u	5495	Yes
3	24	2.9u	155.0u	5497	Yes
4	28	1.1u	174.0u	5500	Yes
5	24	3.8u	179.0u	5503	Yes
6	24	3.7u	217.0u	5506	Yes
7	23	2.9u	153.0u	5508	Yes
8	26	4.8u	169.0u	5510	Yes
9	25	1.2u	152.0u	5513	Yes
10	28	2.6u	228.0u	5516	No
11	26	1.6u	151.0u	5518	Yes
12	24	2.0u	152.0u	5521	Yes
13	26	1.7u	176.0u	5524	Yes
14	29	4.4u	229.0u	5527	No
15	25	3.2u	169.0u	5530	Yes
16	24	4.5u	226.0u	5533	Yes
17	27	3.1u	156.0u	5536	No
18	23	1.5u	176.0u	5539	Yes
19	28	3.5u	225.0u	5542	No
20	28	1.8u	182.0u	5545	Yes
21	27	1.2u	180.0u	5550	Yes
22	28	3.5u	213.0u	5552	Yes
23	24	2.5u	175.0u	5554	Yes
24	27	3.1u	164.0u	5556	Yes
25	26	1.8u	151.0u	5558	Yes
26	26	1.7u	217.0u	5560	No
27	25	3.1u	183.0u	5562	No
28	23	1.3u	185.0u	5564	Yes
29	26	1.4u	219.0u	5566	No
30	24	3.5u	183.0u	5568	Yes

Detection Rate: 76.7 %

Type 3 Radar Statistical Performances					
Trial #	Pulses per Burst	Pulse Width (s)	PRI (s)	Radar Frequency (MHz)	Detection
1	16	8.8u	280.0u	5492	Yes
2	16	8.8u	462.0u	5495	No
3	18	6.0u	378.0u	5497	Yes
4	16	8.8u	413.0u	5500	No
5	17	8.7u	385.0u	5503	Yes
6	17	8.5u	447.0u	5506	Yes
7	16	7.5u	284.0u	5508	No
8	16	9.9u	276.0u	5510	Yes
9	17	9.9u	461.0u	5513	Yes
10	16	8.4u	446.0u	5516	Yes
11	16	8.9u	314.0u	5518	Yes
12	18	6.3u	387.0u	5521	Yes
13	17	8.5u	273.0u	5524	Yes
14	18	8.6u	322.0u	5527	No
15	17	7.0u	286.0u	5530	Yes
16	18	9.2u	305.0u	5533	Yes
17	17	9.2u	316.0u	5536	Yes
18	16	7.4u	214.0u	5539	Yes
19	18	9.3u	255.0u	5542	Yes
20	17	9.6u	240.0u	5545	Yes
21	17	6.0u	205.0u	5550	Yes
22	16	6.9u	202.0u	5552	Yes
23	17	7.9u	405.0u	5554	Yes
24	17	9.1u	397.0u	5556	Yes
25	16	8.2u	485.0u	5558	Yes
26	16	9.9u	428.0u	5560	Yes
27	17	7.2u	247.0u	5562	Yes
28	17	8.7u	457.0u	5564	Yes
29	17	8.1u	327.0u	5566	Yes
30	17	7.0u	429.0u	5568	No

Detection Rate: 83.3 %

Type 4 Radar Statistical Performances					
Trial #	Pulses per Burst	Pulse Width (s)	PRI (s)	Radar Frequency (MHz)	Detection
1	14	16.1u	359.0u	5492	Yes
2	12	19.9u	419.0u	5495	Yes
3	15	19.1u	300.0u	5497	Yes
4	12	16.5u	497.0u	5500	Yes
5	16	11.5u	347.0u	5503	No
6	15	13.0u	396.0u	5506	No
7	16	12.4u	326.0u	5508	Yes
8	14	17.7u	309.0u	5510	Yes
9	14	17.9u	416.0u	5513	Yes
10	14	14.4u	441.0u	5516	Yes
11	14	11.4u	305.0u	5518	No
12	15	17.7u	333.0u	5521	Yes
13	13	17.2u	203.0u	5524	Yes
14	16	16.1u	371.0u	5527	Yes
15	15	19.9u	204.0u	5530	Yes
16	12	12.8u	444.0u	5533	Yes
17	15	15.6u	415.0u	5536	Yes
18	14	19.7u	321.0u	5539	Yes
19	14	19.9u	499.0u	5542	Yes
20	13	13.1u	438.0u	5545	Yes
21	15	16.6u	432.0u	5550	Yes
22	13	18.1u	351.0u	5552	No
23	16	18.6u	382.0u	5554	Yes
24	15	19.2u	484.0u	5556	Yes
25	16	15.7u	496.0u	5558	Yes
26	15	13.7u	368.0u	5560	Yes
27	13	17.7u	311.0u	5562	No
28	13	13.8u	368.0u	5564	Yes
29	13	19.1u	404.0u	5566	Yes
30	13	15.2u	226.0u	5568	No

Detection Rate: 80.0 %

Type 5 Radar Statistical Performances

Trial #	Test Signal Name	Detection
1	LP_Signal_01	Yes
2	LP_Signal_02	Yes
3	LP_Signal_03	Yes
4	LP_Signal_04	Yes
5	LP_Signal_05	Yes
6	LP_Signal_06	Yes
7	LP_Signal_07	Yes
8	LP_Signal_08	Yes
9	LP_Signal_09	Yes
10	LP_Signal_10	Yes
11	LP_Signal_11	Yes
12	LP_Signal_12	Yes
13	LP_Signal_13	Yes
14	LP_Signal_14	Yes
15	LP_Signal_15	Yes
16	LP_Signal_16	Yes
17	LP_Signal_17	Yes
18	LP_Signal_18	Yes
19	LP_Signal_19	Yes
20	LP_Signal_20	Yes
21	LP_Signal_21	Yes
22	LP_Signal_22	Yes
23	LP_Signal_23	Yes
24	LP_Signal_24	Yes
25	LP_Signal_25	Yes
26	LP_Signal_26	Yes
27	LP_Signal_27	Yes
28	LP_Signal_28	Yes
29	LP_Signal_29	Yes
30	LP_Signal_30	Yes

Detection Rate: 100.0 %

Long Pulse Radar Test Signal

Test Signal Name: LP_Signal_01

Number of Bursts in Trial: 12

Chrip Center Frequency: 5493MHz

Burst	Pulses per Burst	Chrip (Hz)	Pulse Width (s)	Pulse 1 to 2 Spacing (s)	Pulse 2 to 3 Spacing (s)	Start Location (s)
1	1	5M	96.5u	-	-	857.4m
2	2	5M	53.0u	1.173m	-	643.5m
3	1	5M	84.3u	-	-	871.6m
4	3	5M	99.1u	1.140m	1.778m	521.9m
5	3	5M	67.5u	1.487m	1.636m	314.7m
6	2	5M	60.2u	1.210m	-	877.7m
7	1	5M	98.6u	-	-	340.6m
8	3	5M	90.3u	1.747m	1.331m	243.1m
9	2	5M	52.8u	1.060m	-	767.7m
10	2	5M	76.4u	1.115m	-	481.2m
11	3	5M	98.3u	1.759m	1.414m	449.9m
12	1	5M	66.6u	-	-	887.3m

Long Pulse Radar Test Signal						
Test Signal Name: LP_Signal_02						
Number of Bursts in Trial: 18						
Chrip Center Frequency: 5493MHz						
Burst	Pulses per Burst	Chrip (Hz)	Pulse Width (s)	Pulse 1 to 2 Spacing (s)	Pulse 2 to 3 Spacing (s)	Start Location (s)
1	1	5M	53.6u	-	-	504.6m
2	3	5M	97.1u	1.798m	1.565m	441.5m
3	3	5M	53.5u	1.548m	1.068m	291.7m
4	2	5M	52.2u	1.395m	-	212.8m
5	2	5M	95.3u	1.226m	-	96.33m
6	2	5M	92.6u	1.470m	-	303.7m
7	1	5M	82.6u	-	-	516.6m
8	1	5M	53.5u	-	-	141.6m
9	2	5M	57.4u	999.6u	-	95.05m
10	2	5M	96.4u	1.888m	-	567.5m
11	2	5M	66.0u	1.443m	-	271.3m
12	1	5M	98.5u	-	-	442.6m
13	2	5M	68.3u	1.114m	-	512.5m
14	2	5M	85.3u	1.613m	-	105.4m
15	3	5M	99.4u	1.752m	1.843m	647.8m
16	2	5M	97.8u	1.644m	-	259.0m
17	1	5M	77.1u	-	-	649.5m
18	1	5M	58.2u	-	-	539.5m

Long Pulse Radar Test Signal						
Test Signal Name: LP_Signal_03						
Number of Bursts in Trial: 14						
Chrip Center Frequency: 5494MHz						
Burst	Pulses per Burst	Chrip (Hz)	Pulse Width (s)	Pulse 1 to 2 Spacing (s)	Pulse 2 to 3 Spacing (s)	Start Location (s)
1	3	7M	62.7u	1.678m	1.717m	280.1m
2	2	7M	77.5u	1.567m	-	308.4m
3	1	7M	98.3u	-	-	380.5m
4	2	7M	85.2u	1.831m	-	205.0m
5	3	7M	91.8u	1.520m	947.2u	688.8m
6	1	7M	91.4u	-	-	69.25m
7	2	7M	76.1u	1.384m	-	699.5m
8	2	7M	68.2u	1.336m	-	142.5m
9	1	7M	87.0u	-	-	439.3m
10	2	7M	85.3u	1.230m	-	171.5m
11	2	7M	75.6u	1.213m	-	309.9m
12	3	7M	82.8u	1.743m	1.125m	450.3m
13	2	7M	74.3u	1.667m	-	190.8m
14	1	7M	77.4u	-	-	385.5m

Long Pulse Radar Test Signal						
Test Signal Name: LP_Signal_04						
Number of Bursts in Trial: 19						
Chrip Center Frequency: 5494MHz						
Burst	Pulses per Burst	Chrip (Hz)	Pulse Width (s)	Pulse 1 to 2 Spacing (s)	Pulse 2 to 3 Spacing (s)	Start Location (s)
1	1	7M	88.9u	-	-	400.9m
2	2	7M	87.7u	1.749m	-	609.2m
3	2	7M	50.6u	1.085m	-	105.0m
4	3	7M	91.1u	1.614m	1.318m	577.2m
5	2	7M	74.9u	973.1u	-	357.6m
6	3	7M	73.2u	1.725m	1.906m	367.0m
7	3	7M	80.3u	945.7u	1.860m	150.4m
8	2	7M	95.3u	1.286m	-	625.2m
9	2	7M	84.7u	1.685m	-	954.0u
10	2	7M	59.4u	1.472m	-	547.2m
11	2	7M	86.9u	1.657m	-	488.3m
12	2	7M	58.6u	1.575m	-	148.0m
13	1	7M	97.1u	-	-	448.7m
14	1	7M	75.6u	-	-	601.2m
15	3	7M	66.8u	1.457m	1.366m	239.7m
16	2	7M	79.2u	1.394m	-	127.7m
17	2	7M	50.1u	1.763m	-	55.41m
18	1	7M	73.1u	-	-	132.9m
19	1	7M	51.8u	-	-	601.6m

Long Pulse Radar Test Signal						
Test Signal Name: LP_Signal_05						
Number of Bursts in Trial: 19						
Chrip Center Frequency: 5496MHz						
Burst	Pulses per Burst	Chrip (Hz)	Pulse Width (s)	Pulse 1 to 2 Spacing (s)	Pulse 2 to 3 Spacing (s)	Start Location (s)
1	2	13M	98.5u	1.185m	-	281.2m
2	2	13M	66.9u	1.351m	-	601.3m
3	3	13M	55.6u	1.069m	1.564m	386.6m
4	1	13M	63.9u	-	-	70.85m
5	2	13M	88.1u	1.499m	-	486.4m
6	2	13M	77.3u	1.188m	-	445.4m
7	2	13M	51.2u	1.501m	-	39.21m
8	2	13M	84.1u	1.309m	-	348.6m
9	3	13M	62.5u	1.360m	1.020m	537.1m
10	2	13M	96.3u	1.862m	-	172.3m
11	1	13M	51.7u	-	-	207.5m
12	2	13M	91.0u	1.645m	-	337.1m
13	2	13M	56.6u	1.739m	-	566.0m
14	3	13M	66.1u	1.150m	1.775m	563.4m
15	2	13M	84.0u	1.515m	-	378.1m
16	1	13M	76.1u	-	-	565.0m
17	2	13M	79.4u	1.295m	-	628.4m
18	2	13M	75.4u	1.198m	-	128.5m
19	2	13M	61.5u	949.5u	-	582.9m

Long Pulse Radar Test Signal						
Test Signal Name: LP_Signal_06						
Number of Bursts in Trial: 12						
Chrip Center Frequency: 5496MHz						
Burst	Pulses per Burst	Chrip (Hz)	Pulse Width (s)	Pulse 1 to 2 Spacing (s)	Pulse 2 to 3 Spacing (s)	Start Location (s)
1	1	13M	98.7u	-	-	633.0m
2	1	13M	57.3u	-	-	438.3m
3	3	13M	68.6u	1.493m	1.610m	875.1m
4	2	13M	97.5u	1.612m	-	685.6m
5	1	13M	55.5u	-	-	747.3m
6	2	13M	62.8u	967.2u	-	788.4m
7	2	13M	80.7u	1.417m	-	652.7m
8	1	13M	65.9u	-	-	782.6m
9	3	13M	79.9u	1.732m	1.557m	410.0m
10	2	13M	76.4u	1.761m	-	78.51m
11	1	13M	58.1u	-	-	580.4m
12	2	13M	78.0u	961.0u	-	162.0m

Long Pulse Radar Test Signal						
Test Signal Name: LP_Signal_07						
Number of Bursts in Trial: 11						
Chrip Center Frequency: 5497MHz						
Burst	Pulses per Burst	Chrip (Hz)	Pulse Width (s)	Pulse 1 to 2 Spacing (s)	Pulse 2 to 3 Spacing (s)	Start Location (s)
1	2	16M	60.9u	1.685m	-	1.030
2	2	16M	86.8u	1.363m	-	1.069
3	2	16M	95.4u	1.521m	-	296.1m
4	3	16M	73.5u	1.628m	1.226m	377.5m
5	2	16M	67.5u	1.036m	-	644.9m
6	3	16M	65.5u	1.798m	1.561m	766.1m
7	3	16M	95.9u	1.094m	1.242m	537.2m
8	2	16M	96.2u	1.578m	-	172.3m
9	2	16M	90.4u	1.274m	-	256.1m
10	2	16M	90.1u	1.319m	-	842.4m
11	2	16M	59.3u	1.600m	-	728.8m

Long Pulse Radar Test Signal						
Test Signal Name: LP_Signal_08						
Number of Bursts in Trial: 16						
Chrip Center Frequency: 5497MHz						
Burst	Pulses per Burst	Chrip (Hz)	Pulse Width (s)	Pulse 1 to 2 Spacing (s)	Pulse 2 to 3 Spacing (s)	Start Location (s)
1	1	16M	53.9u	-	-	653.0m
2	3	16M	87.4u	1.140m	1.207m	109.0m
3	2	16M	56.0u	1.104m	-	462.3m
4	2	16M	62.5u	1.625m	-	704.3m
5	2	16M	66.7u	1.202m	-	296.4m
6	2	16M	65.6u	1.571m	-	169.5m
7	2	16M	65.2u	1.889m	-	703.7m
8	1	16M	67.4u	-	-	78.58m
9	3	16M	70.1u	1.820m	1.460m	419.9m
10	2	16M	62.3u	1.636m	-	7.821m
11	3	16M	79.8u	1.442m	1.551m	384.2m
12	1	16M	81.4u	-	-	378.9m
13	2	16M	75.0u	1.336m	-	742.0m
14	2	16M	74.3u	1.487m	-	726.4m
15	3	16M	88.8u	1.772m	1.153m	168.4m
16	3	16M	67.7u	1.248m	1.211m	647.3m

Long Pulse Radar Test Signal						
Test Signal Name: LP_Signal_09						
Number of Bursts in Trial: 16						
Chrip Center Frequency: 5499MHz						
Burst	Pulses per Burst	Chrip (Hz)	Pulse Width (s)	Pulse 1 to 2 Spacing (s)	Pulse 2 to 3 Spacing (s)	Start Location (s)
1	2	20M	80.2u	1.739m	-	720.6m
2	3	20M	50.1u	1.816m	1.933m	558.9m
3	1	20M	96.2u	-	-	211.8m
4	3	20M	72.6u	1.275m	1.410m	628.1m
5	2	20M	92.6u	1.262m	-	295.1m
6	2	20M	70.1u	1.814m	-	404.0m
7	2	20M	96.2u	1.463m	-	89.45m
8	2	20M	78.6u	1.436m	-	275.4m
9	2	20M	85.9u	1.077m	-	726.5m
10	3	20M	86.3u	1.689m	1.395m	279.8m
11	1	20M	88.0u	-	-	142.6m
12	3	20M	58.3u	1.051m	995.7u	248.6m
13	2	20M	95.3u	1.642m	-	392.4m
14	3	20M	93.1u	1.100m	1.481m	639.1m
15	1	20M	96.7u	-	-	614.9m
16	2	20M	67.1u	1.370m	-	471.2m

Long Pulse Radar Test Signal						
Test Signal Name: LP_Signal_10						
Number of Bursts in Trial: 18						
Chrip Center Frequency: 5499MHz						
Burst	Pulses per Burst	Chrip (Hz)	Pulse Width (s)	Pulse 1 to 2 Spacing (s)	Pulse 2 to 3 Spacing (s)	Start Location (s)
1	2	20M	98.6u	1.198m	-	344.9m
2	2	20M	57.6u	961.4u	-	641.7m
3	1	20M	56.4u	-	-	308.8m
4	1	20M	81.4u	-	-	180.2m
5	1	20M	61.8u	-	-	297.7m
6	2	20M	90.4u	1.563m	-	282.9m
7	3	20M	68.8u	1.515m	1.370m	37.46m
8	1	20M	73.9u	-	-	475.8m
9	2	20M	68.4u	1.684m	-	117.5m
10	3	20M	95.4u	1.490m	1.735m	155.9m
11	1	20M	70.9u	-	-	253.8m
12	1	20M	94.7u	-	-	356.0m
13	3	20M	76.9u	1.750m	1.203m	56.37m
14	3	20M	80.6u	1.024m	1.881m	588.3m
15	2	20M	87.2u	1.015m	-	223.6m
16	2	20M	85.9u	1.898m	-	380.5m
17	1	20M	62.9u	-	-	127.1m
18	2	20M	96.3u	1.532m	-	541.3m

Long Pulse Radar Test Signal						
Test Signal Name: LP_Signal_11						
Number of Bursts in Trial: 13						
Chrip Center Frequency: 5530MHz						
Burst	Pulses per Burst	Chrip (Hz)	Pulse Width (s)	Pulse 1 to 2 Spacing (s)	Pulse 2 to 3 Spacing (s)	Start Location (s)
1	2	5M	64.2u	1.510m	-	171.7m
2	2	5M	85.7u	1.457m	-	23.95m
3	3	5M	93.8u	1.348m	1.769m	685.0m
4	3	5M	85.1u	1.065m	1.624m	112.8m
5	1	5M	84.7u	-	-	797.2m
6	2	5M	80.4u	1.702m	-	14.43m
7	1	5M	98.4u	-	-	314.4m
8	2	5M	71.1u	1.369m	-	529.1m
9	1	5M	98.6u	-	-	667.9m
10	2	5M	91.7u	1.176m	-	571.6m
11	2	5M	69.1u	1.770m	-	615.7m
12	2	5M	90.9u	1.511m	-	676.8m
13	2	5M	89.6u	1.199m	-	683.8m

Long Pulse Radar Test Signal						
Test Signal Name: LP_Signal_12						
Number of Bursts in Trial: 12						
Chrip Center Frequency: 5530MHz						
Burst	Pulses per Burst	Chrip (Hz)	Pulse Width (s)	Pulse 1 to 2 Spacing (s)	Pulse 2 to 3 Spacing (s)	Start Location (s)
1	1	5M	96.5u	-	-	857.4m
2	2	5M	53.0u	1.173m	-	643.5m
3	1	5M	84.3u	-	-	871.6m
4	3	5M	99.1u	1.140m	1.778m	521.9m
5	3	5M	67.5u	1.487m	1.636m	314.7m
6	2	5M	60.2u	1.210m	-	877.7m
7	1	5M	98.6u	-	-	340.6m
8	3	5M	90.3u	1.747m	1.331m	243.1m
9	2	5M	52.8u	1.060m	-	767.7m
10	2	5M	76.4u	1.115m	-	481.2m
11	3	5M	98.3u	1.759m	1.414m	449.9m
12	1	5M	66.6u	-	-	887.3m

Long Pulse Radar Test Signal						
Test Signal Name: LP_Signal_13						
Number of Bursts in Trial: 12						
Chrip Center Frequency: 5530MHz						
Burst	Pulses per Burst	Chrip (Hz)	Pulse Width (s)	Pulse 1 to 2 Spacing (s)	Pulse 2 to 3 Spacing (s)	Start Location (s)
1	2	9M	83.6u	1.774m	-	467.4m
2	2	9M	97.1u	1.796m	-	328.2m
3	1	9M	84.9u	-	-	712.5m
4	1	9M	85.6u	-	-	456.6m
5	2	9M	97.8u	917.2u	-	642.0m
6	2	9M	95.4u	1.079m	-	800.8m
7	1	9M	71.2u	-	-	898.6m
8	3	9M	82.0u	1.666m	1.468m	784.5m
9	3	9M	86.6u	1.322m	1.519m	535.5m
10	1	9M	71.4u	-	-	43.23m
11	2	9M	62.2u	1.268m	-	268.5m
12	2	9M	96.1u	1.888m	-	253.4m

Long Pulse Radar Test Signal						
Test Signal Name: LP_Signal_14						
Number of Bursts in Trial: 18						
Chrip Center Frequency: 5530MHz						
Burst	Pulses per Burst	Chrip (Hz)	Pulse Width (s)	Pulse 1 to 2 Spacing (s)	Pulse 2 to 3 Spacing (s)	Start Location (s)
1	1	9M	92.6u	-	-	574.7m
2	3	9M	67.9u	1.272m	1.316m	302.6m
3	1	9M	85.3u	-	-	195.7m
4	2	9M	87.8u	1.863m	-	517.8m
5	2	9M	73.7u	1.364m	-	350.7m
6	1	9M	55.8u	-	-	569.5m
7	3	9M	99.1u	936.9u	1.756m	652.9m
8	2	9M	94.5u	1.889m	-	175.3m
9	2	9M	69.1u	1.741m	-	186.8m
10	2	9M	60.2u	1.826m	-	144.5m
11	2	9M	90.0u	1.419m	-	500.0m
12	2	9M	98.3u	1.336m	-	157.3m
13	2	9M	94.4u	1.660m	-	479.9m
14	3	9M	91.0u	1.788m	1.474m	137.2m
15	1	9M	74.3u	-	-	351.9m
16	2	9M	55.0u	1.665m	-	89.03m
17	3	9M	85.5u	981.5u	1.182m	444.9m
18	2	9M	86.1u	1.623m	-	259.0m

Long Pulse Radar Test Signal						
Test Signal Name: LP_Signal_15						
Number of Bursts in Trial: 8						
Chrip Center Frequency: 5530MHz						
Burst	Pulses per Burst	Chrip (Hz)	Pulse Width (s)	Pulse 1 to 2 Spacing (s)	Pulse 2 to 3 Spacing (s)	Start Location (s)
1	2	14M	100.0u	1.316m	-	574.2m
2	2	14M	67.5u	1.529m	-	280.0m
3	3	14M	52.4u	1.833m	955.6u	312.3m
4	3	14M	74.3u	1.451m	1.391m	1.205
5	2	14M	82.0u	1.489m	-	1.470
6	2	14M	65.4u	1.871m	-	1.159
7	2	14M	56.9u	1.758m	-	300.0m
8	1	14M	67.1u	-	-	431.5m

Long Pulse Radar Test Signal						
Test Signal Name: LP_Signal_16						
Number of Bursts in Trial: 9						
Chrip Center Frequency: 5530MHz						
Burst	Pulses per Burst	Chrip (Hz)	Pulse Width (s)	Pulse 1 to 2 Spacing (s)	Pulse 2 to 3 Spacing (s)	Start Location (s)
1	2	14M	89.0u	1.663m	-	435.6m
2	1	14M	50.5u	-	-	582.4m
3	2	14M	58.5u	1.078m	-	681.0m
4	3	14M	59.6u	1.582m	1.397m	730.4m
5	2	14M	92.9u	1.695m	-	227.2m
6	2	14M	69.6u	1.367m	-	963.5m
7	2	14M	65.4u	1.684m	-	1.200
8	2	14M	95.7u	1.419m	-	601.2m
9	2	14M	88.7u	1.095m	-	712.2m

Long Pulse Radar Test Signal						
Test Signal Name: LP_Signal_17						
Number of Bursts in Trial: 16						
Chrip Center Frequency: 5530MHz						
Burst	Pulses per Burst	Chrip (Hz)	Pulse Width (s)	Pulse 1 to 2 Spacing (s)	Pulse 2 to 3 Spacing (s)	Start Location (s)
1	1	16M	95.3u	-	-	108.6m
2	2	16M	53.1u	1.606m	-	65.83m
3	3	16M	96.8u	1.488m	1.352m	2.636m
4	2	16M	67.5u	1.301m	-	327.5m
5	3	16M	55.6u	1.122m	1.431m	138.8m
6	1	16M	50.8u	-	-	12.03m
7	2	16M	53.4u	1.503m	-	456.4m
8	3	16M	54.8u	1.412m	1.710m	520.5m
9	3	16M	53.7u	1.685m	1.762m	465.8m
10	2	16M	60.3u	1.837m	-	679.9m
11	2	16M	91.2u	1.027m	-	500.3m
12	2	16M	95.7u	1.804m	-	154.5m
13	2	16M	70.0u	1.808m	-	89.20m
14	2	16M	72.9u	1.045m	-	617.0m
15	2	16M	94.5u	1.540m	-	399.1m
16	3	16M	67.8u	1.932m	1.398m	689.5m

Long Pulse Radar Test Signal						
Test Signal Name: LP_Signal_18						
Number of Bursts in Trial: 12						
Chrip Center Frequency: 5530MHz						
Burst	Pulses per Burst	Chrip (Hz)	Pulse Width (s)	Pulse 1 to 2 Spacing (s)	Pulse 2 to 3 Spacing (s)	Start Location (s)
1	3	16M	81.9u	1.713m	1.130m	406.8m
2	3	16M	94.1u	1.182m	1.311m	673.2m
3	3	16M	88.8u	1.272m	1.897m	962.9m
4	2	16M	85.5u	1.256m	-	689.2m
5	3	16M	91.6u	1.325m	1.053m	396.5m
6	3	16M	58.7u	1.613m	1.768m	692.7m
7	2	16M	89.9u	1.182m	-	988.1m
8	3	16M	74.7u	1.139m	1.384m	783.9m
9	2	16M	74.8u	1.849m	-	722.0m
10	2	16M	55.6u	967.4u	-	325.4m
11	2	16M	74.6u	1.876m	-	549.7m
12	3	16M	97.6u	1.660m	1.245m	109.6m

Long Pulse Radar Test Signal						
Test Signal Name: LP_Signal_19						
Number of Bursts in Trial: 10						
Chrip Center Frequency: 5530MHz						
Burst	Pulses per Burst	Chrip (Hz)	Pulse Width (s)	Pulse 1 to 2 Spacing (s)	Pulse 2 to 3 Spacing (s)	Start Location (s)
1	2	20M	78.6u	1.551m	-	833.2m
2	2	20M	51.6u	990.4u	-	825.2m
3	2	20M	86.8u	1.097m	-	809.6m
4	1	20M	60.5u	-	-	792.9m
5	2	20M	54.9u	1.783m	-	491.4m
6	2	20M	75.7u	1.245m	-	717.7m
7	2	20M	55.0u	1.513m	-	1.155
8	2	20M	79.2u	955.8u	-	118.6m
9	1	20M	56.4u	-	-	881.1m
10	1	20M	97.7u	-	-	978.0m

Long Pulse Radar Test Signal						
Test Signal Name: LP_Signal_20						
Number of Bursts in Trial: 16						
Chrip Center Frequency: 5530MHz						
Burst	Pulses per Burst	Chrip (Hz)	Pulse Width (s)	Pulse 1 to 2 Spacing (s)	Pulse 2 to 3 Spacing (s)	Start Location (s)
1	2	20M	98.1u	1.220m	-	507.2m
2	2	20M	73.5u	1.910m	-	227.2m
3	2	20M	98.2u	1.506m	-	631.2m
4	3	20M	97.9u	1.595m	1.851m	164.0m
5	1	20M	92.9u	-	-	45.06m
6	2	20M	76.6u	1.260m	-	601.8m
7	2	20M	68.1u	1.217m	-	342.9m
8	1	20M	53.3u	-	-	86.38m
9	2	20M	58.0u	978.0u	-	75.50m
10	1	20M	66.6u	-	-	328.5m
11	3	20M	69.0u	1.388m	1.330m	707.6m
12	2	20M	68.3u	1.450m	-	328.0m
13	3	20M	99.1u	1.752m	1.303m	426.0m
14	1	20M	94.8u	-	-	632.9m
15	1	20M	99.7u	-	-	169.8m
16	1	20M	51.5u	-	-	455.1m

Long Pulse Radar Test Signal						
Test Signal Name: LP_Signal_21						
Number of Bursts in Trial: 13						
Chrip Center Frequency: 5567MHz						
Burst	Pulses per Burst	Chrip (Hz)	Pulse Width (s)	Pulse 1 to 2 Spacing (s)	Pulse 2 to 3 Spacing (s)	Start Location (s)
1	2	5M	64.2u	1.510m	-	171.7m
2	2	5M	85.7u	1.457m	-	23.95m
3	3	5M	93.8u	1.348m	1.769m	685.0m
4	3	5M	85.1u	1.065m	1.624m	112.8m
5	1	5M	84.7u	-	-	797.2m
6	2	5M	80.4u	1.702m	-	14.43m
7	1	5M	98.4u	-	-	314.4m
8	2	5M	71.1u	1.369m	-	529.1m
9	1	5M	98.6u	-	-	667.9m
10	2	5M	91.7u	1.176m	-	571.6m
11	2	5M	69.1u	1.770m	-	615.7m
12	2	5M	90.9u	1.511m	-	676.8m
13	2	5M	89.6u	1.199m	-	683.8m

Long Pulse Radar Test Signal						
Test Signal Name: LP_Signal_22						
Number of Bursts in Trial: 16						
Chrip Center Frequency: 5567MHz						
Burst	Pulses per Burst	Chrip (Hz)	Pulse Width (s)	Pulse 1 to 2 Spacing (s)	Pulse 2 to 3 Spacing (s)	Start Location (s)
1	1	5M	59.2u	-	-	243.0m
2	2	5M	94.5u	1.834m	-	299.3m
3	2	5M	95.4u	1.641m	-	566.0m
4	3	5M	59.5u	1.313m	1.332m	354.8m
5	2	5M	62.1u	1.158m	-	618.4m
6	3	5M	73.9u	1.671m	1.534m	629.7m
7	2	5M	50.4u	1.155m	-	384.7m
8	3	5M	62.7u	1.675m	1.571m	94.54m
9	1	5M	52.4u	-	-	45.93m
10	3	5M	55.9u	1.743m	1.537m	37.45m
11	2	5M	62.1u	1.725m	-	173.9m
12	3	5M	65.1u	1.567m	1.369m	549.6m
13	3	5M	80.3u	1.548m	1.117m	530.8m
14	2	5M	85.5u	1.063m	-	265.8m
15	3	5M	54.7u	1.134m	1.657m	49.43m
16	2	5M	85.8u	1.450m	-	382.0m

Long Pulse Radar Test Signal						
Test Signal Name: LP_Signal_23						
Number of Bursts in Trial: 12						
Chrip Center Frequency: 5565MHz						
Burst	Pulses per Burst	Chrip (Hz)	Pulse Width (s)	Pulse 1 to 2 Spacing (s)	Pulse 2 to 3 Spacing (s)	Start Location (s)
1	2	10M	95.2u	1.690m	-	993.9m
2	2	10M	82.3u	1.520m	-	555.8m
3	3	10M	95.0u	1.392m	1.015m	566.4m
4	1	10M	52.8u	-	-	362.2m
5	1	10M	53.1u	-	-	102.8m
6	2	10M	96.4u	1.454m	-	714.3m
7	2	10M	56.0u	1.235m	-	252.4m
8	2	10M	64.8u	1.410m	-	466.8m
9	2	10M	51.9u	1.473m	-	878.3m
10	1	10M	81.5u	-	-	856.4m
11	2	10M	97.8u	1.480m	-	699.6m
12	3	10M	61.7u	1.069m	1.910m	663.4m

Long Pulse Radar Test Signal						
Test Signal Name: LP_Signal_24						
Number of Bursts in Trial: 9						
Chrip Center Frequency: 5565MHz						
Burst	Pulses per Burst	Chrip (Hz)	Pulse Width (s)	Pulse 1 to 2 Spacing (s)	Pulse 2 to 3 Spacing (s)	Start Location (s)
1	3	10M	80.2u	1.716m	1.208m	458.3m
2	2	10M	99.0u	1.877m	-	80.24m
3	1	10M	70.5u	-	-	705.0m
4	1	10M	88.3u	-	-	69.65m
5	2	10M	56.4u	1.516m	-	922.0m
6	1	10M	100.0u	-	-	179.3m
7	2	10M	58.2u	994.8u	-	1.187
8	1	10M	98.0u	-	-	223.9m
9	1	10M	92.7u	-	-	927.1m

Long Pulse Radar Test Signal						
Test Signal Name: LP_Signal_25						
Number of Bursts in Trial: 9						
Chrip Center Frequency: 5564MHz						
Burst	Pulses per Burst	Chrip (Hz)	Pulse Width (s)	Pulse 1 to 2 Spacing (s)	Pulse 2 to 3 Spacing (s)	Start Location (s)
1	2	13M	81.8u	959.2u	-	874.4m
2	1	13M	80.9u	-	-	1.030
3	3	13M	56.3u	999.7u	1.916m	930.7m
4	2	13M	63.6u	1.070m	-	903.9m
5	2	13M	65.0u	1.382m	-	89.36m
6	3	13M	83.5u	1.311m	979.5u	725.0m
7	3	13M	83.8u	918.2u	1.113m	1.114
8	2	13M	51.9u	1.314m	-	1.096
9	2	13M	72.3u	1.174m	-	658.1m

Long Pulse Radar Test Signal						
Test Signal Name: LP_Signal_26						
Number of Bursts in Trial: 12						
Chrip Center Frequency: 5564MHz						
Burst	Pulses per Burst	Chrip (Hz)	Pulse Width (s)	Pulse 1 to 2 Spacing (s)	Pulse 2 to 3 Spacing (s)	Start Location (s)
1	1	13M	98.7u	-	-	633.0m
2	1	13M	57.3u	-	-	438.3m
3	3	13M	68.6u	1.493m	1.610m	875.1m
4	2	13M	97.5u	1.612m	-	685.6m
5	1	13M	55.5u	-	-	747.3m
6	2	13M	62.8u	967.2u	-	788.4m
7	2	13M	80.7u	1.417m	-	652.7m
8	1	13M	65.9u	-	-	782.6m
9	3	13M	79.9u	1.732m	1.557m	410.0m
10	2	13M	76.4u	1.761m	-	78.51m
11	1	13M	58.1u	-	-	580.4m
12	2	13M	78.0u	961.0u	-	162.0m

Long Pulse Radar Test Signal						
Test Signal Name: LP_Signal_27						
Number of Bursts in Trial: 19						
Chrip Center Frequency: 5563MHz						
Burst	Pulses per Burst	Chrip (Hz)	Pulse Width (s)	Pulse 1 to 2 Spacing (s)	Pulse 2 to 3 Spacing (s)	Start Location (s)
1	3	16M	57.4u	1.310m	1.063m	263.4m
2	3	16M	53.6u	1.063m	1.123m	239.3m
3	3	16M	82.4u	1.425m	1.371m	434.0m
4	2	16M	83.1u	1.514m	-	308.5m
5	3	16M	89.8u	1.210m	1.455m	259.5m
6	2	16M	95.6u	1.397m	-	66.09m
7	2	16M	70.5u	1.045m	-	558.6m
8	2	16M	89.0u	1.309m	-	92.83m
9	1	16M	83.7u	-	-	524.2m
10	3	16M	93.5u	1.004m	1.611m	438.4m
11	2	16M	54.3u	1.632m	-	338.8m
12	1	16M	72.4u	-	-	84.23m
13	3	16M	72.1u	1.064m	1.337m	270.5m
14	2	16M	77.9u	1.844m	-	230.5m
15	2	16M	89.1u	1.282m	-	173.5m
16	2	16M	70.0u	1.089m	-	189.6m
17	3	16M	87.1u	1.138m	1.322m	348.7m
18	1	16M	56.9u	-	-	486.2m
19	3	16M	79.4u	1.267m	1.580m	285.8m

Long Pulse Radar Test Signal						
Test Signal Name: LP_Signal_28						
Number of Bursts in Trial: 12						
Chrip Center Frequency: 5563MHz						
Burst	Pulses per Burst	Chrip (Hz)	Pulse Width (s)	Pulse 1 to 2 Spacing (s)	Pulse 2 to 3 Spacing (s)	Start Location (s)
1	3	16M	81.9u	1.713m	1.130m	406.8m
2	3	16M	94.1u	1.182m	1.311m	673.2m
3	3	16M	88.8u	1.272m	1.897m	962.9m
4	2	16M	85.5u	1.256m	-	689.2m
5	3	16M	91.6u	1.325m	1.053m	396.5m
6	3	16M	58.7u	1.613m	1.768m	692.7m
7	2	16M	89.9u	1.182m	-	988.1m
8	3	16M	74.7u	1.139m	1.384m	783.9m
9	2	16M	74.8u	1.849m	-	722.0m
10	2	16M	55.6u	967.4u	-	325.4m
11	2	16M	74.6u	1.876m	-	549.7m
12	3	16M	97.6u	1.660m	1.245m	109.6m

Long Pulse Radar Test Signal						
Test Signal Name: LP_Signal_29						
Number of Bursts in Trial: 10						
Chrip Center Frequency: 5561MHz						
Burst	Pulses per Burst	Chrip (Hz)	Pulse Width (s)	Pulse 1 to 2 Spacing (s)	Pulse 2 to 3 Spacing (s)	Start Location (s)
1	2	20M	78.6u	1.551m	-	833.2m
2	2	20M	51.6u	990.4u	-	825.2m
3	2	20M	86.8u	1.097m	-	809.6m
4	1	20M	60.5u	-	-	792.9m
5	2	20M	54.9u	1.783m	-	491.4m
6	2	20M	75.7u	1.245m	-	717.7m
7	2	20M	55.0u	1.513m	-	1.155
8	2	20M	79.2u	955.8u	-	118.6m
9	1	20M	56.4u	-	-	881.1m
10	1	20M	97.7u	-	-	978.0m

Long Pulse Radar Test Signal						
Test Signal Name: LP_Signal_30						
Number of Bursts in Trial: 16						
Chirp Center Frequency: 5561MHz						
Burst	Pulses per Burst	Chirp (Hz)	Pulse Width (s)	Pulse 1 to 2 Spacing (s)	Pulse 2 to 3 Spacing (s)	Start Location (s)
1	2	20M	98.1u	1.220m	-	507.2m
2	2	20M	73.5u	1.910m	-	227.2m
3	2	20M	98.2u	1.506m	-	631.2m
4	3	20M	97.9u	1.595m	1.851m	164.0m
5	1	20M	92.9u	-	-	45.06m
6	2	20M	76.6u	1.260m	-	601.8m
7	2	20M	68.1u	1.217m	-	342.9m
8	1	20M	53.3u	-	-	86.38m
9	2	20M	58.0u	978.0u	-	75.50m
10	1	20M	66.6u	-	-	328.5m
11	3	20M	69.0u	1.388m	1.330m	707.6m
12	2	20M	68.3u	1.450m	-	328.0m
13	3	20M	99.1u	1.752m	1.303m	426.0m
14	1	20M	94.8u	-	-	632.9m
15	1	20M	99.7u	-	-	169.8m
16	1	20M	51.5u	-	-	455.1m

Type 6 Radar Statistical Performances				
Trial #	Pulses per Burst	Pulse Width (s)	PRI (s)	Detection
1	9	1.0u	333.0u	Yes
2	9	1.0u	333.0u	Yes
3	9	1.0u	333.0u	Yes
4	9	1.0u	333.0u	Yes
5	9	1.0u	333.0u	Yes
6	9	1.0u	333.0u	No
7	9	1.0u	333.0u	Yes
8	9	1.0u	333.0u	Yes
9	9	1.0u	333.0u	Yes
10	9	1.0u	333.0u	Yes
11	9	1.0u	333.0u	Yes
12	9	1.0u	333.0u	Yes
13	9	1.0u	333.0u	Yes
14	9	1.0u	333.0u	Yes
15	9	1.0u	333.0u	Yes
16	9	1.0u	333.0u	Yes
17	9	1.0u	333.0u	Yes
18	9	1.0u	333.0u	Yes
19	9	1.0u	333.0u	Yes
20	9	1.0u	333.0u	Yes
21	9	1.0u	333.0u	Yes
22	9	1.0u	333.0u	Yes
23	9	1.0u	333.0u	Yes
24	9	1.0u	333.0u	Yes
25	9	1.0u	333.0u	Yes
26	9	1.0u	333.0u	No
27	9	1.0u	333.0u	Yes
28	9	1.0u	333.0u	Yes
29	9	1.0u	333.0u	Yes
30	9	1.0u	333.0u	Yes
				Detection Rate: 93.3 %

Type 6 Radar Statistical Performances		
Trial #	Hopping Frequency Sequence Name	Detection
1	HOP_FREQ_SEQ_01	Yes
2	HOP_FREQ_SEQ_02	Yes
3	HOP_FREQ_SEQ_03	Yes
4	HOP_FREQ_SEQ_04	Yes
5	HOP_FREQ_SEQ_05	Yes
6	HOP_FREQ_SEQ_06	No
7	HOP_FREQ_SEQ_07	Yes
8	HOP_FREQ_SEQ_08	Yes
9	HOP_FREQ_SEQ_09	Yes
10	HOP_FREQ_SEQ_10	Yes
11	HOP_FREQ_SEQ_11	Yes
12	HOP_FREQ_SEQ_12	Yes
13	HOP_FREQ_SEQ_13	Yes
14	HOP_FREQ_SEQ_14	Yes
15	HOP_FREQ_SEQ_15	Yes
16	HOP_FREQ_SEQ_16	Yes
17	HOP_FREQ_SEQ_17	Yes
18	HOP_FREQ_SEQ_18	Yes
19	HOP_FREQ_SEQ_19	Yes
20	HOP_FREQ_SEQ_20	Yes
21	HOP_FREQ_SEQ_21	Yes
22	HOP_FREQ_SEQ_22	Yes
23	HOP_FREQ_SEQ_23	Yes
24	HOP_FREQ_SEQ_24	Yes
25	HOP_FREQ_SEQ_25	Yes
26	HOP_FREQ_SEQ_26	No
27	HOP_FREQ_SEQ_27	Yes
28	HOP_FREQ_SEQ_28	Yes
29	HOP_FREQ_SEQ_29	Yes
30	HOP_FREQ_SEQ_30	Yes
		Detection Rate: 93.3 %

Hopping Frequency Sequence Name: HOP_FREQ_SEQ_01							
SEQ#	Frequency (Hz)	SEQ#	Frequency (Hz)	SEQ#	Frequency (Hz)	SEQ#	Frequency (Hz)
1	5.584G	2	5.650G	3	5.556G	4	5.372G
5	5.441G	6	5.637G	7	5.635G	8	5.288G
9	5.697G	10	5.412G	11	5.323G	12	5.452G
13	5.659G	14	5.460G	15	5.641G	16	5.681G
17	5.374G	18	5.301G	19	5.510G	20	5.468G
21	5.585G	22	5.486G	23	5.314G	24	5.677G
25	5.655G	26	5.570G	27	5.687G	28	5.675G
29	5.572G	30	5.583G	31	5.505G	32	5.698G
33	5.350G	34	5.551G	35	5.597G	36	5.707G
37	5.333G	38	5.617G	39	5.259G	40	5.663G
41	5.620G	42	5.398G	43	5.366G	44	5.685G
45	5.516G	46	5.630G	47	5.633G	48	5.445G
49	5.458G	50	5.345G	51	5.680G	52	5.592G
53	5.396G	54	5.463G	55	5.469G	56	5.672G
57	5.518G	58	5.648G	59	5.435G	60	5.297G
61	5.332G	62	5.526G	63	5.586G	64	5.609G
65	5.657G	66	5.430G	67	5.274G	68	5.471G
69	5.310G	70	5.504G	71	5.673G	72	5.281G
73	5.682G	74	5.498G	75	5.688G	76	5.544G
77	5.712G	78	5.634G	79	5.608G	80	5.282G
81	5.631G	82	5.415G	83	5.699G	84	5.360G
85	5.283G	86	5.316G	87	5.472G	88	5.449G
89	5.694G	90	5.269G	91	5.700G	92	5.294G
93	5.692G	94	5.286G	95	5.501G	96	5.689G
97	5.324G	98	5.588G	99	5.536G	100	5.579G

Hopping Frequency Sequence Name: HOP_FREQ_SEQ_02							
SEQ#	Frequency (Hz)	SEQ#	Frequency (Hz)	SEQ#	Frequency (Hz)	SEQ#	Frequency (Hz)
1	5.346G	2	5.501G	3	5.272G	4	5.295G
5	5.403G	6	5.712G	7	5.613G	8	5.429G
9	5.263G	10	5.351G	11	5.476G	12	5.323G
13	5.606G	14	5.355G	15	5.603G	16	5.402G
17	5.721G	18	5.330G	19	5.557G	20	5.354G
21	5.315G	22	5.465G	23	5.590G	24	5.704G
25	5.551G	26	5.303G	27	5.638G	28	5.493G
29	5.480G	30	5.709G	31	5.438G	32	5.255G
33	5.344G	34	5.256G	35	5.651G	36	5.460G
37	5.660G	38	5.343G	39	5.277G	40	5.436G
41	5.658G	42	5.370G	43	5.286G	44	5.446G
45	5.655G	46	5.517G	47	5.394G	48	5.360G
49	5.648G	50	5.425G	51	5.612G	52	5.620G
53	5.592G	54	5.570G	55	5.518G	56	5.298G
57	5.632G	58	5.600G	59	5.448G	60	5.258G
61	5.487G	62	5.701G	63	5.297G	64	5.449G
65	5.691G	66	5.450G	67	5.565G	68	5.348G
69	5.679G	70	5.629G	71	5.380G	72	5.453G
73	5.584G	74	5.335G	75	5.591G	76	5.705G
77	5.398G	78	5.270G	79	5.622G	80	5.514G
81	5.434G	82	5.369G	83	5.485G	84	5.301G
85	5.345G	86	5.618G	87	5.452G	88	5.441G
89	5.474G	90	5.250G	91	5.616G	92	5.710G
93	5.468G	94	5.513G	95	5.692G	96	5.334G
97	5.504G	98	5.347G	99	5.280G	100	5.400G

Hopping Frequency Sequence Name: HOP_FREQ_SEQ_03							
SEQ#	Frequency (Hz)	SEQ#	Frequency (Hz)	SEQ#	Frequency (Hz)	SEQ#	Frequency (Hz)
1	5.520G	2	5.463G	3	5.410G	4	5.684G
5	5.482G	6	5.448G	7	5.370G	8	5.610G
9	5.413G	10	5.667G	11	5.326G	12	5.381G
13	5.443G	14	5.583G	15	5.334G	16	5.642G
17	5.414G	18	5.457G	19	5.385G	20	5.412G
21	5.382G	22	5.578G	23	5.670G	24	5.465G
25	5.483G	26	5.257G	27	5.323G	28	5.674G
29	5.536G	30	5.384G	31	5.596G	32	5.722G
33	5.269G	34	5.643G	35	5.560G	36	5.628G
37	5.580G	38	5.415G	39	5.369G	40	5.636G
41	5.660G	42	5.477G	43	5.678G	44	5.492G
45	5.624G	46	5.337G	47	5.400G	48	5.698G
49	5.640G	50	5.260G	51	5.564G	52	5.403G
53	5.427G	54	5.627G	55	5.350G	56	5.611G
57	5.566G	58	5.691G	59	5.358G	60	5.648G
61	5.262G	62	5.429G	63	5.378G	64	5.590G
65	5.393G	66	5.278G	67	5.718G	68	5.312G
69	5.529G	70	5.305G	71	5.552G	72	5.650G
73	5.454G	74	5.330G	75	5.422G	76	5.341G
77	5.356G	78	5.485G	79	5.551G	80	5.588G
81	5.544G	82	5.716G	83	5.304G	84	5.659G
85	5.277G	86	5.703G	87	5.472G	88	5.575G
89	5.537G	90	5.294G	91	5.690G	92	5.380G
93	5.614G	94	5.362G	95	5.423G	96	5.311G
97	5.637G	98	5.540G	99	5.270G	100	5.302G

Hopping Frequency Sequence Name: HOP_FREQ_SEQ_04							
SEQ#	Frequency (Hz)	SEQ#	Frequency (Hz)	SEQ#	Frequency (Hz)	SEQ#	Frequency (Hz)
1	5.397G	2	5.383G	3	5.462G	4	5.338G
5	5.267G	6	5.261G	7	5.454G	8	5.500G
9	5.603G	10	5.568G	11	5.328G	12	5.467G
13	5.629G	14	5.612G	15	5.544G	16	5.375G
17	5.325G	18	5.507G	19	5.514G	20	5.433G
21	5.718G	22	5.526G	23	5.497G	24	5.520G
25	5.555G	26	5.389G	27	5.628G	28	5.511G
29	5.435G	30	5.424G	31	5.319G	32	5.453G
33	5.493G	34	5.311G	35	5.641G	36	5.415G
37	5.547G	38	5.655G	39	5.711G	40	5.579G
41	5.702G	42	5.260G	43	5.336G	44	5.278G
45	5.314G	46	5.587G	47	5.688G	48	5.598G
49	5.443G	50	5.719G	51	5.291G	52	5.428G
53	5.441G	54	5.377G	55	5.385G	56	5.315G
57	5.609G	58	5.274G	59	5.409G	60	5.546G
61	5.431G	62	5.288G	63	5.324G	64	5.341G
65	5.376G	66	5.689G	67	5.541G	68	5.422G
69	5.695G	70	5.679G	71	5.618G	72	5.465G
73	5.255G	74	5.590G	75	5.634G	76	5.388G
77	5.406G	78	5.420G	79	5.309G	80	5.362G
81	5.425G	82	5.605G	83	5.624G	84	5.374G
85	5.366G	86	5.360G	87	5.645G	88	5.297G
89	5.556G	90	5.554G	91	5.351G	92	5.596G
93	5.302G	94	5.470G	95	5.654G	96	5.299G
97	5.481G	98	5.606G	99	5.487G	100	5.343G

Hopping Frequency Sequence Name: HOP_FREQ_SEQ_05							
SEQ#	Frequency (Hz)	SEQ#	Frequency (Hz)	SEQ#	Frequency (Hz)	SEQ#	Frequency (Hz)
1	5.421G	2	5.644G	3	5.275G	4	5.412G
5	5.320G	6	5.350G	7	5.652G	8	5.620G
9	5.548G	10	5.601G	11	5.640G	12	5.450G
13	5.582G	14	5.702G	15	5.311G	16	5.349G
17	5.489G	18	5.605G	19	5.698G	20	5.407G
21	5.478G	22	5.545G	23	5.267G	24	5.658G
25	5.376G	26	5.707G	27	5.592G	28	5.696G
29	5.655G	30	5.504G	31	5.271G	32	5.416G
33	5.667G	34	5.673G	35	5.347G	36	5.700G
37	5.307G	38	5.723G	39	5.357G	40	5.522G
41	5.417G	42	5.257G	43	5.383G	44	5.419G
45	5.714G	46	5.393G	47	5.261G	48	5.508G
49	5.485G	50	5.260G	51	5.318G	52	5.628G
53	5.278G	54	5.430G	55	5.520G	56	5.392G
57	5.358G	58	5.270G	59	5.627G	60	5.557G
61	5.558G	62	5.305G	63	5.526G	64	5.314G
65	5.528G	66	5.555G	67	5.540G	68	5.380G
69	5.573G	70	5.268G	71	5.459G	72	5.482G
73	5.653G	74	5.353G	75	5.306G	76	5.324G
77	5.497G	78	5.693G	79	5.362G	80	5.514G
81	5.581G	82	5.415G	83	5.368G	84	5.599G
85	5.291G	86	5.704G	87	5.503G	88	5.564G
89	5.611G	90	5.634G	91	5.560G	92	5.300G
93	5.646G	94	5.561G	95	5.692G	96	5.633G
97	5.635G	98	5.492G	99	5.312G	100	5.690G

Hopping Frequency Sequence Name: HOP_FREQ_SEQ_06							
SEQ#	Frequency (Hz)	SEQ#	Frequency (Hz)	SEQ#	Frequency (Hz)	SEQ#	Frequency (Hz)
1	5.510G	2	5.475G	3	5.466G	4	5.512G
5	5.665G	6	5.493G	7	5.595G	8	5.412G
9	5.488G	10	5.435G	11	5.408G	12	5.263G
13	5.569G	14	5.713G	15	5.269G	16	5.687G
17	5.554G	18	5.392G	19	5.455G	20	5.592G
21	5.264G	22	5.670G	23	5.660G	24	5.614G
25	5.715G	26	5.560G	27	5.591G	28	5.461G
29	5.290G	30	5.278G	31	5.714G	32	5.365G
33	5.650G	34	5.307G	35	5.432G	36	5.641G
37	5.490G	38	5.417G	39	5.265G	40	5.457G
41	5.367G	42	5.598G	43	5.308G	44	5.669G
45	5.287G	46	5.413G	47	5.312G	48	5.389G
49	5.495G	50	5.530G	51	5.532G	52	5.525G
53	5.697G	54	5.619G	55	5.494G	56	5.577G
57	5.563G	58	5.342G	59	5.288G	60	5.313G
61	5.513G	62	5.636G	63	5.316G	64	5.428G
65	5.304G	66	5.326G	67	5.681G	68	5.584G
69	5.272G	70	5.363G	71	5.460G	72	5.468G
73	5.710G	74	5.362G	75	5.722G	76	5.262G
77	5.385G	78	5.482G	79	5.336G	80	5.390G
81	5.688G	82	5.277G	83	5.407G	84	5.393G
85	5.334G	86	5.372G	87	5.422G	88	5.322G
89	5.581G	90	5.559G	91	5.346G	92	5.380G
93	5.515G	94	5.258G	95	5.606G	96	5.406G
97	5.564G	98	5.444G	99	5.613G	100	5.526G

Hopping Frequency Sequence Name: HOP_FREQ_SEQ_07							
SEQ#	Frequency (Hz)	SEQ#	Frequency (Hz)	SEQ#	Frequency (Hz)	SEQ#	Frequency (Hz)
1	5.551G	2	5.676G	3	5.484G	4	5.572G
5	5.380G	6	5.718G	7	5.660G	8	5.644G
9	5.397G	10	5.438G	11	5.410G	12	5.256G
13	5.538G	14	5.542G	15	5.550G	16	5.480G
17	5.413G	18	5.461G	19	5.463G	20	5.369G
21	5.640G	22	5.383G	23	5.375G	24	5.488G
25	5.570G	26	5.281G	27	5.613G	28	5.282G
29	5.310G	30	5.273G	31	5.724G	32	5.622G
33	5.633G	34	5.267G	35	5.715G	36	5.523G
37	5.632G	38	5.620G	39	5.567G	40	5.589G
41	5.318G	42	5.263G	43	5.378G	44	5.716G
45	5.289G	46	5.568G	47	5.710G	48	5.516G
49	5.606G	50	5.337G	51	5.283G	52	5.717G
53	5.424G	54	5.651G	55	5.711G	56	5.707G
57	5.698G	58	5.462G	59	5.518G	60	5.445G
61	5.360G	62	5.653G	63	5.307G	64	5.341G
65	5.581G	66	5.457G	67	5.601G	68	5.345G
69	5.658G	70	5.431G	71	5.648G	72	5.253G
73	5.683G	74	5.384G	75	5.398G	76	5.459G
77	5.254G	78	5.607G	79	5.301G	80	5.417G
81	5.347G	82	5.643G	83	5.712G	84	5.514G
85	5.576G	86	5.610G	87	5.386G	88	5.381G
89	5.476G	90	5.680G	91	5.272G	92	5.477G
93	5.565G	94	5.450G	95	5.414G	96	5.343G
97	5.497G	98	5.405G	99	5.503G	100	5.577G

Hopping Frequency Sequence Name: HOP_FREQ_SEQ_08							
SEQ#	Frequency (Hz)	SEQ#	Frequency (Hz)	SEQ#	Frequency (Hz)	SEQ#	Frequency (Hz)
1	5.452G	2	5.443G	3	5.458G	4	5.492G
5	5.281G	6	5.280G	7	5.290G	8	5.685G
9	5.655G	10	5.636G	11	5.369G	12	5.320G
13	5.272G	14	5.644G	15	5.250G	16	5.695G
17	5.303G	18	5.268G	19	5.384G	20	5.351G
21	5.620G	22	5.588G	23	5.447G	24	5.283G
25	5.658G	26	5.566G	27	5.457G	28	5.476G
29	5.626G	30	5.325G	31	5.679G	32	5.590G
33	5.282G	34	5.538G	35	5.269G	36	5.539G
37	5.408G	38	5.400G	39	5.604G	40	5.371G
41	5.520G	42	5.499G	43	5.274G	44	5.352G
45	5.436G	46	5.505G	47	5.394G	48	5.617G
49	5.330G	50	5.652G	51	5.700G	52	5.317G
53	5.592G	54	5.473G	55	5.398G	56	5.573G
57	5.393G	58	5.674G	59	5.635G	60	5.546G
61	5.370G	62	5.542G	63	5.376G	64	5.561G
65	5.385G	66	5.606G	67	5.516G	68	5.613G
69	5.701G	70	5.510G	71	5.397G	72	5.332G
73	5.642G	74	5.651G	75	5.430G	76	5.551G
77	5.560G	78	5.316G	79	5.302G	80	5.382G
81	5.714G	82	5.341G	83	5.429G	84	5.693G
85	5.523G	86	5.470G	87	5.252G	88	5.420G
89	5.266G	90	5.563G	91	5.472G	92	5.601G
93	5.273G	94	5.340G	95	5.296G	96	5.333G
97	5.441G	98	5.550G	99	5.475G	100	5.678G

Hopping Frequency Sequence Name: HOP_FREQ_SEQ_09							
SEQ#	Frequency (Hz)	SEQ#	Frequency (Hz)	SEQ#	Frequency (Hz)	SEQ#	Frequency (Hz)
1	5.618G	2	5.628G	3	5.634G	4	5.468G
5	5.711G	6	5.257G	7	5.588G	8	5.445G
9	5.625G	10	5.675G	11	5.527G	12	5.470G
13	5.707G	14	5.438G	15	5.559G	16	5.499G
17	5.388G	18	5.662G	19	5.594G	20	5.394G
21	5.354G	22	5.678G	23	5.418G	24	5.332G
25	5.696G	26	5.716G	27	5.621G	28	5.450G
29	5.348G	30	5.434G	31	5.452G	32	5.368G
33	5.382G	34	5.254G	35	5.578G	36	5.377G
37	5.269G	38	5.554G	39	5.449G	40	5.430G
41	5.383G	42	5.623G	43	5.401G	44	5.399G
45	5.550G	46	5.586G	47	5.581G	48	5.308G
49	5.512G	50	5.275G	51	5.362G	52	5.363G
53	5.576G	54	5.671G	55	5.342G	56	5.381G
57	5.284G	58	5.390G	59	5.605G	60	5.455G
61	5.503G	62	5.547G	63	5.562G	64	5.429G
65	5.704G	66	5.426G	67	5.411G	68	5.613G
69	5.584G	70	5.311G	71	5.501G	72	5.537G
73	5.451G	74	5.717G	75	5.709G	76	5.695G
77	5.303G	78	5.369G	79	5.514G	80	5.570G
81	5.665G	82	5.592G	83	5.631G	84	5.253G
85	5.622G	86	5.463G	87	5.469G	88	5.518G
89	5.437G	90	5.642G	91	5.630G	92	5.398G
93	5.491G	94	5.367G	95	5.346G	96	5.425G
97	5.414G	98	5.640G	99	5.321G	100	5.393G

Hopping Frequency Sequence Name: HOP_FREQ_SEQ_10							
SEQ#	Frequency (Hz)	SEQ#	Frequency (Hz)	SEQ#	Frequency (Hz)	SEQ#	Frequency (Hz)
1	5.314G	2	5.430G	3	5.302G	4	5.313G
5	5.617G	6	5.493G	7	5.598G	8	5.300G
9	5.712G	10	5.573G	11	5.578G	12	5.340G
13	5.359G	14	5.593G	15	5.351G	16	5.451G
17	5.354G	18	5.389G	19	5.275G	20	5.625G
21	5.515G	22	5.574G	23	5.404G	24	5.552G
25	5.426G	26	5.561G	27	5.685G	28	5.555G
29	5.592G	30	5.363G	31	5.717G	32	5.347G
33	5.252G	34	5.701G	35	5.614G	36	5.608G
37	5.671G	38	5.449G	39	5.556G	40	5.371G
41	5.373G	42	5.652G	43	5.365G	44	5.304G
45	5.537G	46	5.634G	47	5.281G	48	5.647G
49	5.324G	50	5.544G	51	5.447G	52	5.437G
53	5.400G	54	5.289G	55	5.325G	56	5.505G
57	5.603G	58	5.279G	59	5.416G	60	5.446G
61	5.326G	62	5.419G	63	5.550G	64	5.409G
65	5.605G	66	5.316G	67	5.360G	68	5.540G
69	5.370G	70	5.495G	71	5.613G	72	5.467G
73	5.362G	74	5.514G	75	5.298G	76	5.559G
77	5.380G	78	5.636G	79	5.589G	80	5.470G
81	5.551G	82	5.428G	83	5.429G	84	5.716G
85	5.361G	86	5.330G	87	5.441G	88	5.402G
89	5.271G	90	5.297G	91	5.696G	92	5.691G
93	5.376G	94	5.424G	95	5.707G	96	5.307G
97	5.435G	98	5.385G	99	5.638G	100	5.563G

Hopping Frequency Sequence Name: HOP_FREQ_SEQ_11							
SEQ#	Frequency (Hz)	SEQ#	Frequency (Hz)	SEQ#	Frequency (Hz)	SEQ#	Frequency (Hz)
1	5.583G	2	5.494G	3	5.698G	4	5.598G
5	5.625G	6	5.370G	7	5.326G	8	5.606G
9	5.498G	10	5.328G	11	5.694G	12	5.709G
13	5.613G	14	5.481G	15	5.418G	16	5.677G
17	5.448G	18	5.343G	19	5.357G	20	5.554G
21	5.659G	22	5.396G	23	5.303G	24	5.419G
25	5.362G	26	5.428G	27	5.469G	28	5.268G
29	5.394G	30	5.492G	31	5.663G	32	5.720G
33	5.567G	34	5.356G	35	5.635G	36	5.372G
37	5.386G	38	5.345G	39	5.600G	40	5.412G
41	5.258G	42	5.411G	43	5.301G	44	5.618G
45	5.699G	46	5.604G	47	5.463G	48	5.542G
49	5.680G	50	5.670G	51	5.368G	52	5.589G
53	5.553G	54	5.515G	55	5.446G	56	5.304G
57	5.441G	58	5.424G	59	5.620G	60	5.263G
61	5.592G	62	5.629G	63	5.466G	64	5.556G
65	5.636G	66	5.722G	67	5.302G	68	5.656G
69	5.252G	70	5.286G	71	5.369G	72	5.723G
73	5.573G	74	5.569G	75	5.558G	76	5.250G
77	5.500G	78	5.457G	79	5.462G	80	5.562G
81	5.716G	82	5.614G	83	5.347G	84	5.565G
85	5.288G	86	5.627G	87	5.342G	88	5.696G
89	5.712G	90	5.337G	91	5.649G	92	5.538G
93	5.688G	94	5.549G	95	5.272G	96	5.447G
97	5.519G	98	5.323G	99	5.314G	100	5.706G

Hopping Frequency Sequence Name: HOP_FREQ_SEQ_12							
SEQ#	Frequency (Hz)	SEQ#	Frequency (Hz)	SEQ#	Frequency (Hz)	SEQ#	Frequency (Hz)
1	5.511G	2	5.597G	3	5.289G	4	5.670G
5	5.617G	6	5.438G	7	5.491G	8	5.682G
9	5.526G	10	5.298G	11	5.352G	12	5.714G
13	5.689G	14	5.688G	15	5.360G	16	5.431G
17	5.530G	18	5.549G	19	5.478G	20	5.411G
21	5.658G	22	5.356G	23	5.265G	24	5.345G
25	5.520G	26	5.624G	27	5.562G	28	5.674G
29	5.284G	30	5.707G	31	5.464G	32	5.502G
33	5.315G	34	5.297G	35	5.639G	36	5.469G
37	5.407G	38	5.353G	39	5.542G	40	5.458G
41	5.545G	42	5.367G	43	5.569G	44	5.687G
45	5.680G	46	5.722G	47	5.312G	48	5.465G
49	5.574G	50	5.319G	51	5.648G	52	5.702G
53	5.664G	54	5.515G	55	5.613G	56	5.504G
57	5.662G	58	5.251G	59	5.322G	60	5.448G
61	5.395G	62	5.582G	63	5.350G	64	5.563G
65	5.508G	66	5.261G	67	5.577G	68	5.393G
69	5.280G	70	5.374G	71	5.380G	72	5.519G
73	5.460G	74	5.587G	75	5.720G	76	5.653G
77	5.611G	78	5.657G	79	5.596G	80	5.642G
81	5.684G	82	5.604G	83	5.538G	84	5.415G
85	5.692G	86	5.423G	87	5.258G	88	5.336G
89	5.436G	90	5.349G	91	5.287G	92	5.427G
93	5.283G	94	5.711G	95	5.316G	96	5.638G
97	5.507G	98	5.691G	99	5.399G	100	5.610G

Hopping Frequency Sequence Name: HOP_FREQ_SEQ_13							
SEQ#	Frequency (Hz)	SEQ#	Frequency (Hz)	SEQ#	Frequency (Hz)	SEQ#	Frequency (Hz)
1	5.524G	2	5.546G	3	5.257G	4	5.323G
5	5.303G	6	5.498G	7	5.585G	8	5.653G
9	5.540G	10	5.413G	11	5.482G	12	5.462G
13	5.296G	14	5.656G	15	5.626G	16	5.631G
17	5.567G	18	5.711G	19	5.418G	20	5.374G
21	5.666G	22	5.623G	23	5.382G	24	5.408G
25	5.615G	26	5.394G	27	5.593G	28	5.657G
29	5.441G	30	5.395G	31	5.714G	32	5.607G
33	5.254G	34	5.612G	35	5.677G	36	5.717G
37	5.684G	38	5.660G	39	5.273G	40	5.415G
41	5.351G	42	5.484G	43	5.673G	44	5.610G
45	5.442G	46	5.478G	47	5.661G	48	5.563G
49	5.560G	50	5.617G	51	5.463G	52	5.459G
53	5.469G	54	5.417G	55	5.525G	56	5.555G
57	5.493G	58	5.371G	59	5.516G	60	5.663G
61	5.347G	62	5.288G	63	5.580G	64	5.350G
65	5.378G	66	5.700G	67	5.597G	68	5.324G
69	5.458G	70	5.471G	71	5.538G	72	5.599G
73	5.426G	74	5.310G	75	5.688G	76	5.333G
77	5.475G	78	5.258G	79	5.419G	80	5.701G
81	5.600G	82	5.590G	83	5.690G	84	5.528G
85	5.362G	86	5.342G	87	5.502G	88	5.414G
89	5.457G	90	5.297G	91	5.357G	92	5.509G
93	5.274G	94	5.451G	95	5.328G	96	5.539G
97	5.596G	98	5.479G	99	5.474G	100	5.284G

Hopping Frequency Sequence Name: HOP_FREQ_SEQ_14							
SEQ#	Frequency (Hz)	SEQ#	Frequency (Hz)	SEQ#	Frequency (Hz)	SEQ#	Frequency (Hz)
1	5.284G	2	5.688G	3	5.520G	4	5.344G
5	5.339G	6	5.657G	7	5.545G	8	5.607G
9	5.538G	10	5.297G	11	5.658G	12	5.600G
13	5.460G	14	5.285G	15	5.398G	16	5.264G
17	5.303G	18	5.465G	19	5.708G	20	5.443G
21	5.421G	22	5.630G	23	5.386G	24	5.357G
25	5.723G	26	5.684G	27	5.483G	28	5.551G
29	5.529G	30	5.275G	31	5.381G	32	5.444G
33	5.639G	34	5.345G	35	5.326G	36	5.506G
37	5.531G	38	5.679G	39	5.355G	40	5.649G
41	5.560G	42	5.377G	43	5.331G	44	5.428G
45	5.575G	46	5.500G	47	5.509G	48	5.656G
49	5.693G	50	5.376G	51	5.434G	52	5.327G
53	5.542G	54	5.368G	55	5.321G	56	5.349G
57	5.389G	58	5.353G	59	5.606G	60	5.494G
61	5.315G	62	5.568G	63	5.559G	64	5.278G
65	5.680G	66	5.288G	67	5.557G	68	5.405G
69	5.589G	70	5.634G	71	5.721G	72	5.350G
73	5.485G	74	5.481G	75	5.433G	76	5.296G
77	5.691G	78	5.544G	79	5.587G	80	5.599G
81	5.713G	82	5.632G	83	5.676G	84	5.307G
85	5.497G	86	5.328G	87	5.653G	88	5.578G
89	5.332G	90	5.608G	91	5.310G	92	5.445G
93	5.419G	94	5.576G	95	5.503G	96	5.549G
97	5.322G	98	5.683G	99	5.707G	100	5.698G

Hopping Frequency Sequence Name: HOP_FREQ_SEQ_15							
SEQ#	Frequency (Hz)	SEQ#	Frequency (Hz)	SEQ#	Frequency (Hz)	SEQ#	Frequency (Hz)
1	5.522G	2	5.425G	3	5.421G	4	5.722G
5	5.369G	6	5.553G	7	5.395G	8	5.265G
9	5.669G	10	5.543G	11	5.266G	12	5.490G
13	5.724G	14	5.250G	15	5.405G	16	5.579G
17	5.520G	18	5.608G	19	5.686G	20	5.404G
21	5.494G	22	5.560G	23	5.446G	24	5.367G
25	5.545G	26	5.388G	27	5.350G	28	5.402G
29	5.640G	30	5.286G	31	5.273G	32	5.680G
33	5.256G	34	5.292G	35	5.308G	36	5.481G
37	5.304G	38	5.600G	39	5.397G	40	5.299G
41	5.386G	42	5.586G	43	5.602G	44	5.444G
45	5.684G	46	5.505G	47	5.723G	48	5.613G
49	5.532G	50	5.319G	51	5.595G	52	5.370G
53	5.318G	54	5.314G	55	5.487G	56	5.531G
57	5.604G	58	5.272G	59	5.572G	60	5.598G
61	5.384G	62	5.591G	63	5.619G	64	5.695G
65	5.372G	66	5.452G	67	5.443G	68	5.269G
69	5.462G	70	5.568G	71	5.346G	72	5.422G
73	5.257G	74	5.523G	75	5.671G	76	5.307G
77	5.361G	78	5.416G	79	5.433G	80	5.617G
81	5.398G	82	5.351G	83	5.485G	84	5.650G
85	5.347G	86	5.334G	87	5.442G	88	5.276G
89	5.392G	90	5.360G	91	5.456G	92	5.468G
93	5.309G	94	5.328G	95	5.497G	96	5.337G
97	5.294G	98	5.261G	99	5.557G	100	5.665G

Hopping Frequency Sequence Name: HOP_FREQ_SEQ_16							
SEQ#	Frequency (Hz)	SEQ#	Frequency (Hz)	SEQ#	Frequency (Hz)	SEQ#	Frequency (Hz)
1	5.587G	2	5.395G	3	5.533G	4	5.319G
5	5.473G	6	5.361G	7	5.697G	8	5.549G
9	5.680G	10	5.507G	11	5.526G	12	5.374G
13	5.377G	14	5.723G	15	5.444G	16	5.457G
17	5.347G	18	5.517G	19	5.313G	20	5.412G
21	5.720G	22	5.719G	23	5.380G	24	5.410G
25	5.692G	26	5.323G	27	5.466G	28	5.506G
29	5.386G	30	5.286G	31	5.643G	32	5.681G
33	5.370G	34	5.333G	35	5.476G	36	5.498G
37	5.655G	38	5.368G	39	5.612G	40	5.254G
41	5.602G	42	5.627G	43	5.335G	44	5.404G
45	5.718G	46	5.656G	47	5.667G	48	5.431G
49	5.686G	50	5.651G	51	5.585G	52	5.649G
53	5.265G	54	5.474G	55	5.268G	56	5.631G
57	5.376G	58	5.260G	59	5.488G	60	5.521G
61	5.672G	62	5.618G	63	5.403G	64	5.610G
65	5.315G	66	5.556G	67	5.659G	68	5.420G
69	5.596G	70	5.270G	71	5.324G	72	5.546G
73	5.358G	74	5.675G	75	5.295G	76	5.568G
77	5.281G	78	5.630G	79	5.499G	80	5.263G
81	5.325G	82	5.541G	83	5.490G	84	5.371G
85	5.634G	86	5.464G	87	5.352G	88	5.326G
89	5.330G	90	5.606G	91	5.711G	92	5.381G
93	5.580G	94	5.280G	95	5.554G	96	5.362G
97	5.626G	98	5.510G	99	5.716G	100	5.441G

Hopping Frequency Sequence Name: HOP_FREQ_SEQ_17							
SEQ#	Frequency (Hz)	SEQ#	Frequency (Hz)	SEQ#	Frequency (Hz)	SEQ#	Frequency (Hz)
1	5.293G	2	5.283G	3	5.433G	4	5.556G
5	5.494G	6	5.344G	7	5.320G	8	5.656G
9	5.405G	10	5.606G	11	5.323G	12	5.358G
13	5.274G	14	5.521G	15	5.434G	16	5.546G
17	5.644G	18	5.487G	19	5.313G	20	5.676G
21	5.609G	22	5.297G	23	5.565G	24	5.377G
25	5.288G	26	5.397G	27	5.470G	28	5.299G
29	5.645G	30	5.292G	31	5.667G	32	5.473G
33	5.615G	34	5.513G	35	5.558G	36	5.447G
37	5.549G	38	5.362G	39	5.365G	40	5.465G
41	5.483G	42	5.370G	43	5.361G	44	5.702G
45	5.369G	46	5.723G	47	5.328G	48	5.278G
49	5.311G	50	5.539G	51	5.419G	52	5.554G
53	5.262G	54	5.379G	55	5.713G	56	5.493G
57	5.294G	58	5.603G	59	5.304G	60	5.340G
61	5.614G	62	5.350G	63	5.551G	64	5.626G
65	5.295G	66	5.671G	67	5.336G	68	5.694G
69	5.621G	70	5.540G	71	5.648G	72	5.391G
73	5.373G	74	5.682G	75	5.463G	76	5.672G
77	5.559G	78	5.477G	79	5.518G	80	5.607G
81	5.647G	82	5.442G	83	5.720G	84	5.590G
85	5.403G	86	5.580G	87	5.591G	88	5.637G
89	5.506G	90	5.411G	91	5.587G	92	5.543G
93	5.601G	94	5.455G	95	5.697G	96	5.668G
97	5.695G	98	5.271G	99	5.430G	100	5.514G

Hopping Frequency Sequence Name: HOP_FREQ_SEQ_18							
SEQ#	Frequency (Hz)	SEQ#	Frequency (Hz)	SEQ#	Frequency (Hz)	SEQ#	Frequency (Hz)
1	5.715G	2	5.594G	3	5.450G	4	5.473G
5	5.287G	6	5.338G	7	5.346G	8	5.288G
9	5.542G	10	5.306G	11	5.333G	12	5.472G
13	5.490G	14	5.551G	15	5.644G	16	5.651G
17	5.618G	18	5.434G	19	5.691G	20	5.666G
21	5.648G	22	5.558G	23	5.397G	24	5.316G
25	5.602G	26	5.545G	27	5.336G	28	5.701G
29	5.401G	30	5.582G	31	5.576G	32	5.429G
33	5.367G	34	5.527G	35	5.344G	36	5.286G
37	5.304G	38	5.660G	39	5.687G	40	5.631G
41	5.622G	42	5.677G	43	5.383G	44	5.296G
45	5.619G	46	5.503G	47	5.708G	48	5.482G
49	5.624G	50	5.599G	51	5.667G	52	5.298G
53	5.414G	54	5.349G	55	5.548G	56	5.615G
57	5.568G	58	5.424G	59	5.720G	60	5.271G
61	5.369G	62	5.559G	63	5.276G	64	5.356G
65	5.256G	66	5.681G	67	5.540G	68	5.263G
69	5.275G	70	5.629G	71	5.303G	72	5.433G
73	5.481G	74	5.523G	75	5.285G	76	5.407G
77	5.378G	78	5.512G	79	5.650G	80	5.278G
81	5.446G	82	5.546G	83	5.486G	84	5.564G
85	5.613G	86	5.390G	87	5.348G	88	5.468G
89	5.565G	90	5.518G	91	5.600G	92	5.311G
93	5.506G	94	5.484G	95	5.438G	96	5.381G
97	5.553G	98	5.364G	99	5.423G	100	5.343G

Hopping Frequency Sequence Name: HOP_FREQ_SEQ_19							
SEQ#	Frequency (Hz)	SEQ#	Frequency (Hz)	SEQ#	Frequency (Hz)	SEQ#	Frequency (Hz)
1	5.666G	2	5.487G	3	5.470G	4	5.359G
5	5.338G	6	5.472G	7	5.390G	8	5.708G
9	5.589G	10	5.366G	11	5.485G	12	5.519G
13	5.337G	14	5.659G	15	5.501G	16	5.405G
17	5.295G	18	5.369G	19	5.284G	20	5.425G
21	5.661G	22	5.447G	23	5.483G	24	5.267G
25	5.285G	26	5.549G	27	5.306G	28	5.473G
29	5.637G	30	5.578G	31	5.513G	32	5.605G
33	5.623G	34	5.573G	35	5.536G	36	5.663G
37	5.511G	38	5.479G	39	5.611G	40	5.510G
41	5.403G	42	5.301G	43	5.711G	44	5.706G
45	5.259G	46	5.554G	47	5.494G	48	5.254G
49	5.250G	50	5.497G	51	5.291G	52	5.543G
53	5.495G	54	5.376G	55	5.481G	56	5.325G
57	5.506G	58	5.697G	59	5.340G	60	5.378G
61	5.579G	62	5.558G	63	5.664G	64	5.364G
65	5.290G	66	5.467G	67	5.446G	68	5.417G
69	5.684G	70	5.700G	71	5.408G	72	5.545G
73	5.316G	74	5.305G	75	5.616G	76	5.329G
77	5.255G	78	5.601G	79	5.455G	80	5.486G
81	5.478G	82	5.383G	83	5.450G	84	5.358G
85	5.678G	86	5.407G	87	5.514G	88	5.718G
89	5.331G	90	5.468G	91	5.698G	92	5.507G
93	5.312G	94	5.719G	95	5.372G	96	5.570G
97	5.271G	98	5.528G	99	5.582G	100	5.644G

Hopping Frequency Sequence Name: HOP_FREQ_SEQ_20							
SEQ#	Frequency (Hz)	SEQ#	Frequency (Hz)	SEQ#	Frequency (Hz)	SEQ#	Frequency (Hz)
1	5.388G	2	5.645G	3	5.618G	4	5.275G
5	5.406G	6	5.363G	7	5.279G	8	5.639G
9	5.665G	10	5.617G	11	5.579G	12	5.691G
13	5.295G	14	5.602G	15	5.372G	16	5.484G
17	5.516G	18	5.345G	19	5.649G	20	5.597G
21	5.394G	22	5.404G	23	5.487G	24	5.483G
25	5.543G	26	5.722G	27	5.574G	28	5.353G
29	5.528G	30	5.522G	31	5.401G	32	5.467G
33	5.325G	34	5.585G	35	5.277G	36	5.264G
37	5.525G	38	5.586G	39	5.430G	40	5.350G
41	5.445G	42	5.635G	43	5.675G	44	5.285G
45	5.674G	46	5.307G	47	5.328G	48	5.338G
49	5.286G	50	5.540G	51	5.657G	52	5.313G
53	5.546G	54	5.370G	55	5.358G	56	5.611G
57	5.495G	58	5.410G	59	5.268G	60	5.640G
61	5.311G	62	5.513G	63	5.584G	64	5.562G
65	5.518G	66	5.572G	67	5.456G	68	5.680G
69	5.461G	70	5.348G	71	5.505G	72	5.340G
73	5.409G	74	5.699G	75	5.362G	76	5.714G
77	5.706G	78	5.684G	79	5.431G	80	5.463G
81	5.288G	82	5.418G	83	5.374G	84	5.270G
85	5.571G	86	5.414G	87	5.266G	88	5.322G
89	5.547G	90	5.272G	91	5.710G	92	5.327G
93	5.331G	94	5.282G	95	5.403G	96	5.560G
97	5.342G	98	5.321G	99	5.701G	100	5.504G

Hopping Frequency Sequence Name: HOP_FREQ_SEQ_21							
SEQ#	Frequency (Hz)	SEQ#	Frequency (Hz)	SEQ#	Frequency (Hz)	SEQ#	Frequency (Hz)
1	5.637G	2	5.337G	3	5.452G	4	5.302G
5	5.278G	6	5.606G	7	5.696G	8	5.579G
9	5.363G	10	5.285G	11	5.275G	12	5.484G
13	5.427G	14	5.468G	15	5.309G	16	5.607G
17	5.494G	18	5.684G	19	5.272G	20	5.697G
21	5.447G	22	5.367G	23	5.338G	24	5.504G
25	5.465G	26	5.381G	27	5.368G	28	5.471G
29	5.310G	30	5.455G	31	5.553G	32	5.626G
33	5.457G	34	5.420G	35	5.362G	36	5.621G
37	5.700G	38	5.599G	39	5.653G	40	5.615G
41	5.402G	42	5.379G	43	5.490G	44	5.715G
45	5.695G	46	5.595G	47	5.421G	48	5.609G
49	5.664G	50	5.642G	51	5.628G	52	5.674G
53	5.507G	54	5.617G	55	5.656G	56	5.493G
57	5.266G	58	5.714G	59	5.319G	60	5.441G
61	5.478G	62	5.444G	63	5.474G	64	5.575G
65	5.294G	66	5.282G	67	5.328G	68	5.462G
69	5.289G	70	5.724G	71	5.454G	72	5.306G
73	5.380G	74	5.332G	75	5.677G	76	5.374G
77	5.712G	78	5.387G	79	5.472G	80	5.542G
81	5.533G	82	5.426G	83	5.254G	84	5.669G
85	5.271G	86	5.577G	87	5.502G	88	5.403G
89	5.543G	90	5.571G	91	5.513G	92	5.479G
93	5.601G	94	5.482G	95	5.428G	96	5.614G
97	5.336G	98	5.372G	99	5.600G	100	5.470G

Hopping Frequency Sequence Name: HOP_FREQ_SEQ_22							
SEQ#	Frequency (Hz)	SEQ#	Frequency (Hz)	SEQ#	Frequency (Hz)	SEQ#	Frequency (Hz)
1	5.335G	2	5.570G	3	5.334G	4	5.433G
5	5.464G	6	5.451G	7	5.687G	8	5.586G
9	5.254G	10	5.634G	11	5.438G	12	5.722G
13	5.386G	14	5.607G	15	5.290G	16	5.262G
17	5.515G	18	5.441G	19	5.636G	20	5.270G
21	5.256G	22	5.279G	23	5.620G	24	5.447G
25	5.471G	26	5.417G	27	5.473G	28	5.708G
29	5.468G	30	5.362G	31	5.572G	32	5.563G
33	5.328G	34	5.601G	35	5.541G	36	5.629G
37	5.393G	38	5.667G	39	5.531G	40	5.313G
41	5.633G	42	5.403G	43	5.613G	44	5.553G
45	5.465G	46	5.716G	47	5.329G	48	5.356G
49	5.320G	50	5.391G	51	5.255G	52	5.276G
53	5.324G	54	5.271G	55	5.500G	56	5.646G
57	5.404G	58	5.265G	59	5.671G	60	5.616G
61	5.371G	62	5.606G	63	5.477G	64	5.467G
65	5.561G	66	5.359G	67	5.603G	68	5.407G
69	5.426G	70	5.715G	71	5.663G	72	5.680G
73	5.463G	74	5.274G	75	5.567G	76	5.721G
77	5.678G	78	5.657G	79	5.443G	80	5.338G
81	5.293G	82	5.325G	83	5.724G	84	5.402G
85	5.581G	86	5.478G	87	5.507G	88	5.669G
89	5.409G	90	5.495G	91	5.627G	92	5.519G
93	5.508G	94	5.322G	95	5.373G	96	5.382G
97	5.530G	98	5.589G	99	5.587G	100	5.580G

Hopping Frequency Sequence Name: HOP_FREQ_SEQ_23							
SEQ#	Frequency (Hz)	SEQ#	Frequency (Hz)	SEQ#	Frequency (Hz)	SEQ#	Frequency (Hz)
1	5.295G	2	5.251G	3	5.536G	4	5.257G
5	5.694G	6	5.615G	7	5.373G	8	5.529G
9	5.255G	10	5.542G	11	5.604G	12	5.280G
13	5.288G	14	5.479G	15	5.706G	16	5.600G
17	5.420G	18	5.640G	19	5.256G	20	5.260G
21	5.605G	22	5.349G	23	5.466G	24	5.576G
25	5.310G	26	5.696G	27	5.658G	28	5.284G
29	5.286G	30	5.651G	31	5.324G	32	5.570G
33	5.627G	34	5.610G	35	5.541G	36	5.505G
37	5.527G	38	5.481G	39	5.270G	40	5.301G
41	5.667G	42	5.516G	43	5.409G	44	5.299G
45	5.348G	46	5.482G	47	5.617G	48	5.586G
49	5.442G	50	5.297G	51	5.470G	52	5.296G
53	5.417G	54	5.282G	55	5.671G	56	5.676G
57	5.506G	58	5.421G	59	5.438G	60	5.345G
61	5.402G	62	5.350G	63	5.483G	64	5.577G
65	5.573G	66	5.537G	67	5.635G	68	5.426G
69	5.278G	70	5.303G	71	5.276G	72	5.591G
73	5.686G	74	5.568G	75	5.559G	76	5.712G
77	5.621G	78	5.414G	79	5.669G	80	5.398G
81	5.630G	82	5.521G	83	5.662G	84	5.619G
85	5.262G	86	5.578G	87	5.335G	88	5.401G
89	5.645G	90	5.312G	91	5.546G	92	5.292G
93	5.654G	94	5.663G	95	5.557G	96	5.628G
97	5.504G	98	5.305G	99	5.632G	100	5.624G

Hopping Frequency Sequence Name: HOP_FREQ_SEQ_24							
SEQ#	Frequency (Hz)	SEQ#	Frequency (Hz)	SEQ#	Frequency (Hz)	SEQ#	Frequency (Hz)
1	5.471G	2	5.508G	3	5.494G	4	5.442G
5	5.648G	6	5.621G	7	5.433G	8	5.405G
9	5.339G	10	5.302G	11	5.546G	12	5.502G
13	5.268G	14	5.607G	15	5.673G	16	5.406G
17	5.669G	18	5.307G	19	5.453G	20	5.670G
21	5.274G	22	5.570G	23	5.636G	24	5.484G
25	5.599G	26	5.458G	27	5.294G	28	5.595G
29	5.308G	30	5.606G	31	5.556G	32	5.402G
33	5.392G	34	5.626G	35	5.603G	36	5.416G
37	5.645G	38	5.709G	39	5.665G	40	5.407G
41	5.290G	42	5.298G	43	5.628G	44	5.314G
45	5.363G	46	5.366G	47	5.557G	48	5.321G
49	5.722G	50	5.525G	51	5.351G	52	5.390G
53	5.309G	54	5.614G	55	5.464G	56	5.281G
57	5.639G	58	5.293G	59	5.424G	60	5.413G
61	5.332G	62	5.478G	63	5.305G	64	5.398G
65	5.619G	66	5.507G	67	5.642G	68	5.299G
69	5.488G	70	5.480G	71	5.396G	72	5.682G
73	5.450G	74	5.592G	75	5.403G	76	5.374G
77	5.538G	78	5.287G	79	5.282G	80	5.537G
81	5.710G	82	5.641G	83	5.615G	84	5.358G
85	5.613G	86	5.438G	87	5.346G	88	5.386G
89	5.680G	90	5.255G	91	5.486G	92	5.379G
93	5.304G	94	5.320G	95	5.446G	96	5.720G
97	5.503G	98	5.690G	99	5.269G	100	5.306G

Hopping Frequency Sequence Name: HOP_FREQ_SEQ_25							
SEQ#	Frequency (Hz)	SEQ#	Frequency (Hz)	SEQ#	Frequency (Hz)	SEQ#	Frequency (Hz)
1	5.545G	2	5.281G	3	5.677G	4	5.635G
5	5.287G	6	5.663G	7	5.632G	8	5.290G
9	5.395G	10	5.614G	11	5.260G	12	5.396G
13	5.646G	14	5.538G	15	5.390G	16	5.611G
17	5.402G	18	5.647G	19	5.561G	20	5.397G
21	5.373G	22	5.444G	23	5.315G	24	5.300G
25	5.501G	26	5.407G	27	5.670G	28	5.514G
29	5.448G	30	5.343G	31	5.294G	32	5.382G
33	5.580G	34	5.606G	35	5.261G	36	5.329G
37	5.334G	38	5.527G	39	5.480G	40	5.666G
41	5.276G	42	5.422G	43	5.301G	44	5.639G
45	5.661G	46	5.684G	47	5.616G	48	5.369G
49	5.385G	50	5.317G	51	5.590G	52	5.253G
53	5.689G	54	5.375G	55	5.714G	56	5.693G
57	5.496G	58	5.596G	59	5.583G	60	5.529G
61	5.340G	62	5.477G	63	5.723G	64	5.656G
65	5.252G	66	5.662G	67	5.629G	68	5.622G
69	5.335G	70	5.592G	71	5.360G	72	5.333G
73	5.391G	74	5.603G	75	5.374G	76	5.665G
77	5.420G	78	5.681G	79	5.674G	80	5.368G
81	5.324G	82	5.312G	83	5.468G	84	5.319G
85	5.559G	86	5.518G	87	5.367G	88	5.275G
89	5.709G	90	5.262G	91	5.692G	92	5.582G
93	5.584G	94	5.473G	95	5.282G	96	5.331G
97	5.298G	98	5.565G	99	5.470G	100	5.626G

Hopping Frequency Sequence Name: HOP_FREQ_SEQ_26							
SEQ#	Frequency (Hz)	SEQ#	Frequency (Hz)	SEQ#	Frequency (Hz)	SEQ#	Frequency (Hz)
1	5.475G	2	5.337G	3	5.544G	4	5.723G
5	5.509G	6	5.506G	7	5.328G	8	5.327G
9	5.260G	10	5.716G	11	5.542G	12	5.256G
13	5.441G	14	5.349G	15	5.634G	16	5.680G
17	5.545G	18	5.661G	19	5.469G	20	5.704G
21	5.478G	22	5.446G	23	5.393G	24	5.521G
25	5.400G	26	5.306G	27	5.295G	28	5.280G
29	5.367G	30	5.557G	31	5.681G	32	5.471G
33	5.573G	34	5.637G	35	5.554G	36	5.444G
37	5.292G	38	5.552G	39	5.413G	40	5.588G
41	5.252G	42	5.447G	43	5.496G	44	5.582G
45	5.502G	46	5.373G	47	5.311G	48	5.415G
49	5.354G	50	5.412G	51	5.418G	52	5.685G
53	5.267G	54	5.483G	55	5.334G	56	5.626G
57	5.368G	58	5.600G	59	5.307G	60	5.498G
61	5.428G	62	5.341G	63	5.693G	64	5.569G
65	5.495G	66	5.647G	67	5.266G	68	5.481G
69	5.624G	70	5.477G	71	5.399G	72	5.422G
73	5.452G	74	5.689G	75	5.282G	76	5.296G
77	5.344G	78	5.333G	79	5.301G	80	5.595G
81	5.503G	82	5.501G	83	5.277G	84	5.358G
85	5.253G	86	5.419G	87	5.593G	88	5.456G
89	5.673G	90	5.629G	91	5.656G	92	5.671G
93	5.375G	94	5.650G	95	5.459G	96	5.678G
97	5.635G	98	5.615G	99	5.434G	100	5.575G

Hopping Frequency Sequence Name: HOP_FREQ_SEQ_27							
SEQ#	Frequency (Hz)	SEQ#	Frequency (Hz)	SEQ#	Frequency (Hz)	SEQ#	Frequency (Hz)
1	5.289G	2	5.560G	3	5.603G	4	5.697G
5	5.449G	6	5.529G	7	5.462G	8	5.262G
9	5.570G	10	5.701G	11	5.340G	12	5.274G
13	5.651G	14	5.673G	15	5.536G	16	5.712G
17	5.411G	18	5.566G	19	5.686G	20	5.376G
21	5.717G	22	5.531G	23	5.692G	24	5.295G
25	5.611G	26	5.719G	27	5.661G	28	5.667G
29	5.311G	30	5.470G	31	5.287G	32	5.561G
33	5.316G	34	5.517G	35	5.286G	36	5.604G
37	5.556G	38	5.398G	39	5.446G	40	5.350G
41	5.282G	42	5.380G	43	5.549G	44	5.480G
45	5.522G	46	5.408G	47	5.623G	48	5.416G
49	5.263G	50	5.352G	51	5.621G	52	5.674G
53	5.714G	54	5.644G	55	5.665G	56	5.412G
57	5.305G	58	5.315G	59	5.710G	60	5.251G
61	5.471G	62	5.302G	63	5.357G	64	5.575G
65	5.432G	66	5.630G	67	5.456G	68	5.720G
69	5.707G	70	5.513G	71	5.303G	72	5.330G
73	5.482G	74	5.296G	75	5.595G	76	5.457G
77	5.297G	78	5.371G	79	5.632G	80	5.643G
81	5.540G	82	5.687G	83	5.310G	84	5.684G
85	5.721G	86	5.658G	87	5.465G	88	5.341G
89	5.553G	90	5.506G	91	5.563G	92	5.463G
93	5.691G	94	5.417G	95	5.481G	96	5.472G
97	5.581G	98	5.500G	99	5.304G	100	5.568G

Hopping Frequency Sequence Name: HOP_FREQ_SEQ_28							
SEQ#	Frequency (Hz)	SEQ#	Frequency (Hz)	SEQ#	Frequency (Hz)	SEQ#	Frequency (Hz)
1	5.388G	2	5.252G	3	5.315G	4	5.290G
5	5.590G	6	5.638G	7	5.636G	8	5.550G
9	5.335G	10	5.642G	11	5.254G	12	5.566G
13	5.549G	14	5.640G	15	5.279G	16	5.499G
17	5.649G	18	5.267G	19	5.491G	20	5.587G
21	5.712G	22	5.309G	23	5.393G	24	5.260G
25	5.416G	26	5.271G	27	5.293G	28	5.366G
29	5.596G	30	5.446G	31	5.594G	32	5.624G
33	5.438G	34	5.343G	35	5.319G	36	5.313G
37	5.310G	38	5.341G	39	5.650G	40	5.263G
41	5.560G	42	5.403G	43	5.580G	44	5.508G
45	5.265G	46	5.272G	47	5.684G	48	5.479G
49	5.456G	50	5.701G	51	5.277G	52	5.620G
53	5.588G	54	5.289G	55	5.258G	56	5.611G
57	5.327G	58	5.300G	59	5.405G	60	5.564G
61	5.628G	62	5.409G	63	5.670G	64	5.255G
65	5.529G	66	5.497G	67	5.326G	68	5.496G
69	5.711G	70	5.717G	71	5.357G	72	5.724G
73	5.526G	74	5.618G	75	5.274G	76	5.441G
77	5.678G	78	5.544G	79	5.614G	80	5.418G
81	5.386G	82	5.721G	83	5.668G	84	5.379G
85	5.463G	86	5.396G	87	5.664G	88	5.353G
89	5.703G	90	5.298G	91	5.644G	92	5.307G
93	5.509G	94	5.553G	95	5.681G	96	5.589G
97	5.513G	98	5.547G	99	5.527G	100	5.295G

Hopping Frequency Sequence Name: HOP_FREQ_SEQ_29							
SEQ#	Frequency (Hz)	SEQ#	Frequency (Hz)	SEQ#	Frequency (Hz)	SEQ#	Frequency (Hz)
1	5.351G	2	5.612G	3	5.484G	4	5.268G
5	5.493G	6	5.636G	7	5.631G	8	5.693G
9	5.284G	10	5.413G	11	5.451G	12	5.706G
13	5.580G	14	5.382G	15	5.683G	16	5.344G
17	5.712G	18	5.288G	19	5.355G	20	5.361G
21	5.460G	22	5.305G	23	5.584G	24	5.594G
25	5.336G	26	5.358G	27	5.633G	28	5.335G
29	5.696G	30	5.386G	31	5.267G	32	5.517G
33	5.289G	34	5.489G	35	5.313G	36	5.568G
37	5.271G	38	5.514G	39	5.605G	40	5.511G
41	5.473G	42	5.270G	43	5.446G	44	5.626G
45	5.596G	46	5.378G	47	5.718G	48	5.582G
49	5.505G	50	5.297G	51	5.573G	52	5.672G
53	5.603G	54	5.639G	55	5.640G	56	5.346G
57	5.688G	58	5.678G	59	5.258G	60	5.657G
61	5.668G	62	5.512G	63	5.450G	64	5.254G
65	5.327G	66	5.308G	67	5.320G	68	5.434G
69	5.454G	70	5.495G	71	5.326G	72	5.457G
73	5.458G	74	5.577G	75	5.667G	76	5.622G
77	5.647G	78	5.274G	79	5.364G	80	5.628G
81	5.585G	82	5.620G	83	5.250G	84	5.609G
85	5.474G	86	5.420G	87	5.390G	88	5.638G
89	5.311G	90	5.463G	91	5.713G	92	5.412G
93	5.499G	94	5.306G	95	5.348G	96	5.279G
97	5.572G	98	5.559G	99	5.275G	100	5.680G

Hopping Frequency Sequence Name: HOP_FREQ_SEQ_30							
SEQ#	Frequency (Hz)	SEQ#	Frequency (Hz)	SEQ#	Frequency (Hz)	SEQ#	Frequency (Hz)
1	5.673G	2	5.315G	3	5.496G	4	5.668G
5	5.371G	6	5.565G	7	5.279G	8	5.577G
9	5.487G	10	5.664G	11	5.641G	12	5.649G
13	5.386G	14	5.545G	15	5.687G	16	5.393G
17	5.455G	18	5.467G	19	5.480G	20	5.642G
21	5.362G	22	5.602G	23	5.704G	24	5.499G
25	5.260G	26	5.591G	27	5.357G	28	5.605G
29	5.459G	30	5.403G	31	5.328G	32	5.586G
33	5.651G	34	5.520G	35	5.684G	36	5.384G
37	5.677G	38	5.601G	39	5.259G	40	5.251G
41	5.502G	42	5.432G	43	5.346G	44	5.648G
45	5.353G	46	5.612G	47	5.283G	48	5.718G
49	5.321G	50	5.349G	51	5.369G	52	5.627G
53	5.524G	54	5.708G	55	5.381G	56	5.274G
57	5.544G	58	5.409G	59	5.611G	60	5.380G
61	5.580G	62	5.498G	63	5.468G	64	5.257G
65	5.584G	66	5.266G	67	5.509G	68	5.629G
69	5.305G	70	5.324G	71	5.395G	72	5.676G
73	5.533G	74	5.688G	75	5.449G	76	5.388G
77	5.703G	78	5.603G	79	5.262G	80	5.686G
81	5.394G	82	5.661G	83	5.450G	84	5.342G
85	5.355G	86	5.483G	87	5.540G	88	5.538G
89	5.401G	90	5.276G	91	5.526G	92	5.400G
93	5.457G	94	5.654G	95	5.559G	96	5.377G
97	5.513G	98	5.678G	99	5.549G	100	5.301G