

FCC Test Report

Report No.: RF161229C25A

FCC ID: PY316400362

Test Model: RBR40

Series Model: RBS40

Received Date: Dec. 22, 2016

Test Date: Dec. 23, 2016 ~ Mar. 15, 2017

Issued Date: Mar. 16, 2017

Applicant: NETGEAR, INC.

Address: 350 East Plumeria Drive San Jose, CA 95134

Issued By: Bureau Veritas Consumer Products Services (H.K.) Ltd., Taoyuan Branch

Lab Address: No. 47-2, 14th Ling, Chia Pau Vil., Lin Kou Dist., New Taipei City, Taiwan, R.O.C.

Test Location: No. 19, Hwa Ya 2nd Rd., Wen Hwa Vil., Kwei Shan Dist., Taoyuan City 33383, TAIWAN (R.O.C.)



This report is for your exclusive use. Any copying or replication of this report to or for any other person or entity, or use of our name or trademark, is permitted only with our prior written permission. This report sets forth our findings solely with respect to the test samples identified herein. The results set forth in this report are not indicative or representative of the quality or characteristics of the lot from which a test sample was taken or any similar or identical product unless specifically and expressly noted. Our report includes all of the tests requested by you and the results thereof based upon the information that you provided to us. You have 60 days from date of issuance of this report to notify us of any material error or omission caused by our negligence, provided, however, that such notice shall be in writing and shall specifically address the issue you wish to raise. A failure to raise such issue within the prescribed time shall constitute your unqualified acceptance of the completeness of this report, the tests conducted and the correctness of the report contents. Unless specific mention, the uncertainty of measurement has been explicitly taken into account to declare the compliance or non-compliance to the specification. The report must not be used by the client to claim product certification, approval, or endorsement by TAF or any government agencies.

Table of Contents

Release Control Record	4
1 Certificate of Conformity	5
2 Summary of Test Results	6
2.1 Measurement Uncertainty.....	6
2.2 Modification Record.....	6
3 General Information	7
3.1 General Description of EUT.....	7
3.2 Description of Test Modes.....	10
3.2.1 Test Mode Applicability and Tested Channel Detail.....	11
3.3 Duty Cycle of Test Signal.....	13
3.4 Description of Support Units.....	14
3.4.1 Configuration of System under Test.....	14
3.5 General Description of Applied Standards.....	14
4 Test Types and Results	15
4.1 Radiated Emission and Bandedge Measurement.....	15
4.1.1 Limits of Radiated Emission and Bandedge Measurement.....	15
4.1.2 Test Instruments.....	16
4.1.3 Test Procedures.....	17
4.1.4 Deviation from Test Standard.....	18
4.1.5 Test Setup.....	18
4.1.6 EUT Operating Conditions.....	19
4.1.7 Test Results.....	20
4.2 Conducted Emission Measurement.....	42
4.2.1 Limits of Conducted Emission Measurement.....	42
4.2.2 Test Instruments.....	42
4.2.3 Test Procedures.....	43
4.2.4 Deviation from Test Standard.....	43
4.2.5 Test Setup.....	43
4.2.6 EUT Operating Conditions.....	43
4.2.7 Test Results.....	44
4.3 Transmit Power Measurement.....	48
4.3.1 Limits of Transmit Power Measurement.....	48
4.3.2 Test Setup.....	48
4.3.3 Test Instruments.....	48
4.3.4 Test Procedure.....	49
4.3.5 Deviation from Test Standard.....	49
4.3.6 EUT Operating Conditions.....	49
4.3.7 Test Result.....	50
4.4 Occupied Bandwidth Measurement.....	57
4.4.1 Test Setup.....	57
4.4.2 Test Instruments.....	57
4.4.3 Test Procedure.....	57
4.4.4 Test Result.....	58
4.5 Peak Power Spectral Density Measurement.....	62
4.5.1 Limits of Peak Power Spectral Density Measurement.....	62
4.5.2 Test Setup.....	62
4.5.3 Test Instruments.....	62
4.5.4 Test Procedures.....	62
4.5.5 Deviation from Test Standard.....	62
4.5.6 EUT Operating Conditions.....	62
4.5.7 Test Results.....	63
4.6 Frequency Stability.....	66
4.6.1 Limits of Frequency Stability Measurement.....	66

4.6.2 Test Setup.....	66
4.6.3 Test Instruments	66
4.6.4 Test Procedure	66
4.6.5 Deviation from Test Standard	66
4.6.6 EUT Operating Condition	66
4.6.7 Test Results	67
5 Pictures of Test Arrangements.....	68
Appendix – Information on the Testing Laboratories	69

Release Control Record

Issue No.	Description	Date Issued
RF161229C25A	Original release	Mar. 16, 2017

1 Certificate of Conformity

Product: Orbi Router, Orbi Satellite
Brand: NETGEAR
Test Model: RBR40
Series Model: RBS40
Sample Status: Engineering sample
Applicant: NETGEAR, INC.
Test Date: Dec. 23, 2016 ~ Mar. 15, 2017
Standards: 47 CFR FCC Part 15, Subpart E (Section 15.407)
ANSI C63.10:2013

The above equipment has been tested by **Bureau Veritas Consumer Products Services (H.K.) Ltd., Taoyuan Branch**, and found compliance with the requirement of the above standards. The test record, data evaluation & Equipment Under Test (EUT) configurations represented herein are true and accurate accounts of the measurements of the sample's EMC characteristics under the conditions specified in this report.

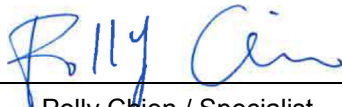
Prepared by :  , **Date:** Mar. 16, 2017
Polly Chien / Specialist

Approved by :  , **Date:** Mar. 16, 2017
Ken Liu / Senior Manager

2 Summary of Test Results

47 CFR FCC Part 15, Subpart E (Section 15.407)			
FCC Clause	Test Item	Result	Remarks
15.407(b)(6)	AC Power Conducted Emissions	Pass	Meet the requirement of limit. Minimum passing margin is -11.96dB at 0.31849MHz.
15.407(b) (1/2/3/4(i/ii)/6)	Radiated Emissions & Band Edge Measurement	Pass	Meet the requirement of limit. Minimum passing margin is -0.2dB at 5350.00MHz.
15.407(a)(1/2/3)	Max Average Transmit Power	Pass	Meet the requirement of limit.
---	Occupied Bandwidth Measurement	-	Reference only.
15.407(a)(1/2/3)	Peak Power Spectral Density	Pass	Meet the requirement of limit.
15.407(g)	Frequency Stability	Pass	Meet the requirement of limit.
15.203	Antenna Requirement	Pass	Antenna connector is I-PEX not a standard connector.

2.1 Measurement Uncertainty

Where relevant, the following measurement uncertainty levels have been estimated for tests performed on the EUT as specified in CISPR 16-4-2:

Measurement	Frequency	Expanded Uncertainty (k=2) (\pm)
Conducted Emissions at mains ports	150kHz ~ 30MHz	2.44 dB
Radiated Emissions up to 1 GHz	30MHz ~ 200MHz	3.59 dB
	200MHz ~ 1000MHz	3.60 dB
Radiated Emissions above 1 GHz	1GHz ~ 18GHz	2.29 dB
	18GHz ~ 40GHz	2.29 dB

2.2 Modification Record

There were no modifications required for compliance.

3 General Information

3.1 General Description of EUT

Product	Orbi Router, Orbi Satellite
Brand	NETGEAR
Test Model	RBR40
Series Model	RBS40
Model Difference	Refer to note for more details
Status of EUT	Engineering sample
Power Supply Rating	12Vdc from adapter
Modulation Type	256QAM, 64QAM, 16QAM, QPSK, BPSK for OFDM
Modulation Technology	OFDM
Transfer Rate	802.11a: 54/48/36/24/18/12/9/6Mbps 802.11n: up to 300Mbps 802.11ac: up to 866.7Mbps
Operating Frequency	5260 ~ 5320MHz, 5500 ~ 5700MHz
Number of Channel	5260 ~ 5320MHz: 802.11a, 802.11n (HT20), 802.11ac (VHT20): 4 802.11n (HT40), 802.11ac (VHT40): 2 802.11ac (VHT80): 1 5500 ~ 5700MHz: 802.11a, 802.11n (HT20), 802.11ac (VHT20): 11 802.11n (HT40), 802.11ac (VHT40): 5 802.11ac (VHT80): 2
Output Power	CDD Mode 5260 ~ 5320MHz: 233.401mW 5500 ~ 5700MHz: 232.855mW Beamforming Mode 5260 ~ 5320MHz: 219.786mW 5500 ~ 5700MHz: 222.331mW
Antenna Type	Refer to note
Antenna Connector	Refer to note
Accessory Device	Adapter
Data Cable Supplied	1.95m non-shielded RJ45 cable w/o core

Note:

1. This report is prepared for FCC class II permissive change. The differences compared with the original report (BV ADT report no.: RF161229C25-1) is adding 5.26GHz to 5.32GHz & 5.50GHz to 5.70GHz by software.
2. All models are electrically identical and different are listed as below. Model: RBR40 is the representative for final test.

Brand	Product Name	Model	Function	Band	RF Module	Difference
NETGEAR	Orbi Router	RBR40	Router	2.4G/ U-NII-2C/ UNII-3	Module 1	1. Master mode only 2. With internet function
				UNII-1/ U-NII-2A	Module 2	
				Bluetooth	BT Module	
	Orbi Satellite	RBS40	Satellite	2.4G/ U-NII-2C / UNII-3	Module 1	Master mode and Client mode for 2.4GHz Client mode for UNII-3
				UNII-1/ U-NII-2A	Module 2	Master mode only for UNII-1
				Bluetooth	BT Module	-

3. The following RF Modules are for the EUT.

Brand	Band	Antenna No.:
Module 1	2.4G	3/4
	U-NII-2C / UNII-3	1/2
Module 2	UNII-1 / U-NII-2A	3/4
BT Module	Bluetooth	5

4. The EUT incorporates a MIMO function. Physically, the EUT provides 2 completed transmitters and 2 receivers.

Band	Modulation Mode	Beamforming Mode	TX Function
5GHz	802.11a	Not Support	2TX
	802.11n (HT20)	Support	2TX
	802.11n (HT40)	Support	2TX
	802.11ac (VHT20)	Support	2TX
	802.11ac (VHT40)	Support	2TX
	802.11ac (VHT80)	Support	2TX

* The modulation and bandwidth are similar for 802.11n mode for 20MHz/40MHz and 802.11ac mode for 20MHz/40MHz, therefore investigated worst case to representative mode in test report. (Final test mode refer section 3.2.1)

* For 5GHz band 802.11n and 802.11ac, CDD mode is the worst case for final radiated emission and power line conducted emission tests after pretesting CDD mode and beamforming mode.

*The EUT was pretesting following mode and Mode A was the worst for the final tests.

Mode	Description
A	Absorber position 1
B	Absorber position 2

5. The EUT uses following antennas.

Antenna Type	Dipole				
Antenna Connector	I-PEX				
Antenna Gain (dBi)					
	2.4GHz Band	5GHz U-NII-1	5GHz U-NII-2A	5GHz U-NII-2C	5GHz U-NII-3
Ant. 1	-	-	-	3.49	3.80
Ant. 2	-	-	-	3.51	3.57
Ant. 3	2.58	3.72	3.56	-	-
Ant. 4	2.89	3.49	3.53	-	-

6. The EUT uses following adapters.

Adapter 1	
Brand	NETGEAR
Model	AD2067F10
P/N	332-10797-01
Input Power	100-120Vac~50/60Hz 1.0A
Output Power	12.0Vdc / 2.5A
Power Line	1.85m DC cable without core attached on adapter

Adapter 2	
Brand	NETGEAR
Model	2ABL030P1 NJ
P/N	332-10948-01
Input Power	100-120Vac~50/60Hz 1.0A
Output Power	12.0Vdc / 2.5A
Power Line	1.8m DC cable without core attached on adapter

3.2 Description of Test Modes

For 5260 ~ 5320MHz

4 channels are provided for 802.11a, 802.11n (HT20), 802.11ac (VHT20):

Channel	Frequency	Channel	Frequency
52	5260 MHz	60	5300 MHz
56	5280 MHz	64	5320 MHz

2 channels are provided for 802.11n (HT40), 802.11ac (VHT40):

Channel	Frequency	Channel	Frequency
54	5270 MHz	62	5310 MHz

1 channel is provided for 802.11ac (VHT80):

Channel	Frequency
58	5290 MHz

For 5500 ~ 5700MHz

11 channels are provided for 802.11a, 802.11n (HT20), 802.11ac (VHT20):

Channel	Frequency	Channel	Frequency
100	5500 MHz	124	5620 MHz
104	5520 MHz	128	5640 MHz
108	5540 MHz	132	5660 MHz
112	5560 MHz	136	5680 MHz
116	5580 MHz	140	5700 MHz
120	5600 MHz		

5 channels are provided for 802.11n (HT40), 802.11ac (VHT40):

Channel	Frequency	Channel	Frequency
102	5510 MHz	126	5630 MHz
110	5550 MHz	134	5670 MHz
118	5590 MHz		

2 channels are provided for 802.11ac (VHT80):

Channel	Frequency	Channel	Frequency
106	5530MHz	122	5610 MHz

3.2.1 Test Mode Applicability and Tested Channel Detail

EUT CONFIGURE MODE	APPLICABLE TO				DESCRIPTION
	RE \geq 1G	RE<1G	PLC	APCM	
A	√	√	√	√	EUT power from adapter 1
B	-	√	√	-	EUT power from adapter 2

Where **RE \geq 1G**: Radiated Emission above 1GHz & Bandedge Measurement
RE<1G: Radiated Emission below 1GHz
PLC: Power Line Conducted Emission
APCM: Antenna Port Conducted Measurement

Note:

1. The EUT had been pre-tested on the positioned of each 3 axis. The worst case was found when positioned on **Z-plane**.
2. "-": Means no effect.

Radiated Emission Test (Above 1GHz):

- Pre-Scan has been conducted to determine the worst-case mode from all possible combinations between available modulations, data rates and antenna ports (if EUT with antenna diversity architecture).
- Following channel(s) was (were) selected for the final test as listed below.

EUT CONFIGURE MODE	MODE	FREQ. BAND (MHz)	AVAILABLE CHANNEL	TESTED CHANNEL	MODULATION TECHNOLOGY	MODULATION TYPE	DATA RATE (Mbps)
A	802.11a	5260-5320	52 to 64	52, 60, 64	OFDM	BPSK	6.0
A	802.11ac (VHT20)		52 to 64	52, 60, 64	OFDM	BPSK	13.0
A	802.11ac (VHT40)		54 to 62	54, 62	OFDM	BPSK	27.0
A	802.11ac (VHT80)		58	58	OFDM	BPSK	58.5
A	802.11a	5500-5700	100 to 140	100, 116, 140	OFDM	BPSK	6.0
A	802.11ac (VHT20)		100 to 140	100, 116, 140	OFDM	BPSK	13.0
A	802.11ac (VHT40)		102 to 134	102, 110, 134	OFDM	BPSK	27.0
A	802.11ac (VHT80)		106 to 122	106, 122	OFDM	BPSK	58.5

Radiated Emission Test (Below 1GHz):

- Pre-Scan has been conducted to determine the worst-case mode from all possible combinations between available modulations, data rates and antenna ports (if EUT with antenna diversity architecture).
- Following channel(s) was (were) selected for the final test as listed below.

EUT CONFIGURE MODE	MODE	FREQ. BAND (MHz)	AVAILABLE CHANNEL	TESTED CHANNEL	MODULATION TECHNOLOGY	MODULATION TYPE	DATA RATE (Mbps)
A, B	802.11a	5260-5320, 5500-5700	52 to 64 52 to 140	60	OFDM	BPSK	6.0

Power Line Conducted Emission Test:

- Pre-Scan has been conducted to determine the worst-case mode from all possible combinations between available modulations, data rates and antenna ports (if EUT with antenna diversity architecture).
- Following channel(s) was (were) selected for the final test as listed below.

EUT CONFIGURE MODE	MODE	FREQ. BAND (MHz)	AVAILABLE CHANNEL	TESTED CHANNEL	MODULATION TECHNOLOGY	MODULATION TYPE	DATA RATE (Mbps)
A, B	802.11a	5260-5320, 5500-5700	52 to 64 52 to 140	60	OFDM	BPSK	6.0

Antenna Port Conducted Measurement:

- This item includes all test value of each mode, but only includes spectrum plot of worst value of each mode.
- Pre-Scan has been conducted to determine the worst-case mode from all possible combinations between available modulations, data rates and antenna ports (if EUT with antenna diversity architecture).
- Following channel(s) was (were) selected for the final test as listed below.

EUT CONFIGURE MODE	MODE	FREQ. BAND (MHz)	AVAILABLE CHANNEL	TESTED CHANNEL	MODULATION TECHNOLOGY	MODULATION TYPE	DATA RATE (Mbps)
A	802.11a	5260-5320	52 to 64	52, 60, 64	OFDM	BPSK	6.0
A	802.11ac (VHT20)		52 to 64	52, 60, 64	OFDM	BPSK	13.0
A	802.11ac (VHT40)		54 to 62	54, 62	OFDM	BPSK	27.0
A	802.11ac (VHT80)		58	58	OFDM	BPSK	58.5
A	802.11a	5500-5700	100 to 140	100, 116, 140	OFDM	BPSK	6.0
A	802.11ac (VHT20)		100 to 140	100, 116, 140	OFDM	BPSK	13.0
A	802.11ac (VHT40)		102 to 134	102, 110, 134	OFDM	BPSK	27.0
A	802.11ac (VHT80)		106 to 122	106, 122	OFDM	BPSK	58.5

Test Condition:

APPLICABLE TO	ENVIRONMENTAL CONDITIONS	INPUT POWER	TESTED BY
RE \geq 1G	25deg. C, 65%RH,	120Vac, 60Hz	Chris Lin
RE $<$ 1G	25deg. C, 75%RH	120Vac, 60Hz	James Yang
PLC	25deg. C, 65%RH	120Vac, 60Hz	Chris Lin
APCM	25deg. C, 60%RH	120Vac, 60Hz	Frank Liu

3.3 Duty Cycle of Test Signal

Duty cycle of test signal is > 98%, duty factor is not required.

Duty cycle of test signal is < 98 %, duty factor is required.

802.11a: Duty cycle = $2.018/2.120 = 0.952$, Duty factor = $10 * \log(1/0.952) = 0.21$

802.11ac (VHT20): Duty cycle = $4.954/5.039 = 0.983$

802.11ac (VHT40): Duty cycle = $2.400/2.500 = 0.960$, Duty factor = $10 * \log(1/0.960) = 0.18$

802.11ac (VHT80): Duty cycle = $1.127/1.218 = 0.925$, Duty factor = $10 * \log(1/0.925) = 0.34$

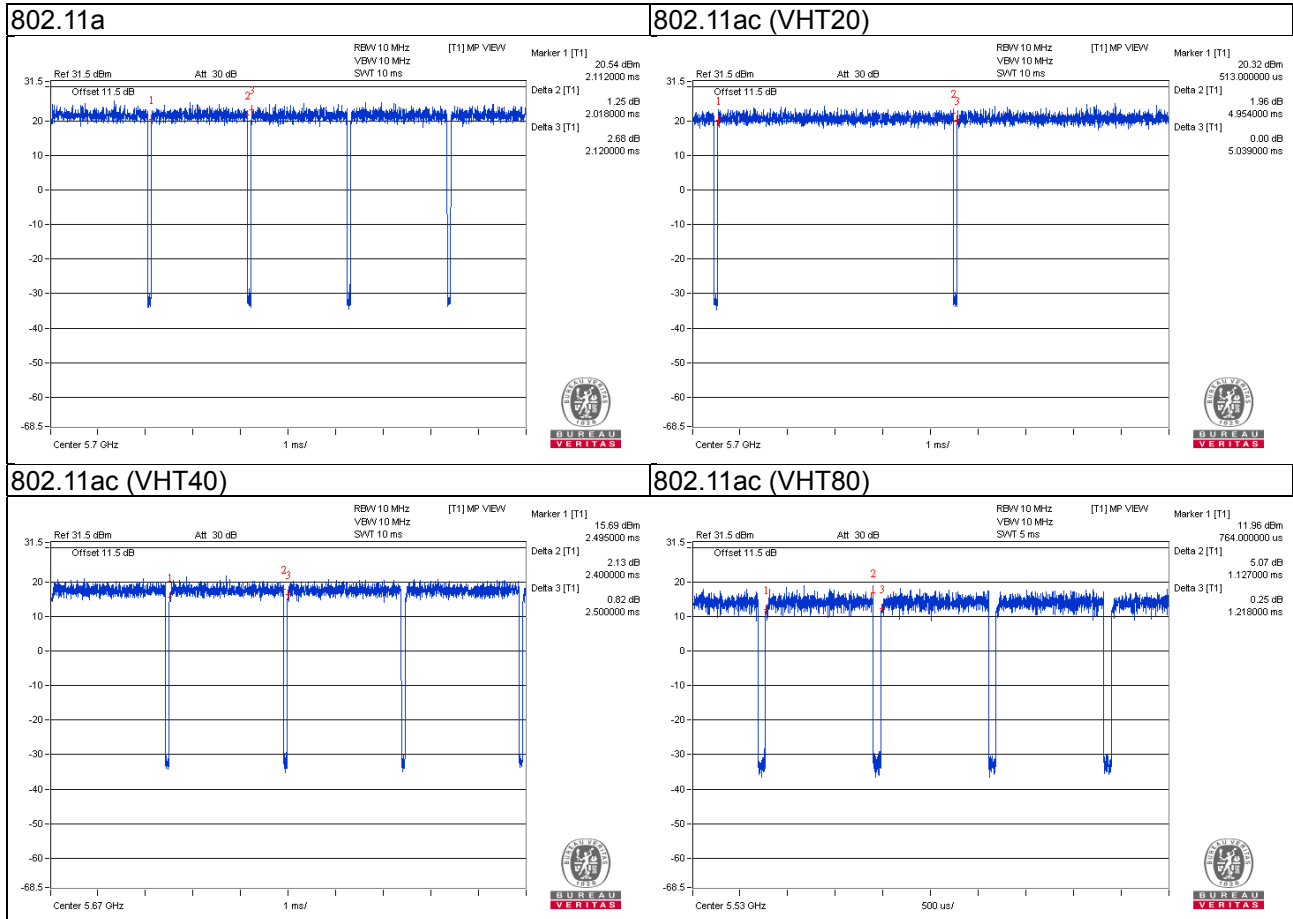

3.4 Description of Support Units

The EUT has been tested as an independent unit together with other necessary accessories or support units. The following support units or accessories were used to form a representative test configuration during the tests.

ID	Product	Brand	Model No.	Serial No.	FCC ID	Remarks
A.	Notebook	DELL	E5410	6RP2YM1	FCC DoC Approved	-
B.	Load	N/A	N/A	N/A	N/A	-

Note:

1. All power cords of the above support units are non-shielded (1.8m).
2. Item A acted as a communication partner to transfer data.

ID	Descriptions	Qty.	Length (m)	Shielding (Yes/No)	Cores (Qty.)	Remarks
1.	RJ45 cable	1	10	N	0	-
2.	RJ45 cable	3	1.8	N	0	-

3.4.1 Configuration of System under Test

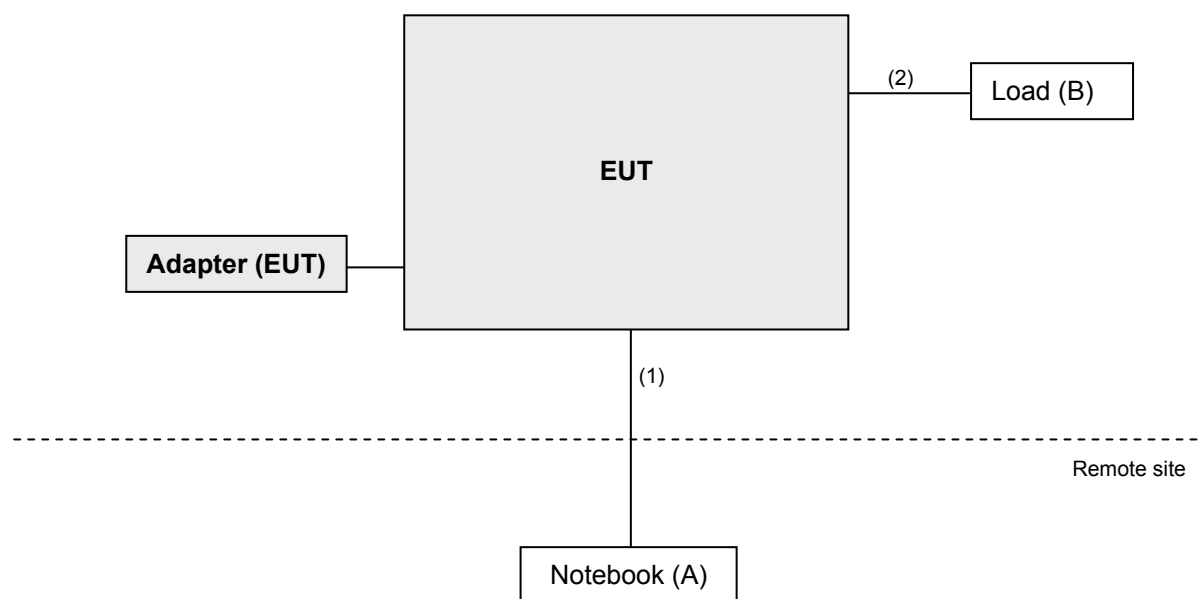

3.5 General Description of Applied Standards

The EUT is a RF Product. According to the specifications of the manufacturer, it must comply with the requirements of the following standards:

FCC Part 15, Subpart E (15.407)

KDB 789033 D02 General UNII Test Procedure New Rules v01r04

KDB 662911 D01 Multiple Transmitter Output v02r01

ANSI C63.10-2013

All test items have been performed and recorded as per the above standards.

Note: The EUT has been verified to comply with the requirements of FCC Part 15, Subpart B, Class B (DoC). The test report has been issued separately.

4 Test Types and Results

4.1 Radiated Emission and Bandedge Measurement

4.1.1 Limits of Radiated Emission and Bandedge Measurement

Radiated emissions which fall in the restricted bands must comply with the radiated emission limits specified as below table.

Frequencies (MHz)	Field Strength (microvolts/meter)	Measurement Distance (meters)
0.009 ~ 0.490	2400/F(kHz)	300
0.490 ~ 1.705	24000/F(kHz)	30
1.705 ~ 30.0	30	30
30 ~ 88	100	3
88 ~ 216	150	3
216 ~ 960	200	3
Above 960	500	3

Note:

1. The lower limit shall apply at the transition frequencies.
2. Emission level (dBuV/m) = 20 log Emission level (uV/m).
3. For frequencies above 1000MHz, the field strength limits are based on average detector, however, the peak field strength of any emission shall not exceed the maximum permitted average limits, specified above by more than 20dB under any condition of modulation.

Limits of unwanted emission out of the restricted bands

Applicable To		Limit	
789033 D02 General UNII Test Procedure New Rules v01r04		Field Strength at 3m	
		PK:74 (dBuV/m)	AV:54 (dBuV/m)
Frequency Band	Applicable To	EIRP Limit	Equivalent Field Strength at 3m
5150~5250 MHz	15.407(b)(1)	PK:-27 (dBm/MHz)	PK:68.2(dBuV/m)
5250~5350 MHz	15.407(b)(2)		
5470~5725 MHz	15.407(b)(3)		
5725~5850 MHz	<input type="checkbox"/> 15.407(b)(4)(i)	PK:-27 (dBm/MHz) ^{*1} PK:10 (dBm/MHz) ^{*2} PK:15.6 (dBm/MHz) ^{*3} PK:27 (dBm/MHz) ^{*4}	PK: 68.2(dBuV/m) ^{*1} PK:105.2 (dBuV/m) ^{*2} PK: 110.8(dBuV/m) ^{*3} PK:122.2 (dBuV/m) ^{*4}
	<input checked="" type="checkbox"/> 15.407(b)(4)(ii)	Emission limits in section 15.247(d)	
^{*1} beyond 75 MHz or more above of the band edge.		^{*2} below the band edge increasing linearly to 10 dBm/MHz at 25 MHz above.	
^{*3} below the band edge increasing linearly to a level of 15.6 dBm/MHz at 5 MHz above.		^{*4} from 5 MHz above or below the band edge increasing linearly to a level of 27 dBm/MHz at the band edge.	

Note: The following formula is used to convert the equipment isotropic radiated power (eirp) to field strength:

$$E = \frac{1000000\sqrt{30P}}{3} \mu\text{V/m, where P is the eirp (Watts).}$$

4.1.2 Test Instruments

Description & Manufacturer	Model No.	Serial No.	Cal. Date	Cal. Due
Test Receiver ROHDE & SCHWARZ	ESCI	100424	Oct. 24, 2016	Oct. 23, 2017
Spectrum Analyzer ROHDE & SCHWARZ	FSP40	100040	Aug. 16, 2016	Aug. 15, 2017
BILOG Antenna SCHWARZBECK	VULB9168	9168-151	Dec. 16, 2016	Dec. 15, 2017
HORN Antenna SCHWARZBECK	BBHA 9120D	9120D-1170	Dec. 15, 2016	Dec. 14, 2017
HORN Antenna SCHWARZBECK	BBHA 9170	BBHA9170241	Dec. 14, 2016	Dec. 13, 2017
Loop Antenna	EM-6879	269	Aug. 11, 2016	Aug. 10, 2017
Preamplifier Agilent	8449B	3008A01960	Aug. 09, 2016	Aug. 08, 2017
Preamplifier Agilent	8447D	2944A10631	Aug. 09, 2016	Aug. 08, 2017
RF signal cable HUBER+SUHNER	SUCOFLEX 104	MY 13380+295012/04	Aug. 09, 2016	Aug. 08, 2017
RF signal cable HUBER+SUHNER	SUCOFLEX 104	Cable-CH4-03 (250724)	Aug. 09, 2016	Aug. 08, 2017
Software BV ADT	ADT_Radiated_ V7.6.15.9.4	NA	NA	NA
Antenna Tower inn-co GmbH	MA 4000	010303	NA	NA
Antenna Tower Controller BV ADT	AT100	AT93021703	NA	NA
Turn Table BV ADT	TT100	TT93021703	NA	NA
Turn Table Controller BV ADT	SC100	SC93021703	NA	NA
High Speed Peak Power Meter	ML2495A	0824012	Aug. 11, 2016	Aug. 10, 2017
Power Sensor	MA2411B	0738171	Aug. 11, 2016	Aug. 10, 2017
WIT Standard Temperature And Humidity Chamber	TH-4S-C	W981030	Jun. 08, 2016	Jun. 07, 2017

- Note:
1. The calibration interval of the above test instruments is 12 months and the calibrations are traceable to NML/ROC and NIST/USA.
 2. The test was performed in HwaYa Chamber 4.
 3. The horn antenna and preamplifier (model: 8449B) are used only for the measurement of emission frequency above 1GHz if tested.
 4. The FCC Site Registration No. is 460141.
 5. The IC Site Registration No. is IC7450F-4.

4.1.3 Test Procedures

For Radiated emission below 30MHz

- a. The EUT was placed on the top of a rotating table 0.8 meters above the ground at a 3 meter chamber room. The table was rotated 360 degrees to determine the position of the highest radiation.
- b. The EUT was set 3 meters away from the interference-receiving antenna, which was mounted on the top of a variable-height antenna tower.
- c. Both X and Y axes of the antenna are set to make the measurement.
- d. For each suspected emission, the EUT was arranged to its worst case and the rotatable table was turned from 0 degrees to 360 degrees to find the maximum reading.
- e. The test-receiver system was set to Quasi-Peak Detect Function and Specified Bandwidth with Maximum Hold Mode.

Note:

1. The resolution bandwidth and video bandwidth of test receiver/spectrum analyzer is 9kHz at frequency below 30MHz.

For Radiated emission above 30MHz

- a. The EUT was placed on the top of a rotating table 0.8 meters (for 30MHz ~ 1GHz) / 1.5 meters (for above 1GHz) above the ground at 3 meter chamber room for test. The table was rotated 360 degrees to determine the position of the highest radiation.
- b. The EUT was set 3 meters away from the interference-receiving antenna, which was mounted on the top of a variable-height antenna tower.
- c. The height of antenna is varied from one meter to four meters above the ground to determine the maximum value of the field strength. Both horizontal and vertical polarizations of the antenna are set to make the measurement.
- d. For each suspected emission, the EUT was arranged to its worst case and then the antenna was tuned to heights from 1 meter to 4 meters and the rotatable table was turned from 0 degrees to 360 degrees to find the maximum reading.
- e. The test-receiver system was set to quasi-peak detect function and specified bandwidth with maximum hold mode when the test frequency is below 1 GHz.
- f. The test-receiver system was set to peak and average detect function and specified bandwidth with maximum hold mode when the test frequency is above 1 GHz. If the peak reading value also meets average limit, measurement with the average detector is unnecessary.

Note:

1. The resolution bandwidth and video bandwidth of test receiver/spectrum analyzer is 120kHz for Quasi-peak detection (QP) at frequency below 1GHz.
2. The resolution bandwidth of test receiver/spectrum analyzer is 1 MHz and the video bandwidth is 3 MHz for Peak detection (PK) at frequency above 1GHz.
3. The resolution bandwidth of test receiver/spectrum analyzer is 1MHz and the video bandwidth is $\geq 1/T$ (Duty cycle < 98%) or 10Hz (Duty cycle $\geq 98\%$) for Average detection (AV) at frequency above 1GHz.
4. All modes of operation were investigated and the worst-case emissions are reported.

4.1.4 Deviation from Test Standard

No deviation.

4.1.5 Test Setup

For Radiated emission below 30MHz

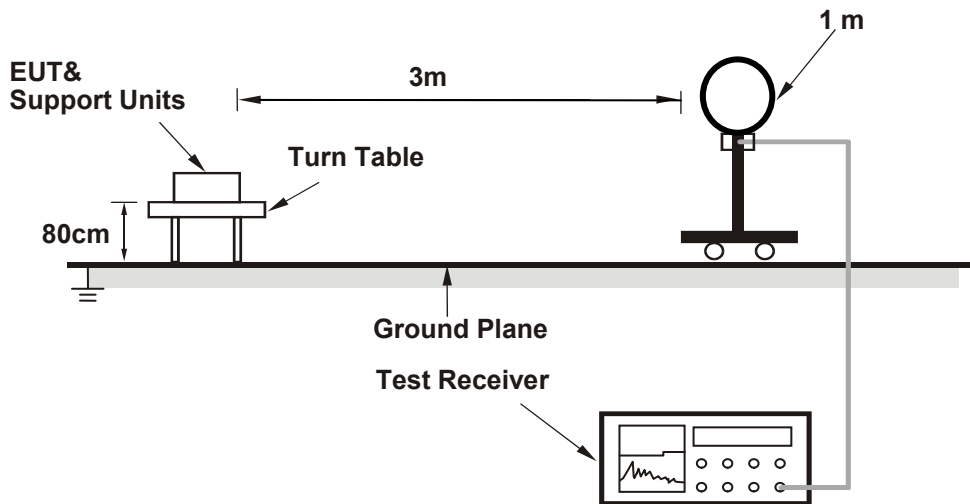

For Radiated emission 30MHz to 1GHz

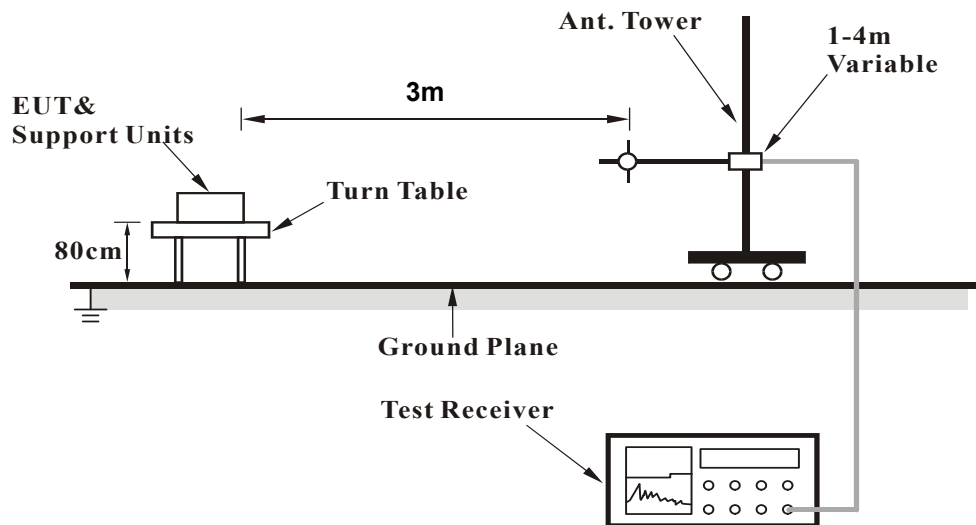

For Radiated emission above 1GHz

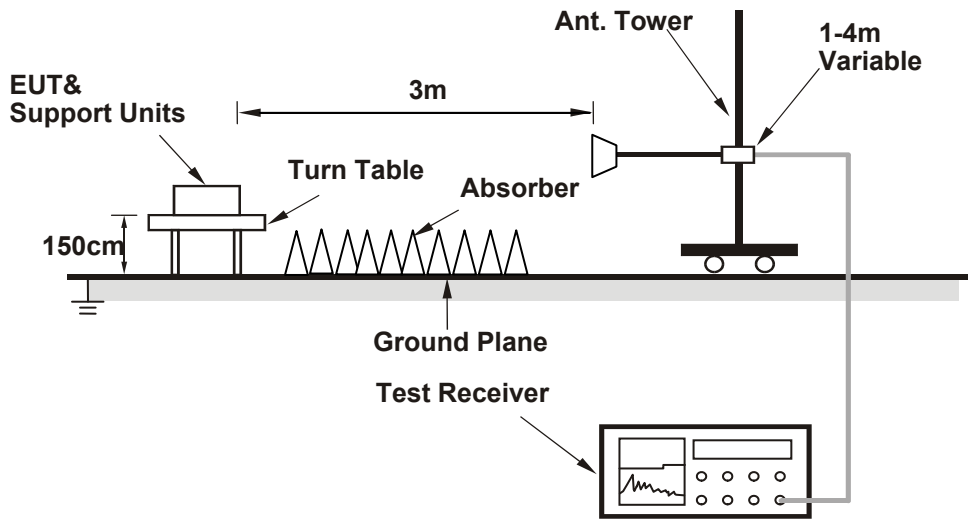

For the actual test configuration, please refer to the attached file (Test Setup Photo).

4.1.6 EUT Operating Conditions

- a. Placed the EUT on the testing table.
- b. Prepared a notebook to act as a communication partner and placed it outside of testing area.
- c. The communication partner connected with EUT via a RJ45 cable and ran a test program (provided by manufacturer) to enable EUT under transmission condition continuously at specific channel frequency.
- d. The communication partner sent data to EUT by command "PING".
- e. The necessary accessories enable the system in full functions.

4.1.7 Test Results

Above 1GHz Worst-Case Data:

802.11a

CHANNEL	TX Channel 52	DETECTOR FUNCTION	Peak (PK) Average (AV)
FREQUENCY RANGE	1GHz ~ 40GHz		

ANTENNA POLARITY & TEST DISTANCE: HORIZONTAL AT 3 M								
NO.	FREQ. (MHz)	EMISSION LEVEL (dBuV/m)	LIMIT (dBuV/m)	MARGIN (dB)	ANTENNA HEIGHT (m)	TABLE ANGLE (Degree)	RAW VALUE (dBuV)	CORRECTION FACTOR (dB/m)
1	5150.00	57.9 PK	74.0	-16.1	1.10 H	239	51.90	6.00
2	5150.00	46.6 AV	54.0	-7.4	1.10 H	239	40.60	6.00
3	*5260.00	106.2 PK			1.10 H	239	66.00	40.20
4	*5260.00	95.5 AV			1.10 H	239	55.30	40.20
5	#10520.00	58.6 PK	74.0	-15.4	1.47 H	156	40.30	18.30
6	#10520.00	46.7 AV	54.0	-7.3	1.47 H	156	28.40	18.30
ANTENNA POLARITY & TEST DISTANCE: VERTICAL AT 3 M								
NO.	FREQ. (MHz)	EMISSION LEVEL (dBuV/m)	LIMIT (dBuV/m)	MARGIN (dB)	ANTENNA HEIGHT (m)	TABLE ANGLE (Degree)	RAW VALUE (dBuV)	CORRECTION FACTOR (dB/m)
1	5150.00	57.7 PK	74.0	-16.3	1.24 V	177	51.70	6.00
2	5150.00	45.2 AV	54.0	-8.8	1.24 V	177	39.20	6.00
3	*5260.00	118.5 PK			1.24 V	177	78.30	40.20
4	*5260.00	108.3 AV			1.24 V	177	68.10	40.20
5	#10520.00	61.9 PK	74.0	-12.1	2.93 V	204	43.60	18.30
6	#10520.00	48.4 AV	54.0	-5.6	2.93 V	204	30.10	18.30

Remark:

1. Emission Level(dBuV/m) = Raw Value(dBuV) + Correction Factor(dB/m)
2. Correction Factor(dB/m) = Antenna Factor(dB/m) + Cable Factor(dB) – Pre-Amplifier Factor(dB)
3. The other emission levels were very low against the limit.
4. Margin value = Emission Level – Limit value
5. " * ": Fundamental frequency.
6. " # ": The radiated frequency is out of the restricted band.

CHANNEL	TX Channel 60	DETECTOR FUNCTION	Peak (PK)
FREQUENCY RANGE	1GHz ~ 40GHz		Average (AV)

ANTENNA POLARITY & TEST DISTANCE: HORIZONTAL AT 3 M

NO.	FREQ. (MHz)	EMISSION LEVEL (dBuV/m)	LIMIT (dBuV/m)	MARGIN (dB)	ANTENNA HEIGHT (m)	TABLE ANGLE (Degree)	RAW VALUE (dBuV)	CORRECTION FACTOR (dB/m)
1	*5300.00	105.1 PK			1.32 H	339	64.90	40.20
2	*5300.00	95.1 AV			1.32 H	339	54.90	40.20
3	10600.00	59.3 PK	74.0	-14.7	1.55 H	224	40.60	18.70
4	10600.00	47.1 AV	54.0	-6.9	1.55 H	224	28.40	18.70

ANTENNA POLARITY & TEST DISTANCE: VERTICAL AT 3 M

NO.	FREQ. (MHz)	EMISSION LEVEL (dBuV/m)	LIMIT (dBuV/m)	MARGIN (dB)	ANTENNA HEIGHT (m)	TABLE ANGLE (Degree)	RAW VALUE (dBuV)	CORRECTION FACTOR (dB/m)
1	*5300.00	118.6 PK			1.20 V	179	78.40	40.20
2	*5300.00	108.1 AV			1.20 V	179	67.90	40.20
3	10600.00	62.1 PK	74.0	-11.9	2.88 V	209	43.40	18.70
4	10600.00	49.1 AV	54.0	-4.9	2.88 V	209	30.40	18.70

Remark:

1. Emission Level(dBuV/m) = Raw Value(dBuV) + Correction Factor(dB/m)
2. Correction Factor(dB/m) = Antenna Factor(dB/m) + Cable Factor(dB) – Pre-Amplifier Factor(dB)
3. The other emission levels were very low against the limit.
4. Margin value = Emission Level – Limit value
5. " * ": Fundamental frequency.
6. " # ": The radiated frequency is out of the restricted band.

CHANNEL	TX Channel 64	DETECTOR FUNCTION	Peak (PK)
FREQUENCY RANGE	1GHz ~ 40GHz		Average (AV)

ANTENNA POLARITY & TEST DISTANCE: HORIZONTAL AT 3 M								
NO.	FREQ. (MHz)	EMISSION LEVEL (dBuV/m)	LIMIT (dBuV/m)	MARGIN (dB)	ANTENNA HEIGHT (m)	TABLE ANGLE (Degree)	RAW VALUE (dBuV)	CORRECTION FACTOR (dB/m)
1	*5320.00	107.2 PK			1.25 H	245	67.00	40.20
2	*5320.00	95.8 AV			1.25 H	245	55.60	40.20
3	5350.00	58.1 PK	74.0	-15.9	1.25 H	245	51.90	6.20
4	5350.00	47.7 AV	54.0	-6.3	1.25 H	245	41.50	6.20
5	10640.00	59.5 PK	74.0	-14.5	1.36 H	97	40.50	19.00
6	10640.00	47.7 AV	54.0	-6.3	1.36 H	97	28.70	19.00
ANTENNA POLARITY & TEST DISTANCE: VERTICAL AT 3 M								
NO.	FREQ. (MHz)	EMISSION LEVEL (dBuV/m)	LIMIT (dBuV/m)	MARGIN (dB)	ANTENNA HEIGHT (m)	TABLE ANGLE (Degree)	RAW VALUE (dBuV)	CORRECTION FACTOR (dB/m)
1	*5320.00	118.6 PK			1.29 V	180	78.40	40.20
2	*5320.00	108.2 AV			1.29 V	180	68.00	40.20
3	5350.00	62.7 PK	74.0	-11.3	1.29 V	180	56.50	6.20
4	5350.00	50.5 AV	54.0	-3.5	1.29 V	180	44.30	6.20
5	10640.00	61.7 PK	74.0	-12.3	2.75 V	225	42.70	19.00
6	10640.00	48.8 AV	54.0	-5.2	2.75 V	225	29.80	19.00

Remark:

1. Emission Level(dBuV/m) = Raw Value(dBuV) + Correction Factor(dB/m)
2. Correction Factor(dB/m) = Antenna Factor(dB/m) + Cable Factor(dB)
– Pre-Amplifier Factor(dB)
3. The other emission levels were very low against the limit.
4. Margin value = Emission Level – Limit value
5. " * ": Fundamental frequency.
6. " # ": The radiated frequency is out of the restricted band.

CHANNEL	TX Channel 100	DETECTOR FUNCTION	Peak (PK)
FREQUENCY RANGE	1GHz ~ 40GHz		Average (AV)

ANTENNA POLARITY & TEST DISTANCE: HORIZONTAL AT 3 M								
NO.	FREQ. (MHz)	EMISSION LEVEL (dBuV/m)	LIMIT (dBuV/m)	MARGIN (dB)	ANTENNA HEIGHT (m)	TABLE ANGLE (Degree)	RAW VALUE (dBuV)	CORRECTION FACTOR (dB/m)
1	5460.00	57.2 PK	74.0	-16.8	1.02 H	158	50.50	6.70
2	5460.00	46.8 AV	54.0	-7.2	1.02 H	158	40.10	6.70
3	#5470.00	60.3 PK	74.0	-13.7	1.02 H	158	53.60	6.70
4	#5470.00	47.5 AV	54.0	-6.5	1.02 H	158	40.80	6.70
5	*5500.00	110.0 PK			1.02 H	158	69.10	40.90
6	*5500.00	99.8 AV			1.02 H	158	58.90	40.90
7	11000.00	60.5 PK	74.0	-13.5	1.32 H	66	41.20	19.30
8	11000.00	47.7 AV	54.0	-6.3	1.32 H	66	28.40	19.30
ANTENNA POLARITY & TEST DISTANCE: VERTICAL AT 3 M								
NO.	FREQ. (MHz)	EMISSION LEVEL (dBuV/m)	LIMIT (dBuV/m)	MARGIN (dB)	ANTENNA HEIGHT (m)	TABLE ANGLE (Degree)	RAW VALUE (dBuV)	CORRECTION FACTOR (dB/m)
1	5460.00	58.4 PK	74.0	-15.6	1.50 V	156	52.10	6.30
2	5460.00	46.5 AV	54.0	-7.5	1.50 V	156	40.20	6.30
3	#5470.00	63.7 PK	74.0	-10.3	1.50 V	156	57.40	6.30
4	#5470.00	50.2 AV	54.0	-3.8	1.50 V	156	43.90	6.30
5	*5500.00	118.1 PK			1.50 V	156	77.70	40.40
6	*5500.00	107.8 AV			1.50 V	156	67.40	40.40
7	11000.00	61.8 PK	74.0	-12.2	2.28 V	101	42.30	19.50
8	11000.00	48.6 AV	54.0	-5.4	2.28 V	101	29.10	19.50

Remark:

1. Emission Level(dBuV/m) = Raw Value(dBuV) + Correction Factor(dB/m)
2. Correction Factor(dB/m) = Antenna Factor(dB/m) + Cable Factor(dB)
– Pre-Amplifier Factor(dB)
3. The other emission levels were very low against the limit.
4. Margin value = Emission Level – Limit value
5. " * ": Fundamental frequency.
6. " # ": The radiated frequency is out of the restricted band.

CHANNEL	TX Channel 116	DETECTOR FUNCTION	Peak (PK)
FREQUENCY RANGE	1GHz ~ 40GHz		Average (AV)

ANTENNA POLARITY & TEST DISTANCE: HORIZONTAL AT 3 M

NO.	FREQ. (MHz)	EMISSION LEVEL (dBuV/m)	LIMIT (dBuV/m)	MARGIN (dB)	ANTENNA HEIGHT (m)	TABLE ANGLE (Degree)	RAW VALUE (dBuV)	CORRECTION FACTOR (dB/m)
1	*5580.00	108.8 PK			1.08 H	158	67.80	41.00
2	*5580.00	98.3 AV			1.08 H	158	57.30	41.00
3	11160.00	61.3 PK	74.0	-12.7	1.32 H	64	41.50	19.80
4	11160.00	48.5 AV	54.0	-5.5	1.32 H	64	28.70	19.80

ANTENNA POLARITY & TEST DISTANCE: VERTICAL AT 3 M

NO.	FREQ. (MHz)	EMISSION LEVEL (dBuV/m)	LIMIT (dBuV/m)	MARGIN (dB)	ANTENNA HEIGHT (m)	TABLE ANGLE (Degree)	RAW VALUE (dBuV)	CORRECTION FACTOR (dB/m)
1	*5580.00	117.7 PK			1.58 V	158	77.20	40.50
2	*5580.00	107.1 AV			1.58 V	158	66.60	40.50
3	11160.00	62.5 PK	74.0	-11.5	2.33 V	108	42.50	20.00
4	11160.00	49.3 AV	54.0	-4.7	2.33 V	108	29.30	20.00

Remark:

1. Emission Level(dBuV/m) = Raw Value(dBuV) + Correction Factor(dB/m)
2. Correction Factor(dB/m) = Antenna Factor(dB/m) + Cable Factor(dB)
– Pre-Amplifier Factor(dB)
3. The other emission levels were very low against the limit.
4. Margin value = Emission Level – Limit value
5. " * ": Fundamental frequency.
6. " # ": The radiated frequency is out of the restricted band.

CHANNEL	TX Channel 140	DETECTOR FUNCTION	Peak (PK)
FREQUENCY RANGE	1GHz ~ 40GHz		Average (AV)

ANTENNA POLARITY & TEST DISTANCE: HORIZONTAL AT 3 M

NO.	FREQ. (MHz)	EMISSION LEVEL (dBuV/m)	LIMIT (dBuV/m)	MARGIN (dB)	ANTENNA HEIGHT (m)	TABLE ANGLE (Degree)	RAW VALUE (dBuV)	CORRECTION FACTOR (dB/m)
1	*5700.00	108.9 PK			1.07 H	159	67.40	41.50
2	*5700.00	98.9 AV			1.07 H	159	57.40	41.50
3	#5725.00	58.7 PK	74.0	-15.3	1.07 H	159	51.40	7.30
4	#5725.00	47.9 AV	54.0	-6.1	1.07 H	159	40.60	7.30
5	11400.00	61.6 PK	74.0	-12.4	1.32 H	64	41.20	20.40
6	11400.00	50.1 AV	54.0	-3.9	1.32 H	64	29.70	20.40

ANTENNA POLARITY & TEST DISTANCE: VERTICAL AT 3 M

NO.	FREQ. (MHz)	EMISSION LEVEL (dBuV/m)	LIMIT (dBuV/m)	MARGIN (dB)	ANTENNA HEIGHT (m)	TABLE ANGLE (Degree)	RAW VALUE (dBuV)	CORRECTION FACTOR (dB/m)
1	*5700.00	118.7 PK			1.21 V	155	77.80	40.90
2	*5700.00	107.9 AV			1.21 V	155	67.00	40.90
3	#5725.00	71.2 PK	74.0	-2.8	1.21 V	155	64.50	6.70
4	#5725.00	52.3 AV	54.0	-1.7	1.21 V	155	45.60	6.70
5	11400.00	62.8 PK	74.0	-11.2	2.07 V	97	42.20	20.60
6	11400.00	50.0 AV	54.0	-4.0	2.07 V	97	29.40	20.60

Remark:

1. Emission Level(dBuV/m) = Raw Value(dBuV) + Correction Factor(dB/m)
2. Correction Factor(dB/m) = Antenna Factor(dB/m) + Cable Factor(dB)
– Pre-Amplifier Factor(dB)
3. The other emission levels were very low against the limit.
4. Margin value = Emission Level – Limit value
5. " * ": Fundamental frequency.
6. " # ": The radiated frequency is out of the restricted band.

802.11ac (VHT20)

CHANNEL	TX Channel 52	DETECTOR FUNCTION	Peak (PK)
FREQUENCY RANGE	1GHz ~ 40GHz		Average (AV)

ANTENNA POLARITY & TEST DISTANCE: HORIZONTAL AT 3 M

NO.	FREQ. (MHz)	EMISSION LEVEL (dBuV/m)	LIMIT (dBuV/m)	MARGIN (dB)	ANTENNA HEIGHT (m)	TABLE ANGLE (Degree)	RAW VALUE (dBuV)	CORRECTION FACTOR (dB/m)
1	5150.00	58.1 PK	74.0	-15.9	1.00 H	171	52.00	6.10
2	5150.00	47.0 AV	54.0	-7.0	1.00 H	171	40.90	6.10
3	*5260.00	105.1 PK			1.00 H	171	64.70	40.40
4	*5260.00	94.4 AV			1.00 H	171	54.00	40.40
5	#10520.00	59.9 PK	74.0	-14.1	1.32 H	64	41.50	18.40
6	#10520.00	47.4 AV	54.0	-6.6	1.32 H	64	29.00	18.40

ANTENNA POLARITY & TEST DISTANCE: VERTICAL AT 3 M

NO.	FREQ. (MHz)	EMISSION LEVEL (dBuV/m)	LIMIT (dBuV/m)	MARGIN (dB)	ANTENNA HEIGHT (m)	TABLE ANGLE (Degree)	RAW VALUE (dBuV)	CORRECTION FACTOR (dB/m)
1	5150.00	57.7 PK	74.0	-16.3	1.23 V	178	51.70	6.00
2	5150.00	44.6 AV	54.0	-9.4	1.23 V	178	38.60	6.00
3	*5260.00	118.7 PK			1.23 V	178	78.50	40.20
4	*5260.00	108.3 AV			1.23 V	178	68.10	40.20
5	#10520.00	59.9 PK	74.0	-14.1	1.09 V	83	41.60	18.30
6	#10520.00	47.5 AV	54.0	-6.5	1.09 V	83	29.20	18.30

Remark:

1. Emission Level(dBuV/m) = Raw Value(dBuV) + Correction Factor(dB/m)
2. Correction Factor(dB/m) = Antenna Factor(dB/m) + Cable Factor(dB)
– Pre-Amplifier Factor(dB)
3. The other emission levels were very low against the limit.
4. Margin value = Emission Level – Limit value
5. " * ": Fundamental frequency.
6. " # ": The radiated frequency is out of the restricted band.

CHANNEL	TX Channel 60	DETECTOR	Peak (PK)
FREQUENCY RANGE	1GHz ~ 40GHz	FUNCTION	Average (AV)

ANTENNA POLARITY & TEST DISTANCE: HORIZONTAL AT 3 M								
NO.	FREQ. (MHz)	EMISSION LEVEL (dBuV/m)	LIMIT (dBuV/m)	MARGIN (dB)	ANTENNA HEIGHT (m)	TABLE ANGLE (Degree)	RAW VALUE (dBuV)	CORRECTION FACTOR (dB/m)
1	*5300.00	106.0 PK			1.00 H	240	65.50	40.50
2	*5300.00	94.9 AV			1.00 H	240	54.40	40.50
3	10600.00	59.8 PK	74.0	-14.2	1.38 H	147	41.00	18.80
4	10600.00	47.5 AV	54.0	-6.5	1.38 H	147	28.70	18.80
ANTENNA POLARITY & TEST DISTANCE: VERTICAL AT 3 M								
NO.	FREQ. (MHz)	EMISSION LEVEL (dBuV/m)	LIMIT (dBuV/m)	MARGIN (dB)	ANTENNA HEIGHT (m)	TABLE ANGLE (Degree)	RAW VALUE (dBuV)	CORRECTION FACTOR (dB/m)
1	*5300.00	118.7 PK			1.07 V	179	78.50	40.20
2	*5300.00	108.3 AV			1.07 V	179	68.10	40.20
3	10600.00	60.5 PK	74.0	-13.5	1.04 V	89	41.80	18.70
4	10600.00	48.1 AV	54.0	-5.9	1.04 V	89	29.40	18.70

Remark:

1. Emission Level(dBuV/m) = Raw Value(dBuV) + Correction Factor(dB/m)
2. Correction Factor(dB/m) = Antenna Factor(dB/m) + Cable Factor(dB)
– Pre-Amplifier Factor(dB)
3. The other emission levels were very low against the limit.
4. Margin value = Emission Level – Limit value
5. " * ": Fundamental frequency.
6. " # ": The radiated frequency is out of the restricted band.

CHANNEL	TX Channel 64	DETECTOR FUNCTION	Peak (PK)
FREQUENCY RANGE	1GHz ~ 40GHz		Average (AV)

ANTENNA POLARITY & TEST DISTANCE: HORIZONTAL AT 3 M

NO.	FREQ. (MHz)	EMISSION LEVEL (dBuV/m)	LIMIT (dBuV/m)	MARGIN (dB)	ANTENNA HEIGHT (m)	TABLE ANGLE (Degree)	RAW VALUE (dBuV)	CORRECTION FACTOR (dB/m)
1	*5320.00	106.3 PK			1.31 H	226	65.80	40.50
2	*5320.00	95.2 AV			1.31 H	226	54.70	40.50
3	5350.00	58.4 PK	74.0	-15.6	1.31 H	226	51.90	6.50
4	5350.00	47.2 AV	54.0	-6.8	1.31 H	226	40.70	6.50
5	10640.00	59.6 PK	74.0	-14.4	1.52 H	64	40.60	19.00
6	10640.00	47.4 AV	54.0	-6.6	1.52 H	64	28.40	19.00

ANTENNA POLARITY & TEST DISTANCE: VERTICAL AT 3 M

NO.	FREQ. (MHz)	EMISSION LEVEL (dBuV/m)	LIMIT (dBuV/m)	MARGIN (dB)	ANTENNA HEIGHT (m)	TABLE ANGLE (Degree)	RAW VALUE (dBuV)	CORRECTION FACTOR (dB/m)
1	*5320.00	119.2 PK			1.15 V	180	79.00	40.20
2	*5320.00	108.8 AV			1.15 V	180	68.60	40.20
3	5350.00	66.4 PK	74.0	-7.6	1.15 V	180	60.20	6.20
4	5350.00	52.2 AV	54.0	-1.8	1.15 V	180	46.00	6.20
5	10640.00	60.4 PK	74.0	-13.6	1.10 V	91	41.40	19.00
6	10640.00	48.0 AV	54.0	-6.0	1.10 V	91	29.00	19.00

Remark:

1. Emission Level(dBuV/m) = Raw Value(dBuV) + Correction Factor(dB/m)
2. Correction Factor(dB/m) = Antenna Factor(dB/m) + Cable Factor(dB)
– Pre-Amplifier Factor(dB)
3. The other emission levels were very low against the limit.
4. Margin value = Emission Level – Limit value
5. " * ": Fundamental frequency.
6. " # ": The radiated frequency is out of the restricted band.

CHANNEL	TX Channel 100	DETECTOR FUNCTION	Peak (PK)
FREQUENCY RANGE	1GHz ~ 40GHz		Average (AV)

ANTENNA POLARITY & TEST DISTANCE: HORIZONTAL AT 3 M								
NO.	FREQ. (MHz)	EMISSION LEVEL (dBuV/m)	LIMIT (dBuV/m)	MARGIN (dB)	ANTENNA HEIGHT (m)	TABLE ANGLE (Degree)	RAW VALUE (dBuV)	CORRECTION FACTOR (dB/m)
1	5460.00	59.7 PK	74.0	-14.3	1.46 H	142	53.00	6.70
2	5460.00	46.4 AV	54.0	-7.6	1.46 H	142	39.70	6.70
3	#5470.00	58.2 PK	74.0	-15.8	1.46 H	142	51.50	6.70
4	#5470.00	46.2 AV	54.0	-7.8	1.46 H	142	39.50	6.70
5	*5500.00	111.1 PK			1.46 H	142	70.20	40.90
6	*5500.00	100.0 AV			1.46 H	142	59.10	40.90
7	11000.00	60.5 PK	74.0	-13.5	1.35 H	204	41.20	19.30
8	11000.00	47.4 AV	54.0	-6.6	1.35 H	204	28.10	19.30
ANTENNA POLARITY & TEST DISTANCE: VERTICAL AT 3 M								
NO.	FREQ. (MHz)	EMISSION LEVEL (dBuV/m)	LIMIT (dBuV/m)	MARGIN (dB)	ANTENNA HEIGHT (m)	TABLE ANGLE (Degree)	RAW VALUE (dBuV)	CORRECTION FACTOR (dB/m)
1	5460.00	60.7 PK	74.0	-13.3	1.52 V	157	54.40	6.30
2	5460.00	46.8 AV	54.0	-7.2	1.52 V	157	40.50	6.30
3	#5470.00	63.9 PK	74.0	-10.1	1.52 V	157	57.60	6.30
4	#5470.00	49.4 AV	54.0	-4.6	1.52 V	157	43.10	6.30
5	*5500.00	118.9 PK			1.52 V	157	78.50	40.40
6	*5500.00	108.2 AV			1.52 V	157	67.80	40.40
7	11000.00	60.9 PK	74.0	-13.1	1.85 V	334	41.40	19.50
8	11000.00	48.0 AV	54.0	-6.0	1.85 V	334	28.50	19.50

Remark:

1. Emission Level(dBuV/m) = Raw Value(dBuV) + Correction Factor(dB/m)
2. Correction Factor(dB/m) = Antenna Factor(dB/m) + Cable Factor(dB)
– Pre-Amplifier Factor(dB)
3. The other emission levels were very low against the limit.
4. Margin value = Emission Level – Limit value
5. " * ": Fundamental frequency.
6. " # ": The radiated frequency is out of the restricted band.

CHANNEL	TX Channel 116	DETECTOR FUNCTION	Peak (PK)
FREQUENCY RANGE	1GHz ~ 40GHz		Average (AV)

ANTENNA POLARITY & TEST DISTANCE: HORIZONTAL AT 3 M

NO.	FREQ. (MHz)	EMISSION LEVEL (dBuV/m)	LIMIT (dBuV/m)	MARGIN (dB)	ANTENNA HEIGHT (m)	TABLE ANGLE (Degree)	RAW VALUE (dBuV)	CORRECTION FACTOR (dB/m)
1	*5580.00	110.5 PK			1.59 H	175	69.50	41.00
2	*5580.00	99.4 AV			1.59 H	175	58.40	41.00
3	11160.00	61.1 PK	74.0	-12.9	1.28 H	209	41.30	19.80
4	11160.00	48.1 AV	54.0	-5.9	1.28 H	209	28.30	19.80

ANTENNA POLARITY & TEST DISTANCE: VERTICAL AT 3 M

NO.	FREQ. (MHz)	EMISSION LEVEL (dBuV/m)	LIMIT (dBuV/m)	MARGIN (dB)	ANTENNA HEIGHT (m)	TABLE ANGLE (Degree)	RAW VALUE (dBuV)	CORRECTION FACTOR (dB/m)
1	*5580.00	118.1 PK			1.56 V	156	77.60	40.50
2	*5580.00	107.7 AV			1.56 V	156	67.20	40.50
3	11160.00	61.7 PK	74.0	-12.3	1.88 V	327	41.70	20.00
4	11160.00	48.4 AV	54.0	-5.6	1.88 V	327	28.40	20.00

Remark:

1. Emission Level(dBuV/m) = Raw Value(dBuV) + Correction Factor(dB/m)
2. Correction Factor(dB/m) = Antenna Factor(dB/m) + Cable Factor(dB)
– Pre-Amplifier Factor(dB)
3. The other emission levels were very low against the limit.
4. Margin value = Emission Level – Limit value
5. " * ": Fundamental frequency.
6. " # ": The radiated frequency is out of the restricted band.

CHANNEL	TX Channel 140	DETECTOR FUNCTION	Peak (PK)
FREQUENCY RANGE	1GHz ~ 40GHz		Average (AV)

ANTENNA POLARITY & TEST DISTANCE: HORIZONTAL AT 3 M

NO.	FREQ. (MHz)	EMISSION LEVEL (dBuV/m)	LIMIT (dBuV/m)	MARGIN (dB)	ANTENNA HEIGHT (m)	TABLE ANGLE (Degree)	RAW VALUE (dBuV)	CORRECTION FACTOR (dB/m)
1	*5700.00	109.6 PK			1.52 H	174	68.10	41.50
2	*5700.00	98.7 AV			1.52 H	174	57.20	41.50
3	#5725.00	59.1 PK	74.0	-14.9	1.52 H	174	51.80	7.30
4	#5725.00	46.8 AV	54.0	-7.2	1.52 H	174	39.50	7.30
5	11400.00	61.3 PK	74.0	-12.7	1.21 H	230	40.90	20.40
6	11400.00	48.5 AV	54.0	-5.5	1.21 H	230	28.10	20.40

ANTENNA POLARITY & TEST DISTANCE: VERTICAL AT 3 M

NO.	FREQ. (MHz)	EMISSION LEVEL (dBuV/m)	LIMIT (dBuV/m)	MARGIN (dB)	ANTENNA HEIGHT (m)	TABLE ANGLE (Degree)	RAW VALUE (dBuV)	CORRECTION FACTOR (dB/m)
1	*5700.00	118.0 PK			1.29 V	156	77.10	40.90
2	*5700.00	107.4 AV			1.29 V	156	66.50	40.90
3	#5725.00	69.8 PK	74.0	-4.2	1.29 V	157	63.10	6.70
4	#5725.00	52.4 AV	54.0	-1.6	1.29 V	157	45.70	6.70
5	11400.00	61.7 PK	74.0	-12.3	1.80 V	321	41.10	20.60
6	11400.00	48.9 AV	54.0	-5.1	1.80 V	321	28.30	20.60

Remark:

1. Emission Level(dBuV/m) = Raw Value(dBuV) + Correction Factor(dB/m)
2. Correction Factor(dB/m) = Antenna Factor(dB/m) + Cable Factor(dB)
– Pre-Amplifier Factor(dB)
3. The other emission levels were very low against the limit.
4. Margin value = Emission Level – Limit value
5. " * ": Fundamental frequency.
6. " # ": The radiated frequency is out of the restricted band.

802.11ac (VHT40)

CHANNEL	TX Channel 54	DETECTOR FUNCTION	Peak (PK)
FREQUENCY RANGE	1GHz ~ 40GHz		Average (AV)

ANTENNA POLARITY & TEST DISTANCE: HORIZONTAL AT 3 M

NO.	FREQ. (MHz)	EMISSION LEVEL (dBuV/m)	LIMIT (dBuV/m)	MARGIN (dB)	ANTENNA HEIGHT (m)	TABLE ANGLE (Degree)	RAW VALUE (dBuV)	CORRECTION FACTOR (dB/m)
1	5150.00	58.0 PK	74.0	-16.0	1.00 H	328	51.90	6.10
2	5150.00	47.0 AV	54.0	-7.0	1.00 H	328	40.90	6.10
3	*5270.00	102.6 PK			1.00 H	328	62.20	40.40
4	*5270.00	93.3 AV			1.00 H	328	52.90	40.40
5	#10540.00	59.5 PK	74.0	-14.5	1.35 H	64	40.90	18.60
6	#10540.00	47.3 AV	54.0	-6.7	1.35 H	64	28.70	18.60

ANTENNA POLARITY & TEST DISTANCE: VERTICAL AT 3 M

NO.	FREQ. (MHz)	EMISSION LEVEL (dBuV/m)	LIMIT (dBuV/m)	MARGIN (dB)	ANTENNA HEIGHT (m)	TABLE ANGLE (Degree)	RAW VALUE (dBuV)	CORRECTION FACTOR (dB/m)
1	5150.00	57.8 PK	74.0	-16.2	1.35 V	179	51.80	6.00
2	5150.00	44.6 AV	54.0	-9.4	1.35 V	179	38.60	6.00
3	*5270.00	115.4 PK			1.35 V	179	75.20	40.20
4	*5270.00	105.7 AV			1.35 V	179	65.50	40.20
5	#10540.00	59.6 PK	74.0	-14.4	1.21 V	34	41.20	18.40
6	#10540.00	47.7 AV	54.0	-6.3	1.21 V	34	29.30	18.40

Remark:

1. Emission Level(dBuV/m) = Raw Value(dBuV) + Correction Factor(dB/m)
2. Correction Factor(dB/m) = Antenna Factor(dB/m) + Cable Factor(dB)
– Pre-Amplifier Factor(dB)
3. The other emission levels were very low against the limit.
4. Margin value = Emission Level – Limit value
5. " * ": Fundamental frequency.
6. " # ": The radiated frequency is out of the restricted band.

CHANNEL	TX Channel 62	DETECTOR FUNCTION	Peak (PK)
FREQUENCY RANGE	1GHz ~ 40GHz		Average (AV)

ANTENNA POLARITY & TEST DISTANCE: HORIZONTAL AT 3 M

NO.	FREQ. (MHz)	EMISSION LEVEL (dBuV/m)	LIMIT (dBuV/m)	MARGIN (dB)	ANTENNA HEIGHT (m)	TABLE ANGLE (Degree)	RAW VALUE (dBuV)	CORRECTION FACTOR (dB/m)
1	*5310.00	103.4 PK			2.90 H	337	62.90	40.50
2	*5310.00	93.0 AV			2.90 H	337	52.50	40.50
3	5350.00	59.2 PK	74.0	-14.8	2.90 H	337	52.70	6.50
4	5350.00	47.0 AV	54.0	-7.0	2.90 H	337	40.50	6.50
5	10620.00	60.1 PK	74.0	-13.9	1.05 H	302	41.20	18.90
6	10620.00	47.6 AV	54.0	-6.4	1.05 H	302	28.70	18.90

ANTENNA POLARITY & TEST DISTANCE: VERTICAL AT 3 M

NO.	FREQ. (MHz)	EMISSION LEVEL (dBuV/m)	LIMIT (dBuV/m)	MARGIN (dB)	ANTENNA HEIGHT (m)	TABLE ANGLE (Degree)	RAW VALUE (dBuV)	CORRECTION FACTOR (dB/m)
1	*5310.00	115.0 PK			1.19 V	177	74.80	40.20
2	*5310.00	105.3 AV			1.19 V	177	65.10	40.20
3	5350.00	65.8 PK	74.0	-8.2	1.19 V	177	59.60	6.20
4	5350.00	53.8 AV	54.0	-0.2	1.19 V	177	47.60	6.20
5	10620.00	60.3 PK	74.0	-13.7	1.12 V	28	41.50	18.80
6	10620.00	48.3 AV	54.0	-5.7	1.12 V	28	29.50	18.80

Remark:

- Emission Level(dBuV/m) = Raw Value(dBuV) + Correction Factor(dB/m)
- Correction Factor(dB/m) = Antenna Factor(dB/m) + Cable Factor(dB)
– Pre-Amplifier Factor(dB)
- The other emission levels were very low against the limit.
- Margin value = Emission Level – Limit value
- " * ": Fundamental frequency.
- " # ": The radiated frequency is out of the restricted band.

CHANNEL	TX Channel 102	DETECTOR FUNCTION	Peak (PK)
FREQUENCY RANGE	1GHz ~ 40GHz		Average (AV)

ANTENNA POLARITY & TEST DISTANCE: HORIZONTAL AT 3 M

NO.	FREQ. (MHz)	EMISSION LEVEL (dBuV/m)	LIMIT (dBuV/m)	MARGIN (dB)	ANTENNA HEIGHT (m)	TABLE ANGLE (Degree)	RAW VALUE (dBuV)	CORRECTION FACTOR (dB/m)
1	5460.00	58.5 PK	74.0	-15.5	1.52 H	172	51.80	6.70
2	5460.00	46.1 AV	54.0	-7.9	1.52 H	172	39.40	6.70
3	#5470.00	62.1 PK	74.0	-11.9	1.52 H	172	55.40	6.70
4	#5470.00	48.9 AV	54.0	-5.1	1.52 H	172	42.20	6.70
5	*5510.00	107.0 PK			1.52 H	172	66.10	40.90
6	*5510.00	97.5 AV			1.52 H	172	56.60	40.90
7	11020.00	60.7 PK	74.0	-13.3	1.36 H	244	41.40	19.30
8	11020.00	47.6 AV	54.0	-6.4	1.36 H	244	28.30	19.30

ANTENNA POLARITY & TEST DISTANCE: VERTICAL AT 3 M

NO.	FREQ. (MHz)	EMISSION LEVEL (dBuV/m)	LIMIT (dBuV/m)	MARGIN (dB)	ANTENNA HEIGHT (m)	TABLE ANGLE (Degree)	RAW VALUE (dBuV)	CORRECTION FACTOR (dB/m)
1	5460.00	65.7 PK	74.0	-8.3	1.47 V	155	59.40	6.30
2	5460.00	51.6 AV	54.0	-2.4	1.47 V	155	45.30	6.30
3	#5470.00	66.9 PK	74.0	-7.1	1.47 V	155	60.60	6.30
4	#5470.00	52.9 AV	54.0	-1.1	1.47 V	155	46.60	6.30
5	*5510.00	115.4 PK			1.47 V	155	75.00	40.40
6	*5510.00	105.8 AV			1.47 V	155	65.40	40.40
7	11020.00	61.2 PK	74.0	-12.8	1.23 V	56	41.70	19.50
8	11020.00	48.1 AV	54.0	-5.9	1.23 V	56	28.60	19.50

Remark:

1. Emission Level(dBuV/m) = Raw Value(dBuV) + Correction Factor(dB/m)
2. Correction Factor(dB/m) = Antenna Factor(dB/m) + Cable Factor(dB)
– Pre-Amplifier Factor(dB)
3. The other emission levels were very low against the limit.
4. Margin value = Emission Level – Limit value
5. " * ": Fundamental frequency.
6. " # ": The radiated frequency is out of the restricted band.

CHANNEL	TX Channel 110	DETECTOR FUNCTION	Peak (PK)
FREQUENCY RANGE	1GHz ~ 40GHz		Average (AV)

ANTENNA POLARITY & TEST DISTANCE: HORIZONTAL AT 3 M

NO.	FREQ. (MHz)	EMISSION LEVEL (dBuV/m)	LIMIT (dBuV/m)	MARGIN (dB)	ANTENNA HEIGHT (m)	TABLE ANGLE (Degree)	RAW VALUE (dBuV)	CORRECTION FACTOR (dB/m)
1	*5550.00	107.6 PK			1.59 H	166	66.60	41.00
2	*5550.00	98.0 AV			1.59 H	166	57.00	41.00
3	11100.00	61.3 PK	74.0	-12.7	1.37 H	248	41.50	19.80
4	11100.00	48.0 AV	54.0	-6.0	1.37 H	248	28.20	19.80

ANTENNA POLARITY & TEST DISTANCE: VERTICAL AT 3 M

NO.	FREQ. (MHz)	EMISSION LEVEL (dBuV/m)	LIMIT (dBuV/m)	MARGIN (dB)	ANTENNA HEIGHT (m)	TABLE ANGLE (Degree)	RAW VALUE (dBuV)	CORRECTION FACTOR (dB/m)
1	*5550.00	115.7 PK			1.37 V	154	75.20	40.50
2	*5550.00	106.0 AV			1.37 V	154	65.50	40.50
3	11100.00	61.9 PK	74.0	-12.1	1.19 V	62	41.90	20.00
4	11100.00	48.4 AV	54.0	-5.6	1.19 V	62	28.40	20.00

Remark:

1. Emission Level(dBuV/m) = Raw Value(dBuV) + Correction Factor(dB/m)
2. Correction Factor(dB/m) = Antenna Factor(dB/m) + Cable Factor(dB)
– Pre-Amplifier Factor(dB)
3. The other emission levels were very low against the limit.
4. Margin value = Emission Level – Limit value
5. " * ": Fundamental frequency.
6. " # ": The radiated frequency is out of the restricted band.

CHANNEL	TX Channel 134	DETECTOR FUNCTION	Peak (PK)
FREQUENCY RANGE	1GHz ~ 40GHz		Average (AV)

ANTENNA POLARITY & TEST DISTANCE: HORIZONTAL AT 3 M

NO.	FREQ. (MHz)	EMISSION LEVEL (dBuV/m)	LIMIT (dBuV/m)	MARGIN (dB)	ANTENNA HEIGHT (m)	TABLE ANGLE (Degree)	RAW VALUE (dBuV)	CORRECTION FACTOR (dB/m)
1	*5670.00	106.7 PK			1.55 H	176	65.40	41.30
2	*5670.00	96.9 AV			1.55 H	176	55.60	41.30
3	#5725.00	58.1 PK	74.0	-15.9	1.55 H	176	50.80	7.30
4	#5725.00	46.0 AV	54.0	-8.0	1.55 H	176	38.70	7.30
5	11340.00	61.7 PK	74.0	-12.3	1.30 H	240	41.50	20.20
6	11340.00	48.2 AV	54.0	-5.8	1.30 H	240	28.00	20.20

ANTENNA POLARITY & TEST DISTANCE: VERTICAL AT 3 M

NO.	FREQ. (MHz)	EMISSION LEVEL (dBuV/m)	LIMIT (dBuV/m)	MARGIN (dB)	ANTENNA HEIGHT (m)	TABLE ANGLE (Degree)	RAW VALUE (dBuV)	CORRECTION FACTOR (dB/m)
1	*5670.00	114.7 PK			1.15 V	154	74.00	40.70
2	*5670.00	105.4 AV			1.15 V	154	64.70	40.70
3	#5725.00	64.5 PK	74.0	-9.5	1.15 V	154	57.80	6.70
4	#5725.00	50.0 AV	54.0	-4.0	1.15 V	154	43.30	6.70
5	11340.00	61.8 PK	74.0	-12.2	1.19 V	71	41.30	20.50
6	11340.00	48.6 AV	54.0	-5.4	1.19 V	71	28.10	20.50

Remark:

1. Emission Level(dBuV/m) = Raw Value(dBuV) + Correction Factor(dB/m)
2. Correction Factor(dB/m) = Antenna Factor(dB/m) + Cable Factor(dB)
- Pre-Amplifier Factor(dB)
3. The other emission levels were very low against the limit.
4. Margin value = Emission Level – Limit value
5. " * ": Fundamental frequency.
6. " # ": The radiated frequency is out of the restricted band.

802.11ac (VHT80)

CHANNEL	TX Channel 58	DETECTOR FUNCTION	Peak (PK) Average (AV)
FREQUENCY RANGE	1GHz ~ 40GHz		

ANTENNA POLARITY & TEST DISTANCE: HORIZONTAL AT 3 M

NO.	FREQ. (MHz)	EMISSION LEVEL (dBuV/m)	LIMIT (dBuV/m)	MARGIN (dB)	ANTENNA HEIGHT (m)	TABLE ANGLE (Degree)	RAW VALUE (dBuV)	CORRECTION FACTOR (dB/m)
1	5150.00	57.6 PK	74.0	-16.4	3.34 H	336	51.50	6.10
2	5150.00	46.8 AV	54.0	-7.2	3.34 H	336	40.70	6.10
3	*5290.00	100.3 PK			3.34 H	336	59.90	40.40
4	*5290.00	90.5 AV			3.34 H	336	50.10	40.40
5	5350.00	57.7 PK	74.0	-16.3	3.34 H	336	51.20	6.50
6	5350.00	47.4 AV	54.0	-6.6	3.34 H	336	40.90	6.50
7	#10580.00	59.9 PK	74.0	-14.1	1.24 H	74	41.20	18.70
8	#10580.00	47.4 AV	54.0	-6.6	1.24 H	74	28.70	18.70

ANTENNA POLARITY & TEST DISTANCE: VERTICAL AT 3 M

NO.	FREQ. (MHz)	EMISSION LEVEL (dBuV/m)	LIMIT (dBuV/m)	MARGIN (dB)	ANTENNA HEIGHT (m)	TABLE ANGLE (Degree)	RAW VALUE (dBuV)	CORRECTION FACTOR (dB/m)
1	5150.00	59.4 PK	74.0	-14.6	1.13 V	175	53.40	6.00
2	5150.00	47.2 AV	54.0	-6.8	1.13 V	175	41.20	6.00
3	*5290.00	110.8 PK			1.13 V	175	70.60	40.20
4	*5290.00	100.9 AV			1.13 V	175	60.70	40.20
5	5350.00	65.3 PK	74.0	-8.7	1.13 V	175	59.10	6.20
6	5350.00	53.5 AV	54.0	-0.5	1.13 V	175	47.30	6.20
7	#10580.00	60.4 PK	74.0	-13.6	1.00 V	49	41.80	18.60
8	#10580.00	47.9 AV	54.0	-6.1	1.00 V	49	29.30	18.60

Remark:

1. Emission Level(dBuV/m) = Raw Value(dBuV) + Correction Factor(dB/m)
2. Correction Factor(dB/m) = Antenna Factor(dB/m) + Cable Factor(dB)
- Pre-Amplifier Factor(dB)
3. The other emission levels were very low against the limit.
4. Margin value = Emission Level – Limit value
5. " * ": Fundamental frequency.
6. " # ": The radiated frequency is out of the restricted band.

CHANNEL	TX Channel 106	DETECTOR FUNCTION	Peak (PK)
FREQUENCY RANGE	1GHz ~ 40GHz		Average (AV)

ANTENNA POLARITY & TEST DISTANCE: HORIZONTAL AT 3 M

NO.	FREQ. (MHz)	EMISSION LEVEL (dBuV/m)	LIMIT (dBuV/m)	MARGIN (dB)	ANTENNA HEIGHT (m)	TABLE ANGLE (Degree)	RAW VALUE (dBuV)	CORRECTION FACTOR (dB/m)
1	5460.00	59.4 PK	74.0	-14.6	1.63 H	173	52.70	6.70
2	5460.00	48.9 AV	54.0	-5.1	1.63 H	173	42.20	6.70
3	#5470.00	61.6 PK	74.0	-12.4	1.63 H	173	54.90	6.70
4	#5470.00	50.7 AV	54.0	-3.3	1.63 H	173	44.00	6.70
5	*5530.00	102.8 PK			1.63 H	173	61.90	40.90
6	*5530.00	93.1 AV			1.63 H	173	52.20	40.90
7	11060.00	60.4 PK	74.0	-13.6	1.39 H	199	40.80	19.60
8	11060.00	48.1 AV	54.0	-5.9	1.39 H	199	28.50	19.60

ANTENNA POLARITY & TEST DISTANCE: VERTICAL AT 3 M

NO.	FREQ. (MHz)	EMISSION LEVEL (dBuV/m)	LIMIT (dBuV/m)	MARGIN (dB)	ANTENNA HEIGHT (m)	TABLE ANGLE (Degree)	RAW VALUE (dBuV)	CORRECTION FACTOR (dB/m)
1	5460.00	66.0 PK	74.0	-8.0	1.55 V	155	59.70	6.30
2	5460.00	52.3 AV	54.0	-1.7	1.55 V	155	46.00	6.30
3	#5470.00	67.7 PK	74.0	-6.3	1.55 V	155	61.40	6.30
4	#5470.00	53.6 AV	54.0	-0.4	1.55 V	155	47.30	6.30
5	*5530.00	111.3 PK			1.55 V	155	70.90	40.40
6	*5530.00	101.5 AV			1.55 V	155	61.10	40.40
7	#5725.00	56.0 PK	74.0	-18.0	1.55 V	155	49.30	6.70
8	#5725.00	45.2 AV	54.0	-8.8	1.55 V	155	38.50	6.70
9	11060.00	60.8 PK	74.0	-13.2	1.72 V	177	41.00	19.80
10	11060.00	48.5 AV	54.0	-5.5	1.72 V	177	28.70	19.80

Remark:

1. Emission Level(dBuV/m) = Raw Value(dBuV) + Correction Factor(dB/m)
2. Correction Factor(dB/m) = Antenna Factor(dB/m) + Cable Factor(dB)
– Pre-Amplifier Factor(dB)
3. The other emission levels were very low against the limit.
4. Margin value = Emission Level – Limit value
5. " * ": Fundamental frequency.
6. " # ": The radiated frequency is out of the restricted band.

CHANNEL	TX Channel 122	DETECTOR FUNCTION	Peak (PK)
FREQUENCY RANGE	1GHz ~ 40GHz		Average (AV)

ANTENNA POLARITY & TEST DISTANCE: HORIZONTAL AT 3 M								
NO.	FREQ. (MHz)	EMISSION LEVEL (dBuV/m)	LIMIT (dBuV/m)	MARGIN (dB)	ANTENNA HEIGHT (m)	TABLE ANGLE (Degree)	RAW VALUE (dBuV)	CORRECTION FACTOR (dB/m)
1	5460.00	58.2 PK	74.0	-15.8	1.56 H	174	51.50	6.70
2	5460.00	44.8 AV	54.0	-9.2	1.56 H	174	38.10	6.70
3	#5470.00	59.5 PK	74.0	-14.5	1.56 H	174	52.80	6.70
4	#5470.00	45.2 AV	54.0	-8.8	1.56 H	174	38.50	6.70
5	*5610.00	102.1 PK			1.56 H	174	61.00	41.10
6	*5610.00	92.3 AV			1.56 H	174	51.20	41.10
7	#5725.00	57.2 PK	74.0	-16.8	1.56 H	174	49.90	7.30
8	#5725.00	45.8 AV	54.0	-8.2	1.56 H	174	38.50	7.30
9	11220.00	60.9 PK	74.0	-13.1	1.38 H	195	41.00	19.90
10	11220.00	48.2 AV	54.0	-5.8	1.38 H	195	28.30	19.90

ANTENNA POLARITY & TEST DISTANCE: VERTICAL AT 3 M								
NO.	FREQ. (MHz)	EMISSION LEVEL (dBuV/m)	LIMIT (dBuV/m)	MARGIN (dB)	ANTENNA HEIGHT (m)	TABLE ANGLE (Degree)	RAW VALUE (dBuV)	CORRECTION FACTOR (dB/m)
1	5460.00	56.4 PK	74.0	-17.6	1.49 V	156	50.10	6.30
2	5460.00	45.3 AV	54.0	-8.7	1.49 V	156	39.00	6.30
3	#5470.00	57.2 PK	74.0	-16.8	1.49 V	156	50.90	6.30
4	#5470.00	46.0 AV	54.0	-8.0	1.49 V	156	39.70	6.30
5	*5610.00	111.3 PK			1.49 V	156	70.80	40.50
6	*5610.00	101.1 AV			1.49 V	156	60.60	40.50
7	#5725.00	60.5 PK	74.0	-13.5	1.49 V	156	53.80	6.70
8	#5725.00	48.9 AV	54.0	-5.1	1.49 V	156	42.20	6.70
9	11220.00	61.2 PK	74.0	-12.8	1.70 V	189	41.10	20.10
10	11220.00	48.6 AV	54.0	-5.4	1.70 V	189	28.50	20.10

Remark:

1. Emission Level(dBuV/m) = Raw Value(dBuV) + Correction Factor(dB/m)
2. Correction Factor(dB/m) = Antenna Factor(dB/m) + Cable Factor(dB)
– Pre-Amplifier Factor(dB)
3. The other emission levels were very low against the limit.
4. Margin value = Emission Level – Limit value
5. " * ": Fundamental frequency.
6. " # ": The radiated frequency is out of the restricted band.

Below 1GHz Worst-Case Data: 802.11a

CHANNEL	TX Channel 60	DETECTOR FUNCTION	Quasi-Peak (QP)
FREQUENCY RANGE	9kHz ~ 1GHz	TEST MODE	A

ANTENNA POLARITY & TEST DISTANCE: HORIZONTAL AT 3 M								
NO.	FREQ. (MHz)	EMISSION LEVEL (dBuV/m)	LIMIT (dBuV/m)	MARGIN (dB)	ANTENNA HEIGHT (m)	TABLE ANGLE (Degree)	RAW VALUE (dBuV)	CORRECTION FACTOR (dB/m)
1	124.98	30.2 QP	43.5	-13.3	2.00 H	197	45.90	-15.70
2	260.81	34.0 QP	46.0	-12.0	1.00 H	257	47.60	-13.60
3	352.01	35.4 QP	46.0	-10.6	1.00 H	180	46.80	-11.40
4	555.75	31.9 QP	46.0	-14.1	1.50 H	351	39.60	-7.70
5	656.65	35.6 QP	46.0	-10.4	1.24 H	343	40.80	-5.20
6	829.34	31.2 QP	46.0	-14.8	1.00 H	66	33.00	-1.80
ANTENNA POLARITY & TEST DISTANCE: VERTICAL AT 3 M								
NO.	FREQ. (MHz)	EMISSION LEVEL (dBuV/m)	LIMIT (dBuV/m)	MARGIN (dB)	ANTENNA HEIGHT (m)	TABLE ANGLE (Degree)	RAW VALUE (dBuV)	CORRECTION FACTOR (dB/m)
1	55.13	36.5 QP	40.0	-3.5	1.50 V	7	51.80	-14.30
2	124.98	34.6 QP	43.5	-8.9	1.00 V	157	50.30	-15.70
3	353.95	32.9 QP	46.0	-13.1	1.00 V	220	44.20	-11.30
4	499.48	31.9 QP	46.0	-14.1	1.24 V	77	40.40	-8.50
5	645.01	35.3 QP	46.0	-10.7	1.00 V	73	40.70	-5.40
6	794.42	32.1 QP	46.0	-13.9	1.24 V	250	34.40	-2.30

Remarks:

- Emission Level(dBuV/m) = Raw Value(dBuV) + Correction Factor(dB/m)
- Correction Factor(dB/m) = Antenna Factor(dB/m) + Cable Factor(dB) – Pre-Amplifier Factor(dB)
- The other emission levels were very low against the limit.
- Margin value = Emission Level – Limit value

CHANNEL	TX Channel 60	DETECTOR FUNCTION	Quasi-Peak (QP)
FREQUENCY RANGE	9kHz ~ 1GHz	TEST MODE	B

ANTENNA POLARITY & TEST DISTANCE: HORIZONTAL AT 3 M

NO.	FREQ. (MHz)	EMISSION LEVEL (dBuV/m)	LIMIT (dBuV/m)	MARGIN (dB)	ANTENNA HEIGHT (m)	TABLE ANGLE (Degree)	RAW VALUE (dBuV)	CORRECTION FACTOR (dB/m)
1	124.98	33.7 QP	43.5	-9.8	2.00 H	121	49.40	-15.70
2	225.88	31.0 QP	46.0	-15.0	1.50 H	261	47.30	-16.30
3	353.95	35.7 QP	46.0	-10.3	1.00 H	217	47.20	-11.50
4	526.64	31.3 QP	46.0	-14.7	2.00 H	169	39.40	-8.10
5	683.81	35.1 QP	46.0	-10.9	1.25 H	168	39.80	-4.70
6	811.88	34.6 QP	46.0	-11.4	1.00 H	125	36.60	-2.00

ANTENNA POLARITY & TEST DISTANCE: VERTICAL AT 3 M

NO.	FREQ. (MHz)	EMISSION LEVEL (dBuV/m)	LIMIT (dBuV/m)	MARGIN (dB)	ANTENNA HEIGHT (m)	TABLE ANGLE (Degree)	RAW VALUE (dBuV)	CORRECTION FACTOR (dB/m)
1	45.42	35.2 QP	40.0	-4.8	1.00 V	13	49.60	-14.40
2	225.88	29.2 QP	46.0	-16.8	1.00 V	339	45.50	-16.30
3	499.48	31.8 QP	46.0	-14.2	1.00 V	113	40.30	-8.50
4	641.13	31.5 QP	46.0	-14.5	1.49 V	232	36.90	-5.40
5	763.37	31.0 QP	46.0	-15.0	1.49 V	7	33.60	-2.60
6	893.38	28.2 QP	46.0	-17.8	1.49 V	260	29.10	-0.90

Remarks:

1. Emission Level(dBuV/m) = Raw Value(dBuV) + Correction Factor(dB/m)
2. Correction Factor(dB/m) = Antenna Factor(dB/m) + Cable Factor(dB)
– Pre-Amplifier Factor(dB)
3. The other emission levels were very low against the limit.
4. Margin value = Emission Level – Limit value

4.2 Conducted Emission Measurement

4.2.1 Limits of Conducted Emission Measurement

Frequency (MHz)	Conducted Limit (dBuV)	
	Quasi-peak	Average
0.15 - 0.5	66 - 56	56 - 46
0.50 - 5.0	56	46
5.0 - 30.0	60	50

- Note:** 1. The lower limit shall apply at the transition frequencies.
 2. The limit decreases in line with the logarithm of the frequency in the range of 0.15 to 0.50MHz.

4.2.2 Test Instruments

Tested date: Mar. 15, 2017

Description & Manufacturer	Model No.	Serial No.	Cal. Date	Cal. Due
Test Receiver ROHDE & SCHWARZ	ESCI	100613	Nov. 21, 2016	Nov. 20, 2017
RF signal cable (with 10dB PAD) Woken	5D-FB	Cable-cond1-01	Dec. 22, 2016	Dec. 21, 2017
LISN ROHDE & SCHWARZ (EUT)	ESH3-Z5	835239/001	Mar. 10, 2017	Mar. 09, 2018
LISN ROHDE & SCHWARZ (Peripheral)	ESH3-Z5	100311	Jul. 28, 2016	Jul. 27, 2017
Software ADT	BV ADT_Cond_ V7.3.7.3	NA	NA	NA

- Note:** 1. The calibration interval of the above test instruments is 12 months and the calibrations are traceable to NML/ROC and NIST/USA.
 2. The test was performed in HwaYa Shielded Room 1.
 3. The VCCI Site Registration No. is C-2040.

4.2.3 Test Procedures

- The EUT was placed 0.4 meters from the conducting wall of the shielded room with EUT being connected to the power mains through a line impedance stabilization network (LISN). Other support units were connected to the power mains through another LISN. The two LISNs provide 50 ohm/ 50uH of coupling impedance for the measuring instrument.
- Both lines of the power mains connected to the EUT were checked for maximum conducted interference.
- The frequency range from 150kHz to 30MHz was searched. Emission levels under (Limit - 20dB) was not recorded.

Note: The resolution bandwidth and video bandwidth of test receiver is 9kHz for quasi-peak detection (QP) and average detection (AV) at frequency 0.15MHz-30MHz.

4.2.4 Deviation from Test Standard

No deviation.

4.2.5 Test Setup

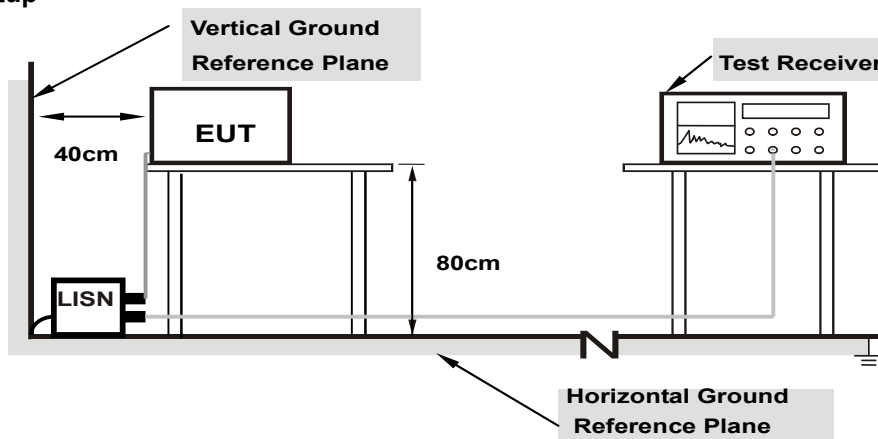

Note: 1.Support units were connected to second LISN.

For the actual test configuration, please refer to the attached file (Test Setup Photo).

4.2.6 EUT Operating Conditions

Same as 4.1.6.

4.2.7 Test Results

Phase	Line (L)	Detector Function	Quasi-Peak (QP) / Average (AV)
Test Mode	A		

No	Freq. [MHz]	Corr. Factor (dB)	Reading Value		Emission Level		Limit		Margin	
			[dB (uV)]		[dB (uV)]		[dB (uV)]		(dB)	
			Q.P.	AV.	Q.P.	AV.	Q.P.	AV.	Q.P.	AV.
1	0.15000	10.40	35.01	16.20	45.41	26.60	66.00	56.00	-20.59	-29.40
2	0.22082	10.44	22.95	9.68	33.39	20.12	62.79	52.79	-29.40	-32.67
3	0.47453	10.50	16.89	12.57	27.39	23.07	56.43	46.43	-29.04	-23.36
4	1.02584	10.46	8.36	2.07	18.82	12.53	56.00	46.00	-37.18	-33.47
5	3.90751	10.65	9.25	0.77	19.90	11.42	56.00	46.00	-36.10	-34.58
6	9.53390	10.88	24.18	17.77	35.06	28.65	60.00	50.00	-24.94	-21.35

Remarks:

1. Q.P. and AV. are abbreviations of quasi-peak and average individually.
2. The emission levels of other frequencies were very low against the limit.
3. Margin value = Emission level - Limit value
4. Correction factor = Insertion loss + Cable loss
5. Emission Level = Correction Factor + Reading Value.

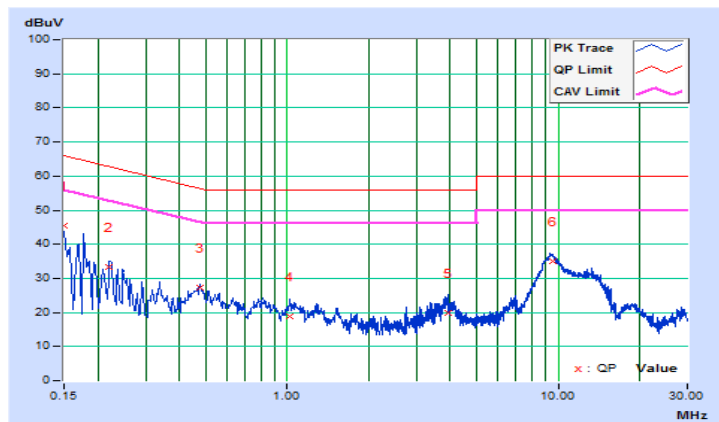

Phase	Neutral (N)	Detector Function	Quasi-Peak (QP) / Average (AV)
Test Mode	A		

No	Freq. [MHz]	Corr. Factor (dB)	Reading Value [dB (uV)]		Emission Level [dB (uV)]		Limit [dB (uV)]		Margin (dB)	
			Q.P.	AV.	Q.P.	AV.	Q.P.	AV.	Q.P.	AV.
			1	0.15391	10.16	38.12	22.64	48.28	32.80	65.79
2	0.18508	10.19	32.27	14.83	42.46	25.02	64.25	54.25	-21.79	-29.23
3	0.48626	10.23	19.13	10.58	29.36	20.81	56.23	46.23	-26.87	-25.42
4	3.99744	10.42	10.43	0.91	20.85	11.33	56.00	46.00	-35.15	-34.67
5	9.46362	10.62	26.52	20.39	37.14	31.01	60.00	50.00	-22.86	-18.99
6	13.54566	10.78	19.01	12.38	29.79	23.16	60.00	50.00	-30.21	-26.84

Remarks:

1. Q.P. and AV. are abbreviations of quasi-peak and average individually.
2. The emission levels of other frequencies were very low against the limit.
3. Margin value = Emission level - Limit value
4. Correction factor = Insertion loss + Cable loss
5. Emission Level = Correction Factor + Reading Value.

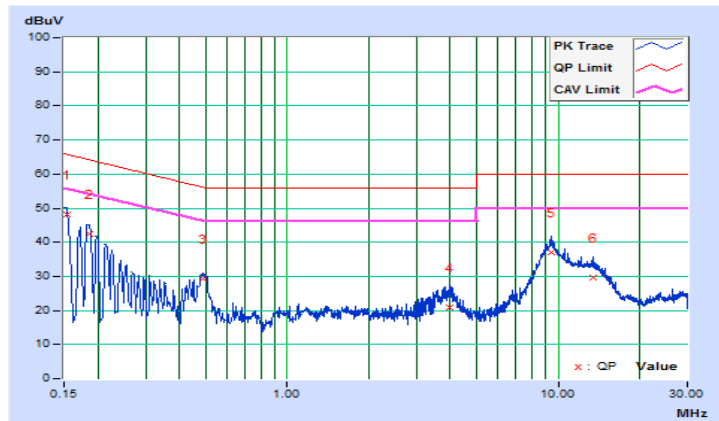

Phase	Line (L)	Detector Function	Quasi-Peak (QP) / Average (AV)
Test Mode	B		

No	Freq. [MHz]	Corr. Factor (dB)	Reading Value [dB (uV)]		Emission Level [dB (uV)]		Limit [dB (uV)]		Margin (dB)	
			Q.P.	AV.	Q.P.	AV.	Q.P.	AV.	Q.P.	AV.
			1	0.15000	10.40	35.41	19.66	45.81	30.06	66.00
2	0.31849	10.48	33.98	27.31	44.46	37.79	59.75	49.75	-15.29	-11.96
3	0.58010	10.49	15.08	9.48	25.57	19.97	56.00	46.00	-30.43	-26.03
4	1.92905	10.52	4.00	-0.09	14.52	10.43	56.00	46.00	-41.48	-35.57
5	6.89084	10.78	10.81	2.66	21.59	13.44	60.00	50.00	-38.41	-36.56
6	13.42054	11.07	14.85	11.79	25.92	22.86	60.00	50.00	-34.08	-27.14

Remarks:

1. Q.P. and AV. are abbreviations of quasi-peak and average individually.
2. The emission levels of other frequencies were very low against the limit.
3. Margin value = Emission level - Limit value
4. Correction factor = Insertion loss + Cable loss
5. Emission Level = Correction Factor + Reading Value.

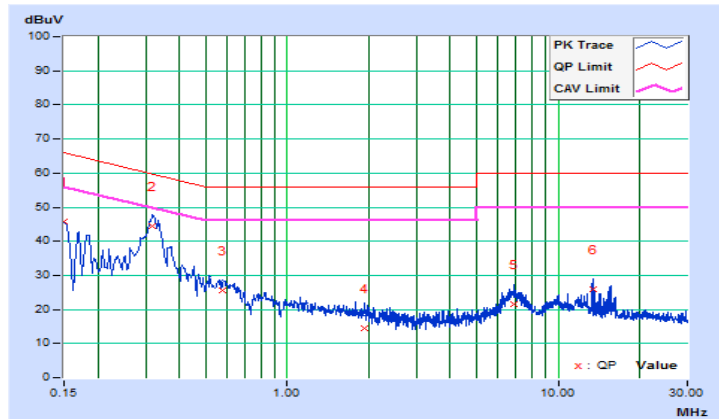

Phase	Neutral (N)	Detector Function	Quasi-Peak (QP) / Average (AV)
Test Mode	B		

No	Freq. [MHz]	Corr. Factor (dB)	Reading Value [dB (uV)]		Emission Level [dB (uV)]		Limit [dB (uV)]		Margin (dB)	
			Q.P.	AV.	Q.P.	AV.	Q.P.	AV.	Q.P.	AV.
			1	0.15391	10.16	34.67	19.69	44.83	29.85	65.79
2	0.32187	10.22	32.84	24.33	43.06	34.55	59.66	49.66	-16.60	-15.11
3	0.57620	10.23	12.15	6.76	22.38	16.99	56.00	46.00	-33.62	-29.01
4	1.66708	10.29	2.02	-2.72	12.31	7.57	56.00	46.00	-43.69	-38.43
5	6.62496	10.52	10.03	2.30	20.55	12.82	60.00	50.00	-39.45	-37.18
6	13.42054	10.78	14.73	11.86	25.51	22.64	60.00	50.00	-34.49	-27.36

Remarks:

1. Q.P. and AV. are abbreviations of quasi-peak and average individually.
2. The emission levels of other frequencies were very low against the limit.
3. Margin value = Emission level - Limit value
4. Correction factor = Insertion loss + Cable loss
5. Emission Level = Correction Factor + Reading Value.

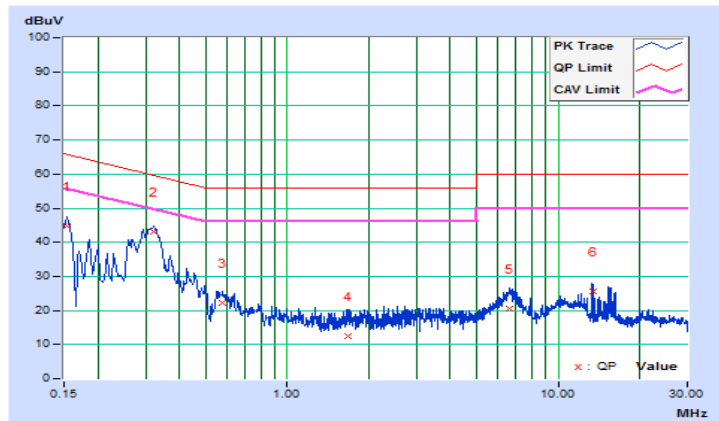

4.3 Transmit Power Measurement

4.3.1 Limits of Transmit Power Measurement

Operation Band	EUT Category		LIMIT
U-NII-1	---	Outdoor Access Point	1 Watt (30 dBm) (Max. e.i.r.p \leq 125mW(21 dBm) at any elevation angle above 30 degrees as measured from the horizon)
	---	Fixed point-to-point Access Point	1 Watt (30 dBm)
	---	Indoor Access Point	1 Watt (30 dBm)
	---	Mobile and Portable client device	250mW (24 dBm)
U-NII-2A	√		250mW (24 dBm) or 11 dBm+10 log B*
U-NII-2C	√		250mW (24 dBm) or 11 dBm+10 log B*
U-NII-3	---		1 Watt (30 dBm)

*B is the 26 dB emission bandwidth in megahertz

Per KDB 662911 Method of conducted output power measurement on IEEE 802.11 devices,

Array Gain = 0 dB (i.e., no array gain) for $N_{ANT} \leq 4$;

Array Gain = 0 dB (i.e., no array gain) for channel widths ≥ 40 MHz for any N_{ANT} ;

Array Gain = $5 \log(N_{ANT}/N_{SS})$ dB or 3 dB, whichever is less for 20-MHz channel widths with $N_{ANT} \geq 5$.

For power measurements on all other devices: Array Gain = $10 \log(N_{ANT}/N_{SS})$ dB.

4.3.2 Test Setup

For Power Output Measurement

802.11a, 802.11ac (VHT20), 802.11ac (VHT40)

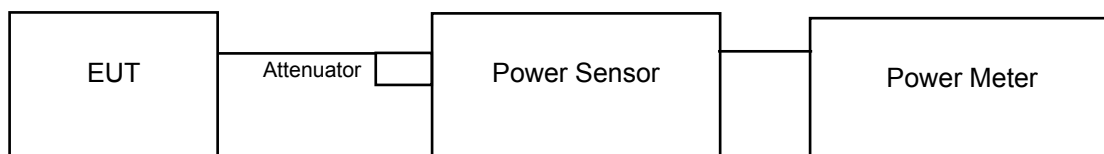

802.11ac (VHT80)

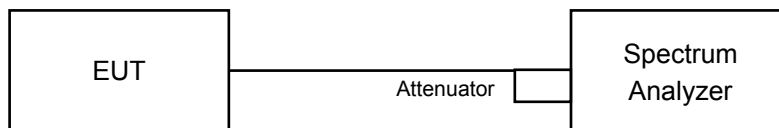

For 26dB Bandwidth

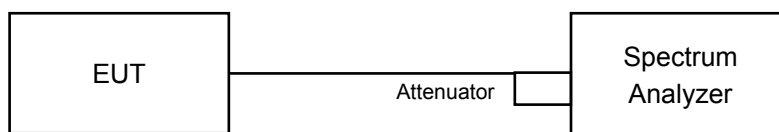

4.3.3 Test Instruments

Refer to section 4.1.2 to get information of above instrument.

4.3.4 Test Procedure

For Average Power Measurement

For 802.11a, 802.11ac (VHT20), 802.11ac (VHT40)

Method PM is used to perform output power measurement, trigger and gating function of wide band power meter is enabled to measure max output power of TX on burst. Duty factor is not added to measured value.

For 802.11ac (VHT80)

- a. Set span to encompass the entire 26 dB EBW (or, alternatively, the entire 99% occupied bandwidth) of the signal.
- b. Set sweep trigger to “free run”.
- c. Set RBW = 1 MHz.
- d. Set VBW \geq 3 MHz
- e. Number of points in sweep \geq 2 Span / RBW.
- f. Sweep time \leq (number of points in sweep) * T
- g. Using emission bandwidth to determine the frequency span for integration the channel bandwidth.
- h. Detector = RMS.
- i. Trace mode = max hold.
- j. Allow max hold to run for at least 60 seconds, or longer as needed to allow the trace to stabilize.
- k. Compute power by integrating the spectrum across the EBW (or, alternatively, the entire 99% occupied bandwidth) of the signal using the instrument’s band power measurement function with band limits set equal to the EBW (or occupied bandwidth) band edges. If the instrument does not have a band power function, sum the spectrum levels (in power units) at 1 MHz intervals extending across the EBW (or, alternatively, the entire 99% occupied bandwidth) of the spectrum.

For 26dB Bandwidth

- a. Set RBW = approximately 1% of the emission bandwidth.
- b. Set the VBW > RBW.
- c. Detector = Peak.
- d. Trace mode = max hold.
- e. Measure the maximum width of the emission that is 26 dB down from the peak of the emission. Compare this with the RBW setting of the analyzer. Readjust RBW and repeat measurement as needed until the RBW/EBW ratio is approximately 1%.

4.3.5 Deviation from Test Standard

No deviation.

4.3.6 EUT Operating Conditions

The software provided by client to enable the EUT under transmission condition continuously at lowest, middle and highest channel frequencies individually.

4.3.7 Test Result

Power Output:

CDD Mode

802.11a

Chan.	Freq. (MHz)	Maximum Conducted Power (dBm)		Total Power (mW)	Total Power (dBm)	Power Limit (dBm)	Pass / Fail
		Chain 0	Chain 1				
52	5260	20.32	20.53	220.627	23.44	23.91	Pass
60	5300	20.59	20.75	233.401	23.68	23.96	Pass
64	5320	20.24	20.63	221.293	23.45	23.95	Pass
100	5500	20.29	20.67	223.586	23.49	23.84	Pass
116	5580	20.28	20.75	225.510	23.53	23.85	Pass
140	5700	20.23	20.33	213.334	23.29	23.82	Pass

Note:

Chain 0

1. $11\text{dBm} + 10\log (19.56) = 23.91 < 24.00\text{dBm}$
2. $11\text{dBm} + 10\log (19.76) = 23.96 < 24.00\text{dBm}$
3. $11\text{dBm} + 10\log (19.71) = 23.95 < 24.00\text{dBm}$
4. $11\text{dBm} + 10\log (19.59) = 23.92 < 24.00\text{dBm}$
5. $11\text{dBm} + 10\log (19.47) = 23.89 < 24.00\text{dBm}$
6. $11\text{dBm} + 10\log (19.49) = 23.90 < 24.00\text{dBm}$

Chain 1

1. $11\text{dBm} + 10\log (19.86) = 23.98 < 24.00\text{dBm}$
2. $11\text{dBm} + 10\log (19.81) = 23.97 < 24.00\text{dBm}$
3. $11\text{dBm} + 10\log (19.71) = 23.95 < 24.00\text{dBm}$
4. $11\text{dBm} + 10\log (19.21) = 23.84 < 24.00\text{dBm}$
5. $11\text{dBm} + 10\log (19.29) = 23.85 < 24.00\text{dBm}$
6. $11\text{dBm} + 10\log (19.15) = 23.82 < 24.00\text{dBm}$

802.11ac (VHT20)

Chan.	Freq. (MHz)	Maximum Conducted Power (dBm)		Total Power (mW)	Total Power (dBm)	Power Limit (dBm)	Pass / Fail
		Chain 0	Chain 1				
52	5260	20.25	20.51	218.385	23.39	24.00	Pass
60	5300	20.37	20.53	221.873	23.46	24.00	Pass
64	5320	20.35	20.62	223.738	23.50	24.00	Pass
100	5500	20.59	20.73	232.855	23.67	24.00	Pass
116	5580	20.26	20.75	225.020	23.52	24.00	Pass
140	5700	20.15	20.43	213.922	23.30	24.00	Pass

Note:

Chain 0

1. $11\text{dBm} + 10\log (20.67) = 24.15 > 24.00\text{dBm}$
2. $11\text{dBm} + 10\log (20.45) = 24.11 > 24.00\text{dBm}$
3. $11\text{dBm} + 10\log (20.50) = 24.12 > 24.00\text{dBm}$
4. $11\text{dBm} + 10\log (20.23) = 24.06 > 24.00\text{dBm}$
5. $11\text{dBm} + 10\log (20.38) = 24.09 > 24.00\text{dBm}$
6. $11\text{dBm} + 10\log (20.53) = 24.12 > 24.00\text{dBm}$

Chain 1

1. $11\text{dBm} + 10\log (20.58) = 24.13 > 24.00\text{dBm}$
2. $11\text{dBm} + 10\log (20.65) = 24.15 > 24.00\text{dBm}$
3. $11\text{dBm} + 10\log (20.57) = 24.13 > 24.00\text{dBm}$
4. $11\text{dBm} + 10\log (20.51) = 24.12 > 24.00\text{dBm}$
5. $11\text{dBm} + 10\log (20.45) = 24.11 > 24.00\text{dBm}$
6. $11\text{dBm} + 10\log (20.31) = 24.08 > 24.00\text{dBm}$

802.11ac (VHT40)

Chan.	Freq. (MHz)	Maximum Conducted Power (dBm)		Total Power (mW)	Total Power (dBm)	Power Limit (dBm)	Pass / Fail
		Chain 0	Chain 1				
54	5270	20.69	20.50	229.422	23.61	24.00	Pass
62	5310	20.34	20.29	215.048	23.33	24.00	Pass
102	5510	20.37	20.58	223.181	23.49	24.00	Pass
110	5550	20.42	20.65	226.299	23.55	24.00	Pass
134	5670	20.26	20.75	225.020	23.52	24.00	Pass

Note:

Chain 0

1. $11\text{dBm} + 10\log (40.64) = 27.09 > 24.00\text{dBm}$
2. $11\text{dBm} + 10\log (40.96) = 27.12 > 24.00\text{dBm}$
3. $11\text{dBm} + 10\log (40.66) = 27.09 > 24.00\text{dBm}$
4. $11\text{dBm} + 10\log (40.81) = 27.11 > 24.00\text{dBm}$
5. $11\text{dBm} + 10\log (40.98) = 27.13 > 24.00\text{dBm}$

Chain 1

1. $11\text{dBm} + 10\log (40.95) = 27.12 > 24.00\text{dBm}$
2. $11\text{dBm} + 10\log (40.83) = 27.11 > 24.00\text{dBm}$
3. $11\text{dBm} + 10\log (40.93) = 27.12 > 24.00\text{dBm}$
4. $11\text{dBm} + 10\log (40.91) = 27.12 > 24.00\text{dBm}$
5. $11\text{dBm} + 10\log (40.64) = 27.09 > 24.00\text{dBm}$

802.11ac (VHT80)

Chan.	Freq. (MHz)	Maximum Conducted Power (dBm)		Total Power (mW)	Total Power (dBm)	Power Limit (dBm)	Pass / Fail
		Chain 0	Chain 1				
58	5290	19.68	19.42	180.395	22.56	24.00	Pass
106	5530	20.08	20.17	205.851	23.14	24.00	Pass
122	5610	20.06	20.44	212.053	23.26	24.00	Pass

Note:

Chain 0

1. $11\text{dBm} + 10\log (83.52) = 30.22 > 24\text{dBm}$
2. $11\text{dBm} + 10\log (83.35) = 30.21 > 24\text{dBm}$
3. $11\text{dBm} + 10\log (83.48) = 30.22 > 24\text{dBm}$

Chain 1

1. $11\text{dBm} + 10\log (83.59) = 30.22 > 24\text{dBm}$
2. $11\text{dBm} + 10\log (83.48) = 30.22 > 24\text{dBm}$
3. $11\text{dBm} + 10\log (83.68) = 30.23 > 24\text{dBm}$

Beamforming Mode

802.11n (HT20)

Chan.	Freq. (MHz)	Maximum Conducted Power (dBm)		Total Power (mW)	Total Power (dBm)	Power Limit (dBm)	Pass / Fail
		Chain 0	Chain 1				
52	5260	20.25	20.51	218.273	23.39	23.44	Pass
60	5300	20.38	20.44	219.786	23.42	23.44	Pass
64	5320	20.33	20.21	212.814	23.28	23.44	Pass
100	5500	20.28	20.55	220.293	23.43	23.49	Pass
116	5580	20.29	20.51	219.280	23.41	23.49	Pass
140	5700	20.15	20.43	213.796	23.30	23.49	Pass

For U-NII-2A: Directional gain = $10 \log[(10^{G1/20} + 10^{G2/20} + \dots + 10^{GN/20})^2/2] = 6.56\text{dBi} > 6\text{dBi}$, so the limit shall be reduced to $24-(6.56-6) = 23.44\text{dBm}$.

For U-NII-2C: Directional gain = $10 \log[(10^{G1/20} + 10^{G2/20} + \dots + 10^{GN/20})^2/2] = 6.51\text{dBi} > 6\text{dBi}$, so the limit shall be reduced to $24-(6.51-6) = 23.49\text{dBm}$.

Note:

Chain 0

1. $11\text{dBm} + 10\log (20.67) = 24.15 > 23.49\text{dBm}$
2. $11\text{dBm} + 10\log (20.45) = 24.11 > 23.49\text{dBm}$
3. $11\text{dBm} + 10\log (20.50) = 24.12 > 23.49\text{dBm}$
4. $11\text{dBm} + 10\log (20.23) = 24.06 > 23.49\text{dBm}$
5. $11\text{dBm} + 10\log (20.38) = 24.09 > 23.49\text{dBm}$
6. $11\text{dBm} + 10\log (20.53) = 24.12 > 23.49\text{dBm}$

Chain 1

1. $11\text{dBm} + 10\log (20.58) = 24.13 > 23.49\text{dBm}$
2. $11\text{dBm} + 10\log (20.65) = 24.15 > 23.49\text{dBm}$
3. $11\text{dBm} + 10\log (20.57) = 24.13 > 23.49\text{dBm}$
4. $11\text{dBm} + 10\log (20.51) = 24.12 > 23.49\text{dBm}$
5. $11\text{dBm} + 10\log (20.45) = 24.11 > 23.49\text{dBm}$
6. $11\text{dBm} + 10\log (20.31) = 24.08 > 23.49\text{dBm}$

802.11n (HT40)

Chan.	Freq. (MHz)	Maximum Conducted Power (dBm)		Total Power (mW)	Total Power (dBm)	Power Limit (dBm)	Pass / Fail
		Chain 0	Chain 1				
54	5270	20.40	20.32	217.270	23.37	23.44	Pass
62	5310	20.34	20.29	215.278	23.33	23.44	Pass
102	5510	20.34	20.55	221.820	23.46	23.49	Pass
110	5550	20.40	20.51	222.331	23.47	23.49	Pass
134	5670	20.27	20.64	222.331	23.47	23.49	Pass

For U-NII-2A: Directional gain = $10 \log[(10^{G1/20} + 10^{G2/20} + \dots + 10^{GN/20})^2/2] = 6.56\text{dBi} > 6\text{dBi}$, so the limit shall be reduced to $24 - (6.56 - 6) = 23.44\text{dBm}$.

For U-NII-2C: Directional gain = $10 \log[(10^{G1/20} + 10^{G2/20} + \dots + 10^{GN/20})^2/2] = 6.51\text{dBi} > 6\text{dBi}$, so the limit shall be reduced to $24 - (6.51 - 6) = 23.49\text{dBm}$.

Note:

Chain 0

1. $11\text{dBm} + 10\log (40.64) = 27.09 > 23.49\text{dBm}$
2. $11\text{dBm} + 10\log (40.96) = 27.12 > 23.49\text{dBm}$
3. $11\text{dBm} + 10\log (40.66) = 27.09 > 23.49\text{dBm}$
4. $11\text{dBm} + 10\log (40.81) = 27.11 > 23.49\text{dBm}$
5. $11\text{dBm} + 10\log (40.98) = 27.13 > 23.49\text{dBm}$

Chain 1

1. $11\text{dBm} + 10\log (40.95) = 27.12 > 23.49\text{dBm}$
2. $11\text{dBm} + 10\log (40.83) = 27.11 > 23.49\text{dBm}$
3. $11\text{dBm} + 10\log (40.93) = 27.12 > 23.49\text{dBm}$
4. $11\text{dBm} + 10\log (40.91) = 27.12 > 23.49\text{dBm}$
5. $11\text{dBm} + 10\log (40.64) = 27.09 > 23.49\text{dBm}$

802.11ac (VHT80)

Chan.	Freq. (MHz)	Maximum Conducted Power (dBm)		Total Power (mW)	Total Power (dBm)	Power Limit (dBm)	Pass / Fail
		Chain 0	Chain 1				
58	5290	19.68	19.42	180.395	22.56	23.44	Pass
106	5530	19.71	19.75	187.947	22.74	23.49	Pass
122	5610	20.06	20.44	212.053	23.26	23.49	Pass

For U-NII-2A: Directional gain = $10 \log[(10^{G1/20} + 10^{G2/20} + \dots + 10^{GN/20})^2/2] = 6.56\text{dBi} > 6\text{dBi}$, so the limit shall be reduced to $24 - (6.56 - 6) = 23.44\text{dBm}$.

For U-NII-2C: Directional gain = $10 \log[(10^{G1/20} + 10^{G2/20} + \dots + 10^{GN/20})^2/2] = 6.51\text{dBi} > 6\text{dBi}$, so the limit shall be reduced to $24 - (6.51 - 6) = 23.49\text{dBm}$.

Note:

Chain 0

1. $11\text{dBm} + 10\log (83.52) = 30.22 > 23.49\text{dBm}$
2. $11\text{dBm} + 10\log (83.35) = 30.21 > 23.49\text{dBm}$
3. $11\text{dBm} + 10\log (83.48) = 30.22 > 23.49\text{dBm}$

Chain 1

1. $11\text{dBm} + 10\log (83.59) = 30.22 > 23.49\text{dBm}$
2. $11\text{dBm} + 10\log (83.48) = 30.22 > 23.49\text{dBm}$
3. $11\text{dBm} + 10\log (83.68) = 30.23 > 23.49\text{dBm}$

26dB Bandwidth:

802.11a

Chan.	Freq. (MHz)	26dBc Bandwidth (MHz)	
		Chain 0	Chain 1
52	5260	19.56	19.86
60	5300	19.76	19.81
64	5320	19.71	19.71
100	5500	19.59	19.21
116	5580	19.47	19.29
140	5700	19.49	19.15

802.11ac (VHT20)

Chan.	Freq. (MHz)	26dBc Bandwidth (MHz)	
		Chain 0	Chain 1
52	5260	20.67	20.58
60	5300	20.45	20.65
64	5320	20.50	20.57
100	5500	20.23	20.51
116	5580	20.38	20.45
140	5700	20.53	20.31

802.11ac (VHT40)

Chan.	Freq. (MHz)	26dBc Bandwidth (MHz)	
		Chain 0	Chain 1
54	5270	40.64	40.95
62	5310	40.96	40.83
102	5510	40.66	40.93
110	5550	40.81	40.91
134	5670	40.98	40.64

802.11ac (VHT80)

Chan.	Freq. (MHz)	26dBc Bandwidth (MHz)	
		Chain 0	Chain 1
58	5290	83.52	83.59
106	5530	83.35	83.48
122	5610	83.48	83.68

Spectrum Plot of Worst Value

802.11a

802.11ac (VHT20)

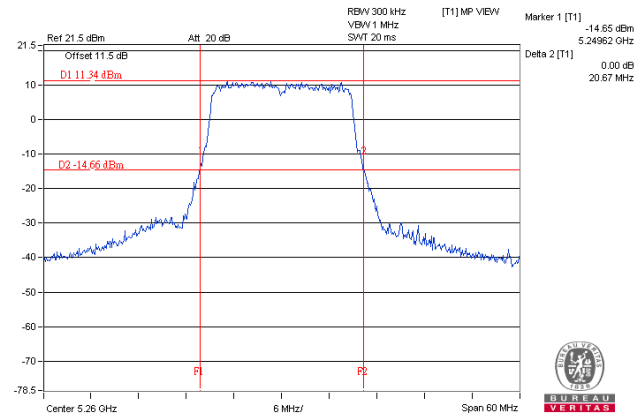
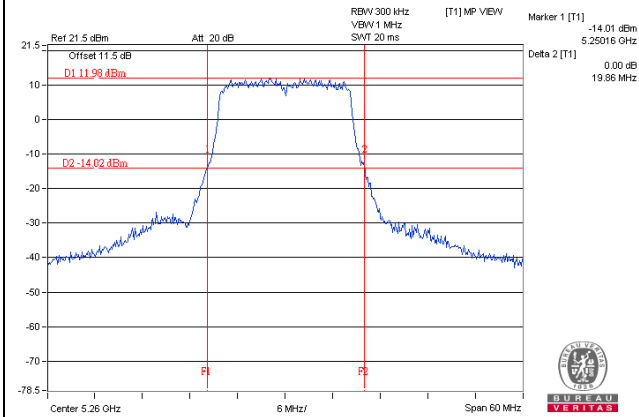

802.11ac (VHT40)

802.11ac (VHT80)

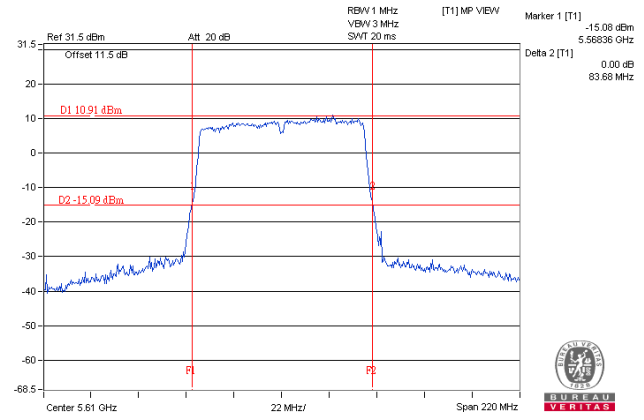
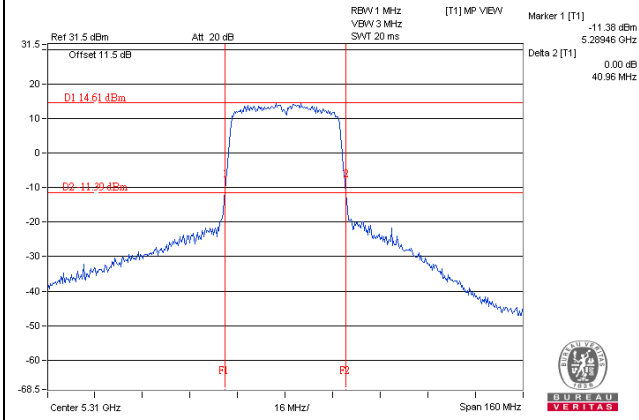

4.4 Occupied Bandwidth Measurement

4.4.1 Test Setup

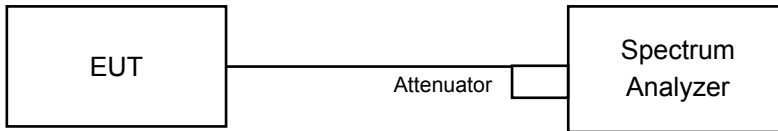

4.4.2 Test Instruments

Refer to section 4.1.2 to get information of above instrument.

4.4.3 Test Procedure

The transmitter output was connected to the spectrum analyzer through an attenuator. The bandwidth of the fundamental frequency was measured by spectrum analyzer with resolution bandwidth in the range of 1% to 5% of the anticipated emission bandwidth, and a video bandwidth at least 3x the resolution bandwidth and set the detector to sample. The width of a frequency band such that, below the lower and above the upper frequency limits, the mean powers emitted are each equal to a specified percentage 0.5 %of the total mean power of a given emission.

4.4.4 Test Result

802.11a

Chan.	Freq. (MHz)	Occupied Bandwidth (MHz)	
		Chain 0	Chain 1
52	5260	16.56	16.44
60	5300	16.44	16.56
64	5320	16.44	16.44
100	5500	16.56	16.44
116	5580	16.56	16.44
140	5700	16.56	16.44

802.11ac (VHT20)

Chan.	Freq. (MHz)	Occupied Bandwidth (MHz)	
		Chain 0	Chain 1
52	5260	17.76	17.64
60	5300	17.64	17.76
64	5320	17.64	17.64
100	5500	17.64	17.64
116	5580	17.64	17.64
140	5700	17.76	17.76

802.11ac (VHT40)

Chan.	Freq. (MHz)	Occupied Bandwidth (MHz)	
		Chain 0	Chain 1
54	5270	36.36	36.24
62	5310	36.36	36.36
102	5510	36.24	36.36
110	5550	36.24	36.36
134	5670	36.24	36.12

802.11ac (VHT80)

Chan.	Freq. (MHz)	Occupied Bandwidth (MHz)	
		Chain 0	Chain 1
58	5290	75.84	76.08
106	5530	75.84	75.84
122	5610	75.60	76.08

Spectrum Plot of Worst Value

802.11a

802.11ac (VHT20)

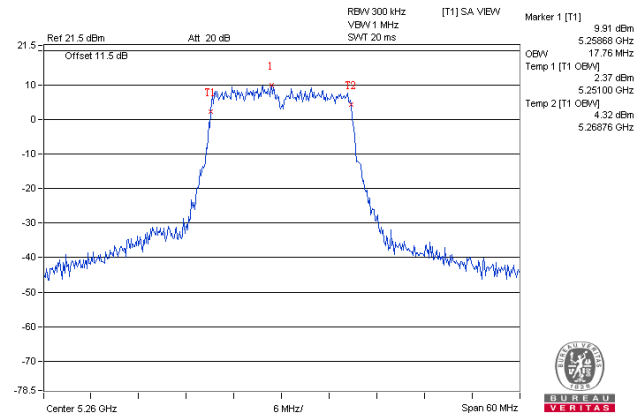
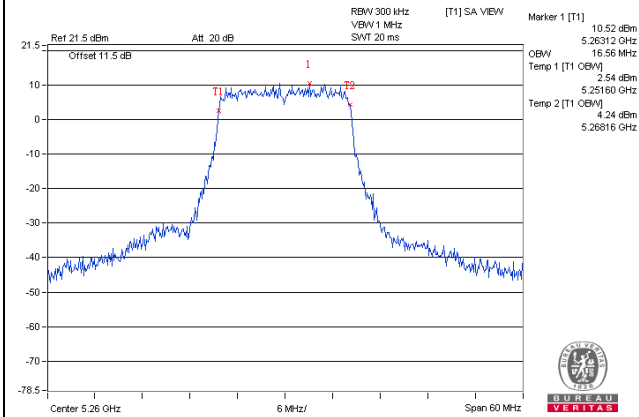

802.11ac (VHT40)

802.11ac (VHT80)

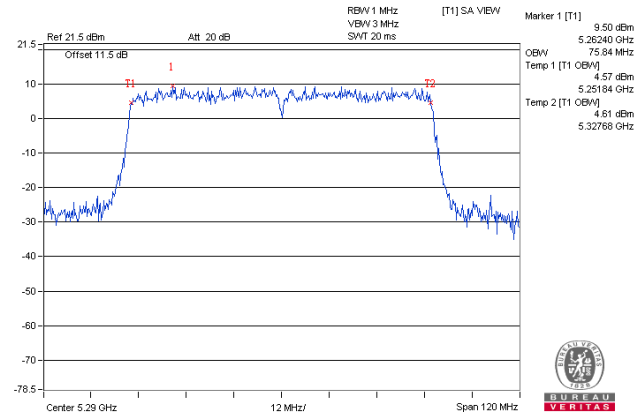
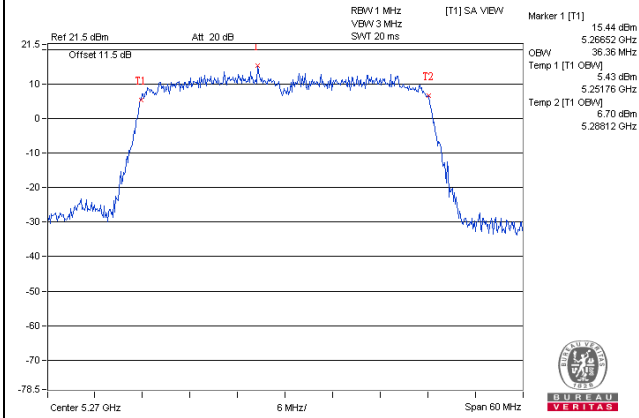

EUT MAXIMUM CONDUCTED POWER

CDD Mode

802.11a

Frequency Band (MHz)	Max. Power	
	Output Power (mW)	Output Power (dBm)
5250~5350	233.401	23.68
5470~5725	225.510	23.53

802.11ac (VHT20)

Frequency Band (MHz)	Max. Power	
	Output Power (mW)	Output Power (dBm)
5250~5350	223.738	23.50
5470~5725	232.855	23.67

802.11ac (VHT40)

Frequency Band (MHz)	Max. Power	
	Output Power (mW)	Output Power (dBm)
5250~5350	229.422	23.61
5470~5725	226.299	23.55

802.11ac (VHT80)

Frequency Band (MHz)	Max. Power	
	Output Power (mW)	Output Power (dBm)
5250~5350	180.395	22.56
5470~5725	212.053	23.26

Beamforming Mode

802.11ac (VHT20)

Frequency Band (MHz)	Max. Power	
	Output Power (mW)	Output Power (dBm)
5250~5350	219.786	23.42
5470~5725	220.293	23.43

802.11ac (VHT40)

Frequency Band (MHz)	Max. Power	
	Output Power (mW)	Output Power (dBm)
5250~5350	217.270	23.37
5470~5725	222.331	23.47

802.11ac (VHT80)

Frequency Band (MHz)	Max. Power	
	Output Power (mW)	Output Power (dBm)
5250~5350	180.395	22.56
5470~5725	212.053	23.26

4.5 Peak Power Spectral Density Measurement

4.5.1 Limits of Peak Power Spectral Density Measurement

Operation Band	EUT Category		LIMIT
U-NII-1	---	Outdoor Access Point	17dBm/ MHz
	---	Fixed point-to-point Access Point	
	---	Indoor Access Point	
	---	Mobile and Portable client device	11dBm/ MHz
U-NII-2A	√		11dBm/ MHz
U-NII-2C	√		11dBm/ MHz
U-NII-3	---		30dBm/ 500kHz

4.5.2 Test Setup

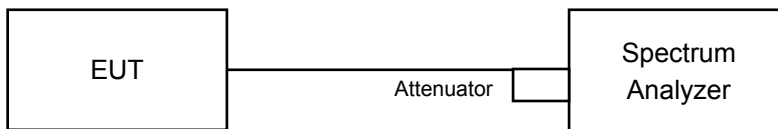

4.5.3 Test Instruments

Refer to section 4.1.2 to get information of above instrument.

4.5.4 Test Procedures

Using method SA-1, Duty cycle >98%:

- Set span to encompass the entire emission bandwidth (EBW) of the signal.
- Set RBW = 1 MHz, Set VBW ≥ 3 MHz, Detector = RMS
- Sweep time = auto, trigger set to “free run”.
- Trace average at least 100 traces in power averaging mode.
- Record the max value

Using method SA-2, Duty cycle <98%

- Set span to encompass the entire emission bandwidth (EBW) of the signal.
- Set RBW = 1 MHz, Set VBW ≥ 3 MHz, Detector = RMS
- Sweep time = auto, trigger set to “free run”.
- Trace average at least 100 traces in power averaging mode.
- Record the max value and add 10 log (1/duty cycle)

4.5.5 Deviation from Test Standard

No deviation.

4.5.6 EUT Operating Conditions

Same as Item 4.3.6.

4.5.7 Test Results

802.11a

Chan.	Freq. (MHz)	PSD W/O Duty Factor (dBm)		Duty Factor (dB)	Total PSD With Duty Factor (dBm)	Max. Limit (dBm)	Pass / Fail
		Chain 0	Chain 1				
52	5260	5.70	5.95	0.21	9.05	10.44	Pass
60	5300	5.95	5.75	0.21	9.08	10.44	Pass
64	5320	5.55	4.77	0.21	8.40	10.44	Pass
100	5500	5.84	4.64	0.21	8.51	10.49	Pass
116	5580	5.83	4.88	0.21	8.60	10.49	Pass
140	5700	5.55	5.13	0.21	8.57	10.49	Pass

Note:

- Method 1 of power density measurement of KDB 662911 is using for calculating total power density. Total power density is summing entire spectra across corresponding frequency bins on the various outputs by computer.
- Directional gain:
 For U-NII-2A: Directional gain = $10 \log[(10^{G1/20} + 10^{G2/20} + \dots + 10^{GN/20})^2/2]$ = 6.56dBi > 6dBi, so the limit shall be reduced to 11-(6.56-6) = 10.44dBm.
 For U-NII-2C: Directional gain = $10 \log[(10^{G1/20} + 10^{G2/20} + \dots + 10^{GN/20})^2/2]$ = 6.51dBi > 6dBi, so the limit shall be reduced to 11-(6.51-6) = 10.49dBm.
- Refer to section 3.3 for duty cycle spectrum plot.

802.11ac (VHT20)

Chan.	Freq. (MHz)	PSD W/O Duty Factor (dBm)		Total PSD (dBm)	Max. Limit (dBm)	Pass / Fail
		Chain 0	Chain 1			
52	5260	5.43	5.08	8.27	10.44	Pass
60	5300	5.03	4.99	8.02	10.44	Pass
64	5320	5.05	5.08	8.08	10.44	Pass
100	5500	5.73	4.31	8.09	10.49	Pass
116	5580	5.35	4.88	8.13	10.49	Pass
140	5700	4.55	4.77	7.67	10.49	Pass

Note:

- Method 1 of power density measurement of KDB 662911 is using for calculating total power density. Total power density is summing entire spectra across corresponding frequency bins on the various outputs by computer.
- Directional gain:
 For U-NII-2A: Directional gain = $10 \log[(10^{G1/20} + 10^{G2/20} + \dots + 10^{GN/20})^2/2]$ = 6.56dBi > 6dBi, so the limit shall be reduced to 11-(6.56-6) = 10.44dBm.
 For U-NII-2C: Directional gain = $10 \log[(10^{G1/20} + 10^{G2/20} + \dots + 10^{GN/20})^2/2]$ = 6.51dBi > 6dBi, so the limit shall be reduced to 11-(6.51-6) = 10.49dBm.

802.11ac (VHT40)

Chan.	Freq. (MHz)	PSD W/O Duty Factor (dBm)		Duty Factor (dB)	Total PSD With Duty Factor (dBm)	Max. Limit (dBm)	Pass / Fail
		Chain 0	Chain 1				
54	5270	2.51	3.54	0.18	6.24	10.44	Pass
62	5310	2.78	2.69	0.18	5.92	10.44	Pass
102	5510	2.86	1.73	0.18	5.52	10.49	Pass
110	5550	2.69	2.23	0.18	5.65	10.49	Pass
134	5670	2.63	1.89	0.18	5.46	10.49	Pass

Note:

- Method 1 of power density measurement of KDB 662911 is using for calculating total power density. Total power density is summing entire spectra across corresponding frequency bins on the various outputs by computer.
- Directional gain:
 For U-NII-2A: Directional gain = $10 \log[(10^{G1/20} + 10^{G2/20} + \dots + 10^{GN/20})^2/2]$ = 6.56dBi > 6dBi, so the limit shall be reduced to 11-(6.56-6) = 10.44dBm.
 For U-NII-2C: Directional gain = $10 \log[(10^{G1/20} + 10^{G2/20} + \dots + 10^{GN/20})^2/2]$ = 6.51dBi > 6dBi, so the limit shall be reduced to 11-(6.51-6) = 10.49dBm.
- Refer to section 3.3 for duty cycle spectrum plot.

802.11ac (VHT80)

Chan.	Freq. (MHz)	PSD W/O Duty Factor (dBm)		Duty Factor (dB)	Total PSD With Duty Factor (dBm)	Max. Limit (dBm)	Pass / Fail
		Chain 0	Chain 1				
58	5290	-0.53	-0.91	0.34	2.63	10.44	Pass
106	5530	-1.11	-1.96	0.34	1.83	10.49	Pass
122	5610	-0.69	-1.82	0.34	2.13	10.49	Pass

Note:

- Method 1 of power density measurement of KDB 662911 is using for calculating total power density. Total power density is summing entire spectra across corresponding frequency bins on the various outputs by computer.
- Directional gain:
 For U-NII-2A: Directional gain = $10 \log[(10^{G1/20} + 10^{G2/20} + \dots + 10^{GN/20})^2/2]$ = 6.56dBi > 6dBi, so the limit shall be reduced to 11-(6.56-6) = 10.44dBm.
 For U-NII-2C: Directional gain = $10 \log[(10^{G1/20} + 10^{G2/20} + \dots + 10^{GN/20})^2/2]$ = 6.51dBi > 6dBi, so the limit shall be reduced to 11-(6.51-6) = 10.49dBm.
- Refer to section 3.3 for duty cycle spectrum plot.

Spectrum Plot of Worst Value

802.11a / Chain 0 / CH 60

802.11ac (VHT20) / Chain 0 / CH 100

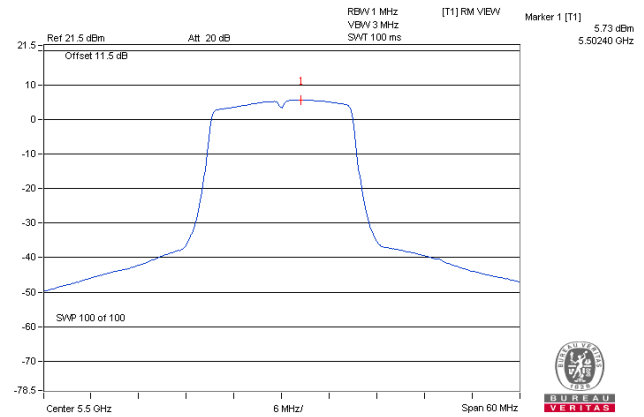
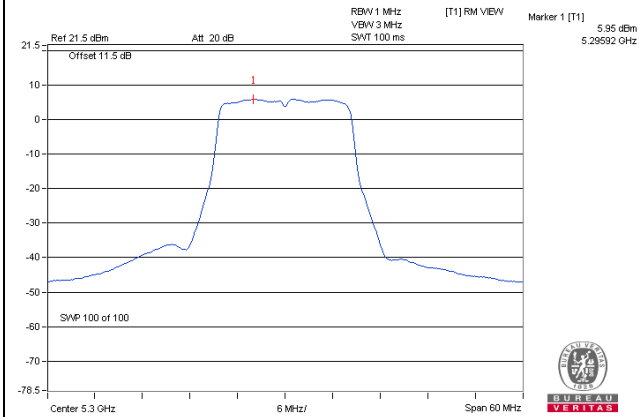

802.11ac (VHT40) / Chain 1 / CH 54

802.11ac (VHT80) / Chain 0 / CH 58

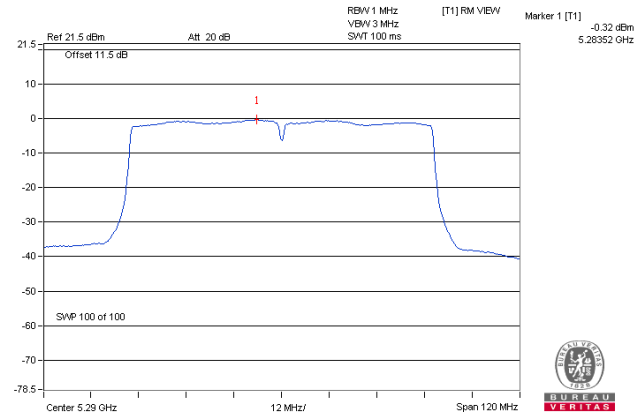
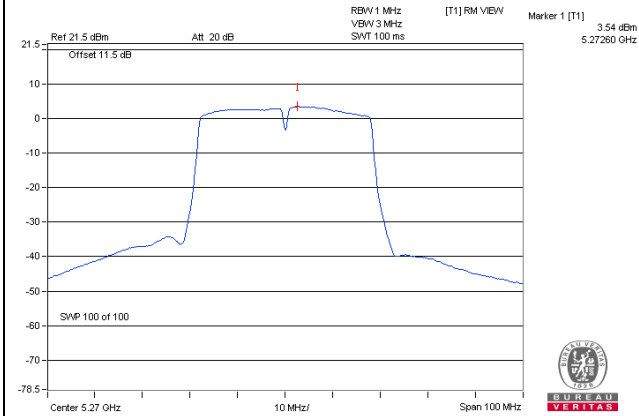

4.6 Frequency Stability

4.6.1 Limits of Frequency Stability Measurement

The frequency of the carrier signal shall be maintained within band of operation

4.6.2 Test Setup

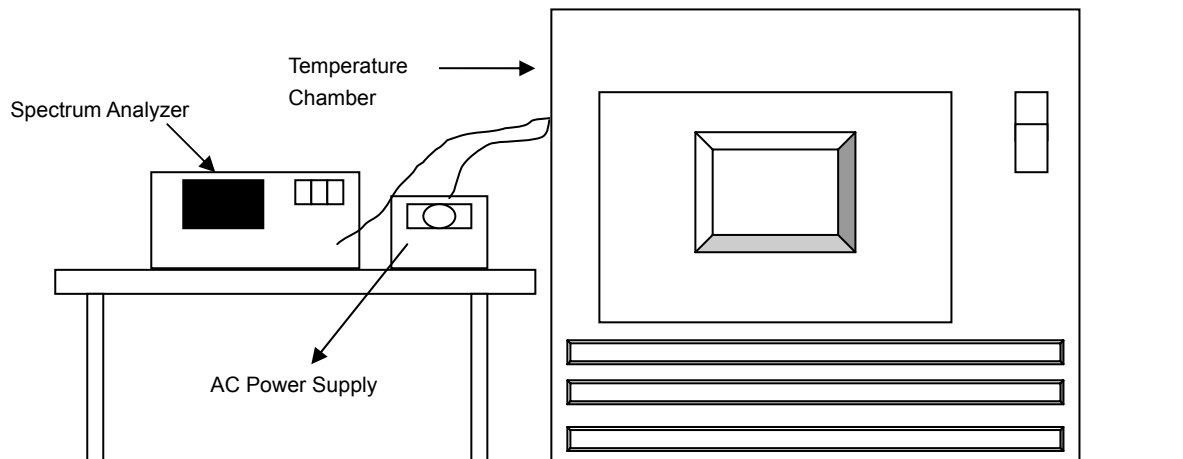

4.6.3 Test Instruments

Refer to section 4.1.2 to get information of above instrument.

4.6.4 Test Procedure

- The EUT was placed inside the environmental test chamber and powered by nominal AC voltage.
- Turn the EUT on and couple its output to a spectrum analyzer.
- Turn the EUT off and set the chamber to the highest temperature specified.
- Allow sufficient time (approximately 30 min) for the temperature of the chamber to stabilize, turn the EUT on and measure the operating frequency after 2, 5, and 10 minutes.
- Repeat step 2 and 3 with the temperature chamber set to the lowest temperature.
- The test chamber was allowed to stabilize at +20 degree C for a minimum of 30 minutes. The supply voltage was then adjusted on the EUT from 85% to 115% and the frequency record.

4.6.5 Deviation from Test Standard

No deviation.

4.6.6 EUT Operating Condition

Set the EUT transmit at un-modulation mode to test frequency stability.

4.6.7 Test Results

Frequency Stability Versus Temp.									
Operating Frequency: 5260MHz									
Temp. (°C)	Power Supply (Vac)	0 Minute		2 Minute		5 Minute		10 Minute	
		Measured Frequency(MHz)	Frequency Drift (%)	Measured Frequency(MHz)	Frequency Drift (%)	Measured Frequency(MHz)	Frequency Drift (%)	Measured Frequency(MHz)	Frequency Drift (%)
50	120	5259.9955	-0.00009	5259.9946	-0.00010	5259.9992	-0.00002	5259.9994	-0.00001
40	120	5260.0158	0.00030	5260.0198	0.00038	5260.0172	0.00033	5260.0173	0.00033
30	120	5259.9739	-0.00050	5259.9738	-0.00050	5259.9729	-0.00052	5259.9750	-0.00048
20	120	5259.9862	-0.00026	5259.9862	-0.00026	5259.9860	-0.00027	5259.9845	-0.00029
10	120	5260.0168	0.00032	5260.0127	0.00024	5260.0138	0.00026	5260.0158	0.00030
0	120	5260.0005	0.00001	5260.0014	0.00003	5259.9997	-0.00001	5260.0014	0.00003
-10	120	5260.0051	0.00010	5260.0053	0.00010	5260.0059	0.00011	5260.0073	0.00014
-20	120	5260.0006	0.00001	5260.0034	0.00006	5260.0034	0.00006	5260.0014	0.00003
-30	120	5259.9900	-0.00019	5259.9922	-0.00015	5259.9903	-0.00018	5259.9911	-0.00017

Frequency Stability Versus Voltage									
Operating Frequency: 5260MHz									
Temp. (°C)	Power Supply (Vac)	0 Minute		2 Minute		5 Minute		10 Minute	
		Measured Frequency(MHz)	Frequency Drift (%)	Measured Frequency(MHz)	Frequency Drift (%)	Measured Frequency(MHz)	Frequency Drift (%)	Measured Frequency(MHz)	Frequency Drift (%)
20	138	5259.9864	-0.00026	5259.9853	-0.00028	5259.9854	-0.00028	5259.9852	-0.00028
	120	5259.9862	-0.00026	5259.9862	-0.00026	5259.9860	-0.00027	5259.9845	-0.00029
	102	5259.9872	-0.00024	5259.9869	-0.00025	5259.9852	-0.00028	5259.9842	-0.00030

5 Pictures of Test Arrangements

Please refer to the attached file (Test Setup Photo).

Appendix – Information on the Testing Laboratories

We, Bureau Veritas Consumer Products Services (H.K.) Ltd., Taoyuan Branch, were founded in 1988 to provide our best service in EMC, Radio, Telecom and Safety consultation. Our laboratories are accredited and approved according to ISO/IEC 17025.

If you have any comments, please feel free to contact us at the following:

Linko EMC/RF Lab

Tel: 886-2-26052180

Fax: 886-2-26051924

Hsin Chu EMC/RF/Telecom Lab

Tel: 886-3-6668565

Fax: 886-3-6668323

Hwa Ya EMC/RF/Safety Lab

Tel: 886-3-3183232

Fax: 886-3-3270892

Email: service.adt@tw.bureauveritas.com

Web Site: www.bureauveritas-adt.com

The address and road map of all our labs can be found in our web site also.

--- END ---