

FCC Test Report

Report No.: RF161229C25-1

FCC ID: PY316400362

Test Model: RBR40

Series Model: RBS40

Received Date: Dec. 22, 2016

Test Date: Dec. 22, 2016 ~ Jan. 25, 2017

Issued Date: Feb. 02, 2017

Applicant: NETGEAR, INC.

Address: 350 East Plumeria Drive San Jose, CA 95134

Issued By: Bureau Veritas Consumer Products Services (H.K.) Ltd., Taoyuan Branch

Lab Address: No. 47-2, 14th Ling, Chia Pau Vil., Lin Kou Dist., New Taipei City, Taiwan (R.O.C.)

Test Location: No. 19, Hwa Ya 2nd Rd., Wen Hwa Vil., Kwei Shan Dist., Taoyuan City 33383, TAIWAN (R.O.C.)



This report is for your exclusive use. Any copying or replication of this report to or for any other person or entity, or use of our name or trademark, is permitted only with our prior written permission. This report sets forth our findings solely with respect to the test samples identified herein. The results set forth in this report are not indicative or representative of the quality or characteristics of the lot from which a test sample was taken or any similar or identical product unless specifically and expressly noted. Our report includes all of the tests requested by you and the results thereof based upon the information that you provided to us. You have 60 days from date of issuance of this report to notify us of any material error or omission caused by our negligence, provided, however, that such notice shall be in writing and shall specifically address the issue you wish to raise. A failure to raise such issue within the prescribed time shall constitute your unqualified acceptance of the completeness of this report, the tests conducted and the correctness of the report contents. Unless specific mention, the uncertainty of measurement has been explicitly taken into account to declare the compliance or non-compliance to the specification. The report must not be used by the client to claim product certification, approval, or endorsement by TAF or any government agencies.

Table of Contents

Release Control Record	4
1 Certificate of Conformity	5
2 Summary of Test Results	6
2.1 Measurement Uncertainty.....	6
2.2 Modification Record.....	6
3 General Information	7
3.1 General Description of EUT.....	7
3.2 Description of Test Modes.....	10
3.2.1 Test Mode Applicability and Tested Channel Detail.....	11
3.3 Duty Cycle of Test Signal.....	13
3.4 Description of Support Units.....	14
3.4.1 Configuration of System under Test.....	14
3.5 General Description of Applied Standard.....	14
4 Test Types and Results	15
4.1 Radiated Emission and Bandedge Measurement.....	15
4.1.1 Limits of Radiated Emission and Bandedge Measurement.....	15
4.1.2 Test Instruments.....	17
4.1.3 Test Procedure.....	18
4.1.4 Deviation from Test Standard.....	18
4.1.5 Test Setup.....	19
4.1.6 EUT Operating Conditions.....	20
4.1.7 Test Results.....	21
4.2 Conducted Emission Measurement.....	41
4.2.1 Limits of Conducted Emission Measurement.....	41
4.2.2 Test Instruments.....	41
4.2.3 Test Procedure.....	42
4.2.4 Deviation from Test Standard.....	42
4.2.5 Test Setup.....	42
4.2.6 EUT Operating Conditions.....	42
4.2.7 Test Results.....	43
4.3 Transmit Power Measurement.....	47
4.3.1 Limits of Transmit Power Measurement.....	47
4.3.2 Test Setup.....	47
4.3.3 Test Instruments.....	47
4.3.4 Test Procedure.....	48
4.3.5 Deviation from Test Standard.....	48
4.3.6 EUT Operating Conditions.....	48
4.3.7 Test Result.....	49
4.4 Peak Power Spectral Density Measurement.....	55
4.4.1 Limits of Peak Power Spectral Density Measurement.....	55
4.4.2 Test Setup.....	55
4.4.3 Test Instruments.....	55
4.4.4 Test Procedure.....	56
4.4.5 Deviation from Test Standard.....	56
4.4.6 EUT Operating Condition.....	56
4.4.7 Test Results.....	57
4.5 Frequency Stability.....	62
4.5.1 Limits of Frequency Stability Measurement.....	62
4.5.2 Test Setup.....	62
4.5.3 Test Instruments.....	62
4.5.4 Test Procedure.....	62
4.5.5 Deviation from Test Standard.....	62
4.5.6 EUT Operating Condition.....	62

4.5.7 Test Results	63
4.6 6dB Bandwidth Measurement	64
4.6.1 Limits of 6dB Bandwidth Measurement	64
4.6.2 Test Setup	64
4.6.3 Test Instruments	64
4.6.4 Test Procedure	64
4.6.5 Deviation from Test Standard	64
4.6.6 EUT Operating Condition	64
4.6.7 Test Results	65
5 Pictures of Test Arrangements	67
Annex A - Radiated Out of Band Emission (OOBE) Measurement (For U-NII-3 band)	68
Appendix – Information on the Testing Laboratories	71

Release Control Record

Issue No.	Description	Date Issued
RF161229C25-1	Original release.	Feb. 02, 2017

1 Certificate of Conformity

Product: 11ac Wireless Router and Extender
Brand: NETGEAR
Test Model: RBR40
Series Model: RBS40
Sample Status: Engineering sample
Applicant: NETGEAR, INC.
Test Date: Dec. 22, 2016 ~ Jan. 25, 2017
Standard: 47 CFR FCC Part 15, Subpart E (Section 15.407)
ANSI C63.10:2013

The above equipment has been tested by **Bureau Veritas Consumer Products Services (H.K.) Ltd., Taoyuan Branch**, and found compliance with the requirement of the above standards. The test record, data evaluation & Equipment Under Test (EUT) configurations represented herein are true and accurate accounts of the measurements of the sample's EMC characteristics under the Conditions specified in this report.

Prepared by :  , **Date:** Feb. 02, 2017
Pettie Chen / Senior Specialist

Approved by :  , **Date:** Feb. 02, 2017
Ken Liu / Senior Manager

2 Summary of Test Results

47 CFR FCC Part 15, Subpart E (Section 15.407)			
FCC Clause	Test Item	Result	Remarks
15.407(b)(6)	AC Power Conducted Emissions	Pass	Meet the requirement of limit. Minimum passing margin is -10.68dB at 0.48203MHz.
15.407(b)(1/2/3/4(i/ii)/6)	Radiated Emissions & Band Edge Measurement*	Pass	Meet the requirement of limit. Minimum passing margin is -0.2dB at 5650.40MHz.
15.407(a)(1/2/3)	Max Average Transmit Power	Pass	Meet the requirement of limit.
15.407(a)(1/2/3)	Peak Power Spectral Density	Pass	Meet the requirement of limit.
15.407(e)	6dB bandwidth	Pass	Meet the requirement of limit. (U-NII-3 Band only)
15.407(g)	Frequency Stability	Pass	Meet the requirement of limit.
15.203	Antenna Requirement	Pass	Antenna connector is I-PEX not a standard connector.

*For U-NII-3 band compliance with rule part 15.407(b)(4)(i), the OOB test plots were recorded in Annex A.

2.1 Measurement Uncertainty

Where relevant, the following measurement uncertainty levels have been estimated for tests performed on the EUT as specified in CISPR 16-4-2:

Measurement	Frequency	Expanded Uncertainty (k=2) (\pm)
Conducted Emissions at mains ports	150kHz ~ 30MHz	2.44 dB
Radiated Emissions up to 1 GHz	30MHz ~ 200MHz	3.59 dB
	200MHz ~ 1000MHz	3.60 dB
Radiated Emissions above 1 GHz	1GHz ~ 18GHz	2.29 dB
	18GHz ~ 40GHz	2.29 dB

2.2 Modification Record

There were no modifications required for compliance.

3 General Information

3.1 General Description of EUT

Product	11ac Wireless Router and Extender
Brand	NETGEAR
Test Model	RBR40
Series Model	RBS40
Model Difference	Refer to Note for more details
Sample Status	Engineering sample
Power Supply Rating	12Vdc from adapter
Modulation Type	256QAM, 64QAM, 16QAM, QPSK, BPSK
Modulation Technology	OFDM
Transfer Rate	802.11a: 54/48/36/24/18/12/9/6Mbps 802.11n: up to 300Mbps 802.11ac: up to 866.7Mbps
Operating Frequency	5180 ~ 5240MHz, 5745 ~ 5825MHz
Number of Channel	5180 ~ 5240MHz: 4 for 802.11a, 802.11n (HT20), 802.11ac (VHT20) 2 for 802.11n (HT40), 802.11ac (VHT40) 1 for 802.11ac (VHT80) 5745 ~ 5825MHz: 5 for 802.11a, 802.11n (HT20), 802.11ac (VHT20) 2 for 802.11n (HT40), 802.11ac (VHT40) 1 for 802.11ac (VHT80)
Output Power	CDD Mode: 5180 ~ 5240MHz: 873.145mW 5745 ~ 5825MHz: 881.224mW Beamforming Mode: 5180 ~ 5240MHz: 855.208mW 5745 ~ 5825MHz: 881.224mW
Antenna Type	Refer to Note
Antenna Connector	Refer to Note
Accessory Device	Adapter
Data Cable Supplied	1.95m non-shielded RJ45 cable

Note:

1. All models are electrically identical except software firmware. Model: RBR40 is the representative for final test.

Brand	Model	Function	Band	RF Module Brand / Model	Difference
NETGEAR	RBR40	Router	2.4G/ UNII-3	Dakota / IPQ-4019	1. Master mode only 2. With internet function
			UNII-1	Besra / QCA9886	
			Bluetooth	QUALCOMM/ CSR8811	
	RBS40	Satellite	2.4G/ UNII-3	Dakota / IPQ-4019	Master mode and Client mode for 2.4GHz Client mode for UNII-3
			UNII-1	Besra / QCA9886	Master mode only for UNII-1
			Bluetooth	QUALCOMM/ CSR8811	-

The following RF Modules are for the EUT.

Brand	Model	Band	Antenna No.:
Dakota	IPQ-4019	2.4G	3/4
Besra	QCA9886	UNII-3	1/2
Besra	QCA9886	UNII-1	3/4
QUALCOMM	CSR8811	Bluetooth	5

2. The EUT incorporates a MIMO function. Physically, the EUT provides 2 completed transmitters and 2 receivers.

Band	Modulation Mode	Beamforming Mode	TX Function
2.4GHz	802.11b	Not Support	2TX
	802.11g	Not Support	2TX
	802.11n (HT20)	Support	2TX
	802.11n (HT40)	Support	2TX
5GHz	802.11a	Not Support	2TX
	802.11n (HT20)	Support	2TX
	802.11n (HT40)	Support	2TX
	802.11ac (VHT20)	Support	2TX
	802.11ac (VHT40)	Support	2TX
	802.11ac (VHT80)	Support	2TX

* The modulation and bandwidth are similar for 802.11n mode for 20MHz/40MHz and 802.11ac mode for 20MHz/40MHz, therefore investigated worst case to representative mode in test report. (Final test mode refer section 3.2.1)

* For 5GHz band 802.11n and 802.11ac, CDD mode is the worst case for final radiated emission and power line conducted emission tests after pretesting CDD mode and beamforming mode.

*The EUT was pretesting following mode and Mode A was the worst for the final tests.

Mode	Description
A	Absorber position 1
B	Absorber position 2

3. The EUT uses following antennas.

Antenna Type	Dipole				
Antenna Connector	I-PEX				
Antenna Gain (dBi)					
	2.4GHz Band	5GHz U-NII-1	5GHz U-NII-2A	5GHz U-NII-2C	5GHz U-NII-3
Ant. 1	-	-	-	3.49	3.80
Ant. 2	-	-	-	3.51	3.57
Ant. 3	2.58	3.72	3.56	-	-
Ant. 4	2.89	3.49	3.53	-	-
Composite Antenna Gain(dBi) (Nss1)					
Ant. 1	-	-	-	5.700	6.094
Ant. 2	-	-	-		
Ant. 3	5.679	5.021	4.401	-	-
Ant. 4				-	-

4. The EUT uses following adapters.

Adapter 1	
Brand	NETGEAR
Model	AD2067F10
P/N	332-10797-01
Input Power	100-120Vac~50/60Hz 1.0A
Output Power	12.0Vdc / 2.5A
Power Line	1.85m DC cable without core attached on adapter

Adapter 2	
Brand	NETGEAR
Model	2ABL030P1 NJ
P/N	332-10948-01
Input Power	100-120Vac~50/60Hz 1.0A
Output Power	12.0Vdc / 2.5A
Power Line	1.8m DC cable without core attached on adapter

* After pre-testing, adapter 1 was the worst case for final test.

5. Spurious emission of the simultaneous operation mode as below and the test data please refer to report no.: RF161229C25-3.

No	Mode
1	WLAN 2.4GHz +BT
2	WLAN 2.4GHz + WLAN 5GHz B1
3	WLAN 2.4GHz + WLAN 5GHz B4
4	BT+ WLAN 5GHz B1
5	BT+ WLAN 5GHz B4
6	WLAN 5GHz B1+ WLAN 5GHz B4
7	WLAN 2.4GHz + WLAN 5GHz B1 + BT
8	WLAN 2.4GHz + WLAN 5GHz B4 + BT
9	WLAN 2.4GHz + WLAN 5GHz B1+ WLAN 5GHz B4
10	WLAN 5GHz B1+ WLAN 5GHz B4 + BT

3.2 Description of Test Modes

FOR 5180 ~ 5240MHz:

4 channels are provided for 802.11a, 802.11n (HT20), 802.11ac (VHT20):

Channel	Frequency	Channel	Frequency
36	5180 MHz	44	5220 MHz
40	5200 MHz	48	5240 MHz

2 channels are provided for 802.11n (HT40), 802.11ac (VHT40):

Channel	Frequency	Channel	Frequency
38	5190 MHz	46	5230 MHz

1 channel is provided for 802.11ac (VHT80):

Channel	Frequency
42	5210MHz

FOR 5745 ~ 5825MHz:

5 channels are provided for 802.11a, 802.11n (HT20), 802.11ac (VHT20):

Channel	Frequency	Channel	Frequency
149	5745MHz	161	5805MHz
153	5765MHz	165	5825MHz
157	5785MHz		

2 channels are provided for 802.11n (HT40), 802.11ac (VHT40):

Channel	Frequency	Channel	Frequency
151	5755MHz	159	5795MHz

1 channel is provided for 802.11ac (VHT80):

Channel	Frequency
155	5775MHz

3.2.1 Test Mode Applicability and Tested Channel Detail

EUT Configure Mode	Applicable to				Description
	RE \geq 1G	RE<1G	PLC	APCM	
A	√	√	√	√	Power from adapter 1
B	-	√	√	-	Power from adapter 2

Where RE \geq 1G: Radiated Emission above 1GHz & Bandedge Measurement
 RE<1G: Radiated Emission below 1GHz
 PLC: Power Line Conducted Emission
 APCM: Antenna Port Conducted Measurement

Note:

- The EUT had been pre-tested on the positioned of each 3 axis. The worst case was found when positioned on **Z-plane**.
- "-": Means no effect.

Radiated Emission Test (Above 1GHz):

- Pre-Scan has been conducted to determine the worst-case mode from all possible combinations between available modulations, data rates and antenna ports (if EUT with antenna diversity architecture).
- Following channel(s) was (were) selected for the final test as listed below.

EUT CONFIGURE MODE	MODE	FREQ. BAND (MHz)	AVAILABLE CHANNEL	TESTED CHANNEL	MODULATION TECHNOLOGY	MODULATION TYPE	DATA RATE (Mbps)
A	802.11a	5180-5240	36 to 48	36, 40, 48	OFDM	BPSK	6.0
A	802.11ac (VHT20)		36 to 48	36, 40, 48	OFDM	BPSK	13.0
A	802.11ac (VHT40)		38 to 46	38, 46	OFDM	BPSK	27.0
A	802.11ac (VHT80)		42	42	OFDM	BPSK	58.5
A	802.11a	5745-5825	149 to 165	149, 157, 165	OFDM	BPSK	6.0
A	802.11ac (VHT20)		149 to 165	149, 157, 165	OFDM	BPSK	13.0
A	802.11ac (VHT40)		151 to 159	151, 159	OFDM	BPSK	27.0
A	802.11ac (VHT80)		155	155	OFDM	BPSK	58.5

Radiated Emission Test (Below 1GHz):

- Pre-Scan has been conducted to determine the worst-case mode from all possible combinations between available modulations, data rates and antenna ports (if EUT with antenna diversity architecture).
- Following channel(s) was (were) selected for the final test as listed below.

EUT CONFIGURE MODE	MODE	FREQ. BAND (MHz)	AVAILABLE CHANNEL	TESTED CHANNEL	MODULATION TECHNOLOGY	MODULATION TYPE	DATA RATE (Mbps)
A, B	802.11a	5180-5240	36 to 48	149	OFDM	BPSK	6.0
	802.11a	5745-5825	149 to 165		OFDM	BPSK	6.0

Power Line Conducted Emission Test:

- Pre-Scan has been conducted to determine the worst-case mode from all possible combinations between available modulations, data rates and antenna ports (if EUT with antenna diversity architecture).
- Following channel(s) was (were) selected for the final test as listed below.

EUT CONFIGURE MODE	MODE	FREQ. BAND (MHz)	AVAILABLE CHANNEL	TESTED CHANNEL	MODULATION TECHNOLOGY	MODULATION TYPE	DATA RATE (Mbps)
A, B	802.11a	5180-5320	36 to 64	149	OFDM	BPSK	6.0
	802.11a	5745-5825	149 to 165		OFDM	BPSK	6.0

Antenna Port Conducted Measurement:

- This item includes all test value of each mode, but only includes spectrum plot of worst value of each mode.
- Pre-Scan has been conducted to determine the worst-case mode from all possible combinations between available modulations, data rates and antenna ports (if EUT with antenna diversity architecture).
- Following channel(s) was (were) selected for the final test as listed below.

EUT CONFIGURE MODE	MODE	FREQ. BAND (MHz)	AVAILABLE CHANNEL	TESTED CHANNEL	MODULATION TECHNOLOGY	MODULATION TYPE	DATA RATE (Mbps)
A	802.11a	5180-5240	36 to 48	36, 40, 48	OFDM	BPSK	6.0
A	802.11ac (VHT20)		36 to 48	36, 40, 48	OFDM	BPSK	13.0
A	802.11ac (VHT40)		38 to 46	38, 46	OFDM	BPSK	27.0
A	802.11ac (VHT80)		42	42	OFDM	BPSK	58.5
A	802.11a	5745-5825	149 to 165	149, 157, 165	OFDM	BPSK	6.0
A	802.11ac (VHT20)		149 to 165	149, 157, 165	OFDM	BPSK	13.0
A	802.11ac (VHT40)		151 to 159	151, 159	OFDM	BPSK	27.0
A	802.11ac (VHT80)		155	155	OFDM	BPSK	58.5

Test Condition:

Applicable to	Environmental Conditions	Input Power	Tested by
RE _≥ 1G	25 deg. C, 65% RH	120Vac, 60Hz	Matthew Yang
RE<1G	25 deg. C, 65% RH	120Vac, 60Hz	Matthew Yang
PLC	20 deg. C, 66% RH	120Vac, 60Hz	James Yang
APCM	24 deg. C, 64% RH	120Vac, 60Hz	Frank Liu Match Tsui

3.3 Duty Cycle of Test Signal

Duty cycle of test signal is $\geq 98\%$, duty factor is not required.

Duty cycle of test signal is $< 98\%$, duty factor shall be considered.

802.11a: Duty cycle = $2.013/2.106 = 0.956$, Duty factor = $10 * \log(1/0.956) = 0.20$

802.11ac (VHT20): Duty cycle = $4.962/5.062 = 0.980$

802.11ac (VHT40): Duty cycle = $2.35/2.475 = 0.949$, Duty factor = $10 * \log(1/0.949) = 0.23$

802.11ac (VHT80): Duty cycle = $1.125/1.21 = 0.930$, Duty factor = $10 * \log(1/0.930) = 0.32$

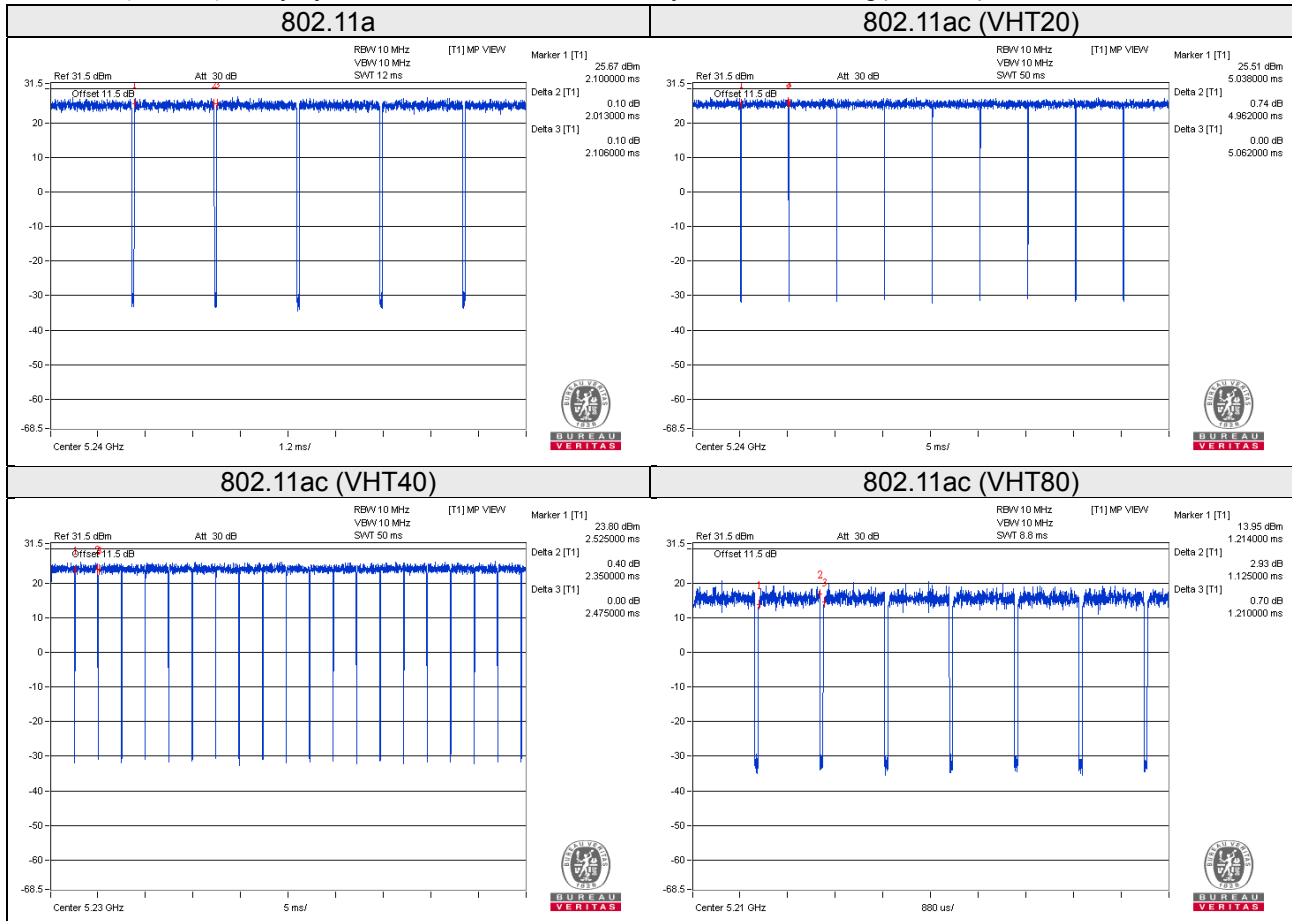

3.4 Description of Support Units

The EUT has been tested as an independent unit together with other necessary accessories or support units. The following support units or accessories were used to form a representative test configuration during the tests.

ID	Product	Brand	Model No.	Serial No.	FCC ID	Remarks
A.	Notebook	DELL	E5410	6RP2YM1	FCC DoC Approved	-
B.	Load	N/A	N/A	N/A	N/A	-

Note:

1. All power cords of the above support units are non-shielded (1.8m).
2. Item A acted as a communication partner to transfer data.

ID	Descriptions	Qty.	Length (m)	Shielding (Yes/No)	Cores (Qty.)	Remarks
1.	RJ45 cable	1	10	N	0	-
2.	RJ45 cable	3	1.8	N	0	-

3.4.1 Configuration of System under Test

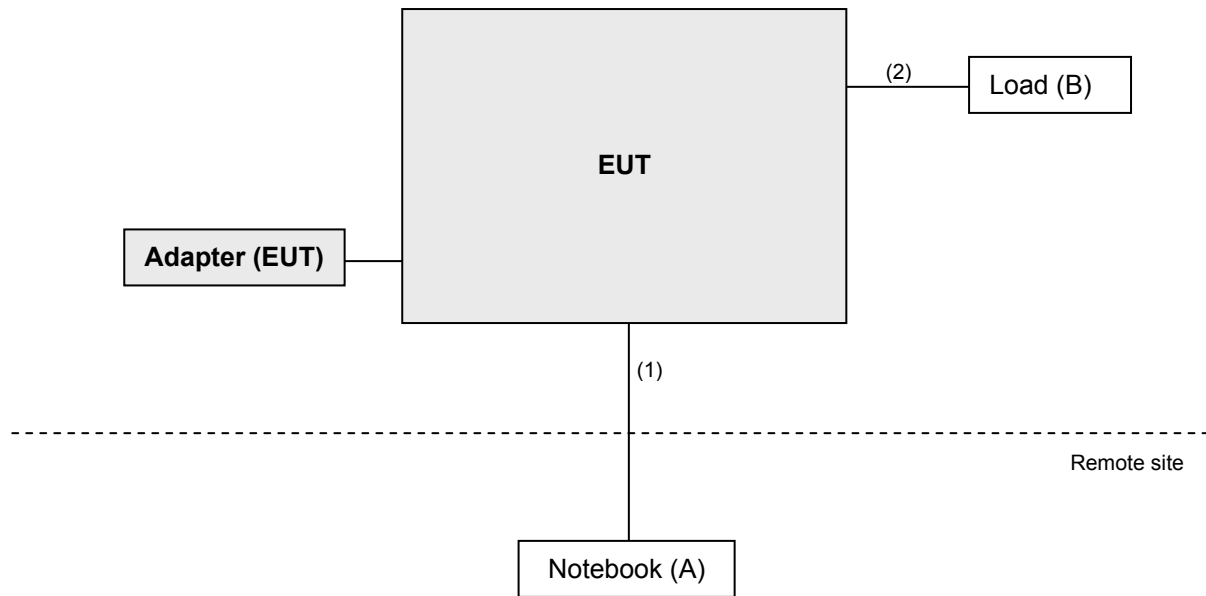

3.5 General Description of Applied Standard

The EUT is a RF Product. According to the specifications of the manufacturer, it must comply with the requirements of the following standards:

FCC Part 15, Subpart E (15.407)
789033 D02 General UNII Test Procedures New Rules v01r03
662911 D01 Multiple Transmitter Output v02r01
 ANSI C63.10:2013

All test items have been performed and recorded as per the above standards.

Note: The EUT has been verified to comply with the requirements of FCC Part 15, Subpart B, Class B (DoC). The test report has been issued separately.

4 Test Types and Results

4.1 Radiated Emission and Bandedge Measurement

4.1.1 Limits of Radiated Emission and Bandedge Measurement

Radiated emissions which fall in the restricted bands must comply with the radiated emission limits specified as below table.

Frequencies (MHz)	Field Strength (microvolts/meter)	Measurement Distance (meters)
0.009 ~ 0.490	2400/F(kHz)	300
0.490 ~ 1.705	24000/F(kHz)	30
1.705 ~ 30.0	30	30
30 ~ 88	100	3
88 ~ 216	150	3
216 ~ 960	200	3
Above 960	500	3

NOTE:

1. The lower limit shall apply at the transition frequencies.
2. Emission level (dBuV/m) = 20 log Emission level (uV/m).
3. For frequencies above 1000MHz, the field strength limits are based on average detector, however, the peak field strength of any emission shall not exceed the maximum permitted average limits, specified above by more than 20dB under any condition of modulation.

LIMITS OF UNWANTED EMISSION OUT OF THE RESTRICTED BANDS

Applicable To		Limit	
789033 D02 General UNII Test Procedure New Rules v01r03		Field Strength at 3m	
		PK:74 (dBµV/m)	AV:54 (dBµV/m)
Frequency Band	Applicable To	EIRP Limit	Equivalent Field Strength at 3m
5150~5250 MHz	15.407(b)(1)	PK:-27 (dBm/MHz)	PK:68.2(dBµV/m)
5250~5350 MHz	15.407(b)(2)		
5470~5725 MHz	15.407(b)(3)		
5725~5850 MHz	<input checked="" type="checkbox"/> 15.407(b)(4)(i)	PK:-27 (dBm/MHz) ^{*1} PK:10 (dBm/MHz) ^{*2} PK:15.6 (dBm/MHz) ^{*3} PK:27 (dBm/MHz) ^{*4}	PK: 68.2(dBµV/m) ^{*1} PK:105.2 (dBµV/m) ^{*2} PK: 110.8(dBµV/m) ^{*3} PK:122.2 (dBµV/m) ^{*4}
	<input type="checkbox"/> 15.407(b)(4)(ii)	Emission limits in section 15.247(d)	
^{*1} beyond 75 MHz or more above of the band edge.		^{*2} below the band edge increasing linearly to 10 dBm/MHz at 25 MHz above.	
^{*3} below the band edge increasing linearly to a level of 15.6 dBm/MHz at 5 MHz above.		^{*4} from 5 MHz above or below the band edge increasing linearly to a level of 27 dBm/MHz at the band edge.	

Note:

The following formula is used to convert the equipment isotropic radiated power (eirp) to field strength:

$$E = \frac{1000000\sqrt{30P}}{3} \mu\text{V/m, where } P \text{ is the eirp (Watts).}$$

4.1.2 Test Instruments

Description & Manufacturer	Model No.	Serial No.	Cal. Date	Cal. Due
Test Receiver ROHDE & SCHWARZ	ESCI	100424	Oct. 24, 2016	Oct. 23, 2017
Spectrum Analyzer ROHDE & SCHWARZ	FSP40	100040	Aug. 16, 2016	Aug. 15, 2017
BILOG Antenna SCHWARZBECK	VULB9168	9168-151	Dec. 16, 2016	Dec. 15, 2017
HORN Antenna SCHWARZBECK	BBHA 9120D	9120D-1170	Dec. 15, 2016	Dec. 14, 2017
HORN Antenna SCHWARZBECK	BBHA 9170	BBHA9170241	Dec. 14, 2016	Dec. 13, 2017
Loop Antenna	EM-6879	269	Aug. 11, 2016	Aug. 10, 2017
Preamplifier Agilent	8449B	3008A01960	Aug. 09, 2016	Aug. 08, 2017
Preamplifier Agilent	8447D	2944A10631	Aug. 09, 2016	Aug. 08, 2017
RF signal cable HUBER+SUHNER	SUCOFLEX 104	MY 13380+295012/04	Aug. 09, 2016	Aug. 08, 2017
RF signal cable HUBER+SUHNER	SUCOFLEX 104	Cable-CH4-03 (250724)	Aug. 09, 2016	Aug. 08, 2017
Software BV ADT	ADT_Radiated_ V7.6.15.9.4	NA	NA	NA
Antenna Tower inn-co GmbH	MA 4000	010303	NA	NA
Antenna Tower Controller BV ADT	AT100	AT93021703	NA	NA
Turn Table BV ADT	TT100	TT93021703	NA	NA
Turn Table Controller BV ADT	SC100	SC93021703	NA	NA
High Speed Peak Power Meter	ML2495A	0824012	Aug. 11, 2016	Aug. 10, 2017
Power Sensor	MA2411B	0738171	Aug. 11, 2016	Aug. 10, 2017
WIT Standard Temperature And Humidity Chamber	TH-4S-C	W981030	Jun. 08, 2016	Jun. 07, 2017

- Note:
1. The calibration interval of the above test instruments is 12 months and the calibrations are traceable to NML/ROC and NIST/USA.
 2. The test was performed in HwaYa Chamber 4.
 3. The horn antenna and preamplifier (model: 8449B) are used only for the measurement of emission frequency above 1GHz if tested.
 4. The FCC Site Registration No. is 460141.
 5. The IC Site Registration No. is IC7450F-4.

4.1.3 Test Procedure

For Radiated emission below 30MHz

- a. The EUT was placed on the top of a rotating table 0.8 meters above the ground at a 3 meter chamber room. The table was rotated 360 degrees to determine the position of the highest radiation.
- b. The EUT was set 3 meters away from the interference-receiving antenna, which was mounted on the top of a variable-height antenna tower.
- c. Both X and Y axes of the antenna are set to make the measurement.
- d. For each suspected emission, the EUT was arranged to its worst case and the rotatable table was turned from 0 degrees to 360 degrees to find the maximum reading.
- e. The test-receiver system was set to Quasi-Peak Detect Function and Specified Bandwidth with Maximum Hold Mode.

NOTE:

1. The resolution bandwidth and video bandwidth of test receiver/spectrum analyzer is 9kHz at frequency below 30MHz.

For Radiated emission above 30MHz

- a. The EUT was placed on the top of a rotating table 0.8 meters (for 30MHz ~ 1GHz) / 1.5 meters (for above 1GHz) above the ground at 3 meter chamber room for test. The table was rotated 360 degrees to determine the position of the highest radiation.
- b. The EUT was set 3 meters away from the interference-receiving antenna, which was mounted on the top of a variable-height antenna tower.
- c. The height of antenna is varied from one meter to four meters above the ground to determine the maximum value of the field strength. Both horizontal and vertical polarizations of the antenna are set to make the measurement.
- d. For each suspected emission, the EUT was arranged to its worst case and then the antenna was tuned to heights from 1 meter to 4 meters and the rotatable table was turned from 0 degrees to 360 degrees to find the maximum reading.
- e. The test-receiver system was set to quasi-peak detect function and specified bandwidth with maximum hold mode when the test frequency is below 1 GHz.
- f. The test-receiver system was set to peak and average detect function and specified bandwidth with maximum hold mode when the test frequency is above 1 GHz. If the peak reading value also meets average limit, measurement with the average detector is unnecessary.

Note:

1. The resolution bandwidth and video bandwidth of test receiver/spectrum analyzer is 120kHz for Quasi-peak detection (QP) at frequency below 1GHz.
2. The resolution bandwidth of test receiver/spectrum analyzer is 1 MHz and the video bandwidth is 3 MHz for Peak detection (PK) at frequency above 1GHz.
3. The resolution bandwidth of test receiver/spectrum analyzer is 1MHz and the video bandwidth is $\geq 1/T$ (Duty cycle < 98%) or 10Hz (Duty cycle $\geq 98\%$) for Average detection (AV) at frequency above 1GHz.
4. All modes of operation were investigated and the worst-case emissions are reported.

4.1.4 Deviation from Test Standard

No deviation.

4.1.5 Test Setup

For Radiated emission below 30MHz

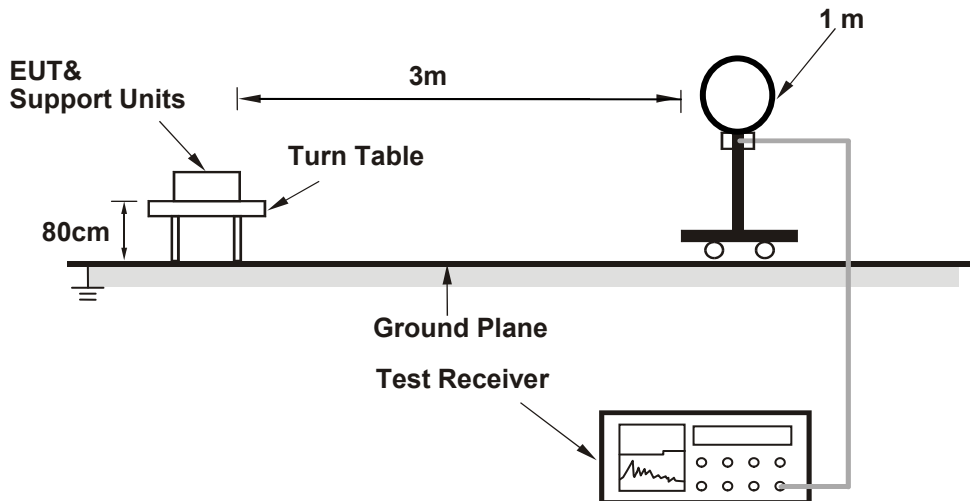

For Radiated emission 30MHz to 1GHz

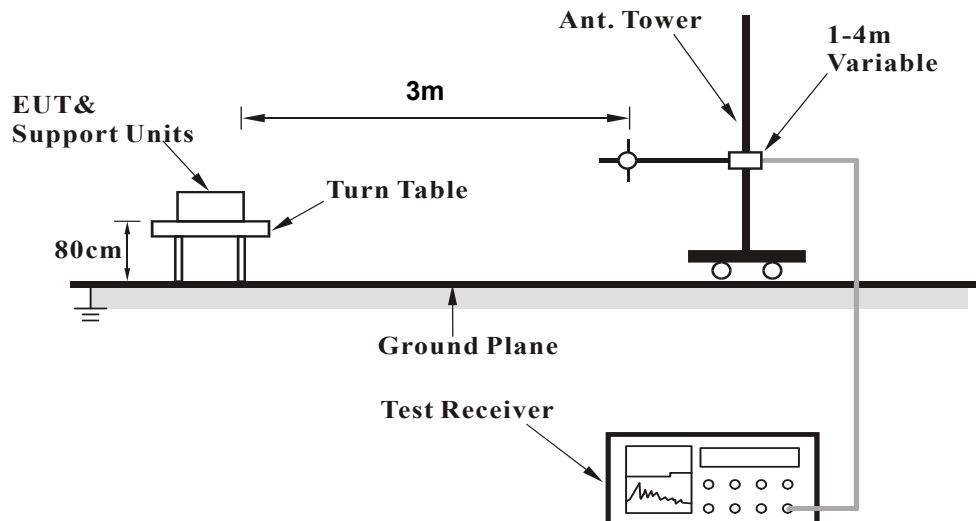

For Radiated emission above 1GHz

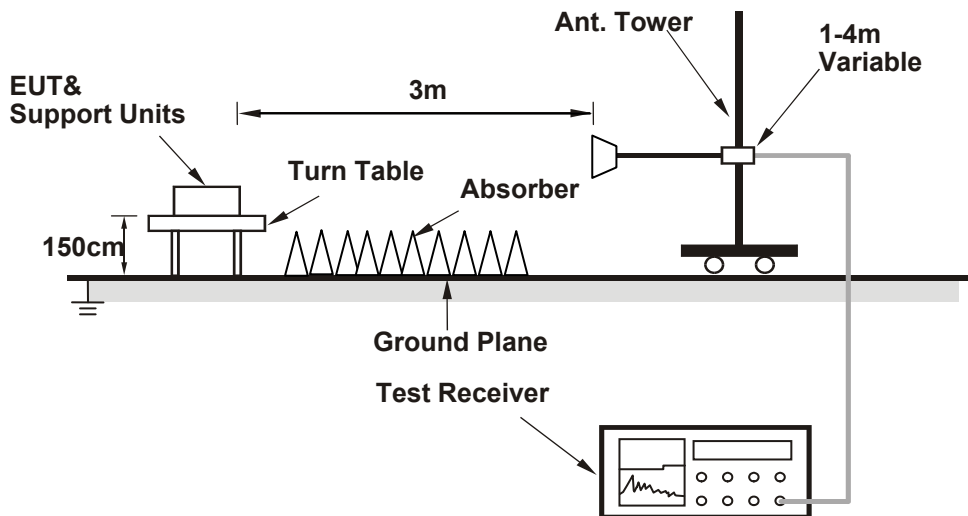

For the actual test configuration, please refer to the attached file (Test Setup Photo).

4.1.6 EUT Operating Conditions

- a. Placed the EUT on the testing table.
- b. Prepared a notebook to act as a communication partner and placed it outside of testing area.
- c. The communication partner connected with EUT via a RJ45 cable and ran a test program (provided by manufacturer) to enable EUT under transmission condition continuously at specific channel frequency.
- d. The communication partner sent data to EUT by command "PING".
- e. The necessary accessories enable the system in full functions.

4.1.7 Test Results

Above 1GHz Worst-Case Data:

802.11a

CHANNEL	TX Channel 36	DETECTOR FUNCTION	Peak (PK)
FREQUENCY RANGE	1GHz ~ 40GHz		Average (AV)

ANTENNA POLARITY & TEST DISTANCE: HORIZONTAL AT 3 M								
NO.	FREQ. (MHz)	EMISSION LEVEL (dBuV/m)	LIMIT (dBuV/m)	MARGIN (dB)	ANTENNA HEIGHT (m)	TABLE ANGLE (Degree)	RAW VALUE (dBuV)	CORRECTION FACTOR (dB/m)
1	5150.00	59.4 PK	74.0	-14.6	1.06 H	149	53.4	6.0
2	5150.00	46.2 AV	54.0	-7.8	1.06 H	149	40.2	6.0
3	*5180.00	109.6 PK			1.06 H	149	69.5	40.1
4	*5180.00	99.2 AV			1.06 H	149	59.1	40.1
5	#10360.00	59.4 PK	74.0	-14.6	1.18 H	234	41.7	17.7
6	#10360.00	46.8 AV	54.0	-7.2	1.18 H	234	29.1	17.7
ANTENNA POLARITY & TEST DISTANCE: VERTICAL AT 3 M								
NO.	FREQ. (MHz)	EMISSION LEVEL (dBuV/m)	LIMIT (dBuV/m)	MARGIN (dB)	ANTENNA HEIGHT (m)	TABLE ANGLE (Degree)	RAW VALUE (dBuV)	CORRECTION FACTOR (dB/m)
1	5150.00	66.1 PK	74.0	-7.9	1.00 V	194	60.1	6.0
2	5150.00	53.5 AV	54.0	-0.5	1.00 V	194	47.5	6.0
3	*5180.00	119.3 PK			1.00 V	194	79.2	40.1
4	*5180.00	109.4 AV			1.00 V	194	69.3	40.1
5	#10360.00	59.2 PK	74.0	-14.8	1.48 V	95	41.5	17.7
6	#10360.00	47.8 AV	54.0	-6.2	1.48 V	95	30.1	17.7

REMARKS:

1. Emission Level(dBuV/m) = Raw Value(dBuV) + Correction Factor(dB/m)
2. Correction Factor(dB/m) = Antenna Factor(dB/m) + Cable Factor(dB)
3. The other emission levels were very low against the limit.
4. Margin value = Emission Level – Limit value
5. " * ": Fundamental frequency.
6. " # ": The radiated frequency is out of the restricted band.

CHANNEL	TX Channel 40	DETECTOR FUNCTION	Peak (PK)
FREQUENCY RANGE	1GHz ~ 40GHz		Average (AV)

ANTENNA POLARITY & TEST DISTANCE: HORIZONTAL AT 3 M

NO.	FREQ. (MHz)	EMISSION LEVEL (dBuV/m)	LIMIT (dBuV/m)	MARGIN (dB)	ANTENNA HEIGHT (m)	TABLE ANGLE (Degree)	RAW VALUE (dBuV)	CORRECTION FACTOR (dB/m)
1	5150.00	60.2 PK	74.0	-13.8	2.28 H	331	54.2	6.0
2	5150.00	46.2 AV	54.0	-7.8	2.28 H	331	40.2	6.0
3	*5200.00	113.3 PK			2.28 H	331	73.2	40.1
4	*5200.00	102.8 AV			2.28 H	331	62.7	40.1
5	#10400.00	60.0 PK	74.0	-14.0	1.76 H	205	42.0	18.0
6	#10400.00	47.5 AV	54.0	-6.5	1.76 H	205	29.5	18.0

ANTENNA POLARITY & TEST DISTANCE: VERTICAL AT 3 M

NO.	FREQ. (MHz)	EMISSION LEVEL (dBuV/m)	LIMIT (dBuV/m)	MARGIN (dB)	ANTENNA HEIGHT (m)	TABLE ANGLE (Degree)	RAW VALUE (dBuV)	CORRECTION FACTOR (dB/m)
1	5150.00	68.6 PK	74.0	-5.4	1.50 V	182	62.6	6.0
2	5150.00	53.7 AV	54.0	-0.3	1.50 V	182	47.7	6.0
3	*5200.00	121.3 PK			1.50 V	182	81.2	40.1
4	*5200.00	111.6 AV			1.50 V	182	71.5	40.1
5	#10400.00	60.6 PK	74.0	-13.4	1.07 V	85	42.6	18.0
6	#10400.00	48.6 AV	54.0	-5.4	1.07 V	85	30.6	18.0

REMARKS:

1. Emission Level(dBuV/m) = Raw Value(dBuV) + Correction Factor(dB/m)
2. Correction Factor(dB/m) = Antenna Factor(dB/m) + Cable Factor(dB)
3. The other emission levels were very low against the limit.
4. Margin value = Emission Level – Limit value
5. " * ": Fundamental frequency.
6. " # ": The radiated frequency is out of the restricted band.

CHANNEL	TX Channel 48	DETECTOR FUNCTION	Peak (PK)
FREQUENCY RANGE	1GHz ~ 40GHz		Average (AV)

ANTENNA POLARITY & TEST DISTANCE: HORIZONTAL AT 3 M

NO.	FREQ. (MHz)	EMISSION LEVEL (dBuV/m)	LIMIT (dBuV/m)	MARGIN (dB)	ANTENNA HEIGHT (m)	TABLE ANGLE (Degree)	RAW VALUE (dBuV)	CORRECTION FACTOR (dB/m)
1	*5240.00	113.2 PK			2.24 H	329	73.0	40.2
2	*5240.00	102.7 AV			2.24 H	329	62.5	40.2
3	5350.00	56.6 PK	74.0	-17.4	2.24 H	329	50.4	6.2
4	5350.00	43.9 AV	54.0	-10.1	2.24 H	329	37.7	6.2
5	#10480.00	59.9 PK	74.0	-14.1	1.69 H	211	41.7	18.2
6	#10480.00	47.5 AV	54.0	-6.5	1.69 H	211	29.3	18.2

ANTENNA POLARITY & TEST DISTANCE: VERTICAL AT 3 M

NO.	FREQ. (MHz)	EMISSION LEVEL (dBuV/m)	LIMIT (dBuV/m)	MARGIN (dB)	ANTENNA HEIGHT (m)	TABLE ANGLE (Degree)	RAW VALUE (dBuV)	CORRECTION FACTOR (dB/m)
1	*5240.00	121.7 PK			1.01 V	204	81.5	40.2
2	*5240.00	111.4 AV			1.01 V	204	71.2	40.2
3	5350.00	58.8 PK	74.0	-15.2	1.09 V	214	52.6	6.2
4	5350.00	47.7 AV	54.0	-6.3	1.09 V	214	41.5	6.2
5	#10480.00	60.8 PK	74.0	-13.2	1.58 V	79	42.6	18.2
6	#10480.00	48.3 AV	54.0	-5.7	1.58 V	79	30.1	18.2

REMARKS:

1. Emission Level(dBuV/m) = Raw Value(dBuV) + Correction Factor(dB/m)
2. Correction Factor(dB/m) = Antenna Factor(dB/m) + Cable Factor(dB)
3. The other emission levels were very low against the limit.
4. Margin value = Emission Level – Limit value
5. " * ": Fundamental frequency.
6. " # ": The radiated frequency is out of the restricted band.

CHANNEL	TX Channel 149	DETECTOR FUNCTION	Peak (PK)
FREQUENCY RANGE	1GHz ~ 40GHz		Average (AV)

ANTENNA POLARITY & TEST DISTANCE: HORIZONTAL AT 3 M

NO.	FREQ. (MHz)	EMISSION LEVEL (dBuV/m)	LIMIT (dBuV/m)	MARGIN (dB)	ANTENNA HEIGHT (m)	TABLE ANGLE (Degree)	RAW VALUE (dBuV)	CORRECTION FACTOR (dB/m)
1	#5643.20	57.6 PK	68.2	-10.6	1.05 H	140	51.1	6.5
2	*5745.00	117.0 PK			1.05 H	140	76.1	40.9
3	*5745.00	106.1 AV			1.05 H	140	65.2	40.9
4	#5992.80	58.6 PK	68.2	-9.6	1.05 H	140	51.4	7.2
5	11490.00	61.8 PK	74.0	-12.2	1.00 H	7	41.3	20.5
6	11490.00	48.0 AV	54.0	-6.0	1.00 H	7	27.5	20.5

ANTENNA POLARITY & TEST DISTANCE: VERTICAL AT 3 M

NO.	FREQ. (MHz)	EMISSION LEVEL (dBuV/m)	LIMIT (dBuV/m)	MARGIN (dB)	ANTENNA HEIGHT (m)	TABLE ANGLE (Degree)	RAW VALUE (dBuV)	CORRECTION FACTOR (dB/m)
1	#5633.60	60.3 PK	68.2	-7.9	2.08 V	310	53.8	6.5
2	*5745.00	122.8 PK			2.08 V	310	81.9	40.9
3	*5745.00	112.7 AV			2.08 V	310	71.8	40.9
4	#5959.20	61.1 PK	68.2	-7.1	2.08 V	310	53.9	7.2
5	11490.00	60.7 PK	74.0	-13.3	1.16 V	108	40.2	20.5
6	11490.00	48.1 AV	54.0	-5.9	1.16 V	108	27.6	20.5

REMARKS:

1. Emission Level(dBuV/m) = Raw Value(dBuV) + Correction Factor(dB/m)
2. Correction Factor(dB/m) = Antenna Factor(dB/m) + Cable Factor(dB)
3. The other emission levels were very low against the limit.
4. Margin value = Emission Level – Limit value
5. " * ": Fundamental frequency.
6. " # ": The radiated frequency is out of the restricted band.

CHANNEL	TX Channel 157	DETECTOR FUNCTION	Peak (PK)
FREQUENCY RANGE	1GHz ~ 40GHz		Average (AV)

ANTENNA POLARITY & TEST DISTANCE: HORIZONTAL AT 3 M

NO.	FREQ. (MHz)	EMISSION LEVEL (dBuV/m)	LIMIT (dBuV/m)	MARGIN (dB)	ANTENNA HEIGHT (m)	TABLE ANGLE (Degree)	RAW VALUE (dBuV)	CORRECTION FACTOR (dB/m)
1	#5612.80	57.8 PK	68.2	-10.4	1.10 H	139	51.5	6.3
2	*5785.00	117.0 PK			1.10 H	139	76.0	41.0
3	*5785.00	106.1 AV			1.10 H	139	65.1	41.0
4	#5948.00	58.1 PK	68.2	-10.1	1.10 H	139	50.9	7.2
5	11570.00	61.4 PK	74.0	-12.6	1.00 H	12	41.1	20.3
6	11570.00	47.9 AV	54.0	-6.1	1.00 H	12	27.6	20.3

ANTENNA POLARITY & TEST DISTANCE: VERTICAL AT 3 M

NO.	FREQ. (MHz)	EMISSION LEVEL (dBuV/m)	LIMIT (dBuV/m)	MARGIN (dB)	ANTENNA HEIGHT (m)	TABLE ANGLE (Degree)	RAW VALUE (dBuV)	CORRECTION FACTOR (dB/m)
1	#5628.80	59.8 PK	68.2	-8.4	1.57 V	153	53.3	6.5
2	*5785.00	122.7 PK			1.57 V	153	81.7	41.0
3	*5785.00	112.2 AV			1.57 V	153	71.2	41.0
4	#5968.00	60.0 PK	68.2	-8.2	1.57 V	153	52.8	7.2
5	11570.00	60.7 PK	74.0	-13.3	1.19 V	104	40.4	20.3
6	11570.00	48.1 AV	54.0	-5.9	1.19 V	104	27.8	20.3

REMARKS:

1. Emission Level(dBuV/m) = Raw Value(dBuV) + Correction Factor(dB/m)
2. Correction Factor(dB/m) = Antenna Factor(dB/m) + Cable Factor(dB)
3. The other emission levels were very low against the limit.
4. Margin value = Emission Level – Limit value
5. " * ": Fundamental frequency.
6. " # ": The radiated frequency is out of the restricted band.

CHANNEL	TX Channel 165	DETECTOR FUNCTION	Peak (PK)
FREQUENCY RANGE	1GHz ~ 40GHz		Average (AV)

ANTENNA POLARITY & TEST DISTANCE: HORIZONTAL AT 3 M

NO.	FREQ. (MHz)	EMISSION LEVEL (dBuV/m)	LIMIT (dBuV/m)	MARGIN (dB)	ANTENNA HEIGHT (m)	TABLE ANGLE (Degree)	RAW VALUE (dBuV)	CORRECTION FACTOR (dB/m)
1	#5618.40	57.5 PK	68.2	-10.7	1.13 H	137	51.1	6.4
2	*5825.00	116.3 PK			1.13 H	137	75.1	41.2
3	*5825.00	105.9 AV			1.13 H	137	64.7	41.2
4	#5969.60	58.1 PK	68.2	-10.1	1.13 H	137	50.9	7.2
5	11650.00	60.9 PK	74.0	-13.1	1.00 H	3	41.0	19.9
6	11650.00	47.5 AV	54.0	-6.5	1.00 H	3	27.6	19.9

ANTENNA POLARITY & TEST DISTANCE: VERTICAL AT 3 M

NO.	FREQ. (MHz)	EMISSION LEVEL (dBuV/m)	LIMIT (dBuV/m)	MARGIN (dB)	ANTENNA HEIGHT (m)	TABLE ANGLE (Degree)	RAW VALUE (dBuV)	CORRECTION FACTOR (dB/m)
1	#5615.20	59.2 PK	68.2	-9.0	1.48 V	152	52.8	6.4
2	*5825.00	123.1 PK			1.48 V	152	81.9	41.2
3	*5825.00	112.7 AV			1.48 V	152	71.5	41.2
4	#5943.20	59.7 PK	68.2	-8.5	1.48 V	152	52.6	7.1
5	11650.00	60.6 PK	74.0	-13.4	1.21 V	111	40.7	19.9
6	11650.00	47.6 AV	54.0	-6.4	1.21 V	111	27.7	19.9

REMARKS:

1. Emission Level(dBuV/m) = Raw Value(dBuV) + Correction Factor(dB/m)
2. Correction Factor(dB/m) = Antenna Factor(dB/m) + Cable Factor(dB)
3. The other emission levels were very low against the limit.
4. Margin value = Emission Level – Limit value
5. " * ": Fundamental frequency.
6. " # ": The radiated frequency is out of the restricted band.

802.11ac (VHT20)

CHANNEL	TX Channel 36	DETECTOR FUNCTION	Peak (PK)
FREQUENCY RANGE	1GHz ~ 40GHz		Average (AV)

ANTENNA POLARITY & TEST DISTANCE: HORIZONTAL AT 3 M

NO.	FREQ. (MHz)	EMISSION LEVEL (dBuV/m)	LIMIT (dBuV/m)	MARGIN (dB)	ANTENNA HEIGHT (m)	TABLE ANGLE (Degree)	RAW VALUE (dBuV)	CORRECTION FACTOR (dB/m)
1	5150.00	59.9 PK	74.0	-14.1	1.95 H	333	53.9	6.0
2	5150.00	46.6 AV	54.0	-7.4	1.95 H	333	40.6	6.0
3	*5180.00	110.0 PK			1.95 H	333	69.9	40.1
4	*5180.00	99.8 AV			1.95 H	333	59.7	40.1
5	#10360.00	58.9 PK	74.0	-15.1	1.32 H	115	41.2	17.7
6	#10360.00	46.3 AV	54.0	-7.7	1.32 H	115	28.6	17.7

ANTENNA POLARITY & TEST DISTANCE: VERTICAL AT 3 M

NO.	FREQ. (MHz)	EMISSION LEVEL (dBuV/m)	LIMIT (dBuV/m)	MARGIN (dB)	ANTENNA HEIGHT (m)	TABLE ANGLE (Degree)	RAW VALUE (dBuV)	CORRECTION FACTOR (dB/m)
1	5150.00	68.2 PK	74.0	-5.8	1.51 V	179	62.2	6.0
2	5150.00	53.3 AV	54.0	-0.7	1.51 V	179	47.3	6.0
3	*5180.00	119.3 PK			1.51 V	179	79.2	40.1
4	*5180.00	109.0 AV			1.51 V	179	68.9	40.1
5	#10360.00	59.2 PK	74.0	-14.8	1.47 V	85	41.5	17.7
6	#10360.00	47.4 AV	54.0	-6.6	1.47 V	85	29.7	17.7

REMARKS:

1. Emission Level(dBuV/m) = Raw Value(dBuV) + Correction Factor(dB/m)
2. Correction Factor(dB/m) = Antenna Factor(dB/m) + Cable Factor(dB)
3. The other emission levels were very low against the limit.
4. Margin value = Emission Level – Limit value
5. " * ": Fundamental frequency.
6. " # ": The radiated frequency is out of the restricted band.

CHANNEL	TX Channel 40	DETECTOR FUNCTION	Peak (PK)
FREQUENCY RANGE	1GHz ~ 40GHz		Average (AV)

ANTENNA POLARITY & TEST DISTANCE: HORIZONTAL AT 3 M

NO.	FREQ. (MHz)	EMISSION LEVEL (dBuV/m)	LIMIT (dBuV/m)	MARGIN (dB)	ANTENNA HEIGHT (m)	TABLE ANGLE (Degree)	RAW VALUE (dBuV)	CORRECTION FACTOR (dB/m)
1	5150.00	58.6 PK	74.0	-15.4	2.08 H	331	52.6	6.0
2	5150.00	46.1 AV	54.0	-7.9	2.08 H	331	40.1	6.0
3	*5200.00	112.6 PK			2.08 H	331	72.5	40.1
4	*5200.00	102.3 AV			2.08 H	331	62.2	40.1
5	#10400.00	59.3 PK	74.0	-14.7	1.40 H	122	41.3	18.0
6	#10400.00	46.4 AV	54.0	-7.6	1.40 H	122	28.4	18.0

ANTENNA POLARITY & TEST DISTANCE: VERTICAL AT 3 M

NO.	FREQ. (MHz)	EMISSION LEVEL (dBuV/m)	LIMIT (dBuV/m)	MARGIN (dB)	ANTENNA HEIGHT (m)	TABLE ANGLE (Degree)	RAW VALUE (dBuV)	CORRECTION FACTOR (dB/m)
1	5150.00	68.4 PK	74.0	-5.6	1.12 V	200	62.4	6.0
2	5150.00	53.8 AV	54.0	-0.2	1.12 V	200	47.8	6.0
3	*5200.00	122.5 PK			1.12 V	200	82.4	40.1
4	*5200.00	112.1 AV			1.12 V	200	72.0	40.1
5	#10400.00	59.5 PK	74.0	-14.5	1.23 V	65	41.5	18.0
6	#10400.00	47.9 AV	54.0	-6.1	1.23 V	65	29.9	18.0

REMARKS:

1. Emission Level(dBuV/m) = Raw Value(dBuV) + Correction Factor(dB/m)
2. Correction Factor(dB/m) = Antenna Factor(dB/m) + Cable Factor(dB)
3. The other emission levels were very low against the limit.
4. Margin value = Emission Level – Limit value
5. " * ": Fundamental frequency.
6. " # ": The radiated frequency is out of the restricted band.

CHANNEL	TX Channel 48	DETECTOR FUNCTION	Peak (PK)
FREQUENCY RANGE	1GHz ~ 40GHz		Average (AV)

ANTENNA POLARITY & TEST DISTANCE: HORIZONTAL AT 3 M

NO.	FREQ. (MHz)	EMISSION LEVEL (dBuV/m)	LIMIT (dBuV/m)	MARGIN (dB)	ANTENNA HEIGHT (m)	TABLE ANGLE (Degree)	RAW VALUE (dBuV)	CORRECTION FACTOR (dB/m)
1	*5240.00	112.9 PK			2.19 H	299	72.7	40.2
2	*5240.00	102.1 AV			2.19 H	299	61.9	40.2
3	5350.00	55.8 PK	74.0	-18.2	2.19 H	299	49.6	6.2
4	5350.00	44.0 AV	54.0	-10.0	2.19 H	299	37.8	6.2
5	#10480.00	59.2 PK	74.0	-14.8	1.56 H	107	41.0	18.2
6	#10480.00	46.6 AV	54.0	-7.4	1.56 H	107	28.4	18.2

ANTENNA POLARITY & TEST DISTANCE: VERTICAL AT 3 M

NO.	FREQ. (MHz)	EMISSION LEVEL (dBuV/m)	LIMIT (dBuV/m)	MARGIN (dB)	ANTENNA HEIGHT (m)	TABLE ANGLE (Degree)	RAW VALUE (dBuV)	CORRECTION FACTOR (dB/m)
1	*5240.00	121.7 PK			1.10 V	169	81.5	40.2
2	*5240.00	111.9 AV			1.10 V	169	71.7	40.2
3	5350.00	57.1 PK	74.0	-16.9	1.10 V	169	50.9	6.2
4	5350.00	47.3 AV	54.0	-6.7	1.10 V	169	41.1	6.2
5	#10480.00	59.5 PK	74.0	-14.5	1.47 V	85	41.3	18.2
6	#10480.00	48.1 AV	54.0	-5.9	1.47 V	85	29.9	18.2

REMARKS:

1. Emission Level(dBuV/m) = Raw Value(dBuV) + Correction Factor(dB/m)
2. Correction Factor(dB/m) = Antenna Factor(dB/m) + Cable Factor(dB)
3. The other emission levels were very low against the limit.
4. Margin value = Emission Level – Limit value
5. " * ": Fundamental frequency.
6. " # ": The radiated frequency is out of the restricted band.

CHANNEL	TX Channel 149	DETECTOR FUNCTION	Peak (PK)
FREQUENCY RANGE	1GHz ~ 40GHz		Average (AV)

ANTENNA POLARITY & TEST DISTANCE: HORIZONTAL AT 3 M

NO.	FREQ. (MHz)	EMISSION LEVEL (dBuV/m)	LIMIT (dBuV/m)	MARGIN (dB)	ANTENNA HEIGHT (m)	TABLE ANGLE (Degree)	RAW VALUE (dBuV)	CORRECTION FACTOR (dB/m)
1	#5609.60	58.3 PK	68.2	-9.9	1.08 H	142	52.0	6.3
2	*5745.00	117.1 PK			1.08 H	142	76.2	40.9
3	*5745.00	106.1 AV			1.08 H	142	65.2	40.9
4	#5950.40	59.3 PK	68.2	-8.9	1.08 H	142	52.1	7.2
5	11490.00	60.8 PK	74.0	-13.2	1.00 H	29	40.3	20.5
6	11490.00	47.9 AV	54.0	-6.1	1.00 H	29	27.4	20.5

ANTENNA POLARITY & TEST DISTANCE: VERTICAL AT 3 M

NO.	FREQ. (MHz)	EMISSION LEVEL (dBuV/m)	LIMIT (dBuV/m)	MARGIN (dB)	ANTENNA HEIGHT (m)	TABLE ANGLE (Degree)	RAW VALUE (dBuV)	CORRECTION FACTOR (dB/m)
1	#5649.60	60.3 PK	68.2	-7.9	1.26 V	158	53.8	6.5
2	*5745.00	122.7 PK			1.52 V	152	81.8	40.9
3	*5745.00	112.7 AV			1.52 V	152	71.8	40.9
4	#5956.80	59.4 PK	68.2	-8.8	1.26 V	158	52.2	7.2
5	11490.00	60.3 PK	74.0	-13.7	1.22 V	94	39.8	20.5
6	11490.00	47.7 AV	54.0	-6.3	1.22 V	94	27.2	20.5

REMARKS:

1. Emission Level(dBuV/m) = Raw Value(dBuV) + Correction Factor(dB/m)
2. Correction Factor(dB/m) = Antenna Factor(dB/m) + Cable Factor(dB)
3. The other emission levels were very low against the limit.
4. Margin value = Emission Level – Limit value
5. " * ": Fundamental frequency.
6. " # ": The radiated frequency is out of the restricted band.

CHANNEL	TX Channel 157	DETECTOR FUNCTION	Peak (PK)
FREQUENCY RANGE	1GHz ~ 40GHz		Average (AV)

ANTENNA POLARITY & TEST DISTANCE: HORIZONTAL AT 3 M

NO.	FREQ. (MHz)	EMISSION LEVEL (dBuV/m)	LIMIT (dBuV/m)	MARGIN (dB)	ANTENNA HEIGHT (m)	TABLE ANGLE (Degree)	RAW VALUE (dBuV)	CORRECTION FACTOR (dB/m)
1	#5644.00	57.8 PK	68.2	-10.4	1.01 H	138	51.3	6.5
2	*5785.00	117.0 PK			1.01 H	138	76.0	41.0
3	*5785.00	106.8 AV			1.01 H	138	65.8	41.0
4	#5944.80	58.5 PK	68.2	-9.7	1.01 H	138	51.4	7.1
5	11570.00	60.9 PK	74.0	-13.1	1.00 H	35	40.6	20.3
6	11570.00	48.0 AV	54.0	-6.0	1.00 H	35	27.7	20.3

ANTENNA POLARITY & TEST DISTANCE: VERTICAL AT 3 M

NO.	FREQ. (MHz)	EMISSION LEVEL (dBuV/m)	LIMIT (dBuV/m)	MARGIN (dB)	ANTENNA HEIGHT (m)	TABLE ANGLE (Degree)	RAW VALUE (dBuV)	CORRECTION FACTOR (dB/m)
1	#5612.80	59.6 PK	68.2	-8.6	1.56 V	153	53.3	6.3
2	*5785.00	122.9 PK			1.56 V	153	81.9	41.0
3	*5785.00	112.2 AV			1.56 V	153	71.2	41.0
4	#5983.20	59.9 PK	68.2	-8.3	1.56 V	153	52.7	7.2
5	11570.00	60.4 PK	74.0	-13.6	1.24 V	98	40.1	20.3
6	11570.00	47.7 AV	54.0	-6.3	1.24 V	98	27.4	20.3

REMARKS:

1. Emission Level(dBuV/m) = Raw Value(dBuV) + Correction Factor(dB/m)
2. Correction Factor(dB/m) = Antenna Factor(dB/m) + Cable Factor(dB)
3. The other emission levels were very low against the limit.
4. Margin value = Emission Level – Limit value
5. " * ": Fundamental frequency.

CHANNEL	TX Channel 165	DETECTOR FUNCTION	Peak (PK)
FREQUENCY RANGE	1GHz ~ 40GHz		Average (AV)

ANTENNA POLARITY & TEST DISTANCE: HORIZONTAL AT 3 M

NO.	FREQ. (MHz)	EMISSION LEVEL (dBuV/m)	LIMIT (dBuV/m)	MARGIN (dB)	ANTENNA HEIGHT (m)	TABLE ANGLE (Degree)	RAW VALUE (dBuV)	CORRECTION FACTOR (dB/m)
1	#5619.20	57.7 PK	68.2	-10.5	1.14 H	140	51.3	6.4
2	*5825.00	116.7 PK			1.14 H	140	75.5	41.2
3	*5825.00	106.2 AV			1.14 H	140	65.0	41.2
4	#5994.40	58.1 PK	68.2	-10.1	1.14 H	140	50.9	7.2
5	11650.00	60.8 PK	74.0	-13.2	1.00 H	30	40.9	19.9
6	11650.00	47.5 AV	54.0	-6.5	1.00 H	30	27.6	19.9

ANTENNA POLARITY & TEST DISTANCE: VERTICAL AT 3 M

NO.	FREQ. (MHz)	EMISSION LEVEL (dBuV/m)	LIMIT (dBuV/m)	MARGIN (dB)	ANTENNA HEIGHT (m)	TABLE ANGLE (Degree)	RAW VALUE (dBuV)	CORRECTION FACTOR (dB/m)
1	#5623.20	58.4 PK	68.2	-9.8	1.61 V	154	51.9	6.5
2	*5825.00	123.1 PK			1.61 V	154	81.9	41.2
3	*5825.00	112.4 AV			1.61 V	154	71.2	41.2
4	#5928.00	58.5 PK	68.2	-9.7	1.61 V	154	51.4	7.1
5	11650.00	60.4 PK	74.0	-13.6	1.28 V	89	40.5	19.9
6	11650.00	47.4 AV	54.0	-6.6	1.28 V	89	27.5	19.9

REMARKS:

1. Emission Level(dBuV/m) = Raw Value(dBuV) + Correction Factor(dB/m)
2. Correction Factor(dB/m) = Antenna Factor(dB/m) + Cable Factor(dB)
3. The other emission levels were very low against the limit.
4. Margin value = Emission Level – Limit value
5. " * ": Fundamental frequency.
6. " # ": The radiated frequency is out of the restricted band.

802.11ac (VHT40)

CHANNEL	TX Channel 38	DETECTOR FUNCTION	Peak (PK)
FREQUENCY RANGE	1GHz ~ 40GHz		Average (AV)

ANTENNA POLARITY & TEST DISTANCE: HORIZONTAL AT 3 M								
NO.	FREQ. (MHz)	EMISSION LEVEL (dBuV/m)	LIMIT (dBuV/m)	MARGIN (dB)	ANTENNA HEIGHT (m)	TABLE ANGLE (Degree)	RAW VALUE (dBuV)	CORRECTION FACTOR (dB/m)
1	5150.00	63.3 PK	74.0	-10.7	2.10 H	300	57.3	6.0
2	5150.00	51.6 AV	54.0	-2.4	2.10 H	300	45.6	6.0
3	*5190.00	106.1 PK			2.10 H	300	66.0	40.1
4	*5190.00	96.6 AV			2.10 H	300	56.5	40.1
5	#10380.00	58.9 PK	74.0	-15.1	1.61 H	58	41.1	17.8
6	#10380.00	46.0 AV	54.0	-8.0	1.61 H	58	28.2	17.8

ANTENNA POLARITY & TEST DISTANCE: VERTICAL AT 3 M								
NO.	FREQ. (MHz)	EMISSION LEVEL (dBuV/m)	LIMIT (dBuV/m)	MARGIN (dB)	ANTENNA HEIGHT (m)	TABLE ANGLE (Degree)	RAW VALUE (dBuV)	CORRECTION FACTOR (dB/m)
1	5150.00	65.8 PK	74.0	-8.2	1.60 V	169	59.8	6.0
2	5150.00	53.5 AV	54.0	-0.5	1.60 V	169	47.5	6.0
3	*5190.00	116.5 PK			1.60 V	169	76.4	40.1
4	*5190.00	106.6 AV			1.60 V	169	66.5	40.1
5	#10380.00	59.1 PK	74.0	-14.9	1.25 V	104	41.3	17.8
6	#10380.00	46.2 AV	54.0	-7.8	1.25 V	104	28.4	17.8

REMARKS:

1. Emission Level(dBuV/m) = Raw Value(dBuV) + Correction Factor(dB/m)
2. Correction Factor(dB/m) = Antenna Factor(dB/m) + Cable Factor(dB)
3. The other emission levels were very low against the limit.
4. Margin value = Emission Level – Limit value
5. " * ": Fundamental frequency.
6. " # ": The radiated frequency is out of the restricted band.

CHANNEL	TX Channel 46	DETECTOR FUNCTION	Peak (PK)
FREQUENCY RANGE	1GHz ~ 40GHz		Average (AV)

ANTENNA POLARITY & TEST DISTANCE: HORIZONTAL AT 3 M

NO.	FREQ. (MHz)	EMISSION LEVEL (dBuV/m)	LIMIT (dBuV/m)	MARGIN (dB)	ANTENNA HEIGHT (m)	TABLE ANGLE (Degree)	RAW VALUE (dBuV)	CORRECTION FACTOR (dB/m)
1	5150.00	58.9 PK	74.0	-15.1	2.17 H	299	52.9	6.0
2	5150.00	46.2 AV	54.0	-7.8	2.17 H	299	40.2	6.0
3	*5230.00	109.4 PK			2.17 H	299	69.2	40.2
4	*5230.00	99.3 AV			2.17 H	299	59.1	40.2
5	5350.00	55.8 PK	74.0	-18.2	2.17 H	299	49.6	6.2
6	5350.00	43.8 AV	54.0	-10.2	2.17 H	299	37.6	6.2
7	#10460.00	59.5 PK	74.0	-14.5	1.66 H	62	41.5	18.0
8	#10460.00	46.3 AV	54.0	-7.7	1.66 H	62	28.3	18.0

ANTENNA POLARITY & TEST DISTANCE: VERTICAL AT 3 M

NO.	FREQ. (MHz)	EMISSION LEVEL (dBuV/m)	LIMIT (dBuV/m)	MARGIN (dB)	ANTENNA HEIGHT (m)	TABLE ANGLE (Degree)	RAW VALUE (dBuV)	CORRECTION FACTOR (dB/m)
1	5150.00	67.5 PK	74.0	-6.5	1.00 V	171	61.5	6.0
2	5150.00	53.3 AV	54.0	-0.7	1.00 V	171	47.3	6.0
3	*5230.00	119.1 PK			1.00 V	171	78.9	40.2
4	*5230.00	109.3 AV			1.00 V	171	69.1	40.2
5	5350.00	58.2 PK	74.0	-15.8	1.00 V	171	52.0	6.2
6	5350.00	45.8 AV	54.0	-8.2	1.00 V	171	39.6	6.2
7	#10460.00	59.8 PK	74.0	-14.2	1.26 V	87	41.8	18.0
8	#10460.00	47.9 AV	54.0	-6.1	1.26 V	87	29.9	18.0

REMARKS:

1. Emission Level(dBuV/m) = Raw Value(dBuV) + Correction Factor(dB/m)
2. Correction Factor(dB/m) = Antenna Factor(dB/m) + Cable Factor(dB)
3. The other emission levels were very low against the limit.
4. Margin value = Emission Level – Limit value
5. " * ": Fundamental frequency.
6. " # ": The radiated frequency is out of the restricted band.

CHANNEL	TX Channel 151	DETECTOR FUNCTION	Peak (PK)
FREQUENCY RANGE	1GHz ~ 40GHz		Average (AV)

ANTENNA POLARITY & TEST DISTANCE: HORIZONTAL AT 3 M

NO.	FREQ. (MHz)	EMISSION LEVEL (dBuV/m)	LIMIT (dBuV/m)	MARGIN (dB)	ANTENNA HEIGHT (m)	TABLE ANGLE (Degree)	RAW VALUE (dBuV)	CORRECTION FACTOR (dB/m)
1	#5629.60	58.5 PK	68.2	-9.7	1.17 H	141	52.0	6.5
2	*5755.00	112.9 PK			1.17 H	141	71.9	41.0
3	*5755.00	103.4 AV			1.17 H	141	62.4	41.0
4	#5932.00	59.1 PK	68.2	-9.1	1.17 H	141	52.0	7.1
5	11550.00	61.5 PK	74.0	-12.5	1.00 H	77	41.2	20.3
6	11550.00	48.1 AV	54.0	-5.9	1.00 H	77	27.8	20.3

ANTENNA POLARITY & TEST DISTANCE: VERTICAL AT 3 M

NO.	FREQ. (MHz)	EMISSION LEVEL (dBuV/m)	LIMIT (dBuV/m)	MARGIN (dB)	ANTENNA HEIGHT (m)	TABLE ANGLE (Degree)	RAW VALUE (dBuV)	CORRECTION FACTOR (dB/m)
1	#5644.00	67.4 PK	68.2	-0.8	1.25 V	341	60.9	6.5
2	*5755.00	120.5 PK			1.25 V	341	79.5	41.0
3	*5755.00	110.1 AV			1.25 V	341	69.1	41.0
4	#5927.20	62.3 PK	68.2	-5.9	1.25 V	341	55.2	7.1
5	11550.00	61.0 PK	74.0	-13.0	1.07 V	260	40.7	20.3
6	11550.00	48.3 AV	54.0	-5.7	1.07 V	260	28.0	20.3

REMARKS:

1. Emission Level(dBuV/m) = Raw Value(dBuV) + Correction Factor(dB/m)
2. Correction Factor(dB/m) = Antenna Factor(dB/m) + Cable Factor(dB)
3. The other emission levels were very low against the limit.
4. Margin value = Emission Level – Limit value
5. " * ": Fundamental frequency.
6. " # ": The radiated frequency is out of the restricted band.

CHANNEL	TX Channel 159	DETECTOR FUNCTION	Peak (PK)
FREQUENCY RANGE	1GHz ~ 40GHz		Average (AV)

ANTENNA POLARITY & TEST DISTANCE: HORIZONTAL AT 3 M

NO.	FREQ. (MHz)	EMISSION LEVEL (dBuV/m)	LIMIT (dBuV/m)	MARGIN (dB)	ANTENNA HEIGHT (m)	TABLE ANGLE (Degree)	RAW VALUE (dBuV)	CORRECTION FACTOR (dB/m)
1	#5642.40	57.5 PK	68.2	-10.7	1.06 H	138	51.0	6.5
2	*5795.00	114.7 PK			1.06 H	138	73.6	41.1
3	*5795.00	104.5 AV			1.06 H	138	63.4	41.1
4	#5938.40	59.1 PK	68.2	-9.1	1.06 H	138	52.0	7.1
5	11590.00	61.5 PK	74.0	-12.5	1.00 H	81	41.3	20.2
6	11590.00	48.3 AV	54.0	-5.7	1.00 H	81	28.1	20.2

ANTENNA POLARITY & TEST DISTANCE: VERTICAL AT 3 M

NO.	FREQ. (MHz)	EMISSION LEVEL (dBuV/m)	LIMIT (dBuV/m)	MARGIN (dB)	ANTENNA HEIGHT (m)	TABLE ANGLE (Degree)	RAW VALUE (dBuV)	CORRECTION FACTOR (dB/m)
1	#5641.60	60.4 PK	68.2	-7.8	1.00 V	54	53.9	6.5
2	*5795.00	121.8 PK			1.00 V	54	80.7	41.1
3	*5795.00	111.3 AV			1.00 V	54	70.2	41.1
4	#5930.40	62.5 PK	68.2	-5.7	1.00 V	54	55.4	7.1
5	11590.00	61.1 PK	74.0	-12.9	1.09 V	258	40.9	20.2
6	11590.00	48.4 AV	54.0	-5.6	1.09 V	258	28.2	20.2

REMARKS:

1. Emission Level(dBuV/m) = Raw Value(dBuV) + Correction Factor(dB/m)
2. Correction Factor(dB/m) = Antenna Factor(dB/m) + Cable Factor(dB)
3. The other emission levels were very low against the limit.
4. Margin value = Emission Level – Limit value
5. " * ": Fundamental frequency.
6. " # ": The radiated frequency is out of the restricted band.

802.11ac (VHT80)

CHANNEL	TX Channel 42	DETECTOR FUNCTION	Peak (PK)
FREQUENCY RANGE	1GHz ~ 40GHz		Average (AV)

ANTENNA POLARITY & TEST DISTANCE: HORIZONTAL AT 3 M								
NO.	FREQ. (MHz)	EMISSION LEVEL (dBuV/m)	LIMIT (dBuV/m)	MARGIN (dB)	ANTENNA HEIGHT (m)	TABLE ANGLE (Degree)	RAW VALUE (dBuV)	CORRECTION FACTOR (dB/m)
1	5139.00	60.2 PK	74.0	-13.8	2.26 H	330	54.2	6.0
2	5139.00	47.7 AV	54.0	-6.3	2.26 H	330	41.7	6.0
3	*5210.00	101.6 PK			2.26 H	330	61.5	40.1
4	*5210.00	92.1 AV			2.26 H	330	52.0	40.1
5	5350.00	56.4 PK	74.0	-17.6	2.26 H	330	50.2	6.2
6	5350.00	43.9 AV	54.0	-10.1	2.26 H	330	37.7	6.2
7	#10420.00	59.4 PK	74.0	-14.6	1.68 H	16	41.4	18.0
8	#10420.00	46.4 AV	54.0	-7.6	1.68 H	16	28.4	18.0

ANTENNA POLARITY & TEST DISTANCE: VERTICAL AT 3 M								
NO.	FREQ. (MHz)	EMISSION LEVEL (dBuV/m)	LIMIT (dBuV/m)	MARGIN (dB)	ANTENNA HEIGHT (m)	TABLE ANGLE (Degree)	RAW VALUE (dBuV)	CORRECTION FACTOR (dB/m)
1	5139.00	67.5 PK	74.0	-6.5	1.39 V	203	61.5	6.0
2	5139.00	53.8 AV	54.0	-0.2	1.39 V	203	47.8	6.0
3	*5210.00	110.9 PK			1.39 V	203	70.8	40.1
4	*5210.00	101.3 AV			1.39 V	203	61.2	40.1
5	5350.00	59.4 PK	74.0	-14.6	1.39 V	203	53.2	6.2
6	5350.00	47.5 AV	54.0	-6.5	1.39 V	203	41.3	6.2
7	#10420.00	59.2 PK	74.0	-14.8	1.17 V	124	41.2	18.0
8	#10420.00	46.6 AV	54.0	-7.4	1.17 V	124	28.6	18.0

REMARKS:

1. Emission Level(dBuV/m) = Raw Value(dBuV) + Correction Factor(dB/m)
2. Correction Factor(dB/m) = Antenna Factor(dB/m) + Cable Factor(dB)
3. The other emission levels were very low against the limit.
4. Margin value = Emission Level – Limit value
5. " * ": Fundamental frequency.
6. " # ": The radiated frequency is out of the restricted band.

CHANNEL	TX Channel 155	DETECTOR FUNCTION	Peak (PK)
FREQUENCY RANGE	1GHz ~ 40GHz		Average (AV)

ANTENNA POLARITY & TEST DISTANCE: HORIZONTAL AT 3 M

NO.	FREQ. (MHz)	EMISSION LEVEL (dBuV/m)	LIMIT (dBuV/m)	MARGIN (dB)	ANTENNA HEIGHT (m)	TABLE ANGLE (Degree)	RAW VALUE (dBuV)	CORRECTION FACTOR (dB/m)
1	#5635.20	63.3 PK	68.2	-4.9	1.00 H	144	56.8	6.5
2	*5775.00	108.2 PK			1.06 H	144	67.2	41.0
3	*5775.00	98.3 AV			1.06 H	144	57.3	41.0
4	#5936.80	60.2 PK	68.2	-8.0	1.06 H	144	53.1	7.1
5	11550.00	61.8 PK	74.0	-12.2	1.00 H	98	41.5	20.3
6	11550.00	48.4 AV	54.0	-5.6	1.00 H	98	28.1	20.3

ANTENNA POLARITY & TEST DISTANCE: VERTICAL AT 3 M

NO.	FREQ. (MHz)	EMISSION LEVEL (dBuV/m)	LIMIT (dBuV/m)	MARGIN (dB)	ANTENNA HEIGHT (m)	TABLE ANGLE (Degree)	RAW VALUE (dBuV)	CORRECTION FACTOR (dB/m)
1	#5650.40	68.3 PK	68.5	-0.2	1.00 V	49	61.8	6.5
2	*5775.00	115.1 PK			1.00 V	49	74.1	41.0
3	*5775.00	105.3 AV			1.00 V	49	64.3	41.0
4	#5939.20	60.9 PK	68.2	-7.3	1.00 V	49	53.8	7.1
5	11550.00	61.1 PK	74.0	-12.9	1.05 V	266	40.8	20.3
6	11550.00	48.6 AV	54.0	-5.4	1.05 V	266	28.3	20.3

REMARKS:

1. Emission Level(dBuV/m) = Raw Value(dBuV) + Correction Factor(dB/m)
2. Correction Factor(dB/m) = Antenna Factor(dB/m) + Cable Factor(dB)
3. The other emission levels were very low against the limit.
4. Margin value = Emission Level – Limit value
5. " * ": Fundamental frequency.
6. " # ": The radiated frequency is out of the restricted band.

Below 1GHz Worst-Case Data: 802.11a

CHANNEL	TX Channel 149	DETECTOR FUNCTION	Quasi-Peak (QP)
FREQUENCY RANGE	9kHz ~ 1GHz	TEST MODE	A

ANTENNA POLARITY & TEST DISTANCE: HORIZONTAL AT 3 M								
NO.	FREQ. (MHz)	EMISSION LEVEL (dBuV/m)	LIMIT (dBuV/m)	MARGIN (dB)	ANTENNA HEIGHT (m)	TABLE ANGLE (Degree)	RAW VALUE (dBuV)	CORRECTION FACTOR (dB/m)
1	124.98	33.7 QP	43.5	-9.8	2.00 H	121	49.4	-15.7
2	249.17	33.6 QP	46.0	-12.4	1.00 H	126	47.8	-14.2
3	353.95	35.7 QP	46.0	-10.3	1.00 H	217	47.2	-11.5
4	590.68	36.9 QP	46.0	-9.1	1.50 H	172	43.5	-6.6
5	790.54	37.3 QP	46.0	-8.7	1.00 H	174	39.7	-2.4
6	939.95	33.5 QP	46.0	-12.5	1.50 H	330	33.5	0.0

ANTENNA POLARITY & TEST DISTANCE: VERTICAL AT 3 M								
NO.	FREQ. (MHz)	EMISSION LEVEL (dBuV/m)	LIMIT (dBuV/m)	MARGIN (dB)	ANTENNA HEIGHT (m)	TABLE ANGLE (Degree)	RAW VALUE (dBuV)	CORRECTION FACTOR (dB/m)
1	45.42	35.2 QP	40.0	-4.8	1.00 V	13	49.6	-14.4
2	249.17	31.7 QP	46.0	-14.3	1.24 V	185	45.9	-14.2
3	355.89	31.3 QP	46.0	-14.7	1.49 V	114	42.8	-11.5
4	588.74	33.5 QP	46.0	-12.5	1.00 V	115	40.1	-6.6
5	798.30	33.7 QP	46.0	-12.3	1.24 V	310	35.9	-2.2
6	939.95	32.5 QP	46.0	-13.5	1.00 V	151	32.5	0.0

REMARKS:

1. Emission Level(dBuV/m) = Raw Value(dBuV) + Correction Factor(dB/m)
2. Correction Factor(dB/m) = Antenna Factor(dB/m) + Cable Factor(dB)
3. The other emission levels were very low against the limit.
4. Margin value = Emission Level – Limit value

CHANNEL	TX Channel 149	DETECTOR FUNCTION	Quasi-Peak (QP)
FREQUENCY RANGE	9kHz ~ 1GHz	TEST MODE	B

ANTENNA POLARITY & TEST DISTANCE: HORIZONTAL AT 3 M								
NO.	FREQ. (MHz)	EMISSION LEVEL (dBuV/m)	LIMIT (dBuV/m)	MARGIN (dB)	ANTENNA HEIGHT (m)	TABLE ANGLE (Degree)	RAW VALUE (dBuV)	CORRECTION FACTOR (dB/m)
1	124.98	30.2 QP	43.5	-13.3	2.00 H	197	45.9	-15.7
2	249.17	35.4 QP	46.0	-10.6	1.24 H	159	49.6	-14.2
3	352.01	35.4 QP	46.0	-10.6	1.00 H	180	46.8	-11.4
4	637.25	36.3 QP	46.0	-9.7	1.24 H	335	41.7	-5.4
5	722.62	37.1 QP	46.0	-8.9	1.00 H	278	41.1	-4.0
6	932.19	31.9 QP	46.0	-14.1	1.50 H	178	32.2	-0.3

ANTENNA POLARITY & TEST DISTANCE: VERTICAL AT 3 M								
NO.	FREQ. (MHz)	EMISSION LEVEL (dBuV/m)	LIMIT (dBuV/m)	MARGIN (dB)	ANTENNA HEIGHT (m)	TABLE ANGLE (Degree)	RAW VALUE (dBuV)	CORRECTION FACTOR (dB/m)
1	55.13	31.5 QP	40.0	-8.5	1.49 V	10	45.8	-14.3
2	124.98	34.6 QP	43.5	-8.9	1.00 V	157	50.3	-15.7
3	353.95	32.9 QP	46.0	-13.1	1.00 V	220	44.2	-11.3
4	652.77	36.6 QP	46.0	-9.4	1.00 V	73	42.0	-5.4
5	722.62	39.0 QP	46.0	-7.0	2.00 V	170	43.0	-4.0
6	932.19	31.1 QP	46.0	-14.9	2.00 V	157	31.4	-0.3

REMARKS:

1. Emission Level(dBuV/m) = Raw Value(dBuV) + Correction Factor(dB/m)
2. Correction Factor(dB/m) = Antenna Factor(dB/m) + Cable Factor(dB)
3. The other emission levels were very low against the limit.
4. Margin value = Emission Level – Limit value

4.2 Conducted Emission Measurement

4.2.1 Limits of Conducted Emission Measurement

Frequency (MHz)	Conducted Limit (dBuV)	
	Quasi-peak	Average
0.15 - 0.5	66 - 56	56 - 46
0.50 - 5.0	56	46
5.0 - 30.0	60	50

Note: 1. The lower limit shall apply at the transition frequencies.

2. The limit decreases in line with the logarithm of the frequency in the range of 0.15 to 0.50MHz.

4.2.2 Test Instruments

Description & Manufacturer	Model No.	Serial No.	Cal. Date	Cal. Due
Test Receiver ROHDE & SCHWARZ	ESCS 30	100288	Aug. 18, 2016	Aug. 17, 2017
RF signal cable (with 10dB PAD) Woken	5D-FB	Cable-cond2-01	Dec. 22, 2016	Dec. 21, 2017
LISN ROHDE & SCHWARZ (EUT)	ESH3-Z5	835239/001	Feb. 26, 2016	Feb. 25, 2017
LISN ROHDE & SCHWARZ (Peripheral)	ESH3-Z5	100312	Jul. 26, 2016	Jul. 25, 2017
Software ADT	BV ADT_Cond_ V7.3.7.3	NA	NA	NA

Note: 1. The calibration interval of the above test instruments is 12 months and the calibrations are traceable to NML/ROC and NIST/USA.

2. The test was performed in HwaYa Shielded Room 2.

3. The VCCI Site Registration No. is C-2047.

4.2.3 Test Procedure

- The EUT was placed 0.4 meters from the conducting wall of the shielded room with EUT being connected to the power mains through a line impedance stabilization network (LISN). Other support units were connected to the power mains through another LISN. The two LISNs provide 50 ohm/ 50uH of coupling impedance for the measuring instrument.
- Both lines of the power mains connected to the EUT were checked for maximum conducted interference.
- The frequency range from 150kHz to 30MHz was searched. Emission levels under (Limit - 20dB) was not recorded.

NOTE: The resolution bandwidth and video bandwidth of test receiver is 9kHz for quasi-peak detection (QP) and average detection (AV) at frequency 0.15MHz-30MHz.

4.2.4 Deviation from Test Standard

No deviation.

4.2.5 Test Setup

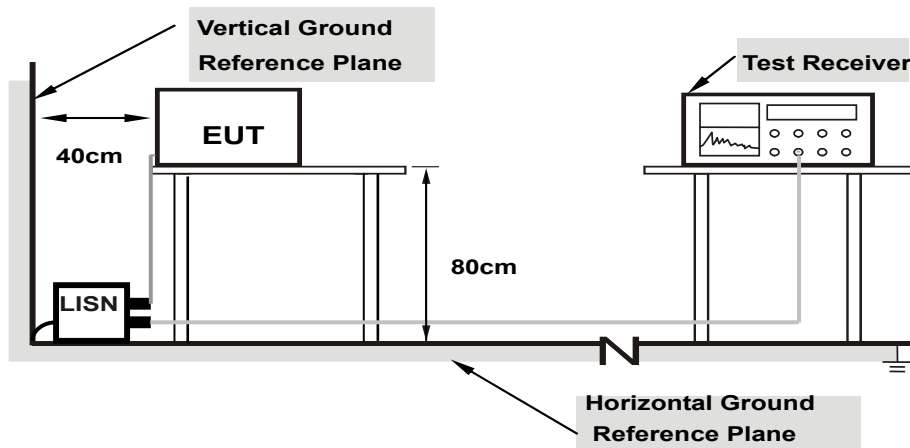

- Note:**
- Support units were connected to second LISN.
 - Both of LISNs (AMN) are 80 cm from EUT and at least 80 from other units and other metal planes

For the actual test configuration, please refer to the attached file (Test Setup Photo).

4.2.6 EUT Operating Conditions

Same as 4.1.6.

4.2.7 Test Results

Phase	Line (L)	Detector Function	Quasi-Peak (QP) / Average (AV)
Test Mode	A		

No	Freq. [MHz]	Corr. Factor (dB)	Reading Value		Emission Level		Limit		Margin	
			[dB (uV)]		[dB (uV)]		[dB (uV)]		(dB)	
			Q.P.	AV.	Q.P.	AV.	Q.P.	AV.	Q.P.	AV.
1	0.15781	10.18	36.43	24.99	46.61	35.17	65.58	55.58	-18.97	-20.41
2	0.17734	10.20	33.15	20.69	43.35	30.89	64.61	54.61	-21.26	-23.72
3	0.32188	10.23	23.41	16.80	33.64	27.03	59.66	49.66	-26.02	-22.63
4	0.48203	10.25	29.22	25.37	39.47	35.62	56.30	46.30	-16.83	-10.68
5	7.22656	10.47	23.59	18.35	34.06	28.82	60.00	50.00	-25.94	-21.18
6	11.83203	10.55	18.39	11.24	28.94	21.79	60.00	50.00	-31.06	-28.21

REMARKS:

1. Q.P. and AV. are abbreviations of quasi-peak and average individually.
2. The emission levels of other frequencies were very low against the limit.
3. Margin value = Emission level - Limit value
4. Correction factor = Insertion loss + Cable loss
5. Emission Level = Correction Factor + Reading Value.

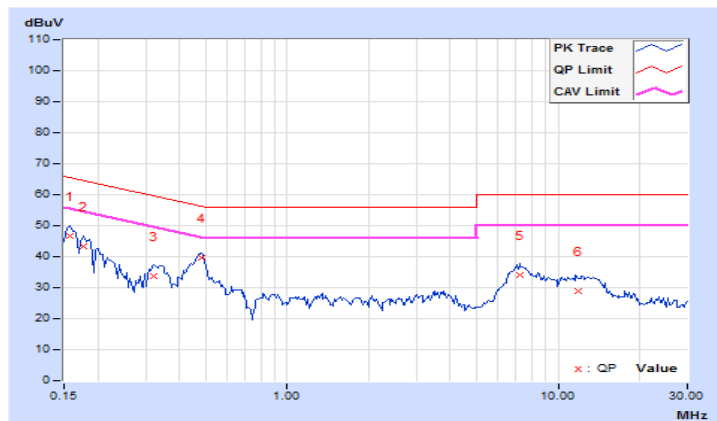

Phase	Neutral (N)	Detector Function	Quasi-Peak (QP) / Average (AV)
Test Mode	A		

No	Freq. [MHz]	Corr. Factor (dB)	Reading Value [dB (uV)]		Emission Level [dB (uV)]		Limit [dB (uV)]		Margin (dB)	
			Q.P.	AV.	Q.P.	AV.	Q.P.	AV.	Q.P.	AV.
			1	0.16172	10.19	37.54	25.15	47.73	35.34	65.38
2	0.34922	10.27	22.06	16.64	32.33	26.91	58.98	48.98	-26.65	-22.07
3	0.48203	10.30	27.52	23.85	37.82	34.15	56.30	46.30	-18.48	-12.15
4	3.32031	10.50	11.27	1.98	21.77	12.48	56.00	46.00	-34.23	-33.52
5	7.11328	10.58	25.72	20.85	36.30	31.43	60.00	50.00	-23.70	-18.57
6	13.85156	10.70	23.75	17.58	34.45	28.28	60.00	50.00	-25.55	-21.72

REMARKS:

1. Q.P. and AV. are abbreviations of quasi-peak and average individually.
2. The emission levels of other frequencies were very low against the limit.
3. Margin value = Emission level - Limit value
4. Correction factor = Insertion loss + Cable loss
5. Emission Level = Correction Factor + Reading Value.

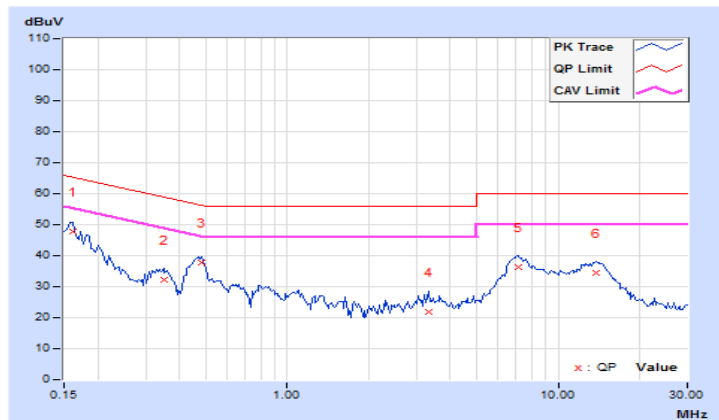

Phase	Line (L)	Detector Function	Quasi-Peak (QP) / Average (AV)
Test Mode	B		

No	Freq. [MHz]	Corr. Factor (dB)	Reading Value [dB (uV)]		Emission Level [dB (uV)]		Limit [dB (uV)]		Margin (dB)	
			Q.P.	AV.	Q.P.	AV.	Q.P.	AV.	Q.P.	AV.
			1	0.16172	10.19	33.25	22.71	43.44	32.90	65.38
2	0.30234	10.23	34.56	25.78	44.79	36.01	60.18	50.18	-15.39	-14.17
3	0.45469	10.25	19.82	13.65	30.07	23.90	56.79	46.79	-26.72	-22.89
4	1.47656	10.34	9.40	1.43	19.74	11.77	56.00	46.00	-36.26	-34.23
5	6.42969	10.46	10.72	2.36	21.18	12.82	60.00	50.00	-38.82	-37.18
6	10.42969	10.53	12.08	6.87	22.61	17.40	60.00	50.00	-37.39	-32.60

REMARKS:

1. Q.P. and AV. are abbreviations of quasi-peak and average individually.
2. The emission levels of other frequencies were very low against the limit.
3. Margin value = Emission level - Limit value
4. Correction factor = Insertion loss + Cable loss
5. Emission Level = Correction Factor + Reading Value.

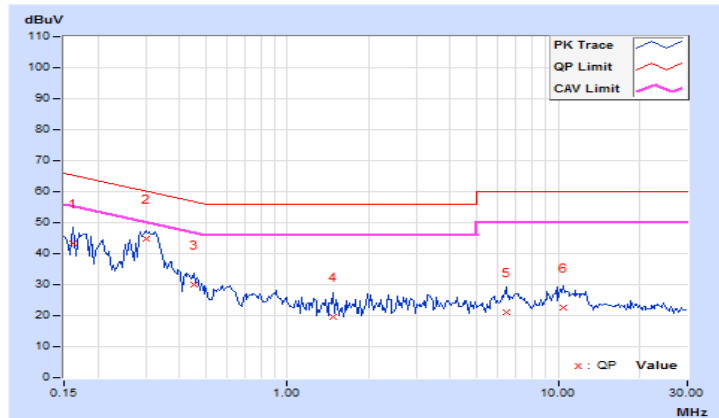

Phase	Neutral (N)	Detector Function	Quasi-Peak (QP) / Average (AV)
Test Mode	B		

No	Freq. [MHz]	Corr. Factor (dB)	Reading Value [dB (uV)]		Emission Level [dB (uV)]		Limit [dB (uV)]		Margin (dB)	
			Q.P.	AV.	Q.P.	AV.	Q.P.	AV.	Q.P.	AV.
			1	0.16562	10.19	33.41	21.48	43.60	31.67	65.18
2	0.29453	10.25	36.01	28.83	46.26	39.08	60.40	50.40	-14.14	-11.32
3	0.42344	10.30	22.14	15.78	32.44	26.08	57.38	47.38	-24.94	-21.30
4	0.62656	10.30	16.65	10.62	26.95	20.92	56.00	46.00	-29.05	-25.08
5	6.77734	10.58	11.99	3.89	22.57	14.47	60.00	50.00	-37.43	-35.53
6	9.85547	10.61	11.28	6.07	21.89	16.68	60.00	50.00	-38.11	-33.32

REMARKS:

1. Q.P. and AV. are abbreviations of quasi-peak and average individually.
2. The emission levels of other frequencies were very low against the limit.
3. Margin value = Emission level - Limit value
4. Correction factor = Insertion loss + Cable loss
5. Emission Level = Correction Factor + Reading Value.

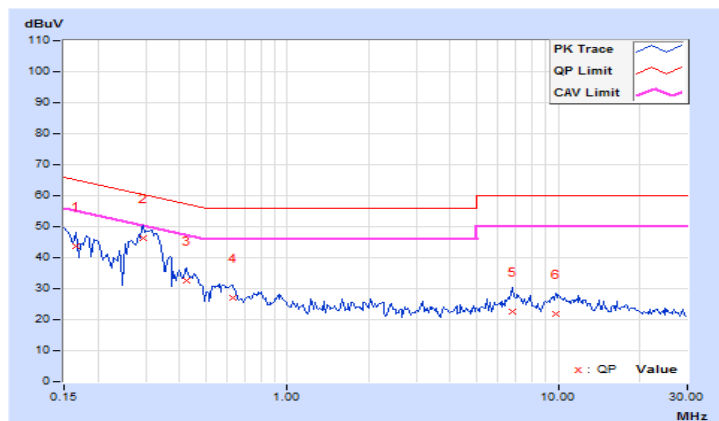

4.3 Transmit Power Measurement

4.3.1 Limits of Transmit Power Measurement

Operation Band	EUT Category		LIMIT
U-NII-1		Outdoor Access Point	1 Watt (30 dBm) (Max. e.i.r.p \leq 125mW (21 dBm) at any elevation angle above 30 degrees as measured from the horizon)
		Fixed point-to-point Access Point	1 Watt (30 dBm)
	√	Indoor Access Point	1 Watt (30 dBm)
		Mobile and Portable client device	250mW (24 dBm)
U-NII-2A	---		250mW (24 dBm) or 11 dBm+10 log B*
U-NII-2C	---		250mW (24 dBm) or 11 dBm+10 log B*
U-NII-3	√		1 Watt (30 dBm)

*B is the 26 dB emission bandwidth in megahertz

Per KDB 662911 Method of conducted output power measurement on IEEE 802.11 devices,

Array Gain = 0 dB (i.e., no array gain) for $N_{ANT} \leq 4$;

Array Gain = 0 dB (i.e., no array gain) for channel widths ≥ 40 MHz for any N_{ANT} ;

Array Gain = $5 \log(N_{ANT}/N_{SS})$ dB or 3 dB, whichever is less for 20-MHz channel widths with $N_{ANT} \geq 5$.

For power measurements on all other devices: Array Gain = $10 \log(N_{ANT}/N_{SS})$ dB.

4.3.2 Test Setup

For Power Output Measurement

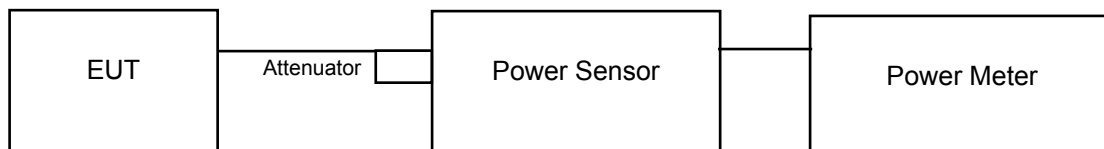

For 26dB and Occupied Bandwidth

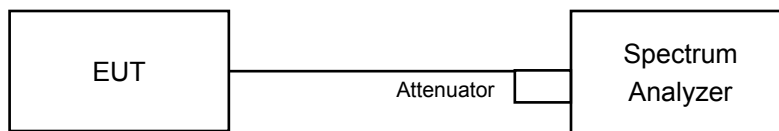

4.3.3 Test Instruments

Refer to section 4.1.2 to get information of above instrument.

4.3.4 Test Procedure

For Average Power Measurement

For 802.11a, 802.11ac (VHT20), 802.11ac (VHT40)

Method PM is used to perform output power measurement, trigger and gating function of wide band power meter is enabled to measure max output power of TX on burst. Duty factor is not added to measured value.

For 802.11ac (VHT80)

- a. Set span to encompass the entire 26 dB EBW (or, alternatively, the entire 99% occupied bandwidth) of the signal.
- b. Set sweep trigger to "free run".
- c. Set RBW = 1 MHz
- d. Set VBW \geq 3 MHz
- e. Number of points in sweep \geq 2 Span / RBW
- f. Sweep time \leq (number of points in sweep) * T
- g. Using emission bandwidth to determine the frequency span for integration the channel bandwidth.
- h. Detector = RMS
- i. Trace mode = max hold
- j. Allow max hold to run for at least 60 seconds, or longer as needed to allow the trace to stabilize.

For Occupied Bandwidth

The transmitter output was connected to the spectrum analyzer through an attenuator. The bandwidth of the fundamental frequency was measured by spectrum analyzer with resolution bandwidth in the range of 1% to 5% of the anticipated emission bandwidth, and a video bandwidth at least 3x the resolution bandwidth and set the detector to Sampling. The width of a frequency band such that, below the lower and above the upper frequency limits, the mean powers emitted are each equal to a specified percentage 0.5 %of the total mean power of a given emission.

4.3.5 Deviation from Test Standard

No deviation.

4.3.6 EUT Operating Conditions

The software provided by client to enable the EUT under transmission Condition continuously at lowest, middle and highest channel frequencies individually.

4.3.7 Test Result

Power Output:

CDD Mode

802.11a

Channel	Frequency (MHz)	Maximum Conducted Power (dBm)		Total Power (mW)	Total Power (dBm)	Power Limit (dBm)	Pass / Fail
		Chain 0	Chain 1				
36	5180	23.84	23.90	487.574	26.88	30	Pass
40	5200	26.33	26.47	873.145	29.41	30	Pass
48	5240	26.03	26.11	809.186	29.08	30	Pass
149	5745	26.30	26.35	858.099	29.34	30	Pass
157	5785	26.27	26.32	852.192	29.31	30	Pass
165	5825	26.24	26.40	857.243	29.33	30	Pass

802.11ac (VHT20)

Channel	Frequency (MHz)	Maximum Conducted Power (dBm)		Total Power (mW)	Total Power (dBm)	Power Limit (dBm)	Pass / Fail
		Chain 0	Chain 1				
36	5180	23.79	23.93	486.504	26.87	30	Pass
40	5200	26.25	26.37	855.208	29.32	30	Pass
48	5240	26.09	26.12	815.704	29.12	30	Pass
149	5745	26.08	26.48	850.140	29.29	30	Pass
157	5785	26.37	26.51	881.224	29.45	30	Pass
165	5825	26.19	26.37	849.422	29.29	30	Pass

802.11ac (VHT40)

Channel	Frequency (MHz)	Maximum Conducted Power (dBm)		Total Power (mW)	Total Power (dBm)	Power Limit (dBm)	Pass / Fail
		Chain 0	Chain 1				
38	5190	21.80	21.88	305.526	24.85	30	Pass
46	5230	24.78	24.91	610.350	27.86	30	Pass
151	5755	26.21	26.50	864.514	29.37	30	Pass
159	5795	26.30	26.52	875.325	29.42	30	Pass

802.11ac (VHT80)

Channel	Frequency (MHz)	Maximum Conducted Power (dBm)		Total Power (mW)	Total Power (dBm)	Power Limit (dBm)	Pass / Fail
		Chain 0	Chain 1				
42	5210	20.92	21.60	268.139	24.28	30	Pass
155	5775	24.14	24.17	520.634	27.17	30	Pass

Beamforming Mode

802.11ac (VHT20)

Channel	Frequency (MHz)	Maximum Conducted Power (dBm)		Total Power (mW)	Total Power (dBm)	Power Limit (dBm)	Pass / Fail
		Chain 0	Chain 1				
36	5180	23.79	23.93	486.504	26.87	30.00	Pass
40	5200	26.25	26.37	855.208	29.32	30.00	Pass
48	5240	26.09	26.12	815.704	29.12	30.00	Pass
149	5745	26.08	26.48	850.140	29.29	29.906	Pass
157	5785	26.37	26.51	881.224	29.45	29.906	Pass
165	5825	26.19	26.37	849.422	29.29	29.906	Pass

For U-NII-1: Directional gain = 5.021dBi < 6dBi, so the limit no need to reduced.

For U-NII-3: Directional gain = 6.094dBi > 6dBi, so the limit shall be reduced to $30 - (6.094 - 6) = 29.906$ dBm.

802.11ac (VHT40)

Channel	Frequency (MHz)	Maximum Conducted Power (dBm)		Total Power (mW)	Total Power (dBm)	Power Limit (dBm)	Pass / Fail
		Chain 0	Chain 1				
38	5190	21.02	21.16	257.091	24.10	30.00	Pass
46	5230	23.59	23.56	455.546	26.59	30.00	Pass
151	5755	25.77	25.59	739.815	28.69	29.906	Pass
159	5795	26.30	26.52	875.325	29.42	29.906	Pass

For U-NII-1: Directional gain = 5.021dBi < 6dBi, so the limit no need to reduced.

For U-NII-3: Directional gain = 6.094dBi > 6dBi, so the limit shall be reduced to $30 - (6.094 - 6) = 29.906$ dBm.

802.11ac (VHT80)

Channel	Frequency (MHz)	Maximum Conducted Power (dBm)		Total Power (mW)	Total Power (dBm)	Power Limit (dBm)	Pass / Fail
		Chain 0	Chain 1				
42	5210	20.11	20.15	206.079	23.14	30.00	Pass
155	5775	21.85	21.96	310.145	24.92	29.906	Pass

For U-NII-1: Directional gain = 5.021dBi < 6dBi, so the limit no need to reduced.

For U-NII-3: Directional gain = 6.094dBi > 6dBi, so the limit shall be reduced to $30 - (6.094 - 6) = 29.906$ dBm.

26dB Bandwidth:

802.11a

Channel	Frequency (MHz)	26dBc Bandwidth (MHz)	
		Chain 0	Chain 1
36	5180	20.33	20.48
40	5200	30.40	38.80
48	5240	25.54	21.74

802.11ac (VHT20)

Channel	Frequency (MHz)	26dBc Bandwidth (MHz)	
		Chain 0	Chain 1
36	5180	20.84	21.09
40	5200	27.28	38.38
48	5240	23.38	21.65

802.11ac (VHT40)

Channel	Frequency (MHz)	26dBc Bandwidth (MHz)	
		Chain 0	Chain 1
38	5190	40.74	40.70
46	5230	81.67	71.85

802.11ac (VHT80)

Channel	Frequency (MHz)	26dBc Bandwidth (MHz)	
		Chain 0	Chain 1
42	5210	83.53	83.07

Spectrum Plot of Worst Value

802.11a

802.11ac (VHT20)

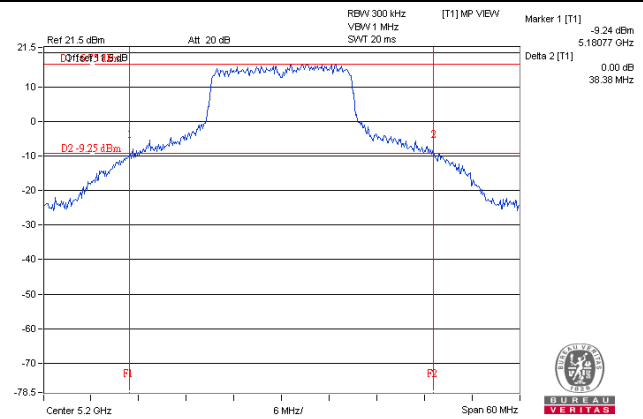
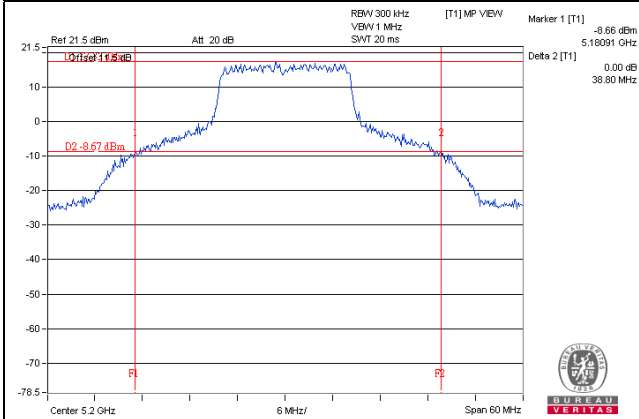

802.11ac (VHT40)

802.11ac (VHT80)

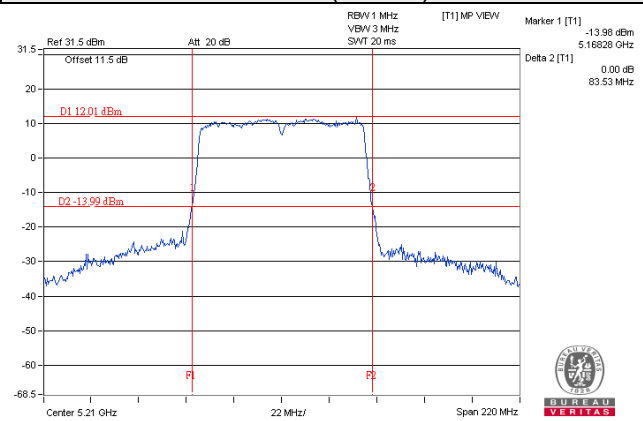
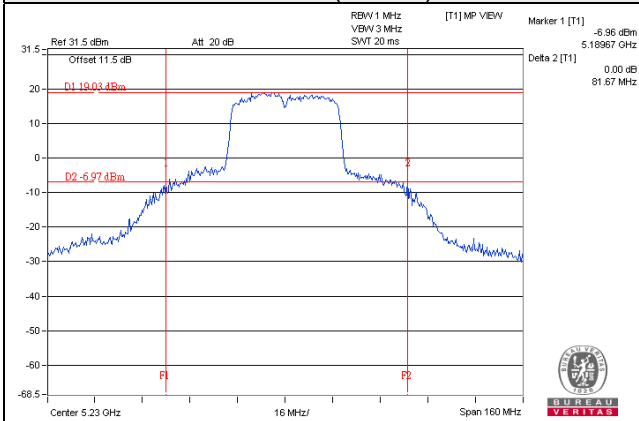

Occupied Bandwidth:

802.11a

Channel	Frequency (MHz)	Occupied Bandwidth (MHz)	
		Chain 0	Chain 1
36	5180	16.56	16.56
40	5200	17.04	20.16
48	5240	16.80	16.68
149	5745	17.28	17.64
157	5785	17.28	19.68
165	5825	18.36	22.44

802.11ac (VHT20)

Channel	Frequency (MHz)	Occupied Bandwidth (MHz)	
		Chain 0	Chain 1
36	5180	17.76	17.76
40	5200	17.88	19.44
48	5240	17.88	17.76
149	5745	18.00	18.36
157	5785	18.12	20.28
165	5825	19.56	21.60

802.11ac (VHT40)

Channel	Frequency (MHz)	Occupied Bandwidth (MHz)	
		Chain 0	Chain 1
38	5190	36.24	36.24
46	5230	36.72	36.72
151	5755	37.08	38.28
159	5795	37.32	39.84

802.11ac (VHT80)

Channel	Frequency (MHz)	Occupied Bandwidth (MHz)	
		Chain 0	Chain 1
42	5210	76.08	75.84
155	5775	75.84	75.60

Spectrum Plot of Worst Value

802.11a

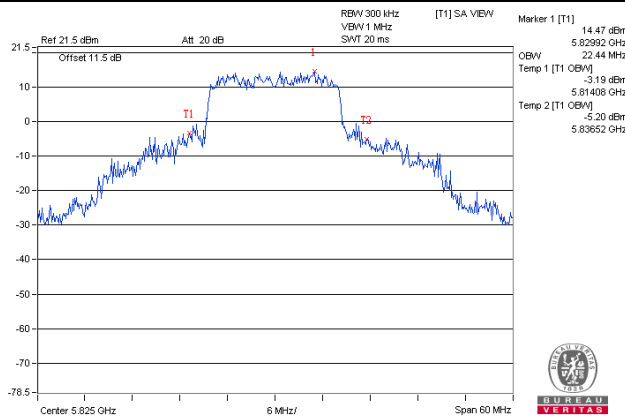

802.11ac (VHT20)

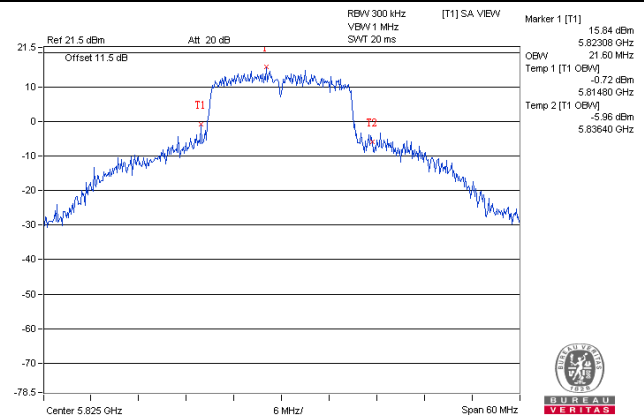

802.11ac (VHT40)

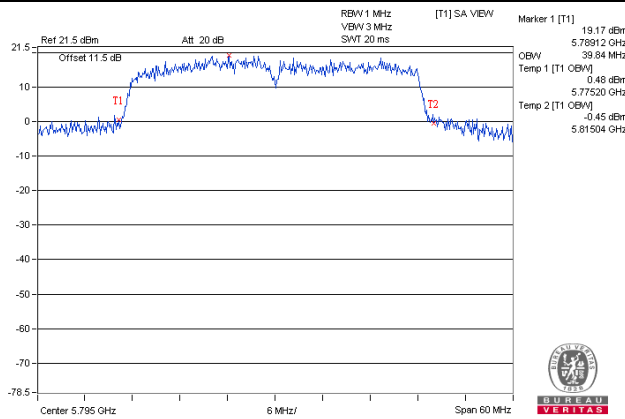

802.11ac (VHT80)

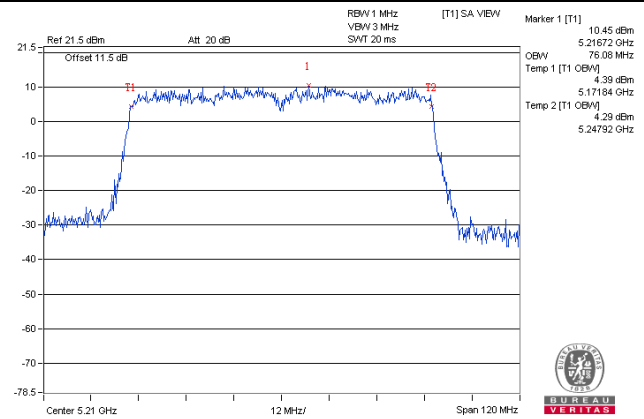

4.4 Peak Power Spectral Density Measurement

4.4.1 Limits of Peak Power Spectral Density Measurement

Operation Band	EUT Category		LIMIT
U-NII-1		Outdoor Access Point	17dBm/ MHz
		Fixed point-to-point Access Point	
	√	Indoor Access Point	
		Mobile and Portable client device	11dBm/ MHz
U-NII-2A	---		11dBm/ MHz
U-NII-2C	---		11dBm/ MHz
U-NII-3	√		30dBm/ 500kHz

4.4.2 Test Setup

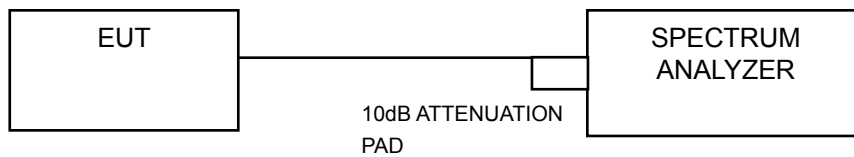

4.4.3 Test Instruments

Refer to section 4.1.2 to get information of above instrument.

4.4.4 Test Procedure

For U-NII-1 band:

Duty cycle of test signal is $\geq 98\%$

Using method SA-1

- 1) Set span to encompass the entire emission bandwidth (EBW) of the signal.
- 2) Set RBW = 1MHz, Set VBW ≥ 3 MHz, Detector = RMS
- 3) Set Channel power measure = 1MHz
- 4) Sweep time = auto, trigger set to "free run".
- 5) Trace average at least 100 traces in power averaging mode.
- 6) Record the max value

Duty cycle of test signal is $< 98\%$

Using method SA-2

- 1) Set span to encompass the entire emission bandwidth (EBW) of the signal.
- 2) Set RBW = 1MHz, Set VBW ≥ 3 MHz, Detector = RMS
- 3) Set Channel power measure = 1MHz
- 4) Sweep time = auto, trigger set to "free run".
- 5) Trace average at least 100 traces in power averaging mode.
- 6) Record the max value and add $10 \log (1/\text{duty cycle})$

For U-NII-3 band:

- 1) Set span to encompass the entire emission bandwidth (EBW) of the signal.
- 2) Set RBW = 300 kHz, Set VBW ≥ 1 RBW, Detector = RMS
- 3) Sweep time = auto, trigger set to "free run".
- 4) Trace average at least 100 traces in power averaging mode.
- 5) Record the max value and add $10 \log (1/\text{duty cycle})$
- 6) Scale the observed power level to an equivalent value in 500 kHz by adjusting (reducing) the measured power by a bandwidth correction factor (BWCF) where $\text{BWCF} = 10 \log (500 \text{ kHz} / 300 \text{ kHz})$

4.4.5 Deviation from Test Standard

No deviation.

4.4.6 EUT Operating Condition

Same as Item 4.3.6.

4.4.7 Test Results

For U-NII-1 Band

802.11a

Chan.	Freq. (MHz)	PSD (dBm)		Total PSD w/o duty factor (dBm)	Duty factor	Total PSD with duty factor (dBm)	Max. Limit (dBm)	Pass / Fail
		Chain 0	Chain 1					
36	5180	9.24	8.53	11.91	0.20	12.11	17.00	Pass
40	5200	11.89	10.88	14.42	0.20	14.62	17.00	Pass
48	5240	9.40	9.05	12.23	0.20	12.43	17.00	Pass

Note:

1. Method 1 of power density measurement of KDB 662911 is using for calculating total power density. Total power density is summing entire spectra across corresponding frequency bins on the various outputs by computer.
2. Directional gain = 5.021dBi < 6dBi, so the limit no need to reduced.
3. Refer to section 3.3 for duty cycle spectrum plot.

802.11ac (VHT20)

Chan.	Freq. (MHz)	PSD (dBm)		Total PSD (dBm)	Max. Limit (dBm)	Pass / Fail
		Chain 0	Chain 1			
36	5180	8.70	8.08	11.41	17.00	Pass
40	5200	11.36	10.69	14.05	17.00	Pass
48	5240	9.01	8.82	11.93	17.00	Pass

Note:

1. Method 1 of power density measurement of KDB 662911 is using for calculating total power density. Total power density is summing entire spectra across corresponding frequency bins on the various outputs by computer.
2. Directional gain = 5.021dBi < 6dBi, so the limit no need to reduced.

802.11ac (VHT40)

Chan.	Freq. (MHz)	PSD (dBm)		Total PSD w/o duty factor (dBm)	Duty factor	Total PSD with duty factor (dBm)	Max. Limit (dBm)	Pass / Fail
		Chain 0	Chain 1					
38	5190	4.95	4.36	7.67	0.23	7.90	17.00	Pass
46	5230	7.80	7.53	10.67	0.23	10.90	17.00	Pass

Note:

1. Method 1 of power density measurement of KDB 662911 is using for calculating total power density. Total power density is summing entire spectra across corresponding frequency bins on the various outputs by computer.
2. Directional gain = 5.021dBi < 6dBi, so the limit no need to reduced.
3. Refer to section 3.3 for duty cycle spectrum plot.

802.11ac (VHT80)

Chan.	Freq. (MHz)	PSD (dBm)		Total PSD w/o duty factor (dBm)	Duty factor	Total PSD with duty factor (dBm)	Max. Limit (dBm)	Pass / Fail
		Chain 0	Chain 1					
42	5210	0.40	0.00	3.21	0.32	3.53	17.00	Pass

Note:

- Method 1 of power density measurement of KDB 662911 is using for calculating total power density. Total power density is summing entire spectra across corresponding frequency bins on the various outputs by computer.
- Directional gain = 5.021dBi < 6dBi, so the limit no need to reduced.
- Refer to section 3.3 for duty cycle spectrum plot.

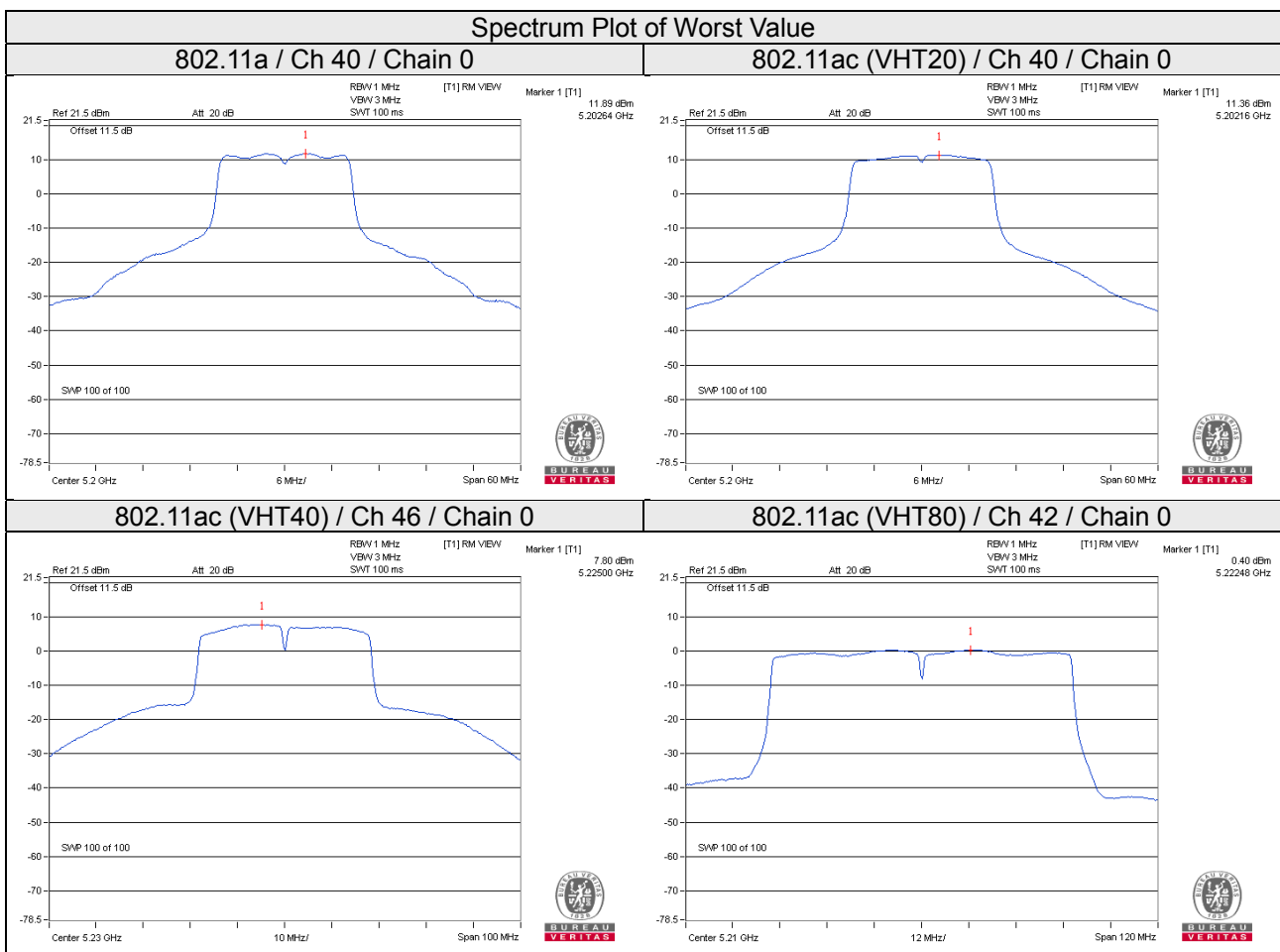

For U-NII-3 Band

802.11a

TX chain	Channel	Freq. (MHz)	PSD (dBm/300kHz)	PSD (dBm/500kHz)	10 log (N=2) dB	Duty factor	Total PSD (dBm/500kHz)	Limit (dBm/500kHz)	Pass / Fail
0	149	5745	3.52	5.74	3.01	0.20	8.95	29.906	Pass
	157	5785	3.37	5.59	3.01	0.20	8.80	29.906	Pass
	165	5825	3.38	5.60	3.01	0.20	8.81	29.906	Pass
1	149	5745	3.79	6.01	3.01	0.20	9.22	29.906	Pass
	157	5785	3.69	5.91	3.01	0.20	9.12	29.906	Pass
	165	5825	3.01	5.23	3.01	0.20	8.44	29.906	Pass

Note:

- Method 1 of power density measurement of KDB 662911 is using for calculating total power density. Total power density is summing entire spectra across corresponding frequency bins on the various outputs by computer.
- Directional gain = 6.094dBi > 6dBi, so the limit shall be reduced to $30-(6.094-6) = 29.906\text{dBm}$.
- Refer to section 3.3 for duty cycle spectrum plot.

802.11ac (VHT20)

TX chain	Channel	Freq. (MHz)	PSD (dBm/300kHz)	PSD (dBm/500kHz)	10 log (N=2) dB	Total PSD (dBm/500kHz)	Limit (dBm/500kHz)	Pass / Fail
0	149	5745	3.13	5.35	3.01	8.36	29.906	Pass
	157	5785	3.21	5.43	3.01	8.44	29.906	Pass
	165	5825	2.85	5.07	3.01	8.08	29.906	Pass
1	149	5745	3.07	5.29	3.01	8.30	29.906	Pass
	157	5785	3.33	5.55	3.01	8.56	29.906	Pass
	165	5825	2.80	5.02	3.01	8.03	29.906	Pass

Note:

- Method 1 of power density measurement of KDB 662911 is using for calculating total power density. Total power density is summing entire spectra across corresponding frequency bins on the various outputs by computer.
- Directional gain = 6.094dBi > 6dBi, so the limit shall be reduced to $30-(6.094-6) = 29.906\text{dBm}$.

802.11ac (VHT40)

TX chain	Channel	Freq. (MHz)	PSD (dBm/300kHz)	PSD (dBm/500kHz)	10 log (N=2) dB	Duty factor	Total PSD (dBm/500kHz)	Limit (dBm/500kHz)	Pass / Fail
0	151	5755	0.85	3.07	3.01	0.23	6.31	29.906	Pass
	159	5795	0.64	2.86	3.01	0.23	6.10	29.906	Pass
1	151	5755	0.87	3.09	3.01	0.23	6.33	29.906	Pass
	159	5795	0.64	2.86	3.01	0.23	6.10	29.906	Pass

Note:

1. Method 1 of power density measurement of KDB 662911 is using for calculating total power density. Total power density is summing entire spectra across corresponding frequency bins on the various outputs by computer.
2. Directional gain = 6.094dBi > 6dBi, so the limit shall be reduced to $30-(6.094-6) = 29.906\text{dBm}$.
3. Refer to section 3.3 for duty cycle spectrum plot.

802.11ac (VHT80)

TX chain	Channel	Freq. (MHz)	PSD (dBm/300kHz)	PSD (dBm/500kHz)	10 log (N=2) dB	Duty factor	Total PSD (dBm/500kHz)	Limit (dBm/500kHz)	Pass / Fail
0	155	5775	-6.18	-3.96	3.01	0.32	-0.63	29.906	Pass
1	155	5775	-5.45	-3.23	3.01	0.32	0.10	29.906	Pass

Note:

1. Method 1 of power density measurement of KDB 662911 is using for calculating total power density. Total power density is summing entire spectra across corresponding frequency bins on the various outputs by computer.
2. Directional gain = 6.094dBi > 6dBi, so the limit shall be reduced to $30-(6.094-6) = 29.906\text{dBm}$.
3. Refer to section 3.3 for duty cycle spectrum plot.

Spectrum Plot of Worst Value

802.11a

802.11ac (VHT20)

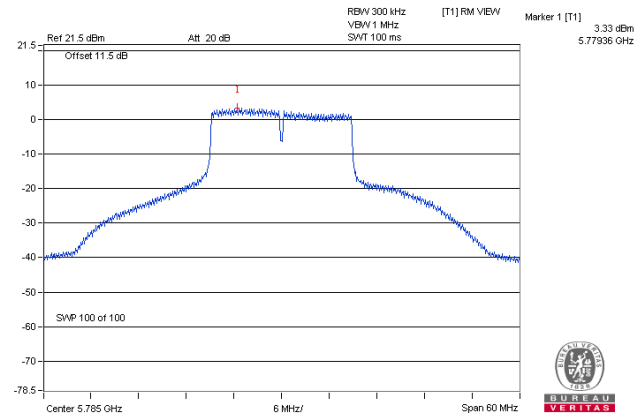
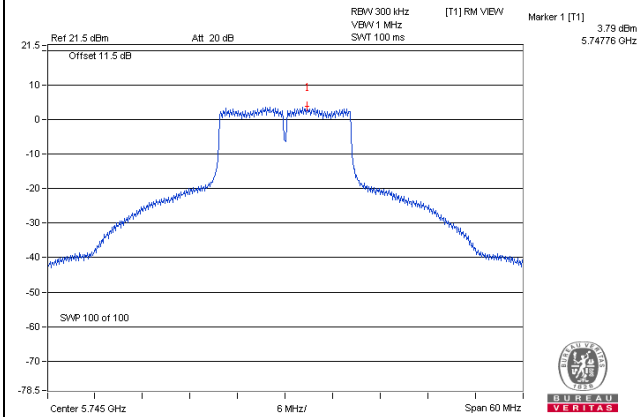

802.11ac (VHT40)

802.11ac (VHT80)

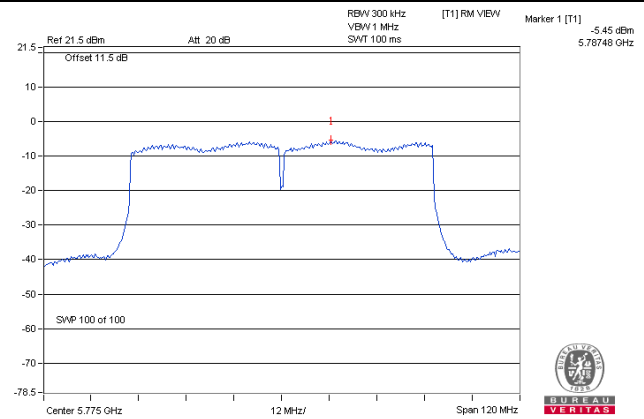
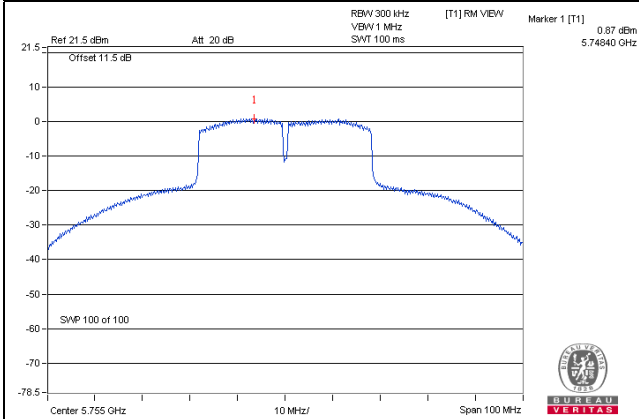

4.5 Frequency Stability

4.5.1 Limits of Frequency Stability Measurement

The frequency of the carrier signal shall be maintained within band of operation

4.5.2 Test Setup

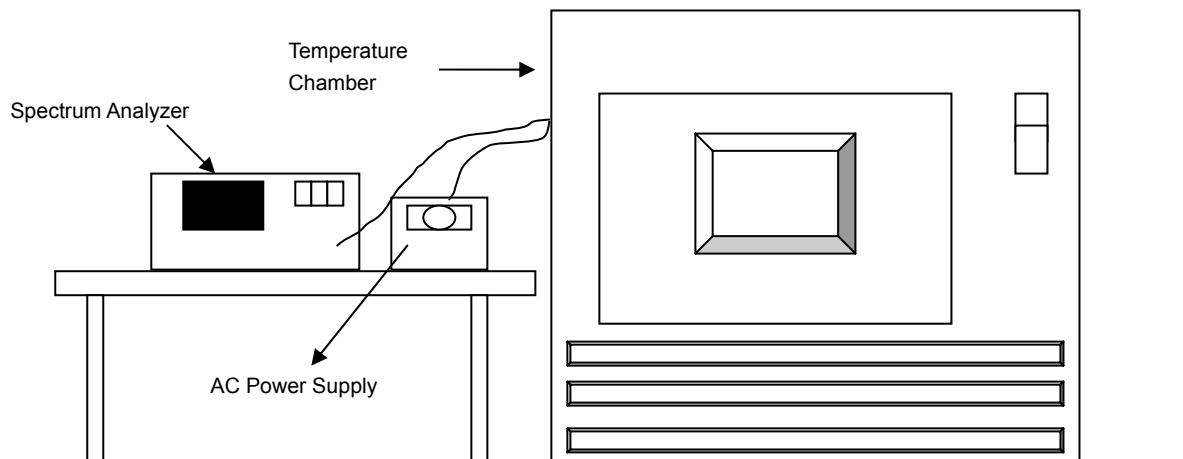

4.5.3 Test Instruments

Refer to section 4.1.2 to get information of above instrument.

4.5.4 Test Procedure

- The EUT was placed inside the environmental test chamber and powered by nominal AC voltage.
- Turn the EUT on and couple its output to a spectrum analyzer.
- Turn the EUT off and set the chamber to the highest temperature specified.
- Allow sufficient time (approximately 30 min) for the temperature of the chamber to stabilize, turn the EUT on and measure the operating frequency after 2, 5, and 10 minutes.
- Repeat step 2 and 3 with the temperature chamber set to the lowest temperature.
- The test chamber was allowed to stabilize at +20 degree C for a minimum of 30 minutes. The supply voltage was then adjusted on the EUT from 85% to 115% and the frequency record.

4.5.5 Deviation from Test Standard

No deviation.

4.5.6 EUT Operating Condition

Set the EUT transmit at un-modulation mode to test frequency stability.

4.5.7 Test Results

Frequency Stability Versus Temp.									
Operating Frequency: 5180MHz									
Temp. (°C)	Power Supply (Vac)	0 Minute		2 Minute		5 Minute		10 Minute	
		Measured Frequency (MHz)	Frequency Drift (%)	Measured Frequency (MHz)	Frequency Drift (%)	Measured Frequency (MHz)	Frequency Drift (%)	Measured Frequency (MHz)	Frequency Drift (%)
50	120	5180.0059	0.00011	5180.0067	0.00013	5180.0057	0.00011	5180.0079	0.00015
40	120	5180.0091	0.00018	5180.0134	0.00026	5180.0108	0.00021	5180.0134	0.00026
30	120	5180.0042	0.00008	5180.0043	0.00008	5180.0050	0.00010	5180.0058	0.00011
20	120	5180.0228	0.00044	5180.0249	0.00048	5180.0220	0.00042	5180.0233	0.00045
10	120	5180.0181	0.00035	5180.0194	0.00037	5180.0197	0.00038	5180.0198	0.00038
0	120	5179.9812	-0.00036	5179.9838	-0.00031	5179.9830	-0.00033	5179.9846	-0.00030
-10	120	5180.0065	0.00013	5180.0060	0.00012	5180.0106	0.00020	5180.0087	0.00017
-20	120	5179.9863	-0.00026	5179.9871	-0.00025	5179.9863	-0.00026	5179.9862	-0.00027
-30	120	5180.0034	0.00007	5180.0053	0.00010	5180.0037	0.00007	5180.0046	0.00009

Frequency Stability Versus Voltage									
Operating Frequency: 5180MHz									
Temp. (°C)	Power Supply (Vac)	0 Minute		2 Minute		5 Minute		10 Minute	
		Measured Frequency (MHz)	Frequency Drift (%)	Measured Frequency (MHz)	Frequency Drift (%)	Measured Frequency (MHz)	Frequency Drift (%)	Measured Frequency (MHz)	Frequency Drift (%)
20	138	5180.0228	0.00044	5180.0240	0.00046	5180.0216	0.00042	5180.0240	0.00046
	120	5180.0228	0.00044	5180.0249	0.00048	5180.0220	0.00042	5180.0233	0.00045
	102	5180.0224	0.00043	5180.0239	0.00046	5180.0213	0.00041	5180.0237	0.00046

4.6 6dB Bandwidth Measurement

4.6.1 Limits of 6dB Bandwidth Measurement

The minimum of 6dB Bandwidth Measurement is 0.5MHz.

4.6.2 Test Setup

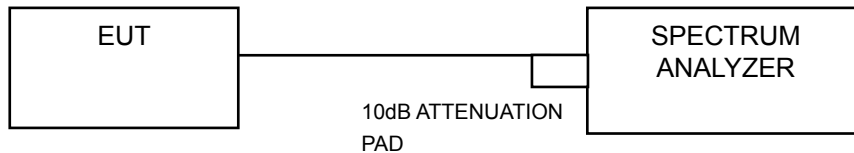

4.6.3 Test Instruments

Refer to section 4.1.2 to get information of above instrument.

4.6.4 Test Procedure

- Set resolution bandwidth (RBW) = 100kHz
- Set the video bandwidth (VBW) $\geq 3 \times$ RBW, Detector = Peak
- Trace mode = max hold
- Sweep = auto couple
- Measure the maximum width of the emission that is constrained by the frequencies associated with the two amplitude points (upper and lower) that are attenuated by 6 dB relative to the maximum level measured in the fundamental emission

4.6.5 Deviation from Test Standard

No deviation.

4.6.6 EUT Operating Condition

The software provided by client to enable the EUT under transmission Condition continuously at lowest, middle and highest channel frequencies individually.

4.6.7 Test Results

802.11a

Channel	Frequency (MHz)	6dB Bandwidth (MHz)		Minimum Limit (MHz)	Pass / Fail
		Chain 0	Chain 1		
149	5745	16.40	16.40	0.5	Pass
157	5785	16.42	16.40	0.5	Pass
165	5825	16.40	15.42	0.5	Pass

802.11ac (VHT20)

Channel	Frequency (MHz)	6dB Bandwidth (MHz)		Minimum Limit (MHz)	Pass / Fail
		Chain 0	Chain 1		
149	5745	17.64	17.66	0.5	Pass
157	5785	17.63	17.64	0.5	Pass
165	5825	17.63	16.95	0.5	Pass

802.11ac (VHT40)

Channel	Frequency (MHz)	6dB Bandwidth (MHz)		Minimum Limit (MHz)	Pass / Fail
		Chain 0	Chain 1		
151	5755	35.55	35.78	0.5	Pass
159	5795	35.80	35.76	0.5	Pass

802.11ac (VHT80)

Channel	Frequency (MHz)	6dB Bandwidth (MHz)		Minimum Limit (MHz)	Pass / Fail
		Chain 0	Chain 1		
155	5775	76.46	76.02	0.5	Pass

Spectrum Plot of Worst Value

802.11a

802.11ac (VHT20)

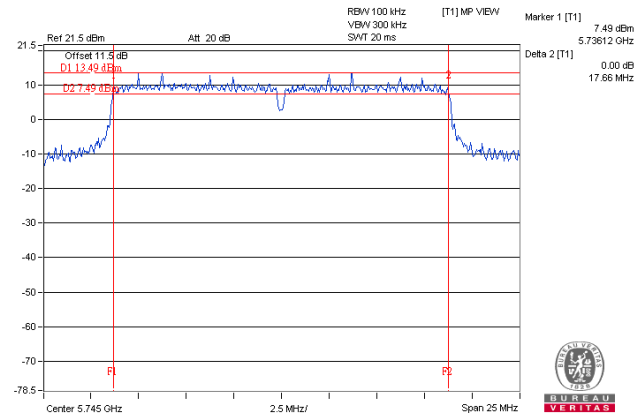
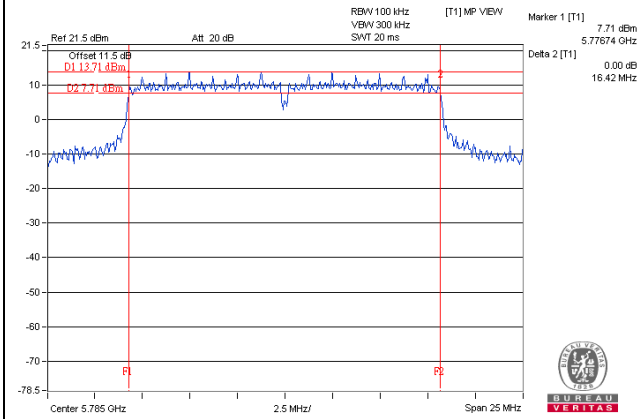

802.11ac (VHT40)

802.11ac (VHT80)

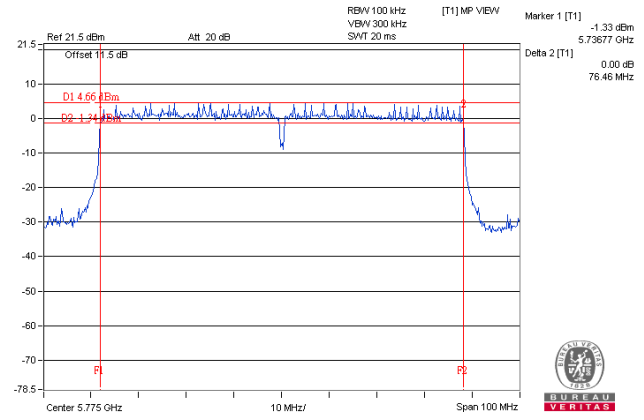
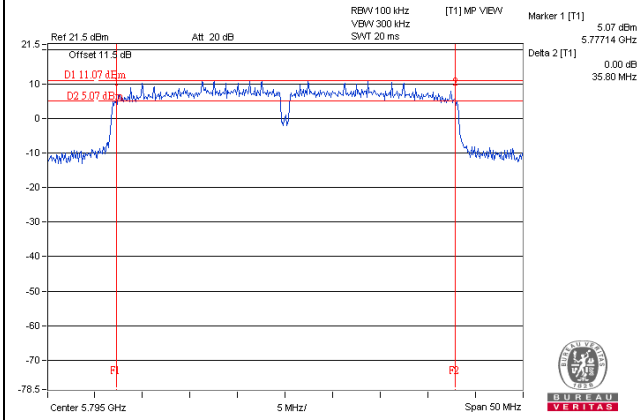

5 Pictures of Test Arrangements

Please refer to the attached file (Test Setup Photo).

Annex A - Radiated Out of Band Emission (OOBE) Measurement (For U-NII-3 band)

802.11a

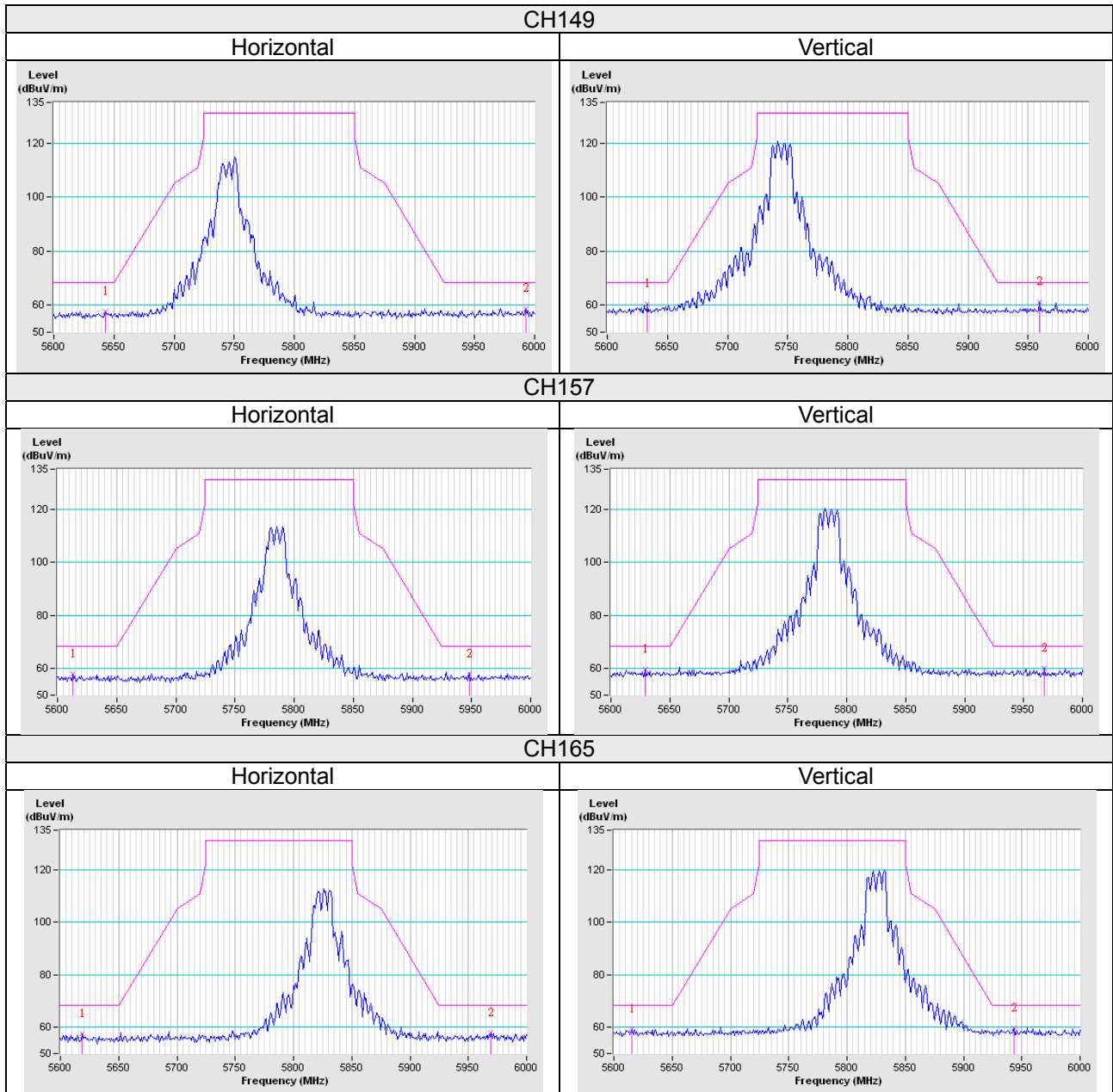

802.11ac (VHT20)

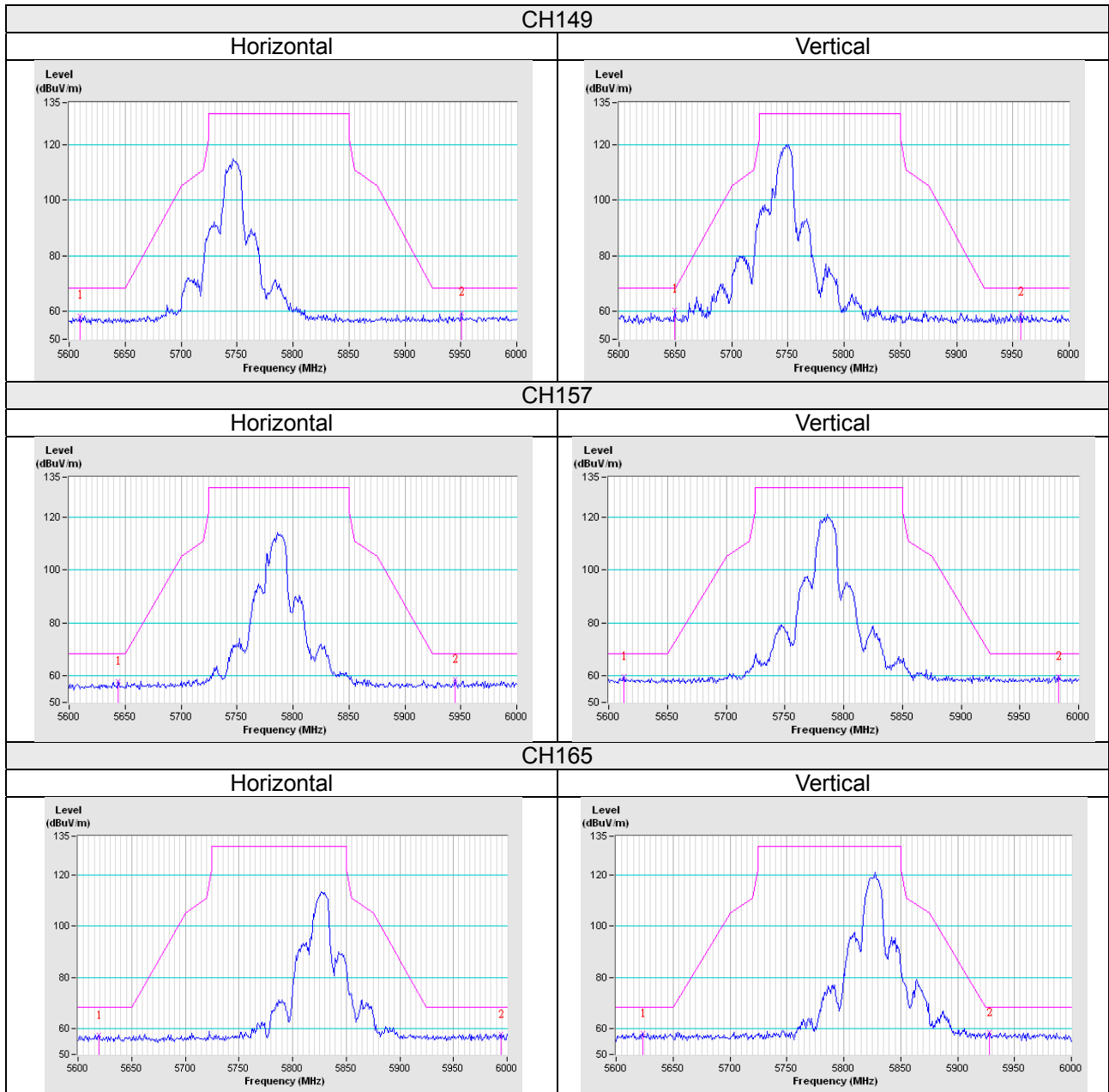

802.11ac (VHT40)

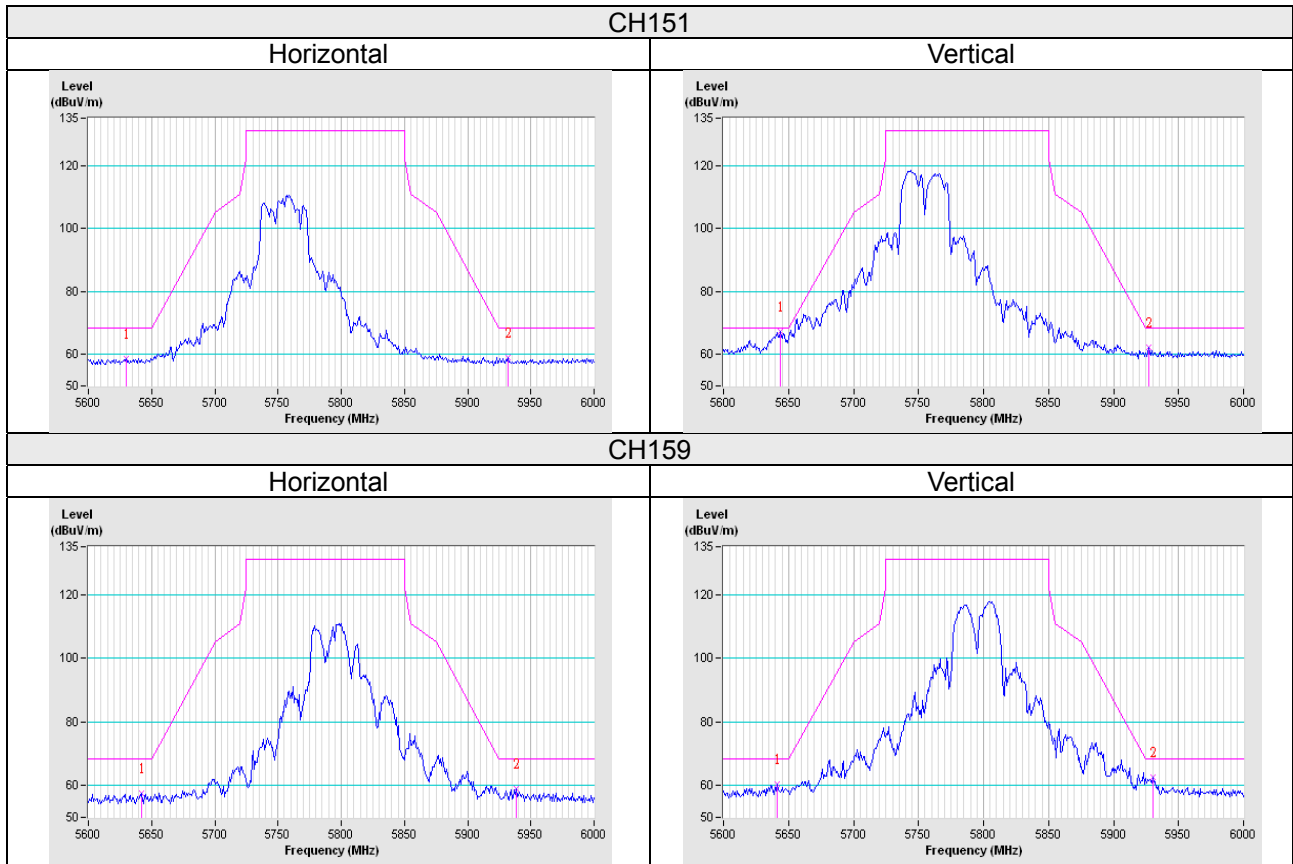

802.11ac (VHT80)

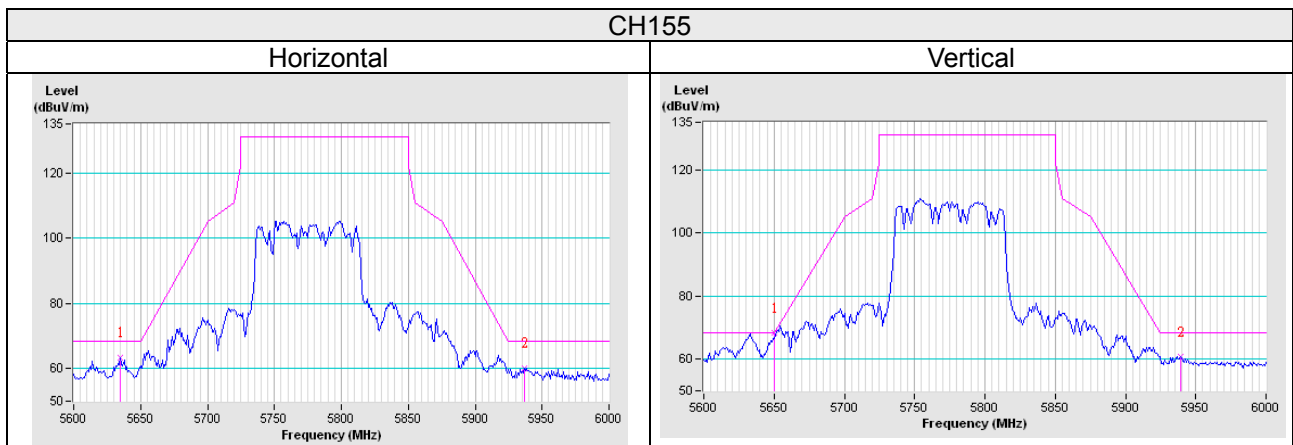

Appendix – Information on the Testing Laboratories

We, Bureau Veritas Consumer Products Services (H.K.) Ltd., Taoyuan Branch, were founded in 1988 to provide our best service in EMC, Radio, Telecom and Safety consultation. Our laboratories are accredited and approved according to ISO/IEC 17025.

If you have any comments, please feel free to contact us at the following:

Linko EMC/RF Lab

Tel: 886-2-26052180

Fax: 886-2-26051924

Hsin Chu EMC/RF/Telecom Lab

Tel: 886-3-6668565

Fax: 886-3-6668323

Hwa Ya EMC/RF/Safety Lab

Tel: 886-3-3183232

Fax: 886-3-3270892

Email: service.adt@tw.bureauveritas.com

Web Site: www.bureauveritas-adt.com

The address and road map of all our labs can be found in our web site also.

--- END ---