

FCC Test Report

Report No.: RF170120D02-1

FCC ID: PY316400358

Test Model: R6020

Received Date: Jan. 20, 2017

Test Date: Jan. 23 ~ Feb. 18, 2017

Issued Date: Feb. 20, 2017

Applicant: NETGEAR INC.

Address: 350 East Plumeria Drive, San Jose, CA 95134, USA

Issued By: Bureau Veritas Consumer Products Services (H.K.) Ltd., Taoyuan Branch

Lab Address: No. 47-2, 14th Ling, Chia Pau Vil., Lin Kou Dist., New Taipei City, Taiwan, R.O.C.



This report is for your exclusive use. Any copying or replication of this report to or for any other person or entity, or use of our name or trademark, is permitted only with our prior written permission. This report sets forth our findings solely with respect to the test samples identified herein. The results set forth in this report are not indicative or representative of the quality or characteristics of the lot from which a test sample was taken or any similar or identical product unless specifically and expressly noted. Our report includes all of the tests requested by you and the results thereof based upon the information that you provided to us. You have 60 days from date of issuance of this report to notify us of any material error or omission caused by our negligence, provided, however, that such notice shall be in writing and shall specifically address the issue you wish to raise. A failure to raise such issue within the prescribed time shall constitute your unqualified acceptance of the completeness of this report, the tests conducted and the correctness of the report contents. Unless specific mention, the uncertainty of measurement has been explicitly taken into account to declare the compliance or non-compliance to the specification. The report must not be used by the client to claim product certification, approval, or endorsement by TAF or any government agencies.

Table of Contents

Release Control Record	4
1 Certificate of Conformity	5
2 Summary of Test Results	6
2.1 Measurement Uncertainty	6
2.2 Modification Record	6
3 General Information	7
3.1 General Description of EUT	7
3.2 Description of Test Modes	9
3.2.1 Test Mode Applicability and Tested Channel Detail	10
3.3 Duty Cycle of Test Signal	12
3.4 Description of Support Units	13
3.4.1 Configuration of System under Test	13
3.5 General Description of Applied Standard	14
4 Test Types and Results	15
4.1 Radiated Emission and Bandedge Measurement.....	15
4.1.1 Limits of Radiated Emission and Bandedge Measurement	15
4.1.2 Test Instruments	16
4.1.3 Test Procedure	17
4.1.4 Deviation from Test Standard	17
4.1.5 Test Setup.....	18
4.1.6 EUT Operating Condition	19
4.1.7 Test Results	20
4.2 Conducted Emission Measurement	39
4.2.1 Limits of Conducted Emission Measurement	39
4.2.2 Test Instruments	39
4.2.3 Test Procedure	40
4.2.4 Deviation from Test Standard	40
4.2.5 Test Setup.....	40
4.2.6 EUT Operating Condition	40
4.2.7 Test Results	41
4.3 Transmit Power Measurement	43
4.3.1 Limits of Transmit Power Measurement	43
4.3.2 Test Setup.....	43
4.3.3 Test Instruments	43
4.3.4 Test Procedure	44
4.3.5 Deviation from Test Standard	44
4.3.6 EUT Operating Condition	44
4.3.7 Test Result.....	45
4.4 Occupied Bandwidth Measurement	48
4.4.1 Test Setup.....	48
4.4.2 Test Instruments	48
4.4.3 Test Procedure	48
4.4.4 Test Results	49
4.5 Peak Power Spectral Density Measurement.....	51
4.5.1 Limits of Peak Power Spectral Density Measurement	51
4.5.2 Test Setup.....	51
4.5.3 Test Instruments	51
4.5.4 Test Procedure	51
4.5.5 Deviation from Test Standard	51
4.5.6 EUT Operating Condition	51
4.5.7 Test Results	52
4.6 Frequency Stability Measurement.....	57

4.6.1	Limits of Frequency Stability Measurement.....	57
4.6.2	Test Setup.....	57
4.6.3	Test Instruments	57
4.6.4	Test Procedure	57
4.6.5	Deviation from Test Standard	57
4.6.6	EUT Operating Condition	57
4.6.7	Test Results	58
4.7	6dB Bandwidth Measurement.....	59
4.7.1	Limits of 6dB Bandwidth Measurement.....	59
4.7.2	Test Setup.....	59
4.7.3	Test Instruments	59
4.7.4	Test Procedure	59
4.7.5	Deviation from Test Standard	59
4.7.6	EUT Operating Condition	59
4.7.7	Test Results	60
5	Pictures of Test Arrangements.....	62
	Annex A- Radiated Out of Band Emission (OOBE) Measurement (For U-NII-3 band).....	63
	Appendix – Information on the Testing Laboratories	66

Release Control Record

Issue No.	Description	Date Issued
RF170120D02-1	Original release.	Feb. 20, 2017

1 Certificate of Conformity

Product: AC750 WiFi Router

Brand: NETGEAR

Test Model: R6020

Sample Status: Engineering sample

Applicant: NETGEAR INC.

Test Date: Jan. 23 ~ Feb. 18, 2017

Standard: 47 CFR FCC Part 15, Subpart E (Section 15.407)
ANSI C63.10: 2013

The above equipment has been tested by **Bureau Veritas Consumer Products Services (H.K.) Ltd., Taoyuan Branch**, and found compliance with the requirement of the above standards. The test record, data evaluation & Equipment Under Test (EUT) configurations represented herein are true and accurate accounts of the measurements of the sample's EMC characteristics under the conditions specified in this report.

Prepared by : Annie Chang , **Date:** Feb. 20, 2017
Annie Chang / Senior Specialist

Approved by : Rex Lai , **Date:** Feb. 20, 2017
Rex Lai / Assistant Manager

2 Summary of Test Results

47 CFR FCC Part 15, Subpart E (Section 15.407)			
FCC Clause	Test Item	Result	Remarks
15.407(b)(6)	AC Power Conducted Emissions	Pass	Meet the requirement of limit. Minimum passing margin is -9.10dB at 0.38828MHz.
15.407(b) (1/2/3/4(i/ii)/6)	Radiated Emissions & Band Edge Measurement*	Pass	Meet the requirement of limit. Minimum passing margin is -0.25dB at 15600.00MHz.
15.407(a)(1/2/3)	Max Average Transmit Power	Pass	Meet the requirement of limit.
---	Occupied Bandwidth Measurement	-	Reference only.
15.407(a)(1/2/3)	Peak Power Spectral Density	Pass	Meet the requirement of limit.
15.407(e)	6dB bandwidth	Pass	Meet the requirement of limit. (U-NII-3 Band only)
15.407(g)	Frequency Stability	Pass	Meet the requirement of limit.
15.203	Antenna Requirement	Pass	Antenna connector is I-PEX not a standard connector.

*For U-NII-3 band compliance with rule part 15.407(b)(4)(i), the OOB test plots were recorded in Annex A.

2.1 Measurement Uncertainty

Where relevant, the following measurement uncertainty levels have been estimated for tests performed on the EUT as specified in CISPR 16-4-2:

Measurement	Frequency	Expanded Uncertainty (k=2) (\pm)
Conducted Emissions at mains ports	150kHz ~ 30MHz	2.77 dB
Radiated Emissions up to 1 GHz	9kHz ~ 30MHz	2.38 dB
	30MHz ~ 1000MHz	5.54 dB
Radiated Emissions above 1 GHz	1GHz ~ 6GHz	4.77 dB
	6GHz ~ 18GHz	5.48 dB

2.2 Modification Record

There were no modifications required for compliance.

3 General Information

3.1 General Description of EUT

Product	AC750 WiFi Router
Brand	NETGEAR
Test Model	R6020
Status of EUT	Engineering sample
Power Supply Rating	12Vdc from adapter (refer to note as below)
Modulation Type	64QAM, 16QAM, QPSK, BPSK 256QAM for OFDM in 11ac mode only.
Modulation Technology	OFDM
Transfer Rate	802.11a: 54/48/36/24/18/12/9/6Mbps 802.11n: up to 300Mbps 802.11ac: up to 867Mbps
Operating Frequency	5180 ~ 5240MHz, 5745 ~ 5825MHz
Number of Channel	5180 ~ 5240MHz 4 for 802.11a, 802.11n (20MHz), 802.11ac (20MHz) 2 for 802.11n (40MHz), 802.11ac (40MHz) 1 for 802.11ac (80MHz) 5745 ~ 5825MHz 5 for 802.11a, 802.11n (20MHz) 802.11ac (20MHz) 2 for 802.11n (40MHz) 802.11ac (40MHz) 1 for 802.11ac (80MHz)
Output Power	5180 ~ 5240MHz: 304.823mW 5745 ~ 5825MHz: 287.797mW
Antenna Type	Refer to note as below
Antenna Connector	Refer to note as below
Accessory Device	N/A
Data Cable Supplied	N/A

Note:

- The EUT incorporates a MIMO function. Physically, the EUT provides two completed transmitters and two receivers.

Modulation Mode	TX FUNCTION
802.11a	2TX
802.11n (20MHz)	2TX
802.11n (40MHz)	2TX
802.11ac (20MHz)	2TX
802.11ac (40MHz)	2TX
802.11ac (80MHz)	2TX

* The modulation and bandwidth are similar for 802.11n mode for 20MHz / 40MHz and 802.11ac mode for 20MHz / 40MHz, therefore investigated worst case to representative mode in test report. (Final test mode refer section 3.2.1)

2. The EUT uses following adapter.

Adapter	1	2
Brand	NETGEAR	NETGEAR
Model	ML12-A120100-A1	AD2071F10
P/N	332-10822-01	332-10838-01
AC Input Power	100-120V ~50/60Hz 0.3A	100-120V~50/60Hz 0.3A
DC Output Power	12V 1.0A	12V 1A
Plug Type	US Plug	US Plug
Power Cord	Non-shielded DC cable (1.8m)	Non-shielded DC cable (1.8m)

After pre-tested, the **adapter 1** was the worst case for final test.

3. The antennas provided to the EUT, please refer to the following table:

Frequency Band (MHz)	Chain No.	Antenna Type	Antenna Gain (dBi)	Connectot Type
5180-5240	Chain 0	Dipole	3.38	I-PEX
	Chain 1	Dipole	3.23	I-PEX
5745-5825	Chain 0	Dipole	3.78	I-PEX
	Chain 1	Dipole	3.82	I-PEX

4. The directional gain table:

Frequency Band (MHz)	Max. Gain (dBi)
5180-5240	6.04
5745-5825	6.37

Note:

1. Non-TxBF mode & TxBF mode antenna gain refer to KDB 662911 F 2) f) (ii)

$$DirectionalGain = 10 \cdot \log \left[\frac{\sum_{j=1}^{N_{SS}} \left\{ \sum_{k=1}^{N_{ANT}} g_{j,k} \right\}^2}{N_{ANT}} \right]$$

where

Each antenna is driven by no more than one spatial stream;

N_{SS} = the number of independent spatial streams of data;

N_{ANT} = the total number of antennas

$g_{j,k} = 10^{G_k/20}$ if the k th antenna is being fed by spatial stream j , or zero if it is not;

G_k is the gain in dBi of the k th antenna.

5. The above EUT information is declared by manufacturer and for more detailed features description, please refer to the manufacturer's specifications or user's manual.

3.2 Description of Test Modes

FOR 5180 ~ 5240MHz

4 channels are provided for 802.11a, 802.11n (20MHz), 802.11ac (20MHz):

Channel	Frequency	Channel	Frequency
36	5180 MHz	44	5220 MHz
40	5200 MHz	48	5240 MHz

2 channels are provided for 802.11n (40MHz), 802.11ac (40MHz):

Channel	Frequency	Channel	Frequency
38	5190 MHz	46	5230 MHz

1 channel is provided for 802.11ac (80MHz):

Channel	Frequency
42	5210MHz

FOR 5745 ~ 5825MHz:

5 channels are provided for 802.11a, 802.11n (20MHz), 802.11ac (20MHz):

Channel	Frequency	Channel	Frequency
149	5745MHz	161	5805MHz
153	5765MHz	165	5825MHz
157	5785MHz		

2 channels are provided for 802.11n (40MHz), 802.11ac (40MHz):

Channel	Frequency	Channel	Frequency
151	5755MHz	159	5795MHz

1 channel is provided for 802.11ac (80MHz):

Channel	Frequency
155	5775MHz

3.2.1 Test Mode Applicability and Tested Channel Detail

EUT Configure Mode	Applicable To				Description
	RE \geq 1G	RE $<$ 1G	PLC	APCM	
-	√	√	√	√	-

Where **RE \geq 1G**: Radiated Emission above 1GHz **RE $<$ 1G**: Radiated Emission below 1GHz
PLC: Power Line Conducted Emission **APCM**: Antenna Port Conducted Measurement

NOTE: The EUT had been pre-tested on the positioned of each 2 axis. The worst case was found when positioned on **X-plane**.

Radiated Emission Test (Above 1GHz):

- Pre-Scan has been conducted to determine the worst-case mode from all possible combinations between available modulations, data rates and antenna ports (if EUT with antenna diversity architecture).
- Following channel(s) was (were) selected for the final test as listed below.

EUT Configure Mode	Mode	FREQ. Band (MHz)	Available Channel	Tested Channel	Modulation Technology	Modulation Type	Data Rate (Mbps)
-	802.11a	5180-5240	36 to 48	36, 40, 48	OFDM	BPSK	6
-	802.11n (20MHz)		36 to 48	36, 40, 48	OFDM	BPSK	6.5
-	802.11n (40MHz)		38 to 46	38, 46	OFDM	BPSK	13.5
-	802.11ac (80MHz)		42	42	OFDM	BPSK	29.3
-	802.11a	5745-5825	149 to 165	149, 157, 165	OFDM	BPSK	6
-	802.11n (20MHz)		149 to 165	149, 157, 165	OFDM	BPSK	6.5
-	802.11n (40MHz)		151 to 159	151, 159	OFDM	BPSK	13.5
-	802.11ac (80MHz)		155	155	OFDM	BPSK	29.3

Radiated Emission Test (Below 1GHz):

- Pre-Scan has been conducted to determine the worst-case mode from all possible combinations between available modulations, data rates and antenna ports (if EUT with antenna diversity architecture).
- Following channel(s) was (were) selected for the final test as listed below.

EUT Configure Mode	Mode	FREQ. Band (MHz)	Available Channel	Tested Channel	Modulation Technology	Modulation Type	Data Rate (Mbps)
-	802.11n (20MHz)	5180-5240	36 to 48	36	OFDM	BPSK	6.5
-	802.11n (20MHz)	5745-5825	149 to 165		OFDM	BPSK	6.5

Power Line Conducted Emission Test:

- Pre-Scan has been conducted to determine the worst-case mode from all possible combinations between available modulations, data rates and antenna ports (if EUT with antenna diversity architecture).
- Following channel(s) was (were) selected for the final test as listed below.

EUT Configure Mode	Mode	FREQ. Band (MHz)	Available Channel	Tested Channel	Modulation Technology	Modulation Type	Data Rate (Mbps)
-	802.11n (20MHz)	5180-5240	36 to 48	36	OFDM	BPSK	6.5
-	802.11n (20MHz)	5745-5825	149 to 165		OFDM	BPSK	6.5

Antenna Port Conducted Measurement:

- This item includes all test value of each mode, but only includes spectrum plot of worst value of each mode.
- Pre-Scan has been conducted to determine the worst-case mode from all possible combinations between available modulations, data rates and antenna ports (if EUT with antenna diversity architecture).
- Following channel(s) was (were) selected for the final test as listed below.

EUT Configure Mode	Mode	FREQ. Band (MHz)	Available Channel	Tested Channel	Modulation Technology	Modulation Type	Data Rate (Mbps)
-	802.11a	5180-5240	36 to 48	36, 40, 48	OFDM	BPSK	6
-	802.11n (20MHz)		36 to 48	36, 40, 48	OFDM	BPSK	6.5
-	802.11n (40MHz)		38 to 46	38, 46	OFDM	BPSK	13.5
-	802.11ac (80MHz)		42	42	OFDM	BPSK	29.3
-	802.11a	5745-5825	149 to 165	149, 157, 165	OFDM	BPSK	6
-	802.11n (20MHz)		149 to 165	149, 157, 165	OFDM	BPSK	6.5
-	802.11n (40MHz)		151 to 159	151, 159	OFDM	BPSK	13.5
-	802.11ac (80MHz)		155	155	OFDM	BPSK	29.3

Test Condition:

Applicable To	Environmental Conditions	Input Power	Tested By
RE \geq 1G	21deg. C, 69%RH	120Vac, 60Hz	Dalen Dai
RE $<$ 1G	21deg. C, 69%RH	120Vac, 60Hz	Dalen Dai
PLC	22deg. C, 77%RH	120Vac, 60Hz	Vincent Chen
APCM	25deg. C, 76%RH	120Vac, 60Hz	Saxon Lee

3.3 Duty Cycle of Test Signal

Duty cycle of test signal is < 98 %, duty factor is required

802.11a: Duty cycle = 1.434/1.565 = 0.916, Duty factor = $10 * \log(1/0.916) = 0.38$

802.11n (20MHz): Duty cycle = 1.333/1.507 = 0.885, Duty factor = $10 * \log(1/0.885) = 0.53$

802.11n (40MHz): Duty cycle = 0.637/0.811 = 0.785, Duty factor = $10 * \log(1/0.785) = 1.05$

802.11ac (80MHz): Duty cycle = 0.286/0.513 = 0.558, Duty factor = $10 * \log(1/0.558) = 2.54$

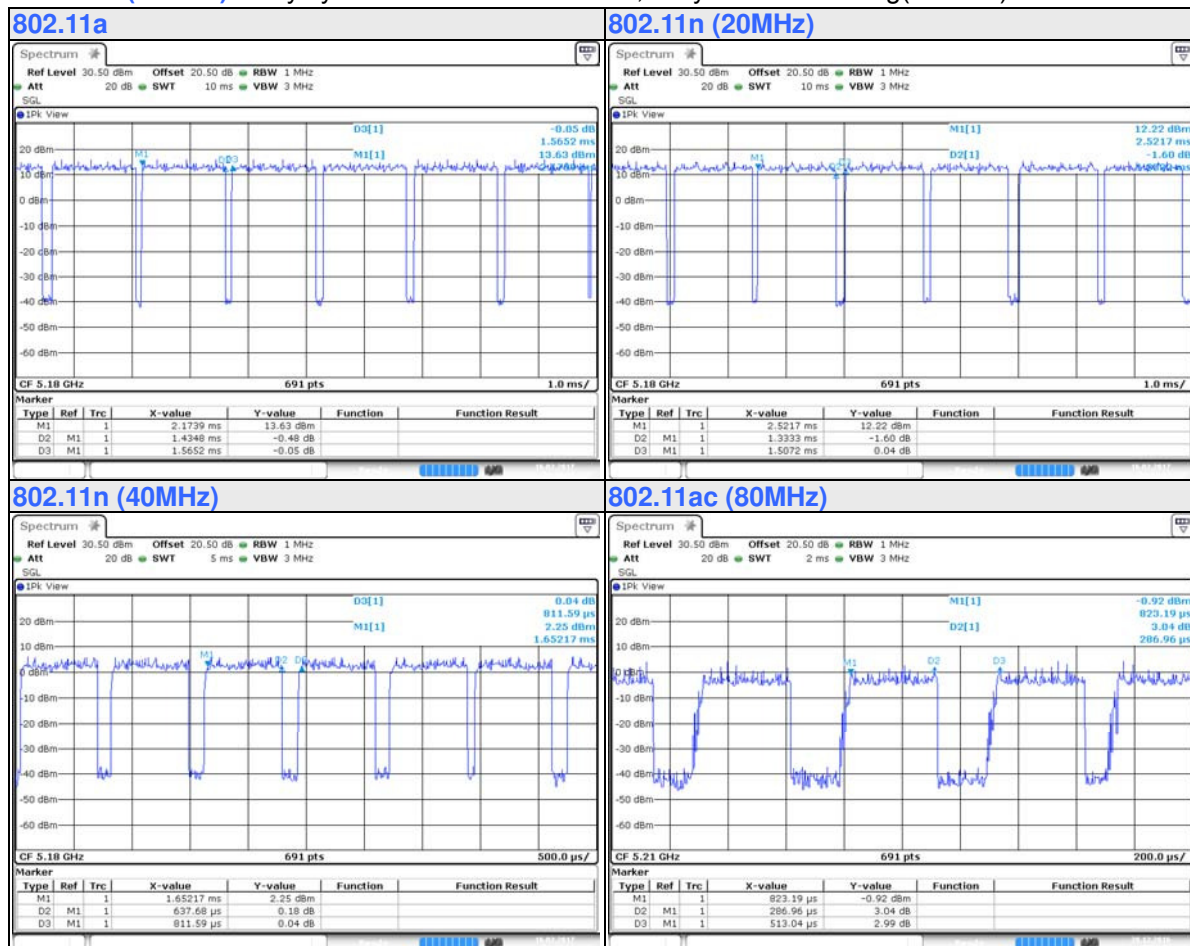

3.4 Description of Support Units

The EUT has been tested as an independent unit together with other necessary accessories or support units. The following support units or accessories were used to form a representative test configuration during the tests.

ID	Product	Brand	Model No.	Serial No.	FCC ID	Remarks
A.	Notebook PC	DELL	PP27L	8SNZ12S	FCC DoC Approved	Provided by Lab
B.	Notebook PC	DELL	E5410	BW33YM1	FCC DoC Approved	Provided by Lab
C.	Load	N/A	N/A	N/A	N/A	Provided by Lab

Note:

1. All power cords of the above support units are non-shielded (1.8m).
2. Items A~B acted as communication partners to transfer data.

ID	Descriptions	Qty.	Length (m)	Shielding (Yes/No)	Cores (Qty.)	Remarks
1.	DC cable	1	1.8	N	0	Supplied by client
2.	LAN cable	2	10	N	0	Provided by Lab
3.	LAN cable	3	1.8	N	0	Provided by Lab

Note: The core(s) is(are) originally attached to the cable(s).

3.4.1 Configuration of System under Test

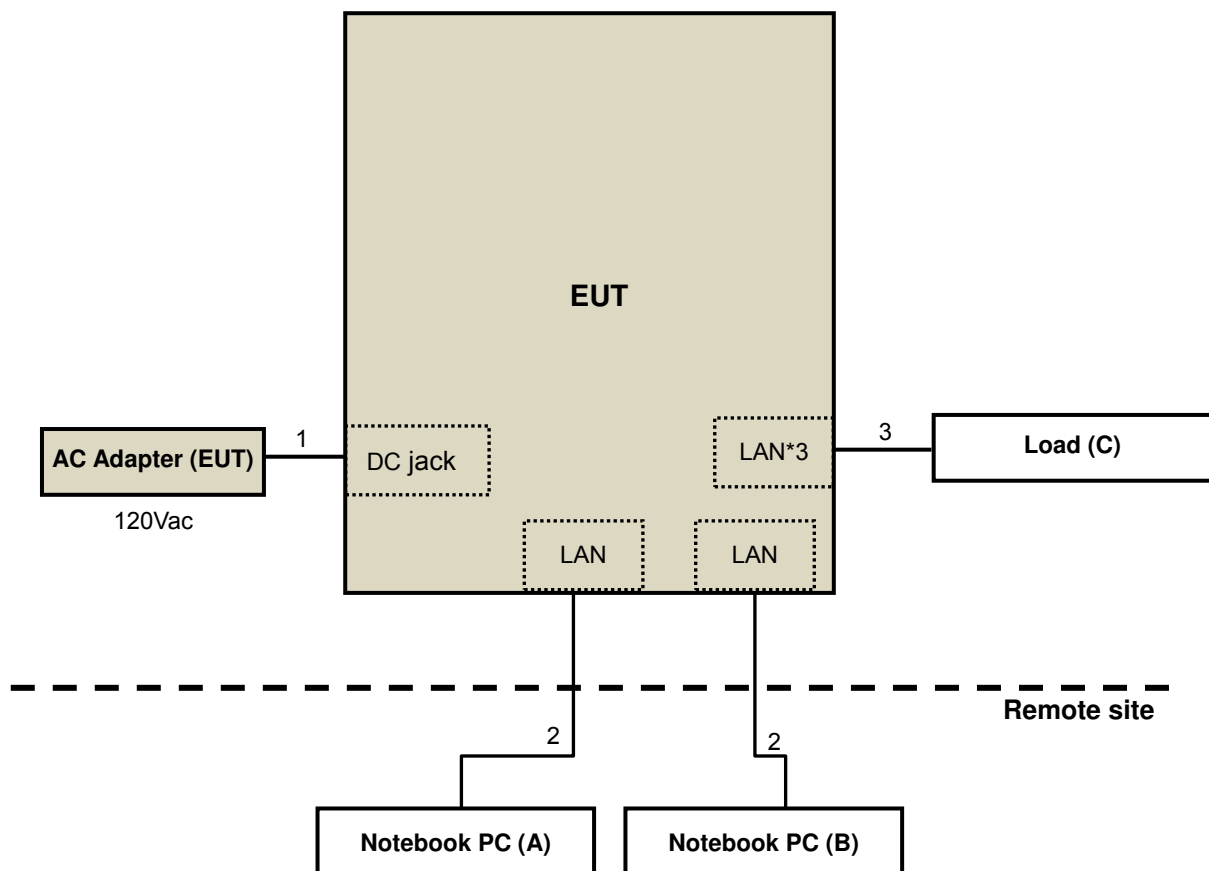

3.5 General Description of Applied Standard

The EUT is a RF Product. According to the specifications of the manufacturer, it must comply with the requirements of the following standards:

FCC Part 15, Subpart E (15.407)
KDB 789033 D02 General UNII Test Procedure New Rules v01r03
KDB 662911 D01 Multiple Transmitter Output v02r01
ANSI C63.10-2013

All test items have been performed and recorded as per the above standards.

NOTE: The EUT has been verified to comply with the requirements of FCC Part 15, Subpart B, Class B (DoC). The test report has been issued separately.

4 Test Types and Results

4.1 Radiated Emission and Bandedge Measurement

4.1.1 Limits of Radiated Emission and Bandedge Measurement

Radiated emissions which fall in the restricted bands must comply with the radiated emission limits specified as below table.

Frequencies (MHz)	Field Strength (microvolts/meter)	Measurement Distance (meters)
0.009 ~ 0.490	2400/F(kHz)	300
0.490 ~ 1.705	24000/F(kHz)	30
1.705 ~ 30.0	30	30
30 ~ 88	100	3
88 ~ 216	150	3
216 ~ 960	200	3
Above 960	500	3

NOTE:

1. The lower limit shall apply at the transition frequencies.
2. Emission level (dBuV/m) = 20 log Emission level (uV/m).
3. For frequencies above 1000MHz, the field strength limits are based on average detector, however, the peak field strength of any emission shall not exceed the maximum permitted average limits, specified above by more than 20dB under any condition of modulation.

Limits of unwanted emission out of the restricted bands

Applicable To		Limit	
789033 D02 General UNII Test Procedure New Rules v01r03		Field Strength at 3m	
		PK:74 (dBµV/m)	AV:54 (dBµV/m)
Frequency Band	Applicable To	EIRP Limit	Equivalent Field Strength at 3m
5150~5250 MHz	15.407(b)(1)	PK:-27 (dBm/MHz)	PK:68.2(dBµV/m)
5250~5350 MHz	15.407(b)(2)		
5470~5725 MHz	15.407(b)(3)		
5725~5850 MHz	<input checked="" type="checkbox"/> 15.407(b)(4)(i)	PK:-27 (dBm/MHz) ^{*1} PK:10 (dBm/MHz) ^{*2} PK:15.6 (dBm/MHz) ^{*3} PK:27 (dBm/MHz) ^{*4}	PK: 68.2(dBµV/m) ^{*1} PK:105.2 (dBµV/m) ^{*2} PK: 110.8(dBµV/m) ^{*3} PK:122.2 (dBµV/m) ^{*4}
	<input type="checkbox"/> 15.407(b)(4)(ii)	Emission limits in section 15.247(d)	
^{*1} beyond 75 MHz or more above of the band edge. ^{*3} below the band edge increasing linearly to a level of 15.6 dBm/MHz at 5 MHz above.		^{*2} below the band edge increasing linearly to 10 dBm/MHz at 25 MHz above. ^{*4} from 5 MHz above or below the band edge increasing linearly to a level of 27 dBm/MHz at the band edge.	

Note:

The following formula is used to convert the equipment isotropic radiated power (eirp) to field strength:

$$E = \frac{1000000\sqrt{30P}}{3} \mu\text{V/m, where P is the eirp (Watts).}$$

4.1.2 Test Instruments

DESCRIPTION & MANUFACTURER	MODEL NO.	SERIAL NO.	CALIBRATED DATE	CALIBRATED UNTIL
HP Preamplifier	8447D	2432A03504	Feb. 26, 2016	Feb. 25, 2017
HP Preamplifier	8449B	3008A01201	Feb. 26, 2016	Feb. 25, 2017
MITEQ Preamplifier	AMF-6F-260400-33-8P	892164	Mar. 01, 2016	Feb. 28, 2017
Agilent TEST RECEIVER	N9038A	MY50010158	Aug. 04, 2016	Aug. 03, 2017
Schwarzbeck Antenna	VULB 9168	139	Dec. 13, 2016	Dec. 12, 2017
Schwarzbeck Antenna	VHBA 9123	480	May 29, 2015	May 28, 2017
Schwarzbeck Horn Antenna	BBHA-9170	212	Dec. 30, 2016	Dec. 29, 2017
Schwarzbeck Horn Antenna	BBHA 9120-D1	D130	Dec. 27, 2016	Dec. 26, 2017
ADT. Turn Table	TT100	0306	NA	NA
ADT. Tower	AT100	0306	NA	NA
Software	Radiated_V7.6.15.9.5	NA	NA	NA
SUHNER RF cable With 4dB PAD	SF104	CABLE-CH6	Aug. 15, 2016	Aug. 14, 2017
SUHNER RF cable With 3dB PAD	SF102	Cable-CH8-3.6m	Aug. 15, 2016	Aug. 14, 2017
KEYSIGHT MIMO Powermeasurement Test set	U2021XA	U2021XA-001	May 25, 2016	May 24, 2017
KEYSIGHT Spectrum Analyzer	N9030A	MY54490260	Jul. 26, 2016	Jul. 25, 2017
Loop Antenna EMCI	LPA600	270	Aug. 20, 2015	Aug. 19, 2017
EMCO Horn Antenna	3115	00028257	Dec. 15, 2016	Dec. 14, 2017
Highpass filter Wainwright Instruments	WHK 3.1/18G-10SS	SN 8	NA	NA
ROHDE & SCHWARZ Spectrum Analyzer	FSV40	101042	Sep. 30, 2016	Sep. 29, 2017
Anritsu Power Sensor	MA2411B	0738404	Apr. 28, 2016	Apr. 27, 2017
Anritsu Power Meter	ML2495A	0842014	Apr. 28, 2016	Apr. 27, 2017
Temperature & Humidity Chamber	MHU-225AU	920409	May 25, 2016	May 24, 2017
DIGITAL POWER METER IDRC	CP-240	240515	Sep. 9, 2016	Sep. 8, 2017
AC Power Source ExTech	CFW-105	E000603	NA	NA

- NOTE:** 1. The calibration interval of the above test instruments is 12/24 months. And the calibrations are traceable to NML/ROC and NIST/USA.
2. The horn antenna and HP preamplifier (model: 8449B) are used only for the measurement of emission frequency above 1GHz if tested.
3. The test was performed in Chamber No. 6.
4. The Industry Canada Reference No. IC 7450E-6.
5. The FCC Site Registration No. is 447212.

4.1.3 Test Procedure

For Radiated emission below 30MHz

- a. The EUT was placed on the top of a rotating table 0.8 meters above the ground at a 3 meter chamber room. The table was rotated 360 degrees to determine the position of the highest radiation.
- b. The EUT was set 3 meters away from the interference-receiving antenna, which was mounted on the top of a variable-height antenna tower.
- c. Both X and Y axes of the antenna are set to make the measurement.
- d. For each suspected emission, the EUT was arranged to its worst case and the rotatable table was turned from 0 degrees to 360 degrees to find the maximum reading.
- e. The test-receiver system was set to Quasi-Peak Detect Function and Specified Bandwidth with Maximum Hold Mode.

NOTE:

1. The resolution bandwidth and video bandwidth of test receiver/spectrum analyzer is 9kHz at frequency below 30MHz.

For Radiated emission above 30MHz

- a. The EUT was placed on the top of a rotating table 0.8 meters (for 30MHz ~ 1GHz) / 1.5 meters (for above 1GHz) above the ground at 3 meter chamber room for test. The table was rotated 360 degrees to determine the position of the highest radiation.
- b. The EUT was set 3 meters away from the interference-receiving antenna, which was mounted on the top of a variable-height antenna tower.
- c. The height of antenna is varied from one meter to four meters above the ground to determine the maximum value of the field strength. Both horizontal and vertical polarizations of the antenna are set to make the measurement.
- d. For each suspected emission, the EUT was arranged to its worst case and then the antenna was tuned to heights from 1 meter to 4 meters and the rotatable table was turned from 0 degrees to 360 degrees to find the maximum reading.
- e. The test-receiver system was set to quasi-peak detect function and specified bandwidth with maximum hold mode when the test frequency is below 1 GHz.
- f. The test-receiver system was set to peak and average detect function and specified bandwidth with maximum hold mode when the test frequency is above 1 GHz. If the peak reading value also meets average limit, measurement with the average detector is unnecessary.

Note:

1. The resolution bandwidth and video bandwidth of test receiver/spectrum analyzer is 120kHz for Quasi-peak detection (QP) at frequency below 1GHz.
2. The resolution bandwidth of test receiver/spectrum analyzer is 1 MHz and the video bandwidth is 3 MHz for Peak detection (PK) at frequency above 1GHz.
3. The resolution bandwidth of test receiver/spectrum analyzer is 1MHz and the video bandwidth is $\geq 1/T$ (Duty cycle < 98%) or 10Hz (Duty cycle $\geq 98\%$) for Average detection (AV) at frequency above 1GHz.
4. All modes of operation were investigated and the worst-case emissions are reported.

4.1.4 Deviation from Test Standard

No deviation.

4.1.5 Test Setup

For Radiated emission below 30MHz

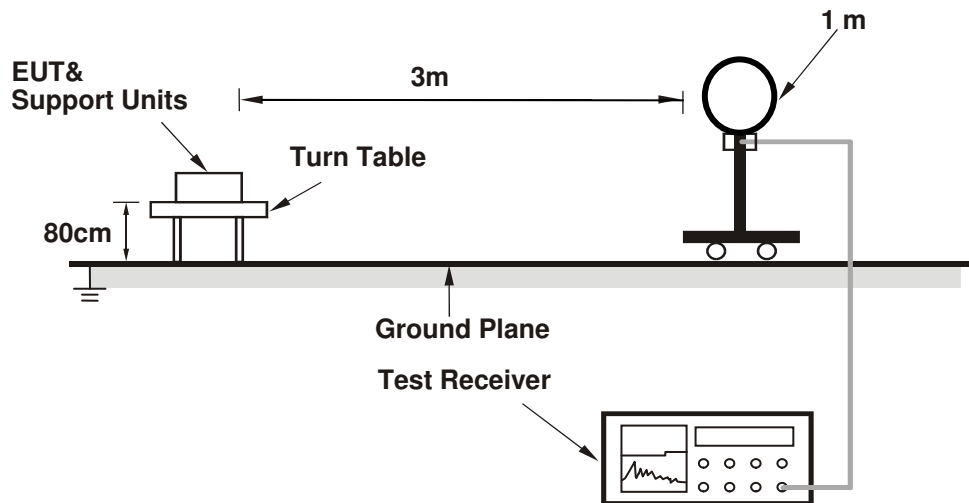

For Radiated emission 30MHz to 1GHz

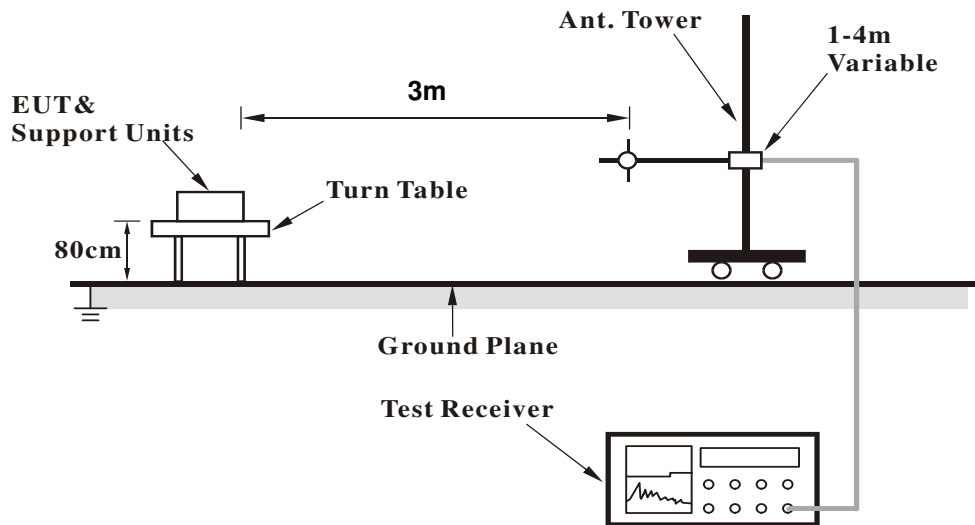

For Radiated emission above 1GHz

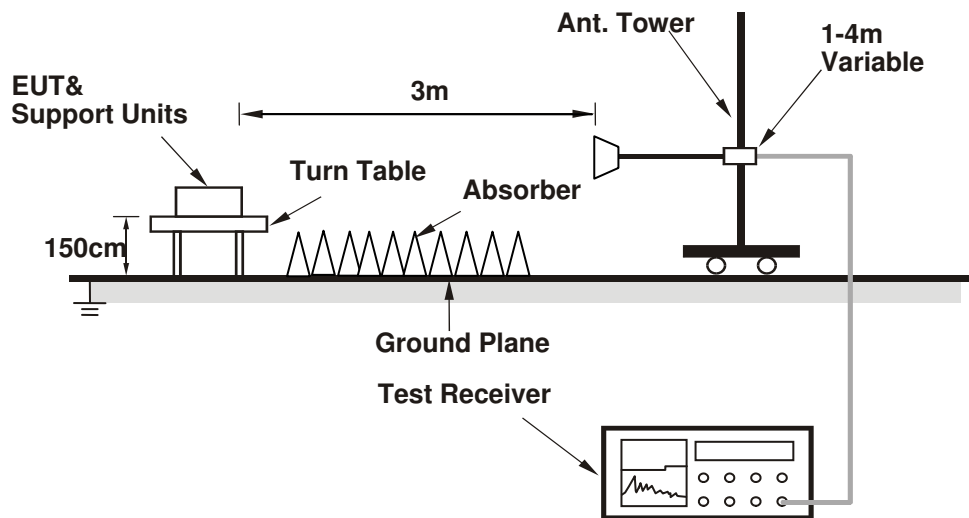

For the actual test configuration, please refer to the attached file (Test Setup Photo).

4.1.6 EUT Operating Condition

- a. Connected the EUT with AC adapter placed on testing table.
- b. Set the EUT under transmission condition continuously at specific channel frequency.

4.1.7 Test Results

Above 1GHz Data:

802.11a

CHANNEL	TX Channel 36	DETECTOR FUNCTION	Peak (PK)
FREQUENCY RANGE	1GHz ~ 40GHz		Average (AV)

ANTENNA POLARITY & TEST DISTANCE: HORIZONTAL AT 3 M

NO.	FREQ. (MHz)	EMISSION LEVEL (dBuV/m)	LIMIT (dBuV/m)	MARGIN (dB)	ANTENNA HEIGHT (m)	TABLE ANGLE (Degree)	RAW VALUE (dBuV)	CORRECTION FACTOR (dB/m)
1	5150.00	63.98 PK	74.00	-10.02	1.74 H	110	56.03	7.95
2	5150.00	48.32 AV	54.00	-5.68	1.74 H	110	40.37	7.95
3	*5180.00	104.46 PK			1.74 H	110	96.37	8.09
4	*5180.00	95.21 AV			1.74 H	110	87.12	8.09
5	#10360.00	54.73 PK	74.00	-19.27	2.23 H	289	36.85	17.88
6	#10360.00	43.78 AV	54.00	-10.22	2.23 H	289	25.90	17.88
7	15540.00	61.61 PK	74.00	-12.39	2.08 H	199	40.07	21.54
8	15540.00	49.97 AV	54.00	-4.03	2.08 H	199	28.43	21.54

ANTENNA POLARITY & TEST DISTANCE: VERTICAL AT 3 M

NO.	FREQ. (MHz)	EMISSION LEVEL (dBuV/m)	LIMIT (dBuV/m)	MARGIN (dB)	ANTENNA HEIGHT (m)	TABLE ANGLE (Degree)	RAW VALUE (dBuV)	CORRECTION FACTOR (dB/m)
1	5150.00	71.44 PK	74.00	-2.56	1.00 V	217	63.49	7.95
2	5150.00	53.73 AV	54.00	-0.27	1.00 V	217	45.78	7.95
3	*5180.00	110.93 PK			1.00 V	217	102.84	8.09
4	*5180.00	101.24 AV			1.00 V	217	93.15	8.09
5	#10360.00	55.69 PK	74.00	-18.31	1.55 V	331	37.81	17.88
6	#10360.00	44.81 AV	54.00	-9.19	1.55 V	331	26.93	17.88
7	15540.00	63.57 PK	74.00	-10.43	1.06 V	190	42.03	21.54
8	15540.00	50.70 AV	54.00	-3.30	1.06 V	190	29.16	21.54

REMARKS:

1. Emission Level(dBuV/m) = Raw Value(dBuV) + Correction Factor(dB/m)
2. Correction Factor(dB/m) = Antenna Factor(dB/m) + Cable Factor(dB) – Pre-Amplifier Factor(dB)
3. The other emission levels were very low against the limit.
4. Margin value = Emission Level – Limit value
5. " * ": Fundamental frequency.
6. " # ": The radiated frequency is out of the restricted band.

CHANNEL	TX Channel 40	DETECTOR FUNCTION	Peak (PK)
FREQUENCY RANGE	1GHz ~ 40GHz		Average (AV)

ANTENNA POLARITY & TEST DISTANCE: HORIZONTAL AT 3 M

NO.	FREQ. (MHz)	EMISSION LEVEL (dBuV/m)	LIMIT (dBuV/m)	MARGIN (dB)	ANTENNA HEIGHT (m)	TABLE ANGLE (Degree)	RAW VALUE (dBuV)	CORRECTION FACTOR (dB/m)
1	*5200.00	106.03 PK			1.69 H	107	97.85	8.18
2	*5200.00	96.80 AV			1.69 H	107	88.62	8.18
3	#10400.00	54.92 PK	74.00	-19.08	2.27 H	302	36.91	18.01
4	#10400.00	44.14 AV	54.00	-9.86	2.27 H	302	26.13	18.01
5	15600.00	64.44 PK	74.00	-9.56	1.84 H	207	42.65	21.79
6	15600.00	50.90 AV	54.00	-3.10	1.84 H	207	29.11	21.79

ANTENNA POLARITY & TEST DISTANCE: VERTICAL AT 3 M

NO.	FREQ. (MHz)	EMISSION LEVEL (dBuV/m)	LIMIT (dBuV/m)	MARGIN (dB)	ANTENNA HEIGHT (m)	TABLE ANGLE (Degree)	RAW VALUE (dBuV)	CORRECTION FACTOR (dB/m)
1	*5200.00	112.34 PK			1.03 V	211	104.16	8.18
2	*5200.00	102.70 AV			1.03 V	211	94.52	8.18
3	#10400.00	56.43 PK	74.00	-17.57	1.63 V	345	38.42	18.01
4	#10400.00	45.56 AV	54.00	-8.44	1.63 V	345	27.55	18.01
5	15600.00	66.71 PK	74.00	-7.29	1.79 V	227	44.92	21.79
6	15600.00	53.68 AV	54.00	-0.32	1.79 V	227	31.89	21.79

REMARKS:

1. Emission Level(dBuV/m) = Raw Value(dBuV) + Correction Factor(dB/m)
2. Correction Factor(dB/m) = Antenna Factor(dB/m) + Cable Factor(dB) – Pre-Amplifier Factor(dB)
3. The other emission levels were very low against the limit.
4. Margin value = Emission Level – Limit value
5. " * ": Fundamental frequency.
6. " # ": The radiated frequency is out of the restricted band.

CHANNEL	TX Channel 48	DETECTOR FUNCTION	Peak (PK)
FREQUENCY RANGE	1GHz ~ 40GHz		Average (AV)

ANTENNA POLARITY & TEST DISTANCE: HORIZONTAL AT 3 M

NO.	FREQ. (MHz)	EMISSION LEVEL (dBuV/m)	LIMIT (dBuV/m)	MARGIN (dB)	ANTENNA HEIGHT (m)	TABLE ANGLE (Degree)	RAW VALUE (dBuV)	CORRECTION FACTOR (dB/m)
1	*5240.00	103.40 PK			1.27 H	125	95.16	8.24
2	*5240.00	93.17 AV			1.27 H	125	84.93	8.24
3	5350.00	59.21 PK	74.00	-14.79	1.27 H	125	50.74	8.47
4	5350.00	45.43 AV	54.00	-8.57	1.27 H	125	36.96	8.47
5	#10480.00	55.53 PK	74.00	-18.47	2.24 H	295	37.16	18.37
6	#10480.00	44.59 AV	54.00	-9.41	2.24 H	295	26.22	18.37
7	15720.00	62.27 PK	74.00	-11.73	1.50 H	53	40.84	21.43
8	15720.00	50.40 AV	54.00	-3.60	1.50 H	53	28.97	21.43

ANTENNA POLARITY & TEST DISTANCE: VERTICAL AT 3 M

NO.	FREQ. (MHz)	EMISSION LEVEL (dBuV/m)	LIMIT (dBuV/m)	MARGIN (dB)	ANTENNA HEIGHT (m)	TABLE ANGLE (Degree)	RAW VALUE (dBuV)	CORRECTION FACTOR (dB/m)
1	*5240.00	112.29 PK			1.00 V	237	104.05	8.24
2	*5240.00	102.51 AV			1.00 V	237	94.27	8.24
3	5350.00	59.70 PK	74.00	-14.30	1.00 V	237	51.23	8.47
4	5350.00	47.01 AV	54.00	-6.99	1.00 V	237	38.54	8.47
5	#10480.00	56.76 PK	74.00	-17.24	1.73 V	222	38.39	18.37
6	#10480.00	45.68 AV	54.00	-8.32	1.73 V	222	27.31	18.37
7	15720.00	66.14 PK	74.00	-7.86	2.90 V	346	44.71	21.43
8	15720.00	53.62 AV	54.00	-0.38	2.90 V	346	32.19	21.43

REMARKS:

1. Emission Level(dBuV/m) = Raw Value(dBuV) + Correction Factor(dB/m)
2. Correction Factor(dB/m) = Antenna Factor(dB/m) + Cable Factor(dB) – Pre-Amplifier Factor(dB)
3. The other emission levels were very low against the limit.
4. Margin value = Emission Level – Limit value
5. " * ": Fundamental frequency.
6. " # ": The radiated frequency is out of the restricted band.

CHANNEL	TX Channel 149	DETECTOR FUNCTION	Peak (PK)
FREQUENCY RANGE	1GHz ~ 40GHz		Average (AV)

ANTENNA POLARITY & TEST DISTANCE: HORIZONTAL AT 3 M

NO.	FREQ. (MHz)	EMISSION LEVEL (dBuV/m)	LIMIT (dBuV/m)	MARGIN (dB)	ANTENNA HEIGHT (m)	TABLE ANGLE (Degree)	RAW VALUE (dBuV)	CORRECTION FACTOR (dB/m)
1	#5594.18	61.04 PK	68.20	-7.16	1.19 H	138	51.36	9.68
2	*5745.00	107.75 PK			1.19 H	138	98.19	9.56
3	*5745.00	97.58 AV			1.19 H	138	88.02	9.56
4	#6021.68	61.26 PK	68.20	-6.94	1.19 H	138	51.07	10.19
5	11490.00	58.91 PK	74.00	-15.09	1.52 H	204	38.94	19.97
6	11490.00	46.14 AV	54.00	-7.86	1.52 H	204	26.17	19.97

ANTENNA POLARITY & TEST DISTANCE: VERTICAL AT 3 M

NO.	FREQ. (MHz)	EMISSION LEVEL (dBuV/m)	LIMIT (dBuV/m)	MARGIN (dB)	ANTENNA HEIGHT (m)	TABLE ANGLE (Degree)	RAW VALUE (dBuV)	CORRECTION FACTOR (dB/m)
1	#5648.32	61.05 PK	68.20	-7.15	2.24 V	345	51.35	9.70
2	*5745.00	116.06 PK			2.24 V	345	106.50	9.56
3	*5745.00	105.51 AV			2.24 V	345	95.95	9.56
4	#5943.77	61.61 PK	68.20	-6.59	2.24 V	345	51.86	9.75
5	11490.00	60.78 PK	74.00	-13.22	1.88 V	229	40.81	19.97
6	11490.00	46.70 AV	54.00	-7.30	1.88 V	229	26.73	19.97

REMARKS:

1. Emission Level(dBuV/m) = Raw Value(dBuV) + Correction Factor(dB/m)
2. Correction Factor(dB/m) = Antenna Factor(dB/m) + Cable Factor(dB) – Pre-Amplifier Factor(dB)
3. The other emission levels were very low against the limit.
4. Margin value = Emission Level – Limit value
5. " * ": Fundamental frequency.
6. " # ": The radiated frequency is out of the restricted band.

CHANNEL	TX Channel 157	DETECTOR FUNCTION	Peak (PK)
FREQUENCY RANGE	1GHz ~ 40GHz		Average (AV)

ANTENNA POLARITY & TEST DISTANCE: HORIZONTAL AT 3 M

NO.	FREQ. (MHz)	EMISSION LEVEL (dBuV/m)	LIMIT (dBuV/m)	MARGIN (dB)	ANTENNA HEIGHT (m)	TABLE ANGLE (Degree)	RAW VALUE (dBuV)	CORRECTION FACTOR (dB/m)
1	#5618.87	59.25 PK	68.20	-8.95	1.24 H	131	49.54	9.71
2	*5785.00	109.26 PK			1.24 H	131	99.81	9.45
3	*5785.00	99.01 AV			1.24 H	131	89.56	9.45
4	#6010.75	58.49 PK	68.20	-9.71	1.24 H	131	48.38	10.11
5	11570.00	59.17 PK	74.00	-14.83	1.60 H	209	38.85	20.32
6	11570.00	46.52 AV	54.00	-7.48	1.60 H	209	26.20	20.32

ANTENNA POLARITY & TEST DISTANCE: VERTICAL AT 3 M

NO.	FREQ. (MHz)	EMISSION LEVEL (dBuV/m)	LIMIT (dBuV/m)	MARGIN (dB)	ANTENNA HEIGHT (m)	TABLE ANGLE (Degree)	RAW VALUE (dBuV)	CORRECTION FACTOR (dB/m)
1	#5568.05	59.72 PK	68.20	-8.48	2.27 V	351	50.13	9.59
2	*5785.00	115.98 PK			2.27 V	351	106.53	9.45
3	*5785.00	104.92 AV			2.27 V	351	95.47	9.45
4	#5977.02	59.35 PK	68.20	-8.85	2.27 V	351	49.42	9.93
5	11570.00	61.25 PK	74.00	-12.75	1.67 V	227	40.93	20.32
6	11570.00	46.91 AV	54.00	-7.09	1.67 V	227	26.59	20.32

REMARKS:

1. Emission Level(dBuV/m) = Raw Value(dBuV) + Correction Factor(dB/m)
2. Correction Factor(dB/m) = Antenna Factor(dB/m) + Cable Factor(dB) – Pre-Amplifier Factor(dB)
3. The other emission levels were very low against the limit.
4. Margin value = Emission Level – Limit value
5. " * ": Fundamental frequency.
6. " # ": The radiated frequency is out of the restricted band.

CHANNEL	TX Channel 165	DETECTOR FUNCTION	Peak (PK)
FREQUENCY RANGE	1GHz ~ 40GHz		Average (AV)

ANTENNA POLARITY & TEST DISTANCE: HORIZONTAL AT 3 M

NO.	FREQ. (MHz)	EMISSION LEVEL (dBuV/m)	LIMIT (dBuV/m)	MARGIN (dB)	ANTENNA HEIGHT (m)	TABLE ANGLE (Degree)	RAW VALUE (dBuV)	CORRECTION FACTOR (dB/m)
1	#5620.77	57.80 PK	68.20	-10.40	1.35 H	109	48.10	9.70
2	*5825.00	108.15 PK			1.35 H	109	98.72	9.43
3	*5825.00	98.27 AV			1.35 H	109	88.84	9.43
4	#6019.30	57.83 PK	68.20	-10.37	1.35 H	109	47.66	10.17
5	11650.00	59.42 PK	74.00	-14.58	1.57 H	217	39.15	20.27
6	11650.00	46.35 AV	54.00	-7.65	1.57 H	217	26.08	20.27

ANTENNA POLARITY & TEST DISTANCE: VERTICAL AT 3 M

NO.	FREQ. (MHz)	EMISSION LEVEL (dBuV/m)	LIMIT (dBuV/m)	MARGIN (dB)	ANTENNA HEIGHT (m)	TABLE ANGLE (Degree)	RAW VALUE (dBuV)	CORRECTION FACTOR (dB/m)
1	#5606.05	60.91 PK	68.20	-7.29	2.21 V	343	51.21	9.70
2	*5825.00	115.64 PK			2.21 V	343	106.21	9.43
3	*5825.00	105.37 AV			2.21 V	343	95.94	9.43
4	#5957.07	60.89 PK	68.20	-7.31	2.21 V	343	51.06	9.83
5	11650.00	61.09 PK	74.00	-12.91	1.74 V	240	40.82	20.27
6	11650.00	46.68 AV	54.00	-7.32	1.74 V	240	26.41	20.27

REMARKS:

1. Emission Level(dBuV/m) = Raw Value(dBuV) + Correction Factor(dB/m)
2. Correction Factor(dB/m) = Antenna Factor(dB/m) + Cable Factor(dB) – Pre-Amplifier Factor(dB)
3. The other emission levels were very low against the limit.
4. Margin value = Emission Level – Limit value
5. " * ": Fundamental frequency.
6. " # ": The radiated frequency is out of the restricted band.

802.11n (20MHz)

CHANNEL	TX Channel 36	DETECTOR FUNCTION	Peak (PK)
FREQUENCY RANGE	1GHz ~ 40GHz		Average (AV)

ANTENNA POLARITY & TEST DISTANCE: HORIZONTAL AT 3 M

NO.	FREQ. (MHz)	EMISSION LEVEL (dBuV/m)	LIMIT (dBuV/m)	MARGIN (dB)	ANTENNA HEIGHT (m)	TABLE ANGLE (Degree)	RAW VALUE (dBuV)	CORRECTION FACTOR (dB/m)
1	5150.00	64.19 PK	74.00	-9.81	1.25 H	129	56.24	7.95
2	5150.00	48.70 AV	54.00	-5.30	1.25 H	129	40.75	7.95
3	*5180.00	103.51 PK			1.25 H	129	95.42	8.09
4	*5180.00	93.66 AV			1.25 H	129	85.57	8.09
5	#10360.00	55.94 PK	74.00	-18.06	2.17 H	290	38.06	17.88
6	#10360.00	44.11 AV	54.00	-9.89	2.17 H	290	26.23	17.88
7	15540.00	62.60 PK	74.00	-11.40	1.54 H	59	41.06	21.54
8	15540.00	48.69 AV	54.00	-5.31	1.54 H	59	27.15	21.54

ANTENNA POLARITY & TEST DISTANCE: VERTICAL AT 3 M

NO.	FREQ. (MHz)	EMISSION LEVEL (dBuV/m)	LIMIT (dBuV/m)	MARGIN (dB)	ANTENNA HEIGHT (m)	TABLE ANGLE (Degree)	RAW VALUE (dBuV)	CORRECTION FACTOR (dB/m)
1	5150.00	73.08 PK	74.00	-0.92	1.00 V	177	65.13	7.95
2	5150.00	53.64 AV	54.00	-0.36	1.00 V	177	45.69	7.95
3	*5180.00	110.44 PK			1.00 V	177	102.35	8.09
4	*5180.00	100.50 AV			1.00 V	177	92.41	8.09
5	#10360.00	56.79 PK	74.00	-17.21	1.64 V	275	38.91	17.88
6	#10360.00	44.92 AV	54.00	-9.08	1.64 V	275	27.04	17.88
7	15540.00	65.04 PK	74.00	-8.96	2.92 V	339	43.50	21.54
8	15540.00	51.36 AV	54.00	-2.64	2.92 V	339	29.82	21.54

REMARKS:

1. Emission Level(dBuV/m) = Raw Value(dBuV) + Correction Factor(dB/m)
2. Correction Factor(dB/m) = Antenna Factor(dB/m) + Cable Factor(dB) – Pre-Amplifier Factor(dB)
3. The other emission levels were very low against the limit.
4. Margin value = Emission Level – Limit value
5. " * ": Fundamental frequency.
6. " # ": The radiated frequency is out of the restricted band.

CHANNEL	TX Channel 40	DETECTOR FUNCTION	Peak (PK)
FREQUENCY RANGE	1GHz ~ 40GHz		Average (AV)

ANTENNA POLARITY & TEST DISTANCE: HORIZONTAL AT 3 M

NO.	FREQ. (MHz)	EMISSION LEVEL (dBuV/m)	LIMIT (dBuV/m)	MARGIN (dB)	ANTENNA HEIGHT (m)	TABLE ANGLE (Degree)	RAW VALUE (dBuV)	CORRECTION FACTOR (dB/m)
1	*5200.00	102.55 PK			1.28 H	131	94.37	8.18
2	*5200.00	92.84 AV			1.28 H	131	84.66	8.18
3	#10400.00	56.52 PK	74.00	-17.48	2.20 H	298	38.51	18.01
4	#10400.00	44.44 AV	54.00	-9.56	2.20 H	298	26.43	18.01
5	15600.00	66.04 PK	74.00	-7.96	1.63 H	50	44.25	21.79
6	15600.00	51.66 AV	54.00	-2.34	1.63 H	50	29.87	21.79

ANTENNA POLARITY & TEST DISTANCE: VERTICAL AT 3 M

NO.	FREQ. (MHz)	EMISSION LEVEL (dBuV/m)	LIMIT (dBuV/m)	MARGIN (dB)	ANTENNA HEIGHT (m)	TABLE ANGLE (Degree)	RAW VALUE (dBuV)	CORRECTION FACTOR (dB/m)
1	*5200.00	111.67 PK			1.03 V	179	103.49	8.18
2	*5200.00	101.99 AV			1.03 V	179	93.81	8.18
3	#10400.00	57.65 PK	74.00	-16.35	1.58 V	277	39.64	18.01
4	#10400.00	45.24 AV	54.00	-8.76	1.58 V	277	27.23	18.01
5	15600.00	67.07 PK	74.00	-6.93	2.99 V	327	45.28	21.79
6	15600.00	53.75 AV	54.00	-0.25	2.99 V	327	31.96	21.79

REMARKS:

1. Emission Level(dBuV/m) = Raw Value(dBuV) + Correction Factor(dB/m)
2. Correction Factor(dB/m) = Antenna Factor(dB/m) + Cable Factor(dB) – Pre-Amplifier Factor(dB)
3. The other emission levels were very low against the limit.
4. Margin value = Emission Level – Limit value
5. " * ": Fundamental frequency.
6. " # ": The radiated frequency is out of the restricted band.

CHANNEL	TX Channel 48	DETECTOR FUNCTION	Peak (PK)
FREQUENCY RANGE	1GHz ~ 40GHz		Average (AV)

ANTENNA POLARITY & TEST DISTANCE: HORIZONTAL AT 3 M

NO.	FREQ. (MHz)	EMISSION LEVEL (dBuV/m)	LIMIT (dBuV/m)	MARGIN (dB)	ANTENNA HEIGHT (m)	TABLE ANGLE (Degree)	RAW VALUE (dBuV)	CORRECTION FACTOR (dB/m)
1	*5240.00	103.09 PK			1.98 H	264	94.85	8.24
2	*5240.00	92.49 AV			1.98 H	264	84.25	8.24
3	5350.00	58.89 PK	74.00	-15.11	1.98 H	264	50.42	8.47
4	5350.00	46.66 AV	54.00	-7.34	1.98 H	264	38.19	8.47
5	#10480.00	57.26 PK	74.00	-16.74	2.15 H	336	38.89	18.37
6	#10480.00	43.61 AV	54.00	-10.39	2.15 H	336	25.24	18.37
7	15720.00	61.95 PK	74.00	-12.05	1.47 H	336	40.52	21.43
8	15720.00	49.79 AV	54.00	-4.21	1.47 H	336	28.36	21.43

ANTENNA POLARITY & TEST DISTANCE: VERTICAL AT 3 M

NO.	FREQ. (MHz)	EMISSION LEVEL (dBuV/m)	LIMIT (dBuV/m)	MARGIN (dB)	ANTENNA HEIGHT (m)	TABLE ANGLE (Degree)	RAW VALUE (dBuV)	CORRECTION FACTOR (dB/m)
1	*5240.00	112.72 PK			2.28 V	295	104.48	8.24
2	*5240.00	101.73 AV			2.28 V	295	93.49	8.24
3	5350.00	60.21 PK	74.00	-13.79	2.28 V	295	51.74	8.47
4	5350.00	47.02 AV	54.00	-6.98	2.28 V	295	38.55	8.47
5	#10480.00	58.06 PK	74.00	-15.94	1.37 V	254	39.69	18.37
6	#10480.00	44.36 AV	54.00	-9.64	1.37 V	254	25.99	18.37
7	15720.00	64.35 PK	74.00	-9.65	3.78 V	142	42.92	21.43
8	15720.00	51.72 AV	54.00	-2.28	3.78 V	142	30.29	21.43

REMARKS:

1. Emission Level(dBuV/m) = Raw Value(dBuV) + Correction Factor(dB/m)
2. Correction Factor(dB/m) = Antenna Factor(dB/m) + Cable Factor(dB) – Pre-Amplifier Factor(dB)
3. The other emission levels were very low against the limit.
4. Margin value = Emission Level – Limit value
5. " * ": Fundamental frequency.
6. " # ": The radiated frequency is out of the restricted band.

CHANNEL	TX Channel 149	DETECTOR FUNCTION	Peak (PK)
FREQUENCY RANGE	1GHz ~ 40GHz		Average (AV)

ANTENNA POLARITY & TEST DISTANCE: HORIZONTAL AT 3 M

NO.	FREQ. (MHz)	EMISSION LEVEL (dBuV/m)	LIMIT (dBuV/m)	MARGIN (dB)	ANTENNA HEIGHT (m)	TABLE ANGLE (Degree)	RAW VALUE (dBuV)	CORRECTION FACTOR (dB/m)
1	#5603.20	57.11 PK	68.20	-11.09	1.29 H	124	47.41	9.70
2	*5745.00	106.97 PK			1.29 H	124	97.41	9.56
3	*5745.00	97.12 AV			1.29 H	124	87.56	9.56
4	#5987.95	58.18 PK	68.20	-10.02	1.29 H	124	48.20	9.98
5	11490.00	59.03 PK	74.00	-14.97	1.66 H	220	39.06	19.97
6	11490.00	46.10 AV	54.00	-7.90	1.66 H	220	26.13	19.97

ANTENNA POLARITY & TEST DISTANCE: VERTICAL AT 3 M

NO.	FREQ. (MHz)	EMISSION LEVEL (dBuV/m)	LIMIT (dBuV/m)	MARGIN (dB)	ANTENNA HEIGHT (m)	TABLE ANGLE (Degree)	RAW VALUE (dBuV)	CORRECTION FACTOR (dB/m)
1	#5633.12	60.69 PK	68.20	-7.51	2.26 V	346	50.98	9.71
2	*5745.00	115.83 PK			2.26 V	346	106.27	9.56
3	*5745.00	105.73 AV			2.26 V	346	96.17	9.56
4	#5961.35	60.78 PK	68.20	-7.42	2.26 V	346	50.93	9.85
5	11490.00	60.91 PK	74.00	-13.09	1.62 V	245	40.94	19.97
6	11490.00	46.62 AV	54.00	-7.38	1.62 V	245	26.65	19.97

REMARKS:

1. Emission Level(dBuV/m) = Raw Value(dBuV) + Correction Factor(dB/m)
2. Correction Factor(dB/m) = Antenna Factor(dB/m) + Cable Factor(dB) – Pre-Amplifier Factor(dB)
3. The other emission levels were very low against the limit.
4. Margin value = Emission Level – Limit value
5. " * ": Fundamental frequency.
6. " # ": The radiated frequency is out of the restricted band.

CHANNEL	TX Channel 157	DETECTOR FUNCTION	Peak (PK)
FREQUENCY RANGE	1GHz ~ 40GHz		Average (AV)

ANTENNA POLARITY & TEST DISTANCE: HORIZONTAL AT 3 M

NO.	FREQ. (MHz)	EMISSION LEVEL (dBuV/m)	LIMIT (dBuV/m)	MARGIN (dB)	ANTENNA HEIGHT (m)	TABLE ANGLE (Degree)	RAW VALUE (dBuV)	CORRECTION FACTOR (dB/m)
1	#5612.23	56.88 PK	68.20	-11.32	1.24 H	128	47.17	9.71
2	*5785.00	106.96 PK			1.24 H	128	97.51	9.45
3	*5785.00	97.07 AV			1.24 H	128	87.62	9.45
4	#6010.27	58.29 PK	68.20	-9.91	1.24 H	128	48.19	10.10
5	11570.00	59.57 PK	74.00	-14.43	1.59 H	217	39.25	20.32
6	11570.00	46.53 AV	54.00	-7.47	1.59 H	217	26.21	20.32

ANTENNA POLARITY & TEST DISTANCE: VERTICAL AT 3 M

NO.	FREQ. (MHz)	EMISSION LEVEL (dBuV/m)	LIMIT (dBuV/m)	MARGIN (dB)	ANTENNA HEIGHT (m)	TABLE ANGLE (Degree)	RAW VALUE (dBuV)	CORRECTION FACTOR (dB/m)
1	#5586.57	61.24 PK	68.20	-6.96	2.27 V	344	51.58	9.66
2	*5785.00	115.91 PK			2.27 V	344	106.46	9.45
3	*5785.00	105.78 AV			2.27 V	344	96.33	9.45
4	#5993.65	60.90 PK	68.20	-7.30	2.27 V	344	50.90	10.00
5	11570.00	61.19 PK	74.00	-12.81	1.58 V	247	40.87	20.32
6	11570.00	47.06 AV	54.00	-6.94	1.58 V	247	26.74	20.32

REMARKS:

1. Emission Level(dBuV/m) = Raw Value(dBuV) + Correction Factor(dB/m)
2. Correction Factor(dB/m) = Antenna Factor(dB/m) + Cable Factor(dB) – Pre-Amplifier Factor(dB)
3. The other emission levels were very low against the limit.
4. Margin value = Emission Level – Limit value
5. " * ": Fundamental frequency.
6. " # ": The radiated frequency is out of the restricted band.

CHANNEL	TX Channel 165	DETECTOR FUNCTION	Peak (PK)
FREQUENCY RANGE	1GHz ~ 40GHz		Average (AV)

ANTENNA POLARITY & TEST DISTANCE: HORIZONTAL AT 3 M

NO.	FREQ. (MHz)	EMISSION LEVEL (dBuV/m)	LIMIT (dBuV/m)	MARGIN (dB)	ANTENNA HEIGHT (m)	TABLE ANGLE (Degree)	RAW VALUE (dBuV)	CORRECTION FACTOR (dB/m)
1	#5584.20	61.00 PK	68.20	-7.20	1.31 H	121	51.36	9.64
2	*5825.00	107.18 PK			1.31 H	121	97.75	9.43
3	*5825.00	97.77 AV			1.31 H	121	88.34	9.43
4	#6015.50	61.32 PK	68.20	-6.88	1.31 H	121	51.18	10.14
5	11650.00	59.45 PK	74.00	-14.55	1.52 H	223	39.18	20.27
6	11650.00	46.36 AV	54.00	-7.64	1.52 H	223	26.09	20.27

ANTENNA POLARITY & TEST DISTANCE: VERTICAL AT 3 M

NO.	FREQ. (MHz)	EMISSION LEVEL (dBuV/m)	LIMIT (dBuV/m)	MARGIN (dB)	ANTENNA HEIGHT (m)	TABLE ANGLE (Degree)	RAW VALUE (dBuV)	CORRECTION FACTOR (dB/m)
1	#5638.82	60.53 PK	68.20	-7.67	2.23 V	347	50.83	9.70
2	*5825.00	116.03 PK			2.23 V	347	106.60	9.43
3	*5825.00	106.27 AV			2.23 V	347	96.84	9.43
4	#5998.87	61.45 PK	68.20	-6.75	2.23 V	347	51.42	10.03
5	11650.00	61.16 PK	74.00	-12.84	1.53 V	239	40.89	20.27
6	11650.00	47.32 AV	54.00	-6.68	1.53 V	239	27.05	20.27

REMARKS:

1. Emission Level(dBuV/m) = Raw Value(dBuV) + Correction Factor(dB/m)
2. Correction Factor(dB/m) = Antenna Factor(dB/m) + Cable Factor(dB) – Pre-Amplifier Factor(dB)
3. The other emission levels were very low against the limit.
4. Margin value = Emission Level – Limit value
5. " * ": Fundamental frequency.
6. " # ": The radiated frequency is out of the restricted band.

802.11n (40MHz)

CHANNEL	TX Channel 38	DETECTOR FUNCTION	Peak (PK)
FREQUENCY RANGE	1GHz ~ 40GHz		Average (AV)

ANTENNA POLARITY & TEST DISTANCE: HORIZONTAL AT 3 M

NO.	FREQ. (MHz)	EMISSION LEVEL (dBuV/m)	LIMIT (dBuV/m)	MARGIN (dB)	ANTENNA HEIGHT (m)	TABLE ANGLE (Degree)	RAW VALUE (dBuV)	CORRECTION FACTOR (dB/m)
1	5150.00	64.26 PK	74.00	-9.74	1.26 H	154	56.31	7.95
2	5150.00	48.14 AV	54.00	-5.86	1.26 H	154	40.19	7.95
3	*5190.00	98.75 PK			1.26 H	154	90.62	8.13
4	*5190.00	89.90 AV			1.26 H	154	81.77	8.13
5	#10380.00	55.80 PK	74.00	-18.20	1.54 H	68	37.85	17.95
6	#10380.00	43.98 AV	54.00	-10.02	1.54 H	68	26.03	17.95

ANTENNA POLARITY & TEST DISTANCE: VERTICAL AT 3 M

NO.	FREQ. (MHz)	EMISSION LEVEL (dBuV/m)	LIMIT (dBuV/m)	MARGIN (dB)	ANTENNA HEIGHT (m)	TABLE ANGLE (Degree)	RAW VALUE (dBuV)	CORRECTION FACTOR (dB/m)
1	5150.00	71.42 PK	74.00	-2.58	2.24 V	22	63.47	7.95
2	5150.00	53.73 AV	54.00	-0.27	2.24 V	22	45.78	7.95
3	*5190.00	107.10 PK			4.00 V	22	98.97	8.13
4	*5190.00	97.47 AV			3.27 V	357	89.34	8.13
5	#10380.00	56.01 PK	74.00	-17.99	1.38 V	269	38.06	17.95
6	#10380.00	44.79 AV	54.00	-9.21	1.38 V	269	26.84	17.95

REMARKS:

1. Emission Level(dBuV/m) = Raw Value(dBuV) + Correction Factor(dB/m)
2. Correction Factor(dB/m) = Antenna Factor(dB/m) + Cable Factor(dB) – Pre-Amplifier Factor(dB)
3. The other emission levels were very low against the limit.
4. Margin value = Emission Level – Limit value
5. " * ": Fundamental frequency.
6. " # ": The radiated frequency is out of the restricted band.

CHANNEL	TX Channel 46	DETECTOR FUNCTION	Peak (PK)
FREQUENCY RANGE	1GHz ~ 40GHz		Average (AV)

ANTENNA POLARITY & TEST DISTANCE: HORIZONTAL AT 3 M

NO.	FREQ. (MHz)	EMISSION LEVEL (dBuV/m)	LIMIT (dBuV/m)	MARGIN (dB)	ANTENNA HEIGHT (m)	TABLE ANGLE (Degree)	RAW VALUE (dBuV)	CORRECTION FACTOR (dB/m)
1	5150.00	63.72 PK	74.00	-10.28	1.29 H	145	55.77	7.95
2	5150.00	48.23 AV	54.00	-5.77	1.29 H	145	40.28	7.95
3	*5230.00	106.07 PK			1.29 H	145	97.84	8.23
4	*5230.00	96.50 AV			1.29 H	145	88.27	8.23
5	5350.00	59.81 PK	74.00	-14.19	1.29 H	145	51.34	8.47
6	5350.00	46.38 AV	54.00	-7.62	1.29 H	145	37.91	8.47
7	#10460.00	56.49 PK	74.00	-17.51	1.61 H	58	38.21	18.28
8	#10460.00	44.67 AV	54.00	-9.33	1.61 H	58	26.39	18.28

ANTENNA POLARITY & TEST DISTANCE: VERTICAL AT 3 M

NO.	FREQ. (MHz)	EMISSION LEVEL (dBuV/m)	LIMIT (dBuV/m)	MARGIN (dB)	ANTENNA HEIGHT (m)	TABLE ANGLE (Degree)	RAW VALUE (dBuV)	CORRECTION FACTOR (dB/m)
1	5150.00	70.69 PK	74.00	-3.31	2.27 V	345	62.74	7.95
2	5150.00	53.64 AV	54.00	-0.36	2.27 V	345	45.69	7.95
3	*5230.00	112.46 PK			2.27 V	345	104.23	8.23
4	*5230.00	103.13 AV			2.27 V	345	94.90	8.23
5	5350.00	61.08 PK	74.00	-12.92	2.27 V	345	52.61	8.47
6	5350.00	46.90 AV	54.00	-7.10	2.27 V	345	38.43	8.47
7	#10460.00	57.19 PK	74.00	-16.81	1.42 V	277	38.91	18.28
8	#10460.00	45.80 AV	54.00	-8.20	1.42 V	277	27.52	18.28

REMARKS:

1. Emission Level(dBuV/m) = Raw Value(dBuV) + Correction Factor(dB/m)
2. Correction Factor(dB/m) = Antenna Factor(dB/m) + Cable Factor(dB) – Pre-Amplifier Factor(dB)
3. The other emission levels were very low against the limit.
4. Margin value = Emission Level – Limit value
5. " * ": Fundamental frequency.
6. " # ": The radiated frequency is out of the restricted band.

CHANNEL	TX Channel 151	DETECTOR FUNCTION	Peak (PK)
FREQUENCY RANGE	1GHz ~ 40GHz		Average (AV)

ANTENNA POLARITY & TEST DISTANCE: HORIZONTAL AT 3 M

NO.	FREQ. (MHz)	EMISSION LEVEL (dBuV/m)	LIMIT (dBuV/m)	MARGIN (dB)	ANTENNA HEIGHT (m)	TABLE ANGLE (Degree)	RAW VALUE (dBuV)	CORRECTION FACTOR (dB/m)
1	#5587.52	56.24 PK	68.20	-11.96	1.29 H	126	46.58	9.66
2	*5755.00	103.70 PK			1.29 H	126	94.16	9.54
3	*5755.00	93.95 AV			1.29 H	126	84.41	9.54
4	#5972.27	55.18 PK	68.20	-13.02	1.29 H	126	45.28	9.90
5	11510.00	59.04 PK	74.00	-14.96	1.55 H	230	39.04	20.00
6	11510.00	45.93 AV	54.00	-8.07	1.55 H	230	25.93	20.00

ANTENNA POLARITY & TEST DISTANCE: VERTICAL AT 3 M

NO.	FREQ. (MHz)	EMISSION LEVEL (dBuV/m)	LIMIT (dBuV/m)	MARGIN (dB)	ANTENNA HEIGHT (m)	TABLE ANGLE (Degree)	RAW VALUE (dBuV)	CORRECTION FACTOR (dB/m)
1	#5649.75	67.86 PK	68.20	-0.34	2.27 V	349	58.16	9.70
2	*5755.00	112.08 PK			2.27 V	349	102.54	9.54
3	*5755.00	102.34 AV			2.27 V	349	92.80	9.54
4	#6024.05	61.36 PK	68.20	-6.84	2.27 V	349	51.16	10.20
5	11510.00	60.66 PK	74.00	-13.34	1.40 V	228	40.66	20.00
6	11510.00	46.88 AV	54.00	-7.12	1.40 V	228	26.88	20.00

REMARKS:

1. Emission Level(dBuV/m) = Raw Value(dBuV) + Correction Factor(dB/m)
2. Correction Factor(dB/m) = Antenna Factor(dB/m) + Cable Factor(dB) – Pre-Amplifier Factor(dB)
3. The other emission levels were very low against the limit.
4. Margin value = Emission Level – Limit value
5. " * ": Fundamental frequency.
6. " # ": The radiated frequency is out of the restricted band.

CHANNEL	TX Channel 159	DETECTOR FUNCTION	Peak (PK)
FREQUENCY RANGE	1GHz ~ 40GHz		Average (AV)

ANTENNA POLARITY & TEST DISTANCE: HORIZONTAL AT 3 M

NO.	FREQ. (MHz)	EMISSION LEVEL (dBuV/m)	LIMIT (dBuV/m)	MARGIN (dB)	ANTENNA HEIGHT (m)	TABLE ANGLE (Degree)	RAW VALUE (dBuV)	CORRECTION FACTOR (dB/m)
1	#5613.18	60.33 PK	68.20	-7.87	1.18 H	129	50.62	9.71
2	*5795.00	106.94 PK			1.18 H	129	97.52	9.42
3	*5795.00	97.21 AV			1.18 H	129	87.79	9.42
4	#5953.75	61.00 PK	68.20	-7.20	1.18 H	129	51.20	9.80
5	11590.00	59.89 PK	74.00	-14.11	1.52 H	227	39.47	20.42
6	11590.00	46.65 AV	54.00	-7.35	1.52 H	227	26.23	20.42

ANTENNA POLARITY & TEST DISTANCE: VERTICAL AT 3 M

NO.	FREQ. (MHz)	EMISSION LEVEL (dBuV/m)	LIMIT (dBuV/m)	MARGIN (dB)	ANTENNA HEIGHT (m)	TABLE ANGLE (Degree)	RAW VALUE (dBuV)	CORRECTION FACTOR (dB/m)
1	#5644.05	63.09 PK	68.20	-5.11	2.22 V	345	53.39	9.70
2	*5795.00	113.11 PK			2.22 V	345	103.69	9.42
3	*5795.00	103.34 AV			2.22 V	345	93.92	9.42
4	#5926.20	63.61 PK	68.20	-4.59	2.22 V	345	53.93	9.68
5	11590.00	61.35 PK	74.00	-12.65	1.75 V	304	40.93	20.42
6	11590.00	47.58 AV	54.00	-6.42	1.75 V	304	27.16	20.42

REMARKS:

1. Emission Level(dBuV/m) = Raw Value(dBuV) + Correction Factor(dB/m)
2. Correction Factor(dB/m) = Antenna Factor(dB/m) + Cable Factor(dB) – Pre-Amplifier Factor(dB)
3. The other emission levels were very low against the limit.
4. Margin value = Emission Level – Limit value
5. " * ": Fundamental frequency.
6. " # ": The radiated frequency is out of the restricted band.

802.11ac (80MHz)

CHANNEL	TX Channel 42	DETECTOR FUNCTION	Peak (PK)
FREQUENCY RANGE	1GHz ~ 40GHz		Average (AV)

ANTENNA POLARITY & TEST DISTANCE: HORIZONTAL AT 3 M

NO.	FREQ. (MHz)	EMISSION LEVEL (dBuV/m)	LIMIT (dBuV/m)	MARGIN (dB)	ANTENNA HEIGHT (m)	TABLE ANGLE (Degree)	RAW VALUE (dBuV)	CORRECTION FACTOR (dB/m)
1	5150.00	62.33 PK	74.00	-11.67	1.22 H	134	54.38	7.95
2	5150.00	47.37 AV	54.00	-6.63	1.22 H	134	39.42	7.95
3	*5210.00	95.31 PK			1.22 H	134	87.12	8.19
4	*5210.00	86.28 AV			1.22 H	134	78.09	8.19
5	5350.00	59.76 PK	74.00	-14.24	1.22 H	134	51.29	8.47
6	5350.00	46.13 AV	54.00	-7.87	1.22 H	134	37.66	8.47
7	#10420.00	55.57 PK	74.00	-18.43	1.60 H	62	37.46	18.11
8	#10420.00	44.26 AV	54.00	-9.74	1.60 H	62	26.15	18.11

ANTENNA POLARITY & TEST DISTANCE: VERTICAL AT 3 M

NO.	FREQ. (MHz)	EMISSION LEVEL (dBuV/m)	LIMIT (dBuV/m)	MARGIN (dB)	ANTENNA HEIGHT (m)	TABLE ANGLE (Degree)	RAW VALUE (dBuV)	CORRECTION FACTOR (dB/m)
1	5150.00	69.22 PK	74.00	-4.78	2.26 V	348	61.27	7.95
2	5150.00	53.56 AV	54.00	-0.44	2.26 V	348	45.61	7.95
3	*5210.00	102.66 PK			2.26 V	348	94.47	8.19
4	*5210.00	92.95 AV			2.26 V	348	84.76	8.19
5	5350.00	60.04 PK	74.00	-13.96	2.26 V	348	51.57	8.47
6	5350.00	46.79 AV	54.00	-7.21	2.26 V	348	38.32	8.47
7	#10420.00	56.51 PK	74.00	-17.49	1.31 V	265	38.40	18.11
8	#10420.00	45.20 AV	54.00	-8.80	1.31 V	265	27.09	18.11

REMARKS:

1. Emission Level(dBuV/m) = Raw Value(dBuV) + Correction Factor(dB/m)
2. Correction Factor(dB/m) = Antenna Factor(dB/m) + Cable Factor(dB) – Pre-Amplifier Factor(dB)
3. The other emission levels were very low against the limit.
4. Margin value = Emission Level – Limit value
5. " * ": Fundamental frequency.
6. " # ": The radiated frequency is out of the restricted band.

CHANNEL	TX Channel 155	DETECTOR FUNCTION	Peak (PK)
FREQUENCY RANGE	1GHz ~ 40GHz		Average (AV)

ANTENNA POLARITY & TEST DISTANCE: HORIZONTAL AT 3 M

NO.	FREQ. (MHz)	EMISSION LEVEL (dBuV/m)	LIMIT (dBuV/m)	MARGIN (dB)	ANTENNA HEIGHT (m)	TABLE ANGLE (Degree)	RAW VALUE (dBuV)	CORRECTION FACTOR (dB/m)
1	#5609.85	60.75 PK	68.20	-7.45	1.23 H	133	51.05	9.70
2	*5775.00	99.54 PK			1.23 H	133	90.06	9.48
3	*5775.00	89.75 AV			1.23 H	133	80.27	9.48
4	#6021.20	61.43 PK	68.20	-6.77	1.23 H	133	51.24	10.19
5	11550.00	59.42 PK	74.00	-14.58	1.51 H	229	39.22	20.20
6	11550.00	46.28 AV	54.00	-7.72	1.51 H	229	26.08	20.20

ANTENNA POLARITY & TEST DISTANCE: VERTICAL AT 3 M

NO.	FREQ. (MHz)	EMISSION LEVEL (dBuV/m)	LIMIT (dBuV/m)	MARGIN (dB)	ANTENNA HEIGHT (m)	TABLE ANGLE (Degree)	RAW VALUE (dBuV)	CORRECTION FACTOR (dB/m)
1	#5649.75	67.61 PK	68.20	-0.59	2.31 V	350	57.91	9.70
2	*5775.00	107.84 PK			2.31 V	350	98.36	9.48
3	*5775.00	97.93 AV			2.31 V	350	88.45	9.48
4	#5933.80	64.08 PK	68.20	-4.12	2.31 V	350	54.38	9.70
5	11550.00	61.02 PK	74.00	-12.98	1.79 V	311	40.82	20.20
6	11550.00	47.25 AV	54.00	-6.75	1.79 V	311	27.05	20.20

REMARKS:

1. Emission Level(dBuV/m) = Raw Value(dBuV) + Correction Factor(dB/m)
2. Correction Factor(dB/m) = Antenna Factor(dB/m) + Cable Factor(dB) – Pre-Amplifier Factor(dB)
3. The other emission levels were very low against the limit.
4. Margin value = Emission Level – Limit value
5. " * ": Fundamental frequency.
6. " # ": The radiated frequency is out of the restricted band.

BELOW 1GHz WORST-CASE DATA: 802.11n (20MHz)

CHANNEL	TX Channel 36	DETECTOR FUNCTION	Quasi-Peak (QP)
FREQUENCY RANGE	9kHz ~ 1GHz		

ANTENNA POLARITY & TEST DISTANCE: HORIZONTAL AT 3 M

NO.	FREQ. (MHz)	EMISSION LEVEL (dBuV/m)	LIMIT (dBuV/m)	MARGIN (dB)	ANTENNA HEIGHT (m)	TABLE ANGLE (Degree)	RAW VALUE (dBuV)	CORRECTION FACTOR (dB/m)
1	66.33	22.42 QP	40.00	-17.58	2.37 H	223	33.50	-11.08
2	172.83	28.48 QP	43.50	-15.02	1.92 H	313	38.30	-9.82
3	303.49	27.99 QP	46.00	-18.01	2.25 H	193	35.53	-7.54
4	497.54	38.10 QP	46.00	-7.90	1.36 H	329	41.52	-3.42
5	805.71	29.79 QP	46.00	-16.21	1.77 H	116	27.83	1.96
6	959.99	33.72 QP	46.00	-12.28	1.54 H	277	29.10	4.62

ANTENNA POLARITY & TEST DISTANCE: VERTICAL AT 3 M

NO.	FREQ. (MHz)	EMISSION LEVEL (dBuV/m)	LIMIT (dBuV/m)	MARGIN (dB)	ANTENNA HEIGHT (m)	TABLE ANGLE (Degree)	RAW VALUE (dBuV)	CORRECTION FACTOR (dB/m)
1	74.57	29.69 QP	40.00	-10.31	1.74 V	162	42.35	-12.66
2	172.78	28.62 QP	43.50	-14.88	2.56 V	181	38.44	-9.82
3	491.09	36.02 QP	46.00	-9.98	1.88 V	274	39.55	-3.53
4	532.65	36.58 QP	46.00	-9.42	1.92 V	255	39.32	-2.74
5	750.56	29.26 QP	46.00	-16.74	2.77 V	258	28.12	1.14
6	921.72	32.26 QP	46.00	-13.74	1.59 V	97	28.34	3.92

REMARKS:

1. Emission Level(dBuV/m) = Raw Value(dBuV) + Correction Factor(dB/m)
2. Correction Factor(dB/m) = Antenna Factor(dB/m) + Cable Factor(dB) – Pre-Amplifier Factor(dB)
3. The other emission levels were very low against the limit.
4. Margin value = Emission Level – Limit value

4.2 Conducted Emission Measurement

4.2.1 Limits of Conducted Emission Measurement

Frequency (MHz)	Conducted Limit (dBuV)	
	Quasi-peak	Average
0.15 - 0.5	66 - 56	56 - 46
0.50 - 5.0	56	46
5.0 - 30.0	60	50

Note: 1. The lower limit shall apply at the transition frequencies.

2. The limit decreases in line with the logarithm of the frequency in the range of 0.15 to 0.50MHz.

4.2.2 Test Instruments

Description & Manufacturer	Model No.	Serial No.	Cal. Date	Cal. Due
ROHDE & SCHWARZ TEST RECEIVER	ESCS 30	838251/021	Oct. 24, 2016	Oct. 23, 2017
ROHDE & SCHWARZ Artificial Mains Network (For EUT)	ENV216	101195	Apr. 25, 2016	Apr. 24, 2017
LISN With Adapter (for EUT)	AD10	C03Ada-002	Apr. 25, 2016	Apr. 24, 2017
EMCO L.I.S.N. (For peripherals)	3825/2	9504-2359	Jul. 25, 2016	Jul. 24, 2017
SCHWARZBECK Artificial Mains Network (For EUT)	NNLK8129	8129229	May 04, 2016	May 03, 2017
Software	Cond_V7.3.7.4	NA	NA	NA
RF cable (JYEBAO) With10dB PAD	5D-FB	Cable-C03.01	Sep. 22, 2016	Sep. 21, 2017
LYNICS Terminator (For EMCO LISN)	0900510	E1-01-300	Jan. 18, 2017	Jan. 17, 2018
LYNICS Terminator (For EMCO LISN)	0900510	E1-01-301	Jan. 18, 2017	Jan. 17, 2018
ROHDE & SCHWARZ Artificial Mains Network (For TV EUT)	ESH3-Z5	100220	Nov. 08, 2016	Nov. 07, 2017
LISN With Adapter (for TV EUT)	100220	N/A	Nov. 08, 2016	Nov. 07, 2017

Notes: 1. The calibration interval of the above test instruments is 12 months and the calibrations are traceable to NML/ROC and NIST/USA.

2. The test was performed in Shielded Room No. 3.

3. The VCCI Site Registration No. C-274.

4.2.3 Test Procedure

- The EUT was placed 0.4 meters from the conducting wall of the shielded room with EUT being connected to the power mains through a line impedance stabilization network (LISN). Other support units were connected to the power mains through another LISN. The two LISNs provide 50 ohm/ 50uH of coupling impedance for the measuring instrument.
- Both lines of the power mains connected to the EUT were checked for maximum conducted interference.
- The frequency range from 150kHz to 30MHz was searched. Emission levels under (Limit - 20dB) was not recorded.

NOTE: All modes of operation were investigated and the worst-case emissions are reported.

4.2.4 Deviation from Test Standard

No deviation.

4.2.5 Test Setup

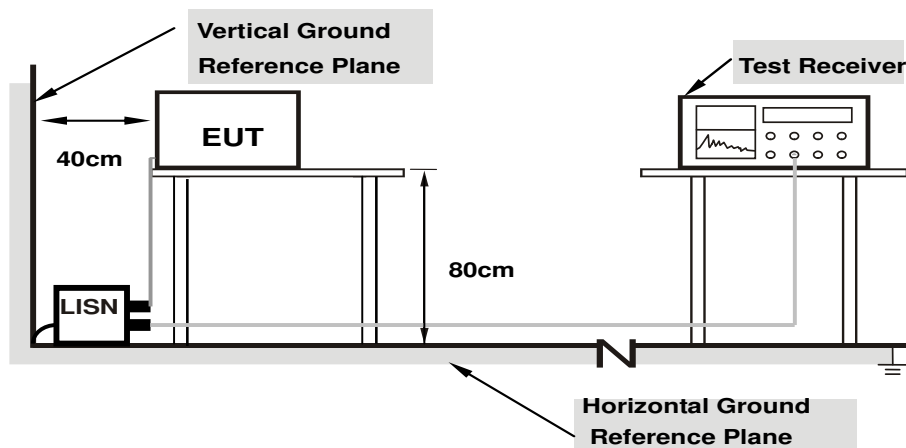

Note: 1.Support units were connected to second LISN.

For the actual test configuration, please refer to the attached file (Test Setup Photo).

4.2.6 EUT Operating Condition

Same as 4.1.6.

4.2.7 Test Results

Phase	Line (L)	Detector Function	Quasi-Peak (QP) / Average (AV)
-------	----------	-------------------	--------------------------------

No	Frequency (MHz)	Correction Factor (dB)	Reading Value (dBuV)		Emission Level (dBuV)		Limit (dBuV)		Margin (dB)	
			Q.P.	AV.	Q.P.	AV.	Q.P.	AV.	Q.P.	AV.
1	0.15781	9.75	26.06	15.66	35.81	25.41	65.58	55.58	-29.77	-30.17
2	0.39219	9.81	30.17	26.68	39.98	36.49	58.02	48.02	-18.04	-11.53
3	0.95078	9.88	13.34	8.80	23.22	18.68	56.00	46.00	-32.78	-27.32
4	2.14453	9.95	8.28	2.31	18.23	12.26	56.00	46.00	-37.77	-33.74
5	4.67188	9.99	7.11	2.71	17.10	12.70	56.00	46.00	-38.90	-33.30
6	10.43750	10.12	7.57	2.40	17.69	12.52	60.00	50.00	-42.31	-37.48

Remarks:

1. Q.P. and AV. are abbreviations of quasi-peak and average individually.
2. The emission levels of other frequencies were very low against the limit.
3. Margin value = Emission level – Limit value
4. Correction factor = Insertion loss + Cable loss
5. Emission Level = Correction Factor + Reading Value

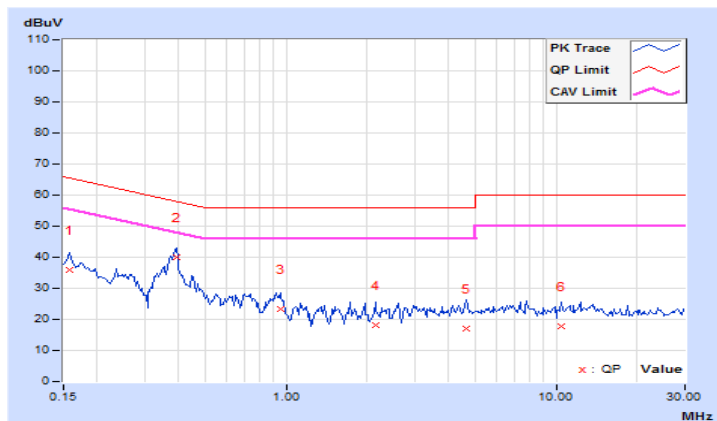

Phase	Neutral (N)	Detector Function	Quasi-Peak (QP) / Average (AV)
-------	-------------	-------------------	--------------------------------

No	Freq. [MHz]	Corr.	Reading Value		Emission Level		Limit		Margin	
		Factor	[dB (uV)]		[dB (uV)]		[dB (uV)]		(dB)	
		(dB)	Q.P.	AV.	Q.P.	AV.	Q.P.	AV.	Q.P.	AV.
1	0.15781	9.71	25.32	16.27	35.03	25.98	65.58	55.58	-30.55	-29.60
2	0.38828	9.74	31.97	29.26	41.71	39.00	58.10	48.10	-16.39	-9.10
3	0.72031	9.75	14.62	10.93	24.37	20.68	56.00	46.00	-31.63	-25.32
4	0.93516	9.75	14.48	10.57	24.23	20.32	56.00	46.00	-31.77	-25.68
5	4.29688	9.84	9.76	3.54	19.60	13.38	56.00	46.00	-36.40	-32.62
6	13.00781	10.05	9.75	2.13	19.80	12.18	60.00	50.00	-40.20	-37.82

REMARKS:

1. Q.P. and AV. are abbreviations of quasi-peak and average individually.
2. The emission levels of other frequencies were very low against the limit.
3. Margin value = Emission level - Limit value
4. Correction factor = Insertion loss + Cable loss
5. Emission Level = Correction Factor + Reading Value.

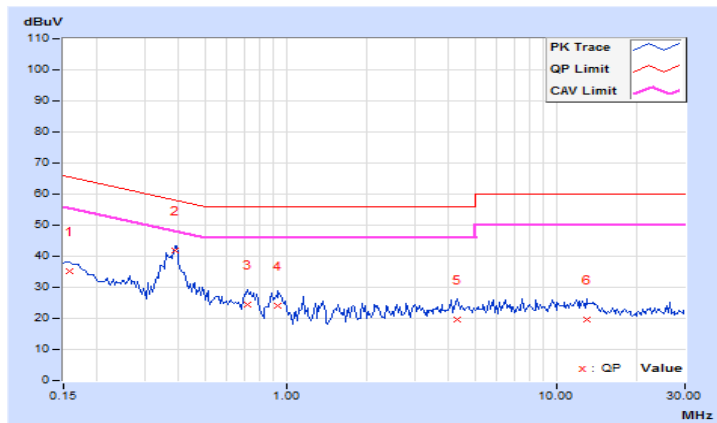

4.3 Transmit Power Measurement

4.3.1 Limits of Transmit Power Measurement

Operation Band	EUT Category		Limit
U-NII-1		Outdoor Access Point	1 Watt (30 dBm) (Max. e.i.r.p \leq 125mW(21 dBm) at any elevation angle above 30 degrees as measured from the horizon)
		Fixed point-to-point Access Point	1 Watt (30 dBm)
	√	Indoor Access Point	1 Watt (30 dBm)
		Mobile and Portable client device	250mW (24 dBm)
U-NII-2A	---		250mW (24 dBm) or 11 dBm+10 log B*
U-NII-2C	---		250mW (24 dBm) or 11 dBm+10 log B*
U-NII-3	√		1 Watt (30 dBm)

*B is the 26 dB emission bandwidth in megahertz

Per KDB 662911 Method of conducted output power measurement on IEEE 802.11 devices,

Array Gain = 0 dB (i.e., no array gain) for $N_{ANT} \leq 4$;

Array Gain = 0 dB (i.e., no array gain) for channel widths ≥ 40 MHz for any N_{ANT} ;

Array Gain = $5 \log(N_{ANT}/N_{SS})$ dB or 3 dB, whichever is less for 20-MHz channel widths with $N_{ANT} \geq 5$.

For power measurements on all other devices: Array Gain = $10 \log(N_{ANT}/N_{SS})$ dB.

4.3.2 Test Setup

FOR POWER OUTPUT MEASUREMENT

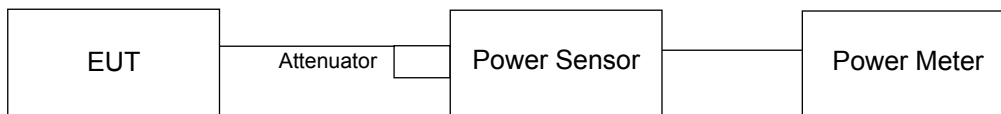

FOR 26dB OCCUPIED BANDWIDTH

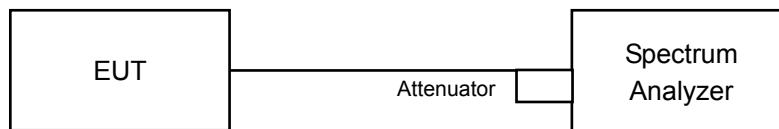

4.3.3 Test Instruments

Refer to section 4.1.2 to get information of above instrument.

4.3.4 Test Procedure

For Average Power Measurement

For 802.11a, 802.11n (20MHz), 802.11n (40MHz)

Method PM is used to perform output power measurement, trigger and gating function of wide band power meter is enabled to measure max output power of TX on burst. Duty factor is not added to measured value.

For 802.11ac (80MHz)

- 1) Set span to encompass the entire 26 dB EBW (or, alternatively, the entire 99% occupied bandwidth) of the signal.
- 2) Set sweep trigger to "free run".
- 3) Set RBW = 1 MHz.
- 4) Set VBW \geq 3 MHz
- 5) Number of points in sweep \geq 2 Span / RBW.
- 6) Sweep time \leq (number of points in sweep) * T
- 7) Using emission bandwidth to determine the frequency span for integration the channel bandwidth.
- 8) Detector = RMS.
- 9) Trace mode = max hold.
- 10) Allow max hold to run for at least 60 seconds, or longer as needed to allow the trace to stabilize.

For 26dB Occupied Bandwidth

- 1) Set RBW = approximately 1% of the emission bandwidth.
- 2) Set the VBW > RBW.
- 3) Detector = Peak.
- 4) Trace mode = max hold.
- 5) Measure the maximum width of the emission that is 26 dB down from the peak of the emission. Compare this with the RBW setting of the analyzer. Readjust RBW and repeat measurement as needed until the RBW/EBW ratio is approximately 1%.

4.3.5 Deviation from Test Standard

No deviation.

4.3.6 EUT Operating Condition

The software provided by client to enable the EUT under transmission condition continuously at lowest, middle and highest channel frequencies individually.

4.3.7 Test Result

Power Output:

802.11a

Chan.	Chan. Freq. (MHz)	Maximum Conducted Power (dBm)		Total Power (mW)	Total Power (dBm)	Power Limit (dBm)	Pass/Fail
		Chain 0	Chain 1				
36	5180	19.86	20.34	204.971	23.12	30.00	Pass
40	5200	20.93	21.41	262.237	24.19	30.00	Pass
48	5240	20.45	21.08	239.15	23.79	30.00	Pass
149	5745	21.63	21.28	279.822	24.47	30.00	Pass
157	5785	21.64	21.31	281.088	24.49	30.00	Pass
165	5825	21.63	21.35	282.004	24.50	30.00	Pass

802.11n (20MHz)

Chan.	Chan. Freq. (MHz)	Maximum Conducted Power (dBm)		Total Power (mW)	Total Power (dBm)	Power Limit (dBm)	Pass/Fail
		Chain 0	Chain 1				
36	5180	19.90	20.52	210.444	23.23	30.00	Pass
40	5200	21.79	21.87	304.823	24.84	30.00	Pass
48	5240	21.64	21.73	294.817	24.70	30.00	Pass
149	5745	21.62	21.42	283.887	24.53	30.00	Pass
157	5785	21.65	21.51	287.797	24.59	30.00	Pass
165	5825	21.70	21.42	286.587	24.57	30.00	Pass

802.11n (40MHz)

Chan.	Chan. Freq. (MHz)	Maximum Conducted Power (dBm)		Total Power (mW)	Total Power (dBm)	Power Limit (dBm)	Pass/Fail
		Chain 0	Chain 1				
38	5190	14.19	14.36	53.532	17.29	30.00	Pass
46	5230	20.11	20.85	224.184	23.51	30.00	Pass
151	5755	19.35	19.19	169.084	22.28	30.00	Pass
159	5795	21.66	21.29	281.141	24.49	30.00	Pass

802.11ac (80MHz)

Chan.	Chan. Freq. (MHz)	Maximum Conducted Power (dBm)		Total Power (mW)	Total Power (dBm)	Power Limit (dBm)	Pass/Fail
		Chain 0	Chain 1				
42	5210	12.26	12.38	34.125	15.33	30.00	Pass
155	5775	17.91	17.77	121.643	20.85	30.00	Pass

26dB Bandwidth:

802.11a

Channel	Channel Frequency (MHz)	26dBc Bandwidth (MHz)		Pass/Fail
		Chain 0	Chain 1	
36	5180	31.27	31.15	Pass
40	5200	35.95	37.62	Pass
48	5240	34.31	34.35	Pass

802.11n (20MHz)

Channel	Channel Frequency (MHz)	26dBc Bandwidth (MHz)		Pass/Fail
		Chain 0	Chain 1	
36	5180	38.52	37.08	Pass
40	5200	39.16	39.18	Pass
48	5240	40.07	39.10	Pass

802.11n (40MHz)

Channel	Channel Frequency (MHz)	26dBc Bandwidth (MHz)		Pass/Fail
		Chain 0	Chain 1	
38	5190	40.93	40.67	Pass
46	5230	78.06	80.36	Pass

802.11ac (80MHz)

Channel	Channel Frequency (MHz)	26dBc Bandwidth (MHz)		Pass/Fail
		Chain 0	Chain 1	
42	5210	93.62	93.62	Pass

Spectrum Plot of Worst Value

802.11a_Chain 1 / CH 40

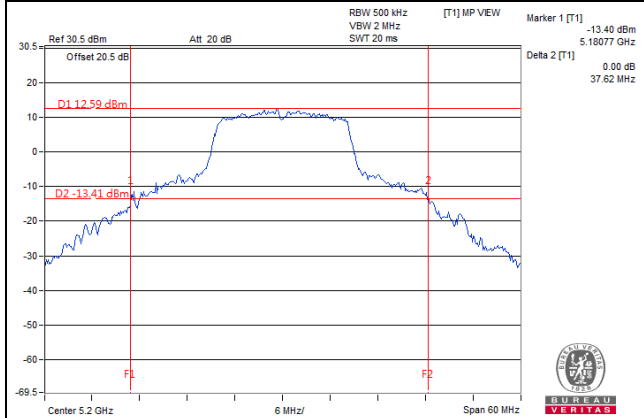

802.11n (20MHz)_Chain 0 / CH 48

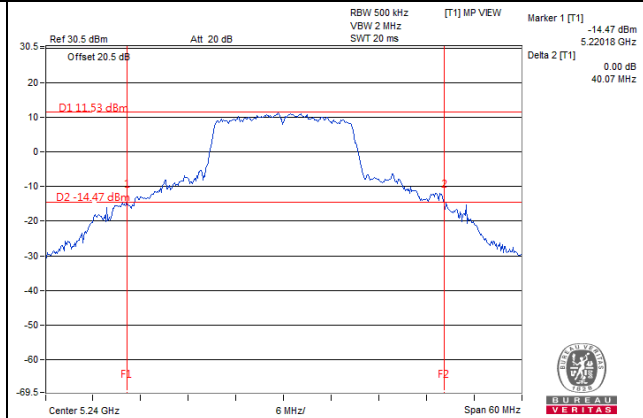

802.11n (40MHz)_Chain 1 / CH 46

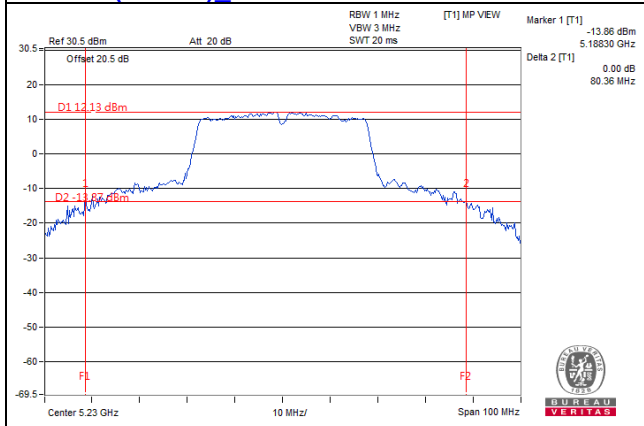

802.11ac (80MHz)_Chain 1 / CH 42

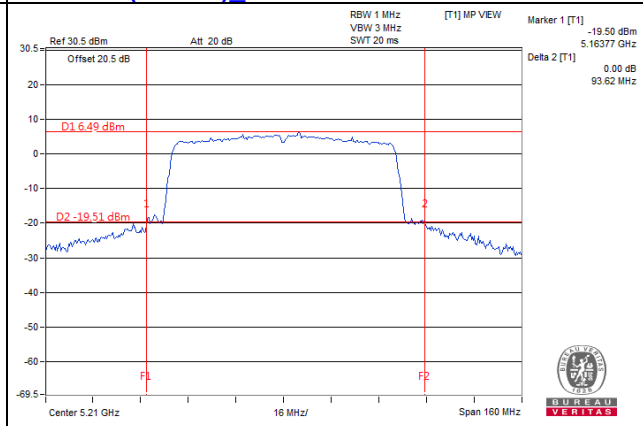

4.4 Occupied Bandwidth Measurement

4.4.1 Test Setup



4.4.2 Test Instruments

Refer to section 4.1.2 to get information of above instrument.

4.4.3 Test Procedure

The transmitter output was connected to the spectrum analyzer through an attenuator. The bandwidth of the fundamental frequency was measured by spectrum analyzer with resolution bandwidth in the range of 1% to 5% of the anticipated emission bandwidth, and a video bandwidth at least 3x the resolution bandwidth and set the detector to SAMPLE. The width of a frequency band such that, below the lower and above the upper frequency limits, the mean powers emitted are each equal to a specified percentage 0.5 %of the total mean power of a given emission.

4.4.4 Test Results

802.11a

Channel	Channel Frequency (MHz)	Occupied Bandwidth (MHz)		Pass / Fail
		Chain 0	Chain 1	
36	5180	17.40	17.40	Pass
40	5200	19.68	19.92	Pass
48	5240	18.00	17.88	Pass
149	5745	24.78	24.90	Pass
157	5785	34.00	33.90	Pass
165	5825	32.60	32.20	Pass

802.11n (20MHz)

Channel	Channel Frequency (MHz)	Occupied Bandwidth (MHz)		Pass / Fail
		Chain 0	Chain 1	
36	5180	18.12	18.12	Pass
40	5200	19.44	19.08	Pass
48	5240	19.80	19.92	Pass
149	5745	36.26	36.60	Pass
157	5785	37.65	37.30	Pass
165	5825	37.60	37.60	Pass

802.11n (40MHz)

Channel	Channel Frequency (MHz)	Occupied Bandwidth (MHz)		Pass / Fail
		Chain 0	Chain 1	
38	5190	36.20	36.20	Pass
46	5230	38.00	38.40	Pass
151	5755	67.97	67.66	Pass
159	5795	66.83	67.16	Pass

802.11ac (80MHz)

Channel	Channel Frequency (MHz)	Occupied Bandwidth (MHz)		Pass / Fail
		Chain 0	Chain 1	
42	5210	75.36	75.12	Pass
155	5775	76.89	76.72	Pass

Spectrum Plot of Worst Value

802.11a_Chain 0 / CH 157

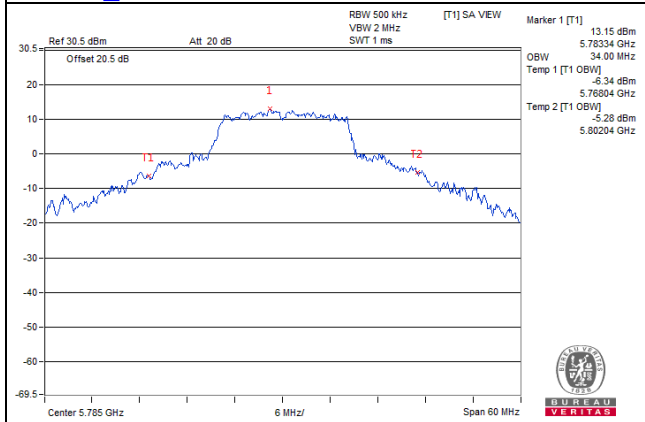

802.11n (20MHz)_Chain 0 / CH 157

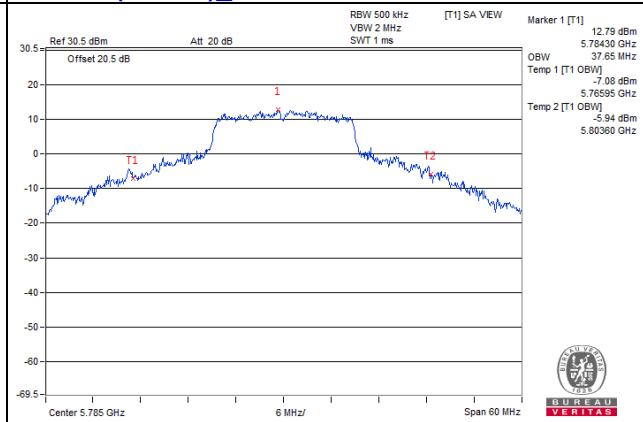

802.11n (40MHz)_Chain 0 / CH 151

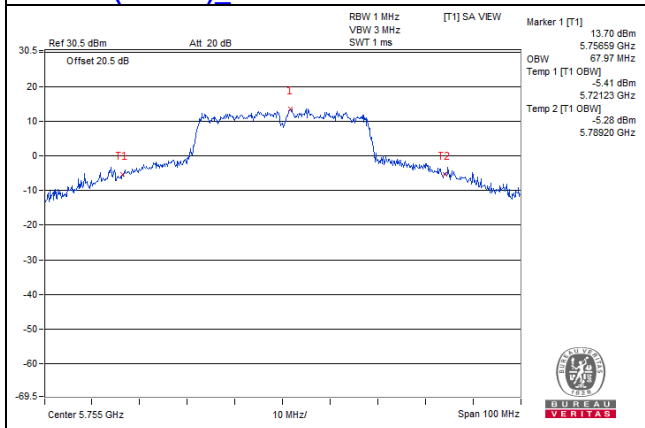

802.11ac (80MHz)_Chain 0 / CH 155

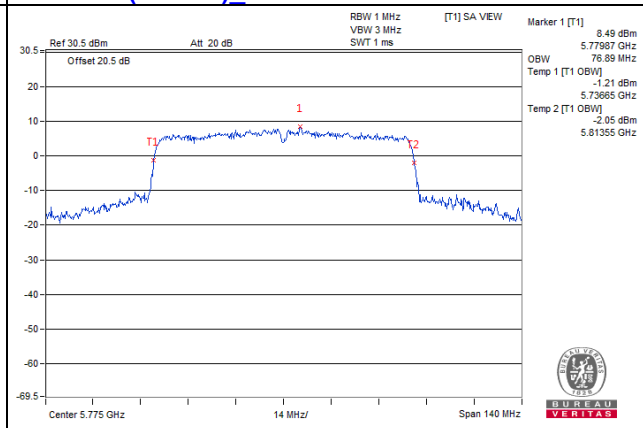

4.5 Peak Power Spectral Density Measurement

4.5.1 Limits of Peak Power Spectral Density Measurement

Operation Band	EUT Category		Limit
U-NII-1		Outdoor Access Point	17dBm/ MHz
		Fixed point-to-point Access Point	
	√	Indoor Access Point	
		Mobile and Portable client device	11dBm/ MHz
U-NII-2A	---		11dBm/ MHz
U-NII-2C	---		11dBm/ MHz
U-NII-3	√		30dBm/ 500kHz

4.5.2 Test Setup

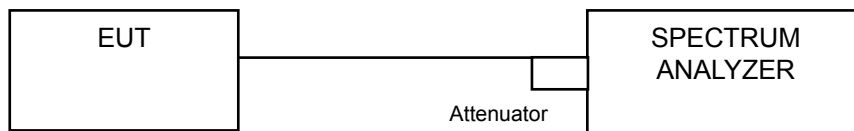

4.5.3 Test Instruments

Refer to section 4.1.2 to get information of above instrument.

4.5.4 Test Procedure

For U-NII-1 band:

Using method SA-2

1. Set span to encompass the entire emission bandwidth (EBW) of the signal.
2. Set RBW = 1 MHz, Set VBW ≥ 3 MHz, Detector = RMS
3. Sweep time = auto, trigger set to “free run”.
4. Trace average at least 100 traces in power averaging mode.
5. Record the max value and add 10 log (1/duty cycle).

For U-NII-3:

- 1) Set span to encompass the entire emission bandwidth (EBW) of the signal.
- 2) Set RBW = 500 kHz, Set VBW ≥ 3 RBW, Detector = RMS
- 3) Sweep time = auto, trigger set to “free run”.
- 4) Trace average at least 100 traces in power averaging mode.
- 5) Record the max value and add 10 log (1/duty cycle)

4.5.5 Deviation from Test Standard

No deviation.

4.5.6 EUT Operating Condition

Same as Item 4.3.6.

4.5.7 Test Results

For U-NII-1 band 802.11a

Chan.	Chan. Freq. (MHz)	PSD (dBm)		Total PSD W/O Duty Factor (dBm)	Duty Factor	Total PSD WITH Duty Factor (dBm)	MAX. Limit (dBm)	Pass / Fail
		Chain 0	Chain 1					
36	5180	5.04	5.25	8.16	0.38	8.54	16.96	Pass
40	5200	6.18	6.26	9.23	0.38	9.61	16.96	Pass
48	5240	5.48	5.69	8.60	0.38	8.98	16.96	Pass

NOTE:

- Method 1 of power density measurement of KDB 662911 is using for calculating total power density. Total power density is summing entire spectra across corresponding frequency bins on the various outputs by computer.
- Directional gain = 6.04dBi >6dBi, so the power spectral density limit shall be reduced to $17-(6.04-6) = 16.96\text{dBm}$.
- Refer to section 3.3 for duty cycle spectrum plot.

802.11n (20MHz)

Chan.	Chan. Freq. (MHz)	PSD (dBm)		Total PSD W/O Duty Factor (dBm)	Duty Factor	Total PSD WITH Duty Factor (dBm)	MAX. Limit (dBm)	Pass / Fail
		Chain 0	Chain 1					
36	5180	4.36	4.27	7.33	0.53	7.86	16.96	Pass
40	5200	5.14	5.33	8.25	0.53	8.78	16.96	Pass
48	5240	5.23	5.41	8.33	0.53	8.86	16.96	Pass

NOTE:

- Method 1 of power density measurement of KDB 662911 is using for calculating total power density. Total power density is summing entire spectra across corresponding frequency bins on the various outputs by computer.
- Directional gain = 6.04dBi >6dBi, so the power spectral density limit shall be reduced to $17-(6.04-6) = 16.96\text{dBm}$.
- Refer to section 3.3 for duty cycle spectrum plot.

802.11n (40MHz)

Chan.	Chan. Freq. (MHz)	PSD (dBm)		Total PSD W/O Duty Factor (dBm)	Duty Factor	Total PSD WITH Duty Factor (dBm)	MAX. Limit (dBm)	Pass / Fail
		Chain 0	Chain 1					
38	5190	-3.26	-3.41	-0.32	1.05	0.73	16.96	Pass
46	5230	1.92	1.79	4.87	1.05	5.92	16.96	Pass

NOTE:

- Method 1 of power density measurement of KDB 662911 is using for calculating total power density. Total power density is summing entire spectra across corresponding frequency bins on the various outputs by computer.
- Directional gain = 6.04dBi >6dBi, so the power spectral density limit shall be reduced to $17-(6.04-6) = 16.96\text{dBm}$.
- Refer to section 3.3 for duty cycle spectrum plot.

802.11ac (80MHz)

Chan.	Chan. Freq. (MHz)	PSD (dBm)		Total PSD W/O Duty Factor (dBm)	Duty Factor	Total PSD With Duty Factor (dBm)	MAX. Limit (dBm)	Pass / Fail
		Chain 0	Chain 1					
42	5210	-4.06	-4.04	-1.05	2.54	1.49	16.96	Pass

NOTE:

- Method 1 of power density measurement of KDB 662911 is using for calculating total power density. Total power density is summing entire spectra across corresponding frequency bins on the various outputs by computer.
- Directional gain = 6.04dBi >6dBi, so the power spectral density limit shall be reduced to 17-(6.04-6) = 16.96dBm.
- Refer to section 3.3 for duty cycle spectrum plot.

Spectrum Plot of Worst Value

802.11a_Chain 1 / CH 40

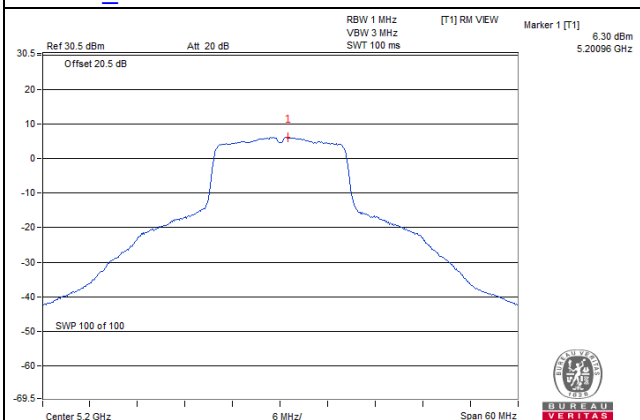

802.11n (20MHz)_Chain 1 / CH 48

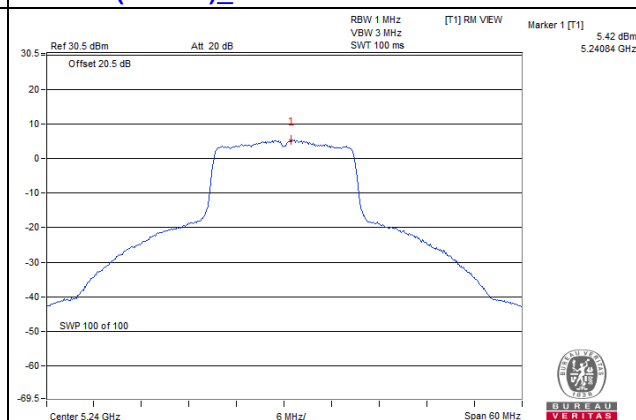

802.11n (40MHz)_Chain 0 / CH 46

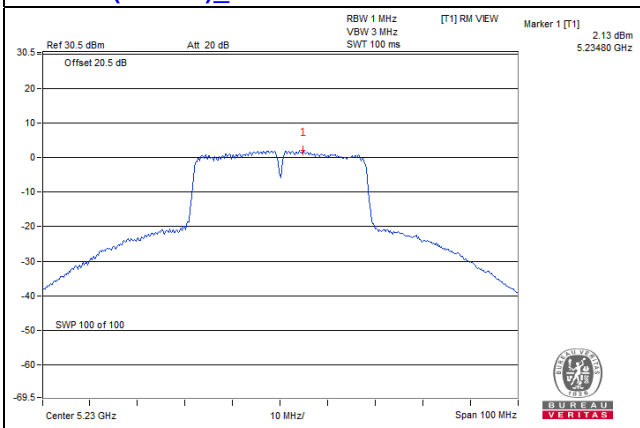

802.11ac (80MHz)_Chain 1 / CH 42

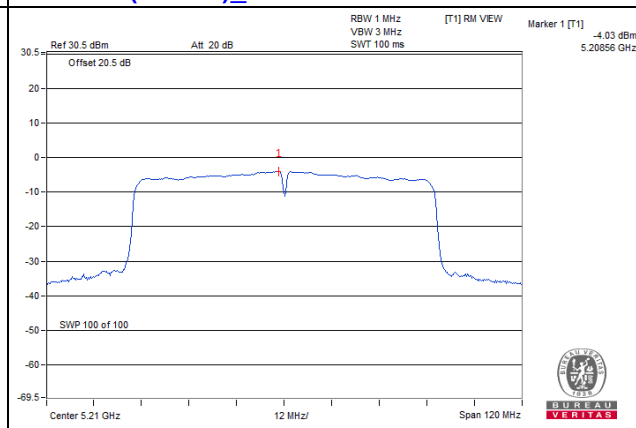

**For U-NII-3:
802.11a**

TX chain	Channel	Freq. (MHz)	PSD (dBm/500kHz)	10 log (N=2) dB	Duty Factor	Total PSD (dBm/500kHz)	Limit (dBm/500kHz)	Pass /Fail
0	149	5745	13.14	3.01	0.38	16.53	29.63	Pass
	157	5785	13.71	3.01	0.38	17.10	29.63	Pass
	165	5825	14.91	3.01	0.38	18.30	29.63	Pass
1	149	5745	13.19	3.01	0.38	16.58	29.63	Pass
	157	5785	13.67	3.01	0.38	17.06	29.63	Pass
	165	5825	14.58	3.01	0.38	17.97	29.63	Pass

NOTE:

1. Directional gain = 6.37dBi >6dBi, so the power spectral density limit shall be reduced to $30-(6.37-6) = 29.63\text{dBm}$.
2. Refer to section 3.3 for duty cycle spectrum plot.

802.11n (20MHz)

TX chain	Channel	Freq. (MHz)	PSD (dBm/500kHz)	10 log (N=2) dB	Duty Factor	Total PSD (dBm/500kHz)	Limit (dBm/500kHz)	Pass /Fail
0	149	5745	15.15	3.01	0.53	18.69	29.63	Pass
	157	5785	13.41	3.01	0.53	16.95	29.63	Pass
	165	5825	15.12	3.01	0.53	18.66	29.63	Pass
1	149	5745	14.77	3.01	0.53	18.31	29.63	Pass
	157	5785	13.32	3.01	0.53	16.86	29.63	Pass
	165	5825	15.71	3.01	0.53	19.25	29.63	Pass

NOTE:

1. Directional gain = 6.37dBi >6dBi, so the power spectral density limit shall be reduced to $30-(6.37-6) = 29.63\text{dBm}$.
2. Refer to section 3.3 for duty cycle spectrum plot.

802.11n (40MHz)

TX chain	Channel	Freq. (MHz)	PSD (dBm/500kHz)	10 log (N=2) dB	Duty Factor	Total PSD (dBm/500kHz)	Limit (dBm/500kHz)	Pass /Fail
0	151	5755	10.42	3.01	1.05	14.48	29.63	Pass
	159	5795	10.51	3.01	1.05	14.57	29.63	Pass
1	151	5755	10.40	3.01	1.05	14.46	29.63	Pass
	159	5795	10.42	3.01	1.05	14.48	29.63	Pass

NOTE:

1. Directional gain = 6.37dBi >6dBi, so the power spectral density limit shall be reduced to $30-(6.37-6) = 29.63\text{dBm}$.
2. Refer to section 3.3 for duty cycle spectrum plot.

802.11ac (80MHz)

TX chain	Channel	Freq. (MHz)	PSD (dBm/500kHz)	10 log (N=2) dB	Duty Factor	Total PSD (dBm/500kHz)	Limit (dBm/500kHz)	Pass /Fail
0	155	5775	4.36	3.01	2.54	9.91	29.63	Pass
1	155	5775	4.63	3.01	2.54	10.18	29.63	Pass

NOTE:

1. Directional gain = 6.37dBi >6dBi, so the power spectral density limit shall be reduced to $30-(6.37-6) = 29.63\text{dBm}$.
2. Refer to section 3.3 for duty cycle spectrum plot.

Spectrum Plot of Worst Value

802.11a_Chain 0 / CH 165

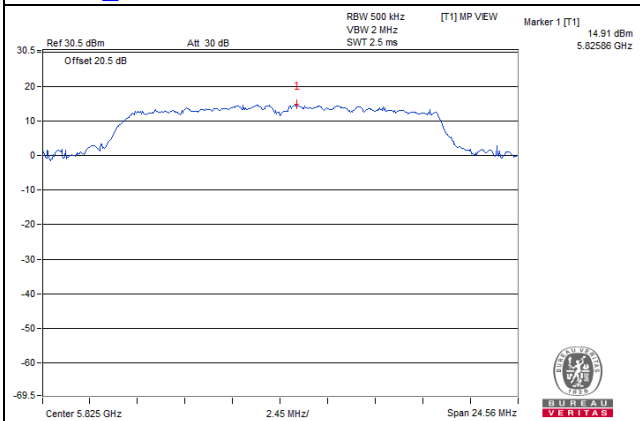

802.11n (20MHz)_Chain 1 / CH 165

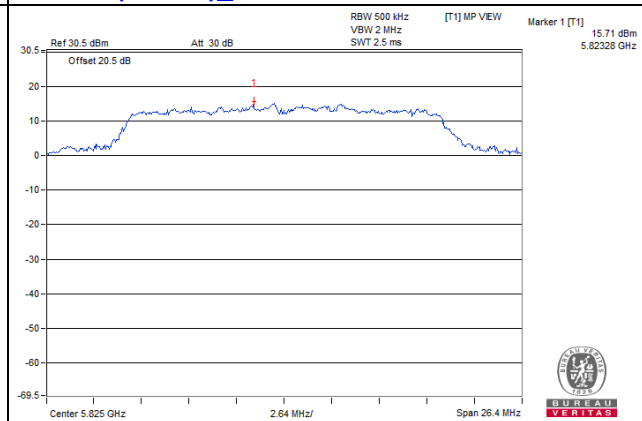

802.11n (40MHz)_Chain 0 / CH 159

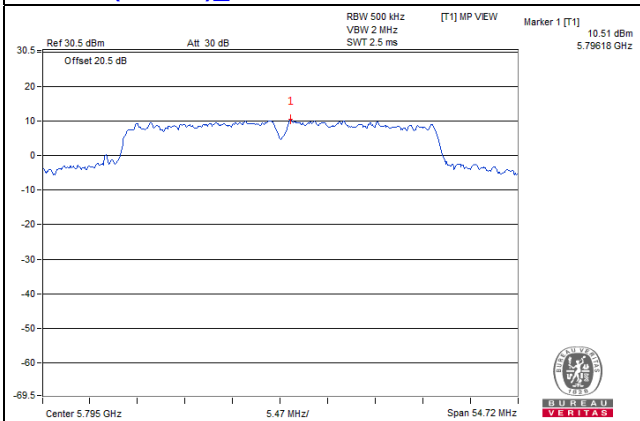

802.11ac (80MHz)_Chain 1 / CH 155

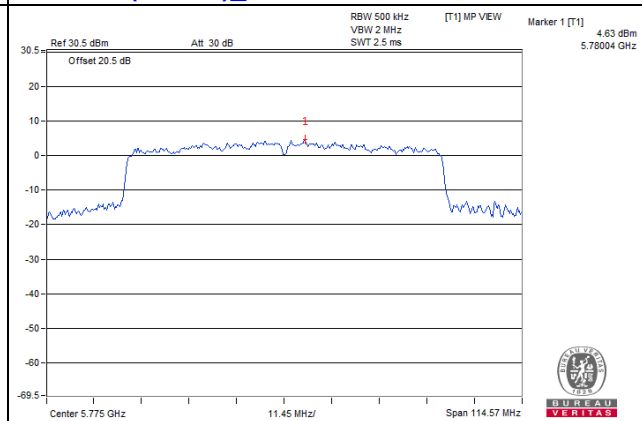

4.6 Frequency Stability Measurement

4.6.1 Limits of Frequency Stability Measurement

The frequency of the carrier signal shall be maintained within band of operation

4.6.2 Test Setup

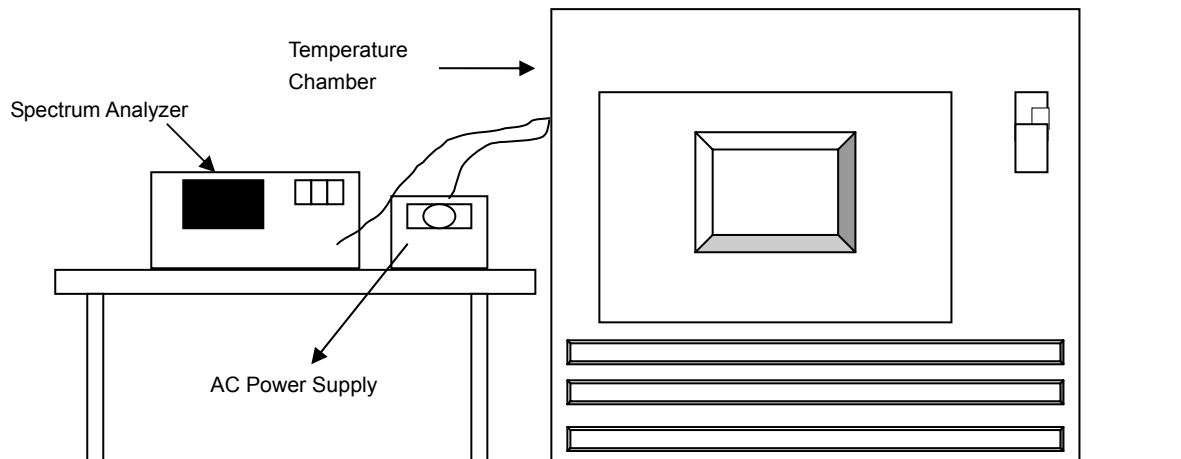

4.6.3 Test Instruments

Refer to section 4.1.2 to get information of above instrument.

4.6.4 Test Procedure

- The EUT was placed inside the environmental test chamber and powered by nominal AC voltage.
- Turn the EUT on and couple its output to a spectrum analyzer.
- Turn the EUT off and set the chamber to the highest temperature specified.
- Allow sufficient time (approximately 30 min) for the temperature of the chamber to stabilize, turn the EUT on and measure the operating frequency after 2, 5, and 10 Minutes.
- Repeat step 2 and 3 with the temperature chamber set to the lowest temperature.
- The test chamber was allowed to stabilize at +20 degree C for a minimum of 30 Minutes. The supply voltage was then adjusted on the EUT from 85% to 115% and the frequency record.

4.6.5 Deviation from Test Standard

No deviation.

4.6.6 EUT Operating Condition

Set the EUT transmit at un-modulation mode to test frequency stability.

4.6.7 Test Results

Frequency Stability Versus Temp.									
Operating Frequency: 5180 MHz									
TEMP. (°C)	Power Supply (Vac)	0 Minute		2 Minute		5 Minute		10 Minute	
		Measured Frequency (MHz)	Pass/Fail	Measured Frequency (MHz)	Pass/Fail	Measured Frequency (MHz)	Pass/Fail	Measured Frequency (MHz)	Pass/Fail
50	120	5180.042469	Pass	5180.042624	Pass	5180.042282	Pass	5180.042464	Pass
40	120	5180.043577	Pass	5180.043357	Pass	5180.043360	Pass	5180.043397	Pass
30	120	5180.04321	Pass	5180.043225	Pass	5180.043089	Pass	5180.043255	Pass
20	120	5180.043008	Pass	5180.042999	Pass	5180.042832	Pass	5180.042849	Pass
10	120	5180.04325	Pass	5180.043352	Pass	5180.043008	Pass	5180.043063	Pass
0	120	5180.043562	Pass	5180.043351	Pass	5180.043542	Pass	5180.043563	Pass
-10	120	5180.043022	Pass	5180.043016	Pass	5180.042871	Pass	5180.04275	Pass
-20	120	5180.043027	Pass	5180.042761	Pass	5180.042398	Pass	5180.042445	Pass

Frequency Stability Versus Voltage									
Operating Frequency: 5180 MHz									
TEMP. (°C)	Power Supply (Vac)	0 Minute		2 Minute		5 Minute		10 Minute	
		Measured Frequency (MHz)	Pass/Fail	Measured Frequency (MHz)	Pass/Fail	Measured Frequency (MHz)	Pass/Fail	Measured Frequency (MHz)	Pass/Fail
20	138	5180.043509	Pass	5180.043393	Pass	5180.043394	Pass	5180.043333	Pass
	120	5180.043008	Pass	5180.042999	Pass	5180.042832	Pass	5180.042849	Pass
	102	5180.043659	Pass	5180.043601	Pass	5180.043367	Pass	5180.04372	Pass

4.7 6dB Bandwidth Measurement

4.7.1 Limits of 6dB Bandwidth Measurement

The minimum of 6dB Bandwidth Measurement is 0.5MHz.

4.7.2 Test Setup

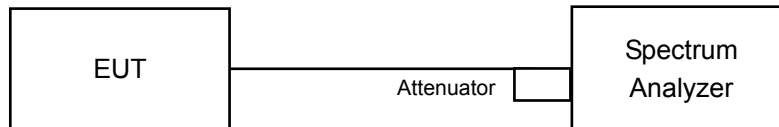

4.7.3 Test Instruments

Refer to section 4.1.2 to get information of above instrument.

4.7.4 Test Procedure

MEASUREMENT PROCEDURE REF

- a. Set resolution bandwidth (RBW) = 100kHz
- b. Set the video bandwidth (VBW) $\geq 3 \times$ RBW, Detector = Peak.
- c. Trace mode = max hold.
- d. Sweep = auto couple.
- e. Measure the maximum width of the emission that is constrained by the frequencies associated with the two amplitude points (upper and lower) that are attenuated by 6 dB relative to the maximum level measured in the fundamental emission

4.7.5 Deviation from Test Standard

No deviation.

4.7.6 EUT Operating Condition

The software provided by client to enable the EUT under transmission condition continuously at lowest, middle and highest channel frequencies individually.

4.7.7 Test Results

802.11a

Channel	Frequency (MHz)	6dB Bandwidth (MHz)		Minimum Limit (MHz)	Pass / Fail
		Chain 0	Chain 1		
149	5745	16.32	16.04	0.5	Pass
157	5785	16.42	16.43	0.5	Pass
165	5825	16.37	16.35	0.5	Pass

802.11n (20MHz)

Channel	Frequency (MHz)	6dB Bandwidth (MHz)		Minimum Limit (MHz)	Pass / Fail
		Chain 0	Chain 1		
149	5745	17.60	17.62	0.5	Pass
157	5785	17.72	17.75	0.5	Pass
165	5825	17.63	17.60	0.5	Pass

802.11n (40MHz)

Channel	Frequency (MHz)	6dB Bandwidth (MHz)		Minimum Limit (MHz)	Pass / Fail
		Chain 0	Chain 1		
151	5755	36.42	36.47	0.5	Pass
159	5795	36.48	36.48	0.5	Pass

802.11ac (80MHz)

Channel	Frequency (MHz)	6dB Bandwidth (MHz)		Minimum Limit (MHz)	Pass / Fail
		Chain 0	Chain 1		
155	5775	76.07	76.38	0.5	Pass

Spectrum Plot of Worst Value

802.11a_Chain 1 / CH 157

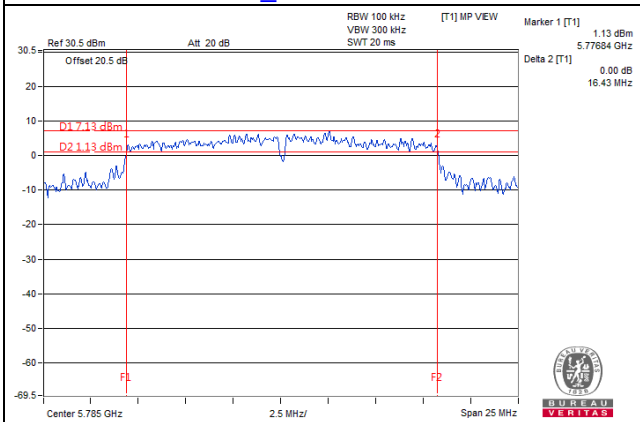

802.11n (20MHz)_Chain 1 / CH 157

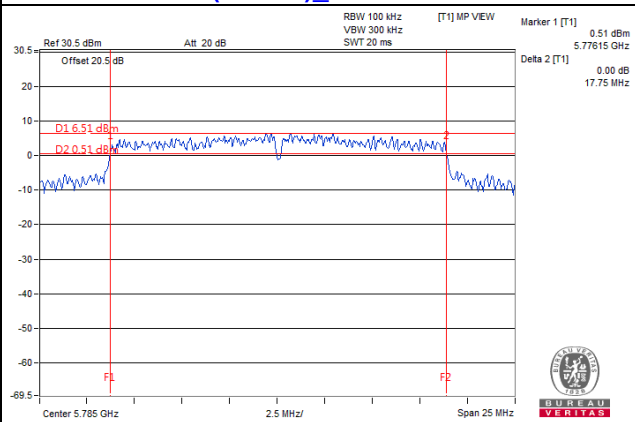

802.11n (40MHz)_Chain 0 / CH 159

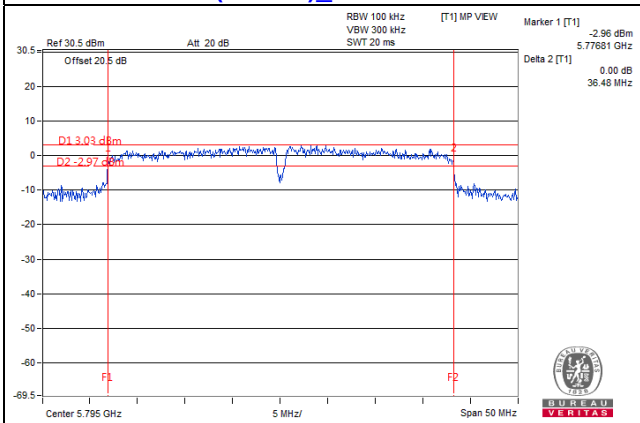

802.11ac (80MHz)_Chain 1 / CH 155

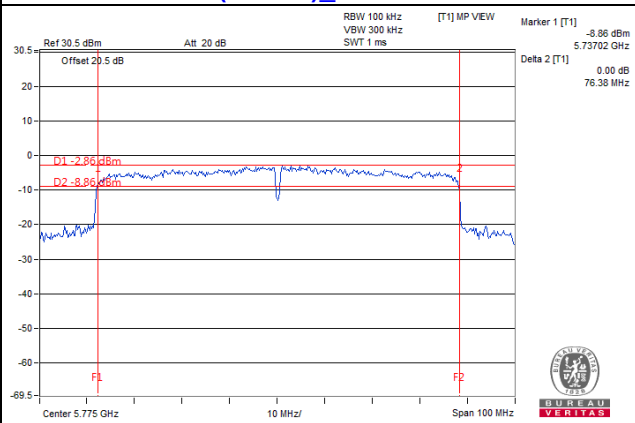

5 Pictures of Test Arrangements

Please refer to the attached file (Test Setup Photo).

Annex A- Radiated Out of Band Emission (OOBE) Measurement (For U-NII-3 band)

802.11a
CH 149

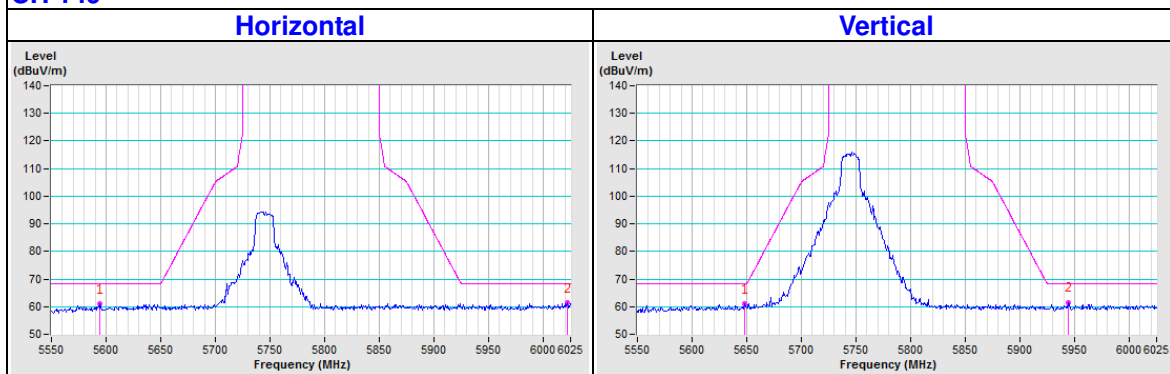

CH 157

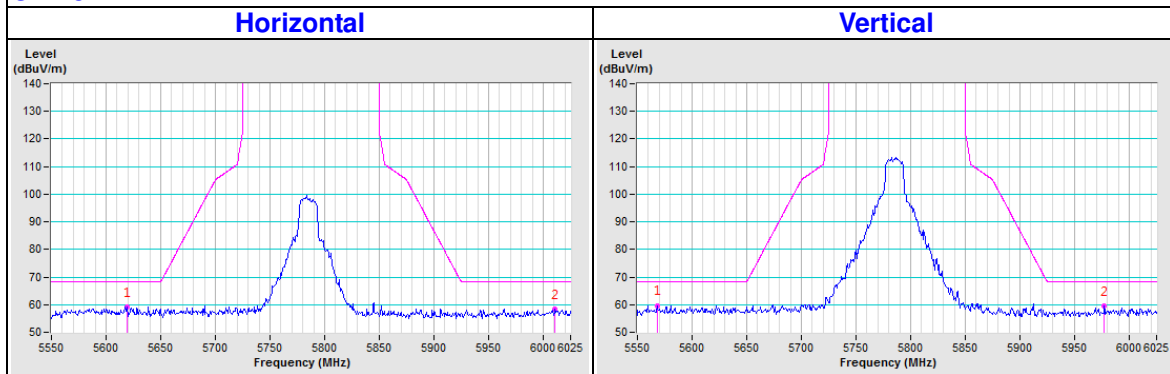

CH 165

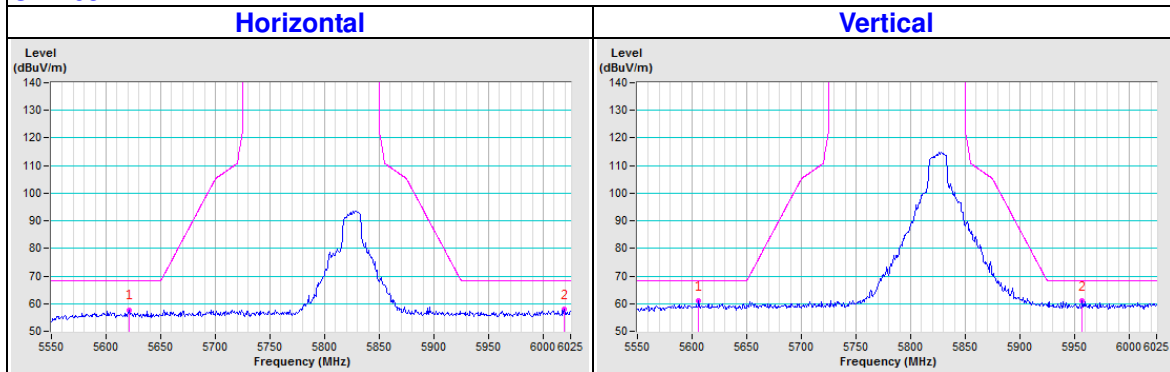

802.11n (20MHz)

CH 149

Horizontal

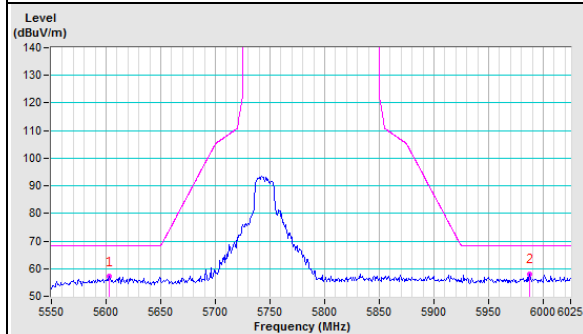

Vertical

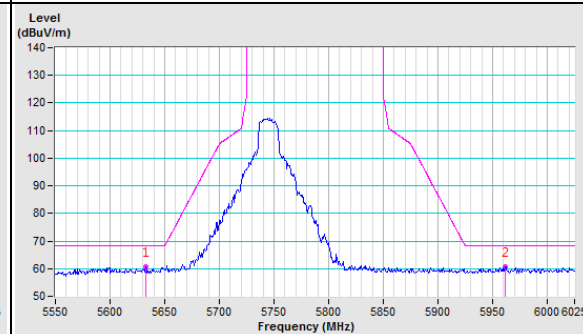

CH 157

Horizontal

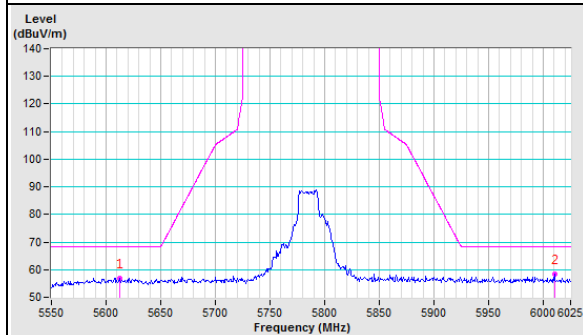

Vertical

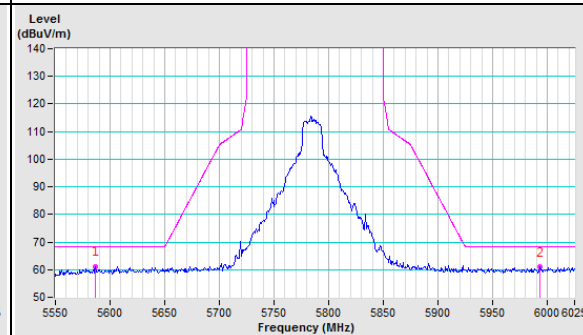

CH 165

Horizontal

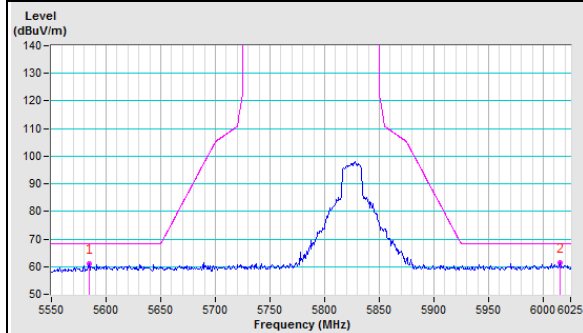

Vertical

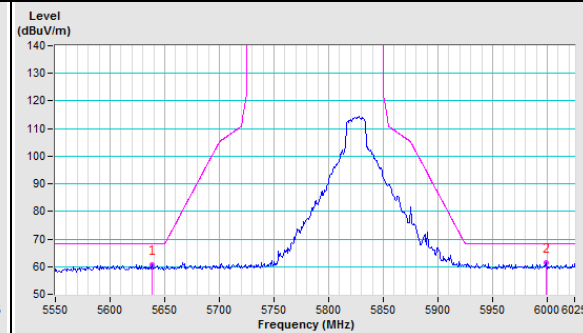

802.11n (40MHz)

CH 151

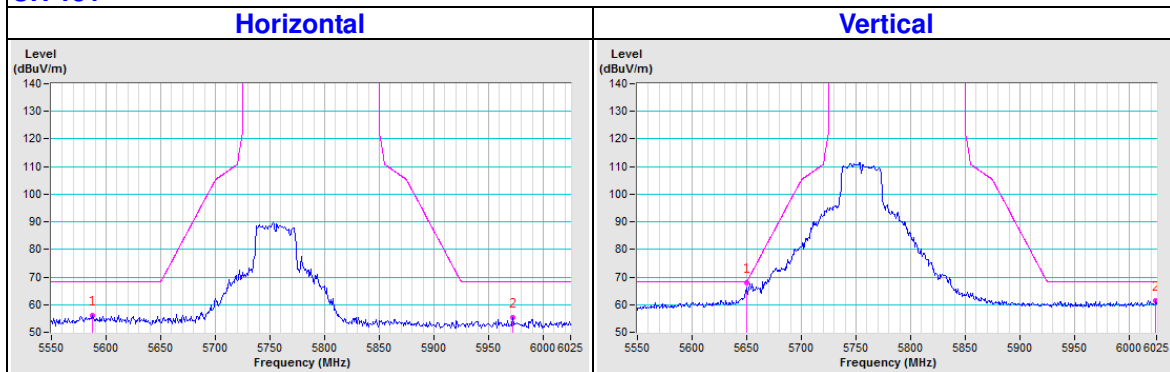

CH 159

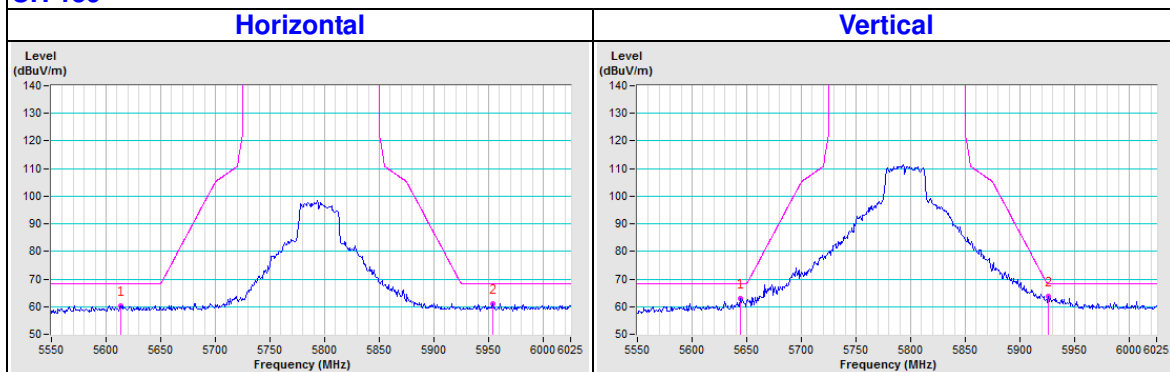

802.11ac (80MHz)

CH 155

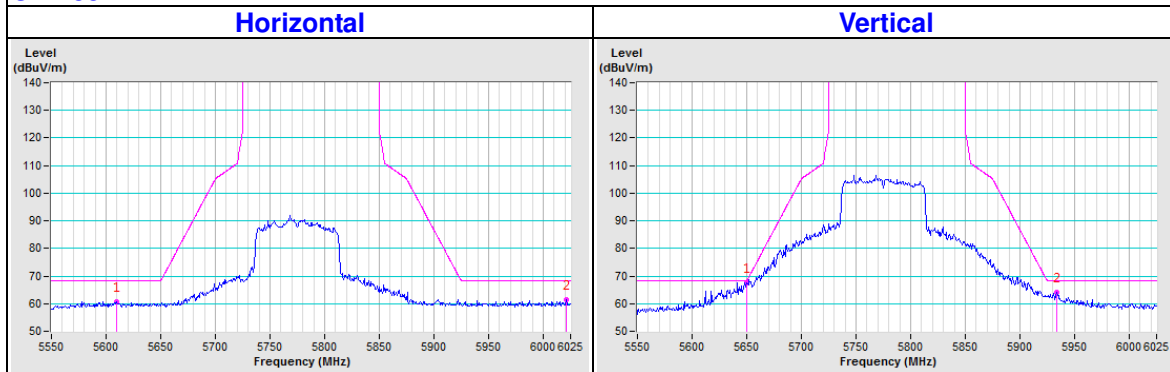

Appendix – Information on the Testing Laboratories

We, Bureau Veritas Consumer Products Services (H.K.) Ltd., Taoyuan Branch, were founded in 1988 to provide our best service in EMC, Radio, Telecom and Safety consultation. Our laboratories are accredited and approved according to ISO/IEC 17025.

If you have any comments, please feel free to contact us at the following:

Linko EMC/RF Lab

Tel: 886-2-26052180

Fax: 886-2-26051924

Hsin Chu EMC/RF/Telecom Lab

Tel: 886-3-6668565

Fax: 886-3-6668323

Hwa Ya EMC/RF/Safety Lab

Tel: 886-3-3183232

Fax: 886-3-3270892

Email: service.adt@tw.bureauveritas.com

Web Site: www.bureauveritas-adt.com

The address and road map of all our labs can be found in our web site also.

--- END ---