

FCC Test Report

Report No.: RF161202E10-1

FCC ID: PY316400356

Test Model: D7000v2

Received Date: Dec. 02, 2016

Test Date: Jan. 06 to Mar. 27, 2017

Issued Date: Apr. 11, 2017

Applicant: NETGEAR, Inc.

Address: 350 East Plumeria Drive San Jose, CA 95134

Issued By: Bureau Veritas Consumer Products Services (H.K.) Ltd., Taoyuan Branch
Hsin Chu Laboratory

Lab Address: E-2, No.1, Li Hsin 1st Road, Hsinchu Science Park, Hsinchu City 300,
Taiwan R.O.C.

Test Location (1): E-2, No.1, Li Hsin 1st Road, Hsinchu Science Park, Hsinchu City 300,
Taiwan R.O.C.

Test Location (2): No. 49, Ln. 206, Wende Rd., Shangshan Tsuen, Chiung Lin Hsiang, Hsin
Chu Hsien 307, Taiwan R.O.C.



This report is for your exclusive use. Any copying or replication of this report to or for any other person or entity, or use of our name or trademark, is permitted only with our prior written permission. This report sets forth our findings solely with respect to the test samples identified herein. The results set forth in this report are not indicative or representative of the quality or characteristics of the lot from which a test sample was taken or any similar or identical product unless specifically and expressly noted. Our report includes all of the tests requested by you and the results thereof based upon the information that you provided to us. You have 60 days from date of issuance of this report to notify us of any material error or omission caused by our negligence, provided, however, that such notice shall be in writing and shall specifically address the issue you wish to raise. A failure to raise such issue within the prescribed time shall constitute your unqualified acceptance of the completeness of this report, the tests conducted and the correctness of the report contents. Unless specific mention, the uncertainty of measurement has been explicitly taken into account to declare the compliance or non-compliance to the specification. The report must not be used by the client to claim product certification, approval, or endorsement by TAF or any government agencies.

Table of Contents

Release Control Record	4
1 Certificate of Conformity	5
2 Summary of Test Results	6
2.1 Measurement Uncertainty	6
2.2 Modification Record	6
3 General Information	7
3.1 General Description of EUT	7
3.2 Description of Test Modes	10
3.2.1 Test Mode Applicability and Tested Channel Detail	11
3.3 Duty Cycle of Test Signal	13
3.4 Description of Support Units	14
3.4.1 Configuration of System under Test	15
3.5 General Description of Applied Standard	16
4 Test Types and Results	17
4.1 Radiated Emission and Bandedge Measurement	17
4.1.1 Limits of Radiated Emission and Bandedge Measurement	17
4.1.2 Test Instruments	18
4.1.3 Test Procedure	19
4.1.4 Deviation from Test Standard	20
4.1.5 Test Setup	20
4.1.6 EUT Operating Condition	21
4.1.7 Test Results	22
4.2 Conducted Emission Measurement	41
4.2.1 Limits of Conducted Emission Measurement	41
4.2.2 Test Instruments	41
4.2.3 Test Procedure	42
4.2.4 Deviation from Test Standard	42
4.2.5 Test Setup	42
4.2.6 EUT Operating Condition	42
4.2.7 Test Results (Mode 1)	43
4.2.8 Test Results (Mode 2)	45
4.3 Transmit Power Measurement	47
4.3.1 Limits of Transmit Power Measurement	47
4.3.2 Test Setup	47
4.3.3 Test Instruments	47
4.3.4 Test Procedure	47
4.3.5 Deviation from Test Standard	47
4.3.6 EUT Operating Condition	47
4.3.7 Test Result	48
4.4 Occupied Bandwidth Measurement	50
4.4.1 Test Setup	50
4.4.2 Test Instruments	50
4.4.3 Test Procedure	50
4.4.4 Test Results	51
4.5 Peak Power Spectral Density Measurement	57
4.5.1 Limits of Peak Power Spectral Density Measurement	57
4.5.2 Test Setup	57
4.5.3 Test Instruments	57
4.5.4 Test Procedure	58
4.5.5 Deviation from Test Standard	58
4.5.6 EUT Operating Condition	58
4.5.7 Test Results	59
4.6 Frequency Stability Measurement	65

4.6.1	Limits of Frequency Stability Measurement	65
4.6.2	Test Setup.....	65
4.6.3	Test Instruments	65
4.6.4	Test Procedure	65
4.6.5	Deviation from Test Standard	65
4.6.6	EUT Operating Condition	65
4.6.7	Test Results	66
4.7	6dB Bandwidth Measurement	67
4.7.1	Limits of 6dB Bandwidth Measurement.....	67
4.7.2	Test Setup.....	67
4.7.3	Test Instruments	67
4.7.4	Test Procedure	67
4.7.5	Deviation from Test Standard	67
4.7.6	EUT Operating Condition	67
4.7.7	Test Results	68
5	Pictures of Test Arrangements.....	70
	Annex A- Radiated Out of Band Emission (OOBE) Measurement (For U-NII-3 band)	71
	Appendix – Information on the Testing Laboratories	74

Release Control Record

Issue No.	Description	Date Issued
RF161202E10-1	Original release.	Apr. 11, 2017

1 Certificate of Conformity

Product: AC1900 WiFi VDSL/ADSL Modem Router

Brand: NETGEAR

Test Model: D7000v2

Sample Status: ENGINEERING SAMPLE

Applicant: NETGEAR, Inc.

Test Date: Jan. 06 to Mar. 27, 2017

Standard: 47 CFR FCC Part 15, Subpart E (Section 15.407)
ANSI C63.10: 2013

The above equipment has been tested by **Bureau Veritas Consumer Products Services (H.K.) Ltd., Taoyuan Branch**, and found compliance with the requirement of the above standards. The test record, data evaluation & Equipment Under Test (EUT) configurations represented herein are true and accurate accounts of the measurements of the sample's EMC characteristics under the conditions specified in this report.

Prepared by : Wendy Wu , **Date:** Apr. 11, 2017
Wendy Wu / Specialist

Approved by : May Chen , **Date:** Apr. 11, 2017
May Chen / Manager

2 Summary of Test Results

47 CFR FCC Part 15, Subpart E (Section 15.407)			
FCC Clause	Test Item	Result	Remarks
15.407(b)(6)	AC Power Conducted Emissions	Pass	Meet the requirement of limit. Minimum passing margin is -3.07dB at 0.28672MHz.
15.407(b) (1/2/3/4(i/ii)/6)	Radiated Emissions & Band Edge Measurement*	Pass	Meet the requirement of limit. Minimum passing margin is -0.1dB at 5150.00MHz, 17235.00MHz, 17355.00MHz, 17385.00MHz.
15.407(a)(1/2/3)	Max Average Transmit Power	Pass	Meet the requirement of limit.
---	Occupied Bandwidth Measurement	-	Reference only.
15.407(a)(1/2/3)	Peak Power Spectral Density	Pass	Meet the requirement of limit.
15.407(e)	6dB bandwidth	Pass	Meet the requirement of limit. (U-NII-3 Band only)
15.407(g)	Frequency Stability	Pass	Meet the requirement of limit.
15.203	Antenna Requirement	Pass	Antenna connector is Re-SMA not a standard connector.

*For U-NII-3 band compliance with rule part 15.407(b)(4)(i), the OOB test plots were recorded in Annex A.

2.1 Measurement Uncertainty

Where relevant, the following measurement uncertainty levels have been estimated for tests performed on the EUT as specified in CISPR 16-4-2:

Measurement	Frequency	Expanded Uncertainty (k=2) (±)
Conducted Emissions at mains ports	150kHz ~ 30MHz	1.84 dB
Radiated Emissions up to 1 GHz	30MHz ~ 1GHz	5.30 dB
Radiated Emissions above 1 GHz	1GHz ~ 6GHz	4.78 dB
	6GHz ~ 18GHz	4.52 dB
	18GHz ~ 40GHz	5.08 dB

2.2 Modification Record

There were no modifications required for compliance.

3 General Information

3.1 General Description of EUT

Product	AC1900 WiFi VDSL/ADSL Modem Router
Brand	NETGEAR
Test Model	D7000v2
Status of EUT	ENGINEERING SAMPLE
Power Supply Rating	DC 12V from power adapter
Modulation Type	CCK, DQPSK, DBPSK for DSSS 64QAM, 16QAM, QPSK, BPSK for OFDM 256QAM for OFDM in 11ac mode and VHT20/40 mode of 2.4GHz Band
Modulation Technology	DSSS, OFDM
Transfer Rate	802.11b: up to 11Mbps 802.11a/g: up to 54Mbps 802.11n: up to 600Mbps 802.11ac: up to 1300Mbps
Operating Frequency	2.4GHz: 2.412 ~ 2.462GHz 5GHz: 5.18 ~ 5.24GHz, 5.745 ~ 5.825GHz
Number of Channel	2.4GHz: 802.11b, 802.11g, 802.11n (HT20), VHT20: 11 802.11n (HT40), VHT40: 7 5GHz: 802.11a, 802.11n (HT20), 802.11ac (VHT20): 9 802.11n (HT40), 802.11ac (VHT40): 4 802.11ac (VHT80): 2
Output Power	2.4GHz: 991.898mW 5GHz: 5.18GHz ~ 5.24GHz: CDD Mode: 804.199mW Beamforming Mode: 796.853mW 5.745GHz ~ 5.825GHz: CDD Mode: 818.141mW Beamforming Mode: 805.477mW
Antenna Type	Refer to Note
Antenna Connector	Refer to Note
Accessory Device	Adapter x 1
Data Cable Supplied	NA

Note:

1. The EUT must be supplied with a power adapter and following different models could be chosen as following table:

No	Brand Name	Model No.	P/N	Spec.	Plug
1	NETGEAR	2ABL030F 1	332-10758-01	Input: 100-240Vac, 50/60Hz, 1A Output: 12Vdc, 2.5A DC output cable: 1.8m, unshielded	FCC
2	NETGEAR	AD2067F10	332-10797-01	Input: 100-240Vac, 50/60Hz, 1A Output: 12Vdc, 2.5A DC output cable: 1.8m, unshielded	FCC

Note:

1. From the above adapters, the radiated emissions worse case was found in Adapter 1. Therefore only the test data of the mode was recorded in this report.

2. Simultaneously transmission condition.

Condition	Technology	
1	WLAN (2.4GHz)	WLAN (5GHz)

Note: The emission of the simultaneous operation has been evaluated and no non-compliance was found.

3. The antennas provided to the EUT, please refer to the following table:

Antenna No.	Ant. Gain(dBi)	Frequency range (GHz)	Antenna Type	Connector Type	Cable Loss(dB)	Cable Length (mm)
1	0.82	2.4~2.4835	Dipole	Re-SMA	0.37	79
	2.76	5.15~5.85			0.57	
2	0.82	2.4~2.4835	Dipole	Re-SMA	0.37	88
	2.76	5.15~5.85			0.62	
3	0.82	2.4~2.4835	Dipole	Re-SMA	0.575	170
	2.76	5.15~5.85			0.62	

Note: For 802.11b mode, Antenna 1 was selected for final test.

4. The EUT incorporates a MIMO function.

For 2.4GHz Band			
MODULATION MODE	DATA RATE (MCS)	TX & RX CONFIGURATION	
802.11b	1 ~ 11Mbps	1TX diversity	1RX Fixed Chain 0
802.11g	6 ~ 54Mbps	3TX	3RX
802.11n (HT20)	MCS 0~7	3TX	3RX
	MCS 8~15	3TX	3RX
	MCS 16~23	3TX	3RX
802.11n (HT40)	MCS 0~7	3TX	3RX
	MCS 8~15	3TX	3RX
	MCS 16~23	3TX	3RX
VHT20	MCS0~8 Nss=1	3TX	3RX
	MCS0~8 Nss=2	3TX	3RX
	MCS0~9 Nss=3	3TX	3RX
VHT40	MCS0~9 Nss=1	3TX	3RX
	MCS0~9 Nss=2	3TX	3RX
	MCS0~9 Nss=3	3TX	3RX
For 5GHz Band			
MODULATION MODE	DATA RATE (MCS)	TX & RX CONFIGURATION	
802.11a	6 ~ 54Mbps	3TX	3RX
802.11n (HT20)	MCS 0~7	3TX	3RX
	MCS 8~15	3TX	3RX
	MCS 16~23	3TX	3RX
802.11n (HT40)	MCS 0~7	3TX	3RX
	MCS 8~15	3TX	3RX
	MCS 16~23	3TX	3RX
802.11ac (VHT20)	MCS 0~8, Nss=1	3TX	3RX
	MCS 0~8, Nss=2	3TX	3RX
	MCS 0~9, Nss=3	3TX	3RX
802.11ac (VHT40)	MCS 0~9, Nss=1	3TX	3RX
	MCS 0~9, Nss=2	3TX	3RX
	MCS 0~9, Nss=3	3TX	3RX
802.11ac (VHT80)	MCS 0~9, Nss=1	3TX	3RX
	MCS 0~9, Nss=2	3TX	3RX
	MCS 0~9, Nss=3	3TX	3RX

Note:

1. All of modulation mode support beamforming function except 802.11a/b/g modulation mode.
2. The modulation and bandwidth are similar for 802.11n mode for 20MHz (40MHz) and 802.11ac mode for 20MHz (40MHz), therefore investigated worst case to representative mode in test report. (Final test mode refer section 3.2.1)
3. The EUT support Beamforming and CDD mode, therefore both mode were investigated and the worst case scenario was identified. The worst case data were presented in test report.

5. The above EUT information is declared by manufacturer and for more detailed features description, please refer to the manufacturer's specifications or user's manual.

3.2 Description of Test Modes

FOR 5180 ~ 5240MHz

4 channels are provided for 802.11a, 802.11n (HT20), 802.11ac (VHT20):

Channel	Frequency	Channel	Frequency
36	5180MHz	44	5220MHz
40	5200MHz	48	5240MHz

2 channels are provided for 802.11n (HT40), 802.11ac (VHT40):

Channel	Frequency	Channel	Frequency
38	5190MHz	46	5230MHz

1 channel is provided for 802.11ac (VHT80):

Channel	Frequency
42	5210MHz

FOR 5745 ~ 5825MHz:

5 channels are provided for 802.11a, 802.11n (HT20), 802.11ac (VHT20):

Channel	Frequency	Channel	Frequency
149	5745MHz	161	5805MHz
153	5765MHz	165	5825MHz
157	5785MHz		

2 channels are provided for 802.11n (HT40), 802.11ac (VHT40):

Channel	Frequency	Channel	Frequency
151	5755MHz	159	5795MHz

1 channel is provided for 802.11ac (VHT80):

Channel	Frequency
155	5775MHz

3.2.1 Test Mode Applicability and Tested Channel Detail

EUT Configure Mode	Applicable To				Description
	RE \geq 1G	RE<1G	PLC	APCM	
1	√	√	√	√	With Adapter 1
2	-	-	√	-	With Adapter 2

Where **RE \geq 1G**: Radiated Emission above 1GHz **RE<1G**: Radiated Emission below 1GHz
PLC: Power Line Conducted Emission **APCM**: Antenna Port Conducted Measurement

NOTE:

1. The EUT had been pre-tested on the positioned of each 2 axis. The worst case was found when positioned on **X-plane**.
2. "-" means no effect.

Radiated Emission Test (Above 1GHz):

- Pre-Scan has been conducted to determine the worst-case mode from all possible combinations between available modulations, data rates and antenna ports (if EUT with antenna diversity architecture).
- Following channel(s) was (were) selected for the final test as listed below.

CDD Mode						
Mode	FREQ. Band (MHz)	Available Channel	Tested Channel	Modulation Technology	Modulation Type	Data Rate (Mbps)
802.11a	5180-5240	36 to 48	36, 40, 48	OFDM	BPSK	6
802.11a	5745-5825	149 to 165	149, 157, 165	OFDM	BPSK	6
Beamforming Mode						
Mode	FREQ. Band (MHz)	Available Channel	Tested Channel	Modulation Technology	Modulation Type	Data Rate (Mbps)
802.11ac (VHT20)	5180-5240	36 to 48	36, 40, 48	OFDM	BPSK	6.5
802.11ac (VHT40)		38 to 46	38, 46	OFDM	BPSK	13.5
802.11ac (VHT80)		42	42	OFDM	BPSK	29.3
802.11ac (VHT20)	5745-5825	149 to 165	149, 157, 165	OFDM	BPSK	6.5
802.11ac (VHT40)		151 to 159	151, 159	OFDM	BPSK	13.5
802.11ac (VHT80)		155	155	OFDM	BPSK	29.3

Radiated Emission Test (Below 1GHz):

- Pre-Scan has been conducted to determine the worst-case mode from all possible combinations between available modulations, data rates and antenna ports (if EUT with antenna diversity architecture).
- Following channel(s) was (were) selected for the final test as listed below.

CDD Mode						
Mode	FREQ. Band (MHz)	Available Channel	Tested Channel	Modulation Technology	Modulation Type	Data Rate (Mbps)
802.11a	5745-5825	149 to 165	157	OFDM	BPSK	6

Power Line Conducted Emission Test:

- Pre-Scan has been conducted to determine the worst-case mode from all possible combinations between available modulations, data rates and antenna ports (if EUT with antenna diversity architecture).
- Following channel(s) was (were) selected for the final test as listed below.

CDD Mode						
Mode	FREQ. Band (MHz)	Available Channel	Tested Channel	Modulation Technology	Modulation Type	Data Rate (Mbps)
802.11a	5745-5825	149 to 165	157	OFDM	BPSK	6

Antenna Port Conducted Measurement:

- This item includes all test value of each mode, but only includes spectrum plot of worst value of each mode.
- Pre-Scan has been conducted to determine the worst-case mode from all possible combinations between available modulations, data rates and antenna ports (if EUT with antenna diversity architecture).
- Following channel(s) was (were) selected for the final test as listed below.

CDD Mode						
Mode	FREQ. Band (MHz)	Available Channel	Tested Channel	Modulation Technology	Modulation Type	Data Rate (Mbps)
802.11a	5180-5240	36 to 48	36, 40, 48	OFDM	BPSK	6
802.11a	5745-5825	149 to 165	149, 157, 165	OFDM	BPSK	6
Beamforming Mode						
Mode	FREQ. Band (MHz)	Available Channel	Tested Channel	Modulation Technology	Modulation Type	Data Rate (Mbps)
802.11ac (VHT20)	5180-5240	36 to 48	36, 40, 48	OFDM	BPSK	6.5
802.11ac (VHT40)		38 to 46	38, 46	OFDM	BPSK	13.5
802.11ac (VHT80)		42	42	OFDM	BPSK	29.3
802.11ac (VHT20)	5745-5825	149 to 165	149, 157, 165	OFDM	BPSK	6.5
802.11ac (VHT40)		151 to 159	151, 159	OFDM	BPSK	13.5
802.11ac (VHT80)		155	155	OFDM	BPSK	29.3

Test Condition:

Applicable To	Environmental Conditions	Input Power	Tested By
RE \geq 1G	25deg. C, 64%RH	120Vac, 60Hz	Weiwei Lo
RE $<$ 1G	24deg. C, 63%RH	120Vac, 60Hz	Jyunchun Lin
PLC	24deg. C, 64%RH	120Vac, 60Hz	Jyunchun Lin
APCM	26deg. C, 67%RH	120Vac, 60Hz	Anderson Chen

3.3 Duty Cycle of Test Signal

Duty cycle of test signal is < 98 %, duty factor shall be considered.

802.11a: Duty cycle = 1.394 ms/1.43 ms = 0.975, Duty factor = $10 * \log(1/0.975) = 0.11$

802.11ac (VHT20): Duty cycle = 1.314 ms/1.365 ms = 0.963, Duty factor = $10 * \log(1/0.963) = 0.17$

802.11ac (VHT40): Duty cycle = 0.654 ms/0.69 ms = 0.948, Duty factor = $10 * \log(1/0.948) = 0.23$

802.11ac (VHT80): Duty cycle = 0.322 ms/0.373 ms = 0.863, Duty factor = $10 * \log(1/0.863) = 0.64$

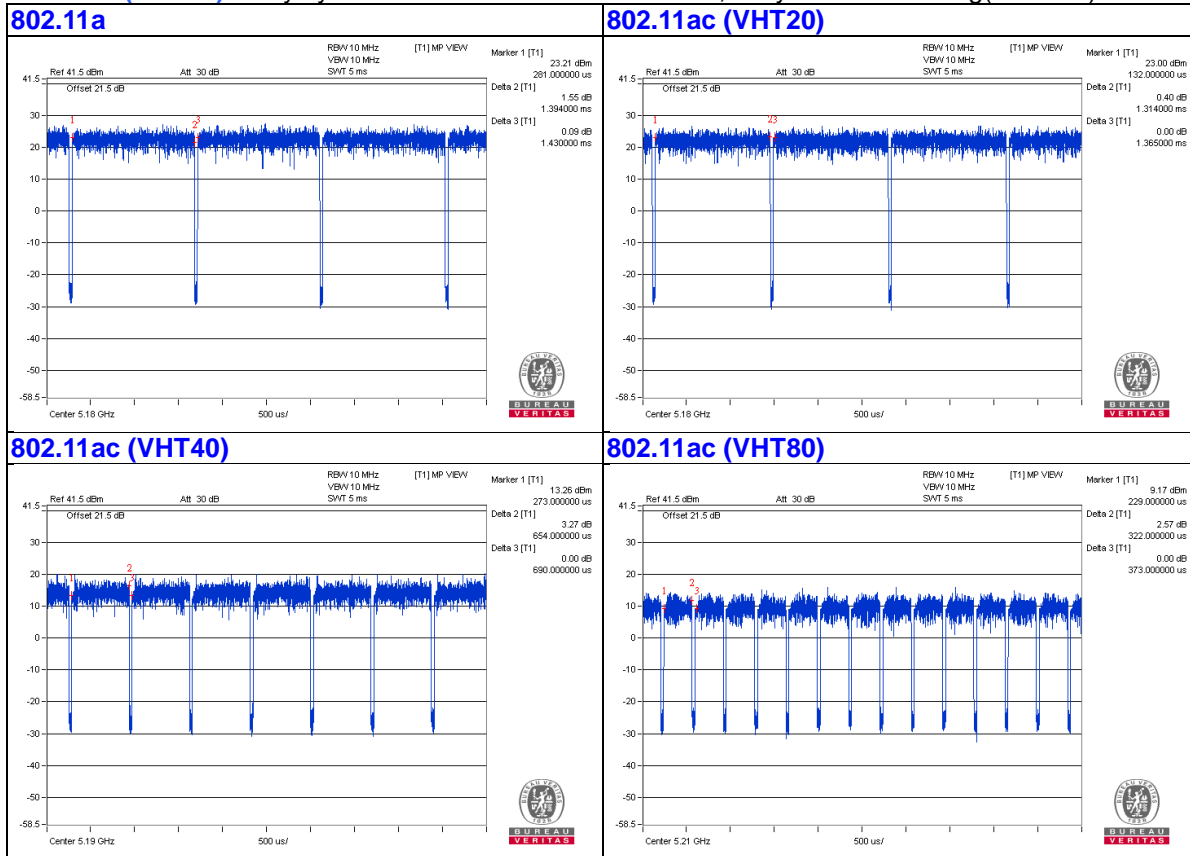

3.4 Description of Support Units

The EUT has been tested as an independent unit together with other necessary accessories or support units. The following support units or accessories were used to form a representative test configuration during the tests.

ID	Product	Brand	Model No.	Serial No.	FCC ID	Remarks
A.	Co-Router	ZyXel	IES-1000	S08024701597	FCC DoC	Provided by Lab
B.	Laptop	DELL	E5430	4YV4VY1	FCC DoC	Provided by Lab
C.	Laptop	DELL	E5430	HYV4VY1	FCC DoC	Provided by Lab
D.	iPod	Apple	MC749TA/A	CC4DN25WDFDM	NA	Provided by Lab
E.	USB Disk	Transcend	16G	NA	NA	Provided by Lab

Note:

1. All power cords of the above support units are non-shielded (1.8m).

ID	Descriptions	Qty.	Length (m)	Shielding (Yes/No)	Cores (Qty.)	Remarks
1.	DC Cable	1	1.8	No	0	Supplied by client
2.	RJ-11 Cable	1	10	No	0	Provided by Lab
3.	RJ-45 Cable	1	10	No	0	Provided by Lab
4.	RJ-45 Cable	1	10	No	0	Provided by Lab
5.	USB Cable	1	0.1	Yes	0	Provided by Lab

3.4.1 Configuration of System under Test

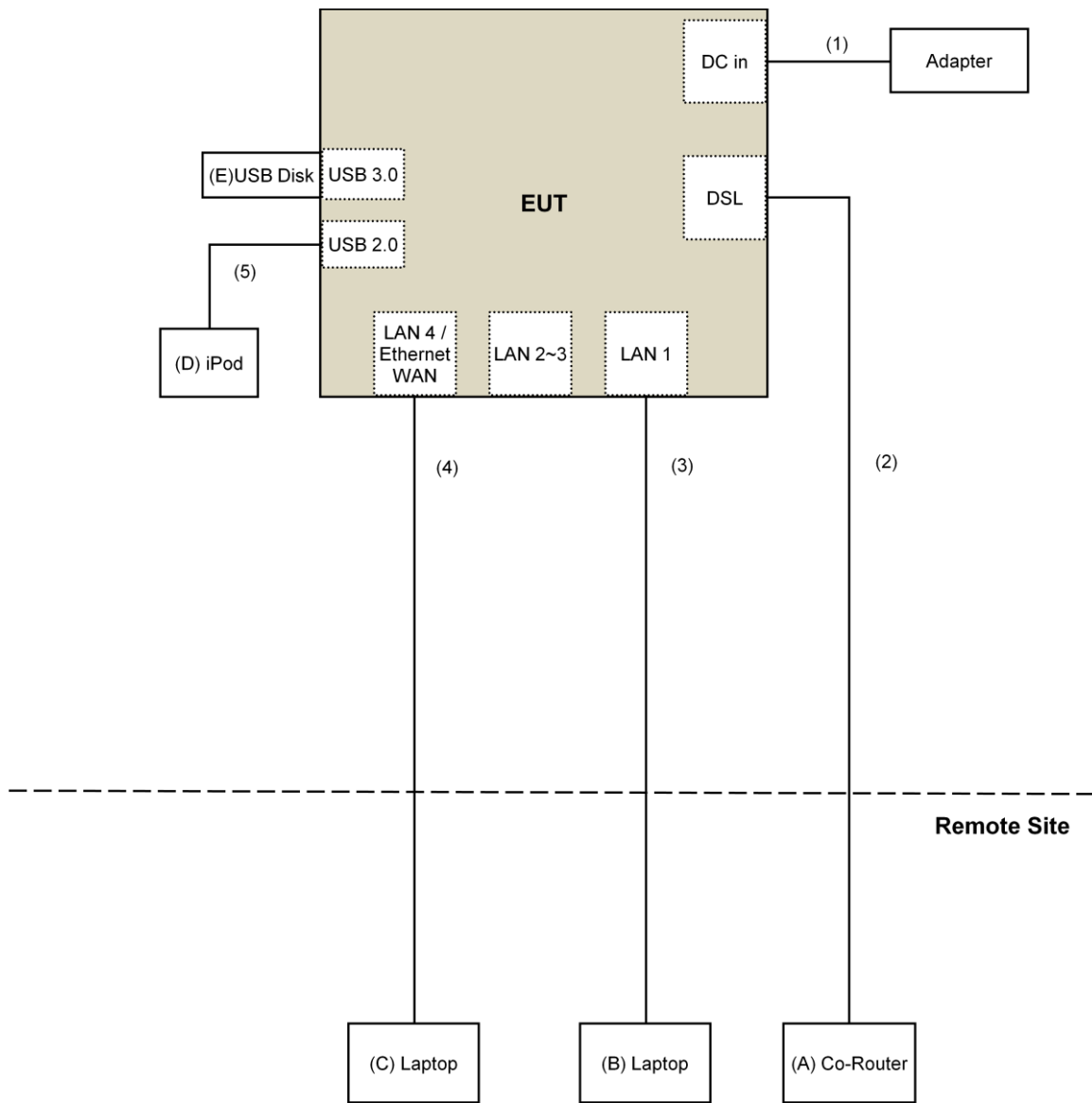

3.5 General Description of Applied Standard

The EUT is a RF Product. According to the specifications of the manufacturer, it must comply with the requirements of the following standards:

FCC Part 15, Subpart E (15.407)
KDB 789033 D02 General UNII Test Procedure New Rules v01r03
KDB 662911 D01 Multiple Transmitter Output v02r01
ANSI C63.10-2013

All test items have been performed and recorded as per the above standards.

NOTE: The EUT has been verified to comply with the requirements of FCC Part 15, Subpart B, Class B (DoC). The test report has been issued separately.

4 Test Types and Results

4.1 Radiated Emission and Bandedge Measurement

4.1.1 Limits of Radiated Emission and Bandedge Measurement

Radiated emissions which fall in the restricted bands must comply with the radiated emission limits specified as below table.

Frequencies (MHz)	Field Strength (microvolts/meter)	Measurement Distance (meters)
0.009 ~ 0.490	2400/F(kHz)	300
0.490 ~ 1.705	24000/F(kHz)	30
1.705 ~ 30.0	30	30
30 ~ 88	100	3
88 ~ 216	150	3
216 ~ 960	200	3
Above 960	500	3

NOTE:

1. The lower limit shall apply at the transition frequencies.
2. Emission level (dBuV/m) = 20 log Emission level (uV/m).
3. For frequencies above 1000MHz, the field strength limits are based on average detector, however, the peak field strength of any emission shall not exceed the maximum permitted average limits, specified above by more than 20dB under any condition of modulation.

Limits of unwanted emission out of the restricted bands

Applicable To		Limit	
789033 D02 General UNII Test Procedure New Rules v01r03		Field Strength at 3m	
		PK:74 (dBuV/m)	AV:54 (dBuV/m)
Frequency Band	Applicable To	EIRP Limit	Equivalent Field Strength at 3m
5150~5250 MHz	15.407(b)(1)	PK:-27 (dBm/MHz)	PK:68.2(dBuV/m)
5250~5350 MHz	15.407(b)(2)		
5470~5725 MHz	15.407(b)(3)		
5725~5850 MHz	<input checked="" type="checkbox"/> 15.407(b)(4)(i)	PK:-27 (dBm/MHz) ^{*1} PK:10 (dBm/MHz) ^{*2} PK:15.6 (dBm/MHz) ^{*3} PK:27 (dBm/MHz) ^{*4}	PK: 68.2(dBuV/m) ^{*1} PK:105.2 (dBuV/m) ^{*2} PK: 110.8(dBuV/m) ^{*3} PK:122.2 (dBuV/m) ^{*4}
	<input type="checkbox"/> 15.407(b)(4)(ii)	Emission limits in section 15.247(d)	
^{*1} beyond 75 MHz or more above of the band edge.		^{*2} below the band edge increasing linearly to 10 dBm/MHz at 25 MHz above.	
^{*3} below the band edge increasing linearly to a level of 15.6 dBm/MHz at 5 MHz above.		^{*4} from 5 MHz above or below the band edge increasing linearly to a level of 27 dBm/MHz at the band edge.	

Note:

The following formula is used to convert the equipment isotropic radiated power (eirp) to field strength:

$$E = \frac{1000000\sqrt{30P}}{3} \mu\text{V/m, where P is the eirp (Watts).}$$

4.1.2 Test Instruments

DESCRIPTION & MANUFACTURER	MODEL NO.	SERIAL NO.	CALIBRATED DATE	CALIBRATED UNTIL
Test Receiver Keysight	N9038A	MY54450088	July 20, 2016	July 19, 2017
Pre-Amplifier ^(*) EMCI	EMC001340	980142	Jan. 20, 2016	Jan. 19, 2018
Loop Antenna ^(*) Electro-Metrics	EM-6879	264	Dec. 16, 2016	Dec. 15, 2018
RF Cable	NA	LOOPCAB-001 LOOPCAB-002	Jan. 17, 2017	Jan. 16, 2018
Pre-Amplifier Mini-Circuits	ZFL-1000VH2B	AMP-ZFL-01	Nov. 10, 2016	Nov. 09, 2017
Trilog Broadband Antenna SCHWARZBECK	VULB 9168	9168-406	Dec. 13, 2016	Dec. 12, 2017
RF Cable	8D	966-4-1 966-4-2 966-4-3	Apr. 02, 2016	Apr. 01, 2017
Fixed attenuator Mini-Circuits	UNAT-5+	PAD-3m-4-01	Oct. 05, 2016	Oct. 04, 2017
Horn_Antenna SCHWARZBECK	BBHA 9120D	9120D-783	Dec. 27, 2016	Dec. 26, 2017
Pre-Amplifier EMCI	EMC12630SE	980385	Feb. 02, 2017	Feb. 01, 2018
RF Cable	EMC104-SM-SM-2000 EMC104-SM-SM-5000 EMC104-SM-SM-5000	160923 150318 150323	Feb. 02, 2017 Mar. 30, 2016 Mar. 30, 2016	Feb. 01, 2018 Mar. 29, 2017 Mar. 29, 2017
Pre-Amplifier EMCI	EMC184045SE	980387	Feb. 02, 2017	Feb. 01, 2018
Horn_Antenna SCHWARZBECK	BBHA 9170	BBHA9170608	Dec. 15, 2016	Dec. 14, 2017
RF Cable	SUCOFLEX 102	36432/2 36433/2	Jan. 15, 2017	Jan. 14, 2018
Software	ADT_Radiated_V8.7.08	NA	NA	NA
Antenna Tower & Turn Table Max-Full	MF-7802	MF780208410	NA	NA
Boresight Antenna Fixture	FBA-01	FBA-SIP02	NA	NA
Spectrum Analyzer R&S	FSv40	100964	June 28, 2016	June 27, 2017
Power meter Anritsu	ML2495A	1014008	May 5, 2016	May 4, 2017
Power sensor Anritsu	MA2411B	0917122	May 5, 2016	May 4, 2017

Note:

1. The calibration interval of the above test instruments is 12 months and the calibrations are traceable to NML/ROC and NIST/USA.
2. *The calibration interval of the above test instruments is 24 months and the calibrations are traceable to NML/ROC and NIST/USA.
3. The test was performed in 966 Chamber No. 4.
4. The FCC Site Registration No. is 292998
5. The CANADA Site Registration No. is 20331-2
- 6 Loop antenna was used for all emissions below 30 MHz.
7. Tested Date: Mar. 21 to 27, 2017

4.1.3 Test Procedure

For Radiated emission below 30MHz

- a. The EUT was placed on the top of a rotating table 0.8 meters above the ground at a 3 meter chamber room. The table was rotated 360 degrees to determine the position of the highest radiation.
- b. The EUT was set 3 meters away from the interference-receiving antenna, which was mounted on the top of a variable-height antenna tower.
- c. Both X and Y axes of the antenna are set to make the measurement.
- d. For each suspected emission, the EUT was arranged to its worst case and the rotatable table was turned from 0 degrees to 360 degrees to find the maximum reading.
- e. The test-receiver system was set to Quasi-Peak Detect Function and Specified Bandwidth with Maximum Hold Mode.

NOTE:

1. The resolution bandwidth and video bandwidth of test receiver/spectrum analyzer is 9kHz at frequency below 30MHz.

For Radiated emission above 30MHz

- a. The EUT was placed on the top of a rotating table 0.8 meters (for 30MHz ~ 1GHz) / 1.5 meters (for above 1GHz) above the ground at 3 meter chamber room for test. The table was rotated 360 degrees to determine the position of the highest radiation.
- b. The EUT was set 3 meters away from the interference-receiving antenna, which was mounted on the top of a variable-height antenna tower.
- c. The height of antenna is varied from one meter to four meters above the ground to determine the maximum value of the field strength. Both horizontal and vertical polarizations of the antenna are set to make the measurement.
- d. For each suspected emission, the EUT was arranged to its worst case and then the antenna was tuned to heights from 1 meter to 4 meters and the rotatable table was turned from 0 degrees to 360 degrees to find the maximum reading.
- e. The test-receiver system was set to quasi-peak detect function and specified bandwidth with maximum hold mode when the test frequency is below 1 GHz.
- f. The test-receiver system was set to peak and average detect function and specified bandwidth with maximum hold mode when the test frequency is above 1 GHz. If the peak reading value also meets average limit, measurement with the average detector is unnecessary.

Note:

1. The resolution bandwidth and video bandwidth of test receiver/spectrum analyzer is 120kHz for Quasi-peak detection (QP) at frequency below 1GHz.
2. The resolution bandwidth of test receiver/spectrum analyzer is 1 MHz and the video bandwidth is 3 MHz for Peak detection (PK) at frequency above 1GHz.
3. The resolution bandwidth of test receiver/spectrum analyzer is 1MHz and the video bandwidth is $\geq 1/T$ (Duty cycle < 98%) or 10Hz (Duty cycle $\geq 98\%$) for Average detection (AV) at frequency above 1GHz.
4. All modes of operation were investigated and the worst-case emissions are reported.

4.1.4 Deviation from Test Standard

No deviation.

4.1.5 Test Setup

For Radiated emission below 30MHz

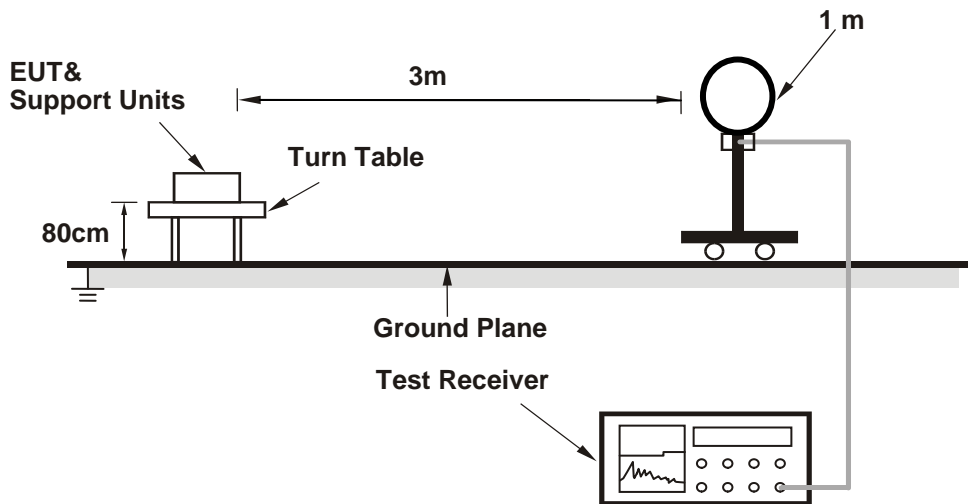

For Radiated emission 30MHz to 1GHz

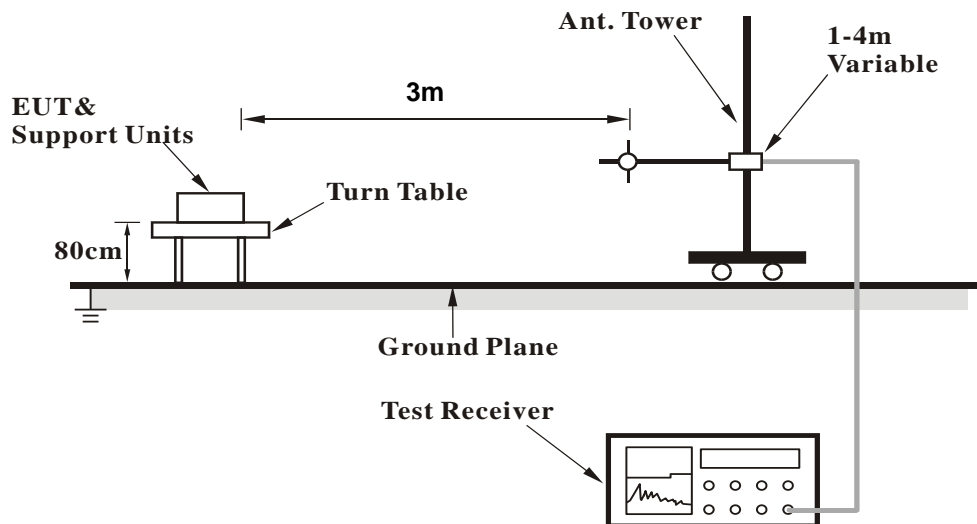

For Radiated emission above 1GHz

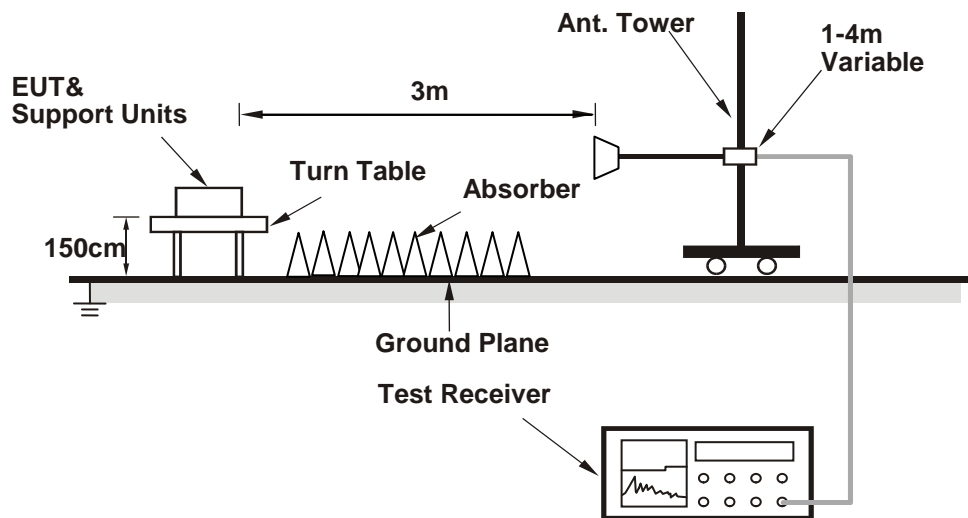

For the actual test configuration, please refer to the attached file (Test Setup Photo).

4.1.6 EUT Operating Condition

- a. Connected the EUT with the Laptop which is placed on remote site.
- b. Controlling software (Lantiq DUT.exe) has been activated to set the EUT on specific status.

4.1.7 Test Results

Above 1GHz Data:

802.11a

CHANNEL	TX Channel 36	DETECTOR FUNCTION	Peak (PK)
FREQUENCY RANGE	1GHz ~ 40GHz		Average (AV)

ANTENNA POLARITY & TEST DISTANCE: HORIZONTAL AT 3 M								
NO.	FREQ. (MHz)	EMISSION LEVEL (dBuV/m)	LIMIT (dBuV/m)	MARGIN (dB)	ANTENNA HEIGHT (m)	TABLE ANGLE (Degree)	RAW VALUE (dBuV)	CORRECTION FACTOR (dB/m)
1	5150.00	59.5 PK	74.0	-14.5	3.02 H	301	56.6	2.9
2	5150.00	42.1 AV	54.0	-11.9	3.02 H	301	39.2	2.9
3	*5180.00	107.9 PK			3.02 H	301	104.9	3.0
4	*5180.00	96.4 AV			3.02 H	301	93.4	3.0
5	#10360.00	53.8 PK	74.0	-20.2	1.81 H	345	41.9	11.9
6	#10360.00	40.1 AV	54.0	-13.9	1.81 H	345	28.2	11.9
7	15540.00	64.5 PK	74.0	-9.5	3.07 H	67	52.3	12.2
8	15540.00	48.9 AV	54.0	-5.1	3.07 H	67	36.7	12.2

ANTENNA POLARITY & TEST DISTANCE: VERTICAL AT 3 M								
NO.	FREQ. (MHz)	EMISSION LEVEL (dBuV/m)	LIMIT (dBuV/m)	MARGIN (dB)	ANTENNA HEIGHT (m)	TABLE ANGLE (Degree)	RAW VALUE (dBuV)	CORRECTION FACTOR (dB/m)
1	5150.00	71.2 PK	74.0	-2.8	2.59 V	205	68.3	2.9
2	5150.00	53.9 AV	54.0	-0.1	2.59 V	205	51.0	2.9
3	*5180.00	118.7 PK			2.59 V	205	115.7	3.0
4	*5180.00	107.9 AV			2.59 V	205	104.9	3.0
5	#10360.00	49.2 PK	74.0	-24.8	2.01 V	329	37.3	11.9
6	#10360.00	37.1 AV	54.0	-16.9	2.01 V	329	25.2	11.9
7	15540.00	62.9 PK	74.0	-11.1	1.03 V	6	50.7	12.2
8	15540.00	47.5 AV	54.0	-6.5	1.03 V	6	35.3	12.2

REMARKS:

1. Emission Level(dBuV/m) = Raw Value(dBuV) + Correction Factor(dB/m)
2. Correction Factor(dB/m) = Antenna Factor(dB/m) + Cable Factor(dB) – Pre-Amplifier Factor(dB)
3. The other emission levels were very low against the limit.
4. Margin value = Emission Level – Limit value
5. " * ": Fundamental frequency.
6. " # ": The radiated frequency is out of the restricted band.

CHANNEL	TX Channel 40	DETECTOR FUNCTION	Peak (PK)
FREQUENCY RANGE	1GHz ~ 40GHz		Average (AV)

ANTENNA POLARITY & TEST DISTANCE: HORIZONTAL AT 3 M

NO.	FREQ. (MHz)	EMISSION LEVEL (dBuV/m)	LIMIT (dBuV/m)	MARGIN (dB)	ANTENNA HEIGHT (m)	TABLE ANGLE (Degree)	RAW VALUE (dBuV)	CORRECTION FACTOR (dB/m)
1	5150.00	51.1 PK	74.0	-22.9	2.96 H	314	48.2	2.9
2	5150.00	39.3 AV	54.0	-14.7	2.96 H	314	36.4	2.9
3	*5200.00	111.3 PK			2.96 H	314	108.3	3.0
4	*5200.00	100.6 AV			2.96 H	314	97.6	3.0
5	#10400.00	57.6 PK	74.0	-16.4	1.87 H	351	45.7	11.9
6	#10400.00	44.0 AV	54.0	-10.0	1.87 H	351	32.1	11.9
7	15600.00	68.4 PK	74.0	-5.6	3.08 H	61	56.1	12.3
8	15600.00	53.0 AV	54.0	-1.0	3.08 H	61	40.7	12.3

ANTENNA POLARITY & TEST DISTANCE: VERTICAL AT 3 M

NO.	FREQ. (MHz)	EMISSION LEVEL (dBuV/m)	LIMIT (dBuV/m)	MARGIN (dB)	ANTENNA HEIGHT (m)	TABLE ANGLE (Degree)	RAW VALUE (dBuV)	CORRECTION FACTOR (dB/m)
1	5150.00	67.5 PK	74.0	-6.5	2.55 V	205	64.6	2.9
2	5150.00	51.3 AV	54.0	-2.7	2.55 V	205	48.4	2.9
3	*5200.00	122.1 PK			2.55 V	205	119.1	3.0
4	*5200.00	112.1 AV			2.55 V	205	109.1	3.0
5	#10400.00	53.0 PK	74.0	-21.0	2.05 V	335	41.1	11.9
6	#10400.00	41.1 AV	54.0	-12.9	2.05 V	335	29.2	11.9
7	15600.00	66.8 PK	74.0	-7.2	1.00 V	0	54.5	12.3
8	15600.00	51.4 AV	54.0	-2.6	1.00 V	0	39.1	12.3

REMARKS:

1. Emission Level(dBuV/m) = Raw Value(dBuV) + Correction Factor(dB/m)
2. Correction Factor(dB/m) = Antenna Factor(dB/m) + Cable Factor(dB) – Pre-Amplifier Factor(dB)
3. The other emission levels were very low against the limit.
4. Margin value = Emission Level – Limit value
5. " * ": Fundamental frequency.
6. " # ": The radiated frequency is out of the restricted band.

CHANNEL	TX Channel 48	DETECTOR FUNCTION	Peak (PK)
FREQUENCY RANGE	1GHz ~ 40GHz		Average (AV)

ANTENNA POLARITY & TEST DISTANCE: HORIZONTAL AT 3 M

NO.	FREQ. (MHz)	EMISSION LEVEL (dBuV/m)	LIMIT (dBuV/m)	MARGIN (dB)	ANTENNA HEIGHT (m)	TABLE ANGLE (Degree)	RAW VALUE (dBuV)	CORRECTION FACTOR (dB/m)
1	5150.00	51.8 PK	74.0	-22.2	2.96 H	327	48.9	2.9
2	5150.00	40.0 AV	54.0	-14.0	2.96 H	327	37.1	2.9
3	*5240.00	110.3 PK			2.96 H	327	107.2	3.1
4	*5240.00	100.0 AV			2.96 H	327	96.9	3.1
5	5350.00	51.2 PK	74.0	-22.8	2.96 H	327	47.8	3.4
6	5350.00	39.5 AV	54.0	-14.5	2.96 H	327	36.1	3.4
7	#10480.00	57.7 PK	74.0	-16.3	1.89 H	354	45.8	11.9
8	#10480.00	44.2 AV	54.0	-9.8	1.89 H	354	32.3	11.9
9	15720.00	67.4 PK	74.0	-6.6	1.72 H	313	54.4	13.0
10	15720.00	53.6 AV	54.0	-0.4	1.72 H	313	40.6	13.0

ANTENNA POLARITY & TEST DISTANCE: VERTICAL AT 3 M

NO.	FREQ. (MHz)	EMISSION LEVEL (dBuV/m)	LIMIT (dBuV/m)	MARGIN (dB)	ANTENNA HEIGHT (m)	TABLE ANGLE (Degree)	RAW VALUE (dBuV)	CORRECTION FACTOR (dB/m)
1	5150.00	55.6 PK	74.0	-18.4	2.54 V	206	52.7	2.9
2	5150.00	44.3 AV	54.0	-9.7	2.54 V	206	41.4	2.9
3	*5240.00	121.1 PK			2.54 V	206	118.0	3.1
4	*5240.00	111.5 AV			2.54 V	206	108.4	3.1
5	5350.00	54.1 PK	74.0	-19.9	2.54 V	206	50.7	3.4
6	5350.00	42.6 AV	54.0	-11.4	2.54 V	206	39.2	3.4
7	#10480.00	53.2 PK	74.0	-20.8	2.04 V	342	41.3	11.9
8	#10480.00	41.4 AV	54.0	-12.6	2.04 V	342	29.5	11.9
9	15720.00	67.6 PK	74.0	-6.4	1.00 V	4	54.6	13.0
10	15720.00	52.0 AV	54.0	-2.0	1.00 V	4	39.0	13.0

REMARKS:

1. Emission Level(dBuV/m) = Raw Value(dBuV) + Correction Factor(dB/m)
2. Correction Factor(dB/m) = Antenna Factor(dB/m) + Cable Factor(dB) – Pre-Amplifier Factor(dB)
3. The other emission levels were very low against the limit.
4. Margin value = Emission Level – Limit value
5. " * ": Fundamental frequency.
6. " # ": The radiated frequency is out of the restricted band.

CHANNEL	TX Channel 149	DETECTOR FUNCTION	Peak (PK)
FREQUENCY RANGE	1GHz ~ 40GHz		Average (AV)

ANTENNA POLARITY & TEST DISTANCE: HORIZONTAL AT 3 M

NO.	FREQ. (MHz)	EMISSION LEVEL (dBuV/m)	LIMIT (dBuV/m)	MARGIN (dB)	ANTENNA HEIGHT (m)	TABLE ANGLE (Degree)	RAW VALUE (dBuV)	CORRECTION FACTOR (dB/m)
1	#5551.94	51.4 PK	68.2	-16.8	3.01 H	330	48.0	3.4
2	*5745.00	108.9 PK			3.01 H	330	104.9	4.0
3	*5745.00	98.5 AV			3.01 H	330	94.5	4.0
4	#5954.26	50.1 PK	68.2	-18.1	3.01 H	330	45.8	4.3
5	11490.00	59.8 PK	74.0	-14.2	2.53 H	168	47.0	12.8
6	11490.00	48.3 AV	54.0	-5.7	2.53 H	168	35.5	12.8
7	#17235.00	69.3 PK	74.0	-4.7	1.72 H	232	51.9	17.4
8	#17235.00	53.9 AV	54.0	-0.1	1.72 H	232	36.5	17.4

ANTENNA POLARITY & TEST DISTANCE: VERTICAL AT 3 M

NO.	FREQ. (MHz)	EMISSION LEVEL (dBuV/m)	LIMIT (dBuV/m)	MARGIN (dB)	ANTENNA HEIGHT (m)	TABLE ANGLE (Degree)	RAW VALUE (dBuV)	CORRECTION FACTOR (dB/m)
1	#5591.94	54.8 PK	68.2	-13.4	2.44 V	221	51.2	3.6
2	*5745.00	119.9 PK			2.44 V	221	115.9	4.0
3	*5745.00	110.0 AV			2.44 V	221	106.0	4.0
4	#5932.62	51.7 PK	68.2	-16.5	2.44 V	221	47.4	4.3
5	11490.00	63.3 PK	74.0	-10.7	1.90 V	170	50.5	12.8
6	11490.00	49.8 AV	54.0	-4.2	1.90 V	170	37.0	12.8
7	#17235.00	62.4 PK	74.0	-11.6	1.86 V	189	45.0	17.4
8	#17235.00	48.8 AV	54.0	-5.2	1.86 V	189	31.4	17.4

REMARKS:

1. Emission Level(dBuV/m) = Raw Value(dBuV) + Correction Factor(dB/m)
2. Correction Factor(dB/m) = Antenna Factor(dB/m) + Cable Factor(dB) – Pre-Amplifier Factor(dB)
3. The other emission levels were very low against the limit.
4. Margin value = Emission Level – Limit value
5. " * ": Fundamental frequency.
6. " # ": The radiated frequency is out of the restricted band.

CHANNEL	TX Channel 157	DETECTOR FUNCTION	Peak (PK)
FREQUENCY RANGE	1GHz ~ 40GHz		Average (AV)

ANTENNA POLARITY & TEST DISTANCE: HORIZONTAL AT 3 M

NO.	FREQ. (MHz)	EMISSION LEVEL (dBuV/m)	LIMIT (dBuV/m)	MARGIN (dB)	ANTENNA HEIGHT (m)	TABLE ANGLE (Degree)	RAW VALUE (dBuV)	CORRECTION FACTOR (dB/m)
1	#5621.11	51.1 PK	68.2	-17.1	3.01 H	330	47.4	3.7
2	*5785.00	109.5 PK			3.01 H	330	105.5	4.0
3	*5785.00	99.0 AV			3.01 H	330	95.0	4.0
4	#6007.06	49.9 PK	68.2	-18.3	3.01 H	330	45.4	4.5
5	11570.00	60.2 PK	74.0	-13.8	2.57 H	172	47.6	12.6
6	11570.00	48.7 AV	54.0	-5.3	2.57 H	172	36.1	12.6
7	#17355.00	68.9 PK	74.0	-5.1	1.70 H	213	50.8	18.1
8	#17355.00	53.9 AV	54.0	-0.1	1.70 H	213	35.8	18.1

ANTENNA POLARITY & TEST DISTANCE: VERTICAL AT 3 M

NO.	FREQ. (MHz)	EMISSION LEVEL (dBuV/m)	LIMIT (dBuV/m)	MARGIN (dB)	ANTENNA HEIGHT (m)	TABLE ANGLE (Degree)	RAW VALUE (dBuV)	CORRECTION FACTOR (dB/m)
1	#5617.08	53.7 PK	68.2	-14.5	2.45 V	242	50.0	3.7
2	*5785.00	120.3 PK			2.45 V	242	116.3	4.0
3	*5785.00	110.1 AV			2.45 V	242	106.1	4.0
4	#5951.36	53.1 PK	68.2	-15.1	2.45 V	242	48.8	4.3
5	11570.00	63.2 PK	74.0	-10.8	1.88 V	161	50.6	12.6
6	11570.00	49.8 AV	54.0	-4.2	1.88 V	161	37.2	12.6
7	#17355.00	61.9 PK	74.0	-12.1	1.90 V	174	43.8	18.1
8	#17355.00	48.5 AV	54.0	-5.5	1.90 V	174	30.4	18.1

REMARKS:

1. Emission Level(dBuV/m) = Raw Value(dBuV) + Correction Factor(dB/m)
2. Correction Factor(dB/m) = Antenna Factor(dB/m) + Cable Factor(dB) – Pre-Amplifier Factor(dB)
3. The other emission levels were very low against the limit.
4. Margin value = Emission Level – Limit value
5. " * ": Fundamental frequency.
6. " # ": The radiated frequency is out of the restricted band.

CHANNEL	TX Channel 165	DETECTOR FUNCTION	Peak (PK)
FREQUENCY RANGE	1GHz ~ 40GHz		Average (AV)

ANTENNA POLARITY & TEST DISTANCE: HORIZONTAL AT 3 M

NO.	FREQ. (MHz)	EMISSION LEVEL (dBuV/m)	LIMIT (dBuV/m)	MARGIN (dB)	ANTENNA HEIGHT (m)	TABLE ANGLE (Degree)	RAW VALUE (dBuV)	CORRECTION FACTOR (dB/m)
1	#5628.10	50.8 PK	68.2	-17.4	3.06 H	330	47.1	3.7
2	*5825.00	109.3 PK			3.06 H	330	105.2	4.1
3	*5825.00	98.9 AV			3.06 H	330	94.8	4.1
4	#5979.11	50.3 PK	68.2	-17.9	3.06 H	330	45.9	4.4
5	11650.00	59.4 PK	74.0	-14.6	2.54 H	178	46.7	12.7
6	11650.00	47.8 AV	54.0	-6.2	2.54 H	178	35.1	12.7
7	#17475.00	68.1 PK	74.0	-5.9	1.71 H	212	49.2	18.9
8	#17475.00	53.8 AV	54.0	-0.2	1.71 H	212	34.9	18.9

ANTENNA POLARITY & TEST DISTANCE: VERTICAL AT 3 M

NO.	FREQ. (MHz)	EMISSION LEVEL (dBuV/m)	LIMIT (dBuV/m)	MARGIN (dB)	ANTENNA HEIGHT (m)	TABLE ANGLE (Degree)	RAW VALUE (dBuV)	CORRECTION FACTOR (dB/m)
1	#5608.95	53.8 PK	68.2	-14.4	2.45 V	240	50.1	3.7
2	*5825.00	120.2 PK			2.45 V	240	116.1	4.1
3	*5825.00	109.7 AV			2.45 V	240	105.6	4.1
4	#5976.23	53.1 PK	68.2	-15.1	2.45 V	240	48.7	4.4
5	11650.00	63.2 PK	74.0	-10.8	1.92 V	170	50.5	12.7
6	11650.00	50.0 AV	54.0	-4.0	1.92 V	170	37.3	12.7
7	#17475.00	62.0 PK	74.0	-12.0	1.88 V	182	43.1	18.9
8	#17475.00	48.6 AV	54.0	-5.4	1.88 V	182	29.7	18.9

REMARKS:

1. Emission Level(dBuV/m) = Raw Value(dBuV) + Correction Factor(dB/m)
2. Correction Factor(dB/m) = Antenna Factor(dB/m) + Cable Factor(dB) – Pre-Amplifier Factor(dB)
3. The other emission levels were very low against the limit.
4. Margin value = Emission Level – Limit value
5. " * ": Fundamental frequency.
6. " # ": The radiated frequency is out of the restricted band.

802.11ac (VHT20)

CHANNEL	TX Channel 36	DETECTOR FUNCTION	Peak (PK)
FREQUENCY RANGE	1GHz ~ 40GHz		Average (AV)

ANTENNA POLARITY & TEST DISTANCE: HORIZONTAL AT 3 M								
NO.	FREQ. (MHz)	EMISSION LEVEL (dBuV/m)	LIMIT (dBuV/m)	MARGIN (dB)	ANTENNA HEIGHT (m)	TABLE ANGLE (Degree)	RAW VALUE (dBuV)	CORRECTION FACTOR (dB/m)
1	5150.00	58.4 PK	74.0	-15.6	3.09 H	339	55.5	2.9
2	5150.00	42.3 AV	54.0	-11.7	3.09 H	339	39.4	2.9
3	*5180.00	108.2 PK			3.09 H	339	105.2	3.0
4	*5180.00	97.6 AV			3.09 H	339	94.6	3.0
5	#10360.00	53.4 PK	74.0	-20.6	1.80 H	357	41.5	11.9
6	#10360.00	39.8 AV	54.0	-14.2	1.80 H	357	27.9	11.9
7	15540.00	64.4 PK	74.0	-9.6	3.04 H	56	52.2	12.2
8	15540.00	49.0 AV	54.0	-5.0	3.04 H	56	36.8	12.2

ANTENNA POLARITY & TEST DISTANCE: VERTICAL AT 3 M								
NO.	FREQ. (MHz)	EMISSION LEVEL (dBuV/m)	LIMIT (dBuV/m)	MARGIN (dB)	ANTENNA HEIGHT (m)	TABLE ANGLE (Degree)	RAW VALUE (dBuV)	CORRECTION FACTOR (dB/m)
1	5150.00	68.9 PK	74.0	-5.1	2.77 V	210	66.0	2.9
2	5150.00	53.9 AV	54.0	-0.1	2.77 V	210	51.0	2.9
3	*5180.00	119.1 PK			2.77 V	210	116.1	3.0
4	*5180.00	108.4 AV			2.77 V	210	105.4	3.0
5	#10360.00	49.0 PK	74.0	-25.0	2.07 V	321	37.1	11.9
6	#10360.00	37.0 AV	54.0	-17.0	2.07 V	321	25.1	11.9
7	15540.00	62.9 PK	74.0	-11.1	1.09 V	21	50.7	12.2
8	15540.00	47.8 AV	54.0	-6.2	1.09 V	21	35.6	12.2

REMARKS:

- Emission Level(dBuV/m) = Raw Value(dBuV) + Correction Factor(dB/m)
- Correction Factor(dB/m) = Antenna Factor(dB/m) + Cable Factor(dB) – Pre-Amplifier Factor(dB)
- The other emission levels were very low against the limit.
- Margin value = Emission Level – Limit value
- " * ": Fundamental frequency.
- " # ": The radiated frequency is out of the restricted band.

CHANNEL	TX Channel 40	DETECTOR FUNCTION	Peak (PK)
FREQUENCY RANGE	1GHz ~ 40GHz		Average (AV)

ANTENNA POLARITY & TEST DISTANCE: HORIZONTAL AT 3 M

NO.	FREQ. (MHz)	EMISSION LEVEL (dBuV/m)	LIMIT (dBuV/m)	MARGIN (dB)	ANTENNA HEIGHT (m)	TABLE ANGLE (Degree)	RAW VALUE (dBuV)	CORRECTION FACTOR (dB/m)
1	5150.00	51.5 PK	74.0	-22.5	3.11 H	329	48.6	2.9
2	5150.00	40.3 AV	54.0	-13.7	3.11 H	329	37.4	2.9
3	*5200.00	111.9 PK			3.11 H	329	108.9	3.0
4	*5200.00	101.5 AV			3.11 H	329	98.5	3.0
5	5350.00	52.1 PK	74.0	-21.9	3.11 H	329	48.7	3.4
6	5350.00	40.8 AV	54.0	-13.2	3.11 H	329	37.4	3.4
7	#10400.00	56.9 PK	74.0	-17.1	1.90 H	359	45.0	11.9
8	#10400.00	43.5 AV	54.0	-10.5	1.90 H	359	31.6	11.9
9	15600.00	63.6 PK	74.0	-10.4	2.28 H	288	51.3	12.3
10	15600.00	52.8 AV	54.0	-1.2	2.28 H	288	40.5	12.3

ANTENNA POLARITY & TEST DISTANCE: VERTICAL AT 3 M

NO.	FREQ. (MHz)	EMISSION LEVEL (dBuV/m)	LIMIT (dBuV/m)	MARGIN (dB)	ANTENNA HEIGHT (m)	TABLE ANGLE (Degree)	RAW VALUE (dBuV)	CORRECTION FACTOR (dB/m)
1	5150.00	61.6 PK	74.0	-12.4	2.64 V	207	58.7	2.9
2	5150.00	50.0 AV	54.0	-4.0	2.64 V	207	47.1	2.9
3	*5200.00	122.8 PK			2.64 V	207	119.8	3.0
4	*5200.00	112.3 AV			2.64 V	207	109.3	3.0
5	5350.00	53.2 PK	74.0	-20.8	2.64 V	207	49.8	3.4
6	5350.00	41.6 AV	54.0	-12.4	2.64 V	207	38.2	3.4
7	#10400.00	53.2 PK	74.0	-20.8	2.06 V	339	41.3	11.9
8	#10400.00	41.3 AV	54.0	-12.7	2.06 V	339	29.4	11.9
9	15600.00	66.8 PK	74.0	-7.2	1.04 V	8	54.5	12.3
10	15600.00	51.5 AV	54.0	-2.5	1.04 V	8	39.2	12.3

REMARKS:

1. Emission Level(dBuV/m) = Raw Value(dBuV) + Correction Factor(dB/m)
2. Correction Factor(dB/m) = Antenna Factor(dB/m) + Cable Factor(dB) – Pre-Amplifier Factor(dB)
3. The other emission levels were very low against the limit.
4. Margin value = Emission Level – Limit value
5. " * ": Fundamental frequency.
6. " # ": The radiated frequency is out of the restricted band.

CHANNEL	TX Channel 48	DETECTOR FUNCTION	Peak (PK)
FREQUENCY RANGE	1GHz ~ 40GHz		Average (AV)

ANTENNA POLARITY & TEST DISTANCE: HORIZONTAL AT 3 M

NO.	FREQ. (MHz)	EMISSION LEVEL (dBuV/m)	LIMIT (dBuV/m)	MARGIN (dB)	ANTENNA HEIGHT (m)	TABLE ANGLE (Degree)	RAW VALUE (dBuV)	CORRECTION FACTOR (dB/m)
1	5150.00	52.1 PK	74.0	-21.9	3.12 H	331	49.2	2.9
2	5150.00	40.4 AV	54.0	-13.6	3.12 H	331	37.5	2.9
3	*5240.00	111.0 PK			3.12 H	331	107.9	3.1
4	*5240.00	101.0 AV			3.12 H	331	97.9	3.1
5	5350.00	50.8 PK	74.0	-23.2	3.12 H	331	47.4	3.4
6	5350.00	39.1 AV	54.0	-14.9	3.12 H	331	35.7	3.4
7	#10480.00	57.3 PK	74.0	-16.7	1.88 H	338	45.4	11.9
8	#10480.00	43.7 AV	54.0	-10.3	1.88 H	338	31.8	11.9
9	15720.00	69.0 PK	74.0	-5.0	1.73 H	57	56.0	13.0
10	15720.00	53.3 AV	54.0	-0.7	1.73 H	57	40.3	13.0

ANTENNA POLARITY & TEST DISTANCE: VERTICAL AT 3 M

NO.	FREQ. (MHz)	EMISSION LEVEL (dBuV/m)	LIMIT (dBuV/m)	MARGIN (dB)	ANTENNA HEIGHT (m)	TABLE ANGLE (Degree)	RAW VALUE (dBuV)	CORRECTION FACTOR (dB/m)
1	5150.00	58.4 PK	74.0	-15.6	2.71 V	207	55.5	2.9
2	5150.00	44.1 AV	54.0	-9.9	2.71 V	207	41.2	2.9
3	*5240.00	121.8 PK			2.71 V	207	118.7	3.1
4	*5240.00	111.8 AV			2.71 V	207	108.7	3.1
5	5350.00	54.7 PK	74.0	-19.3	2.71 V	207	51.3	3.4
6	5350.00	42.7 AV	54.0	-11.3	2.71 V	207	39.3	3.4
7	#10480.00	53.0 PK	74.0	-21.0	2.04 V	336	41.1	11.9
8	#10480.00	41.0 AV	54.0	-13.0	2.04 V	336	29.1	11.9
9	15720.00	67.2 PK	74.0	-6.8	1.03 V	11	54.2	13.0
10	15720.00	51.7 AV	54.0	-2.3	1.03 V	11	38.7	13.0

REMARKS:

1. Emission Level(dBuV/m) = Raw Value(dBuV) + Correction Factor(dB/m)
2. Correction Factor(dB/m) = Antenna Factor(dB/m) + Cable Factor(dB) – Pre-Amplifier Factor(dB)
3. The other emission levels were very low against the limit.
4. Margin value = Emission Level – Limit value
5. " * ": Fundamental frequency.
6. " # ": The radiated frequency is out of the restricted band.

CHANNEL	TX Channel 149	DETECTOR FUNCTION	Peak (PK)
FREQUENCY RANGE	1GHz ~ 40GHz		Average (AV)

ANTENNA POLARITY & TEST DISTANCE: HORIZONTAL AT 3 M

NO.	FREQ. (MHz)	EMISSION LEVEL (dBuV/m)	LIMIT (dBuV/m)	MARGIN (dB)	ANTENNA HEIGHT (m)	TABLE ANGLE (Degree)	RAW VALUE (dBuV)	CORRECTION FACTOR (dB/m)
1	#5594.52	49.8 PK	68.2	-18.4	3.02 H	330	46.2	3.6
2	*5745.00	108.8 PK			3.02 H	330	104.8	4.0
3	*5745.00	99.0 AV			3.02 H	330	95.0	4.0
4	#5934.20	50.0 PK	68.2	-18.2	3.02 H	330	45.7	4.3
5	11490.00	59.5 PK	74.0	-14.5	2.51 H	172	46.7	12.8
6	11490.00	47.8 AV	54.0	-6.2	2.51 H	172	35.0	12.8
7	#17235.00	69.4 PK	74.0	-4.6	1.72 H	242	52.0	17.4
8	#17235.00	53.9 AV	54.0	-0.1	1.72 H	242	36.5	17.4

ANTENNA POLARITY & TEST DISTANCE: VERTICAL AT 3 M

NO.	FREQ. (MHz)	EMISSION LEVEL (dBuV/m)	LIMIT (dBuV/m)	MARGIN (dB)	ANTENNA HEIGHT (m)	TABLE ANGLE (Degree)	RAW VALUE (dBuV)	CORRECTION FACTOR (dB/m)
1	#5592.14	54.6 PK	68.2	-13.6	2.47 V	243	51.0	3.6
2	*5745.00	120.5 PK			2.47 V	243	116.5	4.0
3	*5745.00	110.1 AV			2.47 V	243	106.1	4.0
4	#5986.58	51.4 PK	68.2	-16.8	2.47 V	243	47.0	4.4
5	11490.00	62.8 PK	74.0	-11.2	1.86 V	155	50.0	12.8
6	11490.00	49.4 AV	54.0	-4.6	1.86 V	155	36.6	12.8
7	#17235.00	62.6 PK	74.0	-11.4	1.90 V	197	45.2	17.4
8	#17235.00	49.2 AV	54.0	-4.8	1.90 V	197	31.8	17.4

REMARKS:

- Emission Level(dBuV/m) = Raw Value(dBuV) + Correction Factor(dB/m)
- Correction Factor(dB/m) = Antenna Factor(dB/m) + Cable Factor(dB) – Pre-Amplifier Factor(dB)
- The other emission levels were very low against the limit.
- Margin value = Emission Level – Limit value
- " * ": Fundamental frequency.
- " # ": The radiated frequency is out of the restricted band.

CHANNEL	TX Channel 157	DETECTOR FUNCTION	Peak (PK)
FREQUENCY RANGE	1GHz ~ 40GHz		Average (AV)

ANTENNA POLARITY & TEST DISTANCE: HORIZONTAL AT 3 M

NO.	FREQ. (MHz)	EMISSION LEVEL (dBuV/m)	LIMIT (dBuV/m)	MARGIN (dB)	ANTENNA HEIGHT (m)	TABLE ANGLE (Degree)	RAW VALUE (dBuV)	CORRECTION FACTOR (dB/m)
1	#5621.15	50.7 PK	68.2	-17.5	3.00 H	330	47.0	3.7
2	*5785.00	109.7 PK			3.00 H	330	105.7	4.0
3	*5785.00	99.2 AV			3.00 H	330	95.2	4.0
4	#5997.47	49.9 PK	68.2	-18.3	3.00 H	330	45.5	4.4
5	11570.00	60.2 PK	74.0	-13.8	2.54 H	179	47.6	12.6
6	11570.00	48.8 AV	54.0	-5.2	2.54 H	179	36.2	12.6
7	#17355.00	69.1 PK	74.0	-4.9	1.70 H	240	51.0	18.1
8	#17355.00	53.9 AV	54.0	-0.1	1.70 H	240	35.8	18.1

ANTENNA POLARITY & TEST DISTANCE: VERTICAL AT 3 M

NO.	FREQ. (MHz)	EMISSION LEVEL (dBuV/m)	LIMIT (dBuV/m)	MARGIN (dB)	ANTENNA HEIGHT (m)	TABLE ANGLE (Degree)	RAW VALUE (dBuV)	CORRECTION FACTOR (dB/m)
1	#5586.90	53.2 PK	68.2	-15.0	2.50 V	164	49.6	3.6
2	*5785.00	120.8 PK			2.50 V	164	116.8	4.0
3	*5785.00	110.3 AV			2.50 V	164	106.3	4.0
4	#5969.38	52.7 PK	68.2	-15.5	2.50 V	164	48.3	4.4
5	11570.00	63.7 PK	74.0	-10.3	1.89 V	171	51.1	12.6
6	11570.00	50.2 AV	54.0	-3.8	1.89 V	171	37.6	12.6
7	#17355.00	62.5 PK	74.0	-11.5	1.85 V	197	44.4	18.1
8	#17355.00	48.9 AV	54.0	-5.1	1.85 V	197	30.8	18.1

REMARKS:

1. Emission Level(dBuV/m) = Raw Value(dBuV) + Correction Factor(dB/m)
2. Correction Factor(dB/m) = Antenna Factor(dB/m) + Cable Factor(dB) – Pre-Amplifier Factor(dB)
3. The other emission levels were very low against the limit.
4. Margin value = Emission Level – Limit value
5. " * ": Fundamental frequency.
6. " # ": The radiated frequency is out of the restricted band.

CHANNEL	TX Channel 165	DETECTOR FUNCTION	Peak (PK)
FREQUENCY RANGE	1GHz ~ 40GHz		Average (AV)

ANTENNA POLARITY & TEST DISTANCE: HORIZONTAL AT 3 M

NO.	FREQ. (MHz)	EMISSION LEVEL (dBuV/m)	LIMIT (dBuV/m)	MARGIN (dB)	ANTENNA HEIGHT (m)	TABLE ANGLE (Degree)	RAW VALUE (dBuV)	CORRECTION FACTOR (dB/m)
1	#5603.05	50.6 PK	68.2	-17.6	2.97 H	329	47.0	3.6
2	*5825.00	108.9 PK			2.97 H	329	104.8	4.1
3	*5825.00	99.6 AV			2.97 H	329	95.5	4.1
4	#5991.14	50.5 PK	68.2	-17.7	2.97 H	329	46.1	4.4
5	11650.00	60.3 PK	74.0	-13.7	2.48 H	162	47.6	12.7
6	11650.00	48.5 AV	54.0	-5.5	2.48 H	162	35.8	12.7
7	#17475.00	68.6 PK	74.0	-5.4	1.66 H	211	49.7	18.9
8	#17475.00	53.8 AV	54.0	-0.2	1.66 H	211	34.9	18.9

ANTENNA POLARITY & TEST DISTANCE: VERTICAL AT 3 M

NO.	FREQ. (MHz)	EMISSION LEVEL (dBuV/m)	LIMIT (dBuV/m)	MARGIN (dB)	ANTENNA HEIGHT (m)	TABLE ANGLE (Degree)	RAW VALUE (dBuV)	CORRECTION FACTOR (dB/m)
1	#5585.60	53.3 PK	68.2	-14.9	2.58 V	203	49.7	3.6
2	*5825.00	121.6 PK			2.58 V	203	117.5	4.1
3	*5825.00	111.1 AV			2.58 V	203	107.0	4.1
4	#5953.86	53.4 PK	68.2	-14.8	2.58 V	203	49.1	4.3
5	11650.00	63.7 PK	74.0	-10.3	1.88 V	172	51.0	12.7
6	11650.00	50.2 AV	54.0	-3.8	1.88 V	172	37.5	12.7
7	#17475.00	62.1 PK	74.0	-11.9	1.81 V	203	43.2	18.9
8	#17475.00	48.3 AV	54.0	-5.7	1.81 V	203	29.4	18.9

REMARKS:

1. Emission Level(dBuV/m) = Raw Value(dBuV) + Correction Factor(dB/m)
2. Correction Factor(dB/m) = Antenna Factor(dB/m) + Cable Factor(dB) – Pre-Amplifier Factor(dB)
3. The other emission levels were very low against the limit.
4. Margin value = Emission Level – Limit value
5. " * ": Fundamental frequency.
6. " # ": The radiated frequency is out of the restricted band.

802.11ac (VHT40)

CHANNEL	TX Channel 38	DETECTOR FUNCTION	Peak (PK)
FREQUENCY RANGE	1GHz ~ 40GHz		Average (AV)

ANTENNA POLARITY & TEST DISTANCE: HORIZONTAL AT 3 M

NO.	FREQ. (MHz)	EMISSION LEVEL (dBuV/m)	LIMIT (dBuV/m)	MARGIN (dB)	ANTENNA HEIGHT (m)	TABLE ANGLE (Degree)	RAW VALUE (dBuV)	CORRECTION FACTOR (dB/m)
1	5150.00	55.2 PK	74.0	-18.8	3.02 H	318	52.3	2.9
2	5150.00	41.9 AV	54.0	-12.1	3.02 H	318	39.0	2.9
3	*5190.00	99.7 PK			3.02 H	318	96.7	3.0
4	*5190.00	91.6 AV			3.02 H	318	88.6	3.0
5	5350.00	51.9 PK	74.0	-22.1	3.02 H	318	48.5	3.4
6	5350.00	40.0 AV	54.0	-14.0	3.02 H	318	36.6	3.4
7	#10380.00	51.4 PK	74.0	-22.6	2.44 H	167	39.4	12.0
8	#10380.00	39.5 AV	54.0	-14.5	2.44 H	167	27.5	12.0
9	15570.00	55.6 PK	74.0	-18.4	1.70 H	200	43.3	12.3
10	15570.00	43.6 AV	54.0	-10.4	1.70 H	200	31.3	12.3

ANTENNA POLARITY & TEST DISTANCE: VERTICAL AT 3 M

NO.	FREQ. (MHz)	EMISSION LEVEL (dBuV/m)	LIMIT (dBuV/m)	MARGIN (dB)	ANTENNA HEIGHT (m)	TABLE ANGLE (Degree)	RAW VALUE (dBuV)	CORRECTION FACTOR (dB/m)
1	5150.00	63.5 PK	74.0	-10.5	2.59 V	204	60.6	2.9
2	5150.00	53.9 AV	54.0	-0.1	2.59 V	204	51.0	2.9
3	*5190.00	112.4 PK			2.59 V	204	109.4	3.0
4	*5190.00	103.1 AV			2.59 V	204	100.1	3.0
5	5350.00	54.6 PK	74.0	-19.4	2.59 V	204	51.2	3.4
6	5350.00	44.5 AV	54.0	-9.5	2.59 V	204	41.1	3.4
7	#10380.00	48.6 PK	74.0	-25.4	1.67 V	289	36.6	12.0
8	#10380.00	36.1 AV	54.0	-17.9	1.67 V	289	24.1	12.0
9	15570.00	54.2 PK	74.0	-19.8	1.82 V	201	41.9	12.3
10	15570.00	42.5 AV	54.0	-11.5	1.82 V	201	30.2	12.3

REMARKS:

- Emission Level(dBuV/m) = Raw Value(dBuV) + Correction Factor(dB/m)
- Correction Factor(dB/m) = Antenna Factor(dB/m) + Cable Factor(dB) – Pre-Amplifier Factor(dB)
- The other emission levels were very low against the limit.
- Margin value = Emission Level – Limit value
- " * ": Fundamental frequency.
- " # ": The radiated frequency is out of the restricted band.

CHANNEL	TX Channel 46	DETECTOR FUNCTION	Peak (PK)
FREQUENCY RANGE	1GHz ~ 40GHz		Average (AV)

ANTENNA POLARITY & TEST DISTANCE: HORIZONTAL AT 3 M

NO.	FREQ. (MHz)	EMISSION LEVEL (dBuV/m)	LIMIT (dBuV/m)	MARGIN (dB)	ANTENNA HEIGHT (m)	TABLE ANGLE (Degree)	RAW VALUE (dBuV)	CORRECTION FACTOR (dB/m)
1	5150.00	56.3 PK	74.0	-17.7	2.97 H	327	53.4	2.9
2	5150.00	42.4 AV	54.0	-11.6	2.97 H	327	39.5	2.9
3	*5230.00	104.8 PK			2.97 H	327	101.7	3.1
4	*5230.00	97.1 AV			2.97 H	327	94.0	3.1
5	5350.00	52.4 PK	74.0	-21.6	2.97 H	327	49.0	3.4
6	5350.00	40.5 AV	54.0	-13.5	2.97 H	327	37.1	3.4
7	#10460.00	52.0 PK	74.0	-22.0	1.00 H	0	40.0	12.0
8	#10460.00	43.0 AV	54.0	-11.0	1.00 H	0	31.0	12.0
9	15690.00	62.1 PK	74.0	-11.9	1.59 H	316	49.1	13.0
10	15690.00	50.4 AV	54.0	-3.6	1.59 H	316	37.4	13.0

ANTENNA POLARITY & TEST DISTANCE: VERTICAL AT 3 M

NO.	FREQ. (MHz)	EMISSION LEVEL (dBuV/m)	LIMIT (dBuV/m)	MARGIN (dB)	ANTENNA HEIGHT (m)	TABLE ANGLE (Degree)	RAW VALUE (dBuV)	CORRECTION FACTOR (dB/m)
1	5150.00	64.8 PK	74.0	-9.2	2.57 V	204	61.9	2.9
2	5150.00	53.7 AV	54.0	-0.3	2.57 V	204	50.8	2.9
3	*5230.00	117.5 PK			2.57 V	204	114.4	3.1
4	*5230.00	108.5 AV			2.57 V	204	105.4	3.1
5	5350.00	56.6 PK	74.0	-17.4	2.57 V	204	53.2	3.4
6	5350.00	44.7 AV	54.0	-9.3	2.57 V	204	41.3	3.4
7	#10460.00	51.3 PK	74.0	-22.7	1.69 V	303	39.3	12.0
8	#10460.00	40.7 AV	54.0	-13.3	1.69 V	303	28.7	12.0
9	15690.00	60.0 PK	74.0	-14.0	1.00 V	5	47.0	13.0
10	15690.00	49.4 AV	54.0	-4.6	1.00 V	5	36.4	13.0

REMARKS:

1. Emission Level(dBuV/m) = Raw Value(dBuV) + Correction Factor(dB/m)
2. Correction Factor(dB/m) = Antenna Factor(dB/m) + Cable Factor(dB) – Pre-Amplifier Factor(dB)
3. The other emission levels were very low against the limit.
4. Margin value = Emission Level – Limit value
5. " * ": Fundamental frequency.
6. " # ": The radiated frequency is out of the restricted band.

CHANNEL	TX Channel 151	DETECTOR FUNCTION	Peak (PK)
FREQUENCY RANGE	1GHz ~ 40GHz		Average (AV)

ANTENNA POLARITY & TEST DISTANCE: HORIZONTAL AT 3 M

NO.	FREQ. (MHz)	EMISSION LEVEL (dBuV/m)	LIMIT (dBuV/m)	MARGIN (dB)	ANTENNA HEIGHT (m)	TABLE ANGLE (Degree)	RAW VALUE (dBuV)	CORRECTION FACTOR (dB/m)
1	#5560.40	51.2 PK	68.2	-17.0	3.06 H	328	47.7	3.5
2	*5755.00	105.1 PK			3.06 H	328	101.1	4.0
3	*5755.00	96.8 AV			3.06 H	328	92.8	4.0
4	#5970.15	49.5 PK	68.2	-18.7	3.06 H	328	45.1	4.4
5	11510.00	59.1 PK	74.0	-14.9	2.51 H	160	46.4	12.7
6	11510.00	47.8 AV	54.0	-6.2	2.51 H	160	35.1	12.7
7	#17265.00	68.9 PK	74.0	-5.1	1.66 H	169	51.3	17.6
8	#17265.00	53.8 AV	54.0	-0.2	1.66 H	169	36.2	17.6

ANTENNA POLARITY & TEST DISTANCE: VERTICAL AT 3 M

NO.	FREQ. (MHz)	EMISSION LEVEL (dBuV/m)	LIMIT (dBuV/m)	MARGIN (dB)	ANTENNA HEIGHT (m)	TABLE ANGLE (Degree)	RAW VALUE (dBuV)	CORRECTION FACTOR (dB/m)
1	#5646.20	61.2 PK	68.2	-7.0	2.58 V	204	57.5	3.7
2	*5755.00	117.3 PK			2.58 V	204	113.3	4.0
3	*5755.00	109.3 AV			2.58 V	204	105.3	4.0
4	#5930.65	52.1 PK	68.2	-16.1	2.58 V	204	47.8	4.3
5	11510.00	63.1 PK	74.0	-10.9	1.90 V	180	50.4	12.7
6	11510.00	49.3 AV	54.0	-4.7	1.90 V	180	36.6	12.7
7	#17265.00	61.9 PK	74.0	-12.1	1.90 V	177	44.3	17.6
8	#17265.00	48.1 AV	54.0	-5.9	1.90 V	177	30.5	17.6

REMARKS:

1. Emission Level(dBuV/m) = Raw Value(dBuV) + Correction Factor(dB/m)
2. Correction Factor(dB/m) = Antenna Factor(dB/m) + Cable Factor(dB) – Pre-Amplifier Factor(dB)
3. The other emission levels were very low against the limit.
4. Margin value = Emission Level – Limit value
5. " * ": Fundamental frequency.
6. " # ": The radiated frequency is out of the restricted band.

CHANNEL	TX Channel 159	DETECTOR FUNCTION	Peak (PK)
FREQUENCY RANGE	1GHz ~ 40GHz		Average (AV)

ANTENNA POLARITY & TEST DISTANCE: HORIZONTAL AT 3 M

NO.	FREQ. (MHz)	EMISSION LEVEL (dBuV/m)	LIMIT (dBuV/m)	MARGIN (dB)	ANTENNA HEIGHT (m)	TABLE ANGLE (Degree)	RAW VALUE (dBuV)	CORRECTION FACTOR (dB/m)
1	#5586.29	50.6 PK	68.2	-17.6	3.10 H	330	47.0	3.6
2	*5795.00	106.1 PK			3.10 H	330	102.1	4.0
3	*5795.00	97.8 AV			3.10 H	330	93.8	4.0
4	#5999.77	51.1 PK	68.2	-17.1	3.10 H	330	46.7	4.4
5	11590.00	59.8 PK	74.0	-14.2	2.57 H	159	47.2	12.6
6	11590.00	48.3 AV	54.0	-5.7	2.57 H	159	35.7	12.6
7	#17385.00	69.1 PK	74.0	-4.9	1.80 H	172	50.7	18.4
8	#17385.00	53.9 AV	54.0	-0.1	1.80 H	172	35.5	18.4

ANTENNA POLARITY & TEST DISTANCE: VERTICAL AT 3 M

NO.	FREQ. (MHz)	EMISSION LEVEL (dBuV/m)	LIMIT (dBuV/m)	MARGIN (dB)	ANTENNA HEIGHT (m)	TABLE ANGLE (Degree)	RAW VALUE (dBuV)	CORRECTION FACTOR (dB/m)
1	#5605.81	54.3 PK	68.2	-13.9	2.61 V	203	50.6	3.7
2	*5795.00	117.9 PK			2.61 V	203	113.9	4.0
3	*5795.00	109.1 AV			2.61 V	203	105.1	4.0
4	#5934.74	54.7 PK	68.2	-13.5	2.61 V	203	50.4	4.3
5	11590.00	62.8 PK	74.0	-11.2	1.88 V	176	50.2	12.6
6	11590.00	49.1 AV	54.0	-4.9	1.88 V	176	36.5	12.6
7	#17385.00	61.8 PK	74.0	-12.2	1.86 V	197	43.4	18.4
8	#17385.00	47.9 AV	54.0	-6.1	1.86 V	197	29.5	18.4

REMARKS:

1. Emission Level(dBuV/m) = Raw Value(dBuV) + Correction Factor(dB/m)
2. Correction Factor(dB/m) = Antenna Factor(dB/m) + Cable Factor(dB) – Pre-Amplifier Factor(dB)
3. The other emission levels were very low against the limit.
4. Margin value = Emission Level – Limit value
5. " * ": Fundamental frequency.
6. " # ": The radiated frequency is out of the restricted band.

802.11ac (VHT80)

CHANNEL	TX Channel 42	DETECTOR FUNCTION	Peak (PK)
FREQUENCY RANGE	1GHz ~ 40GHz		Average (AV)

ANTENNA POLARITY & TEST DISTANCE: HORIZONTAL AT 3 M								
NO.	FREQ. (MHz)	EMISSION LEVEL (dBuV/m)	LIMIT (dBuV/m)	MARGIN (dB)	ANTENNA HEIGHT (m)	TABLE ANGLE (Degree)	RAW VALUE (dBuV)	CORRECTION FACTOR (dB/m)
1	5150.00	56.4 PK	74.0	-17.6	3.06 H	336	53.5	2.9
2	5150.00	42.6 AV	54.0	-11.4	3.06 H	336	39.7	2.9
3	*5210.00	94.4 PK			3.06 H	336	91.4	3.0
4	*5210.00	86.5 AV			3.06 H	336	83.5	3.0
5	5350.00	52.6 PK	74.0	-21.4	3.06 H	336	49.2	3.4
6	5350.00	40.8 AV	54.0	-13.2	3.06 H	336	37.4	3.4
7	#10420.00	50.9 PK	74.0	-23.1	2.39 H	163	39.0	11.9
8	#10420.00	39.0 AV	54.0	-15.0	2.39 H	163	27.1	11.9
9	15630.00	56.1 PK	74.0	-17.9	1.66 H	188	43.6	12.5
10	15630.00	43.9 AV	54.0	-10.1	1.66 H	188	31.4	12.5

ANTENNA POLARITY & TEST DISTANCE: VERTICAL AT 3 M								
NO.	FREQ. (MHz)	EMISSION LEVEL (dBuV/m)	LIMIT (dBuV/m)	MARGIN (dB)	ANTENNA HEIGHT (m)	TABLE ANGLE (Degree)	RAW VALUE (dBuV)	CORRECTION FACTOR (dB/m)
1	5150.00	62.5 PK	74.0	-11.5	2.52 V	202	59.6	2.9
2	5150.00	53.9 AV	54.0	-0.1	2.52 V	202	51.0	2.9
3	*5210.00	106.1 PK			2.52 V	202	103.1	3.0
4	*5210.00	97.8 AV			2.52 V	202	94.8	3.0
5	5350.00	53.4 PK	74.0	-20.6	2.52 V	202	50.0	3.4
6	5350.00	42.5 AV	54.0	-11.5	2.52 V	202	39.1	3.4
7	#10420.00	48.3 PK	74.0	-25.7	1.70 V	281	36.4	11.9
8	#10420.00	36.0 AV	54.0	-18.0	1.70 V	281	24.1	11.9
9	15630.00	53.9 PK	74.0	-20.1	1.86 V	215	41.4	12.5
10	15630.00	42.1 AV	54.0	-11.9	1.86 V	215	29.6	12.5

REMARKS:

1. Emission Level(dBuV/m) = Raw Value(dBuV) + Correction Factor(dB/m)
2. Correction Factor(dB/m) = Antenna Factor(dB/m) + Cable Factor(dB) – Pre-Amplifier Factor(dB)
3. The other emission levels were very low against the limit.
4. Margin value = Emission Level – Limit value
5. " * ": Fundamental frequency.
6. " # ": The radiated frequency is out of the restricted band.

CHANNEL	TX Channel 155	DETECTOR FUNCTION	Peak (PK)
FREQUENCY RANGE	1GHz ~ 40GHz		Average (AV)

ANTENNA POLARITY & TEST DISTANCE: HORIZONTAL AT 3 M

NO.	FREQ. (MHz)	EMISSION LEVEL (dBuV/m)	LIMIT (dBuV/m)	MARGIN (dB)	ANTENNA HEIGHT (m)	TABLE ANGLE (Degree)	RAW VALUE (dBuV)	CORRECTION FACTOR (dB/m)
1	#5642.81	52.4 PK	68.2	-15.8	2.98 H	332	48.7	3.7
2	*5775.00	98.5 PK			2.98 H	332	94.5	4.0
3	*5775.00	90.4 AV			2.98 H	332	86.4	4.0
4	#5968.13	50.2 PK	68.2	-18.0	2.98 H	332	45.8	4.4
5	11550.00	56.5 PK	74.0	-17.5	2.53 H	170	43.9	12.6
6	11550.00	44.1 AV	54.0	-9.9	2.53 H	170	31.5	12.6
7	#17325.00	58.9 PK	74.0	-15.1	1.83 H	171	41.1	17.8
8	#17325.00	50.1 AV	54.0	-3.9	1.83 H	171	32.3	17.8

ANTENNA POLARITY & TEST DISTANCE: VERTICAL AT 3 M

NO.	FREQ. (MHz)	EMISSION LEVEL (dBuV/m)	LIMIT (dBuV/m)	MARGIN (dB)	ANTENNA HEIGHT (m)	TABLE ANGLE (Degree)	RAW VALUE (dBuV)	CORRECTION FACTOR (dB/m)
1	#5646.79	67.9 PK	68.2	-0.3	2.46 V	204	64.2	3.7
2	*5775.00	111.8 PK			2.46 V	204	107.8	4.0
3	*5775.00	103.9 AV			2.46 V	204	99.9	4.0
4	#5924.56	64.2 PK	68.5	-4.3	2.46 V	204	59.9	4.3
5	11550.00	59.3 PK	74.0	-14.7	1.90 V	170	46.7	12.6
6	11550.00	45.1 AV	54.0	-8.9	1.90 V	170	32.5	12.6
7	#17325.00	58.3 PK	74.0	-15.7	1.80 V	190	40.5	17.8
8	#17325.00	44.4 AV	54.0	-9.6	1.80 V	190	26.6	17.8

REMARKS:

1. Emission Level(dBuV/m) = Raw Value(dBuV) + Correction Factor(dB/m)
2. Correction Factor(dB/m) = Antenna Factor(dB/m) + Cable Factor(dB) – Pre-Amplifier Factor(dB)
3. The other emission levels were very low against the limit.
4. Margin value = Emission Level – Limit value
5. " * ": Fundamental frequency.
6. " # ": The radiated frequency is out of the restricted band.

Below 1GHz Data:

802.11a

CHANNEL	TX Channel 157	DETECTOR FUNCTION	Quasi-Peak (QP)
FREQUENCY RANGE	9kHz ~ 1GHz		

ANTENNA POLARITY & TEST DISTANCE: HORIZONTAL AT 3 M

NO.	FREQ. (MHz)	EMISSION LEVEL (dBuV/m)	LIMIT (dBuV/m)	MARGIN (dB)	ANTENNA HEIGHT (m)	TABLE ANGLE (Degree)	RAW VALUE (dBuV)	CORRECTION FACTOR (dB/m)
1	88.18	39.8 QP	43.5	-3.7	2.00 H	36	54.3	-14.5
2	432.00	42.2 QP	46.0	-3.8	1.01 H	27	46.4	-4.2
3	540.02	41.9 QP	46.0	-4.1	2.00 H	70	44.1	-2.2
4	600.04	42.7 QP	46.0	-3.3	1.50 H	162	43.1	-0.4
5	780.01	41.6 QP	46.0	-4.4	1.00 H	95	39.1	2.5
6	900.07	41.5 QP	46.0	-4.5	1.50 H	230	37.6	3.9

ANTENNA POLARITY & TEST DISTANCE: VERTICAL AT 3 M

NO.	FREQ. (MHz)	EMISSION LEVEL (dBuV/m)	LIMIT (dBuV/m)	MARGIN (dB)	ANTENNA HEIGHT (m)	TABLE ANGLE (Degree)	RAW VALUE (dBuV)	CORRECTION FACTOR (dB/m)
1	312.01	41.6 QP	46.0	-4.4	1.50 V	250	48.9	-7.3
2	507.00	40.6 QP	46.0	-5.4	1.50 V	196	43.3	-2.7
3	600.02	40.7 QP	46.0	-5.3	1.00 V	72	41.1	-0.4
4	660.04	39.8 QP	46.0	-6.2	1.50 V	23	39.5	0.3
5	780.12	41.2 QP	46.0	-4.8	2.00 V	107	38.7	2.5
6	900.02	41.0 QP	46.0	-5.0	1.00 V	54	37.1	3.9

REMARKS:

1. Emission Level(dBuV/m) = Raw Value(dBuV) + Correction Factor(dB/m)
2. Correction Factor(dB/m) = Antenna Factor(dB/m) + Cable Factor(dB) – Pre-Amplifier Factor(dB)
3. The other emission levels were very low against the limit.
4. Margin value = Emission Level – Limit value

4.2 Conducted Emission Measurement

4.2.1 Limits of Conducted Emission Measurement

Frequency (MHz)	Conducted Limit (dBuV)	
	Quasi-peak	Average
0.15 - 0.5	66 - 56	56 - 46
0.50 - 5.0	56	46
5.0 - 30.0	60	50

Note: 1. The lower limit shall apply at the transition frequencies.

2. The limit decreases in line with the logarithm of the frequency in the range of 0.15 to 0.50MHz.

4.2.2 Test Instruments

DESCRIPTION & MANUFACTURER	MODEL NO.	SERIAL NO.	CALIBRATED DATE	CALIBRATED UNTIL
Test Receiver R&S	ESCS 30	847124/029	Oct. 24, 2016	Oct. 23, 2017
Line-Impedance Stabilization Network (for EUT) R&S	ESH3-Z5	848773/004	Oct. 26, 2016	Oct. 25, 2017
Line-Impedance Stabilization Network (for Peripheral) R&S	ENV216	100072	June 13, 2016	June 12, 2017
50 ohms Terminator	N/A	EMC-02	Sep. 29, 2016	Sep. 28, 2017
RF Cable	5D-FB	COCCAB-001	Sep. 30, 2016	Sep. 29, 2017
10 dB PAD Mini-Circuits	HAT-10+	CONATT-004	June 20, 2016	June 19, 2017
Software BVADT	BVADT_Cond_ V7.3.7.4	NA	NA	NA

Note:

1. The calibration interval of the above test instruments are 12 months and the calibrations are traceable to NML/ROC and NIST/USA.
2. The test was performed in Shielded Room No. 1.
3. Tested Date: Jan. 06, 2017

4.2.3 Test Procedure

- The EUT was placed 0.4 meters from the conducting wall of the shielded room with EUT being connected to the power mains through a line impedance stabilization network (LISN). Other support units were connected to the power mains through another LISN. The two LISNs provide 50 ohm/ 50uH of coupling impedance for the measuring instrument.
- Both lines of the power mains connected to the EUT were checked for maximum conducted interference.
- The frequency range from 150kHz to 30MHz was searched. Emission levels under (Limit - 20dB) was not recorded.

NOTE: All modes of operation were investigated and the worst-case emissions are reported.

4.2.4 Deviation from Test Standard

No deviation.

4.2.5 Test Setup

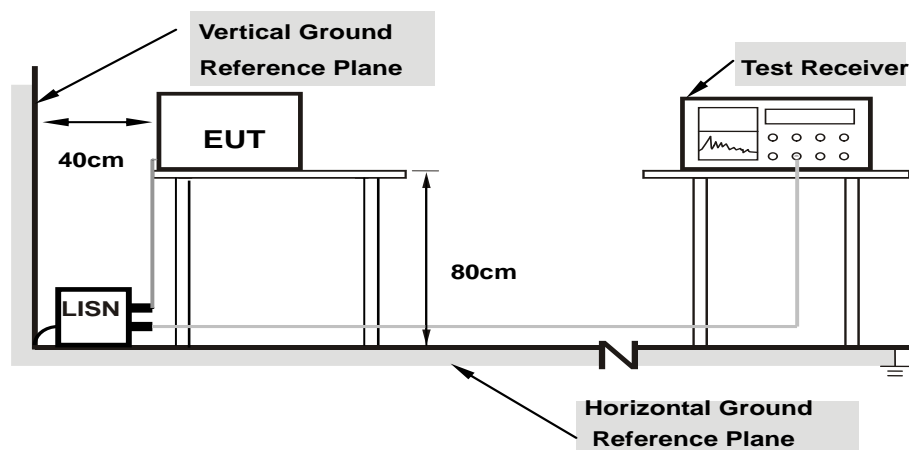

Note: 1.Support units were connected to second LISN.

For the actual test configuration, please refer to the attached file (Test Setup Photo).

4.2.6 EUT Operating Condition

Same as 4.1.6.

4.2.7 Test Results (Mode 1)

Phase	Line (L)	Detector Function	Quasi-Peak (QP) / Average (AV)
-------	----------	-------------------	--------------------------------

No	Freq. [MHz]	Corr.	Reading Value		Emission Level		Limit		Margin	
		Factor (dB)	[dB (uV)]		[dB (uV)]		[dB (uV)]		(dB)	
		Q.P.	AV.	Q.P.	AV.	Q.P.	AV.	Q.P.	AV.	
1	0.19297	10.20	31.62	21.47	41.82	31.67	63.91	53.91	-22.09	-22.24
2	0.29063	10.22	38.78	35.24	49.00	45.46	60.51	50.51	-11.51	-5.05
3	0.31406	10.22	34.57	31.55	44.79	41.77	59.86	49.86	-15.07	-8.09
4	0.34141	10.23	31.45	27.29	41.68	37.52	59.17	49.17	-17.49	-11.65
5	6.44531	10.48	12.55	4.39	23.03	14.87	60.00	50.00	-36.97	-35.13
6	10.65234	10.80	13.41	9.51	24.21	20.31	60.00	50.00	-35.79	-29.69

REMARKS:

1. Q.P. and AV. are abbreviations of quasi-peak and average individually.
2. The emission levels of other frequencies were very low against the limit.
3. Margin value = Emission level - Limit value
4. Correction factor = Insertion loss + Cable loss
5. Emission Level = Correction Factor + Reading Value.

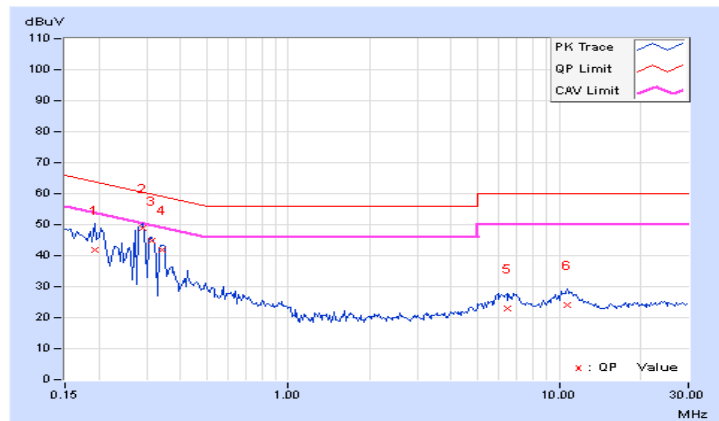

Phase	Neutral (N)	Detector Function	Quasi-Peak (QP) / Average (AV)
-------	-------------	-------------------	--------------------------------

No	Freq. [MHz]	Corr. Factor	Reading Value [dB (uV)]		Emission Level [dB (uV)]		Limit [dB (uV)]		Margin (dB)	
		(dB)	Q.P.	AV.	Q.P.	AV.	Q.P.	AV.	Q.P.	AV.
	1	0.15781	10.19	36.24	22.14	46.43	32.33	65.58	55.58	-19.15
2	0.20078	10.17	34.88	27.82	45.05	37.99	63.58	53.58	-18.53	-15.59
3	0.28672	10.20	40.06	37.35	50.26	47.55	60.62	50.62	-10.36	-3.07
4	0.34650	10.22	32.24	27.18	42.46	37.40	59.05	49.05	-16.59	-11.65
5	0.52891	10.24	17.21	9.61	27.45	19.85	56.00	46.00	-28.55	-26.15
6	10.74609	10.70	13.35	9.53	24.05	20.23	60.00	50.00	-35.95	-29.77

REMARKS:

1. Q.P. and AV. are abbreviations of quasi-peak and average individually.
2. The emission levels of other frequencies were very low against the limit.
3. Margin value = Emission level - Limit value
4. Correction factor = Insertion loss + Cable loss
5. Emission Level = Correction Factor + Reading Value.

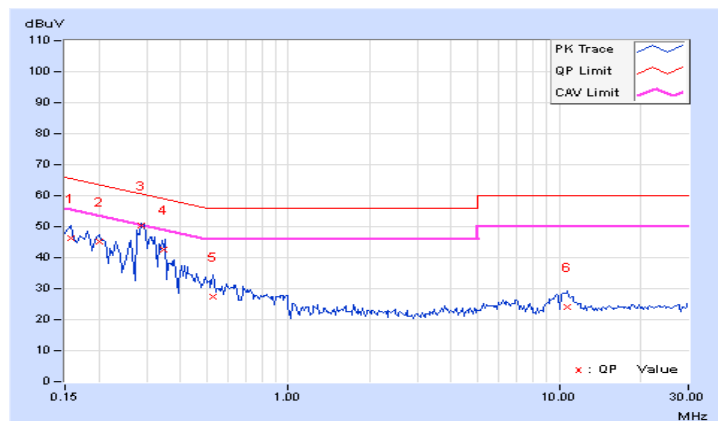

4.2.8 Test Results (Mode 2)

Phase	Line (L)	Detector Function	Quasi-Peak (QP) / Average (AV)
-------	----------	-------------------	--------------------------------

No	Freq. [MHz]	Corr. Factor	Reading Value [dB (uV)]		Emission Level [dB (uV)]		Limit [dB (uV)]		Margin (dB)	
		(dB)	Q.P.	AV.	Q.P.	AV.	Q.P.	AV.	Q.P.	AV.
	1	0.15000	10.20	44.06	31.88	54.26	42.08	66.00	56.00	-11.74
2	0.16953	10.20	36.22	14.23	46.42	24.43	64.98	54.98	-18.56	-30.55
3	0.47422	10.25	25.49	20.93	35.74	31.18	56.44	46.44	-20.70	-15.26
4	3.44922	10.30	15.89	9.47	26.19	19.77	56.00	46.00	-29.81	-26.23
5	7.03906	10.52	29.45	24.05	39.97	34.57	60.00	50.00	-20.03	-15.43
6	12.82422	11.05	22.24	16.43	33.29	27.48	60.00	50.00	-26.71	-22.52

REMARKS:

1. Q.P. and AV. are abbreviations of quasi-peak and average individually.
2. The emission levels of other frequencies were very low against the limit.
3. Margin value = Emission level - Limit value
4. Correction factor = Insertion loss + Cable loss
5. Emission Level = Correction Factor + Reading Value.

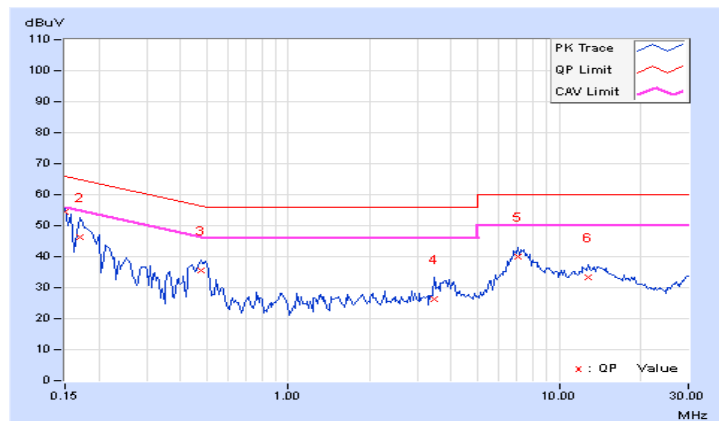

Phase	Neutral (N)	Detector Function	Quasi-Peak (QP) / Average (AV)
-------	-------------	-------------------	--------------------------------

No	Freq.	Corr.	Reading Value		Emission Level		Limit		Margin	
	[MHz]	Factor	[dB (uV)]		[dB (uV)]		[dB (uV)]		(dB)	
		(dB)	Q.P.	AV.	Q.P.	AV.	Q.P.	AV.	Q.P.	AV.
1	0.15000	10.19	42.76	27.23	52.95	37.42	66.00	56.00	-13.05	-18.58
2	0.16953	10.18	36.54	14.51	46.72	24.69	64.98	54.98	-18.26	-30.29
3	0.49375	10.24	26.21	18.25	36.45	28.49	56.10	46.10	-19.65	-17.61
4	0.86094	10.26	21.17	16.27	31.43	26.53	56.00	46.00	-24.57	-19.47
5	7.41016	10.45	29.38	24.00	39.83	34.45	60.00	50.00	-20.17	-15.55
6	13.91016	10.99	21.81	16.03	32.80	27.02	60.00	50.00	-27.20	-22.98

REMARKS:

1. Q.P. and AV. are abbreviations of quasi-peak and average individually.
2. The emission levels of other frequencies were very low against the limit.
3. Margin value = Emission level - Limit value
4. Correction factor = Insertion loss + Cable loss
5. Emission Level = Correction Factor + Reading Value.

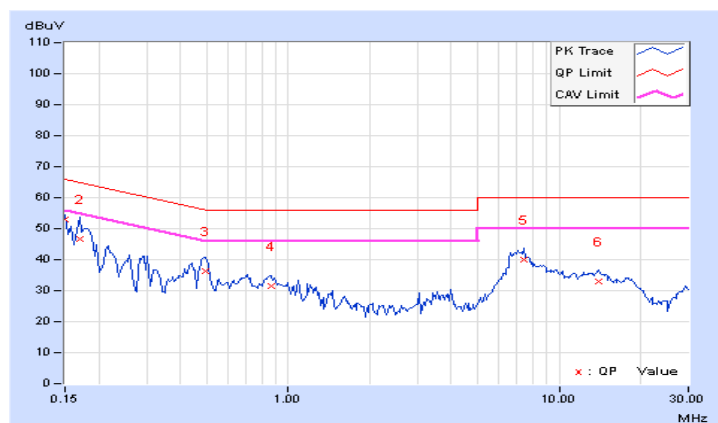

4.3 Transmit Power Measurement

4.3.1 Limits of Transmit Power Measurement

Operation Band	EUT Category		Limit
U-NII-1		Outdoor Access Point	1 Watt (30 dBm) (Max. e.i.r.p \leq 125mW(21 dBm) at any elevation angle above 30 degrees as measured from the horizon)
		Fixed point-to-point Access Point	1 Watt (30 dBm)
	√	Indoor Access Point	1 Watt (30 dBm)
		Mobile and Portable client device	250mW (24 dBm)
U-NII-2A			250mW (24 dBm) or 11 dBm+10 log B*
U-NII-2C			250mW (24 dBm) or 11 dBm+10 log B*
U-NII-3	√		1 Watt (30 dBm)

*B is the 26 dB emission bandwidth in megahertz

Per KDB 662911 Method of conducted output power measurement on IEEE 802.11 devices,

Array Gain = 0 dB (i.e., no array gain) for $N_{ANT} \leq 4$;

Array Gain = 0 dB (i.e., no array gain) for channel widths ≥ 40 MHz for any N_{ANT} ;

Array Gain = $5 \log(N_{ANT}/N_{SS})$ dB or 3 dB, whichever is less for 20-MHz channel widths with $N_{ANT} \geq 5$.

For power measurements on all other devices: Array Gain = $10 \log(N_{ANT}/N_{SS})$ dB.

4.3.2 Test Setup

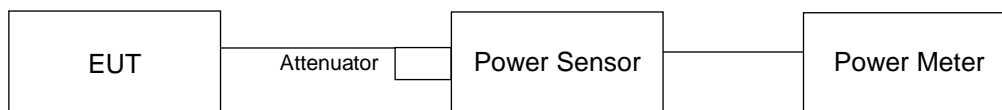

4.3.3 Test Instruments

Refer to section 4.1.2 to get information of above instrument.

4.3.4 Test Procedure

Method PM is used to perform output power measurement, trigger and gating function of wide band power meter is enabled to measure max output power of TX on burst. Duty factor is not added to measured value.

4.3.5 Deviation from Test Standard

No deviation.

4.3.6 EUT Operating Condition

The software provided by client to enable the EUT under transmission condition continuously at lowest, middle and highest channel frequencies individually.

4.3.7 Test Result

CDD Mode
802.11a

Chan.	Chan. Freq. (MHz)	Maximum Conducted Power (dBm)			Total Power (mW)	Total Power (dBm)	Limit (dBm)	Pass / Fail
		Chain 0	Chain 1	Chain 2				
36	5180	21.53	20.02	21.89	397.22	25.99	30.00	Pass
40	5200	24.66	24.01	24.15	804.199	29.05	30.00	Pass
48	5240	24.46	23.42	24.06	753.723	28.77	30.00	Pass
149	5745	24.55	23.72	24.47	800.505	29.03	30.00	Pass
157	5785	24.84	23.67	24.48	818.141	29.13	30.00	Pass
165	5825	24.67	24.04	24.26	813.288	29.10	30.00	Pass

Beamforming Mode
802.11ac (VHT20)

Chan.	Chan. Freq. (MHz)	Maximum Conducted Power (dBm)			Total Power (mW)	Total Power (dBm)	Limit (dBm)	Pass / Fail
		Chain 0	Chain 1	Chain 2				
36	5180	21.23	19.96	21.99	389.947	25.91	29.07	Pass
40	5200	24.55	24.03	24.13	796.853	29.01	29.07	Pass
48	5240	24.39	23.23	24.13	743.988	28.72	29.07	Pass
149	5745	24.64	23.46	24.59	800.632	29.03	29.07	Pass
157	5785	24.87	23.32	24.53	805.477	29.06	29.07	Pass
165	5825	24.77	23.55	24.39	801.169	29.04	29.07	Pass

NOTE: Directional gain = $10 \log[(10^{G1/20} + 10^{G2/20} + 10^{G3/20})^2 / 3] = 6.93\text{dBi} > 6\text{dBi}$, so the power limit shall be reduced to $30 - (6.93 - 6) = 29.07\text{dBm}$.

802.11ac (VHT40)

Chan.	Chan. Freq. (MHz)	Maximum Conducted Power (dBm)			Total Power (mW)	Total Power (dBm)	Limit (dBm)	Pass / Fail
		Chain 0	Chain 1	Chain 2				
38	5190	16.81	15.06	16.89	128.901	21.10	29.07	Pass
46	5230	23.24	22.08	23.80	612.182	27.87	29.07	Pass
151	5755	24.27	23.44	24.36	760.999	28.81	29.07	Pass
159	5795	24.35	23.30	24.31	755.84	28.78	29.07	Pass

NOTE: Directional gain = $10 \log[(10^{G1/20} + 10^{G2/20} + 10^{G3/20})^2 / 3] = 6.93\text{dBi} > 6\text{dBi}$, so the power limit shall be reduced to $30 - (6.93 - 6) = 29.07\text{dBm}$.

802.11ac (VHT80)

Chan.	Chan. Freq. (MHz)	Maximum Conducted Power (dBm)			Total Power (mW)	Total Power (dBm)	Limit (dBm)	Pass / Fail
		Chain 0	Chain 1	Chain 2				
42	5210	15.07	14.46	15.29	93.868	19.73	29.07	Pass
155	5775	23.51	22.85	23.30	630.936	28.00	29.07	Pass

NOTE: Directional gain = $10 \log[(10^{G1/20} + 10^{G2/20} + 10^{G3/20})^2 / 3] = 6.93\text{dBi} > 6\text{dBi}$, so the power limit shall be reduced to $30 - (6.93 - 6) = 29.07\text{dBm}$.

4.4 Occupied Bandwidth Measurement

4.4.1 Test Setup

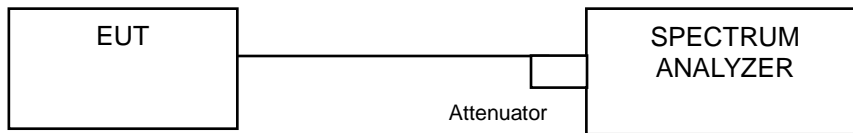

4.4.2 Test Instruments

Refer to section 4.1.2 to get information of above instrument.

4.4.3 Test Procedure

The transmitter output was connected to the spectrum analyzer through an attenuator. The bandwidth of the fundamental frequency was measured by spectrum analyzer with resolution bandwidth in the range of 1% to 5% of the anticipated emission bandwidth, and a video bandwidth at least 3x the resolution bandwidth and set the detector to SAMPLE. The width of a frequency band such that, below the lower and above the upper frequency limits, the mean powers emitted are each equal to a specified percentage 0.5 %of the total mean power of a given emission.

4.4.4 Test Results

CDD Mode

802.11a

Channel	Channel Frequency (MHz)	Occupied Bandwidth (MHz)		
		Chain 0	Chain 1	Chain 2
36	5180	16.92	16.68	16.92
40	5200	17.16	18.24	17.52
48	5240	18.48	17.52	18.24
149	5745	18.60	17.16	19.08
157	5785	17.88	16.92	17.76
165	5825	18.84	17.28	17.64

Beamforming Mode

802.11ac (VHT20)

Channel	Channel Frequency (MHz)	Occupied Bandwidth (MHz)		
		Chain 0	Chain 1	Chain 2
36	5180	18.00	17.88	18.00
40	5200	18.36	18.96	18.36
48	5240	18.84	19.08	18.84
149	5745	18.48	18.12	18.48
157	5785	18.48	18.24	18.48
165	5825	18.72	18.12	18.60

802.11ac (VHT40)

Channel	Channel Frequency (MHz)	Occupied Bandwidth (MHz)		
		Chain 0	Chain 1	Chain 2
38	5190	36.72	37.20	36.72
46	5230	37.20	36.96	37.68
151	5755	37.92	37.20	37.92
159	5795	37.44	36.96	37.92

802.11ac (VHT80)

Channel	Channel Frequency (MHz)	Occupied Bandwidth (MHz)		
		Chain 0	Chain 1	Chain 2
42	5210	75.36	75.36	75.36
155	5775	76.32	75.36	76.32

Spectrum Plot of Worst Value

802.11a_Chain2 / CH149

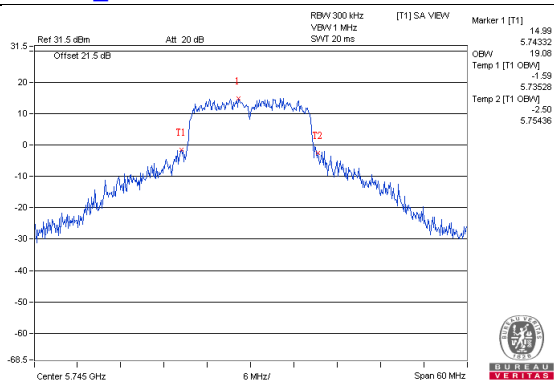

802.11ac (VHT20)_Chain1 / CH48

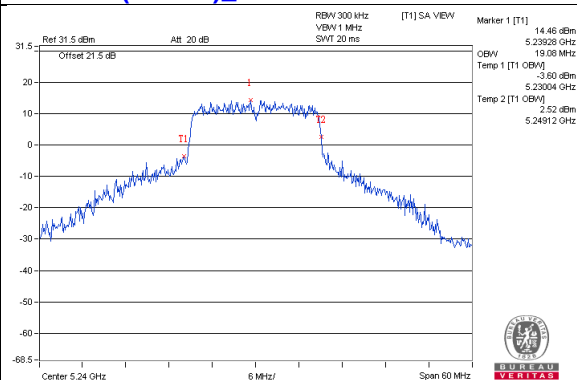

802.11ac (VHT40)_Chain0 / CH151

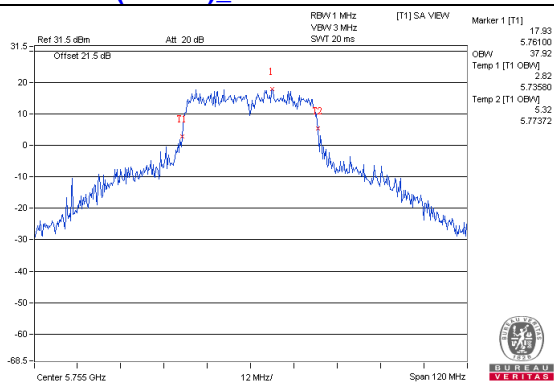

802.11ac (VHT80)_Chain0 / CH155

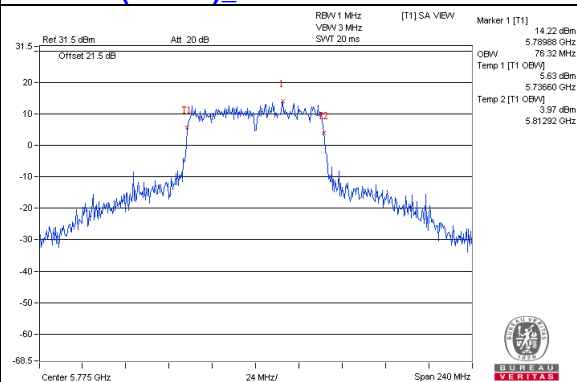

Spectrum Plot for near by DFS band (DFS is required, if 99% OCP straddle into U-NII-2A band)

802.11a_Chain0 / CH48

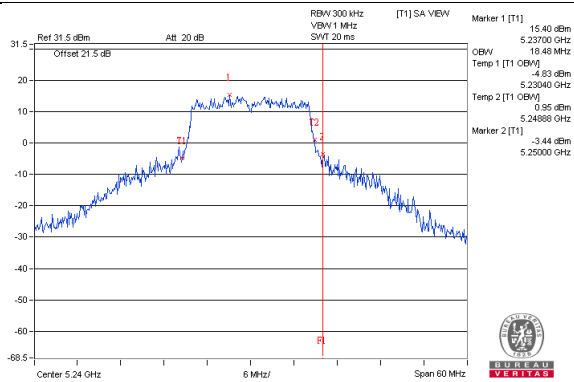

802.11a_Chain1 / CH48

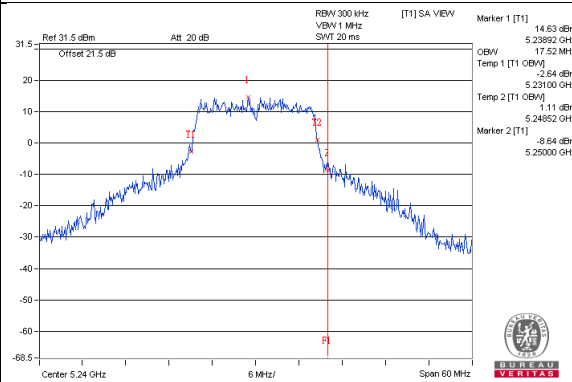

802.11a_Chain2 / CH48

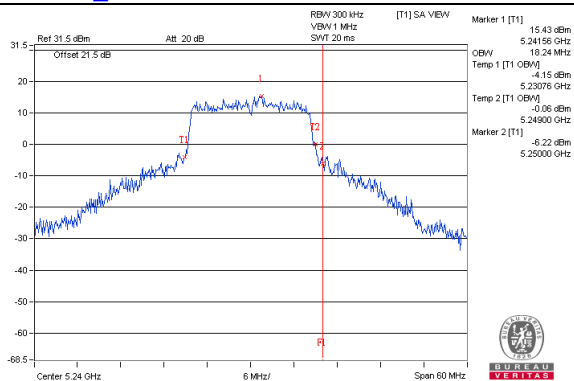

802.11ac(VHT20)_Chain0 / CH48

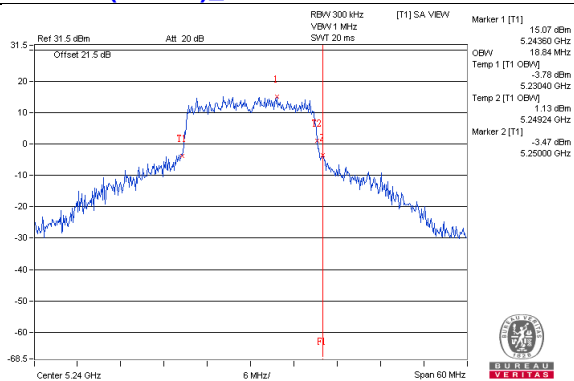

802.11ac(VHT20)_Chain1 / CH48

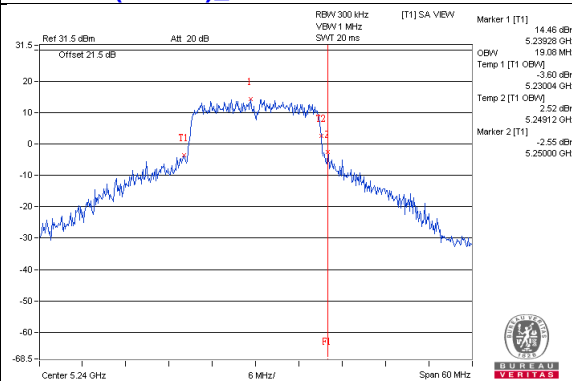

802.11ac(VHT20)_Chain2 / CH48

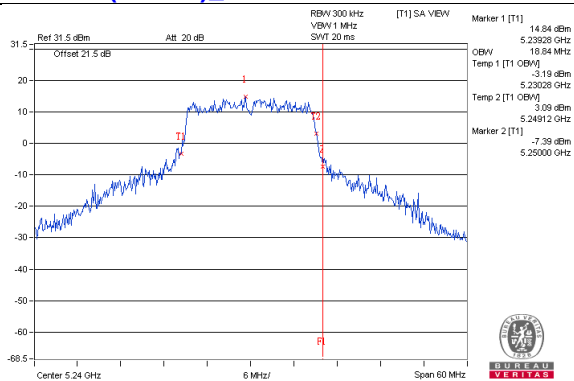

Spectrum Plot for near by DFS band (DFS is required, if 99% OCP straddle into U-NII-2A band)

802.11ac(VHT40)_Chain0 / CH46

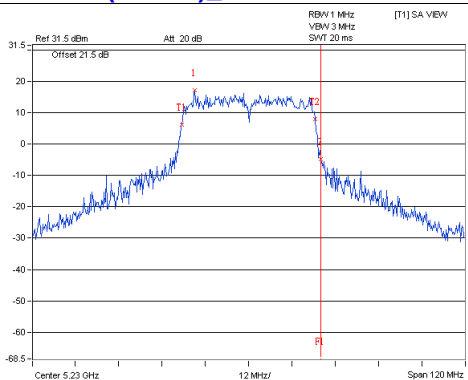

802.11ac(VHT40)_Chain1 / CH46

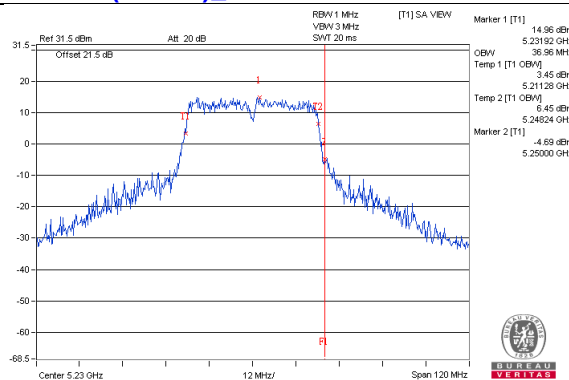

802.11ac(VHT40)_Chain2 / CH46

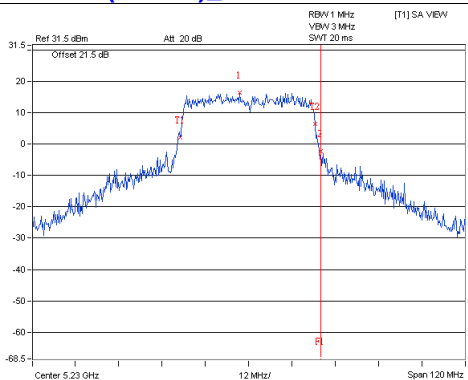

802.11ac(VHT80)_Chain0 / CH42

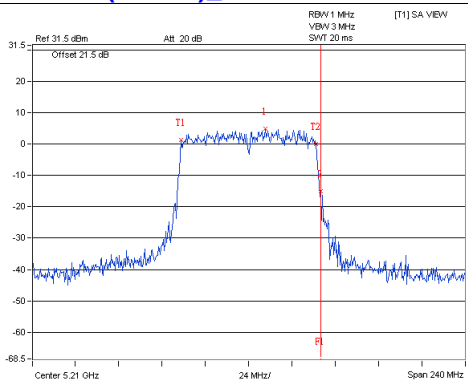

802.11ac(VHT80)_Chain1 / CH42

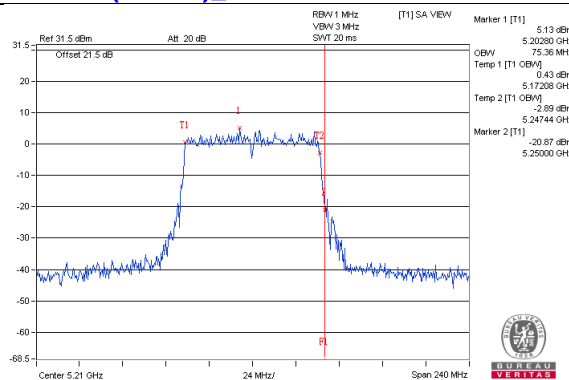

802.11ac(VHT80)_Chain2 / CH42

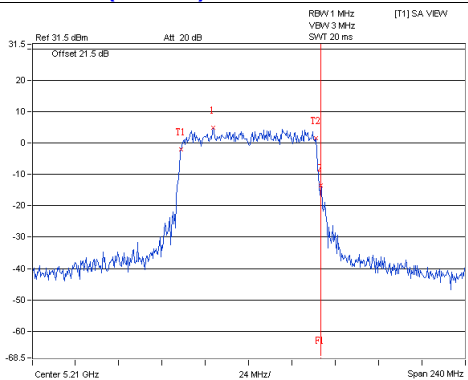

**Spectrum Plot for near by DFS band
(DFS is required, if 99% OCP straddle into U-NII-2C band)**

802.11a_Chain0 / CH149

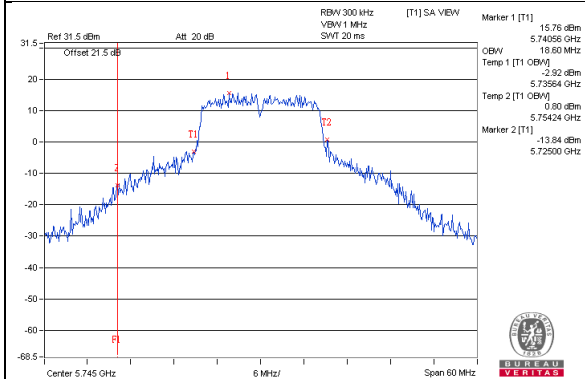

802.11a_Chain1 / CH149

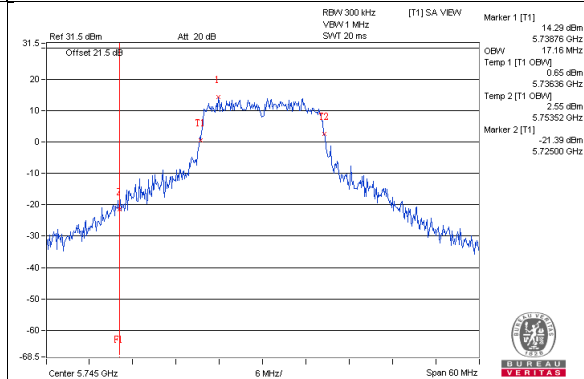

802.11a_Chain2 / CH149

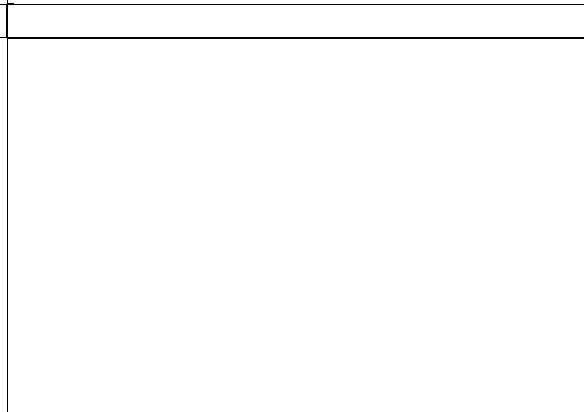
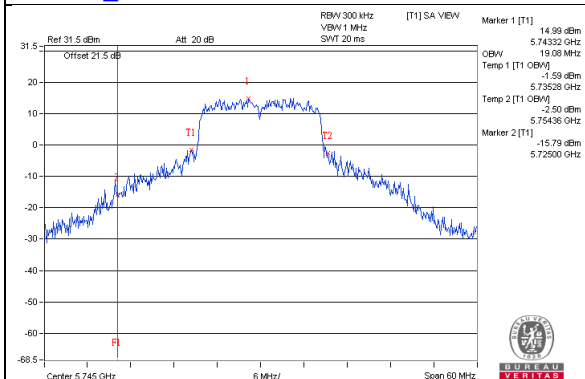

802.11ac(VHT20)_Chain0 / CH149

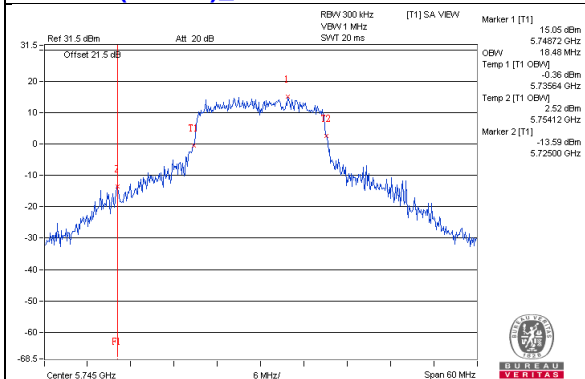

802.11ac(VHT20)_Chain1 / CH149

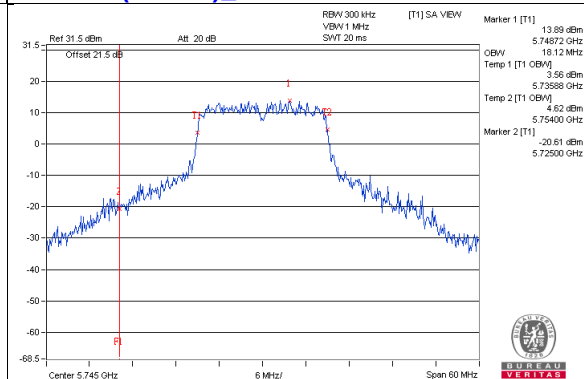

802.11ac(VHT20)_Chain2 / CH149

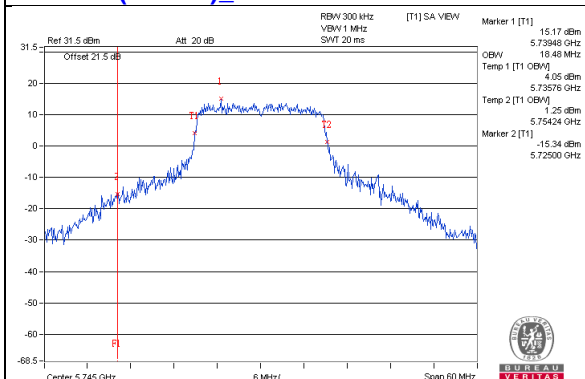

**Spectrum Plot for near by DFS band
(DFS is required, if 99% OCP straddle into U-NII-2C band)**

802.11ac(VHT40)_Chain0 / CH151

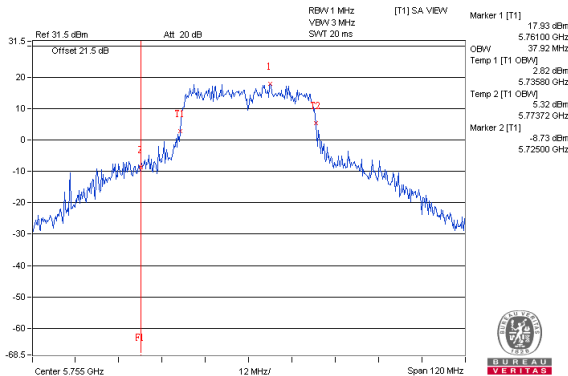

802.11ac(VHT40)_Chain1 / CH151

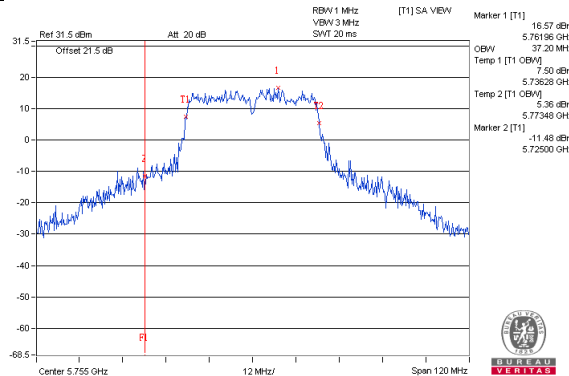

802.11ac(VHT40)_Chain2 / CH151

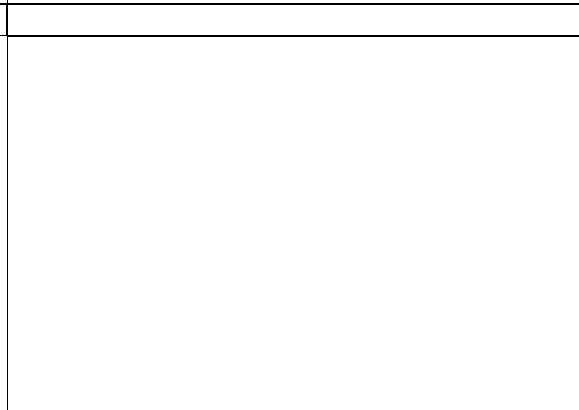
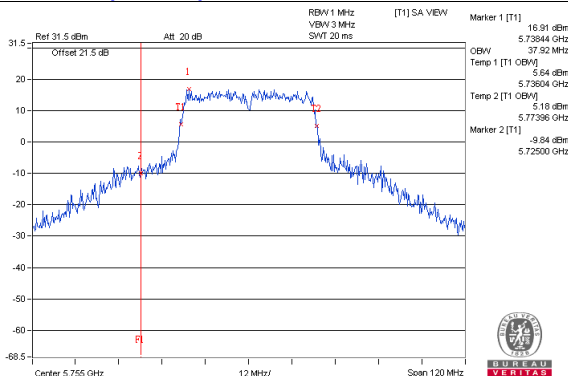

802.11ac(VHT80)_Chain0 / CH155

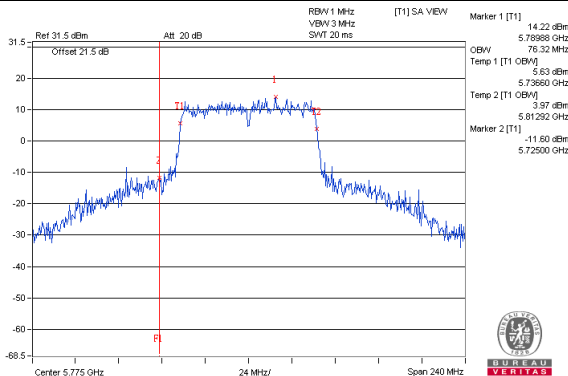

802.11ac(VHT80)_Chain1 / CH155

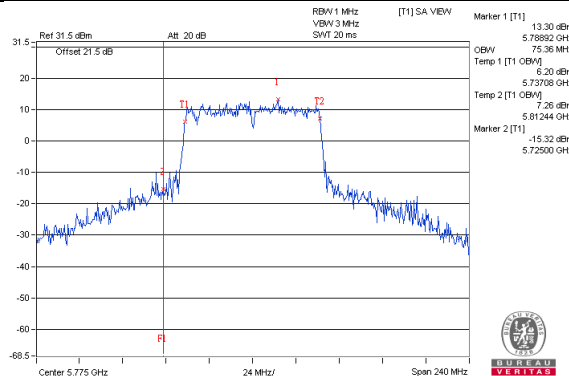

802.11ac(VHT80)_Chain2 / CH155

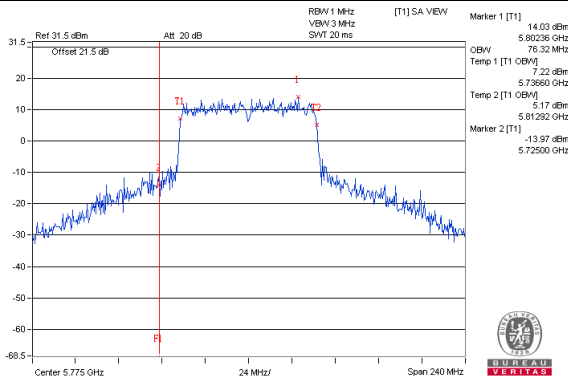

4.5 Peak Power Spectral Density Measurement

4.5.1 Limits of Peak Power Spectral Density Measurement

Operation Band	EUT Category		Limit
U-NII-1		Outdoor Access Point	17dBm/ MHz
		Fixed point-to-point Access Point	
	√	Indoor Access Point	
		Mobile and Portable client device	11dBm/ MHz
U-NII-2A			11dBm/ MHz
U-NII-2C			11dBm/ MHz
U-NII-3	√		30dBm/ 500kHz

4.5.2 Test Setup

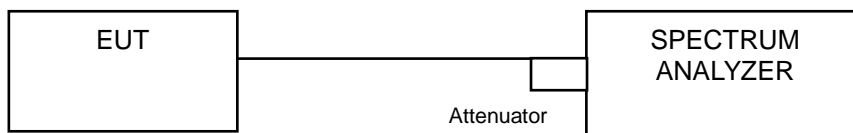

4.5.3 Test Instruments

Refer to section 4.1.2 to get information of above instrument.

4.5.4 Test Procedure

For U-NII-1:

Using method SA-2

1. Set span to encompass the entire emission bandwidth (EBW) of the signal.
2. Set RBW = 1 MHz, Set VBW \geq 3 MHz, Detector = RMS
3. Sweep time = auto, trigger set to "free run".
4. Trace average at least 100 traces in power averaging mode.
5. Record the max value and add $10 \log (1/\text{duty cycle})$

For U-NII-3:

1. Set span to encompass the entire emission bandwidth (EBW) of the signal.
2. Set RBW = 300 kHz, Set VBW \geq 1 MHz, Detector = RMS
3. Use the peak marker function to determine the maximum power level in any 300 kHz band segment within the fundamental EBW.
4. Scale the observed power level to an equivalent value in 500 kHz by adjusting (reducing) the measured power by a bandwidth correction factor (BWCF) where $\text{BWCF} = 10 \log(500 \text{ kHz}/300 \text{ kHz})$
5. Sweep time = auto, trigger set to "free run".
6. Trace average at least 100 traces in power averaging mode.
7. Record the max value and add $10 \log (1/\text{duty cycle})$

4.5.5 Deviation from Test Standard

No deviation.

4.5.6 EUT Operating Condition

Same as Item 4.3.6.

4.5.7 Test Results

For U-NII-1:

CDD Mode

802.11a

Chan.	Chan. Freq. (MHz)	PSD W/O Duty Factor (dBm/MHz)			Duty Factor (dB)	Total PSD With Duty Factor (dBm/MHz)	MAX. Limit (dBm/MHz)	Pass / Fail
		Chain 0	Chain 1	Chain 2				
36	5180	8.11	6.50	8.33	0.11	12.60	16.07	Pass
40	5200	10.01	10.61	11.24	0.11	15.53	16.07	Pass
48	5240	11.21	10.10	11.44	0.11	15.84	16.07	Pass

- Note:**
- Method a) of power density measurement of KDB 662911 is using for calculating total power density. Total power density is summing entire spectra across corresponding frequency bins on the various outputs by computer.
 - Directional gain = $10 \log[(10^{G1/20} + 10^{G2/20} + 10^{G3/20})^2 / 3] = 6.93\text{dBi} > 6\text{dBi}$, so the power density limit shall be reduced to $17-(6.93-6) = 16.07\text{dBm}$.
 - Refer to section 3.3 for duty cycle spectrum plot.

Beamforming Mode

802.11ac (VHT20)

Chan.	Chan. Freq. (MHz)	PSD W/O Duty Factor (dBm/MHz)			Duty Factor (dB)	Total PSD With Duty Factor (dBm/MHz)	MAX. Limit (dBm/MHz)	Pass / Fail
		Chain 0	Chain 1	Chain 2				
36	5180	7.71	5.60	7.80	0.17	12.09	16.07	Pass
40	5200	10.08	10.33	10.44	0.17	15.22	16.07	Pass
48	5240	10.76	10.15	10.82	0.17	15.52	16.07	Pass

- Note:**
- Method a) of power density measurement of KDB 662911 is using for calculating total power density. Total power density is summing entire spectra across corresponding frequency bins on the various outputs by computer.
 - Directional gain = $10 \log[(10^{G1/20} + 10^{G2/20} + 10^{G3/20})^2 / 3] = 6.93\text{dBi} > 6\text{dBi}$, so the power density limit shall be reduced to $17-(6.93-6) = 16.07\text{dBm}$.
 - Refer to section 3.3 for duty cycle spectrum plot.

802.11ac (VHT40)

Chan.	Chan. Freq. (MHz)	PSD W/O Duty Factor (dBm/MHz)			Duty Factor (dB)	Total PSD With Duty Factor (dBm/MHz)	MAX. Limit (dBm/MHz)	Pass / Fail
		Chain 0	Chain 1	Chain 2				
38	5190	-0.23	-1.57	-0.41	0.23	4.31	16.07	Pass
46	5230	6.03	5.09	7.21	0.23	11.20	16.07	Pass

- Note:**
- Method a) of power density measurement of KDB 662911 is using for calculating total power density. Total power density is summing entire spectra across corresponding frequency bins on the various outputs by computer.
 - Directional gain = $10 \log[(10^{G1/20} + 10^{G2/20} + 10^{G3/20})^2 / 3] = 6.93\text{dBi} > 6\text{dBi}$, so the power density limit shall be reduced to $17 - (6.93 - 6) = 16.07\text{dBm}$.
 - Refer to section 3.3 for duty cycle spectrum plot.

802.11ac (VHT80)

Chan.	Chan. Freq. (MHz)	PSD W/O Duty Factor (dBm/MHz)			Duty Factor (dB)	Total PSD With Duty Factor (dBm/MHz)	MAX. Limit (dBm/MHz)	Pass / Fail
		Chain 0	Chain 1	Chain 2				
42	5210	-4.78	-5.70	-5.45	0.64	0.12	16.07	Pass

- Note:**
- Method a) of power density measurement of KDB 662911 is using for calculating total power density. Total power density is summing entire spectra across corresponding frequency bins on the various outputs by computer.
 - Directional gain = $10 \log[(10^{G1/20} + 10^{G2/20} + 10^{G3/20})^2 / 3] = 6.93\text{dBi} > 6\text{dBi}$, so the power density limit shall be reduced to $17 - (6.93 - 6) = 16.07\text{dBm}$.
 - Refer to section 3.3 for duty cycle spectrum plot

Spectrum Plot of Worst Value

802.11a_Chain 2 / CH48

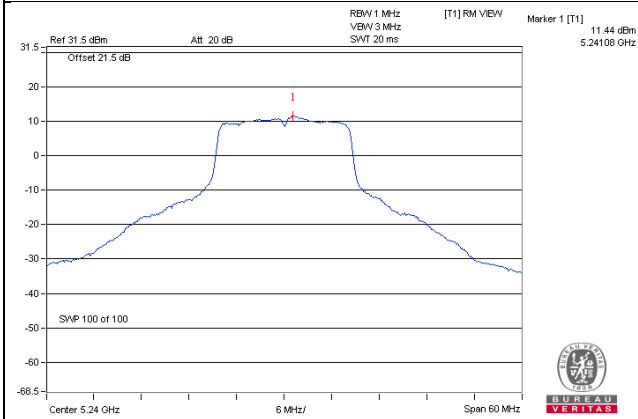

802.11ac (VHT20)_Chain 2 / CH48

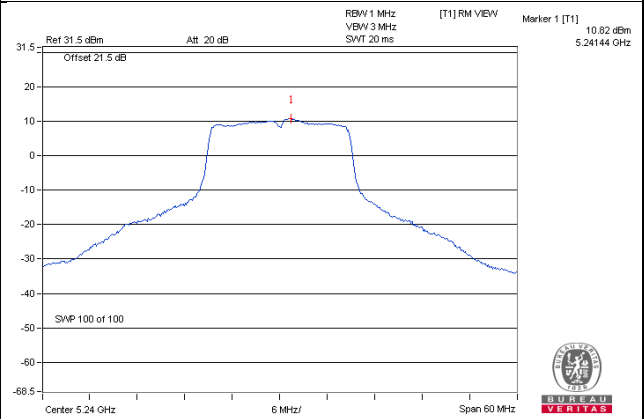

802.11ac (VHT40)_Chain 2 / CH46

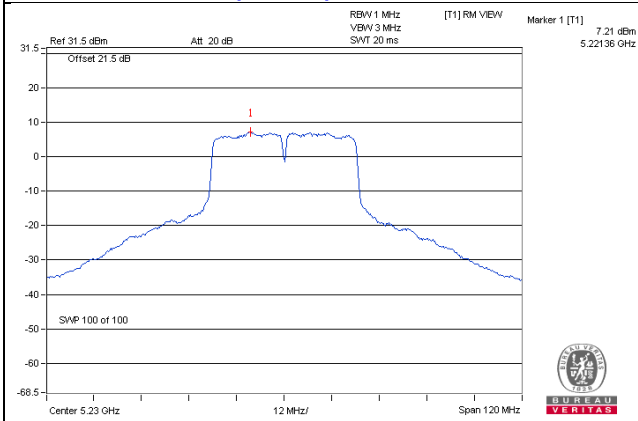

802.11ac (VHT80)_Chain 0 / CH42

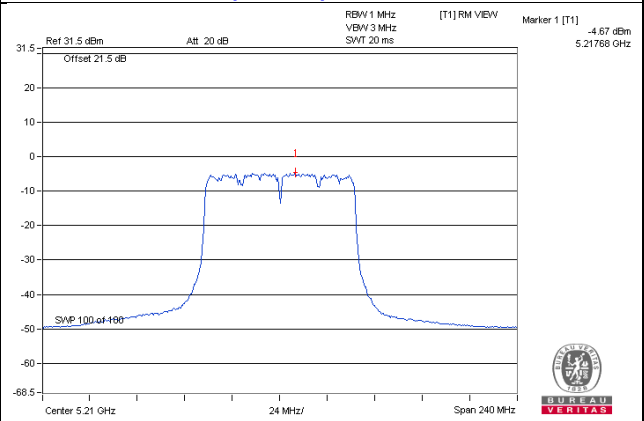

For U-NII-3:
CDD Mode
802.11a

TX chain	Chan.	Chan. Freq. (MHz)	PSD W/O Duty Factor		10 log (N=3) dB	Duty Factor (dB)	Total PSD With Duty Factor (dBm/500kHz)	Limit (dBm/500kHz)	Pass /Fail
			(dBm/300kHz)	(dBm/500kHz)					
0	149	5745	3.30	5.52	4.77	0.11	10.40	29.07	Pass
	157	5785	3.14	5.36	4.77	0.11	10.24	29.07	Pass
	165	5825	3.16	5.38	4.77	0.11	10.26	29.07	Pass
1	149	5745	1.89	4.11	4.77	0.11	8.99	29.07	Pass
	157	5785	1.77	3.99	4.77	0.11	8.87	29.07	Pass
	165	5825	2.42	4.64	4.77	0.11	9.52	29.07	Pass
2	149	5745	3.40	5.62	4.77	0.11	10.50	29.07	Pass
	157	5785	3.06	5.28	4.77	0.11	10.16	29.07	Pass
	165	5825	3.39	5.61	4.77	0.11	10.49	29.07	Pass

Note: 1. Directional gain = $10 \log[(10^{G1/20} + 10^{G2/20} + 10^{G3/20})^2 / 3] = 6.93\text{dBi} > 6\text{dBi}$, so the power density limit shall be reduced to $30 - (6.93 - 6) = 29.07\text{dBm}$.

2. Refer to section 3.3 for duty cycle spectrum plot.

Beamforming Mode
802.11ac (VHT20)

TX chain	Chan.	Chan. Freq. (MHz)	PSD W/O Duty Factor		10 log (N=3) dB	Duty Factor (dB)	Total PSD With Duty Factor (dBm/500kHz)	Limit (dBm/500kHz)	Pass /Fail
			(dBm/300kHz)	(dBm/500kHz)					
0	149	5745	2.61	4.83	4.77	0.17	9.77	29.07	Pass
	157	5785	2.76	4.98	4.77	0.17	9.92	29.07	Pass
	165	5825	2.84	5.06	4.77	0.17	10.00	29.07	Pass
1	149	5745	1.69	3.91	4.77	0.17	8.85	29.07	Pass
	157	5785	1.76	3.98	4.77	0.17	8.92	29.07	Pass
	165	5825	1.61	3.83	4.77	0.17	8.77	29.07	Pass
2	149	5745	2.54	4.76	4.77	0.17	9.70	29.07	Pass
	157	5785	2.68	4.90	4.77	0.17	9.84	29.07	Pass
	165	5825	2.81	5.03	4.77	0.17	9.97	29.07	Pass

Note: 1. Directional gain = $10 \log[(10^{G1/20} + 10^{G2/20} + 10^{G3/20})^2 / 3] = 6.93\text{dBi} > 6\text{dBi}$, so the power density limit shall be reduced to $30 - (6.93 - 6) = 29.07\text{dBm}$.

2. Refer to section 3.3 for duty cycle spectrum plot.

802.11ac (VHT40)

TX chain	Chan.	Chan. Freq. (MHz)	PSD W/O Duty Factor		10 log (N=3) dB	Duty Factor (dB)	Total PSD With Duty Factor (dBm/500kHz)	Limit (dBm/500kHz)	Pass /Fail
			(dBm/300kHz)	(dBm/500kHz)					
0	151	5755	-0.55	1.67	4.77	0.23	6.67	29.07	Pass
	159	5795	-0.73	1.49	4.77	0.23	6.49	29.07	Pass
1	151	5755	-1.56	0.66	4.77	0.23	5.66	29.07	Pass
	159	5795	-1.27	0.95	4.77	0.23	5.95	29.07	Pass
2	151	5755	-0.87	1.35	4.77	0.23	6.35	29.07	Pass
	159	5795	-0.75	1.47	4.77	0.23	6.47	29.07	Pass

Note: 1. Directional gain = $10 \log[(10^{G1/20} + 10^{G2/20} + 10^{G3/20})^2 / 3] = 6.93\text{dBi} > 6\text{dBi}$, so the power density limit shall be reduced to $30 - (6.93 - 6) = 29.07\text{dBm}$.

2. Refer to section 3.3 for duty cycle spectrum plot.

802.11ac (VHT80)

TX chain	Chan.	Chan. Freq. (MHz)	PSD W/O Duty Factor		10 log (N=3) dB	Duty Factor (dB)	Total PSD With Duty Factor (dBm/500kHz)	Limit (dBm/500kHz)	Pass /Fail
			(dBm/300kHz)	(dBm/500kHz)					
0	155	5775	-4.93	-2.71	4.77	0.64	2.70	29.07	Pass
1	155	5775	-5.23	-3.01	4.77	0.64	2.40	29.07	Pass
2	155	5775	-4.79	-2.57	4.77	0.64	2.84	29.07	Pass

Note: 1. Directional gain = $10 \log[(10^{G1/20} + 10^{G2/20} + 10^{G3/20})^2 / 3] = 6.93\text{dBi} > 6\text{dBi}$, so the power density limit shall be reduced to $30 - (6.93 - 6) = 29.07\text{dBm}$.

2. Refer to section 3.3 for duty cycle spectrum plot.

Spectrum Plot of Worst Value

802.11a – Chain 2: CH 149

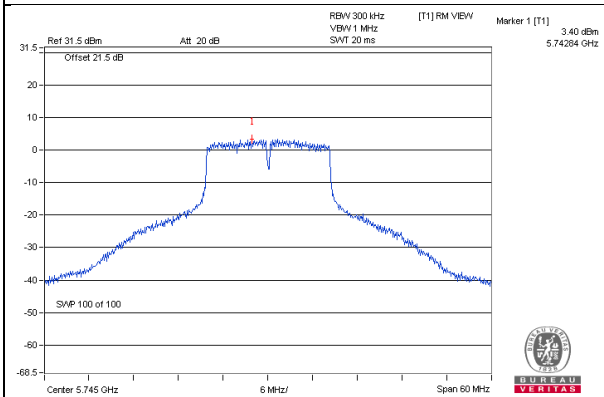

802.11ac (VHT20) – Chain 0: CH 165

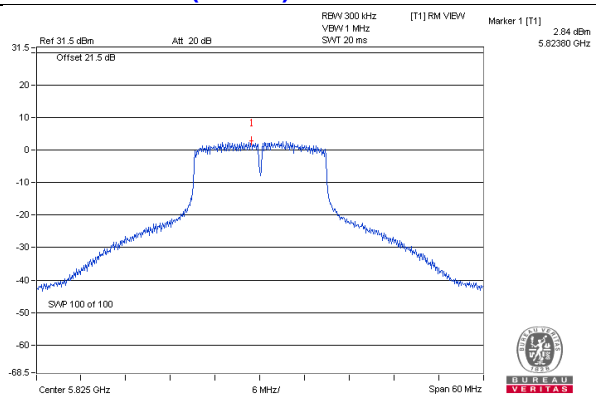

802.11ac (VHT40) – Chain 0: CH 151

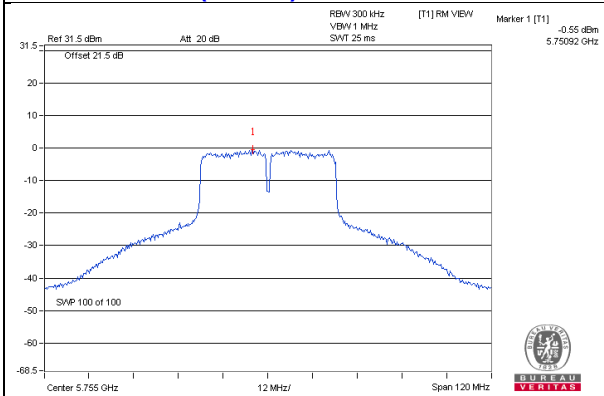

802.11ac (VHT80) – Chain 2: CH 155

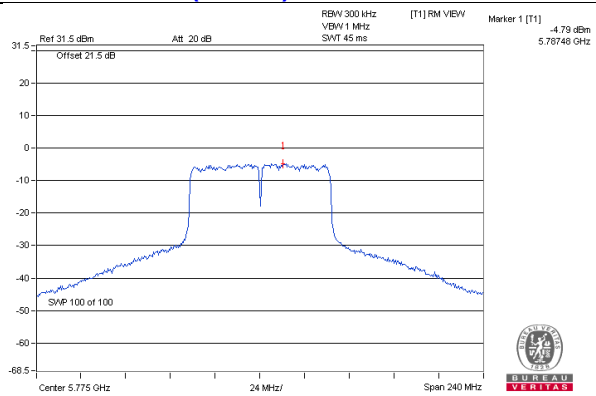

4.6 Frequency Stability Measurement

4.6.1 Limits of Frequency Stability Measurement

The frequency of the carrier signal shall be maintained within band of operation

4.6.2 Test Setup

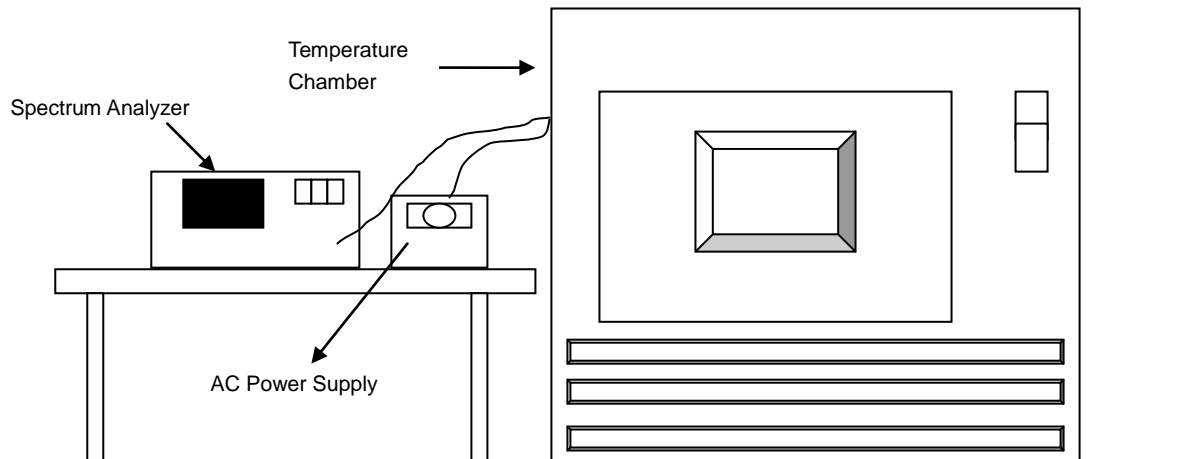

4.6.3 Test Instruments

Refer to section 4.1.2 to get information of above instrument.

4.6.4 Test Procedure

- The EUT was placed inside the environmental test chamber and powered by nominal AC voltage.
- Turn the EUT on and couple its output to a spectrum analyzer.
- Turn the EUT off and set the chamber to the highest temperature specified.
- Allow sufficient time (approximately 30 min) for the temperature of the chamber to stabilize, turn the EUT on and measure the operating frequency after 2, 5, and 10 Minutes.
- Repeat step 2 and 3 with the temperature chamber set to the lowest temperature.
- The test chamber was allowed to stabilize at +20 degree C for a minimum of 30 Minutes. The supply voltage was then adjusted on the EUT from 85% to 115% and the frequency record.

4.6.5 Deviation from Test Standard

No deviation.

4.6.6 EUT Operating Condition

Set the EUT transmit at un-modulation mode to test frequency stability.

4.6.7 Test Results

Frequency Stability Versus Temp.									
Operating Frequency: 5180 MHz									
TEMP. (°C)	Power Supply (Vac)	0 Minute		2 Minute		5 Minute		10 Minute	
		Measured Frequency (MHz)	Pass/Fail	Measured Frequency (MHz)	Pass/Fail	Measured Frequency (MHz)	Pass/Fail	Measured Frequency (MHz)	Pass/Fail
50	120	5180.0145	PASS	5180.017	PASS	5180.0155	PASS	5180.0159	PASS
40	120	5179.9928	PASS	5179.9912	PASS	5179.9927	PASS	5179.9925	PASS
30	120	5179.9769	PASS	5179.9753	PASS	5179.9753	PASS	5179.975	PASS
20	120	5179.9809	PASS	5179.981	PASS	5179.9808	PASS	5179.9835	PASS
10	120	5180.0149	PASS	5180.015	PASS	5180.0132	PASS	5180.0162	PASS
0	120	5179.9927	PASS	5179.9955	PASS	5179.9962	PASS	5179.9922	PASS
-10	120	5180.0084	PASS	5180.0094	PASS	5180.009	PASS	5180.0084	PASS
-20	120	5179.973	PASS	5179.9738	PASS	5179.9748	PASS	5179.9739	PASS
-30	120	5179.992	PASS	5179.9908	PASS	5179.9926	PASS	5179.9906	PASS

Frequency Stability Versus Voltage									
Operating Frequency: 5180 MHz									
TEMP. (°C)	Power Supply (Vac)	0 Minute		2 Minute		5 Minute		10 Minute	
		Measured Frequency (MHz)	Pass/Fail	Measured Frequency (MHz)	Pass/Fail	Measured Frequency (MHz)	Pass/Fail	Measured Frequency (MHz)	Pass/Fail
20	138	5179.9811	PASS	5179.9802	PASS	5179.9811	PASS	5179.9827	PASS
	120	5179.9809	PASS	5179.981	PASS	5179.9808	PASS	5179.9835	PASS
	102	5179.9805	PASS	5179.9807	PASS	5179.9817	PASS	5179.9842	PASS

4.7 6dB Bandwidth Measurement

4.7.1 Limits of 6dB Bandwidth Measurement

The minimum of 6dB Bandwidth Measurement is 0.5MHz.

4.7.2 Test Setup

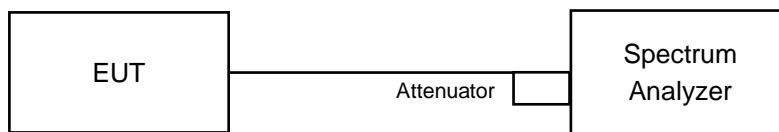

4.7.3 Test Instruments

Refer to section 4.1.2 to get information of above instrument.

4.7.4 Test Procedure

MEASUREMENT PROCEDURE REF

- Set resolution bandwidth (RBW) = 100kHz
- Set the video bandwidth (VBW) $\geq 3 \times$ RBW, Detector = Peak.
- Trace mode = max hold.
- Sweep = auto couple.
- Measure the maximum width of the emission that is constrained by the frequencies associated with the two amplitude points (upper and lower) that are attenuated by 6 dB relative to the maximum level measured in the fundamental emission

4.7.5 Deviation from Test Standard

No deviation.

4.7.6 EUT Operating Condition

The software provided by client to enable the EUT under transmission condition continuously at lowest, middle and highest channel frequencies individually.

4.7.7 Test Results

CDD Mode

802.11a

Channel	Frequency (MHz)	6dB Bandwidth (MHz)			Minimum Limit (MHz)	Pass / Fail
		Chain 0	Chain 1	Chain 2		
149	5745	16.36	16.37	16.36	0.5	PASS
157	5785	16.33	16.36	16.35	0.5	PASS
165	5825	16.37	16.33	16.37	0.5	PASS

Beamforming Mode

802.11ac (VHT20)

Channel	Frequency (MHz)	6dB Bandwidth (MHz)			Minimum Limit (MHz)	Pass / Fail
		Chain 0	Chain 1	Chain 2		
149	5745	17.18	17.28	17.09	0.5	PASS
157	5785	16.38	17.22	17.33	0.5	PASS
165	5825	17.60	17.34	17.38	0.5	PASS

802.11ac (VHT40)

Channel	Frequency (MHz)	6dB Bandwidth (MHz)			Minimum Limit (MHz)	Pass / Fail
		Chain 0	Chain 1	Chain 2		
151	5755	35.28	35.36	35.74	0.5	PASS
159	5795	35.26	35.38	35.37	0.5	PASS

802.11ac (VHT80)

Channel	Frequency (MHz)	6dB Bandwidth (MHz)			Minimum Limit (MHz)	Pass / Fail
		Chain 0	Chain 1	Chain 2		
155	5775	74.37	75.48	75.54	0.5	PASS

Spectrum Plot of Worst Value

802.11a_Chain 0 / CH157

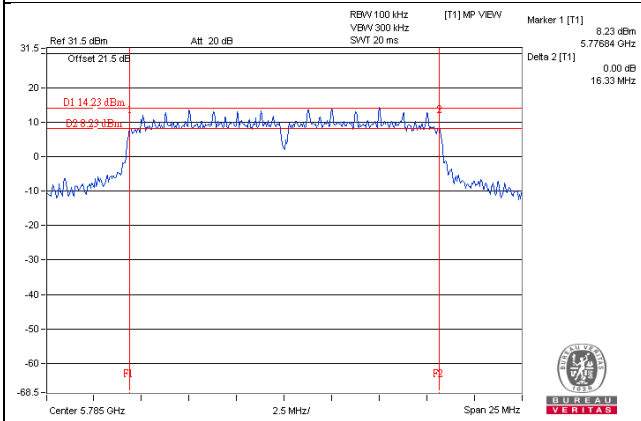

802.11ac (VHT20)_Chain 0 / CH157

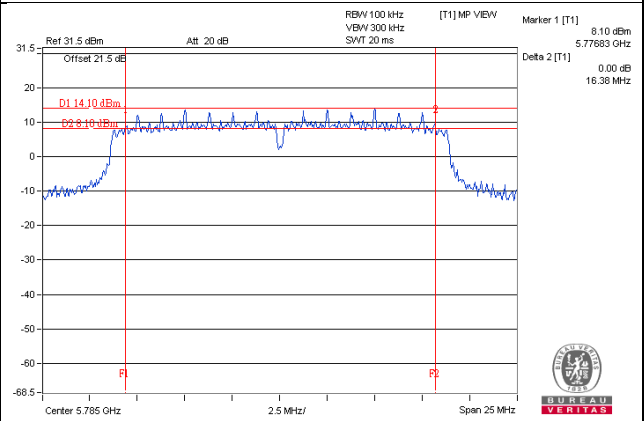

802.11ac (VHT40)_Chain 0 / CH159

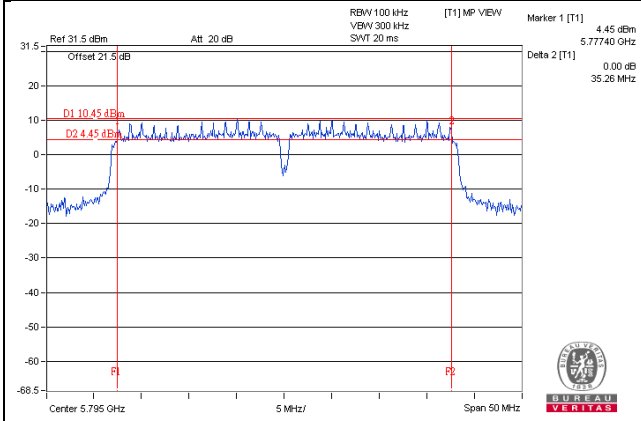

802.11ac (VHT80)_Chain 0 / CH155

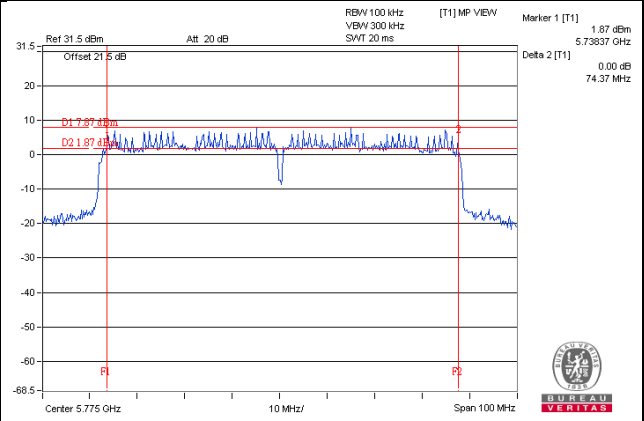

5 Pictures of Test Arrangements

Please refer to the attached file (Test Setup Photo).

Annex A- Radiated Out of Band Emission (OOBE) Measurement (For U-NII-3 band)

802.11a

CH 149 5745 MHz

Horizontal

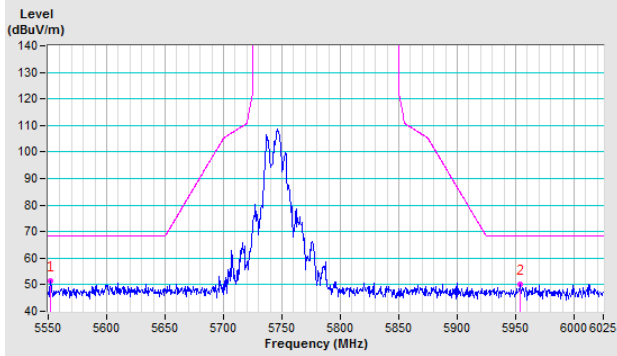

Vertical

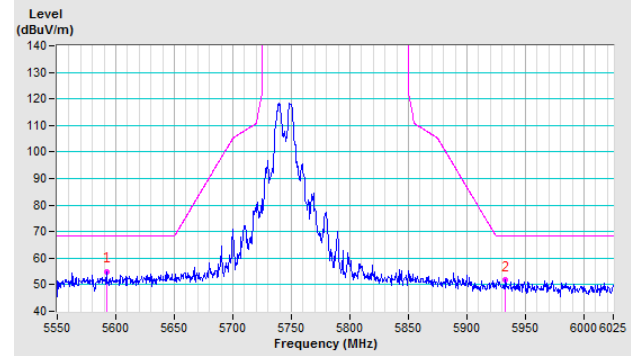

CH 157 5785 MHz

Horizontal

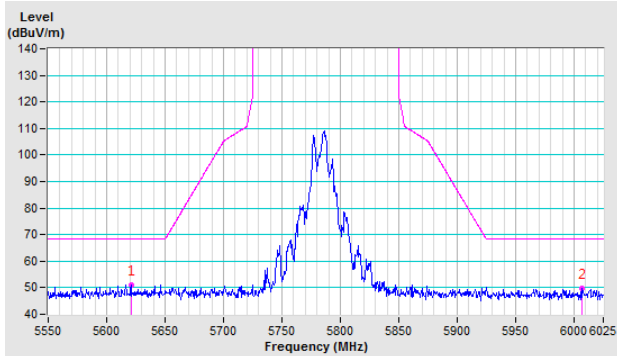

Vertical

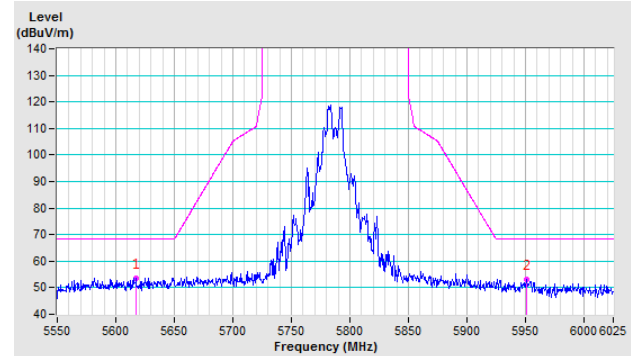

CH 165 5825 MHz

Horizontal

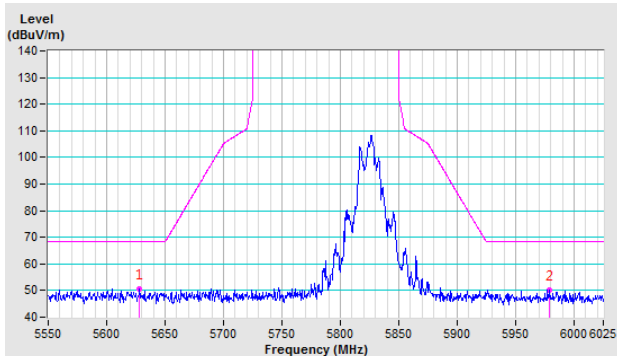

Vertical

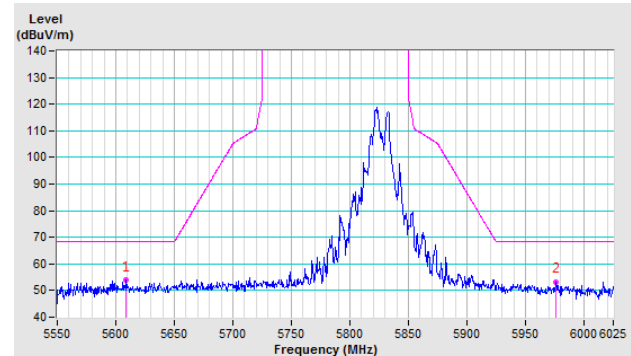

802.11ac (VHT20)

CH 149 5745 MHz

Horizontal

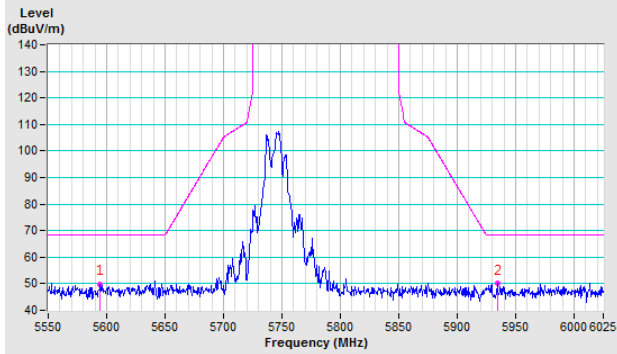

Vertical

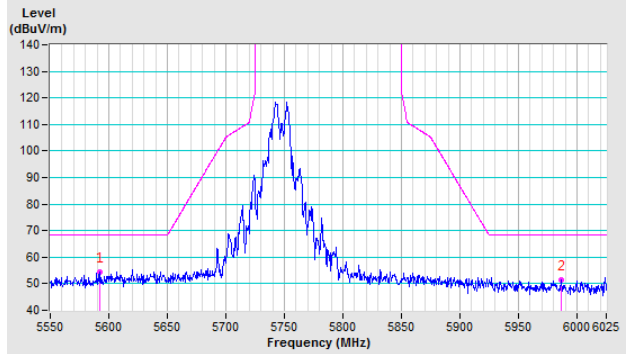

CH 157 5785 MHz

Horizontal

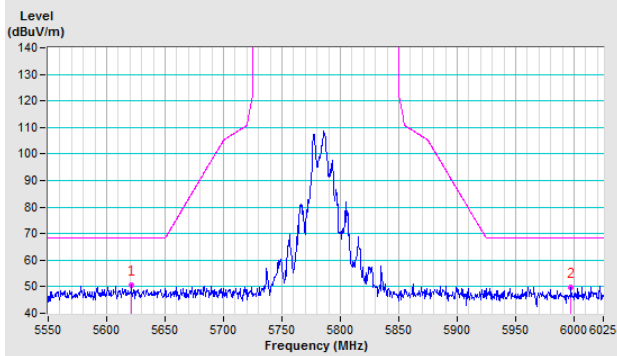

Vertical

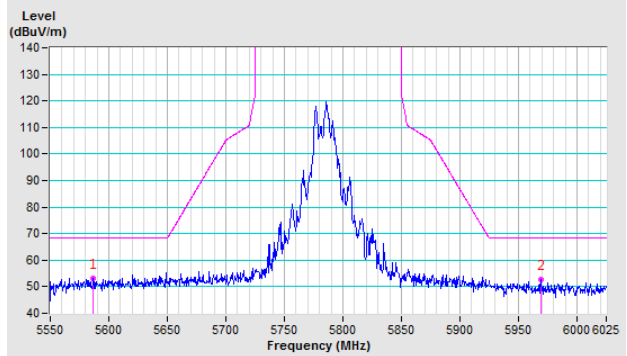

CH 165 5825 MHz

Horizontal

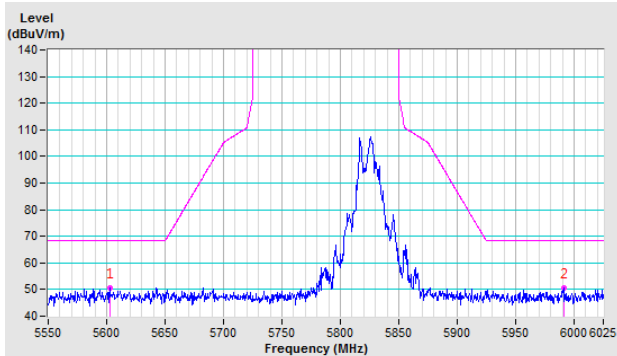

Vertical

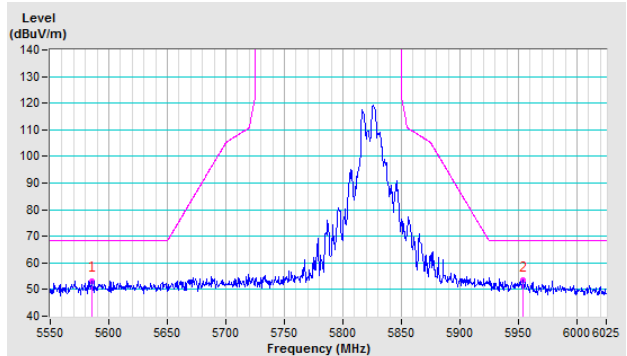

802.11ac (VHT40)

CH 151 5755 MHz

Horizontal

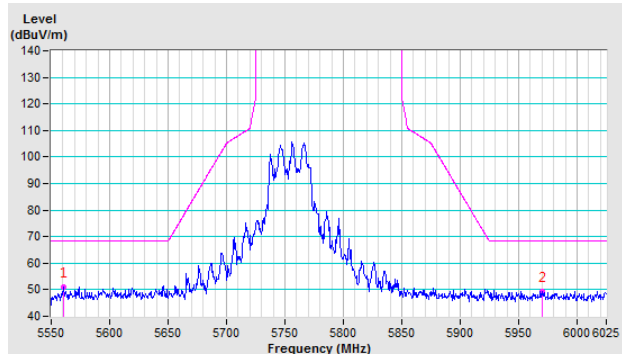

Vertical

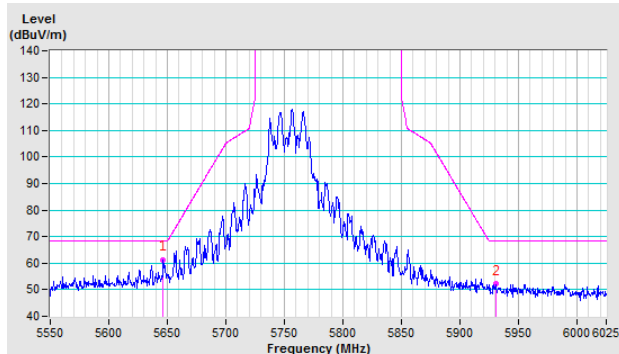

CH 159 5795 MHz

Horizontal

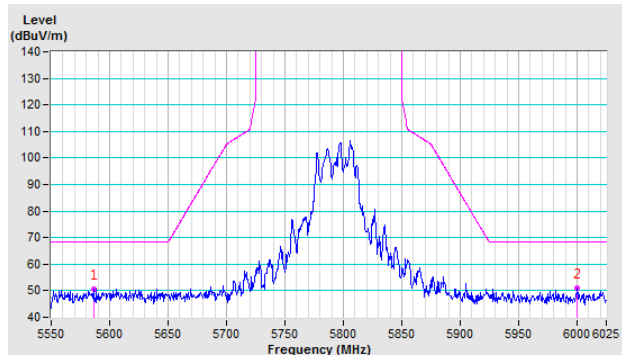

Vertical

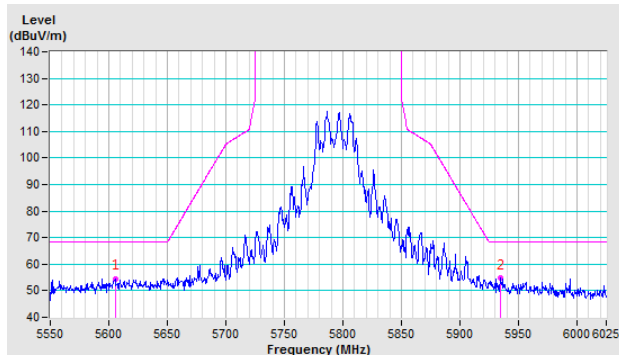

802.11ac (VHT80)

CH 155 5775 MHz

Horizontal

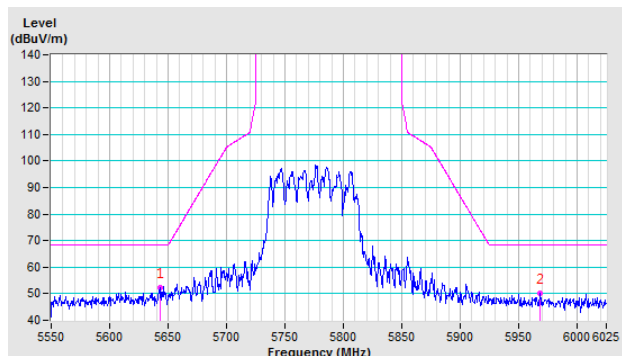

Vertical

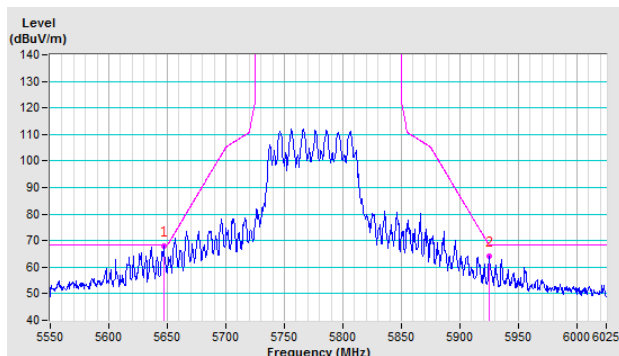

Appendix – Information on the Testing Laboratories

We, Bureau Veritas Consumer Products Services (H.K.) Ltd., Taoyuan Branch, were founded in 1988 to provide our best service in EMC, Radio, Telecom and Safety consultation. Our laboratories are accredited and approved according to ISO/IEC 17025.

If you have any comments, please feel free to contact us at the following:

Linko EMC/RF Lab

Tel: 886-2-26052180

Fax: 886-2-26051924

Hsin Chu EMC/RF/Telecom Lab

Tel: 886-3-6668565

Fax: 886-3-6668323

Hwa Ya EMC/RF/Safety Lab

Tel: 886-3-3183232

Fax: 886-3-3270892

Email: service.adt@tw.bureauveritas.com

Web Site: www.bureauveritas-adt.com

The address and road map of all our labs can be found in our web site also.

--- END ---