

FCC Test Report

Report No.: RF161121E02

FCC ID: PY316200352

Test Model: VML4030

Received Date: Nov. 21,2016

Test Date: Nov. 25 to Dec. 01, 2016

Issued Date: Dec. 15, 2016

Applicant: NETGEAR, Inc.

Address: 350 East Plumeria Drive San Jose, CA 95134

Issued By: Bureau Veritas Consumer Products Services (H.K.) Ltd., Taoyuan Branch
Hsin Chu Laboratory

Lab Address: E-2, No.1, Li Hsin 1st Road, Hsinchu Science Park, Hsinchu City 300,
Taiwan R.O.C.

Test Location (1): E-2, No.1, Li Hsin 1st Road, Hsinchu Science Park, Hsinchu City 300,
Taiwan R.O.C.

Test Location (2): No. 49, Ln. 206, Wende Rd., Shangshan Tsuen, Chiung Lin Hsiang, Hsin
Chu Hsien 307, Taiwan R.O.C.



This report is for your exclusive use. Any copying or replication of this report to or for any other person or entity, or use of our name or trademark, is permitted only with our prior written permission. This report sets forth our findings solely with respect to the test samples identified herein. The results set forth in this report are not indicative or representative of the quality or characteristics of the lot from which a test sample was taken or any similar or identical product unless specifically and expressly noted. Our report includes all of the tests requested by you and the results thereof based upon the information that you provided to us. You have 60 days from date of issuance of this report to notify us of any material error or omission caused by our negligence, provided, however, that such notice shall be in writing and shall specifically address the issue you wish to raise. A failure to raise such issue within the prescribed time shall constitute your unqualified acceptance of the completeness of this report, the tests conducted and the correctness of the report contents. Unless specific mention, the uncertainty of measurement has been explicitly taken into account to declare the compliance or non-compliance to the specification. The report must not be used by the client to claim product certification, approval, or endorsement by TAF or any government agencies.

Table of Contents

Release Control Record	4
1 Certificate of Conformity	5
2 Summary of Test Results	6
2.1 Measurement Uncertainty	6
2.2 Modification Record	6
3 General Information	7
3.1 General Description of EUT	7
3.2 Description of Test Modes	9
3.2.1 Test Mode Applicability and Tested Channel Detail	10
3.3 Duty Cycle of Test Signal	12
3.4 Description of Support Units	13
3.4.1 Configuration of System under Test	14
3.5 General Description of Applied Standards	15
4 Test Types and Results	16
4.1 Radiated Emission and Bandedge Measurement	16
4.1.1 Limits of Radiated Emission and Bandedge Measurement	16
4.1.2 Test Instruments	17
4.1.3 Test Procedures	18
4.1.4 Deviation from Test Standard	18
4.1.5 Test Setup	19
4.1.6 EUT Operating Conditions	20
4.1.7 Test Results	21
4.2 Conducted Emission Measurement	31
4.2.1 Limits of Conducted Emission Measurement	31
4.2.2 Test Instruments	31
4.2.3 Test Procedures	32
4.2.4 Deviation from Test Standard	32
4.2.5 Test Setup	32
4.2.6 EUT Operating Conditions	32
4.2.7 Test Results (Mode 1)	33
4.2.8 Test Results (Mode 2)	35
4.3 6dB Bandwidth Measurement	37
4.3.1 Limits of 6dB Bandwidth Measurement	37
4.3.2 Test Setup	37
4.3.3 Test Instruments	37
4.3.4 Test Procedure	37
4.3.5 Deviation from Test Standard	37
4.3.6 EUT Operating Conditions	37
4.3.7 Test Result	38
4.4 Conducted Output Power Measurement	40
4.4.1 Limits of Conducted Output Power Measurement	40
4.4.2 Test Setup	40
4.4.3 Test Instruments	40
4.4.4 Test Procedures	40
4.4.5 Deviation from Test Standard	40
4.4.6 EUT Operating Conditions	40
4.4.7 Test Results	41
4.5 Power Spectral Density Measurement	43
4.5.1 Limits of Power Spectral Density Measurement	43
4.5.2 Test Setup	43
4.5.3 Test Instruments	43
4.5.4 Test Procedure	43
4.5.5 Deviation from Test Standard	43

4.5.6 EUT Operating Condition	43
4.5.7 Test Results	44
4.6 Conducted Out of Band Emission Measurement	46
4.6.1 Limits of Conducted Out of Band Emission Measurement.....	46
4.6.2 Test Setup.....	46
4.6.3 Test Instruments	46
4.6.4 Test Procedure	46
4.6.5 Deviation from Test Standard	46
4.6.6 EUT Operating Condition	46
4.6.7 Test Results	46
5 Pictures of Test Arrangements.....	50
Appendix – Information on the Testing Laboratories	51

Release Control Record

Issue No.	Description	Date Issued
RF161121E02	Original release.	Dec. 15, 2016

1 Certificate of Conformity

Product: LTE Camera

Brand: NETGEAR

Test Model: VML4030

Sample Status: ENGINEERING SAMPLE

Applicant: NETGEAR, Inc.

Test Date: Nov. 25 to Dec. 01, 2016

Standards: 47 CFR FCC Part 15, Subpart C (Section 15.247)
ANSI C63.10: 2013

The above equipment has been tested by **Bureau Veritas Consumer Products Services (H.K.) Ltd., Taoyuan Branch**, and found compliance with the requirement of the above standards. The test record, data evaluation & Equipment Under Test (EUT) configurations represented herein are true and accurate accounts of the measurements of the sample's EMC characteristics under the conditions specified in this report.

Prepared by : Wendy Wu , **Date:** Dec. 15, 2016
Wendy Wu / Specialist

Approved by : May Chen , **Date:** Dec. 15, 2016
May Chen / Manager

2 Summary of Test Results

47 CFR FCC Part 15, Subpart C (SECTION 15.247)			
FCC Clause	Test Item	Result	Remarks
15.207	AC Power Conducted Emission	PASS	Meet the requirement of limit. Minimum passing margin is -8.70dB at 16.46484MHz.
15.205 / 15.209 / 15.247(d)	Radiated Emissions and Band Edge Measurement	PASS	Meet the requirement of limit. Minimum passing margin is -0.1dB at 2390.00MHz, 2483.50MHz.
15.247(d)	Antenna Port Emission	PASS	Meet the requirement of limit.
15.247(a)(2)	6dB bandwidth	PASS	Meet the requirement of limit.
15.247(b)	Conducted power	PASS	Meet the requirement of limit.
15.247(e)	Power Spectral Density	PASS	Meet the requirement of limit.
15.203	Antenna Requirement	PASS	Antenna connector is i-pex(MHF) not a standard connector.

2.1 Measurement Uncertainty

Where relevant, the following measurement uncertainty levels have been estimated for tests performed on the EUT as specified in CISPR 16-4-2:

Measurement	Frequency	Expanded Uncertainty (k=2) (±)
Conducted Emissions at mains ports	150kHz ~ 30MHz	1.83 dB
Radiated Emissions up to 1 GHz	30MHz ~ 1GHz	5.34 dB
Radiated Emissions above 1 GHz	1GHz ~ 6GHz	3.41 dB
	6GHz ~ 18GHz	3.49 dB
	18GHz ~ 40GHz	3.30 dB

2.2 Modification Record

There were no modifications required for compliance.

3 General Information

3.1 General Description of EUT

Product	LTE Camera
Brand	NETGEAR
Test Model	VML4030
Status of EUT	ENGINEERING SAMPLE
Power Supply Rating	5Vdc or 9Vdc from power adapter or 7.2Vdc from battery
Modulation Type	CCK, DQPSK, DBPSK for DSSS 64QAM, 16QAM, QPSK, BPSK for OFDM
Modulation Technology	DSSS, OFDM
Transfer Rate	802.11b: up to 11Mbps 802.11g: up to 54Mbps 802.11n: up to 72.2Mbps
Operating Frequency	2.412 ~ 2.462GHz
Number of Channel	11
Output Power	358.096mW
Antenna Type	Refer to Note
Antenna Connector	Refer to Note
Accessory Device	Adapter x 1, Battery x 1
Data Cable Supplied	USB cable x 1 (unshielded, 2m)

Note:

1. There are WLAN, WWAN(LTE) and GPS technology used for the EUT.
2. EUT contains a certified module which FCC ID: MCLT77W595.
3. The EUT could be supplied from a power adapter and a battery as following table:

Adapter			
Brand	Model No.	Spec.	P/N
NETGEAR	AD2090320	Input: 100-240Vac, 0.5A, 50/60Hz Output: 5V or 9V, 2A or 2.23A	332-10905-01
Battery			
Brand	Model No.	Spec.	P/N
NETGEAR	A-2	7.2Vdc, 26.35Wh, 3660mAh	308-10030-01

4. The EUT was pre-tested for radiated test under following test modes:

Pre-test Mode	Power
Mode A	USB interface (from adapter)
Mode B	USB interface (from laptop)
Mode C	Battery

From the above modes, the worst radiated test was found in **Mode B**. Therefore only the test data of the modes were recorded in this report.

5. The antenna provided to the EUT, please refer to the following table:

For WLAN								
Antenna Set.	Brand	Model	Antenna Gain (dBi)	Frequency range (GHz)	Antenna Type	Connector Type	Cable Loss (dB)	Cable Length (mm)
1	Master Wave	9 8P4ZMIPF000	2 2	2.4~2.4835	Metal	NA	NA	NA
For LTE								
Antenna Set.	Brand	Model	Antenna Gain (dBi)	Frequency range (MHz)	Antenna Type	Connector Type	Cable Loss (dB)	Cable Length (mm)
2	NA	NA	0	699.7 ~ 850	PIFA	NA	NA	110+/-5
			-1	850 ~ 960				
			2	1710 ~ 1800				
			1	1800 ~ 2000				
			0.8	2500 ~ 2700				
			2	2500 ~ 2700				
For GPS								
Antenna No.	Brand	Model	Antenna Gain (dBi)	Frequency range (MHz)	Antenna Type	Connector Type	Cable Loss (dB)	Cable Length (mm)
3	NA	NA	2	1510 ~ 1575.42	slot	NA	NA	35+/-5

6. The EUT incorporates a SISO function.

MODULATION MODE	DATA RATE (MCS)	TX & RX CONFIGURATION	
802.11b	1~11Mbps	1TX diversity	1RX diversity
802.11g	6~54Mbps	1TX diversity	1RX diversity
802.11n (HT20)	MCS 0~7	1TX diversity	1RX diversity

7. The above EUT information is declared by manufacturer and for more detailed features description, please refer to the manufacturer's specifications or user's manual.

3.2 Description of Test Modes

11 channels are provided for 802.11b, 802.11g and 802.11n (HT20):

Channel	Frequency	Channel	Frequency
1	2412MHz	7	2442MHz
2	2417MHz	8	2447MHz
3	2422MHz	9	2452MHz
4	2427MHz	10	2457MHz
5	2432MHz	11	2462MHz
6	2437MHz		

3.2.1 Test Mode Applicability and Tested Channel Detail

EUT CONFIGURE MODE	APPLICABLE TO				DESCRIPTION
	RE \geq 1G	RE<1G	PLC	APCM	
1	√	√	√	√	With laptop
2	-	-	√	-	With adapter

Where RE \geq 1G: Radiated Emission above 1GHz & Bandedge Measurement
 RE<1G: Radiated Emission below 1GHz
 PLC: Power Line Conducted Emission
 APCM: Antenna Port Conducted Measurement

NOTE: The EUT had been pre-tested on the positioned of each 2 axis. The worst case was found when positioned on **X-plane**.

NOTE: "-" means no effect.

Radiated Emission Test (Above 1GHz):

- Pre-Scan has been conducted to determine the worst-case mode from all possible combinations between available modulations, data rates and antenna ports (if EUT with antenna diversity architecture).
- Following channel(s) was (were) selected for the final test as listed below.

MODE	AVAILABLE CHANNEL	TESTED CHANNEL	MODULATION TECHNOLOGY	MODULATION TYPE	DATA RATE (Mbps)
802.11b	1 to 11	1, 6, 11	DSSS	DBPSK	1
802.11g	1 to 11	1, 6, 11	OFDM	BPSK	6
802.11n (HT20)	1 to 11	1, 6, 11	OFDM	BPSK	6.5

Radiated Emission Test (Below 1GHz):

- Pre-Scan has been conducted to determine the worst-case mode from all possible combinations between available modulations, data rates and antenna ports (if EUT with antenna diversity architecture).
- Following channel(s) was (were) selected for the final test as listed below.

MODE	AVAILABLE CHANNEL	TESTED CHANNEL	MODULATION TECHNOLOGY	MODULATION TYPE	DATA RATE (Mbps)
802.11n (HT20)	1 to 11	6	OFDM	BPSK	6.5

Power Line Conducted Emission Test:

- Pre-Scan has been conducted to determine the worst-case mode from all possible combinations between available modulations, data rates and antenna ports (if EUT with antenna diversity architecture).
- Following channel(s) was (were) selected for the final test as listed below.

MODE	AVAILABLE CHANNEL	TESTED CHANNEL	MODULATION TECHNOLOGY	MODULATION TYPE	DATA RATE (Mbps)
802.11n (HT20)	1 to 11	6	OFDM	BPSK	6.5

Antenna Port Conducted Measurement:

- This item includes all test value of each mode, but only includes spectrum plot of worst value of each mode.
- Pre-Scan has been conducted to determine the worst-case mode from all possible combinations between available modulations, data rates and antenna ports (if EUT with antenna diversity architecture).
- Following channel(s) was (were) selected for the final test as listed below.

MODE	AVAILABLE CHANNEL	TESTED CHANNEL	MODULATION TECHNOLOGY	MODULATION TYPE	DATA RATE (Mbps)
802.11b	1 to 11	1, 6, 11	DSSS	DBPSK	1
802.11g	1 to 11	1, 6, 11	OFDM	BPSK	6
802.11n (HT20)	1 to 11	1, 6, 11	OFDM	BPSK	6.5

Test Condition:

APPLICABLE TO	ENVIRONMENTAL CONDITIONS	INPUT POWER	TESTED BY
RE \geq 1G	23deg. C, 66%RH	120Vac, 60Hz	Terry Huang
RE $<$ 1G	24deg. C, 67%RH	120Vac, 60Hz	Terry Huang
PLC	25deg. C, 75%RH	120Vac, 60Hz	Andy Ho
APCM	25deg. C, 60%RH	120Vac, 60Hz	Gary Cheng

3.3 Duty Cycle of Test Signal

If duty cycle of test signal is $\geq 98\%$, duty factor is not required.

802.11b: Duty cycle = $12.456/12.531 = 0.994$

802.11g: Duty cycle = $2.063/2.085 = 0.989$

802.11n (HT20): Duty cycle = $1.922/1.941 = 0.99$

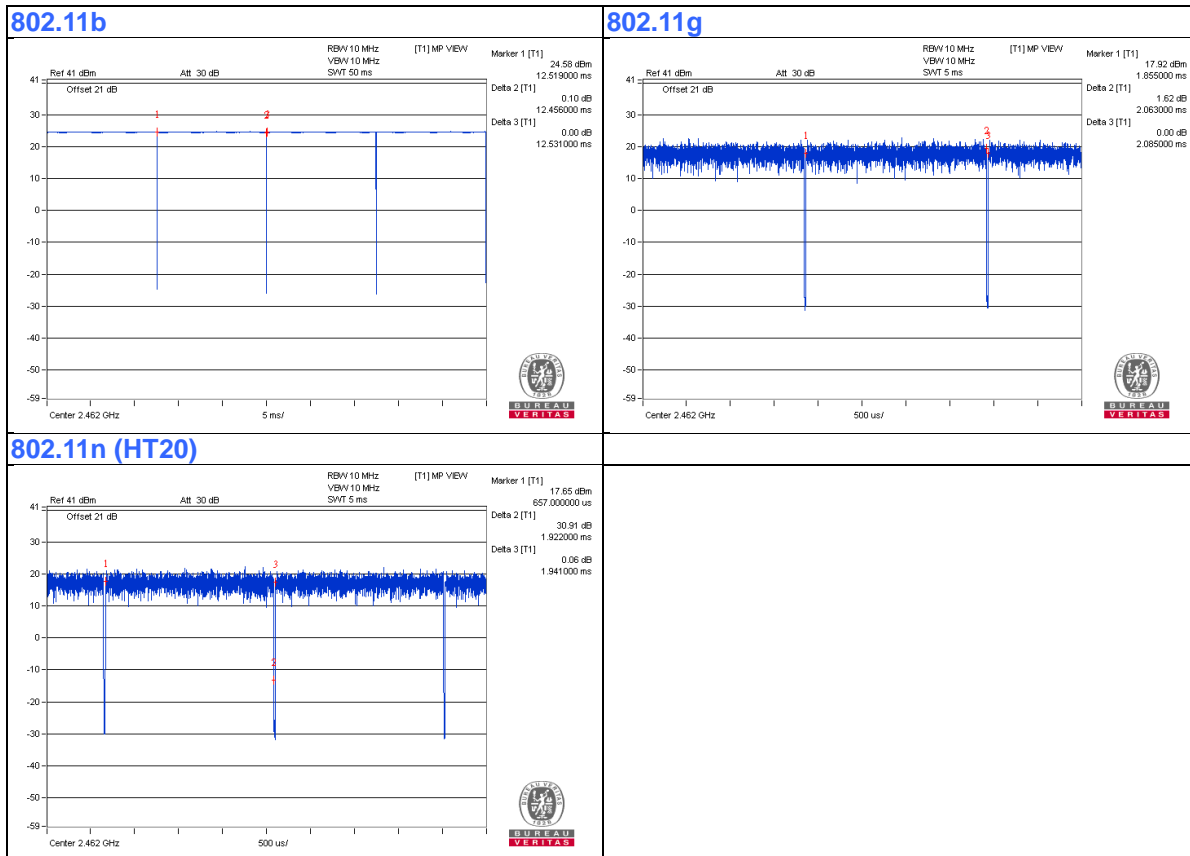

3.4 Description of Support Units

The EUT has been tested as an independent unit together with other necessary accessories or support units. The following support units or accessories were used to form a representative test configuration during the tests.

ID	Product	Brand	Model No.	Serial No.	FCC ID	Remarks
A.	Laptop	DELL	E6420	B92T3R1	FCC DoC	Provided by Lab
B.	microSD Card	Sandisk	NA	NA	NA	Provided by Lab
C.	SIM Card	NA	NA	NA	NA	Provided by Lab

Note:

1. All power cords of the above support units are non-shielded (1.8m).

ID	Descriptions	Qty.	Length (m)	Shielding (Yes/No)	Cores (Qty.)	Remarks
1.	USB Cable	1	1.6	Yes	0	Provided by Lab

3.4.1 Configuration of System under Test

Laptop Mode:

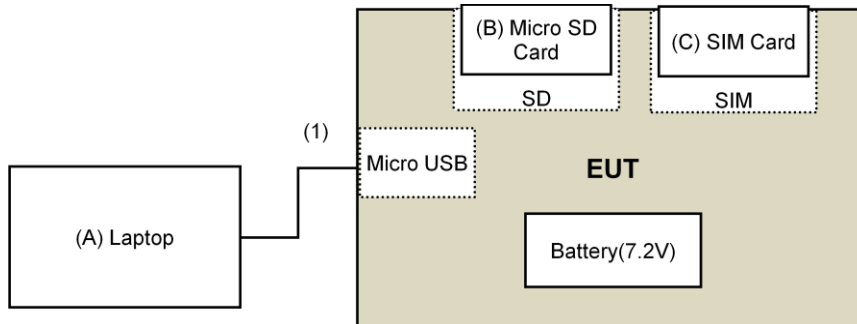

Adapter Mode:

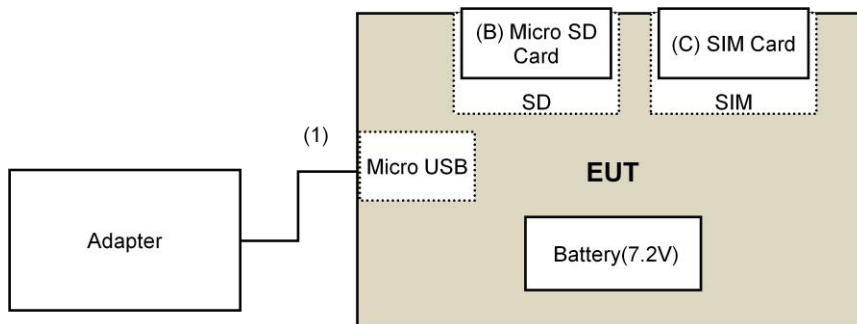

3.5 General Description of Applied Standards

The EUT is a RF Product. According to the specifications of the manufacturer, it must comply with the requirements of the following standards:

FCC Part 15, Subpart C (15.247)
KDB 558074 D01 DTS Meas Guidance v03r05
ANSI C63.10-2013

All test items have been performed and recorded as per the above standards.

NOTE: The EUT has been verified to comply with the requirements of FCC Part 15, Subpart B, Class B (DoC). The test report has been issued separately.

4 Test Types and Results

4.1 Radiated Emission and Bandedge Measurement

4.1.1 Limits of Radiated Emission and Bandedge Measurement

Radiated emissions which fall in the restricted bands must comply with the radiated emission limits specified as below table. Other emissions shall be at least 20dB below the highest level of the desired power:

Frequencies (MHz)	Field Strength (microvolts/meter)	Measurement Distance (meters)
0.009 ~ 0.490	2400/F(kHz)	300
0.490 ~ 1.705	24000/F(kHz)	30
1.705 ~ 30.0	30	30
30 ~ 88	100	3
88 ~ 216	150	3
216 ~ 960	200	3
Above 960	500	3

NOTE:

1. The lower limit shall apply at the transition frequencies.
2. Emission level (dBuV/m) = 20 log Emission level (uV/m).
3. For frequencies above 1000MHz, the field strength limits are based on average detector, however, the peak field strength of any emission shall not exceed the maximum permitted average limits, specified above by more than 20dB under any condition of modulation.

4.1.2 Test Instruments

DESCRIPTION & MANUFACTURER	MODEL NO.	SERIAL NO.	CALIBRATED DATE	CALIBRATED UNTIL
Test Receiver Keysight	N9038A	MY54450088	July 20, 2016	July 19, 2017
Pre-Amplifier ^(*) EMCI	EMC001340	980142	Jan. 20, 2016	Jan. 19, 2018
Loop Antenna ^(*) Electro-Metrics	EM-6879	264	Dec. 16, 2014	Dec. 15, 2016
RF Cable	NA	LOOPCAB-001 LOOPCAB-002	Jan. 18, 2016	Jan. 17, 2017
Pre-Amplifier Mini-Circuits	ZFL-1000VH2B	AMP-ZFL-01	Nov. 10, 2016	Nov. 09, 2017
Trilog Broadband Antenna SCHWARZBECK	VULB 9168	9168-406	Jan. 04, 2016	Jan. 03, 2017
RF Cable	8D	966-4-1 966-4-2 966-4-3	Apr. 02, 2016	Apr. 01, 2017
Fixed attenuator Mini-Circuits	UNAT-5+	PAD-3m-4-01	Oct. 05, 2016	Oct. 04, 2017
Horn_Antenna SCHWARZBECK	BBHA 9120D	9120D-783	Jan. 19, 2016	Jan. 18, 2017
Pre-Amplifier Agilent	8449B	3008A01922	Sep. 18, 2016	Sep. 17, 2017
RF Cable	EMC104-SM-SM-2000 EMC104-SM-SM-5000 EMC104-SM-SM-5000	150318 150323 150324	Mar. 30, 2016	Mar. 29, 2017
Pre-Amplifier EMCI	EMC184045	980143	Jan. 15, 2016	Jan. 14, 2017
Horn_Antenna SCHWARZBECK	BBHA 9170	BBHA9170608	Jan. 08, 2016	Jan. 07, 2017
RF Cable	SUCOFLEX 102	36432/2 36441/2	Jan. 16, 2016	Jan. 15, 2017
Software	ADT_Radiated_V8.7.08	NA	NA	NA
Antenna Tower & Turn Table Max-Full	MF-7802	MF780208410	NA	NA
Boresight Antenna Fixture	FBA-01	FBA-SIP02	NA	NA
Spectrum Analyzer R&S	FSv40	100964	June 28, 2016	June 27, 2017
Power meter Anritsu	ML2495A	1014008	May 5, 2016	May 4, 2017
Power sensor Anritsu	MA2411B	0917122	May 5, 2016	May 4, 2017

Note:

1. The calibration interval of the above test instruments is 12 months and the calibrations are traceable to NML/ROC and NIST/USA.
2. *The calibration interval of the above test instruments is 24 months and the calibrations are traceable to NML/ROC and NIST/USA.
3. The test was performed in 966 Chamber No. 4.
4. The FCC Site Registration No. is 292998
5. The CANADA Site Registration No. is 20331-2
- 6 Loop antenna was used for all emissions below 30 MHz.
7. Tested Date: Nov. 25 to 26, 2016

4.1.3 Test Procedures

For Radiated emission below 30MHz

- a. The EUT was placed on the top of a rotating table 0.8 meters above the ground at a 3 meter chamber room. The table was rotated 360 degrees to determine the position of the highest radiation.
- b. The EUT was set 3 meters away from the interference-receiving antenna, which was mounted on the top of a variable-height antenna tower.
- c. Both X and Y axes of the antenna are set to make the measurement.
- d. For each suspected emission, the EUT was arranged to its worst case and the rotatable table was turned from 0 degrees to 360 degrees to find the maximum reading.
- e. The test-receiver system was set to Quasi-Peak Detect Function and Specified Bandwidth with Maximum Hold Mode.

NOTE:

1. The resolution bandwidth and video bandwidth of test receiver/spectrum analyzer is 9kHz at frequency below 30MHz.

For Radiated emission above 30MHz

- a. The EUT was placed on the top of a rotating table 0.8 meters (for 30MHz ~ 1GHz) / 1.5 meters (for above 1GHz) above the ground at 3 meter chamber room for test. The table was rotated 360 degrees to determine the position of the highest radiation.
- b. The EUT was set 3 meters away from the interference-receiving antenna, which was mounted on the top of a variable-height antenna tower.
- c. The height of antenna is varied from one meter to four meters above the ground to determine the maximum value of the field strength. Both horizontal and vertical polarizations of the antenna are set to make the measurement.
- d. For each suspected emission, the EUT was arranged to its worst case and then the antenna was tuned to heights from 1 meter to 4 meters and the rotatable table was turned from 0 degrees to 360 degrees to find the maximum reading.
- e. The test-receiver system was set to quasi-peak detect function and specified bandwidth with maximum hold mode when the test frequency is below 1 GHz.
- f. The test-receiver system was set to peak and average detect function and specified bandwidth with maximum hold mode when the test frequency is above 1 GHz. If the peak reading value also meets average limit, measurement with the average detector is unnecessary.

Note:

1. The resolution bandwidth and video bandwidth of test receiver/spectrum analyzer is 120kHz for Quasi-peak detection (QP) at frequency below 1GHz.
2. The resolution bandwidth of test receiver/spectrum analyzer is 1 MHz and the video bandwidth is 3 MHz for Peak detection (PK) at frequency above 1GHz.
3. The resolution bandwidth of test receiver/spectrum analyzer is 1MHz and the video bandwidth is $\geq 1/T$ (Duty cycle < 98%) or 10Hz (Duty cycle $\geq 98\%$) for Average detection (AV) at frequency above 1GHz.
4. All modes of operation were investigated and the worst-case emissions are reported.

4.1.4 Deviation from Test Standard

No deviation.

4.1.5 Test Setup

For Radiated emission below 30MHz

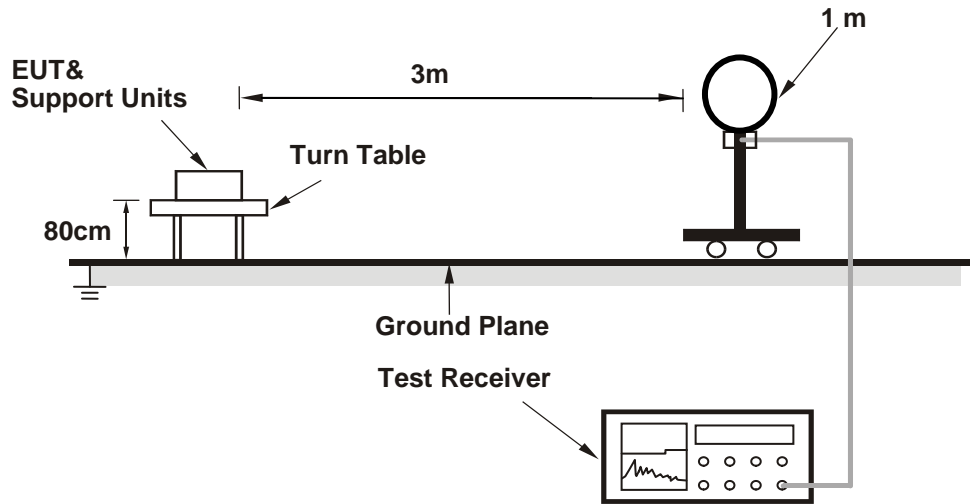

For Radiated emission 30MHz to 1GHz

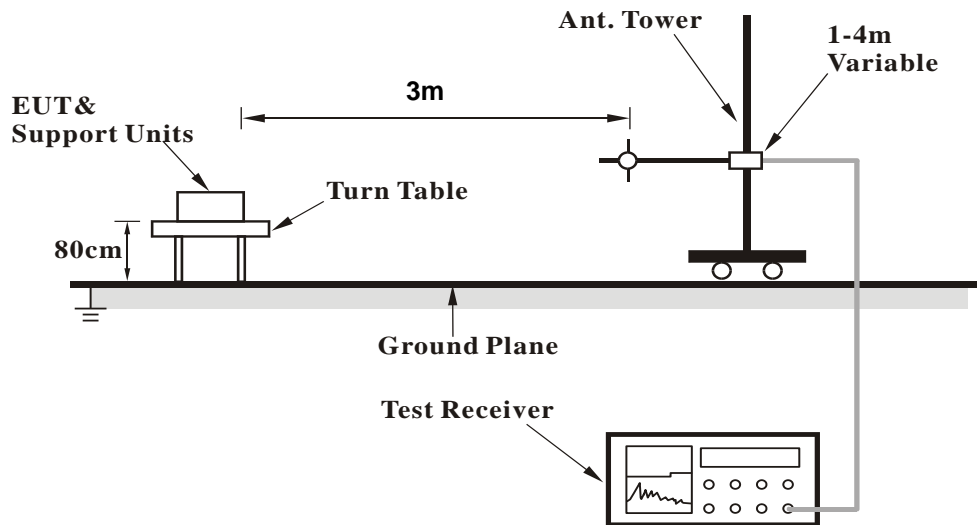

For Radiated emission above 1GHz

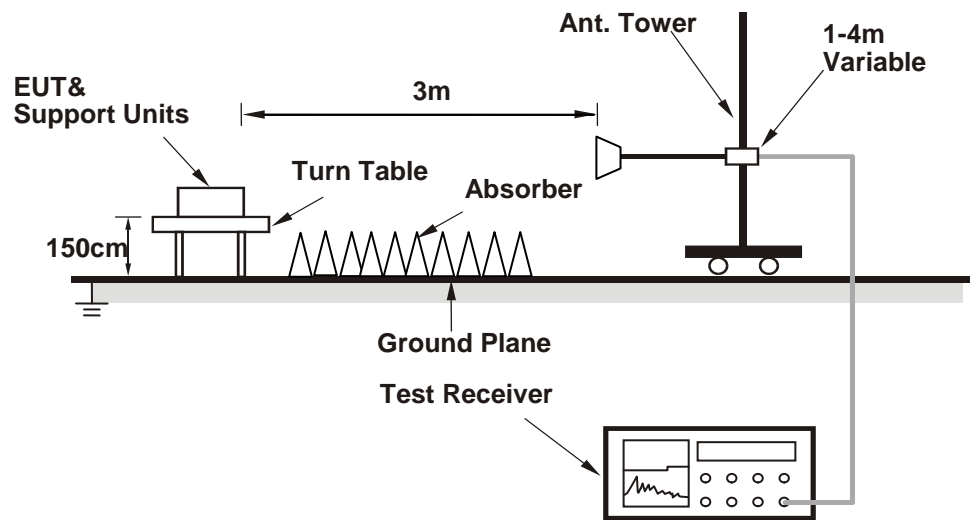

For the actual test configuration, please refer to the attached file (Test Setup Photo).

4.1.6 EUT Operating Conditions

- a. Connected the EUT with the laptop which is placed on remote site.
- b. Controlling software (wl pasted TX.txt command) has been activated to set the EUT on specific status.

4.1.7 Test Results

Above 1GHz Data:

802.11b

CHANNEL	TX Channel 1	DETECTOR FUNCTION	Peak (PK)
FREQUENCY RANGE	1GHz ~ 25GHz		Average (AV)

ANTENNA POLARITY & TEST DISTANCE: HORIZONTAL AT 3 M

NO.	FREQ. (MHz)	EMISSION LEVEL (dBuV/m)	LIMIT (dBuV/m)	MARGIN (dB)	ANTENNA HEIGHT (m)	TABLE ANGLE (Degree)	RAW VALUE (dBuV)	CORRECTION FACTOR (dB/m)
1	2385.30	59.5 PK	74.0	-14.5	1.27 H	245	65.2	-5.7
2	2385.30	53.1 AV	54.0	-0.9	1.27 H	245	58.8	-5.7
3	*2412.00	105.3 PK			1.27 H	245	110.9	-5.6
4	*2412.00	103.0 AV			1.27 H	245	108.6	-5.6
5	4824.00	41.1 PK	74.0	-32.9	1.65 H	37	40.3	0.8
6	4824.00	29.3 AV	54.0	-24.7	1.65 H	37	28.5	0.8

ANTENNA POLARITY & TEST DISTANCE: VERTICAL AT 3 M

NO.	FREQ. (MHz)	EMISSION LEVEL (dBuV/m)	LIMIT (dBuV/m)	MARGIN (dB)	ANTENNA HEIGHT (m)	TABLE ANGLE (Degree)	RAW VALUE (dBuV)	CORRECTION FACTOR (dB/m)
1	2385.30	55.7 PK	74.0	-18.3	2.27 V	232	61.4	-5.7
2	2385.30	48.6 AV	54.0	-5.4	2.27 V	232	54.3	-5.7
3	*2412.00	103.6 PK			2.27 V	232	109.2	-5.6
4	*2412.00	101.3 AV			2.27 V	232	106.9	-5.6
5	4824.00	40.6 PK	74.0	-33.4	1.86 V	304	39.8	0.8
6	4824.00	29.5 AV	54.0	-24.5	1.86 V	304	28.7	0.8

REMARKS:

1. Emission Level(dBuV/m) = Raw Value(dBuV) + Correction Factor(dB/m)
2. Correction Factor(dB/m) = Antenna Factor(dB/m) + Cable Factor(dB) – Pre-Amplifier Factor(dB)
3. The other emission levels were very low against the limit.
4. Margin value = Emission Level – Limit value
5. " * ": Fundamental frequency.

CHANNEL	TX Channel 6	DETECTOR FUNCTION	Peak (PK)
FREQUENCY RANGE	1GHz ~ 25GHz		Average (AV)

ANTENNA POLARITY & TEST DISTANCE: HORIZONTAL AT 3 M

NO.	FREQ. (MHz)	EMISSION LEVEL (dBuV/m)	LIMIT (dBuV/m)	MARGIN (dB)	ANTENNA HEIGHT (m)	TABLE ANGLE (Degree)	RAW VALUE (dBuV)	CORRECTION FACTOR (dB/m)
1	2384.70	51.2 PK	74.0	-22.8	1.00 H	67	56.9	-5.7
2	2384.70	42.4 AV	54.0	-11.6	1.00 H	67	48.1	-5.7
3	*2437.00	106.4 PK			1.00 H	67	111.9	-5.5
4	*2437.00	104.1 AV			1.00 H	67	109.6	-5.5
5	2485.70	54.6 PK	74.0	-19.4	1.00 H	67	60.1	-5.5
6	2485.70	46.5 AV	54.0	-7.5	1.00 H	67	52.0	-5.5
7	4874.00	41.4 PK	74.0	-32.6	2.34 H	59	40.5	0.9
8	4874.00	29.1 AV	54.0	-24.9	2.34 H	59	28.2	0.9
9	7311.00	47.1 PK	74.0	-26.9	1.25 H	198	39.7	7.4
10	7311.00	36.5 AV	54.0	-17.5	1.25 H	198	29.1	7.4

ANTENNA POLARITY & TEST DISTANCE: VERTICAL AT 3 M

NO.	FREQ. (MHz)	EMISSION LEVEL (dBuV/m)	LIMIT (dBuV/m)	MARGIN (dB)	ANTENNA HEIGHT (m)	TABLE ANGLE (Degree)	RAW VALUE (dBuV)	CORRECTION FACTOR (dB/m)
1	2384.70	47.9 PK	74.0	-26.1	1.00 V	109	53.6	-5.7
2	2384.70	38.4 AV	54.0	-15.6	1.00 V	109	44.1	-5.7
3	*2437.00	104.9 PK			1.00 V	109	110.4	-5.5
4	*2437.00	102.7 AV			1.00 V	109	108.2	-5.5
5	2485.70	48.9 PK	74.0	-25.1	1.00 V	109	54.4	-5.5
6	2485.70	39.8 AV	54.0	-14.2	1.00 V	109	45.3	-5.5
7	4874.00	41.8 PK	74.0	-32.2	1.66 V	38	40.9	0.9
8	4874.00	29.8 AV	54.0	-24.2	1.66 V	38	28.9	0.9
9	7311.00	49.2 PK	74.0	-24.8	3.17 V	360	41.8	7.4
10	7311.00	42.9 AV	54.0	-11.1	3.17 V	360	35.5	7.4

REMARKS:

1. Emission Level(dBuV/m) = Raw Value(dBuV) + Correction Factor(dB/m)
2. Correction Factor(dB/m) = Antenna Factor(dB/m) + Cable Factor(dB) – Pre-Amplifier Factor(dB)
3. The other emission levels were very low against the limit.
4. Margin value = Emission Level – Limit value
5. " * ": Fundamental frequency.

CHANNEL	TX Channel 11	DETECTOR FUNCTION	Peak (PK)
FREQUENCY RANGE	1GHz ~ 25GHz		Average (AV)

ANTENNA POLARITY & TEST DISTANCE: HORIZONTAL AT 3 M

NO.	FREQ. (MHz)	EMISSION LEVEL (dBuV/m)	LIMIT (dBuV/m)	MARGIN (dB)	ANTENNA HEIGHT (m)	TABLE ANGLE (Degree)	RAW VALUE (dBuV)	CORRECTION FACTOR (dB/m)
1	*2462.00	106.4 PK			1.01 H	49	111.8	-5.4
2	*2462.00	104.2 AV			1.01 H	49	109.6	-5.4
3	2484.70	60.3 PK	74.0	-13.7	1.01 H	49	65.8	-5.5
4	2484.70	53.8 AV	54.0	-0.2	1.01 H	49	59.3	-5.5
5	4924.00	41.0 PK	74.0	-33.0	1.65 H	25	39.9	1.1
6	4924.00	29.3 AV	54.0	-24.7	1.65 H	25	28.2	1.1
7	7386.00	48.8 PK	74.0	-25.2	3.16 H	360	41.2	7.6
8	7386.00	42.7 AV	54.0	-11.3	3.16 H	360	35.1	7.6

ANTENNA POLARITY & TEST DISTANCE: VERTICAL AT 3 M

NO.	FREQ. (MHz)	EMISSION LEVEL (dBuV/m)	LIMIT (dBuV/m)	MARGIN (dB)	ANTENNA HEIGHT (m)	TABLE ANGLE (Degree)	RAW VALUE (dBuV)	CORRECTION FACTOR (dB/m)
1	*2462.00	105.5 PK			2.41 V	95	110.9	-5.4
2	*2462.00	103.5 AV			2.41 V	95	108.9	-5.4
3	2484.70	58.0 PK	74.0	-16.0	2.41 V	95	63.5	-5.5
4	2484.70	51.9 AV	54.0	-2.1	2.41 V	95	57.4	-5.5
5	4924.00	40.9 PK	74.0	-33.1	1.83 V	308	39.8	1.1
6	4924.00	31.1 AV	54.0	-22.9	1.83 V	308	30.0	1.1
7	7386.00	49.7 PK	74.0	-24.3	3.01 V	360	42.1	7.6
8	7386.00	42.3 AV	54.0	-11.7	3.01 V	360	34.7	7.6

REMARKS:

1. Emission Level(dBuV/m) = Raw Value(dBuV) + Correction Factor(dB/m)
2. Correction Factor(dB/m) = Antenna Factor(dB/m) + Cable Factor(dB) – Pre-Amplifier Factor(dB)
3. The other emission levels were very low against the limit.
4. Margin value = Emission Level – Limit value
5. " * ": Fundamental frequency.

802.11g

CHANNEL	TX Channel 1	DETECTOR FUNCTION	Peak (PK)
FREQUENCY RANGE	1GHz ~ 25GHz		Average (AV)

ANTENNA POLARITY & TEST DISTANCE: HORIZONTAL AT 3 M

NO.	FREQ. (MHz)	EMISSION LEVEL (dBuV/m)	LIMIT (dBuV/m)	MARGIN (dB)	ANTENNA HEIGHT (m)	TABLE ANGLE (Degree)	RAW VALUE (dBuV)	CORRECTION FACTOR (dB/m)
1	2390.00	72.7 PK	74.0	-1.3	1.25 H	246	78.4	-5.7
2	2390.00	53.9 AV	54.0	-0.1	1.25 H	246	59.6	-5.7
3	*2412.00	104.7 PK			1.25 H	246	110.3	-5.6
4	*2412.00	93.5 AV			1.25 H	246	99.1	-5.6
5	4824.00	41.3 PK	74.0	-32.7	1.69 H	38	40.5	0.8
6	4824.00	29.2 AV	54.0	-24.8	1.69 H	38	28.4	0.8

ANTENNA POLARITY & TEST DISTANCE: VERTICAL AT 3 M

NO.	FREQ. (MHz)	EMISSION LEVEL (dBuV/m)	LIMIT (dBuV/m)	MARGIN (dB)	ANTENNA HEIGHT (m)	TABLE ANGLE (Degree)	RAW VALUE (dBuV)	CORRECTION FACTOR (dB/m)
1	2390.00	69.3 PK	74.0	-4.7	1.09 V	126	75.0	-5.7
2	2390.00	51.1 AV	54.0	-2.9	1.09 V	126	56.8	-5.7
3	*2412.00	101.7 PK			1.09 V	126	107.3	-5.6
4	*2412.00	91.9 AV			1.09 V	126	97.5	-5.6
5	4824.00	45.8 PK	74.0	-28.2	2.03 V	19	45.0	0.8
6	4824.00	30.1 AV	54.0	-23.9	2.03 V	19	29.3	0.8

REMARKS:

1. Emission Level(dBuV/m) = Raw Value(dBuV) + Correction Factor(dB/m)
2. Correction Factor(dB/m) = Antenna Factor(dB/m) + Cable Factor(dB) – Pre-Amplifier Factor(dB)
3. The other emission levels were very low against the limit.
4. Margin value = Emission Level – Limit value
5. " * ": Fundamental frequency.

CHANNEL	TX Channel 6	DETECTOR FUNCTION	Peak (PK)
FREQUENCY RANGE	1GHz ~ 25GHz		Average (AV)

ANTENNA POLARITY & TEST DISTANCE: HORIZONTAL AT 3 M

NO.	FREQ. (MHz)	EMISSION LEVEL (dBuV/m)	LIMIT (dBuV/m)	MARGIN (dB)	ANTENNA HEIGHT (m)	TABLE ANGLE (Degree)	RAW VALUE (dBuV)	CORRECTION FACTOR (dB/m)
1	2390.00	64.8 PK	74.0	-9.2	1.01 H	67	70.5	-5.7
2	2390.00	45.8 AV	54.0	-8.2	1.01 H	67	51.5	-5.7
3	*2437.00	109.1 PK			1.01 H	67	114.6	-5.5
4	*2437.00	97.9 AV			1.01 H	67	103.4	-5.5
5	2483.50	70.6 PK	74.0	-3.4	1.01 H	67	76.1	-5.5
6	2483.50	48.8 AV	54.0	-5.2	1.01 H	67	54.3	-5.5
7	4874.00	41.6 PK	74.0	-32.4	3.35 H	265	40.7	0.9
8	4874.00	29.6 AV	54.0	-24.4	3.35 H	265	28.7	0.9
9	7311.00	47.3 PK	74.0	-26.7	2.76 H	208	39.9	7.4
10	7311.00	34.8 AV	54.0	-19.2	2.76 H	208	27.4	7.4

ANTENNA POLARITY & TEST DISTANCE: VERTICAL AT 3 M

NO.	FREQ. (MHz)	EMISSION LEVEL (dBuV/m)	LIMIT (dBuV/m)	MARGIN (dB)	ANTENNA HEIGHT (m)	TABLE ANGLE (Degree)	RAW VALUE (dBuV)	CORRECTION FACTOR (dB/m)
1	2390.00	61.9 PK	74.0	-12.1	1.06 V	122	67.6	-5.7
2	2390.00	44.5 AV	54.0	-9.5	1.06 V	122	50.2	-5.7
3	*2437.00	106.5 PK			1.06 V	122	112.0	-5.5
4	*2437.00	96.5 AV			1.06 V	122	102.0	-5.5
5	2483.50	67.1 PK	74.0	-6.9	1.06 V	122	72.6	-5.5
6	2483.50	45.7 AV	54.0	-8.3	1.06 V	122	51.2	-5.5
7	4874.00	41.8 PK	74.0	-32.2	2.26 V	87	40.9	0.9
8	4874.00	30.5 AV	54.0	-23.5	2.26 V	87	29.6	0.9
9	7311.00	46.2 PK	74.0	-27.8	1.08 V	309	38.8	7.4
10	7311.00	35.2 AV	54.0	-18.8	1.08 V	309	27.8	7.4

REMARKS:

1. Emission Level(dBuV/m) = Raw Value(dBuV) + Correction Factor(dB/m)
2. Correction Factor(dB/m) = Antenna Factor(dB/m) + Cable Factor(dB) – Pre-Amplifier Factor(dB)
3. The other emission levels were very low against the limit.
4. Margin value = Emission Level – Limit value
5. " * ": Fundamental frequency.

CHANNEL	TX Channel 11	DETECTOR FUNCTION	Peak (PK)
FREQUENCY RANGE	1GHz ~ 25GHz		Average (AV)

ANTENNA POLARITY & TEST DISTANCE: HORIZONTAL AT 3 M

NO.	FREQ. (MHz)	EMISSION LEVEL (dBuV/m)	LIMIT (dBuV/m)	MARGIN (dB)	ANTENNA HEIGHT (m)	TABLE ANGLE (Degree)	RAW VALUE (dBuV)	CORRECTION FACTOR (dB/m)
1	*2462.00	104.6 PK			1.04 H	58	110.0	-5.4
2	*2462.00	93.1 AV			1.04 H	58	98.5	-5.4
3	2483.50	73.8 PK	74.0	-0.2	1.04 H	58	79.3	-5.5
4	2483.50	51.0 AV	54.0	-3.0	1.04 H	58	56.5	-5.5
5	4924.00	41.5 PK	74.0	-32.5	3.33 H	250	40.4	1.1
6	4924.00	29.3 AV	54.0	-24.7	3.33 H	250	28.2	1.1
7	7386.00	47.1 PK	74.0	-26.9	2.80 H	202	39.5	7.6
8	7386.00	34.4 AV	54.0	-19.6	2.80 H	202	26.8	7.6

ANTENNA POLARITY & TEST DISTANCE: VERTICAL AT 3 M

NO.	FREQ. (MHz)	EMISSION LEVEL (dBuV/m)	LIMIT (dBuV/m)	MARGIN (dB)	ANTENNA HEIGHT (m)	TABLE ANGLE (Degree)	RAW VALUE (dBuV)	CORRECTION FACTOR (dB/m)
1	*2462.00	102.3 PK			1.00 V	120	107.7	-5.4
2	*2462.00	91.6 AV			1.00 V	120	97.0	-5.4
3	2483.50	69.8 PK	74.0	-4.2	1.00 V	120	75.3	-5.5
4	2483.50	48.3 AV	54.0	-5.7	1.00 V	120	53.8	-5.5
5	4924.00	40.2 PK	74.0	-33.8	1.34 V	202	39.1	1.1
6	4924.00	28.9 AV	54.0	-25.1	1.34 V	202	27.8	1.1
7	7386.00	45.5 PK	74.0	-28.5	3.08 V	223	37.9	7.6
8	7386.00	34.8 AV	54.0	-19.2	3.08 V	223	27.2	7.6

REMARKS:

1. Emission Level(dBuV/m) = Raw Value(dBuV) + Correction Factor(dB/m)
2. Correction Factor(dB/m) = Antenna Factor(dB/m) + Cable Factor(dB) – Pre-Amplifier Factor(dB)
3. The other emission levels were very low against the limit.
4. Margin value = Emission Level – Limit value
5. " * ": Fundamental frequency.

802.11n (HT20)

CHANNEL	TX Channel 1	DETECTOR FUNCTION	Peak (PK)
FREQUENCY RANGE	1GHz ~ 25GHz		Average (AV)

ANTENNA POLARITY & TEST DISTANCE: HORIZONTAL AT 3 M

NO.	FREQ. (MHz)	EMISSION LEVEL (dBuV/m)	LIMIT (dBuV/m)	MARGIN (dB)	ANTENNA HEIGHT (m)	TABLE ANGLE (Degree)	RAW VALUE (dBuV)	CORRECTION FACTOR (dB/m)
1	2390.00	73.8 PK	74.0	-0.2	1.50 H	244	79.5	-5.7
2	2390.00	53.9 AV	54.0	-0.1	1.50 H	244	59.6	-5.7
3	*2412.00	103.9 PK			1.50 H	244	109.5	-5.6
4	*2412.00	92.5 AV			1.50 H	244	98.1	-5.6
5	4824.00	41.4 PK	74.0	-32.6	3.30 H	268	40.6	0.8
6	4824.00	29.7 AV	54.0	-24.3	3.30 H	268	28.9	0.8

ANTENNA POLARITY & TEST DISTANCE: VERTICAL AT 3 M

NO.	FREQ. (MHz)	EMISSION LEVEL (dBuV/m)	LIMIT (dBuV/m)	MARGIN (dB)	ANTENNA HEIGHT (m)	TABLE ANGLE (Degree)	RAW VALUE (dBuV)	CORRECTION FACTOR (dB/m)
1	2390.00	69.4 PK	74.0	-4.6	3.31 V	162	75.1	-5.7
2	2390.00	49.2 AV	54.0	-4.8	3.31 V	162	54.9	-5.7
3	*2412.00	100.6 PK			3.31 V	162	106.2	-5.6
4	*2412.00	90.3 AV			3.31 V	162	95.9	-5.6
5	4824.00	40.9 PK	74.0	-33.1	1.31 V	217	40.1	0.8
6	4824.00	29.3 AV	54.0	-24.7	1.31 V	217	28.5	0.8

REMARKS:

1. Emission Level(dBuV/m) = Raw Value(dBuV) + Correction Factor(dB/m)
2. Correction Factor(dB/m) = Antenna Factor(dB/m) + Cable Factor(dB) – Pre-Amplifier Factor(dB)
3. The other emission levels were very low against the limit.
4. Margin value = Emission Level – Limit value
5. " * ": Fundamental frequency.

CHANNEL	TX Channel 6	DETECTOR FUNCTION	Peak (PK)
FREQUENCY RANGE	1GHz ~ 25GHz		Average (AV)

ANTENNA POLARITY & TEST DISTANCE: HORIZONTAL AT 3 M

NO.	FREQ. (MHz)	EMISSION LEVEL (dBuV/m)	LIMIT (dBuV/m)	MARGIN (dB)	ANTENNA HEIGHT (m)	TABLE ANGLE (Degree)	RAW VALUE (dBuV)	CORRECTION FACTOR (dB/m)
1	2390.00	67.0 PK	74.0	-7.0	1.20 H	242	72.7	-5.7
2	2390.00	48.5 AV	54.0	-5.5	1.20 H	242	54.2	-5.7
3	*2437.00	109.1 PK			1.20 H	242	114.6	-5.5
4	*2437.00	97.8 AV			1.20 H	242	103.3	-5.5
5	2483.50	70.9 PK	74.0	-3.1	1.20 H	242	76.4	-5.5
6	2483.50	46.8 AV	54.0	-7.2	1.20 H	242	52.3	-5.5
7	4874.00	41.9 PK	74.0	-32.1	3.41 H	273	41.0	0.9
8	4874.00	30.2 AV	54.0	-23.8	3.41 H	273	29.3	0.9
9	7311.00	47.4 PK	74.0	-26.6	2.78 H	203	40.0	7.4
10	7311.00	34.3 AV	54.0	-19.7	2.78 H	203	26.9	7.4

ANTENNA POLARITY & TEST DISTANCE: VERTICAL AT 3 M

NO.	FREQ. (MHz)	EMISSION LEVEL (dBuV/m)	LIMIT (dBuV/m)	MARGIN (dB)	ANTENNA HEIGHT (m)	TABLE ANGLE (Degree)	RAW VALUE (dBuV)	CORRECTION FACTOR (dB/m)
1	2390.00	61.4 PK	74.0	-12.6	3.28 V	153	67.1	-5.7
2	2390.00	42.7 AV	54.0	-11.3	3.28 V	153	48.4	-5.7
3	*2437.00	106.2 PK			3.28 V	153	111.7	-5.5
4	*2437.00	95.7 AV			3.28 V	153	101.2	-5.5
5	2483.50	66.1 PK	74.0	-7.9	3.28 V	153	71.6	-5.5
6	2483.50	43.4 AV	54.0	-10.6	3.28 V	153	48.9	-5.5
7	4874.00	40.3 PK	74.0	-33.7	1.36 V	204	39.4	0.9
8	4874.00	30.6 AV	54.0	-23.4	1.36 V	204	29.7	0.9
9	7311.00	45.2 PK	74.0	-28.8	3.09 V	225	37.8	7.4
10	7311.00	34.5 AV	54.0	-19.5	3.09 V	225	27.1	7.4

REMARKS:

1. Emission Level(dBuV/m) = Raw Value(dBuV) + Correction Factor(dB/m)
2. Correction Factor(dB/m) = Antenna Factor(dB/m) + Cable Factor(dB) – Pre-Amplifier Factor(dB)
3. The other emission levels were very low against the limit.
4. Margin value = Emission Level – Limit value
5. " * ": Fundamental frequency.

CHANNEL	TX Channel 11	DETECTOR FUNCTION	Peak (PK)
FREQUENCY RANGE	1GHz ~ 25GHz		Average (AV)

ANTENNA POLARITY & TEST DISTANCE: HORIZONTAL AT 3 M

NO.	FREQ. (MHz)	EMISSION LEVEL (dBuV/m)	LIMIT (dBuV/m)	MARGIN (dB)	ANTENNA HEIGHT (m)	TABLE ANGLE (Degree)	RAW VALUE (dBuV)	CORRECTION FACTOR (dB/m)
1	*2462.00	103.4 PK			1.46 H	68	108.8	-5.4
2	*2462.00	92.3 AV			1.46 H	68	97.7	-5.4
3	2483.50	73.9 PK	74.0	-0.1	1.46 H	68	79.4	-5.5
4	2483.50	51.0 AV	54.0	-3.0	1.46 H	68	56.5	-5.5
5	4924.00	41.0 PK	74.0	-33.0	3.37 H	279	39.9	1.1
6	4924.00	29.1 AV	54.0	-24.9	3.37 H	279	28.0	1.1
7	7386.00	47.1 PK	74.0	-26.9	2.79 H	208	39.5	7.6
8	7386.00	33.8 AV	54.0	-20.2	2.79 H	208	26.2	7.6

ANTENNA POLARITY & TEST DISTANCE: VERTICAL AT 3 M

NO.	FREQ. (MHz)	EMISSION LEVEL (dBuV/m)	LIMIT (dBuV/m)	MARGIN (dB)	ANTENNA HEIGHT (m)	TABLE ANGLE (Degree)	RAW VALUE (dBuV)	CORRECTION FACTOR (dB/m)
1	*2462.00	100.8 PK			3.36 V	156	106.2	-5.4
2	*2462.00	90.5 AV			3.36 V	156	95.9	-5.4
3	2483.50	69.4 PK	74.0	-4.6	3.36 V	156	74.9	-5.5
4	2483.50	47.9 AV	54.0	-6.1	3.36 V	156	53.4	-5.5
5	4924.00	40.5 PK	74.0	-33.5	1.29 V	190	39.4	1.1
6	4924.00	29.0 AV	54.0	-25.0	1.29 V	190	27.9	1.1
7	7386.00	45.4 PK	74.0	-28.6	2.96 V	220	37.8	7.6
8	7386.00	33.5 AV	54.0	-20.5	2.96 V	220	25.9	7.6

REMARKS:

1. Emission Level(dBuV/m) = Raw Value(dBuV) + Correction Factor(dB/m)
2. Correction Factor(dB/m) = Antenna Factor(dB/m) + Cable Factor(dB) – Pre-Amplifier Factor(dB)
3. The other emission levels were very low against the limit.
4. Margin value = Emission Level – Limit value
5. " * ": Fundamental frequency.

Below 1GHz Data:

802.11n (HT20)

CHANNEL	TX Channel 6	DETECTOR FUNCTION	Quasi-Peak (QP)
FREQUENCY RANGE	9kHz ~ 1GHz		

ANTENNA POLARITY & TEST DISTANCE: HORIZONTAL AT 3 M

NO.	FREQ. (MHz)	EMISSION LEVEL (dBuV/m)	LIMIT (dBuV/m)	MARGIN (dB)	ANTENNA HEIGHT (m)	TABLE ANGLE (Degree)	RAW VALUE (dBuV)	CORRECTION FACTOR (dB/m)
1	44.16	24.3 QP	40.0	-15.7	1.00 H	0	32.4	-8.1
2	199.24	32.2 QP	43.5	-11.3	1.00 H	280	43.8	-11.6
3	234.91	37.8 QP	46.0	-8.2	1.00 H	239	48.1	-10.3
4	267.41	32.7 QP	46.0	-13.3	1.00 H	45	41.4	-8.7
5	717.75	35.2 QP	46.0	-10.8	1.00 H	20	33.9	1.3
6	796.57	37.6 QP	46.0	-8.4	1.00 H	349	35.0	2.6

ANTENNA POLARITY & TEST DISTANCE: VERTICAL AT 3 M

NO.	FREQ. (MHz)	EMISSION LEVEL (dBuV/m)	LIMIT (dBuV/m)	MARGIN (dB)	ANTENNA HEIGHT (m)	TABLE ANGLE (Degree)	RAW VALUE (dBuV)	CORRECTION FACTOR (dB/m)
1	44.14	29.9 QP	40.0	-10.1	1.00 V	306	38.0	-8.1
2	199.22	26.1 QP	43.5	-17.4	1.00 V	346	37.7	-11.6
3	235.54	33.3 QP	46.0	-12.7	1.00 V	317	43.5	-10.2
4	389.29	27.3 QP	46.0	-18.7	1.00 V	212	32.7	-5.4
5	499.82	29.9 QP	46.0	-16.1	1.00 V	217	32.3	-2.4
6	719.94	29.5 QP	46.0	-16.5	1.00 V	327	28.2	1.3

REMARKS:

1. Emission Level(dBuV/m) = Raw Value(dBuV) + Correction Factor(dB/m)
2. Correction Factor(dB/m) = Antenna Factor(dB/m) + Cable Factor(dB) – Pre-Amplifier Factor(dB)
3. The other emission levels were very low against the limit.
4. Margin value = Emission Level – Limit value

4.2 Conducted Emission Measurement

4.2.1 Limits of Conducted Emission Measurement

Frequency (MHz)	Conducted Limit (dBuV)	
	Quasi-peak	Average
0.15 - 0.5	66 - 56	56 - 46
0.50 - 5.0	56	46
5.0 - 30.0	60	50

Note: 1. The lower limit shall apply at the transition frequencies.

2. The limit decreases in line with the logarithm of the frequency in the range of 0.15 to 0.50MHz.

4.2.2 Test Instruments

DESCRIPTION & MANUFACTURER	MODEL NO.	SERIAL NO.	CALIBRATED DATE	CALIBRATED UNTIL
Test Receiver R&S	ESCS 30	847124/029	Oct. 24, 2016	Oct. 23, 2017
Line-Impedance Stabilization Network (for EUT) R&S	ESH3-Z5	848773/004	Oct. 26, 2016	Oct. 25, 2017
Line-Impedance Stabilization Network (for Peripheral) R&S	ENV216	100072	June 13, 2016	June 12, 2017
RF Cable	5D-FB	COCCAB-001	Sep. 30, 2016	Sep. 29, 2017
10 dB PAD Mini-Circuits	HAT-10+	CONATT-004	June 20, 2016	June 19, 2017
Software BVADT	BVADT_Cond_ V7.3.7.4	NA	NA	NA

Note:

1. The calibration interval of the above test instruments are 12 months and the calibrations are traceable to NML/ROC and NIST/USA.
2. The test was performed in Shielded Room No. 1.
- 3 Tested Date: Dec. 01, 2016

4.2.3 Test Procedures

- The EUT was placed 0.4 meters from the conducting wall of the shielded room with EUT being connected to the power mains through a line impedance stabilization network (LISN). Other support units were connected to the power mains through another LISN. The two LISNs provide 50 ohm/ 50uH of coupling impedance for the measuring instrument.
- Both lines of the power mains connected to the EUT were checked for maximum conducted interference.
- The frequency range from 150kHz to 30MHz was searched. Emission levels under (Limit - 20dB) was not recorded.

NOTE: The resolution bandwidth and video bandwidth of test receiver is 9kHz for quasi-peak detection (QP) and average detection (AV) at frequency 0.15MHz-30MHz.

4.2.4 Deviation from Test Standard

No deviation.

4.2.5 Test Setup

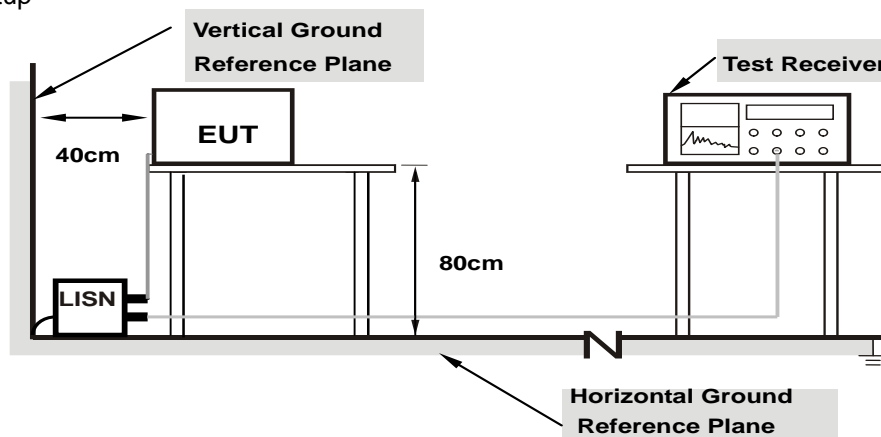

Note: 1.Support units were connected to second LISN.

For the actual test configuration, please refer to the attached file (Test Setup Photo).

4.2.6 EUT Operating Conditions

Same as 4.1.6.

4.2.7 Test Results (Mode 1)

Phase	Line (L)	Detector Function	Quasi-Peak (QP) / Average (AV)
-------	----------	-------------------	--------------------------------

No	Freq. [MHz]	Corr.	Reading Value		Emission Level		Limit		Margin	
		Factor (dB)	[dB (uV)]		[dB (uV)]		[dB (uV)]		(dB)	
			Q.P.	AV.	Q.P.	AV.	Q.P.	AV.	Q.P.	AV.
1	0.15000	10.19	44.53	22.43	54.72	32.62	66.00	56.00	-11.28	-23.38
2	0.16953	10.19	38.69	26.30	48.88	36.49	64.98	54.98	-16.10	-18.49
3	0.26719	10.20	24.01	7.22	34.21	17.42	61.20	51.20	-26.99	-33.78
4	3.97266	10.24	19.58	5.39	29.82	15.63	56.00	46.00	-26.18	-30.37
5	16.46484	11.15	30.55	30.15	41.70	41.30	60.00	50.00	-18.30	-8.70
6	21.16797	11.39	22.91	22.75	34.30	34.14	60.00	50.00	-25.70	-15.86

REMARKS:

1. Q.P. and AV. are abbreviations of quasi-peak and average individually.
2. The emission levels of other frequencies were very low against the limit.
3. Margin value = Emission level - Limit value
4. Correction factor = Insertion loss + Cable loss
5. Emission Level = Correction Factor + Reading Value.

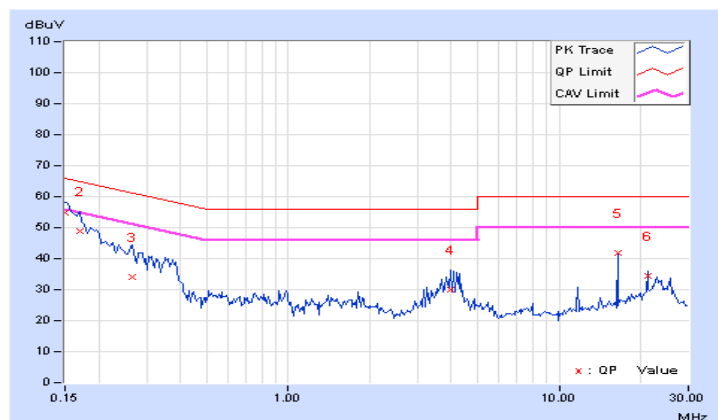

Phase	Neutral (N)	Detector Function	Quasi-Peak (QP) / Average (AV)
-------	-------------	-------------------	--------------------------------

No	Freq. [MHz]	Corr.	Reading Value		Emission Level		Limit		Margin	
		Factor	[dB (uV)]		[dB (uV)]		[dB (uV)]		(dB)	
		(dB)	Q.P.	AV.	Q.P.	AV.	Q.P.	AV.	Q.P.	AV.
1	0.15000	10.18	41.65	24.35	51.83	34.53	66.00	56.00	-14.17	-21.47
2	0.15781	10.18	39.26	18.72	49.44	28.90	65.58	55.58	-16.14	-26.68
3	0.19687	10.16	32.19	17.31	42.35	27.47	63.74	53.74	-21.39	-26.27
4	0.29453	10.18	24.16	13.10	34.34	23.28	60.40	50.40	-26.06	-27.12
5	3.92188	10.16	16.93	4.62	27.09	14.78	56.00	46.00	-28.91	-31.22
6	16.46484	10.94	30.81	30.28	41.75	41.22	60.00	50.00	-18.25	-8.78

REMARKS:

1. Q.P. and AV. are abbreviations of quasi-peak and average individually.
2. The emission levels of other frequencies were very low against the limit.
3. Margin value = Emission level - Limit value
4. Correction factor = Insertion loss + Cable loss
5. Emission Level = Correction Factor + Reading Value.

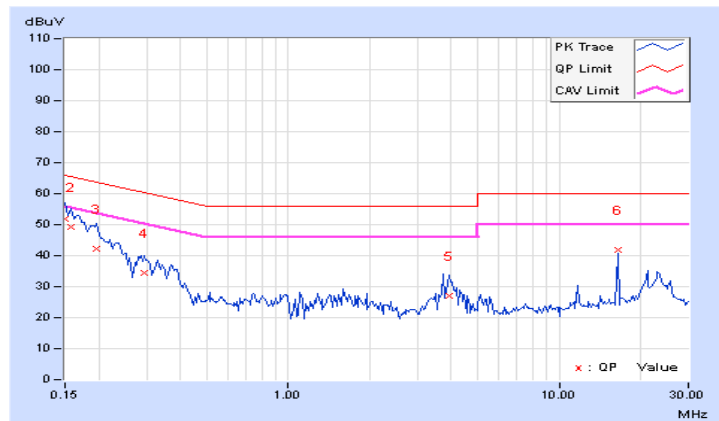

4.2.8 Test Results (Mode 2)

Phase	Line (L)	Detector Function	Quasi-Peak (QP) / Average (AV)
-------	----------	-------------------	--------------------------------

No	Freq. [MHz]	Corr.	Reading Value		Emission Level		Limit		Margin	
		Factor	[dB (uV)]		[dB (uV)]		[dB (uV)]		(dB)	
	(dB)	Q.P.	AV.	Q.P.	AV.	Q.P.	AV.	Q.P.	AV.	
1	0.15391	10.20	21.56	2.23	31.76	12.43	65.79	55.79	-34.03	-43.36
2	0.19687	10.20	19.36	0.70	29.56	10.90	63.74	53.74	-34.18	-42.84
3	0.23203	10.21	14.40	0.92	24.61	11.13	62.38	52.38	-37.77	-41.25
4	0.27500	10.22	9.76	0.79	19.98	11.01	60.97	50.97	-40.99	-39.96
5	0.36875	10.23	11.82	2.52	22.05	12.75	58.53	48.53	-36.48	-35.78
6	24.00000	11.76	14.77	14.19	26.53	25.95	60.00	50.00	-33.47	-24.05

REMARKS:

1. Q.P. and AV. are abbreviations of quasi-peak and average individually.
2. The emission levels of other frequencies were very low against the limit.
3. Margin value = Emission level - Limit value
4. Correction factor = Insertion loss + Cable loss
5. Emission Level = Correction Factor + Reading Value.

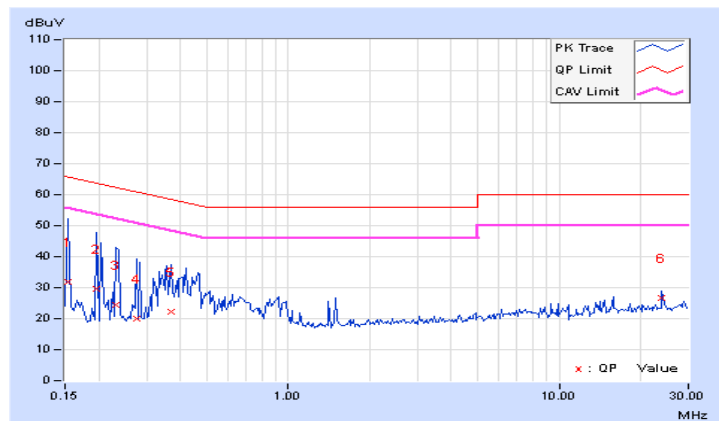

Phase	Neutral (N)	Detector Function	Quasi-Peak (QP) / Average (AV)
-------	-------------	-------------------	--------------------------------

No	Freq. [MHz]	Corr.	Reading Value		Emission Level		Limit		Margin	
		Factor (dB)	[dB (uV)]		[dB (uV)]		[dB (uV)]		(dB)	
			Q.P.	AV.	Q.P.	AV.	Q.P.	AV.	Q.P.	AV.
1	0.15000	10.19	23.93	1.53	34.12	11.72	66.00	56.00	-31.88	-44.28
2	0.18906	10.17	11.98	0.78	22.15	10.95	64.08	54.08	-41.93	-43.13
3	0.48203	10.24	13.17	4.83	23.41	15.07	56.30	46.30	-32.89	-31.23
4	0.87656	10.26	3.83	0.73	14.09	10.99	56.00	46.00	-41.91	-35.01
5	1.52734	10.29	4.21	0.19	14.50	10.48	56.00	46.00	-41.50	-35.52
6	24.00000	11.39	14.45	13.63	25.84	25.02	60.00	50.00	-34.16	-24.98

REMARKS:

1. Q.P. and AV. are abbreviations of quasi-peak and average individually.
2. The emission levels of other frequencies were very low against the limit.
3. Margin value = Emission level - Limit value
4. Correction factor = Insertion loss + Cable loss
5. Emission Level = Correction Factor + Reading Value.

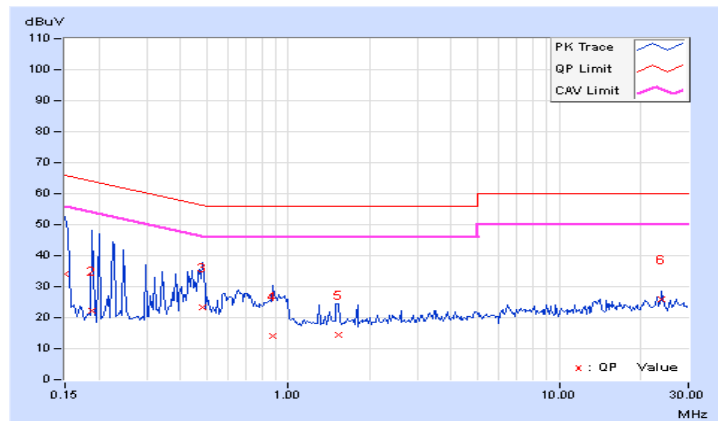

4.3 6dB Bandwidth Measurement

4.3.1 Limits of 6dB Bandwidth Measurement

The minimum of 6dB Bandwidth Measurement is 0.5 MHz.

4.3.2 Test Setup

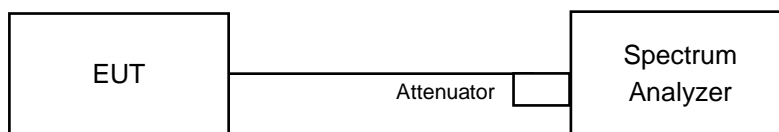

4.3.3 Test Instruments

Refer to section 4.1.2 to get information of above instrument.

4.3.4 Test Procedure

- a. Set resolution bandwidth (RBW) = 100kHz
- b. Set the video bandwidth (VBW) $\geq 3 \times$ RBW, Detector = Peak.
- c. Trace mode = max hold.
- d. Sweep = auto couple.
- e. Measure the maximum width of the emission that is constrained by the frequencies associated with the two amplitude points (upper and lower) that are attenuated by 6 dB relative to the maximum level measured in the fundamental emission

4.3.5 Deviation from Test Standard

No deviation.

4.3.6 EUT Operating Conditions

The software provided by client to enable the EUT under transmission condition continuously at lowest, middle and highest channel frequencies individually.

4.3.7 Test Result

802.11b

Channel	Frequency (MHz)	6dB Bandwidth (MHz)	Minimum Limit (MHz)	Pass / Fail
1	2412	8.57	0.5	PASS
6	2437	10.09	0.5	PASS
11	2462	9.09	0.5	PASS

802.11g

Channel	Frequency (MHz)	6dB Bandwidth (MHz)	Minimum Limit (MHz)	Pass / Fail
1	2412	16.47	0.5	PASS
6	2437	16.47	0.5	PASS
11	2462	16.47	0.5	PASS

802.11n (HT20)

Channel	Frequency (MHz)	6dB Bandwidth (MHz)	Minimum Limit (MHz)	Pass / Fail
1	2412	17.69	0.5	Pass
6	2437	17.70	0.5	Pass
11	2462	17.74	0.5	Pass

Spectrum Plot of Worst Value

802.11b : CH1

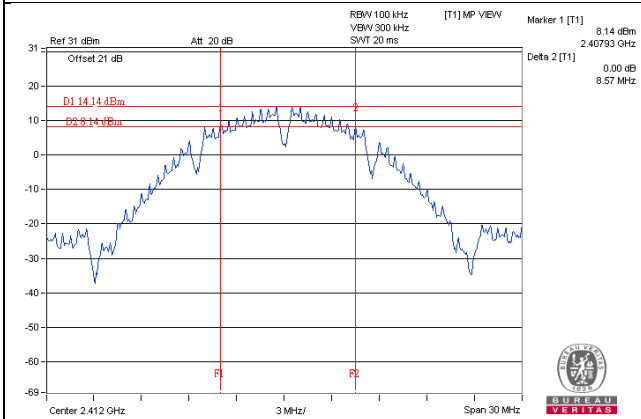

802.11g : CH1

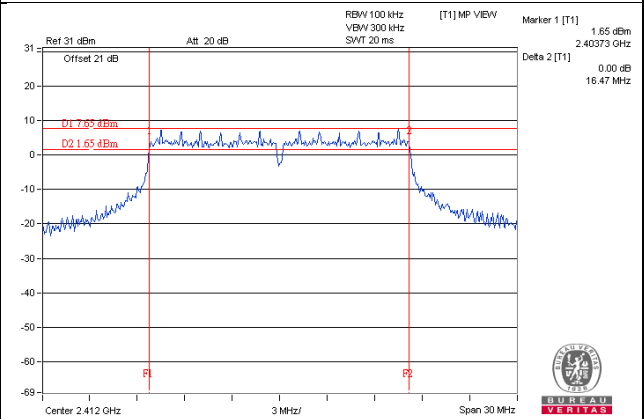

802.11n (HT20) : CH1

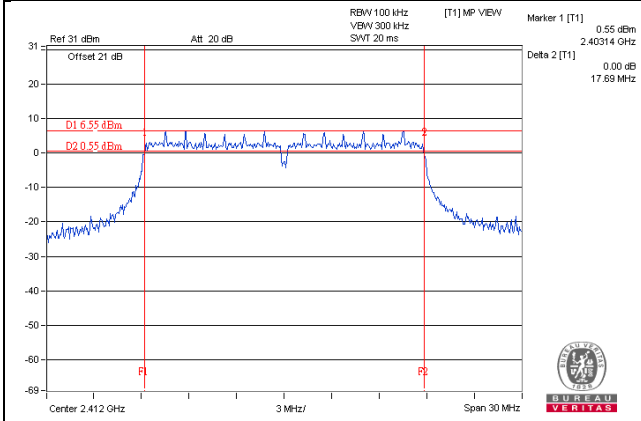

4.4 Conducted Output Power Measurement

4.4.1 Limits of Conducted Output Power Measurement

For systems using digital modulation in the 2400–2483.5 MHz bands: 1 Watt (30dBm)

4.4.2 Test Setup

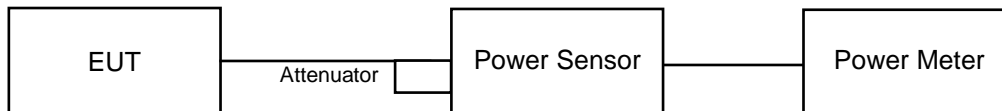

4.4.3 Test Instruments

Refer to section 4.1.2 to get information of above instrument.

4.4.4 Test Procedures

A peak / average power sensor was used on the output port of the EUT. A power meter was used to read the response of the peak / average power sensor. Record the power level.

4.4.5 Deviation from Test Standard

No deviation.

4.4.6 EUT Operating Conditions

Same as Item 4.3.6.

4.4.7 Test Results

FOR PEAK POWER

802.11b

Channel	Frequency (MHz)	Peak Power (mW)	Peak Power (dBm)	Limit (dBm)	Pass/Fail
1	2412	250.035	23.98	30	Pass
6	2437	279.254	24.46	30	Pass
11	2462	252.93	24.03	30	Pass

802.11g

Channel	Frequency (MHz)	Peak Power (mW)	Peak Power (dBm)	Limit (dBm)	Pass/Fail
1	2412	333.426	25.23	30	Pass
6	2437	330.37	25.19	30	Pass
11	2462	232.809	23.67	30	Pass

802.11n (HT20)

Channel	Frequency (MHz)	Peak Power (mW)	Peak Power (dBm)	Limit (dBm)	Pass/Fail
1	2412	306.902	24.87	30	Pass
6	2437	358.096	25.54	30	Pass
11	2462	233.346	23.68	30	Pass

FOR AVERAGE POWER

802.11b

Channel	Frequency (MHz)	Average Power (mW)	Average Power (dBm)
1	2412	160.694	22.06
6	2437	187.068	22.72
11	2462	162.181	22.10

802.11g

Channel	Frequency (MHz)	Average Power (mW)	Average Power (dBm)
1	2412	68.234	18.34
6	2437	167.109	22.23
11	2462	50.234	17.01

802.11n (HT20)

Channel	Frequency (MHz)	Average Power (mW)	Average Power (dBm)
1	2412	57.28	17.58
6	2437	169.434	22.29
11	2462	47.206	16.74

4.5 Power Spectral Density Measurement

4.5.1 Limits of Power Spectral Density Measurement

The Maximum of Power Spectral Density Measurement is 8dBm.

4.5.2 Test Setup

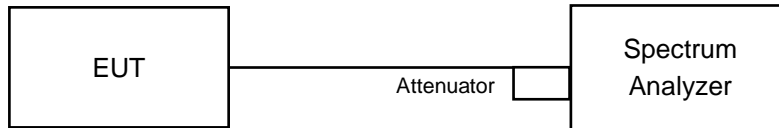

4.5.3 Test Instruments

Refer to section 4.1.2 to get information of above instrument.

4.5.4 Test Procedure

- a. Set analyzer center frequency to DTS channel center frequency.
- b. Set the span to 1.5 times the DTS bandwidth.
- c. Set the RBW to: $3 \text{ kHz} \leq \text{RBW} \leq 100 \text{ kHz}$.
- d. Set the VBW $\geq 3 \times \text{RBW}$.
- e. Detector = peak.
- f. Sweep time = auto couple.
- g. Trace mode = max hold.
- h. Allow trace to fully stabilize.
- i. Use the peak marker function to determine the maximum amplitude level within the RBW.

4.5.5 Deviation from Test Standard

No deviation.

4.5.6 EUT Operating Condition

Same as Item 4.3.6

4.5.7 Test Results

802.11b

Channel	Freq. (MHz)	PSD (dBm/3kHz)	Limit (dBm/3kHz)	Pass /Fail
1	2412	0.01	8	Pass
6	2437	-0.64	8	Pass
11	2462	0.16	8	Pass

802.11g

Channel	Freq. (MHz)	PSD (dBm/3kHz)	Limit (dBm/3kHz)	Pass /Fail
1	2412	-6.92	8	Pass
6	2437	-2.90	8	Pass
11	2462	-9.07	8	Pass

802.11n (HT20)

Channel	Freq. (MHz)	PSD (dBm/3kHz)	Limit (dBm/3kHz)	Pass /Fail
1	2412	-8.30	8	Pass
6	2437	-3.40	8	Pass
11	2462	-9.79	8	Pass

Spectrum Plot of Worst Value

802.11b : CH11

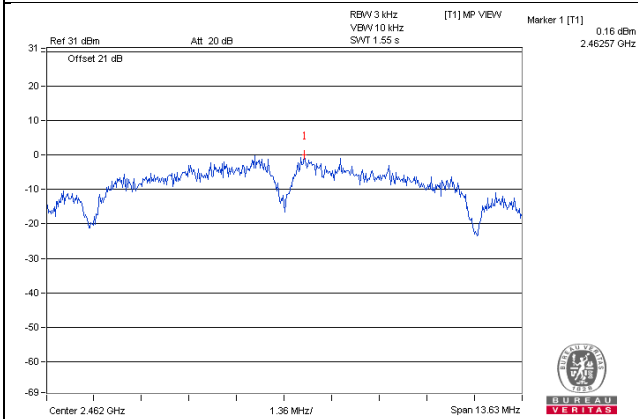

802.11g : CH6

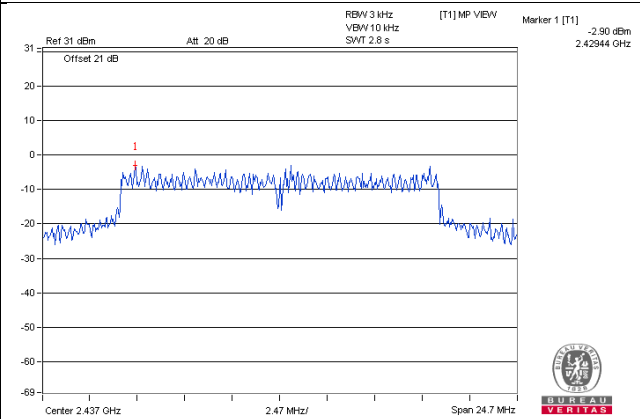

802.11n (HT20) : CH6

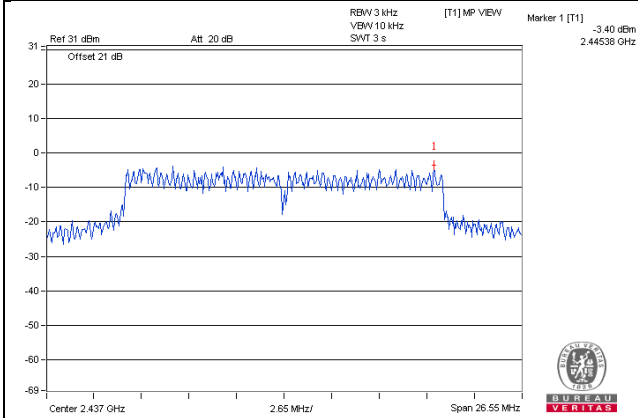

4.6 Conducted Out of Band Emission Measurement

4.6.1 Limits of Conducted Out of Band Emission Measurement

Below 20dB of the highest emission level of operating band (in 100kHz Resolution Bandwidth).

4.6.2 Test Setup

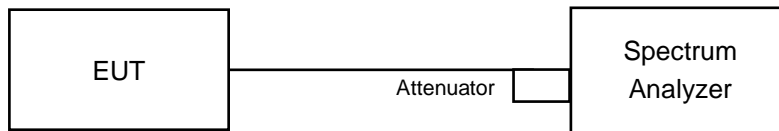

4.6.3 Test Instruments

Refer to section 4.1.2 to get information of above instrument.

4.6.4 Test Procedure

MEASUREMENT PROCEDURE REF

1. Set the RBW = 100 kHz.
2. Set the VBW \geq 300 kHz.
3. Detector = peak.
4. Sweep time = auto couple.
5. Trace mode = max hold.
6. Allow trace to fully stabilize.
7. Use the peak marker function to determine the maximum power level in any 100 kHz band segment within the fundamental EBW.

MEASUREMENT PROCEDURE OOB

1. Set RBW = 100 kHz.
2. Set VBW \geq 300 kHz.
3. Detector = peak.
4. Sweep = auto couple.
5. Trace Mode = max hold.
6. Allow trace to fully stabilize.
7. Use the peak marker function to determine the maximum amplitude level.

4.6.5 Deviation from Test Standard

No deviation.

4.6.6 EUT Operating Condition

Same as Item 4.3.6

4.6.7 Test Results

The spectrum plots are attached on the following pages. D1 line indicates the highest level, and D2 line indicates the 20dB offset below D1. It shows compliance with the requirement.

802.11b

CH 1

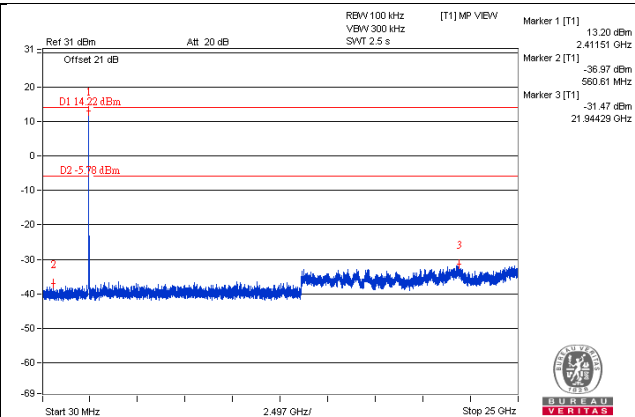
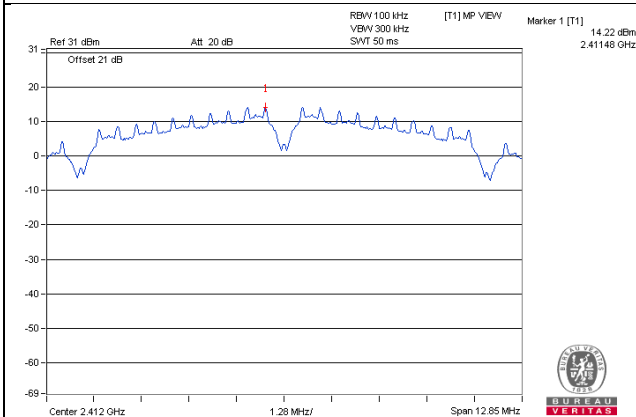

CH 6

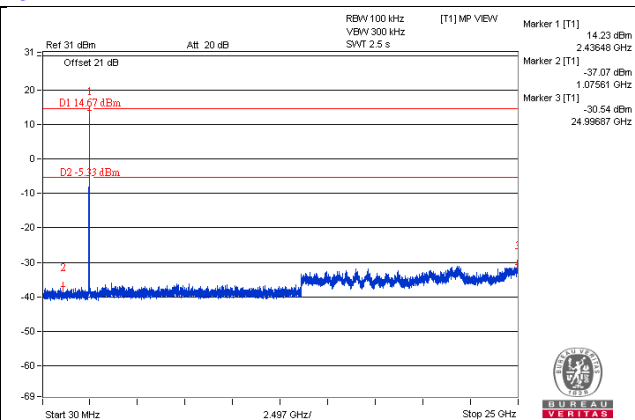
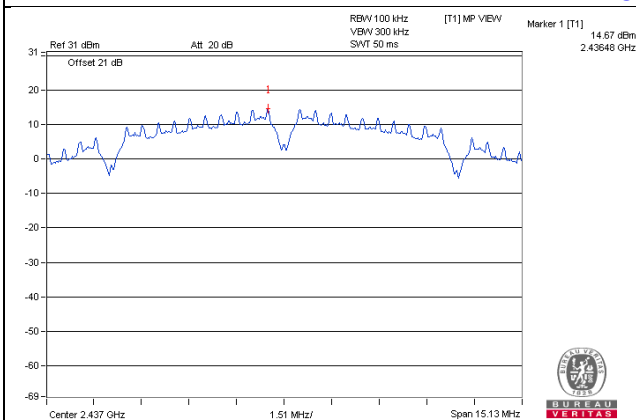

CH 11

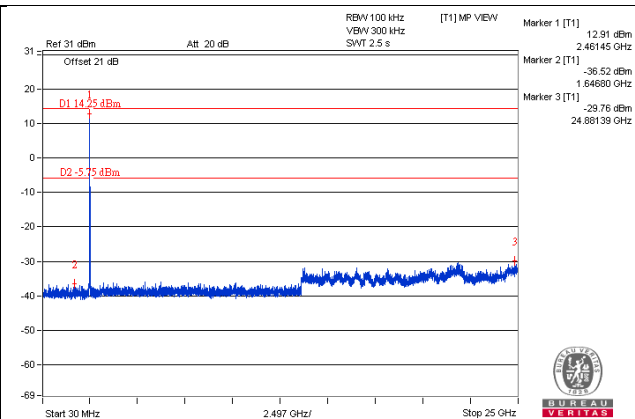
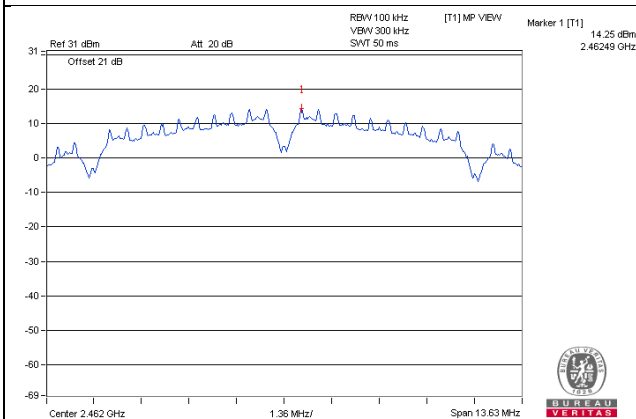

CH 1 Band edge

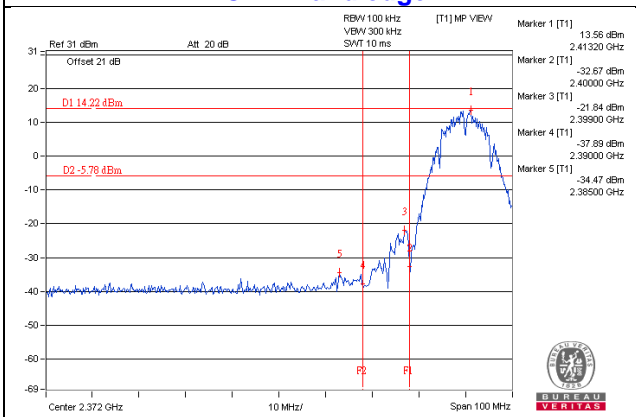

CH 11 Band edge

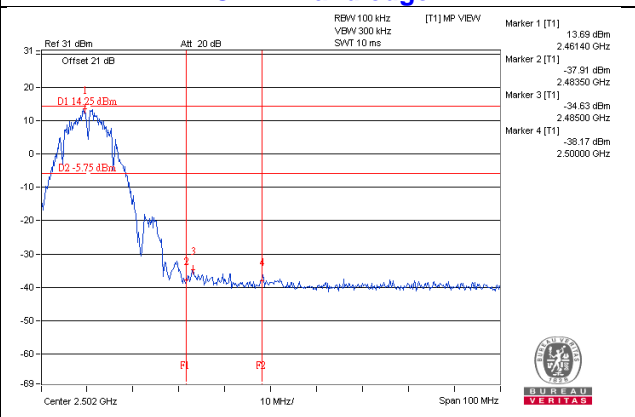

802.11g

CH 1

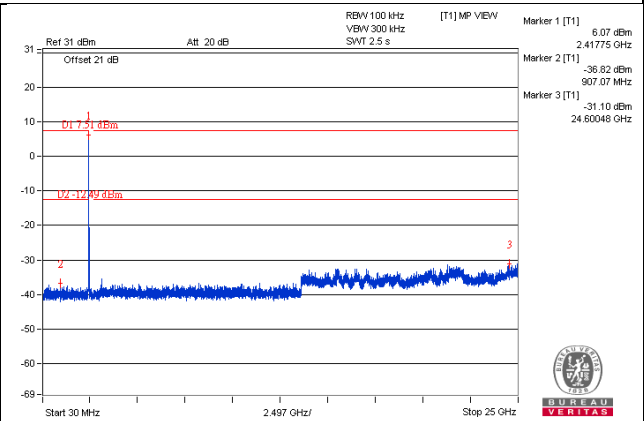
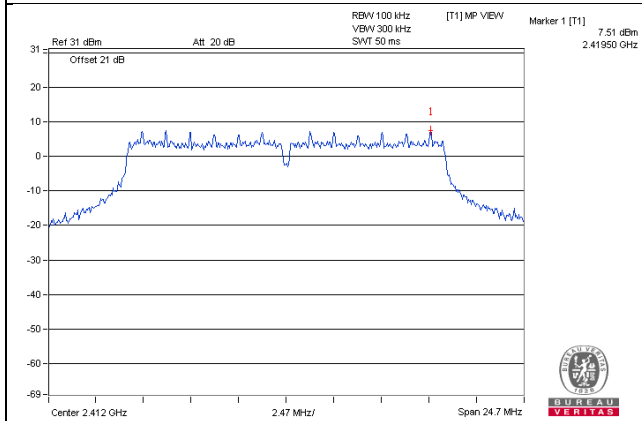

CH 6

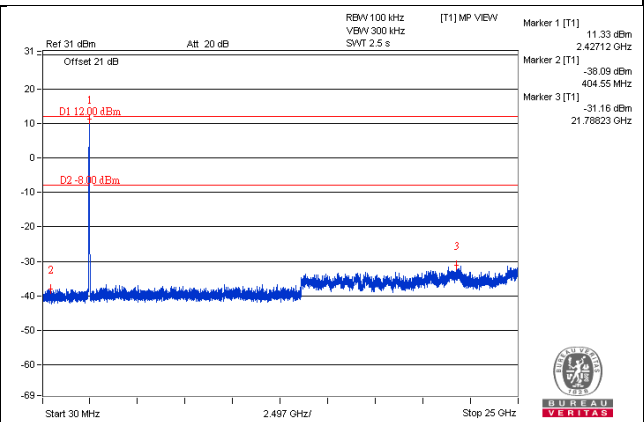
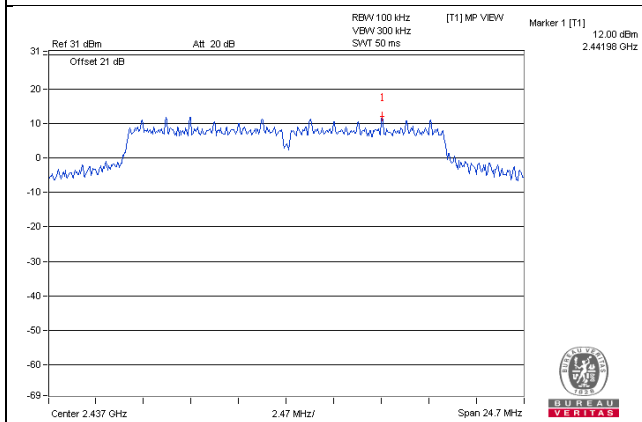

CH 11

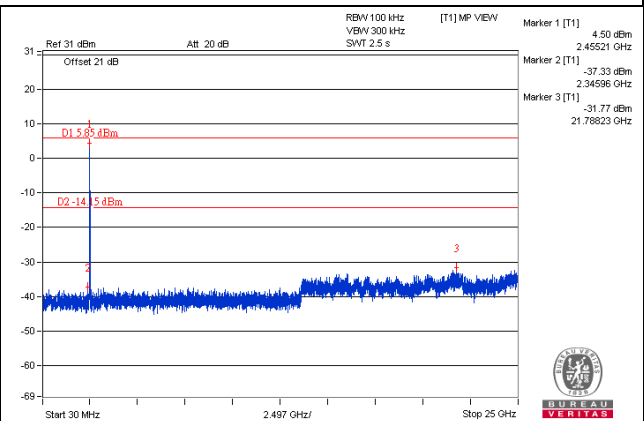
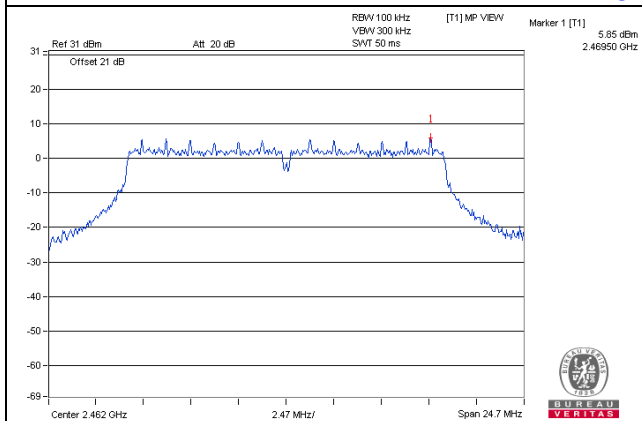

CH 1 Band edge

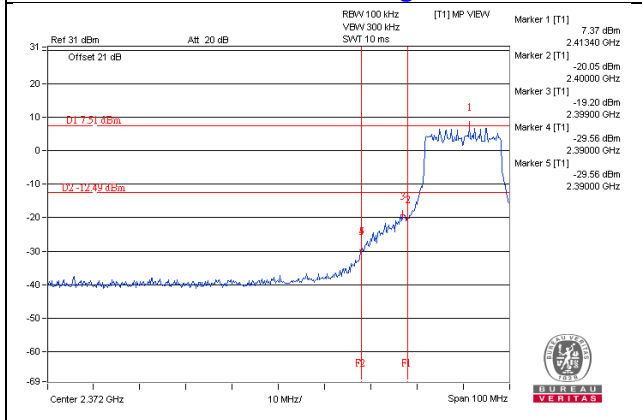

CH 11 Band edge

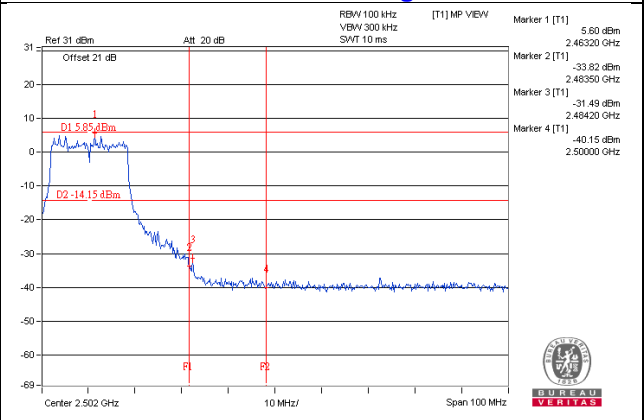

802.11n (HT20)

CH 1

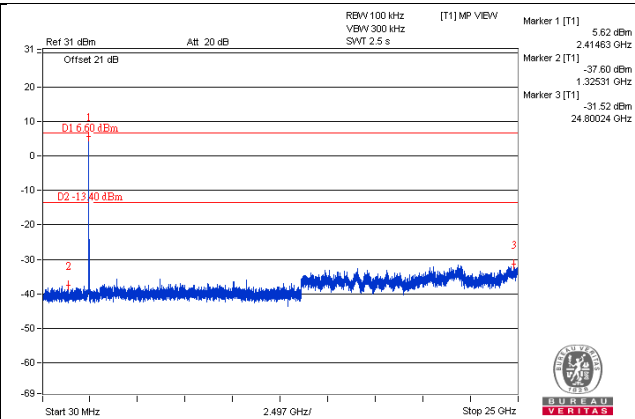
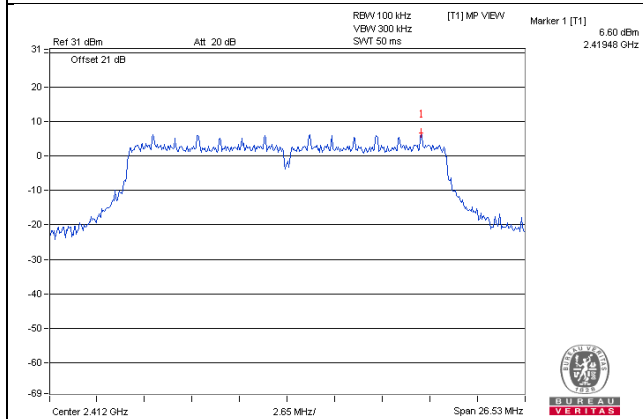

CH 6

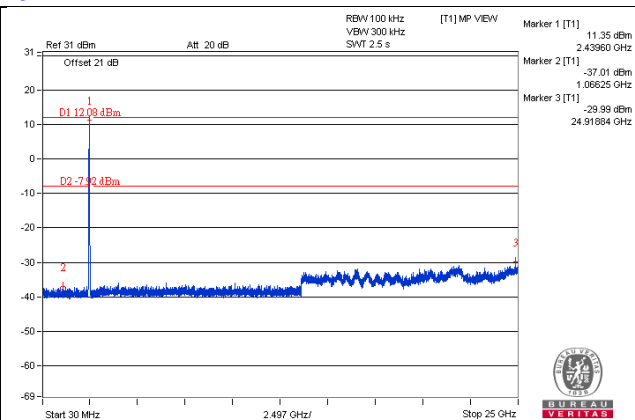
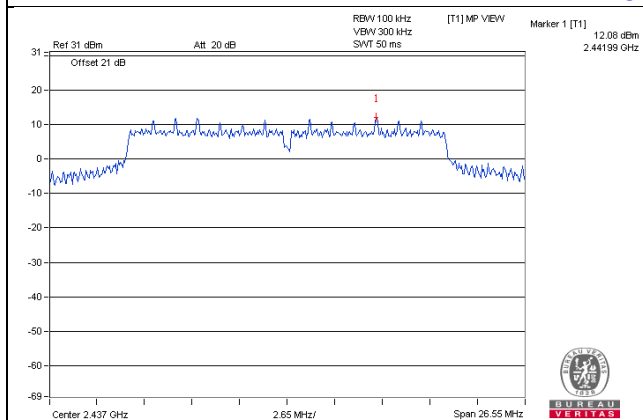

CH 11

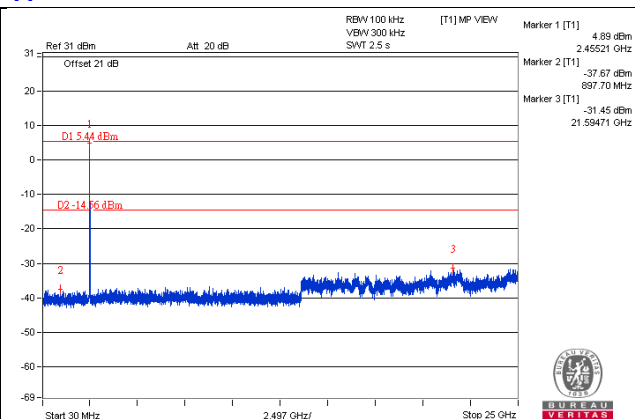
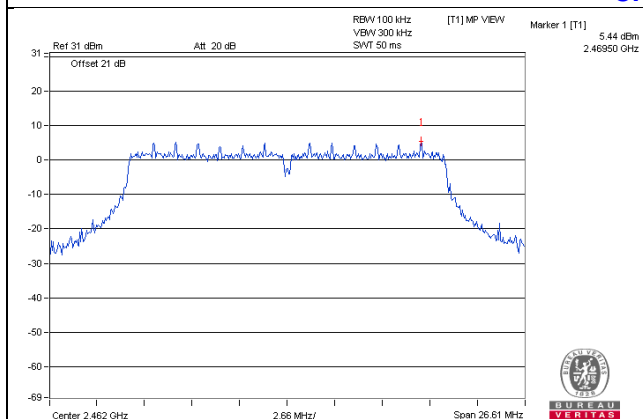

CH 1 Band edge

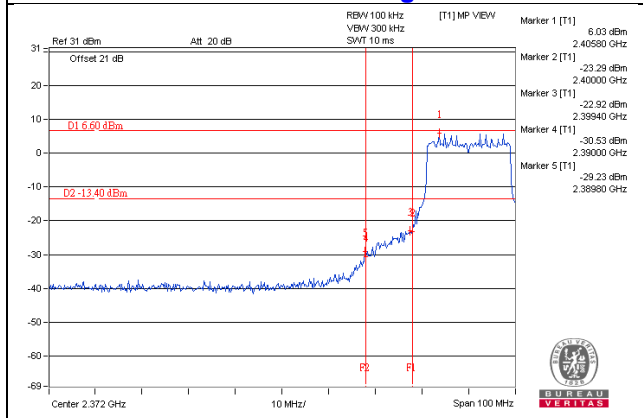

CH 11 Band edge

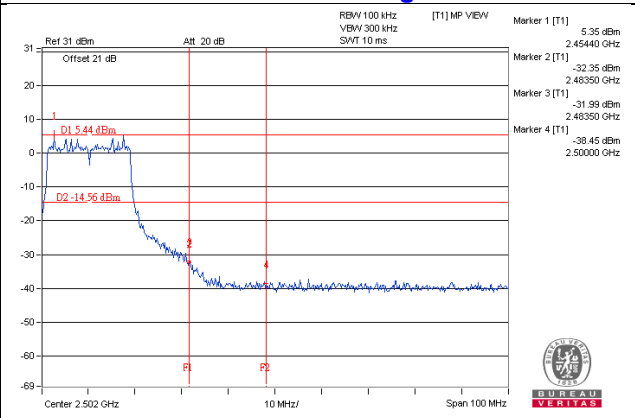

5 Pictures of Test Arrangements

Please refer to the attached file (Test Setup Photo).

Appendix – Information on the Testing Laboratories

We, Bureau Veritas Consumer Products Services (H.K.) Ltd., Taoyuan Branch, were founded in 1988 to provide our best service in EMC, Radio, Telecom and Safety consultation. Our laboratories are accredited and approved according to ISO/IEC 17025.

If you have any comments, please feel free to contact us at the following:

Linko EMC/RF Lab

Tel: 886-2-26052180

Fax: 886-2-26051924

Hsin Chu EMC/RF/Telecom Lab

Tel: 886-3-6668565

Fax: 886-3-6668323

Hwa Ya EMC/RF/Safety Lab

Tel: 886-3-3183232

Fax: 886-3-3270892

Email: service.adt@tw.bureauveritas.com

Web Site: www.bureauveritas-adt.com

The address and road map of all our labs can be found in our web site also.

--- END ---