

FCC Test Report

Report No.: RF160713E08

FCC ID: PY316200350

Test Model: VMB4000

Received Date: July 13, 2016

Test Date: July 25 to Aug. 02, 2016

Issued Date: Aug. 19, 2016

Applicant: NETGEAR, Inc.

Address: 350 East Plumeria Drive San Jose, CA 95134

Issued By: Bureau Veritas Consumer Products Services (H.K.) Ltd., Taoyuan Branch
Hsin Chu Laboratory

Lab Address: E-2, No.1, Li Hsin 1st Road, Hsinchu Science Park, Hsinchu City 300,
Taiwan R.O.C.

Test Location (1): E-2, No.1, Li Hsin 1st Road, Hsinchu Science Park, Hsinchu City 300,
Taiwan R.O.C.

Test Location (2): No. 49, Ln. 206, Wende Rd., Shangshan Tsuen, Chiung Lin Hsiang, Hsin
Chu Hsien 307, Taiwan R.O.C.



This report is for your exclusive use. Any copying or replication of this report to or for any other person or entity, or use of our name or trademark, is permitted only with our prior written permission. This report sets forth our findings solely with respect to the test samples identified herein. The results set forth in this report are not indicative or representative of the quality or characteristics of the lot from which a test sample was taken or any similar or identical product unless specifically and expressly noted. Our report includes all of the tests requested by you and the results thereof based upon the information that you provided to us. You have 60 days from date of issuance of this report to notify us of any material error or omission caused by our negligence, provided, however, that such notice shall be in writing and shall specifically address the issue you wish to raise. A failure to raise such issue within the prescribed time shall constitute your unqualified acceptance of the completeness of this report, the tests conducted and the correctness of the report contents. Unless specific mention, the uncertainty of measurement has been explicitly taken into account to declare the compliance or non-compliance to the specification. The report must not be used by the client to claim product certification, approval, or endorsement by TAF or any government agencies.

Table of Contents

Release Control Record	4
1 Certificate of Conformity	5
2 Summary of Test Results	6
2.1 Measurement Uncertainty.....	6
2.2 Modification Record.....	6
3 General Information	7
3.1 General Description of EUT.....	7
3.2 Description of Test Modes.....	9
3.2.1 Test Mode Applicability and Tested Channel Detail.....	10
3.3 Duty Cycle of Test Signal.....	12
3.4 Description of Support Units.....	13
3.4.1 Configuration of System under Test.....	14
3.5 General Description of Applied Standards.....	15
4 Test Types and Results	16
4.1 Radiated Emission and Bandedge Measurement.....	16
4.1.1 Limits of Radiated Emission and Bandedge Measurement.....	16
4.1.2 Test Instruments.....	17
4.1.3 Test Procedures.....	19
4.1.4 Deviation from Test Standard.....	19
4.1.5 Test Setup.....	20
4.1.6 EUT Operating Conditions.....	20
4.1.7 Test Results.....	21
4.2 Conducted Emission Measurement.....	34
4.2.1 Limits of Conducted Emission Measurement.....	34
4.2.2 Test Instruments.....	34
4.2.3 Test Procedures.....	35
4.2.4 Deviation from Test Standard.....	35
4.2.5 Test Setup.....	35
4.2.6 EUT Operating Conditions.....	35
4.2.7 Test Results (Mode 1).....	36
4.2.8 Test Results (Mode 2).....	38
4.2.9 Test Results (Mode 3).....	40
4.2.10 Test Results (Mode 4).....	42
4.3 6dB Bandwidth Measurement.....	44
4.3.1 Limits of 6dB Bandwidth Measurement.....	44
4.3.2 Test Setup.....	44
4.3.3 Test Instruments.....	44
4.3.4 Test Procedure.....	44
4.3.5 Deviation from Test Standard.....	44
4.3.6 EUT Operating Conditions.....	44
4.3.7 Test Result.....	45
4.4 Conducted Output Power Measurement.....	47
4.4.1 Limits of Conducted Output Power Measurement.....	47
4.4.2 Test Setup.....	47
4.4.3 Test Instruments.....	47
4.4.4 Test Procedures.....	47
4.4.5 Deviation from Test Standard.....	47
4.4.6 EUT Operating Conditions.....	47
4.4.7 Test Results.....	48
4.5 Power Spectral Density Measurement.....	49
4.5.1 Limits of Power Spectral Density Measurement.....	49
4.5.2 Test Setup.....	49
4.5.3 Test Instruments.....	49

4.5.4 Test Procedure	49
4.5.5 Deviation from Test Standard	49
4.5.6 EUT Operating Condition	49
4.5.7 Test Results	50
4.6 Conducted Out of Band Emission Measurement	53
4.6.1 Limits of Conducted Out of Band Emission Measurement	53
4.6.2 Test Setup	53
4.6.3 Test Instruments	53
4.6.4 Test Procedure	53
4.6.5 Deviation from Test Standard	53
4.6.6 EUT Operating Condition	53
4.6.7 Test Results	53
5 Pictures of Test Arrangements	62
Appendix – Information on the Testing Laboratories	63

Release Control Record

Issue No.	Description	Date Issued
RF160713E08	Original release.	Aug. 19, 2016

1 Certificate of Conformity

Product: arlo Base Station
Brand: NETGEAR
Test Model: VMB4000
Sample Status: ENGINEERING SAMPLE
Applicant: NETGEAR, Inc.
Test Date: July 25 to Aug. 02, 2016
Standards: 47 CFR FCC Part 15, Subpart C (Section 15.247)
ANSI C63.10: 2013

The above equipment has been tested by **Bureau Veritas Consumer Products Services (H.K.) Ltd., Taoyuan Branch**, and found compliance with the requirement of the above standards. The test record, data evaluation & Equipment Under Test (EUT) configurations represented herein are true and accurate accounts of the measurements of the sample's EMC characteristics under the conditions specified in this report.

Prepared by : Midoli Peng , **Date:** Aug. 19, 2016
Midoli Peng / Specialist

Approved by : May Chen , **Date:** Aug. 19, 2016
May Chen / Manager

2 Summary of Test Results

47 CFR FCC Part 15, Subpart C (SECTION 15.247)			
FCC Clause	Test Item	Result	Remarks
15.207	AC Power Conducted Emission	PASS	Meet the requirement of limit. Minimum passing margin is -6.03dB at 0.15000MHz.
15.205 / 15.209 / 15.247(d)	Radiated Emissions and Band Edge Measurement	PASS	Meet the requirement of limit. Minimum passing margin is -0.10dB at 2390.00MHz & 2483.50MHz.
15.247(d)	Antenna Port Emission	PASS	Meet the requirement of limit.
15.247(a)(2)	6dB bandwidth	PASS	Meet the requirement of limit.
15.247(b)	Conducted power	PASS	Meet the requirement of limit.
15.247(e)	Power Spectral Density	PASS	Meet the requirement of limit.
15.203	Antenna Requirement	PASS	Antenna connector is i-pex not a standard connector.

2.1 Measurement Uncertainty

Where relevant, the following measurement uncertainty levels have been estimated for tests performed on the EUT as specified in CISPR 16-4-2:

Measurement	Frequency	Expanded Uncertainty (k=2) (±)
Conducted Emissions at mains ports	150kHz ~ 30MHz	1.83 dB
Radiated Emissions up to 1 GHz	30MHz ~ 1GHz	5.19 dB
Radiated Emissions above 1 GHz	1GHz ~ 6GHz	3.43 dB
	6GHz ~ 18GHz	3.49 dB
	18GHz ~ 40GHz	4.11 dB

2.2 Modification Record

There were no modifications required for compliance.

3 General Information

3.1 General Description of EUT

Product	arlo Base Station
Brand	NETGEAR
Test Model	VMB4000
Status of EUT	ENGINEERING SAMPLE
Power Supply Rating	DC 12V from power adapter
Modulation Type	CCK, DQPSK, DBPSK for DSSS 64QAM, 16QAM, QPSK, BPSK for OFDM
Modulation Technology	DSSS, OFDM
Transfer Rate	802.11b: up to 11Mbps 802.11g: up to 54Mbps 802.11n: up to 300Mbps
Operating Frequency	2.412 ~ 2.462GHz
Number of Channel	11 for 802.11b, 802.11g, 802.11n (HT20) 7 for 802.11n (HT40)
Output Power	668.599mW
Antenna Type	Refer to Note
Antenna Connector	Refer to Note
Accessory Device	Adapter x 1
Data Cable Supplied	NA

Note:

1. The EUT could be supplied with a power adapter as following table:

No.	Brand	Model No.	P/N	Spec.
1	NETGEAR	2ABB018F 1 NA	332-10750-01	Input: 100-120Vac, 0.6A, 50/60Hz Output: 12.0V, 1.5A DC output cable (1.8m, unshielded)
2	NETGEAR	AD2032F10	332-10751-01	Input: 100-120Vac, 0.56A, 50/60Hz Output: 12.0V, 1.5A DC output cable (1.8m, unshielded)
3	NETGEAR	2ABB018F NA	332-10748-01	Input: 100-240Vac, 0.6A, 50/60Hz Output: 12.0V, 1.5A DC output cable (1.8m, unshielded)
4	NETGEAR	MU18A2120150-A1	332-10749-01	Input: 100-120Vac, 0.5A, 50/60Hz Output: 12.0V, 1.5A DC output cable (1.8m, unshielded)

From the above adapters, the radiated emission worse case was found in **adapter 3**. Therefore only the test data of the mode was recorded in this report.

2. The antennas provided to the EUT, please refer to the following table:

Ant. No.	Brand	Model	Antenna Gain(dBi) < Including cable loss >	Frequency range (GHz to GHz)	Antenna Type	Connecter Type	Cable Length (mm)
1	Satimo	STAR-006-A-0001	2.5	2.4~2.4835	PIFA	i-pex	70
2	Satimo	STAR-006-A-0001	2.5	2.4~2.4835	PIFA	i-pex	130

3. The EUT incorporates a MIMO function.

MODULATION MODE	DATA RATE (MCS)	TX & RX CONFIGURATION	
802.11b	1 ~ 11Mbps	2TX	2RX
802.11g	6 ~ 54Mbps	2TX	2RX
802.11n (HT20)	MCS 0~7	2TX	2RX
	MCS 8~15	2TX	2RX
802.11n (HT40)	MCS 0~7	2TX	2RX
	MCS 8~15	2TX	2RX

4. The above EUT information is declared by manufacturer and for more detailed features description, please refer to the manufacturer's specifications or user's manual.

3.2 Description of Test Modes

11 channels are provided for 802.11b, 802.11g and 802.11n (HT20):

Channel	Frequency	Channel	Frequency
1	2412MHz	7	2442MHz
2	2417MHz	8	2447MHz
3	2422MHz	9	2452MHz
4	2427MHz	10	2457MHz
5	2432MHz	11	2462MHz
6	2437MHz		

7 channels are provided for 802.11n (HT40):

Channel	Frequency	Channel	Frequency
3	2422MHz	7	2442MHz
4	2427MHz	8	2447MHz
5	2432MHz	9	2452MHz
6	2437MHz		

3.2.1 Test Mode Applicability and Tested Channel Detail

EUT CONFIGURE MODE	APPLICABLE TO				DESCRIPTION
	RE \geq 1G	RE<1G	PLC	APCM	
1	-	-	√	-	With adapter 1
2	-	-	√	-	With adapter 2
3	√	√	√	√	With adapter 3
4	-	-	√	-	With adapter 4

Where RE \geq 1G: Radiated Emission above 1GHz & Bandedge Measurement
 RE<1G: Radiated Emission below 1GHz
 PLC: Power Line Conducted Emission
 APCM: Antenna Port Conducted Measurement

NOTE: "-" means no effect.

Radiated Emission Test (Above 1GHz):

- Pre-Scan has been conducted to determine the worst-case mode from all possible combinations between available modulations, data rates and antenna ports (if EUT with antenna diversity architecture).
- Following channel(s) was (were) selected for the final test as listed below.

MODE	AVAILABLE CHANNEL	TESTED CHANNEL	MODULATION TECHNOLOGY	MODULATION TYPE	DATA RATE (Mbps)
802.11b	1 to 11	1, 6, 11	DSSS	DBPSK	1
802.11g	1 to 11	1, 6, 11	OFDM	BPSK	6
802.11n (HT20)	1 to 11	1, 6, 11	OFDM	BPSK	6.5
802.11n (HT40)	3 to 9	3, 6, 9	OFDM	BPSK	13.5

Radiated Emission Test (Below 1GHz):

- Pre-Scan has been conducted to determine the worst-case mode from all possible combinations between available modulations, data rates and antenna ports (if EUT with antenna diversity architecture).
- Following channel(s) was (were) selected for the final test as listed below.

MODE	AVAILABLE CHANNEL	TESTED CHANNEL	MODULATION TECHNOLOGY	MODULATION TYPE	DATA RATE (Mbps)
802.11b	1 to 11	6	DSSS	DBPSK	1

Power Line Conducted Emission Test:

- Pre-Scan has been conducted to determine the worst-case mode from all possible combinations between available modulations, data rates and antenna ports (if EUT with antenna diversity architecture).
- Following channel(s) was (were) selected for the final test as listed below.

MODE	AVAILABLE CHANNEL	TESTED CHANNEL	MODULATION TECHNOLOGY	MODULATION TYPE	DATA RATE (Mbps)
802.11b	1 to 11	6	DSSS	DBPSK	1

Antenna Port Conducted Measurement:

- This item includes all test value of each mode, but only includes spectrum plot of worst value of each mode.
- Pre-Scan has been conducted to determine the worst-case mode from all possible combinations between available modulations, data rates and antenna ports (if EUT with antenna diversity architecture).
- Following channel(s) was (were) selected for the final test as listed below.

MODE	AVAILABLE CHANNEL	TESTED CHANNEL	MODULATION TECHNOLOGY	MODULATION TYPE	DATA RATE (Mbps)
802.11b	1 to 11	1, 6, 11	DSSS	DBPSK	1
802.11g	1 to 11	1, 6, 11	OFDM	BPSK	6
802.11n (HT20)	1 to 11	1, 6, 11	OFDM	BPSK	6.5
802.11n (HT40)	3 to 9	3, 6, 9	OFDM	BPSK	13.5

Test Condition:

APPLICABLE TO	ENVIRONMENTAL CONDITIONS	INPUT POWER	TESTED BY
RE \geq 1G	26deg. C, 73%RH	120Vac, 60Hz	Russell Yeh
RE $<$ 1G	22deg. C, 74%RH	120Vac, 60Hz	Garyt Cheng
PLC	24deg. C, 61%RH	120Vac, 60Hz	Jyunchun Lin
APCM	26deg. C, 62%RH	120Vac, 60Hz	Anderson Chen

3.3 Duty Cycle of Test Signal

Duty cycle of test signal is $\geq 98\%$, duty factor is not required.

802.11b: Duty cycle = $12.405/12.44 = 0.997$

802.11g: Duty cycle = $2.063/2.09 = 0.987$

802.11n (HT20): Duty cycle = $1.91/1.936 = 0.987$

802.11n (HT40): Duty cycle = $0.945/0.964 = 0.980$

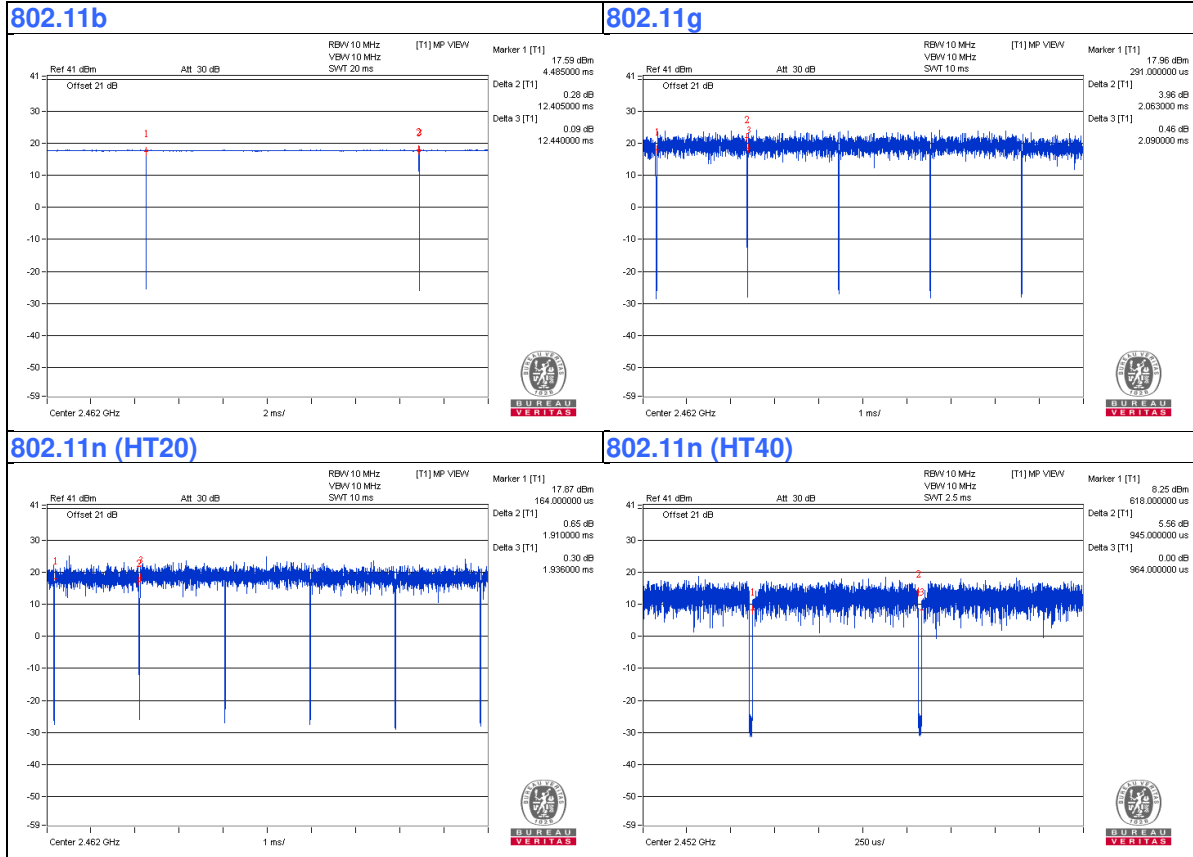

3.4 Description of Support Units

The EUT has been tested as an independent unit together with other necessary accessories or support units. The following support units or accessories were used to form a representative test configuration during the tests.

ID	Product	Brand	Model No.	Serial No.	FCC ID	Remarks
A.	Notebook Computer	DELL	E5430	HYV4VY1	FCC DoC	Provided by Lab
B.	iPod shuffle	Apple	MD778TA/A	CC4JG3SSF4T1	NA	Provided by Lab
C.	iPod shuffle	Apple	MC749TA/A	CC4DN29UDFDM	NA	Provided by Lab

Note:

1. All power cords of the above support units are non-shielded (1.8m).

ID	Descriptions	Qty.	Length (m)	Shielding (Yes/No)	Cores (Qty.)	Remarks
1.	RJ-45 Cable	1	10	No	0	Provided by Lab
2.	DC Cable	1	1.8	No	0	Supplied by client
3.	USB Cable	1	0.1	Yes	0	Provided by Lab
4.	USB Cable	1	0.1	Yes	0	Provided by Lab

3.4.1 Configuration of System under Test

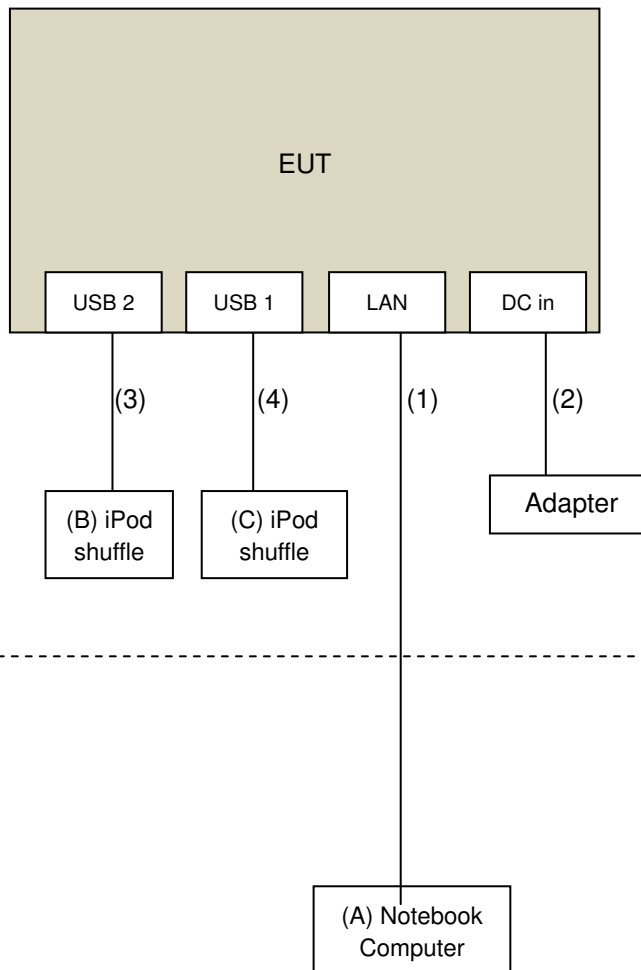

Remote Site

3.5 General Description of Applied Standards

The EUT is a RF Product. According to the specifications of the manufacturer, it must comply with the requirements of the following standards:

FCC Part 15, Subpart C (15.247)
KDB 558074 D01 DTS Meas Guidance v03r05
KDB 662911 D01 Multiple Transmitter Output v02r01
ANSI C63.10-2013

All test items have been performed and recorded as per the above standards.

NOTE: The EUT has been verified to comply with the requirements of FCC Part 15, Subpart B, Class B (DoC). The test report has been issued separately

4 Test Types and Results

4.1 Radiated Emission and Bandedge Measurement

4.1.1 Limits of Radiated Emission and Bandedge Measurement

Radiated emissions which fall in the restricted bands must comply with the radiated emission limits specified as below table. Other emissions shall be at least 30dB below the highest level of the desired power:

Frequencies (MHz)	Field Strength (microvolts/meter)	Measurement Distance (meters)
0.009 ~ 0.490	2400/F(kHz)	300
0.490 ~ 1.705	24000/F(kHz)	30
1.705 ~ 30.0	30	30
30 ~ 88	100	3
88 ~ 216	150	3
216 ~ 960	200	3
Above 960	500	3

NOTE:

1. The lower limit shall apply at the transition frequencies.
2. Emission level (dBuV/m) = 20 log Emission level (uV/m).
3. For frequencies above 1000MHz, the field strength limits are based on average detector, however, the peak field strength of any emission shall not exceed the maximum permitted average limits, specified above by more than 20dB under any condition of modulation.

4.1.2 Test Instruments

DESCRIPTION & MANUFACTURER	MODEL NO.	SERIAL NO.	CALIBRATED DATE	CALIBRATED UNTIL
Test Receiver Keysight	N9038A	MY54450088	July 20, 2016	July 19, 2017
Pre-Amplifier ^(*) EMCI	EMC001340	980142	Jan. 20, 2016	Jan. 19, 2018
Loop Antenna ^(*) Electro-Metrics	EM-6879	264	Dec. 16, 2014	Dec. 15, 2016
RF Cable	NA	LOOPCAB-001 LOOPCAB-002	Jan. 18, 2016	Jan. 17, 2017
Pre-Amplifier Mini-Circuits	ZFL-1000VH2 B	AMP-ZFL-01	Nov. 11, 2015	Nov. 10, 2016
Trilog Broadband Antenna SCHWARZBECK	VULB 9168	9168-406	Jan. 04, 2016	Jan. 03, 2017
RF Cable	8D	966-4-1 966-4-2 966-4-3	Apr. 02, 2016	Apr. 01, 2017
Horn_Antenna SCHWARZBECK	BBHA 9120D	9120D-783	Jan. 19, 2016	Jan. 18, 2017
Pre-Amplifier Agilent	8449B	3008A01922	Sep. 19, 2015	Sep. 18, 2016
RF Cable	EMC104-SM- SM-2000 EMC104-SM- SM-5000 EMC104-SM- SM-5000	150318 150323 150324	Mar. 30, 2016	Mar. 29, 2017
Pre-Amplifier EMCI	EMC184045	980143	Jan. 15, 2016	Jan. 14, 2017
Horn_Antenna SCHWARZBECK	BBHA 9170	BBHA9170608	Jan. 08, 2016	Jan. 07, 2017
RF Cable	SUCOFLEX 102	36432/2 36441/2	Jan. 16, 2016	Jan. 15, 2017
Software	ADT_Radiated _V8.7.07	NA	NA	NA
Antenna Tower & Turn Table Max-Full	MF-7802	MF780208410	NA	NA
Boresight Antenna Fixture	FBA-01	FBA-SIP02	NA	NA
Spectrum Analyzer R&S	FSP40	100036	Jan. 27, 2016	Jan. 26, 2017
Power meter Anritsu	ML2495A	0824006	May 26, 2016	May 25, 2017
Power sensor Anritsu	MA2411B	0738172	May 26, 2016	May 25, 2017

Note:

1. The calibration interval of the above test instruments is 12 months and the calibrations are traceable to NML/ROC and NIST/USA.
2. *The calibration interval of the above test instruments is 24 months and the calibrations are traceable to NML/ROC and NIST/USA.
- 3 Loop antenna was used for all emissions below 30 MHz.
4. The test was performed in 966 Chamber No. 4.
5. The FCC Site Registration No. is 292998
6. The CANADA Site Registration No. is 20331-2
7. Tested Date: July 25 to Aug. 01, 2016

4.1.3 Test Procedures

- a. The EUT was placed on the top of a rotating table 0.8 meters (for below 1GHz) / 1.5 meters (for above 1GHz) above the ground at 3 meter chamber room for test. The table was rotated 360 degrees to determine the position of the highest radiation.
- b. The EUT was set 3 meters away from the interference-receiving antenna, which was mounted on the top of a variable-height antenna tower.
- c. The height of antenna is varied from one meter to four meters above the ground to determine the maximum value of the field strength. Both horizontal and vertical polarizations of the antenna are set to make the measurement.
- d. For each suspected emission, the EUT was arranged to its worst case and then the antenna was tuned to heights from 1 meter to 4 meters and the rotatable table was turned from 0 degrees to 360 degrees to find the maximum reading.
- e. The test-receiver system was set to quasi-peak detect function and specified bandwidth with maximum hold mode when the test frequency is below 1 GHz.
- f. The test-receiver system was set to peak and average detect function and specified bandwidth with maximum hold mode when the test frequency is above 1 GHz. If the peak reading value also meets average limit, measurement with the average detector is unnecessary.

Note:

1. The resolution bandwidth and video bandwidth of test receiver/spectrum analyzer is 120kHz for Quasi-peak detection (QP) at frequency below 1GHz.
2. The resolution bandwidth of test receiver/spectrum analyzer is 1 MHz and the video bandwidth is 3 MHz for Peak detection (PK) at frequency above 1GHz.
3. The resolution bandwidth of test receiver/spectrum analyzer is 1MHz and the video bandwidth is 3MHz for RMS Average (Duty cycle < 98%) for Average detection (AV) at frequency above 1GHz, then the measurement results was added to a correction factor ($10 \log(1/\text{duty cycle})$).
4. The resolution bandwidth of test receiver/spectrum analyzer is 1MHz and the video bandwidth is 10Hz (Duty cycle $\geq 98\%$) for Average detection (AV) at frequency above 1GHz.
5. All modes of operation were investigated and the worst-case emissions are reported.

4.1.4 Deviation from Test Standard

No deviation.

4.1.5 Test Setup

<Frequency Range below 1GHz>

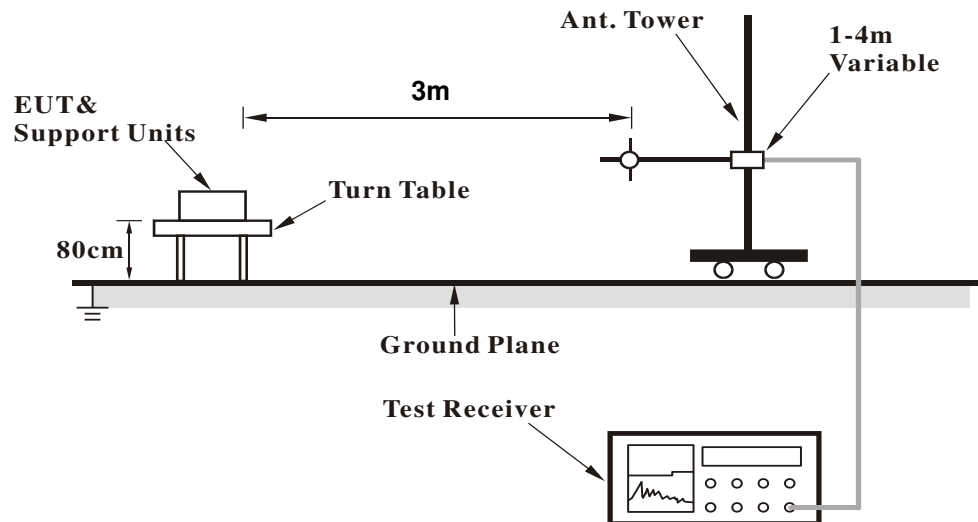

<Frequency Range above 1GHz>

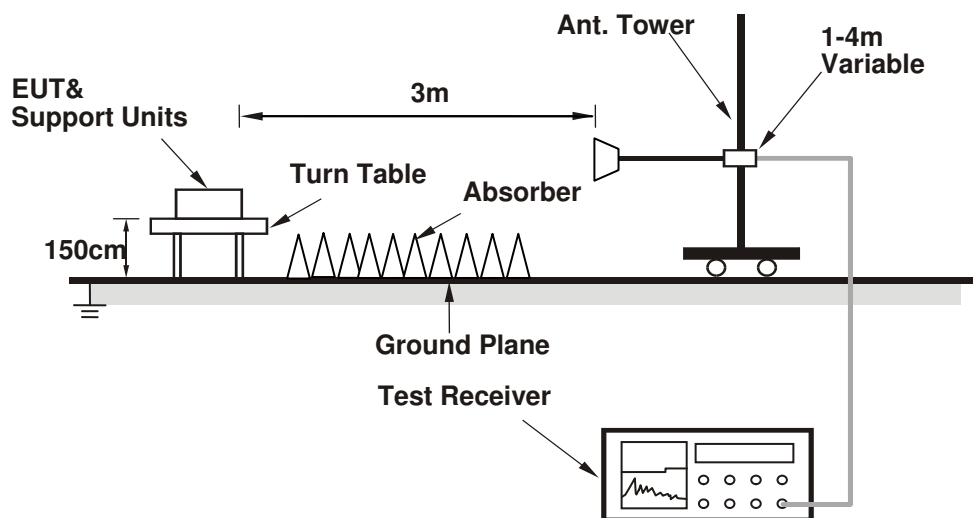

For the actual test configuration, please refer to the attached file (Test Setup Photo).

4.1.6 EUT Operating Conditions

- Connect the EUT with the support unit A (Notebook Computer) which is placed outside of testing area.
- The communication partner run test program "Mtool. 2.0.3.2" to enable EUT under transmission/receiving condition continuously at specific channel frequency.

4.1.7 Test Results

Above 1GHz Data :

802.11b

CHANNEL	TX Channel 1	DETECTOR FUNCTION	Peak (PK)
FREQUENCY RANGE	1GHz ~ 25GHz		Average (AV)

ANTENNA POLARITY & TEST DISTANCE: HORIZONTAL AT 3 M

NO.	FREQ. (MHz)	EMISSION LEVEL (dBuV/m)	LIMIT (dBuV/m)	MARGIN (dB)	ANTENNA HEIGHT (m)	TABLE ANGLE (Degree)	RAW VALUE (dBuV)	CORRECTION FACTOR (dB/m)
1	2390.00	63.4 PK	74.0	-10.6	1.43 H	188	67.6	-4.2
2	2390.00	50.6 AV	54.0	-3.4	1.43 H	188	54.8	-4.2
3	*2412.00	108.4 PK			1.43 H	188	112.5	-4.1
4	*2412.00	106.2 AV			1.43 H	188	110.3	-4.1
5	4824.00	43.3 PK	74.0	-30.7	3.01 H	53	41.0	2.3
6	4824.00	34.4 AV	54.0	-19.6	3.01 H	53	32.1	2.3

ANTENNA POLARITY & TEST DISTANCE: VERTICAL AT 3 M

NO.	FREQ. (MHz)	EMISSION LEVEL (dBuV/m)	LIMIT (dBuV/m)	MARGIN (dB)	ANTENNA HEIGHT (m)	TABLE ANGLE (Degree)	RAW VALUE (dBuV)	CORRECTION FACTOR (dB/m)
1	2390.00	65.9 PK	74.0	-8.1	1.60 V	23	70.1	-4.2
2	2390.00	53.9 AV	54.0	-0.1	1.60 V	23	58.1	-4.2
3	*2412.00	110.9 PK			1.60 V	23	115.0	-4.1
4	*2412.00	108.2 AV			1.60 V	23	112.3	-4.1
5	4824.00	43.5 PK	74.0	-30.5	1.28 V	114	41.2	2.3
6	4824.00	34.7 AV	54.0	-19.3	1.28 V	114	32.4	2.3

REMARKS:

1. Emission Level(dBuV/m) = Raw Value(dBuV) + Correction Factor(dB/m)
2. Correction Factor(dB/m) = Antenna Factor(dB/m) + Cable Factor(dB) – Pre-Amplifier Factor(dB)
3. The other emission levels were very low against the limit.
4. Margin value = Emission Level – Limit value
5. " * ": Fundamental frequency.

CHANNEL	TX Channel 6	DETECTOR FUNCTION	Peak (PK)
FREQUENCY RANGE	1GHz ~ 25GHz		Average (AV)

ANTENNA POLARITY & TEST DISTANCE: HORIZONTAL AT 3 M

NO.	FREQ. (MHz)	EMISSION LEVEL (dBuV/m)	LIMIT (dBuV/m)	MARGIN (dB)	ANTENNA HEIGHT (m)	TABLE ANGLE (Degree)	RAW VALUE (dBuV)	CORRECTION FACTOR (dB/m)
1	2390.00	58.3 PK	74.0	-15.7	1.52 H	183	62.5	-4.2
2	2390.00	49.9 AV	54.0	-4.1	1.52 H	183	54.1	-4.2
3	*2437.00	118.1 PK			1.52 H	183	122.1	-4.0
4	*2437.00	115.6 AV			1.52 H	183	119.6	-4.0
5	2483.50	60.2 PK	74.0	-13.8	1.52 H	183	64.2	-4.0
6	2483.50	51.4 AV	54.0	-2.6	1.52 H	183	55.4	-4.0
7	4874.00	44.4 PK	74.0	-29.6	3.00 H	55	41.9	2.5
8	4874.00	36.4 AV	54.0	-17.6	3.00 H	55	33.9	2.5
9	7311.00	52.7 PK	74.0	-21.3	3.00 H	55	43.8	8.9
10	7311.00	43.9 AV	54.0	-10.1	3.00 H	55	35.0	8.9

ANTENNA POLARITY & TEST DISTANCE: VERTICAL AT 3 M

NO.	FREQ. (MHz)	EMISSION LEVEL (dBuV/m)	LIMIT (dBuV/m)	MARGIN (dB)	ANTENNA HEIGHT (m)	TABLE ANGLE (Degree)	RAW VALUE (dBuV)	CORRECTION FACTOR (dB/m)
1	2390.00	59.4 PK	74.0	-14.6	1.19 V	18	63.6	-4.2
2	2390.00	51.1 AV	54.0	-2.9	1.19 V	18	55.3	-4.2
3	*2437.00	120.2 PK			1.19 V	18	124.2	-4.0
4	*2437.00	117.9 AV			1.19 V	18	121.9	-4.0
5	2483.50	61.2 PK	74.0	-12.8	1.19 V	18	65.2	-4.0
6	2483.50	53.2 AV	54.0	-0.8	1.19 V	18	57.2	-4.0
7	4874.00	46.8 PK	74.0	-27.2	1.48 V	137	44.3	2.5
8	4874.00	37.5 AV	54.0	-16.5	1.48 V	137	35.0	2.5
9	7311.00	53.3 PK	74.0	-20.7	2.37 V	193	44.4	8.9
10	7311.00	44.5 AV	54.0	-9.5	2.37 V	193	35.6	8.9

REMARKS:

- Emission Level(dBuV/m) = Raw Value(dBuV) + Correction Factor(dB/m)
- Correction Factor(dB/m) = Antenna Factor(dB/m) + Cable Factor(dB) – Pre-Amplifier Factor(dB)
- The other emission levels were very low against the limit.
- Margin value = Emission Level – Limit value
- " * ": Fundamental frequency.

CHANNEL	TX Channel 11	DETECTOR FUNCTION	Peak (PK)
FREQUENCY RANGE	1GHz ~ 25GHz		Average (AV)

ANTENNA POLARITY & TEST DISTANCE: HORIZONTAL AT 3 M

NO.	FREQ. (MHz)	EMISSION LEVEL (dBuV/m)	LIMIT (dBuV/m)	MARGIN (dB)	ANTENNA HEIGHT (m)	TABLE ANGLE (Degree)	RAW VALUE (dBuV)	CORRECTION FACTOR (dB/m)
1	*2462.00	109.1 PK			1.48 H	176	113.2	-4.1
2	*2462.00	106.6 AV			1.48 H	176	110.7	-4.1
3	2483.50	63.6 PK	74.0	-10.4	1.48 H	176	67.6	-4.0
4	2483.50	50.9 AV	54.0	-3.1	1.48 H	176	54.9	-4.0
5	4924.00	43.0 PK	74.0	-31.0	3.02 H	43	40.5	2.5
6	4924.00	34.3 AV	54.0	-19.7	3.02 H	43	31.8	2.5
7	7386.00	49.9 PK	74.0	-24.1	2.02 H	158	40.6	9.3
8	7386.00	40.8 AV	54.0	-13.2	2.02 H	158	31.5	9.3

ANTENNA POLARITY & TEST DISTANCE: VERTICAL AT 3 M

NO.	FREQ. (MHz)	EMISSION LEVEL (dBuV/m)	LIMIT (dBuV/m)	MARGIN (dB)	ANTENNA HEIGHT (m)	TABLE ANGLE (Degree)	RAW VALUE (dBuV)	CORRECTION FACTOR (dB/m)
1	*2462.00	111.4 PK			1.71 V	20	115.5	-4.1
2	*2462.00	108.3 AV			1.71 V	20	112.4	-4.1
3	2483.50	65.7 PK	74.0	-8.3	1.71 V	20	69.7	-4.0
4	2483.50	53.9 AV	54.0	-0.1	1.71 V	20	57.9	-4.0
5	4924.00	47.1 PK	74.0	-26.9	1.45 V	123	44.6	2.5
6	4924.00	37.6 AV	54.0	-16.4	1.45 V	123	35.1	2.5
7	7386.00	53.0 PK	74.0	-21.0	2.34 V	185	43.7	9.3
8	7386.00	44.4 AV	54.0	-9.6	2.34 V	185	35.1	9.3

REMARKS:

1. Emission Level(dBuV/m) = Raw Value(dBuV) + Correction Factor(dB/m)
2. Correction Factor(dB/m) = Antenna Factor(dB/m) + Cable Factor(dB) – Pre-Amplifier Factor(dB)
3. The other emission levels were very low against the limit.
4. Margin value = Emission Level – Limit value
5. " * ": Fundamental frequency.

802.11g

CHANNEL	TX Channel 1	DETECTOR FUNCTION	Peak (PK)
FREQUENCY RANGE	1GHz ~ 25GHz		Average (AV)

ANTENNA POLARITY & TEST DISTANCE: HORIZONTAL AT 3 M

NO.	FREQ. (MHz)	EMISSION LEVEL (dBuV/m)	LIMIT (dBuV/m)	MARGIN (dB)	ANTENNA HEIGHT (m)	TABLE ANGLE (Degree)	RAW VALUE (dBuV)	CORRECTION FACTOR (dB/m)
1	2390.00	62.8 PK	74.0	-11.2	1.50 H	193	67.0	-4.2
2	2390.00	48.2 AV	54.0	-5.8	1.50 H	193	52.4	-4.2
3	*2412.00	110.5 PK			1.50 H	193	114.6	-4.1
4	*2412.00	99.1 AV			1.50 H	193	103.2	-4.1
5	4824.00	42.5 PK	74.0	-31.5	3.08 H	75	40.2	2.3
6	4824.00	32.9 AV	54.0	-21.1	3.08 H	75	30.6	2.3

ANTENNA POLARITY & TEST DISTANCE: VERTICAL AT 3 M

NO.	FREQ. (MHz)	EMISSION LEVEL (dBuV/m)	LIMIT (dBuV/m)	MARGIN (dB)	ANTENNA HEIGHT (m)	TABLE ANGLE (Degree)	RAW VALUE (dBuV)	CORRECTION FACTOR (dB/m)
1	2390.00	71.9 PK	74.0	-2.1	1.59 V	18	76.1	-4.2
2	2390.00	53.9 AV	54.0	-0.1	1.59 V	18	58.1	-4.2
3	*2412.00	113.9 PK			2.03 V	24	118.0	-4.1
4	*2412.00	102.2 AV			2.03 V	24	106.3	-4.1
5	4824.00	42.8 PK	74.0	-31.2	1.34 V	122	40.5	2.3
6	4824.00	33.2 AV	54.0	-20.8	1.34 V	122	30.9	2.3

REMARKS:

1. Emission Level(dBuV/m) = Raw Value(dBuV) + Correction Factor(dB/m)
2. Correction Factor(dB/m) = Antenna Factor(dB/m) + Cable Factor(dB) – Pre-Amplifier Factor(dB)
3. The other emission levels were very low against the limit.
4. Margin value = Emission Level – Limit value
5. " * ": Fundamental frequency.

CHANNEL	TX Channel 6	DETECTOR FUNCTION	Peak (PK)
FREQUENCY RANGE	1GHz ~ 25GHz		Average (AV)

ANTENNA POLARITY & TEST DISTANCE: HORIZONTAL AT 3 M

NO.	FREQ. (MHz)	EMISSION LEVEL (dBuV/m)	LIMIT (dBuV/m)	MARGIN (dB)	ANTENNA HEIGHT (m)	TABLE ANGLE (Degree)	RAW VALUE (dBuV)	CORRECTION FACTOR (dB/m)
1	2390.00	57.5 PK	74.0	-16.5	1.34 H	184	61.7	-4.2
2	2390.00	49.6 AV	54.0	-4.4	1.34 H	184	53.8	-4.2
3	*2437.00	117.1 PK			1.34 H	184	121.1	-4.0
4	*2437.00	106.3 AV			1.34 H	184	110.3	-4.0
5	2483.50	60.3 PK	74.0	-13.7	1.34 H	184	64.3	-4.0
6	2483.50	51.8 AV	54.0	-2.2	1.34 H	184	55.8	-4.0
7	4874.00	44.9 PK	74.0	-29.1	3.07 H	69	42.4	2.5
8	4874.00	36.6 AV	54.0	-17.4	3.07 H	69	34.1	2.5
9	7311.00	51.5 PK	74.0	-22.5	1.87 H	144	42.6	8.9
10	7311.00	42.8 AV	54.0	-11.2	1.87 H	144	33.9	8.9

ANTENNA POLARITY & TEST DISTANCE: VERTICAL AT 3 M

NO.	FREQ. (MHz)	EMISSION LEVEL (dBuV/m)	LIMIT (dBuV/m)	MARGIN (dB)	ANTENNA HEIGHT (m)	TABLE ANGLE (Degree)	RAW VALUE (dBuV)	CORRECTION FACTOR (dB/m)
1	2390.00	69.0 PK	74.0	-5.0	1.78 V	38	73.2	-4.2
2	2390.00	50.5 AV	54.0	-3.5	1.78 V	38	54.7	-4.2
3	*2437.00	119.6 PK			2.52 V	22	123.6	-4.0
4	*2437.00	108.5 AV			2.52 V	22	112.5	-4.0
5	2483.50	73.9 PK	74.0	-0.1	1.78 V	38	77.9	-4.0
6	2483.50	53.9 AV	54.0	-0.1	1.78 V	38	57.9	-4.0
7	4874.00	45.1 PK	74.0	-28.9	1.30 V	113	42.6	2.5
8	4874.00	36.2 AV	54.0	-17.8	1.30 V	113	33.7	2.5
9	7311.00	51.4 PK	74.0	-22.6	2.41 V	193	42.5	8.9
10	7311.00	42.7 AV	54.0	-11.3	2.41 V	193	33.8	8.9

REMARKS:

- Emission Level(dBuV/m) = Raw Value(dBuV) + Correction Factor(dB/m)
- Correction Factor(dB/m) = Antenna Factor(dB/m) + Cable Factor(dB) – Pre-Amplifier Factor(dB)
- The other emission levels were very low against the limit.
- Margin value = Emission Level – Limit value
- " * ": Fundamental frequency.

CHANNEL	TX Channel 11	DETECTOR FUNCTION	Peak (PK)
FREQUENCY RANGE	1GHz ~ 25GHz		Average (AV)

ANTENNA POLARITY & TEST DISTANCE: HORIZONTAL AT 3 M

NO.	FREQ. (MHz)	EMISSION LEVEL (dBuV/m)	LIMIT (dBuV/m)	MARGIN (dB)	ANTENNA HEIGHT (m)	TABLE ANGLE (Degree)	RAW VALUE (dBuV)	CORRECTION FACTOR (dB/m)
1	*2462.00	116.4 PK			1.33 H	173	120.5	-4.1
2	*2462.00	98.0 AV			1.33 H	173	102.1	-4.1
3	2483.50	68.4 PK	74.0	-5.6	1.33 H	173	72.4	-4.0
4	2483.50	51.2 AV	54.0	-2.8	1.33 H	173	55.2	-4.0
5	4924.00	44.6 PK	74.0	-29.4	3.04 H	66	42.1	2.5
6	4924.00	36.1 AV	54.0	-17.9	3.04 H	66	33.6	2.5
7	7386.00	51.7 PK	74.0	-22.3	1.98 H	174	42.4	9.3
8	7386.00	43.0 AV	54.0	-11.0	1.98 H	174	33.7	9.3

ANTENNA POLARITY & TEST DISTANCE: VERTICAL AT 3 M

NO.	FREQ. (MHz)	EMISSION LEVEL (dBuV/m)	LIMIT (dBuV/m)	MARGIN (dB)	ANTENNA HEIGHT (m)	TABLE ANGLE (Degree)	RAW VALUE (dBuV)	CORRECTION FACTOR (dB/m)
1	*2462.00	112.4 PK			2.03 V	20	116.5	-4.1
2	*2462.00	100.5 AV			2.03 V	20	104.6	-4.1
3	2483.50	70.4 PK	74.0	-3.6	1.64 V	20	74.4	-4.0
4	2483.50	53.8 AV	54.0	-0.2	1.64 V	20	57.8	-4.0
5	4924.00	44.8 PK	74.0	-29.2	1.30 V	127	42.3	2.5
6	4924.00	35.7 AV	54.0	-18.3	1.30 V	127	33.2	2.5
7	7386.00	52.0 PK	74.0	-22.0	2.40 V	207	42.7	9.3
8	7386.00	43.0 AV	54.0	-11.0	2.40 V	207	33.7	9.3

REMARKS:

1. Emission Level(dBuV/m) = Raw Value(dBuV) + Correction Factor(dB/m)
2. Correction Factor(dB/m) = Antenna Factor(dB/m) + Cable Factor(dB) – Pre-Amplifier Factor(dB)
3. The other emission levels were very low against the limit.
4. Margin value = Emission Level – Limit value
5. " * ": Fundamental frequency.

802.11n (HT20)

CHANNEL	TX Channel 1	DETECTOR FUNCTION	Peak (PK)
FREQUENCY RANGE	1GHz ~ 25GHz		Average (AV)

ANTENNA POLARITY & TEST DISTANCE: HORIZONTAL AT 3 M

NO.	FREQ. (MHz)	EMISSION LEVEL (dBuV/m)	LIMIT (dBuV/m)	MARGIN (dB)	ANTENNA HEIGHT (m)	TABLE ANGLE (Degree)	RAW VALUE (dBuV)	CORRECTION FACTOR (dB/m)
1	2390.00	63.3 PK	74.0	-10.7	1.54 H	209	67.5	-4.2
2	2390.00	48.5 AV	54.0	-5.5	1.54 H	209	52.7	-4.2
3	*2412.00	110.6 PK			1.54 H	209	114.7	-4.1
4	*2412.00	99.2 AV			1.54 H	209	103.3	-4.1
5	4824.00	42.2 PK	74.0	-31.8	3.12 H	84	39.9	2.3
6	4824.00	32.9 AV	54.0	-21.1	3.12 H	84	30.6	2.3

ANTENNA POLARITY & TEST DISTANCE: VERTICAL AT 3 M

NO.	FREQ. (MHz)	EMISSION LEVEL (dBuV/m)	LIMIT (dBuV/m)	MARGIN (dB)	ANTENNA HEIGHT (m)	TABLE ANGLE (Degree)	RAW VALUE (dBuV)	CORRECTION FACTOR (dB/m)
1	2390.00	69.6 PK	74.0	-4.4	1.57 V	22	73.8	-4.2
2	2390.00	53.9 AV	54.0	-0.1	1.57 V	22	58.1	-4.2
3	*2412.00	113.6 PK			1.57 V	22	117.7	-4.1
4	*2412.00	102.0 AV			1.57 V	22	106.1	-4.1
5	4824.00	43.2 PK	74.0	-30.8	1.31 V	129	40.9	2.3
6	4824.00	33.7 AV	54.0	-20.3	1.31 V	129	31.4	2.3

REMARKS:

1. Emission Level(dBuV/m) = Raw Value(dBuV) + Correction Factor(dB/m)
2. Correction Factor(dB/m) = Antenna Factor(dB/m) + Cable Factor(dB) – Pre-Amplifier Factor(dB)
3. The other emission levels were very low against the limit.
4. Margin value = Emission Level – Limit value
5. " * ": Fundamental frequency.

CHANNEL	TX Channel 6	DETECTOR FUNCTION	Peak (PK)
FREQUENCY RANGE	1GHz ~ 25GHz		Average (AV)

ANTENNA POLARITY & TEST DISTANCE: HORIZONTAL AT 3 M

NO.	FREQ. (MHz)	EMISSION LEVEL (dBuV/m)	LIMIT (dBuV/m)	MARGIN (dB)	ANTENNA HEIGHT (m)	TABLE ANGLE (Degree)	RAW VALUE (dBuV)	CORRECTION FACTOR (dB/m)
1	2390.00	57.1 PK	74.0	-16.9	1.38 H	191	61.3	-4.2
2	2390.00	49.5 AV	54.0	-4.5	1.38 H	191	53.7	-4.2
3	*2437.00	116.3 PK			1.38 H	191	120.3	-4.0
4	*2437.00	104.2 AV			1.38 H	191	108.2	-4.0
5	2483.50	60.4 PK	74.0	-13.6	1.38 H	191	64.4	-4.0
6	2483.50	51.9 AV	54.0	-2.1	1.38 H	191	55.9	-4.0
7	4874.00	44.6 PK	74.0	-29.4	3.13 H	70	42.1	2.5
8	4874.00	36.3 AV	54.0	-17.7	3.13 H	70	33.8	2.5
9	7311.00	52.0 PK	74.0	-22.0	1.87 H	145	43.1	8.9
10	7311.00	43.3 AV	54.0	-10.7	1.87 H	145	34.4	8.9

ANTENNA POLARITY & TEST DISTANCE: VERTICAL AT 3 M

NO.	FREQ. (MHz)	EMISSION LEVEL (dBuV/m)	LIMIT (dBuV/m)	MARGIN (dB)	ANTENNA HEIGHT (m)	TABLE ANGLE (Degree)	RAW VALUE (dBuV)	CORRECTION FACTOR (dB/m)
1	2390.00	70.6 PK	74.0	-3.4	1.97 V	14	74.8	-4.2
2	2390.00	50.2 AV	54.0	-3.8	1.97 V	14	54.4	-4.2
3	*2437.00	118.3 PK			1.57 V	19	122.3	-4.0
4	*2437.00	106.6 AV			1.57 V	19	110.6	-4.0
5	2483.50	73.0 PK	74.0	-1.0	1.97 V	14	77.0	-4.0
6	2483.50	53.9 AV	54.0	-0.1	1.97 V	14	57.9	-4.0
7	4874.00	45.1 PK	74.0	-28.9	1.29 V	107	42.6	2.5
8	4874.00	36.3 AV	54.0	-17.7	1.29 V	107	33.8	2.5
9	7311.00	51.4 PK	74.0	-22.6	2.46 V	187	42.5	8.9
10	7311.00	42.6 AV	54.0	-11.4	2.46 V	187	33.7	8.9

REMARKS:

- Emission Level(dBuV/m) = Raw Value(dBuV) + Correction Factor(dB/m)
- Correction Factor(dB/m) = Antenna Factor(dB/m) + Cable Factor(dB) – Pre-Amplifier Factor(dB)
- The other emission levels were very low against the limit.
- Margin value = Emission Level – Limit value
- " * ": Fundamental frequency.

CHANNEL	TX Channel 11	DETECTOR FUNCTION	Peak (PK)
FREQUENCY RANGE	1GHz ~ 25GHz		Average (AV)

ANTENNA POLARITY & TEST DISTANCE: HORIZONTAL AT 3 M

NO.	FREQ. (MHz)	EMISSION LEVEL (dBuV/m)	LIMIT (dBuV/m)	MARGIN (dB)	ANTENNA HEIGHT (m)	TABLE ANGLE (Degree)	RAW VALUE (dBuV)	CORRECTION FACTOR (dB/m)
1	*2462.00	115.9 PK			1.34 H	164	120.0	-4.1
2	*2462.00	97.8 AV			1.34 H	164	101.9	-4.1
3	2483.50	68.1 PK	74.0	-5.9	1.34 H	164	72.1	-4.0
4	2483.50	50.7 AV	54.0	-3.3	1.34 H	164	54.7	-4.0
5	4924.00	44.6 PK	74.0	-29.4	3.05 H	63	42.1	2.5
6	4924.00	36.1 AV	54.0	-17.9	3.05 H	63	33.6	2.5
7	7386.00	51.3 PK	74.0	-22.7	1.99 H	181	42.0	9.3
8	7386.00	42.8 AV	54.0	-11.2	1.99 H	181	33.5	9.3

ANTENNA POLARITY & TEST DISTANCE: VERTICAL AT 3 M

NO.	FREQ. (MHz)	EMISSION LEVEL (dBuV/m)	LIMIT (dBuV/m)	MARGIN (dB)	ANTENNA HEIGHT (m)	TABLE ANGLE (Degree)	RAW VALUE (dBuV)	CORRECTION FACTOR (dB/m)
1	*2462.00	112.4 PK			1.59 V	24	116.5	-4.1
2	*2462.00	99.8 AV			1.59 V	24	103.9	-4.1
3	2483.50	72.5 PK	74.0	-1.5	1.59 V	27	76.5	-4.0
4	2483.50	53.8 AV	54.0	-0.2	1.59 V	27	57.8	-4.0
5	4924.00	44.5 PK	74.0	-29.5	1.27 V	120	42.0	2.5
6	4924.00	35.5 AV	54.0	-18.5	1.27 V	120	33.0	2.5
7	7386.00	52.0 PK	74.0	-22.0	2.37 V	205	42.7	9.3
8	7386.00	43.1 AV	54.0	-10.9	2.37 V	205	33.8	9.3

REMARKS:

1. Emission Level(dBuV/m) = Raw Value(dBuV) + Correction Factor(dB/m)
2. Correction Factor(dB/m) = Antenna Factor(dB/m) + Cable Factor(dB) – Pre-Amplifier Factor(dB)
3. The other emission levels were very low against the limit.
4. Margin value = Emission Level – Limit value
5. " * ": Fundamental frequency.

802.11n (HT40)

CHANNEL	TX Channel 3	DETECTOR FUNCTION	Peak (PK)
FREQUENCY RANGE	1GHz ~ 25GHz		Average (AV)

ANTENNA POLARITY & TEST DISTANCE: HORIZONTAL AT 3 M

NO.	FREQ. (MHz)	EMISSION LEVEL (dBuV/m)	LIMIT (dBuV/m)	MARGIN (dB)	ANTENNA HEIGHT (m)	TABLE ANGLE (Degree)	RAW VALUE (dBuV)	CORRECTION FACTOR (dB/m)
1	2390.00	69.8 PK	74.0	-4.2	1.33 H	152	74.0	-4.2
2	2390.00	51.4 AV	54.0	-2.6	1.33 H	152	55.6	-4.2
3	*2422.00	109.4 PK			1.33 H	152	113.5	-4.1
4	*2422.00	95.3 AV			1.33 H	152	99.4	-4.1
5	4844.00	43.2 PK	74.0	-30.8	3.01 H	49	40.9	2.3
6	4844.00	34.4 AV	54.0	-19.6	3.01 H	49	32.1	2.3
7	7266.00	50.8 PK	74.0	-23.2	1.96 H	182	42.0	8.8
8	7266.00	42.2 AV	54.0	-11.8	1.96 H	182	33.4	8.8

ANTENNA POLARITY & TEST DISTANCE: VERTICAL AT 3 M

NO.	FREQ. (MHz)	EMISSION LEVEL (dBuV/m)	LIMIT (dBuV/m)	MARGIN (dB)	ANTENNA HEIGHT (m)	TABLE ANGLE (Degree)	RAW VALUE (dBuV)	CORRECTION FACTOR (dB/m)
1	2390.00	71.5 PK	74.0	-2.5	2.10 V	20	75.7	-4.2
2	2390.00	53.6 AV	54.0	-0.4	2.10 V	20	57.8	-4.2
3	*2422.00	111.6 PK			2.10 V	20	115.7	-4.1
4	*2422.00	97.0 AV			2.10 V	20	101.1	-4.1
5	4844.00	44.3 PK	74.0	-29.7	1.25 V	105	42.0	2.3
6	4844.00	34.7 AV	54.0	-19.3	1.25 V	105	32.4	2.3
7	7266.00	50.6 PK	74.0	-23.4	2.38 V	212	41.8	8.8
8	7266.00	41.5 AV	54.0	-12.5	2.38 V	212	32.7	8.8

REMARKS:

- Emission Level(dBuV/m) = Raw Value(dBuV) + Correction Factor(dB/m)
- Correction Factor(dB/m) = Antenna Factor(dB/m) + Cable Factor(dB) – Pre-Amplifier Factor(dB)
- The other emission levels were very low against the limit.
- Margin value = Emission Level – Limit value
- " * ": Fundamental frequency.

CHANNEL	TX Channel 6	DETECTOR FUNCTION	Peak (PK)
FREQUENCY RANGE	1GHz ~ 25GHz		Average (AV)

ANTENNA POLARITY & TEST DISTANCE: HORIZONTAL AT 3 M

NO.	FREQ. (MHz)	EMISSION LEVEL (dBuV/m)	LIMIT (dBuV/m)	MARGIN (dB)	ANTENNA HEIGHT (m)	TABLE ANGLE (Degree)	RAW VALUE (dBuV)	CORRECTION FACTOR (dB/m)
1	2390.00	68.6 PK	74.0	-5.4	1.30 H	162	72.8	-4.2
2	2390.00	49.6 AV	54.0	-4.4	1.30 H	162	53.8	-4.2
3	*2437.00	108.3 PK			1.30 H	162	112.3	-4.0
4	*2437.00	95.3 AV			1.30 H	162	99.3	-4.0
5	2483.50	70.4 PK	74.0	-3.6	1.30 H	162	74.4	-4.0
6	2483.50	51.4 AV	54.0	-2.6	1.30 H	162	55.4	-4.0
7	4874.00	43.5 PK	74.0	-30.5	3.01 H	54	41.0	2.5
8	4874.00	34.7 AV	54.0	-19.3	3.01 H	54	32.2	2.5
9	7311.00	50.6 PK	74.0	-23.4	1.94 H	167	41.7	8.9
10	7311.00	42.0 AV	54.0	-12.0	1.94 H	167	33.1	8.9

ANTENNA POLARITY & TEST DISTANCE: VERTICAL AT 3 M

NO.	FREQ. (MHz)	EMISSION LEVEL (dBuV/m)	LIMIT (dBuV/m)	MARGIN (dB)	ANTENNA HEIGHT (m)	TABLE ANGLE (Degree)	RAW VALUE (dBuV)	CORRECTION FACTOR (dB/m)
1	2390.00	70.6 PK	74.0	-3.4	2.10 V	18	74.8	-4.2
2	2390.00	51.6 AV	54.0	-2.4	2.10 V	18	55.8	-4.2
3	*2437.00	110.7 PK			2.10 V	18	114.7	-4.0
4	*2437.00	97.8 AV			2.10 V	18	101.8	-4.0
5	2483.50	72.1 PK	74.0	-1.9	2.10 V	18	76.1	-4.0
6	2483.50	53.6 AV	54.0	-0.4	2.10 V	18	57.6	-4.0
7	4874.00	43.9 PK	74.0	-30.1	1.30 V	105	41.4	2.5
8	4874.00	34.3 AV	54.0	-19.7	1.30 V	105	31.8	2.5
9	7311.00	50.0 PK	74.0	-24.0	2.33 V	203	41.1	8.9
10	7311.00	41.2 AV	54.0	-12.8	2.33 V	203	32.3	8.9

REMARKS:

1. Emission Level(dBuV/m) = Raw Value(dBuV) + Correction Factor(dB/m)
2. Correction Factor(dB/m) = Antenna Factor(dB/m) + Cable Factor(dB) – Pre-Amplifier Factor(dB)
3. The other emission levels were very low against the limit.
4. Margin value = Emission Level – Limit value
5. " * ": Fundamental frequency.

CHANNEL	TX Channel 9	DETECTOR FUNCTION	Peak (PK)
FREQUENCY RANGE	1GHz ~ 25GHz		Average (AV)

ANTENNA POLARITY & TEST DISTANCE: HORIZONTAL AT 3 M

NO.	FREQ. (MHz)	EMISSION LEVEL (dBuV/m)	LIMIT (dBuV/m)	MARGIN (dB)	ANTENNA HEIGHT (m)	TABLE ANGLE (Degree)	RAW VALUE (dBuV)	CORRECTION FACTOR (dB/m)
1	*2452.00	106.3 PK			1.32 H	166	110.4	-4.1
2	*2452.00	93.6 AV			1.32 H	166	97.7	-4.1
3	2483.50	70.4 PK	74.0	-3.6	1.32 H	166	74.4	-4.0
4	2483.50	51.4 AV	54.0	-2.6	1.32 H	166	55.4	-4.0
5	4904.00	42.7 PK	74.0	-31.3	2.98 H	47	40.2	2.5
6	4904.00	34.0 AV	54.0	-20.0	2.98 H	47	31.5	2.5
7	7356.00	51.2 PK	74.0	-22.8	1.91 H	196	42.0	9.2
8	7356.00	42.6 AV	54.0	-11.4	1.91 H	196	33.4	9.2

ANTENNA POLARITY & TEST DISTANCE: VERTICAL AT 3 M

NO.	FREQ. (MHz)	EMISSION LEVEL (dBuV/m)	LIMIT (dBuV/m)	MARGIN (dB)	ANTENNA HEIGHT (m)	TABLE ANGLE (Degree)	RAW VALUE (dBuV)	CORRECTION FACTOR (dB/m)
1	*2452.00	108.4 PK			2.10 V	23	112.5	-4.1
2	*2452.00	95.8 AV			2.10 V	23	99.9	-4.1
3	2483.50	72.4 PK	74.0	-1.6	2.10 V	23	76.4	-4.0
4	2483.50	53.9 AV	54.0	-0.1	2.10 V	23	57.9	-4.0
5	4904.00	44.2 PK	74.0	-29.8	1.29 V	113	41.7	2.5
6	4904.00	34.6 AV	54.0	-19.4	1.29 V	113	32.1	2.5
7	7356.00	50.3 PK	74.0	-23.7	2.39 V	213	41.1	9.2
8	7356.00	41.2 AV	54.0	-12.8	2.39 V	213	32.0	9.2

REMARKS:

1. Emission Level(dBuV/m) = Raw Value(dBuV) + Correction Factor(dB/m)
2. Correction Factor(dB/m) = Antenna Factor(dB/m) + Cable Factor(dB) – Pre-Amplifier Factor(dB)
3. The other emission levels were very low against the limit.
4. Margin value = Emission Level – Limit value
5. " * ": Fundamental frequency.

Below 1GHz Data:

802.11b

CHANNEL	TX Channel 6	DETECTOR FUNCTION	Quasi-Peak (QP)
FREQUENCY RANGE	Below 1GHz		

ANTENNA POLARITY & TEST DISTANCE: HORIZONTAL AT 3 M

NO.	FREQ. (MHz)	EMISSION LEVEL (dBuV/m)	LIMIT (dBuV/m)	MARGIN (dB)	ANTENNA HEIGHT (m)	TABLE ANGLE (Degree)	RAW VALUE (dBuV)	CORRECTION FACTOR (dB/m)
1	90.41	34.1 QP	43.5	-9.4	2.10 H	296	48.6	-14.5
2	143.32	29.8 QP	43.5	-13.7	2.50 H	270	38.5	-8.7
3	240.03	37.2 QP	46.0	-8.8	1.10 H	342	47.5	-10.3
4	360.04	33.4 QP	46.0	-12.6	1.10 H	356	40.0	-6.6
5	380.58	42.0 QP	46.0	-4.0	2.50 H	22	48.0	-6.0
6	480.01	41.4 QP	46.0	-4.6	2.10 H	65	44.6	-3.2

ANTENNA POLARITY & TEST DISTANCE: VERTICAL AT 3 M

NO.	FREQ. (MHz)	EMISSION LEVEL (dBuV/m)	LIMIT (dBuV/m)	MARGIN (dB)	ANTENNA HEIGHT (m)	TABLE ANGLE (Degree)	RAW VALUE (dBuV)	CORRECTION FACTOR (dB/m)
1	38.12	36.8 QP	40.0	-3.2	1.10 V	12	46.0	-9.2
2	56.55	35.6 QP	40.0	-4.4	1.10 V	221	44.6	-9.0
3	101.93	36.5 QP	43.5	-7.0	1.10 V	243	49.1	-12.6
4	240.00	33.5 QP	46.0	-12.5	1.10 V	14	43.8	-10.3
5	381.33	34.2 QP	46.0	-11.8	3.10 V	282	40.2	-6.0
6	480.01	39.6 QP	46.0	-6.4	1.10 V	288	42.8	-3.2

REMARKS:

1. Emission Level(dBuV/m) = Raw Value(dBuV) + Correction Factor(dB/m)
2. Correction Factor(dB/m) = Antenna Factor(dB/m) + Cable Factor(dB) – Pre-Amplifier Factor(dB)
3. The other emission levels were very low against the limit.
4. Margin value = Emission Level – Limit value

4.2 Conducted Emission Measurement

4.2.1 Limits of Conducted Emission Measurement

Frequency (MHz)	Conducted Limit (dBuV)	
	Quasi-peak	Average
0.15 - 0.5	66 - 56	56 - 46
0.50 - 5.0	56	46
5.0 - 30.0	60	50

Note: 1. The lower limit shall apply at the transition frequencies.

2. The limit decreases in line with the logarithm of the frequency in the range of 0.15 to 0.50MHz.

4.2.2 Test Instruments

DESCRIPTION & MANUFACTURER	MODEL NO.	SERIAL NO.	CALIBRATED DATE	CALIBRATED UNTIL
Test Receiver R&S	ESCS 30	847124/029	Oct. 23, 2015	Oct. 22, 2016
Line-Impedance Stabilization Network (for EUT) R&S	ESH3-Z5	848773/004	Oct. 28, 2015	Oct. 27, 2016
RF Cable	5D-FB	COACAB-002	Mar. 04, 2016	Mar. 03, 2017
10 dB PAD Mini-Circuits	HAT-10+	CONATT-004	Jun. 20, 2016	Jun. 19, 2017
Software BVADT	BVADT_Cond_ V7.3.7.3	NA	NA	NA

Note:

1. The calibration interval of the above test instruments are 12 months and the calibrations are traceable to NML/ROC and NIST/USA.
2. The test was performed in Shielded Room No. 1.
- 3 Tested Date: Aug. 01, 2016

4.2.3 Test Procedures

- The EUT was placed 0.4 meters from the conducting wall of the shielded room with EUT being connected to the power mains through a line impedance stabilization network (LISN). Other support units were connected to the power mains through another LISN. The two LISNs provide 50 ohm/ 50uH of coupling impedance for the measuring instrument.
- Both lines of the power mains connected to the EUT were checked for maximum conducted interference.
- The frequency range from 150kHz to 30MHz was searched. Emission levels under (Limit - 20dB) was not recorded.

NOTE: The resolution bandwidth and video bandwidth of test receiver is 9kHz for quasi-peak detection (QP) and average detection (AV) at frequency 0.15MHz-30MHz.

4.2.4 Deviation from Test Standard

No deviation.

4.2.5 Test Setup

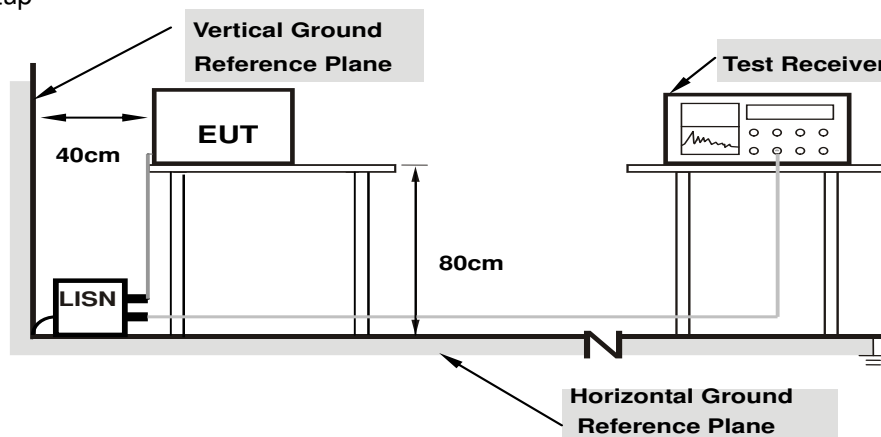

Note: 1.Support units were connected to second LISN.

For the actual test configuration, please refer to the attached file (Test Setup Photo).

4.2.6 EUT Operating Conditions

Same as 4.1.6.

4.2.7 Test Results (Mode 1)

Phase	Line (L)	Detector Function	Quasi-Peak (QP) / Average (AV)
-------	----------	-------------------	--------------------------------

Phase Of Power : Line (L)										
No	Frequency (MHz)	Correction Factor (dB)	Reading Value (dBuV)		Emission Level (dBuV)		Limit (dBuV)		Margin (dB)	
			Q.P.	AV.	Q.P.	AV.	Q.P.	AV.	Q.P.	AV.
1	0.16562	10.21	31.97	20.69	42.18	30.90	65.18	55.18	-22.99	-24.27
2	0.20078	10.22	34.65	27.11	44.87	37.33	63.58	53.58	-18.71	-16.25
3	0.28672	10.22	39.08	34.06	49.30	44.28	60.62	50.62	-11.32	-6.34
4	0.52891	10.23	18.36	13.15	28.59	23.38	56.00	46.00	-27.41	-22.62
5	3.65625	10.29	16.75	9.85	27.04	20.14	56.00	46.00	-28.96	-25.86
6	14.53516	11.02	14.28	10.85	25.30	21.87	60.00	50.00	-34.70	-28.13

Remarks:

1. Q.P. and AV. are abbreviations of quasi-peak and average individually.
2. The emission levels of other frequencies were very low against the limit.
3. Margin value = Emission level – Limit value
4. Correction factor = Insertion loss + Cable loss
5. Emission Level = Correction Factor + Reading Value

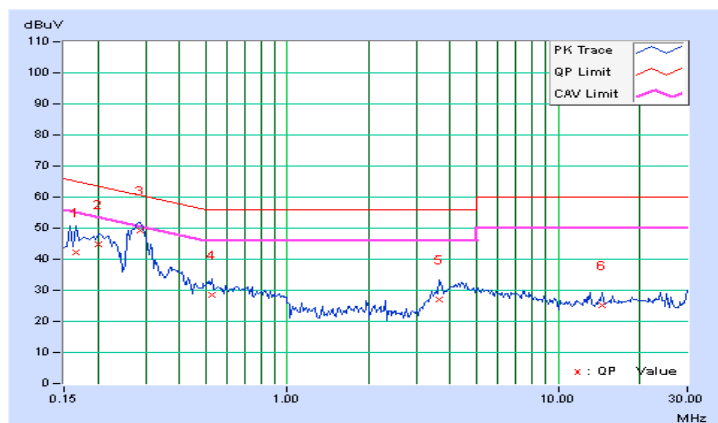

Phase	Neutral (N)	Detector Function	Quasi-Peak (QP) / Average (AV)
-------	-------------	-------------------	--------------------------------

Phase Of Power : Neutral (N)										
No	Frequency (MHz)	Correction Factor (dB)	Reading Value (dBuV)		Emission Level (dBuV)		Limit (dBuV)		Margin (dB)	
			Q.P.	AV.	Q.P.	AV.	Q.P.	AV.	Q.P.	AV.
1	0.16172	10.19	32.05	21.98	42.24	32.17	65.38	55.38	-23.13	-23.20
2	0.20078	10.21	32.40	24.81	42.61	35.02	63.58	53.58	-20.97	-18.56
3	0.28281	10.21	37.72	32.38	47.93	42.59	60.73	50.73	-12.81	-8.15
4	0.39219	10.20	22.46	17.47	32.66	27.67	58.02	48.02	-25.36	-20.35
5	0.96641	10.24	17.30	13.35	27.54	23.59	56.00	46.00	-28.46	-22.41
6	3.86719	10.25	22.00	16.64	32.25	26.89	56.00	46.00	-23.75	-19.11

Remarks:

1. Q.P. and AV. are abbreviations of quasi-peak and average individually.
2. The emission levels of other frequencies were very low against the limit.
3. Margin value = Emission level – Limit value
4. Correction factor = Insertion loss + Cable loss
5. Emission Level = Correction Factor + Reading Value

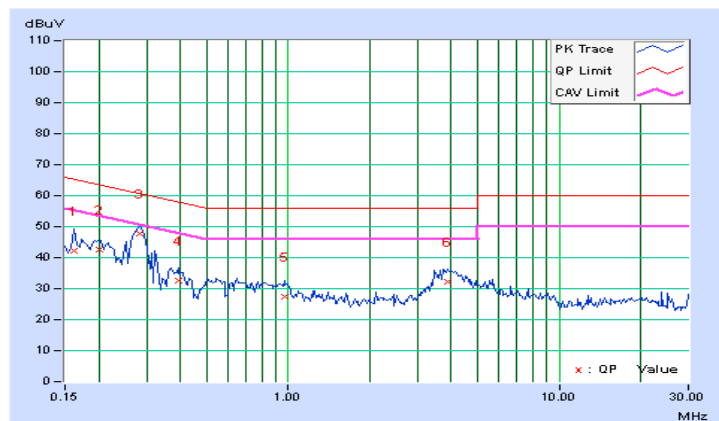

4.2.8 Test Results (Mode 2)

Phase	Line (L)	Detector Function	Quasi-Peak (QP) / Average (AV)
-------	----------	-------------------	--------------------------------

Phase Of Power : Line (L)										
No	Frequency (MHz)	Correction Factor (dB)	Reading Value (dBuV)		Emission Level (dBuV)		Limit (dBuV)		Margin (dB)	
			Q.P.	AV.	Q.P.	AV.	Q.P.	AV.	Q.P.	AV.
1	0.15391	10.21	48.28	34.34	58.49	44.55	65.79	55.79	-7.30	-11.24
2	0.25547	10.22	34.08	22.55	44.30	32.77	61.58	51.58	-17.28	-18.81
3	0.32969	10.22	36.48	30.98	46.70	41.20	59.46	49.46	-12.76	-8.26
4	0.42344	10.22	24.31	9.80	34.53	20.02	57.38	47.38	-22.85	-27.36
5	0.60313	10.23	14.22	6.55	24.45	16.78	56.00	46.00	-31.55	-29.22
6	26.60938	11.47	19.07	15.97	30.54	27.44	60.00	50.00	-29.46	-22.56

Remarks:

1. Q.P. and AV. are abbreviations of quasi-peak and average individually.
2. The emission levels of other frequencies were very low against the limit.
3. Margin value = Emission level – Limit value
4. Correction factor = Insertion loss + Cable loss
5. Emission Level = Correction Factor + Reading Value

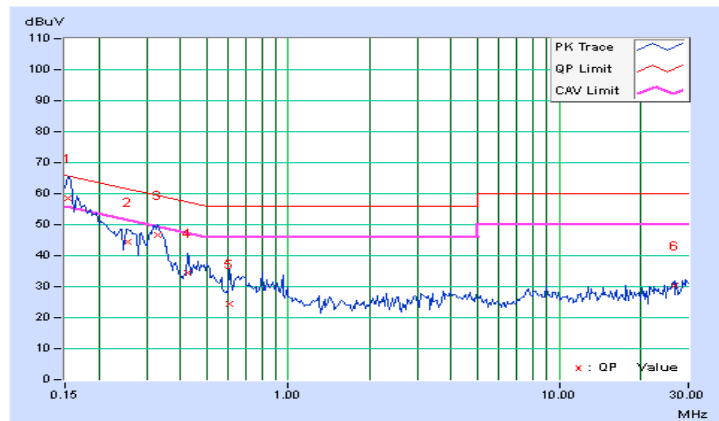

Phase	Neutral (N)	Detector Function	Quasi-Peak (QP) / Average (AV)
-------	-------------	-------------------	--------------------------------

Phase Of Power : Neutral (N)										
No	Frequency (MHz)	Correction Factor (dB)	Reading Value (dBuV)		Emission Level (dBuV)		Limit (dBuV)		Margin (dB)	
			Q.P.	AV.	Q.P.	AV.	Q.P.	AV.	Q.P.	AV.
1	0.15000	10.19	49.78	36.10	59.97	46.29	66.00	56.00	-6.03	-9.71
2	0.17734	10.20	44.08	30.23	54.28	40.43	64.61	54.61	-10.33	-14.18
3	0.32969	10.20	36.68	30.98	46.88	41.18	59.46	49.46	-12.58	-8.28
4	0.44688	10.20	22.71	14.53	32.91	24.73	56.93	46.93	-24.02	-22.20
5	4.00781	10.25	15.43	7.52	25.68	17.77	56.00	46.00	-30.32	-28.23
6	26.60938	11.13	23.54	20.52	34.67	31.65	60.00	50.00	-25.33	-18.35

Remarks:

1. Q.P. and AV. are abbreviations of quasi-peak and average individually.
2. The emission levels of other frequencies were very low against the limit.
3. Margin value = Emission level – Limit value
4. Correction factor = Insertion loss + Cable loss
5. Emission Level = Correction Factor + Reading Value

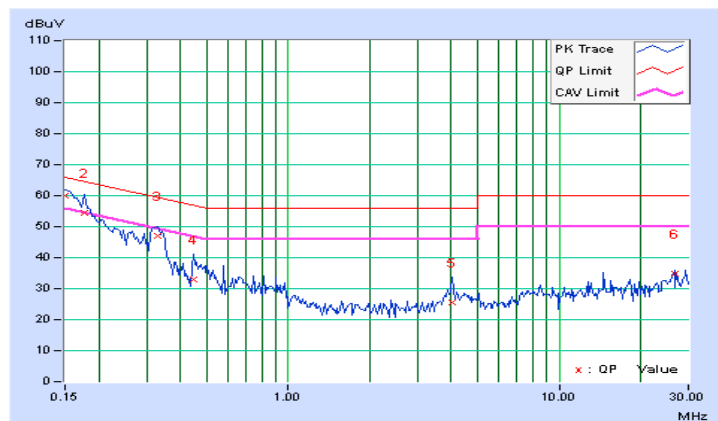

4.2.9 Test Results (Mode 3)

Phase	Line (L)	Detector Function	Quasi-Peak (QP) / Average (AV)
-------	----------	-------------------	--------------------------------

Phase Of Power : Line (L)										
No	Frequency (MHz)	Correction Factor (dB)	Reading Value (dBuV)		Emission Level (dBuV)		Limit (dBuV)		Margin (dB)	
			Q.P.	AV.	Q.P.	AV.	Q.P.	AV.	Q.P.	AV.
1	0.18125	10.22	31.95	21.96	42.17	32.18	64.43	54.43	-22.26	-22.25
2	0.21641	10.22	34.59	27.81	44.81	38.03	62.96	52.96	-18.15	-14.93
3	0.27500	10.22	40.29	33.10	50.51	43.32	60.97	50.97	-10.46	-7.65
4	3.48438	10.30	18.26	12.11	28.56	22.41	56.00	46.00	-27.44	-23.59
5	4.67188	10.33	15.68	9.87	26.01	20.20	56.00	46.00	-29.99	-25.80
6	26.00000	11.46	21.61	20.41	33.07	31.87	60.00	50.00	-26.93	-18.13

Remarks:

1. Q.P. and AV. are abbreviations of quasi-peak and average individually.
2. The emission levels of other frequencies were very low against the limit.
3. Margin value = Emission level – Limit value
4. Correction factor = Insertion loss + Cable loss
5. Emission Level = Correction Factor + Reading Value

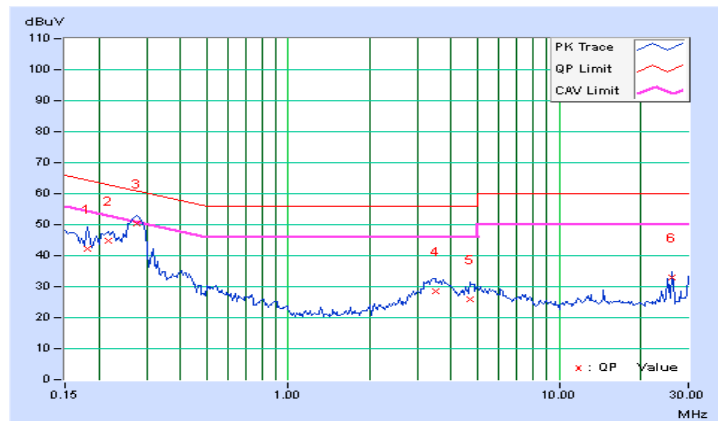

Phase	Neutral (N)	Detector Function	Quasi-Peak (QP) / Average (AV)
-------	-------------	-------------------	--------------------------------

Phase Of Power : Neutral (N)										
No	Frequency (MHz)	Correction Factor (dB)	Reading Value (dBuV)		Emission Level (dBuV)		Limit (dBuV)		Margin (dB)	
			Q.P.	AV.	Q.P.	AV.	Q.P.	AV.	Q.P.	AV.
1	0.15781	10.19	33.80	21.33	43.99	31.52	65.58	55.58	-21.59	-24.06
2	0.22031	10.21	33.53	27.59	43.74	37.80	62.81	52.81	-19.07	-15.01
3	0.27109	10.21	38.30	32.18	48.51	42.39	61.08	51.08	-12.58	-8.70
4	0.41563	10.20	19.65	14.23	29.85	24.43	57.54	47.54	-27.68	-23.10
5	3.40234	10.26	17.92	12.15	28.18	22.41	56.00	46.00	-27.82	-23.59
6	26.00000	11.13	24.65	22.83	35.78	33.96	60.00	50.00	-24.22	-16.04

Remarks:

1. Q.P. and AV. are abbreviations of quasi-peak and average individually.
2. The emission levels of other frequencies were very low against the limit.
3. Margin value = Emission level – Limit value
4. Correction factor = Insertion loss + Cable loss
5. Emission Level = Correction Factor + Reading Value

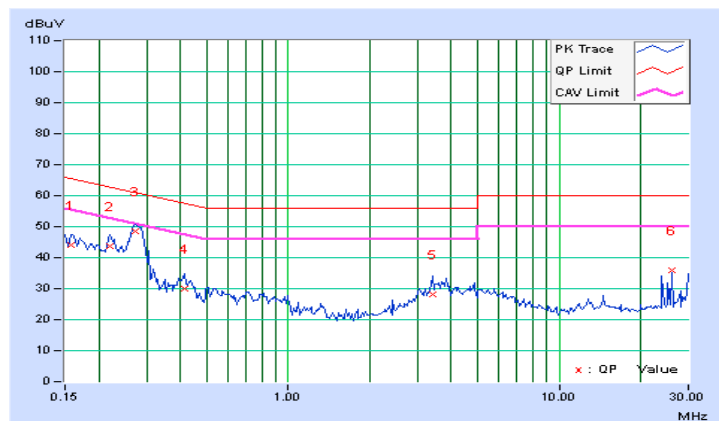

4.2.10 Test Results (Mode 4)

Phase	Line (L)	Detector Function	Quasi-Peak (QP) / Average (AV)
-------	----------	-------------------	--------------------------------

Phase Of Power : Line (L)										
No	Frequency (MHz)	Correction Factor (dB)	Reading Value (dBuV)		Emission Level (dBuV)		Limit (dBuV)		Margin (dB)	
			Q.P.	AV.	Q.P.	AV.	Q.P.	AV.	Q.P.	AV.
1	0.16172	10.21	45.67	30.57	55.88	40.78	65.38	55.38	-9.49	-14.59
2	0.21641	10.22	36.01	22.60	46.23	32.82	62.96	52.96	-16.73	-20.14
3	0.38712	10.22	30.64	30.04	40.86	40.26	58.13	48.13	-17.27	-7.87
4	1.19922	10.27	18.04	11.93	28.31	22.20	56.00	46.00	-27.69	-23.80
5	5.42578	10.37	20.27	13.99	30.64	24.36	60.00	50.00	-29.36	-25.64
6	26.00000	11.46	19.32	17.62	30.78	29.08	60.00	50.00	-29.22	-20.92

Remarks:

1. Q.P. and AV. are abbreviations of quasi-peak and average individually.
2. The emission levels of other frequencies were very low against the limit.
3. Margin value = Emission level – Limit value
4. Correction factor = Insertion loss + Cable loss
5. Emission Level = Correction Factor + Reading Value

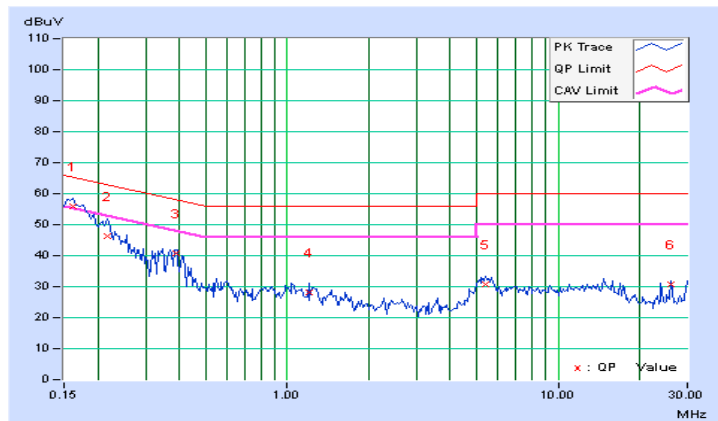

Phase	Neutral (N)	Detector Function	Quasi-Peak (QP) / Average (AV)
-------	-------------	-------------------	--------------------------------

Phase Of Power : Neutral (N)										
No	Frequency (MHz)	Correction Factor (dB)	Reading Value (dBuV)		Emission Level (dBuV)		Limit (dBuV)		Margin (dB)	
			Q.P.	AV.	Q.P.	AV.	Q.P.	AV.	Q.P.	AV.
1	0.15391	10.19	46.43	33.12	56.62	43.31	65.79	55.79	-9.16	-12.47
2	0.18516	10.20	41.39	25.75	51.59	35.95	64.25	54.25	-12.66	-18.30
3	0.24766	10.21	29.85	16.51	40.06	26.72	61.84	51.84	-21.78	-25.12
4	0.38844	10.20	28.85	28.41	39.05	38.61	58.10	48.10	-19.05	-9.49
5	5.58984	10.32	22.78	17.63	33.10	27.95	60.00	50.00	-26.90	-22.05
6	14.56641	10.86	16.64	11.92	27.50	22.78	60.00	50.00	-32.50	-27.22

Remarks:

1. Q.P. and AV. are abbreviations of quasi-peak and average individually.
2. The emission levels of other frequencies were very low against the limit.
3. Margin value = Emission level – Limit value
4. Correction factor = Insertion loss + Cable loss
5. Emission Level = Correction Factor + Reading Value

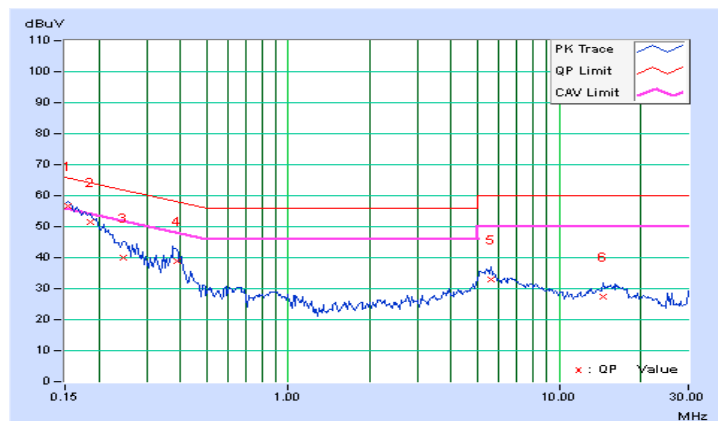

4.3 6dB Bandwidth Measurement

4.3.1 Limits of 6dB Bandwidth Measurement

The minimum of 6dB Bandwidth Measurement is 0.5 MHz.

4.3.2 Test Setup

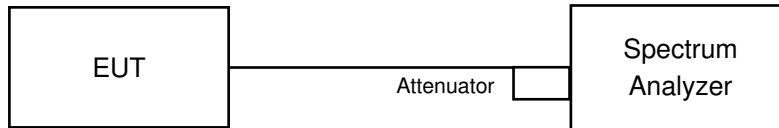

4.3.3 Test Instruments

Refer to section 4.1.2 to get information of above instrument.

4.3.4 Test Procedure

- a. Set resolution bandwidth (RBW) = 100kHz
- b. Set the video bandwidth (VBW) $\geq 3 \times$ RBW, Detector = Peak.
- c. Trace mode = max hold.
- d. Sweep = auto couple.
- e. Measure the maximum width of the emission that is constrained by the frequencies associated with the two amplitude points (upper and lower) that are attenuated by 6 dB relative to the maximum level measured in the fundamental emission

4.3.5 Deviation from Test Standard

No deviation.

4.3.6 EUT Operating Conditions

The software provided by client to enable the EUT under transmission condition continuously at lowest, middle and highest channel frequencies individually.

4.3.7 Test Result

802.11b

Channel	Frequency (MHz)	6dB Bandwidth (MHz)		Minimum Limit (MHz)	Pass / Fail
		Chain 0	Chain 1		
1	2412	9.04	8.58	0.5	PASS
6	2437	9.07	9.06	0.5	PASS
11	2462	9.07	9.09	0.5	PASS

802.11g

Channel	Frequency (MHz)	6dB Bandwidth (MHz)		Minimum Limit (MHz)	Pass / Fail
		Chain 0	Chain 1		
1	2412	16.42	16.43	0.5	PASS
6	2437	16.37	16.42	0.5	PASS
11	2462	16.41	16.44	0.5	PASS

802.11n (HT20)

Channel	Frequency (MHz)	6dB Bandwidth (MHz)		Minimum Limit (MHz)	Pass / Fail
		Chain 0	Chain 1		
1	2412	17.64	17.66	0.5	PASS
6	2437	17.62	17.66	0.5	PASS
11	2462	17.68	17.69	0.5	PASS

802.11n (HT40)

Channel	Frequency (MHz)	6dB Bandwidth (MHz)		Minimum Limit (MHz)	Pass / Fail
		Chain 0	Chain 1		
3	2422	36.54	36.51	0.5	Pass
6	2437	36.55	36.54	0.5	Pass
9	2452	36.52	36.54	0.5	Pass

Spectrum Plot of Worst Value

802.11b / Chain 1 : CH1

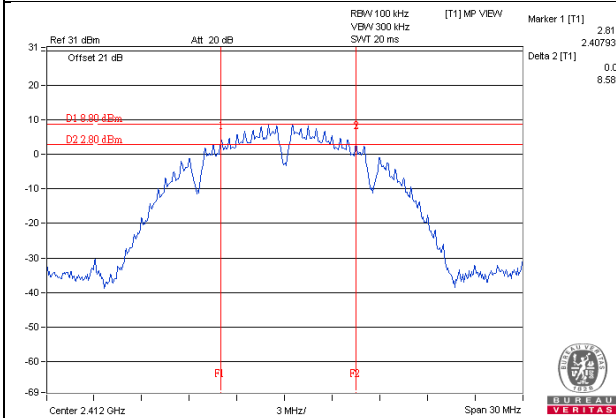

802.11g / Chain 0 : CH6

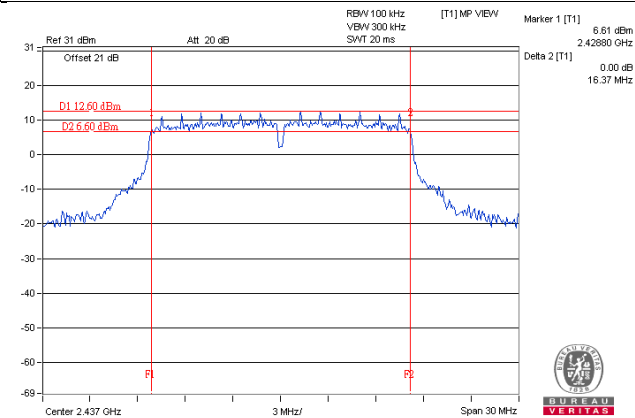

802.11n (HT20) / Chain 0 : CH6

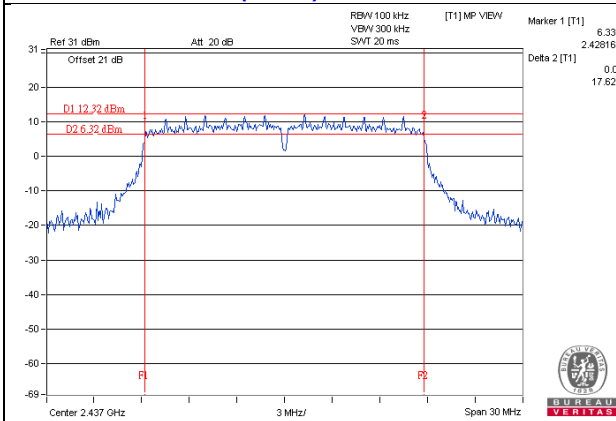

802.11n (HT40) / Chain 1 : CH3

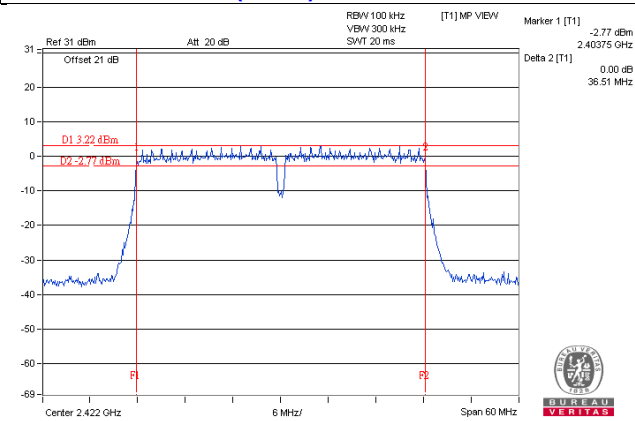

4.4 Conducted Output Power Measurement

4.4.1 Limits of Conducted Output Power Measurement

For systems using digital modulation in the 2400–2483.5 MHz bands: 1 Watt (30dBm)

Per KDB 662911 D01 Multiple Transmitter Output Method of conducted output power measurement on IEEE 802.11 devices,

Array Gain = 0 dB (i.e., no array gain) for $N_{ANT} \leq 4$;

Array Gain = 0 dB (i.e., no array gain) for channel widths ≥ 40 MHz for any N_{ANT} ;

Array Gain = $5 \log(N_{ANT}/N_{SS})$ dB or 3 dB, whichever is less for 20-MHz channel widths with $N_{ANT} \geq 5$.

For power measurements on all other devices: Array Gain = $10 \log(N_{ANT}/N_{SS})$ dB.

4.4.2 Test Setup

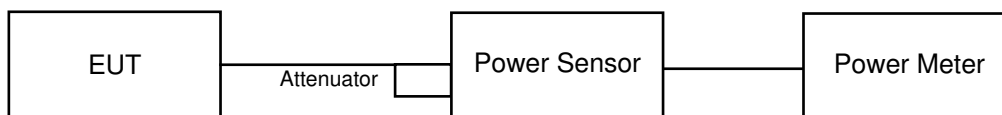

4.4.3 Test Instruments

Refer to section 4.1.2 to get information of above instrument.

4.4.4 Test Procedures

An average power sensor was used on the output port of the EUT. A power meter was used to read the response of the average power sensor. Record the power level.

4.4.5 Deviation from Test Standard

No deviation.

4.4.6 EUT Operating Conditions

Same as Item 4.3.6.

4.4.7 Test Results

802.11b

Chan.	Freq. (MHz)	Avg. Power (dBm)		Total Power (mW)	Total Power (dBm)	Limit (dBm)	Pass / Fail
		Chain 0	Chain 1				
1	2412	17.15	17.63	109.823	20.41	30	Pass
6	2437	25.47	25.00	668.599	28.25	30	Pass
11	2462	16.04	16.20	81.866	19.13	30	Pass

802.11g

Chan.	Freq. (MHz)	Avg. Power (dBm)		Total Power (mW)	Total Power (dBm)	Limit (dBm)	Pass / Fail
		Chain 0	Chain 1				
1	2412	18.42	18.60	141.946	21.52	30	Pass
6	2437	23.10	23.16	411.188	26.14	30	Pass
11	2462	17.35	17.37	108.901	20.37	30	Pass

802.11n (HT20)

Chan.	Freq. (MHz)	Avg. Power (dBm)		Total Power (mW)	Total Power (dBm)	Limit (dBm)	Pass / Fail
		Chain 0	Chain 1				
1	2412	17.24	17.32	106.917	20.29	30	Pass
6	2437	23.01	23.15	406.524	26.09	30	Pass
11	2462	17.11	17.27	104.737	20.20	30	Pass

802.11n (HT40)

Chan.	Freq. (MHz)	Avg. Power (dBm)		Total Power (mW)	Total Power (dBm)	Limit (dBm)	Pass / Fail
		Chain 0	Chain 1				
3	2422	17.23	17.52	109.339	20.39	30	Pass
6	2437	19.25	19.14	166.175	22.21	30	Pass
9	2452	16.39	16.65	89.789	19.53	30	Pass

4.5 Power Spectral Density Measurement

4.5.1 Limits of Power Spectral Density Measurement

The Maximum of Power Spectral Density Measurement is 8dBm.

4.5.2 Test Setup

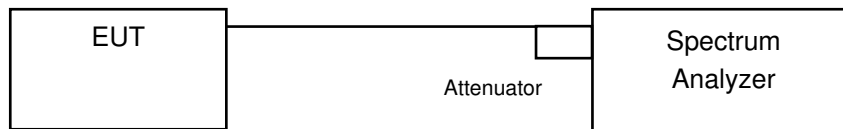

4.5.3 Test Instruments

Refer to section 4.1.2 to get information of above instrument.

4.5.4 Test Procedure

- Set instrument center frequency to DTS channel center frequency.
- Set span to at least 1.5 times the OBW.
- Set RBW to: $3 \text{ kHz} \leq \text{RBW} \leq 100 \text{ kHz}$.
- Set VBW $\geq 3 \times \text{RBW}$.
- Detector = power averaging (RMS) or sample detector (when RMS not available).
- Ensure that the number of measurement points in the sweep $\geq 2 \times \text{span}/\text{RBW}$.
- Sweep time = auto couple.
- Employ trace averaging (RMS) mode over a minimum of 100 traces.
- Use the peak marker function to determine the maximum amplitude level.

4.5.5 Deviation from Test Standard

No deviation.

4.5.6 EUT Operating Condition

Same as Item 4.3.6

4.5.7 Test Results

802.11b

TX chain	Channel	Freq. (MHz)	PSD (dBm/10kHz)	10 log (N=2) dB	Total PSD (dBm/10kHz)	Limit (dBm/3kHz)	Pass /Fail
0	1	2412	-10.94	3.01	-7.93	8	Pass
	6	2437	-2.81	3.01	0.20	8	Pass
	11	2462	-12.01	3.01	-9.00	8	Pass
1	1	2412	-10.96	3.01	-7.95	8	Pass
	6	2437	-3.21	3.01	-0.20	8	Pass
	11	2462	-11.27	3.01	-8.26	8	Pass

NOTE: Directional gain = $2.5\text{dBi} + 10\log(2) = 5.51\text{dBi} > 6\text{dBi}$, so the power density limit shall not be reduced.

802.11g

TX chain	Channel	Freq. (MHz)	PSD (dBm/10kHz)	10 log (N=2) dB	Total PSD (dBm/10kHz)	Limit (dBm/3kHz)	Pass /Fail
0	1	2412	-10.27	3.01	-7.26	8	Pass
	6	2437	-4.48	3.01	-1.47	8	Pass
	11	2462	-11.61	3.01	-8.60	8	Pass
1	1	2412	-9.71	3.01	-6.70	8	Pass
	6	2437	-5.54	3.01	-2.53	8	Pass
	11	2462	-11.30	3.01	-8.29	8	Pass

NOTE: Directional gain = $2.5\text{dBi} + 10\log(2) = 5.51\text{dBi} > 6\text{dBi}$, so the power density limit shall not be reduced.

802.11n (HT20)

TX chain	Channel	Freq. (MHz)	PSD (dBm/10kHz)	10 log (N=2) dB	Total PSD (dBm/10kHz)	Limit (dBm/3kHz)	Pass /Fail
0	1	2412	-13.08	3.01	-10.07	8	Pass
	6	2437	-6.56	3.01	-3.55	8	Pass
	11	2462	-13.29	3.01	-10.28	8	Pass
1	1	2412	-12.38	3.01	-9.37	8	Pass
	6	2437	-7.24	3.01	-4.23	8	Pass
	11	2462	-12.91	3.01	-9.90	8	Pass

NOTE: Directional gain = $2.5\text{dBi} + 10\log(2) = 5.51\text{dBi} > 6\text{dBi}$, so the power density limit shall not be reduced.

802.11n (HT40)

TX chain	Channel	Freq. (MHz)	PSD (dBm/10kHz)	10 log (N=2) dB	Total PSD (dBm/10kHz)	Limit (dBm/3kHz)	Pass /Fail
0	3	2422	-15.73	3.01	-12.72	8	Pass
	6	2437	-13.36	3.01	-10.35	8	Pass
	9	2452	-15.95	3.01	-12.94	8	Pass
1	3	2422	-14.22	3.01	-11.21	8	Pass
	6	2437	-14.55	3.01	-11.54	8	Pass
	9	2452	-15.96	3.01	-12.95	8	Pass

NOTE: Directional gain = $2.5\text{dBi} + 10\log(2) = 5.51\text{dBi} > 6\text{dBi}$, so the power density limit shall not be reduced.

Spectrum Plot of Worst Value

802.11b / Chain 0 : CH6

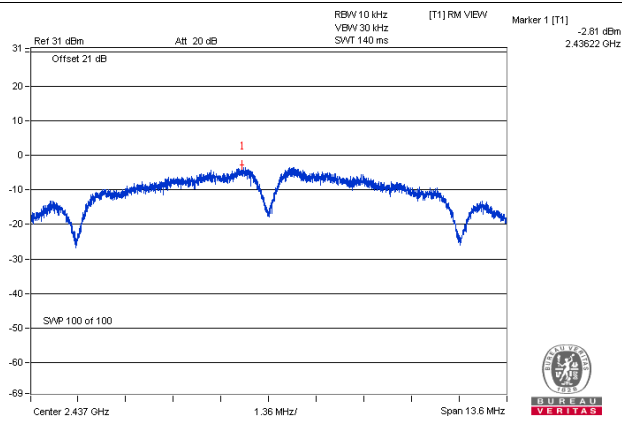

802.11g / Chain 0 : CH6

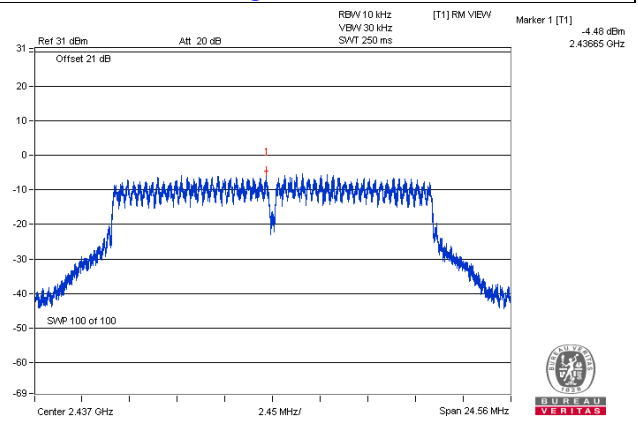

802.11n (HT20) / Chain 0 : CH6

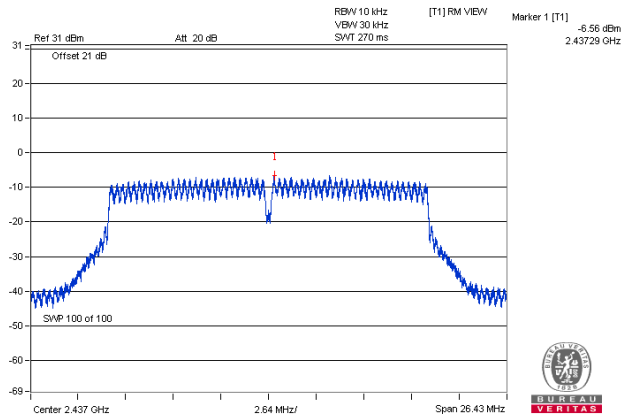

802.11n (HT40) / Chain 0 : CH6

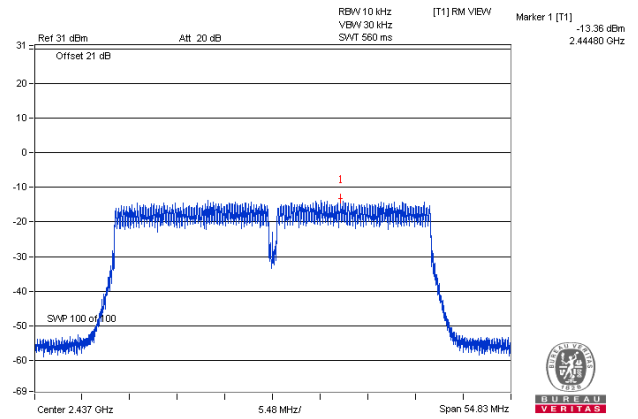

4.6 Conducted Out of Band Emission Measurement

4.6.1 Limits of Conducted Out of Band Emission Measurement

Below 30dB of the highest emission level of operating band (in 100kHz Resolution Bandwidth).

4.6.2 Test Setup

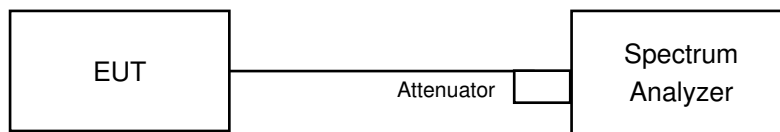

4.6.3 Test Instruments

Refer to section 4.1.2 to get information of above instrument.

4.6.4 Test Procedure

MEASUREMENT PROCEDURE REF

1. Set the RBW = 100 kHz.
2. Set the VBW \geq 300 kHz.
3. Detector = peak.
4. Sweep time = auto couple.
5. Trace mode = max hold.
6. Allow trace to fully stabilize.
7. Use the peak marker function to determine the maximum power level in any 100 kHz band segment within the fundamental EBW.

MEASUREMENT PROCEDURE OOB

1. Set RBW = 100 kHz.
2. Set VBW \geq 300 kHz.
3. Detector = peak.
4. Sweep = auto couple.
5. Trace Mode = max hold.
6. Allow trace to fully stabilize.
7. Use the peak marker function to determine the maximum amplitude level.

4.6.5 Deviation from Test Standard

No deviation.

4.6.6 EUT Operating Condition

Same as Item 4.3.6

4.6.7 Test Results

The spectrum plots are attached on the following pages. D1 line indicates the highest level, and D2 line indicates the 30dB offset below D1. It shows compliance with the requirement.

802.11b

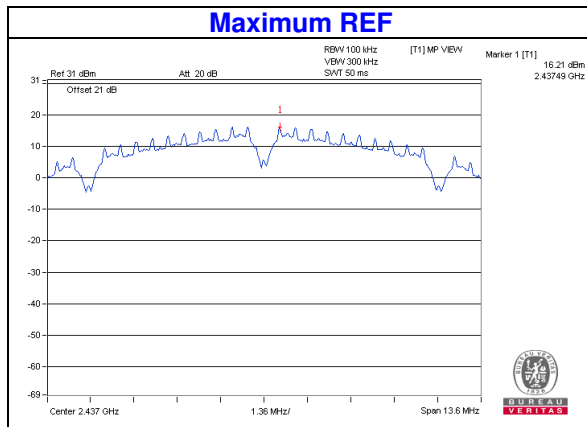

Chain 0

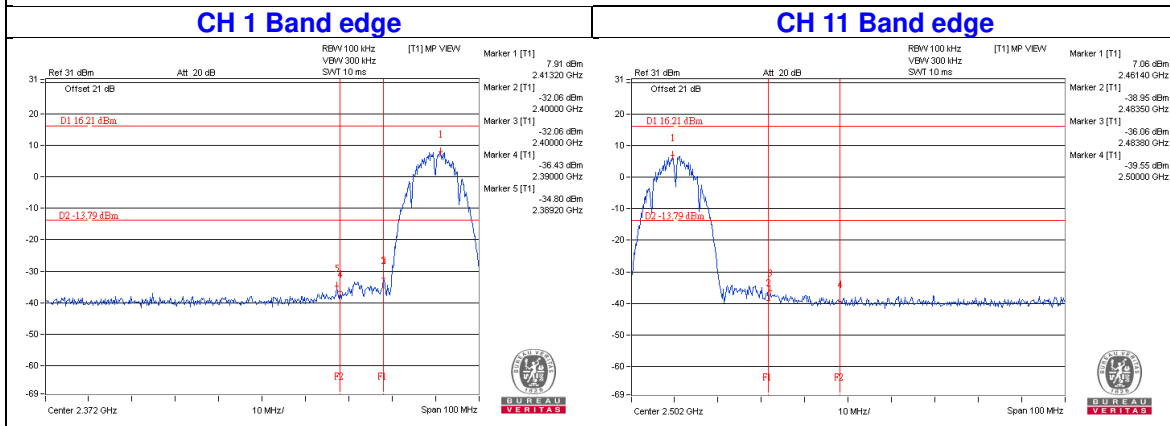
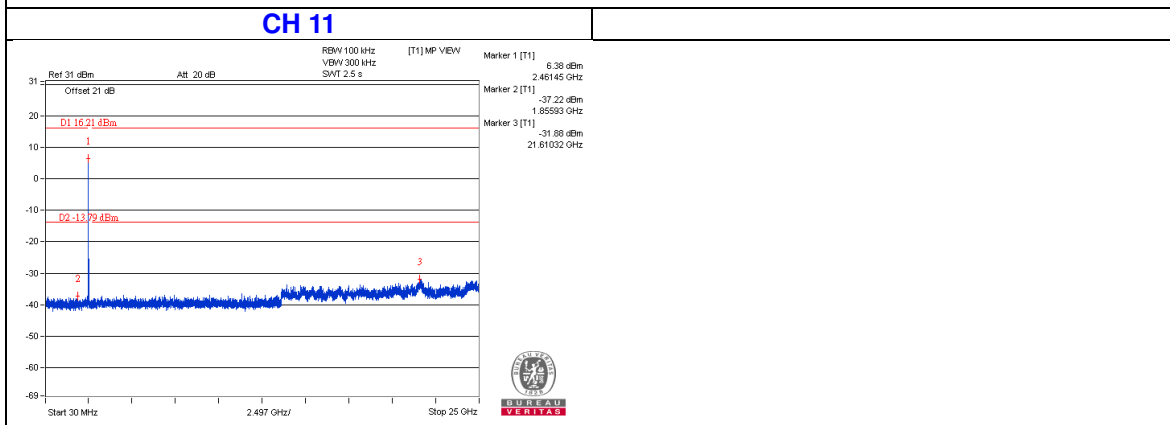
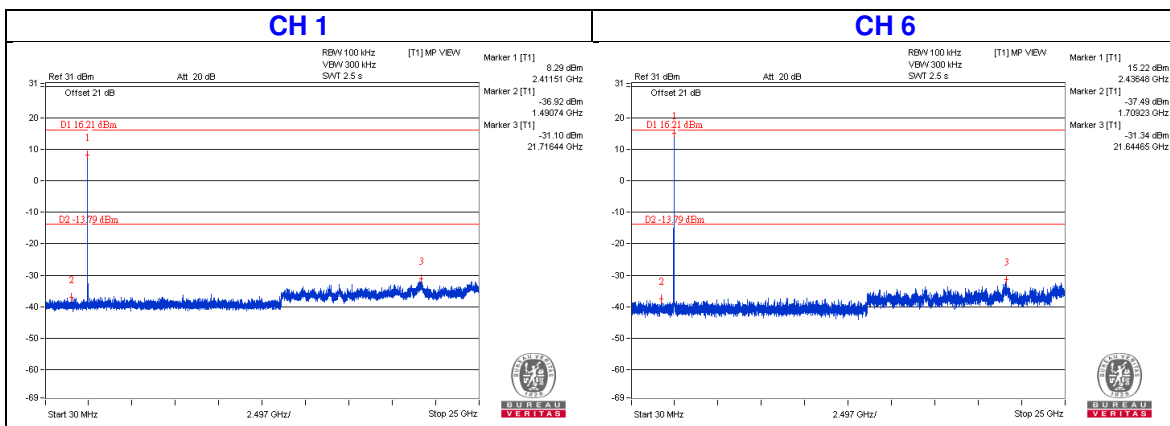

Chain 1

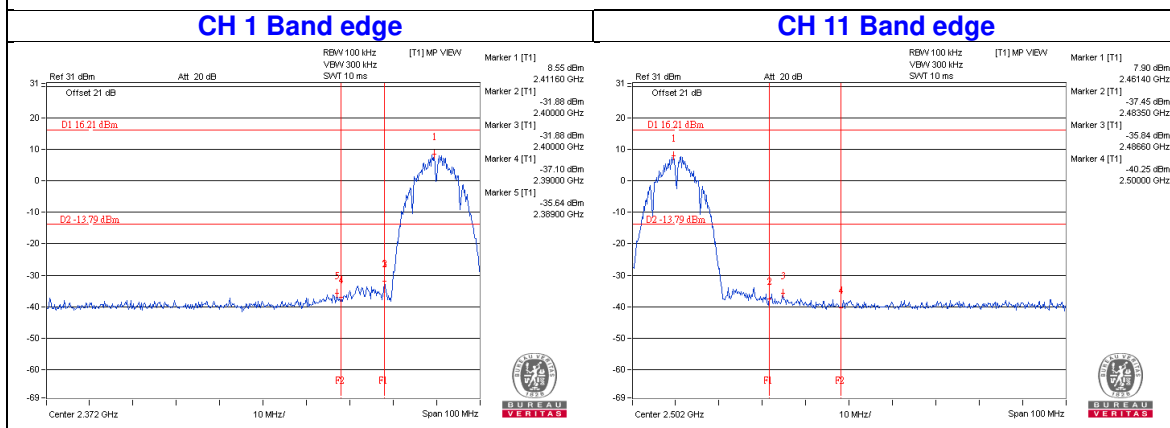
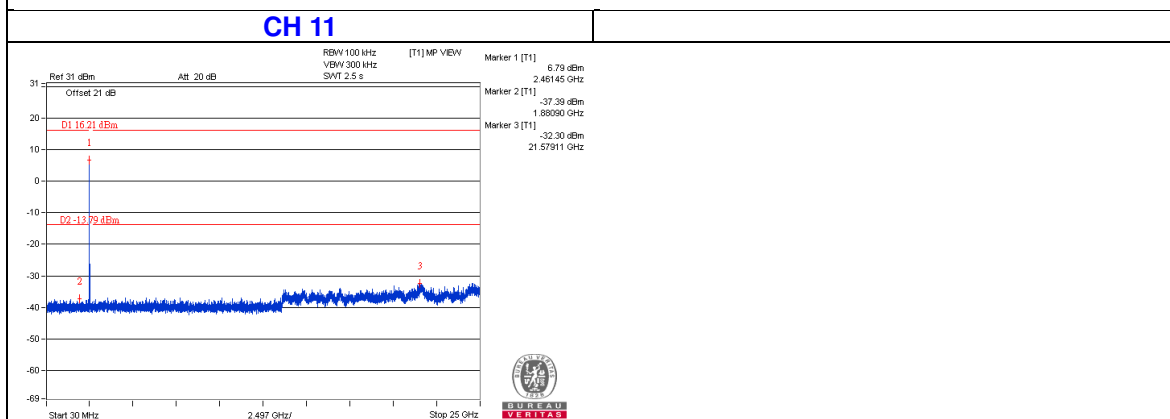
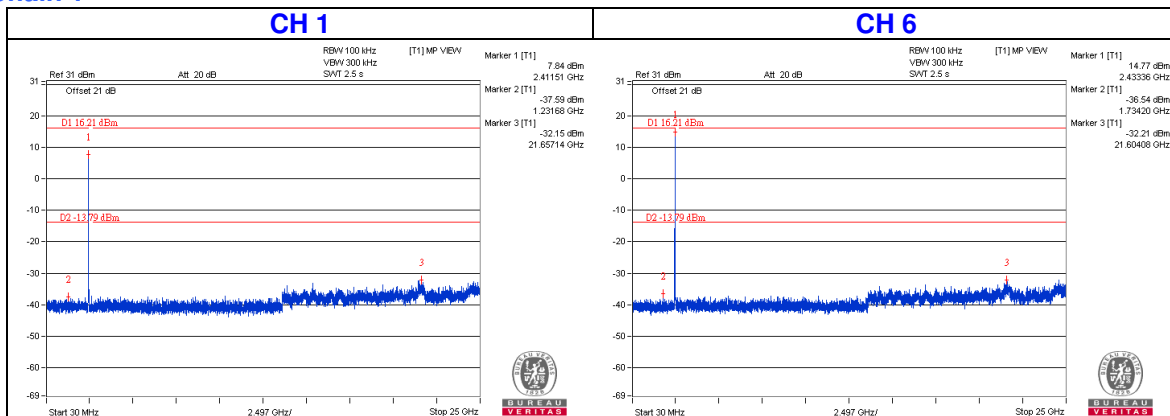

802.11g

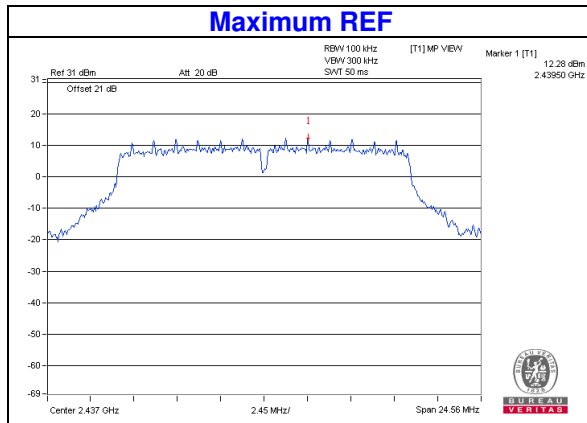

Chain 0

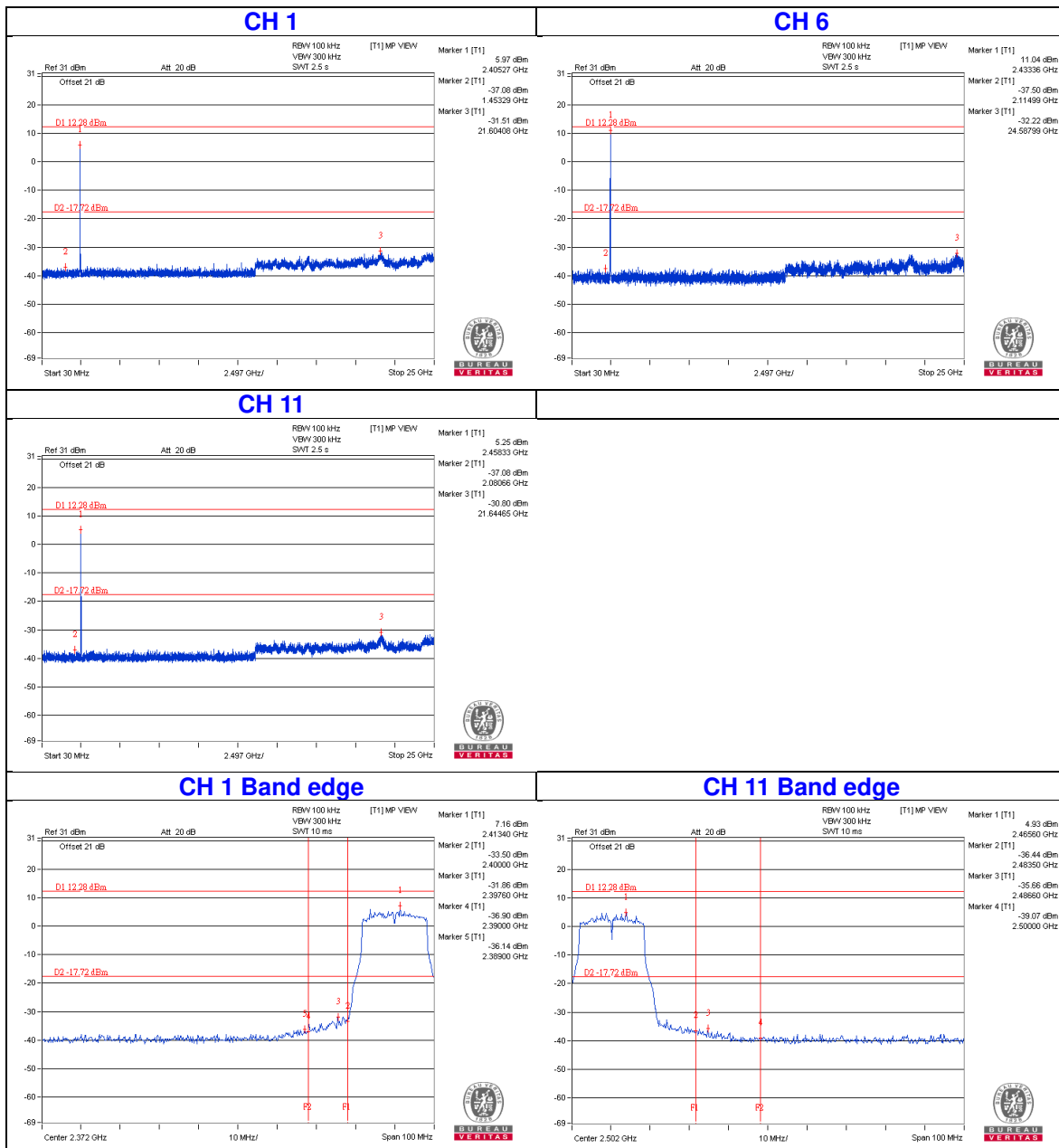

Chain 1

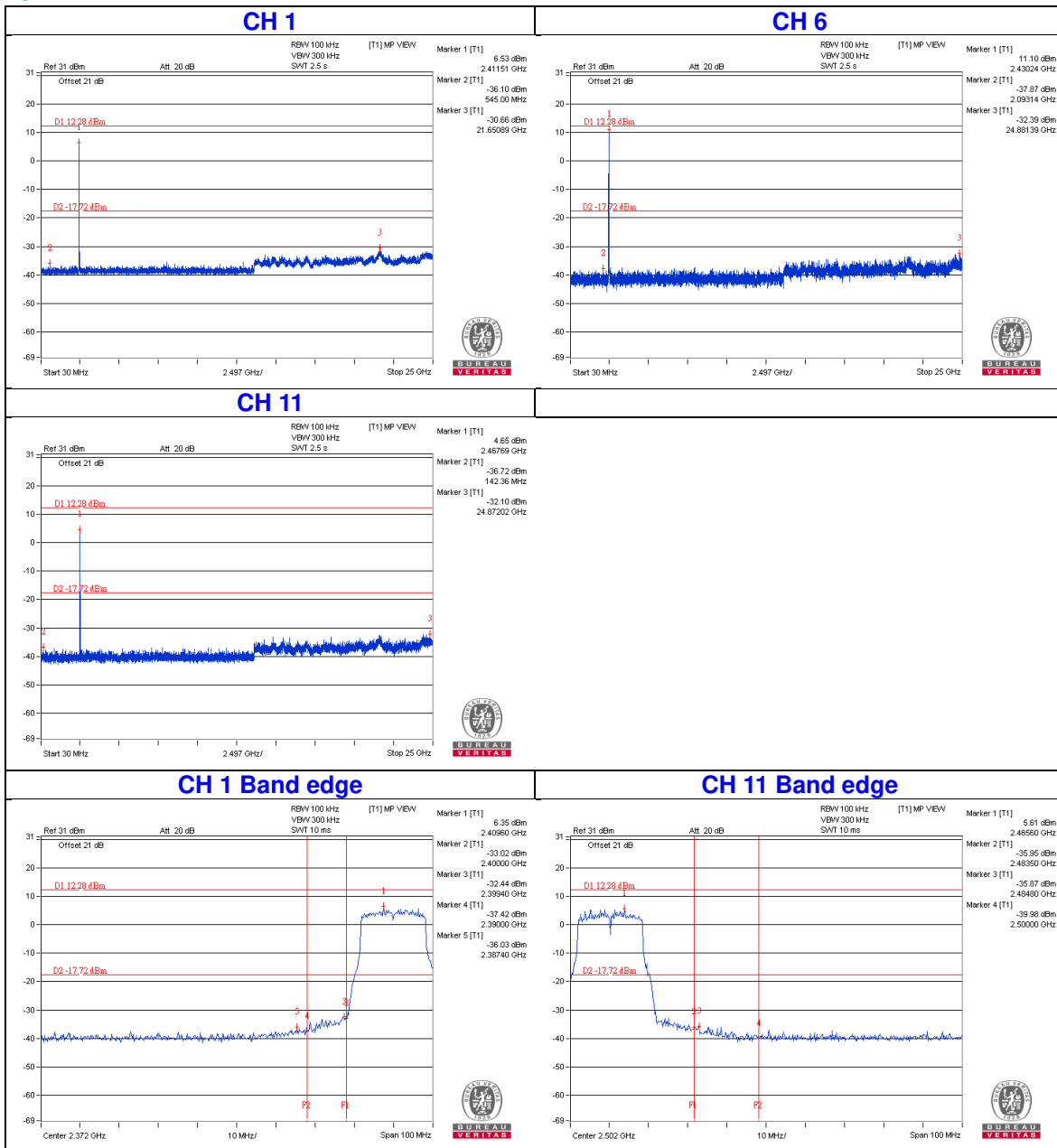

802.11n (HT20)

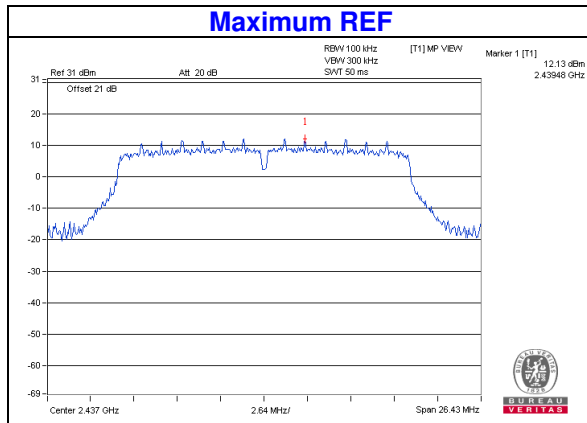

Chain 0

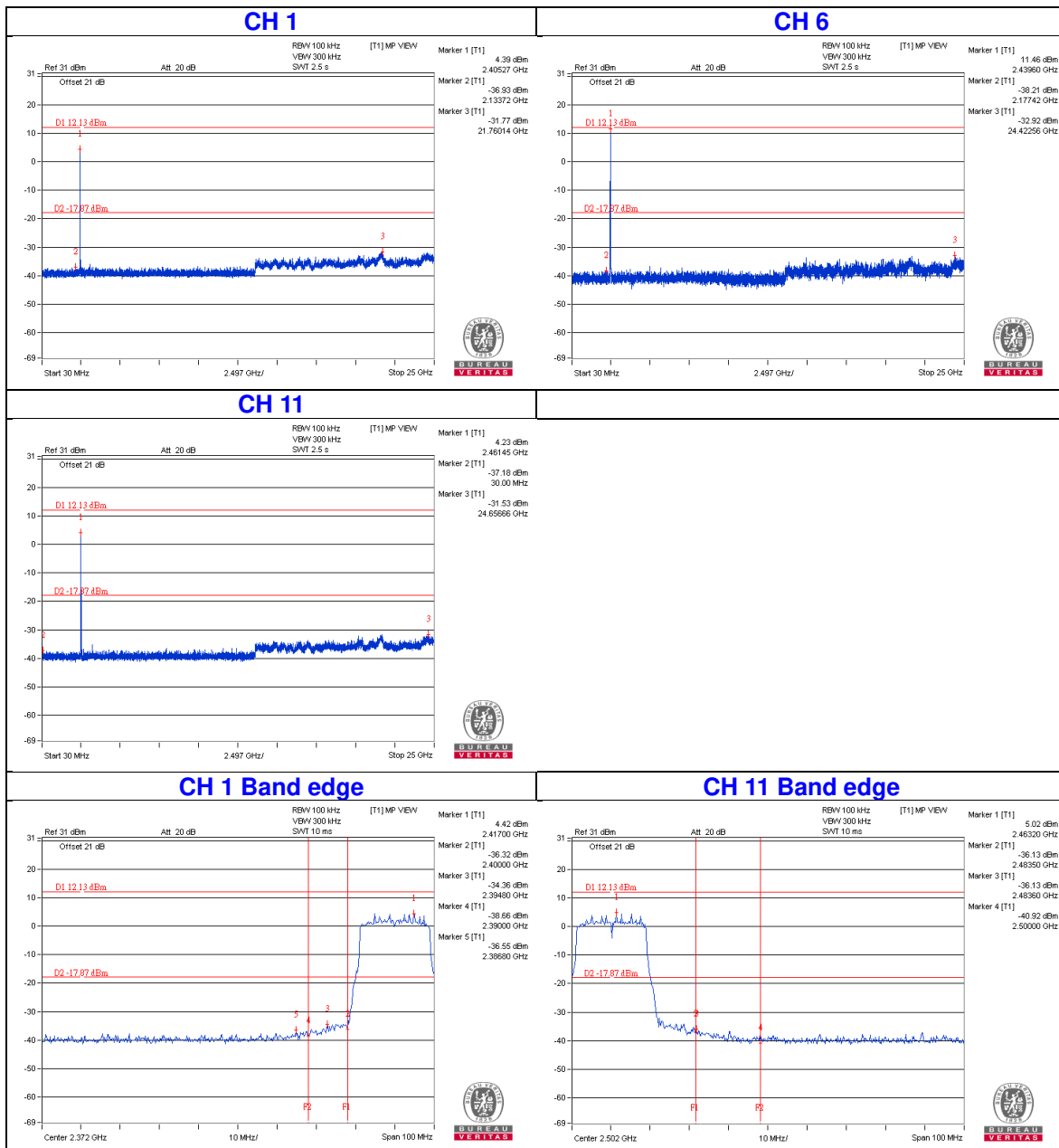

Chain 1

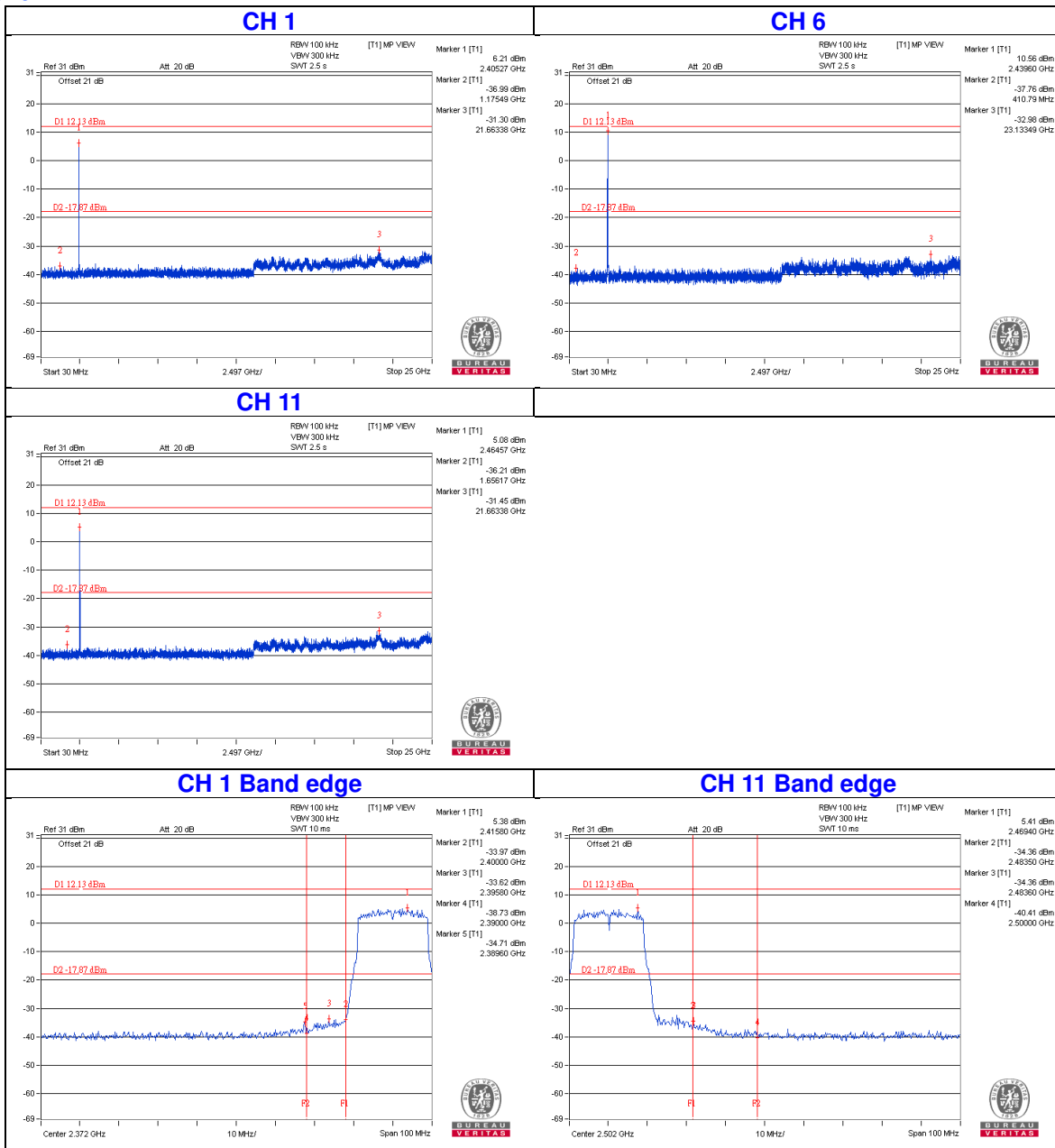

802.11n (HT40)

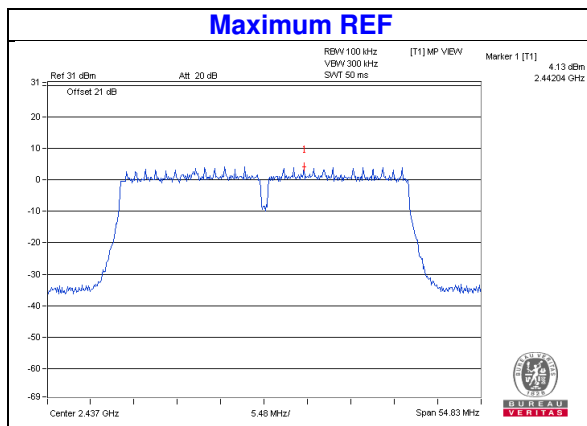

Chain 0

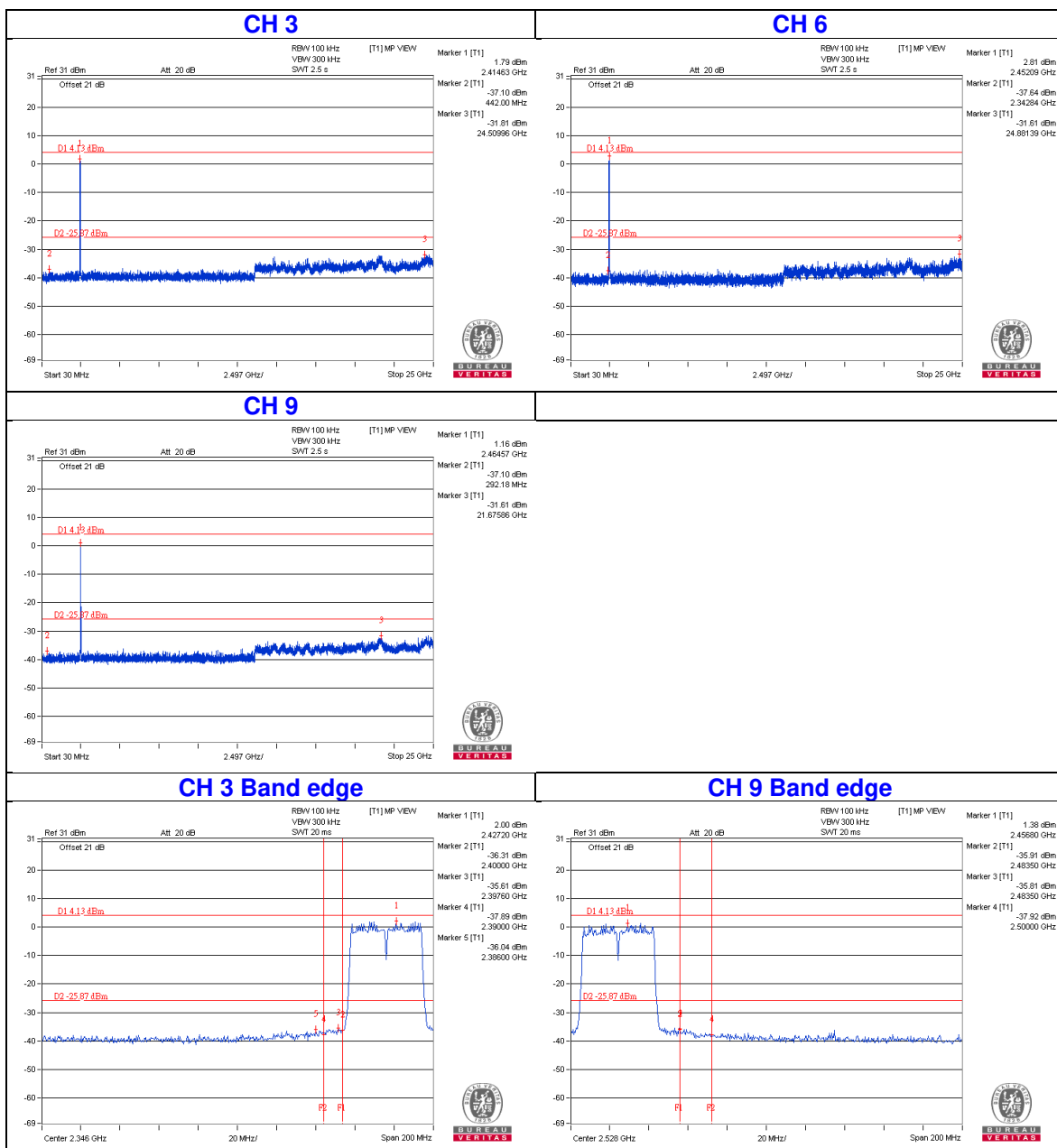

Chain 1

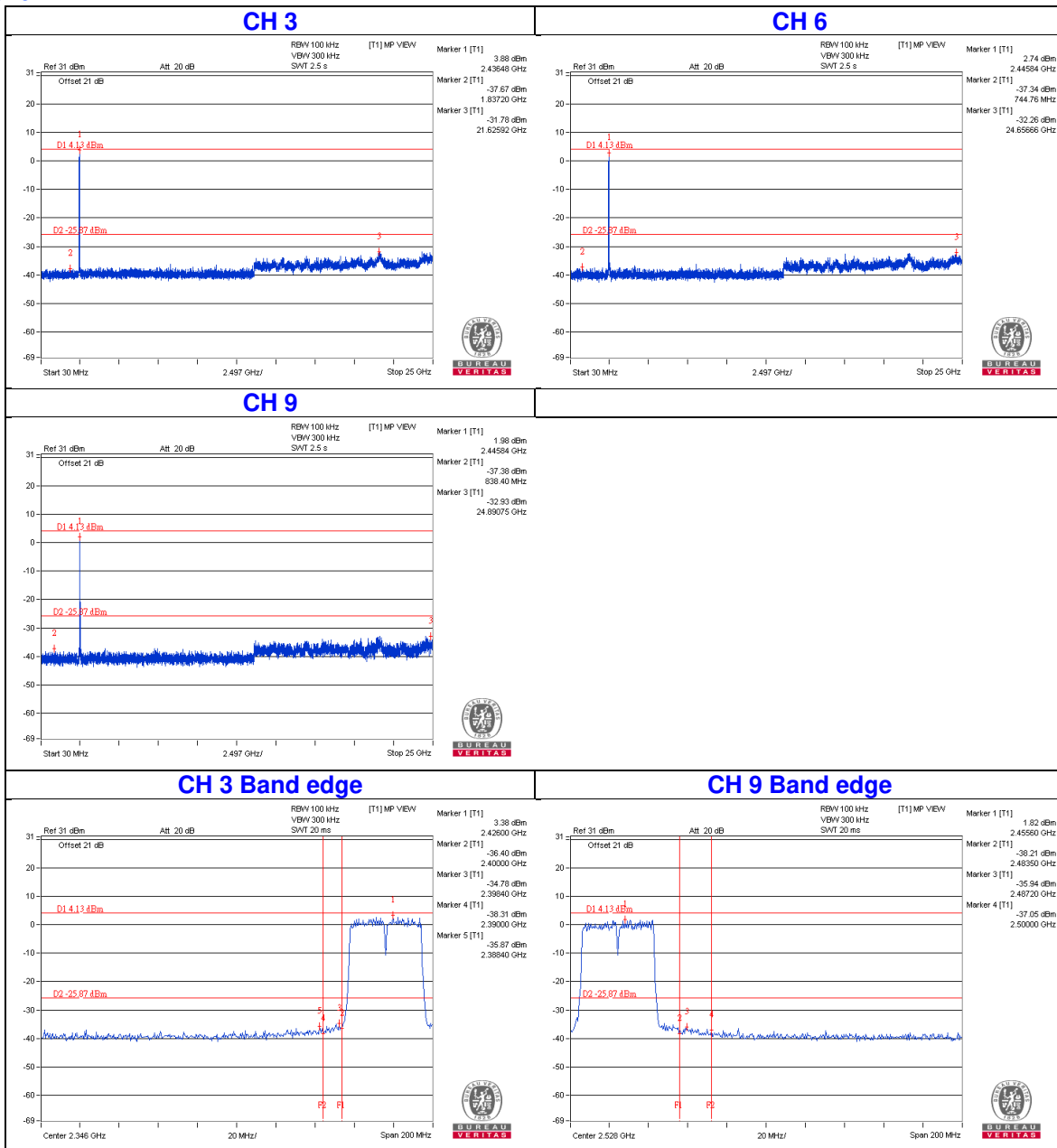

5 Pictures of Test Arrangements

Please refer to the attached file (Test Setup Photo).

Appendix – Information on the Testing Laboratories

We, Bureau Veritas Consumer Products Services (H.K.) Ltd., Taoyuan Branch, were founded in 1988 to provide our best service in EMC, Radio, Telecom and Safety consultation. Our laboratories are accredited and approved according to ISO/IEC 17025.

If you have any comments, please feel free to contact us at the following:

Linko EMC/RF Lab

Tel: 886-2-26052180

Fax: 886-2-26051924

Hsin Chu EMC/RF/Telecom Lab

Tel: 886-3-6668565

Fax: 886-3-6668323

Hwa Ya EMC/RF/Safety Lab

Tel: 886-3-3183232

Fax: 886-3-3270892

Email: service.adt@tw.bureauveritas.com

Web Site: www.bureauveritas-adt.com

The address and road map of all our labs can be found in our web site also.

--- END ---