

FCC Test Report

Report No.: RF150925E07B-1

FCC ID: PY316100338

Test Model: VMC3040S

Received Date: Sep. 25, 2015

Test Date: Oct. 22 to 23, 2015 & Mar. 03 to 25, 2016

Issued Date: Apr. 07, 2016

Applicant: NETGEAR, Inc.

Address: 350 East Plumeria Drive San Jose, CA 95134

Issued By: Bureau Veritas Consumer Products Services (H.K.) Ltd., Taoyuan Branch
Hsin Chu Laboratory

Lab Address: E-2, No.1, Li Hsin 1st Road, Hsinchu Science Park, Hsinchu City 300,
Taiwan R.O.C.

Test Location (1): E-2, No.1, Li Hsin 1st Road, Hsinchu Science Park, Hsinchu City 300,
Taiwan R.O.C.

Test Location (2): No. 49, Ln. 206, Wende Rd., Shangshan Tsuen, Chiung Lin Hsiang, Hsin
Chu Hsien 307, Taiwan R.O.C.



This report is for your exclusive use. Any copying or replication of this report to or for any other person or entity, or use of our name or trademark, is permitted only with our prior written permission. This report sets forth our findings solely with respect to the test samples identified herein. The results set forth in this report are not indicative or representative of the quality or characteristics of the lot from which a test sample was taken or any similar or identical product specifically and expressly noted. Our report includes all of the tests requested by you and the results thereof based upon the information that you provided to us. You have 60 days from date of issuance of this report to notify us of any material error or omission caused by our negligence, provided, however, that such notice shall be in writing and shall specifically address the issue you wish to raise. A failure to raise such issue within the prescribed time shall constitute your unqualified acceptance of the completeness of this report, the tests conducted and the correctness of the report contents. Unless specific mention, the uncertainty of measurement has been explicitly taken into account to declare the compliance or non-compliance to the specification. The report must not be used by the client to claim product certification, approval, or endorsement by TAF or any government agencies.

Table of Contents

Release Control Record	4
1 Certificate of Conformity	5
2 Summary of Test Results	6
2.1 Measurement Uncertainty	6
2.2 Modification Record	6
3 General Information	7
3.1 General Description of EUT	7
3.2 Description of Test Modes	10
3.2.1 Test Mode Applicability and Tested Channel Detail.....	12
3.3 Duty Cycle of Test Signal	14
3.4 Description of Support Units	15
3.4.1 Configuration of System under Test	15
3.5 General Description of Applied Standard.....	18
4 Test Types and Results	19
4.1 Radiated Emission and Bandedge Measurement.....	19
4.1.1 Limits of Radiated Emission and Bandedge Measurement	19
4.1.2 Test Instruments	20
4.1.3 Test Procedure	22
4.1.4 Deviation from Test Standard	22
4.1.5 Test Setup.....	23
4.1.6 EUT Operating Condition	23
4.1.7 Test Results	24
4.2 Conducted Emission Measurement	58
4.2.1 Limits of Conducted Emission Measurement	58
4.2.2 Test Instruments	58
4.2.3 Test Procedure	59
4.2.4 Deviation from Test Standard	59
4.2.5 Test Setup.....	59
4.2.6 EUT Operating Condition	59
4.2.7 Test Results (Mode 1).....	60
4.2.8 Test Results (Mode 2).....	62
4.2.9 Test Results (Mode 3).....	64
4.3 Transmit Power Measurement	66
4.3.1 Limits of Transmit Power Measurement	66
4.3.2 Test Setup.....	66
4.3.3 Test Instruments	66
4.3.4 Test Procedure	66
4.3.5 Deviation from Test Standard	67
4.3.6 EUT Operating Condition	67
4.3.7 Test Result.....	68
4.4 Peak Power Spectral Density Measurement	73
4.4.1 Limits of Peak Power Spectral Density Measurement	73
4.4.2 Test Setup.....	73
4.4.3 Test Instruments	73
4.4.4 Test Procedure	73
4.4.5 Deviation from Test Standard	74
4.4.6 EUT Operating Condition	74
4.4.7 Test Results	75
4.5 Frequency Stability Measurement	80
4.5.1 Limits of Frequency Stability Measurement	80
4.5.2 Test Setup.....	80
4.5.3 Test Instruments	80
4.5.4 Test Procedure	80



4.5.5	Deviation from Test Standard	80
4.5.6	EUT Operating Condition	80
4.5.7	Test Results	81
4.6	6dB Bandwidth Measurement	82
4.6.1	Limits of 6dB Bandwidth Measurement	82
4.6.2	Test Setup	82
4.6.3	Test Instruments	82
4.6.4	Test Procedure	82
4.6.5	Deviation from Test Standard	82
4.6.6	EUT Operating Condition	82
4.6.7	Test Results	83
5	Pictures of Test Arrangements	85
	Appendix – Information on the Testing Laboratories	86



A D T

Release Control Record

Issue No.	Description	Date Issued
RF150925E07B-1	Original release.	Apr. 07, 2016

2 Summary of Test Results

47 CFR FCC Part 15, Subpart E (SECTION 15.407)			
FCC Clause	Test Item	Result	Remarks
15.407(b)(6)	AC Power Conducted Emissions	Pass	Meet the requirement of limit. Minimum passing margin is -3.29dB at 16.22831MHz.
15.407(b)(1/2/3/4/6)	Radiated Emissions & Band Edge Measurement	Pass	Meet the requirement of limit. Minimum passing margin is -0.1dB at 10600.00MHz, 5850.00MHz, 5350.00MHz & 5725.00MHz.
15.407(a)(1/2/3)	Max Average Transmit Power	PASS	Meet the requirement of limit.
15.407(a)(1/2/3)	Peak Power Spectral Density	PASS	Meet the requirement of limit.
15.407(e)	6dB bandwidth	PASS	Meet the requirement of limit. (U-NII-3 Band only)
15.407(g)	Frequency Stability	PASS	Meet the requirement of limit.
15.203	Antenna Requirement	PASS	No antenna connector is used.

NOTE: 1. The EUT was operating in 2.4 ~ 2.4835GHz, 5.15~5.35GHz, 5.47~5.7GHz and 5.725~5.850GHz frequencies band. This report was recorded the RF parameters including 5.15~5.35GHz, 5.47~5.7GHz and 5.725~5.850GHz. For the 2.4 ~ 2.4835GHz RF parameters was recorded in another test report.

2.1 Measurement Uncertainty

Where relevant, the following measurement uncertainty levels have been estimated for tests performed on the EUT as specified in CISPR 16-4-2:

Measurement	Frequency	Expanded Uncertainty (k=2) (±)
Conducted Emissions at mains ports	150kHz ~ 30MHz	2.86 dB
Radiated Emissions up to 1 GHz	30MHz ~ 1000MHz	5.19 dB
Radiated Emissions above 1 GHz	1GHz ~ 6GHz	3.43 dB
	6GHz ~ 18GHz	3.49 dB
	18GHz ~ 40GHz	4.11 dB

2.2 Modification Record

There were no modifications required for compliance.

3 General Information

3.1 General Description of EUT

Product	Arlo Q Plus
Brand	NETGEAR
Test Model	VMC3040S
Status of EUT	ENGINEERING SAMPLE
Power Supply Rating	DC 5V from Micro USB
Modulation Type	CCK, DQPSK, DBPSK for DSSS 64QAM, 16QAM, QPSK, BPSK for OFDM
Modulation Technology	DSSS, OFDM
Transfer Rate	802.11b: up to 11Mbps 802.11a/g: up to 54Mbps 802.11n : up to 450Mbps
Operating Frequency	For 15.407 5.18 ~ 5.24GHz, 5.26 ~ 5.32GHz, 5.50 ~ 5.70GHz, 5.745 ~ 5.825GHz
	For 15.247 2.412 ~ 2.462GHz
Number of Channel	For 15.407 24 for 802.11a, 802.11n (HT20) 11 for 802.11n (HT40)
	For 15.247 11 for 802.11b/g, 802.11n (HT20)
Output Power	For 15.407 802.11a: 185.904mW 802.11n (HT20): 172.398mW 802.11n (HT40): 200.775mW
	For 15.247 802.11b: 277.308mW 802.11g: 332.644mW 802.11n (HT20): 562.159mW
Antenna Type	Refer to Note
Antenna Connector	Refer to Note
Accessory Device	USB adapter x 1 POE adapter x1
Data Cable Supplied	Mini USB Cable (Shielded, 3m) x 1 POE adapter cable(Unshielded, 0.1m) x 1

Note:

- 2.4GHz and 5GHz technology cannot transmit at same time.
- The antennas provided to the EUT, please refer to the following table:

Antenna No.	Transmitter Circuit	Brand	Model	Antenna Gain (dBi) including cable loss	Antenna Type	Connector Type	Frequency range (GHz to GHz)
1	Chain (0)	Netgear	NA	0.91	PIFA	NA	2.4~2.4835
				1.83			5.15~5.25
				1.91			5.25~5.35
				1.29			5.47~5.725
				2.12			5.725~5.85
2	Chain (1)	Netgear	NA	1.01	Monopole	NA	2.4~2.4835
				1.12			5.15~5.25
				1.91			5.25~5.35
				2.18			5.47~5.725
				2.27			5.725~5.85

- The EUT power needs to be supplied from USB adapters or POE adapter, the information is as below table:

USB adapter				
No	Brand	Model No.	P/N	Spec.
1	NETGEAR	ADS-12DA-05 05010EPCU	332-10813-01	Input: 100-240V, 50/60Hz, 0.3A Output: 5V, 2A
2	NETGEAR	AD2037320	332-10809-01	
POE adapter				
No	Brand	Part number	Spec.	
1	NETGEAR	107-11054-01	Rating 36-57V 350mA	
Note				
1. From the above adapters, adapter 1 was selected as representative adapter for the test and its data was recorded in this report.				

- The EUT incorporates a MIMO function.

2.4GHz Band			
MODULATION MODE	DATA RATE (MCS)	TX & RX CONFIGURATION	
802.11b	1 ~ 11Mbps	2TX	2RX
802.11g	6 ~ 54Mbps	2TX	2RX
802.11n (HT20)	MCS 0~7	2TX	2RX
	MCS 8~15	2TX	2RX
5GHz Band			
MODULATION MODE	DATA RATE (MCS)	TX & RX CONFIGURATION	
802.11a	6 ~ 54Mbps	2TX	2RX
802.11n (HT20)	MCS 0~7	2TX	2RX
	MCS 8~15	2TX	2RX
802.11n (HT40)	MCS 0~7	2TX	2RX
	MCS 8~15	2TX	2RX

5. For radiated, the EUT was pre-tested under the following modes:

Test Mode	Description
Mode A	Power from USB adapter
Mode B	Power from POE adapter (LAN port)
Mode C	Power from POE adapter (USB interface)

From the above modes, the worst cases were found in Mode C (below 1GHz) & Mode A (above 1GHz). Therefore only the test data of the modes were recorded in this report.

6. The above EUT information is declared by manufacturer and for more detailed features description, please refer to the manufacturer's specifications or user's manual.

3.2 Description of Test Modes

FOR 5180 ~ 5240MHz

4 channels are provided for 802.11a, 802.11n (HT20):

Channel	Frequency	Channel	Frequency
36	5180 MHz	44	5220 MHz
40	5200 MHz	48	5240 MHz

2 channels are provided for 802.11n (HT40):

Channel	Frequency	Channel	Frequency
38	5190 MHz	46	5230 MHz

FOR 5260 ~ 5320MHz

4 channels are provided for 802.11a, 802.11n (HT20):

Channel	Frequency	Channel	Frequency
52	5260 MHz	60	5300 MHz
56	5280 MHz	64	5320 MHz

2 channels are provided for 802.11n (HT40):

Channel	Frequency	Channel	Frequency
54	5270 MHz	62	5310 MHz

FOR 5500 ~ 5700MHz

11 channels are provided for 802.11a, 802.11n (HT20):

Channel	Frequency	Channel	Frequency
100	5500 MHz	124	5620 MHz
104	5520 MHz	128	5640 MHz
108	5540 MHz	132	5660 MHz
112	5560 MHz	136	5680 MHz
116	5580 MHz	140	5700 MHz
120	5600 MHz		

5 channels are provided for 802.11n (HT40):

Channel	Frequency	Channel	Frequency
102	5510 MHz	126	5630 MHz
110	5550 MHz	134	5670 MHz
118	5590 MHz		

FOR 5745 ~ 5825MHz:

5 channels are provided for 802.11a, 802.11n (HT20):

Channel	Frequency	Channel	Frequency
149	5745MHz	161	5805MHz
153	5765MHz	165	5825MHz
157	5785MHz		

2 channels are provided for 802.11n (HT40):

Channel	Frequency	Channel	Frequency
151	5755MHz	159	5795MHz

3.2.1 Test Mode Applicability and Tested Channel Detail

EUT CONFIGURE MODE	APPLICABLE TO				DESCRIPTION
	RE \geq 1G	RE<1G	PLC	APCM	
1	√	-	√	√	Power from USB adapter
2	-	-	√	-	Power from POE adapter (LAN port)
3	-	√	√	-	Power from POE adapter (USB interface)

Where RE \geq 1G: Radiated Emission above 1GHz & Bandedge Measurement

RE<1G: Radiated Emission below 1GHz

PLC: Power Line Conducted Emission

APCM: Antenna Port Conducted Measurement

NOTE : 1.The EUT had been pre-tested on the positioned of each 3 axis. The worst case was found when positioned on Y-plane

2. "-" means no effect.

Radiated Emission Test (Above 1GHz):

Pre-Scan has been conducted to determine the worst-case mode from all possible combinations between available modulations, data rates and antenna ports (if EUT with antenna diversity architecture).

Following channel(s) was (were) selected for the final test as listed below.

MODE	FREQ. BAND (MHz)	AVAILABLE CHANNEL	TESTED CHANNEL	MODULATION TECHNOLOGY	MODULATION TYPE	DATA RATE (Mbps)
802.11a	5180-5240	36 to 48	36, 40, 48	OFDM	BPSK	6
802.11n (HT20)		36 to 48	36, 40, 48	OFDM	BPSK	6.5
802.11n (HT40)		38 to 46	38, 46	OFDM	BPSK	13.5
802.11a	5260-5320	52 to 64	52, 60, 64	OFDM	BPSK	6
802.11n (HT20)		52 to 64	52, 60, 64	OFDM	BPSK	6.5
802.11n (HT40)		54 to 62	54, 62	OFDM	BPSK	13.5
802.11a	5500-5700	100 to 140	100, 116, 140	OFDM	BPSK	6
802.11n (HT20)		100 to 140	100, 116, 140	OFDM	BPSK	6.5
802.11n (HT40)		102 to 134	102, 110, 134	OFDM	BPSK	13.5
802.11a	5745-5825	149 to 165	149, 157, 165	OFDM	BPSK	6
802.11n (HT20)		149 to 165	149, 157, 165	OFDM	BPSK	6.5
802.11n (HT40)		151 to 159	151, 159	OFDM	BPSK	13.5

Radiated Emission Test (Below 1GHz):

Pre-Scan has been conducted to determine the worst-case mode from all possible combinations between available modulations, data rates and antenna ports (if EUT with antenna diversity architecture).

Following channel(s) was (were) selected for the final test as listed below.

MODE	FREQ. BAND (MHz)	AVAILABLE CHANNEL	TESTED CHANNEL	MODULATION TECHNOLOGY	MODULATION TYPE	DATA RATE (Mbps)
802.11n (HT40)	5180-5320 5500-5700 5745-5825	36 to 64 100 to 140 149 to 165	54	OFDM	BPSK	13.5

Power Line Conducted Emission Test:

- Pre-Scan has been conducted to determine the worst-case mode from all possible combinations between available modulations, data rates and antenna ports (if EUT with antenna diversity architecture).
- Following channel(s) was (were) selected for the final test as listed below.

MODE	FREQ. BAND (MHz)	AVAILABLE CHANNEL	TESTED CHANNEL	MODULATION TECHNOLOGY	MODULATION TYPE	DATA RATE (Mbps)
802.11n (HT40)	5180-5320	36 to 64	54	OFDM	BPSK	13.5
	5500-5700	100 to 140				
	5745-5825	149 to 165				

Antenna Port Conducted Measurement:

- This item includes all test value of each mode, but only includes spectrum plot of worst value of each mode.
- Pre-Scan has been conducted to determine the worst-case mode from all possible combinations between available modulations, data rates and antenna ports (if EUT with antenna diversity architecture).
- Following channel(s) was (were) selected for the final test as listed below.

MODE	FREQ. BAND (MHz)	AVAILABLE CHANNEL	TESTED CHANNEL	MODULATION TECHNOLOGY	MODULATION TYPE	DATA RATE (Mbps)
802.11a	5180-5240	36 to 48	36, 40, 48	OFDM	BPSK	6
802.11n (HT20)		36 to 48	36, 40, 48	OFDM	BPSK	6.5
802.11n (HT40)		38 to 46	38, 46	OFDM	BPSK	13.5
802.11a	5260-5320	52 to 64	52, 60, 64	OFDM	BPSK	6
802.11n (HT20)		52 to 64	52, 60, 64	OFDM	BPSK	6.5
802.11n (HT40)		54 to 62	54, 62	OFDM	BPSK	13.5
802.11a	5500-5700	100 to 140	100, 116, 140	OFDM	BPSK	6
802.11n (HT20)		100 to 140	100, 116, 140	OFDM	BPSK	6.5
802.11n (HT40)		102 to 134	102, 110, 134	OFDM	BPSK	13.5
802.11a	5745-5825	149 to 165	149, 157, 165	OFDM	BPSK	6
802.11n (HT20)		149 to 165	149, 157, 165	OFDM	BPSK	6.5
802.11n (HT40)		151 to 159	151, 159	OFDM	BPSK	13.5

Test Condition:

APPLICABLE TO	ENVIRONMENTAL CONDITIONS	INPUT POWER	TESTED BY
RE \geq 1G	24deg. C, 69%RH	120Vac, 60Hz	Gary Cheng
RE $<$ 1G	23deg. C, 72%RH	120Vac, 60Hz	Gary Cheng
PLC	19deg. C, 67%RH	120Vac, 60Hz	Wythe Lin
	22deg. C, 71%RH		Gavin Peng
APCM	25deg. C, 60%RH	120Vac, 60Hz	Anderson Chen

3.3 Duty Cycle of Test Signal

Duty cycle of test signal is > 98 %, duty factor is required

802.11a: Duty cycle = $2.061/2.1 = 0.981$

802.11n (HT20): Duty cycle = $1.917/1.956 = 0.98$

802.11n (HT40): Duty cycle = $0.95/0.969 = 0.98$

802.11a

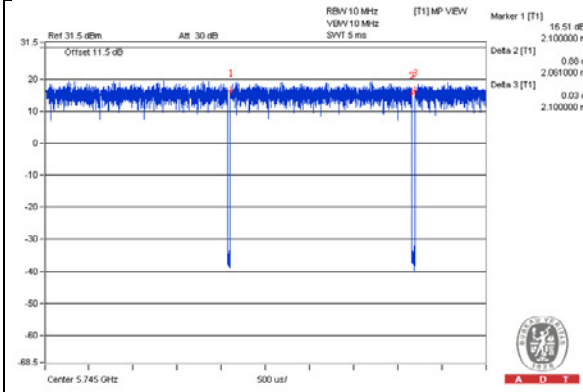

802.11n (HT20)

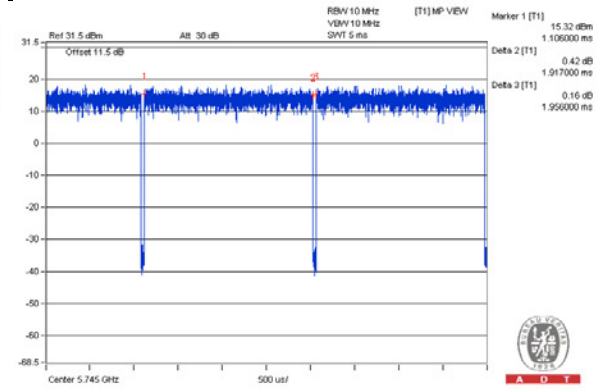

802.11n (HT40)

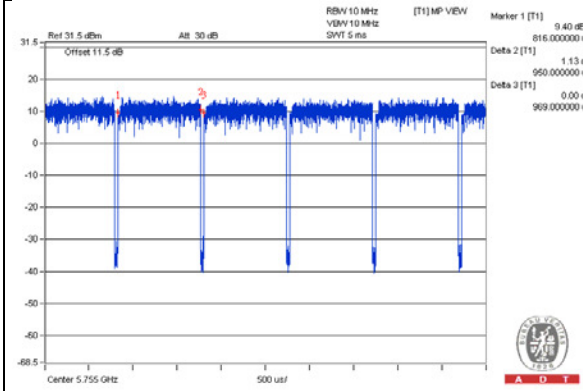

3.4 Description of Support Units

The EUT has been tested as an independent unit together with other necessary accessories or support units. The following support units or accessories were used to form a representative test configuration during the tests.

ID	Product	Brand	Model No.	Serial No.	FCC ID	Remarks
A.	Micro SD card	SanDisk	2G	NA	NA	Provided by Lab
B.	NOTEBOOK COMPUTER	DELL	E5440	6FC7F12	FCC DoC	Provided by Lab
C.	POE	PowerDsine	PD-9001GR/AT/AC	NA	NA	Provided by Lab

Note:

1. All power cords of the above support units are non-shielded (1.8m).

ID	Descriptions	Qty.	Length (m)	Shielding (Yes/No)	Cores (Qty.)	Remarks
1.	RJ45	1	10	No	0	Provided by Lab
2.	mini USB	1	3	Yes	0	Supplied by client
3.	POE cable	1	0.1	No	0	Supplied by client
4.	RJ45	1	1	No	0	Provided by Lab

3.4.1 Configuration of System under Test

For test mode 1:

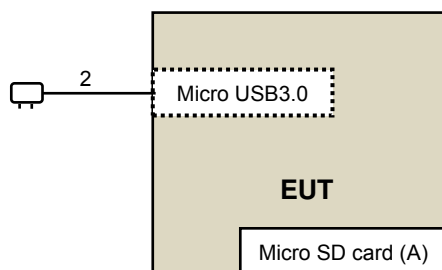

For test mode 2

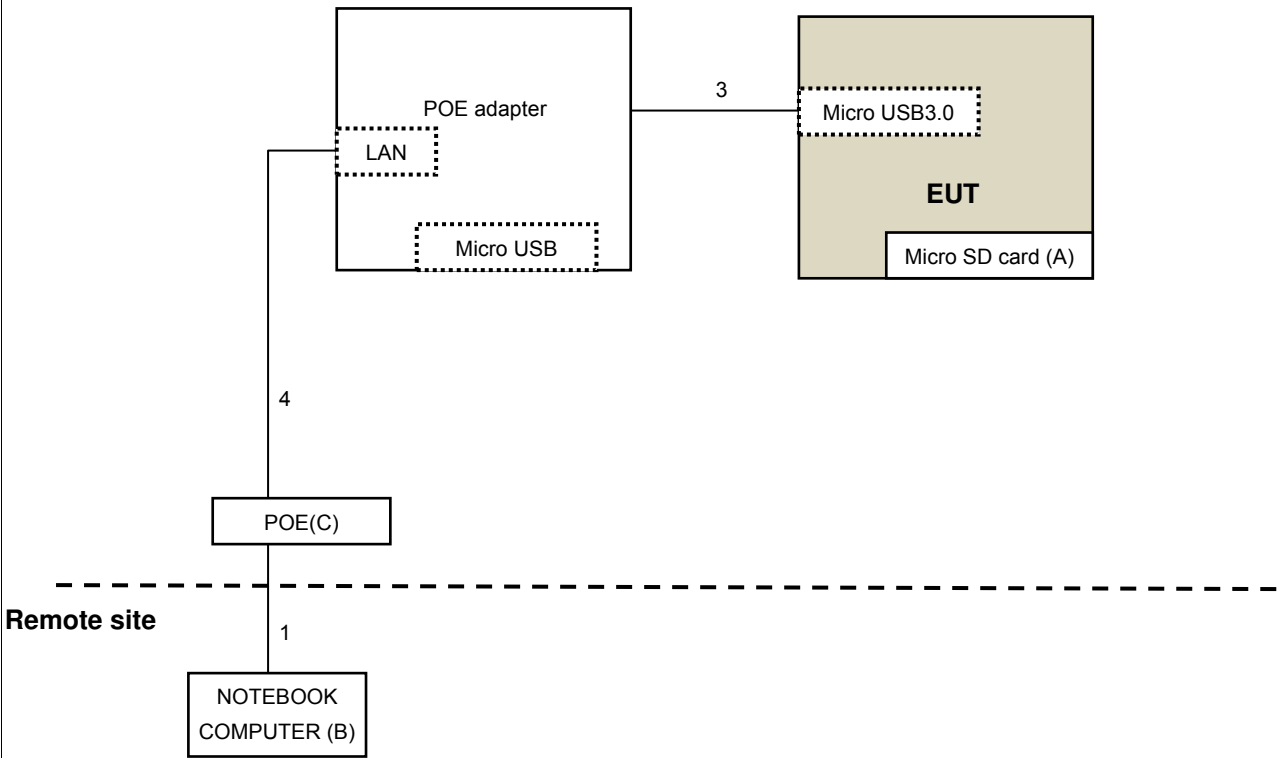

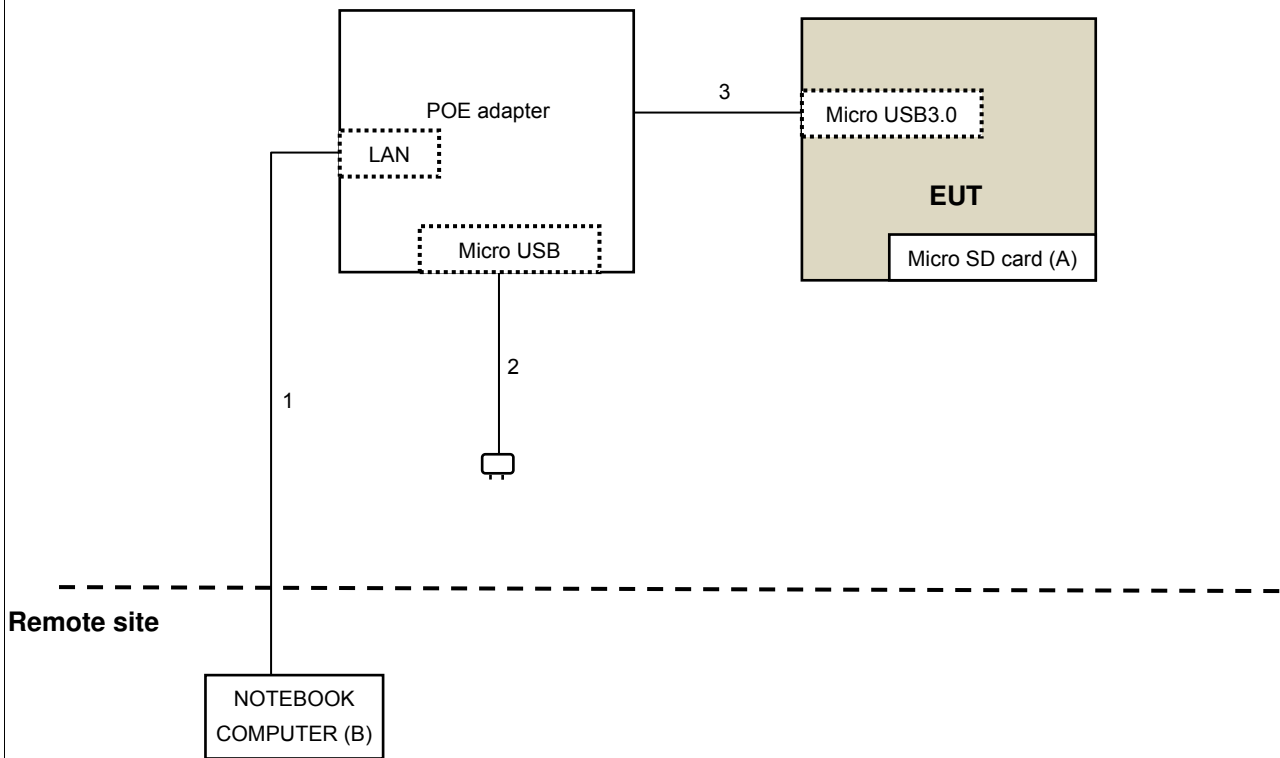
For test mode 3

3.5 General Description of Applied Standard

The EUT is a RF Product. According to the specifications of the manufacturer, it must comply with the requirements of the following standards:

FCC Part 15, Subpart E (15.407)

KDB 789033 D02 General UNII Test Procedure New Rules v01r02

KDB 662911 D01 Multiple Transmitter Output v02r01

ANSI C63.10-2013

All test items have been performed and recorded as per the above standards.

4 Test Types and Results

4.1 Radiated Emission and Bandedge Measurement

4.1.1 Limits of Radiated Emission and Bandedge Measurement

Radiated emissions which fall in the restricted bands must comply with the radiated emission limits specified as below table.

Frequencies (MHz)	Field Strength (microvolts/meter)	Measurement Distance (meters)
0.009 ~ 0.490	2400/F(kHz)	300
0.490 ~ 1.705	24000/F(kHz)	30
1.705 ~ 30.0	30	30
30 ~ 88	100	3
88 ~ 216	150	3
216 ~ 960	200	3
Above 960	500	3

NOTE:

1. The lower limit shall apply at the transition frequencies.
2. Emission level (dBuV/m) = 20 log Emission level (uV/m).
3. For frequencies above 1000MHz, the field strength limits are based on average detector, however, the peak field strength of any emission shall not exceed the maximum permitted average limits, specified above by more than 20dB under any condition of modulation.

LIMITS OF UNWANTED EMISSION OUT OF THE RESTRICTED BANDS

APPLICABLE TO	LIMIT	
KDB 789033 D02 General UNII Test Procedure New Rules v01r02	FIELD STRENGTH AT 3m	
	PK:74 (dBuV/m)	AV:54 (dBuV/m)
APPLICABLE TO	EIRP LIMIT	EQUIVALENT FIELD STRENGTH AT 3m
15.407(b)(1)	PK:-27 (dBm/MHz)	PK:68.2(dBuV/m)
15.407(b)(2)		
15.407(b)(3)		
15.407(b)(4)	PK:-27 (dBm/MHz) ^{*1} PK:-17 (dBm/MHz) ^{*2}	PK: 68.2(dBuV/m) ^{*1} PK:78.2 (dBuV/m) ^{*2}

NOTE: ^{*1} beyond 10MHz of the band edge ^{*2} within 10 MHz of band edge

The following formula is used to convert the equipment isotropic radiated power (eirp) to field strength:

$$E = \frac{1000000\sqrt{30P}}{3} \mu\text{V/m, where } P \text{ is the eirp (Watts).}$$

4.1.2 Test Instruments

For Below 1GHz test:

DESCRIPTION & MANUFACTURER	MODEL NO.	SERIAL NO.	CALIBRATED DATE	CALIBRATED UNTIL
Test Receiver Agilent	N9038A	MY54450088	July 24, 2015	July 23, 2016
Pre-Amplifier ^(*) EMCI	EMC001340	980142	Jan. 20, 2016	Jan. 19, 2018
Loop Antenna ^(*) Electro-Metrics	EM-6879	264	Dec. 16, 2014	Dec. 15, 2016
RF Cable	NA	LOOPCAB-001 LOOPCAB-002	Jan. 18, 2016	Jan. 17, 2017
Pre-Amplifier Mini-Circuits	ZFL-1000VH2 B	AMP-ZFL-01	Nov. 11, 2015	Nov. 10, 2016
Trilog Broadband Antenna SCHWARZBECK	VULB 9168	9168-406	Jan. 04, 2016	Jan. 03, 2017
RF Cable	8D	966-4-1 966-4-2 966-4-3	Apr. 03, 2015	Apr. 02, 2016
Software	ADT_Radiated _V8.7.07	NA	NA	NA
Antenna Tower & Turn Table CT	NA	NA	NA	NA

Note:

1. The calibration interval of the above test instruments is 12 months and the calibrations are traceable to NML/ROC and NIST/USA.
2. *The calibration interval of the above test instruments is 24 months and the calibrations are traceable to NML/ROC and NIST/USA.
3. Loop antenna was used for all emissions below 30 MHz.
4. The test was performed in 966 Chamber No. 4.
5. The FCC Site Registration No. is 292998
6. The CANADA Site Registration No. is 20331-2
- 7 Tested Date: Mar. 03, 2016

**For other test items:**

DESCRIPTION & MANUFACTURER	MODEL NO.	SERIAL NO.	CALIBRATED DATE	CALIBRATED UNTIL
Test Receiver Agilent	N9038A	MY54450088	July 24, 2015	July 23, 2016
Horn_Antenna SCHWARZBECK	BBHA 9120D	9120D-783	Feb. 06, 2015	Feb. 05, 2016
Pre-Amplifier Agilent	8449B	3008A01922	Sep. 19, 2015	Sep. 18, 2016
RF Cable	EMC104-SM- SM-2000 EMC104-SM- SM-5000 EMC104-SM- SM-5000	150318 150323 150324	Mar. 31, 2015	Mar. 30, 2016
Spectrum Analyzer R&S	FSV40	100964	June 26, 2015	June 25, 2016
Pre-Amplifier EMCI	EMC184045	980143	Jan. 16, 2015	Jan. 15, 2016
Horn_Antenna SCHWARZBECK	BBHA 9170	BBHA9170608	Feb. 05, 2015	Feb. 04, 2016
RF Cable	SUCOFLEX 104	329751/4 RF104-204	Dec. 11, 2014	Dec. 10, 2015
Software	ADT_Radiated _V8.7.07	NA	NA	NA
Antenna Tower & Turn Table CT	NA	NA	NA	NA
Spectrum Analyzer R&S	FSP40	100060	May 08, 2015	May 07, 2016
Power Meter Anritsu	ML2495A	1014008	Apr. 28, 2015	Apr. 27, 2016
Power Sensor Anritsu	MA2411B	0917122	Apr. 28, 2015	Apr. 27, 2016
Temperature & Humidity Chamber TERCHY	MHU-225AU	911033	Dec. 08, 2014	Dec. 07, 2015

Note:

1. The calibration interval of the above test instruments is 12 months and the calibrations are traceable to NML/ROC and NIST/USA.
2. The test was performed in 966 Chamber No. 4.
3. The FCC Site Registration No. is 292998
4. The CANADA Site Registration No. is 20331-2
5. Tested Date: Oct. 22 to 23, 2015

4.1.3 Test Procedure

- a. The EUT was placed on the top of a rotating table 0.8 meters (for below 1GHz) / 1.5 meters (for above 1GHz) above the ground at 3 meter chamber room for test. The table was rotated 360 degrees to determine the position of the highest radiation.
- b. The EUT was set 3 meters away from the interference-receiving antenna, which was mounted on the top of a variable-height antenna tower.
- c. The height of antenna is varied from one meter to four meters above the ground to determine the maximum value of the field strength. Both horizontal and vertical polarizations of the antenna are set to make the measurement.
- d. For each suspected emission, the EUT was arranged to its worst case and then the antenna was tuned to heights from 1 meter to 4 meters and the rotatable table was turned from 0 degrees to 360 degrees to find the maximum reading.
- e. The test-receiver system was set to quasi-peak detect function and specified bandwidth with maximum hold mode when the test frequency is below 1 GHz.
- f. The test-receiver system was set to peak and average detect function and specified bandwidth with maximum hold mode when the test frequency is above 1 GHz. If the peak reading value also meets average limit, measurement with the average detector is unnecessary.

Note:

1. The resolution bandwidth and video bandwidth of test receiver/spectrum analyzer is 120kHz for Quasi-peak detection (QP) at frequency below 1GHz.
2. The resolution bandwidth of test receiver/spectrum analyzer is 1 MHz and the video bandwidth is 3 MHz for Peak detection (PK) at frequency above 1GHz.
3. The resolution bandwidth of test receiver/spectrum analyzer is 1MHz and the video bandwidth is 3MHz for RMS Average (Duty cycle < 98%) for Average detection (AV) at frequency above 1GHz, then the measurement results was added to a correction factor ($10 \log(1/\text{duty cycle})$).
4. The resolution bandwidth of test receiver/spectrum analyzer is 1MHz and the video bandwidth is 10Hz (Duty cycle $\geq 98\%$) for Average detection (AV) at frequency above 1GHz.
5. All modes of operation were investigated and the worst-case emissions are reported.

4.1.4 Deviation from Test Standard

No deviation.

4.1.5 Test Setup

<Frequency Range below 1GHz>

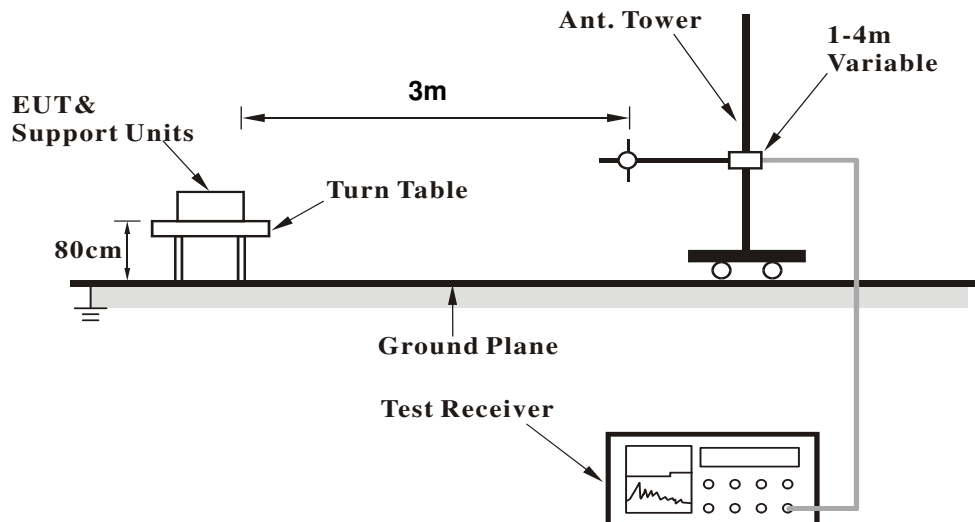

<Frequency Range above 1GHz>

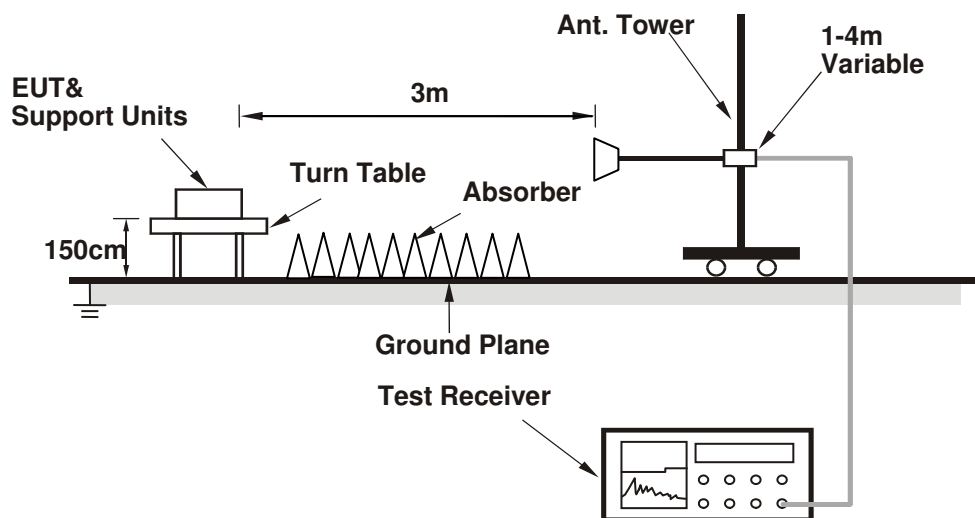

For the actual test configuration, please refer to the attached file (Test Setup Photo).

4.1.6 EUT Operating Condition

1. Controlling software (Console Paster command [VMC3040 WiFi test command.txt]) has been activated to set the EUT on specific status.

4.1.7 Test Results

Above 1GHz Data:

802.11a

CHANNEL	TX Channel 36	DETECTOR FUNCTION	Peak (PK)
FREQUENCY RANGE	1GHz ~ 40GHz		Average (AV)

ANTENNA POLARITY & TEST DISTANCE: HORIZONTAL AT 3 M

NO.	FREQ. (MHz)	EMISSION LEVEL (dBuV/m)	LIMIT (dBuV/m)	MARGIN (dB)	ANTENNA HEIGHT (m)	TABLE ANGLE (Degree)	RAW VALUE (dBuV)	CORRECTION FACTOR (dB/m)
1	5150.00	71.4 PK	74.0	-2.6	1.61 H	326	70.76	0.64
2	5150.00	53.4 AV	54.0	-0.6	1.61 H	326	52.76	0.64
3	*5180.00	110.9 PK			1.61 H	326	110.17	0.73
4	*5180.00	99.7 AV			1.61 H	326	98.97	0.73
5	#10360.00	68.4 PK	74.0	-5.6	1.84 H	106	57.65	10.75
6	#10360.00	53.0 AV	54.0	-1.0	1.84 H	106	42.25	10.75
7	15540.00	52.5 PK	74.0	-21.5	1.64 H	217	39.35	13.15
8	15540.00	40.1 AV	54.0	-13.9	1.64 H	217	26.95	13.15

ANTENNA POLARITY & TEST DISTANCE: VERTICAL AT 3 M

NO.	FREQ. (MHz)	EMISSION LEVEL (dBuV/m)	LIMIT (dBuV/m)	MARGIN (dB)	ANTENNA HEIGHT (m)	TABLE ANGLE (Degree)	RAW VALUE (dBuV)	CORRECTION FACTOR (dB/m)
1	5150.00	68.0 PK	74.0	-6.0	1.47 V	70	67.36	0.64
2	5150.00	53.2 AV	54.0	-0.8	1.47 V	70	52.56	0.64
3	*5180.00	110.8 PK			1.47 V	70	110.07	0.73
4	*5180.00	99.4 AV			1.47 V	70	98.67	0.73
5	#10360.00	65.2 PK	74.0	-8.8	1.01 V	240	54.45	10.75
6	#10360.00	53.6 AV	54.0	-0.4	1.01 V	240	42.85	10.75
7	15540.00	51.5 PK	74.0	-22.5	1.47 V	196	38.35	13.15
8	15540.00	39.1 AV	54.0	-14.9	1.47 V	196	25.95	13.15

REMARKS:

1. Emission Level(dBuV/m) = Raw Value(dBuV) + Correction Factor(dB/m)
2. Correction Factor(dB/m) = Antenna Factor(dB/m) + Cable Factor(dB) – Pre-Amplifier Factor(dB)
3. The other emission levels were very low against the limit.
4. Margin value = Emission Level – Limit value
5. " * ": Fundamental frequency.
6. " # ": The radiated frequency is out of the restricted band.

CHANNEL	TX Channel 40	DETECTOR FUNCTION	Peak (PK)
FREQUENCY RANGE	1GHz ~ 40GHz		Average (AV)

ANTENNA POLARITY & TEST DISTANCE: HORIZONTAL AT 3 M

NO.	FREQ. (MHz)	EMISSION LEVEL (dBuV/m)	LIMIT (dBuV/m)	MARGIN (dB)	ANTENNA HEIGHT (m)	TABLE ANGLE (Degree)	RAW VALUE (dBuV)	CORRECTION FACTOR (dB/m)
1	*5200.00	108.8 PK			1.54 H	72	108.01	0.79
2	*5200.00	97.3 AV			1.54 H	72	96.51	0.79
3	#10400.00	65.7 PK	74.0	-8.3	1.75 H	109	54.60	11.10
4	#10400.00	51.4 AV	54.0	-2.6	1.75 H	109	40.30	11.10
5	15600.00	52.5 PK	74.0	-21.5	1.62 H	202	39.28	13.22
6	15600.00	40.3 AV	54.0	-13.7	1.62 H	202	27.08	13.22

ANTENNA POLARITY & TEST DISTANCE: VERTICAL AT 3 M

NO.	FREQ. (MHz)	EMISSION LEVEL (dBuV/m)	LIMIT (dBuV/m)	MARGIN (dB)	ANTENNA HEIGHT (m)	TABLE ANGLE (Degree)	RAW VALUE (dBuV)	CORRECTION FACTOR (dB/m)
1	*5200.00	109.4 PK			1.48 V	72	108.61	0.79
2	*5200.00	97.8 AV			1.48 V	72	97.01	0.79
3	#10400.00	68.4 PK	74.0	-5.6	2.38 V	157	57.30	11.10
4	#10400.00	53.5 AV	54.0	-0.5	2.38 V	157	42.40	11.10
5	15600.00	51.1 PK	74.0	-22.9	1.45 V	194	37.88	13.22
6	15600.00	38.8 AV	54.0	-15.2	1.45 V	194	25.58	13.22

REMARKS:

1. Emission Level(dBuV/m) = Raw Value(dBuV) + Correction Factor(dB/m)
2. Correction Factor(dB/m) = Antenna Factor(dB/m) + Cable Factor(dB) – Pre-Amplifier Factor(dB)
3. The other emission levels were very low against the limit.
4. Margin value = Emission Level – Limit value
5. " * ": Fundamental frequency.
6. " # ": The radiated frequency is out of the restricted band.

CHANNEL	TX Channel 48	DETECTOR FUNCTION	Peak (PK)
FREQUENCY RANGE	1GHz ~ 40GHz		Average (AV)

ANTENNA POLARITY & TEST DISTANCE: HORIZONTAL AT 3 M

NO.	FREQ. (MHz)	EMISSION LEVEL (dBuV/m)	LIMIT (dBuV/m)	MARGIN (dB)	ANTENNA HEIGHT (m)	TABLE ANGLE (Degree)	RAW VALUE (dBuV)	CORRECTION FACTOR (dB/m)
1	*5240.00	108.1 PK			1.58 H	71	107.18	0.92
2	*5240.00	96.8 AV			1.58 H	71	95.88	0.92
3	5350.00	51.5 PK	74.0	-22.5	1.58 H	71	50.32	1.18
4	5350.00	38.7 AV	54.0	-15.3	1.58 H	71	37.52	1.18
5	#10480.00	68.6 PK	74.0	-5.4	1.85 H	111	57.66	10.94
6	#10480.00	53.7 AV	54.0	-0.3	1.85 H	111	42.76	10.94
7	15720.00	52.6 PK	74.0	-21.4	1.64 H	215	40.07	12.53
8	15720.00	40.5 AV	54.0	-13.5	1.64 H	215	27.97	12.53

ANTENNA POLARITY & TEST DISTANCE: VERTICAL AT 3 M

NO.	FREQ. (MHz)	EMISSION LEVEL (dBuV/m)	LIMIT (dBuV/m)	MARGIN (dB)	ANTENNA HEIGHT (m)	TABLE ANGLE (Degree)	RAW VALUE (dBuV)	CORRECTION FACTOR (dB/m)
1	*5240.00	111.1 PK			1.43 V	68	110.18	0.92
2	*5240.00	99.2 AV			1.43 V	68	98.28	0.92
3	5350.00	53.3 PK	74.0	-20.7	1.43 V	68	52.12	1.18
4	5350.00	39.1 AV	54.0	-14.9	1.43 V	68	37.92	1.18
5	#10480.00	68.8 PK	74.0	-5.2	2.30 V	206	57.86	10.94
6	#10480.00	53.3 AV	54.0	-0.7	2.30 V	206	42.36	10.94
7	15720.00	51.9 PK	74.0	-22.1	1.44 V	188	39.37	12.53
8	15720.00	39.5 AV	54.0	-14.5	1.44 V	188	26.97	12.53

REMARKS:

1. Emission Level(dBuV/m) = Raw Value(dBuV) + Correction Factor(dB/m)
2. Correction Factor(dB/m) = Antenna Factor(dB/m) + Cable Factor(dB) – Pre-Amplifier Factor(dB)
3. The other emission levels were very low against the limit.
4. Margin value = Emission Level – Limit value
5. " * ": Fundamental frequency.
6. " # ": The radiated frequency is out of the restricted band.

CHANNEL	TX Channel 52	DETECTOR FUNCTION	Peak (PK)
FREQUENCY RANGE	1GHz ~ 40GHz		Average (AV)

ANTENNA POLARITY & TEST DISTANCE: HORIZONTAL AT 3 M

NO.	FREQ. (MHz)	EMISSION LEVEL (dBuV/m)	LIMIT (dBuV/m)	MARGIN (dB)	ANTENNA HEIGHT (m)	TABLE ANGLE (Degree)	RAW VALUE (dBuV)	CORRECTION FACTOR (dB/m)
1	5150.00	51.4 PK	74.0	-22.6	1.58 H	85	50.76	0.64
2	5150.00	38.7 AV	54.0	-15.3	1.58 H	85	38.06	0.64
3	*5260.00	107.5 PK			1.58 H	56	106.49	1.01
4	*5260.00	97.4 AV			1.58 H	56	96.39	1.01
5	#10520.00	64.3 PK	74.0	-9.7	1.87 H	108	53.31	10.99
6	#10520.00	50.4 AV	54.0	-3.6	1.87 H	108	39.41	10.99
7	15780.00	53.4 PK	74.0	-20.6	1.65 H	227	40.99	12.41
8	15780.00	41.0 AV	54.0	-13.0	1.65 H	227	28.59	12.41

ANTENNA POLARITY & TEST DISTANCE: VERTICAL AT 3 M

NO.	FREQ. (MHz)	EMISSION LEVEL (dBuV/m)	LIMIT (dBuV/m)	MARGIN (dB)	ANTENNA HEIGHT (m)	TABLE ANGLE (Degree)	RAW VALUE (dBuV)	CORRECTION FACTOR (dB/m)
1	5150.00	51.9 PK	74.0	-22.1	1.50 V	68	51.26	0.64
2	5150.00	37.9 AV	54.0	-16.1	1.50 V	68	37.26	0.64
3	*5260.00	109.8 PK			1.50 V	68	108.79	1.01
4	*5260.00	98.7 AV			1.50 V	68	97.69	1.01
5	#10520.00	68.4 PK	74.0	-5.6	2.42 V	196	57.41	10.99
6	#10520.00	53.3 AV	54.0	-0.7	2.42 V	196	42.31	10.99
7	15780.00	50.7 PK	74.0	-23.3	1.51 V	192	38.29	12.41
8	15780.00	38.4 AV	54.0	-15.6	1.51 V	192	25.99	12.41

REMARKS:

1. Emission Level(dBuV/m) = Raw Value(dBuV) + Correction Factor(dB/m)
2. Correction Factor(dB/m) = Antenna Factor(dB/m) + Cable Factor(dB) – Pre-Amplifier Factor(dB)
3. The other emission levels were very low against the limit.
4. Margin value = Emission Level – Limit value
5. " * ": Fundamental frequency.
6. " # ": The radiated frequency is out of the restricted band.

CHANNEL	TX Channel 60	DETECTOR FUNCTION	Peak (PK)
FREQUENCY RANGE	1GHz ~ 40GHz		Average (AV)

ANTENNA POLARITY & TEST DISTANCE: HORIZONTAL AT 3 M

NO.	FREQ. (MHz)	EMISSION LEVEL (dBuV/m)	LIMIT (dBuV/m)	MARGIN (dB)	ANTENNA HEIGHT (m)	TABLE ANGLE (Degree)	RAW VALUE (dBuV)	CORRECTION FACTOR (dB/m)
1	*5300.00	110.2 PK			1.57 H	50	109.06	1.14
2	*5300.00	98.4 AV			1.57 H	50	97.26	1.14
3	10600.00	64.4 PK	74.0	-9.6	1.78 H	106	53.06	11.34
4	10600.00	53.0 AV	54.0	-1.0	1.78 H	106	41.66	11.34
5	15900.00	53.4 PK	74.0	-20.6	1.64 H	241	40.90	12.50
6	15900.00	41.0 AV	54.0	-13.0	1.64 H	241	28.50	12.50

ANTENNA POLARITY & TEST DISTANCE: VERTICAL AT 3 M

NO.	FREQ. (MHz)	EMISSION LEVEL (dBuV/m)	LIMIT (dBuV/m)	MARGIN (dB)	ANTENNA HEIGHT (m)	TABLE ANGLE (Degree)	RAW VALUE (dBuV)	CORRECTION FACTOR (dB/m)
1	*5300.00	110.9 PK			1.42 V	65	109.76	1.14
2	*5300.00	99.8 AV			1.42 V	65	98.66	1.14
3	10600.00	66.2 PK	74.0	-7.8	1.01 V	233	54.86	11.34
4	10600.00	53.9 AV	54.0	-0.1	1.01 V	233	42.56	11.34
5	15900.00	51.0 PK	74.0	-23.0	1.49 V	197	38.50	12.50
6	15900.00	38.9 AV	54.0	-15.1	1.49 V	197	26.40	12.50

REMARKS:

1. Emission Level(dBuV/m) = Raw Value(dBuV) + Correction Factor(dB/m)
2. Correction Factor(dB/m) = Antenna Factor(dB/m) + Cable Factor(dB) – Pre-Amplifier Factor(dB)
3. The other emission levels were very low against the limit.
4. Margin value = Emission Level – Limit value
5. " * ": Fundamental frequency.



CHANNEL	TX Channel 64	DETECTOR FUNCTION	Peak (PK)
FREQUENCY RANGE	1GHz ~ 40GHz		Average (AV)

ANTENNA POLARITY & TEST DISTANCE: HORIZONTAL AT 3 M

NO.	FREQ. (MHz)	EMISSION LEVEL (dBuV/m)	LIMIT (dBuV/m)	MARGIN (dB)	ANTENNA HEIGHT (m)	TABLE ANGLE (Degree)	RAW VALUE (dBuV)	CORRECTION FACTOR (dB/m)
1	*5320.00	112.2 PK			2.06 H	304	111.04	1.16
2	*5320.00	100.3 AV			2.06 H	304	99.14	1.16
3	5350.00	71.4 PK	74.0	-2.6	2.06 H	304	70.22	1.18
4	5350.00	53.9 AV	54.0	-0.1	2.06 H	304	52.72	1.18
5	10640.00	64.5 PK	74.0	-9.5	1.76 H	103	53.15	11.35
6	10640.00	53.2 AV	54.0	-0.8	1.76 H	103	41.85	11.35
7	15960.00	53.1 PK	74.0	-20.9	1.67 H	249	40.69	12.41
8	15960.00	40.7 AV	54.0	-13.3	1.67 H	249	28.29	12.41

ANTENNA POLARITY & TEST DISTANCE: VERTICAL AT 3 M

NO.	FREQ. (MHz)	EMISSION LEVEL (dBuV/m)	LIMIT (dBuV/m)	MARGIN (dB)	ANTENNA HEIGHT (m)	TABLE ANGLE (Degree)	RAW VALUE (dBuV)	CORRECTION FACTOR (dB/m)
1	*5320.00	111.5 PK			1.36 V	62	110.34	1.16
2	*5320.00	100.0 AV			1.36 V	62	98.84	1.16
3	5350.00	69.1 PK	74.0	-4.9	1.36 V	62	67.92	1.18
4	5350.00	52.8 AV	54.0	-1.2	1.36 V	62	51.62	1.18
5	10640.00	67.6 PK	74.0	-6.4	2.35 V	196	56.25	11.35
6	10640.00	53.4 AV	54.0	-0.6	2.35 V	196	42.05	11.35
7	15960.00	51.5 PK	74.0	-22.5	1.47 V	211	39.09	12.41
8	15960.00	39.2 AV	54.0	-14.8	1.47 V	211	26.79	12.41

REMARKS:

1. Emission Level(dBuV/m) = Raw Value(dBuV) + Correction Factor(dB/m)
2. Correction Factor(dB/m) = Antenna Factor(dB/m) + Cable Factor(dB) – Pre-Amplifier Factor(dB)
3. The other emission levels were very low against the limit.
4. Margin value = Emission Level – Limit value
5. " * ": Fundamental frequency.

CHANNEL	TX Channel 100	DETECTOR FUNCTION	Peak (PK)
FREQUENCY RANGE	1GHz ~ 40GHz		Average (AV)

ANTENNA POLARITY & TEST DISTANCE: HORIZONTAL AT 3 M

NO.	FREQ. (MHz)	EMISSION LEVEL (dBuV/m)	LIMIT (dBuV/m)	MARGIN (dB)	ANTENNA HEIGHT (m)	TABLE ANGLE (Degree)	RAW VALUE (dBuV)	CORRECTION FACTOR (dB/m)
1	#5470.00	69.1 PK	74.0	-4.9	1.51 H	68	67.73	1.37
2	#5470.00	51.9 AV	54.0	-2.1	1.51 H	68	50.53	1.37
3	*5500.00	109.7 PK			1.51 H	68	108.26	1.44
4	*5500.00	99.6 AV			1.51 H	68	98.16	1.44
5	11000.00	56.1 PK	74.0	-17.9	2.32 H	142	43.57	12.53
6	11000.00	42.3 AV	54.0	-11.7	2.32 H	142	29.77	12.53
7	#16500.00	53.1 PK	74.0	-20.9	1.64 H	237	37.65	15.45
8	#16500.00	40.7 AV	54.0	-13.3	1.64 H	237	25.25	15.45

ANTENNA POLARITY & TEST DISTANCE: VERTICAL AT 3 M

NO.	FREQ. (MHz)	EMISSION LEVEL (dBuV/m)	LIMIT (dBuV/m)	MARGIN (dB)	ANTENNA HEIGHT (m)	TABLE ANGLE (Degree)	RAW VALUE (dBuV)	CORRECTION FACTOR (dB/m)
1	#5470.00	68.8 PK	74.0	-5.2	1.51 V	70	67.43	1.37
2	#5470.00	51.5 AV	54.0	-2.5	1.51 V	70	50.13	1.37
3	*5500.00	111.2 PK			1.51 V	70	109.76	1.44
4	*5500.00	100.1 AV			1.51 V	70	98.66	1.44
5	11000.00	56.7 PK	74.0	-17.3	1.51 V	197	44.17	12.53
6	11000.00	43.2 AV	54.0	-10.8	1.51 V	197	30.67	12.53
7	#16500.00	51.5 PK	74.0	-22.5	1.51 V	222	36.05	15.45
8	#16500.00	39.4 AV	54.0	-14.6	1.51 V	222	23.95	15.45

REMARKS:

1. Emission Level(dBuV/m) = Raw Value(dBuV) + Correction Factor(dB/m)
2. Correction Factor(dB/m) = Antenna Factor(dB/m) + Cable Factor(dB) – Pre-Amplifier Factor(dB)
3. The other emission levels were very low against the limit.
4. Margin value = Emission Level – Limit value
5. " * ": Fundamental frequency.
6. " # ": The radiated frequency is out of the restricted band.

CHANNEL	TX Channel 116	DETECTOR FUNCTION	Peak (PK)
FREQUENCY RANGE	1GHz ~ 40GHz		Average (AV)

ANTENNA POLARITY & TEST DISTANCE: HORIZONTAL AT 3 M

NO.	FREQ. (MHz)	EMISSION LEVEL (dBuV/m)	LIMIT (dBuV/m)	MARGIN (dB)	ANTENNA HEIGHT (m)	TABLE ANGLE (Degree)	RAW VALUE (dBuV)	CORRECTION FACTOR (dB/m)
1	*5580.00	110.2 PK			1.98 H	108	108.68	1.52
2	*5580.00	98.5 AV			1.98 H	108	96.98	1.52
3	11160.00	64.5 PK	74.0	-9.5	2.20 H	298	52.11	12.39
4	11160.00	49.2 AV	54.0	-4.8	2.20 H	298	36.81	12.39
5	#16740.00	52.6 PK	74.0	-21.4	1.69 H	227	36.52	16.08
6	#16740.00	40.4 AV	54.0	-13.6	1.69 H	227	24.32	16.08

ANTENNA POLARITY & TEST DISTANCE: VERTICAL AT 3 M

NO.	FREQ. (MHz)	EMISSION LEVEL (dBuV/m)	LIMIT (dBuV/m)	MARGIN (dB)	ANTENNA HEIGHT (m)	TABLE ANGLE (Degree)	RAW VALUE (dBuV)	CORRECTION FACTOR (dB/m)
1	*5580.00	111.7 PK			1.56 V	64	110.18	1.52
2	*5580.00	99.2 AV			1.56 V	64	97.68	1.52
3	11160.00	62.8 PK	74.0	-11.2	1.75 V	203	50.41	12.39
4	11160.00	47.6 AV	54.0	-6.4	1.75 V	203	35.21	12.39
5	#16740.00	51.2 PK	74.0	-22.8	1.50 V	234	35.12	16.08
6	#16740.00	39.4 AV	54.0	-14.6	1.50 V	234	23.32	16.08

REMARKS:

1. Emission Level(dBuV/m) = Raw Value(dBuV) + Correction Factor(dB/m)
2. Correction Factor(dB/m) = Antenna Factor(dB/m) + Cable Factor(dB) – Pre-Amplifier Factor(dB)
3. The other emission levels were very low against the limit.
4. Margin value = Emission Level – Limit value
5. " * ": Fundamental frequency.
6. " # ": The radiated frequency is out of the restricted band.



CHANNEL	TX Channel 140	DETECTOR FUNCTION	Peak (PK)
FREQUENCY RANGE	1GHz ~ 40GHz		Average (AV)

ANTENNA POLARITY & TEST DISTANCE: HORIZONTAL AT 3 M

NO.	FREQ. (MHz)	EMISSION LEVEL (dBuV/m)	LIMIT (dBuV/m)	MARGIN (dB)	ANTENNA HEIGHT (m)	TABLE ANGLE (Degree)	RAW VALUE (dBuV)	CORRECTION FACTOR (dB/m)
1	*5700.00	106.4 PK			1.61 H	205	104.75	1.65
2	*5700.00	95.2 AV			1.61 H	205	93.55	1.65
3	#5725.00	65.9 PK	74.0	-8.1	1.61 H	205	64.22	1.68
4	#5725.00	50.2 AV	54.0	-3.8	1.61 H	205	48.52	1.68
5	11400.00	56.0 PK	74.0	-18.0	2.35 H	152	43.43	12.57
6	11400.00	42.1 AV	54.0	-11.9	2.35 H	152	29.53	12.57
7	#17100.00	53.0 PK	74.0	-21.0	1.61 H	245	35.70	17.30
8	#17100.00	40.4 AV	54.0	-13.6	1.61 H	245	23.10	17.30

ANTENNA POLARITY & TEST DISTANCE: VERTICAL AT 3 M

NO.	FREQ. (MHz)	EMISSION LEVEL (dBuV/m)	LIMIT (dBuV/m)	MARGIN (dB)	ANTENNA HEIGHT (m)	TABLE ANGLE (Degree)	RAW VALUE (dBuV)	CORRECTION FACTOR (dB/m)
1	*5700.00	108.1 PK			1.59 V	44	106.45	1.65
2	*5700.00	96.7 AV			1.59 V	44	95.05	1.65
3	#5725.00	67.8 PK	74.0	-6.2	1.59 V	44	66.12	1.68
4	#5725.00	51.4 AV	54.0	-2.6	1.59 V	44	49.72	1.68
5	11400.00	56.5 PK	74.0	-17.5	1.57 V	203	43.93	12.57
6	11400.00	42.3 AV	54.0	-11.7	1.57 V	203	29.73	12.57
7	#17100.00	50.9 PK	74.0	-23.1	1.54 V	221	33.60	17.30
8	#17100.00	39.1 AV	54.0	-14.9	1.54 V	221	21.80	17.30

REMARKS:

1. Emission Level(dBuV/m) = Raw Value(dBuV) + Correction Factor(dB/m)
2. Correction Factor(dB/m) = Antenna Factor(dB/m) + Cable Factor(dB) – Pre-Amplifier Factor(dB)
3. The other emission levels were very low against the limit.
4. Margin value = Emission Level – Limit value
5. " * ": Fundamental frequency.
6. " # ": The radiated frequency is out of the restricted band.

CHANNEL	TX Channel 149	DETECTOR FUNCTION	Peak (PK)
FREQUENCY RANGE	1GHz ~ 40GHz		Average (AV)

ANTENNA POLARITY & TEST DISTANCE: HORIZONTAL AT 3 M

NO.	FREQ. (MHz)	EMISSION LEVEL (dBuV/m)	LIMIT (dBuV/m)	MARGIN (dB)	ANTENNA HEIGHT (m)	TABLE ANGLE (Degree)	RAW VALUE (dBuV)	CORRECTION FACTOR (dB/m)
1	#5715.00	59.3 PK	74.0	-14.7	1.51 H	102	57.63	1.67
2	#5715.00	46.1 AV	54.0	-7.9	1.51 H	102	44.43	1.67
3	#5725.00	73.2 PK	78.2	-5.0	1.51 H	102	71.52	1.68
4	*5745.00	107.1 PK			1.51 H	102	105.39	1.71
5	*5745.00	95.9 AV			1.51 H	102	94.19	1.71
6	11490.00	56.2 PK	74.0	-17.8	2.37 H	154	43.60	12.60
7	11490.00	42.3 AV	54.0	-11.7	2.37 H	154	29.70	12.60
8	#17235.00	53.3 PK	74.0	-20.7	1.56 H	241	35.75	17.55
9	#17235.00	40.5 AV	54.0	-13.5	1.56 H	241	22.95	17.55

ANTENNA POLARITY & TEST DISTANCE: VERTICAL AT 3 M

NO.	FREQ. (MHz)	EMISSION LEVEL (dBuV/m)	LIMIT (dBuV/m)	MARGIN (dB)	ANTENNA HEIGHT (m)	TABLE ANGLE (Degree)	RAW VALUE (dBuV)	CORRECTION FACTOR (dB/m)
1	#5715.00	59.3 PK	74.0	-14.7	1.70 V	232	57.63	1.67
2	#5715.00	46.1 AV	54.0	-7.9	1.70 V	232	44.43	1.67
3	#5725.00	76.8 PK	78.2	-1.4	1.70 V	232	75.12	1.68
4	*5745.00	106.8 PK			1.70 V	232	105.09	1.71
5	*5745.00	95.6 AV			1.70 V	232	93.89	1.71
6	11490.00	56.3 PK	74.0	-17.7	1.59 V	192	43.70	12.60
7	11490.00	41.8 AV	54.0	-12.2	1.59 V	192	29.20	12.60
8	#17235.00	50.6 PK	74.0	-23.4	1.59 V	214	33.05	17.55
9	#17235.00	38.8 AV	54.0	-15.2	1.59 V	214	21.25	17.55

REMARKS:

1. Emission Level(dBuV/m) = Raw Value(dBuV) + Correction Factor(dB/m)
2. Correction Factor(dB/m) = Antenna Factor(dB/m) + Cable Factor(dB) – Pre-Amplifier Factor(dB)
3. The other emission levels were very low against the limit.
4. Margin value = Emission Level – Limit value
5. " * ": Fundamental frequency.
6. " # ": The radiated frequency is out of the restricted band.

CHANNEL	TX Channel 157	DETECTOR FUNCTION	Peak (PK)
FREQUENCY RANGE	1GHz ~ 40GHz		Average (AV)

ANTENNA POLARITY & TEST DISTANCE: HORIZONTAL AT 3 M

NO.	FREQ. (MHz)	EMISSION LEVEL (dBuV/m)	LIMIT (dBuV/m)	MARGIN (dB)	ANTENNA HEIGHT (m)	TABLE ANGLE (Degree)	RAW VALUE (dBuV)	CORRECTION FACTOR (dB/m)
1	*5785.00	111.2 PK			1.79 H	98	109.44	1.76
2	*5785.00	98.9 AV			1.79 H	98	97.14	1.76
3	11570.00	67.3 PK	74.0	-6.7	1.93 H	286	54.96	12.34
4	11570.00	52.2 AV	54.0	-1.8	1.93 H	286	39.86	12.34
5	#17355.00	53.6 PK	74.0	-20.4	1.62 H	253	35.43	18.17
6	#17355.00	40.6 AV	54.0	-13.4	1.62 H	253	22.43	18.17

ANTENNA POLARITY & TEST DISTANCE: VERTICAL AT 3 M

NO.	FREQ. (MHz)	EMISSION LEVEL (dBuV/m)	LIMIT (dBuV/m)	MARGIN (dB)	ANTENNA HEIGHT (m)	TABLE ANGLE (Degree)	RAW VALUE (dBuV)	CORRECTION FACTOR (dB/m)
1	*5785.00	112.7 PK			1.56 V	231	110.94	1.76
2	*5785.00	99.4 AV			1.56 V	231	97.64	1.76
3	11570.00	65.3 PK	74.0	-8.7	1.84 V	24	52.96	12.34
4	11570.00	50.7 AV	54.0	-3.3	1.84 V	24	38.36	12.34
5	#17355.00	50.8 PK	74.0	-23.2	1.58 V	14	32.63	18.17
6	#17355.00	39.2 AV	54.0	-14.8	1.58 V	14	21.03	18.17

REMARKS:

1. Emission Level(dBuV/m) = Raw Value(dBuV) + Correction Factor(dB/m)
2. Correction Factor(dB/m) = Antenna Factor(dB/m) + Cable Factor(dB) – Pre-Amplifier Factor(dB)
3. The other emission levels were very low against the limit.
4. Margin value = Emission Level – Limit value
5. " * ": Fundamental frequency.
6. " # ": The radiated frequency is out of the restricted band.

CHANNEL	TX Channel 165	DETECTOR FUNCTION	Peak (PK)
FREQUENCY RANGE	1GHz ~ 40GHz		Average (AV)

ANTENNA POLARITY & TEST DISTANCE: HORIZONTAL AT 3 M

NO.	FREQ. (MHz)	EMISSION LEVEL (dBuV/m)	LIMIT (dBuV/m)	MARGIN (dB)	ANTENNA HEIGHT (m)	TABLE ANGLE (Degree)	RAW VALUE (dBuV)	CORRECTION FACTOR (dB/m)
1	*5825.00	110.1 PK			1.68 H	111	108.32	1.78
2	*5825.00	98.3 AV			1.68 H	111	96.52	1.78
3	#5850.00	75.9 PK	78.2	-2.3	1.68 H	111	74.13	1.77
4	#5860.00	66.6 PK	74.0	-7.4	1.68 H	111	64.83	1.77
5	#5860.00	50.1 AV	54.0	-3.9	1.68 H	111	48.33	1.77
6	11650.00	68.3 PK	74.0	-5.7	1.81 H	341	56.14	12.16
7	11650.00	53.7 AV	54.0	-0.3	1.81 H	341	41.54	12.16
8	#17475.00	53.6 PK	74.0	-20.4	1.66 H	269	34.86	18.74
9	#17475.00	40.3 AV	54.0	-13.7	1.66 H	269	21.56	18.74

ANTENNA POLARITY & TEST DISTANCE: VERTICAL AT 3 M

NO.	FREQ. (MHz)	EMISSION LEVEL (dBuV/m)	LIMIT (dBuV/m)	MARGIN (dB)	ANTENNA HEIGHT (m)	TABLE ANGLE (Degree)	RAW VALUE (dBuV)	CORRECTION FACTOR (dB/m)
1	*5825.00	108.8 PK			2.02 V	236	107.02	1.78
2	*5825.00	97.0 AV			2.02 V	236	95.22	1.78
3	#5850.00	75.7 PK	78.2	-2.5	2.02 V	236	73.93	1.77
4	#5860.00	66.1 PK	74.0	-7.9	2.02 V	236	64.33	1.77
5	#5860.00	50.0 AV	54.0	-4.0	2.02 V	236	48.23	1.77
6	11650.00	65.9 PK	74.0	-8.1	1.76 V	24	53.74	12.16
7	11650.00	51.5 AV	54.0	-2.5	1.76 V	24	39.34	12.16
8	#17475.00	50.8 PK	74.0	-23.2	1.55 V	5	32.06	18.74
9	#17475.00	39.1 AV	54.0	-14.9	1.55 V	5	20.36	18.74

REMARKS:

1. Emission Level(dBuV/m) = Raw Value(dBuV) + Correction Factor(dB/m)
2. Correction Factor(dB/m) = Antenna Factor(dB/m) + Cable Factor(dB) – Pre-Amplifier Factor(dB)
3. The other emission levels were very low against the limit.
4. Margin value = Emission Level – Limit value
5. " * ": Fundamental frequency.
6. " # ": The radiated frequency is out of the restricted band.

802.11n (HT20)

CHANNEL	TX Channel 36	DETECTOR FUNCTION	Peak (PK)
FREQUENCY RANGE	1GHz ~ 40GHz		Average (AV)

ANTENNA POLARITY & TEST DISTANCE: HORIZONTAL AT 3 M

NO.	FREQ. (MHz)	EMISSION LEVEL (dBuV/m)	LIMIT (dBuV/m)	MARGIN (dB)	ANTENNA HEIGHT (m)	TABLE ANGLE (Degree)	RAW VALUE (dBuV)	CORRECTION FACTOR (dB/m)
1	5150.00	68.8 PK	74.0	-5.2	1.48 H	72	68.16	0.64
2	5150.00	51.2 AV	54.0	-2.8	1.48 H	72	50.56	0.64
3	*5180.00	108.3 PK			1.48 H	72	107.57	0.73
4	*5180.00	96.6 AV			1.48 H	72	95.87	0.73
5	#10360.00	63.5 PK	74.0	-10.5	1.60 H	278	52.75	10.75
6	#10360.00	49.2 AV	54.0	-4.8	1.60 H	278	38.45	10.75
7	15540.00	53.6 PK	74.0	-20.4	1.71 H	267	40.45	13.15
8	15540.00	40.3 AV	54.0	-13.7	1.71 H	267	27.15	13.15

ANTENNA POLARITY & TEST DISTANCE: VERTICAL AT 3 M

NO.	FREQ. (MHz)	EMISSION LEVEL (dBuV/m)	LIMIT (dBuV/m)	MARGIN (dB)	ANTENNA HEIGHT (m)	TABLE ANGLE (Degree)	RAW VALUE (dBuV)	CORRECTION FACTOR (dB/m)
1	5150.00	69.5 PK	74.0	-4.5	1.48 V	239	68.86	0.64
2	5150.00	52.8 AV	54.0	-1.2	1.48 V	239	52.16	0.64
3	*5180.00	108.7 PK			1.48 V	239	107.97	0.73
4	*5180.00	97.1 AV			1.48 V	239	96.37	0.73
5	#10360.00	67.1 PK	74.0	-6.9	2.30 V	360	56.35	10.75
6	#10360.00	52.3 AV	54.0	-1.7	2.30 V	360	41.55	10.75
7	15540.00	50.4 PK	74.0	-23.6	1.50 V	19	37.25	13.15
8	15540.00	38.8 AV	54.0	-15.2	1.50 V	19	25.65	13.15

REMARKS:

- Emission Level(dBuV/m) = Raw Value(dBuV) + Correction Factor(dB/m)
- Correction Factor(dB/m) = Antenna Factor(dB/m) + Cable Factor(dB) – Pre-Amplifier Factor(dB)
- The other emission levels were very low against the limit.
- Margin value = Emission Level – Limit value
- " * ": Fundamental frequency.
- " # ": The radiated frequency is out of the restricted band.

CHANNEL	TX Channel 40	DETECTOR FUNCTION	Peak (PK)
FREQUENCY RANGE	1GHz ~ 40GHz		Average (AV)

ANTENNA POLARITY & TEST DISTANCE: HORIZONTAL AT 3 M

NO.	FREQ. (MHz)	EMISSION LEVEL (dBuV/m)	LIMIT (dBuV/m)	MARGIN (dB)	ANTENNA HEIGHT (m)	TABLE ANGLE (Degree)	RAW VALUE (dBuV)	CORRECTION FACTOR (dB/m)
1	5150.00	56.7 PK	74.0	-17.3	1.51 H	85	56.06	0.64
2	5150.00	40.8 AV	54.0	-13.2	1.51 H	85	40.16	0.64
3	*5200.00	108.3 PK			1.51 H	85	107.51	0.79
4	*5200.00	96.7 AV			1.51 H	85	95.91	0.79
5	#10400.00	68.6 PK	74.0	-5.4	1.83 H	279	57.50	11.10
6	#10400.00	53.4 AV	54.0	-0.6	1.83 H	279	42.30	11.10
7	15600.00	53.9 PK	74.0	-20.1	1.65 H	275	40.68	13.22
8	15600.00	40.7 AV	54.0	-13.3	1.65 H	275	27.48	13.22

ANTENNA POLARITY & TEST DISTANCE: VERTICAL AT 3 M

NO.	FREQ. (MHz)	EMISSION LEVEL (dBuV/m)	LIMIT (dBuV/m)	MARGIN (dB)	ANTENNA HEIGHT (m)	TABLE ANGLE (Degree)	RAW VALUE (dBuV)	CORRECTION FACTOR (dB/m)
1	5150.00	57.4 PK	74.0	-16.6	1.68 V	88	56.76	0.64
2	5150.00	41.9 AV	54.0	-12.1	1.68 V	88	41.26	0.64
3	*5200.00	110.4 PK			1.68 V	88	109.61	0.79
4	*5200.00	97.0 AV			1.68 V	88	96.21	0.79
5	#10400.00	67.8 PK	74.0	-6.2	1.01 V	242	56.70	11.10
6	#10400.00	52.1 AV	54.0	-1.9	1.01 V	242	41.00	11.10
7	15600.00	50.1 PK	74.0	-23.9	1.53 V	29	36.88	13.22
8	15600.00	38.4 AV	54.0	-15.6	1.53 V	29	25.18	13.22

REMARKS:

1. Emission Level(dBuV/m) = Raw Value(dBuV) + Correction Factor(dB/m)
2. Correction Factor(dB/m) = Antenna Factor(dB/m) + Cable Factor(dB) – Pre-Amplifier Factor(dB)
3. The other emission levels were very low against the limit.
4. Margin value = Emission Level – Limit value
5. " * ": Fundamental frequency.
6. " # ": The radiated frequency is out of the restricted band.

CHANNEL	TX Channel 48	DETECTOR FUNCTION	Peak (PK)
FREQUENCY RANGE	1GHz ~ 40GHz		Average (AV)

ANTENNA POLARITY & TEST DISTANCE: HORIZONTAL AT 3 M

NO.	FREQ. (MHz)	EMISSION LEVEL (dBuV/m)	LIMIT (dBuV/m)	MARGIN (dB)	ANTENNA HEIGHT (m)	TABLE ANGLE (Degree)	RAW VALUE (dBuV)	CORRECTION FACTOR (dB/m)
1	*5240.00	107.0 PK			1.47 H	86	106.08	0.92
2	*5240.00	95.6 AV			1.47 H	86	94.68	0.92
3	#10480.00	61.7 PK	74.0	-12.3	1.43 H	360	50.76	10.94
4	#10480.00	48.4 AV	54.0	-5.6	1.43 H	360	37.46	10.94
5	15720.00	54.1 PK	74.0	-19.9	1.61 H	267	41.57	12.53
6	15720.00	40.6 AV	54.0	-13.4	1.61 H	267	28.07	12.53

ANTENNA POLARITY & TEST DISTANCE: VERTICAL AT 3 M

NO.	FREQ. (MHz)	EMISSION LEVEL (dBuV/m)	LIMIT (dBuV/m)	MARGIN (dB)	ANTENNA HEIGHT (m)	TABLE ANGLE (Degree)	RAW VALUE (dBuV)	CORRECTION FACTOR (dB/m)
1	*5240.00	108.1 PK			1.89 V	242	107.18	0.92
2	*5240.00	96.0 AV			1.89 V	242	95.08	0.92
3	#10480.00	68.5 PK	74.0	-5.5	2.21 V	360	57.56	10.94
4	#10480.00	53.4 AV	54.0	-0.6	2.21 V	360	42.46	10.94
5	15720.00	49.5 PK	74.0	-24.5	1.48 V	37	36.97	12.53
6	15720.00	38.1 AV	54.0	-15.9	1.48 V	37	25.57	12.53

REMARKS:

1. Emission Level(dBuV/m) = Raw Value(dBuV) + Correction Factor(dB/m)
2. Correction Factor(dB/m) = Antenna Factor(dB/m) + Cable Factor(dB) – Pre-Amplifier Factor(dB)
3. The other emission levels were very low against the limit.
4. Margin value = Emission Level – Limit value
5. " * ": Fundamental frequency.
6. " # ": The radiated frequency is out of the restricted band.

CHANNEL	TX Channel 52	DETECTOR FUNCTION	Peak (PK)
FREQUENCY RANGE	1GHz ~ 40GHz		Average (AV)

ANTENNA POLARITY & TEST DISTANCE: HORIZONTAL AT 3 M

NO.	FREQ. (MHz)	EMISSION LEVEL (dBuV/m)	LIMIT (dBuV/m)	MARGIN (dB)	ANTENNA HEIGHT (m)	TABLE ANGLE (Degree)	RAW VALUE (dBuV)	CORRECTION FACTOR (dB/m)
1	*5260.00	107.1 PK			1.49 H	90	106.09	1.01
2	*5260.00	95.9 AV			1.49 H	90	94.89	1.01
3	#10520.00	62.9 PK	74.0	-11.1	1.55 H	180	51.91	10.99
4	#10520.00	49.2 AV	54.0	-4.8	1.55 H	180	38.21	10.99
5	15780.00	54.3 PK	74.0	-19.7	1.66 H	264	41.89	12.41
6	15780.00	40.6 AV	54.0	-13.4	1.66 H	264	28.19	12.41

ANTENNA POLARITY & TEST DISTANCE: VERTICAL AT 3 M

NO.	FREQ. (MHz)	EMISSION LEVEL (dBuV/m)	LIMIT (dBuV/m)	MARGIN (dB)	ANTENNA HEIGHT (m)	TABLE ANGLE (Degree)	RAW VALUE (dBuV)	CORRECTION FACTOR (dB/m)
1	*5260.00	108.6 PK			1.42 V	251	107.59	1.01
2	*5260.00	96.2 AV			1.42 V	251	95.19	1.01
3	#10520.00	68.5 PK	74.0	-5.5	2.32 V	21	57.51	10.99
4	#10520.00	53.6 AV	54.0	-0.4	2.32 V	21	42.61	10.99
5	15780.00	49.0 PK	74.0	-25.0	1.43 V	42	36.59	12.41
6	15780.00	37.7 AV	54.0	-16.3	1.43 V	42	25.29	12.41

REMARKS:

1. Emission Level(dBuV/m) = Raw Value(dBuV) + Correction Factor(dB/m)
2. Correction Factor(dB/m) = Antenna Factor(dB/m) + Cable Factor(dB) – Pre-Amplifier Factor(dB)
3. The other emission levels were very low against the limit.
4. Margin value = Emission Level – Limit value
5. " * ": Fundamental frequency.
6. " # ": The radiated frequency is out of the restricted band.



CHANNEL	TX Channel 60	DETECTOR FUNCTION	Peak (PK)
FREQUENCY RANGE	1GHz ~ 40GHz		Average (AV)

ANTENNA POLARITY & TEST DISTANCE: HORIZONTAL AT 3 M

NO.	FREQ. (MHz)	EMISSION LEVEL (dBuV/m)	LIMIT (dBuV/m)	MARGIN (dB)	ANTENNA HEIGHT (m)	TABLE ANGLE (Degree)	RAW VALUE (dBuV)	CORRECTION FACTOR (dB/m)
1	*5300.00	106.7 PK			1.54 H	76	105.56	1.14
2	*5300.00	95.3 AV			1.54 H	76	94.16	1.14
3	10600.00	63.1 PK	74.0	-10.9	1.50 H	184	51.76	11.34
4	10600.00	49.4 AV	54.0	-4.6	1.50 H	184	38.06	11.34
5	15900.00	54.3 PK	74.0	-19.7	1.70 H	249	41.80	12.50
6	15900.00	40.7 AV	54.0	-13.3	1.70 H	249	28.20	12.50

ANTENNA POLARITY & TEST DISTANCE: VERTICAL AT 3 M

NO.	FREQ. (MHz)	EMISSION LEVEL (dBuV/m)	LIMIT (dBuV/m)	MARGIN (dB)	ANTENNA HEIGHT (m)	TABLE ANGLE (Degree)	RAW VALUE (dBuV)	CORRECTION FACTOR (dB/m)
1	*5300.00	107.6 PK			1.44 V	250	106.46	1.14
2	*5300.00	95.7 AV			1.44 V	250	94.56	1.14
3	10600.00	68.9 PK	74.0	-5.1	2.32 V	22	57.56	11.34
4	10600.00	53.1 AV	54.0	-0.9	2.32 V	22	41.76	11.34
5	15900.00	48.8 PK	74.0	-25.2	1.45 V	41	36.30	12.50
6	15900.00	37.4 AV	54.0	-16.6	1.45 V	41	24.90	12.50

REMARKS:

1. Emission Level(dBuV/m) = Raw Value(dBuV) + Correction Factor(dB/m)
2. Correction Factor(dB/m) = Antenna Factor(dB/m) + Cable Factor(dB) – Pre-Amplifier Factor(dB)
3. The other emission levels were very low against the limit.
4. Margin value = Emission Level – Limit value
5. " * ": Fundamental frequency.



CHANNEL	TX Channel 64	DETECTOR FUNCTION	Peak (PK)
FREQUENCY RANGE	1GHz ~ 40GHz		Average (AV)

ANTENNA POLARITY & TEST DISTANCE: HORIZONTAL AT 3 M

NO.	FREQ. (MHz)	EMISSION LEVEL (dBuV/m)	LIMIT (dBuV/m)	MARGIN (dB)	ANTENNA HEIGHT (m)	TABLE ANGLE (Degree)	RAW VALUE (dBuV)	CORRECTION FACTOR (dB/m)
1	*5320.00	110.5 PK			1.63 H	136	109.34	1.16
2	*5320.00	98.5 AV			1.63 H	136	97.34	1.16
3	5350.00	67.8 PK	74.0	-6.2	1.63 H	136	66.62	1.18
4	5350.00	51.7 AV	54.0	-2.3	1.63 H	136	50.52	1.18
5	10640.00	65.8 PK	74.0	-8.2	1.79 H	291	54.45	11.35
6	10640.00	51.7 AV	54.0	-2.3	1.79 H	291	40.35	11.35
7	15960.00	54.1 PK	74.0	-19.9	1.67 H	251	41.69	12.41
8	15960.00	40.6 AV	54.0	-13.4	1.67 H	251	28.19	12.41

ANTENNA POLARITY & TEST DISTANCE: VERTICAL AT 3 M

NO.	FREQ. (MHz)	EMISSION LEVEL (dBuV/m)	LIMIT (dBuV/m)	MARGIN (dB)	ANTENNA HEIGHT (m)	TABLE ANGLE (Degree)	RAW VALUE (dBuV)	CORRECTION FACTOR (dB/m)
1	*5320.00	109.2 PK			1.56 V	242	108.04	1.16
2	*5320.00	97.8 AV			1.56 V	242	96.64	1.16
3	5350.00	67.1 PK	74.0	-6.9	1.56 V	242	65.92	1.18
4	5350.00	51.2 AV	54.0	-2.8	1.56 V	242	50.02	1.18
5	10640.00	67.0 PK	74.0	-7.0	2.14 V	360	55.65	11.35
6	10640.00	52.9 AV	54.0	-1.1	2.14 V	360	41.55	11.35
7	15960.00	48.5 PK	74.0	-25.5	1.42 V	28	36.09	12.41
8	15960.00	37.1 AV	54.0	-16.9	1.42 V	28	24.69	12.41

REMARKS:

1. Emission Level(dBuV/m) = Raw Value(dBuV) + Correction Factor(dB/m)
2. Correction Factor(dB/m) = Antenna Factor(dB/m) + Cable Factor(dB) – Pre-Amplifier Factor(dB)
3. The other emission levels were very low against the limit.
4. Margin value = Emission Level – Limit value
5. " * ": Fundamental frequency.



CHANNEL	TX Channel 100	DETECTOR FUNCTION	Peak (PK)
FREQUENCY RANGE	1GHz ~ 40GHz		Average (AV)

ANTENNA POLARITY & TEST DISTANCE: HORIZONTAL AT 3 M

NO.	FREQ. (MHz)	EMISSION LEVEL (dBuV/m)	LIMIT (dBuV/m)	MARGIN (dB)	ANTENNA HEIGHT (m)	TABLE ANGLE (Degree)	RAW VALUE (dBuV)	CORRECTION FACTOR (dB/m)
1	#5470.00	67.6 PK	74.0	-6.4	1.54 H	92	66.23	1.37
2	#5470.00	50.8 AV	54.0	-3.2	1.54 H	92	49.43	1.37
3	*5500.00	110.6 PK			1.54 H	92	109.16	1.44
4	*5500.00	98.3 AV			1.54 H	92	96.86	1.44
5	11000.00	57.0 PK	74.0	-17.0	1.85 H	295	44.47	12.53
6	11000.00	42.8 AV	54.0	-11.2	1.85 H	295	30.27	12.53
7	#16500.00	54.9 PK	74.0	-19.1	1.66 H	239	39.45	15.45
8	#16500.00	41.1 AV	54.0	-12.9	1.66 H	239	25.65	15.45

ANTENNA POLARITY & TEST DISTANCE: VERTICAL AT 3 M

NO.	FREQ. (MHz)	EMISSION LEVEL (dBuV/m)	LIMIT (dBuV/m)	MARGIN (dB)	ANTENNA HEIGHT (m)	TABLE ANGLE (Degree)	RAW VALUE (dBuV)	CORRECTION FACTOR (dB/m)
1	#5470.00	68.4 PK	74.0	-5.6	1.69 V	230	67.03	1.37
2	#5470.00	51.2 AV	54.0	-2.8	1.69 V	230	49.83	1.37
3	*5500.00	109.2 PK			1.69 V	230	107.76	1.44
4	*5500.00	97.9 AV			1.69 V	230	96.46	1.44
5	11000.00	58.1 PK	74.0	-15.9	1.56 V	203	45.57	12.53
6	11000.00	44.0 AV	54.0	-10.0	1.56 V	203	31.47	12.53
7	#16500.00	48.1 PK	74.0	-25.9	1.40 V	28	32.65	15.45
8	#16500.00	36.9 AV	54.0	-17.1	1.40 V	28	21.45	15.45

REMARKS:

1. Emission Level(dBuV/m) = Raw Value(dBuV) + Correction Factor(dB/m)
2. Correction Factor(dB/m) = Antenna Factor(dB/m) + Cable Factor(dB) – Pre-Amplifier Factor(dB)
3. The other emission levels were very low against the limit.
4. Margin value = Emission Level – Limit value
5. " * ": Fundamental frequency.
6. " # ": The radiated frequency is out of the restricted band.

CHANNEL	TX Channel 116	DETECTOR FUNCTION	Peak (PK)
FREQUENCY RANGE	1GHz ~ 40GHz		Average (AV)

ANTENNA POLARITY & TEST DISTANCE: HORIZONTAL AT 3 M

NO.	FREQ. (MHz)	EMISSION LEVEL (dBuV/m)	LIMIT (dBuV/m)	MARGIN (dB)	ANTENNA HEIGHT (m)	TABLE ANGLE (Degree)	RAW VALUE (dBuV)	CORRECTION FACTOR (dB/m)
1	*5580.00	109.8 PK			1.50 H	106	108.28	1.52
2	*5580.00	99.1 AV			1.50 H	106	97.58	1.52
3	11160.00	66.3 PK	74.0	-7.7	2.16 H	296	53.91	12.39
4	11160.00	50.9 AV	54.0	-3.1	2.16 H	296	38.51	12.39
5	#16740.00	55.2 PK	74.0	-18.8	1.61 H	240	39.12	16.08
6	#16740.00	41.6 AV	54.0	-12.4	1.61 H	240	25.52	16.08

ANTENNA POLARITY & TEST DISTANCE: VERTICAL AT 3 M

NO.	FREQ. (MHz)	EMISSION LEVEL (dBuV/m)	LIMIT (dBuV/m)	MARGIN (dB)	ANTENNA HEIGHT (m)	TABLE ANGLE (Degree)	RAW VALUE (dBuV)	CORRECTION FACTOR (dB/m)
1	*5580.00	109.4 PK			1.95 V	231	107.88	1.52
2	*5580.00	97.6 AV			1.95 V	231	96.08	1.52
3	11160.00	62.8 PK	74.0	-11.2	2.14 V	35	50.41	12.39
4	11160.00	49.1 AV	54.0	-4.9	2.14 V	35	36.71	12.39
5	#16740.00	48.6 PK	74.0	-25.4	1.41 V	35	32.52	16.08
6	#16740.00	37.3 AV	54.0	-16.7	1.41 V	35	21.22	16.08

REMARKS:

1. Emission Level(dBuV/m) = Raw Value(dBuV) + Correction Factor(dB/m)
2. Correction Factor(dB/m) = Antenna Factor(dB/m) + Cable Factor(dB) – Pre-Amplifier Factor(dB)
3. The other emission levels were very low against the limit.
4. Margin value = Emission Level – Limit value
5. " * ": Fundamental frequency.
6. " # ": The radiated frequency is out of the restricted band.

CHANNEL	TX Channel 140	DETECTOR FUNCTION	Peak (PK)
FREQUENCY RANGE	1GHz ~ 40GHz		Average (AV)

ANTENNA POLARITY & TEST DISTANCE: HORIZONTAL AT 3 M

NO.	FREQ. (MHz)	EMISSION LEVEL (dBuV/m)	LIMIT (dBuV/m)	MARGIN (dB)	ANTENNA HEIGHT (m)	TABLE ANGLE (Degree)	RAW VALUE (dBuV)	CORRECTION FACTOR (dB/m)
1	*5700.00	109.3 PK			1.47 H	86	107.65	1.65
2	*5700.00	97.2 AV			1.47 H	86	95.55	1.65
3	#5725.00	70.0 PK	74.0	-4.0	1.47 H	86	68.32	1.68
4	#5725.00	53.1 AV	54.0	-0.9	1.47 H	86	51.42	1.68
5	11400.00	54.6 PK	74.0	-19.4	1.80 H	286	42.03	12.57
6	11400.00	40.7 AV	54.0	-13.3	1.80 H	286	28.13	12.57
7	#17100.00	55.3 PK	74.0	-18.7	1.67 H	245	38.00	17.30
8	#17100.00	41.6 AV	54.0	-12.4	1.67 H	245	24.30	17.30

ANTENNA POLARITY & TEST DISTANCE: VERTICAL AT 3 M

NO.	FREQ. (MHz)	EMISSION LEVEL (dBuV/m)	LIMIT (dBuV/m)	MARGIN (dB)	ANTENNA HEIGHT (m)	TABLE ANGLE (Degree)	RAW VALUE (dBuV)	CORRECTION FACTOR (dB/m)
1	*5700.00	106.3 PK			1.76 V	152	104.65	1.65
2	*5700.00	95.2 AV			1.76 V	152	93.55	1.65
3	#5725.00	68.1 PK	74.0	-5.9	1.76 V	152	66.42	1.68
4	#5725.00	51.4 AV	54.0	-2.6	1.76 V	152	49.72	1.68
5	11400.00	56.5 PK	74.0	-17.5	1.56 V	210	43.93	12.57
6	11400.00	42.5 AV	54.0	-11.5	1.56 V	210	29.93	12.57
7	#17100.00	48.0 PK	74.0	-26.0	1.41 V	50	30.70	17.30
8	#17100.00	36.8 AV	54.0	-17.2	1.41 V	50	19.50	17.30

REMARKS:

1. Emission Level(dBuV/m) = Raw Value(dBuV) + Correction Factor(dB/m)
2. Correction Factor(dB/m) = Antenna Factor(dB/m) + Cable Factor(dB) – Pre-Amplifier Factor(dB)
3. The other emission levels were very low against the limit.
4. Margin value = Emission Level – Limit value
5. " * ": Fundamental frequency.
6. " # ": The radiated frequency is out of the restricted band.

CHANNEL	TX Channel 149	DETECTOR FUNCTION	Peak (PK)
FREQUENCY RANGE	1GHz ~ 40GHz		Average (AV)

ANTENNA POLARITY & TEST DISTANCE: HORIZONTAL AT 3 M

NO.	FREQ. (MHz)	EMISSION LEVEL (dBuV/m)	LIMIT (dBuV/m)	MARGIN (dB)	ANTENNA HEIGHT (m)	TABLE ANGLE (Degree)	RAW VALUE (dBuV)	CORRECTION FACTOR (dB/m)
1	#5715.00	53.2 PK	74.0	-20.8	1.64 H	95	51.53	1.67
2	#5715.00	40.1 AV	54.0	-13.9	1.64 H	95	38.43	1.67
3	#5725.00	75.6 PK	78.2	-2.6	1.64 H	95	73.92	1.68
4	*5745.00	108.2 PK			1.64 H	95	106.49	1.71
5	*5745.00	95.5 AV			1.64 H	95	93.79	1.71
6	11490.00	54.6 PK	74.0	-19.4	1.82 H	287	42.00	12.60
7	11490.00	40.7 AV	54.0	-13.3	1.82 H	287	28.10	12.60
8	#17235.00	55.5 PK	74.0	-18.5	1.63 H	239	37.95	17.55
9	#17235.00	42.0 AV	54.0	-12.0	1.63 H	239	24.45	17.55

ANTENNA POLARITY & TEST DISTANCE: VERTICAL AT 3 M

NO.	FREQ. (MHz)	EMISSION LEVEL (dBuV/m)	LIMIT (dBuV/m)	MARGIN (dB)	ANTENNA HEIGHT (m)	TABLE ANGLE (Degree)	RAW VALUE (dBuV)	CORRECTION FACTOR (dB/m)
1	#5715.00	53.6 PK	74.0	-20.4	1.57 V	228	51.93	1.67
2	#5715.00	40.2 AV	54.0	-13.8	1.57 V	228	38.53	1.67
3	#5725.00	74.8 PK	78.2	-3.4	1.57 V	228	73.12	1.68
4	*5745.00	104.8 PK			1.57 V	228	103.09	1.71
5	*5745.00	93.4 AV			1.57 V	228	91.69	1.71
6	11490.00	56.7 PK	74.0	-17.3	1.60 V	224	44.10	12.60
7	11490.00	42.6 AV	54.0	-11.4	1.60 V	224	30.00	12.60
8	#17235.00	48.3 PK	74.0	-25.7	1.38 V	38	30.75	17.55
9	#17235.00	37.2 AV	54.0	-16.8	1.38 V	38	19.65	17.55

REMARKS:

1. Emission Level(dBuV/m) = Raw Value(dBuV) + Correction Factor(dB/m)
2. Correction Factor(dB/m) = Antenna Factor(dB/m) + Cable Factor(dB) – Pre-Amplifier Factor(dB)
3. The other emission levels were very low against the limit.
4. Margin value = Emission Level – Limit value
5. " * ": Fundamental frequency.
6. " # ": The radiated frequency is out of the restricted band.

CHANNEL	TX Channel 157	DETECTOR FUNCTION	Peak (PK)
FREQUENCY RANGE	1GHz ~ 40GHz		Average (AV)

ANTENNA POLARITY & TEST DISTANCE: HORIZONTAL AT 3 M

NO.	FREQ. (MHz)	EMISSION LEVEL (dBuV/m)	LIMIT (dBuV/m)	MARGIN (dB)	ANTENNA HEIGHT (m)	TABLE ANGLE (Degree)	RAW VALUE (dBuV)	CORRECTION FACTOR (dB/m)
1	*5785.00	111.4 PK			1.68 H	111	109.64	1.76
2	*5785.00	99.3 AV			1.68 H	111	97.54	1.76
3	11570.00	68.3 PK	74.0	-5.7	2.16 H	305	55.96	12.34
4	11570.00	52.7 AV	54.0	-1.3	2.16 H	305	40.36	12.34
5	#17355.00	55.6 PK	74.0	-18.4	1.63 H	229	37.43	18.17
6	#17355.00	42.2 AV	54.0	-11.8	1.63 H	229	24.03	18.17

ANTENNA POLARITY & TEST DISTANCE: VERTICAL AT 3 M

NO.	FREQ. (MHz)	EMISSION LEVEL (dBuV/m)	LIMIT (dBuV/m)	MARGIN (dB)	ANTENNA HEIGHT (m)	TABLE ANGLE (Degree)	RAW VALUE (dBuV)	CORRECTION FACTOR (dB/m)
1	*5785.00	109.5 PK			1.50 V	151	107.74	1.76
2	*5785.00	97.2 AV			1.50 V	151	95.44	1.76
3	11570.00	63.8 PK	74.0	-10.2	1.83 V	343	51.46	12.34
4	11570.00	50.1 AV	54.0	-3.9	1.83 V	343	37.76	12.34
5	#17355.00	48.6 PK	74.0	-25.4	1.42 V	31	30.43	18.17
6	#17355.00	37.7 AV	54.0	-16.3	1.42 V	31	19.53	18.17

REMARKS:

1. Emission Level(dBuV/m) = Raw Value(dBuV) + Correction Factor(dB/m)
2. Correction Factor(dB/m) = Antenna Factor(dB/m) + Cable Factor(dB) – Pre-Amplifier Factor(dB)
3. The other emission levels were very low against the limit.
4. Margin value = Emission Level – Limit value
5. " * ": Fundamental frequency.
6. " # ": The radiated frequency is out of the restricted band.

CHANNEL	TX Channel 165	DETECTOR FUNCTION	Peak (PK)
FREQUENCY RANGE	1GHz ~ 40GHz		Average (AV)

ANTENNA POLARITY & TEST DISTANCE: HORIZONTAL AT 3 M

NO.	FREQ. (MHz)	EMISSION LEVEL (dBuV/m)	LIMIT (dBuV/m)	MARGIN (dB)	ANTENNA HEIGHT (m)	TABLE ANGLE (Degree)	RAW VALUE (dBuV)	CORRECTION FACTOR (dB/m)
1	*5825.00	109.4 PK			1.38 H	113	107.62	1.78
2	*5825.00	97.4 AV			1.38 H	113	95.62	1.78
3	#5850.00	78.1 PK	78.2	-0.1	1.38 H	113	76.33	1.77
4	#5860.00	64.6 PK	74.0	-9.4	1.38 H	113	62.83	1.77
5	#5860.00	48.7 AV	54.0	-5.3	1.38 H	113	46.93	1.77
6	11650.00	61.5 PK	74.0	-12.5	1.79 H	321	49.34	12.16
7	11650.00	47.8 AV	54.0	-6.2	1.79 H	321	35.64	12.16
8	#17475.00	55.6 PK	74.0	-18.4	1.66 H	238	36.86	18.74
9	#17475.00	41.9 AV	54.0	-12.1	1.66 H	238	23.16	18.74

ANTENNA POLARITY & TEST DISTANCE: VERTICAL AT 3 M

NO.	FREQ. (MHz)	EMISSION LEVEL (dBuV/m)	LIMIT (dBuV/m)	MARGIN (dB)	ANTENNA HEIGHT (m)	TABLE ANGLE (Degree)	RAW VALUE (dBuV)	CORRECTION FACTOR (dB/m)
1	*5825.00	108.3 PK			1.87 V	155	106.52	1.78
2	*5825.00	96.3 AV			1.87 V	155	94.52	1.78
3	#5850.00	78.0 PK	78.2	-0.2	1.87 V	155	76.23	1.77
4	#5860.00	65.3 PK	74.0	-8.7	1.87 V	155	63.53	1.77
5	#5860.00	49.4 AV	54.0	-4.6	1.87 V	155	47.63	1.77
6	11650.00	57.8 PK	74.0	-16.2	1.60 V	193	45.64	12.16
7	11650.00	43.8 AV	54.0	-10.2	1.60 V	193	31.64	12.16
8	#17475.00	48.8 PK	74.0	-25.2	1.39 V	21	30.06	18.74
9	#17475.00	37.3 AV	54.0	-16.7	1.39 V	21	18.56	18.74

REMARKS:

1. Emission Level(dBuV/m) = Raw Value(dBuV) + Correction Factor(dB/m)
2. Correction Factor(dB/m) = Antenna Factor(dB/m) + Cable Factor(dB) – Pre-Amplifier Factor(dB)
3. The other emission levels were very low against the limit.
4. Margin value = Emission Level – Limit value
5. " * ": Fundamental frequency.
6. " # ": The radiated frequency is out of the restricted band.

802.11n (HT40)

CHANNEL	TX Channel 38	DETECTOR FUNCTION	Peak (PK)
FREQUENCY RANGE	1GHz ~ 40GHz		Average (AV)

ANTENNA POLARITY & TEST DISTANCE: HORIZONTAL AT 3 M

NO.	FREQ. (MHz)	EMISSION LEVEL (dBuV/m)	LIMIT (dBuV/m)	MARGIN (dB)	ANTENNA HEIGHT (m)	TABLE ANGLE (Degree)	RAW VALUE (dBuV)	CORRECTION FACTOR (dB/m)
1	5150.00	66.5 PK	74.0	-7.5	2.04 H	239	65.86	0.64
2	5150.00	52.2 AV	54.0	-1.8	2.04 H	239	51.56	0.64
3	*5190.00	106.3 PK			2.04 H	239	105.55	0.75
4	*5190.00	93.3 AV			2.04 H	239	92.55	0.75
5	#10380.00	54.5 PK	74.0	-19.5	1.77 H	300	43.57	10.93
6	#10380.00	40.5 AV	54.0	-13.5	1.77 H	300	29.57	10.93
7	15570.00	55.2 PK	74.0	-18.8	1.66 H	237	42.01	13.19
8	15570.00	41.9 AV	54.0	-12.1	1.66 H	237	28.71	13.19

ANTENNA POLARITY & TEST DISTANCE: VERTICAL AT 3 M

NO.	FREQ. (MHz)	EMISSION LEVEL (dBuV/m)	LIMIT (dBuV/m)	MARGIN (dB)	ANTENNA HEIGHT (m)	TABLE ANGLE (Degree)	RAW VALUE (dBuV)	CORRECTION FACTOR (dB/m)
1	5150.00	64.2 PK	74.0	-9.8	1.46 V	262	63.56	0.64
2	5150.00	49.3 AV	54.0	-4.7	1.46 V	262	48.66	0.64
3	*5190.00	106.0 PK			1.46 V	262	105.25	0.75
4	*5190.00	92.6 AV			1.46 V	262	91.85	0.75
5	#10380.00	57.0 PK	74.0	-17.0	1.58 V	236	46.07	10.93
6	#10380.00	43.0 AV	54.0	-11.0	1.58 V	236	32.07	10.93
7	15570.00	48.0 PK	74.0	-26.0	1.39 V	44	34.81	13.19
8	15570.00	37.0 AV	54.0	-17.0	1.39 V	44	23.81	13.19

REMARKS:

- Emission Level(dBuV/m) = Raw Value(dBuV) + Correction Factor(dB/m)
- Correction Factor(dB/m) = Antenna Factor(dB/m) + Cable Factor(dB) – Pre-Amplifier Factor(dB)
- The other emission levels were very low against the limit.
- Margin value = Emission Level – Limit value
- " * ": Fundamental frequency.
- " # ": The radiated frequency is out of the restricted band.

CHANNEL	TX Channel 46	DETECTOR FUNCTION	Peak (PK)
FREQUENCY RANGE	1GHz ~ 40GHz		Average (AV)

ANTENNA POLARITY & TEST DISTANCE: HORIZONTAL AT 3 M

NO.	FREQ. (MHz)	EMISSION LEVEL (dBuV/m)	LIMIT (dBuV/m)	MARGIN (dB)	ANTENNA HEIGHT (m)	TABLE ANGLE (Degree)	RAW VALUE (dBuV)	CORRECTION FACTOR (dB/m)
1	5150.00	67.6 PK	74.0	-6.4	2.17 H	219	66.96	0.64
2	5150.00	52.1 AV	54.0	-1.9	2.17 H	219	51.46	0.64
3	*5230.00	112.0 PK			2.17 H	219	111.10	0.90
4	*5230.00	97.9 AV			2.17 H	219	97.00	0.90
5	#10460.00	62.7 PK	74.0	-11.3	1.64 H	347	51.73	10.97
6	#10460.00	50.0 AV	54.0	-4.0	1.64 H	347	39.03	10.97
7	15690.00	55.4 PK	74.0	-18.6	1.70 H	236	42.76	12.64
8	15690.00	42.0 AV	54.0	-12.0	1.70 H	236	29.36	12.64

ANTENNA POLARITY & TEST DISTANCE: VERTICAL AT 3 M

NO.	FREQ. (MHz)	EMISSION LEVEL (dBuV/m)	LIMIT (dBuV/m)	MARGIN (dB)	ANTENNA HEIGHT (m)	TABLE ANGLE (Degree)	RAW VALUE (dBuV)	CORRECTION FACTOR (dB/m)
1	5150.00	65.5 PK	74.0	-8.5	1.73 V	269	64.86	0.64
2	5150.00	49.1 AV	54.0	-4.9	1.73 V	269	48.46	0.64
3	*5230.00	112.6 PK			1.73 V	269	111.70	0.90
4	*5230.00	98.2 AV			1.73 V	269	97.30	0.90
5	#10460.00	66.8 PK	74.0	-7.2	1.86 V	335	55.83	10.97
6	#10460.00	52.9 AV	54.0	-1.1	1.86 V	335	41.93	10.97
7	15690.00	47.7 PK	74.0	-26.3	1.45 V	51	35.06	12.64
8	15690.00	36.7 AV	54.0	-17.3	1.45 V	51	24.06	12.64

REMARKS:

1. Emission Level(dBuV/m) = Raw Value(dBuV) + Correction Factor(dB/m)
2. Correction Factor(dB/m) = Antenna Factor(dB/m) + Cable Factor(dB) – Pre-Amplifier Factor(dB)
3. The other emission levels were very low against the limit.
4. Margin value = Emission Level – Limit value
5. " * ": Fundamental frequency.
6. " # ": The radiated frequency is out of the restricted band.



CHANNEL	TX Channel 54	DETECTOR FUNCTION	Peak (PK)
FREQUENCY RANGE	1GHz ~ 40GHz		Average (AV)

ANTENNA POLARITY & TEST DISTANCE: HORIZONTAL AT 3 M

NO.	FREQ. (MHz)	EMISSION LEVEL (dBuV/m)	LIMIT (dBuV/m)	MARGIN (dB)	ANTENNA HEIGHT (m)	TABLE ANGLE (Degree)	RAW VALUE (dBuV)	CORRECTION FACTOR (dB/m)
1	*5270.00	110.9 PK			2.12 H	263	109.87	1.03
2	*5270.00	96.8 AV			2.12 H	263	95.77	1.03
3	5350.00	66.5 PK	74.0	-7.5	2.12 H	263	65.32	1.18
4	5350.00	51.6 AV	54.0	-2.4	2.12 H	263	50.42	1.18
5	#10540.00	58.2 PK	74.0	-15.8	1.53 H	181	47.12	11.08
6	#10540.00	47.5 AV	54.0	-6.5	1.53 H	181	36.42	11.08
7	15810.00	56.1 PK	74.0	-17.9	1.69 H	251	43.72	12.38
8	15810.00	42.4 AV	54.0	-11.6	1.69 H	251	30.02	12.38

ANTENNA POLARITY & TEST DISTANCE: VERTICAL AT 3 M

NO.	FREQ. (MHz)	EMISSION LEVEL (dBuV/m)	LIMIT (dBuV/m)	MARGIN (dB)	ANTENNA HEIGHT (m)	TABLE ANGLE (Degree)	RAW VALUE (dBuV)	CORRECTION FACTOR (dB/m)
1	*5270.00	112.4 PK			1.75 V	259	111.37	1.03
2	*5270.00	97.7 AV			1.75 V	259	96.67	1.03
3	5350.00	63.7 PK	74.0	-10.3	1.75 V	259	62.52	1.18
4	5350.00	48.5 AV	54.0	-5.5	1.75 V	259	47.32	1.18
5	#10540.00	65.1 PK	74.0	-8.9	2.23 V	343	54.02	11.08
6	#10540.00	51.9 AV	54.0	-2.1	2.23 V	343	40.82	11.08
7	15810.00	47.5 PK	74.0	-26.5	1.42 V	64	35.12	12.38
8	15810.00	36.6 AV	54.0	-17.4	1.42 V	64	24.22	12.38

REMARKS:

1. Emission Level(dBuV/m) = Raw Value(dBuV) + Correction Factor(dB/m)
2. Correction Factor(dB/m) = Antenna Factor(dB/m) + Cable Factor(dB) – Pre-Amplifier Factor(dB)
3. The other emission levels were very low against the limit.
4. Margin value = Emission Level – Limit value
5. " * ": Fundamental frequency.
6. " # ": The radiated frequency is out of the restricted band.

CHANNEL	TX Channel 62	DETECTOR FUNCTION	Peak (PK)
FREQUENCY RANGE	1GHz ~ 40GHz		Average (AV)

ANTENNA POLARITY & TEST DISTANCE: HORIZONTAL AT 3 M

NO.	FREQ. (MHz)	EMISSION LEVEL (dBuV/m)	LIMIT (dBuV/m)	MARGIN (dB)	ANTENNA HEIGHT (m)	TABLE ANGLE (Degree)	RAW VALUE (dBuV)	CORRECTION FACTOR (dB/m)
1	*5310.00	108.2 PK			2.12 H	257	107.05	1.15
2	*5310.00	94.5 AV			2.12 H	257	93.35	1.15
3	5350.00	70.5 PK	74.0	-3.5	2.12 H	257	69.32	1.18
4	5350.00	53.9 AV	54.0	-0.1	2.12 H	257	52.72	1.18
5	10620.00	54.4 PK	74.0	-19.6	1.78 H	291	43.06	11.34
6	10620.00	40.3 AV	54.0	-13.7	1.78 H	291	28.96	11.34
7	15930.00	55.3 PK	74.0	-18.7	1.71 H	235	42.85	12.45
8	15930.00	42.0 AV	54.0	-12.0	1.71 H	235	29.55	12.45

ANTENNA POLARITY & TEST DISTANCE: VERTICAL AT 3 M

NO.	FREQ. (MHz)	EMISSION LEVEL (dBuV/m)	LIMIT (dBuV/m)	MARGIN (dB)	ANTENNA HEIGHT (m)	TABLE ANGLE (Degree)	RAW VALUE (dBuV)	CORRECTION FACTOR (dB/m)
1	*5310.00	107.1 PK			1.44 V	127	105.95	1.15
2	*5310.00	94.0 AV			1.44 V	127	92.85	1.15
3	5350.00	67.9 PK	74.0	-6.1	1.44 V	127	66.72	1.18
4	5350.00	53.8 AV	54.0	-0.2	1.44 V	127	52.62	1.18
5	10620.00	56.8 PK	74.0	-17.2	1.54 V	251	45.46	11.34
6	10620.00	42.8 AV	54.0	-11.2	1.54 V	251	31.46	11.34
7	15930.00	47.5 PK	74.0	-26.5	1.42 V	35	35.05	12.45
8	15930.00	36.8 AV	54.0	-17.2	1.42 V	35	24.35	12.45

REMARKS:

1. Emission Level(dBuV/m) = Raw Value(dBuV) + Correction Factor(dB/m)
2. Correction Factor(dB/m) = Antenna Factor(dB/m) + Cable Factor(dB) – Pre-Amplifier Factor(dB)
3. The other emission levels were very low against the limit.
4. Margin value = Emission Level – Limit value
5. " * ": Fundamental frequency.

CHANNEL	TX Channel 100	DETECTOR FUNCTION	Peak (PK)
FREQUENCY RANGE	1GHz ~ 40GHz		Average (AV)

ANTENNA POLARITY & TEST DISTANCE: HORIZONTAL AT 3 M

NO.	FREQ. (MHz)	EMISSION LEVEL (dBuV/m)	LIMIT (dBuV/m)	MARGIN (dB)	ANTENNA HEIGHT (m)	TABLE ANGLE (Degree)	RAW VALUE (dBuV)	CORRECTION FACTOR (dB/m)
1	#5470.00	69.3 PK	74.0	-4.7	2.12 H	263	67.93	1.37
2	#5470.00	53.1 AV	54.0	-0.9	2.12 H	263	51.73	1.37
3	*5510.00	109.5 PK			2.12 H	263	108.05	1.45
4	*5510.00	95.6 AV			2.12 H	263	94.15	1.45
5	11020.00	53.9 PK	74.0	-20.1	1.73 H	287	41.39	12.51
6	11020.00	39.9 AV	54.0	-14.1	1.73 H	287	27.39	12.51
7	#16530.00	55.4 PK	74.0	-18.6	1.75 H	235	39.83	15.57
8	#16530.00	42.0 AV	54.0	-12.0	1.75 H	235	26.43	15.57

ANTENNA POLARITY & TEST DISTANCE: VERTICAL AT 3 M

NO.	FREQ. (MHz)	EMISSION LEVEL (dBuV/m)	LIMIT (dBuV/m)	MARGIN (dB)	ANTENNA HEIGHT (m)	TABLE ANGLE (Degree)	RAW VALUE (dBuV)	CORRECTION FACTOR (dB/m)
1	#5470.00	66.0 PK	74.0	-8.0	1.51 V	128	64.63	1.37
2	#5470.00	51.8 AV	54.0	-2.2	1.51 V	128	50.43	1.37
3	*5510.00	106.4 PK			1.51 V	128	104.95	1.45
4	*5510.00	94.0 AV			1.51 V	128	92.55	1.45
5	11020.00	56.1 PK	74.0	-17.9	1.59 V	258	43.59	12.51
6	11020.00	42.3 AV	54.0	-11.7	1.59 V	258	29.79	12.51
7	#16530.00	47.3 PK	74.0	-26.7	1.44 V	42	31.73	15.57
8	#16530.00	36.7 AV	54.0	-17.3	1.44 V	42	21.13	15.57

REMARKS:

1. Emission Level(dBuV/m) = Raw Value(dBuV) + Correction Factor(dB/m)
2. Correction Factor(dB/m) = Antenna Factor(dB/m) + Cable Factor(dB) – Pre-Amplifier Factor(dB)
3. The other emission levels were very low against the limit.
4. Margin value = Emission Level – Limit value
5. " * ": Fundamental frequency.
6. " # ": The radiated frequency is out of the restricted band.

CHANNEL	TX Channel 110	DETECTOR FUNCTION	Peak (PK)
FREQUENCY RANGE	1GHz ~ 40GHz		Average (AV)

ANTENNA POLARITY & TEST DISTANCE: HORIZONTAL AT 3 M

NO.	FREQ. (MHz)	EMISSION LEVEL (dBuV/m)	LIMIT (dBuV/m)	MARGIN (dB)	ANTENNA HEIGHT (m)	TABLE ANGLE (Degree)	RAW VALUE (dBuV)	CORRECTION FACTOR (dB/m)
1	#5470.00	67.4 PK	74.0	-6.6	2.20 H	257	66.03	1.37
2	#5470.00	51.9 AV	54.0	-2.1	2.20 H	257	50.53	1.37
3	*5550.00	114.6 PK			2.20 H	257	113.11	1.49
4	*5550.00	101.1 AV			2.20 H	257	99.61	1.49
5	11100.00	56.1 PK	74.0	-17.9	2.32 H	142	43.70	12.40
6	11100.00	42.3 AV	54.0	-11.7	2.32 H	142	29.90	12.40
7	#16650.00	55.0 PK	74.0	-19.0	1.77 H	241	39.07	15.93
8	#16650.00	41.9 AV	54.0	-12.1	1.77 H	241	25.97	15.93

ANTENNA POLARITY & TEST DISTANCE: VERTICAL AT 3 M

NO.	FREQ. (MHz)	EMISSION LEVEL (dBuV/m)	LIMIT (dBuV/m)	MARGIN (dB)	ANTENNA HEIGHT (m)	TABLE ANGLE (Degree)	RAW VALUE (dBuV)	CORRECTION FACTOR (dB/m)
1	#5470.00	66.8 PK	74.0	-7.2	1.62 V	126	65.43	1.37
2	#5470.00	51.3 AV	54.0	-2.7	1.62 V	126	49.93	1.37
3	*5550.00	103.5 PK			1.62 V	126	102.01	1.49
4	*5550.00	99.8 AV			1.62 V	126	98.31	1.49
5	11100.00	59.4 PK	74.0	-14.6	1.54 V	252	47.00	12.40
6	11100.00	44.1 AV	54.0	-9.9	1.54 V	252	31.70	12.40
7	#16650.00	47.2 PK	74.0	-26.8	1.49 V	33	31.27	15.93
8	#16650.00	36.4 AV	54.0	-17.6	1.49 V	33	20.47	15.93

REMARKS:

1. Emission Level(dBuV/m) = Raw Value(dBuV) + Correction Factor(dB/m)
2. Correction Factor(dB/m) = Antenna Factor(dB/m) + Cable Factor(dB) – Pre-Amplifier Factor(dB)
3. The other emission levels were very low against the limit.
4. Margin value = Emission Level – Limit value
5. " * ": Fundamental frequency.
6. " # ": The radiated frequency is out of the restricted band.

CHANNEL	TX Channel 134	DETECTOR FUNCTION	Peak (PK)
FREQUENCY RANGE	1GHz ~ 40GHz		Average (AV)

ANTENNA POLARITY & TEST DISTANCE: HORIZONTAL AT 3 M

NO.	FREQ. (MHz)	EMISSION LEVEL (dBuV/m)	LIMIT (dBuV/m)	MARGIN (dB)	ANTENNA HEIGHT (m)	TABLE ANGLE (Degree)	RAW VALUE (dBuV)	CORRECTION FACTOR (dB/m)
1	*5670.00	114.6 PK			2.04 H	264	112.98	1.62
2	*5670.00	101.3 AV			2.04 H	264	99.68	1.62
3	#5725.00	70.0 PK	74.0	-4.0	2.04 H	264	68.32	1.68
4	#5725.00	53.9 AV	54.0	-0.1	2.04 H	264	52.22	1.68
5	11340.00	61.5 PK	74.0	-12.5	1.76 H	313	48.64	12.86
6	11340.00	47.9 AV	54.0	-6.1	1.76 H	313	35.04	12.86
7	#17010.00	55.6 PK	74.0	-18.4	1.65 H	253	38.60	17.00
8	#17010.00	41.7 AV	54.0	-12.3	1.65 H	253	24.70	17.00

ANTENNA POLARITY & TEST DISTANCE: VERTICAL AT 3 M

NO.	FREQ. (MHz)	EMISSION LEVEL (dBuV/m)	LIMIT (dBuV/m)	MARGIN (dB)	ANTENNA HEIGHT (m)	TABLE ANGLE (Degree)	RAW VALUE (dBuV)	CORRECTION FACTOR (dB/m)
1	*5670.00	111.6 PK			1.11 V	126	109.98	1.62
2	*5670.00	98.6 AV			1.11 V	126	96.98	1.62
3	#5725.00	67.8 PK	74.0	-6.2	1.11 V	126	66.12	1.68
4	#5725.00	51.2 AV	54.0	-2.8	1.11 V	126	49.52	1.68
5	11340.00	57.1 PK	74.0	-16.9	1.65 V	202	44.24	12.86
6	11340.00	43.4 AV	54.0	-10.6	1.65 V	202	30.54	12.86
7	#17010.00	48.7 PK	74.0	-25.3	1.44 V	14	31.70	17.00
8	#17010.00	37.5 AV	54.0	-16.5	1.44 V	14	20.50	17.00

REMARKS:

1. Emission Level(dBuV/m) = Raw Value(dBuV) + Correction Factor(dB/m)
2. Correction Factor(dB/m) = Antenna Factor(dB/m) + Cable Factor(dB) – Pre-Amplifier Factor(dB)
3. The other emission levels were very low against the limit.
4. Margin value = Emission Level – Limit value
5. " * ": Fundamental frequency.
6. " # ": The radiated frequency is out of the restricted band.

CHANNEL	TX Channel 151	DETECTOR FUNCTION	Peak (PK)
FREQUENCY RANGE	1GHz ~ 40GHz		Average (AV)

ANTENNA POLARITY & TEST DISTANCE: HORIZONTAL AT 3 M

NO.	FREQ. (MHz)	EMISSION LEVEL (dBuV/m)	LIMIT (dBuV/m)	MARGIN (dB)	ANTENNA HEIGHT (m)	TABLE ANGLE (Degree)	RAW VALUE (dBuV)	CORRECTION FACTOR (dB/m)
1	#5715.00	66.8 PK	74.0	-7.2	1.49 H	260	65.13	1.67
2	#5715.00	51.1 AV	54.0	-2.9	1.49 H	260	49.43	1.67
3	#5725.00	72.3 PK	78.2	-5.9	1.49 H	260	70.62	1.68
4	*5755.00	105.9 PK			1.49 H	260	104.18	1.72
5	*5755.00	92.6 AV			1.49 H	260	90.88	1.72
6	11510.00	61.1 PK	74.0	-12.9	1.79 H	315	48.54	12.56
7	11510.00	47.8 AV	54.0	-6.2	1.79 H	315	35.24	12.56
8	#17265.00	55.5 PK	74.0	-18.5	1.61 H	253	37.86	17.64
9	#17265.00	41.9 AV	54.0	-12.1	1.61 H	253	24.26	17.64

ANTENNA POLARITY & TEST DISTANCE: VERTICAL AT 3 M

NO.	FREQ. (MHz)	EMISSION LEVEL (dBuV/m)	LIMIT (dBuV/m)	MARGIN (dB)	ANTENNA HEIGHT (m)	TABLE ANGLE (Degree)	RAW VALUE (dBuV)	CORRECTION FACTOR (dB/m)
1	#5715.00	68.5 PK	74.0	-5.5	1.35 V	127	66.83	1.67
2	#5715.00	52.8 AV	54.0	-1.2	1.35 V	127	51.13	1.67
3	#5725.00	74.5 PK	78.2	-3.7	1.35 V	127	72.82	1.68
4	*5755.00	106.4 PK			1.35 V	127	104.68	1.72
5	*5755.00	93.2 AV			1.35 V	127	91.48	1.72
6	11510.00	57.3 PK	74.0	-16.7	1.60 V	211	44.74	12.56
7	11510.00	43.3 AV	54.0	-10.7	1.60 V	211	30.74	12.56
8	#17265.00	48.5 PK	74.0	-25.5	1.43 V	4	30.86	17.64
9	#17265.00	37.2 AV	54.0	-16.8	1.43 V	4	19.56	17.64

REMARKS:

1. Emission Level(dBuV/m) = Raw Value(dBuV) + Correction Factor(dB/m)
2. Correction Factor(dB/m) = Antenna Factor(dB/m) + Cable Factor(dB) – Pre-Amplifier Factor(dB)
3. The other emission levels were very low against the limit.
4. Margin value = Emission Level – Limit value
5. " * ": Fundamental frequency.
6. " # ": The radiated frequency is out of the restricted band.

CHANNEL	TX Channel 159	DETECTOR FUNCTION	Peak (PK)
FREQUENCY RANGE	1GHz ~ 40GHz		Average (AV)

ANTENNA POLARITY & TEST DISTANCE: HORIZONTAL AT 3 M

NO.	FREQ. (MHz)	EMISSION LEVEL (dBuV/m)	LIMIT (dBuV/m)	MARGIN (dB)	ANTENNA HEIGHT (m)	TABLE ANGLE (Degree)	RAW VALUE (dBuV)	CORRECTION FACTOR (dB/m)
1	#5715.00	58.0 PK	74.0	-16.0	1.00 H	256	56.33	1.67
2	#5715.00	44.1 AV	54.0	-9.9	1.00 H	256	42.43	1.67
3	#5725.00	62.8 PK	78.2	-15.4	1.00 H	256	61.12	1.68
4	*5795.00	111.0 PK			1.00 H	256	109.23	1.77
5	*5795.00	97.2 AV			1.00 H	256	95.43	1.77
6	#5850.00	72.3 PK	78.2	-5.9	1.00 H	256	70.53	1.77
7	#5860.00	67.0 PK	74.0	-7.0	1.00 H	256	65.23	1.77
8	#5860.00	50.6 AV	54.0	-3.4	1.00 H	256	48.83	1.77
9	11590.00	61.7 PK	74.0	-12.3	1.87 H	316	49.44	12.26
10	11590.00	50.2 AV	54.0	-3.8	1.87 H	316	37.94	12.26
11	#17385.00	55.7 PK	74.0	-18.3	1.66 H	255	37.32	18.38
12	#17385.00	42.0 AV	54.0	-12.0	1.66 H	255	23.62	18.38

ANTENNA POLARITY & TEST DISTANCE: VERTICAL AT 3 M

NO.	FREQ. (MHz)	EMISSION LEVEL (dBuV/m)	LIMIT (dBuV/m)	MARGIN (dB)	ANTENNA HEIGHT (m)	TABLE ANGLE (Degree)	RAW VALUE (dBuV)	CORRECTION FACTOR (dB/m)
1	#5715.00	61.1 PK	74.0	-12.9	1.71 V	125	59.43	1.67
2	#5715.00	46.9 AV	54.0	-7.1	1.71 V	125	45.23	1.67
3	#5725.00	67.8 PK	78.2	-10.4	1.71 V	125	66.12	1.68
4	*5795.00	109.4 PK			1.71 V	125	107.63	1.77
5	*5795.00	96.8 AV			1.71 V	125	95.03	1.77
6	#5850.00	71.3 PK	78.2	-6.9	1.71 V	125	69.53	1.77
7	#5860.00	67.8 PK	74.0	-6.2	1.71 V	125	66.03	1.77
8	#5860.00	52.1 AV	54.0	-1.9	1.71 V	125	50.33	1.77
9	11590.00	60.1 PK	74.0	-13.9	1.81 V	329	47.84	12.26
10	11590.00	49.7 AV	54.0	-4.3	1.81 V	329	37.44	12.26
11	#17385.00	48.2 PK	74.0	-25.8	1.45 V	12	29.82	18.38
12	#17385.00	37.2 AV	54.0	-16.8	1.45 V	12	18.82	18.38

REMARKS:

1. Emission Level(dBuV/m) = Raw Value(dBuV) + Correction Factor(dB/m)
2. Correction Factor(dB/m) = Antenna Factor(dB/m) + Cable Factor(dB) – Pre-Amplifier Factor(dB)
3. The other emission levels were very low against the limit.
4. Margin value = Emission Level – Limit value
5. " * ": Fundamental frequency.
6. " # ": The radiated frequency is out of the restricted band.

Below 1GHz Data:
802.11n (HT40)

CHANNEL	TX Channel 54	DETECTOR FUNCTION	Quasi-Peak (QP)
FREQUENCY RANGE	Below 1GHz		

ANTENNA POLARITY & TEST DISTANCE: HORIZONTAL AT 3 M

NO.	FREQ. (MHz)	EMISSION LEVEL (dBuV/m)	LIMIT (dBuV/m)	MARGIN (dB)	ANTENNA HEIGHT (m)	TABLE ANGLE (Degree)	RAW VALUE (dBuV)	CORRECTION FACTOR (dB/m)
1	47.50	31.2 QP	40.0	-8.8	2.90 H	201	40.06	-8.85
2	79.30	36.3 QP	40.0	-3.7	2.10 H	100	49.67	-13.39
3	125.10	36.3 QP	43.5	-7.2	2.10 H	102	46.64	-10.31
4	250.12	39.3 QP	46.0	-6.7	1.10 H	210	49.16	-9.84
5	336.10	42.1 QP	46.0	-3.9	1.10 H	107	48.98	-6.86
6	564.90	35.9 QP	46.0	-10.1	1.10 H	215	37.57	-1.68

ANTENNA POLARITY & TEST DISTANCE: VERTICAL AT 3 M

NO.	FREQ. (MHz)	EMISSION LEVEL (dBuV/m)	LIMIT (dBuV/m)	MARGIN (dB)	ANTENNA HEIGHT (m)	TABLE ANGLE (Degree)	RAW VALUE (dBuV)	CORRECTION FACTOR (dB/m)
1	37.44	33.7 QP	40.0	-6.3	1.10 V	109	43.13	-9.41
2	78.34	35.4 QP	40.0	-4.6	1.10 V	190	48.62	-13.22
3	250.15	35.2 QP	46.0	-10.8	1.10 V	242	45.04	-9.84
4	336.11	33.1 QP	46.0	-12.9	1.40 V	217	39.98	-6.86
5	388.70	41.7 QP	46.0	-4.3	1.49 V	157	47.35	-5.69
6	575.12	32.9 QP	46.0	-13.1	1.40 V	10	34.27	-1.37

REMARKS:

1. Emission Level(dBuV/m) = Raw Value(dBuV) + Correction Factor(dB/m)
2. Correction Factor(dB/m) = Antenna Factor(dB/m) + Cable Factor(dB) – Pre-Amplifier Factor(dB)
3. The other emission levels were very low against the limit.
4. Margin value = Emission Level – Limit value

4.2 Conducted Emission Measurement

4.2.1 Limits of Conducted Emission Measurement

Frequency (MHz)	Conducted Limit (dBuV)	
	Quasi-peak	Average
0.15 - 0.5	66 - 56	56 - 46
0.50 - 5.0	56	46
5.0 - 30.0	60	50

Note: 1. The lower limit shall apply at the transition frequencies.

2. The limit decreases in line with the logarithm of the frequency in the range of 0.15 to 0.50MHz.

4.2.2 Test Instruments

DESCRIPTION & MANUFACTURER	MODEL NO.	SERIAL NO.	CALIBRATED DATE	CALIBRATED UNTIL
Test Receiver R&S	ESCS 30	100375	May 06, 2015	May 05, 2016
Line-Impedance Stabilization Network (for EUT) SCHWARZBECK	NSLK-8127	8127-522	Sep. 01, 2015	Aug. 31, 2016
Line-Impedance Stabilization Network (for Peripheral) R&S	ENV216	100072	June 11, 2015	June 10, 2016
RF Cable	5D-FB	COCCAB-001	Mar. 08, 2016	Mar. 07, 2017
50 ohms Terminator	N/A	EMC-03	Sep. 23, 2015	Sep. 22, 2016
50 ohms Terminator	N/A	EMC-02	Oct. 01, 2015	Sep. 30, 2016
50 ohms Terminator	E1-011315	13	Dec. 11 2015	Dec. 10 2016
Software BVADT	BVADT_Cond_ V7.3.7.3	NA	NA	NA

Note:

1. The calibration interval of the above test instruments are 12 months and the calibrations are traceable to NML/ROC and NIST/USA.
2. The test was performed in Shielded Room No. C.
3. The VCCI Con C Registration No. is C-3611.
4. Tested Date: Mar. 09 to 25, 2016

4.2.3 Test Procedure

- The EUT was placed 0.4 meters from the conducting wall of the shielded room with EUT being connected to the power mains through a line impedance stabilization network (LISN). Other support units were connected to the power mains through another LISN. The two LISNs provide 50 ohm/ 50uH of coupling impedance for the measuring instrument.
- Both lines of the power mains connected to the EUT were checked for maximum conducted interference.
- The frequency range from 150kHz to 30MHz was searched. Emission levels under (Limit - 20dB) was not recorded.

NOTE: All modes of operation were investigated and the worst-case emissions are reported.

4.2.4 Deviation from Test Standard

No deviation.

4.2.5 Test Setup

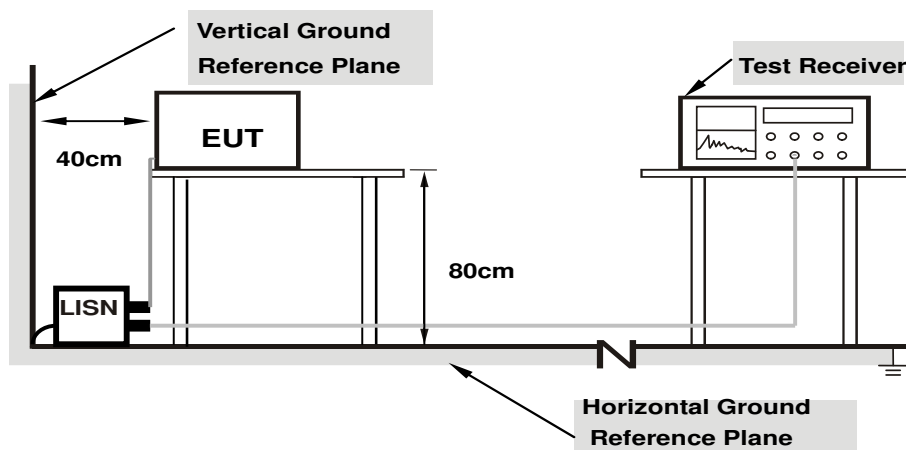

- Note:**
- Support units were connected to second LISN.
 - Both of LISNs (AMN) are 80 cm from EUT and at least 80 from other units and other metal planes

For the actual test configuration, please refer to the attached file (Test Setup Photo).

4.2.6 EUT Operating Condition

Same as 4.1.6.

4.2.7 Test Results (Mode 1)

Phase	Line (L)	Detector Function	Quasi-Peak (QP) / Average (AV)
-------	----------	-------------------	--------------------------------

Phase Of Power : Line (L)										
No	Frequency (MHz)	Correction Factor (dB)	Reading Value (dBuV)		Emission Level (dBuV)		Limit (dBuV)		Margin (dB)	
			Q.P.	AV.	Q.P.	AV.	Q.P.	AV.	Q.P.	AV.
1	0.15000	10.32	31.67	24.48	41.99	34.80	66.00	56.00	-24.01	-21.20
2	0.44297	10.29	21.08	14.20	31.37	24.49	57.01	47.01	-25.63	-22.51
3	0.88828	10.24	14.71	2.75	24.95	12.99	56.00	46.00	-31.05	-33.01
4	2.07813	10.27	17.48	4.40	27.75	14.67	56.00	46.00	-28.25	-31.33
5	15.25000	10.80	25.22	18.27	36.02	29.07	60.00	50.00	-23.98	-20.93
6	17.69141	10.88	25.99	22.69	36.87	33.57	60.00	50.00	-23.13	-16.43

Remarks:

1. Q.P. and AV. are abbreviations of quasi-peak and average individually.
2. The emission levels of other frequencies were very low against the limit.
3. Margin value = Emission level – Limit value
4. Correction factor = Insertion loss + Cable loss
5. Emission Level = Correction Factor + Reading Value

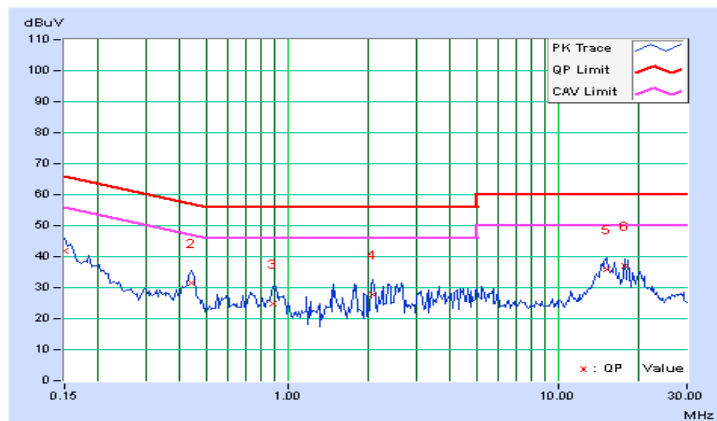

Phase	Neutral (N)	Detector Function	Quasi-Peak (QP) / Average (AV)
-------	-------------	-------------------	--------------------------------

Phase Of Power : Neutral (N)										
No	Frequency (MHz)	Correction Factor (dB)	Reading Value (dBuV)		Emission Level (dBuV)		Limit (dBuV)		Margin (dB)	
			Q.P.	AV.	Q.P.	AV.	Q.P.	AV.	Q.P.	AV.
1	0.15781	10.30	29.72	18.79	40.02	29.09	65.58	55.58	-25.56	-26.49
2	0.20469	10.26	20.75	8.28	31.01	18.54	63.42	53.42	-32.41	-34.88
3	0.43906	10.28	25.67	22.41	35.95	32.69	57.08	47.08	-21.13	-14.39
4	0.95859	10.22	14.39	8.01	24.61	18.23	56.00	46.00	-31.39	-27.77
5	15.25000	10.82	25.52	18.69	36.34	29.51	60.00	50.00	-23.66	-20.49
6	18.24219	10.92	27.32	23.51	38.24	34.43	60.00	50.00	-21.76	-15.57

Remarks:

1. Q.P. and AV. are abbreviations of quasi-peak and average individually.
2. The emission levels of other frequencies were very low against the limit.
3. Margin value = Emission level – Limit value
4. Correction factor = Insertion loss + Cable loss
5. Emission Level = Correction Factor + Reading Value

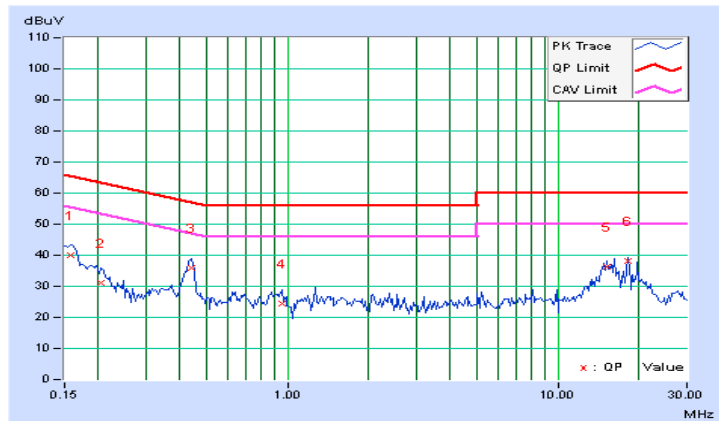

4.2.8 Test Results (Mode 2)

Phase	Line (L)	Detector Function	Quasi-Peak (QP) / Average (AV)
-------	----------	-------------------	--------------------------------

Phase Of Power : Line (L)										
No	Frequency (MHz)	Correction Factor (dB)	Reading Value (dBuV)		Emission Level (dBuV)		Limit (dBuV)		Margin (dB)	
			Q.P.	AV.	Q.P.	AV.	Q.P.	AV.	Q.P.	AV.
1	0.15000	10.26	31.86	22.04	42.12	32.30	66.00	56.00	-23.88	-23.70
2	0.42344	10.24	32.35	26.74	42.59	36.98	57.38	47.38	-14.79	-10.40
3	0.86094	10.19	18.27	11.53	28.46	21.72	56.00	46.00	-27.54	-24.28
4	16.22656	10.81	38.01	35.37	48.82	46.18	60.00	50.00	-11.18	-3.82
5	19.70703	10.91	30.90	27.83	41.81	38.74	60.00	50.00	-18.19	-11.26
6	23.12891	10.96	32.10	30.24	43.06	41.20	60.00	50.00	-16.94	-8.80

Remarks:

1. Q.P. and AV. are abbreviations of quasi-peak and average individually.
2. The emission levels of other frequencies were very low against the limit.
3. Margin value = Emission level – Limit value
4. Correction factor = Insertion loss + Cable loss
5. Emission Level = Correction Factor + Reading Value

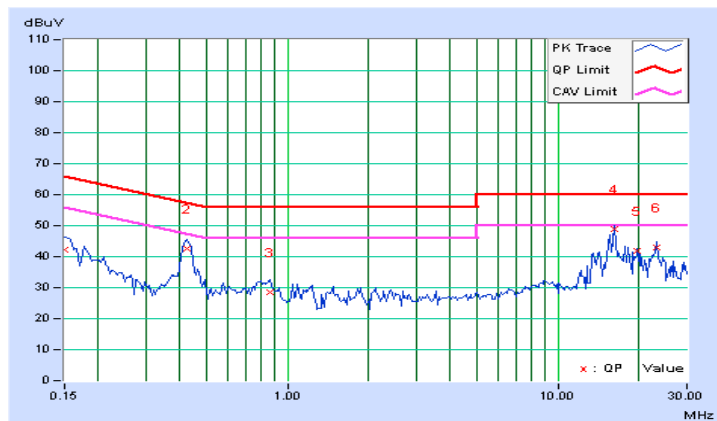

Phase	Neutral (N)	Detector Function	Quasi-Peak (QP) / Average (AV)
-------	-------------	-------------------	--------------------------------

Phase Of Power : Neutral (N)										
No	Frequency (MHz)	Correction Factor (dB)	Reading Value (dBuV)		Emission Level (dBuV)		Limit (dBuV)		Margin (dB)	
			Q.P.	AV.	Q.P.	AV.	Q.P.	AV.	Q.P.	AV.
1	0.15781	10.23	33.26	25.33	43.49	35.56	65.58	55.58	-22.08	-20.01
2	0.42734	10.22	33.18	27.27	43.40	37.49	57.30	47.30	-13.91	-9.82
3	13.35938	10.70	30.03	27.38	40.73	38.08	60.00	50.00	-19.27	-11.92
4	16.22831	10.83	38.91	35.88	49.74	46.71	60.00	50.00	-10.26	-3.29
5	19.70703	10.94	31.61	28.54	42.55	39.48	60.00	50.00	-17.45	-10.52
6	22.88672	10.98	26.38	24.67	37.36	35.65	60.00	50.00	-22.64	-14.35

Remarks:

1. Q.P. and AV. are abbreviations of quasi-peak and average individually.
2. The emission levels of other frequencies were very low against the limit.
3. Margin value = Emission level – Limit value
4. Correction factor = Insertion loss + Cable loss
5. Emission Level = Correction Factor + Reading Value

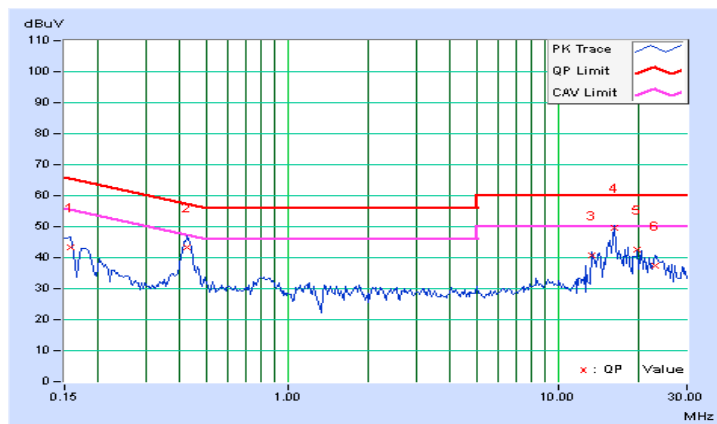

4.2.9 Test Results (Mode 3)

Phase	Line (L)	Detector Function	Quasi-Peak (QP) / Average (AV)
-------	----------	-------------------	--------------------------------

Phase Of Power : Line (L)										
No	Frequency (MHz)	Correction Factor (dB)	Reading Value (dBuV)		Emission Level (dBuV)		Limit (dBuV)		Margin (dB)	
			Q.P.	AV.	Q.P.	AV.	Q.P.	AV.	Q.P.	AV.
1	0.15000	10.32	31.65	24.66	41.97	34.98	66.00	56.00	-24.03	-21.02
2	0.44297	10.29	21.26	14.32	31.55	24.61	57.01	47.01	-25.45	-22.39
3	1.50000	10.25	17.00	2.32	27.25	12.57	56.00	46.00	-28.75	-33.43
4	2.64063	10.31	16.58	1.94	26.89	12.25	56.00	46.00	-29.11	-33.75
5	4.46094	10.44	12.81	0.26	23.25	10.70	56.00	46.00	-32.75	-35.30
6	15.20703	10.80	20.14	11.35	30.94	22.15	60.00	50.00	-29.06	-27.85

Remarks:

1. Q.P. and AV. are abbreviations of quasi-peak and average individually.
2. The emission levels of other frequencies were very low against the limit.
3. Margin value = Emission level – Limit value
4. Correction factor = Insertion loss + Cable loss
5. Emission Level = Correction Factor + Reading Value

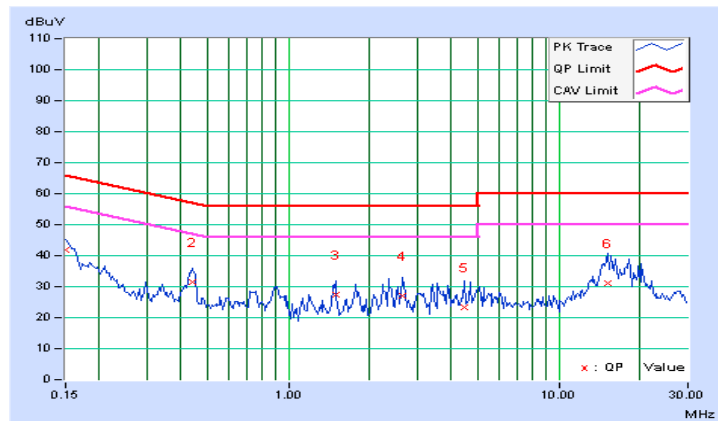

Phase	Neutral (N)	Detector Function	Quasi-Peak (QP) / Average (AV)
-------	-------------	-------------------	--------------------------------

Phase Of Power : Neutral (N)										
No	Frequency (MHz)	Correction Factor (dB)	Reading Value (dBuV)		Emission Level (dBuV)		Limit (dBuV)		Margin (dB)	
			Q.P.	AV.	Q.P.	AV.	Q.P.	AV.	Q.P.	AV.
1	0.15391	10.30	27.56	16.40	37.86	26.70	65.79	55.79	-27.92	-29.08
2	0.18516	10.27	21.15	7.70	31.42	17.97	64.25	54.25	-32.83	-36.28
3	0.43516	10.28	25.33	22.17	35.61	32.45	57.15	47.15	-21.55	-14.71
4	2.07422	10.27	15.41	6.42	25.68	16.69	56.00	46.00	-30.32	-29.31
5	15.37500	10.82	23.30	15.33	34.12	26.15	60.00	50.00	-25.88	-23.85
6	18.24609	10.92	25.53	21.54	36.45	32.46	60.00	50.00	-23.55	-17.54

Remarks:

1. Q.P. and AV. are abbreviations of quasi-peak and average individually.
2. The emission levels of other frequencies were very low against the limit.
3. Margin value = Emission level – Limit value
4. Correction factor = Insertion loss + Cable loss
5. Emission Level = Correction Factor + Reading Value

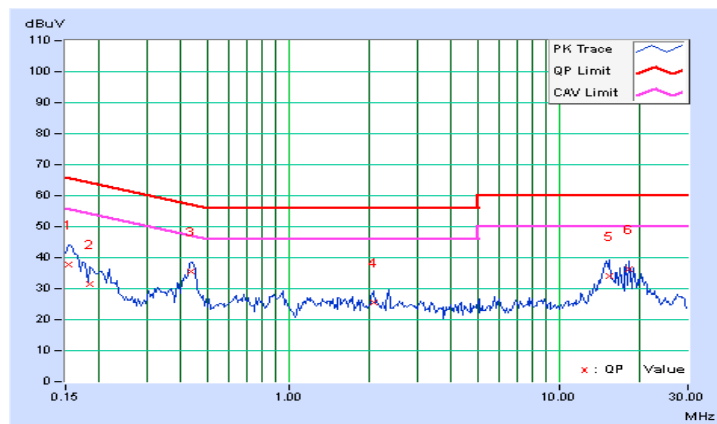

4.3 Transmit Power Measurement

4.3.1 Limits of Transmit Power Measurement

Operation Band	EUT Category		LIMIT
U-NII-1		Outdoor Access Point	1 Watt (30 dBm) (Max. e.i.r.p \leq 125mW(21 dBm) at any elevation angle above 30 degrees as measured from the horizon)
		Fixed point-to-point Access Point	1 Watt (30 dBm)
		Indoor Access Point	1 Watt (30 dBm)
	√	Mobile and Portable client device	250mW (24 dBm)
U-NII-2A		√	250mW (24 dBm) or 11 dBm+10 log B*
U-NII-2C		√	250mW (24 dBm) or 11 dBm+10 log B*
U-NII-3		√	1 Watt (30 dBm)

*B is the 26 dB emission bandwidth in megahertz

Per KDB 662911 D01 Multiple Transmitter Output v02r01 Method of conducted output power measurement on IEEE 802.11 devices,

Array Gain = 0 dB (i.e., no array gain) for $N_{ANT} \leq 4$;

Array Gain = 0 dB (i.e., no array gain) for channel widths ≥ 40 MHz for any N_{ANT} ;

Array Gain = $5 \log(N_{ANT}/N_{SS})$ dB or 3 dB, whichever is less for 20-MHz channel widths with $N_{ANT} \geq 5$.

For power measurements on all other devices: Array Gain = $10 \log(N_{ANT}/N_{SS})$ dB.

4.3.2 Test Setup

FOR POWER OUTPUT MEASUREMENT

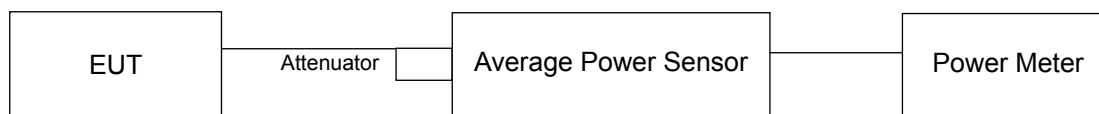

FOR 26dB OCCUPIED BANDWIDTH

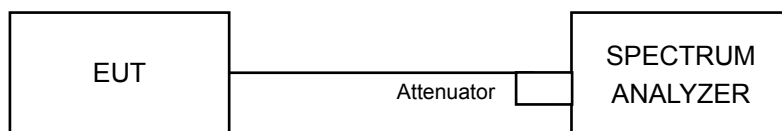

4.3.3 Test Instruments

Refer to section 4.1.2 to get information of above instrument.

4.3.4 Test Procedure

FOR AVERAGE POWER MEASUREMENT

Method PM is used to perform output power measurement, trigger and gating function of wide band power meter is enabled to measure max output power of TX on burst. Duty factor is not added to measured value.

FOR 26dB OCCUPIED BANDWIDTH

1. Set RBW = approximately 1% of the emission bandwidth.
2. Set the VBW > RBW.
3. Detector = Peak.
4. Trace mode = max hold.
5. Measure the maximum width of the emission that is 26 dB down from the peak of the emission. Compare this with the RBW setting of the analyzer. Readjust RBW and repeat measurement as needed until the RBW/EBW ratio is approximately 1%.

4.3.5 Deviation from Test Standard

No deviation.

4.3.6 EUT Operating Condition

The software provided by client to enable the EUT under transmission condition continuously at lowest, middle and highest channel frequencies individually.

4.3.7 Test Result

POWER OUTPUT:

Chan.	Chan. Freq. (MHz)	Average Power (dBm)		Total Power (mW)	Total Power (dBm)	Limit (dBm)	Pass / Fail
		Chain 0	Chain 1				
802.11a							
36	5180	17.88	17.28	114.832	20.60	24.00	PASS
40	5200	17.72	17.67	117.635	20.71	24.00	PASS
48	5240	17.83	17.21	113.276	20.54	24.00	PASS
52	5260	16.91	16.53	94.069	19.73	24.00	PASS
60	5300	17.86	17.54	117.848	20.71	24.00	PASS
64	5320	17.67	17.65	116.689	20.67	24.00	PASS
100	5500	17.97	16.58	108.16	20.34	24.00	PASS
116	5580	18.10	20.84	185.904	22.69	24.00	PASS
140	5700	15.60	16.80	84.171	19.25	24.00	PASS
149	5745	14.01	14.63	54.217	17.34	30.00	PASS
157	5785	19.71	19.51	182.872	22.62	30.00	PASS
165	5825	18.83	17.68	134.998	21.30	30.00	PASS
802.11n(HT20)							
36	5180	17.14	17.93	113.848	20.56	24.00	PASS
40	5200	18.00	17.67	121.575	20.85	24.00	PASS
48	5240	18.23	17.24	119.493	20.77	24.00	PASS
52	5260	18.46	17.84	130.96	21.17	24.00	PASS
60	5300	17.47	17.46	111.566	20.48	24.00	PASS
64	5320	17.80	17.77	120.097	20.80	24.00	PASS
100	5500	17.71	16.20	100.707	20.03	24.00	PASS
116	5580	18.16	20.17	169.456	22.29	24.00	PASS
140	5700	15.35	16.10	75.015	18.75	24.00	PASS
149	5745	14.13	14.14	51.824	17.15	30.00	PASS
157	5785	19.34	19.37	172.398	22.37	30.00	PASS
165	5825	17.82	16.39	104.085	20.17	30.00	PASS



Chan.	Chan. Freq. (MHz)	Average Power (dBm)		Total Power (mW)	Total Power (dBm)	Limit (dBm)	Pass / Fail
		Chain 0	Chain 1				
802.11n(HT40)							
38	5190	13.50	13.92	47.047	16.73	24.00	PASS
46	5230	20.14	19.89	200.775	23.03	24.00	PASS
54	5270	19.98	19.87	196.592	22.94	24.00	PASS
62	5310	13.85	13.93	48.983	16.90	24.00	PASS
102	5510	13.82	13.01	44.098	16.44	24.00	PASS
110	5550	19.43	20.22	192.896	22.85	24.00	PASS
134	5670	17.26	18.34	121.445	20.84	24.00	PASS
151	5755	13.16	13.83	44.856	16.52	30.00	PASS
159	5795	18.88	18.93	155.431	21.92	30.00	PASS

26dB OCCUPIED BANDWIDTH

Channel	Frequency (MHz)	26dBc Bandwidth (MHz)	
		Chain 0	Chain 1
802.11a			
36	5180	37.25	36.18
40	5200	35.75	35.78
48	5240	38.21	38.18
52	5260	35.54	35.37
60	5300	35.94	35.64
64	5320	35.71	35.50
100	5500	36.67	35.52
120	5600	43.89	44.83
140	5700	27.33	28.04
802.11n(HT20)			
36	5180	39.68	39.31
40	5200	40.56	40.80
48	5240	39.81	39.74
52	5260	41.61	41.20
60	5300	38.04	38.07
64	5320	37.86	37.97
100	5500	38.17	39.38
120	5600	50.06	48.76
140	5700	27.52	28.94
802.11n(HT40)			
38	5190	45.11	44.79
46	5230	60.00	60.00
54	5270	85.68	86.39
62	5310	44.37	43.82
102	5510	42.96	42.89
110	5550	82.76	80.63
134	5670	57.27	60.76

Note: For U-NII-2A, U-NII-2C Band output power limitation is determined based on 26dBc bandwidth

Power Limit = 11dBm + 10logB < U-NII-2A, U-NII-2C >

Channel Number	Freq.(MHz)	Min. B(MHz)	Determined Conducted Limit (dBm)
802.11a			
52	5260	35.37	26.48 > 24
60	5300	35.64	26.51 > 24
64	5320	35.50	26.5 > 24
100	5500	35.52	26.5 > 24
120	5600	43.89	27.42 > 24
140	5700	27.33	25.36 > 24
802.11n(HT20)			
52	5260	41.20	27.14 > 24
60	5300	38.04	26.8 > 24
64	5320	37.86	26.78 > 24
100	5500	38.17	26.81 > 24
120	5600	48.76	27.88 > 24
140	5700	27.52	25.39 > 24
802.11n(HT40)			
54	5270	85.68	30.32 > 24
62	5310	43.82	27.41 > 24
102	5510	42.89	27.32 > 24
110	5550	80.63	30.06 > 24
134	5670	57.27	28.57 > 24

Spectrum Plot of Worst Value

802.11a / Chain 0 / CH140

802.11n (HT20) / Chain 0 / 140

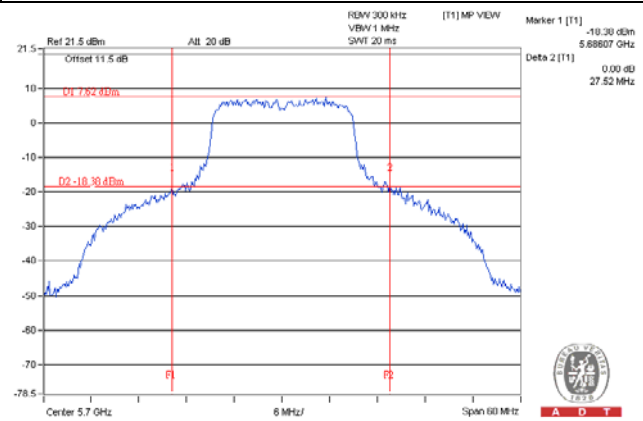
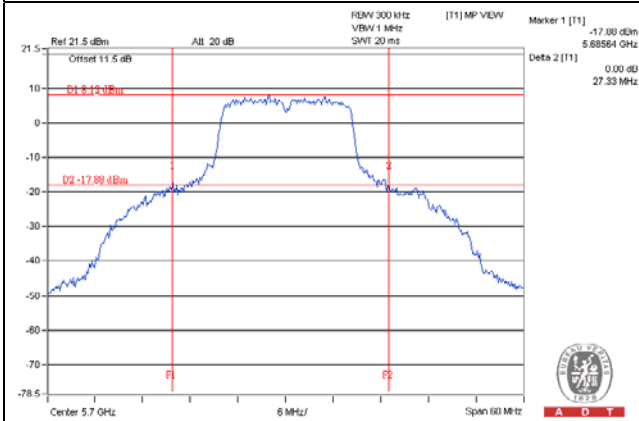

802.11n (HT40) / Chain 1 / CH102

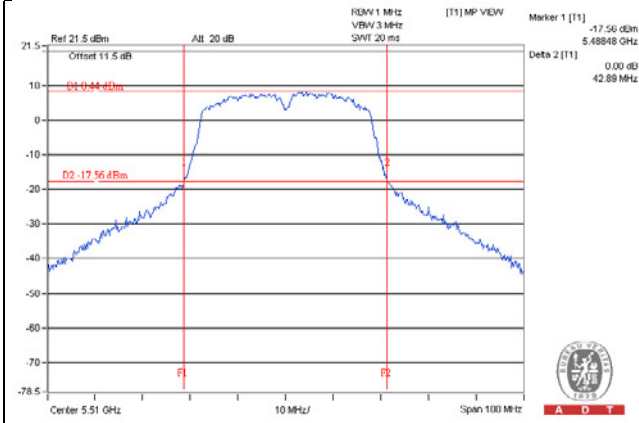

4.4 Peak Power Spectral Density Measurement

4.4.1 Limits of Peak Power Spectral Density Measurement

Operation Band	EUT Category		LIMIT
U-NII-1		Outdoor Access Point	17dBm/ MHz
		Fixed point-to-point Access Point	
		Indoor Access Point	
	√	Mobile and Portable client device	11dBm/ MHz
U-NII-2A		√	11dBm/ MHz
U-NII-2C		√	11dBm/ MHz
U-NII-3		√	30dBm/ 500kHz

4.4.2 Test Setup

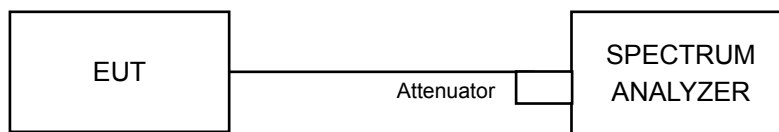

4.4.3 Test Instruments

Refer to section 4.1.2 to get information of above instrument.

4.4.4 Test Procedure

For U-NII-1, U-NII-2A & U-NII-2C

Using method SA-1

- Set span to encompass the entire emission bandwidth (EBW) of the signal.
- Set RBW = 1 MHz, Set VBW ≥ 3 MHz, Detector = RMS
- Sweep time = auto, trigger set to “free run”.
- Trace average at least 100 traces in power averaging mode.
- Record the max value

For U-NII-3:

- Set span to encompass the entire emission bandwidth (EBW) of the signal.
- Set RBW = 300 kHz, Set VBW ≥ 1 MHz, Detector = RMS
- Use the peak marker function to determine the maximum power level in any 300 kHz band segment within the fundamental EBW.
- Scale the observed power level to an equivalent value in 500 kHz by adjusting (reducing) the measured power by a bandwidth correction factor (BWCF) where $BWCF = 10\log(500\text{ kHz}/300\text{kHz})$
- Sweep time = auto, trigger set to “free run”.
- Trace average at least 100 traces in power averaging mode.
- Record the max value

4.4.5 Deviation from Test Standard

No deviation.

4.4.6 EUT Operating Condition

Same as Item 4.3.6.

4.4.7 Test Results

For U-NII-1, U-NII-2A & U-NII-2C:

Chan.	Chan. Freq. (MHz)	PSD (dBm/MHz)		Total Power Density (dBm/MHz)	MAX. Limit (dBm/MHz)	Pass / Fail
		Chain 0	Chain 1			
802.11a						
36	5180	3.69	2.96	6.35	11	PASS
40	5200	3.71	3.56	6.65	11	PASS
48	5240	4.63	4.47	7.56	11	PASS
52	5260	3.62	3.49	6.57	11	PASS
60	5300	4.50	4.43	7.48	11	PASS
64	5320	4.38	4.25	7.33	11	PASS
100	5500	3.89	3.97	6.94	11	PASS
116	5580	6.30	6.31	9.32	11	PASS
140	5700	2.17	2.34	5.27	11	PASS
802.11n(HT20)						
36	5180	2.81	2.73	5.78	11	PASS
40	5200	4.34	4.18	7.27	11	PASS
48	5240	4.35	4.15	7.26	11	PASS
52	5260	4.94	4.76	7.86	11	PASS
60	5300	3.89	3.75	6.83	11	PASS
64	5320	4.15	3.96	7.07	11	PASS
100	5500	3.60	3.67	6.65	11	PASS
116	5580	6.92	7.09	10.02	11	PASS
140	5700	1.81	1.96	4.90	11	PASS

Chan.	Chan. Freq. (MHz)	PSD (dBm/MHz)		Total Power Density (dBm/MHz)	MAX. Limit (dBm/MHz)	Pass / Fail
		Chain 0	Chain 1			
802.11n(HT40)						
38	5190	-3.14	-3.24	-0.18	11.00	PASS
46	5230	3.01	3.65	6.35	11.00	PASS
54	5270	5.35	4.68	8.04	11.00	PASS
62	5310	-1.95	-2.54	0.78	11.00	PASS
102	5510	-3.33	-3.42	-0.36	11.00	PASS
110	5550	3.71	3.91	6.82	11.00	PASS
134	5670	0.80	0.89	3.86	11.00	PASS

- Note: 1. Method 1 of power density measurement of KDB 662911 is using for calculating total power density. Total power density is summing entire spectra across corresponding frequency bins on the various outputs by computer.
2. For 5150~5250MHz: Directional gain = $10 \log[(10^{G1/20} + 10^{G2/20})^2 / 2] = 4.49\text{dBi} < 6\text{dBi}$, so the power limit shall not be reduced.
3. For 5250~5350MHz: Directional gain = $10 \log[(10^{G1/20} + 10^{G2/20})^2 / 2] = 4.92\text{dBi} < 6\text{dBi}$, so the power limit shall not be reduced.
4. For 5470~5725MHz: Directional gain = $10 \log[(10^{G1/20} + 10^{G2/20})^2 / 2] = 4.76\text{dBi} < 6\text{dBi}$, so the power limit shall not be reduced.

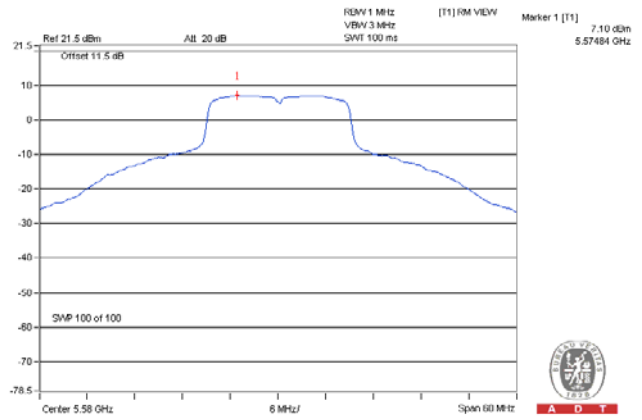
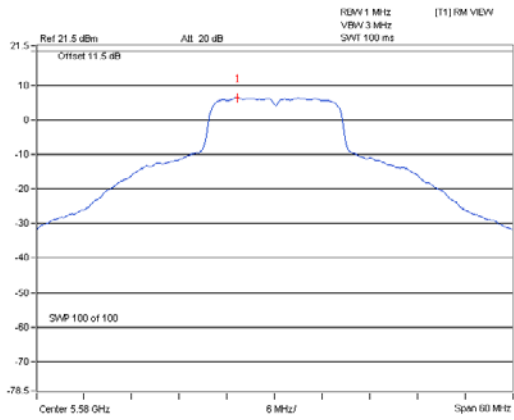
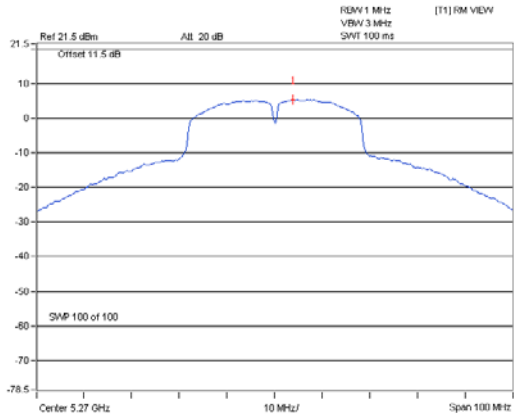
Spectrum Plot of Worst Value**802.11a / Chain 1 / CH116****802.11n (HT20) / Chain 1 / CH116****802.11n (HT40) / Chain 0 / CH54**

For U-NII-3:

TX chain	Chan.	Chan. Freq. (MHz)	PSD W/O Duty Factor		10 log (N=2) dB	Total PSD With Duty Factor (dBm/500kHz)	Limit (dBm/500kHz)	Pass /Fail
			(dBm/300kHz)	(dBm/500kHz)				
802.11a								
0	149	5745	-6.77	-4.55	3.01	-1.54	30	Pass
	157	5785	-1.38	0.84	3.01	3.85	30	Pass
	165	5825	-4.09	-1.87	3.01	1.14	30	Pass
1	149	5745	-7.94	-5.72	3.01	-2.71	30	Pass
	157	5785	-1.75	0.47	3.01	3.48	30	Pass
	165	5825	-3.91	-1.69	3.01	1.32	30	Pass
802.11n (HT20)								
0	149	5745	-8.16	-5.94	3.01	-2.93	30	Pass
	157	5785	-2.00	0.22	3.01	3.23	30	Pass
	165	5825	-5.37	-3.15	3.01	-0.14	30	Pass
1	149	5745	-8.17	-5.95	3.01	-2.94	30	Pass
	157	5785	-2.10	0.12	3.01	3.13	30	Pass
	165	5825	-5.50	-3.28	3.01	-0.27	30	Pass
802.11n (HT40)								
0	151	5745	-11.88	-9.66	3.01	-6.65	30	Pass
	159	5785	-6.27	-4.05	3.01	-1.04	30	Pass
1	151	5745	-12.30	-10.08	3.01	-7.07	30	Pass
	159	5785	-6.07	-3.85	3.01	-0.84	30	Pass

Note: 1. Directional gain = $10 \log[(10^{G1/20} + 10^{G2/20})^2 / 2] = 5.21\text{dBi} < 6\text{dBi}$, so the power density limit shall not be reduced.

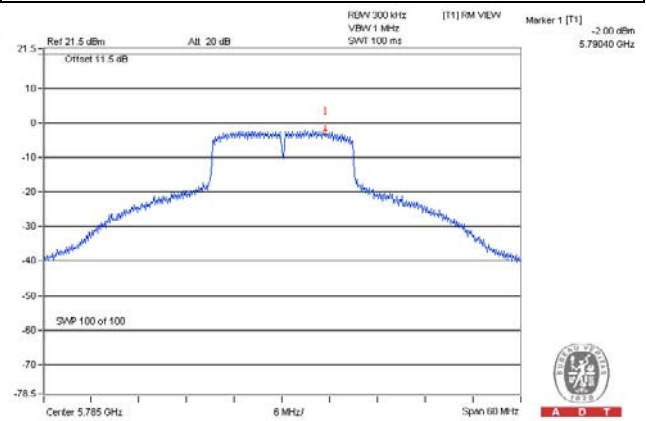
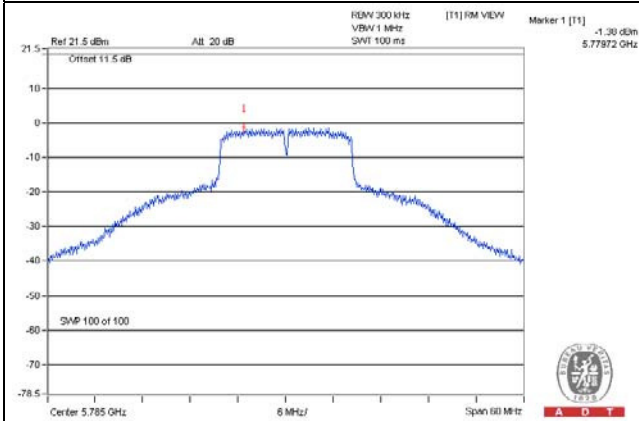
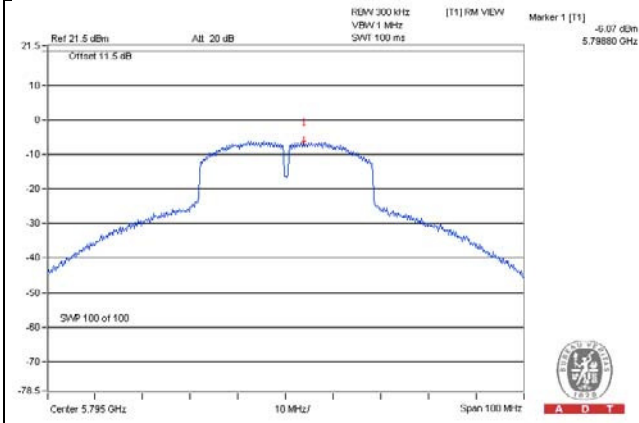
Spectrum Plot of Worst Value**802.11a / Chain 0 / CH157****802.11n (HT20) / Chain 0 / CH157****802.11n (HT40) / Chain 1 / CH159**

4.5 Frequency Stability Measurement

4.5.1 Limits of Frequency Stability Measurement

The frequency of the carrier signal shall be maintained within band of operation

4.5.2 Test Setup

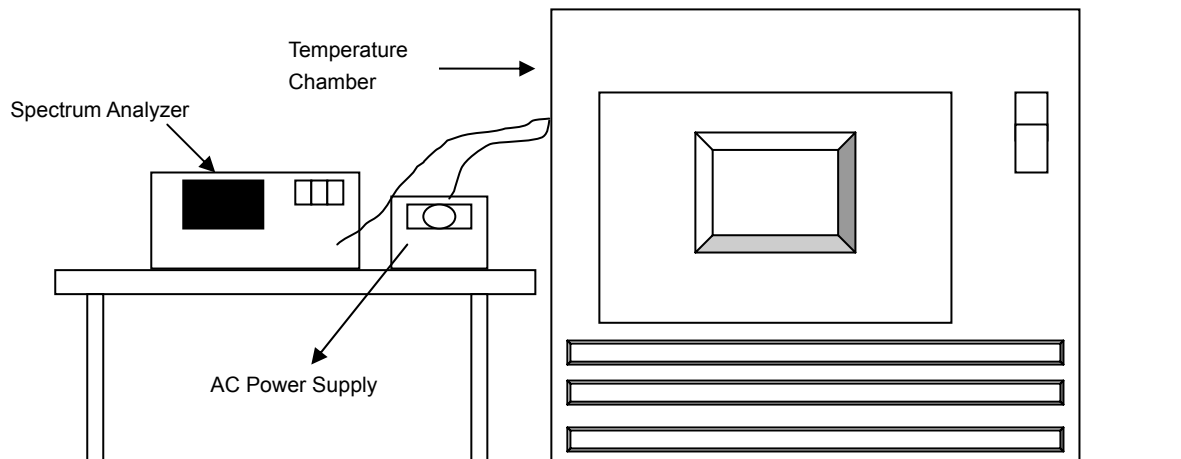

4.5.3 Test Instruments

Refer to section 4.1.2 to get information of above instrument.

4.5.4 Test Procedure

- The EUT was placed inside the environmental test chamber and powered by nominal AC voltage.
- Turn the EUT on and couple its output to a spectrum analyzer.
- Turn the EUT off and set the chamber to the highest temperature specified.
- Allow sufficient time (approximately 30 min) for the temperature of the chamber to stabilize, turn the EUT on and measure the operating frequency after 2, 5, and 10 minutes.
- Repeat step 2 and 3 with the temperature chamber set to the lowest temperature.
- The test chamber was allowed to stabilize at +20 degree C for a minimum of 30 minutes. The supply voltage was then adjusted on the EUT from 85% to 115% and the frequency record.

4.5.5 Deviation from Test Standard

No deviation.

4.5.6 EUT Operating Condition

Set the EUT transmit at un-modulation mode to test frequency stability.

4.5.7 Test Results

FREQUENCY STABILITY VERSUS TEMP.									
OPERATING FREQUENCY: 5180MHz									
TEMP. (°C)	POWER SUPPLY (Vac)	0 MINUTE		2 MINUTE		5 MINUTE		10 MINUTE	
		Measured Frequency (MHz)	Frequency Drift (%)	Measured Frequency (MHz)	Frequency Drift (%)	Measured Frequency (MHz)	Frequency Drift (%)	Measured Frequency (MHz)	Frequency Drift (%)
50	120	5179.9832	-0.00032	5179.9855	-0.00028	5179.9863	-0.00026	5179.9853	-0.00028
40	120	5179.9907	-0.00018	5179.9951	-0.00009	5179.9944	-0.00011	5179.9948	-0.00010
30	120	5180.0126	0.00024	5180.0148	0.00029	5180.013	0.00025	5180.0157	0.00030
20	120	5179.9845	-0.00030	5179.9818	-0.00035	5179.9827	-0.00033	5179.9837	-0.00031
10	120	5180.0044	0.00008	5180.0059	0.00011	5180.0066	0.00013	5180.0079	0.00015
0	120	5179.984	-0.00031	5179.9875	-0.00024	5179.9863	-0.00026	5179.9871	-0.00025
-10	120	5179.9781	-0.00042	5179.98	-0.00039	5179.9759	-0.00047	5179.979	-0.00041
-20	120	5180.0097	0.00019	5180.0114	0.00022	5180.0128	0.00025	5180.0121	0.00023
-30	120	5180.0152	0.00029	5180.0202	0.00039	5180.0155	0.00030	5180.0177	0.00034

FREQUENCY STABILITY VERSUS VOLTAGE									
OPERATING FREQUENCY: 5180MHz									
TEMP. (°C)	POWER SUPPLY (Vac)	0 MINUTE		2 MINUTE		5 MINUTE		10 MINUTE	
		Measured Frequency (MHz)	Frequency Drift (%)	Measured Frequency (MHz)	Frequency Drift (%)	Measured Frequency (MHz)	Frequency Drift (%)	Measured Frequency (MHz)	Frequency Drift (%)
20	138	5179.9836	-0.00032	5179.9817	-0.00035	5179.9827	-0.00033	5179.9834	-0.00032
	120	5179.9845	-0.00030	5179.9818	-0.00035	5179.9827	-0.00033	5179.9837	-0.00031
	102	5179.9835	-0.00032	5179.9826	-0.00034	5179.9823	-0.00034	5179.9836	-0.00032

4.6 6dB Bandwidth Measurement

4.6.1 Limits of 6dB Bandwidth Measurement

The minimum of 6dB Bandwidth Measurement is 0.5MHz.

4.6.2 Test Setup

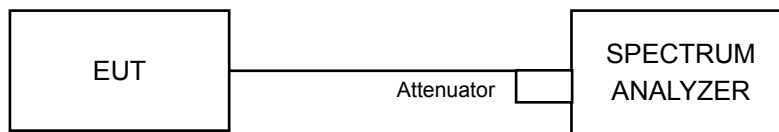

4.6.3 Test Instruments

Refer to section 4.1.2 to get information of above instrument.

4.6.4 Test Procedure

MEASUREMENT PROCEDURE REF

- Set resolution bandwidth (RBW) = 100kHz
- Set the video bandwidth (VBW) $\geq 3 \times$ RBW, Detector = Peak.
- Trace mode = max hold.
- Sweep = auto couple.
- Measure the maximum width of the emission that is constrained by the frequencies associated with the two amplitude points (upper and lower) that are attenuated by 6 dB relative to the maximum level measured in the fundamental emission

4.6.5 Deviation from Test Standard

No deviation.

4.6.6 EUT Operating Condition

The software provided by client to enable the EUT under transmission condition continuously at lowest, middle and highest channel frequencies individually.

4.6.7 Test Results

Channel	Frequency (MHz)	6dB Bandwidth (MHz)		Minimum Limit (MHz)	Pass / Fail
		Chain 0	Chain 1		
802.11a					
149	5745	15.66	15.40	0.5	Pass
157	5785	15.22	15.53	0.5	Pass
165	5825	15.17	15.22	0.5	Pass
802.11n (HT20)					
149	5745	16.04	16.03	0.5	Pass
157	5785	16.21	16.15	0.5	Pass
165	5825	16.02	16.18	0.5	Pass
802.11n (HT40)					
151	5755	32.70	32.66	0.5	Pass
159	5795	31.38	32.63	0.5	Pass

Spectrum Plot of Worst Value

802.11a / Chain 0 / CH165

802.11n (HT20) / Chain 0 / CH165

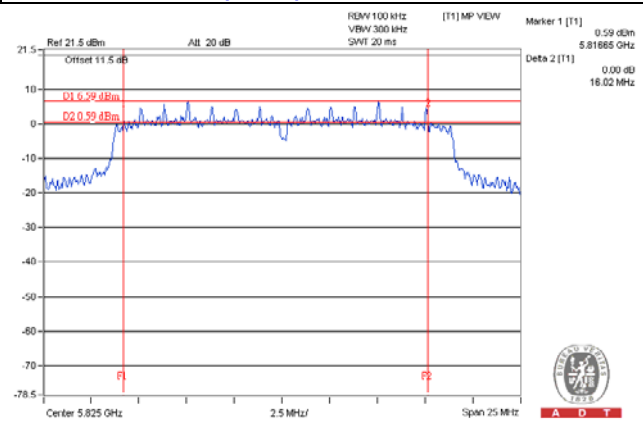
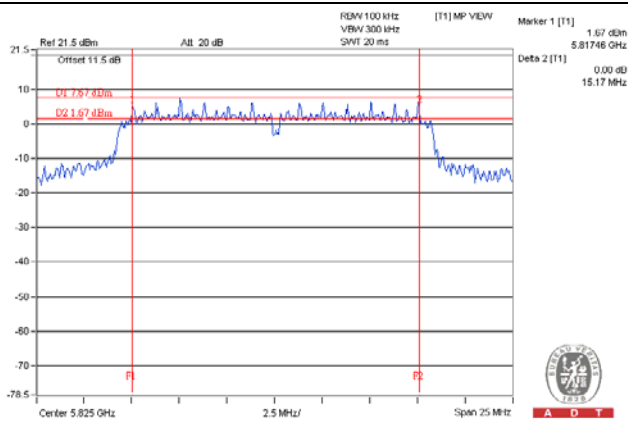

802.11n (HT40) / Chain 0 / CH159

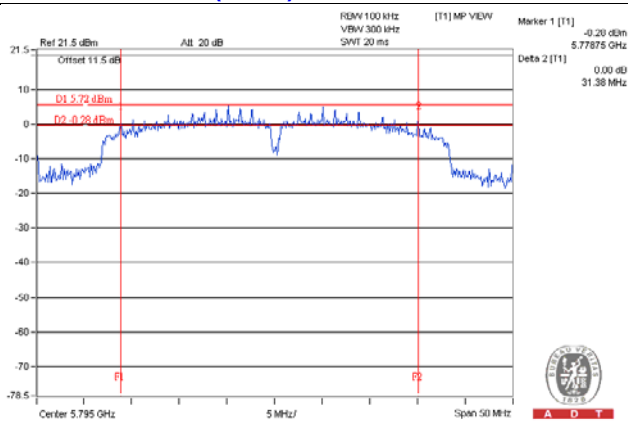

5 Pictures of Test Arrangements

Please refer to the attached file (Test Setup Photo).

Appendix – Information on the Testing Laboratories

We, Bureau Veritas Consumer Products Services (H.K.) Ltd., Taoyuan Branch, were founded in 1988 to provide our best service in EMC, Radio, Telecom and Safety consultation. Our laboratories are accredited and approved according to ISO/IEC 17025.

If you have any comments, please feel free to contact us at the following:

Linko EMC/RF Lab

Tel: 886-2-26052180

Fax: 886-2-26051924

Hsin Chu EMC/RF Lab/Telecom Lab

Tel: 886-3-6668565

Fax: 886-3-6668323

Hwa Ya EMC/RF/Safety

Tel: 886-3-3183232

Fax: 886-3-3270892

Email: service.adt@tw.bureauveritas.com

Web Site: www.bureauveritas-adt.com

The address and road map of all our labs can be found in our web site also.

--- END ---