

FCC Test Report

Report No.: RF160202C08-1

FCC ID: PY316100336

Test Model: C3000v2, C3700v2

Received Date: Feb. 02, 2016

Test Date: Nov. 01 to 04, 2016

Issued Date: Mar. 30, 2017

Applicant: NETGEAR, Inc.

Address: 350 East Plumeria Drive San Jose, CA 95134

Issued By: Bureau Veritas Consumer Products Services (H.K.) Ltd., Taoyuan Branch
Hsin Chu Laboratory

Lab Address: E-2, No.1, Li Hsin 1st Road, Hsinchu Science Park, Hsinchu City 300,
Taiwan R.O.C.

Test Location (1): E-2, No.1, Li Hsin 1st Road, Hsinchu Science Park, Hsinchu City 300,
Taiwan R.O.C.

Test Location (2): No. 49, Ln. 206, Wende Rd., Shangshan Tsuen, Chiung Lin Hsiang, Hsin
Chu Hsien 307, Taiwan R.O.C.



This report is for your exclusive use. Any copying or replication of this report to or for any other person or entity, or use of our name or trademark, is permitted only with our prior written permission. This report sets forth our findings solely with respect to the test samples identified herein. The results set forth in this report are not indicative or representative of the quality or characteristics of the lot from which a test sample was taken or any similar or identical product unless specifically and expressly noted. Our report includes all of the tests requested by you and the results thereof based upon the information that you provided to us. You have 60 days from date of issuance of this report to notify us of any material error or omission caused by our negligence, provided, however, that such notice shall be in writing and shall specifically address the issue you wish to raise. A failure to raise such issue within the prescribed time shall constitute your unqualified acceptance of the completeness of this report, the tests conducted and the correctness of the report contents. Unless specific mention, the uncertainty of measurement has been explicitly taken into account to declare the compliance or non-compliance to the specification. The report must not be used by the client to claim product certification, approval, or endorsement by TAF or any government agencies.

Table of Contents

Release Control Record	4
1 Certificate of Conformity	5
2 Summary of Test Results	6
2.1 Measurement Uncertainty	6
2.2 Modification Record	6
3 General Information	7
3.1 General Description of EUT	7
3.2 Description of Test Modes	10
3.2.1 Test Mode Applicability and Tested Channel Detail	11
3.3 Duty Cycle of Test Signal	13
3.4 Description of Support Units	14
3.4.1 Configuration of System under Test	15
3.5 General Description of Applied Standard	16
4 Test Types and Results	17
4.1 Radiated Emission and Bandedge Measurement	17
4.1.1 Limits of Radiated Emission and Bandedge Measurement	17
4.1.2 Test Instruments	18
4.1.3 Test Procedure	19
4.1.4 Deviation from Test Standard	19
4.1.5 Test Setup	20
4.1.6 EUT Operating Condition	21
4.1.7 Test Results (Mode 2)	22
4.2 Conducted Emission Measurement	41
4.2.1 Limits of Conducted Emission Measurement	41
4.2.2 Test Instruments	41
4.2.3 Test Procedure	42
4.2.4 Deviation from Test Standard	42
4.2.5 Test Setup	42
4.2.6 EUT Operating Condition	42
4.2.7 Test Results (Mode 1)	43
4.2.8 Test Results (Mode 2)	45
4.2.9 Test Results (Mode 3)	47
4.2.10 Test Results (Mode 4)	49
4.3 Transmit Power Measurement	51
4.3.1 Limits of Transmit Power Measurement	51
4.3.2 Test Setup	51
4.3.3 Test Instruments	51
4.3.4 Test Procedure	51
4.3.5 Deviation from Test Standard	51
4.3.6 EUT Operating Condition	51
4.3.7 Test Result	52
4.4 Occupied Bandwidth Measurement	56
4.4.1 Test Setup	56
4.4.2 Test Instruments	56
4.4.3 Test Procedure	56
4.4.4 Test Results	57
4.5 Peak Power Spectral Density Measurement	63
4.5.1 Limits of Peak Power Spectral Density Measurement	63
4.5.2 Test Setup	63
4.5.3 Test Instruments	63
4.5.4 Test Procedure	64
4.5.5 Deviation from Test Standard	64
4.5.6 EUT Operating Condition	64

4.5.7 Test Results	65
4.6 Frequency Stability Measurement.....	71
4.6.1 Limits of Frequency Stability Measurement	71
4.6.2 Test Setup.....	71
4.6.3 Test Instruments	71
4.6.4 Test Procedure	71
4.6.5 Deviation from Test Standard	71
4.6.6 EUT Operating Condition	71
4.6.7 Test Results	72
4.7 6dB Bandwidth Measurement	73
4.7.1 Limits of 6dB Bandwidth Measurement.....	73
4.7.2 Test Setup.....	73
4.7.3 Test Instruments	73
4.7.4 Test Procedure	73
4.7.5 Deviation from Test Standard	73
4.7.6 EUT Operating Condition	73
4.7.7 Test Results	74
5 Pictures of Test Arrangements.....	76
Annex A- Radiated Out of Band Emission (OOBE) Measurement (For U-NII-3 band)	77
Appendix – Information on the Testing Laboratories	80

Release Control Record

Issue No.	Description	Date Issued
RF160202C08-1	Original release.	Mar. 30, 2017

1 Certificate of Conformity

Product: Cable Gateway

Brand: Netgear

Test Model: C3000v2, C3700v2

Sample Status: ENGINEERING SAMPLE

Applicant: NETGEAR, Inc.

Test Date: Nov. 01 to 04, 2016

Standard: 47 CFR FCC Part 15, Subpart E (Section 15.407)
ANSI C63.10: 2013

The above equipment has been tested by **Bureau Veritas Consumer Products Services (H.K.) Ltd., Taoyuan Branch**, and found compliance with the requirement of the above standards. The test record, data evaluation & Equipment Under Test (EUT) configurations represented herein are true and accurate accounts of the measurements of the sample's EMC characteristics under the conditions specified in this report.

Prepared by : Cindy Hsin , **Date:** Mar. 30, 2017
Cindy Hsin / Specialist

Approved by : May Chen , **Date:** Mar. 30, 2017
May Chen / Manager

2 Summary of Test Results

47 CFR FCC Part 15, Subpart E (Section 15.407)			
FCC Clause	Test Item	Result	Remarks
15.407(b)(6)	AC Power Conducted Emissions	Pass	Meet the requirement of limit. Minimum passing margin is -7.55dB at 0.16562MHz.
15.407(b) (1/2/3/4(i/ii)/6)	Radiated Emissions & Band Edge Measurement*	Pass	Meet the requirement of limit. Minimum passing margin is -0.1dB at 5350.00MHz, 5150.00MHz,
15.407(a)(1/2/3)	Max Average Transmit Power	Pass	Meet the requirement of limit.
---	Occupied Bandwidth Measurement	-	Reference only.
15.407(a)(1/2/3)	Peak Power Spectral Density	Pass	Meet the requirement of limit.
15.407(e)	6dB bandwidth	Pass	Meet the requirement of limit. (U-NII-3 Band only)
15.407(g)	Frequency Stability	Pass	Meet the requirement of limit.
15.203	Antenna Requirement	Pass	No antenna connector is used.

*For U-NII-3 band compliance with rule part 15.407(b)(4)(i), the OOB test plots were recorded in Annex A.

2.1 Measurement Uncertainty

Where relevant, the following measurement uncertainty levels have been estimated for tests performed on the EUT as specified in CISPR 16-4-2:

Measurement	Frequency	Expanded Uncertainty (k=2) (\pm)
Conducted Emissions at mains ports	150kHz ~ 30MHz	1.83 dB
Radiated Emissions up to 1 GHz	30MHz ~ 1GHz	5.34 dB
Radiated Emissions above 1 GHz	1GHz ~ 6GHz	3.41 dB
	6GHz ~ 18GHz	3.49 dB
	18GHz ~ 40GHz	3.30 dB

2.2 Modification Record

There were no modifications required for compliance.

3 General Information

3.1 General Description of EUT

Product	Cable Gateway
Brand	Netgear
Test Model	C3000v2, C3700v2
Status of EUT	ENGINEERING SAMPLE
Power Supply Rating	12Vdc from power adapter
Modulation Type	CCK, DQPSK, DBPSK for DSSS 64QAM, 16QAM, QPSK, BPSK for OFDM 256QAM for OFDM in 11ac mode only
Modulation Technology	DSSS, OFDM
Transfer Rate	802.11b: up to 11Mbps 802.11a/g: up to 54Mbps 802.11n: up to 300Mbps 802.11ac: up to 866Mbps
Operating Frequency	2.4GHz: 2.412 ~ 2.462GHz 5GHz: 5.18 ~ 5.24GHz and 5.745 ~ 5.825GHz
Number of Channel	2.4GHz: 802.11b, 802.11g, 802.11n (HT20): 11 802.11n (HT40): 7 5GHz: 802.11a, 802.11n (HT20), 802.11ac (VHT20): 9 802.11n (HT40), 802.11ac (VHT40): 4 802.11ac (VHT80): 2
Output Power	2.4GHz: 375.048mW 5GHz: 5.18GHz ~ 5.24GHz: CDD Mode: 273.781mW Beamforming Mode: 273.781mW 5.745GHz ~ 5.825GHz: CDD Mode: 687.473mW Beamforming Mode: 687.473mW
Antenna Type	Refer to Note
Antenna Connector	NA
Accessory Device	Adapter x 1
Data Cable Supplied	LAN cable (Unshielded, 0.95m) x1

Note:

1. All models are listed as below.

Brand	Model	Difference
NETGEAR	C3700v2	2.4G + 5G
	C3000v2	2.4G

From the above models, model: **C3700v2** was selected as representative models for the test and its data was recorded in this report

2. Simultaneously transmission condition.

Condition	Technology	
1	WLAN (2.4GHz)	WLAN (5GHz)

Note: The emission of the simultaneous operation has been evaluated and no non-compliance was found.

3. The EUT must be supplied with a power adapter and following different models could be chosen as following table:

No	Brand Name	Model No.	PN	Spec.
1	NETGEAR	2ABB018F 1 NA	332-10750-01	Input: 100-120Vac, 50/60Hz, 0.6A Output: 12.0Vdc, 1.5A DC output cable (Unshielded, 1.8m)
2	NETGEAR	AD2032F10	332-10751-01	Input: 100-120Vac, 50/60Hz, 0.56A Output: 12Vdc, 1.5A DC output cable (Unshielded, 1.8m)
3	NETGEAR	2ABL030F 1 NA	332-10758-01	Input: 100-120Vac, 50/60Hz, 1.0A Output: 12.0Vdc, 2.5A DC output cable (Unshielded, 1.8m)
4	NETGEAR	AD2067F10	332-10797-01	Input: 100-120Vac, 50/60Hz, 1.0A Output: 12.0Vdc, 2.5A DC output cable (Unshielded, 1.85m)

Note: From the above adapters, the radiated emission worse case was found in Adapter 2. Therefore only the test data of the mode was recorded in this report.

4. The antennas provided to the EUT, please refer to the following table:

Antenna No.	Brand	Model	Antenna Gain(dBi)	Frequency range (GHz ~ GHz)	Antenna Type
1	NA	NA	3.84	2.4~2.4835	PCB
			4.78	5.15~5.25	
			4.58	5.725~5.85	
2	NA	NA	3.84	2.4~2.4835	PCB
			4.78	5.15~5.25	
			4.58	5.725~5.85	

5. The EUT incorporates a MIMO function.

2.4GHz Band			
MODULATION MODE	DATA RATE (MCS)	TX & RX CONFIGURATION	
802.11b	1 ~ 11Mbps	1Tx diversity	2RX
802.11g	6 ~ 54Mbps	2TX	2RX
802.11n (HT20)	MCS 0~7	2TX	2RX
	MCS 8~15	2TX	2RX
802.11n (HT40)	MCS 0~7	2TX	2RX
	MCS 8~15	2TX	2RX
5GHz Band			
MODULATION MODE	DATA RATE (MCS)	TX & RX CONFIGURATION	
802.11a	6 ~ 54Mbps	2TX	2RX
802.11n (HT20)	MCS 0~7	2TX	2RX
	MCS 8~15	2TX	2RX
802.11n (HT40)	MCS 0~7	2TX	2RX
	MCS 8~15	2TX	2RX
802.11ac (VHT20)	MCS0~8 Nss=1	2TX	2RX
	MCS0~8 Nss=2	2TX	2RX
802.11ac (VHT40)	MCS0~9 Nss=1	2TX	2RX
	MCS0~9 Nss=2	2TX	2RX
802.11ac (VHT80)	MCS0~9 Nss=1	2TX	2RX
	MCS0~9 Nss=2	2TX	2RX

Note:

1. All of modulation mode support beamforming function except 802.11a/b/g modulation mode

6. The above EUT information is declared by manufacturer and for more detailed features description, please refer to the manufacturer's specifications or user's manual.

3.2 Description of Test Modes

FOR 5180 ~ 5240MHz

4 channels are provided for 802.11a, 802.11n (HT20), 802.11ac (VHT20):

Channel	Frequency	Channel	Frequency
36	5180 MHz	44	5220 MHz
40	5200 MHz	48	5240 MHz

2 channels are provided for 802.11n (HT40), 802.11ac (VHT40):

Channel	Frequency	Channel	Frequency
38	5190 MHz	46	5230 MHz

1 channel is provided for 802.11ac (VHT80):

Channel	Frequency
42	5210MHz

FOR 5745 ~ 5825MHz:

5 channels are provided for 802.11a, 802.11n (HT20), 802.11ac (VHT20):

Channel	Frequency	Channel	Frequency
149	5745MHz	161	5805MHz
153	5765MHz	165	5825MHz
157	5785MHz		

2 channels are provided for 802.11n (HT40), 802.11ac (VHT40):

Channel	Frequency	Channel	Frequency
151	5755MHz	159	5795MHz

1 channel is provided for 802.11ac (VHT80):

Channel	Frequency
155	5775MHz

3.2.1 Test Mode Applicability and Tested Channel Detail

EUT Configure Mode	Applicable To				Description
	RE \geq 1G	RE $<$ 1G	PLC	APCM	
1	-	-	√	-	With adapter 1
2	√	√	√	√	With adapter 2
3	-	-	√	-	With adapter 3
4	-	-	√	-	With adapter 4

Where **RE \geq 1G**: Radiated Emission above 1GHz **RE $<$ 1G**: Radiated Emission below 1GHz
PLC: Power Line Conducted Emission **APCM**: Antenna Port Conducted Measurement

Radiated Emission Test (Above 1GHz):

- Pre-Scan has been conducted to determine the worst-case mode from all possible combinations between available modulations, data rates and antenna ports (if EUT with antenna diversity architecture).
- Following channel(s) was (were) selected for the final test as listed below.

CDD Mode						
Mode	FREQ. Band (MHz)	Available Channel	Tested Channel	Modulation Technology	Modulation Type	Data Rate (Mbps)
802.11a	5180-5240	36 to 48	36, 40, 48	OFDM	BPSK	6
802.11ac (VHT20)		36 to 48	36, 40, 48	OFDM	BPSK	6.5
802.11ac (VHT40)		38 to 46	38, 46	OFDM	BPSK	13.5
802.11ac (VHT80)		42	42	OFDM	BPSK	29.3
802.11a	5745-5825	149 to 165	149, 157, 165	OFDM	BPSK	6
802.11ac (VHT20)		149 to 165	149, 157, 165	OFDM	BPSK	6.5
802.11ac (VHT40)		151 to 159	151, 159	OFDM	BPSK	13.5
802.11ac (VHT80)		155	155	OFDM	BPSK	29.3

Radiated Emission Test (Below 1GHz):

- Pre-Scan has been conducted to determine the worst-case mode from all possible combinations between available modulations, data rates and antenna ports (if EUT with antenna diversity architecture).
- Following channel(s) was (were) selected for the final test as listed below.

CDD Mode						
Mode	FREQ. Band (MHz)	Available Channel	Tested Channel	Modulation Technology	Modulation Type	Data Rate (Mbps)
802.11ac (VHT20)	5745-5825	149 to 165	147	OFDM	BPSK	6.5

Power Line Conducted Emission Test:

- Pre-Scan has been conducted to determine the worst-case mode from all possible combinations between available modulations, data rates and antenna ports (if EUT with antenna diversity architecture).
- Following channel(s) was (were) selected for the final test as listed below.

CDD Mode						
Mode	FREQ. Band (MHz)	Available Channel	Tested Channel	Modulation Technology	Modulation Type	Data Rate (Mbps)
802.11ac (VHT20)	5745-5825	149 to 165	147	OFDM	BPSK	6.5

Antenna Port Conducted Measurement:

- This item includes all test value of each mode, but only includes spectrum plot of worst value of each mode.
- Pre-Scan has been conducted to determine the worst-case mode from all possible combinations between available modulations, data rates and antenna ports (if EUT with antenna diversity architecture).
- Following channel(s) was (were) selected for the final test as listed below.

CDD Mode						
Mode	FREQ. Band (MHz)	Available Channel	Tested Channel	Modulation Technology	Modulation Type	Data Rate (Mbps)
802.11a	5180-5240	36 to 48	36, 40, 48	OFDM	BPSK	6
802.11ac (VHT20)		36 to 48	36, 40, 48	OFDM	BPSK	6.5
802.11ac (VHT40)		38 to 46	38, 46	OFDM	BPSK	13.5
802.11ac (VHT80)		42	42	OFDM	BPSK	29.3
802.11a	5745-5825	149 to 165	149, 157, 165	OFDM	BPSK	6
802.11ac (VHT20)		149 to 165	149, 157, 165	OFDM	BPSK	6.5
802.11ac (VHT40)		151 to 159	151, 159	OFDM	BPSK	13.5
802.11ac (VHT80)		155	155	OFDM	BPSK	29.3
Beamforming Mode (Output power only)						
Mode	FREQ. Band (MHz)	Available Channel	Tested Channel	Modulation Technology	Modulation Type	Data Rate (Mbps)
802.11ac (VHT20)	5180-5240	36 to 48	36, 40, 48	OFDM	BPSK	6.5
802.11ac (VHT40)		38 to 46	38, 46	OFDM	BPSK	13.5
802.11ac (VHT80)		42	42	OFDM	BPSK	29.3
802.11ac (VHT20)	5745-5825	149 to 165	149, 157, 165	OFDM	BPSK	6.5
802.11ac (VHT40)		151 to 159	151, 159	OFDM	BPSK	13.5
802.11ac (VHT80)		155	155	OFDM	BPSK	29.3

Test Condition:

APPLICABLE TO	ENVIRONMENTAL CONDITIONS	INPUT POWER	TESTED BY
RE \geq 1G	24deg. C, 63%RH	120Vac, 60Hz	Jyunchun Lin
RE $<$ 1G	22deg. C, 70%RH	120Vac, 60Hz	Weiwei Lo
PLC	25deg. C, 75%RH	120Vac, 60Hz	Barry Lee
APCM	25deg. C, 60%RH	120Vac, 60Hz	Gary Cheng Barry Lee

3.3 Duty Cycle of Test Signal

If duty cycle of test signal is $\geq 98\%$, duty factor is not required.

If duty cycle of test signal is $< 98\%$, duty factor shall be considered.

802.11a: Duty cycle = $2.062 \text{ ms} / 2.084 \text{ ms} = 0.989$

802.11ac (VHT20): Duty cycle = $1.92 \text{ ms} / 1.939 \text{ ms} = 0.99$

802.11ac (VHT40): Duty cycle = $0.944 \text{ ms} / 0.979 \text{ ms} = 0.964$ Duty factor = $10 * \log(1/0.964) = 0.16$

802.11ac (VHT80): Duty cycle = $0.459 \text{ ms} / 0.478 \text{ ms} = 0.96$, Duty factor = $10 * \log(1/0.96) = 0.18$

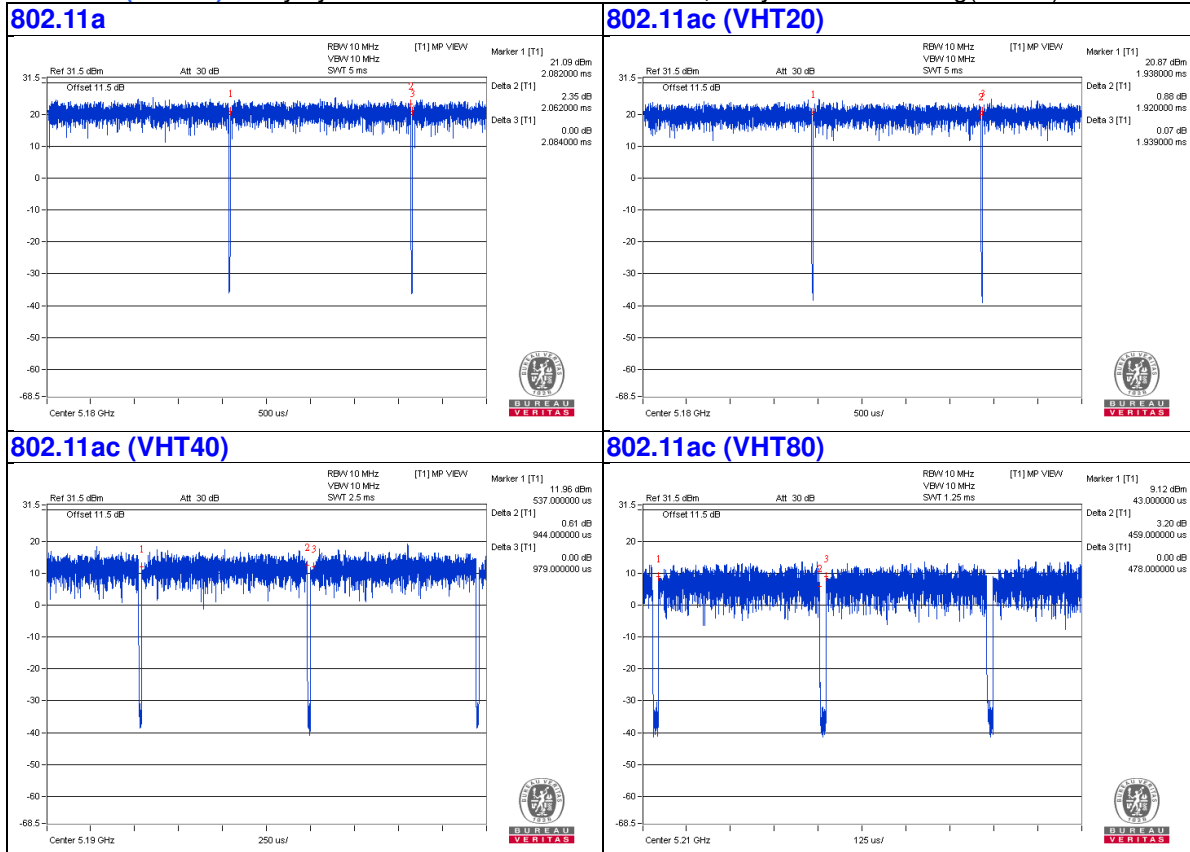

3.4 Description of Support Units

The EUT has been tested as an independent unit together with other necessary accessories or support units. The following support units or accessories were used to form a representative test configuration during the tests.

ID	Product	Brand	Model No.	Serial No.	FCC ID	Remarks
A.	Laptop	DELL	PP32LA	FSLB32S	FCC DoC	Provided by Lab
B.	Laptop	LENOVO	E440	PF071LWC	FCC DoC	Provided by Lab
C.	iPod	Apple	MD778TA/A	CC4JG680F4T1	FCC DoC	Provided by Lab

Note:

1. All power cords of the above support units are non-shielded (1.8m).

ID	Descriptions	Qty.	Length (m)	Shielding (Yes/No)	Cores (Qty.)	Remarks
1.	RJ-45 Cable	1	10	No	0	Provided by Lab
2.	RJ-45 Cable	1	10	No	0	Provided by Lab
3.	DC Cable	1	1.8	No	0	Supplied by client
4.	USB Cable	1	0.1	Yes	0	Provided by Lab
5.	Coaxial Cable	1	10	Yes	0	Provided by Lab

3.4.1 Configuration of System under Test

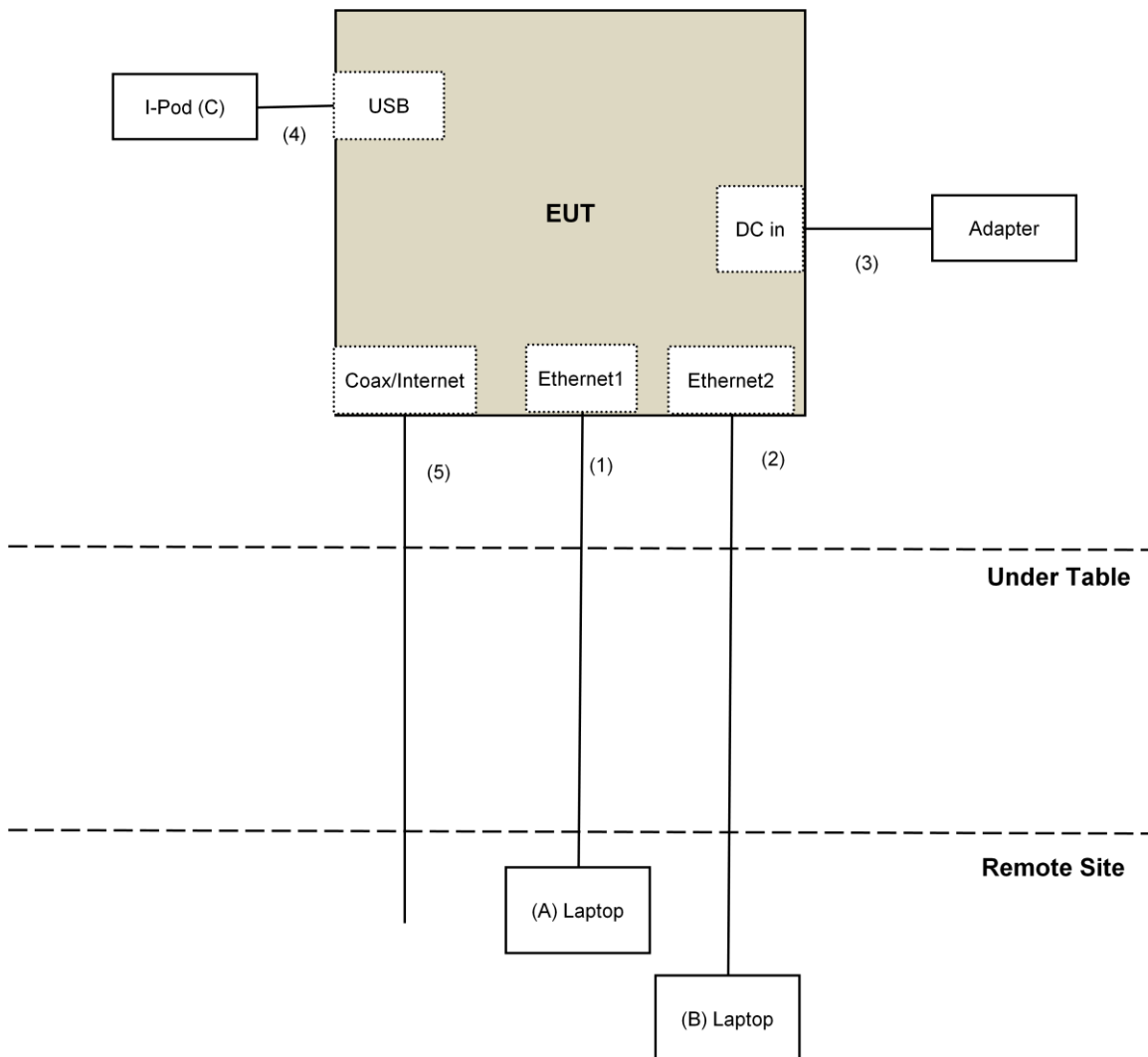

3.5 General Description of Applied Standard

The EUT is a RF Product. According to the specifications of the manufacturer, it must comply with the requirements of the following standards:

FCC Part 15, Subpart E (15.407)
KDB 789033 D02 General UNII Test Procedure New Rules v01r03
KDB 662911 D01 Multiple Transmitter Output v02r01
ANSI C63.10-2013

All test items have been performed and recorded as per the above standards.

NOTE: The EUT has been verified to comply with the requirements of FCC Part 15, Subpart B, Class B (DoC). The test report has been issued separately.

4 Test Types and Results

4.1 Radiated Emission and Bandedge Measurement

4.1.1 Limits of Radiated Emission and Bandedge Measurement

Radiated emissions which fall in the restricted bands must comply with the radiated emission limits specified as below table.

Frequencies (MHz)	Field Strength (microvolts/meter)	Measurement Distance (meters)
0.009 ~ 0.490	2400/F(kHz)	300
0.490 ~ 1.705	24000/F(kHz)	30
1.705 ~ 30.0	30	30
30 ~ 88	100	3
88 ~ 216	150	3
216 ~ 960	200	3
Above 960	500	3

NOTE:

1. The lower limit shall apply at the transition frequencies.
2. Emission level (dBuV/m) = 20 log Emission level (uV/m).
3. For frequencies above 1000MHz, the field strength limits are based on average detector, however, the peak field strength of any emission shall not exceed the maximum permitted average limits, specified above by more than 20dB under any condition of modulation.

Limits of unwanted emission out of the restricted bands

Applicable To		Limit	
789033 D02 General UNII Test Procedure New Rules v01r03		Field Strength at 3m	
		PK:74 (dBμV/m)	AV:54 (dBμV/m)
Frequency Band	Applicable To	EIRP Limit	Equivalent Field Strength at 3m
5150~5250 MHz	15.407(b)(1)	PK:-27 (dBm/MHz)	PK:68.2(dBμV/m)
5250~5350 MHz	15.407(b)(2)		
5470~5725 MHz	15.407(b)(3)		
5725~5850 MHz	<input checked="" type="checkbox"/> 15.407(b)(4)(i)	PK:-27 (dBm/MHz) ^{*1} PK:10 (dBm/MHz) ^{*2} PK:15.6 (dBm/MHz) ^{*3} PK:27 (dBm/MHz) ^{*4}	PK: 68.2(dBμV/m) ^{*1} PK:105.2 (dBμV/m) ^{*2} PK: 110.8(dBμV/m) ^{*3} PK:122.2 (dBμV/m) ^{*4}
	<input type="checkbox"/> 15.407(b)(4)(ii)	Emission limits in section 15.247(d)	
^{*1} beyond 75 MHz or more above of the band edge.		^{*2} below the band edge increasing linearly to 10 dBm/MHz at 25 MHz above.	
^{*3} below the band edge increasing linearly to a level of 15.6 dBm/MHz at 5 MHz above.		^{*4} from 5 MHz above or below the band edge increasing linearly to a level of 27 dBm/MHz at the band edge.	

Note:

The following formula is used to convert the equipment isotropic radiated power (eirp) to field strength:

$$E = \frac{1000000\sqrt{30P}}{3} \mu\text{V/m, where } P \text{ is the eirp (Watts).}$$

4.1.2 Test Instruments

DESCRIPTION & MANUFACTURER	MODEL NO.	SERIAL NO.	CALIBRATED DATE	CALIBRATED UNTIL
Test Receiver Keysight	N9038A	MY54450088	July 20, 2016	July 19, 2017
Pre-Amplifier ^(*) EMCI	EMC001340	980142	Jan. 20, 2016	Jan. 19, 2018
Loop Antenna ^(*) Electro-Metrics	EM-6879	264	Dec. 16, 2014	Dec. 15, 2016
RF Cable	NA	LOOPCAB-001 LOOPCAB-002	Jan. 18, 2016	Jan. 17, 2017
Pre-Amplifier Mini-Circuits	ZFL-1000VH2B	AMP-ZFL-01	Nov. 11, 2015	Nov. 10, 2016
Trilog Broadband Antenna SCHWARZBECK	VULB 9168	9168-406	Jan. 04, 2016	Jan. 03, 2017
RF Cable	8D	966-4-1 966-4-2 966-4-3	Apr. 02, 2016	Apr. 01, 2017
Horn Antenna SCHWARZBECK	BBHA 9120D	9120D-783	Jan. 19, 2016	Jan. 18, 2017
Pre-Amplifier Agilent	8449B	3008A01922	Sep. 18, 2016	Sep. 17, 2017
RF Cable	EMC104-SM-SM-2000 EMC104-SM-SM-5000 EMC104-SM-SM-5000	150318 150323 150324	Mar. 30, 2016	Mar. 29, 2017
Pre-Amplifier EMCI	EMC184045	980143	Jan. 15, 2016	Jan. 14, 2017
Horn Antenna SCHWARZBECK	BBHA 9170	BBHA9170608	Jan. 08, 2016	Jan. 07, 2017
RF Cable	SUCOFLEX 102	36432/2 36441/2	Jan. 16, 2016	Jan. 15, 2017
Software	ADT_Radiated_V8.7.08	NA	NA	NA
Antenna Tower & Turn Table Max-Full	MF-7802	MF780208410	NA	NA
Boresight Antenna Fixture	FBA-01	FBA-SIP02	NA	NA
Spectrum Analyzer R&S	FSP40	100060	May 11, 2016	May 10, 2017
Power meter Anritsu	ML2495A	1014008	May 05, 2016	May 4, 2017
Power sensor Anritsu	MA2411B	0917122	May 05, 2016	May 4, 2017
AC Power Source Extech Electronics	6205	1440452	NA	NA
Temperature & Humidity Chamber Giant Force	GTH-150-40-SP-AR	MAA0812-008	Jan. 15, 2016	Jan. 14, 2017
Digital Multimeter FLUKE	87III	73680266	Nov. 10, 2015	Nov. 09, 2016

Note:

1. The calibration interval of the above test instruments is 12 months and the calibrations are traceable to NML/ROC and NIST/USA.
2. *The calibration interval of the above test instruments is 24 months and the calibrations are traceable to NML/ROC and NIST/USA.
3. The test was performed in 966 Chamber No. 4.
4. The FCC Site Registration No. is 292998
5. The CANADA Site Registration No. is 20331-2
6. Loop antenna was used for all emissions below 30 MHz.
7. Tested Date: Nov. 02, 2016

4.1.3 Test Procedure

For Radiated emission below 30MHz

- a. The EUT was placed on the top of a rotating table 0.8 meters above the ground at a 3 meter chamber room. The table was rotated 360 degrees to determine the position of the highest radiation.
- b. The EUT was set 3 meters away from the interference-receiving antenna, which was mounted on the top of a variable-height antenna tower.
- c. Both X and Y axes of the antenna are set to make the measurement.
- d. For each suspected emission, the EUT was arranged to its worst case and the rotatable table was turned from 0 degrees to 360 degrees to find the maximum reading.
- e. The test-receiver system was set to Quasi-Peak Detect Function and Specified Bandwidth with Maximum Hold Mode.

NOTE:

1. The resolution bandwidth and video bandwidth of test receiver/spectrum analyzer is 9kHz at frequency below 30MHz.

For Radiated emission above 30MHz

- a. The EUT was placed on the top of a rotating table 0.8 meters (for 30MHz ~ 1GHz) / 1.5 meters (for above 1GHz) above the ground at 3 meter chamber room for test. The table was rotated 360 degrees to determine the position of the highest radiation.
- b. The EUT was set 3 meters away from the interference-receiving antenna, which was mounted on the top of a variable-height antenna tower.
- c. The height of antenna is varied from one meter to four meters above the ground to determine the maximum value of the field strength. Both horizontal and vertical polarizations of the antenna are set to make the measurement.
- d. For each suspected emission, the EUT was arranged to its worst case and then the antenna was tuned to heights from 1 meter to 4 meters and the rotatable table was turned from 0 degrees to 360 degrees to find the maximum reading.
- e. The test-receiver system was set to quasi-peak detect function and specified bandwidth with maximum hold mode when the test frequency is below 1 GHz.
- f. The test-receiver system was set to peak and average detect function and specified bandwidth with maximum hold mode when the test frequency is above 1 GHz. If the peak reading value also meets average limit, measurement with the average detector is unnecessary.

Note:

1. The resolution bandwidth and video bandwidth of test receiver/spectrum analyzer is 120kHz for Quasi-peak detection (QP) at frequency below 1GHz.
2. The resolution bandwidth of test receiver/spectrum analyzer is 1 MHz and the video bandwidth is 3 MHz for Peak detection (PK) at frequency above 1GHz.
3. The resolution bandwidth of test receiver/spectrum analyzer is 1MHz and the video bandwidth is $\geq 1/T$ (Duty cycle < 98%) or 10Hz (Duty cycle $\geq 98\%$) for Average detection (AV) at frequency above 1GHz.
4. All modes of operation were investigated and the worst-case emissions are reported.

4.1.4 Deviation from Test Standard

No deviation.

4.1.5 Test Setup

For Radiated emission below 30MHz

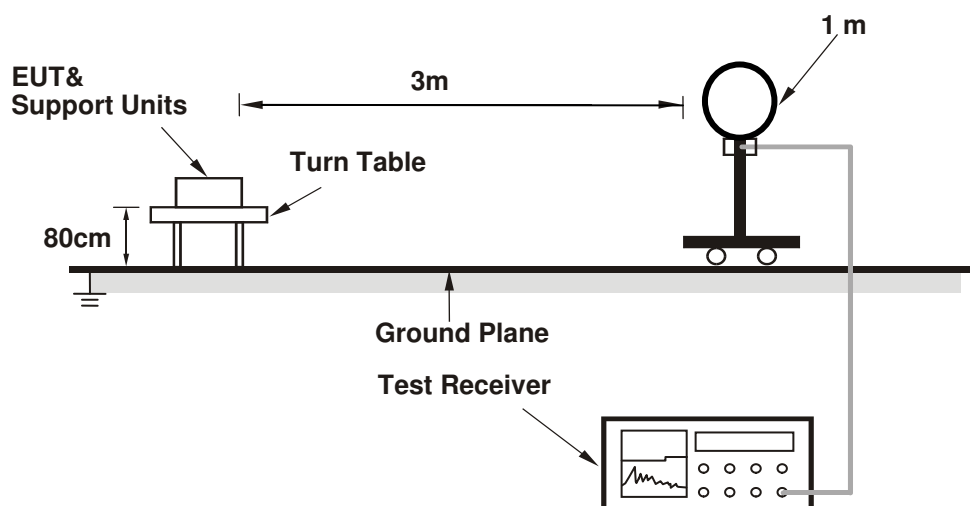

For Radiated emission 30MHz to 1GHz

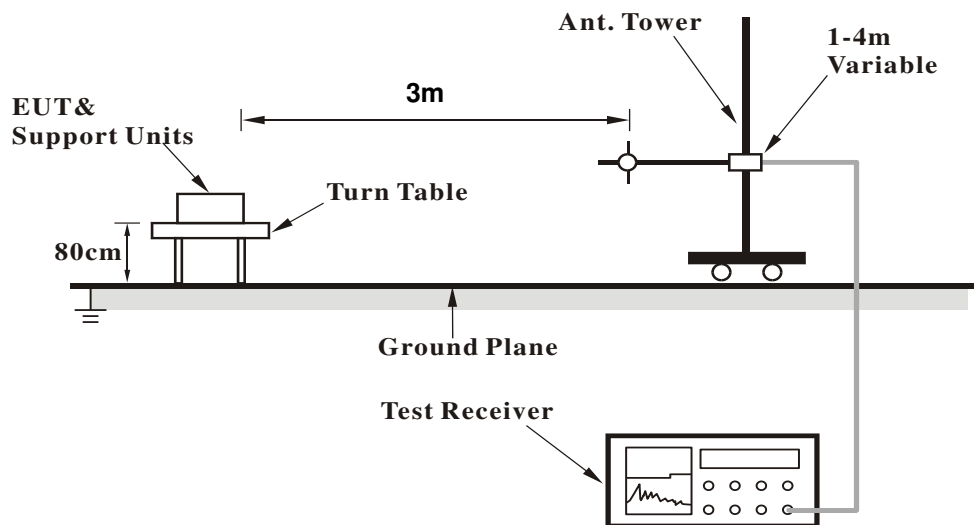

For Radiated emission above 1GHz

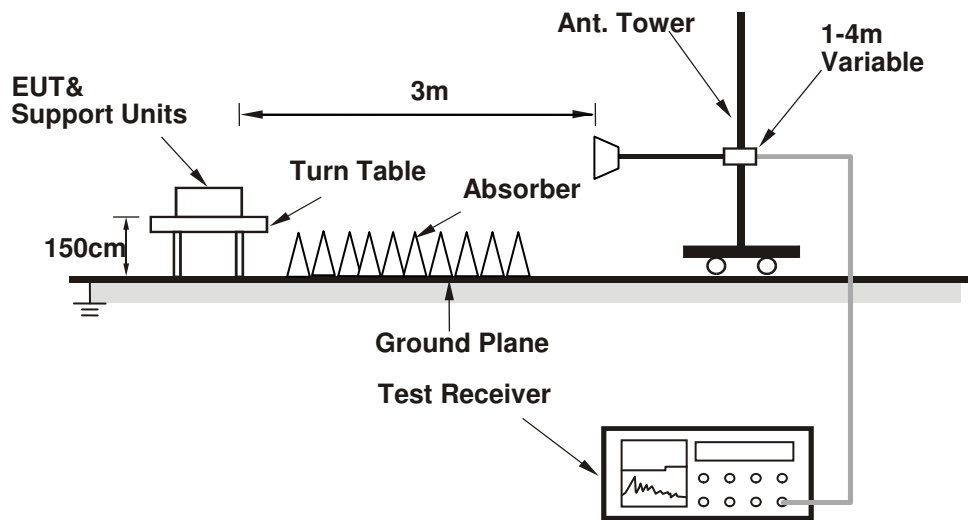

For the actual test configuration, please refer to the attached file (Test Setup Photo).

4.1.6 EUT Operating Condition

- a. Connected the EUT with the laptop which is placed on remote site.
- b. Controlling software (MTool_2.0.1.1.exe) has been activated to set the EUT on specific status.

4.1.7 Test Results (Mode 2)

Above 1GHz Data:

802.11a

CHANNEL	TX Channel 36	DETECTOR FUNCTION	Peak (PK)
FREQUENCY RANGE	1GHz ~ 40GHz		Average (AV)

ANTENNA POLARITY & TEST DISTANCE: HORIZONTAL AT 3 M

NO.	FREQ. (MHz)	EMISSION LEVEL (dBuV/m)	LIMIT (dBuV/m)	MARGIN (dB)	ANTENNA HEIGHT (m)	TABLE ANGLE (Degree)	RAW VALUE (dBuV)	CORRECTION FACTOR (dB/m)
1	5150.00	71.8 PK	74.0	-2.2	3.85 H	112	70.3	1.5
2	5150.00	53.7 AV	54.0	-0.3	3.85 H	112	52.2	1.5
3	*5180.00	114.8 PK			3.85 H	112	113.2	1.6
4	*5180.00	104.9 AV			3.85 H	112	103.3	1.6
5	#10360.00	51.8 PK	74.0	-22.2	2.70 H	165	40.3	11.5
6	#10360.00	39.6 AV	54.0	-14.4	2.70 H	165	28.1	11.5
7	15540.00	53.0 PK	74.0	-21.0	2.16 H	145	39.9	13.1
8	15540.00	41.0 AV	54.0	-13.0	2.16 H	145	27.9	13.1

ANTENNA POLARITY & TEST DISTANCE: VERTICAL AT 3 M

NO.	FREQ. (MHz)	EMISSION LEVEL (dBuV/m)	LIMIT (dBuV/m)	MARGIN (dB)	ANTENNA HEIGHT (m)	TABLE ANGLE (Degree)	RAW VALUE (dBuV)	CORRECTION FACTOR (dB/m)
1	5150.00	69.5 PK	74.0	-4.5	1.54 V	266	68.0	1.5
2	5150.00	52.0 AV	54.0	-2.0	1.54 V	266	50.5	1.5
3	*5180.00	108.5 PK			1.54 V	266	106.9	1.6
4	*5180.00	98.5 AV			1.54 V	266	96.9	1.6
5	#10360.00	52.1 PK	74.0	-21.9	1.85 V	211	40.6	11.5
6	#10360.00	39.5 AV	54.0	-14.5	1.85 V	211	28.0	11.5

REMARKS:

1. Emission Level(dBuV/m) = Raw Value(dBuV) + Correction Factor(dB/m)
2. Correction Factor(dB/m) = Antenna Factor(dB/m) + Cable Factor(dB) – Pre-Amplifier Factor(dB)
3. The other emission levels were very low against the limit.
4. Margin value = Emission Level – Limit value
5. " * ": Fundamental frequency.
6. " # ": The radiated frequency is out of the restricted band.

CHANNEL	TX Channel 40	DETECTOR FUNCTION	Peak (PK)
FREQUENCY RANGE	1GHz ~ 40GHz		Average (AV)

ANTENNA POLARITY & TEST DISTANCE: HORIZONTAL AT 3 M

NO.	FREQ. (MHz)	EMISSION LEVEL (dBuV/m)	LIMIT (dBuV/m)	MARGIN (dB)	ANTENNA HEIGHT (m)	TABLE ANGLE (Degree)	RAW VALUE (dBuV)	CORRECTION FACTOR (dB/m)
1	5150.00	61.9 PK	74.0	-12.1	3.82 H	98	60.4	1.5
2	5150.00	51.8 AV	54.0	-2.2	3.82 H	98	50.3	1.5
3	*5200.00	114.8 PK			3.82 H	98	113.1	1.7
4	*5200.00	104.7 AV			3.82 H	98	103.0	1.7
5	5350.00	63.7 PK	74.0	-10.3	3.82 H	98	61.8	1.9
6	5350.00	53.8 AV	54.0	-0.2	3.82 H	98	51.9	1.9
7	#10400.00	52.6 PK	74.0	-21.4	2.77 H	167	41.0	11.6
8	#10400.00	39.4 AV	54.0	-14.6	2.77 H	167	27.8	11.6
9	15600.00	52.5 PK	74.0	-21.5	2.08 H	139	39.4	13.1
10	15600.00	40.5 AV	54.0	-13.5	2.08 H	139	27.4	13.1

ANTENNA POLARITY & TEST DISTANCE: VERTICAL AT 3 M

NO.	FREQ. (MHz)	EMISSION LEVEL (dBuV/m)	LIMIT (dBuV/m)	MARGIN (dB)	ANTENNA HEIGHT (m)	TABLE ANGLE (Degree)	RAW VALUE (dBuV)	CORRECTION FACTOR (dB/m)
1	5150.00	60.0 PK	74.0	-14.0	1.58 V	275	58.5	1.5
2	5150.00	48.5 AV	54.0	-5.5	1.58 V	275	47.0	1.5
3	*5200.00	108.6 PK			1.58 V	275	106.9	1.7
4	*5200.00	98.7 AV			1.58 V	275	97.0	1.7
5	5350.00	61.2 PK	74.0	-12.8	1.58 V	275	59.3	1.9
6	5350.00	50.5 AV	54.0	-3.5	1.58 V	275	48.6	1.9
7	#10400.00	51.8 PK	74.0	-22.2	1.80 V	201	40.2	11.6
8	#10400.00	39.4 AV	54.0	-14.6	1.80 V	201	27.8	11.6
9	15600.00	52.5 PK	74.0	-21.5	1.48 V	243	39.4	13.1
10	15600.00	40.7 AV	54.0	-13.3	1.48 V	243	27.6	13.1

REMARKS:

1. Emission Level(dBuV/m) = Raw Value(dBuV) + Correction Factor(dB/m)
2. Correction Factor(dB/m) = Antenna Factor(dB/m) + Cable Factor(dB) – Pre-Amplifier Factor(dB)
3. The other emission levels were very low against the limit.
4. Margin value = Emission Level – Limit value
5. " * ": Fundamental frequency.
6. " # ": The radiated frequency is out of the restricted band.

CHANNEL	TX Channel 48	DETECTOR FUNCTION	Peak (PK)
FREQUENCY RANGE	1GHz ~ 40GHz		Average (AV)

ANTENNA POLARITY & TEST DISTANCE: HORIZONTAL AT 3 M

NO.	FREQ. (MHz)	EMISSION LEVEL (dBuV/m)	LIMIT (dBuV/m)	MARGIN (dB)	ANTENNA HEIGHT (m)	TABLE ANGLE (Degree)	RAW VALUE (dBuV)	CORRECTION FACTOR (dB/m)
1	*5240.00	114.9 PK			3.98 H	109	113.3	1.6
2	*5240.00	105.1 AV			3.98 H	109	103.5	1.6
3	5350.00	63.4 PK	74.0	-10.6	3.98 H	109	61.5	1.9
4	5350.00	53.9 AV	54.0	-0.1	3.98 H	109	52.0	1.9
5	#10480.00	52.5 PK	74.0	-21.5	2.64 H	160	40.5	12.0
6	#10480.00	39.5 AV	54.0	-14.5	2.64 H	160	27.5	12.0
7	15720.00	52.8 PK	74.0	-21.2	2.11 H	150	39.6	13.2
8	15720.00	40.6 AV	54.0	-13.4	2.11 H	150	27.4	13.2

ANTENNA POLARITY & TEST DISTANCE: VERTICAL AT 3 M

NO.	FREQ. (MHz)	EMISSION LEVEL (dBuV/m)	LIMIT (dBuV/m)	MARGIN (dB)	ANTENNA HEIGHT (m)	TABLE ANGLE (Degree)	RAW VALUE (dBuV)	CORRECTION FACTOR (dB/m)
1	*5240.00	108.8 PK			1.56 V	273	107.2	1.6
2	*5240.00	98.9 AV			1.56 V	273	97.3	1.6
3	5350.00	61.0 PK	74.0	-13.0	1.56 V	273	59.1	1.9
4	5350.00	50.6 AV	54.0	-3.4	1.56 V	273	48.7	1.9
5	#10480.00	52.0 PK	74.0	-22.0	1.83 V	209	40.0	12.0
6	#10480.00	39.3 AV	54.0	-14.7	1.83 V	209	27.3	12.0
7	15720.00	52.8 PK	74.0	-21.2	1.55 V	244	39.6	13.2
8	15720.00	40.5 AV	54.0	-13.5	1.55 V	244	27.3	13.2

REMARKS:

1. Emission Level(dBuV/m) = Raw Value(dBuV) + Correction Factor(dB/m)
2. Correction Factor(dB/m) = Antenna Factor(dB/m) + Cable Factor(dB) – Pre-Amplifier Factor(dB)
3. The other emission levels were very low against the limit.
4. Margin value = Emission Level – Limit value
5. " * ": Fundamental frequency.
6. " # ": The radiated frequency is out of the restricted band.

CHANNEL	TX Channel 149	DETECTOR FUNCTION	Peak (PK)
FREQUENCY RANGE	1GHz ~ 40GHz		Average (AV)

ANTENNA POLARITY & TEST DISTANCE: HORIZONTAL AT 3 M

NO.	FREQ. (MHz)	EMISSION LEVEL (dBuV/m)	LIMIT (dBuV/m)	MARGIN (dB)	ANTENNA HEIGHT (m)	TABLE ANGLE (Degree)	RAW VALUE (dBuV)	CORRECTION FACTOR (dB/m)
1	*5745.00	117.4 PK			3.78 H	96	114.7	2.7
2	*5745.00	107.0 AV			3.78 H	96	104.3	2.7
3	11490.00	52.7 PK	74.0	-21.3	2.68 H	158	39.3	13.4
4	11490.00	40.6 AV	54.0	-13.4	2.68 H	158	27.2	13.4
5	#17235.00	56.7 PK	74.0	-17.3	2.16 H	147	38.4	18.3
6	#17235.00	44.8 AV	54.0	-9.2	2.16 H	147	26.5	18.3

ANTENNA POLARITY & TEST DISTANCE: VERTICAL AT 3 M

NO.	FREQ. (MHz)	EMISSION LEVEL (dBuV/m)	LIMIT (dBuV/m)	MARGIN (dB)	ANTENNA HEIGHT (m)	TABLE ANGLE (Degree)	RAW VALUE (dBuV)	CORRECTION FACTOR (dB/m)
1	*5745.00	114.3 PK			3.82 V	31	111.6	2.7
2	*5745.00	103.2 AV			3.82 V	31	100.5	2.7
3	11490.00	52.5 PK	74.0	-21.5	1.79 V	215	39.1	13.4
4	11490.00	40.4 AV	54.0	-13.6	1.79 V	215	27.0	13.4
5	#17235.00	56.8 PK	74.0	-17.2	1.61 V	230	38.5	18.3
6	#17235.00	44.7 AV	54.0	-9.3	1.61 V	230	26.4	18.3

REMARKS:

1. Emission Level(dBuV/m) = Raw Value(dBuV) + Correction Factor(dB/m)
2. Correction Factor(dB/m) = Antenna Factor(dB/m) + Cable Factor(dB) – Pre-Amplifier Factor(dB)
3. The other emission levels were very low against the limit.
4. Margin value = Emission Level – Limit value
5. " * ": Fundamental frequency.
6. " # ": The radiated frequency is out of the restricted band.

CHANNEL	TX Channel 157	DETECTOR FUNCTION	Peak (PK)
FREQUENCY RANGE	1GHz ~ 40GHz		Average (AV)

ANTENNA POLARITY & TEST DISTANCE: HORIZONTAL AT 3 M

NO.	FREQ. (MHz)	EMISSION LEVEL (dBuV/m)	LIMIT (dBuV/m)	MARGIN (dB)	ANTENNA HEIGHT (m)	TABLE ANGLE (Degree)	RAW VALUE (dBuV)	CORRECTION FACTOR (dB/m)
1	*5785.00	117.7 PK			3.74 H	102	115.0	2.7
2	*5785.00	107.2 AV			3.74 H	102	104.5	2.7
3	11570.00	52.8 PK	74.0	-21.2	2.63 H	162	39.7	13.1
4	11570.00	40.7 AV	54.0	-13.3	2.63 H	162	27.6	13.1
5	#17355.00	56.9 PK	74.0	-17.1	2.08 H	140	38.1	18.8
6	#17355.00	45.2 AV	54.0	-8.8	2.08 H	140	26.4	18.8

ANTENNA POLARITY & TEST DISTANCE: VERTICAL AT 3 M

NO.	FREQ. (MHz)	EMISSION LEVEL (dBuV/m)	LIMIT (dBuV/m)	MARGIN (dB)	ANTENNA HEIGHT (m)	TABLE ANGLE (Degree)	RAW VALUE (dBuV)	CORRECTION FACTOR (dB/m)
1	*5785.00	114.5 PK			3.72 V	31	111.8	2.7
2	*5785.00	103.3 AV			3.72 V	31	100.6	2.7
3	11570.00	53.0 PK	74.0	-21.0	1.79 V	223	39.9	13.1
4	11570.00	40.8 AV	54.0	-13.2	1.79 V	223	27.7	13.1
5	#17355.00	56.4 PK	74.0	-17.6	1.61 V	231	37.6	18.8
6	#17355.00	44.6 AV	54.0	-9.4	1.61 V	231	25.8	18.8

REMARKS:

- Emission Level(dBuV/m) = Raw Value(dBuV) + Correction Factor(dB/m)
- Correction Factor(dB/m) = Antenna Factor(dB/m) + Cable Factor(dB) – Pre-Amplifier Factor(dB)
- The other emission levels were very low against the limit.
- Margin value = Emission Level – Limit value
- " * ": Fundamental frequency.
- " # ": The radiated frequency is out of the restricted band.

CHANNEL	TX Channel 165	DETECTOR FUNCTION	Peak (PK)
FREQUENCY RANGE	1GHz ~ 40GHz		Average (AV)

ANTENNA POLARITY & TEST DISTANCE: HORIZONTAL AT 3 M

NO.	FREQ. (MHz)	EMISSION LEVEL (dBuV/m)	LIMIT (dBuV/m)	MARGIN (dB)	ANTENNA HEIGHT (m)	TABLE ANGLE (Degree)	RAW VALUE (dBuV)	CORRECTION FACTOR (dB/m)
1	*5825.00	118.3 PK			3.71 H	99	115.6	2.7
2	*5825.00	107.5 AV			3.71 H	99	104.8	2.7
3	11650.00	53.1 PK	74.0	-20.9	2.70 H	152	40.0	13.1
4	11650.00	40.5 AV	54.0	-13.5	2.70 H	152	27.4	13.1
5	#17475.00	57.4 PK	74.0	-16.6	2.22 H	150	38.2	19.2
6	#17475.00	45.6 AV	54.0	-8.4	2.22 H	150	26.4	19.2

ANTENNA POLARITY & TEST DISTANCE: VERTICAL AT 3 M

NO.	FREQ. (MHz)	EMISSION LEVEL (dBuV/m)	LIMIT (dBuV/m)	MARGIN (dB)	ANTENNA HEIGHT (m)	TABLE ANGLE (Degree)	RAW VALUE (dBuV)	CORRECTION FACTOR (dB/m)
1	*5825.00	114.4 PK			3.84 V	33	111.7	2.7
2	*5825.00	103.3 AV			3.84 V	33	100.6	2.7
3	11650.00	52.6 PK	74.0	-21.4	1.76 V	205	39.5	13.1
4	11650.00	40.8 AV	54.0	-13.2	1.76 V	205	27.7	13.1
5	#17475.00	56.8 PK	74.0	-17.2	1.58 V	241	37.6	19.2
6	#17475.00	44.9 AV	54.0	-9.1	1.58 V	241	25.7	19.2

REMARKS:

1. Emission Level(dBuV/m) = Raw Value(dBuV) + Correction Factor(dB/m)
2. Correction Factor(dB/m) = Antenna Factor(dB/m) + Cable Factor(dB) – Pre-Amplifier Factor(dB)
3. The other emission levels were very low against the limit.
4. Margin value = Emission Level – Limit value
5. " * ": Fundamental frequency.
6. " # ": The radiated frequency is out of the restricted band.

802.11ac (VHT20)

CHANNEL	TX Channel 36	DETECTOR FUNCTION	Peak (PK)
FREQUENCY RANGE	1GHz ~ 40GHz		Average (AV)

ANTENNA POLARITY & TEST DISTANCE: HORIZONTAL AT 3 M

NO.	FREQ. (MHz)	EMISSION LEVEL (dBuV/m)	LIMIT (dBuV/m)	MARGIN (dB)	ANTENNA HEIGHT (m)	TABLE ANGLE (Degree)	RAW VALUE (dBuV)	CORRECTION FACTOR (dB/m)
1	5150.00	70.3 PK	74.0	-3.7	3.84 H	101	68.8	1.5
2	5150.00	53.9 AV	54.0	-0.1	3.84 H	101	52.4	1.5
3	*5180.00	113.7 PK			3.84 H	101	112.1	1.6
4	*5180.00	103.6 AV			3.84 H	101	102.0	1.6
5	#10360.00	51.9 PK	74.0	-22.1	2.65 H	162	40.4	11.5
6	#10360.00	39.5 AV	54.0	-14.5	2.65 H	162	28.0	11.5
7	15540.00	53.1 PK	74.0	-20.9	2.19 H	151	40.0	13.1
8	15540.00	40.9 AV	54.0	-13.1	2.19 H	151	27.8	13.1

ANTENNA POLARITY & TEST DISTANCE: VERTICAL AT 3 M

NO.	FREQ. (MHz)	EMISSION LEVEL (dBuV/m)	LIMIT (dBuV/m)	MARGIN (dB)	ANTENNA HEIGHT (m)	TABLE ANGLE (Degree)	RAW VALUE (dBuV)	CORRECTION FACTOR (dB/m)
1	5150.00	68.5 PK	74.0	-5.5	4.00 V	20	67.0	1.5
2	5150.00	50.6 AV	54.0	-3.4	4.00 V	20	49.1	1.5
3	*5180.00	109.5 PK			4.00 V	20	107.9	1.6
4	*5180.00	99.0 AV			4.00 V	20	97.4	1.6
5	#10360.00	51.7 PK	74.0	-22.3	1.89 V	204	40.2	11.5
6	#10360.00	39.2 AV	54.0	-14.8	1.89 V	204	27.7	11.5
7	15540.00	52.5 PK	74.0	-21.5	1.48 V	230	39.4	13.1
8	15540.00	40.7 AV	54.0	-13.3	1.48 V	230	27.6	13.1

REMARKS:

- Emission Level(dBuV/m) = Raw Value(dBuV) + Correction Factor(dB/m)
- Correction Factor(dB/m) = Antenna Factor(dB/m) + Cable Factor(dB) – Pre-Amplifier Factor(dB)
- The other emission levels were very low against the limit.
- Margin value = Emission Level – Limit value
- " * ": Fundamental frequency.
- " # ": The radiated frequency is out of the restricted band.

CHANNEL	TX Channel 40	DETECTOR FUNCTION	Peak (PK)
FREQUENCY RANGE	1GHz ~ 40GHz		Average (AV)

ANTENNA POLARITY & TEST DISTANCE: HORIZONTAL AT 3 M

NO.	FREQ. (MHz)	EMISSION LEVEL (dBuV/m)	LIMIT (dBuV/m)	MARGIN (dB)	ANTENNA HEIGHT (m)	TABLE ANGLE (Degree)	RAW VALUE (dBuV)	CORRECTION FACTOR (dB/m)
1	5150.00	64.2 PK	74.0	-9.8	3.63 H	106	62.7	1.5
2	5150.00	53.9 AV	54.0	-0.1	3.63 H	106	52.4	1.5
3	*5200.00	115.8 PK			3.63 H	106	114.1	1.7
4	*5200.00	105.1 AV			3.63 H	106	103.4	1.7
5	5350.00	63.9 PK	74.0	-10.1	3.63 H	106	62.0	1.9
6	5350.00	52.8 AV	54.0	-1.2	3.63 H	106	50.9	1.9
7	#10400.00	51.9 PK	74.0	-22.1	2.64 H	164	40.3	11.6
8	#10400.00	39.9 AV	54.0	-14.1	2.64 H	164	28.3	11.6
9	15600.00	52.9 PK	74.0	-21.1	2.18 H	160	39.8	13.1
10	15600.00	40.8 AV	54.0	-13.2	2.18 H	160	27.7	13.1

ANTENNA POLARITY & TEST DISTANCE: VERTICAL AT 3 M

NO.	FREQ. (MHz)	EMISSION LEVEL (dBuV/m)	LIMIT (dBuV/m)	MARGIN (dB)	ANTENNA HEIGHT (m)	TABLE ANGLE (Degree)	RAW VALUE (dBuV)	CORRECTION FACTOR (dB/m)
1	5150.00	62.9 PK	74.0	-11.1	3.97 V	22	61.4	1.5
2	5150.00	48.9 AV	54.0	-5.1	3.97 V	22	47.4	1.5
3	*5200.00	110.7 PK			3.97 V	22	109.0	1.7
4	*5200.00	100.0 AV			3.97 V	22	98.3	1.7
5	5350.00	59.2 PK	74.0	-14.8	3.97 V	22	57.3	1.9
6	5350.00	47.7 AV	54.0	-6.3	3.97 V	22	45.8	1.9
7	#10400.00	52.2 PK	74.0	-21.8	1.86 V	219	40.6	11.6
8	#10400.00	39.4 AV	54.0	-14.6	1.86 V	219	27.8	11.6
9	15600.00	52.9 PK	74.0	-21.1	1.45 V	223	39.8	13.1
10	15600.00	40.7 AV	54.0	-13.3	1.45 V	223	27.6	13.1

REMARKS:

- Emission Level(dBuV/m) = Raw Value(dBuV) + Correction Factor(dB/m)
- Correction Factor(dB/m) = Antenna Factor(dB/m) + Cable Factor(dB) – Pre-Amplifier Factor(dB)
- The other emission levels were very low against the limit.
- Margin value = Emission Level – Limit value
- " * ": Fundamental frequency.
- " # ": The radiated frequency is out of the restricted band.

CHANNEL	TX Channel 48	DETECTOR FUNCTION	Peak (PK)
FREQUENCY RANGE	1GHz ~ 40GHz		Average (AV)

ANTENNA POLARITY & TEST DISTANCE: HORIZONTAL AT 3 M

NO.	FREQ. (MHz)	EMISSION LEVEL (dBuV/m)	LIMIT (dBuV/m)	MARGIN (dB)	ANTENNA HEIGHT (m)	TABLE ANGLE (Degree)	RAW VALUE (dBuV)	CORRECTION FACTOR (dB/m)
1	*5240.00	115.4 PK			3.58 H	102	113.8	1.6
2	*5240.00	104.7 AV			3.58 H	102	103.1	1.6
3	5350.00	64.1 PK	74.0	-9.9	3.58 H	102	62.2	1.9
4	5350.00	53.4 AV	54.0	-0.6	3.58 H	102	51.5	1.9
5	#10480.00	52.3 PK	74.0	-21.7	2.64 H	162	40.3	12.0
6	#10480.00	39.8 AV	54.0	-14.2	2.64 H	162	27.8	12.0
7	15720.00	53.4 PK	74.0	-20.6	2.13 H	144	40.2	13.2
8	15720.00	41.2 AV	54.0	-12.8	2.13 H	144	28.0	13.2

ANTENNA POLARITY & TEST DISTANCE: VERTICAL AT 3 M

NO.	FREQ. (MHz)	EMISSION LEVEL (dBuV/m)	LIMIT (dBuV/m)	MARGIN (dB)	ANTENNA HEIGHT (m)	TABLE ANGLE (Degree)	RAW VALUE (dBuV)	CORRECTION FACTOR (dB/m)
1	*5240.00	110.5 PK			4.00 V	25	108.9	1.6
2	*5240.00	100.1 AV			4.00 V	25	98.5	1.6
3	5350.00	60.5 PK	74.0	-13.5	4.00 V	25	58.6	1.9
4	5350.00	48.5 AV	54.0	-5.5	4.00 V	25	46.6	1.9
5	#10480.00	52.5 PK	74.0	-21.5	1.82 V	198	40.5	12.0
6	#10480.00	39.9 AV	54.0	-14.1	1.82 V	198	27.9	12.0
7	15720.00	52.8 PK	74.0	-21.2	1.47 V	252	39.6	13.2
8	15720.00	40.5 AV	54.0	-13.5	1.47 V	252	27.3	13.2

REMARKS:

1. Emission Level(dBuV/m) = Raw Value(dBuV) + Correction Factor(dB/m)
2. Correction Factor(dB/m) = Antenna Factor(dB/m) + Cable Factor(dB) – Pre-Amplifier Factor(dB)
3. The other emission levels were very low against the limit.
4. Margin value = Emission Level – Limit value
5. " * ": Fundamental frequency.
6. " # ": The radiated frequency is out of the restricted band.

CHANNEL	TX Channel 149	DETECTOR FUNCTION	Peak (PK)
FREQUENCY RANGE	1GHz ~ 40GHz		Average (AV)

ANTENNA POLARITY & TEST DISTANCE: HORIZONTAL AT 3 M

NO.	FREQ. (MHz)	EMISSION LEVEL (dBuV/m)	LIMIT (dBuV/m)	MARGIN (dB)	ANTENNA HEIGHT (m)	TABLE ANGLE (Degree)	RAW VALUE (dBuV)	CORRECTION FACTOR (dB/m)
1	*5745.00	116.8 PK			3.75 H	100	114.1	2.7
2	*5745.00	106.5 AV			3.75 H	100	103.8	2.7
3	11490.00	52.9 PK	74.0	-21.1	2.59 H	160	39.5	13.4
4	11490.00	40.8 AV	54.0	-13.2	2.59 H	160	27.4	13.4
5	#17235.00	56.8 PK	74.0	-17.2	2.10 H	135	38.5	18.3
6	#17235.00	44.1 AV	54.0	-9.9	2.10 H	135	25.8	18.3

ANTENNA POLARITY & TEST DISTANCE: VERTICAL AT 3 M

NO.	FREQ. (MHz)	EMISSION LEVEL (dBuV/m)	LIMIT (dBuV/m)	MARGIN (dB)	ANTENNA HEIGHT (m)	TABLE ANGLE (Degree)	RAW VALUE (dBuV)	CORRECTION FACTOR (dB/m)
1	*5745.00	114.9 PK			3.98 V	33	112.2	2.7
2	*5745.00	103.6 AV			3.98 V	33	100.9	2.7
3	11490.00	52.8 PK	74.0	-21.2	1.75 V	221	39.4	13.4
4	11490.00	40.7 AV	54.0	-13.3	1.75 V	221	27.3	13.4
5	#17235.00	56.2 PK	74.0	-17.8	1.62 V	244	37.9	18.3
6	#17235.00	44.5 AV	54.0	-9.5	1.62 V	244	26.2	18.3

REMARKS:

1. Emission Level(dBuV/m) = Raw Value(dBuV) + Correction Factor(dB/m)
2. Correction Factor(dB/m) = Antenna Factor(dB/m) + Cable Factor(dB) – Pre-Amplifier Factor(dB)
3. The other emission levels were very low against the limit.
4. Margin value = Emission Level – Limit value
5. " * ": Fundamental frequency.
6. " # ": The radiated frequency is out of the restricted band.

CHANNEL	TX Channel 157	DETECTOR FUNCTION	Peak (PK)
FREQUENCY RANGE	1GHz ~ 40GHz		Average (AV)

ANTENNA POLARITY & TEST DISTANCE: HORIZONTAL AT 3 M

NO.	FREQ. (MHz)	EMISSION LEVEL (dBuV/m)	LIMIT (dBuV/m)	MARGIN (dB)	ANTENNA HEIGHT (m)	TABLE ANGLE (Degree)	RAW VALUE (dBuV)	CORRECTION FACTOR (dB/m)
1	*5785.00	117.6 PK			3.74 H	98	114.9	2.7
2	*5785.00	107.0 AV			3.74 H	98	104.3	2.7
3	11570.00	53.0 PK	74.0	-21.0	2.57 H	162	39.9	13.1
4	11570.00	41.1 AV	54.0	-12.9	2.57 H	162	28.0	13.1
5	#17355.00	57.2 PK	74.0	-16.8	2.07 H	139	38.4	18.8
6	#17355.00	44.5 AV	54.0	-9.5	2.07 H	139	25.7	18.8

ANTENNA POLARITY & TEST DISTANCE: VERTICAL AT 3 M

NO.	FREQ. (MHz)	EMISSION LEVEL (dBuV/m)	LIMIT (dBuV/m)	MARGIN (dB)	ANTENNA HEIGHT (m)	TABLE ANGLE (Degree)	RAW VALUE (dBuV)	CORRECTION FACTOR (dB/m)
1	*5785.00	114.5 PK			3.73 V	32	111.8	2.7
2	*5785.00	103.1 AV			3.73 V	32	100.4	2.7
3	11570.00	53.3 PK	74.0	-20.7	1.78 V	223	40.2	13.1
4	11570.00	40.9 AV	54.0	-13.1	1.78 V	223	27.8	13.1
5	#17355.00	56.6 PK	74.0	-17.4	1.66 V	232	37.8	18.8
6	#17355.00	44.9 AV	54.0	-9.1	1.66 V	232	26.1	18.8

REMARKS:

1. Emission Level(dBuV/m) = Raw Value(dBuV) + Correction Factor(dB/m)
2. Correction Factor(dB/m) = Antenna Factor(dB/m) + Cable Factor(dB) – Pre-Amplifier Factor(dB)
3. The other emission levels were very low against the limit.
4. Margin value = Emission Level – Limit value
5. " * ": Fundamental frequency.
6. " # ": The radiated frequency is out of the restricted band.

CHANNEL	TX Channel 165	DETECTOR FUNCTION	Peak (PK)
FREQUENCY RANGE	1GHz ~ 40GHz		Average (AV)

ANTENNA POLARITY & TEST DISTANCE: HORIZONTAL AT 3 M

NO.	FREQ. (MHz)	EMISSION LEVEL (dBuV/m)	LIMIT (dBuV/m)	MARGIN (dB)	ANTENNA HEIGHT (m)	TABLE ANGLE (Degree)	RAW VALUE (dBuV)	CORRECTION FACTOR (dB/m)
1	*5825.00	118.7 PK			3.72 H	97	116.0	2.7
2	*5825.00	107.2 AV			3.72 H	97	104.5	2.7
3	11650.00	53.4 PK	74.0	-20.6	2.44 H	168	40.3	13.1
4	11650.00	41.8 AV	54.0	-12.2	2.44 H	168	28.7	13.1
5	#17475.00	57.7 PK	74.0	-16.3	2.01 H	141	38.5	19.2
6	#17475.00	44.9 AV	54.0	-9.1	2.01 H	141	25.7	19.2

ANTENNA POLARITY & TEST DISTANCE: VERTICAL AT 3 M

NO.	FREQ. (MHz)	EMISSION LEVEL (dBuV/m)	LIMIT (dBuV/m)	MARGIN (dB)	ANTENNA HEIGHT (m)	TABLE ANGLE (Degree)	RAW VALUE (dBuV)	CORRECTION FACTOR (dB/m)
1	*5825.00	113.2 PK			3.69 V	31	110.5	2.7
2	*5825.00	102.2 AV			3.69 V	31	99.5	2.7
3	11650.00	53.2 PK	74.0	-20.8	1.78 V	237	40.1	13.1
4	11650.00	41.2 AV	54.0	-12.8	1.78 V	237	28.1	13.1
5	#17475.00	56.4 PK	74.0	-17.6	1.56 V	244	37.2	19.2
6	#17475.00	44.6 AV	54.0	-9.4	1.56 V	244	25.4	19.2

REMARKS:

1. Emission Level(dBuV/m) = Raw Value(dBuV) + Correction Factor(dB/m)
2. Correction Factor(dB/m) = Antenna Factor(dB/m) + Cable Factor(dB) – Pre-Amplifier Factor(dB)
3. The other emission levels were very low against the limit.
4. Margin value = Emission Level – Limit value
5. " * ": Fundamental frequency.
6. " # ": The radiated frequency is out of the restricted band.

802.11ac (VHT40)

CHANNEL	TX Channel 38	DETECTOR FUNCTION	Peak (PK)
FREQUENCY RANGE	1GHz ~ 40GHz		Average (AV)

ANTENNA POLARITY & TEST DISTANCE: HORIZONTAL AT 3 M

NO.	FREQ. (MHz)	EMISSION LEVEL (dBuV/m)	LIMIT (dBuV/m)	MARGIN (dB)	ANTENNA HEIGHT (m)	TABLE ANGLE (Degree)	RAW VALUE (dBuV)	CORRECTION FACTOR (dB/m)
1	5150.00	70.5 PK	74.0	-3.5	3.62 H	105	69.0	1.5
2	5150.00	53.7 AV	54.0	-0.3	3.62 H	105	52.2	1.5
3	*5190.00	107.8 PK			3.62 H	105	106.1	1.7
4	*5190.00	96.3 AV			3.62 H	105	94.6	1.7
5	5350.00	58.7 PK	74.0	-15.3	3.62 H	105	56.8	1.9
6	5350.00	49.1 AV	54.0	-4.9	3.62 H	105	47.2	1.9
7	#10380.00	52.1 PK	74.0	-21.9	2.70 H	164	40.6	11.5
8	#10380.00	39.9 AV	54.0	-14.1	2.70 H	164	28.4	11.5
9	15570.00	52.9 PK	74.0	-21.1	2.16 H	137	39.8	13.1
10	15570.00	40.9 AV	54.0	-13.1	2.16 H	137	27.8	13.1

ANTENNA POLARITY & TEST DISTANCE: VERTICAL AT 3 M

NO.	FREQ. (MHz)	EMISSION LEVEL (dBuV/m)	LIMIT (dBuV/m)	MARGIN (dB)	ANTENNA HEIGHT (m)	TABLE ANGLE (Degree)	RAW VALUE (dBuV)	CORRECTION FACTOR (dB/m)
1	5150.00	68.3 PK	74.0	-5.7	3.90 V	22	66.8	1.5
2	5150.00	46.6 AV	54.0	-7.4	3.90 V	22	45.1	1.5
3	*5190.00	103.8 PK			3.90 V	22	102.1	1.7
4	*5190.00	92.7 AV			3.90 V	22	91.0	1.7
5	5350.00	55.6 PK	74.0	-18.4	3.90 V	22	53.7	1.9
6	5350.00	44.0 AV	54.0	-10.0	3.90 V	22	42.1	1.9
7	#10380.00	52.9 PK	74.0	-21.1	1.83 V	195	41.4	11.5
8	#10380.00	40.3 AV	54.0	-13.7	1.83 V	195	28.8	11.5
9	15570.00	52.7 PK	74.0	-21.3	1.41 V	257	39.6	13.1
10	15570.00	40.6 AV	54.0	-13.4	1.41 V	257	27.5	13.1

REMARKS:

1. Emission Level(dBuV/m) = Raw Value(dBuV) + Correction Factor(dB/m)
2. Correction Factor(dB/m) = Antenna Factor(dB/m) + Cable Factor(dB) – Pre-Amplifier Factor(dB)
3. The other emission levels were very low against the limit.
4. Margin value = Emission Level – Limit value
5. " * ": Fundamental frequency.
6. " # ": The radiated frequency is out of the restricted band.

CHANNEL	TX Channel 46	DETECTOR FUNCTION	Peak (PK)
FREQUENCY RANGE	1GHz ~ 40GHz		Average (AV)

ANTENNA POLARITY & TEST DISTANCE: HORIZONTAL AT 3 M

NO.	FREQ. (MHz)	EMISSION LEVEL (dBuV/m)	LIMIT (dBuV/m)	MARGIN (dB)	ANTENNA HEIGHT (m)	TABLE ANGLE (Degree)	RAW VALUE (dBuV)	CORRECTION FACTOR (dB/m)
1	*5230.00	112.8 PK			3.55 H	101	111.2	1.6
2	*5230.00	101.1 AV			3.55 H	101	99.5	1.6
3	5350.00	61.4 PK	74.0	-12.6	3.55 H	101	59.5	1.9
4	5350.00	50.6 AV	54.0	-3.4	3.55 H	101	48.7	1.9
5	#10460.00	51.9 PK	74.0	-22.1	2.67 H	169	40.0	11.9
6	#10460.00	39.5 AV	54.0	-14.5	2.67 H	169	27.6	11.9
7	15690.00	53.5 PK	74.0	-20.5	2.15 H	150	40.2	13.3
8	15690.00	41.2 AV	54.0	-12.8	2.15 H	150	27.9	13.3

ANTENNA POLARITY & TEST DISTANCE: VERTICAL AT 3 M

NO.	FREQ. (MHz)	EMISSION LEVEL (dBuV/m)	LIMIT (dBuV/m)	MARGIN (dB)	ANTENNA HEIGHT (m)	TABLE ANGLE (Degree)	RAW VALUE (dBuV)	CORRECTION FACTOR (dB/m)
1	*5230.00	107.3 PK			3.83 V	22	105.7	1.6
2	*5230.00	96.2 AV			3.83 V	22	94.6	1.6
3	5350.00	58.2 PK	74.0	-15.8	3.83 V	22	56.3	1.9
4	5350.00	46.0 AV	54.0	-8.0	3.83 V	22	44.1	1.9
5	#10460.00	52.1 PK	74.0	-21.9	1.85 V	194	40.2	11.9
6	#10460.00	39.4 AV	54.0	-14.6	1.85 V	194	27.5	11.9
7	15690.00	53.3 PK	74.0	-20.7	1.52 V	245	40.0	13.3
8	15690.00	40.7 AV	54.0	-13.3	1.52 V	245	27.4	13.3

REMARKS:

1. Emission Level(dBuV/m) = Raw Value(dBuV) + Correction Factor(dB/m)
2. Correction Factor(dB/m) = Antenna Factor(dB/m) + Cable Factor(dB) – Pre-Amplifier Factor(dB)
3. The other emission levels were very low against the limit.
4. Margin value = Emission Level – Limit value
5. " * ": Fundamental frequency.
6. " # ": The radiated frequency is out of the restricted band.

CHANNEL	TX Channel 151	DETECTOR FUNCTION	Peak (PK)
FREQUENCY RANGE	1GHz ~ 40GHz		Average (AV)

ANTENNA POLARITY & TEST DISTANCE: HORIZONTAL AT 3 M

NO.	FREQ. (MHz)	EMISSION LEVEL (dBuV/m)	LIMIT (dBuV/m)	MARGIN (dB)	ANTENNA HEIGHT (m)	TABLE ANGLE (Degree)	RAW VALUE (dBuV)	CORRECTION FACTOR (dB/m)
1	*5755.00	115.0 PK			3.77 H	109	112.3	2.7
2	*5755.00	103.4 AV			3.77 H	109	100.7	2.7
3	11510.00	53.1 PK	74.0	-20.9	2.33 H	154	39.7	13.4
4	11510.00	42.2 AV	54.0	-11.8	2.33 H	154	28.8	13.4
5	#17265.00	57.9 PK	74.0	-16.1	2.03 H	144	39.6	18.3
6	#17265.00	44.8 AV	54.0	-9.2	2.03 H	144	26.5	18.3

ANTENNA POLARITY & TEST DISTANCE: VERTICAL AT 3 M

NO.	FREQ. (MHz)	EMISSION LEVEL (dBuV/m)	LIMIT (dBuV/m)	MARGIN (dB)	ANTENNA HEIGHT (m)	TABLE ANGLE (Degree)	RAW VALUE (dBuV)	CORRECTION FACTOR (dB/m)
1	*5755.00	111.6 PK			3.73 V	29	108.9	2.7
2	*5755.00	99.6 AV			3.73 V	29	96.9	2.7
3	11510.00	53.4 PK	74.0	-20.6	1.84 V	248	40.0	13.4
4	11510.00	41.5 AV	54.0	-12.5	1.84 V	248	28.1	13.4
5	#17265.00	56.2 PK	74.0	-17.8	1.55 V	250	37.9	18.3
6	#17265.00	44.4 AV	54.0	-9.6	1.55 V	250	26.1	18.3

REMARKS:

1. Emission Level(dBuV/m) = Raw Value(dBuV) + Correction Factor(dB/m)
2. Correction Factor(dB/m) = Antenna Factor(dB/m) + Cable Factor(dB) – Pre-Amplifier Factor(dB)
3. The other emission levels were very low against the limit.
4. Margin value = Emission Level – Limit value
5. " * ": Fundamental frequency.
6. " # ": The radiated frequency is out of the restricted band.

CHANNEL	TX Channel 159	DETECTOR FUNCTION	Peak (PK)
FREQUENCY RANGE	1GHz ~ 40GHz		Average (AV)

ANTENNA POLARITY & TEST DISTANCE: HORIZONTAL AT 3 M

NO.	FREQ. (MHz)	EMISSION LEVEL (dBuV/m)	LIMIT (dBuV/m)	MARGIN (dB)	ANTENNA HEIGHT (m)	TABLE ANGLE (Degree)	RAW VALUE (dBuV)	CORRECTION FACTOR (dB/m)
1	*5795.00	112.9 PK			3.80 H	105	110.2	2.7
2	*5795.00	101.6 AV			3.80 H	105	98.9	2.7
3	11590.00	53.8 PK	74.0	-20.2	2.40 H	160	40.8	13.0
4	11590.00	42.7 AV	54.0	-11.3	2.40 H	160	29.7	13.0
5	#17385.00	58.2 PK	74.0	-15.8	2.10 H	138	39.2	19.0
6	#17385.00	45.3 AV	54.0	-8.7	2.10 H	138	26.3	19.0

ANTENNA POLARITY & TEST DISTANCE: VERTICAL AT 3 M

NO.	FREQ. (MHz)	EMISSION LEVEL (dBuV/m)	LIMIT (dBuV/m)	MARGIN (dB)	ANTENNA HEIGHT (m)	TABLE ANGLE (Degree)	RAW VALUE (dBuV)	CORRECTION FACTOR (dB/m)
1	*5795.00	110.8 PK			3.73 V	33	108.1	2.7
2	*5795.00	99.7 AV			3.73 V	33	97.0	2.7
3	11590.00	53.2 PK	74.0	-20.8	1.83 V	242	40.2	13.0
4	11590.00	41.3 AV	54.0	-12.7	1.83 V	242	28.3	13.0
5	#17385.00	56.3 PK	74.0	-17.7	1.50 V	248	37.3	19.0
6	#17385.00	44.8 AV	54.0	-9.2	1.50 V	248	25.8	19.0

REMARKS:

1. Emission Level(dBuV/m) = Raw Value(dBuV) + Correction Factor(dB/m)
2. Correction Factor(dB/m) = Antenna Factor(dB/m) + Cable Factor(dB) – Pre-Amplifier Factor(dB)
3. The other emission levels were very low against the limit.
4. Margin value = Emission Level – Limit value
5. " * " : Fundamental frequency.
6. " # " : The radiated frequency is out of the restricted band.

802.11ac (VHT80)

CHANNEL	TX Channel 42	DETECTOR FUNCTION	Peak (PK)
FREQUENCY RANGE	1GHz ~ 40GHz		Average (AV)

ANTENNA POLARITY & TEST DISTANCE: HORIZONTAL AT 3 M

NO.	FREQ. (MHz)	EMISSION LEVEL (dBuV/m)	LIMIT (dBuV/m)	MARGIN (dB)	ANTENNA HEIGHT (m)	TABLE ANGLE (Degree)	RAW VALUE (dBuV)	CORRECTION FACTOR (dB/m)
1	5150.00	70.3 PK	74.0	-3.7	3.60 H	112	68.8	1.5
2	5150.00	53.7 AV	54.0	-0.3	3.60 H	112	52.2	1.5
3	*5210.00	105.4 PK			3.60 H	112	103.7	1.7
4	*5210.00	92.6 AV			3.60 H	112	90.9	1.7
5	5350.00	59.2 PK	74.0	-14.8	3.60 H	112	57.3	1.9
6	5350.00	48.5 AV	54.0	-5.5	3.60 H	112	46.6	1.9
7	#10420.00	51.6 PK	74.0	-22.4	2.63 H	167	39.9	11.7
8	#10420.00	39.3 AV	54.0	-14.7	2.63 H	167	27.6	11.7
9	15630.00	53.2 PK	74.0	-20.8	2.21 H	156	40.0	13.2
10	15630.00	41.2 AV	54.0	-12.8	2.21 H	156	28.0	13.2

ANTENNA POLARITY & TEST DISTANCE: VERTICAL AT 3 M

NO.	FREQ. (MHz)	EMISSION LEVEL (dBuV/m)	LIMIT (dBuV/m)	MARGIN (dB)	ANTENNA HEIGHT (m)	TABLE ANGLE (Degree)	RAW VALUE (dBuV)	CORRECTION FACTOR (dB/m)
1	5150.00	67.5 PK	74.0	-6.5	3.92 V	22	66.0	1.5
2	5150.00	49.0 AV	54.0	-5.0	3.92 V	22	47.5	1.5
3	*5210.00	100.7 PK			3.92 V	22	99.0	1.7
4	*5210.00	90.6 AV			3.92 V	22	88.9	1.7
5	5350.00	55.3 PK	74.0	-18.7	3.92 V	22	53.4	1.9
6	5350.00	44.0 AV	54.0	-10.0	3.92 V	22	42.1	1.9
7	#10420.00	51.8 PK	74.0	-22.2	1.89 V	204	40.1	11.7
8	#10420.00	39.2 AV	54.0	-14.8	1.89 V	204	27.5	11.7
9	15630.00	53.7 PK	74.0	-20.3	1.50 V	232	40.5	13.2
10	15630.00	41.0 AV	54.0	-13.0	1.50 V	232	27.8	13.2

REMARKS:

- Emission Level(dBuV/m) = Raw Value(dBuV) + Correction Factor(dB/m)
- Correction Factor(dB/m) = Antenna Factor(dB/m) + Cable Factor(dB) – Pre-Amplifier Factor(dB)
- The other emission levels were very low against the limit.
- Margin value = Emission Level – Limit value
- " * ": Fundamental frequency.
- " # ": The radiated frequency is out of the restricted band.

CHANNEL	TX Channel 155	DETECTOR FUNCTION	Peak (PK)
FREQUENCY RANGE	1GHz ~ 40GHz		Average (AV)

ANTENNA POLARITY & TEST DISTANCE: HORIZONTAL AT 3 M

NO.	FREQ. (MHz)	EMISSION LEVEL (dBuV/m)	LIMIT (dBuV/m)	MARGIN (dB)	ANTENNA HEIGHT (m)	TABLE ANGLE (Degree)	RAW VALUE (dBuV)	CORRECTION FACTOR (dB/m)
1	*5775.00	110.3 PK			3.77 H	94	107.6	2.7
2	*5775.00	100.1 AV			3.77 H	94	97.4	2.7
3	11550.00	52.3 PK	74.0	-21.7	2.48 H	154	39.1	13.2
4	11550.00	39.3 AV	54.0	-14.7	2.48 H	154	26.1	13.2
5	#17325.00	57.4 PK	74.0	-16.6	2.17 H	149	38.8	18.6
6	#17325.00	45.2 AV	54.0	-8.8	2.17 H	149	26.6	18.6

ANTENNA POLARITY & TEST DISTANCE: VERTICAL AT 3 M

NO.	FREQ. (MHz)	EMISSION LEVEL (dBuV/m)	LIMIT (dBuV/m)	MARGIN (dB)	ANTENNA HEIGHT (m)	TABLE ANGLE (Degree)	RAW VALUE (dBuV)	CORRECTION FACTOR (dB/m)
1	*5775.00	106.6 PK			3.76 V	32	103.9	2.7
2	*5775.00	96.6 AV			3.76 V	32	93.9	2.7
3	11550.00	53.0 PK	74.0	-21.0	1.77 V	244	39.8	13.2
4	11550.00	40.9 AV	54.0	-13.1	1.77 V	244	27.7	13.2
5	#17325.00	56.2 PK	74.0	-17.8	1.56 V	229	37.6	18.6
6	#17325.00	44.7 AV	54.0	-9.3	1.56 V	229	26.1	18.6

REMARKS:

1. Emission Level(dBuV/m) = Raw Value(dBuV) + Correction Factor(dB/m)
2. Correction Factor(dB/m) = Antenna Factor(dB/m) + Cable Factor(dB) – Pre-Amplifier Factor(dB)
3. The other emission levels were very low against the limit.
4. Margin value = Emission Level – Limit value
5. " * ": Fundamental frequency.
6. " # ": The radiated frequency is out of the restricted band.

Below 1GHz Data:

802.11ac (VHT20)

CHANNEL	TX Channel 149	DETECTOR FUNCTION	Quasi-Peak (QP)
FREQUENCY RANGE	9KHz ~ 1GHz		

ANTENNA POLARITY & TEST DISTANCE: HORIZONTAL AT 3 M

NO.	FREQ. (MHz)	EMISSION LEVEL (dBuV/m)	LIMIT (dBuV/m)	MARGIN (dB)	ANTENNA HEIGHT (m)	TABLE ANGLE (Degree)	RAW VALUE (dBuV)	CORRECTION FACTOR (dB/m)
1	33.15	29.8 QP	40.0	-10.2	2.00 H	290	39.5	-9.7
2	84.13	30.9 QP	40.0	-9.1	2.00 H	103	45.1	-14.2
3	215.32	31.1 QP	43.5	-12.4	2.00 H	98	43.1	-12.0
4	250.00	29.5 QP	46.0	-16.5	1.00 H	283	39.5	-10.0
5	374.98	33.4 QP	46.0	-12.6	1.00 H	243	39.4	-6.0
6	625.00	33.4 QP	46.0	-12.6	1.50 H	0	33.4	0.0

ANTENNA POLARITY & TEST DISTANCE: VERTICAL AT 3 M

NO.	FREQ. (MHz)	EMISSION LEVEL (dBuV/m)	LIMIT (dBuV/m)	MARGIN (dB)	ANTENNA HEIGHT (m)	TABLE ANGLE (Degree)	RAW VALUE (dBuV)	CORRECTION FACTOR (dB/m)
1	98.36	32.2 QP	43.5	-11.3	1.00 V	0	45.4	-13.2
2	207.56	30.3 QP	43.5	-13.2	1.00 V	0	42.3	-12.0
3	250.00	29.7 QP	46.0	-16.3	2.00 V	0	39.7	-10.0
4	375.00	32.6 QP	46.0	-13.4	1.50 V	87	38.6	-6.0
5	540.00	29.2 QP	46.0	-16.8	1.00 V	207	31.4	-2.2
6	675.03	29.3 QP	46.0	-16.7	1.50 V	284	29.1	0.2
7	750.01	31.5 QP	46.0	-14.5	1.50 V	331	29.6	1.9

REMARKS:

1. Emission Level(dBuV/m) = Raw Value(dBuV) + Correction Factor(dB/m)
2. Correction Factor(dB/m) = Antenna Factor(dB/m) + Cable Factor(dB) – Pre-Amplifier Factor(dB)
3. The other emission levels were very low against the limit.
4. Margin value = Emission Level – Limit value

4.2 Conducted Emission Measurement

4.2.1 Limits of Conducted Emission Measurement

Frequency (MHz)	Conducted Limit (dBuV)	
	Quasi-peak	Average
0.15 - 0.5	66 - 56	56 - 46
0.50 - 5.0	56	46
5.0 - 30.0	60	50

Note: 1. The lower limit shall apply at the transition frequencies.

2. The limit decreases in line with the logarithm of the frequency in the range of 0.15 to 0.50MHz.

4.2.2 Test Instruments

DESCRIPTION & MANUFACTURER	MODEL NO.	SERIAL NO.	CALIBRATED DATE	CALIBRATED UNTIL
Test Receiver R&S	ESCS 30	100287	Apr. 16, 2016	Apr. 15, 2017
Line-Impedance Stabilization Network (for EUT) SCHWARZBECK	NSLK-8127	8127-523	Oct. 11, 2016	Oct. 10, 2017
Line-Impedance Stabilization Network (for Peripheral) R&S	ENV216	100071	Nov. 11, 2015	Nov. 10, 2016
RF Cable	5D-FB	COACAB-001	May 24, 2016	May 23, 2017
10 dB PAD Mini-Circuits	HAT-10+	CONATT-001	Sep. 13, 2016	Sep. 12, 2017
50 ohms Terminator	N/A	EMC-01	Oct. 06, 2016	Oct. 05, 2017
50 ohms Terminator	N/A	EMC-02	Sep. 29, 2016	Sep. 28, 2017
Software BVADT	BVADT_Cond_ V7.3.7.4	NA	NA	NA

Note:

1. The calibration interval of the above test instruments are 12 months and the calibrations are traceable to NML/ROC and NIST/USA.
2. The test was performed in Shielded Room No. C.
3. The VCCI Con C Registration No. is C-3611.
4. Tested Date: Nov. 03 to 04, 2016

4.2.3 Test Procedure

- The EUT was placed 0.4 meters from the conducting wall of the shielded room with EUT being connected to the power mains through a line impedance stabilization network (LISN). Other support units were connected to the power mains through another LISN. The two LISNs provide 50 ohm/ 50uH of coupling impedance for the measuring instrument.
- Both lines of the power mains connected to the EUT were checked for maximum conducted interference.
- The frequency range from 150kHz to 30MHz was searched. Emission levels under (Limit - 20dB) was not recorded.

NOTE: All modes of operation were investigated and the worst-case emissions are reported.

4.2.4 Deviation from Test Standard

No deviation.

4.2.5 Test Setup

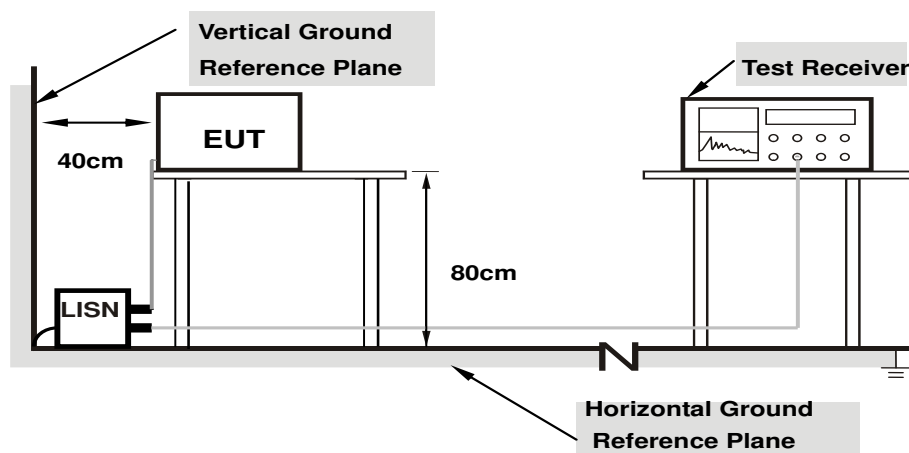

Note: 1.Support units were connected to second LISN.

For the actual test configuration, please refer to the attached file (Test Setup Photo).

4.2.6 EUT Operating Condition

Same as 4.1.6.

4.2.7 Test Results (Mode 1)

Phase	Line (L)	Detector Function	Quasi-Peak (QP) / Average (AV)
-------	----------	-------------------	--------------------------------

No	Freq. [MHz]	Corr.	Reading Value		Emission Level		Limit		Margin	
		Factor (dB)	[dB (uV)]		[dB (uV)]		[dB (uV)]		(dB)	
			Q.P.	AV.	Q.P.	AV.	Q.P.	AV.	Q.P.	AV.
1	0.16562	10.30	35.69	29.73	45.99	40.03	65.18	55.18	-19.19	-15.15
2	0.22812	10.30	31.43	24.19	41.73	34.49	62.52	52.52	-20.79	-18.03
3	0.32188	10.32	30.84	25.04	41.16	35.36	59.66	49.66	-18.50	-14.30
4	0.40781	10.34	21.59	15.83	31.93	26.17	57.69	47.69	-25.76	-21.52
5	3.72656	10.49	24.77	19.31	35.26	29.80	56.00	46.00	-20.74	-16.20
6	20.28516	10.99	3.57	-1.43	14.56	9.56	60.00	50.00	-45.44	-40.44

REMARKS:

1. Q.P. and AV. are abbreviations of quasi-peak and average individually.
2. The emission levels of other frequencies were very low against the limit.
3. Margin value = Emission level - Limit value
4. Correction factor = Insertion loss + Cable loss
5. Emission Level = Correction Factor + Reading Value.

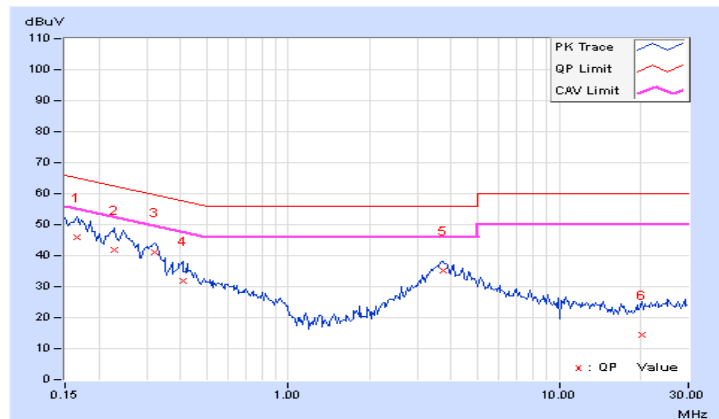

Phase	Neutral (N)	Detector Function	Quasi-Peak (QP) / Average (AV)
-------	-------------	-------------------	--------------------------------

No	Freq. [MHz]	Corr.	Reading Value		Emission Level		Limit		Margin	
		Factor (dB)	[dB (uV)]		[dB (uV)]		[dB (uV)]		(dB)	
			Q.P.	AV.	Q.P.	AV.	Q.P.	AV.	Q.P.	AV.
1	0.15781	10.36	33.15	25.69	43.51	36.05	65.58	55.58	-22.07	-19.53
2	0.21641	10.37	31.15	24.29	41.52	34.66	62.96	52.96	-21.44	-18.30
3	0.31016	10.40	28.34	21.91	38.74	32.31	59.97	49.97	-21.23	-17.66
4	0.93906	10.54	12.25	6.38	22.79	16.92	56.00	46.00	-33.21	-29.08
5	3.41016	10.56	24.61	18.96	35.17	29.52	56.00	46.00	-20.83	-16.48
6	22.12891	11.03	6.29	1.62	17.32	12.65	60.00	50.00	-42.68	-37.35

REMARKS:

1. Q.P. and AV. are abbreviations of quasi-peak and average individually.
2. The emission levels of other frequencies were very low against the limit.
3. Margin value = Emission level - Limit value
4. Correction factor = Insertion loss + Cable loss
5. Emission Level = Correction Factor + Reading Value.

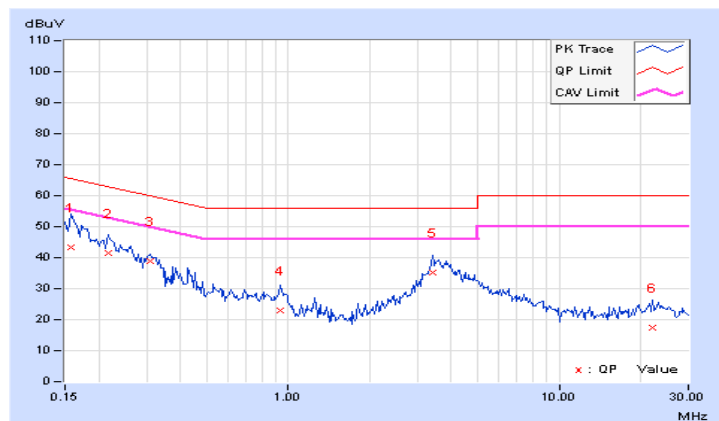

4.2.8 Test Results (Mode 2)

Phase	Line (L)	Detector Function	Quasi-Peak (QP) / Average (AV)
-------	----------	-------------------	--------------------------------

No	Freq. [MHz]	Corr.	Reading Value		Emission Level		Limit		Margin	
		Factor (dB)	[dB (uV)]		[dB (uV)]		[dB (uV)]		(dB)	
	Q.P.	AV.	Q.P.	AV.	Q.P.	AV.	Q.P.	AV.	Q.P.	AV.
1	0.16562	10.30	47.33	33.35	57.63	43.65	65.18	55.18	-7.55	-11.53
2	0.18516	10.29	40.51	18.55	50.80	28.84	64.25	54.25	-13.45	-25.41
3	0.22422	10.30	39.37	29.00	49.67	39.30	62.66	52.66	-12.99	-13.36
4	0.24375	10.30	34.81	17.85	45.11	28.15	61.97	51.97	-16.86	-23.82
5	0.33359	10.32	35.58	27.31	45.90	37.63	59.36	49.36	-13.46	-11.73
6	0.41563	10.34	26.50	12.15	36.84	22.49	57.54	47.54	-20.70	-25.05
7	15.71484	10.84	25.91	18.25	36.75	29.09	60.00	50.00	-23.25	-20.91

REMARKS:

1. Q.P. and AV. are abbreviations of quasi-peak and average individually.
2. The emission levels of other frequencies were very low against the limit.
3. Margin value = Emission level - Limit value
4. Correction factor = Insertion loss + Cable loss
5. Emission Level = Correction Factor + Reading Value.

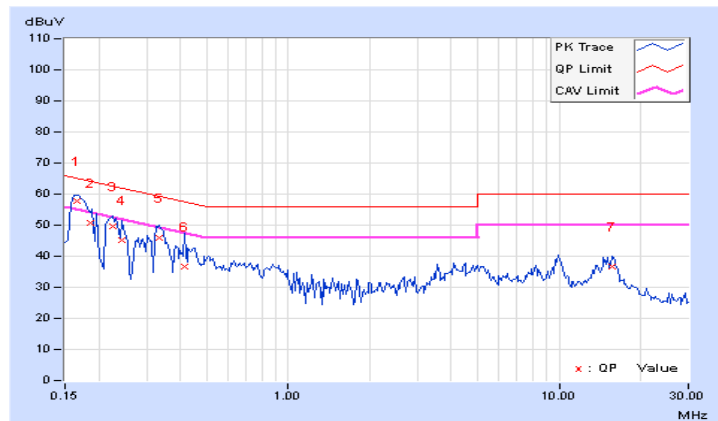

Phase	Neutral (N)	Detector Function	Quasi-Peak (QP) / Average (AV)
-------	-------------	-------------------	--------------------------------

No	Freq. [MHz]	Corr. Factor	Reading Value [dB (uV)]		Emission Level [dB (uV)]		Limit [dB (uV)]		Margin (dB)	
		(dB)	Q.P.	AV.	Q.P.	AV.	Q.P.	AV.	Q.P.	AV.
	1	0.16172	10.36	45.64	28.39	56.00	38.75	65.38	55.38	-9.38
2	0.18516	10.36	39.87	20.24	50.23	30.60	64.25	54.25	-14.02	-23.65
3	0.22422	10.37	39.54	28.53	49.91	38.90	62.66	52.66	-12.75	-13.76
4	0.25156	10.38	35.03	14.85	45.41	25.23	61.71	51.71	-16.30	-26.48
5	0.34141	10.42	33.71	24.03	44.13	34.45	59.17	49.17	-15.04	-14.72
6	0.50156	10.46	25.83	17.47	36.29	27.93	56.00	46.00	-19.71	-18.07
7	9.85547	10.67	23.88	17.08	34.55	27.75	60.00	50.00	-25.45	-22.25

REMARKS:

1. Q.P. and AV. are abbreviations of quasi-peak and average individually.
2. The emission levels of other frequencies were very low against the limit.
3. Margin value = Emission level - Limit value
4. Correction factor = Insertion loss + Cable loss
5. Emission Level = Correction Factor + Reading Value.

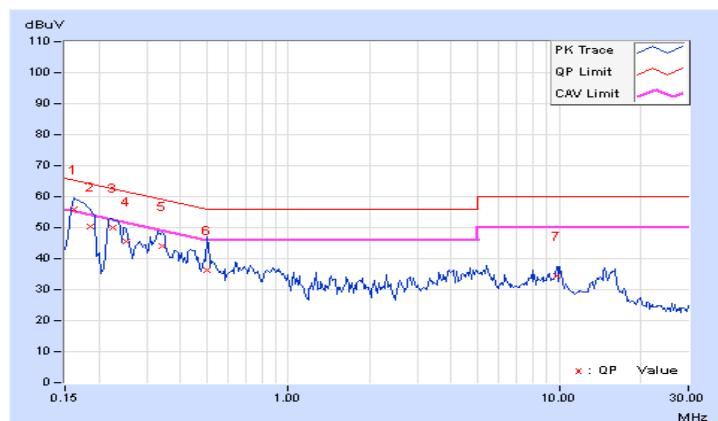

4.2.9 Test Results (Mode 3)

Phase	Line (L)	Detector Function	Quasi-Peak (QP) / Average (AV)
-------	----------	-------------------	--------------------------------

No	Freq. [MHz]	Corr.	Reading Value		Emission Level		Limit		Margin	
		Factor	[dB (uV)]		[dB (uV)]		[dB (uV)]		(dB)	
	(dB)	Q.P.	AV.	Q.P.	AV.	Q.P.	AV.	Q.P.	AV.	
1	0.15391	10.30	41.61	28.51	51.91	38.81	65.79	55.79	-13.88	-16.98
2	0.17344	10.30	36.89	26.07	47.19	36.37	64.79	54.79	-17.60	-18.42
3	0.21250	10.29	35.94	26.83	46.23	37.12	63.11	53.11	-16.88	-15.99
4	0.29844	10.31	39.45	33.20	49.76	43.51	60.29	50.29	-10.53	-6.78
5	0.34141	10.33	27.25	19.21	37.58	29.54	59.17	49.17	-21.59	-19.63
6	0.52891	10.37	17.66	9.97	28.03	20.34	56.00	46.00	-27.97	-25.66
7	9.94922	10.64	16.05	8.99	26.69	19.63	60.00	50.00	-33.31	-30.37

REMARKS:

1. Q.P. and AV. are abbreviations of quasi-peak and average individually.
2. The emission levels of other frequencies were very low against the limit.
3. Margin value = Emission level - Limit value
4. Correction factor = Insertion loss + Cable loss
5. Emission Level = Correction Factor + Reading Value.

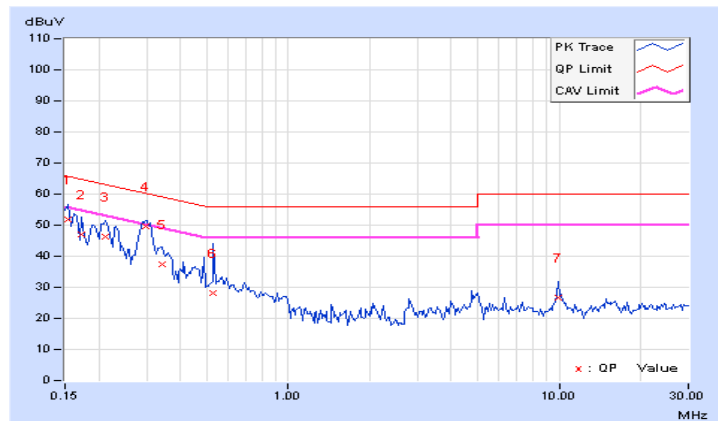

Phase	Neutral (N)	Detector Function	Quasi-Peak (QP) / Average (AV)
-------	-------------	-------------------	--------------------------------

No	Freq. [MHz]	Corr. Factor	Reading Value [dB (uV)]		Emission Level [dB (uV)]		Limit [dB (uV)]		Margin (dB)	
		(dB)	Q.P.	AV.	Q.P.	AV.	Q.P.	AV.	Q.P.	AV.
	1	0.15391	10.36	40.88	28.57	51.24	38.93	65.79	55.79	-14.55
2	0.16953	10.36	37.56	26.59	47.92	36.95	64.98	54.98	-17.06	-18.03
3	0.22031	10.37	34.39	24.65	44.76	35.02	62.81	52.81	-18.05	-17.79
4	0.29844	10.40	38.32	31.52	48.72	41.92	60.29	50.29	-11.57	-8.37
5	0.35703	10.42	26.21	19.87	36.63	30.29	58.80	48.80	-22.17	-18.51
6	4.69141	10.58	12.95	5.41	23.53	15.99	56.00	46.00	-32.47	-30.01
7	6.72656	10.62	7.09	2.29	17.71	12.91	60.00	50.00	-42.29	-37.09

REMARKS:

1. Q.P. and AV. are abbreviations of quasi-peak and average individually.
2. The emission levels of other frequencies were very low against the limit.
3. Margin value = Emission level - Limit value
4. Correction factor = Insertion loss + Cable loss
5. Emission Level = Correction Factor + Reading Value.

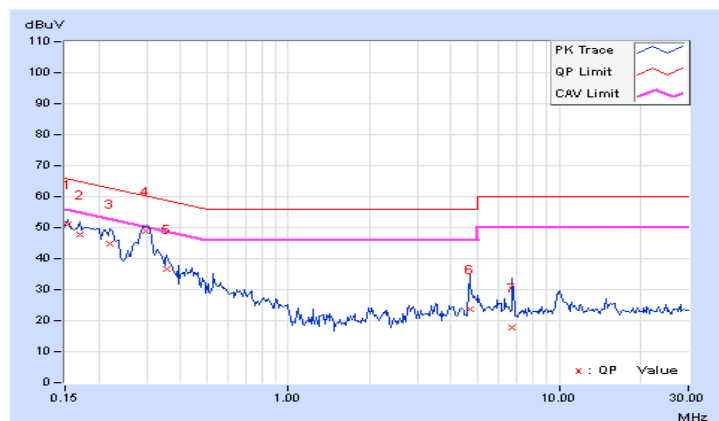

4.2.10 Test Results (Mode 4)

Phase	Line (L)	Detector Function	Quasi-Peak (QP) / Average (AV)
-------	----------	-------------------	--------------------------------

No	Freq. [MHz]	Corr.	Reading Value		Emission Level		Limit		Margin	
		Factor	[dB (uV)]		[dB (uV)]		[dB (uV)]		(dB)	
	(dB)	Q.P.	AV.	Q.P.	AV.	Q.P.	AV.	Q.P.	AV.	
1	0.15391	10.30	38.53	27.27	48.83	37.57	65.79	55.79	-16.96	-18.22
2	0.18125	10.29	34.28	25.41	44.57	35.70	64.43	54.43	-19.86	-18.73
3	0.42344	10.35	22.14	18.64	32.49	28.99	57.38	47.38	-24.89	-18.39
4	0.48203	10.36	26.19	22.81	36.55	33.17	56.30	46.30	-19.75	-13.13
5	7.05469	10.57	26.40	20.22	36.97	30.79	60.00	50.00	-23.03	-19.21
6	9.94531	10.64	24.36	17.54	35.00	28.18	60.00	50.00	-25.00	-21.82

REMARKS:

1. Q.P. and AV. are abbreviations of quasi-peak and average individually.
2. The emission levels of other frequencies were very low against the limit.
3. Margin value = Emission level - Limit value
4. Correction factor = Insertion loss + Cable loss
5. Emission Level = Correction Factor + Reading Value.

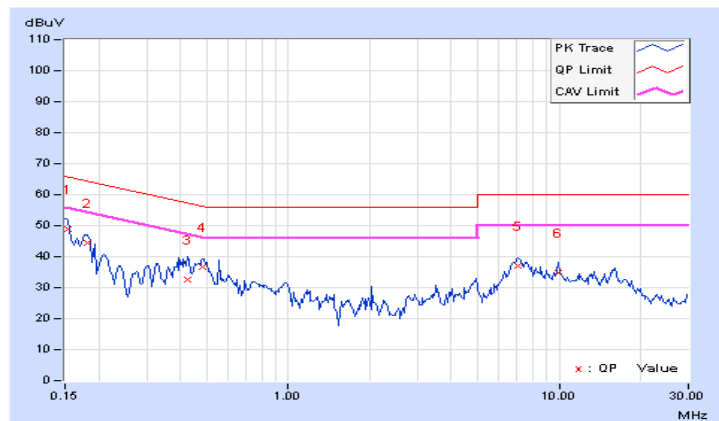

Phase	Neutral (N)	Detector Function	Quasi-Peak (QP) / Average (AV)
-------	-------------	-------------------	--------------------------------

No	Freq. [MHz]	Corr. Factor	Reading Value [dB (uV)]		Emission Level [dB (uV)]		Limit [dB (uV)]		Margin (dB)	
		(dB)	Q.P.	AV.	Q.P.	AV.	Q.P.	AV.	Q.P.	AV.
	1	0.15391	10.36	38.13	26.59	48.49	36.95	65.79	55.79	-17.30
2	0.18125	10.36	34.05	25.19	44.41	35.55	64.43	54.43	-20.02	-18.88
3	0.20859	10.36	29.04	17.55	39.40	27.91	63.26	53.26	-23.86	-25.35
4	0.30234	10.40	25.26	20.48	35.66	30.88	60.18	50.18	-24.52	-19.30
5	0.45859	10.45	25.94	20.31	36.39	30.76	56.72	46.72	-20.33	-15.96
6	6.81641	10.62	24.89	19.45	35.51	30.07	60.00	50.00	-24.49	-19.93
7	9.89063	10.67	23.73	17.73	34.40	28.40	60.00	50.00	-25.60	-21.60

REMARKS:

1. Q.P. and AV. are abbreviations of quasi-peak and average individually.
2. The emission levels of other frequencies were very low against the limit.
3. Margin value = Emission level - Limit value
4. Correction factor = Insertion loss + Cable loss
5. Emission Level = Correction Factor + Reading Value.

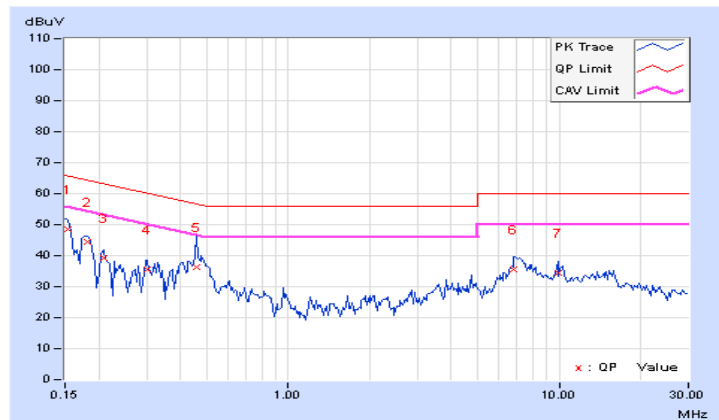

4.3 Transmit Power Measurement

4.3.1 Limits of Transmit Power Measurement

Operation Band	EUT Category		Limit
U-NII-1		Outdoor Access Point	1 Watt (30 dBm) (Max. e.i.r.p \leq 125mW(21 dBm) at any elevation angle above 30 degrees as measured from the horizon)
		Fixed point-to-point Access Point	1 Watt (30 dBm)
	√	Indoor Access Point	1 Watt (30 dBm)
		Mobile and Portable client device	250mW (24 dBm)
U-NII-2A			250mW (24 dBm) or 11 dBm+10 log B*
U-NII-2C			250mW (24 dBm) or 11 dBm+10 log B*
U-NII-3	√		1 Watt (30 dBm)

*B is the 26 dB emission bandwidth in megahertz

Per KDB 662911 Method of conducted output power measurement on IEEE 802.11 devices,

Array Gain = 0 dB (i.e., no array gain) for $N_{ANT} \leq 4$;

Array Gain = 0 dB (i.e., no array gain) for channel widths ≥ 40 MHz for any N_{ANT} ;

Array Gain = $5 \log(N_{ANT}/N_{SS})$ dB or 3 dB, whichever is less for 20-MHz channel widths with $N_{ANT} \geq 5$.

For power measurements on all other devices: Array Gain = $10 \log(N_{ANT}/N_{SS})$ dB.

4.3.2 Test Setup

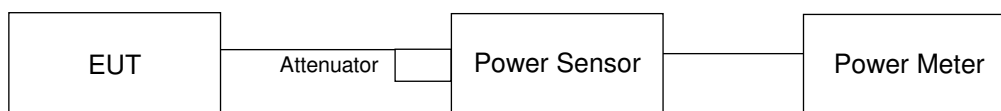

4.3.3 Test Instruments

Refer to section 4.1.2 to get information of above instrument.

4.3.4 Test Procedure

Method PM is used to perform output power measurement, trigger and gating function of wide band power meter is enabled to measure max output power of TX on burst. Duty factor is not added to measured value.

4.3.5 Deviation from Test Standard

No deviation.

4.3.6 EUT Operating Condition

The software provided by client to enable the EUT under transmission condition continuously at lowest, middle and highest channel frequencies individually.

4.3.7 Test Result

CDD Mode

802.11a

CHAN.	FREQ. (MHz)	Maximum Conducted Power (dBm)		Total Power (mW)	Total Power (dBm)	Power Limit (dBm)	Pass/Fail
		CHAIN 0	CHAIN 1				
36	5180	20.71	20.41	227.662	23.57	30	Pass
40	5200	20.78	20.44	230.336	23.62	30	Pass
48	5240	20.40	20.07	211.273	23.25	30	Pass
149	5745	24.92	24.56	596.215	27.75	30	Pass
157	5785	25.11	24.77	624.256	27.95	30	Pass
165	5825	25.05	24.69	614.332	27.88	30	Pass

802.11ac (VHT20)

CHAN.	FREQ. (MHz)	Maximum Conducted Power (dBm)		Total Power (mW)	Total Power (dBm)	Power Limit (dBm)	Pass/Fail
		CHAIN 0	CHAIN 1				
36	5180	20.32	20.07	209.272	23.21	30	Pass
40	5200	21.51	21.21	273.709	24.37	30	Pass
48	5240	21.54	21.18	273.781	24.37	30	Pass
149	5745	25.50	25.22	687.473	28.37	30	Pass
157	5785	25.40	25.13	672.574	28.28	30	Pass
165	5825	25.22	24.86	638.856	28.05	30	Pass

802.11ac (VHT40)

CHAN.	FREQ. (MHz)	Maximum Conducted Power (dBm)		Total Power (mW)	Total Power (dBm)	Power Limit (dBm)	Pass/Fail
		CHAIN 0	CHAIN 1				
38	5190	16.75	16.42	91.168	19.60	30	Pass
46	5230	21.34	21.06	263.788	24.21	30	Pass
151	5755	25.44	25.09	672.794	28.28	30	Pass
159	5795	25.29	24.93	649.237	28.12	30	Pass

802.11ac (VHT80)

CHAN.	CHAN. FREQ. (MHz)	Maximum Conducted Power (dBm)		Total Power (mW)	Total Power (dBm)	Power Limit (dBm)	Pass/Fail
		CHAIN 0	CHAIN 1				
42	5210	16.33	16.06	83.319	19.21	30	Pass
155	5775	24.92	24.63	600.858	27.79	30	Pass

Beamforming Mode

802.11ac (VHT20)

CHAN.	FREQ. (MHz)	Maximum Conducted Power (dBm)		Total Power (mW)	Total Power (dBm)	Power Limit (dBm)	Pass/Fail
		CHAIN 0	CHAIN 1				
36	5180	20.32	20.07	209.272	23.21	28.21	Pass
40	5200	21.51	21.21	273.709	24.37	28.21	Pass
48	5240	21.54	21.18	273.781	24.37	28.21	Pass
149	5745	25.50	25.22	687.473	28.37	28.41	Pass
157	5785	25.40	25.13	672.574	28.28	28.41	Pass
165	5825	25.22	24.86	638.856	28.05	28.41	Pass

- Note:** 1. For U_NII-1: The directional gain = $4.78\text{dBi} + 10\log(2) = 7.79\text{dBi} > 6\text{dBi}$, so the power limit shall be reduced to $30-(7.79-6) = 28.21\text{dBm}$.
2. For U_NII-3: The directional gain = $4.58\text{dBi} + 10\log(2) = 7.79\text{dBi} > 6\text{dBi}$, so the power limit shall be reduced to $30-(7.59-6) = 28.41\text{dBm}$.

802.11ac (VHT40)

CHAN.	FREQ. (MHz)	Maximum Conducted Power (dBm)		Total Power (mW)	Total Power (dBm)	Power Limit (dBm)	Pass/Fail
		CHAIN 0	CHAIN 1				
38	5190	16.75	16.42	91.168	19.60	28.21	Pass
46	5230	21.34	21.06	263.788	24.21	28.21	Pass
151	5755	25.44	25.09	672.794	28.28	28.41	Pass
159	5795	25.29	24.93	649.237	28.12	28.41	Pass

- Note:** 1. For U_NII-1: The directional gain = $4.78\text{dBi} + 10\log(2) = 7.79\text{dBi} > 6\text{dBi}$, so the power limit shall be reduced to $30-(7.79-6) = 28.21\text{dBm}$.
2. For U_NII-3: The directional gain = $4.58\text{dBi} + 10\log(2) = 7.79\text{dBi} > 6\text{dBi}$, so the power limit shall be reduced to $30-(7.59-6) = 28.41\text{dBm}$.

802.11ac (VHT80)

CHAN.	CHAN. FREQ. (MHz)	Maximum Conducted Power (dBm)		Total Power (mW)	Total Power (dBm)	Power Limit (dBm)	Pass/Fail
		CHAIN 0	CHAIN 1				
42	5210	16.33	16.06	83.319	19.21	28.21	Pass
155	5775	24.92	24.63	600.858	27.79	28.41	Pass

- Note:** 1. For U_NII-1: The directional gain = $4.78\text{dBi} + 10\log(2) = 7.79\text{dBi} > 6\text{dBi}$, so the power limit shall be reduced to $30 - (7.79 - 6) = 28.21\text{dBm}$.
2. For U_NII-3: The directional gain = $4.58\text{dBi} + 10\log(2) = 7.79\text{dBi} > 6\text{dBi}$, so the power limit shall be reduced to $30 - (7.59 - 6) = 28.41\text{dBm}$.

4.4 Occupied Bandwidth Measurement

4.4.1 Test Setup



4.4.2 Test Instruments

Refer to section 4.1.2 to get information of above instrument.

4.4.3 Test Procedure

The transmitter output was connected to the spectrum analyzer through an attenuator. The bandwidth of the fundamental frequency was measured by spectrum analyzer with resolution bandwidth in the range of 1% to 5% of the anticipated emission bandwidth, and a video bandwidth at least 3x the resolution bandwidth and set the detector to SAMPLE. The width of a frequency band such that, below the lower and above the upper frequency limits, the mean powers emitted are each equal to a specified percentage 0.5 %of the total mean power of a given emission.

4.4.4 Test Results

802.11a

Channel	Channel Frequency (MHz)	Occupied Bandwidth (MHz)	
		CHAIN 0	CHAIN 1
36	5180	16.92	17.28
40	5200	16.92	17.16
48	5240	16.80	17.04
149	5745	27.60	28.56
157	5785	26.64	28.92
165	5825	27.36	29.88

802.11ac (VHT20)

Channel	Channel Frequency (MHz)	Occupied Bandwidth (MHz)	
		CHAIN 0	CHAIN 1
36	5180	17.88	18.00
40	5200	18.00	18.60
48	5240	17.88	18.12
149	5745	28.08	30.24
157	5785	28.68	30.96
165	5825	28.56	31.92

802.11ac (VHT40)

Channel	Channel Frequency (MHz)	Occupied Bandwidth (MHz)	
		CHAIN 0	CHAIN 1
38	5190	36.72	36.72
46	5230	36.72	37.20
151	5755	40.32	47.28
159	5795	52.56	62.40

802.11ac (VHT80)

Channel	Channel Frequency (MHz)	Occupied Bandwidth (MHz)	
		CHAIN 0	CHAIN 1
42	5210	75.36	75.84
155	5775	76.32	76.32

Spectrum Plot of Worst Value

802.11a_Chain1 / CH165

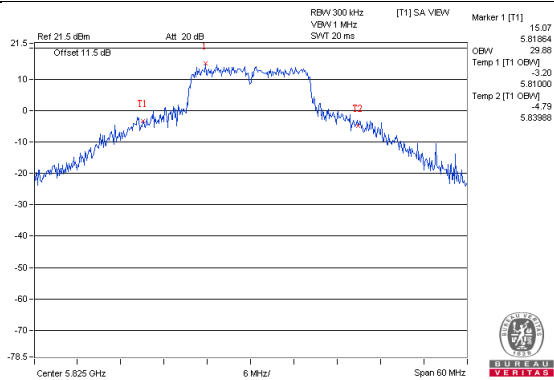

802.11ac (VHT20)_Chain1 / CH165

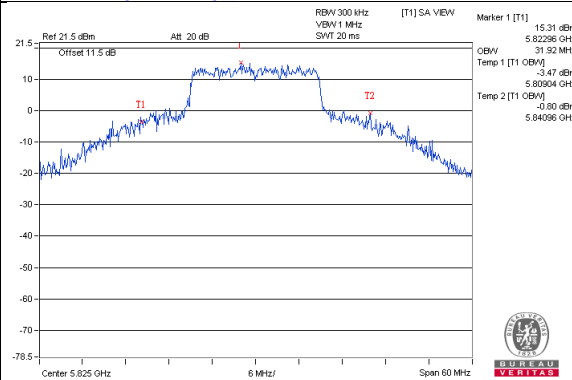

802.11ac (VHT40)_Chain1 / CH159

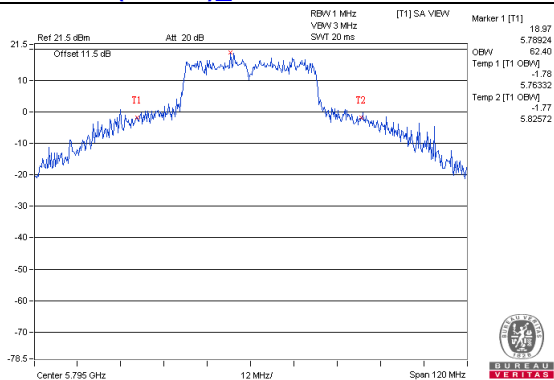

802.11ac (VHT80)_Chain0 / CH155

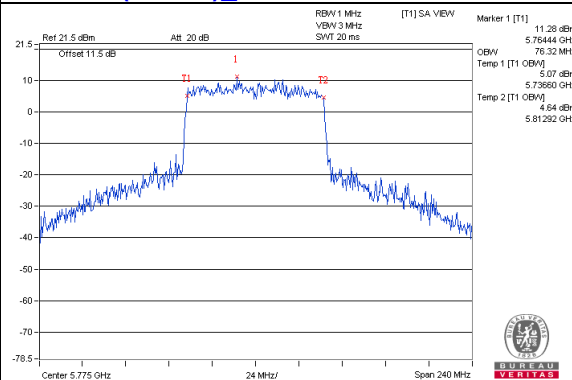

Spectrum Plot for near by DFS band (DFS is required, if 99% OCP straddle into U-NII-2A band)

802.11a_Chain0 / CH48

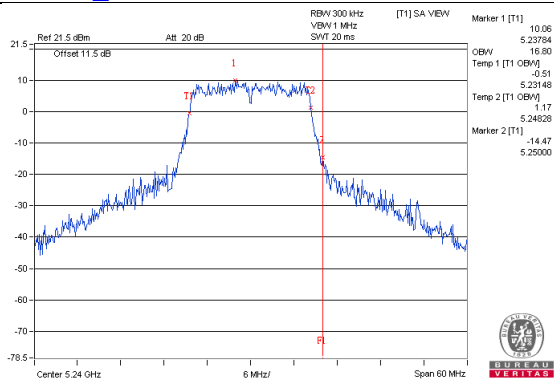

802.11a_Chain1 / CH48

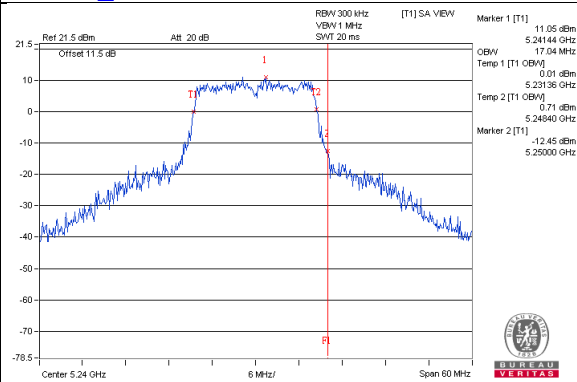

802.11ac(VHT20)_Chain0 / CH48

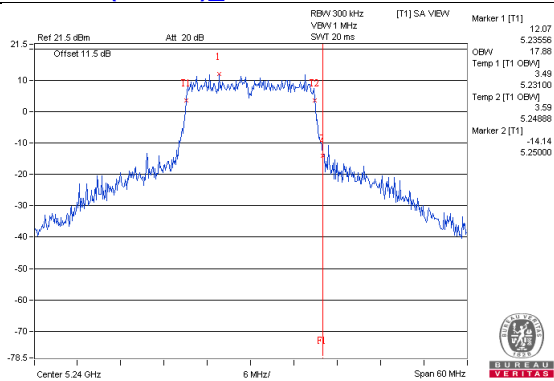

802.11ac(VHT20)_Chain1 / CH48

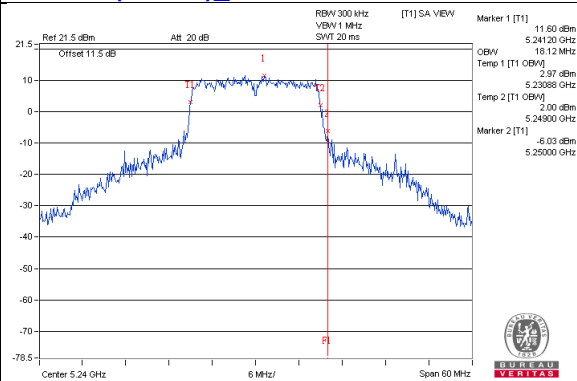

**Spectrum Plot for near by DFS band
(DFS is required, if 99% OCP straddle into U-NII-2A band)**

802.11ac(VHT40)_Chain0 / CH46

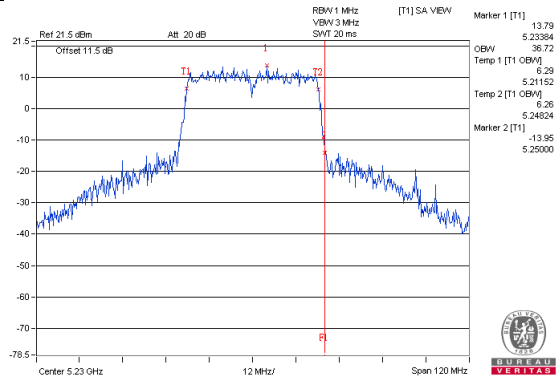

802.11ac(VHT40)_Chain1 / CH46

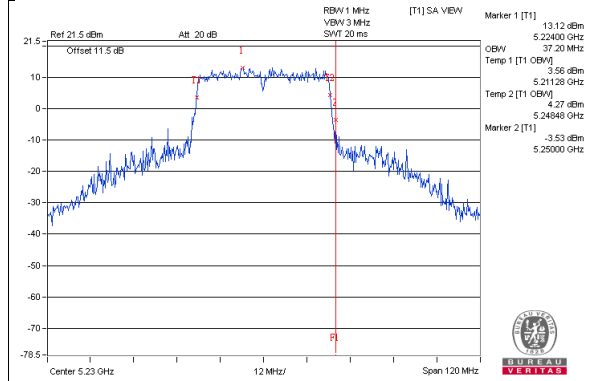

802.11ac(VHT80)_Chain0 / CH42

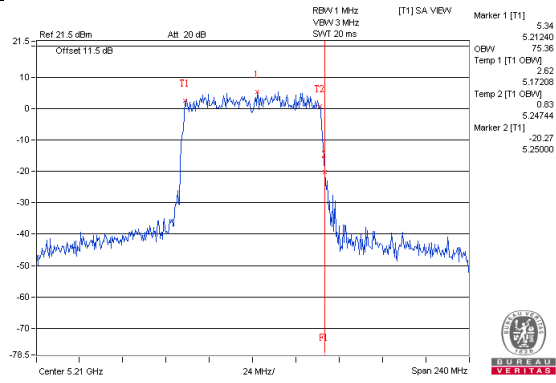

802.11ac(VHT80)_Chain1 / CH42

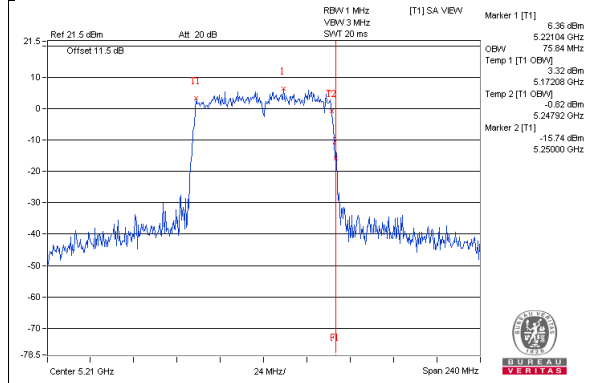

**Spectrum Plot for near by DFS band
(DFS is required, if 99% OCP straddle into U-NII-2C band)**

802.11a_Chain0 / CH149

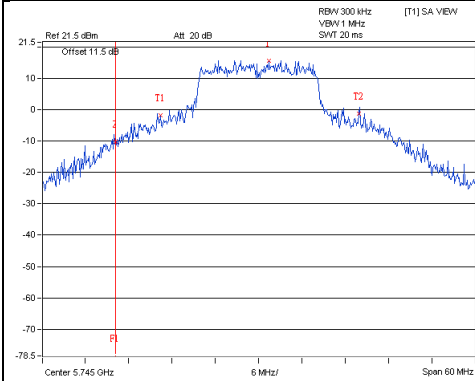

802.11a_Chain1 / CH149

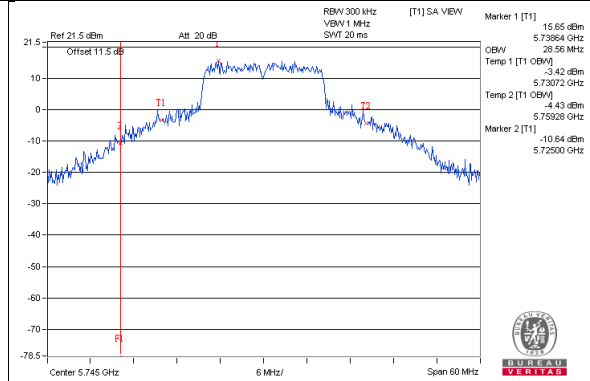

802.11ac(VHT20)_Chain0 / CH149

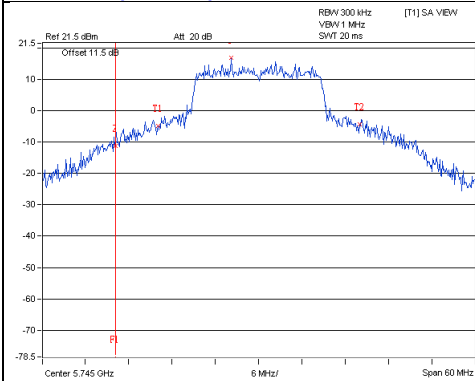

802.11ac(VHT20)_Chain1 / CH149

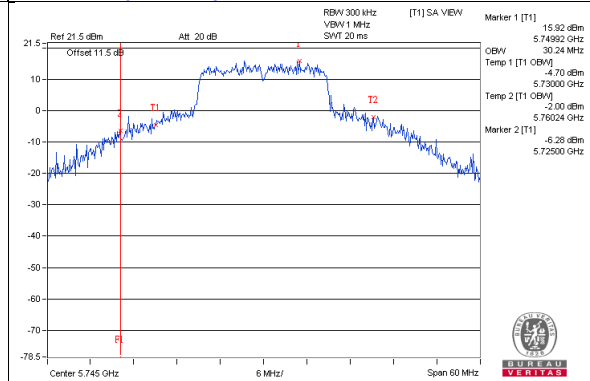

Spectrum Plot for near by DFS band (DFS is required, if 99% OCP straddle into U-NII-2C band)

802.11ac(VHT40)_Chain0 / CH151

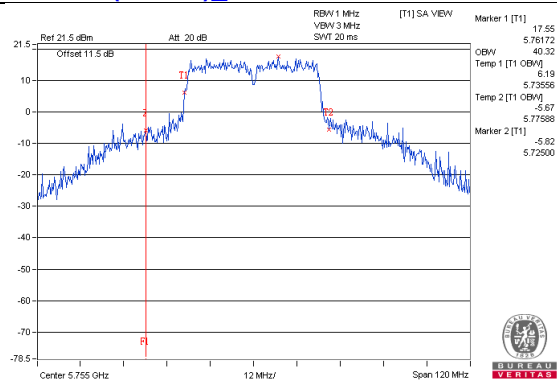

802.11ac(VHT40)_Chain1 / CH151

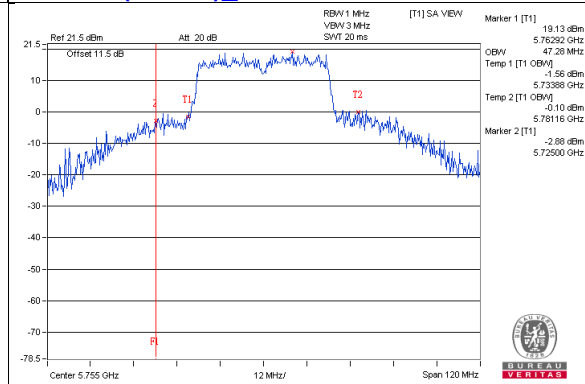

802.11ac(VHT80)_Chain0 / CH155

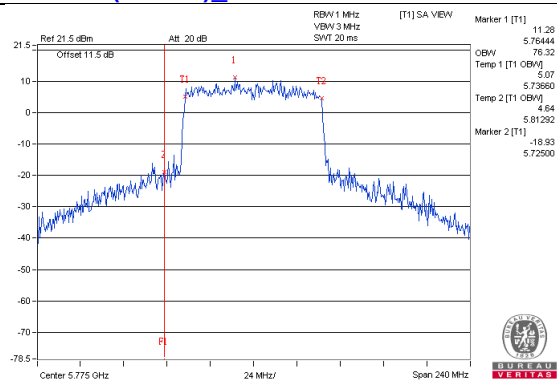

802.11ac(VHT80)_Chain1 / CH155

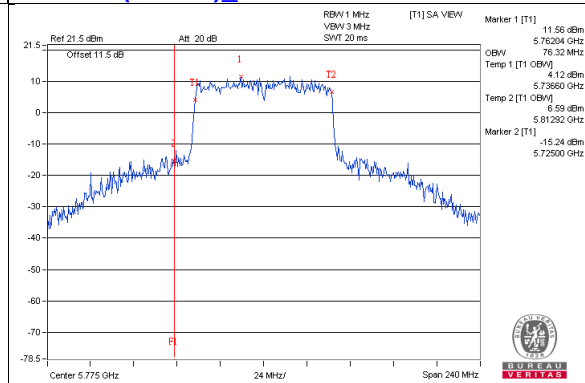

4.5 Peak Power Spectral Density Measurement

4.5.1 Limits of Peak Power Spectral Density Measurement

Operation Band	EUT Category		Limit
U-NII-1		Outdoor Access Point	17dBm/ MHz
		Fixed point-to-point Access Point	
	√	Indoor Access Point	11dBm/ MHz
		Mobile and Portable client device	
U-NII-2A			11dBm/ MHz
U-NII-2C			11dBm/ MHz
U-NII-3	√		30dBm/ 500kHz

4.5.2 Test Setup

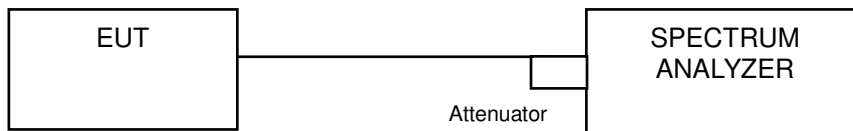

4.5.3 Test Instruments

Refer to section 4.1.2 to get information of above instrument.

4.5.4 Test Procedure

802.11a, 802.11ac (VHT20)

For U-NII-1:

Using method SA-1

1. Set span to encompass the entire emission bandwidth (EBW) of the signal.
2. Set RBW = 1 MHz, Set VBW \geq 3 MHz, Detector = RMS
3. Sweep time = auto, trigger set to "free run".
4. Trace average at least 100 traces in power averaging mode.
5. Record the max value

For U-NII-3:

1. Set span to encompass the entire emission bandwidth (EBW) of the signal.
2. Set RBW = 300 kHz, Set VBW \geq 1 MHz, Detector = RMS
3. Use the peak marker function to determine the maximum power level in any 300 kHz band segment within the fundamental EBW.
4. Scale the observed power level to an equivalent value in 500 kHz by adjusting (reducing) the measured power by a bandwidth correction factor (BWCF) where $BWCF = 10\log(500 \text{ kHz}/300\text{kHz})$
5. Sweep time = auto, trigger set to "free run".
6. Trace average at least 100 traces in power averaging mode.
7. Record the max value

802.11ac (VHT40), 802.11ac (VHT80)

For U-NII-1:

Using method SA-2

1. Set span to encompass the entire emission bandwidth (EBW) of the signal.
2. Set RBW = 1 MHz, Set VBW \geq 3 MHz, Detector = RMS
3. Sweep time = auto, trigger set to "free run".
4. Trace average at least 100 traces in power averaging mode.
5. Record the max value and add $10 \log (1/\text{duty cycle})$

For U-NII-3:

1. Set span to encompass the entire emission bandwidth (EBW) of the signal.
2. Set RBW = 300 kHz, Set VBW \geq 1 MHz, Detector = RMS
3. Use the peak marker function to determine the maximum power level in any 300 kHz band segment within the fundamental EBW.
4. Scale the observed power level to an equivalent value in 500 kHz by adjusting (reducing) the measured power by a bandwidth correction factor (BWCF) where $BWCF = 10\log(500 \text{ kHz}/300\text{kHz})$
5. Sweep time = auto, trigger set to "free run".
6. Trace average at least 100 traces in power averaging mode.
7. Record the max value and add $10 \log (1/\text{duty cycle})$

4.5.5 Deviation from Test Standard

No deviation.

4.5.6 EUT Operating Condition

Same as Item 4.3.6.

4.5.7 Test Results

For U-NII-1:

802.11a

Chan.	Chan. Freq. (MHz)	PSD (dBm/MHz)		Total Power Density (dBm/MHz)	MAX. Limit (dBm/MHz)	Pass / Fail
		Chain 0	Chain 1			
36	5180	6.51	6.59	9.56	15.21	Pass
40	5200	6.69	6.79	9.75	15.21	Pass
48	5240	6.43	6.46	9.46	15.21	Pass

- Note:** 1. Method a) of power density measurement of KDB 662911 is using for calculating total power density. Total power density is summing entire spectra across corresponding frequency bins on the various outputs by computer.
 2. Directional gain = $4.78\text{dBi} + 10\log(2) = 7.79\text{dBi} > 6\text{dBi}$, so the power density limit shall be reduced to $17 - (7.79 - 6) = 15.21\text{dBm}$.

802.11ac (VHT20)

Chan.	Chan. Freq. (MHz)	PSD (dBm/MHz)		Total Power Density (dBm/MHz)	MAX. Limit (dBm/MHz)	Pass / Fail
		Chain 0	Chain 1			
36	5180	5.46	5.99	8.74	15.21	Pass
40	5200	7.09	7.43	10.27	15.21	Pass
48	5240	7.12	7.72	10.44	15.21	Pass

- Note:** 1. Method a) of power density measurement of KDB 662911 is using for calculating total power density. Total power density is summing entire spectra across corresponding frequency bins on the various outputs by computer.
 2. Directional gain = $4.78\text{dBi} + 10\log(2) = 7.79\text{dBi} > 6\text{dBi}$, so the power density limit shall be reduced to $17 - (7.79 - 6) = 15.21\text{dBm}$.

802.11ac (VHT40)

Chan.	Chan. Freq. (MHz)	PSD W/O Duty Factor (dBm)		Duty Factor (dB)	Total PSD With Duty Factor (dBm)	MAX. Limit (dBm)	Pass / Fail
		Chain 0	Chain 1				
38	5190	-1.51	-0.42	0.16	2.24	15.21	Pass
46	5230	3.06	4.02	0.16	6.73	15.21	Pass

- Note:** 1. Method a) of power density measurement of KDB 662911 is using for calculating total power density. Total power density is summing entire spectra across corresponding frequency bins on the various outputs by computer.
 2. Directional gain = $4.78\text{dBi} + 10\log(2) = 7.79\text{dBi} > 6\text{dBi}$, so the power density limit shall be reduced to $17 - (7.79 - 6) = 15.21\text{dBm}$.
 3. Refer to section 3.3 for duty cycle spectrum plot

802.11ac (VHT80)

Chan.	Chan. Freq. (MHz)	PSD W/O Duty Factor (dBm)		Duty Factor (dB)	Total PSD With Duty Factor (dBm)	MAX. Limit (dBm)	Pass / Fail
		Chain 0	Chain 1				
42	5210	-4.49	-3.43	0.18	-0.74	15.21	Pass

- Note:**
- Method a) of power density measurement of KDB 662911 is using for calculating total power density. Total power density is summing entire spectra across corresponding frequency bins on the various outputs by computer.
 - Directional gain = $4.78\text{dBi} + 10\log(2) = 7.79\text{dBi} > 6\text{dBi}$, so the power density limit shall be reduced to $17-(7.79-6) = 15.21\text{dBm}$.
 - Refer to section 3.3 for duty cycle spectrum plot

Spectrum Plot of Worst Value

802.11a_Chain 1 / CH40

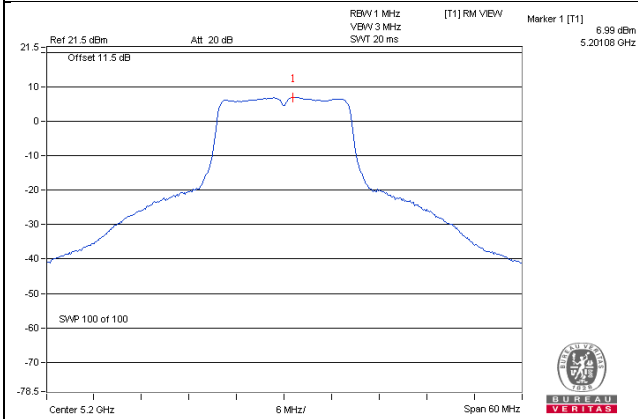

802.11ac (VHT20)_Chain 1 / CH48

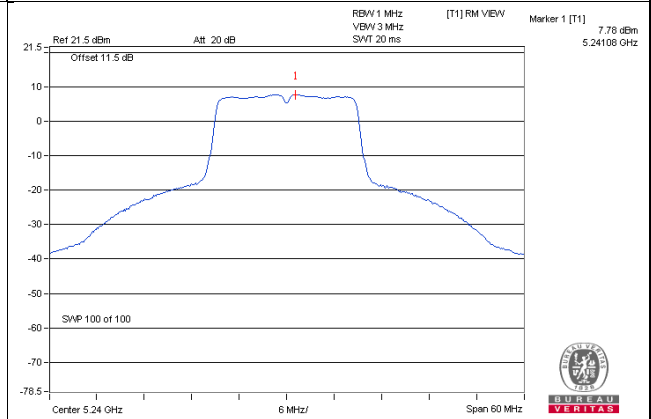

802.11ac (VHT40)_Chain 0 / CH46

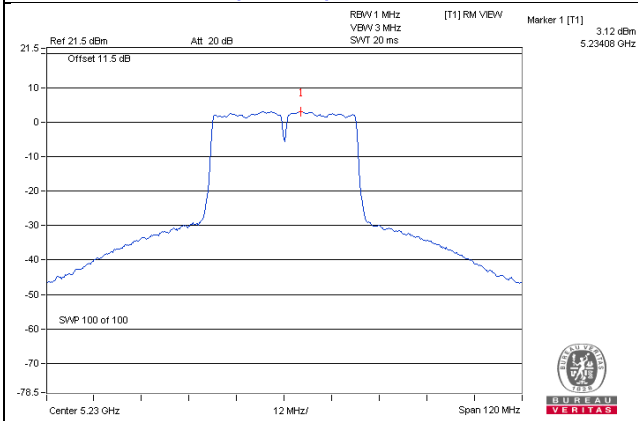

802.11ac (VHT80)_Chain 1 / CH42

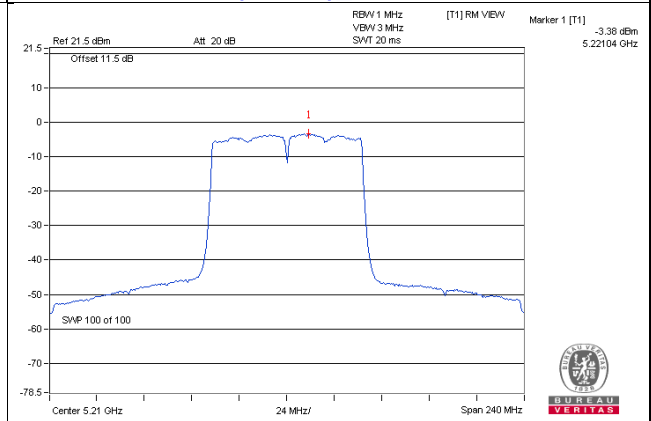

For U-NII-3:
802.11a

TX chain	Channel	Freq. (MHz)	PSD (dBm/300kHz)	PSD (dBm/500kHz)	10 log (N=2) dB	Total PSD (dBm/500kHz)	Limit (dBm/500kHz)	Pass /Fail
0	149	5745	2.77	4.99	3.01	8.00	28.41	Pass
	157	5785	2.78	5.00	3.01	8.01	28.41	Pass
	165	5825	2.33	4.55	3.01	7.56	28.41	Pass
1	149	5745	3.35	5.57	3.01	8.58	28.41	Pass
	157	5785	3.23	5.45	3.01	8.46	28.41	Pass
	165	5825	3.03	5.25	3.01	8.26	28.41	Pass

Note: 1. Directional gain = $4.58\text{dBi} + 10\log(3) = 7.59\text{dBi} > 6\text{dBi}$, so the power density limit shall be reduced to $30-(7.59-6) = 28.41\text{dBm}$.

802.11ac (VHT20)

TX chain	Channel	Freq. (MHz)	PSD (dBm/300kHz)	PSD (dBm/500kHz)	10 log (N=2) dB	Total PSD (dBm/500kHz)	Limit (dBm/500kHz)	Pass /Fail
0	149	5745	2.48	4.70	3.01	7.71	28.41	Pass
	157	5785	2.16	4.38	3.01	7.39	28.41	Pass
	165	5825	1.98	4.20	3.01	7.21	28.41	Pass
1	149	5745	3.23	5.45	3.01	8.46	28.41	Pass
	157	5785	2.86	5.08	3.01	8.09	28.41	Pass
	165	5825	2.70	4.92	3.01	7.93	28.41	Pass

Note: 1. Directional gain = $4.58\text{dBi} + 10\log(3) = 7.59\text{dBi} > 6\text{dBi}$, so the power density limit shall be reduced to $30-(7.59-6) = 28.41\text{dBm}$.

802.11ac (VHT40)

TX chain	Chan.	Chan. Freq. (MHz)	PSD W/O Duty Factor		10 log (N=2) dB	Duty Factor (dB)	Total PSD With Duty Factor (dBm/500kHz)	Limit (dBm/500kHz)	Pass /Fail
			(dBm/300kHz)	(dBm/500kHz)					
0	151	5755	-0.86	1.36	3.01	0.16	4.53	28.41	Pass
	159	5795	-1.43	0.79	3.01	0.16	3.96	28.41	Pass
1	151	5755	-0.23	1.99	3.01	0.16	5.16	28.41	Pass
	159	5795	-0.27	1.95	3.01	0.16	5.12	28.41	Pass

Note: 1. Directional gain = $4.58\text{dBi} + 10\log(3) = 7.59\text{dBi} > 6\text{dBi}$, so the power density limit shall be reduced to $30-(7.59-6) = 28.41\text{dBm}$.

2. Refer to section 3.3 for duty cycle spectrum plot.

802.11ac (VHT80)

TX chain	Chan.	Chan. Freq. (MHz)	PSD W/O Duty Factor		10 log (N=2) dB	Duty Factor (dB)	Total PSD With Duty Factor (dBm/500kHz)	Limit (dBm/500kHz)	Pass /Fail
			(dBm/300kHz)	(dBm/500kHz)					
0	155	5775	-8.25	-6.03	3.01	0.18	-2.84	28.41	Pass
1	155	5775	-6.82	-4.60	3.01	0.18	-1.41	28.41	Pass

Note: 1. Directional gain = $4.58\text{dBi} + 10\log(3) = 7.59\text{dBi} > 6\text{dBi}$, so the power density limit shall be reduced to $30 - (7.59 - 6) = 28.41\text{dBm}$.

2. Refer to section 3.3 for duty cycle spectrum plot.

Spectrum Plot of Worst Value

802.11a – Chain 1: CH 149

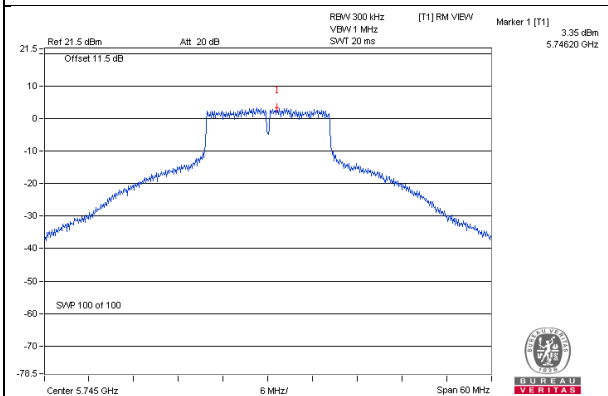

802.11ac (VHT20) – Chain 1: CH 149

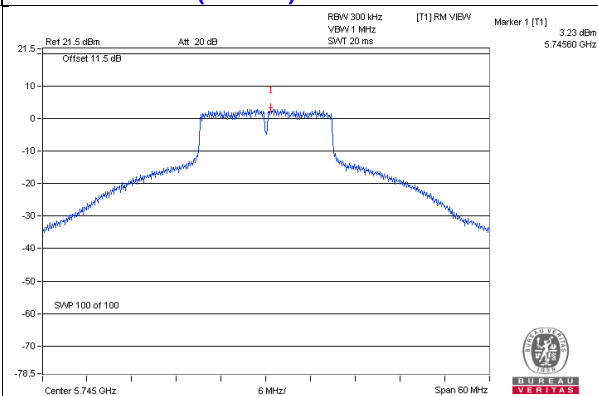

802.11ac (VHT40) – Chain 1: CH 151

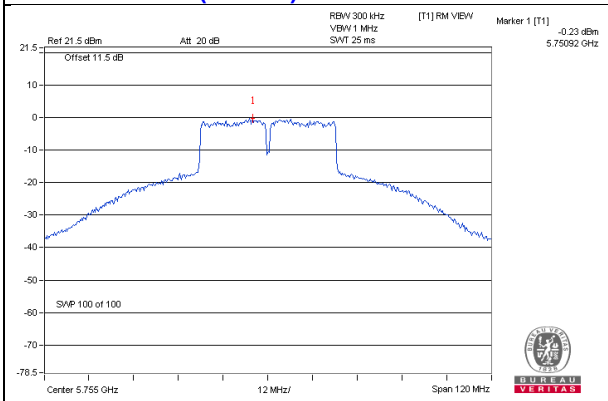

802.11ac (VHT80) – Chain 1: CH 155

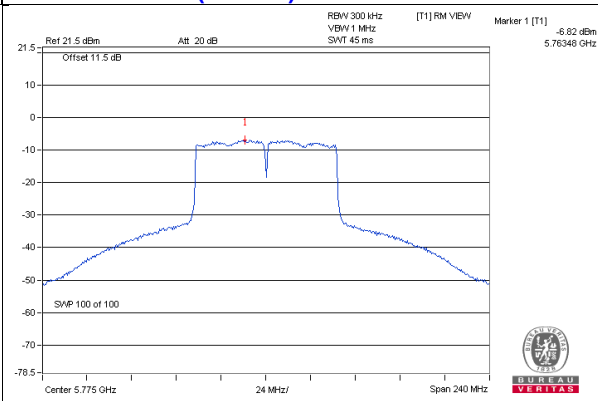

4.6 Frequency Stability Measurement

4.6.1 Limits of Frequency Stability Measurement

The frequency of the carrier signal shall be maintained within band of operation

4.6.2 Test Setup

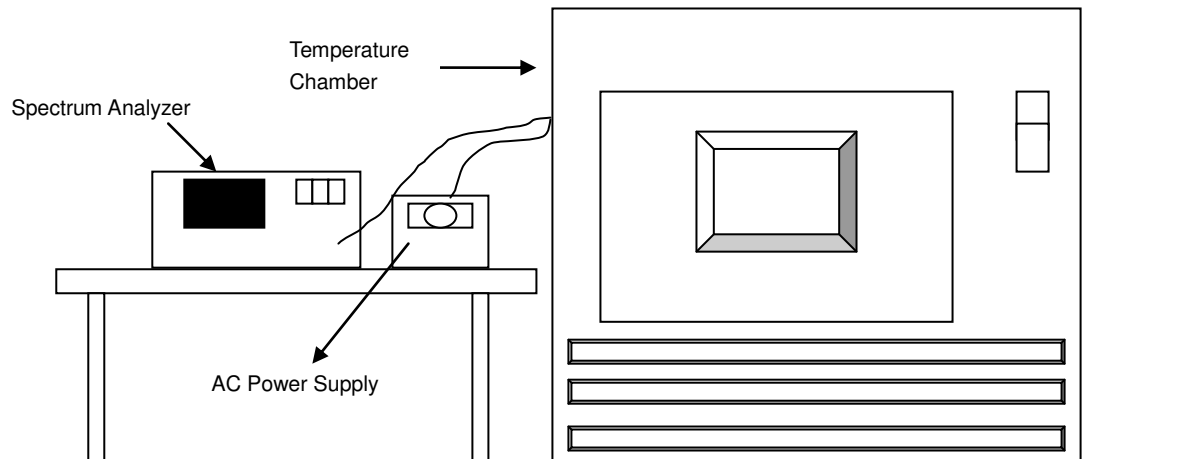

4.6.3 Test Instruments

Refer to section 4.1.2 to get information of above instrument.

4.6.4 Test Procedure

- The EUT was placed inside the environmental test chamber and powered by nominal AC voltage.
- Turn the EUT on and couple its output to a spectrum analyzer.
- Turn the EUT off and set the chamber to the highest temperature specified.
- Allow sufficient time (approximately 30 min) for the temperature of the chamber to stabilize, turn the EUT on and measure the operating frequency after 2, 5, and 10 Minutes.
- Repeat step 2 and 3 with the temperature chamber set to the lowest temperature.
- The test chamber was allowed to stabilize at +20 degree C for a minimum of 30 Minutes. The supply voltage was then adjusted on the EUT from 85% to 115% and the frequency record.

4.6.5 Deviation from Test Standard

No deviation.

4.6.6 EUT Operating Condition

Set the EUT transmit at un-modulation mode to test frequency stability.

4.6.7 Test Results

Frequency Stability Versus Temp.									
Operating Frequency: 5180 MHz									
TEMP. (°C)	Power Supply (Vac)	0 Minute		2 Minute		5 Minute		10 Minute	
		Measured Frequency (MHz)	Pass/Fail	Measured Frequency (MHz)	Pass/Fail	Measured Frequency (MHz)	Pass/Fail	Measured Frequency (MHz)	Pass/Fail
50	120	5179.9893	Pass	5179.9895	Pass	5179.9852	Pass	5179.9868	Pass
40	120	5180.0159	Pass	5180.0197	Pass	5180.0186	Pass	5180.0166	Pass
30	120	5180.0119	Pass	5180.0131	Pass	5180.0106	Pass	5180.0107	Pass
20	120	5180.0192	Pass	5180.0221	Pass	5180.0218	Pass	5180.0204	Pass
10	120	5179.9784	Pass	5179.978	Pass	5179.9784	Pass	5179.9781	Pass
0	120	5180.0087	Pass	5180.0117	Pass	5180.0099	Pass	5180.009	Pass
-10	120	5179.994	Pass	5179.9948	Pass	5179.9957	Pass	5179.9944	Pass
-20	120	5180.0155	Pass	5180.0193	Pass	5180.0199	Pass	5180.0155	Pass
-30	120	5180.0163	Pass	5180.0179	Pass	5180.0173	Pass	5180.0153	Pass

Frequency Stability Versus Voltage									
Operating Frequency: 5180 MHz									
TEMP. (°C)	Power Supply (Vac)	0 Minute		2 Minute		5 Minute		10 Minute	
		Measured Frequency (MHz)	Pass/Fail	Measured Frequency (MHz)	Pass/Fail	Measured Frequency (MHz)	Pass/Fail	Measured Frequency (MHz)	Pass/Fail
20	138	5180.0189	Pass	5180.0226	Pass	5180.0213	Pass	5180.0199	Pass
	120	5180.0192	Pass	5180.0221	Pass	5180.0218	Pass	5180.0204	Pass
	102	5180.0187	Pass	5180.0222	Pass	5180.0225	Pass	5180.0212	Pass

4.7 6dB Bandwidth Measurement

4.7.1 Limits of 6dB Bandwidth Measurement

The minimum of 6dB Bandwidth Measurement is 0.5MHz.

4.7.2 Test Setup

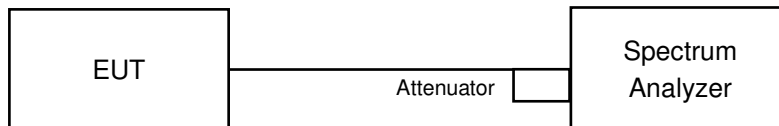

4.7.3 Test Instruments

Refer to section 4.1.2 to get information of above instrument.

4.7.4 Test Procedure

MEASUREMENT PROCEDURE REF

- a. Set resolution bandwidth (RBW) = 100kHz
- b. Set the video bandwidth (VBW) $\geq 3 \times$ RBW, Detector = Peak.
- c. Trace mode = max hold.
- d. Sweep = auto couple.
- e. Measure the maximum width of the emission that is constrained by the frequencies associated with the two amplitude points (upper and lower) that are attenuated by 6 dB relative to the maximum level measured in the fundamental emission

4.7.5 Deviation from Test Standard

No deviation.

4.7.6 EUT Operating Condition

The software provided by client to enable the EUT under transmission condition continuously at lowest, middle and highest channel frequencies individually.

4.7.7 Test Results

802.11a

Channel	Frequency (MHz)	6dB Bandwidth (MHz)		Minimum Limit (MHz)	Pass / Fail
		Chain 0	Chain 1		
149	5745	16.38	16.37	0.5	PASS
157	5785	16.39	16.37	0.5	PASS
165	5825	16.38	16.37	0.5	PASS

802.11ac (VHT20)

Channel	Frequency (MHz)	6dB Bandwidth (MHz)		Minimum Limit (MHz)	Pass / Fail
		Chain 0	Chain 1		
149	5745	17.62	17.60	0.5	PASS
157	5785	17.63	17.59	0.5	PASS
165	5825	17.59	17.60	0.5	PASS

802.11ac (VHT40)

Channel	Frequency (MHz)	6dB Bandwidth (MHz)		Minimum Limit (MHz)	Pass / Fail
		Chain 0	Chain 1		
151	5755	36.38	36.37	0.5	PASS
159	5795	36.40	36.44	0.5	PASS

802.11ac (VHT80)

Channel	Frequency (MHz)	6dB Bandwidth (MHz)		Minimum Limit (MHz)	Pass / Fail
		Chain 0	Chain 1		
155	5775	76.02	75.82	0.5	PASS

Spectrum Plot of Worst Value

802.11a_Chain 1/ CH157

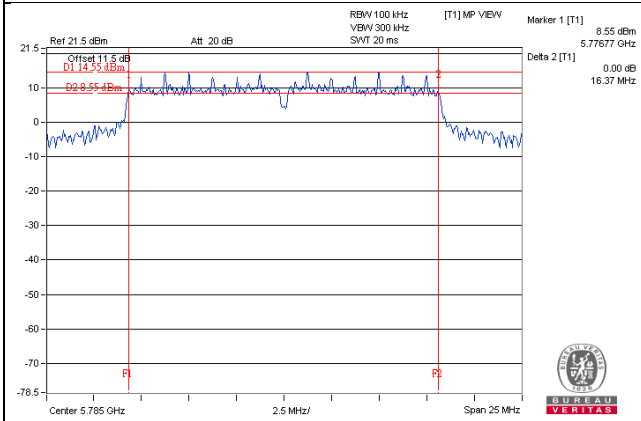

802.11ac (VHT20)_Chain 1/ CH157

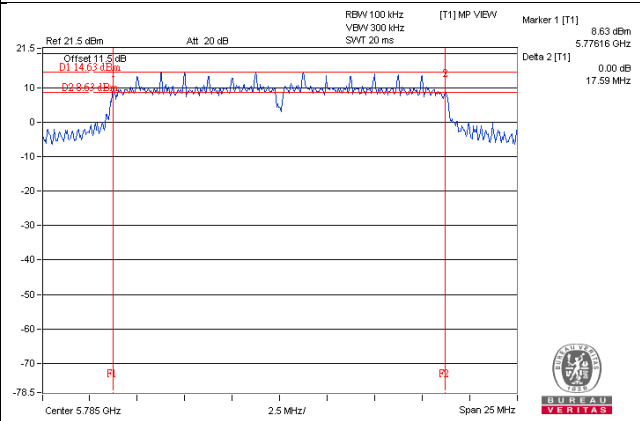

802.11ac (VHT40)_Chain 1/ CH151

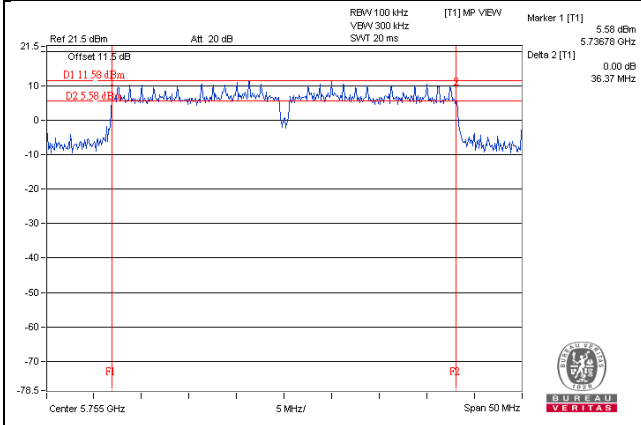

802.11ac (VHT80)_Chain 1/ CH155

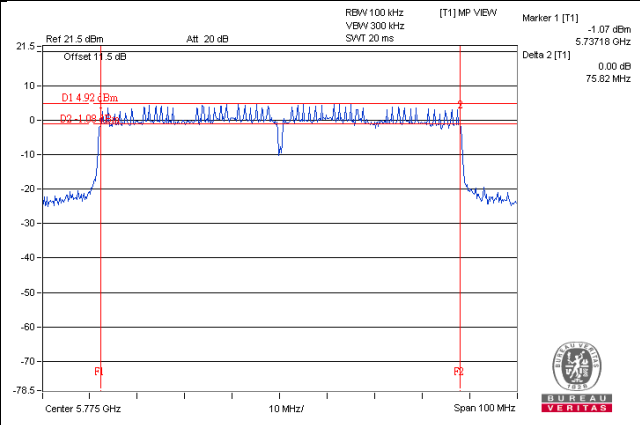

5 Pictures of Test Arrangements

Please refer to the attached file (Test Setup Photo).

Annex A- Radiated Out of Band Emission (OOBE) Measurement (For U-NII-3 band)

802.11a

CH 149 5745 MHz

Horizontal

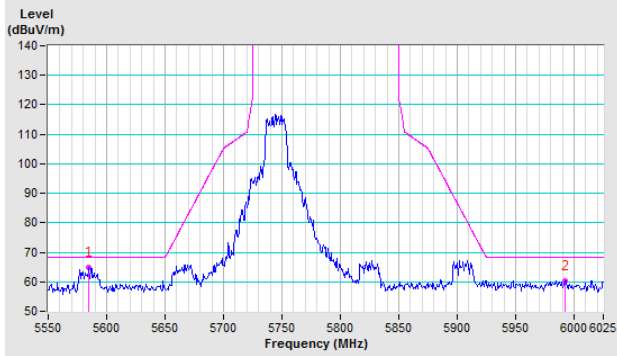

Vertical

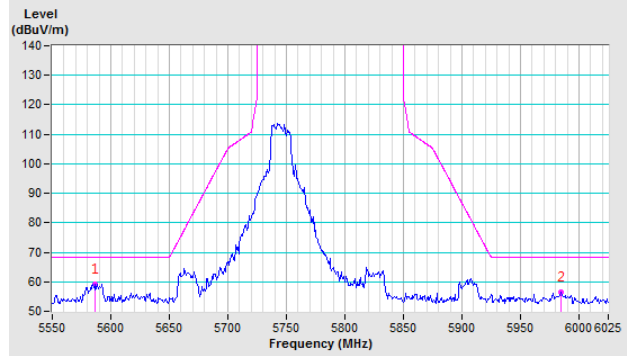

CH 157 5785 MHz

Horizontal

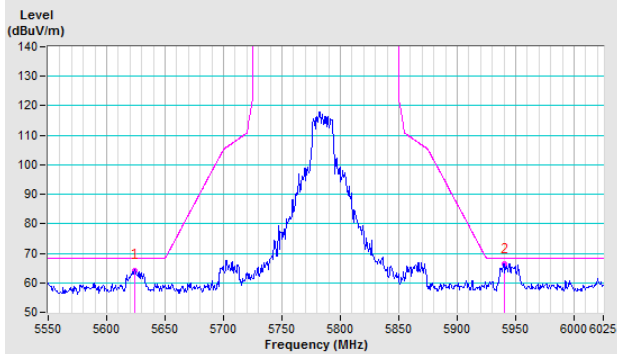

Vertical

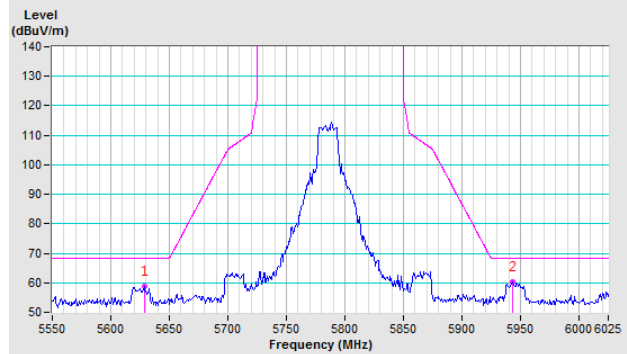

CH 165 5825 MHz

Horizontal

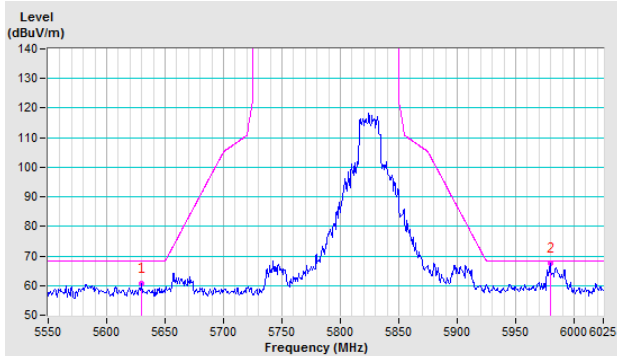

Vertical

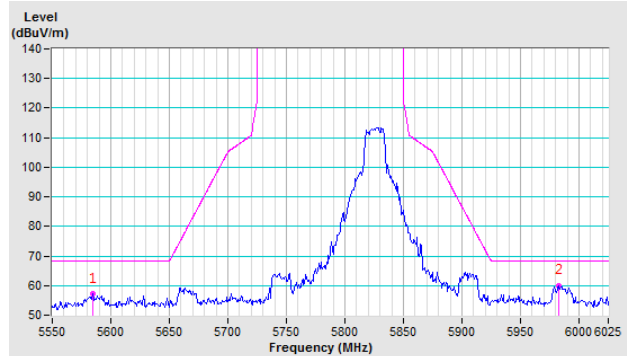

802.11ac (VHT20)

CH 149 5745 MHz

Horizontal

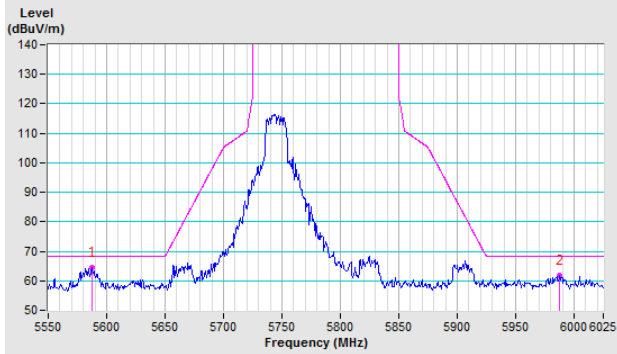

Vertical

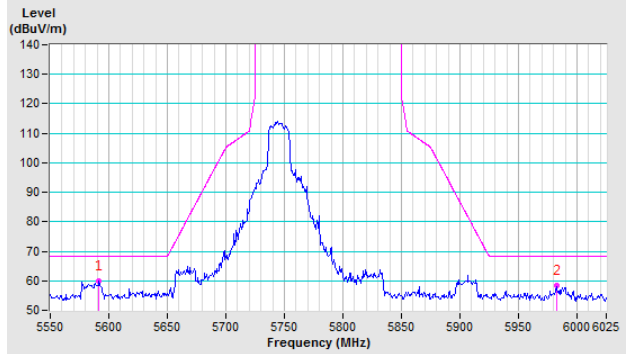

CH 157 5785 MHz

Horizontal

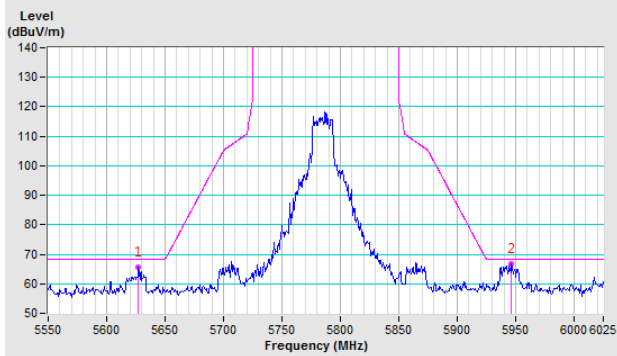

Vertical

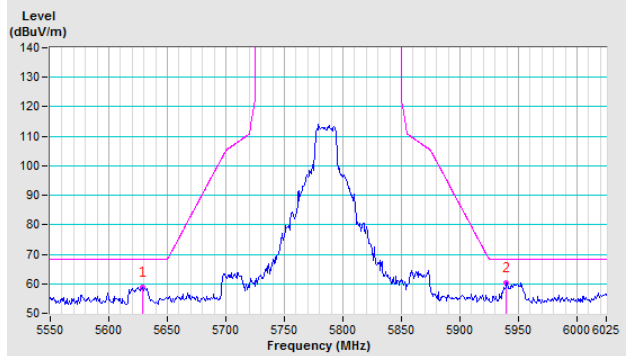

CH 165 5825 MHz

Horizontal

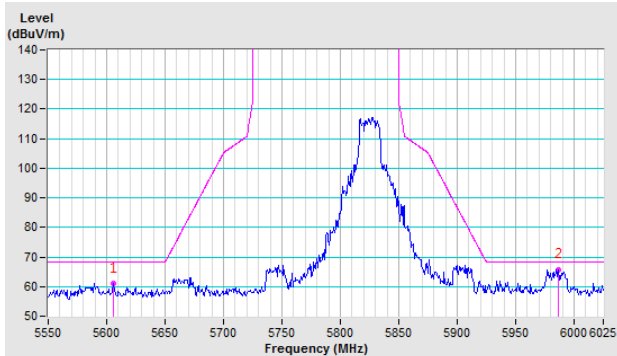

Vertical

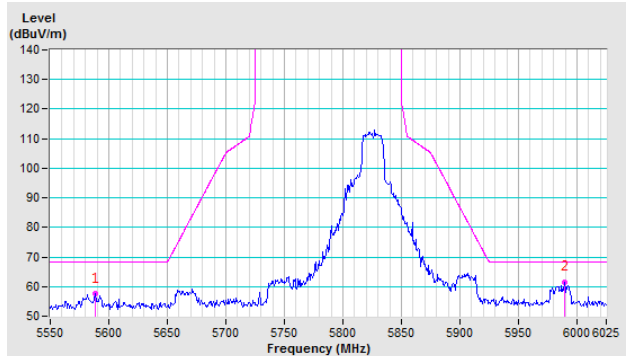

802.11ac (VHT40)

CH 151 5755 MHz

Horizontal

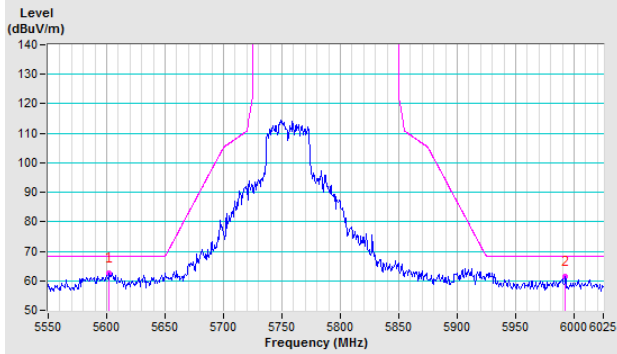

Vertical

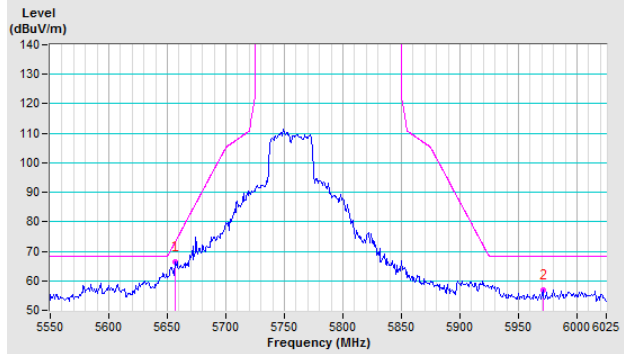

CH 159 5795 MHz

Horizontal

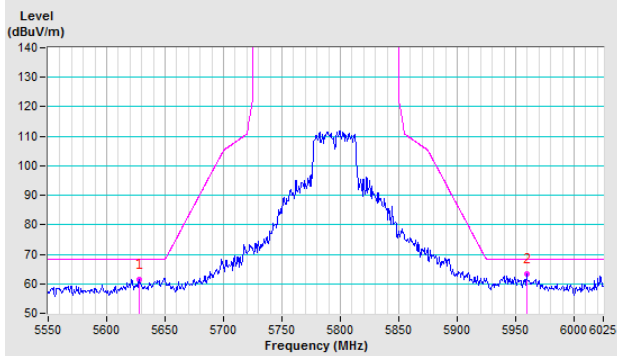

Vertical

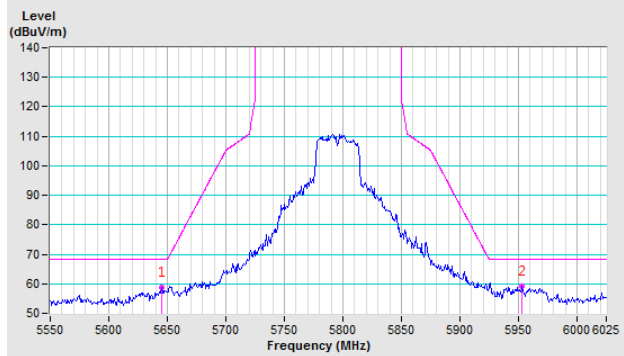

802.11ac (VHT80)

CH 155 5775 MHz

Horizontal

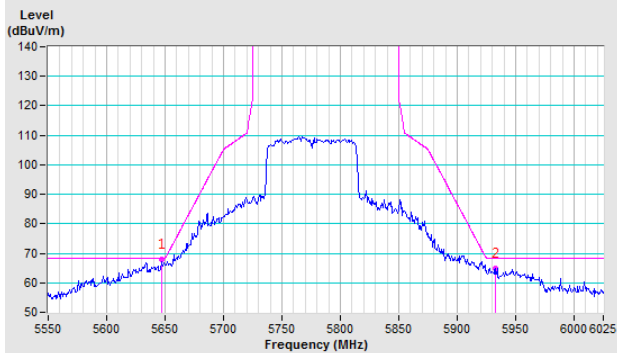

Vertical

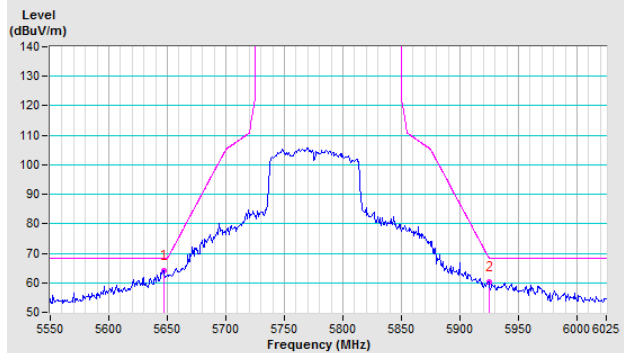

Appendix – Information on the Testing Laboratories

We, Bureau Veritas Consumer Products Services (H.K.) Ltd., Taoyuan Branch, were founded in 1988 to provide our best service in EMC, Radio, Telecom and Safety consultation. Our laboratories are accredited and approved according to ISO/IEC 17025.

If you have any comments, please feel free to contact us at the following:

Linko EMC/RF Lab

Tel: 886-2-26052180

Fax: 886-2-26051924

Hsin Chu EMC/RF/Telecom Lab

Tel: 886-3-6668565

Fax: 886-3-6668323

Hwa Ya EMC/RF/Safety Lab

Tel: 886-3-3183232

Fax: 886-3-3270892

Email: service.adt@tw.bureauveritas.com

Web Site: www.bureauveritas-adt.com

The address and road map of all our labs can be found in our web site also.

--- END ---