

## FCC Test Report

**Report No.:** RF160715C03A

**FCC ID:** PY316100334

**Test Model:** EX6150v2

**Received Date:** Oct. 21, 2016

**Test Date:** Oct. 30 ~ Dec. 01, 2016

**Issued Date:** Dec. 05, 2016

**Applicant:** NETGEAR Inc.

**Address:** 350 East Plumeria Drive San Jose, CA 95134

**Issued By:** Bureau Veritas Consumer Products Services (H.K.) Ltd., Taoyuan Branch

**Lab Address:** No. 47-2, 14th Ling, Chia Pau Vil., Lin Kou Dist., New Taipei City, Taiwan (R.O.C.)

**Test Location:** No.19, Hwa Ya 2nd Rd., Wen Hwa Vil., Kwei Shan Dist., Taoyuan City 33383, TAIWAN (R.O.C.)



This report is for your exclusive use. Any copying or replication of this report to or for any other person or entity, or use of our name or trademark, is permitted only with our prior written permission. This report sets forth our findings solely with respect to the test samples identified herein. The results set forth in this report are not indicative or representative of the quality or characteristics of the lot from which a test sample was taken or any similar or identical product unless specifically and expressly noted. Our report includes all of the tests requested by you and the results thereof based upon the information that you provided to us. You have 60 days from date of issuance of this report to notify us of any material error or omission caused by our negligence, provided, however, that such notice shall be in writing and shall specifically address the issue you wish to raise. A failure to raise such issue within the prescribed time shall constitute your unqualified acceptance of the completeness of this report, the tests conducted and the correctness of the report contents. Unless specifically mentioned, the uncertainty of measurement has been explicitly taken into account to declare the compliance or non-compliance to the specification. The report must not be used by the client to claim product certification, approval, or endorsement by TAF or any government agencies.

## Table of Contents

<b>Release Control Record</b> .....	<b>4</b>
<b>1 Certificate of Conformity</b> .....	<b>5</b>
<b>2 Summary of Test Results</b> .....	<b>6</b>
2.1 Measurement Uncertainty.....	6
2.2 Modification Record.....	6
<b>3 General Information</b> .....	<b>7</b>
3.1 General Description of EUT.....	7
3.2 Description of Test Modes.....	9
3.2.1 Test Mode Applicability and Tested Channel Detail.....	10
3.3 Duty Cycle of Test Signal.....	13
3.4 Description of Support Units.....	14
3.4.1 Configuration of System under Test.....	14
3.5 General Description of Applied Standards.....	14
<b>4 Test Types and Results</b> .....	<b>15</b>
4.1 Radiated Emission and Bandedge Measurement.....	15
4.1.1 Limits of Radiated Emission and Bandedge Measurement.....	15
4.1.2 Test Instruments.....	16
4.1.3 Test Procedures.....	17
4.1.4 Deviation from Test Standard.....	17
4.1.5 Test Set Up.....	18
4.1.6 EUT Operating Conditions.....	19
4.1.7 Test Results.....	20
4.2 Conducted Emission Measurement.....	41
4.2.1 Limits of Conducted Emission Measurement.....	41
4.2.2 Test Instruments.....	41
4.2.3 Test Procedures.....	42
4.2.4 Deviation from Test Standard.....	42
4.2.5 Test Setup.....	42
4.2.6 EUT Operating Conditions.....	42
4.2.7 Test Results.....	43
4.3 Transmit Power Measurement.....	45
4.3.1 Limits of Transmit Power Measurement.....	45
4.3.2 Test Setup.....	45
4.3.3 Test Instruments.....	45
4.3.4 Test Procedure.....	46
4.3.5 Deviation from Test Standard.....	46
4.3.6 EUT Operating Conditions.....	46
4.3.7 Test Result.....	47
4.4 Occupied Bandwidth Measurement.....	54
4.4.1 Test Setup.....	54
4.4.2 Test Instruments.....	54
4.4.3 Test Procedure.....	54
4.4.4 Test Result.....	55
4.5 Peak Power Spectral Density Measurement.....	59
4.5.1 Limits of Peak Power Spectral Density Measurement.....	59
4.5.2 Test Setup.....	59
4.5.3 Test Instruments.....	59
4.5.4 Test Procedures.....	59
4.5.5 Deviation from Test Standard.....	59
4.5.6 EUT Operating Conditions.....	59
4.5.7 Test Results.....	60
4.6 Frequency Stability.....	63
4.6.1 Limits of Frequency Stability Measurement.....	63

4.6.2 Test Setup.....	63
4.6.3 Test Instruments .....	63
4.6.4 Test Procedure .....	63
4.6.5 Deviation from Test Standard .....	64
4.6.6 EUT Operating Condition .....	64
4.6.7 Test Results .....	64
<b>5 Pictures of Test Arrangements.....</b>	<b>65</b>
<b>Appendix – Information on the Testing Laboratories .....</b>	<b>66</b>

### Release Control Record

Issue No.	Description	Date Issued
RF160715C03A	Original release	Dec. 05, 2016

## 1 Certificate of Conformity

**Product:** AC1200 WiFi Range Extender

**Brand:** NETGEAR

**Test Model:** EX6150v2

**Sample Status:** Engineering sample

**Applicant:** NETGEAR Inc.

**Test Date:** Oct. 30 ~ Dec. 01, 2016

**Standards:** 47 CFR FCC Part 15, Subpart E (Section 15.407)  
ANSI C63.10:2013

The above equipment has been tested by **Bureau Veritas Consumer Products Services (H.K.) Ltd., Taoyuan Branch**, and found compliance with the requirement of the above standards. The test record, data evaluation & Equipment Under Test (EUT) configurations represented herein are true and accurate accounts of the measurements of the sample's EMC characteristics under the conditions specified in this report.

**Prepared by :** Celine Chou , **Date:** Dec. 05, 2016  
Celine Chou / Specialist

**Approved by :** Ken Liu , **Date:** Dec. 05, 2016  
Ken Liu / Senior Manager

## 2 Summary of Test Results

47 CFR FCC Part 15, Subpart E (Section 15.407)			
FCC Clause	Test Item	Result	Remarks
15.407(b)(6)	AC Power Conducted Emissions	Pass	Meet the requirement of limit. Minimum passing margin is -9.19dB at 0.16564MHz.
15.407(b)(1/2/3/4(i/ii)/6)	Radiated Emissions & Band Edge Measurement	Pass	Meet the requirement of limit. Minimum passing margin is -0.1dB at 5725.00MHz.
15.407(a)(1/2/3)	Max Average Transmit Power	Pass	Meet the requirement of limit.
---	Occupied Bandwidth Measurement	-	Reference only.
15.407(a)(1/2/3)	Peak Power Spectral Density	Pass	Meet the requirement of limit.
15.407(g)	Frequency Stability	Pass	Meet the requirement of limit.
15.203	Antenna Requirement	Pass	Antenna connector is i-pex(MHF) not a standard connector.

### 2.1 Measurement Uncertainty

Where relevant, the following measurement uncertainty levels have been estimated for tests performed on the EUT as specified in CISPR 16-4-2:

Measurement	Frequency	Expanded Uncertainty (k=2) ( $\pm$ )
Conducted Emissions at mains ports	150kHz ~ 30MHz	2.44 dB
Radiated Emissions up to 1 GHz	30MHz ~ 200MHz	3.59 dB
	200MHz ~ 1000MHz	3.60 dB
Radiated Emissions above 1 GHz	1GHz ~ 18GHz	2.29 dB
	18GHz ~ 40GHz	2.29 dB

### 2.2 Modification Record

There were no modifications required for compliance.

### 3 General Information

#### 3.1 General Description of EUT

Product	AC1200 WiFi Range Extender
Brand	NETGEAR
Test Model	EX6150v2
Sample Status	Engineering sample
Power Supply Rating	100-240Vac
Modulation Type	256QAM, 64QAM, 16QAM, QPSK, BPSK for OFDM
Modulation Technology	OFDM
Transfer Rate	802.11a: 54.0/ 48.0/ 36.0/ 24.0/ 18.0/ 12.0/ 9.0/ 6.0Mbps 802.11n: up to 300Mbps 802.11ac: up to 866.7Mbps
Operating Frequency	5260 ~ 5320MHz, 5500 ~ 5700MHz
Number of Channel	5260 ~ 5320MHz: 802.11a, 802.11n (HT20), 802.11ac (VHT20): 4 802.11n (HT40), 802.11ac (VHT40): 2 802.11ac (VHT80): 1 5500 ~ 5700MHz: 802.11a, 802.11n (HT20), 802.11ac (VHT20): 11 802.11n (HT40), 802.11ac (VHT40): 5 802.11ac (VHT80): 2
Output Power	CDD Mode: 5260 ~ 5320MHz: 233.224mW 5500 ~ 5700MHz: 232.134mW Beamforming Mode: 5260 ~ 5320MHz: 215.886mW 5500 ~ 5700MHz: 214.146mW
Antenna Type	Dipole antenna with 3.48dBi gain
Antenna Connector	i-pex(MHF)
Accessory Device	NA
Data Cable Supplied	NA

**Note:**

1. This report is prepared for FCC class II permissive change. The difference compared with the original report (BV ADT report no.: RF160715C03-1) is adding 5.26GHz to 5.32GHz and 5.50GHz to 5.70GHz by software.

2. The EUT incorporates a MIMO function. Physically, the EUT provides 2 completed transmitters and 2 receivers.

Modulation Mode	TX Function	Beamforming
802.11a	2TX	Not Support
802.11n (HT20)	2TX	Support
802.11n (HT40)	2TX	Support
802.11ac (VHT20)	2TX	Support
802.11ac (VHT40)	2TX	Support
802.11ac (VHT80)	2TX	Support

\*The modulation and bandwidth are similar for 802.11n mode for HT20 / HT40 and 802.11ac mode for VHT20 / VHT40, therefore investigated worst case to representative mode in test report. (Final test mode refer section 3.2.1)

\* For 5GHz band, CDD mode for all test items and beamforming mode only for transmit power tested after pre-tested.

\*The EUT incorporates AP & Extender functions, they are comply with standard, therefore, we chose worse case for AP function to performed the representative test after assessment

3. 2.4GHz and 5GHz technology can transmit at same time.

4. Spurious emission of the simultaneous operation (2.4GHz and 5GHz) has been evaluated and no non-compliance was found.



### 3.2 Description of Test Modes

#### For 5260 ~ 5320MHz

4 channels are provided for 802.11a, 802.11n (HT20), 802.11ac (VHT20):

Channel	Frequency	Channel	Frequency
52	5260 MHz	60	5300 MHz
56	5280 MHz	64	5320 MHz

2 channels are provided for 802.11n (HT40), 802.11ac (VHT40):

Channel	Frequency	Channel	Frequency
54	5270 MHz	62	5310 MHz

1 channel is provided for 802.11ac (VHT80):

Channel	Frequency
58	5290 MHz

#### For 5500 ~ 5700MHz

11 channels are provided for 802.11a, 802.11n (HT20), 802.11ac (VHT20):

Channel	Frequency	Channel	Frequency
100	5500 MHz	124	5620 MHz
104	5520 MHz	128	5640 MHz
108	5540 MHz	132	5660 MHz
112	5560 MHz	136	5680 MHz
116	5580 MHz	140	5700 MHz
120	5600 MHz		

5 channels are provided for 802.11n (HT40), 802.11ac (VHT40):

Channel	Frequency	Channel	Frequency
102	5510 MHz	126	5630 MHz
110	5550 MHz	134	5670 MHz
118	5590 MHz		

2 channels are provided for 802.11ac (VHT80):

Channel	Frequency	Channel	Frequency
106	5530 MHz	122	5610 MHz

### 3.2.1 Test Mode Applicability and Tested Channel Detail

EUT CONFIGURE MODE	APPLICABLE TO				DESCRIPTION
	RE $\geq$ 1G	RE<1G	PLC	APCM	
-	√	√	√	√	-

Where **RE $\geq$ 1G**: Radiated Emission above 1GHz & Bandedge Measurement      **RE<1G**: Radiated Emission below 1GHz  
**PLC**: Power Line Conducted Emission      **APCM**: Antenna Port Conducted Measurement

Note: The EUT had been pre-tested on the positioned of each 3 axis. The worst case was found when positioned on **X-plane**.

#### Radiated Emission Test (Above 1GHz):

- Pre-Scan has been conducted to determine the worst-case mode from all possible combinations between available modulations, data rates and antenna ports (if EUT with antenna diversity architecture).
- Following channel(s) was (were) selected for the final test as listed below.

EUT CONFIGURE MODE	MODE	FREQ. BAND (MHz)	AVAILABLE CHANNEL	TESTED CHANNEL	MODULATION TECHNOLOGY	MODULATION TYPE	DATA RATE (Mbps)
-	802.11a	5260-5320	52 to 64	52, 60, 64	OFDM	BPSK	6.0
-	802.11n (HT20)		52 to 64	52, 60, 64	OFDM	BPSK	7.2
-	802.11n (HT40)		54 to 62	54, 62	OFDM	BPSK	15.0
-	802.11ac (VHT80)		58	58	OFDM	BPSK	58.5
-	802.11a	5500-5700	100 to 140	100, 116, 140	OFDM	BPSK	6.0
-	802.11n (HT20)		100 to 140	100, 116, 140	OFDM	BPSK	7.2
-	802.11n (HT40)		102 to 134	102, 110, 134	OFDM	BPSK	15.0
-	802.11ac (VHT80)		106 to 122	106, 122	OFDM	BPSK	58.5

#### Radiated Emission Test (Below 1GHz):

- Pre-Scan has been conducted to determine the worst-case mode from all possible combinations between available modulations, data rates and antenna ports (if EUT with antenna diversity architecture).
- Following channel(s) was (were) selected for the final test as listed below.

EUT CONFIGURE MODE	MODE	FREQ. BAND (MHz)	AVAILABLE CHANNEL	TESTED CHANNEL	MODULATION TECHNOLOGY	MODULATION TYPE	DATA RATE (Mbps)
-	802.11a	5260-5320	52 to 64	52	OFDM	BPSK	6.0
-	802.11a	5500-5700	100 to 140		OFDM	BPSK	6.0

#### Power Line Conducted Emission Test:

- Pre-Scan has been conducted to determine the worst-case mode from all possible combinations between available modulations, data rates and antenna ports (if EUT with antenna diversity architecture).
- Following channel(s) was (were) selected for the final test as listed below.

EUT CONFIGURE MODE	MODE	FREQ. BAND (MHz)	AVAILABLE CHANNEL	TESTED CHANNEL	MODULATION TECHNOLOGY	MODULATION TYPE	DATA RATE (Mbps)
-	802.11a	5260-5320	52 to 64	52	OFDM	BPSK	6.0
-	802.11a	5500-5700	100 to 140		OFDM	BPSK	6.0

### Transmit Power Measurement

- This item includes all test value of each mode, but only includes spectrum plot of worst value of each mode.
- Pre-Scan has been conducted to determine the worst-case mode from all possible combinations between available modulations, data rates and antenna ports (if EUT with antenna diversity architecture).
- Following channel(s) was (were) selected for the final test as listed below.

EUT CONFIGURE MODE	MODE	FREQ. BAND (MHz)	AVAILABLE CHANNEL	TESTED CHANNEL	MODULATION TECHNOLOGY	MODULATION TYPE	DATA RATE (Mbps)
CDD Mode							
-	802.11a	5260-5320	52 to 64	52, 60, 64	OFDM	BPSK	6.0
-	802.11n (HT20)		52 to 64	52, 60, 64	OFDM	BPSK	7.2
-	802.11n (HT40)		54 to 62	54, 62	OFDM	BPSK	15.0
-	802.11ac (VHT80)		58	58	OFDM	BPSK	58.5
-	802.11a	5500-5700	100 to 140	100, 116, 140	OFDM	BPSK	6.0
-	802.11n (HT20)		100 to 140	100, 116, 140	OFDM	BPSK	7.2
-	802.11n (HT40)		102 to 134	102, 110, 134	OFDM	BPSK	15.0
-	802.11ac (VHT80)		106 to 122	106, 122	OFDM	BPSK	58.5
Beamforming Mode							
-	802.11ac (VHT20)	5260-5320	52 to 64	52, 60, 64	OFDM	BPSK	7.2
-	802.11ac (VHT40)		54 to 62	54, 62	OFDM	BPSK	15.0
-	802.11ac (VHT80)		58	58	OFDM	BPSK	58.5
-	802.11ac (VHT20)	5500-5700	100 to 140	100, 116, 140	OFDM	BPSK	7.2
-	802.11ac (VHT40)		102 to 134	102, 110, 134	OFDM	BPSK	15.0
-	802.11ac (VHT80)		106 to 122	106, 122	OFDM	BPSK	58.5

### Peak Power Spectral Density and Bandwidth Measurement:

- This item includes all test value of each mode, but only includes spectrum plot of worst value of each mode.
- Pre-Scan has been conducted to determine the worst-case mode from all possible combinations between available modulations, data rates and antenna ports (if EUT with antenna diversity architecture).
- Following channel(s) was (were) selected for the final test as listed below.

EUT CONFIGURE MODE	MODE	FREQ. BAND (MHz)	AVAILABLE CHANNEL	TESTED CHANNEL	MODULATION TECHNOLOGY	MODULATION TYPE	DATA RATE (Mbps)
-	802.11a	5260-5320	52 to 64	52, 60, 64	OFDM	BPSK	6.0
-	802.11n (HT20)		52 to 64	52, 60, 64	OFDM	BPSK	7.2
-	802.11n (HT40)		54 to 62	54, 62	OFDM	BPSK	15.0
-	802.11ac (VHT80)		58	58	OFDM	BPSK	58.5
-	802.11a	5500-5700	100 to 140	100, 116, 140	OFDM	BPSK	6.0
-	802.11n (HT20)		100 to 140	100, 116, 140	OFDM	BPSK	7.2
-	802.11n (HT40)		102 to 134	102, 110, 134	OFDM	BPSK	15.0
-	802.11ac (VHT80)		106 to 122	106, 122	OFDM	BPSK	58.5

**Frequency Stability:**

- Pre-Scan has been conducted to determine the worst-case mode from all possible combinations between available modulations, data rates and antenna ports (if EUT with antenna diversity architecture).
- Following channel(s) was (were) selected for the final test as listed below.

EUT CONFIGURE MODE	MODE	FREQ. BAND (MHz)	AVAILABLE CHANNEL	TESTED CHANNEL	MODULATION TECHNOLOGY	MODULATION TYPE	DATA RATE (Mbps)
-	802.11a	5260-5320	52 to 64	52	OFDM	BPSK	6.0
-	802.11a	5500-5700	100 to 140		OFDM	BPSK	6.0

**Test Condition:**

APPLICABLE TO	ENVIRONMENTAL CONDITIONS	INPUT POWER	TESTED BY
RE $\geq$ 1G	25deg. C, 65%RH	120Vac, 60Hz	Chris Lin
RE $<$ 1G	23deg. C, 70%RH	120Vac, 60Hz	Chris Lin
PLC	25deg. C, 65%RH	120Vac, 60Hz	Chris Lin
APCM	25deg. C, 60%RH	120Vac, 60Hz	Cedric Wu

### 3.3 Duty Cycle of Test Signal

802.11a, 802.11n (HT40), 802.11ac (VHT80): Duty cycle of test signal is < 98 %, duty factor is required.  
 802.11n (HT20): Duty cycle of test signal is > 98 %, duty factor is not required.

802.11a: Duty cycle =  $2.061/2.144 = 0.961$ , Duty factor =  $10 * \log(1/0.961) = 0.17$

802.11n (HT20): Duty cycle =  $4.990/5.078 = 0.983$

802.11n (HT40): Duty cycle =  $2.425/2.527 = 0.960$ , Duty factor =  $10 * \log(1/0.960) = 0.18$

802.11ac (VHT80): Duty cycle =  $1.146/1.238 = 0.926$ , Duty factor =  $10 * \log(1/0.926) = 0.34$

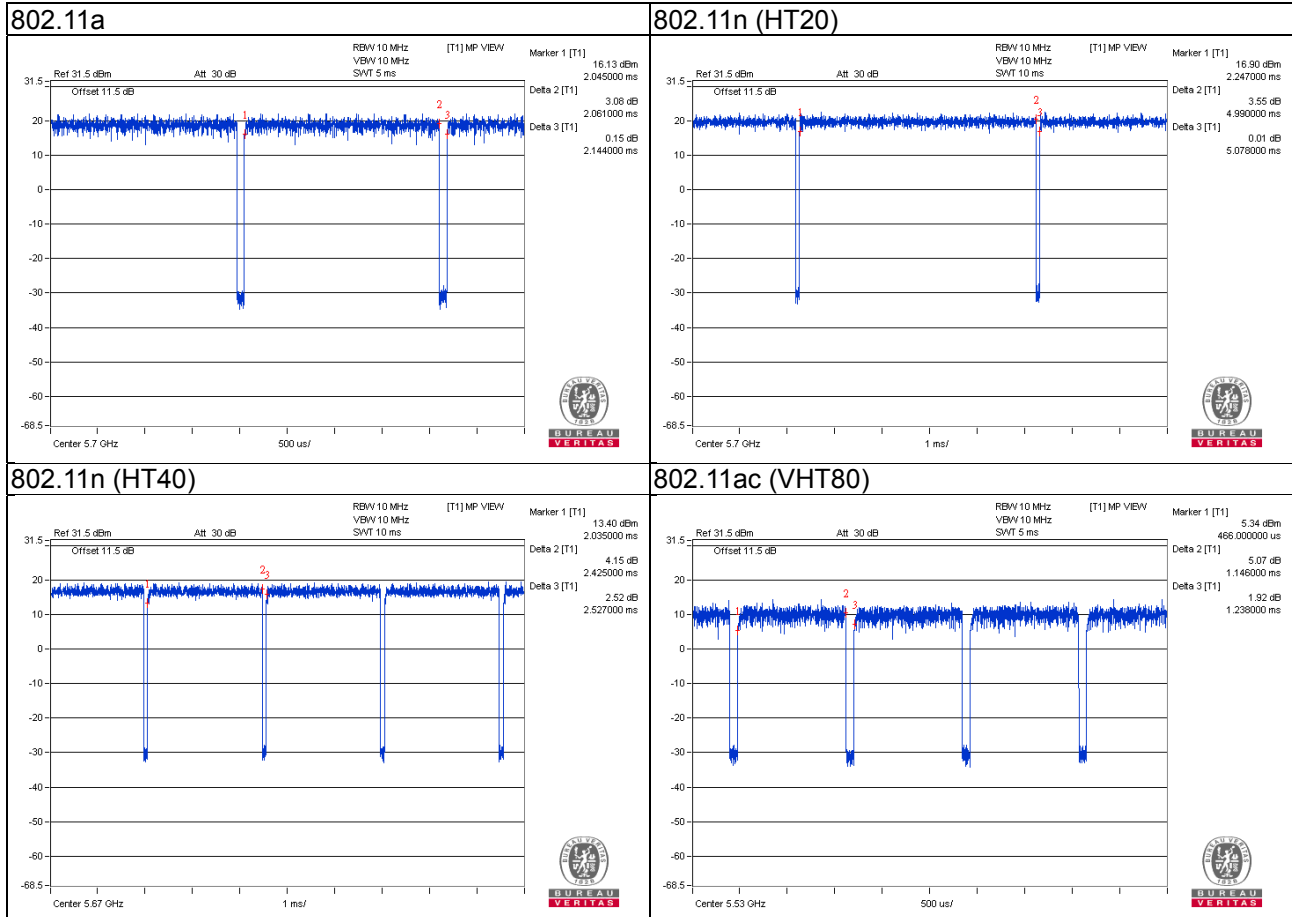

### 3.4 Description of Support Units

The EUT has been tested as an independent unit together with other necessary accessories or support units. The following support units or accessories were used to form a representative test configuration during the tests.

ID	Product	Brand	Model No.	Serial No.	FCC ID	Remarks
A.	Notebook	DELL	E5410	6RP2YM1	FCC DoC Approved	-

Note:

1. All power cords of the above support units are non-shielded (1.8m).
2. Item A acted as communication partner to transfer data.

ID	Descriptions	Qty.	Length (m)	Shielding (Yes/No)	Cores (Qty.)	Remarks
1.	RJ45, Cat5e	1	3	N	0	-

#### 3.4.1 Configuration of System under Test

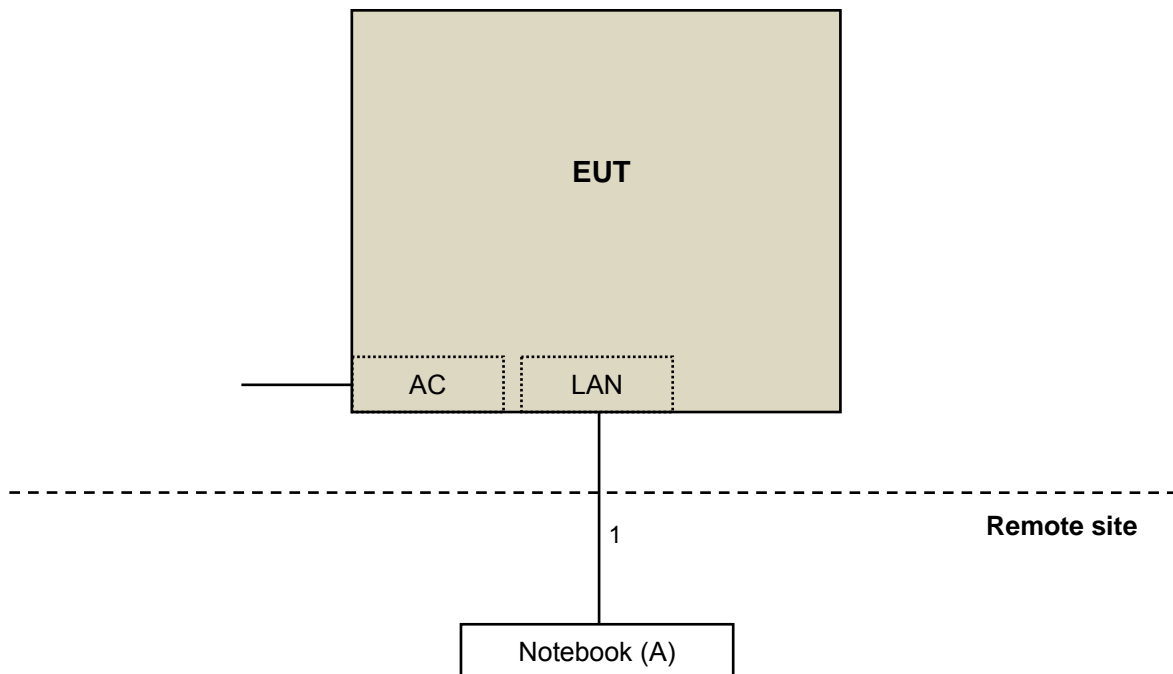

### 3.5 General Description of Applied Standards

The EUT is a RF Product. According to the specifications of the manufacturer, it must comply with the requirements of the following standards:

**FCC Part 15, Subpart E (15.407)**

**KDB 789033 D02 General UNII Test Procedure New Rules v01r04**

**KDB 662911 D01 Multiple Transmitter Output v02r01**

ANSI C63.10-2013

All test items have been performed and recorded as per the above standards.

Note: The EUT has been verified to comply with the requirements of FCC Part 15, Subpart B, Class B (DoC). The test report has been issued separately.

## 4 Test Types and Results

### 4.1 Radiated Emission and Bandedge Measurement

#### 4.1.1 Limits of Radiated Emission and Bandedge Measurement

Radiated emissions which fall in the restricted bands must comply with the radiated emission limits specified as below table.

Frequencies (MHz)	Field Strength (microvolts/meter)	Measurement Distance (meters)
0.009 ~ 0.490	2400/F(kHz)	300
0.490 ~ 1.705	24000/F(kHz)	30
1.705 ~ 30.0	30	30
30 ~ 88	100	3
88 ~ 216	150	3
216 ~ 960	200	3
Above 960	500	3

#### NOTE:

1. The lower limit shall apply at the transition frequencies.
2. Emission level (dBuV/m) = 20 log Emission level (uV/m).
3. For frequencies above 1000MHz, the field strength limits are based on average detector, however, the peak field strength of any emission shall not exceed the maximum permitted average limits, specified above by more than 20dB under any condition of modulation.

Limits of unwanted emission out of the restricted bands

Applicable To		Limit	
789033 D02 General UNII Test Procedure New Rules v01r04		Field Strength at 3m	
		PK: 74 (dBuV/m)	AV: 54 (dBuV/m)
Frequency Band	Applicable To	EIRP Limit	Equivalent Field Strength at 3m
5150~5250 MHz	15.407(b)(1)	PK: -27 (dBm/MHz)	PK: 68.2(dBμV/m)
5250~5350 MHz	15.407(b)(2)		
5470~5725 MHz	15.407(b)(3)		
5725~5850 MHz	<input checked="" type="checkbox"/> 15.407(b)(4)(i)	PK: -27 (dBm/MHz) <sup>*1</sup> PK: 10 (dBm/MHz) <sup>*2</sup> PK: 15.6 (dBm/MHz) <sup>*3</sup> PK: 27 (dBm/MHz) <sup>*4</sup>	PK: 68.2(dBμV/m) <sup>*1</sup> PK: 105.2 (dBμV/m) <sup>*2</sup> PK: 110.8(dBμV/m) <sup>*3</sup> PK: 122.2 (dBμV/m) <sup>*4</sup>
	<input type="checkbox"/> 15.407(b)(4)(ii)	Emission limits in section 15.247(d)	
<sup>*1</sup> beyond 75 MHz or more above of the band edge.		<sup>*2</sup> below the band edge increasing linearly to 10 dBm/MHz at 25 MHz above.	
<sup>*3</sup> below the band edge increasing linearly to a level of 15.6 dBm/MHz at 5 MHz above.		<sup>*4</sup> from 5 MHz above or below the band edge increasing linearly to a level of 27 dBm/MHz at the band edge.	

**Note:** The following formula is used to convert the equipment isotropic radiated power (eirp) to field strength:

$$E = \frac{1000000 \sqrt{30P}}{3} \mu\text{V/m, where P is the eirp (Watts).}$$

#### 4.1.2 Test Instruments

Description & Manufacturer	Model No.	Serial No.	Cal. Date	Cal. Due
Test Receiver ROHDE & SCHWARZ	ESCI	100424	Oct. 24, 2016	Oct. 23, 2017
Spectrum Analyzer ROHDE & SCHWARZ	FSP40	100040	Aug. 16, 2016	Aug. 15, 2017
BILOG Antenna SCHWARZBECK	VULB9168	9168-155	Jan. 07, 2016	Jan. 06, 2017
HORN Antenna SCHWARZBECK	BBHA 9120D	9120D-1170	Jan. 08, 2016	Jan. 07, 2017
HORN Antenna SCHWARZBECK	BBHA 9170	BBHA9170241	Jan. 18, 2016	Jan. 17, 2017
Loop Antenna	EM-6879	269	Aug. 11, 2016	Aug. 10, 2017
Preamplifier Agilent	8449B	3008A01960	Aug. 09, 2016	Aug. 08, 2017
Preamplifier Agilent	8447D	2944A10631	Aug. 09, 2016	Aug. 08, 2017
RF signal cable HUBER+SUHNER	SUCOFLEX 104	MY 13380+295012/04	Aug. 09, 2016	Aug. 08, 2017
RF signal cable HUBER+SUHNER	SUCOFLEX 104	Cable-CH4-03 (250724)	Aug. 09, 2016	Aug. 08, 2017
Software BV ADT	ADT_Radiated_ V7.6.15.9.4	NA	NA	NA
Antenna Tower inn-co GmbH	MA 4000	010303	NA	NA
Antenna Tower Controller BV ADT	AT100	AT93021703	NA	NA
Turn Table BV ADT	TT100	TT93021703	NA	NA
Turn Table Controller BV ADT	SC100	SC93021703	NA	NA
26GHz ~ 40GHz Amplifier	EM26400	815221	Oct. 17, 2016	Oct. 16, 2017
High Speed Peak Power Meter	ML2495A	0824012	Aug. 11, 2016	Aug. 10, 2017
Power Sensor	MA2411B	0738171	Aug. 11, 2016	Aug. 10, 2017
WIT Standard Temperature And Humidity Chamber	TH-4S-C	W981030	Jun. 08, 2016	Jun. 07, 2017

- Note: 1. The calibration interval of the above test instruments is 12 months and the calibrations are traceable to NML/ROC and NIST/USA.  
 2. The test was performed in HwaYa Chamber 4.  
 3. The horn antenna and preamplifier (model: 8449B) are used only for the measurement of emission frequency above 1GHz if tested.  
 4. The FCC Site Registration No. is 460141.  
 5. The IC Site Registration No. is IC7450F-4.



### 4.1.3 Test Procedures

#### For Radiated emission below 30MHz

- a. The EUT was placed on the top of a rotating table 0.8 meters above the ground at a 3 meter chamber room. The table was rotated 360 degrees to determine the position of the highest radiation.
- b. The EUT was set 3 meters away from the interference-receiving antenna, which was mounted on the top of a variable-height antenna tower.
- c. Both X and Y axes of the antenna are set to make the measurement.
- d. For each suspected emission, the EUT was arranged to its worst case and the rotatable table was turned from 0 degrees to 360 degrees to find the maximum reading.
- e. The test-receiver system was set to Quasi-Peak Detect Function and Specified Bandwidth with Maximum Hold Mode.

**Note:**

1. The resolution bandwidth and video bandwidth of test receiver/spectrum analyzer is 9kHz at frequency below 30MHz.

#### For Radiated emission above 30MHz

- a. The EUT was placed on the top of a rotating table 0.8 meters (for 30MHz ~ 1GHz) / 1.5 meters (for above 1GHz) above the ground at 3 meter chamber room for test. The table was rotated 360 degrees to determine the position of the highest radiation.
- b. The EUT was set 3 meters away from the interference-receiving antenna, which was mounted on the top of a variable-height antenna tower.
- c. The height of antenna is varied from one meter to four meters above the ground to determine the maximum value of the field strength. Both horizontal and vertical polarizations of the antenna are set to make the measurement.
- d. For each suspected emission, the EUT was arranged to its worst case and then the antenna was tuned to heights from 1 meter to 4 meters and the rotatable table was turned from 0 degrees to 360 degrees to find the maximum reading.
- e. The test-receiver system was set to quasi-peak detect function and specified bandwidth with maximum hold mode when the test frequency is below 1 GHz.
- f. The test-receiver system was set to peak and average detect function and specified bandwidth with maximum hold mode when the test frequency is above 1 GHz. If the peak reading value also meets average limit, measurement with the average detector is unnecessary.

**Note:**

1. The resolution bandwidth and video bandwidth of test receiver/spectrum analyzer is 120kHz for Quasi-peak detection (QP) at frequency below 1GHz.
2. The resolution bandwidth of test receiver/spectrum analyzer is 1 MHz and the video bandwidth is 3 MHz for Peak detection (PK) at frequency above 1GHz.
3. The resolution bandwidth of test receiver/spectrum analyzer is 1MHz and the video bandwidth is  $\geq 1/T$  (Duty cycle < 98%) or 10Hz (Duty cycle  $\geq 98\%$ ) for Average detection (AV) at frequency above 1GHz.
4. All modes of operation were investigated and the worst-case emissions are reported.

### 4.1.4 Deviation from Test Standard

No deviation.

#### 4.1.5 Test Set Up

##### For Radiated emission below 30MHz

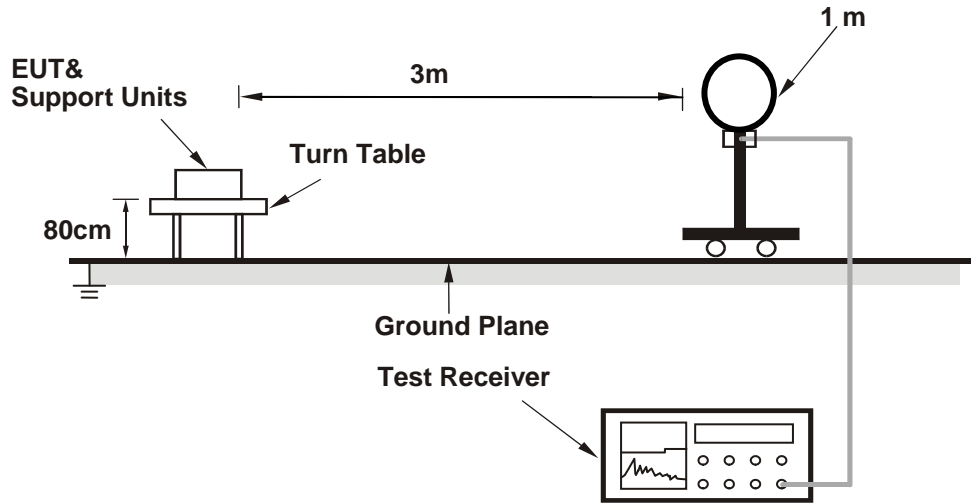

##### For Radiated emission 30MHz to 1GHz

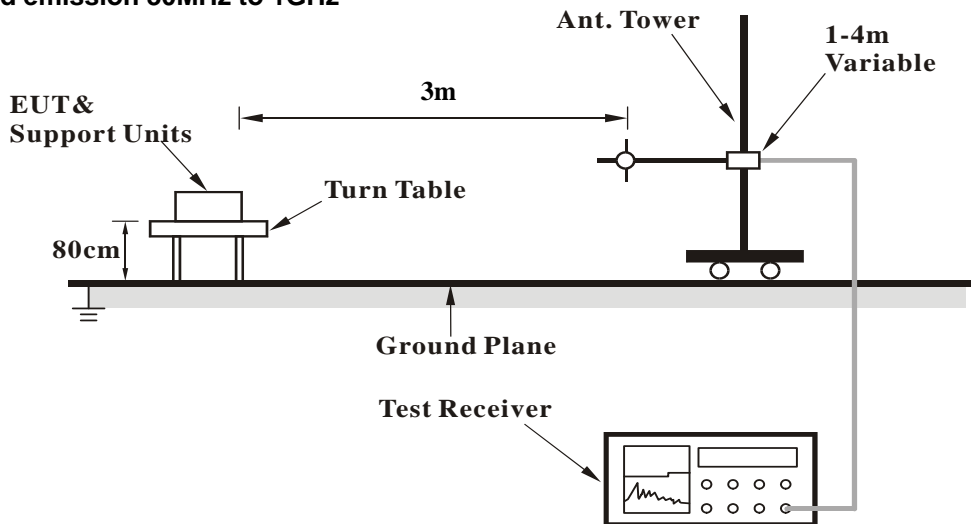

### For Radiated emission above 1GHz

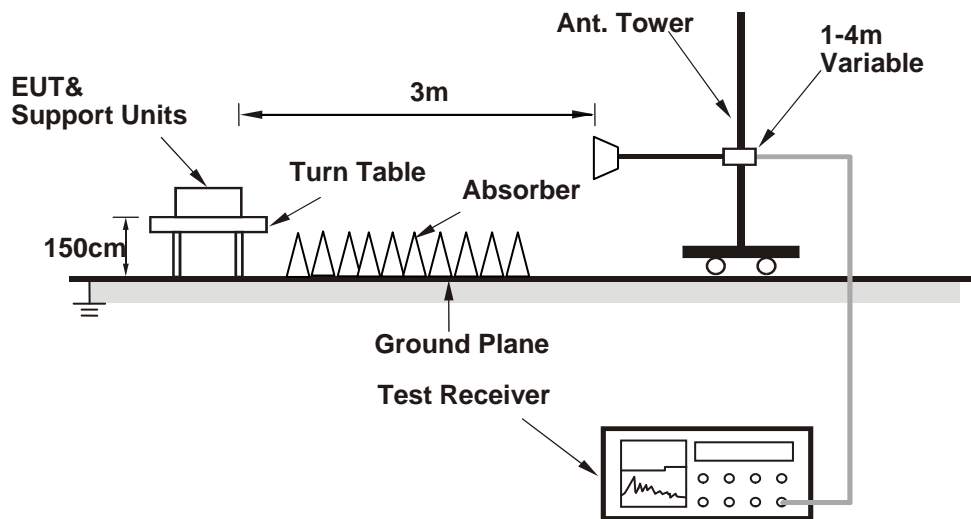

For the actual test configuration, please refer to the attached file (Test Setup Photo).

#### 4.1.6 EUT Operating Conditions

- Placed the EUT on the testing table.
- Prepared a notebook to act as a communication partner and placed it outside of testing area.
- The communication partner connected with EUT via a RJ45 cable and ran a test program (provided by manufacturer) to enable EUT under transmission condition continuously at specific channel frequency.
- The communication partner sent data to EUT by command "PING".

#### 4.1.7 Test Results

Above 1GHz Worst-case Data:

802.11a

CHANNEL	TX Channel 52	DETECTOR	Peak (PK)
FREQUENCY RANGE	1GHz ~ 40GHz	FUNCTION	Average (AV)

ANTENNA POLARITY & TEST DISTANCE: HORIZONTAL AT 3 M								
NO.	FREQ. (MHz)	EMISSION LEVEL (dBuV/m)	LIMIT (dBuV/m)	MARGIN (dB)	ANTENNA HEIGHT (m)	TABLE ANGLE (Degree)	RAW VALUE (dBuV)	CORRECTION FACTOR (dB/m)
1	5150.00	57.9 PK	74.0	-16.1	1.43 H	13	51.9	6.0
2	5150.00	44.8 AV	54.0	-9.2	1.43 H	13	38.8	6.0
3	*5260.00	107.0 PK			1.43 H	13	66.8	40.2
4	*5260.00	96.7 AV			1.43 H	13	56.5	40.2
5	#10520.00	58.9 PK	74.0	-15.1	1.07 H	41	40.6	18.3
6	#10520.00	47.0 AV	54.0	-7.0	1.07 H	41	28.7	18.3
ANTENNA POLARITY & TEST DISTANCE: VERTICAL AT 3 M								
NO.	FREQ. (MHz)	EMISSION LEVEL (dBuV/m)	LIMIT (dBuV/m)	MARGIN (dB)	ANTENNA HEIGHT (m)	TABLE ANGLE (Degree)	RAW VALUE (dBuV)	CORRECTION FACTOR (dB/m)
1	5150.00	61.1 PK	74.0	-12.9	1.93 V	303	55.1	6.0
2	5150.00	47.5 AV	54.0	-6.5	1.93 V	303	41.5	6.0
3	*5260.00	118.3 PK			1.93 V	303	78.1	40.2
4	*5260.00	108.7 AV			1.93 V	303	68.5	40.2
5	#10520.00	59.8 PK	74.0	-14.2	1.58 V	74	41.5	18.3
6	#10520.00	48.7 AV	54.0	-5.3	1.58 V	74	30.4	18.3

Remark:

1. Emission Level(dBuV/m) = Raw Value(dBuV) + Correction Factor(dB/m)
2. Correction Factor(dB/m) = Antenna Factor(dB/m) + Cable Factor(dB)
3. The other emission levels were very low against the limit.
4. Margin value = Emission Level – Limit value
5. " \* ": Fundamental frequency.
6. " # ": The radiated frequency is out of the restricted band.

CHANNEL	TX Channel 60	DETECTOR FUNCTION	Peak (PK)
FREQUENCY RANGE	1GHz ~ 40GHz		Average (AV)

**ANTENNA POLARITY & TEST DISTANCE: HORIZONTAL AT 3 M**

NO.	FREQ. (MHz)	EMISSION LEVEL (dBuV/m)	LIMIT (dBuV/m)	MARGIN (dB)	ANTENNA HEIGHT (m)	TABLE ANGLE (Degree)	RAW VALUE (dBuV)	CORRECTION FACTOR (dB/m)
1	*5300.00	108.0 PK			1.47 H	314	67.8	40.2
2	*5300.00	97.3 AV			1.47 H	314	57.1	40.2
3	10600.00	59.3 PK	74.0	-14.7	1.10 H	58	40.6	18.7
4	10600.00	46.8 AV	54.0	-7.2	1.10 H	58	28.1	18.7

**ANTENNA POLARITY & TEST DISTANCE: VERTICAL AT 3 M**

NO.	FREQ. (MHz)	EMISSION LEVEL (dBuV/m)	LIMIT (dBuV/m)	MARGIN (dB)	ANTENNA HEIGHT (m)	TABLE ANGLE (Degree)	RAW VALUE (dBuV)	CORRECTION FACTOR (dB/m)
1	*5300.00	119.8 PK			1.59 V	313	79.6	40.2
2	*5300.00	109.0 AV			1.59 V	313	68.8	40.2
3	10600.00	60.2 PK	74.0	-13.8	1.36 V	98	41.5	18.7
4	10600.00	49.1 AV	54.0	-4.9	1.36 V	98	30.4	18.7

**Remark:**

1. Emission Level(dBuV/m) = Raw Value(dBuV) + Correction Factor(dB/m)
2. Correction Factor(dB/m) = Antenna Factor(dB/m) + Cable Factor(dB)
3. The other emission levels were very low against the limit.
4. Margin value = Emission Level – Limit value
5. " \* ": Fundamental frequency.
6. " # ": The radiated frequency is out of the restricted band.

CHANNEL	TX Channel 64	DETECTOR FUNCTION	Peak (PK)
FREQUENCY RANGE	1GHz ~ 40GHz		Average (AV)

**ANTENNA POLARITY & TEST DISTANCE: HORIZONTAL AT 3 M**

NO.	FREQ. (MHz)	EMISSION LEVEL (dBuV/m)	LIMIT (dBuV/m)	MARGIN (dB)	ANTENNA HEIGHT (m)	TABLE ANGLE (Degree)	RAW VALUE (dBuV)	CORRECTION FACTOR (dB/m)
1	5150.00	57.9 PK	74.0	-16.1	1.12 H	310	51.9	6.0
2	5150.00	44.7 AV	54.0	-9.3	1.12 H	310	38.7	6.0
3	*5320.00	107.2 PK			1.12 H	310	67.0	40.2
4	*5320.00	93.2 AV			1.12 H	310	53.0	40.2
5	10640.00	59.0 PK	74.0	-15.0	1.32 H	64	40.0	19.0
6	10640.00	47.1 AV	54.0	-6.9	1.32 H	64	28.1	19.0

**ANTENNA POLARITY & TEST DISTANCE: VERTICAL AT 3 M**

NO.	FREQ. (MHz)	EMISSION LEVEL (dBuV/m)	LIMIT (dBuV/m)	MARGIN (dB)	ANTENNA HEIGHT (m)	TABLE ANGLE (Degree)	RAW VALUE (dBuV)	CORRECTION FACTOR (dB/m)
1	*5320.00	116.4 PK			1.66 V	309	76.2	40.2
2	*5320.00	105.9 AV			1.66 V	309	65.7	40.2
3	5350.00	69.7 PK	74.0	-4.3	1.66 V	309	63.5	6.2
4	5350.00	53.6 AV	54.0	-0.4	1.66 V	309	47.4	6.2
5	10640.00	60.2 PK	74.0	-13.8	1.55 V	224	41.2	19.0
6	10640.00	49.1 AV	54.0	-4.9	1.55 V	224	30.1	19.0

**Remark:**

1. Emission Level(dBuV/m) = Raw Value(dBuV) + Correction Factor(dB/m)
2. Correction Factor(dB/m) = Antenna Factor(dB/m) + Cable Factor(dB)
3. The other emission levels were very low against the limit.
4. Margin value = Emission Level – Limit value
5. " \* ": Fundamental frequency.
6. " # ": The radiated frequency is out of the restricted band.

CHANNEL	TX Channel 100	DETECTOR FUNCTION	Peak (PK)
FREQUENCY RANGE	1GHz ~ 40GHz		Average (AV)

ANTENNA POLARITY & TEST DISTANCE: HORIZONTAL AT 3 M								
NO.	FREQ. (MHz)	EMISSION LEVEL (dBuV/m)	LIMIT (dBuV/m)	MARGIN (dB)	ANTENNA HEIGHT (m)	TABLE ANGLE (Degree)	RAW VALUE (dBuV)	CORRECTION FACTOR (dB/m)
1	5460.00	61.7 PK	74.0	-12.3	1.40 H	317	55.4	6.3
2	5460.00	46.8 AV	54.0	-7.2	1.40 H	317	40.5	6.3
3	#5470.00	66.2 PK	74.0	-7.8	1.40 H	317	59.9	6.3
4	#5470.00	51.3 AV	54.0	-2.7	1.40 H	317	45.0	6.3
5	*5500.00	104.4 PK			1.40 H	317	64.0	40.4
6	*5500.00	94.7 AV			1.40 H	317	54.3	40.4
7	11000.00	60.1 PK	74.0	-13.9	1.07 H	44	40.6	19.5
8	11000.00	48.2 AV	54.0	-5.8	1.07 H	44	28.7	19.5
ANTENNA POLARITY & TEST DISTANCE: VERTICAL AT 3 M								
NO.	FREQ. (MHz)	EMISSION LEVEL (dBuV/m)	LIMIT (dBuV/m)	MARGIN (dB)	ANTENNA HEIGHT (m)	TABLE ANGLE (Degree)	RAW VALUE (dBuV)	CORRECTION FACTOR (dB/m)
1	5460.00	60.9 PK	74.0	-13.1	1.66 V	310	54.6	6.3
2	5460.00	48.1 AV	54.0	-5.9	1.66 V	310	41.8	6.3
3	#5470.00	69.2 PK	74.0	-4.8	1.66 V	310	62.9	6.3
4	#5470.00	53.5 AV	54.0	-0.5	1.66 V	310	47.2	6.3
5	*5500.00	114.6 PK			1.66 V	310	74.2	40.4
6	*5500.00	104.8 AV			1.66 V	310	64.4	40.4
7	11000.00	62.1 PK	74.0	-11.9	1.52 V	98	42.6	19.5
8	11000.00	49.6 AV	54.0	-4.4	1.52 V	98	30.1	19.5

Remark:

1. Emission Level(dBuV/m) = Raw Value(dBuV) + Correction Factor(dB/m)
2. Correction Factor(dB/m) = Antenna Factor(dB/m) + Cable Factor(dB)
3. The other emission levels were very low against the limit.
4. Margin value = Emission Level – Limit value
5. " \* ": Fundamental frequency.
6. " # ": The radiated frequency is out of the restricted band.

CHANNEL	TX Channel 116	DETECTOR FUNCTION	Peak (PK)
FREQUENCY RANGE	1GHz ~ 40GHz		Average (AV)

**ANTENNA POLARITY & TEST DISTANCE: HORIZONTAL AT 3 M**

NO.	FREQ. (MHz)	EMISSION LEVEL (dBuV/m)	LIMIT (dBuV/m)	MARGIN (dB)	ANTENNA HEIGHT (m)	TABLE ANGLE (Degree)	RAW VALUE (dBuV)	CORRECTION FACTOR (dB/m)
1	*5580.00	107.0 PK			1.56 H	41	66.5	40.5
2	*5580.00	96.6 AV			1.56 H	41	56.1	40.5
3	11160.00	60.9 PK	74.0	-13.1	1.26 H	54	40.9	20.0
4	11160.00	48.1 AV	54.0	-5.9	1.26 H	54	28.1	20.0

**ANTENNA POLARITY & TEST DISTANCE: VERTICAL AT 3 M**

NO.	FREQ. (MHz)	EMISSION LEVEL (dBuV/m)	LIMIT (dBuV/m)	MARGIN (dB)	ANTENNA HEIGHT (m)	TABLE ANGLE (Degree)	RAW VALUE (dBuV)	CORRECTION FACTOR (dB/m)
1	*5580.00	117.9 PK			1.56 V	307	77.4	40.5
2	*5580.00	108.0 AV			1.56 V	307	67.5	40.5
3	11160.00	62.6 PK	74.0	-11.4	1.07 V	87	42.6	20.0
4	11160.00	50.4 AV	54.0	-3.6	1.07 V	87	30.4	20.0

**Remark:**

1. Emission Level(dBuV/m) = Raw Value(dBuV) + Correction Factor(dB/m)
2. Correction Factor(dB/m) = Antenna Factor(dB/m) + Cable Factor(dB)
3. The other emission levels were very low against the limit.
4. Margin value = Emission Level – Limit value
5. " \* ": Fundamental frequency.
6. " # ": The radiated frequency is out of the restricted band.



CHANNEL	TX Channel 140	DETECTOR FUNCTION	Peak (PK)
FREQUENCY RANGE	1GHz ~ 40GHz		Average (AV)

ANTENNA POLARITY & TEST DISTANCE: HORIZONTAL AT 3 M								
NO.	FREQ. (MHz)	EMISSION LEVEL (dBuV/m)	LIMIT (dBuV/m)	MARGIN (dB)	ANTENNA HEIGHT (m)	TABLE ANGLE (Degree)	RAW VALUE (dBuV)	CORRECTION FACTOR (dB/m)
1	*5700.00	105.3 PK			1.38 H	299	64.4	40.9
2	*5700.00	95.4 AV			1.38 H	299	54.5	40.9
3	#5725.00	63.9 PK	74.0	-10.1	1.38 H	299	57.2	6.7
4	#5725.00	47.4 AV	54.0	-6.6	1.38 H	299	40.7	6.7
5	11400.00	60.9 PK	74.0	-13.1	1.55 H	226	40.3	20.6
6	11400.00	48.7 AV	54.0	-5.3	1.55 H	226	28.1	20.6

ANTENNA POLARITY & TEST DISTANCE: VERTICAL AT 3 M								
NO.	FREQ. (MHz)	EMISSION LEVEL (dBuV/m)	LIMIT (dBuV/m)	MARGIN (dB)	ANTENNA HEIGHT (m)	TABLE ANGLE (Degree)	RAW VALUE (dBuV)	CORRECTION FACTOR (dB/m)
1	*5700.00	112.5 PK			1.52 V	309	71.6	40.9
2	*5700.00	102.5 AV			1.52 V	309	61.6	40.9
3	#5725.00	70.2 PK	74.0	-3.8	1.52 V	309	63.5	6.7
4	#5725.00	<b>53.9 AV</b>	<b>54.0</b>	<b>-0.1</b>	<b>1.52 V</b>	<b>309</b>	<b>47.2</b>	<b>6.7</b>
5	11400.00	63.2 PK	74.0	-10.8	1.47 V	87	42.6	20.6
6	11400.00	51.2 AV	54.0	-2.8	1.47 V	87	30.6	20.6

Remark:

1. Emission Level(dBuV/m) = Raw Value(dBuV) + Correction Factor(dB/m)
2. Correction Factor(dB/m) = Antenna Factor(dB/m) + Cable Factor(dB)
3. The other emission levels were very low against the limit.
4. Margin value = Emission Level – Limit value
5. " \* ": Fundamental frequency.
6. " # ": The radiated frequency is out of the restricted band.

802.11n (HT20)

CHANNEL	TX Channel 52	DETECTOR FUNCTION	Peak (PK)
FREQUENCY RANGE	1GHz ~ 40GHz		Average (AV)

ANTENNA POLARITY & TEST DISTANCE: HORIZONTAL AT 3 M

NO.	FREQ. (MHz)	EMISSION LEVEL (dBuV/m)	LIMIT (dBuV/m)	MARGIN (dB)	ANTENNA HEIGHT (m)	TABLE ANGLE (Degree)	RAW VALUE (dBuV)	CORRECTION FACTOR (dB/m)
1	5150.00	59.0 PK	74.0	-15.0	1.42 H	14	53.0	6.0
2	5150.00	44.6 AV	54.0	-9.4	1.42 H	14	38.6	6.0
3	*5260.00	108.2 PK			1.42 H	14	68.0	40.2
4	*5260.00	96.6 AV			1.42 H	14	56.4	40.2
5	#10520.00	58.6 PK	74.0	-15.4	1.07 H	41	40.3	18.3
6	#10520.00	47.0 AV	54.0	-7.0	1.07 H	41	28.7	18.3

ANTENNA POLARITY & TEST DISTANCE: VERTICAL AT 3 M

NO.	FREQ. (MHz)	EMISSION LEVEL (dBuV/m)	LIMIT (dBuV/m)	MARGIN (dB)	ANTENNA HEIGHT (m)	TABLE ANGLE (Degree)	RAW VALUE (dBuV)	CORRECTION FACTOR (dB/m)
1	5150.00	59.9 PK	74.0	-14.1	1.45 V	312	53.9	6.0
2	5150.00	44.9 AV	54.0	-9.1	1.45 V	312	38.9	6.0
3	*5260.00	118.9 PK			1.45 V	312	78.7	40.2
4	*5260.00	108.7 AV			1.45 V	312	68.5	40.2
5	#10520.00	60.9 PK	74.0	-13.1	1.32 V	64	42.6	18.3
6	#10520.00	48.4 AV	54.0	-5.6	1.32 V	64	30.1	18.3

Remark:

1. Emission Level(dBuV/m) = Raw Value(dBuV) + Correction Factor(dB/m)
2. Correction Factor(dB/m) = Antenna Factor(dB/m) + Cable Factor(dB)
3. The other emission levels were very low against the limit.
4. Margin value = Emission Level – Limit value
5. " \* ": Fundamental frequency.
6. " # ": The radiated frequency is out of the restricted band.

CHANNEL	TX Channel 60	DETECTOR FUNCTION	Peak (PK)
FREQUENCY RANGE	1GHz ~ 40GHz		Average (AV)

ANTENNA POLARITY & TEST DISTANCE: HORIZONTAL AT 3 M								
NO.	FREQ. (MHz)	EMISSION LEVEL (dBuV/m)	LIMIT (dBuV/m)	MARGIN (dB)	ANTENNA HEIGHT (m)	TABLE ANGLE (Degree)	RAW VALUE (dBuV)	CORRECTION FACTOR (dB/m)
1	*5300.00	107.3 PK			1.54 H	110	67.1	40.2
2	*5300.00	96.3 AV			1.54 H	110	56.1	40.2
3	10600.00	59.4 PK	74.0	-14.6	1.26 H	35	40.7	18.7
4	10600.00	46.8 AV	54.0	-7.2	1.26 H	35	28.1	18.7
ANTENNA POLARITY & TEST DISTANCE: VERTICAL AT 3 M								
NO.	FREQ. (MHz)	EMISSION LEVEL (dBuV/m)	LIMIT (dBuV/m)	MARGIN (dB)	ANTENNA HEIGHT (m)	TABLE ANGLE (Degree)	RAW VALUE (dBuV)	CORRECTION FACTOR (dB/m)
1	*5300.00	118.9 PK			1.58 V	307	78.7	40.2
2	*5300.00	108.7 AV			1.58 V	307	68.5	40.2
3	10600.00	60.5 PK	74.0	-13.5	1.05 V	64	41.8	18.7
4	10600.00	48.8 AV	54.0	-5.2	1.05 V	64	30.1	18.7

Remark:

1. Emission Level(dBuV/m) = Raw Value(dBuV) + Correction Factor(dB/m)
2. Correction Factor(dB/m) = Antenna Factor(dB/m) + Cable Factor(dB)
3. The other emission levels were very low against the limit.
4. Margin value = Emission Level – Limit value
5. " \* ": Fundamental frequency.
6. " # ": The radiated frequency is out of the restricted band.

CHANNEL	TX Channel 64	DETECTOR FUNCTION	Peak (PK)
FREQUENCY RANGE	1GHz ~ 40GHz		Average (AV)

ANTENNA POLARITY & TEST DISTANCE: HORIZONTAL AT 3 M								
NO.	FREQ. (MHz)	EMISSION LEVEL (dBuV/m)	LIMIT (dBuV/m)	MARGIN (dB)	ANTENNA HEIGHT (m)	TABLE ANGLE (Degree)	RAW VALUE (dBuV)	CORRECTION FACTOR (dB/m)
1	*5320.00	104.6 PK			1.23 H	318	64.4	40.2
2	*5320.00	94.0 AV			1.23 H	318	53.8	40.2
3	5350.00	60.2 PK	74.0	-13.8	1.23 H	318	54.0	6.2
4	5350.00	46.3 AV	54.0	-7.7	1.23 H	318	40.1	6.2
5	10640.00	59.6 PK	74.0	-14.4	1.17 H	41	40.6	19.0
6	10640.00	47.7 AV	54.0	-6.3	1.17 H	41	28.7	19.0

ANTENNA POLARITY & TEST DISTANCE: VERTICAL AT 3 M								
NO.	FREQ. (MHz)	EMISSION LEVEL (dBuV/m)	LIMIT (dBuV/m)	MARGIN (dB)	ANTENNA HEIGHT (m)	TABLE ANGLE (Degree)	RAW VALUE (dBuV)	CORRECTION FACTOR (dB/m)
1	*5320.00	116.1 PK			1.72 V	310	75.9	40.2
2	*5320.00	105.7 AV			1.72 V	310	65.5	40.2
3	5350.00	70.7 PK	74.0	-3.3	1.72 V	310	64.5	6.2
4	5350.00	53.5 AV	54.0	-0.5	1.72 V	310	47.3	6.2
5	10640.00	61.6 PK	74.0	-12.4	1.07 V	41	42.6	19.0
6	10640.00	49.1 AV	54.0	-4.9	1.07 V	41	30.1	19.0

Remark:

1. Emission Level(dBuV/m) = Raw Value(dBuV) + Correction Factor(dB/m)
2. Correction Factor(dB/m) = Antenna Factor(dB/m) + Cable Factor(dB)
3. The other emission levels were very low against the limit.
4. Margin value = Emission Level – Limit value
5. " \* ": Fundamental frequency.
6. " # ": The radiated frequency is out of the restricted band.

CHANNEL	TX Channel 100	DETECTOR FUNCTION	Peak (PK)
FREQUENCY RANGE	1GHz ~ 40GHz		Average (AV)

ANTENNA POLARITY & TEST DISTANCE: HORIZONTAL AT 3 M								
NO.	FREQ. (MHz)	EMISSION LEVEL (dBuV/m)	LIMIT (dBuV/m)	MARGIN (dB)	ANTENNA HEIGHT (m)	TABLE ANGLE (Degree)	RAW VALUE (dBuV)	CORRECTION FACTOR (dB/m)
1	5460.00	58.4 PK	74.0	-15.6	N/A H	N/A	52.1	6.3
2	5460.00	47.2 AV	54.0	-6.8	N/A H	N/A	40.9	6.3
3	#5470.00	66.8 PK	74.0	-7.2	1.58 H	40	60.5	6.3
4	#5470.00	50.1 AV	54.0	-3.9	1.58 H	40	43.8	6.3
5	*5500.00	108.1 PK			1.58 H	40	67.7	40.4
6	*5500.00	96.5 AV			1.58 H	40	56.1	40.4
7	11000.00	59.6 PK	74.0	-14.4	1.32 H	64	40.1	19.5
8	11000.00	47.9 AV	54.0	-6.1	1.32 H	64	28.4	19.5
ANTENNA POLARITY & TEST DISTANCE: VERTICAL AT 3 M								
NO.	FREQ. (MHz)	EMISSION LEVEL (dBuV/m)	LIMIT (dBuV/m)	MARGIN (dB)	ANTENNA HEIGHT (m)	TABLE ANGLE (Degree)	RAW VALUE (dBuV)	CORRECTION FACTOR (dB/m)
1	5460.00	64.7 PK	74.0	-9.3	1.51 V	313	58.4	6.3
2	5460.00	48.9 AV	54.0	-5.1	1.51 V	313	42.6	6.3
3	#5470.00	71.1 PK	74.0	-2.9	1.51 V	313	64.8	6.3
4	#5470.00	53.5 AV	54.0	-0.5	1.51 V	313	47.2	6.3
5	*5500.00	116.1 PK			1.51 V	313	75.7	40.4
6	*5500.00	105.5 AV			1.51 V	313	65.1	40.4
7	11000.00	62.1 PK	74.0	-11.9	1.06 V	98	42.6	19.5
8	11000.00	49.6 AV	54.0	-4.4	1.06 V	98	30.1	19.5

Remark:

1. Emission Level(dBuV/m) = Raw Value(dBuV) + Correction Factor(dB/m)
2. Correction Factor(dB/m) = Antenna Factor(dB/m) + Cable Factor(dB)
3. The other emission levels were very low against the limit.
4. Margin value = Emission Level – Limit value
5. " \* ": Fundamental frequency.
6. " # ": The radiated frequency is out of the restricted band.

CHANNEL	TX Channel 116	DETECTOR FUNCTION	Peak (PK)
FREQUENCY RANGE	1GHz ~ 40GHz		Average (AV)

**ANTENNA POLARITY & TEST DISTANCE: HORIZONTAL AT 3 M**

NO.	FREQ. (MHz)	EMISSION LEVEL (dBuV/m)	LIMIT (dBuV/m)	MARGIN (dB)	ANTENNA HEIGHT (m)	TABLE ANGLE (Degree)	RAW VALUE (dBuV)	CORRECTION FACTOR (dB/m)
1	*5580.00	108.7 PK			1.66 H	39	68.2	40.5
2	*5580.00	97.8 AV			1.66 H	39	57.3	40.5
3	11160.00	60.6 PK	74.0	-13.4	1.07 H	41	40.6	20.0
4	11160.00	48.4 AV	54.0	-5.6	1.07 H	41	28.4	20.0

**ANTENNA POLARITY & TEST DISTANCE: VERTICAL AT 3 M**

NO.	FREQ. (MHz)	EMISSION LEVEL (dBuV/m)	LIMIT (dBuV/m)	MARGIN (dB)	ANTENNA HEIGHT (m)	TABLE ANGLE (Degree)	RAW VALUE (dBuV)	CORRECTION FACTOR (dB/m)
1	*5580.00	116.8 PK			1.56 V	306	76.3	40.5
2	*5580.00	106.5 AV			1.56 V	306	66.0	40.5
3	11160.00	62.5 PK	74.0	-11.5	1.06 V	38	42.5	20.0
4	11160.00	50.2 AV	54.0	-3.8	1.06 V	38	30.2	20.0

**Remark:**

1. Emission Level(dBuV/m) = Raw Value(dBuV) + Correction Factor(dB/m)
2. Correction Factor(dB/m) = Antenna Factor(dB/m) + Cable Factor(dB)
3. The other emission levels were very low against the limit.
4. Margin value = Emission Level – Limit value
5. " \* ": Fundamental frequency.
6. " # ": The radiated frequency is out of the restricted band.

CHANNEL	TX Channel 140	DETECTOR FUNCTION	Peak (PK)
FREQUENCY RANGE	1GHz ~ 40GHz		Average (AV)

**ANTENNA POLARITY & TEST DISTANCE: HORIZONTAL AT 3 M**

NO.	FREQ. (MHz)	EMISSION LEVEL (dBuV/m)	LIMIT (dBuV/m)	MARGIN (dB)	ANTENNA HEIGHT (m)	TABLE ANGLE (Degree)	RAW VALUE (dBuV)	CORRECTION FACTOR (dB/m)
1	*5700.00	106.7 PK			1.29 H	301	65.8	40.9
2	*5700.00	96.3 AV			1.29 H	301	55.4	40.9
3	#5725.00	68.6 PK	74.0	-5.4	1.29 H	301	61.9	6.7
4	#5725.00	50.6 AV	54.0	-3.4	1.29 H	301	43.9	6.7
5	11400.00	60.9 PK	74.0	-13.1	1.36 H	98	40.3	20.6
6	11400.00	48.8 AV	54.0	-5.2	1.36 H	98	28.2	20.6

**ANTENNA POLARITY & TEST DISTANCE: VERTICAL AT 3 M**

NO.	FREQ. (MHz)	EMISSION LEVEL (dBuV/m)	LIMIT (dBuV/m)	MARGIN (dB)	ANTENNA HEIGHT (m)	TABLE ANGLE (Degree)	RAW VALUE (dBuV)	CORRECTION FACTOR (dB/m)
1	*5700.00	114.4 PK			1.54 V	314	73.5	40.9
2	*5700.00	103.7 AV			1.54 V	314	62.8	40.9
3	#5725.00	72.0 PK	74.0	-2.0	1.54 V	314	65.3	6.7
4	#5725.00	53.8 AV	54.0	-0.2	1.54 V	314	47.1	6.7
5	11400.00	62.1 PK	74.0	-11.9	1.32 V	64	41.5	20.6
6	11400.00	50.8 AV	54.0	-3.2	1.32 V	64	30.2	20.6

**Remark:**

1. Emission Level(dBuV/m) = Raw Value(dBuV) + Correction Factor(dB/m)
2. Correction Factor(dB/m) = Antenna Factor(dB/m) + Cable Factor(dB)
3. The other emission levels were very low against the limit.
4. Margin value = Emission Level – Limit value
5. " \* ": Fundamental frequency.
6. " # ": The radiated frequency is out of the restricted band.

802.11n (HT40)

CHANNEL	TX Channel 54	DETECTOR FUNCTION	Peak (PK) Average (AV)
FREQUENCY RANGE	1GHz ~ 40GHz		

ANTENNA POLARITY & TEST DISTANCE: HORIZONTAL AT 3 M

NO.	FREQ. (MHz)	EMISSION LEVEL (dBuV/m)	LIMIT (dBuV/m)	MARGIN (dB)	ANTENNA HEIGHT (m)	TABLE ANGLE (Degree)	RAW VALUE (dBuV)	CORRECTION FACTOR (dB/m)
1	5150.00	57.9 PK	74.0	-16.1	1.19 H	19	51.9	6.0
2	5150.00	45.0 AV	54.0	-9.0	1.19 H	19	39.0	6.0
3	*5270.00	104.1 PK			1.19 H	19	63.9	40.2
4	*5270.00	94.0 AV			1.19 H	19	53.8	40.2
5	#10540.00	58.7 PK	74.0	-15.3	1.16 H	31	40.3	18.4
6	#10540.00	47.1 AV	54.0	-6.9	1.16 H	31	28.7	18.4

ANTENNA POLARITY & TEST DISTANCE: VERTICAL AT 3 M

NO.	FREQ. (MHz)	EMISSION LEVEL (dBuV/m)	LIMIT (dBuV/m)	MARGIN (dB)	ANTENNA HEIGHT (m)	TABLE ANGLE (Degree)	RAW VALUE (dBuV)	CORRECTION FACTOR (dB/m)
1	5150.00	60.2 PK	74.0	-13.8	1.73 V	308	54.2	6.0
2	5150.00	46.6 AV	54.0	-7.4	1.73 V	308	40.6	6.0
3	*5270.00	116.1 PK			1.73 V	308	75.9	40.2
4	*5270.00	106.1 AV			1.73 V	308	65.9	40.2
5	#10540.00	59.6 PK	74.0	-14.4	1.26 V	35	41.2	18.4
6	#10540.00	48.8 AV	54.0	-5.2	1.26 V	35	30.4	18.4

Remark:

1. Emission Level(dBuV/m) = Raw Value(dBuV) + Correction Factor(dB/m)
2. Correction Factor(dB/m) = Antenna Factor(dB/m) + Cable Factor(dB)
3. The other emission levels were very low against the limit.
4. Margin value = Emission Level – Limit value
5. " \* ": Fundamental frequency.
6. " # ": The radiated frequency is out of the restricted band.



CHANNEL	TX Channel 62	DETECTOR FUNCTION	Peak (PK)
FREQUENCY RANGE	1GHz ~ 40GHz		Average (AV)

**ANTENNA POLARITY & TEST DISTANCE: HORIZONTAL AT 3 M**

NO.	FREQ. (MHz)	EMISSION LEVEL (dBuV/m)	LIMIT (dBuV/m)	MARGIN (dB)	ANTENNA HEIGHT (m)	TABLE ANGLE (Degree)	RAW VALUE (dBuV)	CORRECTION FACTOR (dB/m)
1	*5310.00	98.3 PK			1.46 H	316	58.1	40.2
2	*5310.00	88.5 AV			1.46 H	316	48.3	40.2
3	5350.00	63.0 PK	74.0	-11.0	1.46 H	316	56.8	6.2
4	5350.00	46.3 AV	54.0	-7.7	1.46 H	316	40.1	6.2
5	10620.00	59.4 PK	74.0	-14.6	1.17 H	41	40.6	18.8
6	10620.00	47.5 AV	54.0	-6.5	1.17 H	41	28.7	18.8

**ANTENNA POLARITY & TEST DISTANCE: VERTICAL AT 3 M**

NO.	FREQ. (MHz)	EMISSION LEVEL (dBuV/m)	LIMIT (dBuV/m)	MARGIN (dB)	ANTENNA HEIGHT (m)	TABLE ANGLE (Degree)	RAW VALUE (dBuV)	CORRECTION FACTOR (dB/m)
1	*5310.00	110.7 PK			1.74 V	310	70.5	40.2
2	*5310.00	100.3 AV			1.74 V	310	60.1	40.2
3	5350.00	67.8 PK	74.0	-6.2	1.74 V	310	61.6	6.2
4	5350.00	53.7 AV	54.0	-0.3	1.74 V	310	47.5	6.2
5	10620.00	60.3 PK	74.0	-13.7	1.47 V	87	41.5	18.8
6	10620.00	48.7 AV	54.0	-5.3	1.47 V	87	29.9	18.8

**Remark:**

1. Emission Level(dBuV/m) = Raw Value(dBuV) + Correction Factor(dB/m)
2. Correction Factor(dB/m) = Antenna Factor(dB/m) + Cable Factor(dB)
3. The other emission levels were very low against the limit.
4. Margin value = Emission Level – Limit value
5. " \* ": Fundamental frequency.
6. " # ": The radiated frequency is out of the restricted band.

CHANNEL	TX Channel 102	DETECTOR FUNCTION	Peak (PK)
FREQUENCY RANGE	1GHz ~ 40GHz		Average (AV)

ANTENNA POLARITY & TEST DISTANCE: HORIZONTAL AT 3 M								
NO.	FREQ. (MHz)	EMISSION LEVEL (dBuV/m)	LIMIT (dBuV/m)	MARGIN (dB)	ANTENNA HEIGHT (m)	TABLE ANGLE (Degree)	RAW VALUE (dBuV)	CORRECTION FACTOR (dB/m)
1	5460.00	57.4 PK	74.0	-16.6	3.73 H	23	51.1	6.3
2	5460.00	45.8 AV	54.0	-8.2	3.73 H	23	39.5	6.3
3	#5470.00	61.3 PK	74.0	-12.7	3.73 H	23	55.0	6.3
4	#5470.00	47.8 AV	54.0	-6.2	3.73 H	23	41.5	6.3
5	*5510.00	100.5 PK			3.73 H	23	60.1	40.4
6	*5510.00	91.3 AV			3.73 H	23	50.9	40.4
7	11020.00	60.2 PK	74.0	-13.8	1.10 H	227	40.7	19.5
8	11020.00	47.0 AV	54.0	-7.0	1.10 H	227	27.5	19.5
ANTENNA POLARITY & TEST DISTANCE: VERTICAL AT 3 M								
NO.	FREQ. (MHz)	EMISSION LEVEL (dBuV/m)	LIMIT (dBuV/m)	MARGIN (dB)	ANTENNA HEIGHT (m)	TABLE ANGLE (Degree)	RAW VALUE (dBuV)	CORRECTION FACTOR (dB/m)
1	5460.00	62.6 PK	74.0	-11.4	1.38 V	308	56.3	6.3
2	5460.00	48.6 AV	54.0	-5.4	1.38 V	308	42.3	6.3
3	#5470.00	70.0 PK	74.0	-4.0	1.38 V	308	63.7	6.3
4	#5470.00	53.8 AV	54.0	-0.2	1.38 V	308	47.5	6.3
5	*5510.00	108.9 PK			1.38 V	308	68.5	40.4
6	*5510.00	99.2 AV			1.38 V	308	58.8	40.4
7	11020.00	60.7 PK	74.0	-13.3	1.00 V	103	41.2	19.5
8	11020.00	47.1 AV	54.0	-6.9	1.00 V	103	27.6	19.5

Remark:

1. Emission Level(dBuV/m) = Raw Value(dBuV) + Correction Factor(dB/m)
2. Correction Factor(dB/m) = Antenna Factor(dB/m) + Cable Factor(dB)
3. The other emission levels were very low against the limit.
4. Margin value = Emission Level – Limit value
5. " \* ": Fundamental frequency.
6. " # ": The radiated frequency is out of the restricted band.

CHANNEL	TX Channel 110	DETECTOR FUNCTION	Peak (PK)
FREQUENCY RANGE	1GHz ~ 40GHz		Average (AV)

ANTENNA POLARITY & TEST DISTANCE: HORIZONTAL AT 3 M								
NO.	FREQ. (MHz)	EMISSION LEVEL (dBuV/m)	LIMIT (dBuV/m)	MARGIN (dB)	ANTENNA HEIGHT (m)	TABLE ANGLE (Degree)	RAW VALUE (dBuV)	CORRECTION FACTOR (dB/m)
1	5460.00	56.5 PK	74.0	-17.5	3.72 H	30	50.2	6.3
2	5460.00	45.1 AV	54.0	-8.9	3.72 H	30	38.8	6.3
3	#5470.00	56.8 PK	74.0	-17.2	3.72 H	30	50.5	6.3
4	#5470.00	46.3 AV	54.0	-7.7	3.72 H	30	40.0	6.3
5	*5550.00	103.3 PK			3.72 H	30	62.8	40.5
6	*5550.00	93.6 AV			3.72 H	30	53.1	40.5
7	11100.00	61.1 PK	74.0	-12.9	1.12 H	224	41.1	20.0
8	11100.00	47.7 AV	54.0	-6.3	1.12 H	224	27.7	20.0
ANTENNA POLARITY & TEST DISTANCE: VERTICAL AT 3 M								
NO.	FREQ. (MHz)	EMISSION LEVEL (dBuV/m)	LIMIT (dBuV/m)	MARGIN (dB)	ANTENNA HEIGHT (m)	TABLE ANGLE (Degree)	RAW VALUE (dBuV)	CORRECTION FACTOR (dB/m)
1	5460.00	62.1 PK	74.0	-11.9	1.31 V	310	55.8	6.3
2	5460.00	49.0 AV	54.0	-5.0	1.31 V	310	42.7	6.3
3	#5470.00	68.5 PK	74.0	-5.5	1.31 V	310	62.2	6.3
<b>4</b>	<b>#5470.00</b>	<b>53.9 AV</b>	<b>54.0</b>	<b>-0.1</b>	<b>1.31 V</b>	<b>310</b>	<b>47.6</b>	<b>6.3</b>
5	*5550.00	112.5 PK			1.31 V	310	72.0	40.5
6	*5550.00	102.5 AV			1.31 V	310	62.0	40.5
7	11100.00	61.4 PK	74.0	-12.6	1.00 V	108	41.4	20.0
8	11100.00	47.8 AV	54.0	-6.2	1.00 V	108	27.8	20.0

Remark:

1. Emission Level(dBuV/m) = Raw Value(dBuV) + Correction Factor(dB/m)
2. Correction Factor(dB/m) = Antenna Factor(dB/m) + Cable Factor(dB)
3. The other emission levels were very low against the limit.
4. Margin value = Emission Level – Limit value
5. " \* ": Fundamental frequency.
6. " # ": The radiated frequency is out of the restricted band.

CHANNEL	TX Channel 134	DETECTOR FUNCTION	Peak (PK)
FREQUENCY RANGE	1GHz ~ 40GHz		Average (AV)

**ANTENNA POLARITY & TEST DISTANCE: HORIZONTAL AT 3 M**

NO.	FREQ. (MHz)	EMISSION LEVEL (dBuV/m)	LIMIT (dBuV/m)	MARGIN (dB)	ANTENNA HEIGHT (m)	TABLE ANGLE (Degree)	RAW VALUE (dBuV)	CORRECTION FACTOR (dB/m)
1	*5670.00	102.6 PK			3.60 H	55	61.9	40.7
2	*5670.00	92.5 AV			3.60 H	55	51.8	40.7
3	#5725.00	60.0 PK	74.0	-14.0	3.60 H	55	53.3	6.7
4	#5725.00	47.7 AV	54.0	-6.3	3.60 H	55	41.0	6.7
5	11340.00	61.4 PK	74.0	-12.6	1.13 H	233	40.9	20.5
6	11340.00	48.1 AV	54.0	-5.9	1.13 H	233	27.6	20.5

**ANTENNA POLARITY & TEST DISTANCE: VERTICAL AT 3 M**

NO.	FREQ. (MHz)	EMISSION LEVEL (dBuV/m)	LIMIT (dBuV/m)	MARGIN (dB)	ANTENNA HEIGHT (m)	TABLE ANGLE (Degree)	RAW VALUE (dBuV)	CORRECTION FACTOR (dB/m)
1	*5670.00	110.0 PK			1.32 V	309	69.3	40.7
2	*5670.00	100.2 AV			1.32 V	309	59.5	40.7
3	#5725.00	67.0 PK	74.0	-7.0	1.32 V	309	60.3	6.7
4	#5725.00	53.5 AV	54.0	-0.5	1.32 V	309	46.8	6.7
5	11340.00	61.6 PK	74.0	-12.4	1.00 V	99	41.1	20.5
6	11340.00	48.4 AV	54.0	-5.6	1.00 V	99	27.9	20.5

**Remark:**

1. Emission Level(dBuV/m) = Raw Value(dBuV) + Correction Factor(dB/m)
2. Correction Factor(dB/m) = Antenna Factor(dB/m) + Cable Factor(dB)
3. The other emission levels were very low against the limit.
4. Margin value = Emission Level – Limit value
5. " \* ": Fundamental frequency.
6. " # ": The radiated frequency is out of the restricted band.

802.11ac (VHT80)

CHANNEL	TX Channel 58	DETECTOR FUNCTION	Peak (PK)
FREQUENCY RANGE	1GHz ~ 40GHz		Average (AV)

ANTENNA POLARITY & TEST DISTANCE: HORIZONTAL AT 3 M

NO.	FREQ. (MHz)	EMISSION LEVEL (dBuV/m)	LIMIT (dBuV/m)	MARGIN (dB)	ANTENNA HEIGHT (m)	TABLE ANGLE (Degree)	RAW VALUE (dBuV)	CORRECTION FACTOR (dB/m)
1	*5290.00	93.7 PK			1.25 H	11	53.5	40.2
2	*5290.00	83.7 AV			1.25 H	11	43.5	40.2
3	5350.00	60.7 PK	74.0	-13.3	1.25 H	11	54.5	6.2
4	5350.00	47.7 AV	54.0	-6.3	1.25 H	11	41.5	6.2
5	#10580.00	58.9 PK	74.0	-15.1	1.17 H	41	40.3	18.6
6	#10580.00	47.0 AV	54.0	-7.0	1.17 H	41	28.4	18.6

ANTENNA POLARITY & TEST DISTANCE: VERTICAL AT 3 M

NO.	FREQ. (MHz)	EMISSION LEVEL (dBuV/m)	LIMIT (dBuV/m)	MARGIN (dB)	ANTENNA HEIGHT (m)	TABLE ANGLE (Degree)	RAW VALUE (dBuV)	CORRECTION FACTOR (dB/m)
1	*5290.00	106.0 PK			1.77 V	310	65.8	40.2
2	*5290.00	95.7 AV			1.77 V	310	55.5	40.2
3	5350.00	68.7 PK	74.0	-5.3	1.77 V	310	62.5	6.2
4	5350.00	53.7 AV	54.0	-0.3	1.77 V	310	47.5	6.2
5	#10580.00	60.1 PK	74.0	-13.9	1.32 V	64	41.5	18.6
6	#10580.00	48.8 AV	54.0	-5.2	1.32 V	64	30.2	18.6

Remark:

1. Emission Level(dBuV/m) = Raw Value(dBuV) + Correction Factor(dB/m)
2. Correction Factor(dB/m) = Antenna Factor(dB/m) + Cable Factor(dB)
3. The other emission levels were very low against the limit.
4. Margin value = Emission Level – Limit value
5. " \* ": Fundamental frequency.
6. " # ": The radiated frequency is out of the restricted band.

CHANNEL	TX Channel 106	DETECTOR FUNCTION	Peak (PK)
FREQUENCY RANGE	1GHz ~ 40GHz		Average (AV)

**ANTENNA POLARITY & TEST DISTANCE: HORIZONTAL AT 3 M**

NO.	FREQ. (MHz)	EMISSION LEVEL (dBuV/m)	LIMIT (dBuV/m)	MARGIN (dB)	ANTENNA HEIGHT (m)	TABLE ANGLE (Degree)	RAW VALUE (dBuV)	CORRECTION FACTOR (dB/m)
1	5460.00	56.4 PK	74.0	-17.6	3.73 H	57	50.1	6.3
2	5460.00	44.8 AV	54.0	-9.2	3.73 H	57	38.5	6.3
3	#5470.00	58.2 PK	74.0	-15.8	3.73 H	57	51.9	6.3
4	#5470.00	46.8 AV	54.0	-7.2	3.73 H	57	40.5	6.3
5	*5530.00	95.3 PK			3.73 H	57	54.9	40.4
6	*5530.00	85.2 AV			3.73 H	57	44.8	40.4
7	#5725.00	57.3 PK	74.0	-16.7	3.73 H	57	50.6	6.7
8	#5725.00	44.1 AV	54.0	-9.9	3.73 H	57	37.4	6.7
9	11060.00	59.8 PK	74.0	-14.2	1.15 H	211	40.0	19.8
10	11060.00	48.0 AV	54.0	-6.0	1.15 H	211	28.2	19.8

**ANTENNA POLARITY & TEST DISTANCE: VERTICAL AT 3 M**

NO.	FREQ. (MHz)	EMISSION LEVEL (dBuV/m)	LIMIT (dBuV/m)	MARGIN (dB)	ANTENNA HEIGHT (m)	TABLE ANGLE (Degree)	RAW VALUE (dBuV)	CORRECTION FACTOR (dB/m)
1	5460.00	62.9 PK	74.0	-11.1	1.37 V	308	56.6	6.3
2	5460.00	48.8 AV	54.0	-5.2	1.37 V	308	42.5	6.3
3	#5470.00	66.9 PK	74.0	-7.1	1.37 V	308	60.6	6.3
4	#5470.00	53.5 AV	54.0	-0.5	1.37 V	308	47.2	6.3
5	*5530.00	104.0 PK			1.37 V	308	63.6	40.4
6	*5530.00	93.8 AV			1.37 V	308	53.4	40.4
7	#5725.00	57.2 PK	74.0	-16.8	1.37 V	308	50.5	6.7
8	#5725.00	44.3 AV	54.0	-9.7	1.37 V	308	37.6	6.7
9	11060.00	60.0 PK	74.0	-14.0	1.00 V	89	40.2	19.8
10	11060.00	48.4 AV	54.0	-5.6	1.00 V	89	28.6	19.8

**Remark:**

1. Emission Level(dBuV/m) = Raw Value(dBuV) + Correction Factor(dB/m)
2. Correction Factor(dB/m) = Antenna Factor(dB/m) + Cable Factor(dB)
3. The other emission levels were very low against the limit.
4. Margin value = Emission Level – Limit value
5. " \* ": Fundamental frequency.
6. " # ": The radiated frequency is out of the restricted band.

CHANNEL	TX Channel 122	DETECTOR FUNCTION	Peak (PK)
FREQUENCY RANGE	1GHz ~ 40GHz		Average (AV)

**ANTENNA POLARITY & TEST DISTANCE: HORIZONTAL AT 3 M**

NO.	FREQ. (MHz)	EMISSION LEVEL (dBuV/m)	LIMIT (dBuV/m)	MARGIN (dB)	ANTENNA HEIGHT (m)	TABLE ANGLE (Degree)	RAW VALUE (dBuV)	CORRECTION FACTOR (dB/m)
1	5460.00	57.7 PK	74.0	-16.3	3.65 H	32	51.4	6.3
2	5460.00	45.2 AV	54.0	-8.8	3.65 H	32	38.9	6.3
3	#5470.00	57.3 PK	74.0	-16.7	3.65 H	32	51.0	6.3
4	#5470.00	45.6 AV	54.0	-8.4	3.65 H	32	39.3	6.3
5	*5610.00	100.1 PK			3.65 H	32	59.6	40.5
6	*5610.00	90.4 AV			3.65 H	32	49.9	40.5
7	#5725.00	57.3 PK	74.0	-16.7	3.65 H	32	50.6	6.7
8	#5725.00	45.5 AV	54.0	-8.5	3.65 H	32	38.8	6.7
9	11220.00	60.3 PK	74.0	-13.7	1.19 H	202	40.2	20.1
10	11220.00	48.5 AV	54.0	-5.5	1.19 H	202	28.4	20.1

**ANTENNA POLARITY & TEST DISTANCE: VERTICAL AT 3 M**

NO.	FREQ. (MHz)	EMISSION LEVEL (dBuV/m)	LIMIT (dBuV/m)	MARGIN (dB)	ANTENNA HEIGHT (m)	TABLE ANGLE (Degree)	RAW VALUE (dBuV)	CORRECTION FACTOR (dB/m)
1	5460.00	58.6 PK	74.0	-15.4	1.30 V	306	52.3	6.3
2	5460.00	46.8 AV	54.0	-7.2	1.30 V	306	40.5	6.3
3	#5470.00	62.6 PK	74.0	-11.4	1.30 V	306	56.3	6.3
4	#5470.00	47.9 AV	54.0	-6.1	1.30 V	306	41.6	6.3
5	*5610.00	107.1 PK			1.30 V	306	66.6	40.5
6	*5610.00	96.6 AV			1.30 V	306	56.1	40.5
7	#5725.00	61.6 PK	74.0	-12.4	1.30 V	306	54.9	6.7
8	#5725.00	50.0 AV	54.0	-4.0	1.30 V	306	43.3	6.7
9	11220.00	61.3 PK	74.0	-12.7	1.00 V	97	41.2	20.1
10	11220.00	48.8 AV	54.0	-5.2	1.00 V	97	28.7	20.1

**Remark:**

1. Emission Level(dBuV/m) = Raw Value(dBuV) + Correction Factor(dB/m)
2. Correction Factor(dB/m) = Antenna Factor(dB/m) + Cable Factor(dB)
3. The other emission levels were very low against the limit.
4. Margin value = Emission Level – Limit value
5. " \* ": Fundamental frequency.
6. " # ": The radiated frequency is out of the restricted band.

Below 1GHz worst-case data: 802.11a

CHANNEL	TX Channel 52	DETECTOR FUNCTION	Quasi-Peak (QP)
FREQUENCY RANGE	9kHz ~ 1GHz		

ANTENNA POLARITY & TEST DISTANCE: HORIZONTAL AT 3 M								
NO.	FREQ. (MHz)	EMISSION LEVEL (dBuV/m)	LIMIT (dBuV/m)	MARGIN (dB)	ANTENNA HEIGHT (m)	TABLE ANGLE (Degree)	RAW VALUE (dBuV)	CORRECTION FACTOR (dB/m)
1	192.89	25.3 QP	43.5	-18.2	1.50 H	247	41.8	-16.5
2	350.07	20.4 QP	46.0	-25.6	1.00 H	201	32.6	-12.2
3	532.46	25.4 QP	46.0	-20.6	1.50 H	21	34.4	-9.0
4	650.83	34.8 QP	46.0	-11.2	1.24 H	12	41.1	-6.3
5	749.79	29.0 QP	46.0	-17.0	1.00 H	128	32.9	-3.9
6	936.07	29.7 QP	46.0	-16.3	1.50 H	128	30.7	-1.0
ANTENNA POLARITY & TEST DISTANCE: VERTICAL AT 3 M								
NO.	FREQ. (MHz)	EMISSION LEVEL (dBuV/m)	LIMIT (dBuV/m)	MARGIN (dB)	ANTENNA HEIGHT (m)	TABLE ANGLE (Degree)	RAW VALUE (dBuV)	CORRECTION FACTOR (dB/m)
1	51.24	31.3 QP	40.0	-8.7	1.26 V	7	45.2	-13.9
2	429.62	21.3 QP	46.0	-24.7	1.26 V	173	31.8	-10.5
3	532.46	26.9 QP	46.0	-19.1	1.26 V	98	35.9	-9.0
4	648.89	31.4 QP	46.0	-14.6	1.00 V	53	37.7	-6.3
5	749.79	27.5 QP	46.0	-18.5	1.00 V	148	31.4	-3.9
6	875.91	30.3 QP	46.0	-15.7	1.00 V	182	32.5	-2.2

Remark:

1. Emission Level(dBuV/m) = Raw Value(dBuV) + Correction Factor(dB/m)
2. Correction Factor(dB/m) = Antenna Factor(dB/m) + Cable Factor(dB)
3. The other emission levels were very low against the limit.
4. Margin value = Emission Level – Limit value



## 4.2 Conducted Emission Measurement

### 4.2.1 Limits of Conducted Emission Measurement

Frequency (MHz)	Conducted Limit (dBuV)	
	Quasi-peak	Average
0.15 - 0.5	66 - 56	56 - 46
0.50 - 5.0	56	46
5.0 - 30.0	60	50

- Note:** 1. The lower limit shall apply at the transition frequencies.  
 2. The limit decreases in line with the logarithm of the frequency in the range of 0.15 to 0.50MHz.

### 4.2.2 Test Instruments

Description & Manufacturer	Model No.	Serial No.	Cal. Date	Cal. Due
Test Receiver ROHDE & SCHWARZ	ESCI	100424	Oct. 24, 2016	Oct. 23, 2017
RF signal cable (with 10dB PAD) Woken	5D-FB	Cable-cond1-01	Dec. 26, 2015	Dec. 25, 2016
LISN ROHDE & SCHWARZ (EUT)	ESH3-Z5	835239/001	Feb. 26, 2016	Feb. 25, 2017
LISN ROHDE & SCHWARZ (Peripheral)	ESH3-Z5	100311	Jul. 28, 2016	Jul. 27, 2017
Software ADT	BV ADT_Cond_ V7.3.7.3	NA	NA	NA

- Note:** 1. The calibration interval of the above test instruments is 12 months and the calibrations are traceable to NML/ROC and NIST/USA.  
 2. The test was performed in HwaYa Shielded Room 1.  
 3. The VCCI Site Registration No. is C-2040.

### 4.2.3 Test Procedures

- The EUT was placed 0.4 meters from the conducting wall of the shielded room with EUT being connected to the power mains through a line impedance stabilization network (LISN). Other support units were connected to the power mains through another LISN. The two LISNs provide 50 ohm/ 50uH of coupling impedance for the measuring instrument.
- Both lines of the power mains connected to the EUT were checked for maximum conducted interference.
- The frequency range from 150kHz to 30MHz was searched. Emission levels under (Limit - 20dB) was not recorded.

**NOTE:** The resolution bandwidth and video bandwidth of test receiver is 9kHz for quasi-peak detection (QP) and average detection (AV) at frequency 0.15MHz-30MHz.

### 4.2.4 Deviation from Test Standard

No deviation.

### 4.2.5 Test Setup

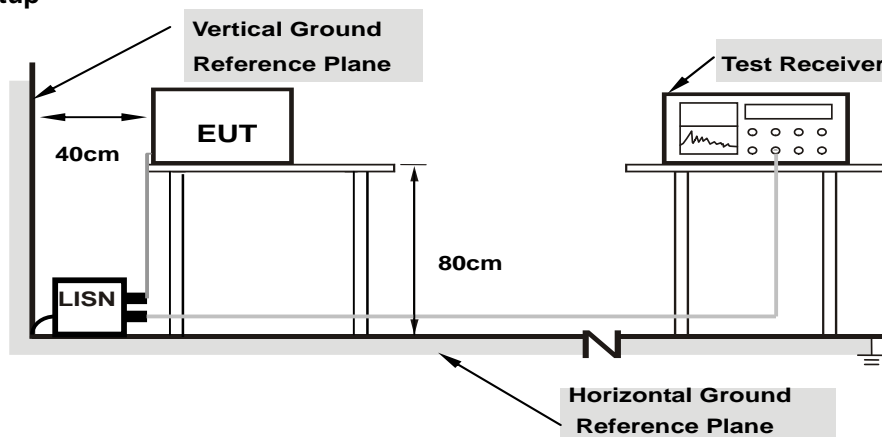

**Note:** 1.Support units were connected to second LISN.

For the actual test configuration, please refer to the attached file (Test Setup Photo).

### 4.2.6 EUT Operating Conditions

Same as 4.1.6.

#### 4.2.7 Test Results

Phase	Line (L)	Detector Function	Quasi-Peak (QP) / Average (AV)
-------	----------	-------------------	--------------------------------

No	Freq. [MHz]	Corr. Factor (dB)	Reading Value [dB (uV)]		Emission Level [dB (uV)]		Limit [dB (uV)]		Margin (dB)	
			Q.P.	AV.	Q.P.	AV.	Q.P.	AV.	Q.P.	AV.
			<b>1</b>	<b>0.16564</b>	<b>10.02</b>	<b>40.85</b>	<b>35.97</b>	<b>50.87</b>	<b>45.99</b>	<b>65.18</b>
2	0.18953	10.03	36.22	21.36	46.25	31.39	64.06	54.06	-17.81	-22.67
3	0.24796	10.05	30.74	25.69	40.79	35.74	61.83	51.83	-21.04	-16.09
4	0.37304	10.11	19.74	10.85	29.85	20.96	58.43	48.43	-28.58	-27.47
5	0.54491	10.14	22.63	12.74	32.77	22.88	56.00	46.00	-23.23	-23.12
6	9.74905	10.72	22.41	14.55	33.13	25.27	60.00	50.00	-26.87	-24.73

Remarks:

1. Q.P. and AV. are abbreviations of quasi-peak and average individually.
2. The emission levels of other frequencies were very low against the limit.
3. Margin value = Emission level - Limit value
4. Correction factor = Insertion loss + Cable loss
5. Emission Level = Correction Factor + Reading Value.

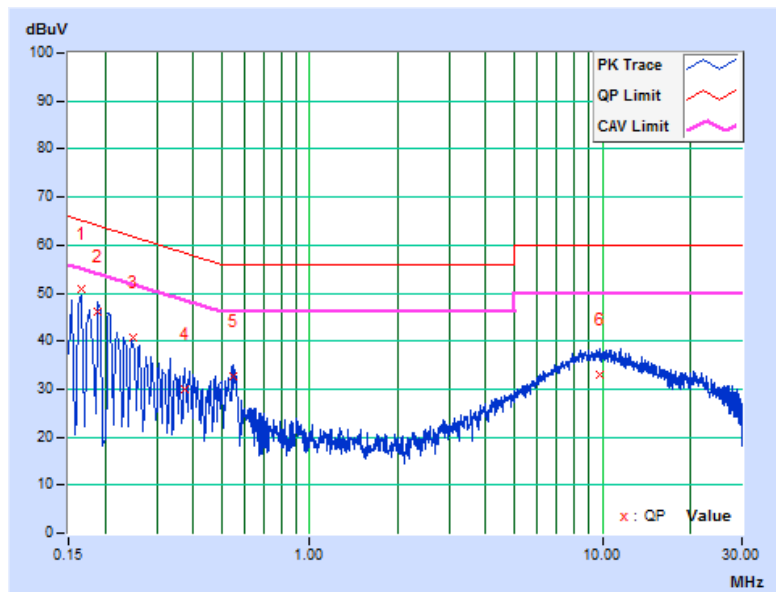

Phase	Neutral (N)	Detector Function	Quasi-Peak (QP) / Average (AV)
-------	-------------	-------------------	--------------------------------

No	Freq. [MHz]	Corr. Factor (dB)	Reading Value [dB (uV)]		Emission Level [dB (uV)]		Limit [dB (uV)]		Margin (dB)	
			Q.P.	AV.	Q.P.	AV.	Q.P.	AV.	Q.P.	AV.
			1	0.15000	10.03	36.63	26.41	46.66	36.44	66.00
2	0.17346	10.03	35.55	24.33	45.58	34.36	64.79	54.79	-19.21	-20.43
3	0.20511	10.04	32.69	22.74	42.73	32.78	63.40	53.40	-20.67	-20.62
4	0.54089	10.15	24.36	19.54	34.51	29.69	56.00	46.00	-21.49	-16.31
5	0.92027	10.20	15.74	10.97	25.94	21.17	56.00	46.00	-30.06	-24.83
6	8.92795	10.73	30.45	25.41	41.18	36.14	60.00	50.00	-18.82	-13.86

Remarks:

1. Q.P. and AV. are abbreviations of quasi-peak and average individually.
2. The emission levels of other frequencies were very low against the limit.
3. Margin value = Emission level - Limit value
4. Correction factor = Insertion loss + Cable loss
5. Emission Level = Correction Factor + Reading Value.

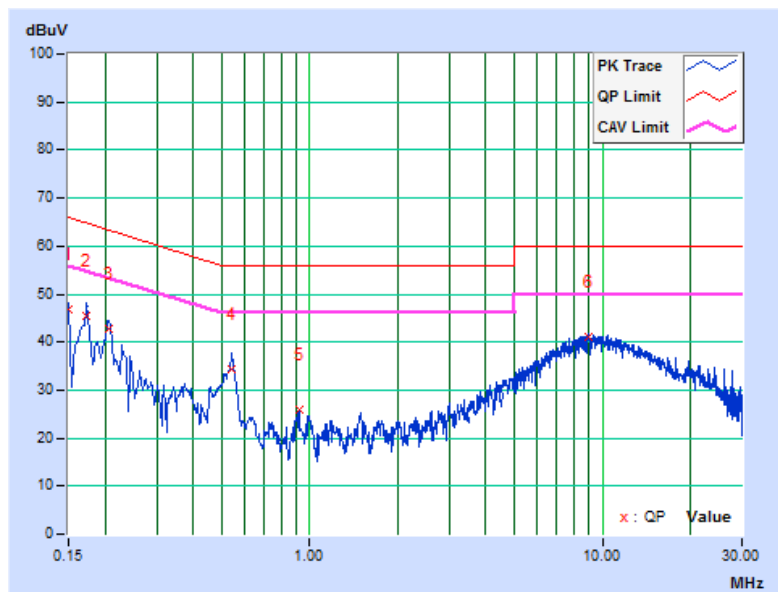

### 4.3 Transmit Power Measurement

#### 4.3.1 Limits of Transmit Power Measurement

Operation Band	EUT Category	LIMIT
U-NII-1	Outdoor Access Point	1 Watt (30 dBm) (Max. e.i.r.p $\leq$ 125mW(21 dBm) at any elevation angle above 30 degrees as measured from the horizon)
	Fixed point-to-point Access Point	1 Watt (30 dBm)
	Indoor Access Point	1 Watt (30 dBm)
	Mobile and Portable client device	250mW (24 dBm)
U-NII-2A	√	250mW (24 dBm) or 11 dBm+10 log B*
U-NII-2C	√	250mW (24 dBm) or 11 dBm+10 log B*
U-NII-3		1 Watt (30 dBm)

\*B is the 26 dB emission bandwidth in megahertz

Per KDB 662911 Method of conducted output power measurement on IEEE 802.11 devices,

Array Gain = 0 dB (i.e., no array gain) for  $N_{ANT} \leq 4$ ;

Array Gain = 0 dB (i.e., no array gain) for channel widths  $\geq 40$  MHz for any  $N_{ANT}$ ;

Array Gain =  $5 \log(N_{ANT}/N_{SS})$  dB or 3 dB, whichever is less for 20-MHz channel widths with  $N_{ANT} \geq 5$ .

For power measurements on all other devices: Array Gain =  $10 \log(N_{ANT}/N_{SS})$  dB.

#### 4.3.2 Test Setup

For Power Output Measurement

802.11a, 802.11n (HT20), 802.11n (HT40)

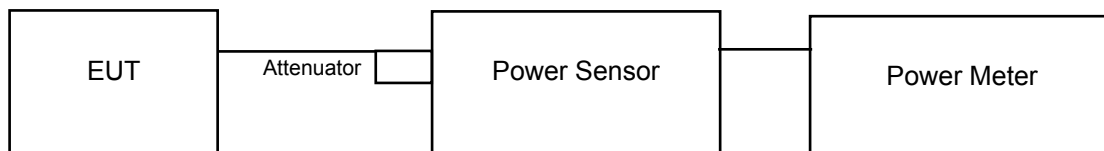

802.11ac (VHT80)

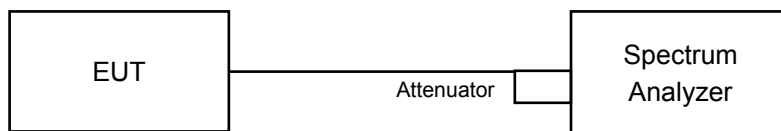

For 26dB Bandwidth

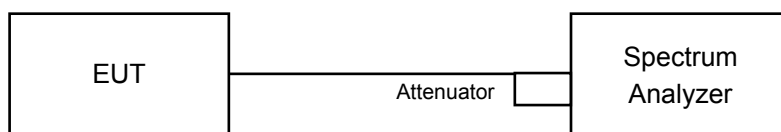

#### 4.3.3 Test Instruments

Refer to section 4.1.2 to get information of above instrument.

#### 4.3.4 Test Procedure

##### For Average Power Measurement

##### For 802.11a, 802.11n (HT20), 802.11n (HT40)

Method PM is used to perform output power measurement, trigger and gating function of wide band power meter is enabled to measure max output power of TX on burst. Duty factor is not added to measured value.

##### For 802.11ac (VHT80)

- a. Set span to encompass the entire 26 dB EBW (or, alternatively, the entire 99% occupied bandwidth) of the signal.
- b. Set sweep trigger to "free run".
- c. Set RBW = 1 MHz.
- d. Set VBW  $\geq$  3 MHz
- e. Number of points in sweep  $\geq$  2 Span / RBW.
- f. Sweep time  $\leq$  (number of points in sweep) \* T
- g. Using emission bandwidth to determine the frequency span for integration the channel bandwidth.
- h. Detector = RMS.
- i. Trace mode = max hold.
- j. Allow max hold to run for at least 60 seconds, or longer as needed to allow the trace to stabilize.
- k. Compute power by integrating the spectrum across the EBW (or, alternatively, the entire 99% occupied bandwidth) of the signal using the instrument's band power measurement function with band limits set equal to the EBW (or occupied bandwidth) band edges. If the instrument does not have a band power function, sum the spectrum levels (in power units) at 1 MHz intervals extending across the EBW (or, alternatively, the entire 99% occupied bandwidth) of the spectrum.

##### For 26dB Bandwidth

- a. Set RBW = approximately 1% of the emission bandwidth.
- b. Set the VBW > RBW.
- c. Detector = Peak.
- d. Trace mode = max hold.
- e. Measure the maximum width of the emission that is 26 dB down from the peak of the emission. Compare this with the RBW setting of the analyzer. Readjust RBW and repeat measurement as needed until the RBW/EBW ratio is approximately 1%.

#### 4.3.5 Deviation from Test Standard

No deviation.

#### 4.3.6 EUT Operating Conditions

The software provided by client to enable the EUT under transmission condition continuously at lowest, middle and highest channel frequencies individually.

### 4.3.7 Test Result

Power Output:

CDD Mode

802.11a

Chan.	Freq. (MHz)	Maximum Conducted Power (dBm)		Total Power (mW)	Total Power (dBm)	Power Limit (dBm)	Pass / Fail
		Chain 0	Chain 1				
52	5260	20.78	20.49	231.618	23.65	24.00	Pass
60	5300	20.78	20.43	230.082	23.62	24.00	Pass
64	5320	18.27	18.24	133.824	21.27	24.00	Pass
100	5500	18.76	18.29	142.615	21.54	24.00	Pass
116	5580	20.78	20.51	<b>232.134</b>	23.66	24.00	Pass
140	5700	19.35	19.09	167.195	22.23	24.00	Pass

Note:

Chain 0

1.  $11\text{dBm} + 10\log ( 23.86 ) = 24.78 > 24\text{dBm}$
2.  $11\text{dBm} + 10\log ( 25.02 ) = 24.98 > 24\text{dBm}$
3.  $11\text{dBm} + 10\log ( 22.25 ) = 24.47 > 24\text{dBm}$
4.  $11\text{dBm} + 10\log ( 23.70 ) = 24.75 > 24\text{dBm}$
5.  $11\text{dBm} + 10\log ( 28.31 ) = 25.52 > 24\text{dBm}$
6.  $11\text{dBm} + 10\log ( 24.03 ) = 24.81 > 24\text{dBm}$

Chain 1

1.  $11\text{dBm} + 10\log ( 23.85 ) = 24.77 > 24\text{dBm}$
2.  $11\text{dBm} + 10\log ( 25.29 ) = 25.03 > 24\text{dBm}$
3.  $11\text{dBm} + 10\log ( 21.98 ) = 24.42 > 24\text{dBm}$
4.  $11\text{dBm} + 10\log ( 23.27 ) = 24.67 > 24\text{dBm}$
5.  $11\text{dBm} + 10\log ( 27.73 ) = 25.43 > 24\text{dBm}$
6.  $11\text{dBm} + 10\log ( 25.88 ) = 25.13 > 24\text{dBm}$

802.11n (HT20)

Chan.	Freq. (MHz)	Maximum Conducted Power (dBm)		Total Power (mW)	Total Power (dBm)	Power Limit (dBm)	Pass / Fail
		Chain 0	Chain 1				
52	5260	20.81	20.52	<b>233.224</b>	23.68	24.00	Pass
60	5300	20.78	20.50	231.876	23.65	24.00	Pass
64	5320	17.87	17.73	120.528	20.81	24.00	Pass
100	5500	19.32	18.87	162.597	22.11	24.00	Pass
116	5580	20.77	20.48	231.085	23.64	24.00	Pass
140	5700	19.82	19.67	188.623	22.76	24.00	Pass

Note:

Chain 0

1.  $11\text{dBm} + 10\log ( 25.35 ) = 25.04 > 24\text{dBm}$
2.  $11\text{dBm} + 10\log ( 24.53 ) = 24.90 > 24\text{dBm}$
3.  $11\text{dBm} + 10\log ( 23.55 ) = 24.72 > 24\text{dBm}$
4.  $11\text{dBm} + 10\log ( 24.46 ) = 24.88 > 24\text{dBm}$
5.  $11\text{dBm} + 10\log ( 30.93 ) = 25.90 > 24\text{dBm}$
6.  $11\text{dBm} + 10\log ( 24.54 ) = 24.90 > 24\text{dBm}$

Chain 1

1.  $11\text{dBm} + 10\log ( 24.02 ) = 24.81 > 24\text{dBm}$
2.  $11\text{dBm} + 10\log ( 25.11 ) = 25.00 > 24\text{dBm}$
3.  $11\text{dBm} + 10\log ( 23.43 ) = 24.70 > 24\text{dBm}$
4.  $11\text{dBm} + 10\log ( 23.90 ) = 24.78 > 24\text{dBm}$
5.  $11\text{dBm} + 10\log ( 30.68 ) = 25.87 > 24\text{dBm}$
6.  $11\text{dBm} + 10\log ( 25.88 ) = 25.13 > 24\text{dBm}$

802.11n (HT40)

Chan.	Freq. (MHz)	Maximum Conducted Power (dBm)		Total Power (mW)	Total Power (dBm)	Power Limit (dBm)	Pass / Fail
		Chain 0	Chain 1				
54	5270	20.74	20.48	230.263	23.62	24.00	Pass
62	5310	15.31	14.78	64.024	18.06	24.00	Pass
102	5510	17.31	16.72	100.816	20.04	24.00	Pass
110	5550	20.75	20.51	231.310	23.64	24.00	Pass
134	5670	19.85	19.39	183.501	22.64	24.00	Pass

Note:

Chain 0

1.  $11\text{dBm} + 10\log ( 48.94 ) = 27.90 > 24\text{dBm}$
2.  $11\text{dBm} + 10\log ( 46.63 ) = 27.69 > 24\text{dBm}$
3.  $11\text{dBm} + 10\log ( 46.56 ) = 27.68 > 24\text{dBm}$
4.  $11\text{dBm} + 10\log ( 56.90 ) = 28.55 > 24\text{dBm}$
5.  $11\text{dBm} + 10\log ( 52.68 ) = 28.22 > 24\text{dBm}$

Chain 1

1.  $11\text{dBm} + 10\log ( 48.37 ) = 27.85 > 24\text{dBm}$
2.  $11\text{dBm} + 10\log ( 46.76 ) = 27.70 > 24\text{dBm}$
3.  $11\text{dBm} + 10\log ( 46.31 ) = 27.66 > 24\text{dBm}$
4.  $11\text{dBm} + 10\log ( 56.90 ) = 28.55 > 24\text{dBm}$
5.  $11\text{dBm} + 10\log ( 68.08 ) = 29.33 > 24\text{dBm}$



802.11ac (VHT80)

Chan.	Freq. (MHz)	Maximum Conducted Power (dBm)		Total Power (mW)	Total Power (dBm)	Power Limit (dBm)	Pass / Fail
		Chain 0	Chain 1				
58	5290	15.24	14.69	62.864	17.98	24.00	Pass
106	5530	14.92	14.36	58.336	17.66	24.00	Pass
122	5610	20.68	20.53	229.93	23.62	24.00	Pass

Note:

Chain 0

1.  $11\text{dBm} + 10\log ( 90.47 ) = 30.57 > 24\text{dBm}$
2.  $11\text{dBm} + 10\log ( 90.09 ) = 30.55 > 24\text{dBm}$
3.  $11\text{dBm} + 10\log ( 104.08 ) = 31.17 > 24\text{dBm}$

Chain 1

1.  $11\text{dBm} + 10\log ( 89.42 ) = 30.51 > 24\text{dBm}$
2.  $11\text{dBm} + 10\log ( 89.61 ) = 30.52 > 24\text{dBm}$
3.  $11\text{dBm} + 10\log ( 118.08 ) = 31.72 > 24\text{dBm}$

Beamforming Mode

802.11ac (VHT20)

Chan.	Freq. (MHz)	Maximum Conducted Power (dBm)		Total Power (mW)	Total Power (dBm)	Power Limit (dBm)	Pass / Fail
		Chain 0	Chain 1				
52	5260	20.46	20.20	<b>215.886</b>	23.34	23.51	Pass
60	5300	20.42	20.15	213.668	23.30	23.51	Pass
64	5320	17.53	17.38	111.326	20.47	23.51	Pass
100	5500	17.45	16.87	104.231	20.18	23.51	Pass
116	5580	20.42	20.17	<b>214.146</b>	23.31	23.51	Pass
140	5700	15.58	15.34	70.339	18.47	23.51	Pass

Note: Directional gain = 3.48dBi + 10log(2) = 6.49dBi > 6dBi, so the power limit shall be reduced to 24-(6.49-6) = 23.51dBm.

Chain 0

1. 11dBm + 10log ( 25.35 ) = 25.04 > 23.51dBm
2. 11dBm + 10log ( 24.53 ) = 24.90 > 23.51dBm
3. 11dBm + 10log ( 23.55 ) = 24.72 > 23.51dBm
4. 11dBm + 10log ( 24.46 ) = 24.88 > 23.51dBm
5. 11dBm + 10log ( 30.93 ) = 25.90 > 23.51dBm
6. 11dBm + 10log ( 24.54 ) = 24.90 > 23.51dBm

Chain 1

1. 11dBm + 10log ( 24.02 ) = 24.81 > 23.51dBm
2. 11dBm + 10log ( 25.11 ) = 25.00 > 23.51dBm
3. 11dBm + 10log ( 23.43 ) = 24.70 > 23.51dBm
4. 11dBm + 10log ( 23.90 ) = 24.78 > 23.51dBm
5. 11dBm + 10log ( 30.68 ) = 25.87 > 23.51dBm
6. 11dBm + 10log ( 25.88 ) = 25.13 > 23.51dBm

802.11ac (VHT40)

Chan.	Freq. (MHz)	Maximum Conducted Power (dBm)		Total Power (mW)	Total Power (dBm)	Power Limit (dBm)	Pass / Fail
		Chain 0	Chain 1				
54	5270	19.82	19.35	182.039	22.60	23.51	Pass
62	5310	13.38	12.94	41.456	16.18	23.51	Pass
102	5510	14.13	13.63	48.949	16.90	23.51	Pass
110	5550	19.82	19.34	181.841	22.60	23.51	Pass
134	5670	16.02	15.73	77.405	18.89	23.51	Pass

Note: Directional gain = 3.48dBi + 10log(2) = 6.49dBi > 6dBi, so the power limit shall be reduced to 24-(6.49-6) = 23.51dBm.

Chain 0

1. 11dBm + 10log ( 48.94 ) = 27.90 > 23.51dBm
2. 11dBm + 10log ( 46.63 ) = 27.69 > 23.51dBm
3. 11dBm + 10log ( 46.56 ) = 27.68 > 23.51dBm
4. 11dBm + 10log ( 56.90 ) = 28.55 > 23.51dBm
5. 11dBm + 10log ( 52.68 ) = 28.22 > 23.51dBm

Chain 1

1. 11dBm + 10log ( 48.37 ) = 27.85 > 23.51dBm
2. 11dBm + 10log ( 46.76 ) = 27.70 > 23.51dBm
3. 11dBm + 10log ( 46.31 ) = 27.66 > 23.51dBm
4. 11dBm + 10log ( 56.90 ) = 28.55 > 23.51dBm
5. 11dBm + 10log ( 68.08 ) = 29.33 > 23.51dBm

802.11ac (VHT80)

Chan.	Freq. (MHz)	Maximum Conducted Power (dBm)		Total Power (mW)	Total Power (dBm)	Power Limit (dBm)	Pass / Fail
		Chain 0	Chain 1				
58	5290	14.31	13.92	51.637	17.13	23.51	Pass
106	5530	13.19	12.68	39.380	15.95	23.51	Pass
122	5610	20.18	20.24	209.914	23.22	23.51	Pass

Note: Directional gain = 3.48dBi + 10log(2) = 6.49dBi > 6dBi, so the power limit shall be reduced to 24-(6.49-6) = 23.51dBm.

Note:

Chain 0

1. 11dBm + 10log ( 90.47 ) = 30.57 > 23.51dBm
2. 11dBm + 10log ( 90.09 ) = 30.55 > 23.51dBm
3. 11dBm + 10log ( 104.08 ) = 31.17 > 23.51dBm

Chain 1

1. 11dBm + 10log ( 89.42 ) = 30.51 > 23.51dBm
2. 11dBm + 10log ( 89.61 ) = 30.52 > 23.51dBm
3. 11dBm + 10log ( 118.08 ) = 31.72 > 23.51dBm

26dB Bandwidth:

802.11a

Chan.	Freq. (MHz)	26dBc Bandwidth (MHz)	
		Chain 0	Chain 1
52	5260	23.86	23.85
60	5300	25.02	25.29
64	5320	22.25	21.98
100	5500	23.70	23.27
116	5580	28.31	27.73
140	5700	24.03	25.88

802.11n (HT20)

Chan.	Freq. (MHz)	26dBc Bandwidth (MHz)	
		Chain 0	Chain 1
52	5260	25.35	24.02
60	5300	24.53	25.11
64	5320	23.55	23.43
100	5500	24.46	23.90
116	5580	30.93	30.68
140	5700	24.54	25.88

802.11n (HT40)

Chan.	Freq. (MHz)	26dBc Bandwidth (MHz)	
		Chain 0	Chain 1
54	5270	48.94	48.37
62	5310	46.63	46.76
102	5510	46.56	46.31
110	5550	56.90	56.90
134	5670	52.68	68.08

802.11ac (VHT80)

Chan.	Freq. (MHz)	26dBc Bandwidth (MHz)	
		Chain 0	Chain 1
58	5290	90.47	89.42
106	5530	90.09	89.61
122	5610	104.08	118.08

### Spectrum Plot of Worst Value

**802.11a**

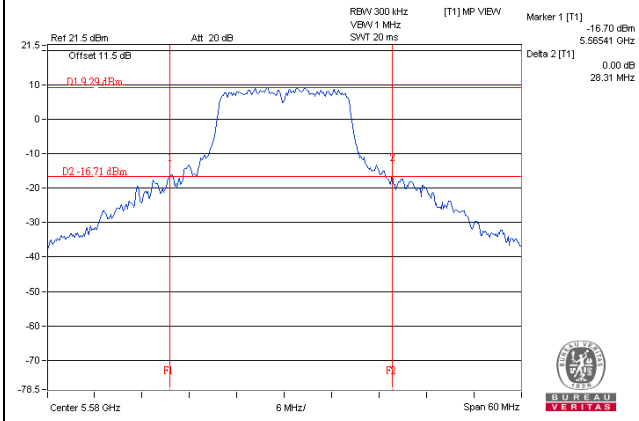

**802.11n (HT20)**

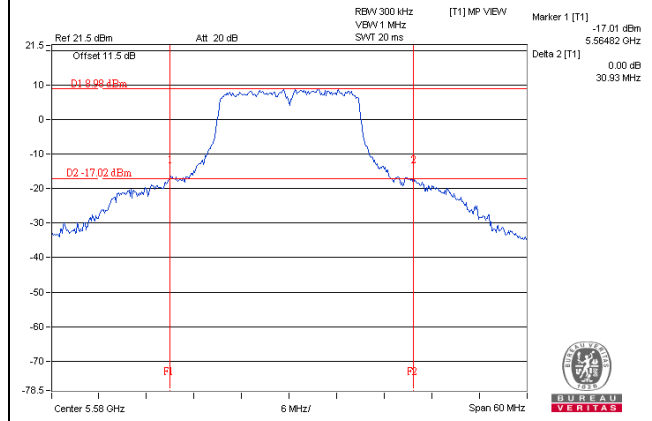

**802.11n (HT40)**

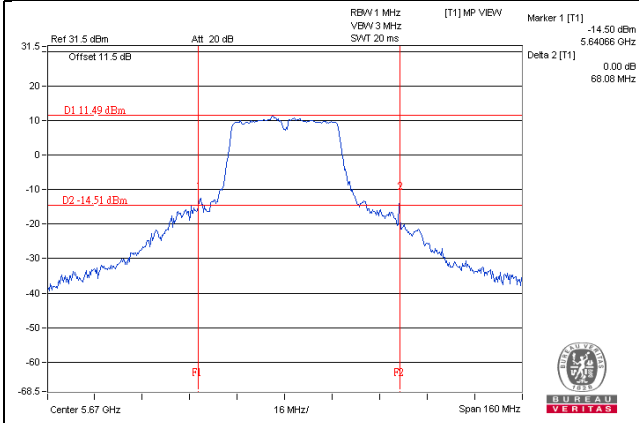

**802.11ac (VHT80)**

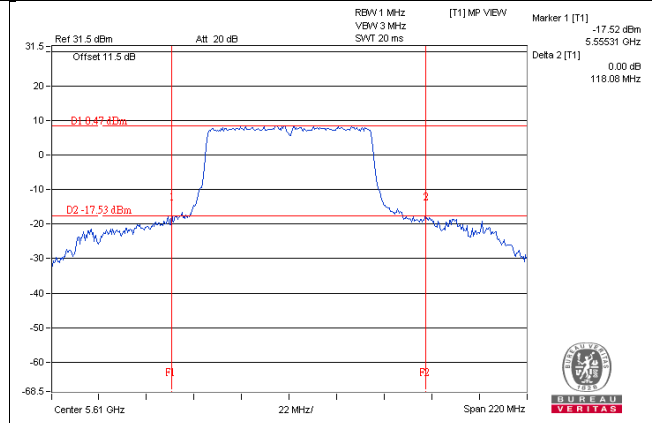

## 4.4 Occupied Bandwidth Measurement

### 4.4.1 Test Setup

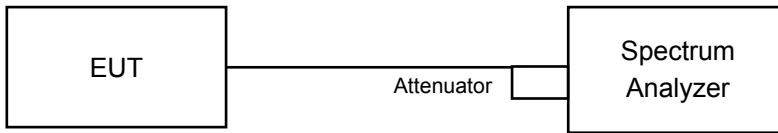

### 4.4.2 Test Instruments

Refer to section 4.1.2 to get information of above instrument.

### 4.4.3 Test Procedure

The transmitter output was connected to the spectrum analyzer through an attenuator. The bandwidth of the fundamental frequency was measured by spectrum analyzer with resolution bandwidth in the range of 1% to 5% of the anticipated emission bandwidth, and a video bandwidth at least 3x the resolution bandwidth and set the detector to Sample. The width of a frequency band such that, below the lower and above the upper frequency limits, the mean powers emitted are each equal to a specified percentage 0.5 %of the total mean power of a given emission.

#### 4.4.4 Test Result

##### 802.11a

Chan.	Freq. (MHz)	Occupied Bandwidth (MHz)	
		Chain 0	Chain 1
52	5260	16.92	16.80
60	5300	16.92	16.80
64	5320	16.92	16.80
100	5500	16.92	16.80
116	5580	17.16	17.04
140	5700	16.92	16.92

##### 802.11n (HT20)

Chan.	Freq. (MHz)	Occupied Bandwidth (MHz)	
		Chain 0	Chain 1
52	5260	18.12	18.12
60	5300	18.12	18.12
64	5320	18.00	17.88
100	5500	18.12	18.00
116	5580	18.36	18.36
140	5700	18.12	18.12

##### 802.11n (HT40)

Chan.	Freq. (MHz)	Occupied Bandwidth (MHz)	
		Chain 0	Chain 1
54	5270	37.20	37.32
62	5310	37.20	36.96
102	5510	37.20	37.20
110	5550	37.32	37.32
134	5670	37.20	37.44

##### 802.11ac (VHT80)

Chan.	Freq. (MHz)	Occupied Bandwidth (MHz)	
		Chain 0	Chain 1
58	5290	76.56	76.32
106	5530	76.56	76.32
122	5610	76.56	76.80

### Spectrum Plot of Worst Value

802.11a

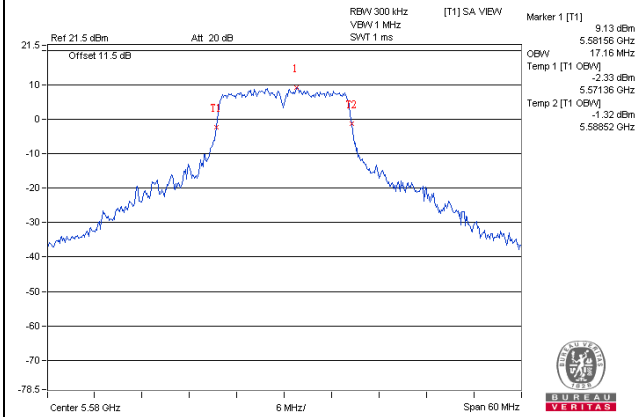

802.11n (HT20)

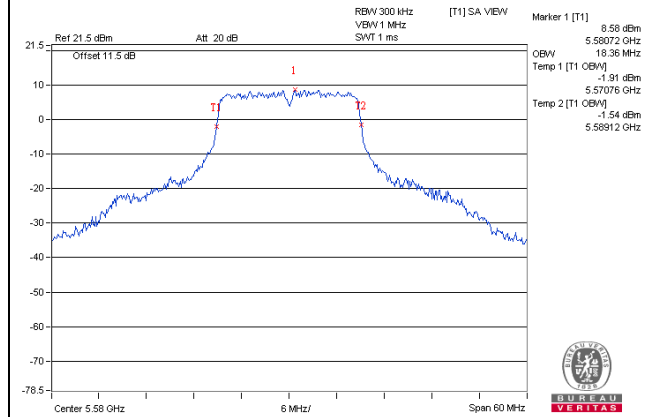

802.11n (HT40)

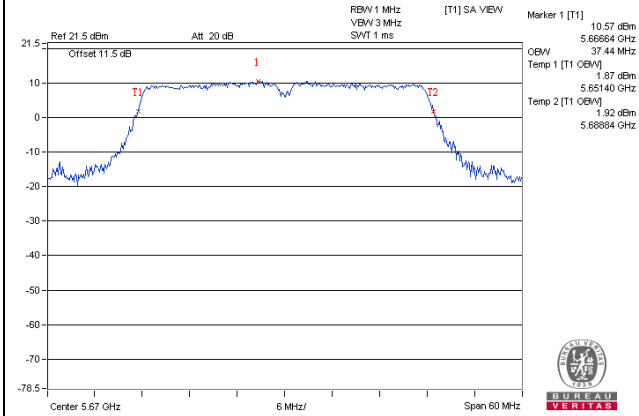

802.11ac (VHT80)

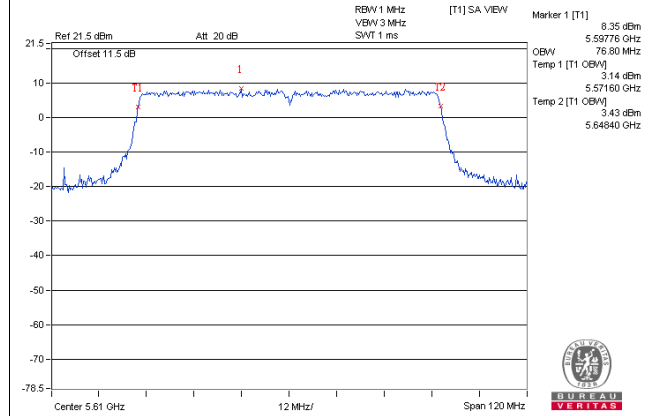



EUT MAXIMUM CONDUCTED POWER

CDD Mode

802.11a

Frequency Band (MHz)	Max. Power	
	Output Power (mW)	Output Power (dBm)
5250~5350	231.618	23.65
5470~5725	232.134	23.66

802.11n (HT20)

Frequency Band (MHz)	Max. Power	
	Output Power (mW)	Output Power (dBm)
5250~5350	233.224	23.68
5470~5725	231.085	23.64

802.11n (HT40)

Frequency Band (MHz)	Max. Power	
	Output Power (mW)	Output Power (dBm)
5250~5350	230.263	23.62
5470~5725	231.310	23.64

802.11ac (VHT80)

Frequency Band (MHz)	Max. Power	
	Output Power (mW)	Output Power (dBm)
5250~5350	62.864	17.98
5470~5725	229.930	23.62

Beamforming Mode

802.11ac (VHT20)

Frequency Band (MHz)	Max. Power	
	Output Power (mW)	Output Power (dBm)
5250~5350	215.886	23.34
5470~5725	214.146	23.31

802.11ac (VHT40)

Frequency Band (MHz)	Max. Power	
	Output Power (mW)	Output Power (dBm)
5250~5350	182.039	22.60
5470~5725	181.841	22.60

802.11ac (VHT80)

Frequency Band (MHz)	Max. Power	
	Output Power (mW)	Output Power (dBm)
5250~5350	51.637	17.13
5470~5725	209.914	23.22

## 4.5 Peak Power Spectral Density Measurement

### 4.5.1 Limits of Peak Power Spectral Density Measurement

Operation Band	EUT Category		LIMIT
U-NII-1		Outdoor Access Point	17dBm/ MHz
		Fixed point-to-point Access Point	
		Indoor Access Point	
		Mobile and Portable client device	11dBm/ MHz
U-NII-2A	√		11dBm/ MHz
U-NII-2C	√		11dBm/ MHz
U-NII-3			30dBm/ 500kHz

### 4.5.2 Test Setup

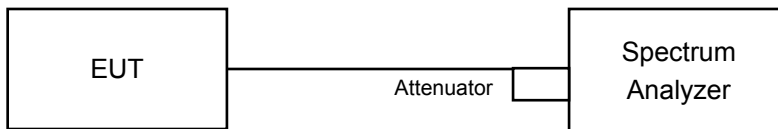

### 4.5.3 Test Instruments

Refer to section 4.1.2 to get information of above instrument.

### 4.5.4 Test Procedures

Using method SA-1, Duty cycle >98%:

- Set span to encompass the entire emission bandwidth (EBW) of the signal.
- Set RBW = 1 MHz, Set VBW ≥ 3 MHz, Detector = RMS
- Sweep time = auto, trigger set to “free run”.
- Trace average at least 100 traces in power averaging mode.
- Record the max value

Using method SA-2, Duty cycle <98%

- Set span to encompass the entire emission bandwidth (EBW) of the signal.
- Set RBW = 1 MHz, Set VBW ≥ 3 MHz, Detector = RMS
- Sweep time = auto, trigger set to “free run”.
- Trace average at least 100 traces in power averaging mode.
- Record the max value and add 10 log (1/duty cycle)

### 4.5.5 Deviation from Test Standard

No deviation.

### 4.5.6 EUT Operating Conditions

Same as Item 4.3.6.

#### 4.5.7 Test Results

##### 802.11a

Chan.	Freq. (MHz)	PSD w/o Duty Factor (dBm)		Duty Factor (dB)	Total PSD with Duty Factor (dBm)	Max. Limit (dBm)	Pass / Fail
		Chain 0	Chain 1				
52	5260	4.23	4.19	0.17	7.39	10.51	Pass
60	5300	4.26	4.29	0.17	7.46	10.51	Pass
64	5320	2.22	1.98	0.17	5.28	10.51	Pass
100	5500	2.99	3.57	0.17	6.47	10.51	Pass
116	5580	4.72	5.03	0.17	8.06	10.51	Pass
140	5700	2.62	3.93	0.17	6.51	10.51	Pass

Note:

1. Method 1 of power density measurement of KDB 662911 is using for calculating total power density. Total power density is summing entire spectra across corresponding frequency bins on the various outputs by computer.
2. Directional gain =  $3.48\text{dBi} + 10\log(2) = 6.49\text{dBi} > 6\text{dBi}$ , so the power density limit shall be reduced to  $11-(6.49-6) = 10.51\text{dBm}$ .
3. Refer to section 3.3 for duty cycle spectrum plot.

##### 802.11n (HT20)

Chan.	Freq. (MHz)	PSD (dBm/MHz)		Total PSD (dBm/MHz)	Max. Limit (dBm/MHz)	Pass / Fail
		Chain 0	Chain 1			
52	5260	4.12	4.38	7.26	10.51	Pass
60	5300	4.22	4.28	7.25	10.51	Pass
64	5320	1.82	1.63	4.73	10.51	Pass
100	5500	3.73	3.46	6.60	10.51	Pass
116	5580	4.51	5.08	7.81	10.51	Pass
140	5700	2.87	3.95	6.45	10.51	Pass

Note:

1. Method 1 of power density measurement of KDB 662911 is using for calculating total power density. Total power density is summing entire spectra across corresponding frequency bins on the various outputs by computer.
2. Directional gain =  $3.48\text{dBi} + 10\log(2) = 6.49\text{dBi} > 6\text{dBi}$ , so the power density limit shall be reduced to  $11-(6.49-6) = 10.51\text{dBm}$ .

802.11n (HT40)

Chan.	Freq. (MHz)	PSD w/o Duty Factor (dBm)		Duty Factor (dB)	Total PSD with Duty Factor (dBm)	Max. Limit (dBm)	Pass / Fail
		Chain 0	Chain 1				
54	5270	0.38	0.57	0.18	3.66	10.51	Pass
62	5310	-4.29	-4.44	0.18	-1.18	10.51	Pass
102	5510	-1.54	-1.49	0.18	1.67	10.51	Pass
110	5550	1.06	0.98	0.18	4.21	10.51	Pass
134	5670	-0.15	0.78	0.18	3.53	10.51	Pass

Note:

1. Method 1 of power density measurement of KDB 662911 is using for calculating total power density. Total power density is summing entire spectra across corresponding frequency bins on the various outputs by computer.
2. Directional gain =  $3.48\text{dBi} + 10\log(2) = 6.49\text{dBi} > 6\text{dBi}$ , so the power density limit shall be reduced to  $11-(6.49-6) = 10.51\text{dBm}$ .
3. Refer to section 3.3 for duty cycle spectrum plot.

802.11ac (VHT80)

Chan.	Freq. (MHz)	PSD w/o Duty Factor (dBm)		Duty Factor (dB)	Total PSD with Duty Factor (dBm)	Max. Limit (dBm)	Pass / Fail
		Chain 0	Chain 1				
58	5290	-7.81	-8.24	0.34	-4.68	10.51	Pass
106	5530	-7.41	-7.29	0.34	-4.01	10.51	Pass
122	5610	-2.66	-2.74	0.34	0.64	10.51	Pass

Note:

1. Method 1 of power density measurement of KDB 662911 is using for calculating total power density. Total power density is summing entire spectra across corresponding frequency bins on the various outputs by computer.
2. Directional gain =  $3.48\text{dBi} + 10\log(2) = 6.49\text{dBi} > 6\text{dBi}$ , so the power density limit shall be reduced to  $11-(6.49-6) = 10.51\text{dBm}$ .
3. Refer to section 3.3 for duty cycle spectrum plot.

### Spectrum Plot of Worst Value

**802.11a / Chain 1 / CH 116**

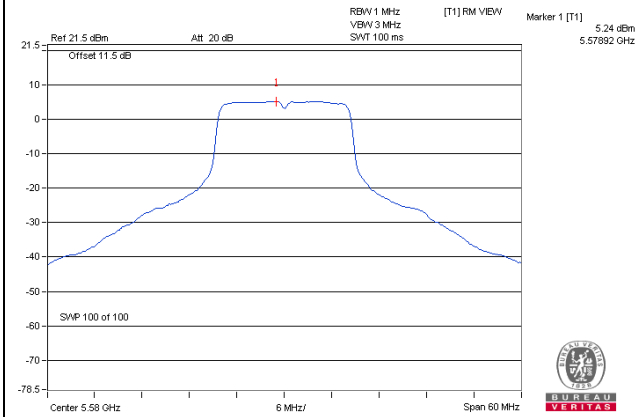

**802.11n (HT20) / Chain 1 / CH 116**

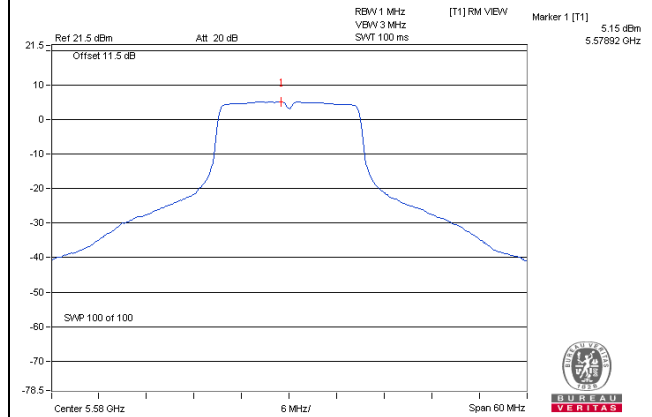

**802.11n (HT40) / Chain 0 / CH 110**

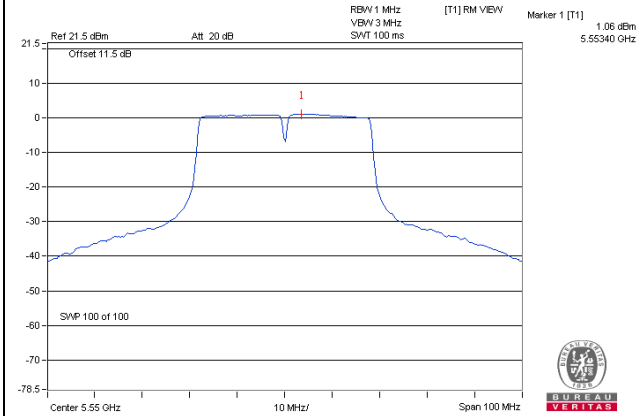

**802.11ac (VHT80) / Chain 0 / CH 122**

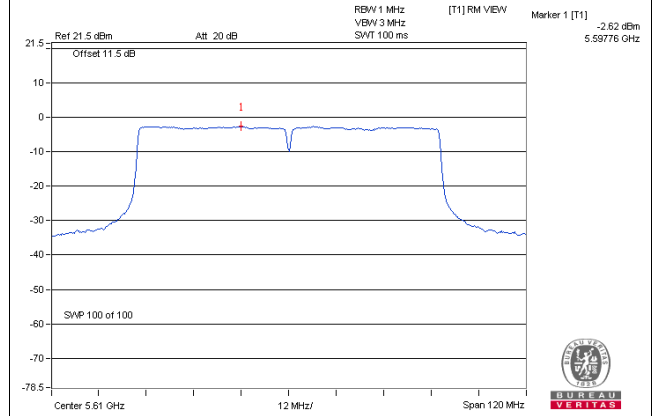

## 4.6 Frequency Stability

### 4.6.1 Limits of Frequency Stability Measurement

The frequency of the carrier signal shall be maintained within band of operation

### 4.6.2 Test Setup

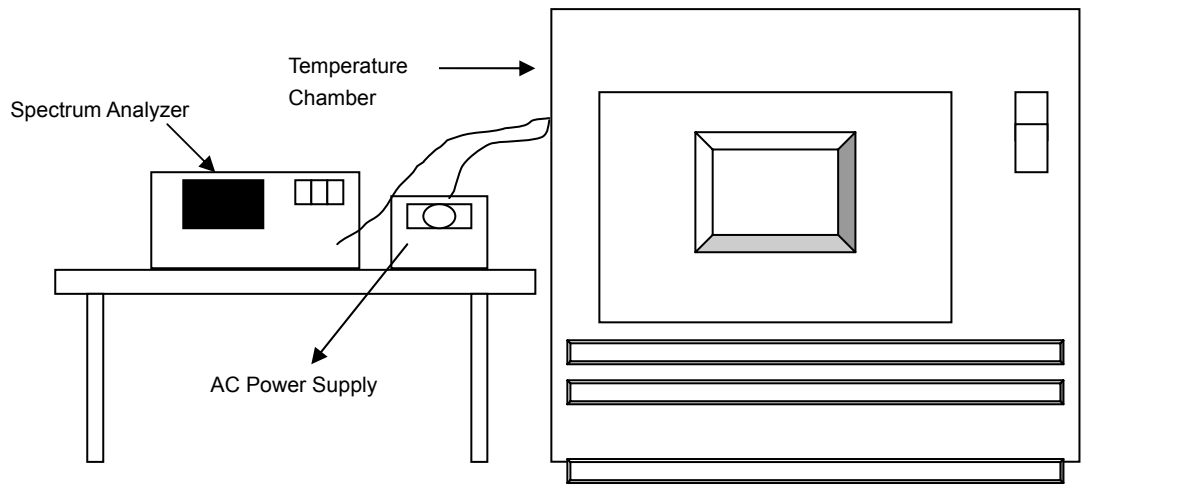

### 4.6.3 Test Instruments

Description & Manufacturer	Model No.	Serial No.	Cal. Date	Cal. Due
Spectrum Analyzer Agilent	E4446A	MY51100039	Aug. 29, 2016	Aug. 28, 2017
WIT Standard Temperature And Humidity Chamber	TH-4S-C	W981030	Jun. 08, 2016	Jun. 07, 2017
Digital Multimeter Fluke	87-III	70360742	Jul. 01, 2016	Jun. 30, 2017
AC Power Supply Exttech	CFW-105	E000603	NA	NA

Note: The calibration interval of the above test instruments is 12 months and the calibrations are traceable to NML/ROC and NIST/USA.

### 4.6.4 Test Procedure

- The EUT was placed inside the environmental test chamber and powered by nominal AC voltage.
- Turn the EUT on and couple its output to a spectrum analyzer.
- Turn the EUT off and set the chamber to the highest temperature specified.
- Allow sufficient time (approximately 30 min) for the temperature of the chamber to stabilize, turn the EUT on and measure the operating frequency after 2, 5, and 10 minutes.
- Repeat step 2 and 3 with the temperature chamber set to the lowest temperature.
- The test chamber was allowed to stabilize at +20 degree C for a minimum of 30 minutes. The supply voltage was then adjusted on the EUT from 85% to 115% and the frequency record.

#### 4.6.5 Deviation from Test Standard

No deviation.

#### 4.6.6 EUT Operating Condition

Set the EUT transmit at un-modulation mode to test frequency stability.

#### 4.6.7 Test Results

Frequency Stability Versus Temp.									
Operating Frequency: 5260MHz									
Temp. (°C)	Power Supply (Vac)	0 Minute		2 Minute		5 Minute		10 Minute	
		Measured Frequency(MHz)	Frequency Drift (%)	Measured Frequency(MHz)	Frequency Drift (%)	Measured Frequency(MHz)	Frequency Drift (%)	Measured Frequency(MHz)	Frequency Drift (%)
50	120	5259.9841	-0.00030	5259.9827	-0.00033	5259.987	-0.00025	5259.9834	-0.00032
40	120	5260.0178	0.00034	5260.021	0.00040	5260.0216	0.00041	5260.0207	0.00039
30	120	5260.0173	0.00033	5260.0214	0.00041	5260.0217	0.00041	5260.0209	0.00040
20	120	5260.0038	0.00007	5260.0058	0.00011	5260.0054	0.00010	5260.0078	0.00015
10	120	5260.0034	0.00006	5260.0026	0.00005	5260.0024	0.00005	5260.0036	0.00007
0	120	5259.9952	-0.00009	5259.9951	-0.00009	5259.997	-0.00006	5259.9965	-0.00007
-10	120	5260.021	0.00040	5260.0207	0.00039	5260.0206	0.00039	5260.0248	0.00047
-20	120	5260.0049	0.00009	5260.0048	0.00009	5260.0038	0.00007	5260.0079	0.00015
-30	120	5259.9988	-0.00002	5259.9997	-0.00001	5259.9996	-0.00001	5260.0008	0.00002

Frequency Stability Versus Voltage									
Operating Frequency: 5260MHz									
Temp. (°C)	Power Supply (Vac)	0 Minute		2 Minute		5 Minute		10 Minute	
		Measured Frequency(MHz)	Frequency Drift (%)	Measured Frequency(MHz)	Frequency Drift (%)	Measured Frequency(MHz)	Frequency Drift (%)	Measured Frequency(MHz)	Frequency Drift (%)
20	138	5260.0031	0.00006	5260.0059	0.00011	5260.0054	0.00010	5260.0078	0.00015
	120	5260.0038	0.00007	5260.0058	0.00011	5260.0054	0.00010	5260.0078	0.00015
	102	5260.0036	0.00007	5260.0053	0.00010	5260.0064	0.00012	5260.0082	0.00016



## 5 Pictures of Test Arrangements

Please refer to the attached file (Test Setup Photo).

## Appendix – Information on the Testing Laboratories

We, Bureau Veritas Consumer Products Services (H.K.) Ltd., Taoyuan Branch, were founded in 1988 to provide our best service in EMC, Radio, Telecom and Safety consultation. Our laboratories are accredited and approved according to ISO/IEC 17025.

If you have any comments, please feel free to contact us at the following:

**Linko EMC/RF Lab**

Tel: 886-2-26052180

Fax: 886-2-26051924

**Hsin Chu EMC/RF/Telecom Lab**

Tel: 886-3-6668565

Fax: 886-3-6668323

**Hwa Ya EMC/RF/Safety Lab**

Tel: 886-3-3183232

Fax: 886-3-3270892

**Email:** [service.adt@tw.bureauveritas.com](mailto:service.adt@tw.bureauveritas.com)

**Web Site:** [www.bureauveritas-adt.com](http://www.bureauveritas-adt.com)

The address and road map of all our labs can be found in our web site also.

--- END ---