

## FCC Test Report

**Report No.:** RF150624E07-1

**FCC ID:** PY315300321

**Test Model:** WAC730

**Received Date:** June 24, 2015

**Test Date:** Aug. 06 to 12, 2015

**Issued Date:** Aug. 20, 2015

**Applicant:** NETGEAR, Inc.

**Address:** 350 East Plumeria Drive San Jose, CA 95134

**Issued By:** Bureau Veritas Consumer Products Services (H.K.) Ltd., Taoyuan Branch  
Hsin Chu Laboratory

**Lab Address:** No. 81-1, Lu Liao Keng, 9th Ling, Wu Lung Tsuen, Chiung Lin Hsiang, Hsin  
Chu Hsien 307, Taiwan R.O.C.

**Test Location (1):** No. 81-1, Lu Liao Keng, 9th Ling, Wu Lung Tsuen, Chiung Lin Hsiang, Hsin  
Chu Hsien 307, Taiwan R.O.C.

**Test Location (2):** No. 49, Ln. 206, Wende Rd., Shangshan Tsuen, Chiung Lin Hsiang, Hsin  
Chu Hsien 307, Taiwan R.O.C.

**Test Location (3):** E-2, No.1, Li Hsin 1st Road, Hsinchu Science Park, Hsinchu City, Taiwan  
R.O.C.



This report is for your exclusive use. Any copying or replication of this report to or for any other person or entity, or use of our name or trademark, is permitted only with our prior written permission. This report sets forth our findings solely with respect to the test samples identified herein. The results set forth in this report are not indicative or representative of the quality or characteristics of the lot from which a test sample was taken or any similar or identical product unless specifically and expressly noted. Our report includes all of the tests requested by you and the results thereof based upon the information that you provided to us. You have 60 days from date of issuance of this report to notify us of any material error or omission caused by our negligence, provided, however, that such notice shall be in writing and shall specifically address the issue you wish to raise. A failure to raise such issue within the prescribed time shall constitute your unqualified acceptance of the completeness of this report, the tests conducted and the correctness of the report contents. Unless specific mention, the uncertainty of measurement has been explicitly taken into account to declare the compliance or non-compliance to the specification. The report must not be used by the client to claim product certification, approval, or endorsement by TAF or any government agencies.

## Table of Contents

<b>Release Control Record</b> .....	<b>4</b>
<b>1 Certificate of Conformity</b> .....	<b>5</b>
<b>2 Summary of Test Results</b> .....	<b>6</b>
2.1 Measurement Uncertainty .....	6
2.2 Modification Record .....	6
<b>3 General Information</b> .....	<b>7</b>
3.1 General Description of EUT .....	7
3.2 Description of Test Modes .....	10
3.2.1 Test Mode Applicability and Tested Channel Detail.....	11
3.3 Duty Cycle of Test Signal .....	14
3.4 Description of Support Units .....	15
3.4.1 Configuration of System under Test .....	16
3.5 General Description of Applied Standard.....	18
<b>4 Test Types and Results</b> .....	<b>19</b>
4.1 Radiated Emission and Bandedge Measurement.....	19
4.1.1 Limits of Radiated Emission and Bandedge Measurement .....	19
4.1.2 Test Instruments .....	20
4.1.3 Test Procedure .....	21
4.1.4 Deviation from Test Standard .....	21
4.1.5 Test Setup.....	22
4.1.6 EUT Operating Condition .....	22
4.1.7 Test Results (Mode 1).....	23
4.1.8 Test Results (Mode 2).....	42
4.2 Conducted Emission Measurement .....	61
4.2.1 Limits of Conducted Emission Measurement .....	61
4.2.2 Test Instruments .....	61
4.2.3 Test Procedure .....	62
4.2.4 Deviation from Test Standard .....	62
4.2.5 Test Setup.....	62
4.2.6 EUT Operating Condition .....	62
4.2.7 Test Results (Mode 1).....	63
4.2.8 Test Results (Mode 3).....	65
4.2.9 Test Results (Mode 4).....	67
4.3 Transmit Power Measurement .....	69
4.3.1 Limits of Transmit Power Measurement .....	69
4.3.2 Test Setup.....	69
4.3.3 Test Instruments .....	69
4.3.4 Test Procedure .....	69
4.3.5 Deviation from Test Standard .....	69
4.3.6 EUT Operating Condition .....	69
4.3.7 Test Result.....	70
4.4 Peak Power Spectral Density Measurement .....	72
4.4.1 Limits of Peak Power Spectral Density Measurement .....	72
4.4.2 Test Setup.....	72
4.4.3 Test Instruments .....	72
4.4.4 Test Procedure .....	73
4.4.5 Deviation from Test Standard .....	73
4.4.6 EUT Operating Condition .....	73
4.4.7 Test Results .....	74
4.5 Frequency Stability Measurement .....	79
4.5.1 Limits of Frequency Stability Measurement .....	79
4.5.2 Test Setup.....	79
4.5.3 Test Instruments .....	79

4.5.4	Test Procedure .....	79
4.5.5	Deviation from Test Standard .....	79
4.5.6	EUT Operating Condition .....	79
4.5.7	Test Results .....	80
4.6	6dB Bandwidth Measurement .....	81
4.6.1	Limits of 6dB Bandwidth Measurement .....	81
4.6.2	Test Setup .....	81
4.6.3	Test Instruments .....	81
4.6.4	Test Procedure .....	81
4.6.5	Deviation from Test Standard .....	81
4.6.6	EUT Operating Condition .....	81
4.6.7	Test Results .....	82
<b>5</b>	<b>Pictures of Test Arrangements .....</b>	<b>84</b>
	<b>Appendix – Information on the Testing Laboratories .....</b>	<b>85</b>



A D T

### Release Control Record

Issue No.	Description	Date Issued
RF150624E07-1	Original release.	Aug. 20, 2015



## 2 Summary of Test Results

47 CFR FCC Part 15, Subpart E (SECTION 15.407)			
FCC Clause	Test Item	Result	Remarks
15.407(b)(6)	AC Power Conducted Emissions	Pass	Meet the requirement of limit. Minimum passing margin is -5.97dB at 0.30234MHz.
15.407(b)(1/2/3/4/6)	Radiated Emissions & Band Edge Measurement	Pass	Meet the requirement of limit. Minimum passing margin is -0.1dB at 5715.00MHz.
15.407(a)(1/2/3)	Max Average Transmit Power	Pass	Meet the requirement of limit.
15.407(a)(1/2/3)	Peak Power Spectral Density	Pass	Meet the requirement of limit.
15.407(e)	6dB bandwidth	Pass	Meet the requirement of limit. (U-NII-3 Band only)
15.407(g)	Frequency Stability	Pass	Meet the requirement of limit.
15.203	Antenna Requirement	Pass	Antenna connector is R-SMA and i-pex not a standard connector.

**NOTE:** The EUT was operating in 2400 ~ 2483.5MHz, 5150~5250MHz and 5725~5850MHz frequencies band. This report was recorded the RF parameters including 5150~5250MHz and 5725~5850MHz. For the 2400 ~ 2483.5MHz RF parameters was recorded in another test report.

### 2.1 Measurement Uncertainty

Where relevant, the following measurement uncertainty levels have been estimated for tests performed on the EUT as specified in CISPR 16-4-2:

Measurement	Frequency	Expanded Uncertainty (k=2) (±)
Conducted Emissions at mains ports	150kHz ~ 30MHz	2.86 dB
Radiated Emissions up to 1 GHz	30MHz ~1GHz	5.37 dB
Radiated Emissions above 1 GHz	1GHz ~ 6GHz	3.65 dB
	6GHz ~ 18GHz	3.88 dB
	18GHz ~ 40GHz	4.11 dB

### 2.2 Modification Record

There were no modifications required for compliance.

### 3 General Information

#### 3.1 General Description of EUT

Product	ProSAFE Dual Band Wireless AC Access Point
Brand	NETGEAR
Test Model	WAC730
Status of EUT	MASS-PRODUCTION
Power Supply Rating	12Vdc from power adapter or 55Vdc from POE
Modulation Type	CCK, DQPSK, DBPSK for DSSS 64QAM, 16QAM, QPSK, BPSK for OFDM 256QAM for OFDM in 11ac mode
Modulation Technology	DSSS, OFDM
Transfer Rate	802.11b: up to 11Mbps 802.11a: up to 54Mbps 802.11n: up to 450Mbps 802.11ac: up to 1300Mbps
Operating Frequency	<b>For 15.407</b> 5.18 ~ 5.24GHz, 5.745 ~ 5.825GHz
	<b>For 15.247</b> 2.412 ~ 2.462GHz
Number of Channel	<b>For 15.407</b> 9 for 802.11a, 802.11n (HT20), 802.11ac (VHT20) 4 for 802.11n (HT40), 802.11ac (VHT40) 2 for 802.11ac (VHT80)
	<b>For 15.247</b> 11 for 802.11b, 802.11g, 802.11n (HT20) 7 for 802.11n (HT40)
Output Power	<b>For 15.407</b> <b>5.18~5.24 GHz</b> <b>CDD Mode:</b> 802.11a: 54.228mW 802.11ac (VHT20): 54.834mW 802.11ac (VHT40): 92.996mW 802.11ac (VHT80): 42.972mW <b>Beamforming Mode:</b> 802.11ac (VHT20): 32.022mW 802.11ac (VHT40): 49.089mW 802.11ac (VHT80): 38.3mW <b>5.745~5.825 GHz</b> <b>CDD Mode:</b> 802.11a: 173.751mW <b>Beamforming Mode:</b> 802.11ac (VHT20): 143.114mW 802.11ac (VHT40): 131.378mW 802.11ac (VHT80): 53.012mW
	<b>For 15.247</b> <b>CDD Mode:</b> 802.11b: 484.435mW 802.11g: 459.676mW 802.11n (HT20): 456.631mW 802.11n (HT40): 120.047mW <b>Beamforming Mode:</b> 802.11n (HT20): 386.973mW 802.11n (HT40): 120.047mW
Antenna Type	Refer to Note

Antenna Connector	Refer to Note
Accessory Device	Adapter x 1
Data Cable Supplied	NA

Note:

- 2.4GHz and 5GHz technology can transmit at same time.
- The antennas provided to the EUT, please refer to the following table:

External Antenna									
PCB Chain No.	Brand	Model	Antenna Gain (dBi) (Exclude cable loss)	Cable Loss (dB)	Net Gain (dBi)	Cable Length (mm)	Frequency range (GHz to GHz)	Antenna Type	Connector Type
Chain (0) (Left)	Master Wave Tech.	98364PRXS004	0.8	0.8	0	180	2.4~2.4835	Dipole	R-SMA
			1.5	1.5	0		5.15~5.25		
			1.6	1.5	0.1		5.25~5.35		
			0.7	1.5	-0.8		5.47~5.725		
			0.5	1.5	-1		5.725~5.85		
Chain (1) (Mid)	Master Wave Tech.	98364PRXS004	0.8	0.5	0.3	60	2.4~2.4835	Dipole	R-SMA
			1.5	0.9	0.6		5.15~5.25		
			1.6	0.9	0.7		5.25~5.35		
			0.7	0.9	-0.2		5.47~5.725		
			0.5	0.9	-0.4		5.725~5.85		
Chain (2) (Right)	Master Wave Tech.	98364PRXS004	0.8	0.9	-0.1	190	2.4~2.4835	Dipole	R-SMA
			1.4	1.7	-0.3		5.15~5.25		
			1.6	1.7	-0.1		5.25~5.35		
			0.7	1.7	-1		5.47~5.725		
			0.7	1.7	-1		5.725~5.85		
Internal Antenna									
PCB Chain No.	Brand	Model	Antenna Gain (dBi)		Frequency range (GHz to GHz)		Antenna Type	Connector Type	
Chain (0)	NA	NA	5		2.4~2.4835		PIFA	i-pex(MHF)	
			6		5.15~5.25				
			6		5.25~5.35				
			6		5.47~5.725				
			6		5.725~5.85				
Chain (1)	NA	NA	5		2.4~2.4835		PIFA	i-pex(MHF)	
			6		5.15~5.25				
			6		5.25~5.35				
			6		5.47~5.725				
			6		5.725~5.85				
Chain (2)	NA	NA	5		2.4~2.4835		PIFA	i-pex(MHF)	
			6		5.15~5.25				
			6		5.25~5.35				
			6		5.47~5.725				
			6		5.725~5.85				



3. The EUT must be supplied with POE or a power adapter and following two different models could be chosen as following table:

Adapter				
No	Brand Name	Model No.	P/N	Spec.
1	NETGEAR	2ABL030F 1	332-10758-01	Input: 100-120V, 1.0A, 50/60Hz Output: 12V, 2.5A DC output cable: 1.8m, unshielded
2	NETGEAR	ADS-40FPA-12	332-10759-01	Input: 100-120V, 1.0A, 60Hz Output: 12V, 2.5A DC output cable: 1.8m, unshielded

POE (test only, not for sale)

No	Brand Name	Model No.	Spec.
1	Microsemi Corp.	PD-9001GR/AC	Input: 100-240V, 0.8A, 50/60Hz Output: 55V, 0.6A

Note: From the above adapters & POE, the radiated emission worse case was found in adapter 2. Therefore only the test data of the mode was recorded in this report.

4. The EUT incorporates a MIMO function with beamforming.(Except for 802.11a/b/g)

2.4GHz Band			
MODULATION MODE	DATA RATE (MCS)	TX & RX CONFIGURATION	
802.11b	1 ~ 11Mbps	3TX	3RX
802.11g	6 ~ 54Mbps	3TX	3RX
802.11n (HT20)	MCS 0~7	3TX	3RX
	MCS 8~15	3TX	3RX
	MCS 16~23	3TX	3RX
802.11n (HT40)	MCS 0~7	3TX	3RX
	MCS 8~15	3TX	3RX
	MCS 16~23	3TX	3RX
5GHz Band			
MODULATION MODE	DATA RATE (MCS)	TX & RX CONFIGURATION	
802.11a	6 ~ 54Mbps	3TX	3RX
802.11n (HT20)	MCS 0~7	3TX	3RX
	MCS 8~15	3TX	3RX
	MCS 16~23	3TX	3RX
802.11n (HT40)	MCS 0~7	3TX	3RX
	MCS 8~15	3TX	3RX
	MCS 16~23	3TX	3RX
802.11ac (VHT20)	MCS 0~8, Nss=1	3TX	3RX
	MCS 0~8, Nss=2	3TX	3RX
	MCS 0~9, Nss=3	3TX	3RX
802.11ac (VHT40)	MCS 0~9, Nss=1	3TX	3RX
	MCS 0~9, Nss=2	3TX	3RX
	MCS 0~9, Nss=3	3TX	3RX
802.11ac (VHT80)	MCS 0~9, Nss=1	3TX	3RX
	MCS 0~9, Nss=2	3TX	3RX
	MCS 0~9, Nss=3	3TX	3RX

The modulation and bandwidth are similar for 802.11n mode for 20MHz (40MHz) and 802.11ac mode for 20MHz (40MHz), therefore investigated worst case to representative mode in test report. (Final test mode refer section 3.2.1)

- The emission of the simultaneous operation (2.4GHz & 5GHz) has been evaluated and no non-compliance was found.
- The above EUT information is declared by manufacturer and for more detailed features description, please refer to the manufacturer's specifications or user's manual.

### 3.2 Description of Test Modes

#### FOR 5180 ~ 5240MHz

4 channels are provided for 802.11a, 802.11n (HT20), 802.11ac (VHT20):

Channel	Frequency	Channel	Frequency
36	5180 MHz	44	5220 MHz
40	5200 MHz	48	5240 MHz

2 channels are provided for 802.11n (HT40), 802.11ac (VHT40):

Channel	Frequency	Channel	Frequency
38	5190 MHz	46	5230 MHz

1 channel is provided for 802.11ac (VHT80):

Channel	Frequency
42	5210MHz

#### FOR 5745 ~ 5825MHz:

5 channels are provided for 802.11a, 802.11n (HT20), 802.11ac (VHT20):

Channel	Frequency	Channel	Frequency
149	5745MHz	161	5805MHz
153	5765MHz	165	5825MHz
157	5785MHz		

2 channels are provided for 802.11n (HT40), 802.11ac (VHT40):

Channel	Frequency	Channel	Frequency
151	5755MHz	159	5795MHz

1 channel is provided for 802.11ac (VHT80):

Channel	Frequency
155	5775MHz

### 3.2.1 Test Mode Applicability and Tested Channel Detail

EUT CONFIGURE MODE	APPLICABLE TO				DESCRIPTION
	RE $\geq$ 1G	RE $<$ 1G	PLC	APCM	
1	√	√	√	√	With adapter 2 + Internal antenna
2	√	√	-	-	With adapter 2 + External antenna
3	-	-	√	-	With adapter 1 + Internal antenna
4	-	-	√	-	With POE + Internal antenna

Where **RE $\geq$ 1G**: Radiated Emission above 1GHz      **RE $<$ 1G**: Radiated Emission below 1GHz  
**PLC**: Power Line Conducted Emission      **APCM**: Antenna Port Conducted Measurement

**NOTE:**

1. The EUT had been pre-tested on the positioned of each 2 axis. The worst case was found when positioned on **Y-plane**
2. “-” means no effect.

#### **Radiated Emission Test (Above 1GHz):**

- Pre-Scan has been conducted to determine the worst-case mode from all possible combinations between available modulations, data rates and antenna ports (if EUT with antenna diversity architecture).
- Following channel(s) was (were) selected for the final test as listed below.

CDD MODE						
MODE	FREQ. BAND (MHz)	AVAILABLE CHANNEL	TESTED CHANNEL	MODULATION TECHNOLOGY	MODULATION TYPE	DATA RATE (Mbps)
802.11a	5180-5240	36 to 48	36, 40, 48	OFDM	BPSK	6
802.11ac (VHT20)	5180-5240	36 to 48	36, 40, 48	OFDM	BPSK	6.5
802.11ac (VHT40)		38 to 46	38, 46	OFDM	BPSK	13.5
802.11ac (VHT80)		42	42	OFDM	BPSK	29.3
802.11a	5745-5825	149 to 165	149, 157, 165	OFDM	BPSK	6
Beamforming MODE						
MODE	FREQ. BAND (MHz)	AVAILABLE CHANNEL	TESTED CHANNEL	MODULATION TECHNOLOGY	MODULATION TYPE	DATA RATE (Mbps)
802.11ac (VHT20)	5745-5825	149 to 165	149, 157, 165	OFDM	BPSK	6.5
802.11ac (VHT40)		151 to 159	151, 159	OFDM	BPSK	13.5
802.11ac (VHT80)		155	155	OFDM	BPSK	29.3

#### **Radiated Emission Test (Below 1GHz):**

- Pre-Scan has been conducted to determine the worst-case mode from all possible combinations between available modulations, data rates and antenna ports (if EUT with antenna diversity architecture).
- Following channel(s) was (were) selected for the final test as listed below.

CDD MODE						
MODE	FREQ. BAND (MHz)	AVAILABLE CHANNEL	TESTED CHANNEL	MODULATION TECHNOLOGY	MODULATION TYPE	DATA RATE (Mbps)
802.11a	5180-5240 5745-5825	36 to 48 149 to 165	165	OFDM	BPSK	6

**Power Line Conducted Emission Test:**

- Pre-Scan has been conducted to determine the worst-case mode from all possible combinations between available modulations, data rates and antenna ports (if EUT with antenna diversity architecture).
- Following channel(s) was (were) selected for the final test as listed below.

<b>CDD MODE</b>						
MODE	FREQ. BAND (MHz)	AVAILABLE CHANNEL	TESTED CHANNEL	MODULATION TECHNOLOGY	MODULATION TYPE	DATA RATE (Mbps)
802.11a	5180-5240 5745-5825	36 to 48 149 to 165	165	OFDM	BPSK	6

**Antenna Port Conducted Measurement:**

- This item includes all test value of each mode, but only includes spectrum plot of worst value of each mode.
- Pre-Scan has been conducted to determine the worst-case mode from all possible combinations between available modulations, data rates and antenna ports (if EUT with antenna diversity architecture).
- Following channel(s) was (were) selected for the final test as listed below.

<b>CDD MODE</b>						
<b>For Transmit Power / Power Spectral Density Measurement</b>						
MODE	FREQ. BAND (MHz)	AVAILABLE CHANNEL	TESTED CHANNEL	MODULATION TECHNOLOGY	MODULATION TYPE	DATA RATE (Mbps)
802.11a	5180-5240	36 to 48	36, 40, 48	OFDM	BPSK	6
802.11ac (VHT20)		36 to 48	36, 40, 48	OFDM	BPSK	6.5
802.11ac (VHT40)		38 to 46	38, 46	OFDM	BPSK	13.5
802.11ac (VHT80)		42	42	OFDM	BPSK	29.3
<b>For Transmit Power / Power Spectral Density Measurement / 6dB Bandwidth Measurement</b>						
802.11a	5745-5825	149 to 165	149, 157, 165	OFDM	BPSK	6
<b>Beamforming MODE</b>						
MODE	FREQ. BAND (MHz)	AVAILABLE CHANNEL	TESTED CHANNEL	MODULATION TECHNOLOGY	MODULATION TYPE	DATA RATE (Mbps)
<b>For Transmit Power Measurement</b>						
MODE	FREQ. BAND (MHz)	AVAILABLE CHANNEL	TESTED CHANNEL	MODULATION TECHNOLOGY	MODULATION TYPE	DATA RATE (Mbps)
802.11ac (VHT20)	5180-5240	36 to 48	36, 40, 48	OFDM	BPSK	6.5
802.11ac (VHT40)		38 to 46	38, 46	OFDM	BPSK	13.5
802.11ac (VHT80)		42	42	OFDM	BPSK	29.3
<b>For Transmit Power / Power Spectral Density Measurement / 6dB Bandwidth Measurement</b>						
802.11ac (VHT20)	5745-5825	149 to 165	149, 157, 165	OFDM	BPSK	6.5
802.11ac (VHT40)		151 to 159	151, 159	OFDM	BPSK	13.5
802.11ac (VHT80)		155	155	OFDM	BPSK	29.3



**Test Condition:**

APPLICABLE TO	ENVIRONMENTAL CONDITIONS	INPUT POWER	TESTED BY
RE≥1G	22deg. C, 68%RH	120Vac, 60Hz	Andy Ho
RE<1G	25deg. C, 69%RH	120Vac, 60Hz	Weiwei Lo
PLC	28deg. C, 59%RH	120Vac, 60Hz	Wythe Lin
APCM	25deg. C, 60%RH	120Vac, 60Hz	Anderson Chen

### 3.3 Duty Cycle of Test Signal

If duty cycle of test signal is  $\geq 98\%$ , duty factor is not required.

If duty cycle of test signal is  $< 98\%$ , duty factor shall be considered.

**802.11a:** Duty cycle =  $2.061 \text{ ms} / 2.099 \text{ ms} = 0.982$

**802.11ac (VHT20):** Duty cycle =  $1.918 \text{ ms} / 1.955 \text{ ms} = 0.981$

**802.11ac (VHT40):** Duty cycle =  $0.942 \text{ ms} / 0.974 \text{ ms} = 0.967$ , Duty factor =  $10 * \log(1/0.967) = 0.15$

**802.11ac (VHT80):** Duty cycle =  $0.457 \text{ ms} / 0.477 \text{ ms} = 0.958$ , Duty factor =  $10 * \log(1/0.958) = 0.19$

**802.11a** **802.11ac (VHT20)**

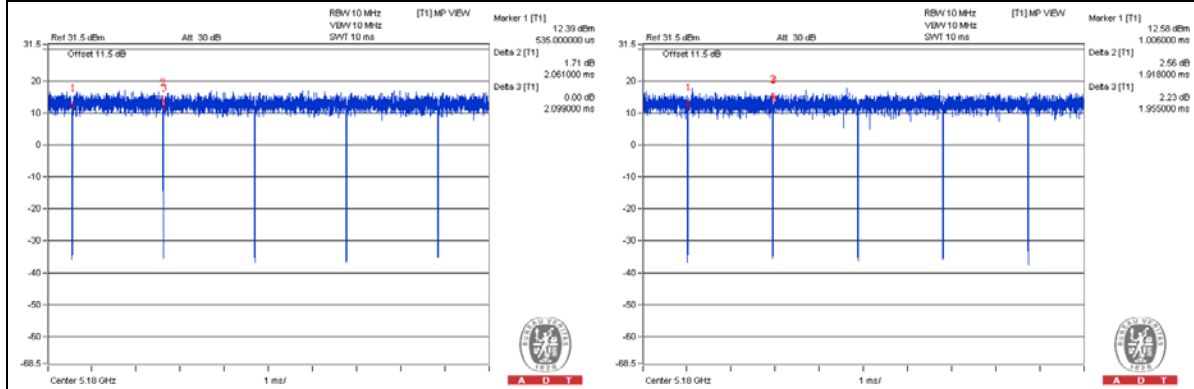

**802.11ac (VHT40)** **802.11ac (VHT80)**

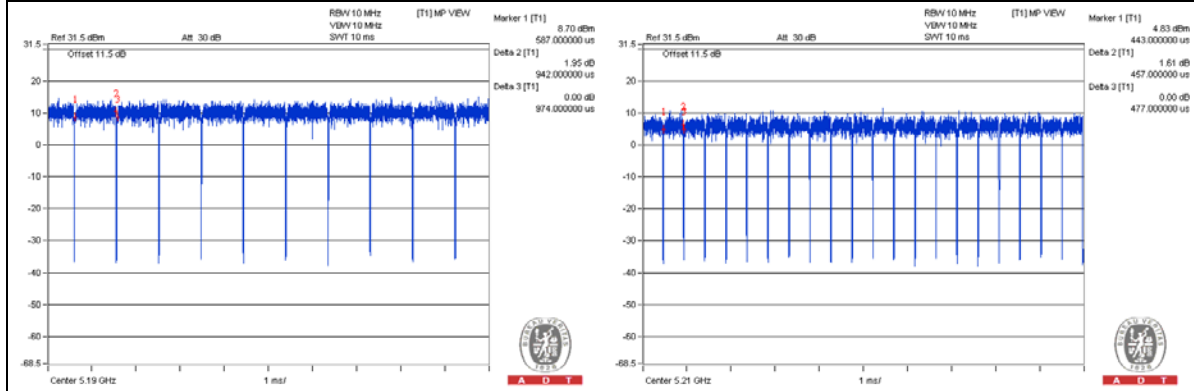

### 3.4 Description of Support Units

The EUT has been tested as an independent unit together with other necessary accessories or support units. The following support units or accessories were used to form a representative test configuration during the tests.

With adapter test Mode						
ID	Product	Brand	Model No.	Serial No.	FCC ID	Remarks
A.	NOTEBOOK COMPUTER	DELL	PP32LA	DSL32S	FCC DoC	Provided by Lab

Note:

1. All power cords of the above support units are non-shielded (1.8m).

With adapter test Mode						
ID	Descriptions	Qty.	Length (m)	Shielding (Yes/No)	Cores (Qty.)	Remarks
1.	DC	1	1.8	No	0	Supplied by Client
2.	RJ-45	1	10	No	0	Provided by Lab
3.	RJ-45 to RS232	1	1	No	0	Provided by Lab

With POE test Mode						
ID	Product	Brand	Model No.	Serial No.	FCC ID	Remarks
A.	NOTEBOOK COMPUTER	DELL	E5430	HYV4VY1	FCC DoC	Provided by Lab
B.	POE	Microsemi Corp.	PD-9001GR/AC	NA	NA	Supplied by Client

Note:

1. All power cords of the above support units are non-shielded (1.8m).

With POE test Mode						
ID	Descriptions	Qty.	Length (m)	Shielding (Yes/No)	Cores (Qty.)	Remarks
1.	RJ-45	3	10	No	0	Provided by Lab
2.	RJ-45	1	3	No	0	Provided by Lab
3.	RJ-45 to RS232	1	1	No	0	Provided by Lab

### 3.4.1 Configuration of System under Test

**With adapter test Mode:**

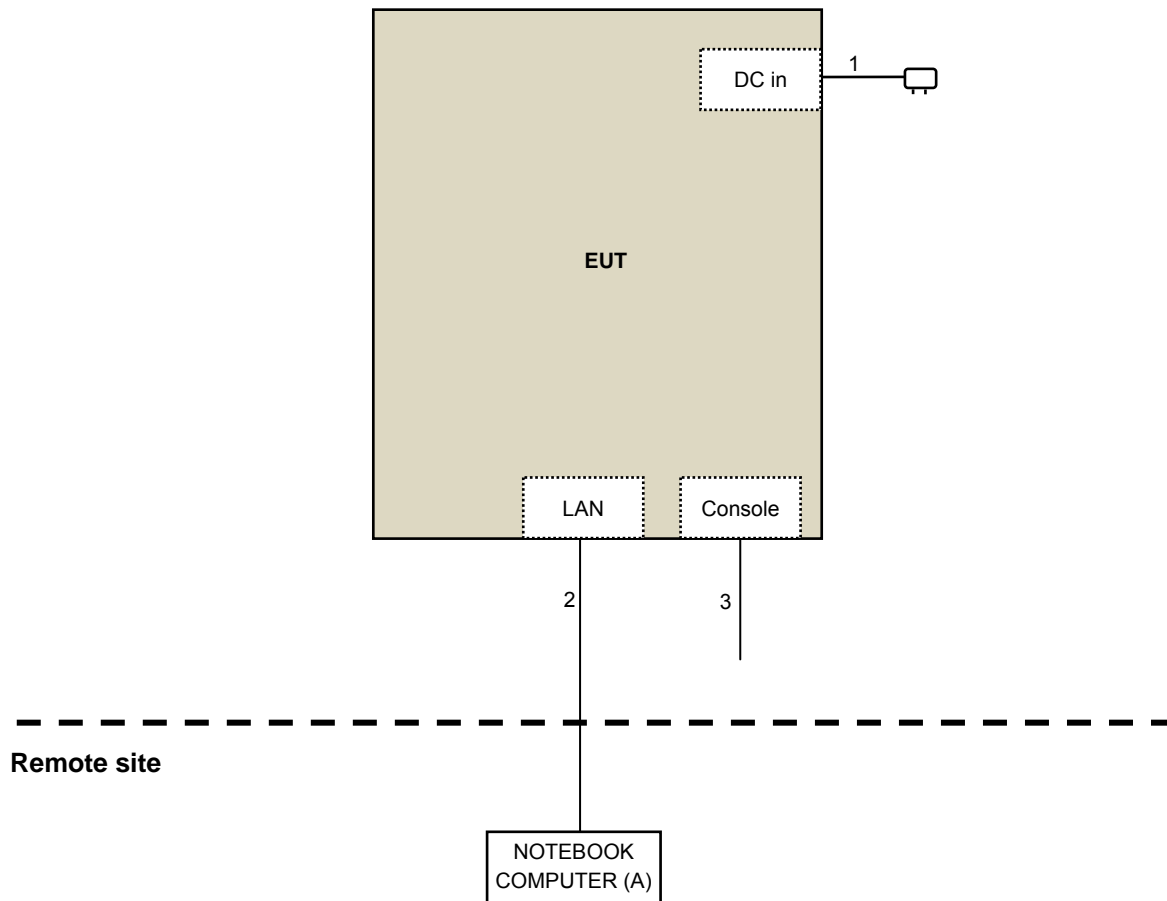



With POE test Mode:

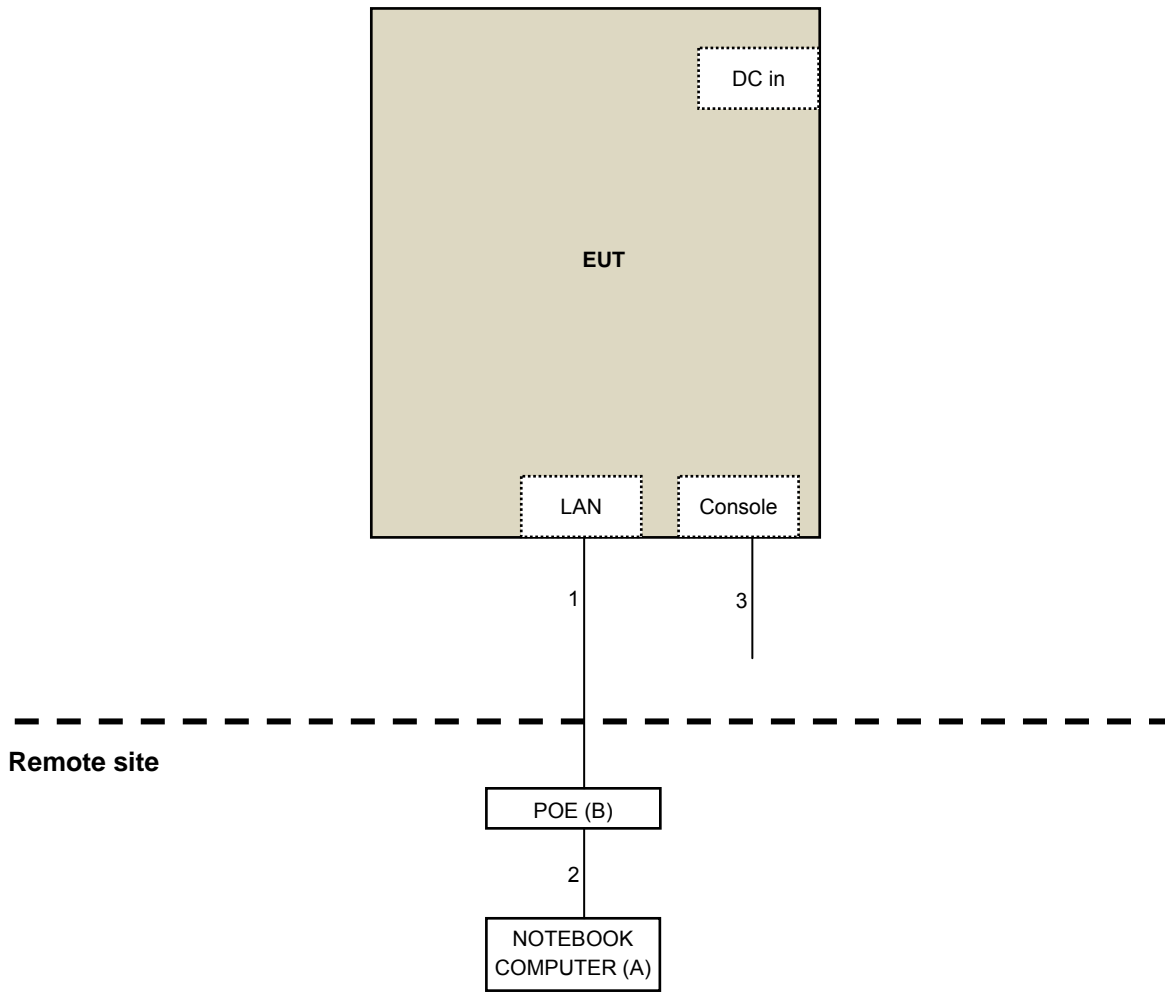

### 3.5 General Description of Applied Standard

The EUT is a RF Product. According to the specifications of the manufacturer, it must comply with the requirements of the following standards:

**FCC Part 15, Subpart E (15.407)**  
**789033 D02 General UNII Test Procedure New Rules v01**  
**662911 D01 Multiple Transmitter Output v02r01**  
ANSI C63.10-2013

All test items have been performed and recorded as per the above standards.

**NOTE:** The EUT has been verified to comply with the requirements of FCC Part 15, Subpart B, Class B (DoC). The test report has been issued separately.

## 4 Test Types and Results

### 4.1 Radiated Emission and Bandedge Measurement

#### 4.1.1 Limits of Radiated Emission and Bandedge Measurement

Radiated emissions which fall in the restricted bands must comply with the radiated emission limits specified as below table.

Frequencies (MHz)	Field Strength (microvolts/meter)	Measurement Distance (meters)
0.009 ~ 0.490	2400/F(kHz)	300
0.490 ~ 1.705	24000/F(kHz)	30
1.705 ~ 30.0	30	30
30 ~ 88	100	3
88 ~ 216	150	3
216 ~ 960	200	3
Above 960	500	3

#### NOTE:

1. The lower limit shall apply at the transition frequencies.
2. Emission level (dBuV/m) = 20 log Emission level (uV/m).
3. For frequencies above 1000MHz, the field strength limits are based on average detector, however, the peak field strength of any emission shall not exceed the maximum permitted average limits, specified above by more than 20dB under any condition of modulation.

#### LIMITS OF UNWANTED EMISSION OUT OF THE RESTRICTED BANDS

APPLICABLE TO	LIMIT	
789033 D02 General UNII Test Procedure New Rules v01	FIELD STRENGTH AT 3m	
	PK:74 (dBuV/m)	AV:54 (dBuV/m)
APPLICABLE TO	EIRP LIMIT	EQUIVALENT FIELD STRENGTH AT 3m
15.407(b)(1)	PK:-27 (dBm/MHz)	PK:68.2(dBuV/m)
15.407(b)(2)		
15.407(b)(3)		
15.407(b)(4)	PK:-27 (dBm/MHz) <sup>*1</sup> PK:-17 (dBm/MHz) <sup>*2</sup>	PK: 68.2(dBuV/m) <sup>*1</sup> PK:78.2 (dBuV/m) <sup>*2</sup>

**NOTE:** <sup>\*1</sup> beyond 10MHz of the band edge <sup>\*2</sup> within 10 MHz of band edge

The following formula is used to convert the equipment isotropic radiated power (eirp) to field strength:

$$E = \frac{1000000\sqrt{30P}}{3} \mu\text{V/m, where P is the eirp (Watts).}$$

**4.1.2 Test Instruments**

<b>DESCRIPTION &amp; MANUFACTURER</b>	<b>MODEL NO.</b>	<b>SERIAL NO.</b>	<b>CALIBRATED DATE</b>	<b>CALIBRATED UNTIL</b>
Test Receiver Agilent	N9038A	MY51210105	July 24, 2015	July 23, 2016
Pre-Amplifier Mini-Circuits	ZFL-1000VH2 B	AMP-ZFL-03	Nov. 12, 2014	Nov. 11, 2015
Trilog Broadband Antenna SCHWARZBECK	VULB 9168	9168-360	Feb. 06, 2015	Feb. 05, 2016
RF Cable	8D-FB	CHGCAB-001 -1 CHGCAB-001 -2	Oct. 04, 2014	Oct. 03, 2015
	RF-141	CHGCAB-004	Oct. 04, 2014	Oct. 03, 2015
Horn_Antenna AISI	AIH.8018	000032009111 0	Feb. 09, 2015	Feb. 08, 2016
Pre-Amplifier Agilent	8449B	3008A02578	June 23, 2015	June 22, 2016
RF Cable	NA	131205 131216 131217 SNMY23684/ 4	Jan. 16, 2015	Jan. 15, 2016
Spectrum Analyzer R&S	FSV40	100964	June 26, 2015	June 25, 2016
Pre-Amplifier SPACEK LABS	SLKKa-48-6	9K16	Dec. 12, 2014	Dec. 11, 2015
Horn_Antenna SCHWARZBECK	BBHA 9170	9170-424	Feb. 05, 2015	Feb. 04, 2016
RF Cable	NA	329751/4 RF104-204	Dec. 11, 2014	Dec. 10, 2015
Software	ADT_Radiated _V8.7.07	NA	NA	NA
Antenna Tower & Turn Table CT	NA	NA	NA	NA
Power Meter Anritsu	ML2495A	1014008	Apr. 28, 2015	Apr. 27, 2016
Power Sensor Anritsu	MA2411B	0917122	Apr. 28, 2015	Apr. 27, 2016
SPECTRUM ANALYZER R&S	FSP 40	100060	May 08, 2015	May 07, 2016
Temperature & Humidity Chamber GIANTFORCE	GTH-150-40-S P-AR	MAA0812-00 8	Jan. 12, 2015	Jan. 11, 2016

**Note:**

1. The calibration interval of the above test instruments is 12 months and the calibrations are traceable to NML/ROC and NIST/USA.
2. The test was performed in 966 Chamber No. G.
3. The FCC Site Registration No. is 966073.
4. The VCCI Site Registration No. is G-137.
5. The CANADA Site Registration No. is IC 7450H-2.
6. Tested Date: Aug. 10 to 12, 2015

#### 4.1.3 Test Procedure

- a. The EUT was placed on the top of a rotating table 0.8 meters (for below 1GHz) / 1.5 meters (for above 1GHz) above the ground at 3 meter chamber room for test. The table was rotated 360 degrees to determine the position of the highest radiation.
- b. The EUT was set 3 meters away from the interference-receiving antenna, which was mounted on the top of a variable-height antenna tower.
- c. The height of antenna is varied from one meter to four meters above the ground to determine the maximum value of the field strength. Both horizontal and vertical polarizations of the antenna are set to make the measurement.
- d. For each suspected emission, the EUT was arranged to its worst case and then the antenna was tuned to heights from 1 meter to 4 meters and the rotatable table was turned from 0 degrees to 360 degrees to find the maximum reading.
- e. The test-receiver system was set to quasi-peak detect function and specified bandwidth with maximum hold mode when the test frequency is below 1 GHz.
- f. The test-receiver system was set to peak and average detect function and specified bandwidth with maximum hold mode when the test frequency is above 1 GHz. If the peak reading value also meets average limit, measurement with the average detector is unnecessary.

**Note:**

1. The resolution bandwidth and video bandwidth of test receiver/spectrum analyzer is 120kHz for Quasi-peak detection (QP) at frequency below 1GHz.
2. The resolution bandwidth of test receiver/spectrum analyzer is 1 MHz and the video bandwidth is 3 MHz for Peak detection (PK) at frequency above 1GHz.
3. The resolution bandwidth of test receiver/spectrum analyzer is 1MHz and the video bandwidth is 3MHz for RMS Average (Duty cycle < 98%) for Average detection (AV) at frequency above 1GHz, then the measurement results was added to a correction factor ( $10 \log(1/\text{duty cycle})$ ).
4. The resolution bandwidth of test receiver/spectrum analyzer is 1MHz and the video bandwidth is 10Hz (Duty cycle  $\geq 98\%$ ) for Average detection (AV) at frequency above 1GHz.
5. All modes of operation were investigated and the worst-case emissions are reported.

#### 4.1.4 Deviation from Test Standard

No deviation.

#### 4.1.5 Test Setup

##### <Frequency Range below 1GHz>

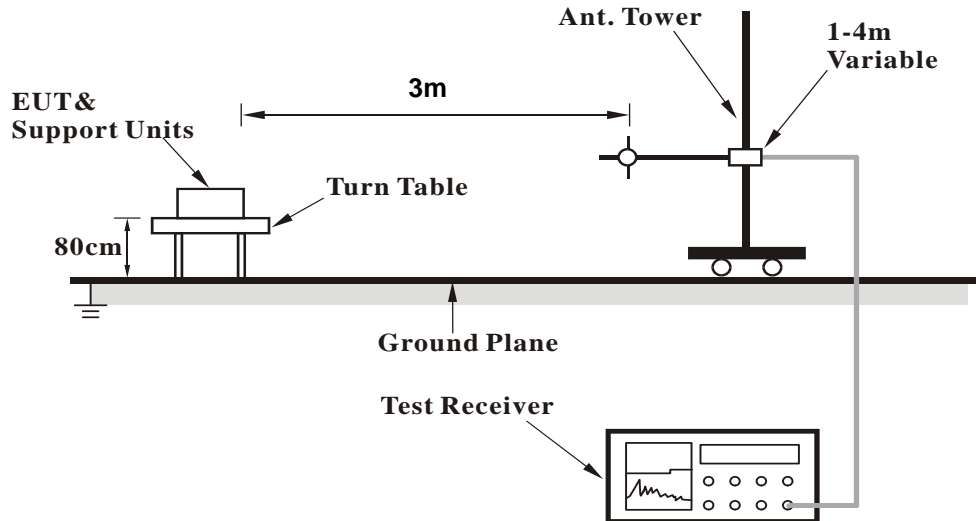

##### <Frequency Range above 1GHz>

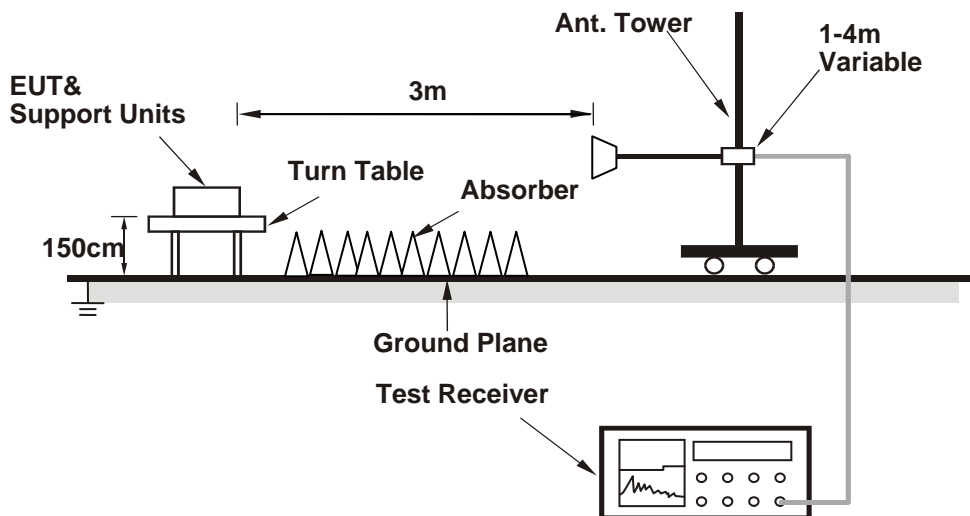

For the actual test configuration, please refer to the attached file (Test Setup Photo).

#### 4.1.6 EUT Operating Condition

1. Connect the EUT with the support unit A (NOTEBOOK COMPUTER) which is placed on remote site.
2. Controlling software (Mtool.exe V1.0.0.10) has been activated to set the EUT on specific status.

4.1.7 Test Results (Mode 1)

Above 1GHz Data:

CDD Mode

802.11a

<b>CHANNEL</b>	TX Channel 36	<b>DETECTOR FUNCTION</b>	Peak (PK)
<b>FREQUENCY RANGE</b>	1GHz ~ 40GHz		Average (AV)

**ANTENNA POLARITY & TEST DISTANCE: HORIZONTAL AT 3 M**

NO.	FREQ. (MHz)	EMISSION LEVEL (dBuV/m)	LIMIT (dBuV/m)	MARGIN (dB)	ANTENNA HEIGHT (m)	TABLE ANGLE (Degree)	RAW VALUE (dBuV)	CORRECTION FACTOR (dB/m)
1	5103.00	52.8 PK	74.0	-21.2	1.80 H	360	42.91	9.89
2	5103.00	41.9 AV	54.0	-12.1	1.80 H	360	32.01	9.89
3	*5180.00	109.4 PK			1.40 H	313	99.10	10.30
4	*5180.00	98.7 AV			1.40 H	313	88.40	10.30
5	#10360.00	55.7 PK	74.0	-18.3	1.37 H	21	39.00	16.70
6	#10360.00	41.1 AV	54.0	-12.9	1.37 H	21	24.40	16.70
7	15540.00	54.4 PK	74.0	-19.6	1.48 H	211	32.84	21.56
8	15540.00	40.2 AV	54.0	-13.8	1.48 H	211	18.64	21.56

**ANTENNA POLARITY & TEST DISTANCE: VERTICAL AT 3 M**

NO.	FREQ. (MHz)	EMISSION LEVEL (dBuV/m)	LIMIT (dBuV/m)	MARGIN (dB)	ANTENNA HEIGHT (m)	TABLE ANGLE (Degree)	RAW VALUE (dBuV)	CORRECTION FACTOR (dB/m)
1	5103.00	54.2 PK	74.0	-19.8	1.87 V	339	44.31	9.89
2	5103.00	43.1 AV	54.0	-10.9	1.87 V	339	33.21	9.89
3	*5180.00	111.0 PK			1.52 V	43	100.70	10.30
4	*5180.00	100.4 AV			1.52 V	43	90.10	10.30
5	#10360.00	53.8 PK	74.0	-20.2	1.50 V	339	37.10	16.70
6	#10360.00	40.5 AV	54.0	-13.5	1.50 V	339	23.80	16.70
7	15540.00	54.7 PK	74.0	-19.3	1.53 V	208	33.14	21.56
8	15540.00	40.0 AV	54.0	-14.0	1.53 V	208	18.44	21.56

**REMARKS:**

1. Emission Level(dBuV/m) = Raw Value(dBuV) + Correction Factor(dB/m)
2. Correction Factor(dB/m) = Antenna Factor(dB/m) + Cable Factor(dB) – Pre-Amplifier Factor(dB)
3. The other emission levels were very low against the limit.
4. Margin value = Emission Level – Limit value
5. " \* ": Fundamental frequency.
6. " # ": The radiated frequency is out of the restricted band.

<b>CHANNEL</b>	TX Channel 40	<b>DETECTOR FUNCTION</b>	Peak (PK)
<b>FREQUENCY RANGE</b>	1GHz ~ 40GHz		Average (AV)

**ANTENNA POLARITY & TEST DISTANCE: HORIZONTAL AT 3 M**

NO.	FREQ. (MHz)	EMISSION LEVEL (dBuV/m)	LIMIT (dBuV/m)	MARGIN (dB)	ANTENNA HEIGHT (m)	TABLE ANGLE (Degree)	RAW VALUE (dBuV)	CORRECTION FACTOR (dB/m)
1	5117.00	56.0 PK	74.0	-18.0	1.41 H	305	46.04	9.96
2	5117.00	44.7 AV	54.0	-9.3	1.41 H	305	34.74	9.96
3	*5200.00	108.8 PK			1.37 H	286	98.40	10.40
4	*5200.00	98.2 AV			1.37 H	286	87.80	10.40
5	5356.00	58.7 PK	74.0	-15.3	1.31 H	301	47.92	10.78
6	5356.00	47.5 AV	54.0	-6.5	1.31 H	301	36.72	10.78
7	#10400.00	55.8 PK	74.0	-18.2	1.39 H	31	38.89	16.91
8	#10400.00	40.9 AV	54.0	-13.1	1.39 H	31	23.99	16.91
9	15600.00	54.3 PK	74.0	-19.7	1.53 H	222	32.56	21.74
10	15600.00	39.9 AV	54.0	-14.1	1.53 H	222	18.16	21.74

**ANTENNA POLARITY & TEST DISTANCE: VERTICAL AT 3 M**

NO.	FREQ. (MHz)	EMISSION LEVEL (dBuV/m)	LIMIT (dBuV/m)	MARGIN (dB)	ANTENNA HEIGHT (m)	TABLE ANGLE (Degree)	RAW VALUE (dBuV)	CORRECTION FACTOR (dB/m)
1	5117.00	58.4 PK	74.0	-15.6	1.57 V	45	48.44	9.96
2	5117.00	46.8 AV	54.0	-7.2	1.57 V	45	36.84	9.96
3	*5200.00	110.2 PK			1.54 V	58	99.80	10.40
4	*5200.00	99.6 AV			1.54 V	58	89.20	10.40
5	5356.00	59.8 PK	74.0	-14.2	1.60 V	360	49.02	10.78
6	5356.00	49.0 AV	54.0	-5.0	1.60 V	360	38.22	10.78
7	#10400.00	53.9 PK	74.0	-20.1	1.47 V	326	36.99	16.91
8	#10400.00	40.3 AV	54.0	-13.7	1.47 V	326	23.39	16.91
9	15600.00	55.1 PK	74.0	-18.9	1.51 V	198	33.36	21.74
10	15600.00	40.1 AV	54.0	-13.9	1.51 V	198	18.36	21.74

**REMARKS:**

1. Emission Level(dBuV/m) = Raw Value(dBuV) + Correction Factor(dB/m)
2. Correction Factor(dB/m) = Antenna Factor(dB/m) + Cable Factor(dB) – Pre-Amplifier Factor(dB)
3. The other emission levels were very low against the limit.
4. Margin value = Emission Level – Limit value
5. " \* ": Fundamental frequency.
6. " # ": The radiated frequency is out of the restricted band.





<b>CHANNEL</b>	TX Channel 48	<b>DETECTOR FUNCTION</b>	Peak (PK)
<b>FREQUENCY RANGE</b>	1GHz ~ 40GHz		Average (AV)

**ANTENNA POLARITY & TEST DISTANCE: HORIZONTAL AT 3 M**

NO.	FREQ. (MHz)	EMISSION LEVEL (dBuV/m)	LIMIT (dBuV/m)	MARGIN (dB)	ANTENNA HEIGHT (m)	TABLE ANGLE (Degree)	RAW VALUE (dBuV)	CORRECTION FACTOR (dB/m)
1	*5240.00	108.9 PK			1.41 H	299	98.41	10.49
2	*5240.00	98.4 AV			1.41 H	299	87.91	10.49
3	5396.00	61.1 PK	74.0	-12.9	1.41 H	299	50.19	10.91
4	5396.00	49.4 AV	54.0	-4.6	1.41 H	299	38.49	10.91
5	#10480.00	55.6 PK	74.0	-18.4	1.38 H	45	39.11	16.49
6	#10480.00	40.5 AV	54.0	-13.5	1.38 H	45	24.01	16.49
7	15720.00	54.5 PK	74.0	-19.5	1.55 H	210	32.34	22.16
8	15720.00	40.0 AV	54.0	-14.0	1.55 H	210	17.84	22.16

**ANTENNA POLARITY & TEST DISTANCE: VERTICAL AT 3 M**

NO.	FREQ. (MHz)	EMISSION LEVEL (dBuV/m)	LIMIT (dBuV/m)	MARGIN (dB)	ANTENNA HEIGHT (m)	TABLE ANGLE (Degree)	RAW VALUE (dBuV)	CORRECTION FACTOR (dB/m)
1	*5240.00	110.8 PK			1.54 V	53	100.31	10.49
2	*5240.00	100.1 AV			1.54 V	53	89.61	10.49
3	5396.00	63.7 PK	74.0	-10.3	1.66 V	360	52.79	10.91
4	5396.00	51.6 AV	54.0	-2.4	1.66 V	360	40.69	10.91
5	#10480.00	53.9 PK	74.0	-20.1	1.51 V	314	37.41	16.49
6	#10480.00	40.2 AV	54.0	-13.8	1.51 V	314	23.71	16.49
7	15720.00	55.0 PK	74.0	-19.0	1.47 V	201	32.84	22.16
8	15720.00	40.0 AV	54.0	-14.0	1.47 V	201	17.84	22.16

**REMARKS:**

1. Emission Level(dBuV/m) = Raw Value(dBuV) + Correction Factor(dB/m)
2. Correction Factor(dB/m) = Antenna Factor(dB/m) + Cable Factor(dB) – Pre-Amplifier Factor(dB)
3. The other emission levels were very low against the limit.
4. Margin value = Emission Level – Limit value
5. " \* ": Fundamental frequency.
6. " # ": The radiated frequency is out of the restricted band.

**CDD Mode**
**802.11a**

<b>CHANNEL</b>	TX Channel 149	<b>DETECTOR FUNCTION</b>	Peak (PK)
<b>FREQUENCY RANGE</b>	1GHz ~ 40GHz		Average (AV)

**ANTENNA POLARITY & TEST DISTANCE: HORIZONTAL AT 3 M**

NO.	FREQ. (MHz)	EMISSION LEVEL (dBuV/m)	LIMIT (dBuV/m)	MARGIN (dB)	ANTENNA HEIGHT (m)	TABLE ANGLE (Degree)	RAW VALUE (dBuV)	CORRECTION FACTOR (dB/m)
1	#5715.00	63.2 PK	74.0	-10.8	1.41 H	306	51.74	11.46
2	#5715.00	45.2 AV	54.0	-8.8	1.41 H	306	33.74	11.46
3	#5725.00	74.4 PK	78.2	-3.8	1.41 H	306	62.91	11.49
4	*5745.00	112.0 PK			1.41 H	306	100.45	11.55
5	*5745.00	101.9 AV			1.41 H	306	90.35	11.55
6	11490.00	56.2 PK	74.0	-17.8	1.40 H	37	38.96	17.24
7	11490.00	40.8 AV	54.0	-13.2	1.40 H	37	23.56	17.24
8	#17235.00	54.3 PK	74.0	-19.7	1.50 H	195	27.75	26.55
9	#17235.00	40.1 AV	54.0	-13.9	1.50 H	195	13.55	26.55

**ANTENNA POLARITY & TEST DISTANCE: VERTICAL AT 3 M**

NO.	FREQ. (MHz)	EMISSION LEVEL (dBuV/m)	LIMIT (dBuV/m)	MARGIN (dB)	ANTENNA HEIGHT (m)	TABLE ANGLE (Degree)	RAW VALUE (dBuV)	CORRECTION FACTOR (dB/m)
1	#5667.00	65.4 PK	68.2	-2.8	1.97 V	358	54.07	11.33
2	#5715.00	65.5 PK	74.0	-8.5	1.96 V	356	54.04	11.46
3	#5715.00	46.4 AV	54.0	-7.6	1.96 V	356	34.94	11.46
4	#5725.00	77.8 PK	78.2	-0.4	1.96 V	356	66.31	11.49
5	*5745.00	114.9 PK			1.96 V	356	103.35	11.55
6	*5745.00	104.2 AV			1.96 V	356	92.65	11.55
7	11490.00	53.9 PK	74.0	-20.1	1.53 V	319	36.66	17.24
8	11490.00	40.2 AV	54.0	-13.8	1.53 V	319	22.96	17.24
9	#17235.00	55.3 PK	74.0	-18.7	1.44 V	205	28.75	26.55
10	#17235.00	40.0 AV	54.0	-14.0	1.44 V	205	13.45	26.55

**REMARKS:**

1. Emission Level(dBuV/m) = Raw Value(dBuV) + Correction Factor(dB/m)
2. Correction Factor(dB/m) = Antenna Factor(dB/m) + Cable Factor(dB) – Pre-Amplifier Factor(dB)
3. The other emission levels were very low against the limit.
4. Margin value = Emission Level – Limit value
5. " \* ": Fundamental frequency.
6. " # ": The radiated frequency is out of the restricted band.

<b>CHANNEL</b>	TX Channel 157	<b>DETECTOR FUNCTION</b>	Peak (PK)
<b>FREQUENCY RANGE</b>	1GHz ~ 40GHz		Average (AV)

**ANTENNA POLARITY & TEST DISTANCE: HORIZONTAL AT 3 M**

NO.	FREQ. (MHz)	EMISSION LEVEL (dBuV/m)	LIMIT (dBuV/m)	MARGIN (dB)	ANTENNA HEIGHT (m)	TABLE ANGLE (Degree)	RAW VALUE (dBuV)	CORRECTION FACTOR (dB/m)
1	#5707.00	64.4 PK	68.2	-3.8	1.35 H	315	52.97	11.43
2	*5785.00	112.6 PK			1.38 H	314	100.92	11.68
3	*5785.00	102.3 AV			1.38 H	314	90.62	11.68
4	#5850.00	63.0 PK	78.2	-15.2	1.38 H	314	51.27	11.73
5	#5867.00	62.5 PK	68.2	-5.7	1.50 H	302	50.77	11.73
6	11570.00	56.0 PK	74.0	-18.0	1.41 H	46	38.33	17.67
7	11570.00	40.5 AV	54.0	-13.5	1.41 H	46	22.83	17.67
8	#17355.00	54.4 PK	74.0	-19.6	1.47 H	184	27.67	26.73
9	#17355.00	40.4 AV	54.0	-13.6	1.47 H	184	13.67	26.73

**ANTENNA POLARITY & TEST DISTANCE: VERTICAL AT 3 M**

NO.	FREQ. (MHz)	EMISSION LEVEL (dBuV/m)	LIMIT (dBuV/m)	MARGIN (dB)	ANTENNA HEIGHT (m)	TABLE ANGLE (Degree)	RAW VALUE (dBuV)	CORRECTION FACTOR (dB/m)
1	#5707.00	67.6 PK	68.2	-0.6	2.16 V	357	56.17	11.43
2	*5785.00	115.3 PK			2.04 V	355	103.62	11.68
3	*5785.00	104.7 AV			2.04 V	355	93.02	11.68
4	#5850.00	65.3 PK	78.2	-12.9	2.04 V	355	53.57	11.73
5	#5867.00	65.8 PK	68.2	-2.4	2.08 V	359	54.07	11.73
6	11570.00	53.7 PK	74.0	-20.3	1.50 V	332	36.03	17.67
7	11570.00	39.7 AV	54.0	-14.3	1.50 V	332	22.03	17.67
8	#17355.00	55.6 PK	74.0	-18.4	1.48 V	218	28.87	26.73
9	#17355.00	40.4 AV	54.0	-13.6	1.48 V	218	13.67	26.73

**REMARKS:**

1. Emission Level(dBuV/m) = Raw Value(dBuV) + Correction Factor(dB/m)
2. Correction Factor(dB/m) = Antenna Factor(dB/m) + Cable Factor(dB) – Pre-Amplifier Factor(dB)
3. The other emission levels were very low against the limit.
4. Margin value = Emission Level – Limit value
5. " \* ": Fundamental frequency.
6. " # ": The radiated frequency is out of the restricted band.

<b>CHANNEL</b>	TX Channel 165	<b>DETECTOR FUNCTION</b>	Peak (PK)
<b>FREQUENCY RANGE</b>	1GHz ~ 40GHz		Average (AV)

**ANTENNA POLARITY & TEST DISTANCE: HORIZONTAL AT 3 M**

NO.	FREQ. (MHz)	EMISSION LEVEL (dBuV/m)	LIMIT (dBuV/m)	MARGIN (dB)	ANTENNA HEIGHT (m)	TABLE ANGLE (Degree)	RAW VALUE (dBuV)	CORRECTION FACTOR (dB/m)
1	*5825.00	115.1 PK			1.39 H	325	103.36	11.74
2	*5825.00	104.9 AV			1.39 H	325	93.16	11.74
3	#5850.00	72.9 PK	78.2	-5.3	1.39 H	325	61.17	11.73
4	#5860.00	68.0 PK	74.0	-6.0	1.39 H	325	56.27	11.73
5	#5860.00	46.4 AV	54.0	-7.6	1.39 H	325	34.67	11.73
6	#5987.00	65.4 PK	68.2	-2.8	2.05 H	330	53.13	12.27
7	11650.00	55.9 PK	74.0	-18.1	1.41 H	44	38.06	17.84
8	11650.00	40.7 AV	54.0	-13.3	1.41 H	44	22.86	17.84
9	#17475.00	53.9 PK	74.0	-20.1	1.49 H	181	26.59	27.31
10	#17475.00	40.0 AV	54.0	-14.0	1.49 H	181	12.69	27.31

**ANTENNA POLARITY & TEST DISTANCE: VERTICAL AT 3 M**

NO.	FREQ. (MHz)	EMISSION LEVEL (dBuV/m)	LIMIT (dBuV/m)	MARGIN (dB)	ANTENNA HEIGHT (m)	TABLE ANGLE (Degree)	RAW VALUE (dBuV)	CORRECTION FACTOR (dB/m)
1	*5825.00	118.1 PK			1.93 V	357	106.36	11.74
2	*5825.00	107.2 AV			1.93 V	357	95.46	11.74
3	#5850.00	76.2 PK	78.2	-2.0	1.93 V	357	64.47	11.73
4	#5860.00	72.1 PK	74.0	-1.9	1.93 V	357	60.37	11.73
5	#5860.00	49.7 AV	54.0	-4.3	1.93 V	357	37.97	11.73
6	#5987.00	67.8 PK	68.2	-0.4	2.05 V	359	55.53	12.27
7	11650.00	53.5 PK	74.0	-20.5	1.44 V	321	35.66	17.84
8	11650.00	39.3 AV	54.0	-14.7	1.44 V	321	21.46	17.84
9	#17475.00	55.2 PK	74.0	-18.8	1.46 V	215	27.89	27.31
10	#17475.00	40.0 AV	54.0	-14.0	1.46 V	215	12.69	27.31

**REMARKS:**

1. Emission Level(dBuV/m) = Raw Value(dBuV) + Correction Factor(dB/m)
2. Correction Factor(dB/m) = Antenna Factor(dB/m) + Cable Factor(dB) – Pre-Amplifier Factor(dB)
3. The other emission levels were very low against the limit.
4. Margin value = Emission Level – Limit value
5. " \* ": Fundamental frequency.
6. " # ": The radiated frequency is out of the restricted band.

**CDD Mode**

**802.11ac (VHT20)**

<b>CHANNEL</b>	TX Channel 36	<b>DETECTOR FUNCTION</b>	Peak (PK)
<b>FREQUENCY RANGE</b>	1GHz ~ 40GHz		Average (AV)

**ANTENNA POLARITY & TEST DISTANCE: HORIZONTAL AT 3 M**

NO.	FREQ. (MHz)	EMISSION LEVEL (dBuV/m)	LIMIT (dBuV/m)	MARGIN (dB)	ANTENNA HEIGHT (m)	TABLE ANGLE (Degree)	RAW VALUE (dBuV)	CORRECTION FACTOR (dB/m)
1	5098.00	50.6 PK	74.0	-23.4	1.41 H	356	40.73	9.87
2	5098.00	39.7 AV	54.0	-14.3	1.41 H	356	29.83	9.87
3	5150.00	59.6 PK	74.0	-14.4	1.37 H	319	49.47	10.13
4	5150.00	40.1 AV	54.0	-13.9	1.37 H	319	29.97	10.13
5	*5180.00	108.2 PK			1.37 H	319	97.90	10.30
6	*5180.00	98.7 AV			1.37 H	319	88.40	10.30
7	#10360.00	55.9 PK	74.0	-18.1	1.40 H	42	39.20	16.70
8	#10360.00	40.8 AV	54.0	-13.2	1.40 H	42	24.10	16.70
9	15540.00	53.7 PK	74.0	-20.3	1.50 H	176	32.14	21.56
10	15540.00	40.1 AV	54.0	-13.9	1.50 H	176	18.54	21.56

**ANTENNA POLARITY & TEST DISTANCE: VERTICAL AT 3 M**

NO.	FREQ. (MHz)	EMISSION LEVEL (dBuV/m)	LIMIT (dBuV/m)	MARGIN (dB)	ANTENNA HEIGHT (m)	TABLE ANGLE (Degree)	RAW VALUE (dBuV)	CORRECTION FACTOR (dB/m)
1	5098.00	53.8 PK	74.0	-20.2	1.76 V	337	43.93	9.87
2	5098.00	43.1 AV	54.0	-10.9	1.76 V	337	33.23	9.87
3	5150.00	63.6 PK	74.0	-10.4	1.72 V	360	53.47	10.13
4	5150.00	43.6 AV	54.0	-10.4	1.72 V	360	33.47	10.13
5	*5180.00	112.8 PK			1.72 V	360	102.50	10.30
6	*5180.00	100.6 AV			1.72 V	360	90.30	10.30
7	#10360.00	53.8 PK	74.0	-20.2	1.44 V	326	37.10	16.70
8	#10360.00	39.3 AV	54.0	-14.7	1.44 V	326	22.60	16.70
9	15540.00	55.6 PK	74.0	-18.4	1.42 V	226	34.04	21.56
10	15540.00	40.2 AV	54.0	-13.8	1.42 V	226	18.64	21.56

**REMARKS:**

1. Emission Level(dBuV/m) = Raw Value(dBuV) + Correction Factor(dB/m)
2. Correction Factor(dB/m) = Antenna Factor(dB/m) + Cable Factor(dB) – Pre-Amplifier Factor(dB)
3. The other emission levels were very low against the limit.
4. Margin value = Emission Level – Limit value
5. " \* ": Fundamental frequency.
6. " # ": The radiated frequency is out of the restricted band.

<b>CHANNEL</b>	TX Channel 40	<b>DETECTOR FUNCTION</b>	Peak (PK)
<b>FREQUENCY RANGE</b>	1GHz ~ 40GHz		Average (AV)

**ANTENNA POLARITY & TEST DISTANCE: HORIZONTAL AT 3 M**

NO.	FREQ. (MHz)	EMISSION LEVEL (dBuV/m)	LIMIT (dBuV/m)	MARGIN (dB)	ANTENNA HEIGHT (m)	TABLE ANGLE (Degree)	RAW VALUE (dBuV)	CORRECTION FACTOR (dB/m)
1	5121.00	59.8 PK	74.0	-14.2	1.68 H	285	49.81	9.99
2	5121.00	47.8 AV	54.0	-6.2	1.68 H	285	37.81	9.99
3	*5200.00	108.2 PK			1.36 H	315	97.80	10.40
4	*5200.00	98.0 AV			1.36 H	315	87.60	10.40
5	5361.00	60.9 PK	74.0	-13.1	1.42 H	332	50.11	10.79
6	5361.00	49.8 AV	54.0	-4.2	1.42 H	332	39.01	10.79
7	#10400.00	56.2 PK	74.0	-17.8	1.43 H	36	39.29	16.91
8	#10400.00	41.1 AV	54.0	-12.9	1.43 H	36	24.19	16.91
9	15600.00	54.3 PK	74.0	-19.7	1.45 H	190	32.56	21.74
10	15600.00	40.5 AV	54.0	-13.5	1.45 H	190	18.76	21.74

**ANTENNA POLARITY & TEST DISTANCE: VERTICAL AT 3 M**

NO.	FREQ. (MHz)	EMISSION LEVEL (dBuV/m)	LIMIT (dBuV/m)	MARGIN (dB)	ANTENNA HEIGHT (m)	TABLE ANGLE (Degree)	RAW VALUE (dBuV)	CORRECTION FACTOR (dB/m)
1	5121.00	59.6 PK	74.0	-14.4	1.70 V	49	49.61	9.99
2	5121.00	47.3 AV	54.0	-6.7	1.70 V	49	37.31	9.99
3	*5200.00	112.3 PK			1.88 V	360	101.90	10.40
4	*5200.00	100.6 AV			1.88 V	360	90.20	10.40
5	5361.00	60.6 PK	74.0	-13.4	1.64 V	0	49.81	10.79
6	5361.00	50.2 AV	54.0	-3.8	1.64 V	0	39.41	10.79
7	#10400.00	53.3 PK	74.0	-20.7	1.39 V	331	36.39	16.91
8	#10400.00	39.1 AV	54.0	-14.9	1.39 V	331	22.19	16.91
9	15600.00	55.6 PK	74.0	-18.4	1.47 V	213	33.86	21.74
10	15600.00	40.1 AV	54.0	-13.9	1.47 V	213	18.36	21.74

**REMARKS:**

1. Emission Level(dBuV/m) = Raw Value(dBuV) + Correction Factor(dB/m)
2. Correction Factor(dB/m) = Antenna Factor(dB/m) + Cable Factor(dB) – Pre-Amplifier Factor(dB)
3. The other emission levels were very low against the limit.
4. Margin value = Emission Level – Limit value
5. " \* ": Fundamental frequency.
6. " # ": The radiated frequency is out of the restricted band.



<b>CHANNEL</b>	TX Channel 48	<b>DETECTOR FUNCTION</b>	Peak (PK)
<b>FREQUENCY RANGE</b>	1GHz ~ 40GHz		Average (AV)

**ANTENNA POLARITY & TEST DISTANCE: HORIZONTAL AT 3 M**

NO.	FREQ. (MHz)	EMISSION LEVEL (dBuV/m)	LIMIT (dBuV/m)	MARGIN (dB)	ANTENNA HEIGHT (m)	TABLE ANGLE (Degree)	RAW VALUE (dBuV)	CORRECTION FACTOR (dB/m)
1	*5240.00	107.9 PK			1.36 H	322	97.41	10.49
2	*5240.00	97.6 AV			1.36 H	322	87.11	10.49
3	5401.00	59.1 PK	74.0	-14.9	1.36 H	322	48.18	10.92
4	5401.00	48.9 AV	54.0	-5.1	1.36 H	322	37.98	10.92
5	#10480.00	56.0 PK	74.0	-18.0	1.45 H	28	39.51	16.49
6	#10480.00	40.8 AV	54.0	-13.2	1.45 H	28	24.31	16.49
7	15720.00	54.5 PK	74.0	-19.5	1.44 H	178	32.34	22.16
8	15720.00	40.8 AV	54.0	-13.2	1.44 H	178	18.64	22.16

**ANTENNA POLARITY & TEST DISTANCE: VERTICAL AT 3 M**

NO.	FREQ. (MHz)	EMISSION LEVEL (dBuV/m)	LIMIT (dBuV/m)	MARGIN (dB)	ANTENNA HEIGHT (m)	TABLE ANGLE (Degree)	RAW VALUE (dBuV)	CORRECTION FACTOR (dB/m)
1	*5240.00	112.5 PK			1.80 V	360	102.01	10.49
2	*5240.00	101.0 AV			1.80 V	360	90.51	10.49
3	5401.00	62.5 PK	74.0	-11.5	1.76 V	5	51.58	10.92
4	5401.00	52.2 AV	54.0	-1.8	1.76 V	5	41.28	10.92
5	#10480.00	53.3 PK	74.0	-20.7	1.35 V	333	36.81	16.49
6	#10480.00	38.8 AV	54.0	-15.2	1.35 V	333	22.31	16.49
7	15720.00	55.4 PK	74.0	-18.6	1.45 V	203	33.24	22.16
8	15720.00	39.8 AV	54.0	-14.2	1.45 V	203	17.64	22.16

**REMARKS:**

1. Emission Level(dBuV/m) = Raw Value(dBuV) + Correction Factor(dB/m)
2. Correction Factor(dB/m) = Antenna Factor(dB/m) + Cable Factor(dB) – Pre-Amplifier Factor(dB)
3. The other emission levels were very low against the limit.
4. Margin value = Emission Level – Limit value
5. " \* ": Fundamental frequency.
6. " # ": The radiated frequency is out of the restricted band.

**Beamforming Mode**
**802.11ac (VHT20)**

<b>CHANNEL</b>	TX Channel 149	<b>DETECTOR FUNCTION</b>	Peak (PK)
<b>FREQUENCY RANGE</b>	1GHz ~ 40GHz		Average (AV)

**ANTENNA POLARITY & TEST DISTANCE: HORIZONTAL AT 3 M**

NO.	FREQ. (MHz)	EMISSION LEVEL (dBuV/m)	LIMIT (dBuV/m)	MARGIN (dB)	ANTENNA HEIGHT (m)	TABLE ANGLE (Degree)	RAW VALUE (dBuV)	CORRECTION FACTOR (dB/m)
1	#5665.00	59.0 PK	68.2	-9.2	1.65 H	254	47.67	11.33
2	#5715.00	56.7 PK	74.0	-17.3	1.40 H	318	45.24	11.46
3	#5715.00	41.9 AV	54.0	-12.1	1.40 H	318	30.44	11.46
4	#5725.00	73.5 PK	78.2	-4.7	1.40 H	318	62.01	11.49
5	*5745.00	108.5 PK			1.40 H	318	96.95	11.55
6	*5745.00	98.3 AV			1.40 H	318	86.75	11.55
7	11490.00	55.8 PK	74.0	-18.2	1.51 H	15	38.56	17.24
8	11490.00	40.9 AV	54.0	-13.1	1.51 H	15	23.66	17.24
9	#17235.00	54.5 PK	74.0	-19.5	1.47 H	183	27.95	26.55
10	#17235.00	40.8 AV	54.0	-13.2	1.47 H	183	14.25	26.55

**ANTENNA POLARITY & TEST DISTANCE: VERTICAL AT 3 M**

NO.	FREQ. (MHz)	EMISSION LEVEL (dBuV/m)	LIMIT (dBuV/m)	MARGIN (dB)	ANTENNA HEIGHT (m)	TABLE ANGLE (Degree)	RAW VALUE (dBuV)	CORRECTION FACTOR (dB/m)
1	#5665.00	62.4 PK	68.2	-5.8	1.98 V	4	51.07	11.33
2	#5715.00	60.1 PK	74.0	-13.9	1.83 V	360	48.64	11.46
3	#5715.00	44.2 AV	54.0	-9.8	1.83 V	360	32.74	11.46
4	#5725.00	77.6 PK	78.2	-0.6	1.83 V	360	66.11	11.49
5	*5745.00	112.6 PK			1.83 V	360	101.05	11.55
6	*5745.00	101.5 AV			1.83 V	360	89.95	11.55
7	11490.00	53.0 PK	74.0	-21.0	1.32 V	319	35.76	17.24
8	11490.00	38.6 AV	54.0	-15.4	1.32 V	319	21.36	17.24
9	#17235.00	55.5 PK	74.0	-18.5	1.49 V	201	28.95	26.55
10	#17235.00	40.2 AV	54.0	-13.8	1.49 V	201	13.65	26.55

**REMARKS:**

- Emission Level(dBuV/m) = Raw Value(dBuV) + Correction Factor(dB/m)
- Correction Factor(dB/m) = Antenna Factor(dB/m) + Cable Factor(dB) – Pre-Amplifier Factor(dB)
- The other emission levels were very low against the limit.
- Margin value = Emission Level – Limit value
- " \* ": Fundamental frequency.
- " # ": The radiated frequency is out of the restricted band.



<b>CHANNEL</b>	TX Channel 157	<b>DETECTOR FUNCTION</b>	Peak (PK)
<b>FREQUENCY RANGE</b>	1GHz ~ 40GHz		Average (AV)

**ANTENNA POLARITY & TEST DISTANCE: HORIZONTAL AT 3 M**

NO.	FREQ. (MHz)	EMISSION LEVEL (dBuV/m)	LIMIT (dBuV/m)	MARGIN (dB)	ANTENNA HEIGHT (m)	TABLE ANGLE (Degree)	RAW VALUE (dBuV)	CORRECTION FACTOR (dB/m)
1	#5706.00	63.8 PK	68.2	-4.4	1.66 H	287	52.38	11.42
2	*5785.00	113.4 PK			1.40 H	309	101.72	11.68
3	*5785.00	103.1 AV			1.40 H	309	91.42	11.68
4	#5850.00	62.3 PK	78.2	-15.9	1.40 H	309	50.57	11.73
5	#5866.00	64.0 PK	68.2	-4.2	1.57 H	289	52.27	11.73
6	11570.00	56.2 PK	74.0	-17.8	1.48 H	27	38.53	17.67
7	11570.00	41.2 AV	54.0	-12.8	1.48 H	27	23.53	17.67
8	#17355.00	54.8 PK	74.0	-19.2	1.50 H	195	28.07	26.73
9	#17355.00	40.9 AV	54.0	-13.1	1.50 H	195	14.17	26.73

**ANTENNA POLARITY & TEST DISTANCE: VERTICAL AT 3 M**

NO.	FREQ. (MHz)	EMISSION LEVEL (dBuV/m)	LIMIT (dBuV/m)	MARGIN (dB)	ANTENNA HEIGHT (m)	TABLE ANGLE (Degree)	RAW VALUE (dBuV)	CORRECTION FACTOR (dB/m)
1	#5706.00	67.4 PK	68.2	-0.8	2.00 V	360	55.98	11.42
2	*5785.00	116.7 PK			1.88 V	2	105.02	11.68
3	*5785.00	105.4 AV			1.88 V	2	93.72	11.68
4	#5850.00	65.7 PK	78.2	-12.5	1.88 V	2	53.97	11.73
5	#5866.00	67.3 PK	68.2	-0.9	1.70 V	360	55.57	11.73
6	11570.00	53.0 PK	74.0	-21.0	1.35 V	312	35.33	17.67
7	11570.00	38.4 AV	54.0	-15.6	1.35 V	312	20.73	17.67
8	#17355.00	55.4 PK	74.0	-18.6	1.52 V	188	28.67	26.73
9	#17355.00	40.4 AV	54.0	-13.6	1.52 V	188	13.67	26.73

**REMARKS:**

1. Emission Level(dBuV/m) = Raw Value(dBuV) + Correction Factor(dB/m)
2. Correction Factor(dB/m) = Antenna Factor(dB/m) + Cable Factor(dB) – Pre-Amplifier Factor(dB)
3. The other emission levels were very low against the limit.
4. Margin value = Emission Level – Limit value
5. " \* ": Fundamental frequency.
6. " # ": The radiated frequency is out of the restricted band.

<b>CHANNEL</b>	TX Channel 165	<b>DETECTOR FUNCTION</b>	Peak (PK)
<b>FREQUENCY RANGE</b>	1GHz ~ 40GHz		Average (AV)

**ANTENNA POLARITY & TEST DISTANCE: HORIZONTAL AT 3 M**

NO.	FREQ. (MHz)	EMISSION LEVEL (dBuV/m)	LIMIT (dBuV/m)	MARGIN (dB)	ANTENNA HEIGHT (m)	TABLE ANGLE (Degree)	RAW VALUE (dBuV)	CORRECTION FACTOR (dB/m)
1	*5825.00	113.0 PK			1.35 H	302	101.26	11.74
2	*5825.00	102.8 AV			1.35 H	302	91.06	11.74
3	#5850.00	74.7 PK	78.2	-3.5	1.35 H	302	62.97	11.73
4	#5860.00	66.9 PK	74.0	-7.1	1.35 H	302	55.17	11.73
5	#5860.00	47.0 AV	54.0	-7.0	1.35 H	302	35.27	11.73
6	#5986.00	64.4 PK	68.2	-3.8	1.42 H	255	52.13	12.27
7	11650.00	55.6 PK	74.0	-18.4	1.53 H	38	37.76	17.84
8	11650.00	40.8 AV	54.0	-13.2	1.53 H	38	22.96	17.84
9	#17475.00	54.8 PK	74.0	-19.2	1.44 H	189	27.49	27.31
10	#17475.00	41.2 AV	54.0	-12.8	1.44 H	189	13.89	27.31

**ANTENNA POLARITY & TEST DISTANCE: VERTICAL AT 3 M**

NO.	FREQ. (MHz)	EMISSION LEVEL (dBuV/m)	LIMIT (dBuV/m)	MARGIN (dB)	ANTENNA HEIGHT (m)	TABLE ANGLE (Degree)	RAW VALUE (dBuV)	CORRECTION FACTOR (dB/m)
1	*5825.00	117.1 PK			1.74 V	360	105.36	11.74
2	*5825.00	105.9 AV			1.74 V	360	94.16	11.74
3	#5850.00	77.9 PK	78.2	-0.3	1.74 V	360	66.17	11.73
4	#5860.00	70.5 PK	74.0	-3.5	1.74 V	360	58.77	11.73
5	#5860.00	50.2 AV	54.0	-3.8	1.74 V	360	38.47	11.73
6	#5986.00	68.0 PK	68.2	-0.2	1.73 V	7	55.73	12.27
7	11650.00	52.6 PK	74.0	-21.4	1.35 V	311	34.76	17.84
8	11650.00	38.3 AV	54.0	-15.7	1.35 V	311	20.46	17.84
9	#17475.00	56.1 PK	74.0	-17.9	1.56 V	186	28.79	27.31
10	#17475.00	40.9 AV	54.0	-13.1	1.56 V	186	13.59	27.31

**REMARKS:**

- Emission Level(dBuV/m) = Raw Value(dBuV) + Correction Factor(dB/m)
- Correction Factor(dB/m) = Antenna Factor(dB/m) + Cable Factor(dB) – Pre-Amplifier Factor(dB)
- The other emission levels were very low against the limit.
- Margin value = Emission Level – Limit value
- " \* ": Fundamental frequency.
- " # ": The radiated frequency is out of the restricted band.

**CDD Mode**
**802.11ac (VHT40)**

<b>CHANNEL</b>	TX Channel 38	<b>DETECTOR FUNCTION</b>	Peak (PK)
<b>FREQUENCY RANGE</b>	1GHz ~ 40GHz		Average (AV)

**ANTENNA POLARITY & TEST DISTANCE: HORIZONTAL AT 3 M**

NO.	FREQ. (MHz)	EMISSION LEVEL (dBuV/m)	LIMIT (dBuV/m)	MARGIN (dB)	ANTENNA HEIGHT (m)	TABLE ANGLE (Degree)	RAW VALUE (dBuV)	CORRECTION FACTOR (dB/m)
1	5150.00	69.7 PK	74.0	-4.3	1.30 H	298	59.57	10.13
2	5150.00	49.8 AV	54.0	-4.2	1.30 H	298	39.67	10.13
3	*5190.00	105.1 PK			1.30 H	298	94.75	10.35
4	*5190.00	95.9 AV			1.30 H	298	85.55	10.35
5	5350.00	55.1 PK	74.0	-18.9	1.30 H	298	44.33	10.77
6	5350.00	44.7 AV	54.0	-9.3	1.30 H	298	33.93	10.77
7	#10380.00	56.2 PK	74.0	-17.8	1.49 H	37	39.39	16.81
8	#10380.00	41.1 AV	54.0	-12.9	1.49 H	37	24.29	16.81
9	15570.00	54.3 PK	74.0	-19.7	1.44 H	178	32.65	21.65
10	15570.00	41.0 AV	54.0	-13.0	1.44 H	178	19.35	21.65

**ANTENNA POLARITY & TEST DISTANCE: VERTICAL AT 3 M**

NO.	FREQ. (MHz)	EMISSION LEVEL (dBuV/m)	LIMIT (dBuV/m)	MARGIN (dB)	ANTENNA HEIGHT (m)	TABLE ANGLE (Degree)	RAW VALUE (dBuV)	CORRECTION FACTOR (dB/m)
1	5150.00	72.8 PK	74.0	-1.2	1.69 V	50	62.67	10.13
2	5150.00	53.2 AV	54.0	-0.8	1.69 V	50	43.07	10.13
3	*5190.00	110.0 PK			1.69 V	50	99.65	10.35
4	*5190.00	97.8 AV			1.69 V	50	87.45	10.35
5	5350.00	58.2 PK	74.0	-15.8	1.69 V	50	47.43	10.77
6	5350.00	46.9 AV	54.0	-7.1	1.69 V	50	36.13	10.77
7	#10380.00	52.4 PK	74.0	-21.6	1.39 V	298	35.59	16.81
8	#10380.00	38.2 AV	54.0	-15.8	1.39 V	298	21.39	16.81
9	15570.00	56.2 PK	74.0	-17.8	1.55 V	202	34.55	21.65
10	15570.00	40.9 AV	54.0	-13.1	1.55 V	202	19.25	21.65

**REMARKS:**

- Emission Level(dBuV/m) = Raw Value(dBuV) + Correction Factor(dB/m)
- Correction Factor(dB/m) = Antenna Factor(dB/m) + Cable Factor(dB) – Pre-Amplifier Factor(dB)
- The other emission levels were very low against the limit.
- Margin value = Emission Level – Limit value
- " \* ": Fundamental frequency.
- " # ": The radiated frequency is out of the restricted band.

<b>CHANNEL</b>	TX Channel 46	<b>DETECTOR FUNCTION</b>	Peak (PK)
<b>FREQUENCY RANGE</b>	1GHz ~ 40GHz		Average (AV)

**ANTENNA POLARITY & TEST DISTANCE: HORIZONTAL AT 3 M**

NO.	FREQ. (MHz)	EMISSION LEVEL (dBuV/m)	LIMIT (dBuV/m)	MARGIN (dB)	ANTENNA HEIGHT (m)	TABLE ANGLE (Degree)	RAW VALUE (dBuV)	CORRECTION FACTOR (dB/m)
1	5150.00	62.0 PK	74.0	-12.0	1.34 H	311	51.87	10.13
2	5150.00	47.5 AV	54.0	-6.5	1.34 H	311	37.37	10.13
3	*5230.00	107.8 PK			1.34 H	311	97.33	10.47
4	*5230.00	98.4 AV			1.34 H	311	87.93	10.47
5	5350.00	59.0 PK	74.0	-15.0	1.34 H	311	48.23	10.77
6	5350.00	47.7 AV	54.0	-6.3	1.34 H	311	36.93	10.77
7	#10460.00	55.9 PK	74.0	-18.1	1.44 H	28	39.30	16.60
8	#10460.00	40.8 AV	54.0	-13.2	1.44 H	28	24.20	16.60
9	15690.00	53.7 PK	74.0	-20.3	1.50 H	191	31.64	22.06
10	15690.00	40.5 AV	54.0	-13.5	1.50 H	191	18.44	22.06

**ANTENNA POLARITY & TEST DISTANCE: VERTICAL AT 3 M**

NO.	FREQ. (MHz)	EMISSION LEVEL (dBuV/m)	LIMIT (dBuV/m)	MARGIN (dB)	ANTENNA HEIGHT (m)	TABLE ANGLE (Degree)	RAW VALUE (dBuV)	CORRECTION FACTOR (dB/m)
1	5150.00	63.8 PK	74.0	-10.2	1.69 V	47	53.67	10.13
2	5150.00	50.5 AV	54.0	-3.5	1.69 V	47	40.37	10.13
3	*5230.00	111.5 PK			1.69 V	47	101.03	10.47
4	*5230.00	99.5 AV			1.69 V	47	89.03	10.47
5	5350.00	62.1 PK	74.0	-11.9	1.69 V	47	51.33	10.77
6	5350.00	50.9 AV	54.0	-3.1	1.69 V	47	40.13	10.77
7	#10460.00	51.9 PK	74.0	-22.1	1.37 V	309	35.30	16.60
8	#10460.00	37.9 AV	54.0	-16.1	1.37 V	309	21.30	16.60
9	15690.00	56.8 PK	74.0	-17.2	1.50 V	200	34.74	22.06
10	15690.00	41.4 AV	54.0	-12.6	1.50 V	200	19.34	22.06

**REMARKS:**

1. Emission Level(dBuV/m) = Raw Value(dBuV) + Correction Factor(dB/m)
2. Correction Factor(dB/m) = Antenna Factor(dB/m) + Cable Factor(dB) – Pre-Amplifier Factor(dB)
3. The other emission levels were very low against the limit.
4. Margin value = Emission Level – Limit value
5. " \* ": Fundamental frequency.
6. " # ": The radiated frequency is out of the restricted band.

**Beamforming Mode**  
**802.11ac (VHT40)**

<b>CHANNEL</b>	TX Channel 151	<b>DETECTOR FUNCTION</b>	Peak (PK)
<b>FREQUENCY RANGE</b>	1GHz ~ 40GHz		Average (AV)

**ANTENNA POLARITY & TEST DISTANCE: HORIZONTAL AT 3 M**

NO.	FREQ. (MHz)	EMISSION LEVEL (dBuV/m)	LIMIT (dBuV/m)	MARGIN (dB)	ANTENNA HEIGHT (m)	TABLE ANGLE (Degree)	RAW VALUE (dBuV)	CORRECTION FACTOR (dB/m)
1	#5715.00	64.1 PK	74.0	-9.9	1.34 H	308	52.64	11.46
2	#5715.00	47.5 AV	54.0	-6.5	1.34 H	308	36.04	11.46
3	#5725.00	73.9 PK	78.2	-4.3	1.34 H	308	62.41	11.49
4	*5755.00	106.0 PK			1.34 H	308	94.41	11.59
5	*5755.00	95.8 AV			1.34 H	308	84.21	11.59
6	11510.00	56.0 PK	74.0	-18.0	1.48 H	21	38.75	17.25
7	11510.00	40.6 AV	54.0	-13.4	1.48 H	21	23.35	17.25
8	#17265.00	54.2 PK	74.0	-19.8	1.47 H	196	27.72	26.48
9	#17265.00	40.9 AV	54.0	-13.1	1.47 H	196	14.42	26.48

**ANTENNA POLARITY & TEST DISTANCE: VERTICAL AT 3 M**

NO.	FREQ. (MHz)	EMISSION LEVEL (dBuV/m)	LIMIT (dBuV/m)	MARGIN (dB)	ANTENNA HEIGHT (m)	TABLE ANGLE (Degree)	RAW VALUE (dBuV)	CORRECTION FACTOR (dB/m)
1	#5715.00	67.2 PK	74.0	-6.8	1.91 V	8	55.74	11.46
2	#5715.00	50.1 AV	54.0	-3.9	1.91 V	8	38.64	11.46
3	#5725.00	77.5 PK	78.2	-0.7	1.91 V	8	66.01	11.49
4	*5755.00	109.4 PK			1.91 V	8	97.81	11.59
5	*5755.00	98.0 AV			1.91 V	8	86.41	11.59
6	11510.00	52.5 PK	74.0	-21.5	1.33 V	294	35.25	17.25
7	11510.00	38.3 AV	54.0	-15.7	1.33 V	294	21.05	17.25
8	#17265.00	56.2 PK	74.0	-17.8	1.51 V	196	29.72	26.48
9	#17265.00	41.0 AV	54.0	-13.0	1.51 V	196	14.52	26.48

**REMARKS:**

1. Emission Level(dBuV/m) = Raw Value(dBuV) + Correction Factor(dB/m)
2. Correction Factor(dB/m) = Antenna Factor(dB/m) + Cable Factor(dB) – Pre-Amplifier Factor(dB)
3. The other emission levels were very low against the limit.
4. Margin value = Emission Level – Limit value
5. " \* ": Fundamental frequency.
6. " # ": The radiated frequency is out of the restricted band.

<b>CHANNEL</b>	TX Channel 159	<b>DETECTOR FUNCTION</b>	Peak (PK)
<b>FREQUENCY RANGE</b>	1GHz ~ 40GHz		Average (AV)

**ANTENNA POLARITY & TEST DISTANCE: HORIZONTAL AT 3 M**

NO.	FREQ. (MHz)	EMISSION LEVEL (dBuV/m)	LIMIT (dBuV/m)	MARGIN (dB)	ANTENNA HEIGHT (m)	TABLE ANGLE (Degree)	RAW VALUE (dBuV)	CORRECTION FACTOR (dB/m)
1	*5795.00	109.7 PK			1.39 H	319	97.98	11.72
2	*5795.00	99.5 AV			1.39 H	319	87.78	11.72
3	#5850.00	69.8 PK	78.2	-8.4	1.39 H	319	58.07	11.73
4	#5860.00	66.0 PK	74.0	-8.0	1.39 H	319	54.27	11.73
5	#5860.00	50.5 AV	54.0	-3.5	1.39 H	319	38.77	11.73
6	11590.00	55.5 PK	74.0	-18.5	1.51 H	21	37.70	17.80
7	11590.00	40.3 AV	54.0	-13.7	1.51 H	21	22.50	17.80
8	#17385.00	53.8 PK	74.0	-20.2	1.53 H	181	26.88	26.92
9	#17385.00	40.5 AV	54.0	-13.5	1.53 H	181	13.58	26.92

**ANTENNA POLARITY & TEST DISTANCE: VERTICAL AT 3 M**

NO.	FREQ. (MHz)	EMISSION LEVEL (dBuV/m)	LIMIT (dBuV/m)	MARGIN (dB)	ANTENNA HEIGHT (m)	TABLE ANGLE (Degree)	RAW VALUE (dBuV)	CORRECTION FACTOR (dB/m)
1	*5795.00	113.9 PK			1.02 V	5	102.18	11.72
2	*5795.00	102.1 AV			1.02 V	5	90.38	11.72
3	#5850.00	73.8 PK	78.2	-4.4	1.02 V	5	62.07	11.73
4	#5860.00	69.5 PK	74.0	-4.5	1.02 V	5	57.77	11.73
5	#5860.00	53.7 AV	54.0	-0.3	1.02 V	5	41.97	11.73
6	11590.00	52.2 PK	74.0	-21.8	1.29 V	294	34.40	17.80
7	11590.00	37.9 AV	54.0	-16.1	1.29 V	294	20.10	17.80
8	#17385.00	55.8 PK	74.0	-18.2	1.53 V	207	28.88	26.92
9	#17385.00	40.6 AV	54.0	-13.4	1.53 V	207	13.68	26.92

**REMARKS:**

1. Emission Level(dBuV/m) = Raw Value(dBuV) + Correction Factor(dB/m)
2. Correction Factor(dB/m) = Antenna Factor(dB/m) + Cable Factor(dB) – Pre-Amplifier Factor(dB)
3. The other emission levels were very low against the limit.
4. Margin value = Emission Level – Limit value
5. " \* ": Fundamental frequency.
6. " # ": The radiated frequency is out of the restricted band.

**CDD Mode**
**802.11ac (VHT80)**

<b>CHANNEL</b>	TX Channel 42	<b>DETECTOR FUNCTION</b>	Peak (PK)
<b>FREQUENCY RANGE</b>	1GHz ~ 40GHz		Average (AV)

**ANTENNA POLARITY & TEST DISTANCE: HORIZONTAL AT 3 M**

NO.	FREQ. (MHz)	EMISSION LEVEL (dBuV/m)	LIMIT (dBuV/m)	MARGIN (dB)	ANTENNA HEIGHT (m)	TABLE ANGLE (Degree)	RAW VALUE (dBuV)	CORRECTION FACTOR (dB/m)
1	5150.00	69.2 PK	74.0	-4.8	1.37 H	307	59.07	10.13
2	5150.00	50.8 AV	54.0	-3.2	1.37 H	307	40.67	10.13
3	*5210.00	100.8 PK			1.37 H	307	90.38	10.42
4	*5210.00	90.6 AV			1.37 H	307	80.18	10.42
5	5350.00	53.3 PK	74.0	-20.7	1.37 H	307	42.53	10.77
6	5350.00	42.7 AV	54.0	-11.3	1.37 H	307	31.93	10.77
7	#10420.00	55.3 PK	74.0	-18.7	1.50 H	32	38.49	16.81
8	#10420.00	40.0 AV	54.0	-14.0	1.50 H	32	23.19	16.81
9	15630.00	53.9 PK	74.0	-20.1	1.56 H	192	32.05	21.85
10	15630.00	40.4 AV	54.0	-13.6	1.56 H	192	18.55	21.85

**ANTENNA POLARITY & TEST DISTANCE: VERTICAL AT 3 M**

NO.	FREQ. (MHz)	EMISSION LEVEL (dBuV/m)	LIMIT (dBuV/m)	MARGIN (dB)	ANTENNA HEIGHT (m)	TABLE ANGLE (Degree)	RAW VALUE (dBuV)	CORRECTION FACTOR (dB/m)
1	5150.00	72.4 PK	74.0	-1.6	1.69 V	47	62.27	10.13
2	5150.00	53.6 AV	54.0	-0.4	1.69 V	47	43.47	10.13
3	*5210.00	105.0 PK			1.69 V	47	94.58	10.42
4	*5210.00	92.9 AV			1.69 V	47	82.48	10.42
5	5350.00	56.7 PK	74.0	-17.3	1.69 V	47	45.93	10.77
6	5350.00	44.8 AV	54.0	-9.2	1.69 V	47	34.03	10.77
7	#10420.00	52.7 PK	74.0	-21.3	1.30 V	301	35.89	16.81
8	#10420.00	38.1 AV	54.0	-15.9	1.30 V	301	21.29	16.81
9	15630.00	56.2 PK	74.0	-17.8	1.49 V	212	34.35	21.85
10	15630.00	40.9 AV	54.0	-13.1	1.49 V	212	19.05	21.85

**REMARKS:**

- Emission Level(dBuV/m) = Raw Value(dBuV) + Correction Factor(dB/m)
- Correction Factor(dB/m) = Antenna Factor(dB/m) + Cable Factor(dB) – Pre-Amplifier Factor(dB)
- The other emission levels were very low against the limit.
- Margin value = Emission Level – Limit value
- " \* ": Fundamental frequency.
- " # ": The radiated frequency is out of the restricted band.

**Beamforming Mode**  
**802.11ac (VHT80)**

<b>CHANNEL</b>	TX Channel 155	<b>DETECTOR FUNCTION</b>	Peak (PK)
<b>FREQUENCY RANGE</b>	1GHz ~ 40GHz		Average (AV)

**ANTENNA POLARITY & TEST DISTANCE: HORIZONTAL AT 3 M**

NO.	FREQ. (MHz)	EMISSION LEVEL (dBuV/m)	LIMIT (dBuV/m)	MARGIN (dB)	ANTENNA HEIGHT (m)	TABLE ANGLE (Degree)	RAW VALUE (dBuV)	CORRECTION FACTOR (dB/m)
1	#5715.00	67.1 PK	74.0	-6.9	1.31 H	294	55.64	11.46
2	#5715.00	50.7 AV	54.0	-3.3	1.31 H	294	39.24	11.46
3	#5725.00	72.0 PK	78.2	-6.2	1.31 H	294	60.51	11.49
4	*5775.00	103.3 PK			1.31 H	294	91.64	11.66
5	*5775.00	92.1 AV			1.31 H	294	80.44	11.66
6	#5850.00	67.3 PK	78.2	-10.9	1.31 H	294	55.57	11.73
7	#5860.00	61.0 PK	74.0	-13.0	1.31 H	294	49.27	11.73
8	#5860.00	46.4 AV	54.0	-7.6	1.31 H	294	34.67	11.73
9	11550.00	55.4 PK	74.0	-18.6	1.56 H	24	37.87	17.53
10	11550.00	39.8 AV	54.0	-14.2	1.56 H	24	22.27	17.53
11	#17325.00	53.9 PK	74.0	-20.1	1.56 H	181	27.36	26.54
12	#17325.00	40.7 AV	54.0	-13.3	1.56 H	181	14.16	26.54

**ANTENNA POLARITY & TEST DISTANCE: VERTICAL AT 3 M**

NO.	FREQ. (MHz)	EMISSION LEVEL (dBuV/m)	LIMIT (dBuV/m)	MARGIN (dB)	ANTENNA HEIGHT (m)	TABLE ANGLE (Degree)	RAW VALUE (dBuV)	CORRECTION FACTOR (dB/m)
1	#5715.00	70.5 PK	74.0	-3.5	1.96 V	360	59.04	11.46
2	#5715.00	53.9 AV	54.0	-0.1	1.96 V	360	42.44	11.46
3	#5725.00	75.3 PK	78.2	-2.9	1.96 V	360	63.81	11.49
4	*5775.00	106.4 PK			1.96 V	360	94.74	11.66
5	*5775.00	94.4 AV			1.96 V	360	82.74	11.66
6	#5850.00	70.7 PK	78.2	-7.5	1.96 V	360	58.97	11.73
7	#5860.00	64.1 PK	74.0	-9.9	1.96 V	360	52.37	11.73
8	#5860.00	49.0 AV	54.0	-5.0	1.96 V	360	37.27	11.73
9	11550.00	52.9 PK	74.0	-21.1	1.25 V	311	35.37	17.53
10	11550.00	38.3 AV	54.0	-15.7	1.25 V	311	20.77	17.53
11	#17325.00	55.9 PK	74.0	-18.1	1.47 V	204	29.36	26.54
12	#17325.00	40.6 AV	54.0	-13.4	1.47 V	204	14.06	26.54

**REMARKS:**

1. Emission Level(dBuV/m) = Raw Value(dBuV) + Correction Factor(dB/m)
2. Correction Factor(dB/m) = Antenna Factor(dB/m) + Cable Factor(dB) – Pre-Amplifier Factor(dB)
3. The other emission levels were very low against the limit.
4. Margin value = Emission Level – Limit value
5. " \* ": Fundamental frequency.
6. " # ": The radiated frequency is out of the restricted band.



**Below 1GHz Data:**

**CDD Mode**

**802.11a**

<b>CHANNEL</b>	TX Channel 165	<b>DETECTOR FUNCTION</b>	Quasi-Peak (QP)
<b>FREQUENCY RANGE</b>	Below 1GHz		

**ANTENNA POLARITY & TEST DISTANCE: HORIZONTAL AT 3 M**

NO.	FREQ. (MHz)	EMISSION LEVEL (dBuV/m)	LIMIT (dBuV/m)	MARGIN (dB)	ANTENNA HEIGHT (m)	TABLE ANGLE (Degree)	RAW VALUE (dBuV)	CORRECTION FACTOR (dB/m)
1	47.80	25.1 QP	40.0	-14.9	1.00 H	263	38.14	-13.04
2	165.99	27.0 QP	43.5	-16.5	1.00 H	100	40.31	-13.32
3	323.81	27.7 QP	46.0	-18.3	1.00 H	316	38.95	-11.23
4	375.03	24.0 QP	46.0	-22.0	1.00 H	301	34.01	-9.97
5	500.01	24.5 QP	46.0	-21.5	1.00 H	316	31.36	-6.83
6	806.78	33.1 QP	46.0	-12.9	1.00 H	21	33.59	-0.50

**ANTENNA POLARITY & TEST DISTANCE: VERTICAL AT 3 M**

NO.	FREQ. (MHz)	EMISSION LEVEL (dBuV/m)	LIMIT (dBuV/m)	MARGIN (dB)	ANTENNA HEIGHT (m)	TABLE ANGLE (Degree)	RAW VALUE (dBuV)	CORRECTION FACTOR (dB/m)
1	39.51	35.1 QP	40.0	-4.9	1.00 V	241	48.67	-13.54
2	74.57	25.9 QP	40.0	-14.1	1.00 V	300	42.26	-16.40
3	108.81	26.8 QP	43.5	-16.7	1.00 V	0	42.91	-16.07
4	165.99	28.6 QP	43.5	-14.9	1.00 V	98	41.90	-13.32
5	500.01	29.4 QP	46.0	-16.6	1.00 V	358	36.26	-6.83
6	806.49	30.9 QP	46.0	-15.1	1.00 V	340	31.36	-0.50

**REMARKS:**

1. Emission Level(dBuV/m) = Raw Value(dBuV) + Correction Factor(dB/m)
2. Correction Factor(dB/m) = Antenna Factor(dB/m) + Cable Factor(dB) – Pre-Amplifier Factor(dB)
3. The other emission levels were very low against the limit.
4. Margin value = Emission Level – Limit value

#### 4.1.8 Test Results (Mode 2)

#### Above 1GHz Data:

#### CDD Mode

#### 802.11a

<b>CHANNEL</b>	TX Channel 36	<b>DETECTOR FUNCTION</b>	Peak (PK)
<b>FREQUENCY RANGE</b>	1GHz ~ 40GHz		Average (AV)

#### ANTENNA POLARITY & TEST DISTANCE: HORIZONTAL AT 3 M

NO.	FREQ. (MHz)	EMISSION LEVEL (dBuV/m)	LIMIT (dBuV/m)	MARGIN (dB)	ANTENNA HEIGHT (m)	TABLE ANGLE (Degree)	RAW VALUE (dBuV)	CORRECTION FACTOR (dB/m)
1	5104.00	56.1 PK	74.0	-17.9	1.36 H	302	46.21	9.89
2	5104.00	40.6 AV	54.0	-13.4	1.36 H	302	30.71	9.89
3	5150.00	56.0 PK	74.0	-18.0	1.36 H	302	45.87	10.13
4	5150.00	40.3 AV	54.0	-13.7	1.36 H	302	30.17	10.13
5	*5180.00	99.7 PK			1.36 H	302	89.40	10.30
6	*5180.00	90.3 AV			1.36 H	302	80.00	10.30
7	#10360.00	56.0 PK	74.0	-18.0	1.36 H	14	39.30	16.70
8	#10360.00	41.2 AV	54.0	-12.8	1.36 H	14	24.50	16.70
9	15540.00	54.1 PK	74.0	-19.9	1.46 H	226	32.54	21.56
10	15540.00	39.9 AV	54.0	-14.1	1.46 H	226	18.34	21.56

#### ANTENNA POLARITY & TEST DISTANCE: VERTICAL AT 3 M

NO.	FREQ. (MHz)	EMISSION LEVEL (dBuV/m)	LIMIT (dBuV/m)	MARGIN (dB)	ANTENNA HEIGHT (m)	TABLE ANGLE (Degree)	RAW VALUE (dBuV)	CORRECTION FACTOR (dB/m)
1	5104.00	53.3 PK	74.0	-20.7	1.57 V	183	43.41	9.89
2	5104.00	41.8 AV	54.0	-12.2	1.57 V	183	31.91	9.89
3	5150.00	56.3 PK	74.0	-17.7	1.45 V	184	46.17	10.13
4	5150.00	42.1 AV	54.0	-11.9	1.45 V	184	31.97	10.13
5	*5180.00	107.5 PK			1.45 V	184	97.20	10.30
6	*5180.00	98.0 AV			1.45 V	184	87.70	10.30
7	#10360.00	54.0 PK	74.0	-20.0	1.53 V	329	37.30	16.70
8	#10360.00	40.5 AV	54.0	-13.5	1.53 V	329	23.80	16.70
9	15540.00	54.4 PK	74.0	-19.6	1.57 V	196	32.84	21.56
10	15540.00	39.9 AV	54.0	-14.1	1.57 V	196	18.34	21.56

#### REMARKS:

1. Emission Level(dBuV/m) = Raw Value(dBuV) + Correction Factor(dB/m)
2. Correction Factor(dB/m) = Antenna Factor(dB/m) + Cable Factor(dB) – Pre-Amplifier Factor(dB)
3. The other emission levels were very low against the limit.
4. Margin value = Emission Level – Limit value
5. " \* ": Fundamental frequency.
6. " # ": The radiated frequency is out of the restricted band.

<b>CHANNEL</b>	TX Channel 40	<b>DETECTOR FUNCTION</b>	Peak (PK)
<b>FREQUENCY RANGE</b>	1GHz ~ 40GHz		Average (AV)

**ANTENNA POLARITY & TEST DISTANCE: HORIZONTAL AT 3 M**

NO.	FREQ. (MHz)	EMISSION LEVEL (dBuV/m)	LIMIT (dBuV/m)	MARGIN (dB)	ANTENNA HEIGHT (m)	TABLE ANGLE (Degree)	RAW VALUE (dBuV)	CORRECTION FACTOR (dB/m)
1	5122.00	55.4 PK	74.0	-18.6	1.40 H	328	45.41	9.99
2	5122.00	40.2 AV	54.0	-13.8	1.40 H	328	30.21	9.99
3	*5200.00	100.0 PK			1.40 H	328	89.60	10.40
4	*5200.00	90.3 AV			1.40 H	328	79.90	10.40
5	5362.00	55.5 PK	74.0	-18.5	1.40 H	328	44.70	10.80
6	5362.00	40.2 AV	54.0	-13.8	1.40 H	328	29.40	10.80
7	#10400.00	56.2 PK	74.0	-17.8	1.39 H	16	39.29	16.91
8	#10400.00	41.3 AV	54.0	-12.7	1.39 H	16	24.39	16.91
9	15600.00	54.8 PK	74.0	-19.2	1.52 H	224	33.06	21.74
10	15600.00	40.3 AV	54.0	-13.7	1.52 H	224	18.56	21.74

**ANTENNA POLARITY & TEST DISTANCE: VERTICAL AT 3 M**

NO.	FREQ. (MHz)	EMISSION LEVEL (dBuV/m)	LIMIT (dBuV/m)	MARGIN (dB)	ANTENNA HEIGHT (m)	TABLE ANGLE (Degree)	RAW VALUE (dBuV)	CORRECTION FACTOR (dB/m)
1	5122.00	57.7 PK	74.0	-16.3	1.40 V	183	47.71	9.99
2	5122.00	47.4 AV	54.0	-6.6	1.40 V	183	37.41	9.99
3	*5200.00	107.6 PK			1.49 V	174	97.20	10.40
4	*5200.00	97.9 AV			1.49 V	174	87.50	10.40
5	5362.00	51.9 PK	74.0	-22.1	1.38 V	12	41.10	10.80
6	5362.00	42.4 AV	54.0	-11.6	1.38 V	12	31.60	10.80
7	#10400.00	54.0 PK	74.0	-20.0	1.50 V	325	37.09	16.91
8	#10400.00	40.6 AV	54.0	-13.4	1.50 V	325	23.69	16.91
9	15600.00	54.4 PK	74.0	-19.6	1.54 V	194	32.66	21.74
10	15600.00	39.8 AV	54.0	-14.2	1.54 V	194	18.06	21.74

**REMARKS:**

1. Emission Level(dBuV/m) = Raw Value(dBuV) + Correction Factor(dB/m)
2. Correction Factor(dB/m) = Antenna Factor(dB/m) + Cable Factor(dB) – Pre-Amplifier Factor(dB)
3. The other emission levels were very low against the limit.
4. Margin value = Emission Level – Limit value
5. " \* ": Fundamental frequency.
6. " # ": The radiated frequency is out of the restricted band.

<b>CHANNEL</b>	TX Channel 48	<b>DETECTOR FUNCTION</b>	Peak (PK)
<b>FREQUENCY RANGE</b>	1GHz ~ 40GHz		Average (AV)

**ANTENNA POLARITY & TEST DISTANCE: HORIZONTAL AT 3 M**

NO.	FREQ. (MHz)	EMISSION LEVEL (dBuV/m)	LIMIT (dBuV/m)	MARGIN (dB)	ANTENNA HEIGHT (m)	TABLE ANGLE (Degree)	RAW VALUE (dBuV)	CORRECTION FACTOR (dB/m)
1	5087.00	56.0 PK	74.0	-18.0	1.40 H	310	46.16	9.84
2	5087.00	40.3 AV	54.0	-13.7	1.40 H	310	30.46	9.84
3	*5240.00	99.7 PK			1.40 H	310	89.21	10.49
4	*5240.00	90.3 AV			1.40 H	310	79.81	10.49
5	5393.00	55.8 PK	74.0	-18.2	1.40 H	310	44.91	10.89
6	5393.00	40.4 AV	54.0	-13.6	1.40 H	310	29.51	10.89
7	#10480.00	55.6 PK	74.0	-18.4	1.37 H	5	39.11	16.49
8	#10480.00	41.1 AV	54.0	-12.9	1.37 H	5	24.61	16.49
9	15720.00	54.0 PK	74.0	-20.0	1.45 H	221	31.84	22.16
10	15720.00	39.9 AV	54.0	-14.1	1.45 H	221	17.74	22.16

**ANTENNA POLARITY & TEST DISTANCE: VERTICAL AT 3 M**

NO.	FREQ. (MHz)	EMISSION LEVEL (dBuV/m)	LIMIT (dBuV/m)	MARGIN (dB)	ANTENNA HEIGHT (m)	TABLE ANGLE (Degree)	RAW VALUE (dBuV)	CORRECTION FACTOR (dB/m)
1	5087.00	57.3 PK	74.0	-16.7	1.53 V	193	47.46	9.84
2	5087.00	50.9 AV	54.0	-3.1	1.53 V	193	41.06	9.84
3	*5240.00	107.7 PK			1.44 V	172	97.21	10.49
4	*5240.00	98.0 AV			1.44 V	172	87.51	10.49
5	5393.00	57.7 PK	74.0	-16.3	1.59 V	345	46.81	10.89
6	5393.00	46.7 AV	54.0	-7.3	1.59 V	345	35.81	10.89
7	#10480.00	54.1 PK	74.0	-19.9	1.46 V	348	37.61	16.49
8	#10480.00	40.9 AV	54.0	-13.1	1.46 V	348	24.41	16.49
9	15720.00	54.6 PK	74.0	-19.4	1.57 V	222	32.44	22.16
10	15720.00	39.7 AV	54.0	-14.3	1.57 V	222	17.54	22.16

**REMARKS:**

1. Emission Level(dBuV/m) = Raw Value(dBuV) + Correction Factor(dB/m)
2. Correction Factor(dB/m) = Antenna Factor(dB/m) + Cable Factor(dB) – Pre-Amplifier Factor(dB)
3. The other emission levels were very low against the limit.
4. Margin value = Emission Level – Limit value
5. " \* ": Fundamental frequency.
6. " # ": The radiated frequency is out of the restricted band.

**CDD Mode**
**802.11a**

<b>CHANNEL</b>	TX Channel 149	<b>DETECTOR FUNCTION</b>	Peak (PK)
<b>FREQUENCY RANGE</b>	1GHz ~ 40GHz		Average (AV)

**ANTENNA POLARITY & TEST DISTANCE: HORIZONTAL AT 3 M**

NO.	FREQ. (MHz)	EMISSION LEVEL (dBuV/m)	LIMIT (dBuV/m)	MARGIN (dB)	ANTENNA HEIGHT (m)	TABLE ANGLE (Degree)	RAW VALUE (dBuV)	CORRECTION FACTOR (dB/m)
1	#5666.00	52.3 PK	74.0	-21.7	1.36 H	307	40.97	11.33
2	#5666.00	40.5 AV	54.0	-13.5	1.36 H	307	29.17	11.33
3	#5725.00	67.1 PK	78.2	-11.1	1.36 H	307	55.61	11.49
4	*5745.00	104.8 PK			1.36 H	307	93.25	11.55
5	*5745.00	95.0 AV			1.36 H	307	83.45	11.55
6	#5907.00	51.7 PK	74.0	-22.3	1.36 H	307	39.92	11.78
7	#5907.00	41.8 AV	54.0	-12.2	1.36 H	307	30.02	11.78
8	11490.00	55.4 PK	74.0	-18.6	1.42 H	32	38.16	17.24
9	11490.00	40.7 AV	54.0	-13.3	1.42 H	32	23.46	17.24
10	#17235.00	54.2 PK	74.0	-19.8	1.45 H	202	27.65	26.55
11	#17235.00	40.1 AV	54.0	-13.9	1.45 H	202	13.55	26.55

**ANTENNA POLARITY & TEST DISTANCE: VERTICAL AT 3 M**

NO.	FREQ. (MHz)	EMISSION LEVEL (dBuV/m)	LIMIT (dBuV/m)	MARGIN (dB)	ANTENNA HEIGHT (m)	TABLE ANGLE (Degree)	RAW VALUE (dBuV)	CORRECTION FACTOR (dB/m)
1	#5666.00	60.2 PK	74.0	-13.8	1.93 V	244	48.87	11.33
2	#5666.00	48.5 AV	54.0	-5.5	1.93 V	244	37.17	11.33
3	#5725.00	75.4 PK	78.2	-2.8	1.76 V	243	63.91	11.49
4	*5745.00	112.6 PK			1.76 V	243	101.05	11.55
5	*5745.00	102.6 AV			1.76 V	243	91.05	11.55
6	#5907.00	59.0 PK	74.0	-15.0	1.69 V	212	47.22	11.78
7	#5907.00	49.4 AV	54.0	-4.6	1.69 V	212	37.62	11.78
8	11490.00	53.4 PK	74.0	-20.6	1.56 V	326	36.16	17.24
9	11490.00	40.3 AV	54.0	-13.7	1.56 V	326	23.06	17.24
10	#17235.00	54.4 PK	74.0	-19.6	1.55 V	199	27.85	26.55
11	#17235.00	39.6 AV	54.0	-14.4	1.55 V	199	13.05	26.55

**REMARKS:**

1. Emission Level(dBuV/m) = Raw Value(dBuV) + Correction Factor(dB/m)
2. Correction Factor(dB/m) = Antenna Factor(dB/m) + Cable Factor(dB) – Pre-Amplifier Factor(dB)
3. The other emission levels were very low against the limit.
4. Margin value = Emission Level – Limit value
5. " \* ": Fundamental frequency.
6. " # ": The radiated frequency is out of the restricted band.

<b>CHANNEL</b>	TX Channel 157	<b>DETECTOR FUNCTION</b>	Peak (PK)
<b>FREQUENCY RANGE</b>	1GHz ~ 40GHz		Average (AV)

**ANTENNA POLARITY & TEST DISTANCE: HORIZONTAL AT 3 M**

NO.	FREQ. (MHz)	EMISSION LEVEL (dBuV/m)	LIMIT (dBuV/m)	MARGIN (dB)	ANTENNA HEIGHT (m)	TABLE ANGLE (Degree)	RAW VALUE (dBuV)	CORRECTION FACTOR (dB/m)
1	#5706.00	54.9 PK	74.0	-19.1	1.35 H	329	43.48	11.42
2	#5706.00	41.8 AV	54.0	-12.2	1.35 H	329	30.38	11.42
3	*5785.00	106.9 PK			1.35 H	329	95.22	11.68
4	*5785.00	95.7 AV			1.35 H	329	84.02	11.68
5	#5867.00	50.9 PK	74.0	-23.1	1.35 H	329	39.17	11.73
6	#5867.00	40.9 AV	54.0	-13.1	1.35 H	329	29.17	11.73
7	11570.00	56.2 PK	74.0	-17.8	1.39 H	11	38.53	17.67
8	11570.00	41.5 AV	54.0	-12.5	1.39 H	11	23.83	17.67
9	#17355.00	55.1 PK	74.0	-18.9	1.46 H	213	28.37	26.73
10	#17355.00	40.6 AV	54.0	-13.4	1.46 H	213	13.87	26.73

**ANTENNA POLARITY & TEST DISTANCE: VERTICAL AT 3 M**

NO.	FREQ. (MHz)	EMISSION LEVEL (dBuV/m)	LIMIT (dBuV/m)	MARGIN (dB)	ANTENNA HEIGHT (m)	TABLE ANGLE (Degree)	RAW VALUE (dBuV)	CORRECTION FACTOR (dB/m)
1	#5706.00	63.1 PK	74.0	-10.9	2.24 V	213	51.68	11.42
2	#5706.00	50.2 AV	54.0	-3.8	2.24 V	213	38.78	11.42
3	*5785.00	114.6 PK			1.73 V	245	102.92	11.68
4	*5785.00	103.4 AV			1.73 V	245	91.72	11.68
5	#5867.00	58.9 PK	74.0	-15.1	2.12 V	198	47.17	11.73
6	#5867.00	48.9 AV	54.0	-5.1	2.12 V	198	37.17	11.73
7	11570.00	54.3 PK	74.0	-19.7	1.45 V	355	36.63	17.67
8	11570.00	40.8 AV	54.0	-13.2	1.45 V	355	23.13	17.67
9	#17355.00	54.4 PK	74.0	-19.6	1.48 V	222	27.67	26.73
10	#17355.00	39.7 AV	54.0	-14.3	1.48 V	222	12.97	26.73

**REMARKS:**

1. Emission Level(dBuV/m) = Raw Value(dBuV) + Correction Factor(dB/m)
2. Correction Factor(dB/m) = Antenna Factor(dB/m) + Cable Factor(dB) – Pre-Amplifier Factor(dB)
3. The other emission levels were very low against the limit.
4. Margin value = Emission Level – Limit value
5. " \* ": Fundamental frequency.
6. " # ": The radiated frequency is out of the restricted band.

<b>CHANNEL</b>	TX Channel 165	<b>DETECTOR FUNCTION</b>	Peak (PK)
<b>FREQUENCY RANGE</b>	1GHz ~ 40GHz		Average (AV)

**ANTENNA POLARITY & TEST DISTANCE: HORIZONTAL AT 3 M**

NO.	FREQ. (MHz)	EMISSION LEVEL (dBuV/m)	LIMIT (dBuV/m)	MARGIN (dB)	ANTENNA HEIGHT (m)	TABLE ANGLE (Degree)	RAW VALUE (dBuV)	CORRECTION FACTOR (dB/m)
1	*5825.00	108.3 PK			1.41 H	329	96.56	11.74
2	*5825.00	98.3 AV			1.41 H	329	86.56	11.74
3	#5850.00	66.3 PK	78.2	-11.9	1.41 H	329	54.57	11.73
4	#5860.00	55.6 PK	74.0	-18.4	1.41 H	329	43.87	11.73
5	#5860.00	40.0 AV	54.0	-14.0	1.41 H	329	28.27	11.73
6	#5906.00	55.8 PK	74.0	-18.2	1.41 H	329	44.03	11.77
7	#5906.00	40.4 AV	54.0	-13.6	1.41 H	329	28.63	11.77
8	11650.00	55.7 PK	74.0	-18.3	1.35 H	11	37.86	17.84
9	11650.00	41.3 AV	54.0	-12.7	1.35 H	11	23.46	17.84
10	#17475.00	53.9 PK	74.0	-20.1	1.43 H	225	26.59	27.31
11	#17475.00	39.8 AV	54.0	-14.2	1.43 H	225	12.49	27.31

**ANTENNA POLARITY & TEST DISTANCE: VERTICAL AT 3 M**

NO.	FREQ. (MHz)	EMISSION LEVEL (dBuV/m)	LIMIT (dBuV/m)	MARGIN (dB)	ANTENNA HEIGHT (m)	TABLE ANGLE (Degree)	RAW VALUE (dBuV)	CORRECTION FACTOR (dB/m)
1	*5825.00	116.6 PK			1.71 V	210	104.86	11.74
2	*5825.00	106.5 AV			1.71 V	210	94.76	11.74
3	#5850.00	74.8 PK	78.2	-3.4	1.71 V	210	63.07	11.73
4	#5860.00	67.7 PK	74.0	-6.3	1.71 V	210	55.97	11.73
5	#5860.00	46.0 AV	54.0	-8.0	1.71 V	210	34.27	11.73
6	#5906.00	61.9 PK	74.0	-12.1	1.76 V	209	50.13	11.77
7	#5906.00	50.1 AV	54.0	-3.9	1.76 V	209	38.33	11.77
8	11650.00	53.7 PK	74.0	-20.3	1.54 V	325	35.86	17.84
9	11650.00	40.5 AV	54.0	-13.5	1.54 V	325	22.66	17.84
10	#17475.00	55.2 PK	74.0	-18.8	1.49 V	217	27.89	27.31
11	#17475.00	40.3 AV	54.0	-13.7	1.49 V	217	12.99	27.31

**REMARKS:**

1. Emission Level(dBuV/m) = Raw Value(dBuV) + Correction Factor(dB/m)
2. Correction Factor(dB/m) = Antenna Factor(dB/m) + Cable Factor(dB) – Pre-Amplifier Factor(dB)
3. The other emission levels were very low against the limit.
4. Margin value = Emission Level – Limit value
5. " \* ": Fundamental frequency.
6. " # ": The radiated frequency is out of the restricted band.

**CDD Mode**
**802.11ac (VHT20)**

<b>CHANNEL</b>	TX Channel 36	<b>DETECTOR FUNCTION</b>	Peak (PK)
<b>FREQUENCY RANGE</b>	1GHz ~ 40GHz		Average (AV)

**ANTENNA POLARITY & TEST DISTANCE: HORIZONTAL AT 3 M**

NO.	FREQ. (MHz)	EMISSION LEVEL (dBuV/m)	LIMIT (dBuV/m)	MARGIN (dB)	ANTENNA HEIGHT (m)	TABLE ANGLE (Degree)	RAW VALUE (dBuV)	CORRECTION FACTOR (dB/m)
1	5150.00	55.4 PK	74.0	-18.6	1.41 H	312	45.27	10.13
2	5150.00	40.0 AV	54.0	-14.0	1.41 H	312	29.87	10.13
3	*5180.00	101.0 PK			1.41 H	312	90.70	10.30
4	*5180.00	91.3 AV			1.41 H	312	81.00	10.30
5	#10360.00	55.3 PK	74.0	-18.7	1.34 H	29	38.60	16.70
6	#10360.00	41.0 AV	54.0	-13.0	1.34 H	29	24.30	16.70
7	15540.00	54.3 PK	74.0	-19.7	1.46 H	208	32.74	21.56
8	15540.00	40.0 AV	54.0	-14.0	1.46 H	208	18.44	21.56

**ANTENNA POLARITY & TEST DISTANCE: VERTICAL AT 3 M**

NO.	FREQ. (MHz)	EMISSION LEVEL (dBuV/m)	LIMIT (dBuV/m)	MARGIN (dB)	ANTENNA HEIGHT (m)	TABLE ANGLE (Degree)	RAW VALUE (dBuV)	CORRECTION FACTOR (dB/m)
1	5150.00	55.9 PK	74.0	-18.1	2.07 V	15	45.77	10.13
2	5150.00	40.5 AV	54.0	-13.5	2.07 V	15	30.37	10.13
3	*5180.00	108.9 PK			2.07 V	15	98.60	10.30
4	*5180.00	99.1 AV			2.07 V	15	88.80	10.30
5	#10360.00	53.9 PK	74.0	-20.1	1.47 V	355	37.20	16.70
6	#10360.00	40.8 AV	54.0	-13.2	1.47 V	355	24.10	16.70
7	15540.00	54.2 PK	74.0	-19.8	1.51 V	219	32.64	21.56
8	15540.00	39.6 AV	54.0	-14.4	1.51 V	219	18.04	21.56

**REMARKS:**

1. Emission Level(dBuV/m) = Raw Value(dBuV) + Correction Factor(dB/m)
2. Correction Factor(dB/m) = Antenna Factor(dB/m) + Cable Factor(dB) – Pre-Amplifier Factor(dB)
3. The other emission levels were very low against the limit.
4. Margin value = Emission Level – Limit value
5. " \* ": Fundamental frequency.
6. " # ": The radiated frequency is out of the restricted band.



<b>CHANNEL</b>	TX Channel 40	<b>DETECTOR FUNCTION</b>	Peak (PK)
<b>FREQUENCY RANGE</b>	1GHz ~ 40GHz		Average (AV)

**ANTENNA POLARITY & TEST DISTANCE: HORIZONTAL AT 3 M**

NO.	FREQ. (MHz)	EMISSION LEVEL (dBuV/m)	LIMIT (dBuV/m)	MARGIN (dB)	ANTENNA HEIGHT (m)	TABLE ANGLE (Degree)	RAW VALUE (dBuV)	CORRECTION FACTOR (dB/m)
1	5019.00	56.4 PK	74.0	-17.6	1.43 H	305	46.74	9.66
2	5019.00	40.9 AV	54.0	-13.1	1.43 H	305	31.24	9.66
3	*5200.00	100.8 PK			1.43 H	305	90.40	10.40
4	*5200.00	90.9 AV			1.43 H	305	80.50	10.40
5	5358.00	56.3 PK	74.0	-17.7	1.43 H	305	45.51	10.79
6	5358.00	40.8 AV	54.0	-13.2	1.43 H	305	30.01	10.79
7	#10400.00	55.4 PK	74.0	-18.6	1.34 H	35	38.49	16.91
8	#10400.00	40.8 AV	54.0	-13.2	1.34 H	35	23.89	16.91
9	15600.00	53.8 PK	74.0	-20.2	1.47 H	216	32.06	21.74
10	15600.00	39.8 AV	54.0	-14.2	1.47 H	216	18.06	21.74

**ANTENNA POLARITY & TEST DISTANCE: VERTICAL AT 3 M**

NO.	FREQ. (MHz)	EMISSION LEVEL (dBuV/m)	LIMIT (dBuV/m)	MARGIN (dB)	ANTENNA HEIGHT (m)	TABLE ANGLE (Degree)	RAW VALUE (dBuV)	CORRECTION FACTOR (dB/m)
1	5019.00	57.0 PK	74.0	-17.0	1.92 V	187	47.34	9.66
2	5019.00	44.9 AV	54.0	-9.1	1.92 V	187	35.24	9.66
3	*5200.00	109.1 PK			2.06 V	6	98.70	10.40
4	*5200.00	99.2 AV			2.06 V	6	88.80	10.40
5	5358.00	59.3 PK	74.0	-14.7	1.84 V	223	48.51	10.79
6	5358.00	48.4 AV	54.0	-5.6	1.84 V	223	37.61	10.79
7	#10400.00	54.2 PK	74.0	-19.8	1.56 V	347	37.29	16.91
8	#10400.00	40.6 AV	54.0	-13.4	1.56 V	347	23.69	16.91
9	15600.00	55.1 PK	74.0	-18.9	1.58 V	202	33.36	21.74
10	15600.00	40.3 AV	54.0	-13.7	1.58 V	202	18.56	21.74

**REMARKS:**

1. Emission Level(dBuV/m) = Raw Value(dBuV) + Correction Factor(dB/m)
2. Correction Factor(dB/m) = Antenna Factor(dB/m) + Cable Factor(dB) – Pre-Amplifier Factor(dB)
3. The other emission levels were very low against the limit.
4. Margin value = Emission Level – Limit value
5. " \* ": Fundamental frequency.
6. " # ": The radiated frequency is out of the restricted band.

<b>CHANNEL</b>	TX Channel 48	<b>DETECTOR FUNCTION</b>	Peak (PK)
<b>FREQUENCY RANGE</b>	1GHz ~ 40GHz		Average (AV)

**ANTENNA POLARITY & TEST DISTANCE: HORIZONTAL AT 3 M**

NO.	FREQ. (MHz)	EMISSION LEVEL (dBuV/m)	LIMIT (dBuV/m)	MARGIN (dB)	ANTENNA HEIGHT (m)	TABLE ANGLE (Degree)	RAW VALUE (dBuV)	CORRECTION FACTOR (dB/m)
1	5078.00	55.5 PK	74.0	-18.5	1.36 H	320	45.69	9.81
2	5078.00	40.1 AV	54.0	-13.9	1.36 H	320	30.29	9.81
3	*5240.00	100.8 PK			1.36 H	320	90.31	10.49
4	*5240.00	90.7 AV			1.36 H	320	80.21	10.49
5	5402.00	55.8 PK	74.0	-18.2	1.36 H	320	44.88	10.92
6	5402.00	40.5 AV	54.0	-13.5	1.36 H	320	29.58	10.92
7	#10480.00	55.2 PK	74.0	-18.8	1.42 H	7	38.71	16.49
8	#10480.00	40.7 AV	54.0	-13.3	1.42 H	7	24.21	16.49
9	15720.00	54.2 PK	74.0	-19.8	1.43 H	225	32.04	22.16
10	15720.00	40.2 AV	54.0	-13.8	1.43 H	225	18.04	22.16

**ANTENNA POLARITY & TEST DISTANCE: VERTICAL AT 3 M**

NO.	FREQ. (MHz)	EMISSION LEVEL (dBuV/m)	LIMIT (dBuV/m)	MARGIN (dB)	ANTENNA HEIGHT (m)	TABLE ANGLE (Degree)	RAW VALUE (dBuV)	CORRECTION FACTOR (dB/m)
1	5078.00	57.7 PK	74.0	-16.3	2.06 V	357	47.89	9.81
2	5078.00	47.2 AV	54.0	-6.8	2.06 V	357	37.39	9.81
3	*5240.00	108.8 PK			2.11 V	26	98.31	10.49
4	*5240.00	99.0 AV			2.11 V	26	88.51	10.49
5	5402.00	61.2 PK	74.0	-12.8	2.48 V	196	50.28	10.92
6	5402.00	50.9 AV	54.0	-3.1	2.48 V	196	39.98	10.92
7	#10480.00	53.7 PK	74.0	-20.3	1.54 V	343	37.21	16.49
8	#10480.00	40.2 AV	54.0	-13.8	1.54 V	343	23.71	16.49
9	15720.00	54.4 PK	74.0	-19.6	1.57 V	224	32.24	22.16
10	15720.00	40.0 AV	54.0	-14.0	1.57 V	224	17.84	22.16

**REMARKS:**

1. Emission Level(dBuV/m) = Raw Value(dBuV) + Correction Factor(dB/m)
2. Correction Factor(dB/m) = Antenna Factor(dB/m) + Cable Factor(dB) – Pre-Amplifier Factor(dB)
3. The other emission levels were very low against the limit.
4. Margin value = Emission Level – Limit value
5. " \* ": Fundamental frequency.
6. " # ": The radiated frequency is out of the restricted band.

**Beamforming Mode**
**802.11ac (VHT20)**

<b>CHANNEL</b>	TX Channel 149	<b>DETECTOR FUNCTION</b>	Peak (PK)
<b>FREQUENCY RANGE</b>	1GHz ~ 40GHz		Average (AV)

**ANTENNA POLARITY & TEST DISTANCE: HORIZONTAL AT 3 M**

NO.	FREQ. (MHz)	EMISSION LEVEL (dBuV/m)	LIMIT (dBuV/m)	MARGIN (dB)	ANTENNA HEIGHT (m)	TABLE ANGLE (Degree)	RAW VALUE (dBuV)	CORRECTION FACTOR (dB/m)
1	#5715.00	55.7 PK	74.0	-18.3	1.45 H	298	44.24	11.46
2	#5715.00	40.3 AV	54.0	-13.7	1.45 H	298	28.84	11.46
3	#5725.00	67.0 PK	78.2	-11.2	1.45 H	298	55.51	11.49
4	*5745.00	103.7 PK			1.45 H	298	92.15	11.55
5	*5745.00	92.7 AV			1.45 H	298	81.15	11.55
6	#5906.00	56.3 PK	74.0	-17.7	1.45 H	298	44.53	11.77
7	#5906.00	40.7 AV	54.0	-13.3	1.45 H	298	28.93	11.77
8	11490.00	55.6 PK	74.0	-18.4	1.41 H	36	38.36	17.24
9	11490.00	41.2 AV	54.0	-12.8	1.41 H	36	23.96	17.24
10	#17235.00	54.1 PK	74.0	-19.9	1.43 H	210	27.55	26.55
11	#17235.00	39.9 AV	54.0	-14.1	1.43 H	210	13.35	26.55

**ANTENNA POLARITY & TEST DISTANCE: VERTICAL AT 3 M**

NO.	FREQ. (MHz)	EMISSION LEVEL (dBuV/m)	LIMIT (dBuV/m)	MARGIN (dB)	ANTENNA HEIGHT (m)	TABLE ANGLE (Degree)	RAW VALUE (dBuV)	CORRECTION FACTOR (dB/m)
1	#5715.00	55.0 PK	74.0	-19.0	2.12 V	360	43.54	11.46
2	#5715.00	46.8 AV	54.0	-7.2	2.12 V	360	35.34	11.46
3	#5725.00	74.6 PK	78.2	-3.6	2.11 V	187	63.11	11.49
4	*5745.00	112.0 PK			2.11 V	187	100.45	11.55
5	*5745.00	100.9 AV			2.11 V	187	89.35	11.55
6	#5906.00	55.1 PK	74.0	-18.9	2.17 V	360	43.33	11.77
7	#5906.00	47.1 AV	54.0	-6.9	2.17 V	360	35.33	11.77
8	11490.00	54.0 PK	74.0	-20.0	1.50 V	339	36.76	17.24
9	11490.00	40.9 AV	54.0	-13.1	1.50 V	339	23.66	17.24
10	#17235.00	55.1 PK	74.0	-18.9	1.47 V	213	28.55	26.55
11	#17235.00	40.2 AV	54.0	-13.8	1.47 V	213	13.65	26.55

**REMARKS:**

- Emission Level(dBuV/m) = Raw Value(dBuV) + Correction Factor(dB/m)
- Correction Factor(dB/m) = Antenna Factor(dB/m) + Cable Factor(dB) – Pre-Amplifier Factor(dB)
- The other emission levels were very low against the limit.
- Margin value = Emission Level – Limit value
- " \* ": Fundamental frequency.
- " # ": The radiated frequency is out of the restricted band.

<b>CHANNEL</b>	TX Channel 157	<b>DETECTOR FUNCTION</b>	Peak (PK)
<b>FREQUENCY RANGE</b>	1GHz ~ 40GHz		Average (AV)

**ANTENNA POLARITY & TEST DISTANCE: HORIZONTAL AT 3 M**

NO.	FREQ. (MHz)	EMISSION LEVEL (dBuV/m)	LIMIT (dBuV/m)	MARGIN (dB)	ANTENNA HEIGHT (m)	TABLE ANGLE (Degree)	RAW VALUE (dBuV)	CORRECTION FACTOR (dB/m)
1	#5706.00	56.7 PK	74.0	-17.3	1.38 H	318	45.28	11.42
2	#5706.00	43.2 AV	54.0	-10.8	1.38 H	318	31.78	11.42
3	*5785.00	107.1 PK			1.38 H	318	95.42	11.68
4	*5785.00	95.9 AV			1.38 H	318	84.22	11.68
5	#5850.00	54.5 PK	78.2	-23.7	1.38 H	318	42.77	11.73
6	#5866.00	56.3 PK	74.0	-17.7	1.38 H	318	44.57	11.73
7	#5866.00	40.8 AV	54.0	-13.2	1.38 H	318	29.07	11.73
8	11570.00	56.0 PK	74.0	-18.0	1.34 H	13	38.33	17.67
9	11570.00	41.5 AV	54.0	-12.5	1.34 H	13	23.83	17.67
10	#17355.00	54.5 PK	74.0	-19.5	1.48 H	214	27.77	26.73
11	#17355.00	40.6 AV	54.0	-13.4	1.48 H	214	13.87	26.73

**ANTENNA POLARITY & TEST DISTANCE: VERTICAL AT 3 M**

NO.	FREQ. (MHz)	EMISSION LEVEL (dBuV/m)	LIMIT (dBuV/m)	MARGIN (dB)	ANTENNA HEIGHT (m)	TABLE ANGLE (Degree)	RAW VALUE (dBuV)	CORRECTION FACTOR (dB/m)
1	#5706.00	64.6 PK	74.0	-9.4	2.23 V	196	53.18	11.42
2	#5706.00	51.0 AV	54.0	-3.0	2.23 V	196	39.58	11.42
3	*5785.00	115.3 PK			2.14 V	180	103.62	11.68
4	*5785.00	104.2 AV			2.14 V	180	92.52	11.68
5	#5850.00	62.2 PK	78.2	-16.0	2.14 V	180	50.47	11.73
6	#5866.00	64.2 PK	74.0	-9.8	2.05 V	289	52.47	11.73
7	#5866.00	49.0 AV	54.0	-5.0	2.05 V	289	37.27	11.73
8	11570.00	53.7 PK	74.0	-20.3	1.52 V	334	36.03	17.67
9	11570.00	40.3 AV	54.0	-13.7	1.52 V	334	22.63	17.67
10	#17355.00	54.9 PK	74.0	-19.1	1.58 V	216	28.17	26.73
11	#17355.00	40.1 AV	54.0	-13.9	1.58 V	216	13.37	26.73

**REMARKS:**

1. Emission Level(dBuV/m) = Raw Value(dBuV) + Correction Factor(dB/m)
2. Correction Factor(dB/m) = Antenna Factor(dB/m) + Cable Factor(dB) – Pre-Amplifier Factor(dB)
3. The other emission levels were very low against the limit.
4. Margin value = Emission Level – Limit value
5. " \* ": Fundamental frequency.
6. " # ": The radiated frequency is out of the restricted band.

<b>CHANNEL</b>	TX Channel 165	<b>DETECTOR FUNCTION</b>	Peak (PK)
<b>FREQUENCY RANGE</b>	1GHz ~ 40GHz		Average (AV)

**ANTENNA POLARITY & TEST DISTANCE: HORIZONTAL AT 3 M**

NO.	FREQ. (MHz)	EMISSION LEVEL (dBuV/m)	LIMIT (dBuV/m)	MARGIN (dB)	ANTENNA HEIGHT (m)	TABLE ANGLE (Degree)	RAW VALUE (dBuV)	CORRECTION FACTOR (dB/m)
1	*5825.00	107.6 PK			1.38 H	317	95.86	11.74
2	*5825.00	96.3 AV			1.38 H	317	84.56	11.74
3	#5850.00	67.0 PK	78.2	-11.2	1.38 H	317	55.27	11.73
4	#5860.00	56.5 PK	74.0	-17.5	1.38 H	317	44.77	11.73
5	#5860.00	41.6 AV	54.0	-12.4	1.38 H	317	29.87	11.73
6	#5986.00	53.3 PK	74.0	-20.7	1.38 H	317	41.03	12.27
7	#5986.00	41.9 AV	54.0	-12.1	1.38 H	317	29.63	12.27
8	11650.00	55.6 PK	74.0	-18.4	1.31 H	36	37.76	17.84
9	11650.00	40.8 AV	54.0	-13.2	1.31 H	36	22.96	17.84
10	#17475.00	54.2 PK	74.0	-19.8	1.50 H	198	26.89	27.31
11	#17475.00	39.8 AV	54.0	-14.2	1.50 H	198	12.49	27.31

**ANTENNA POLARITY & TEST DISTANCE: VERTICAL AT 3 M**

NO.	FREQ. (MHz)	EMISSION LEVEL (dBuV/m)	LIMIT (dBuV/m)	MARGIN (dB)	ANTENNA HEIGHT (m)	TABLE ANGLE (Degree)	RAW VALUE (dBuV)	CORRECTION FACTOR (dB/m)
1	*5825.00	115.7 PK			2.09 V	180	103.96	11.74
2	*5825.00	104.7 AV			2.09 V	180	92.96	11.74
3	#5850.00	74.9 PK	78.2	-3.3	2.09 V	180	63.17	11.73
4	#5860.00	64.1 PK	74.0	-9.9	2.09 V	180	52.37	11.73
5	#5860.00	49.1 AV	54.0	-4.9	2.09 V	180	37.37	11.73
6	#5986.00	61.5 PK	74.0	-12.5	2.08 V	186	49.23	12.27
7	#5986.00	50.2 AV	54.0	-3.8	2.08 V	186	37.93	12.27
8	11650.00	53.8 PK	74.0	-20.2	1.52 V	349	35.96	17.84
9	11650.00	40.7 AV	54.0	-13.3	1.52 V	349	22.86	17.84
10	#17475.00	55.1 PK	74.0	-18.9	1.57 V	194	27.79	27.31
11	#17475.00	40.3 AV	54.0	-13.7	1.57 V	194	12.99	27.31

**REMARKS:**

1. Emission Level(dBuV/m) = Raw Value(dBuV) + Correction Factor(dB/m)
2. Correction Factor(dB/m) = Antenna Factor(dB/m) + Cable Factor(dB) – Pre-Amplifier Factor(dB)
3. The other emission levels were very low against the limit.
4. Margin value = Emission Level – Limit value
5. " \* ": Fundamental frequency.
6. " # ": The radiated frequency is out of the restricted band.

**CDD Mode**
**802.11ac (VHT40)**

<b>CHANNEL</b>	TX Channel 38	<b>DETECTOR FUNCTION</b>	Peak (PK)
<b>FREQUENCY RANGE</b>	1GHz ~ 40GHz		Average (AV)

**ANTENNA POLARITY & TEST DISTANCE: HORIZONTAL AT 3 M**

NO.	FREQ. (MHz)	EMISSION LEVEL (dBuV/m)	LIMIT (dBuV/m)	MARGIN (dB)	ANTENNA HEIGHT (m)	TABLE ANGLE (Degree)	RAW VALUE (dBuV)	CORRECTION FACTOR (dB/m)
1	5150.00	56.1 PK	74.0	-17.9	1.39 H	321	45.97	10.13
2	5150.00	40.7 AV	54.0	-13.3	1.39 H	321	30.57	10.13
3	*5190.00	99.8 PK			1.39 H	321	89.45	10.35
4	*5190.00	87.5 AV			1.39 H	321	77.15	10.35
5	5350.00	55.8 PK	74.0	-18.2	1.39 H	321	45.03	10.77
6	5350.00	40.4 AV	54.0	-13.6	1.39 H	321	29.63	10.77
7	#10380.00	55.5 PK	74.0	-18.5	1.38 H	27	38.69	16.81
8	#10380.00	40.9 AV	54.0	-13.1	1.38 H	27	24.09	16.81
9	15570.00	54.5 PK	74.0	-19.5	1.43 H	205	32.85	21.65
10	15570.00	40.6 AV	54.0	-13.4	1.43 H	205	18.95	21.65

**ANTENNA POLARITY & TEST DISTANCE: VERTICAL AT 3 M**

NO.	FREQ. (MHz)	EMISSION LEVEL (dBuV/m)	LIMIT (dBuV/m)	MARGIN (dB)	ANTENNA HEIGHT (m)	TABLE ANGLE (Degree)	RAW VALUE (dBuV)	CORRECTION FACTOR (dB/m)
1	5150.00	69.8 PK	74.0	-4.2	1.50 V	360	59.67	10.13
2	5150.00	49.7 AV	54.0	-4.3	1.50 V	360	39.57	10.13
3	*5190.00	107.4 PK			1.50 V	360	97.05	10.35
4	*5190.00	95.3 AV			1.50 V	360	84.95	10.35
5	5350.00	55.1 PK	74.0	-18.9	1.50 V	360	44.33	10.77
6	5350.00	44.9 AV	54.0	-9.1	1.50 V	360	34.13	10.77
7	#10380.00	53.5 PK	74.0	-20.5	1.53 V	325	36.69	16.81
8	#10380.00	40.5 AV	54.0	-13.5	1.53 V	325	23.69	16.81
9	15570.00	55.5 PK	74.0	-18.5	1.47 V	222	33.85	21.65
10	15570.00	40.5 AV	54.0	-13.5	1.47 V	222	18.85	21.65

**REMARKS:**

1. Emission Level(dBuV/m) = Raw Value(dBuV) + Correction Factor(dB/m)
2. Correction Factor(dB/m) = Antenna Factor(dB/m) + Cable Factor(dB) – Pre-Amplifier Factor(dB)
3. The other emission levels were very low against the limit.
4. Margin value = Emission Level – Limit value
5. " \* ": Fundamental frequency.
6. " # ": The radiated frequency is out of the restricted band.

<b>CHANNEL</b>	TX Channel 46	<b>DETECTOR FUNCTION</b>	Peak (PK)
<b>FREQUENCY RANGE</b>	1GHz ~ 40GHz		Average (AV)

**ANTENNA POLARITY & TEST DISTANCE: HORIZONTAL AT 3 M**

NO.	FREQ. (MHz)	EMISSION LEVEL (dBuV/m)	LIMIT (dBuV/m)	MARGIN (dB)	ANTENNA HEIGHT (m)	TABLE ANGLE (Degree)	RAW VALUE (dBuV)	CORRECTION FACTOR (dB/m)
1	5150.00	55.7 PK	74.0	-18.3	1.38 H	310	45.57	10.13
2	5150.00	40.2 AV	54.0	-13.8	1.38 H	310	30.07	10.13
3	*5230.00	99.8 PK			1.38 H	310	89.33	10.47
4	*5230.00	90.5 AV			1.38 H	310	80.03	10.47
5	5350.00	55.7 PK	74.0	-18.3	1.38 H	310	44.93	10.77
6	5350.00	40.5 AV	54.0	-13.5	1.38 H	310	29.73	10.77
7	#10460.00	55.4 PK	74.0	-18.6	1.37 H	7	38.80	16.60
8	#10460.00	40.6 AV	54.0	-13.4	1.37 H	7	24.00	16.60
9	15690.00	54.3 PK	74.0	-19.7	1.46 H	203	32.24	22.06
10	15690.00	40.2 AV	54.0	-13.8	1.46 H	203	18.14	22.06

**ANTENNA POLARITY & TEST DISTANCE: VERTICAL AT 3 M**

NO.	FREQ. (MHz)	EMISSION LEVEL (dBuV/m)	LIMIT (dBuV/m)	MARGIN (dB)	ANTENNA HEIGHT (m)	TABLE ANGLE (Degree)	RAW VALUE (dBuV)	CORRECTION FACTOR (dB/m)
1	5150.00	61.8 PK	74.0	-12.2	1.54 V	360	51.67	10.13
2	5150.00	47.2 AV	54.0	-6.8	1.54 V	360	37.07	10.13
3	*5230.00	107.6 PK			1.54 V	360	97.13	10.47
4	*5230.00	98.4 AV			1.54 V	360	87.93	10.47
5	5350.00	59.5 PK	74.0	-14.5	1.54 V	360	48.73	10.77
6	5350.00	48.0 AV	54.0	-6.0	1.54 V	360	37.23	10.77
7	#10460.00	53.7 PK	74.0	-20.3	1.53 V	355	37.10	16.60
8	#10460.00	40.2 AV	54.0	-13.8	1.53 V	355	23.60	16.60
9	15690.00	55.1 PK	74.0	-18.9	1.51 V	206	33.04	22.06
10	15690.00	40.2 AV	54.0	-13.8	1.51 V	206	18.14	22.06

**REMARKS:**

1. Emission Level(dBuV/m) = Raw Value(dBuV) + Correction Factor(dB/m)
2. Correction Factor(dB/m) = Antenna Factor(dB/m) + Cable Factor(dB) – Pre-Amplifier Factor(dB)
3. The other emission levels were very low against the limit.
4. Margin value = Emission Level – Limit value
5. " \* ": Fundamental frequency.
6. " # ": The radiated frequency is out of the restricted band.

**Beamforming Mode**  
**802.11ac (VHT40)**

<b>CHANNEL</b>	TX Channel 151	<b>DETECTOR FUNCTION</b>	Peak (PK)
<b>FREQUENCY RANGE</b>	1GHz ~ 40GHz		Average (AV)

**ANTENNA POLARITY & TEST DISTANCE: HORIZONTAL AT 3 M**

NO.	FREQ. (MHz)	EMISSION LEVEL (dBuV/m)	LIMIT (dBuV/m)	MARGIN (dB)	ANTENNA HEIGHT (m)	TABLE ANGLE (Degree)	RAW VALUE (dBuV)	CORRECTION FACTOR (dB/m)
1	#5715.00	55.1 PK	74.0	-18.9	1.46 H	324	43.64	11.46
2	#5715.00	40.0 AV	54.0	-14.0	1.46 H	324	28.54	11.46
3	#5725.00	66.9 PK	78.2	-11.3	1.46 H	324	55.41	11.49
4	*5755.00	99.2 PK			1.46 H	324	87.61	11.59
5	*5755.00	88.0 AV			1.46 H	324	76.41	11.59
6	#5909.00	55.6 PK	74.0	-18.4	1.46 H	324	43.81	11.79
7	#5909.00	40.1 AV	54.0	-13.9	1.46 H	324	28.31	11.79
8	11510.00	55.7 PK	74.0	-18.3	1.38 H	29	38.45	17.25
9	11510.00	40.9 AV	54.0	-13.1	1.38 H	29	23.65	17.25
10	#17265.00	54.4 PK	74.0	-19.6	1.52 H	225	27.92	26.48
11	#17265.00	40.0 AV	54.0	-14.0	1.52 H	225	13.52	26.48

**ANTENNA POLARITY & TEST DISTANCE: VERTICAL AT 3 M**

NO.	FREQ. (MHz)	EMISSION LEVEL (dBuV/m)	LIMIT (dBuV/m)	MARGIN (dB)	ANTENNA HEIGHT (m)	TABLE ANGLE (Degree)	RAW VALUE (dBuV)	CORRECTION FACTOR (dB/m)
1	#5715.00	66.4 PK	74.0	-7.6	1.69 V	220	54.94	11.46
2	#5715.00	47.4 AV	54.0	-6.6	1.69 V	220	35.94	11.46
3	#5725.00	74.6 PK	78.2	-3.6	1.69 V	220	63.11	11.49
4	*5755.00	107.7 PK			1.69 V	220	96.11	11.59
5	*5755.00	96.3 AV			1.69 V	220	84.71	11.59
6	#5909.00	56.7 PK	74.0	-17.3	1.69 V	220	44.91	11.79
7	#5909.00	45.0 AV	54.0	-9.0	1.69 V	220	33.21	11.79
8	11510.00	53.6 PK	74.0	-20.4	1.47 V	354	36.35	17.25
9	11510.00	40.3 AV	54.0	-13.7	1.47 V	354	23.05	17.25
10	#17265.00	54.9 PK	74.0	-19.1	1.51 V	207	28.42	26.48
11	#17265.00	39.9 AV	54.0	-14.1	1.51 V	207	13.42	26.48

**REMARKS:**

1. Emission Level(dBuV/m) = Raw Value(dBuV) + Correction Factor(dB/m)
2. Correction Factor(dB/m) = Antenna Factor(dB/m) + Cable Factor(dB) – Pre-Amplifier Factor(dB)
3. The other emission levels were very low against the limit.
4. Margin value = Emission Level – Limit value
5. " \* ": Fundamental frequency.
6. " # ": The radiated frequency is out of the restricted band.



<b>CHANNEL</b>	TX Channel 159	<b>DETECTOR FUNCTION</b>	Peak (PK)
<b>FREQUENCY RANGE</b>	1GHz ~ 40GHz		Average (AV)

**ANTENNA POLARITY & TEST DISTANCE: HORIZONTAL AT 3 M**

NO.	FREQ. (MHz)	EMISSION LEVEL (dBuV/m)	LIMIT (dBuV/m)	MARGIN (dB)	ANTENNA HEIGHT (m)	TABLE ANGLE (Degree)	RAW VALUE (dBuV)	CORRECTION FACTOR (dB/m)
1	*5795.00	102.6 PK			1.35 H	323	90.88	11.72
2	*5795.00	92.4 AV			1.35 H	323	80.68	11.72
3	#5850.00	62.9 PK	78.2	-15.3	1.35 H	323	51.17	11.73
4	#5860.00	59.0 PK	74.0	-15.0	1.35 H	323	47.27	11.73
5	#5860.00	43.4 AV	54.0	-10.6	1.35 H	323	31.67	11.73
6	11590.00	56.3 PK	74.0	-17.7	1.42 H	21	38.50	17.80
7	11590.00	41.4 AV	54.0	-12.6	1.42 H	21	23.60	17.80
8	#17385.00	54.0 PK	74.0	-20.0	1.51 H	213	27.08	26.92
9	#17385.00	39.8 AV	54.0	-14.2	1.51 H	213	12.88	26.92

**ANTENNA POLARITY & TEST DISTANCE: VERTICAL AT 3 M**

NO.	FREQ. (MHz)	EMISSION LEVEL (dBuV/m)	LIMIT (dBuV/m)	MARGIN (dB)	ANTENNA HEIGHT (m)	TABLE ANGLE (Degree)	RAW VALUE (dBuV)	CORRECTION FACTOR (dB/m)
1	*5795.00	110.2 PK			1.70 V	229	98.48	11.72
2	*5795.00	100.0 AV			1.70 V	229	88.28	11.72
3	#5850.00	71.1 PK	78.2	-7.1	1.70 V	229	59.37	11.73
4	#5860.00	67.3 PK	74.0	-6.7	1.70 V	229	55.57	11.73
5	#5860.00	51.7 AV	54.0	-2.3	1.70 V	229	39.97	11.73
6	11590.00	53.9 PK	74.0	-20.1	1.51 V	336	36.10	17.80
7	11590.00	40.3 AV	54.0	-13.7	1.51 V	336	22.50	17.80
8	#17385.00	54.5 PK	74.0	-19.5	1.50 V	207	27.58	26.92
9	#17385.00	39.5 AV	54.0	-14.5	1.50 V	207	12.58	26.92

**REMARKS:**

1. Emission Level(dBuV/m) = Raw Value(dBuV) + Correction Factor(dB/m)
2. Correction Factor(dB/m) = Antenna Factor(dB/m) + Cable Factor(dB) – Pre-Amplifier Factor(dB)
3. The other emission levels were very low against the limit.
4. Margin value = Emission Level – Limit value
5. " \* ": Fundamental frequency.
6. " # ": The radiated frequency is out of the restricted band.

**CDD Mode**
**802.11ac (VHT80)**

<b>CHANNEL</b>	TX Channel 42	<b>DETECTOR FUNCTION</b>	Peak (PK)
<b>FREQUENCY RANGE</b>	1GHz ~ 40GHz		Average (AV)

**ANTENNA POLARITY & TEST DISTANCE: HORIZONTAL AT 3 M**

NO.	FREQ. (MHz)	EMISSION LEVEL (dBuV/m)	LIMIT (dBuV/m)	MARGIN (dB)	ANTENNA HEIGHT (m)	TABLE ANGLE (Degree)	RAW VALUE (dBuV)	CORRECTION FACTOR (dB/m)
1	5150.00	60.1 PK	74.0	-13.9	1.46 H	297	49.97	10.13
2	5150.00	42.8 AV	54.0	-11.2	1.46 H	297	32.67	10.13
3	*5210.00	95.5 PK			1.46 H	297	85.08	10.42
4	*5210.00	83.4 AV			1.46 H	297	72.98	10.42
5	5350.00	53.5 PK	74.0	-20.5	1.46 H	297	42.73	10.77
6	5350.00	40.3 AV	54.0	-13.7	1.46 H	297	29.53	10.77
7	#10420.00	56.0 PK	74.0	-18.0	1.38 H	13	39.19	16.81
8	#10420.00	41.3 AV	54.0	-12.7	1.38 H	13	24.49	16.81
9	15630.00	53.9 PK	74.0	-20.1	1.47 H	220	32.05	21.85
10	15630.00	39.8 AV	54.0	-14.2	1.47 H	220	17.95	21.85

**ANTENNA POLARITY & TEST DISTANCE: VERTICAL AT 3 M**

NO.	FREQ. (MHz)	EMISSION LEVEL (dBuV/m)	LIMIT (dBuV/m)	MARGIN (dB)	ANTENNA HEIGHT (m)	TABLE ANGLE (Degree)	RAW VALUE (dBuV)	CORRECTION FACTOR (dB/m)
1	5150.00	68.1 PK	74.0	-5.9	1.51 V	360	57.97	10.13
2	5150.00	50.5 AV	54.0	-3.5	1.51 V	360	40.37	10.13
3	*5210.00	103.3 PK			1.51 V	360	92.88	10.42
4	*5210.00	91.1 AV			1.51 V	360	80.68	10.42
5	5350.00	53.9 PK	74.0	-20.1	1.51 V	360	43.13	10.77
6	5350.00	40.7 AV	54.0	-13.3	1.51 V	360	29.93	10.77
7	#10420.00	53.4 PK	74.0	-20.6	1.55 V	329	36.59	16.81
8	#10420.00	40.1 AV	54.0	-13.9	1.55 V	329	23.29	16.81
9	15630.00	54.1 PK	74.0	-19.9	1.55 V	218	32.25	21.85
10	15630.00	39.6 AV	54.0	-14.4	1.55 V	218	17.75	21.85

**REMARKS:**

1. Emission Level(dBuV/m) = Raw Value(dBuV) + Correction Factor(dB/m)
2. Correction Factor(dB/m) = Antenna Factor(dB/m) + Cable Factor(dB) – Pre-Amplifier Factor(dB)
3. The other emission levels were very low against the limit.
4. Margin value = Emission Level – Limit value
5. " \* ": Fundamental frequency.
6. " # ": The radiated frequency is out of the restricted band.

**Beamforming Mode**  
**802.11ac (VHT80)**

<b>CHANNEL</b>	TX Channel 155	<b>DETECTOR FUNCTION</b>	Peak (PK)
<b>FREQUENCY RANGE</b>	1GHz ~ 40GHz		Average (AV)

**ANTENNA POLARITY & TEST DISTANCE: HORIZONTAL AT 3 M**

NO.	FREQ. (MHz)	EMISSION LEVEL (dBuV/m)	LIMIT (dBuV/m)	MARGIN (dB)	ANTENNA HEIGHT (m)	TABLE ANGLE (Degree)	RAW VALUE (dBuV)	CORRECTION FACTOR (dB/m)
1	#5715.00	60.8 PK	74.0	-13.2	1.37 H	310	49.34	11.46
2	#5715.00	44.0 AV	54.0	-10.0	1.37 H	310	32.54	11.46
3	#5725.00	63.7 PK	78.2	-14.5	1.37 H	310	52.21	11.49
4	*5775.00	97.6 PK			1.37 H	310	85.94	11.66
5	*5775.00	85.6 AV			1.37 H	310	73.94	11.66
6	#5850.00	60.2 PK	78.2	-18.0	1.37 H	310	48.47	11.73
7	#5860.00	54.0 PK	74.0	-20.0	1.37 H	310	42.27	11.73
8	#5860.00	41.0 AV	54.0	-13.0	1.37 H	310	29.27	11.73
9	11550.00	56.0 PK	74.0	-18.0	1.40 H	7	38.47	17.53
10	11550.00	41.5 AV	54.0	-12.5	1.40 H	7	23.97	17.53
11	#17325.00	54.6 PK	74.0	-19.4	1.45 H	212	28.06	26.54
12	#17325.00	40.3 AV	54.0	-13.7	1.45 H	212	13.76	26.54

**ANTENNA POLARITY & TEST DISTANCE: VERTICAL AT 3 M**

NO.	FREQ. (MHz)	EMISSION LEVEL (dBuV/m)	LIMIT (dBuV/m)	MARGIN (dB)	ANTENNA HEIGHT (m)	TABLE ANGLE (Degree)	RAW VALUE (dBuV)	CORRECTION FACTOR (dB/m)
1	#5715.00	68.3 PK	74.0	-5.7	1.99 V	238	56.84	11.46
2	#5715.00	51.8 AV	54.0	-2.2	1.99 V	238	40.34	11.46
3	#5725.00	71.8 PK	78.2	-6.4	1.99 V	238	60.31	11.49
4	*5775.00	105.3 PK			1.99 V	238	93.64	11.66
5	*5775.00	93.3 AV			1.99 V	238	81.64	11.66
6	#5850.00	68.3 PK	78.2	-9.9	1.99 V	238	56.57	11.73
7	#5860.00	64.2 PK	74.0	-9.8	1.99 V	238	52.47	11.73
8	#5860.00	46.5 AV	54.0	-7.5	1.99 V	238	34.77	11.73
9	11550.00	54.0 PK	74.0	-20.0	1.49 V	346	36.47	17.53
10	11550.00	40.7 AV	54.0	-13.3	1.49 V	346	23.17	17.53
11	#17325.00	54.6 PK	74.0	-19.4	1.58 V	195	28.06	26.54
12	#17325.00	40.1 AV	54.0	-13.9	1.58 V	195	13.56	26.54

**REMARKS:**

1. Emission Level(dBuV/m) = Raw Value(dBuV) + Correction Factor(dB/m)
2. Correction Factor(dB/m) = Antenna Factor(dB/m) + Cable Factor(dB) – Pre-Amplifier Factor(dB)
3. The other emission levels were very low against the limit.
4. Margin value = Emission Level – Limit value
5. " \* ": Fundamental frequency.
6. " # ": The radiated frequency is out of the restricted band.

**Below 1GHz Data:**

**CDD Mode**

**802.11a**

<b>CHANNEL</b>	TX Channel 165	<b>DETECTOR FUNCTION</b>	Quasi-Peak (QP)
<b>FREQUENCY RANGE</b>	Below 1GHz		

**ANTENNA POLARITY & TEST DISTANCE: HORIZONTAL AT 3 M**

NO.	FREQ. (MHz)	EMISSION LEVEL (dBuV/m)	LIMIT (dBuV/m)	MARGIN (dB)	ANTENNA HEIGHT (m)	TABLE ANGLE (Degree)	RAW VALUE (dBuV)	CORRECTION FACTOR (dB/m)
1	50.42	23.4 QP	40.0	-16.7	1.00 H	262	36.48	-13.13
2	106.73	25.3 QP	43.5	-18.2	1.20 H	81	41.62	-16.33
3	166.29	28.9 QP	43.5	-14.7	1.20 H	92	42.18	-13.33
4	231.71	20.6 QP	46.0	-25.4	1.20 H	282	35.92	-15.33
5	325.27	28.4 QP	46.0	-17.6	1.20 H	331	39.60	-11.18
6	806.82	33.2 QP	46.0	-12.8	1.00 H	17	33.73	-0.50

**ANTENNA POLARITY & TEST DISTANCE: VERTICAL AT 3 M**

NO.	FREQ. (MHz)	EMISSION LEVEL (dBuV/m)	LIMIT (dBuV/m)	MARGIN (dB)	ANTENNA HEIGHT (m)	TABLE ANGLE (Degree)	RAW VALUE (dBuV)	CORRECTION FACTOR (dB/m)
1	47.80	36.0 QP	40.0	-4.0	1.00 V	163	49.05	-13.04
2	108.81	25.9 QP	43.5	-17.6	1.35 V	355	41.93	-16.07
3	165.99	27.6 QP	43.5	-15.9	1.20 V	267	40.92	-13.32
4	325.27	23.3 QP	46.0	-22.7	1.35 V	275	34.48	-11.18
5	594.01	25.1 QP	46.0	-20.9	1.35 V	307	29.59	-4.51
6	709.29	26.8 QP	46.0	-19.2	1.35 V	351	29.42	-2.65

**REMARKS:**

1. Emission Level(dBuV/m) = Raw Value(dBuV) + Correction Factor(dB/m)
2. Correction Factor(dB/m) = Antenna Factor(dB/m) + Cable Factor(dB) – Pre-Amplifier Factor(dB)
3. The other emission levels were very low against the limit.
4. Margin value = Emission Level – Limit value

## 4.2 Conducted Emission Measurement

### 4.2.1 Limits of Conducted Emission Measurement

Frequency (MHz)	Conducted Limit (dBuV)	
	Quasi-peak	Average
0.15 - 0.5	66 - 56	56 - 46
0.50 - 5.0	56	46
5.0 - 30.0	60	50

Note: 1. The lower limit shall apply at the transition frequencies.

2. The limit decreases in line with the logarithm of the frequency in the range of 0.15 to 0.50MHz.

### 4.2.2 Test Instruments

DESCRIPTION & MANUFACTURER	MODEL NO.	SERIAL NO.	CALIBRATED DATE	CALIBRATED UNTIL
Test Receiver R&S	ESCS 30	100287	Apr. 17, 2015	Apr. 16, 2016
Line-Impedance Stabilization Network (for EUT) SCHWARZBECK	NSLK-8127	8127-523	Sep. 29, 2014	Sep. 28, 2015
RF Cable	5D-FB	COACAB-001	May 25, 2015	May 24, 2016
50 ohms Terminator	50	3	Oct. 17, 2014	Oct. 16, 2015
50 ohms Terminator	N/A	EMC-04	Oct. 21, 2014	Oct. 20, 2015
Software BVADT	BVADT_Cond_ V7.3.7.3	NA	NA	NA
Line-Impedance Stabilization Network (for Peripheral) R&S	ENV216	100071	Nov. 10, 2014	Nov. 09, 2015

**Note:**

1. The calibration interval of the above test instruments are 12 months and the calibrations are traceable to NML/ROC and NIST/USA.
2. The test was performed in Shielded Room No. A.
3. The VCCI Con A Registration No. is C-817.
4. Tested Date: Aug. 06, 2015

#### 4.2.3 Test Procedure

- The EUT was placed 0.4 meters from the conducting wall of the shielded room with EUT being connected to the power mains through a line impedance stabilization network (LISN). Other support units were connected to the power mains through another LISN. The two LISNs provide 50 ohm/ 50uH of coupling impedance for the measuring instrument.
- Both lines of the power mains connected to the EUT were checked for maximum conducted interference.
- The frequency range from 150kHz to 30MHz was searched. Emission levels under (Limit - 20dB) was not recorded.

**NOTE:** All modes of operation were investigated and the worst-case emissions are reported.

#### 4.2.4 Deviation from Test Standard

No deviation.

#### 4.2.5 Test Setup

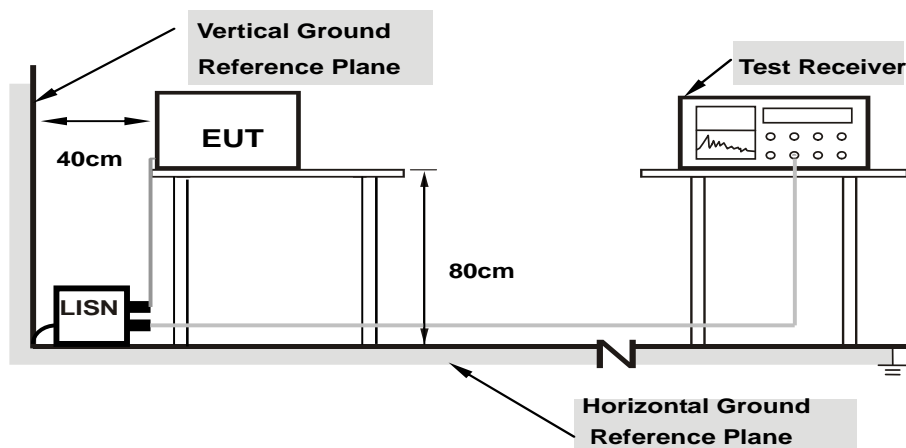

**Note: 1.Support units were connected to second LISN.**

For the actual test configuration, please refer to the attached file (Test Setup Photo).

#### 4.2.6 EUT Operating Condition

Same as 4.1.6.

4.2.7 Test Results (Mode 1)

Phase	Line (L)	Detector Function	Quasi-Peak (QP) / Average (AV)
-------	----------	-------------------	--------------------------------

No	Freq. [MHz]	Corr.	Reading Value		Emission Level		Limit		Margin	
		Factor	[dB (uV)]		[dB (uV)]		[dB (uV)]		(dB)	
	(dB)	Q.P.	AV.	Q.P.	AV.	Q.P.	AV.	Q.P.	AV.	
1	0.15781	0.10	45.62	26.78	45.72	26.88	65.58	55.58	-19.86	-28.70
2	0.20078	0.10	41.96	30.28	42.06	30.38	63.58	53.58	-21.52	-23.20
3	0.22812	0.11	37.76	22.88	37.87	22.99	62.52	52.52	-24.65	-29.53
4	0.26719	0.12	34.16	22.34	34.28	22.46	61.20	51.20	-26.92	-28.74
5	0.35313	0.15	27.60	10.28	27.75	10.43	58.89	48.89	-31.14	-38.46
6	4.64844	0.36	28.88	23.04	29.24	23.40	56.00	46.00	-26.76	-22.60

**REMARKS:**

1. Q.P. and AV. are abbreviations of quasi-peak and average individually.
2. The emission levels of other frequencies were very low against the limit.
3. Margin value = Emission level - Limit value
4. Correction factor = Insertion loss + Cable loss
5. Emission Level = Correction Factor + Reading Value.

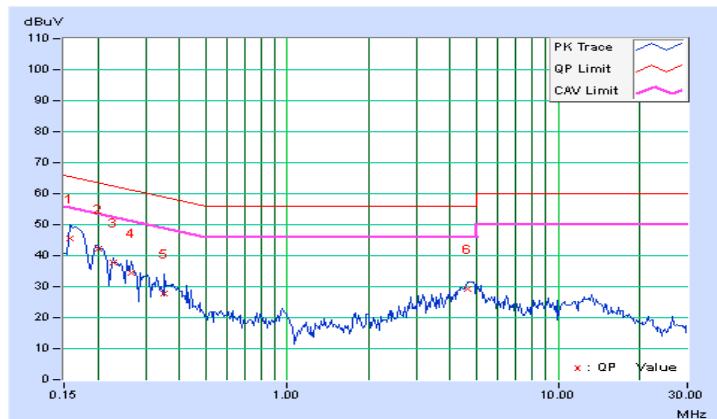

Phase	Neutral (N)	Detector Function	Quasi-Peak (QP) / Average (AV)
-------	-------------	-------------------	--------------------------------

No	Freq. [MHz]	Corr.	Reading Value		Emission Level		Limit		Margin	
		Factor	[dB (uV)]		[dB (uV)]		[dB (uV)]		(dB)	
		(dB)	Q.P.	AV.	Q.P.	AV.	Q.P.	AV.	Q.P.	AV.
1	0.16562	0.09	48.16	37.52	48.25	37.61	65.18	55.18	-16.93	-17.57
2	0.20078	0.10	42.24	30.70	42.34	30.80	63.58	53.58	-21.24	-22.78
3	0.23203	0.11	37.64	25.24	37.75	25.35	62.38	52.38	-24.63	-27.03
4	0.26328	0.12	34.90	23.96	35.02	24.08	61.33	51.33	-26.31	-27.25
5	0.39219	0.15	31.44	22.84	31.59	22.99	58.02	48.02	-26.43	-25.03
6	4.86719	0.34	28.62	22.62	28.96	22.96	56.00	46.00	-27.04	-23.04

**REMARKS:**

1. Q.P. and AV. are abbreviations of quasi-peak and average individually.
2. The emission levels of other frequencies were very low against the limit.
3. Margin value = Emission level - Limit value
4. Correction factor = Insertion loss + Cable loss
5. Emission Level = Correction Factor + Reading Value.

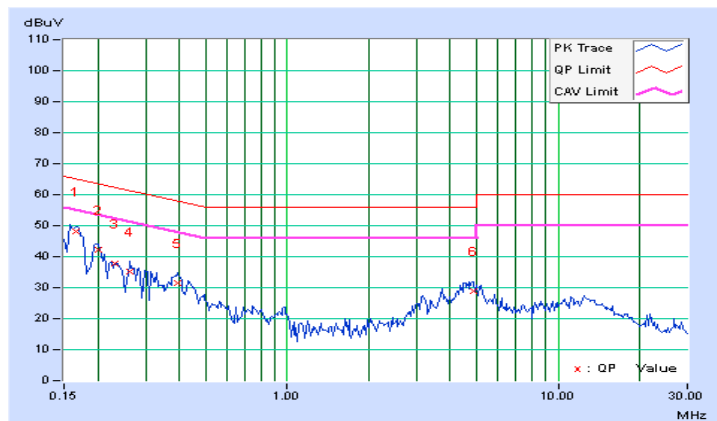



4.2.8 Test Results (Mode 3)

Phase	Line (L)	Detector Function	Quasi-Peak (QP) / Average (AV)
-------	----------	-------------------	--------------------------------

No	Freq. [MHz]	Corr.	Reading Value		Emission Level		Limit		Margin	
		Factor	[dB (uV)]		[dB (uV)]		[dB (uV)]		(dB)	
	(dB)	Q.P.	AV.	Q.P.	AV.	Q.P.	AV.	Q.P.	AV.	
1	0.16562	0.10	46.74	37.66	46.84	37.76	65.18	55.18	-18.34	-17.42
2	0.17344	0.10	45.30	33.76	45.40	33.86	64.79	54.79	-19.40	-20.94
3	0.20859	0.10	44.14	36.92	44.24	37.02	63.26	53.26	-19.02	-16.24
4	0.27500	0.12	40.88	30.52	41.00	30.64	60.97	50.97	-19.96	-20.32
<b>5</b>	<b>0.30234</b>	<b>0.13</b>	<b>46.82</b>	<b>44.08</b>	<b>46.95</b>	<b>44.21</b>	<b>60.18</b>	<b>50.18</b>	<b>-13.23</b>	<b>-5.97</b>
6	4.63281	0.36	26.54	20.72	26.90	21.08	56.00	46.00	-29.10	-24.92

**REMARKS:**

1. Q.P. and AV. are abbreviations of quasi-peak and average individually.
2. The emission levels of other frequencies were very low against the limit.
3. Margin value = Emission level - Limit value
4. Correction factor = Insertion loss + Cable loss
5. Emission Level = Correction Factor + Reading Value.

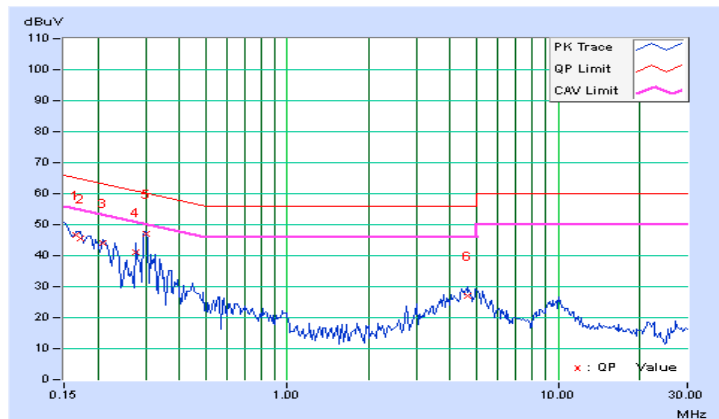

Phase	Neutral (N)	Detector Function	Quasi-Peak (QP) / Average (AV)
-------	-------------	-------------------	--------------------------------

No	Freq. [MHz]	Corr.	Reading Value		Emission Level		Limit		Margin	
		Factor	[dB (uV)]		[dB (uV)]		[dB (uV)]		(dB)	
		(dB)	Q.P.	AV.	Q.P.	AV.	Q.P.	AV.	Q.P.	AV.
1	0.15391	0.09	46.90	35.72	46.99	35.81	65.79	55.79	-18.80	-19.98
2	0.16953	0.09	45.40	36.14	45.49	36.23	64.98	54.98	-19.49	-18.75
3	0.19687	0.10	42.56	31.32	42.66	31.42	63.74	53.74	-21.08	-22.32
4	0.21641	0.10	43.92	35.52	44.02	35.62	62.96	52.96	-18.93	-17.33
5	0.30234	0.13	44.52	41.50	44.65	41.63	60.18	50.18	-15.53	-8.55
6	4.80859	0.34	26.56	20.48	26.90	20.82	56.00	46.00	-29.10	-25.18

**REMARKS:**

1. Q.P. and AV. are abbreviations of quasi-peak and average individually.
2. The emission levels of other frequencies were very low against the limit.
3. Margin value = Emission level - Limit value
4. Correction factor = Insertion loss + Cable loss
5. Emission Level = Correction Factor + Reading Value.

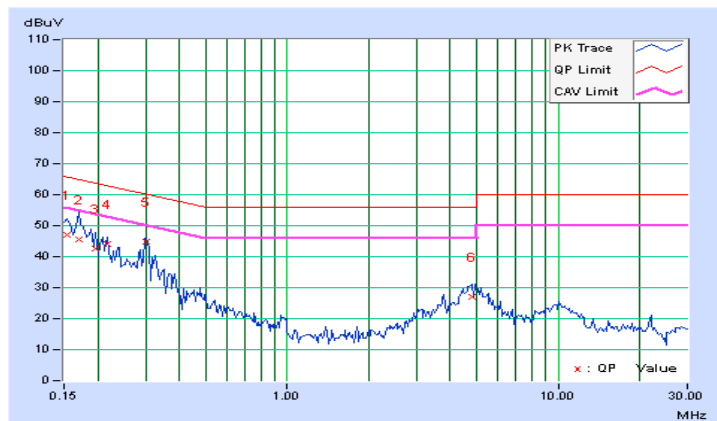

4.2.9 Test Results (Mode 4)

Phase	Line (L)	Detector Function	Quasi-Peak (QP) / Average (AV)
-------	----------	-------------------	--------------------------------

No	Freq. [MHz]	Corr.	Reading Value		Emission Level		Limit		Margin	
		Factor	[dB (uV)]		[dB (uV)]		[dB (uV)]		(dB)	
	(dB)	Q.P.	AV.	Q.P.	AV.	Q.P.	AV.	Q.P.	AV.	
1	0.15000	0.10	49.00	41.28	49.10	41.38	66.00	56.00	-16.90	-14.62
2	0.18906	0.10	43.16	36.10	43.26	36.20	64.08	54.08	-20.82	-17.88
3	0.22422	0.11	39.06	30.10	39.17	30.21	62.66	52.66	-23.49	-22.45
4	0.40781	0.16	39.96	30.60	40.12	30.76	57.69	47.69	-17.57	-16.93
5	6.38672	0.42	36.38	30.62	36.80	31.04	60.00	50.00	-23.20	-18.96
6	26.83203	0.88	38.78	35.80	39.66	36.68	60.00	50.00	-20.34	-13.32

**REMARKS:**

1. Q.P. and AV. are abbreviations of quasi-peak and average individually.
2. The emission levels of other frequencies were very low against the limit.
3. Margin value = Emission level - Limit value
4. Correction factor = Insertion loss + Cable loss
5. Emission Level = Correction Factor + Reading Value.

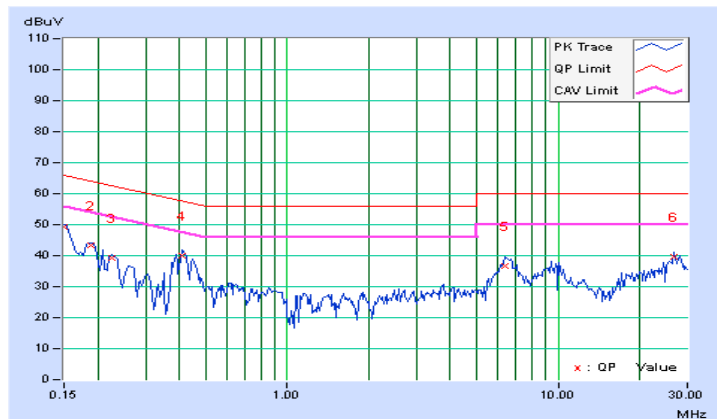

Phase	Neutral (N)	Detector Function	Quasi-Peak (QP) / Average (AV)
-------	-------------	-------------------	--------------------------------

No	Freq. [MHz]	Corr.	Reading Value		Emission Level		Limit		Margin	
		Factor	[dB (uV)]		[dB (uV)]		[dB (uV)]		(dB)	
		(dB)	Q.P.	AV.	Q.P.	AV.	Q.P.	AV.	Q.P.	AV.
1	0.15000	0.08	49.04	40.70	49.12	40.78	66.00	56.00	-16.88	-15.22
2	0.16953	0.09	39.26	15.92	39.35	16.01	64.98	54.98	-25.63	-38.97
3	0.18906	0.10	42.90	35.54	43.00	35.64	64.08	54.08	-21.08	-18.44
4	0.22422	0.11	38.84	29.66	38.95	29.77	62.66	52.66	-23.72	-22.90
5	0.40781	0.15	38.12	28.78	38.27	28.93	57.69	47.69	-19.42	-18.76
6	6.35156	0.39	35.98	30.36	36.37	30.75	60.00	50.00	-23.63	-19.25

**REMARKS:**

1. Q.P. and AV. are abbreviations of quasi-peak and average individually.
2. The emission levels of other frequencies were very low against the limit.
3. Margin value = Emission level - Limit value
4. Correction factor = Insertion loss + Cable loss
5. Emission Level = Correction Factor + Reading Value.

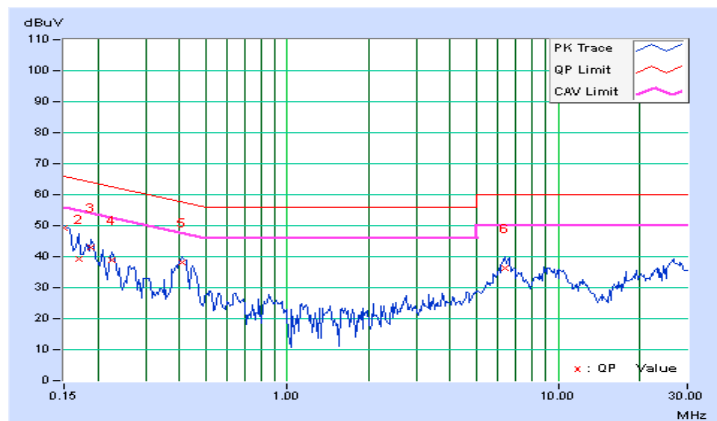

### 4.3 Transmit Power Measurement

#### 4.3.1 Limits of Transmit Power Measurement

Operation Band	EUT Category		LIMIT
U-NII-1		Outdoor Access Point	1 Watt (30 dBm) (Max. e.i.r.p $\leq$ 125mW(21 dBm) at any elevation angle above 30 degrees as measured from the horizon)
		Fixed point-to-point Access Point	1 Watt (30 dBm)
	√	Indoor Access Point	1 Watt (30 dBm)
		Mobile and Portable client device	250mW (24 dBm)
U-NII-2A			250mW (24 dBm) or 11 dBm+10 log B*
U-NII-2C			250mW (24 dBm) or 11 dBm+10 log B*
U-NII-3	√		1 Watt (30 dBm)

\*B is the 26 dB emission bandwidth in megahertz

Per KDB 662911 Method of conducted output power measurement on IEEE 802.11 devices,

Array Gain = 0 dB (i.e., no array gain) for  $N_{ANT} \leq 4$ ;

Array Gain = 0 dB (i.e., no array gain) for channel widths  $\geq 40$  MHz for any  $N_{ANT}$ ;

Array Gain =  $5 \log(N_{ANT}/N_{SS})$  dB or 3 dB, whichever is less for 20-MHz channel widths with  $N_{ANT} \geq 5$ .

For power measurements on all other devices: Array Gain =  $10 \log(N_{ANT}/N_{SS})$  dB.

#### 4.3.2 Test Setup

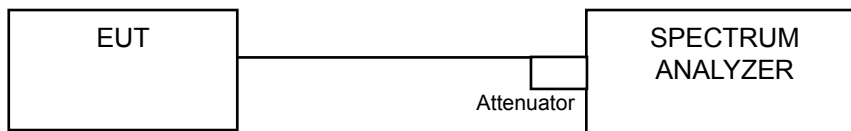

#### 4.3.3 Test Instruments

Refer to section 4.1.2 to get information of above instrument.

#### 4.3.4 Test Procedure

Method PM is used to perform output power measurement, trigger and gating function of wide band power meter is enabled to measure max output power of TX on burst. Duty factor is not added to measured value.

#### 4.3.5 Deviation from Test Standard

No deviation.

#### 4.3.6 EUT Operating Condition

The software provided by client to enable the EUT under transmission condition continuously at lowest, middle and highest channel frequencies individually.

### 4.3.7 Test Result

#### CDD Mode

#### POWER OUTPUT:

Chan.	Chan. Freq. (MHz)	Maximum Conducted Power (dBm)			Total Power (mW)	Total Power (dBm)	Limit (dBm)	Pass / Fail
		Chain 0	Chain 1	Chain 2				
<b>802.11a</b>								
36	5180	12.80	12.44	11.68	51.317	17.10	30	Pass
40	5200	12.88	12.49	11.71	51.976	17.16	30	Pass
48	5240	12.98	12.84	11.80	54.228	17.34	30	Pass
149	5745	15.48	14.94	13.92	91.167	19.60	30	Pass
157	5785	16.20	16.03	15.03	113.616	20.55	30	Pass
165	5825	18.18	17.49	17.15	173.751	22.40	30	Pass
<b>802.11ac (VHT20)</b>								
36	5180	13.00	12.56	11.69	52.74	17.22	30	Pass
40	5200	13.16	12.62	11.88	54.399	17.36	30	Pass
48	5240	13.00	12.63	12.19	54.834	17.39	30	Pass
<b>802.11ac (VHT40)</b>								
38	5190	13.27	12.73	12.00	55.831	17.47	30	Pass
46	5230	15.42	14.73	14.54	92.996	19.68	30	Pass
<b>802.11ac (VHT80)</b>								
42	5210	12.26	11.34	10.98	42.972	16.33	30	Pass

**Beamforming Mode**

Chan.	Chan. Freq. (MHz)	Maximum Conducted Power (dBm)			Total Power (mW)	Total Power (dBm)	Limit (dBm)	Pass / Fail
		Chain 0	Chain 1	Chain 2				
<b>802.11ac (VHT20)</b>								
36	5180	10.99	10.60	9.02	32.022	15.05	25.23	Pass
40	5200	10.73	10.31	8.87	30.279	14.81	25.23	Pass
48	5240	10.77	10.42	9.12	31.121	14.93	25.23	Pass
149	5745	13.47	13.24	11.97	59.059	17.71	25.23	Pass
157	5785	17.12	16.58	15.92	136.106	21.34	25.23	Pass
165	5825	17.23	16.75	16.33	143.114	21.56	25.23	Pass
<b>802.11ac (VHT40)</b>								
38	5190	12.00	11.66	11.00	43.093	16.34	25.23	Pass
46	5230	12.63	12.39	11.28	49.089	16.91	25.23	Pass
151	5755	13.40	13.06	11.74	57.036	17.56	25.23	Pass
159	5795	17.10	16.24	15.80	131.378	21.19	25.23	Pass
<b>802.11ac (VHT80)</b>								
42	5210	11.76	10.84	10.48	38.3	15.83	25.23	Pass
155	5775	13.07	12.62	11.60	53.012	17.24	25.23	Pass

Note: 1. Directional gain = 6dBi + 10log(3) = 10.77dBi > 6dBi, so the power limit shall be reduced to 30-(10.77-6) = 25.23dBm.

#### 4.4 Peak Power Spectral Density Measurement

##### 4.4.1 Limits of Peak Power Spectral Density Measurement

Operation Band	EUT Category		LIMIT
U-NII-1		Outdoor Access Point	17dBm/ MHz
		Fixed point-to-point Access Point	
	√	Indoor Access Point	
		Mobile and Portable client device	11dBm/ MHz
U-NII-2A			11dBm/ MHz
U-NII-2C			11dBm/ MHz
U-NII-3	√		30dBm/ 500kHz

##### 4.4.2 Test Setup

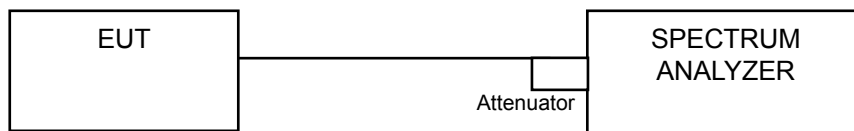

##### 4.4.3 Test Instruments

Refer to section 4.1.2 to get information of above instrument.



#### 4.4.4 Test Procedure

##### 802.11a & 802.11ac (VH20)

###### For U-NII-1 band:

###### Using method SA-1

1. Set span to encompass the entire emission bandwidth (EBW) of the signal.
2. Set RBW = 1 MHz, Set VBW  $\geq$  3 MHz, Detector = RMS
3. Sweep time = auto, trigger set to "free run".
4. Trace average at least 100 traces in power averaging mode.
5. Record the max value

###### For U-NII-3 band:

1. Set span to encompass the entire emission bandwidth (EBW) of the signal.
2. Set RBW = 300 kHz, Set VBW  $\geq$  1 MHz, Detector = RMS
3. Use the peak marker function to determine the maximum power level in any 300 kHz band segment within the fundamental EBW.
4. Scale the observed power level to an equivalent value in 500 kHz by adjusting (reducing) the measured power by a bandwidth correction factor (BWCF) where  $BWCF = 10\log(500 \text{ kHz}/300\text{kHz})$
5. Sweep time = auto, trigger set to "free run".
6. Trace average at least 100 traces in power averaging mode.
7. Record the max value

##### 802.11ac (VHT40) & 802.11ac (VHT80)

###### For U-NII-1 band:

###### Using method SA-2

1. Set span to encompass the entire emission bandwidth (EBW) of the signal.
2. Set RBW = 1 MHz, Set VBW  $\geq$  3 MHz, Detector = RMS
3. Sweep time = auto, trigger set to "free run".
4. Trace average at least 100 traces in power averaging mode.
5. Record the max value and add  $10 \log (1/\text{duty cycle})$

###### For U-NII-3 band:

1. Set span to encompass the entire emission bandwidth (EBW) of the signal.
2. Set RBW = 300 kHz, Set VBW  $\geq$  1 MHz, Detector = RMS
3. Use the peak marker function to determine the maximum power level in any 300 kHz band segment within the fundamental EBW.
4. Scale the observed power level to an equivalent value in 500 kHz by adjusting (reducing) the measured power by a bandwidth correction factor (BWCF) where  $BWCF = 10\log(500 \text{ kHz}/300\text{kHz})$
5. Sweep time = auto, trigger set to "free run".
6. Trace average at least 100 traces in power averaging mode.
7. Record the max value and add  $10 \log (1/\text{duty cycle})$

#### 4.4.5 Deviation from Test Standard

No deviation.

#### 4.4.6 EUT Operating Condition

Same as Item 4.3.6.

4.4.7 Test Results  
**For U-NII-1 Band**  
**CDD Mode**

Chan.	Chan. Freq. (MHz)	PSD (dBm)			Total Power Density (dBm)	MAX. Limit (dBm)	Pass / Fail
		Chain 0	Chain 1	Chain 2			
<b>802.11a</b>							
36	5180	-2.18	-0.97	-1.90	3.12	12.23	Pass
40	5200	-1.87	-0.69	-1.66	3.40	12.23	Pass
48	5240	-1.75	-0.49	-1.44	3.58	12.23	Pass
<b>802.11ac (VHT20)</b>							
36	5180	-2.26	-1.40	-2.09	2.87	12.23	Pass
40	5200	-1.91	-1.12	-1.70	3.21	12.23	Pass
48	5240	-1.70	-1.03	-1.41	3.40	12.23	Pass

- Note: 1. Method a) of power density measurement of KDB 662911 is using for calculating total power density. Total power density is summing entire spectra across corresponding frequency bins on the various outputs by computer.
2. Directional gain =  $6\text{dBi} + 10\log(3) = 10.77\text{dBi} > 6\text{dBi}$  , so the power density limit shall be reduced to  $17-(10.77-6) = 12.23\text{dBm}$ .

Chan.	Chan. Freq. (MHz)	PSD w/o duty factor (dBm)			Duty Factor (dB)	Total PSD with Duty Factor (dBm)	MAX. Limit (dBm)	Pass / Fail
		Chain 0	Chain 1	Chain 2				
<b>802.11ac (VHT40)</b>								
38	5190	-4.86	-3.86	-4.25	0.15	0.61	12.23	Pass
46	5230	-2.33	-1.80	-2.04	0.15	2.87	12.23	Pass
<b>802.11ac (VHT80)</b>								
42	5210	-8.55	-7.93	-8.31	0.19	-3.30	12.23	Pass

- Note: 1. Method a) of power density measurement of KDB 662911 is using for calculating total power density. Total power density is summing entire spectra across corresponding frequency bins on the various outputs by computer.
2. Directional gain =  $6\text{dBi} + 10\log(3) = 10.77\text{dBi} > 6\text{dBi}$  , so the power density limit shall be reduced to  $17-(10.77-6) = 12.23\text{dBm}$ .
3. Refer to section 3.3 for duty cycle spectrum plot.

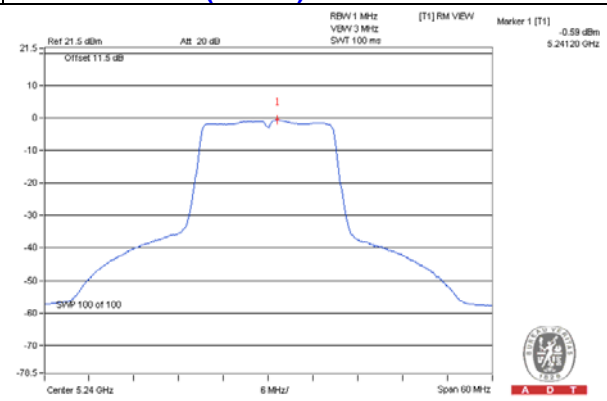
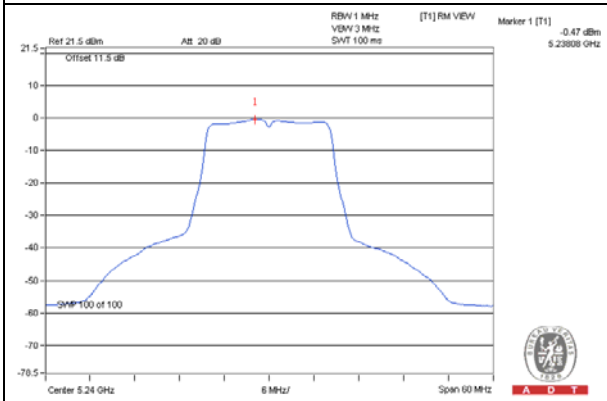
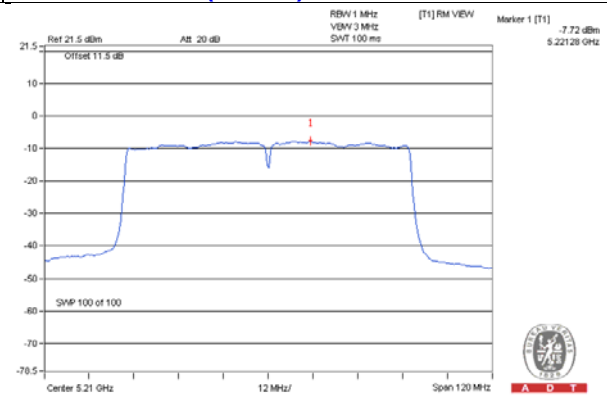
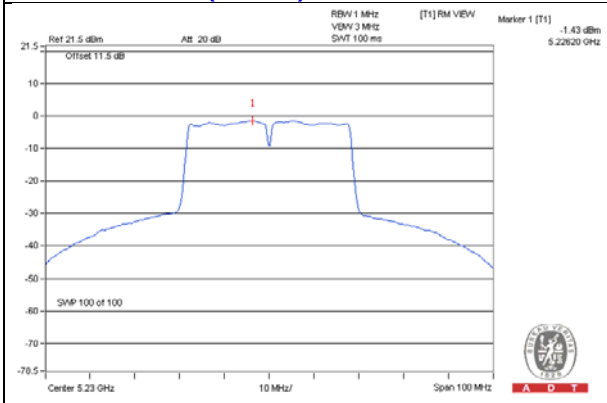
**SPECTRUM PLOT OF WORST VALUE****802.11a – Chain 1: CH 48****802.11ac (VHT20) – Chain 1: CH 48****802.11ac (VHT40) – Chain 1: CH 46****802.11ac (VHT80) – Chain 1: CH 42**

## For U-NII-3 Band

### CDD Mode

TX chain	Channel	Freq. (MHz)	PSD (dBm/300kHz)	PSD (dBm/500kHz)	10 log (N=3) dB	Total PSD (dBm/500kHz)	Limit (dBm/500kHz)	Pass /Fail
<b>802.11a</b>								
0	149	5745	-7.16	-4.94	4.77	-0.17	25.23	Pass
	157	5785	-6.19	-3.97	4.77	0.80	25.23	Pass
	165	5825	-4.04	-1.82	4.77	2.95	25.23	Pass
1	149	5745	-5.85	-3.63	4.77	1.14	25.23	Pass
	157	5785	-5.09	-2.87	4.77	1.90	25.23	Pass
	165	5825	-3.04	-0.82	4.77	3.95	25.23	Pass
2	149	5745	-6.57	-4.35	4.77	0.42	25.23	Pass
	157	5785	-5.75	-3.53	4.77	1.24	25.23	Pass
	165	5825	-3.40	-1.18	4.77	3.59	25.23	Pass

Note: 1. Directional gain =  $6\text{dBi} + 10\log(3) = 10.77\text{dBi} > 6\text{dBi}$  , so the power density limit shall be reduced to  $30 - (10.77 - 6) = 25.23\text{dBm}$ .

### SPECTRUM PLOT OF WORST VALUE

#### 802.11a – Chain 1: CH 165

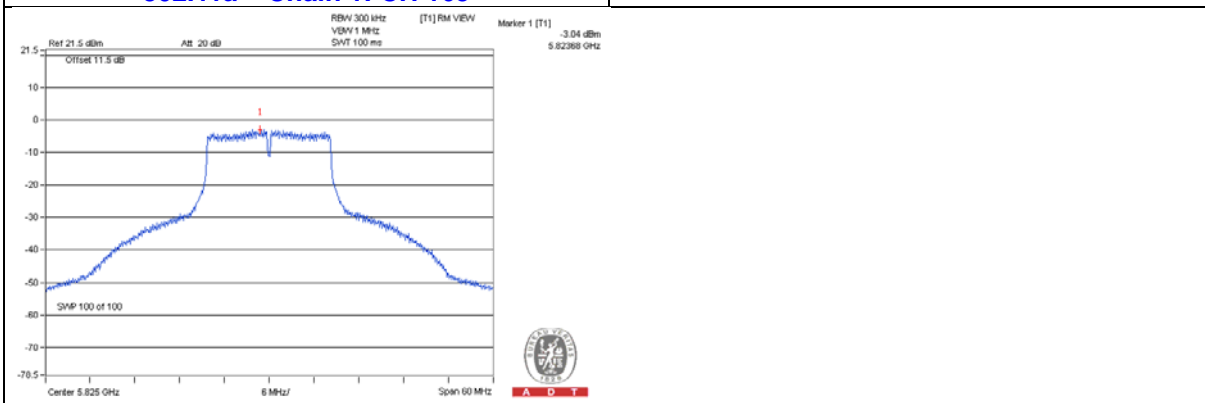

### Beamforming Mode

TX chain	Channel	Freq. (MHz)	PSD (dBm/300kHz)	PSD (dBm/500kHz)	10 log (N=3) dB	Total PSD (dBm/500kHz)	Limit (dBm/500kHz)	Pass /Fail
<b>802.11ac (VHT20)</b>								
0	149	5745	-9.05	-6.83	4.77	-2.06	25.23	Pass
	157	5785	-5.17	-2.95	4.77	1.82	25.23	Pass
	165	5825	-5.06	-2.84	4.77	1.93	25.23	Pass
1	149	5745	-8.07	-5.85	4.77	-1.08	25.23	Pass
	157	5785	-4.39	-2.17	4.77	2.60	25.23	Pass
	165	5825	-4.22	-2.00	4.77	2.77	25.23	Pass
2	149	5745	-9.25	-7.03	4.77	-2.26	25.23	Pass
	157	5785	-5.17	-2.95	4.77	1.82	25.23	Pass
	165	5825	-5.09	-2.87	4.77	1.90	25.23	Pass

TX chain	Chan.	Chan. Freq. (MHz)	PSD W/O Duty Factor		10 log (N=3) dB	Duty Factor (dB)	Total PSD With Duty Factor (dBm/500kHz)	Limit (dBm/500kHz)	Pass /Fail
			(dBm/300kHz)	(dBm/500kHz)					
<b>802.11ac (VHT40)</b>									
0	151	5755	-12.93	-10.71	4.77	0.15	-5.79	25.23	Pass
	159	5795	-7.00	-4.78	4.77	0.15	0.14	25.23	Pass
1	151	5755	-11.68	-9.46	4.77	0.15	-4.54	25.23	Pass
	159	5795	-8.11	-5.89	4.77	0.15	-0.97	25.23	Pass
2	151	5755	-12.98	-10.76	4.77	0.15	-5.84	25.23	Pass
	159	5795	-8.72	-6.50	4.77	0.15	-1.58	25.23	Pass

### 802.11ac (VHT80)

0	155	5775	-16.22	-14.00	4.77	0.19	-9.04	25.23	Pass
1	155	5775	-14.71	-12.49	4.77	0.19	-7.53	25.23	Pass
2	155	5775	-15.94	-13.72	4.77	0.19	-8.76	25.23	Pass

Note: 1. Directional gain =  $6\text{dBi} + 10\log(3) = 10.77\text{dBi} > 6\text{dBi}$  , so the power density limit shall be reduced to  $30 - (10.77 - 6) = 25.23\text{dBm}$ .

2. Refer to section 3.3 for duty cycle spectrum plot.

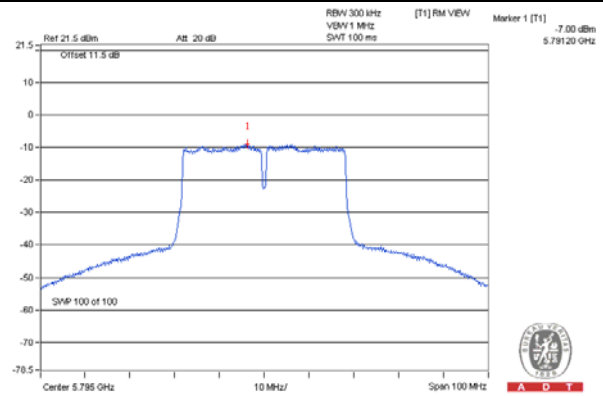
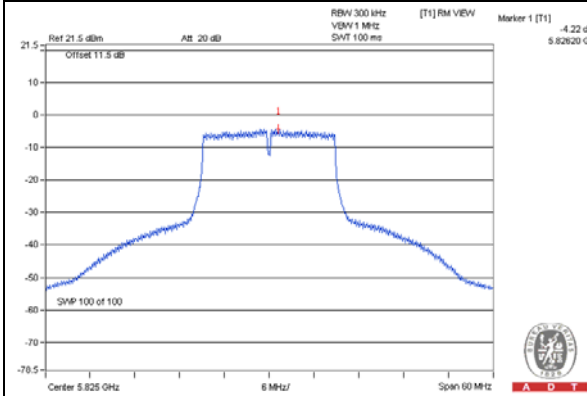
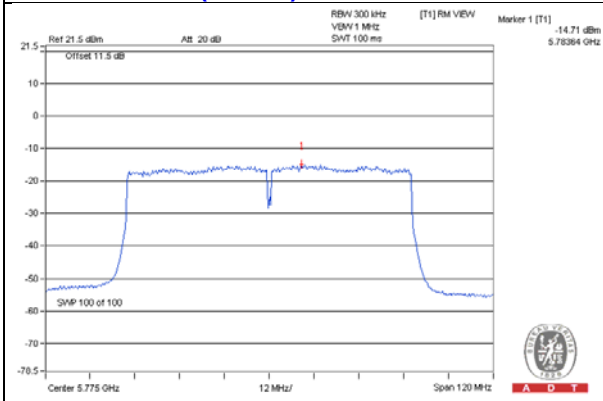
**SPECTRUM PLOT OF WORST VALUE****802.11ac (VHT20) – Chain 1: CH 165****802.11ac (VHT40) – Chain 0: CH 159****802.11ac (VHT80) – Chain 1: CH 155**

## 4.5 Frequency Stability Measurement

### 4.5.1 Limits of Frequency Stability Measurement

The frequency of the carrier signal shall be maintained within band of operation

### 4.5.2 Test Setup

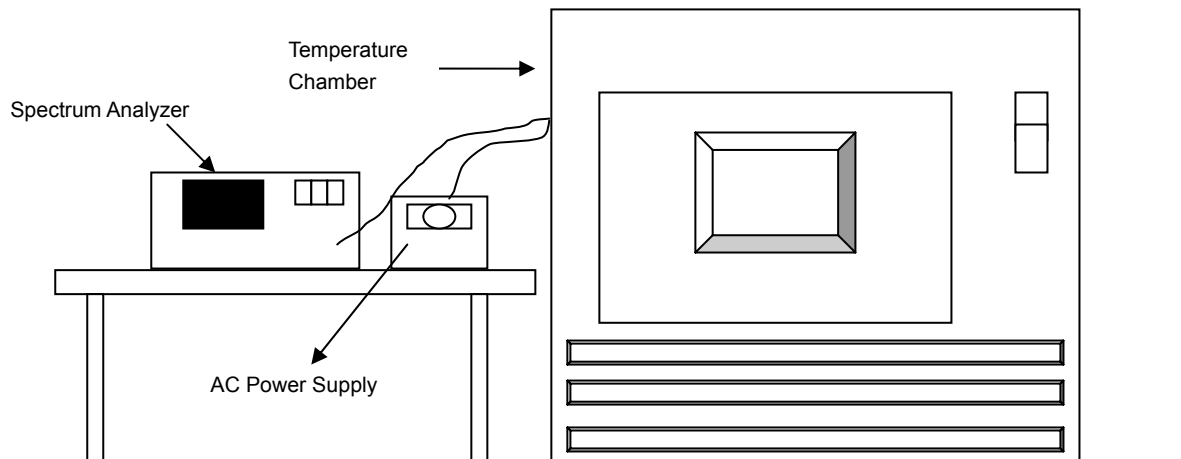

### 4.5.3 Test Instruments

Refer to section 4.1.2 to get information of above instrument.

### 4.5.4 Test Procedure

- The EUT was placed inside the environmental test chamber and powered by nominal AC voltage.
- Turn the EUT on and couple its output to a spectrum analyzer.
- Turn the EUT off and set the chamber to the highest temperature specified.
- Allow sufficient time (approximately 30 min) for the temperature of the chamber to stabilize, turn the EUT on and measure the operating frequency after 2, 5, and 10 minutes.
- Repeat step 2 and 3 with the temperature chamber set to the lowest temperature.
- The test chamber was allowed to stabilize at +20 degree C for a minimum of 30 minutes. The supply voltage was then adjusted on the EUT from 85% to 115% and the frequency record.

### 4.5.5 Deviation from Test Standard

No deviation.

### 4.5.6 EUT Operating Condition

Set the EUT transmit at un-modulation mode to test frequency stability.

4.5.7 Test Results

FREQUENCY STABILITY VERSUS TEMP.									
OPERATING FREQUENCY: 5180MHz									
TEMP. (°C)	POWER SUPPLY (Vac)	0 MINUTE		2 MINUTE		5 MINUTE		10 MINUTE	
		Measured Frequency (MHz)	Frequency Drift (%)	Measured Frequency (MHz)	Frequency Drift (%)	Measured Frequency (MHz)	Frequency Drift (%)	Measured Frequency (MHz)	Frequency Drift (%)
50	120	5180.0203	0.00039	5180.0225	0.00043	5180.0226	0.00044	5180.0215	0.00042
40	120	5179.9939	-0.00012	5179.9939	-0.00012	5179.9939	-0.00012	5179.9939	-0.00012
30	120	5179.9831	-0.00033	5179.9827	-0.00033	5179.985	-0.00029	5179.9861	-0.00027
20	120	5179.9717	-0.00055	5179.9758	-0.00047	5179.972	-0.00054	5179.976	-0.00046
10	120	5180.008	0.00015	5180.0033	0.00006	5180.0061	0.00012	5180.0039	0.00008
0	120	5180.0193	0.00037	5180.0152	0.00029	5180.0193	0.00037	5180.0163	0.00031
-10	120	5180.016	0.00031	5180.0186	0.00036	5180.0139	0.00027	5180.014	0.00027
-20	120	5180.0017	0.00003	5180.0052	0.00010	5180.0013	0.00003	5180.0054	0.00010
-30	120	5180.013	0.00025	5180.0132	0.00025	5180.0116	0.00022	5180.0125	0.00024

FREQUENCY STABILITY VERSUS VOLTAGE									
OPERATING FREQUENCY: 5180MHz									
TEMP. (°C)	POWER SUPPLY (Vac)	0 MINUTE		2 MINUTE		5 MINUTE		10 MINUTE	
		Measured Frequency (MHz)	Frequency Drift (%)	Measured Frequency (MHz)	Frequency Drift (%)	Measured Frequency (MHz)	Frequency Drift (%)	Measured Frequency (MHz)	Frequency Drift (%)
20	138	5179.9715	-0.00055	5179.976	-0.00046	5179.972	-0.00054	5179.9752	-0.00048
	120	5179.9717	-0.00055	5179.9758	-0.00047	5179.972	-0.00054	5179.976	-0.00046
	102	5179.9714	-0.00055	5179.9752	-0.00048	5179.9716	-0.00055	5179.9761	-0.00046



## 4.6 6dB Bandwidth Measurement

### 4.6.1 Limits of 6dB Bandwidth Measurement

The minimum of 6dB Bandwidth Measurement is 0.5MHz.

### 4.6.2 Test Setup

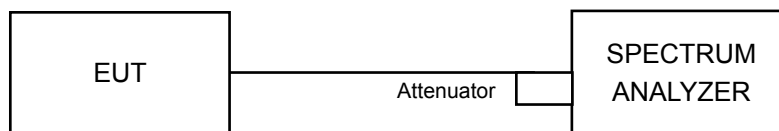

### 4.6.3 Test Instruments

Refer to section 4.1.2 to get information of above instrument.

### 4.6.4 Test Procedure

#### MEASUREMENT PROCEDURE REF

- a. Set resolution bandwidth (RBW) = 100kHz
- b. Set the video bandwidth (VBW)  $\geq 3 \times$  RBW, Detector = Peak.
- c. Trace mode = max hold.
- d. Sweep = auto couple.
- e. Measure the maximum width of the emission that is constrained by the frequencies associated with the two amplitude points (upper and lower) that are attenuated by 6 dB relative to the maximum level measured in the fundamental emission

### 4.6.5 Deviation from Test Standard

No deviation.

### 4.6.6 EUT Operating Condition

The software provided by client to enable the EUT under transmission condition continuously at lowest, middle and highest channel frequencies individually.

#### 4.6.7 Test Results

##### CDD Mode

Channel	Frequency (MHz)	6dB Bandwidth (MHz)			Minimum Limit (MHz)	Pass / Fail
		Chain 0	Chain 1	Chain 2		
<b>802.11a</b>						
149	5745	16.39	16.42	16.41	0.5	Pass
157	5785	16.40	16.38	16.40	0.5	Pass
165	5825	16.37	16.38	16.42	0.5	Pass

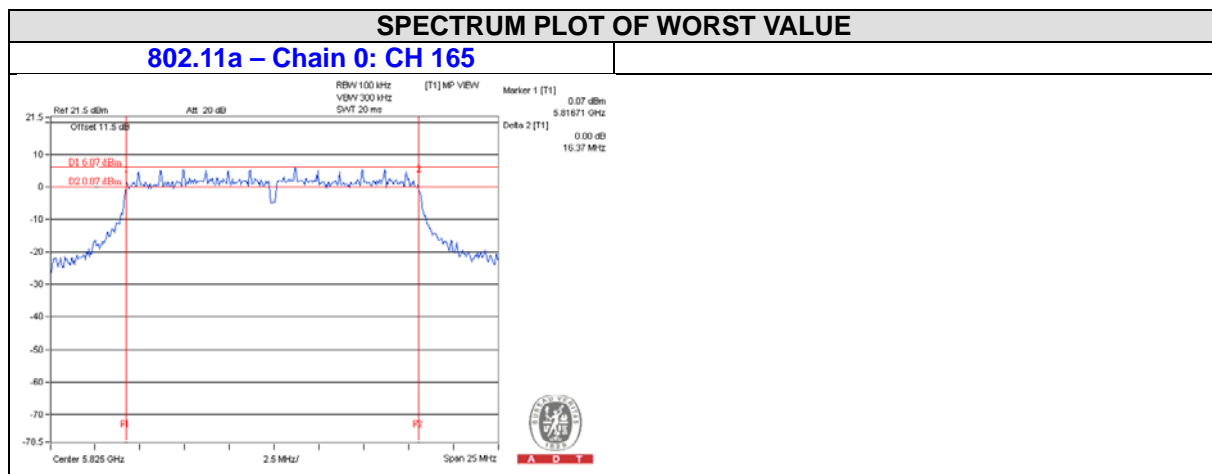

### Beamforming Mode

Channel	Frequency (MHz)	6dB Bandwidth (MHz)			Minimum Limit (MHz)	Pass / Fail
		Chain 0	Chain 1	Chain 2		
<b>802.11ac (VHT20)</b>						
149	5745	17.65	17.65	17.66	0.5	Pass
157	5785	17.63	17.65	17.63	0.5	Pass
165	5825	17.62	17.66	17.64	0.5	Pass
<b>802.11ac (VHT40)</b>						
151	5755	36.43	36.49	36.44	0.5	Pass
159	5795	36.41	36.43	36.45	0.5	Pass
<b>802.11ac (VHT80)</b>						
155	5775	75.77	76.12	75.99	0.5	Pass

### SPECTRUM PLOT OF WORST VALUE

**802.11ac (VHT20) – Chain 0: CH 165**

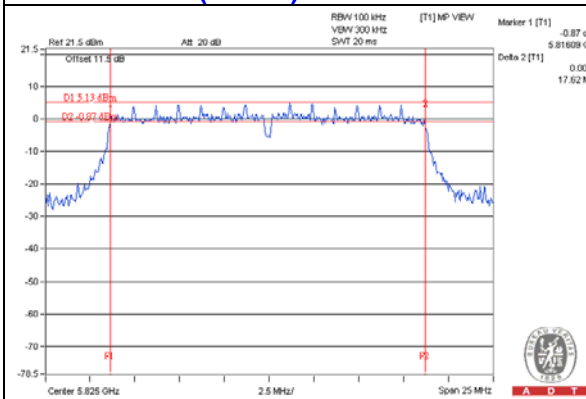

**802.11ac (VHT40) – Chain 0: CH 159**

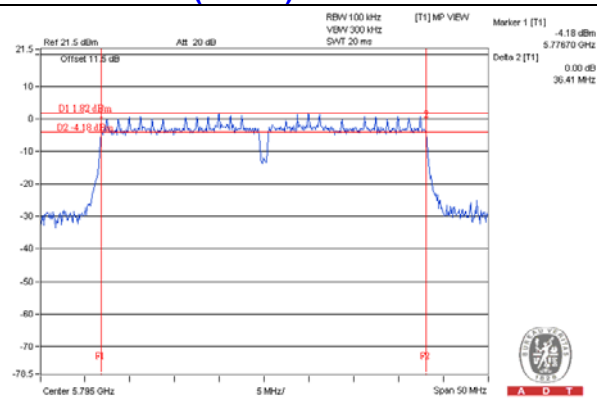

**802.11ac (VHT80) – Chain 0: CH 155**

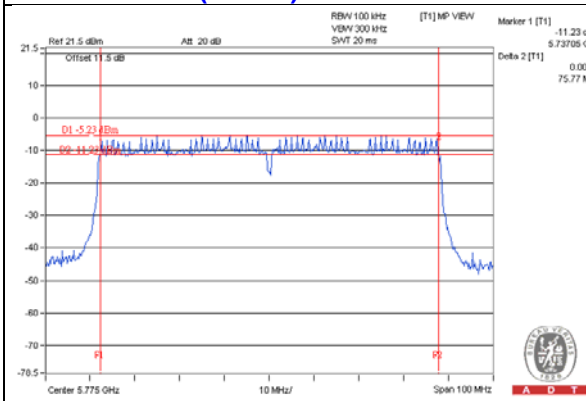

## 5 Pictures of Test Arrangements

Please refer to the attached file (Test Setup Photo).

## Appendix – Information on the Testing Laboratories

We, Bureau Veritas Consumer Products Services (H.K.) Ltd., Taoyuan Branch, were founded in 1988 to provide our best service in EMC, Radio, Telecom and Safety consultation. Our laboratories are accredited and approved according to ISO/IEC 17025.

If you have any comments, please feel free to contact us at the following:

**Linko EMC/RF Lab**

Tel: 886-2-26052180

Fax: 886-2-26051924

**Hsin Chu EMC/RF Lab/Telecom Lab**

Tel: 886-3-5935343

Fax: 886-3-5935342

**Hwa Ya EMC/RF/Safety**

Tel: 886-3-3183232

Fax: 886-3-3270892

**Email:** [service.adt@tw.bureauveritas.com](mailto:service.adt@tw.bureauveritas.com)

**Web Site:** [www.bureauveritas-adt.com](http://www.bureauveritas-adt.com)

The address and road map of all our labs can be found in our web site also.

--- END ---